

# Operating Instructions

## Deltabar PMD78B

Differential pressure measurement  
PROFINET over Ethernet-APL





A0023555

- Make sure the document is stored in a safe place such that it is always available when working on or with the device
- Avoid danger to individuals or the facility: read the "Basic safety instructions" section carefully, as well as all other safety instructions in the document that are specific to working procedures

The manufacturer reserves the right to modify technical data without prior notice. The Endress+Hauser sales organization will supply you with current information and updates to these instructions.

## Table of contents

<b>1</b>	<b>About this document</b> .....	<b>5</b>	8.2	Device master file (GSD) .....	45
1.1	Document function .....	5	8.3	Cyclic data transmission .....	47
1.2	Symbols .....	5	8.4	System redundancy S2 .....	49
1.3	List of abbreviations .....	7	<b>9</b>	<b>Commissioning</b> .....	<b>50</b>
1.4	Documentation .....	7	9.1	Preliminaries .....	50
1.5	Registered trademarks .....	7	9.2	Function check .....	50
<b>2</b>	<b>Basic safety instructions</b> .....	<b>8</b>	9.3	Establishing a connection via FieldCare and DeviceCare .....	50
2.1	Requirements for the personnel .....	8	9.4	Hardware settings .....	51
2.2	Intended use .....	8	9.5	Configuring the communication parameters via the software .....	51
2.3	Workplace safety .....	8	9.6	Setting the operating language .....	52
2.4	Operational safety .....	8	9.7	Configuring the device .....	53
2.5	Product safety .....	9	9.8	"Simulation" submenu .....	59
2.6	IT security .....	9	9.9	Protecting settings from unauthorized access .....	60
2.7	Device-specific IT security .....	9	<b>10</b>	<b>Operation</b> .....	<b>62</b>
<b>3</b>	<b>Product description</b> .....	<b>11</b>	10.1	Reading off the device locking status .....	62
3.1	Product design .....	11	10.2	Reading off measured values .....	62
<b>4</b>	<b>Incoming acceptance and product identification</b> .....	<b>14</b>	10.3	Adapting the device to process conditions ....	62
4.1	Incoming acceptance .....	14	<b>11</b>	<b>Diagnosis and troubleshooting</b> .....	<b>64</b>
4.2	Product identification .....	14	11.1	General troubleshooting .....	64
4.3	Storage and transport .....	15	11.2	Diagnostics information via LED .....	66
<b>5</b>	<b>Mounting</b> .....	<b>16</b>	11.3	Diagnostic information on local display .....	67
5.1	Mounting requirements .....	16	11.4	Diagnostic information in the Web browser ..	68
5.2	Mounting the device .....	20	11.5	Diagnostic list .....	69
5.3	Post-mounting check .....	29	11.6	Event logbook .....	71
<b>6</b>	<b>Electrical connection</b> .....	<b>30</b>	11.7	Resetting the device .....	74
6.1	Connecting requirements .....	30	11.8	Firmware history .....	75
6.2	Connecting the device .....	30	<b>12</b>	<b>Maintenance</b> .....	<b>76</b>
6.3	Ensuring the degree of protection .....	34	12.1	Maintenance work .....	76
6.4	Post-connection check .....	34	<b>13</b>	<b>Repair</b> .....	<b>77</b>
<b>7</b>	<b>Operation options</b> .....	<b>35</b>	13.1	General information .....	77
7.1	Overview of operation options .....	35	13.2	Spare parts .....	77
7.2	Operating keys and DIP switches on the electronic insert .....	35	13.3	Return .....	78
7.3	Structure and function of the operating menu .....	35	13.4	Disposal .....	78
7.4	local display .....	36	<b>14</b>	<b>Accessories</b> .....	<b>79</b>
7.5	Access to operating menu via web browser ...	38	14.1	Device-specific accessories .....	79
7.6	Access to the operating menu via the operating tool .....	42	14.2	Device Viewer .....	79
7.7	HistoROM .....	44	<b>15</b>	<b>Technical data</b> .....	<b>80</b>
<b>8</b>	<b>System integration</b> .....	<b>45</b>	15.1	Output .....	80
8.1	Overview of device description files .....	45	15.2	Environment .....	82
			15.3	Process .....	85

**Index**..... **91**

# 1 About this document

## 1.1 Document function

These Operating Instructions contain all the information that is required in various phases of the life cycle of the device: from product identification, incoming acceptance and storage, to mounting, connection, operation and commissioning through to troubleshooting, maintenance and disposal.

## 1.2 Symbols

### 1.2.1 Safety symbols

** DANGER**

This symbol alerts you to a dangerous situation. Failure to avoid this situation will result in serious or fatal injury.

** WARNING**

This symbol alerts you to a dangerous situation. Failure to avoid this situation can result in serious or fatal injury.

** CAUTION**

This symbol alerts you to a dangerous situation. Failure to avoid this situation can result in minor or medium injury.

**NOTICE**

This symbol contains information on procedures and other facts which do not result in personal injury.

### 1.2.2 Electrical symbols

**Ground connection:** 

Terminal for connection to the grounding system.

### 1.2.3 Symbols for certain types of information

**Permitted:** 

Procedures, processes or actions that are permitted.

**Forbidden:** 

Procedures, processes or actions that are forbidden.

**Additional information:** 

**Reference to documentation:** 

**Reference to page:** 

**Series of steps:** [1.](#), [2.](#), [3.](#)

**Result of an individual step:** 



## 1.2.4 Symbols in graphics

**Item numbers:** 1, 2, 3 ...

**Series of steps:** [1.](#), [2.](#), [3.](#)

**Views:** A, B, C, ...

## 1.2.5 Symbols on the device

**Safety instructions:**  → 

Observe the safety instructions contained in the associated Operating Instructions.

### 1.3 List of abbreviations

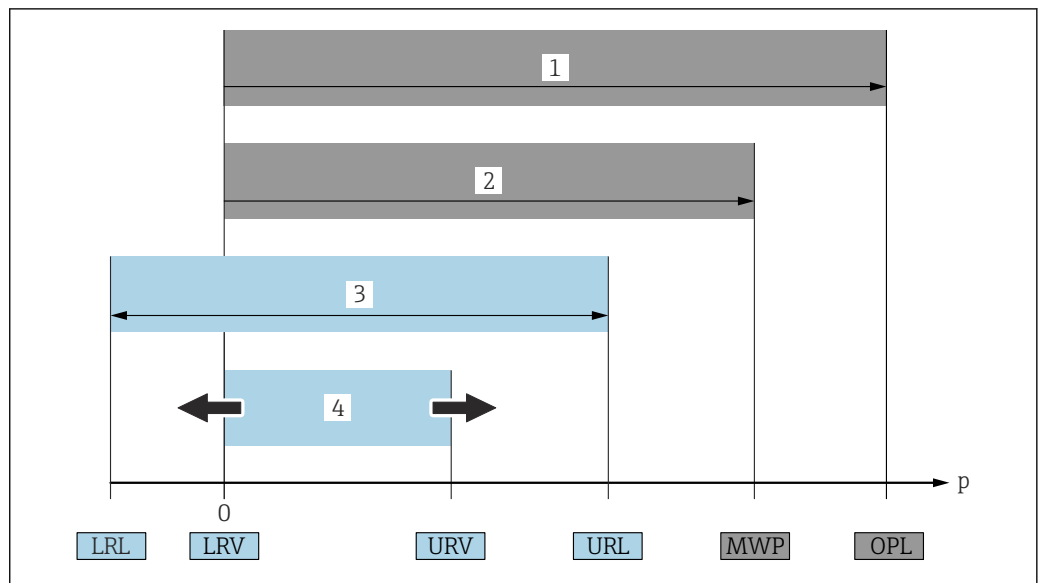

- 1 OPL: The OPL (overpressure limit = measuring cell overload limit) for the device depends on the lowest-rated element, with regard to pressure, of the selected components, i.e. the process connection has to be taken into consideration in addition to the measuring cell. Pay attention to the pressure/temperature dependency.
- 2 The MWP (maximum working pressure) for the measuring cells depends on the lowest-rated element, with regard to pressure, of the selected components, i.e. the process connection has to be taken into consideration in addition to the measuring cell. Pay attention to the pressure/temperature dependency. The MWP may be applied at the device for an unlimited period of time. The MWP can be found on the nameplate.
- 3 The maximum measuring range corresponds to the span between the LRL and URL. This measuring range is equivalent to the maximum calibratable/adjustable span.
- 4 The calibrated/adjusted span corresponds to the span between the LRV and URV. Factory setting: 0 to URL. Other calibrated spans can be ordered as customized spans.

*p* Pressure

LRL Lower range limit

URL Upper range limit

LRV Lower range value

URV Upper range value

TD Turn down. Example - see the following section.

### 1.4 Documentation

All available documents can be downloaded using:

- the serial number of the device (see cover page for description) or
- the data matrix code of the device (see cover page for description) or
- the "Downloads" area of the website [www.endress.com](http://www.endress.com)

#### 1.4.1 Supplementary device-dependent documentation

Additional documents are supplied depending on the device version ordered: Always comply strictly with the instructions in the supplementary documentation. The supplementary documentation is an integral part of the device documentation.

### 1.5 Registered trademarks

**PROFINET®**

Registered trademark of the PROFIBUS User Organization, Karlsruhe, Germany

## 2 Basic safety instructions

### 2.1 Requirements for the personnel

The personnel for installation, commissioning, diagnostics and maintenance must fulfill the following requirements:

- ▶ Trained, qualified specialists must have a relevant qualification for this specific function and task
- ▶ Are authorized by the plant owner/operator
- ▶ Are familiar with federal/national regulations
- ▶ Before beginning work, the specialist staff must have read and understood the instructions in the Operating Instructions and supplementary documentation as well as in the certificates (depending on the application)
- ▶ Follow instructions and comply with conditions

The operating personnel must fulfill the following requirements:

- ▶ Being instructed and authorized according to the requirements of the task by the facility's owner-operator
- ▶ Following the instructions in these Operating Instructions

### 2.2 Intended use

The Deltabar is a differential pressure transmitter for measuring pressure, flow, level and differential pressure.

#### 2.2.1 Incorrect use

The manufacturer is not liable for damage caused by improper or non-intended use.

Verification for borderline cases:

- ▶ For special fluids and fluids for cleaning, Endress+Hauser is glad to provide assistance in verifying the corrosion resistance of fluid-wetted materials, but does not accept any warranty or liability.

### 2.3 Workplace safety

When working on and with the device:

- ▶ Wear the required personal protective equipment according to federal/national regulations.
- ▶ Switch off the supply voltage before connecting the device.

### 2.4 Operational safety

Risk of injury!

- ▶ Operate the device only if it is in proper technical condition, free from errors and faults.
- ▶ The operator is responsible for the interference-free operation of the device.

#### Modifications to the device

Unauthorized modifications to the device are not permitted and can lead to unforeseeable dangers:

- ▶ If, despite this, modifications are required, consult with Endress+Hauser.

#### Repair

To ensure continued operational safety and reliability:

- ▶ Carry out repairs on the device only if they are expressly permitted.
- ▶ Observe federal/national regulations pertaining to the repair of an electrical device.



- ▶ Use original spare parts and accessories from Endress+Hauser only.

### Hazardous area

To eliminate the risk of danger to persons or the facility when the device is used in the approval-related area (e.g. explosion protection, pressure equipment safety):

- ▶ Check the nameplate to verify if the device ordered can be put to its intended use in the approval-related area.
- ▶ Observe the specifications in the separate supplementary documentation that is an integral part of these Instructions.

## 2.5 Product safety

This device is designed in accordance with good engineering practice to meet state-of-the-art safety requirements, has been tested, and left the factory in a condition in which it is safe to operate.

It meets general safety standards and legal requirements. It also complies with the EC directives listed in the device-specific EC Declaration of Conformity. Endress+Hauser confirms this by affixing the CE mark to the device.

## 2.6 IT security

Endress+Hauser can only provide a warranty if the device is installed and used as described in the Operating Instructions. The device is equipped with security mechanisms to protect it against any inadvertent changes to the device settings. IT security measures in line with operators' security standards and designed to provide additional protection for the device and device data transfer must be implemented by the operators themselves.

## 2.7 Device-specific IT security

The device offers specific functions to support protective measures by the operator. These functions can be configured by the user and guarantee greater in-operation safety if used correctly. An overview of the most important functions is provided in the following section:

- Write protection via hardware write protection switch
- Access code to change user role (applies to operation via the display, Bluetooth or FieldCare, DeviceCare and asset management tools (e.g. AMS, PDM and Web server)

Function/interface	Factory setting	Recommendation
Access code (also applies to Web server login or FieldCare connection)	Not enabled (0000)	Assign a customized access code during commissioning.
Web server	Enabled	On an individual basis following risk assessment.
Service interface (CDI)	Enabled	On an individual basis following risk assessment.
Write protection via hardware write protection switch	Not enabled	On an individual basis following risk assessment.

### 2.7.1 Protecting access via a password

Different passwords are available to protect write access to the parameters of the device.

Protect write access to the parameters of the device via the local display, Web browser or operating tool (e.g. FieldCare, DeviceCare). Access authorization is clearly regulated through the use of a user-specific access code.

### User-specific access code

Write access to the parameters of the device via the local display, Web browser or operating tool (e.g. FieldCare, DeviceCare) can be protected using the editable, user-specific access code.

When delivered, the device does not have an access code and this code corresponds to 0000 (open).

### General notes on the use of passwords

- During commissioning, change the access code used when the device was delivered
- When defining and managing the access code, comply with the general rules for the generation of a secure password
- The user is responsible for managing the access code and for using the code with due care
- If the password is lost, refer to the "Resetting the device" section

## 2.7.2 Access via Web server

Thanks to the integrated Web server, the device can be operated and configured using a Web browser and via PROFINET with Ethernet-APL. In addition to the measured values, status information on the device is displayed and can be used to monitor device health. Furthermore the device data can be managed and the network parameters can be configured.

Access to the network is required for the PROFINET with Ethernet-APL connection.

#### *Supported functions*

Data exchange between the operating unit (such as a notebook, for example,) and measuring device:

- Export parameter settings (PDF file, create documentation of the measuring point configuration)
- Export the Heartbeat Technology verification report (PDF file, only available with the "Heartbeat Verification" application package)
- Download driver (GSDML) for system integration

The Web server is enabled when the device is delivered. The Web server can be disabled via the **Web server functionality** parameter if necessary (e.g. after commissioning).

The device and status information can be hidden on the login page. This prevents unauthorized access to the information.



Detailed information on the device parameters:  
"Description of Device Parameters" document

## 3 Product description

### 3.1 Product design

#### 3.1.1 Measuring cell for differential pressure with metallic membrane

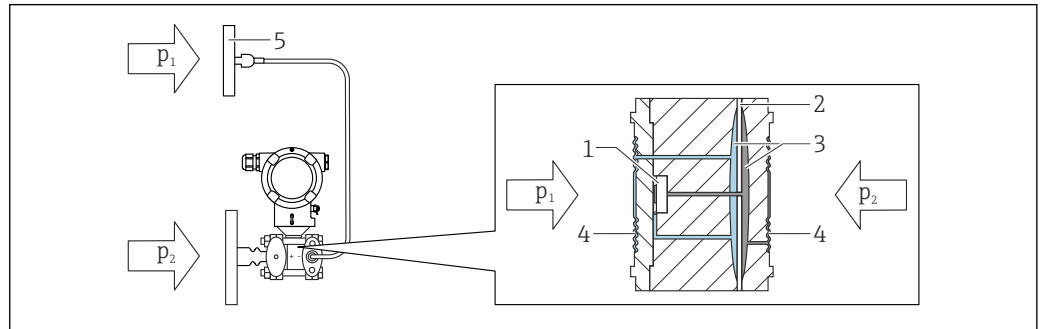

A0043081

☐ 1 Capillary on the second side (P1) is optional

- 1 Measuring element
- 2 Middle diaphragm
- 3 Fill fluid
- 4 Internal membrane
- 5 Membrane of the diaphragm seal
- $p_1$  Pressure 1
- $p_2$  Pressure 2

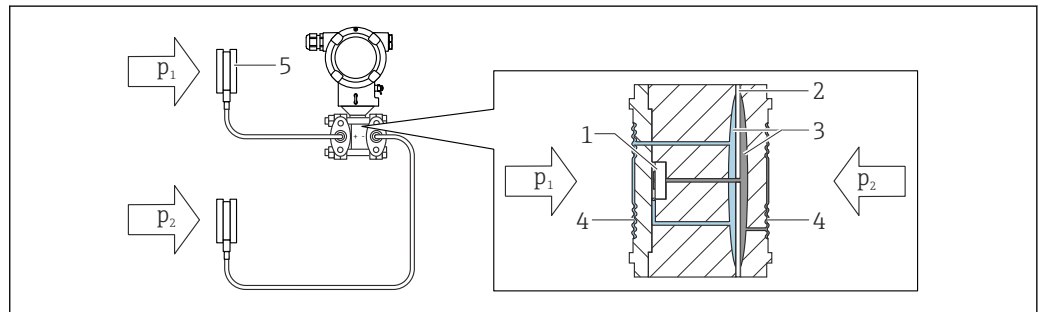

A0043082

- 1 Measuring element
- 2 Middle diaphragm
- 3 Fill fluid
- 4 Internal membrane
- 5 Membrane of the diaphragm seal
- $p_1$  Pressure 1
- $p_2$  Pressure 2

The pressures applied are transferred from the membrane of the diaphragm seal to the internal membrane of the measuring cell by means of an incompressible fill fluid. This causes a deflection of the membranes on both sides. A second fill fluid transfers the pressure to a side of the measuring element where a resistance bridge is located (semiconductor technology). The change in the bridge output voltage, which depends on the differential pressure, is measured and processed further.

### Applications for diaphragm seals

Diaphragm seal systems are used if the process and the device need to be separated. Diaphragm seal systems offer clear advantages in the following instances:

- In the case of extreme process temperatures - through the use of temperature isolators or capillaries
- In the case of strong vibrations - decouple the process from the device by using a capillary
- In the case of aggressive or corrosive media - through the use of high-durability membrane materials
- In the case of media that crystallize or contain solids - through the choice of suitable coatings
- In the case of heterogeneous and fibrous process media
- If extreme measuring point cleaning is necessary, or in the event of very damp mounting locations
- For mounting locations that are difficult to access

### 3.1.2 Level measurement (volume and mass):

#### Diaphragm seal with temperature isolator on both sides

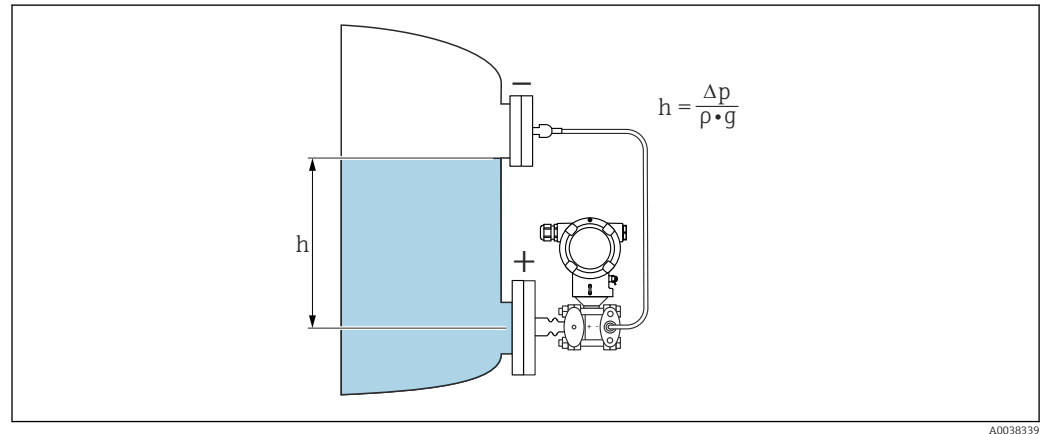

A0038339

- h* Height (level)  
*Δp* Differential pressure  
*ρ* Density of the medium  
*g* Gravitational acceleration

#### Diaphragm seal on both sides with capillary

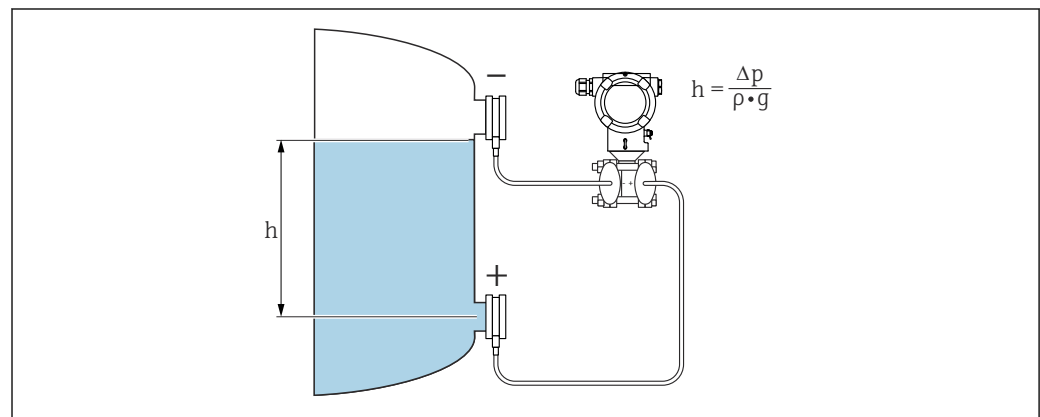

A0038345

- h* Height (level)  
*Δp* Differential pressure  
*ρ* Density of the medium  
*g* Gravitational acceleration

**Advantages:**

- Volume and mass measurements in any vessel shape with a freely programmable characteristic curve
- Has a wide range of uses, e.g.:
  - For level measurement in vessels with pressure overlay
  - For foam formation
  - In vessels with agitators or screen fittings
  - For liquid gases
  - For standard level measurement

## 4 Incoming acceptance and product identification

### 4.1 Incoming acceptance

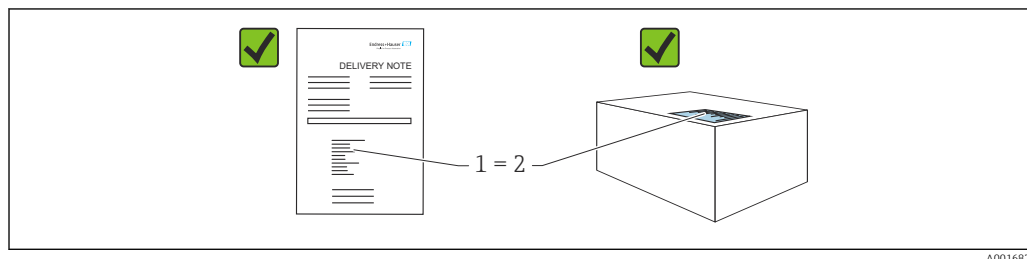

- Is the order code on the delivery note (1) identical to the order code on the product sticker (2)?
- Are the goods undamaged?
- Do the data on the nameplate correspond to the order specifications and the delivery note?
- Is the documentation available?
- If required (see nameplate): are the Safety Instructions (XA) provided?



If you can answer "no" to any of these questions, please contact Endress+Hauser.

#### 4.1.1 Scope of delivery

The scope of delivery comprises:

- Device
- Optional accessories

Accompanying documentation:

- Brief Operating Instructions
- Final inspection report
- Additional Safety Instructions for devices with approvals (e.g. ATEX, IECEx, NEPSI, etc.)
- Optional: factory calibration form, test certificates



The Operating Instructions are available on the Internet at:

[www.endress.com](http://www.endress.com) → Download

### 4.2 Product identification

The following options are available for identification of the device:

- Nameplate specifications
- Order code with breakdown of the device features on the delivery note
- Enter the serial numbers from the nameplates in *Device Viewer* ([www.endress.com/deviceviewer](http://www.endress.com/deviceviewer)): all the information about the device is displayed.

#### 4.2.1 Manufacturer address

Endress+Hauser SE+Co. KG  
 Hauptstraße 1  
 79689 Maulburg, Germany  
 Place of manufacture: See nameplate.

### 4.2.2 Nameplate

Different nameplates are used depending on the device version.

The nameplates contain the following information:

- Manufacturer name and device name
- Address of the certificate holder and country of manufacture
- Order code and serial number
- Technical data
- Approval-specific information

Compare the data on the nameplate with your order.

## 4.3 Storage and transport

### 4.3.1 Storage conditions

- Use the original packaging
- Store the device in clean and dry conditions and protect from damage caused by shocks

#### Storage temperature range

See Technical Information.

### 4.3.2 Transporting the product to the measuring point

#### WARNING

##### **Incorrect transport!**

Housing and membrane may become damaged, and there is a risk of injury!

- ▶ Transport the device to the measuring point in the original packaging.

#### WARNING

##### **Incorrect transport!**

Capillaries may become damaged, and there is a risk of injury!

- ▶ Do not use capillaries as a carrying aid for the diaphragm seals.

## 5 Mounting

### NOTICE

**The device can be damaged if handled incorrectly!**

- ▶ The removal of the screws with item number (1) is not permissible under any circumstances and will void the warranty.

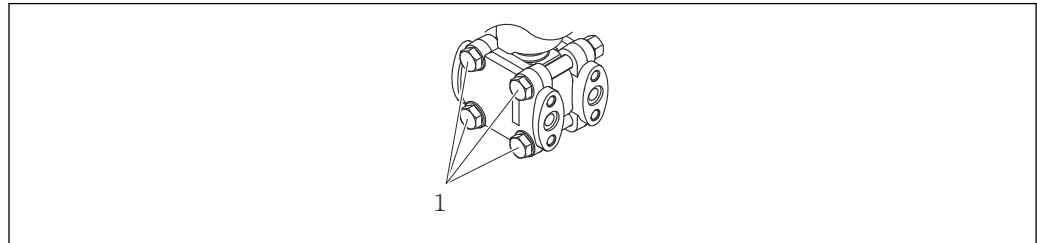

A0025336

### 5.1 Mounting requirements

#### 5.1.1 General instructions

- Do not clean or touch the membrane with hard and/or pointed objects.
- Do not remove the protection on the membrane until just before installation.

Always firmly tighten the housing cover and the cable entries.

1. Counter-tighten the cable entries.
2. Tighten the coupling nut.

#### 5.1.2 Installation instructions

- To ensure optimal readability of the local display, adjust the housing and local display
- Endress+Hauser offers a mounting bracket to mount the device on pipes or walls
- Use flushing rings for flanges, flange seals and pancake seals if buildup or clogging can be expected at the membrane
  - The flushing ring is clamped between the process connection and the flange, flange seal or pancake seal
  - Material buildup in front of the membrane is flushed away, and the pressure chamber is vented, via the two lateral flushing holes
- When measuring in media containing solids (e.g. dirty liquids), installing separators and drain valves is useful for capturing and removing sediment
- Using a valve manifold allows for easy commissioning, installation and maintenance without interrupting the process
- When mounting the device, establishing the electrical connection and during operation: prevent the penetration of moisture into the housing
- Point the cable and plug downwards as much as possible to prevent moisture from entering (e.g. rainwater or condensation)



### 5.1.3 Installation instructions for devices with diaphragm seals

#### NOTICE

#### Improper handling!

Damage to the device!

- ▶ The diaphragm seal and pressure transmitter form a closed, calibrated system which has been filled with diaphragm seal fill fluid. Never open any of the holes for fill fluid.
- ▶ Ensure strain relief to prevent the capillary from bending (bending radius  $\geq$  100 mm (3.94 in)).
- ▶ Do not use capillaries as a carrying aid for the diaphragm seals.
- ▶ Observe the application limits of the fill fluid.

#### General information

In the case of devices with diaphragm seals and capillaries, the zero point shift caused by the hydrostatic pressure of the filling liquid column in the capillaries must be taken into account when selecting the measuring cell. Perform zero adjustment if necessary. If a measuring cell with a small measuring range is selected, a position adjustment can cause the measuring cell to go over range (position adjustment due to zero point offset, caused by the orientation of the fill fluid liquid column).

For devices with a capillary, use a suitable bracket (mounting bracket) for mounting.

When mounting, sufficient strain relief must be provided for the capillary to prevent the capillary from bending (capillary bending radius  $\geq$  100 mm (3.94 in)).

Mount the capillary so that it is vibration-free (in order to avoid additional pressure fluctuations).

Do not mount capillaries in the vicinity of heating or cooling lines and protect them against direct sunlight.

More detailed installation instructions are provided in the Applicator "[Sizing Diaphragm Seal](#)".

#### Vacuum applications

In vacuum applications, mount the pressure transmitter below the diaphragm seal. This prevents additional vacuum loading of the diaphragm seal caused by the presence of fill fluid in the capillary.

If the pressure transmitter is mounted above the diaphragm seal, do not exceed the maximum height difference  $h_1$ . The height difference  $h_1$  is shown in the Applicator "[Sizing Diaphragm Seal](#)".

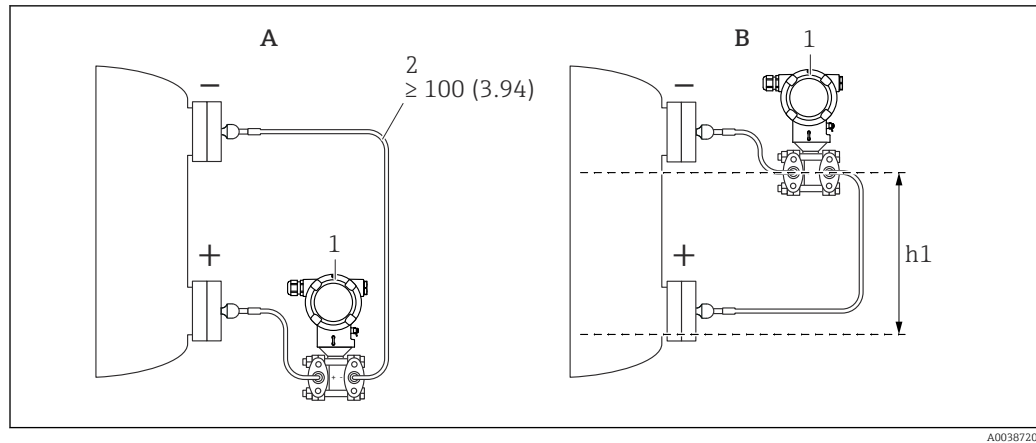

A0038720

Unit of measurement mm (in)

A Recommended installation in a vacuum application

B Installation above the lower diaphragm seal

h1 Height difference (is shown in the Applicator "Sizing Diaphragm Seal")

1 Device

2 Bending radius  $\geq 100$  mm (3.94 in). Ensure strain relief to prevent the capillary from bending.

The maximum height difference depends on the density of the fill fluid and the lowest absolute pressure that can ever occur at the diaphragm seal (empty vessel).

#### Information on cleaning

Endress+Hauser provides flushing rings as an accessory to enable the membrane to be cleaned without removing the transmitter from the process.



For more information: contact the Endress+Hauser sales office.

#### 5.1.4 Installing pressure piping

- For recommendations for routing pressure piping, refer to DIN 19210 "Differential pressure piping for flow measurement devices" or the corresponding national or international standards
- When routing the pressure piping outdoors, ensure sufficient anti-freeze protection, e.g. by using pipe heat tracing
- Install the pressure piping with a monotonic gradient of at least 10%

### 5.1.5 Orientation

#### Diaphragm seal on one side or both sides with temperature isolator

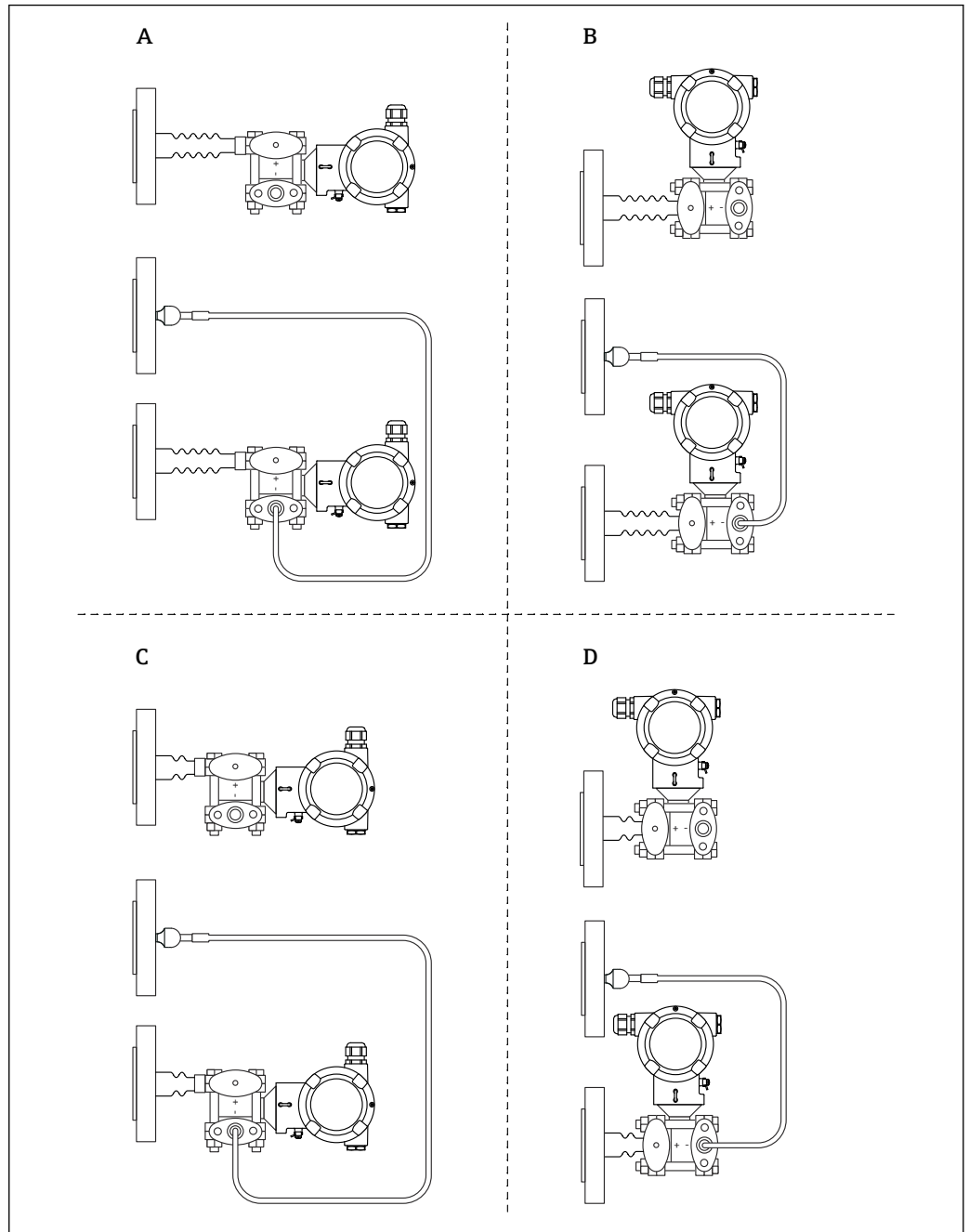

A0038658

- A Design HP side: Transmitter horizontal, temperature isolator long
- B Design HP side: Transmitter vertical, temperature isolator long
- C Design HP side: Transmitter horizontal, temperature isolator short
- D Design HP side: Transmitter vertical, temperature isolator short

### Diaphragm seal on one side or both sides with capillary

In vacuum applications, mount the pressure transmitter below the lower diaphragm seal.

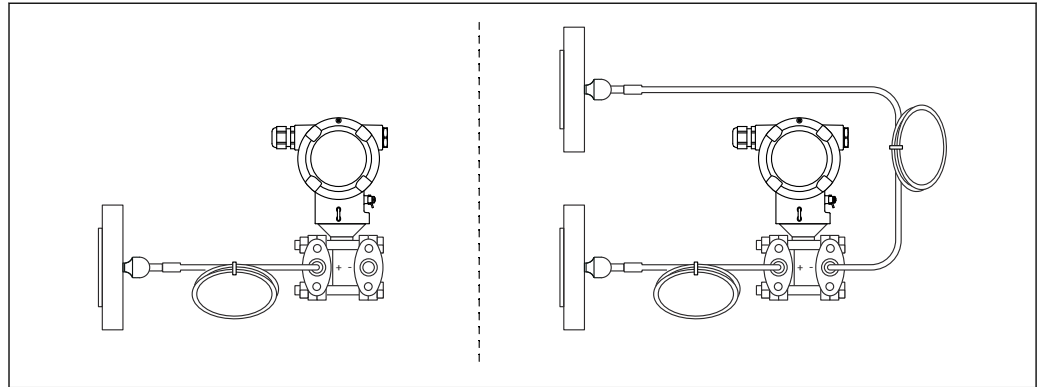

A0039528

**i** Use "[Sizing Diaphragm Seal](#)" for the installation check.

## 5.2 Mounting the device

### 5.2.1 Level measurement

Level measurement in an open vessel, diaphragm seal on one side with temperature isolator

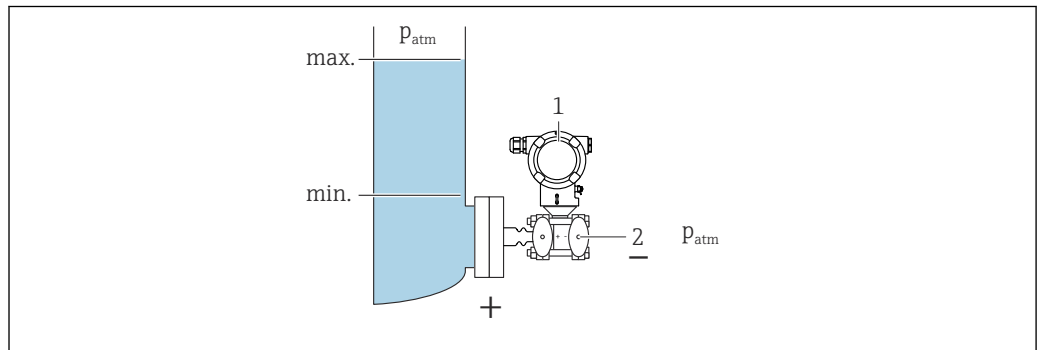

A0038702

- 1 Device
- 2 The negative side is open to atmospheric pressure

- Mount the device directly on the vessel
- The negative side is open to atmospheric pressure

**Level measurement in a closed vessel, diaphragm seal on one side with temperature isolator**

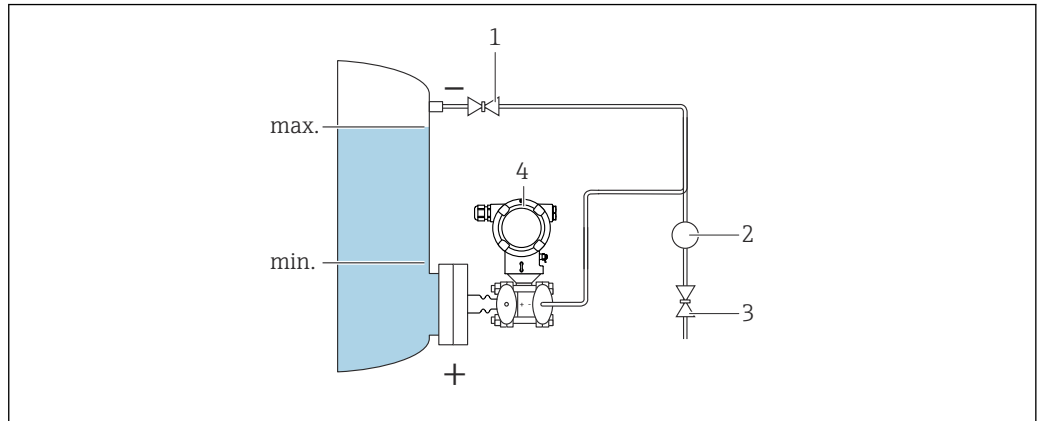

A0038703

- 1 Shutoff valve
- 2 Separator
- 3 Drain valve
- 4 Device

- Mount the device directly on the vessel
- Always connect the piping on the negative side above the maximum level

**Level measurement in a closed vessel, diaphragm seal on one side or both sides with capillary**

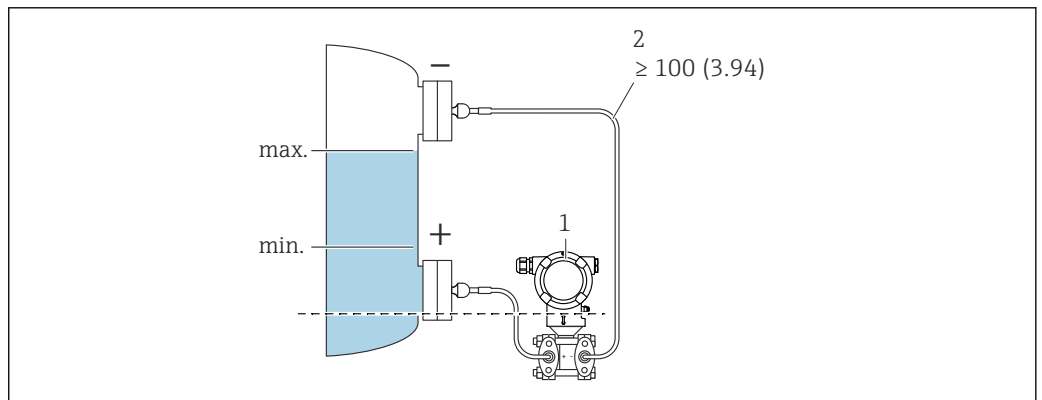

A0038705

- 1 Device
- 2 Ensure strain relief to prevent the capillary from bending (bending radius  $\geq 100$  mm (3.94 in)).

Mount the device below the lower diaphragm seal

Level measurement is only guaranteed between the upper edge of the lower diaphragm seal and the lower edge of the upper diaphragm seal.

**Level measurement in a closed vessel with superimposed vapor, diaphragm seal on one side with temperature isolator**

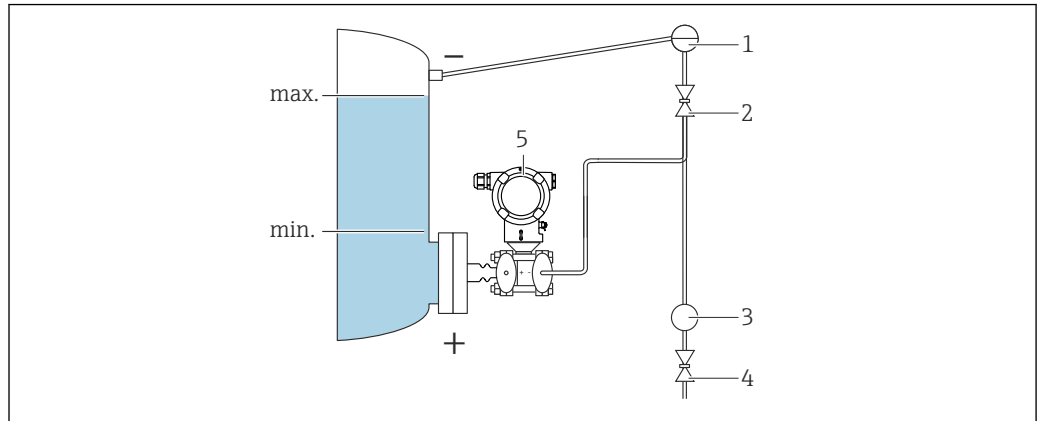

A0038707

- 1 Condensate trap
- 2 Shutoff valve
- 3 Separator
- 4 Drain valve
- 5 Device

- Mount the device directly on the vessel
- Always connect the piping on the negative side above the maximum level
- The condensate trap ensures constant pressure on the negative side
- When measuring in media with solid parts (such as dirty liquids) installing separators and drain valves is useful for capturing and removing sediment

**5.2.2 Differential pressure measurement**

**Differential pressure measurement in gases, vapors and liquids, diaphragm seal on one side or two sides with capillary**

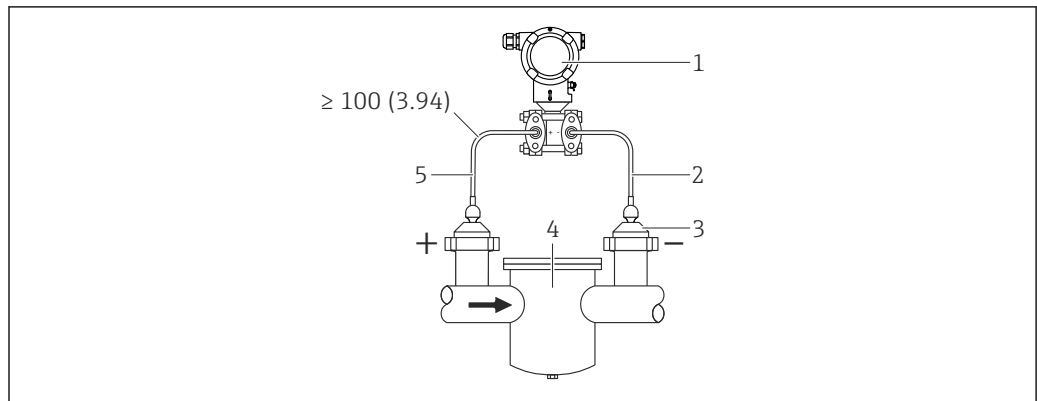

A0038710

- 1 Device
- 2 Capillary
- 3 Diaphragm seal
- 4 e.g. filter
- 5 Ensure strain relief to prevent the capillary from bending (bending radius  $\geq 100$  mm (3.94 in)).

- Mount diaphragm seals with capillaries on pipes at the top or side
- In vacuum applications, mount the device below the measuring point

### 5.2.3 Oxygen applications (gaseous)

Oxygen and other gases can react explosively to oils, grease and plastics. The following precautions must be taken:

- All components of the system, such as devices, must be cleaned in accordance with national requirements.
- Depending on the materials used, a certain maximum temperature and a maximum pressure must not be exceeded for oxygen applications.

The cleaning of the device (not accessories) is provided as an optional service.

- $p_{\max}$ : PN of the flange, max. 80 bar (1 200 psi)
- $T_{\max}$ : 60 °C (140 °F)

### 5.2.4 Thermal insulation when mounting with a temperature isolator

The device may only be insulated up to a certain height. The maximum permitted insulation height applies to an insulation material with a thermal conductivity  $\leq 0.04 \text{ W}/(\text{m} \times \text{K})$  and to the maximum permitted ambient temperature and process temperature. The data were determined under the application "quiescent air".

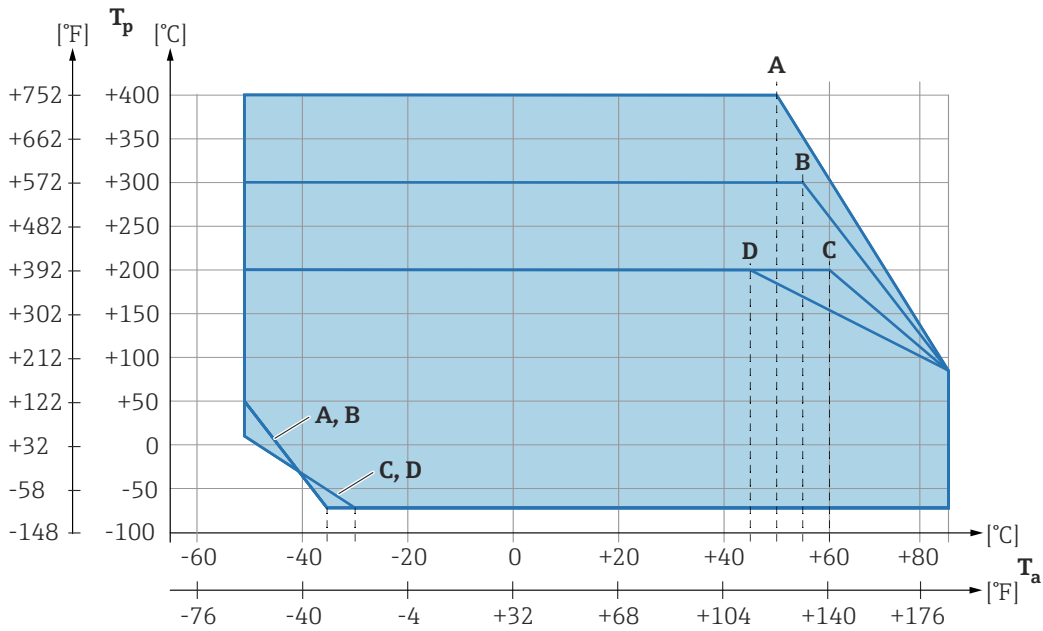
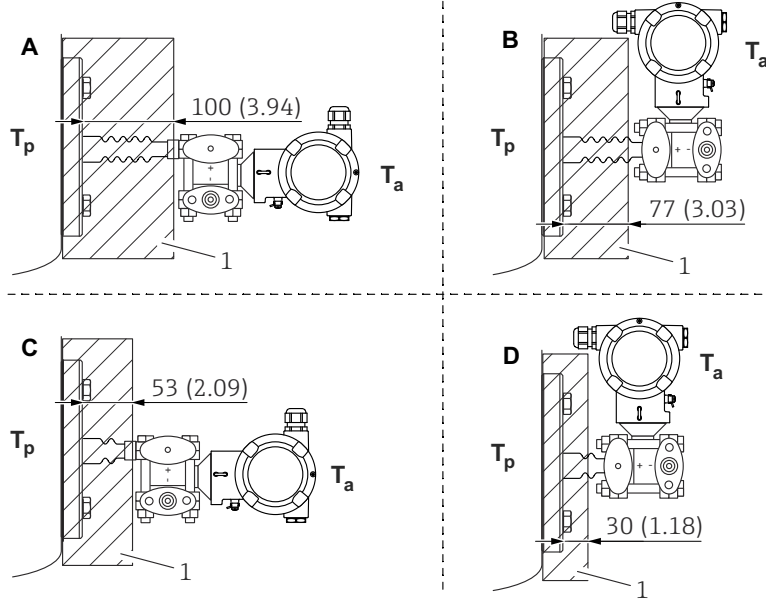

A0039331

- 1 Insulation material
- A Transmitter horizontal, temperature isolator long
- B Transmitter vertical, temperature isolator long
- C Transmitter horizontal, temperature isolator short
- D Transmitter vertical, temperature isolator short

Without insulation, the ambient temperature decreases by 5 K.

Item	$T_a^{1)}$	$T_p^{2)}$
A	50 °C (122 °F)	400 °C (752 °F)
	85 °C (185 °F)	85 °C (185 °F) <sup>3)</sup>
	-50 °C (-58 °F)	50 °C (122 °F)
	-35 °C (-31 °F)	-70 °C (-94 °F)
B	55 °C (131 °F)	300 °C (572 °F) <sup>3)</sup>
	85 °C (185 °F)	85 °C (185 °F)



Item	T <sub>a</sub> <sup>1)</sup>	T <sub>p</sub> <sup>2)</sup>
	-50 °C (-58 °F)	50 °C (122 °F)
	-35 °C (-31 °F)	-70 °C (-94 °F)
<b>C</b>	60 °C (140 °F)	200 °C (392 °F) <sup>3)</sup>
	85 °C (185 °F)	85 °C (185 °F)
	-50 °C (-58 °F)	10 °C (50 °F)
	-30 °C (-22 °F)	-70 °C (-94 °F)
<b>D</b>	67 °C (153 °F)	200 °C (392 °F) <sup>3)</sup>
	85 °C (185 °F)	85 °C (185 °F)
	-50 °C (-58 °F)	10 °C (50 °F)
	-30 °C (-22 °F)	-70 °C (-94 °F)

- 1) Maximum ambient temperature at transmitter
- 2) Maximum process temperature
- 3) Process temperature: max. +400 °C (+752 °F), depending on the fill fluid used.

### 5.2.5 Seal for flange mounting

**NOTICE**

**Seal pressing against the membrane!**

Incorrect measurement results!

- ▶ Ensure that the seal is not touching the membrane.

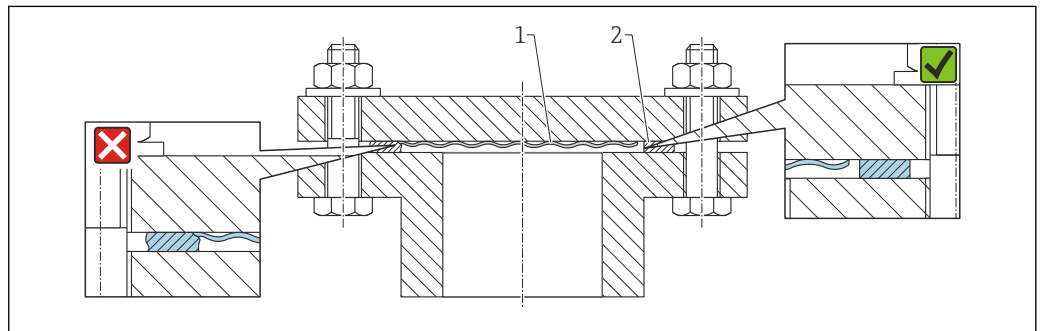

A0017743

- 1 Membrane
- 2 Seal

### 5.2.6 Wall and pipe mounting

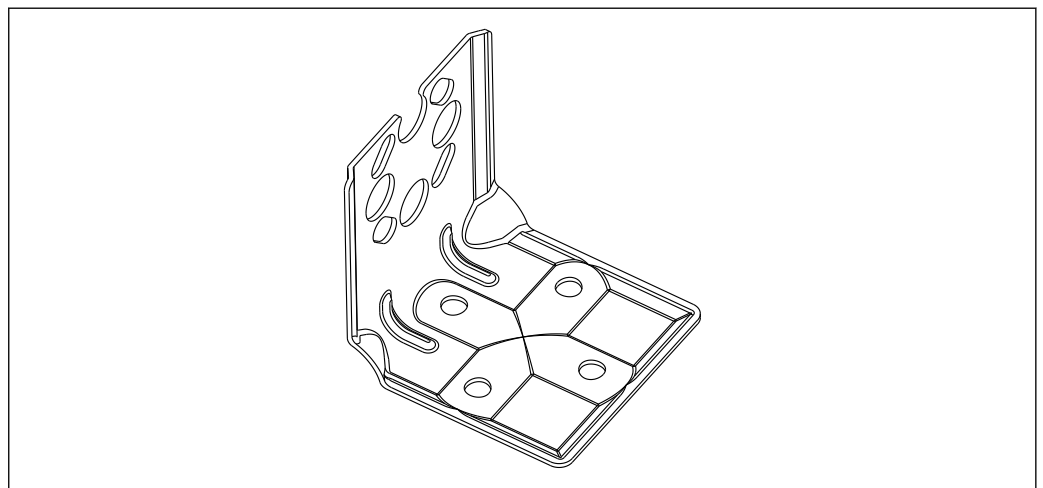

A0031326

- Bracket for wall and pipe mounting including retaining bracket for pipe mounting and two nuts
- The material of the screws used to secure the device depends on the order code

 For technical data (e.g. materials, dimensions or order numbers), see the accessory document SD01553P.

### 5.2.7 Wall and pipe mounting with a manifold (optional)

- Mount the device on a shutoff device, e.g. manifold or shutoff valve
- Use the bracket provided. This make device removal easier.

 For technical data (e.g. materials, dimensions or order numbers), see the accessory document SD01553P.

### 5.2.8 Mounting bracket for separate housing

The separate housing can be mounted on walls or pipes (for pipes with a diameter of 1 ¼" to 2") using the mounting bracket.

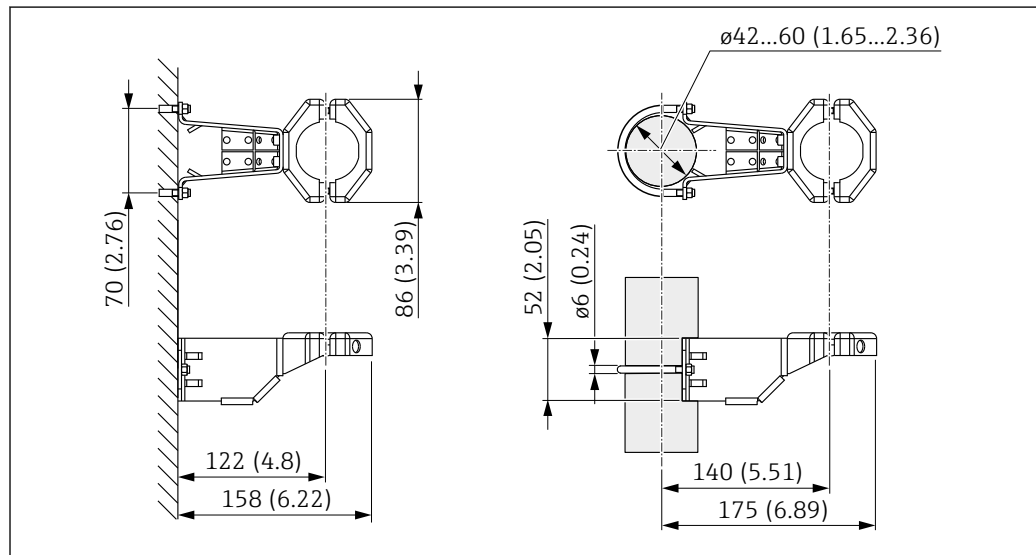

Unit of measurement mm (in)

Ordering information:

Can be ordered as a separate accessory, part number 71102216

 The mounting bracket is included in the delivery if you order the device with a separate housing.

When mounting on a pipe, tighten the nuts on the bracket uniformly with a torque of at least 5 Nm (3.69 lbf ft).

### 5.2.9 Assembling and mounting the separate housing

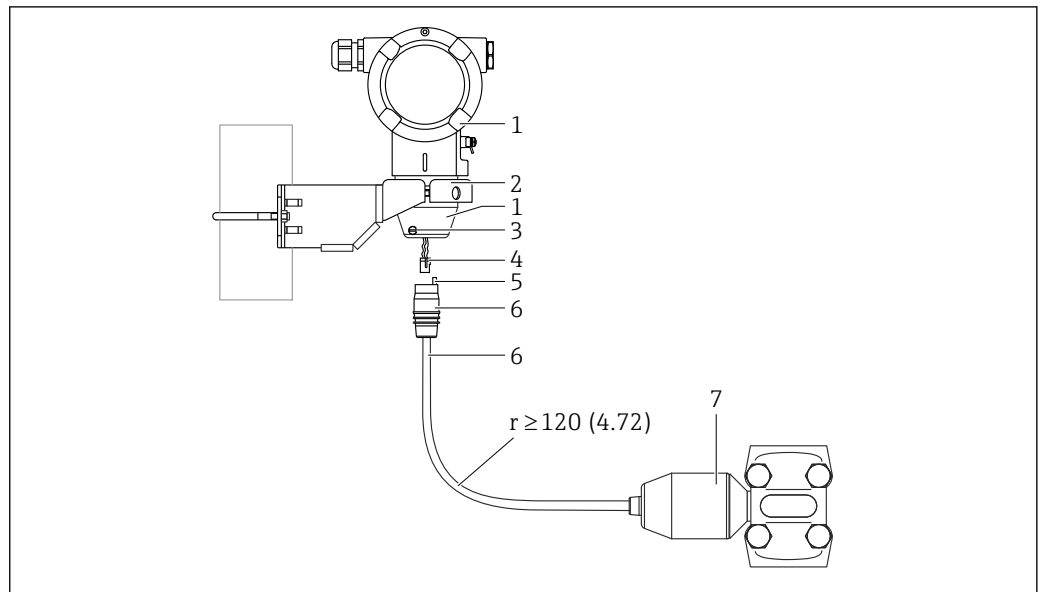

Unit of measurement mm (in)

- 1 Housing mounted with housing adapter, included
- 2 Mounting bracket provided, suitable for pipe and wall mounting (for pipe diameters from 1 ¼" to 2")
- 3 Locking screw
- 4 Plug
- 5 Pressure compensation
- 6 Cable with connection jack
- 7 In the separate housing version, the measuring cell is delivered with the process connection and cable already mounted.

#### Assembly and mounting

1. Insert the connector (item 4) into the corresponding connection jack of the cable (item 6).
2. Insert the cable with the socket (item 6) into the housing adapter (item 1) to the end stop.
3. Tighten the locking screw (item 3).
4. Mount the housing on a wall or pipe with the mounting bracket (item 2). When mounting on a pipe, tighten the nuts on the bracket uniformly with a torque of at least 5 Nm (3.69 lbf ft). Mount the cable with a bending radius ( $r$ )  $\geq$  120 mm (4.72 in).

### 5.2.10 Turning the display module

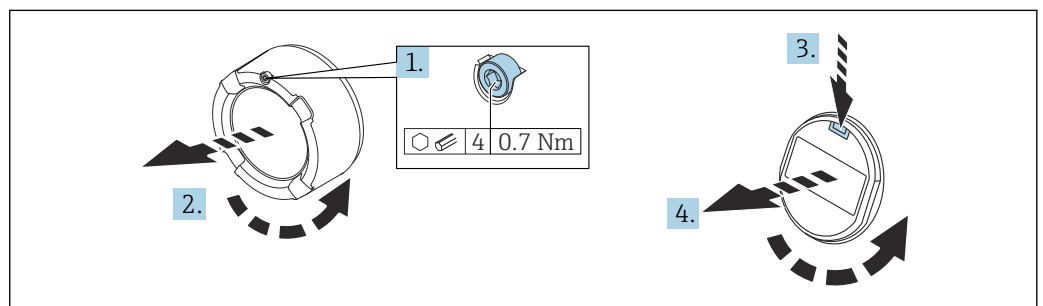

**⚠ WARNING****Supply voltage switched on!**

Risk of electric shock and/or explosion!

- ▶ Switch off the supply voltage before opening the device.

**⚠ CAUTION**

**Dual-compartment housing: When opening the terminal compartment cover, fingers can get trapped between the cover and the pressure compensation filter.**

- ▶ Open the cover slowly.

1. If fitted: release the screw of the cover lock for the electronics compartment cover using the Allen key.
2. Unscrew the electronics compartment cover from the transmitter housing and check the cover seal.
3. Press the release mechanism and remove the display module.
4. Turn the display module to the desired position: maximum  $4 \times 90^\circ$  in each direction. Fit the display module on the electronics compartment in the desired position until it clicks into place. Screw the electronics compartment cover back onto the transmitter housing. If provided: tighten the screw of the cover lock using the Allen key 0.7 Nm (0.52 lbf ft)  $\pm$ 0.2 Nm (0.15 lbf ft).

### 5.2.11 Closing the housing covers

**NOTICE****Thread and housing cover damaged from dirt and fouling!**

- ▶ Remove dirt (e.g. sand.) on the thread of the cover and housing.
- ▶ If you continue to encounter resistance when closing the cover, check the thread again for fouling.

**Housing thread**

The threads of the electronics and connection compartment can be coated with an anti-friction coating.

The following applies for all housing materials:

- ✘ **Do not lubricate the housing threads.**

### 5.2.12 Turning the housing

The housing can be rotated up to  $380^\circ$  by loosening the locking screw.

**Your benefits**

- Easy mounting due to optimum alignment of housing
- Easily accessible device operation
- Optimum readability of the onsite display (optional)

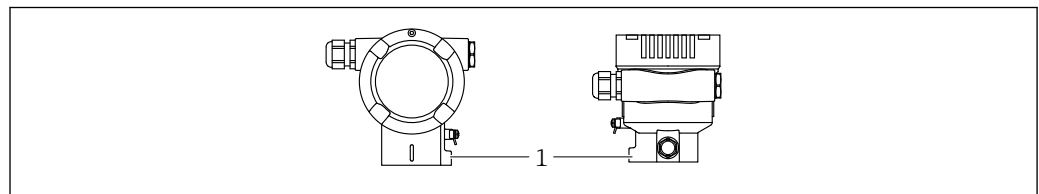

A0043807

1 Locking screw

**NOTICE****The housing cannot be unscrewed fully.**

- ▶ Loosen the external locking screw by a maximum of 1.5 turns. If the screw is unscrewed too much or completely (beyond the screw anchor point), small parts (counter disk) can become loose and fall out.
- ▶ Tighten the securing screw (hex socket 4 mm (0.16 in)) with maximum 3.5 Nm (2.58 lbf ft)  $\pm$  0.3 Nm (0.22 lbf ft).

### 5.3 Post-mounting check

- Is the device undamaged (visual inspection)?
- Are the measuring point identification and labeling correct (visual inspection)?
- Is the device protected against precipitation and direct sunlight?
- Are the securing screws and cover lock tightened securely?
- Does the measuring device meet the measuring point specifications?

For example:

- Process temperature
- Process pressure
- Ambient temperature
- Measuring range

## 6 Electrical connection

### 6.1 Connecting requirements

#### 6.1.1 Potential equalization

The protective ground on the device must not be connected. If necessary, the potential matching line can be connected to the outer ground terminal of the device before the device is connected.

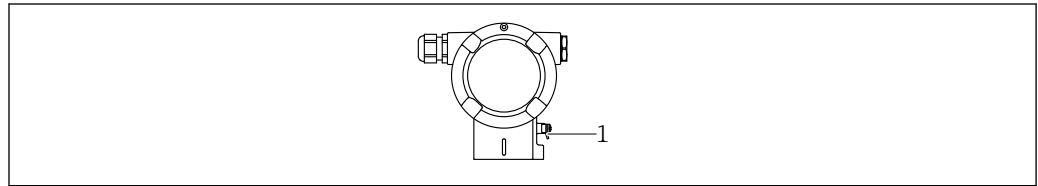

A0045412

1 Ground terminal for connecting the potential matching line

#### **⚠ WARNING**

#### **Explosion Hazard!**

► Please refer to the separate documentation on applications in hazardous areas for the safety instructions.

- i** For optimum electromagnetic compatibility:
- Keep the potential matching line as short as possible
  - Maintain a cross-section of at least 2.5 mm<sup>2</sup> (14 AWG)

### 6.2 Connecting the device

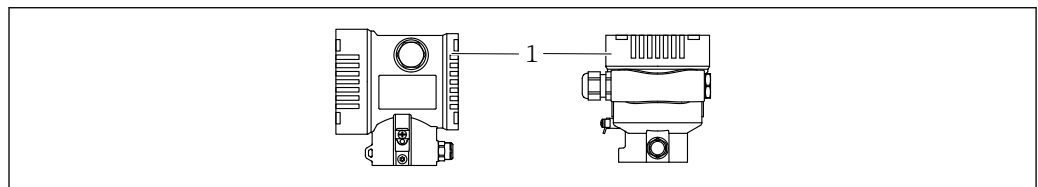

A0043806

1 Connection compartment cover

#### **i** Housing thread

The threads of the electronics and connection compartment can be coated with an anti-friction coating.

The following applies for all housing materials:

- ⊗ Do not lubricate the housing threads.**

#### 6.2.1 Supply voltage

APL performance class A (9.6 to 15 V<sub>DC</sub> 540 mW)

- i** The APL field switch must be safety-approved (e.g. PELV, SELV, Class 2) and must comply with the relevant protocol specifications.

#### 6.2.2 Terminals

- Supply voltage and internal ground terminal: 0.5 to 2.5 mm<sup>2</sup> (20 to 14 AWG)
- External ground terminal: 0.5 to 4 mm<sup>2</sup> (20 to 12 AWG)

### 6.2.3 Cable specification

- Protective ground or grounding of the cable shield: rated cross-section  $> 1 \text{ mm}^2$  (17 AWG)  
Rated cross-section of  $0.5 \text{ mm}^2$  (20 AWG) to  $2.5 \text{ mm}^2$  (13 AWG)
- Cable outer diameter:  $\varnothing 5$  to 12 mm (0.2 to 0.47 in) depends on the cable gland used (see Technical Information)

#### PROFINET with Ethernet-APL

The reference cable type for APL segments is fieldbus cable type A, MAU type 1 and 3 (specified in IEC 61158-2). This cable meets the requirements for intrinsically safe applications according to IEC TS 60079-47 and can also be used in non-intrinsically safe applications.

Cable type	A
Cable capacitance	45 to 200 nF/km
Loop resistance	15 to 150 $\Omega$ /km
Cable inductance	0.4 to 1 mH/km

Further details are provided in the Ethernet-APL Engineering Guideline (<https://www.ethernet-apl.org>).

### 6.2.4 Overvoltage protection

#### Devices without optional overvoltage protection

Equipment from Endress+Hauser fulfills the requirements of the product standard IEC / DIN EN 61326-1 (Table 2 Industrial Environment).

Depending on the type of port (DC power supply, input/output port) different testing levels according to IEC / DIN EN 61326-1 against transient overvoltages (Surge) are applied (IEC / DIN EN 61000-4-5 Surge):

Test level on DC power ports and input / output ports is 1000 V line to earth

#### Devices with optional overvoltage protection

- Spark-over voltage: min. 400 V DC
- Tested according to IEC / DIN EN 60079-14 sub chapter 12.3 (IEC / DIN EN 60060-1 chapter 7)
- Nominal discharge current: 10 kA

#### Overvoltage category

Overvoltage category II

## 6.2.5 Wiring

### **⚠ WARNING**

#### **Supply voltage might be connected!**

Risk of electric shock and/or explosion!

- ▶ If the device is used in hazardous areas, comply with national standards and the specifications in the Safety Instructions (XAs). Use the specified cable gland.
- ▶ The supply voltage must match the specifications on the nameplate.
- ▶ Switch off the supply voltage before connecting the device.
- ▶ If necessary, the potential matching line can be connected to the outer ground terminal of the transmitter before the device is connected.
- ▶ A suitable circuit breaker should be provided for the device in accordance with IEC/EN 61010.
- ▶ The cables must be adequately insulated, with due consideration given to the supply voltage and the overvoltage category.
- ▶ The connecting cables must offer adequate temperature stability, with due consideration given to the ambient temperature.
- ▶ Only operate the device with the covers closed.
- ▶ Protective circuits against reverse polarity, HF influences and overvoltage peaks are integrated.

Connect the device in the following order:

1. Release the cover lock (if provided).
2. Unscrew the cover.
3. Guide the cables into the cable glands or cable entries.
4. Connect the cables.
5. Tighten the cable glands or cable entries so that they are leak-tight. Counter-tighten the housing entry. Use a suitable tool with width across flats AF24/25 8 Nm (5.9 lbf ft) for the M20 cable gland.
6. Screw the cover securely back onto the connection compartment.
7. If fitted: tighten the screw of the cover lock using the Allen key 0.7 Nm (0.52 lbf ft)  $\pm 0.2$  Nm (0.15 lbf ft).



## 6.2.6 Terminal assignment

### Dual compartment housing

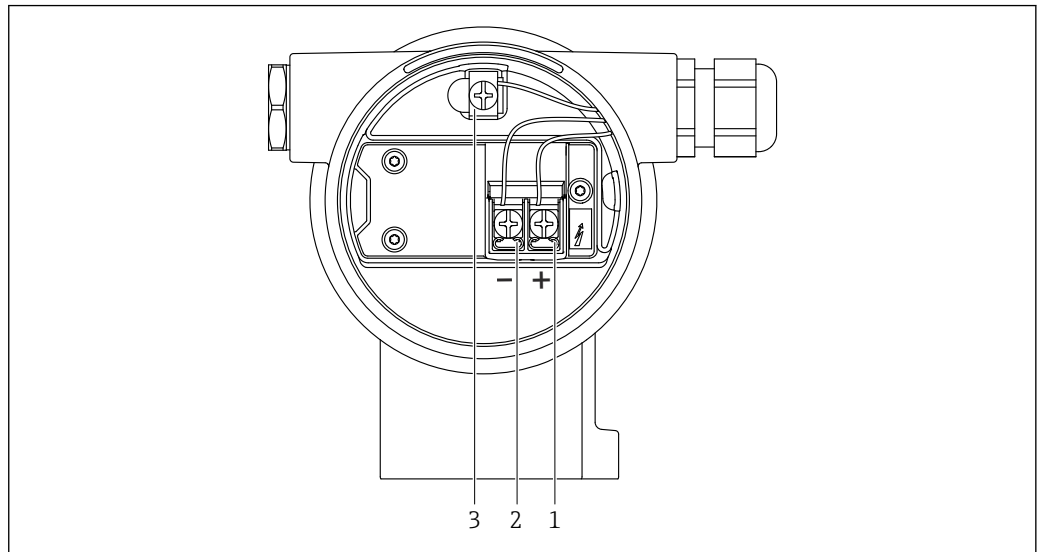

 2 Connection terminals and ground terminal in the connection compartment

- 1 Positive terminal
- 2 Negative terminal
- 3 Internal ground terminal

## 6.2.7 Cable entries

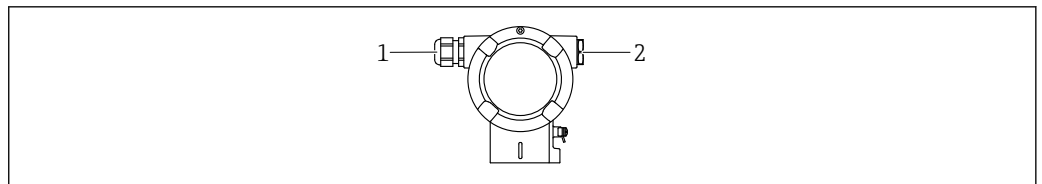

- 1 Cable entry
- 2 Dummy plug

The type of cable entry depends on the device version ordered.

 Always route connecting cables downwards so that moisture cannot penetrate the connection compartment.

If necessary, create a drip loop or use a weather protection cover.

## 6.2.8 Available device plugs

 In the case of devices with a plug, it is not necessary to open the housing for connection purposes.

Use the enclosed seals to prevent the penetration of moisture into the device.

### Devices with M12 plug

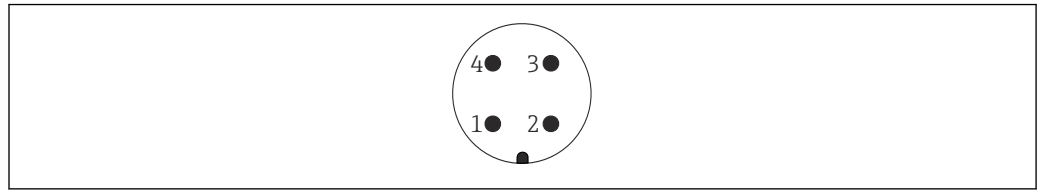

A0011175

- 1 APL signal -
- 2 APL signal +
- 3 Shielding
- 4 Not assigned

## 6.3 Ensuring the degree of protection

### 6.3.1 Cable entries

- Gland M20, plastic, IP66/68 TYPE 4X/6P
- Gland M20, brass nickel plated, IP66/68 TYPE 4X/6P
- Gland M20, 316L, IP66/68 TYPE 4X/6P
- Thread M20, IP66/68 TYPE 4X/6P
- Thread G1/2, IP66/68 TYPE 4X/6P
  - If the G1/2 thread is selected, the device is delivered with an M20 thread as standard and a G1/2 adapter is included with the delivery, along with the corresponding documentation
- Thread NPT1/2, IP66/68 TYPE 4X/6P
- Dummy plug transport protection: IP22, TYPE 2
- M12 plug
  - When housing is closed and connecting cable is plugged in: IP66/67, NEMA Type 4X
  - When housing is open or connecting cable is not plugged in: IP20, NEMA Type 1

#### NOTICE

#### **M12 plug and HAN7D plug: incorrect mounting can invalidate the IP protection class!**

- ▶ The degree of protection only applies if the connecting cable used is plugged in and screwed tight.
- ▶ The degree of protection only applies if the connecting cable used is specified according to IP67, NEMA Type 4X.
- ▶ The IP protection classes are only maintained if the dummy cap is used or the cable is connected.

## 6.4 Post-connection check

After wiring the device, perform the following checks:

- Is the potential matching line connected?
- Is the terminal assignment correct?
- Are the cable glands and dummy plugs leak-tight?
- Are the fieldbus connectors properly secured?
- Are the covers screwed down correctly?

## 7 Operation options

### 7.1 Overview of operation options

- Operation via operating keys and DIP switches on the electronic insert
- Operation via optical operating keys on the device display (optional)
- Operation via Bluetooth® wireless technology (with optional Bluetooth device display) with Smartblue app or FieldXpert, DeviceCare
- Operation via Web server
- PROFINET: Operation via Fieldcare, DeviceCare, FDI Hosts (e.g. PDM)

### 7.2 Operating keys and DIP switches on the electronic insert

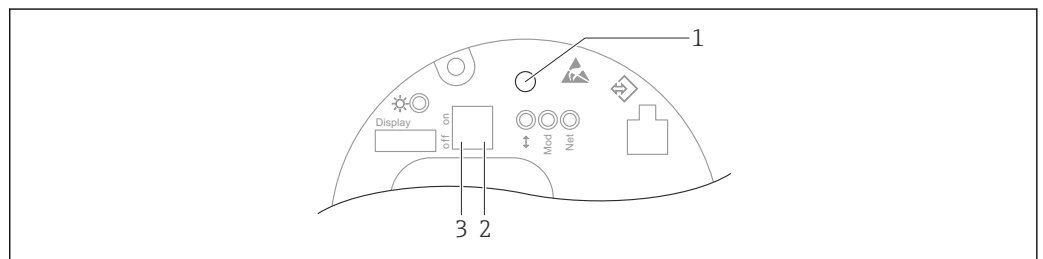

A0046061

- 1 Operating key for position adjustment (zero point correction) and device reset
- 2 DIP switch for setting the service IP address
- 3 DIP switch for locking and unlocking the device

**i** The setting of the DIP switches has priority over the settings made via other operation methods (e.g. FieldCare/DeviceCare).

### 7.3 Structure and function of the operating menu

The differences between the structure of the operating menus of the local display and the Endress+Hauser FieldCare or DeviceCare operating tools can be summarized as follows:

The local display is suitable for configuring simple applications.

More elaborate applications can be configured with the Endress+Hauser FieldCare or DeviceCare operating tools as well as Bluetooth and the SmartBlue App and the device display.

More elaborate applications can be configured with the web server.

"Wizards" help the user to commission the various applications. The user is guided through the individual configuration steps.

#### 7.3.1 User roles and related access authorization

The two user roles, **Operator** and **Maintenance** (order configuration), have different write access to the parameters if a device-specific access code has been defined. This access code protects the device configuration from unauthorized access.

If an incorrect access code is entered, the user retains the **Operator** option user role.

## 7.4 local display

### 7.4.1 Device display (optional)

Functions:

- Display of measured values and fault and notice messages
- Background lighting, which switches from green to red in the event of an error
- The device display can be removed for easier operation
- In the dual compartment, L-form housing, the device display fits into both housing parts (top and side).

 The device displays are available with the additional option of Bluetooth® wireless technology.

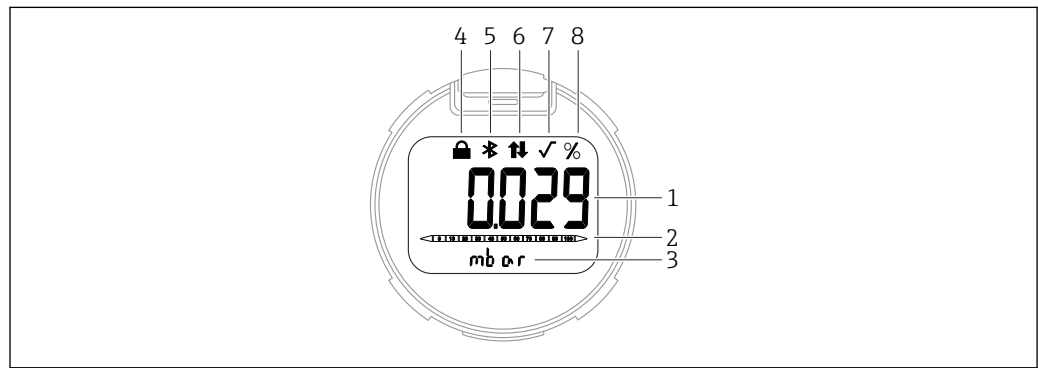

A0047143

 3 Segment display

- 1 Measured value (up to 5 digits)
- 2 Bar graph (not for PROFINET with Ethernet-APL)
- 3 Unit of measured value
- 4 Locked (symbol appears when the device is locked)
- 5 Bluetooth (symbol flashes if Bluetooth connection is active)
- 6 communication via PROFINET is active
- 7 Has no function in the case of PROFINET with Ethernet-APL
- 8 Measured value output in %

The following graphics are examples. The display depends on the display settings.

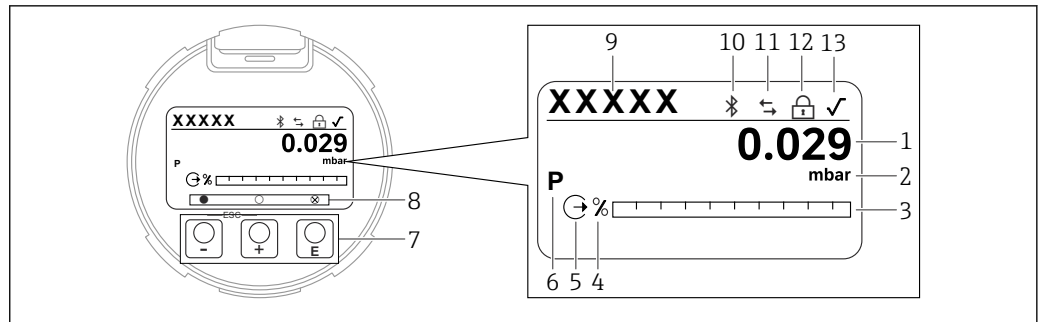

A0047141

4 Graphic display with optical operating keys.

- 1 Measured value (up to 12 digits)
- 2 Unit of measured value
- 3 Bar graph (not for PROFINET with Ethernet-APL)
- 4 Bar graph unit
- 5 Symbol for current output
- 6 Symbol for displayed measured value (e.g. p = pressure)
- 7 Optical operating keys
- 8 Symbols for key feedback. Different display symbols are possible: circle (not filled in) = key pressed briefly; circle (filled in) = key pressed for longer; circle (with X) = no operation possible due to Bluetooth connection
- 9 Device Tag
- 10 Bluetooth (symbol flashes if Bluetooth connection is active)
- 11 communication via PROFINET is active
- 12 Locked (symbol appears when the device is locked)
- 13 Symbol for square root extraction

- operating key
  - Navigate down in the picklist
  - Edit the numerical values or characters within a function
- operating key
  - Navigate up in the picklist
  - Edit the numerical values or characters within a function
- operating key
  - Confirm entry
  - Jump to the next item
  - Select a menu item and activate edit mode
  - Unlock/lock the display operation
  - Press and hold the key to display a short description of the selected parameter (if available)
- key and key (ESC function)
  - Exit the edit mode for a parameter without saving the changed value
  - Menu at a selection level: pressing the keys simultaneously takes the user back up a level in the menu
  - Press and hold the keys simultaneously to return to the upper level

## 7.4.2 Operation via Bluetooth® wireless technology (optional)

### Requirement

- Device with Bluetooth display
- Smartphone or tablet with Endress+Hauser SmartBlue app or PC with DeviceCare from version 1.07.00 or FieldXpert SMT70

The connection has a range of up to 25 m (82 ft). The range can vary depending on environmental conditions such as attachments, walls or ceilings.

- The operating keys on the display are locked as soon as the device is connected via Bluetooth.

### SmartBlue app

1. Scan the QR code or enter "SmartBlue" in the search field of the App Store or Google Play.



A0039186

2. Start the SmartBlue app.
3. Select device from livelist displayed.
4. Login:
  - ↳ Enter the user name: admin  
Password: serial number of the device.
5. Change the password after logging in for the first time!

#### Prerequisites

#### System requirements

The SmartBlue app is available to download for smartphones or tablets. For information on the compatibility of the SmartBlue App with mobile end devices, see "App Store (Apple)" or "Google Play Store".

#### Initial password

The serial number of the device serves as the initial password when the connection is established for the first time.

## 7.5 Access to operating menu via web browser

### 7.5.1 Function scope

Thanks to the integrated Web server the device can be operated and configured via a Web browser. The structure of the operating menu is the same as for the local display. In addition to the measured values, device status information is also displayed and allows users to monitor the status of the device. Furthermore the device data can be managed and the network parameters can be configured.

### 7.5.2 Prerequisites

#### Computer software

##### Recommended operating systems

- Microsoft Windows 7 or higher.
- Mobile operating systems:
  - iOS
  - Android

 Microsoft Windows XP is supported.

##### Web browsers supported

- Microsoft Internet Explorer 8 or higher
- Microsoft Edge
- Mozilla Firefox
- Google Chrome
- Safari

## Computer settings

### User rights

Corresponding user rights (e.g., administrator rights) for TCP/IP and proxy server settings are required (for changing the IP address, subnet mask etc.).

### Proxy server settings of the web browser

The web browser *Use proxy server for LAN* setting must be **disabled**.

### JavaScript

JavaScript must be enabled.

 When installing a new firmware version: To enable correct data display, clear the temporary memory (cache) of the web browser under **Internet options**.

## 7.5.3 Connecting the device

### Via PROFINET with Ethernet-APL network

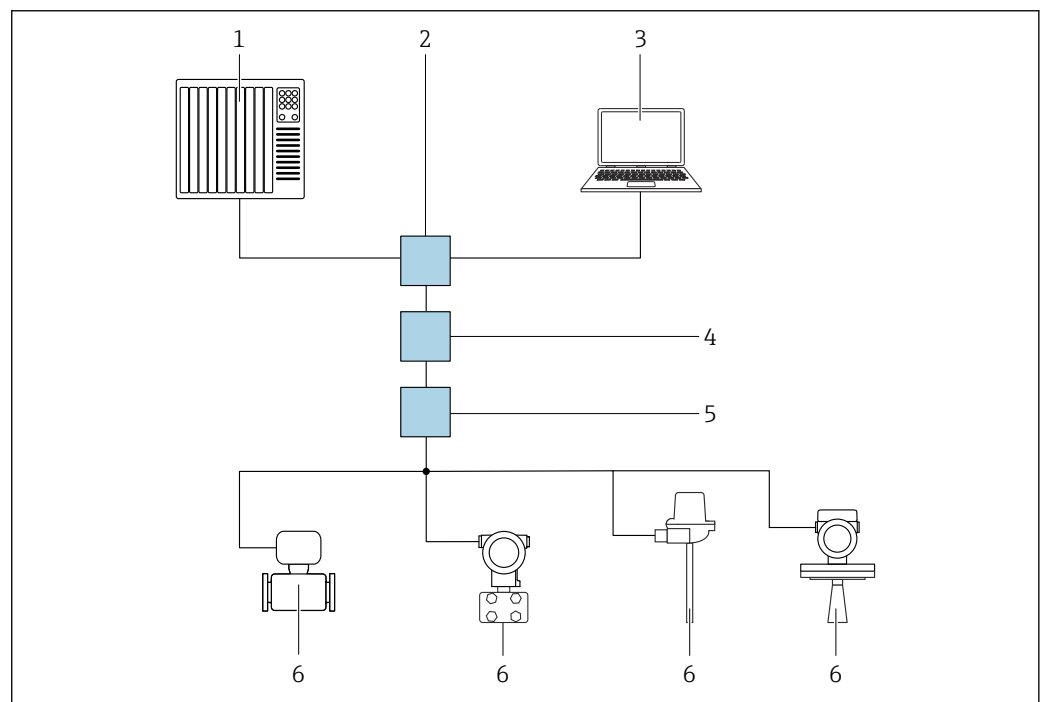

 5 Options for remote operation via PROFINET with Ethernet-APL network: star topology

- 1 Automation system, e.g. Simatic S7 (Siemens)
- 2 Ethernet switch
- 3 Computer with Web browser (e.g., Microsoft Edge) for accessing the integrated device Web server or computer with operating tool (e.g., FieldCare, DeviceCare, SIMATIC PDM) with iDTM Profinet Communication
- 4 APL power switch (optional)
- 5 APL field switch
- 6 APL field device

Call up the website via the computer in the network. The IP address of the device must be known.

The IP address can be assigned to the device in a variety of ways:

- Dynamic Configuration Protocol (DCP), factory setting  
The automation system (e.g. Siemens S7) automatically assigns the IP address to the device
- Software addressing  
The IP address is entered via the IP address parameter
- DIP switch for service  
The device then has the fixed IP address 192.168.1.212  
  - 📘 The IP address is only adopted following a restart.
  - The IP address can now be used to establish the connection to the network

The default setting is that the device uses the Dynamic Configuration Protocol (DCP). The automation system (e.g. Siemens S7) automatically assigns the IP of the device.

### Starting the web browser and logging in

1. Start the web browser on the computer.
2. Enter the IP address of the web server in the address line of the web browser:  
192.168.1.212  
  - ↳ The login page appears.

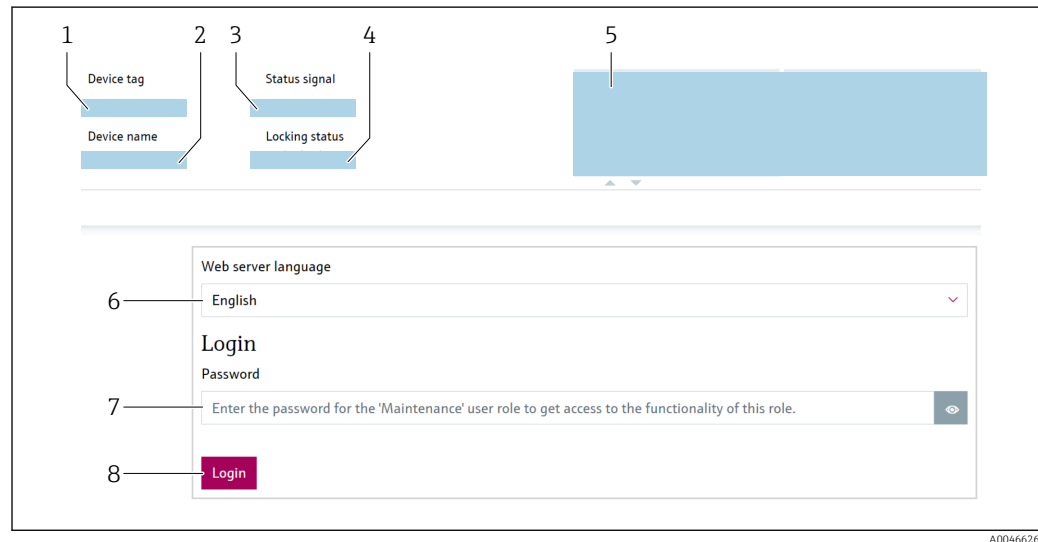

- 1 Device tag
- 2 Device name
- 3 Status signal
- 4 Locking status
- 5 Current measured values
- 6 Select the language
- 7 Enter the "Password" parameter
- 8 Login

1. Select the preferred **Language** parameter for the web browser.
2. Enter the **Password** parameter.
3. Confirm entry with Login .



### 7.5.4 User interface

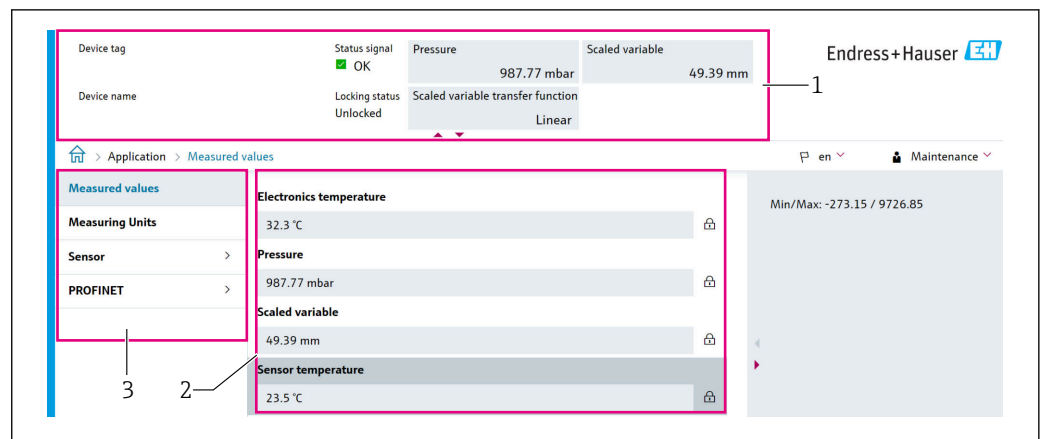

A0046168

- 1 Header
- 2 Work area
- 3 Navigation area

#### Header

The following information appears in the header:

- **Device tag** parameter,
- Device name
- Status signal
- Locking status
- Current measured values

#### Navigation area

If a function is selected in the function bar, the submenus of the function open in the navigation area. The user can now navigate within the menu structure.

#### Work area

Depending on the selected function and the related submenus, various actions can be performed in this area:

- Configuration of parameters
- Reading of measured values
- Calling up help texts

### 7.5.5 Disabling the web server

The web server of the measuring device can be switched on and off as required using the **Web server functionality** parameter.

#### Navigation

"System" menu → Connectivity → Interfaces

#### Parameter overview with brief description

Parameter	Description	Selection
Web server functionality	Switch web server on and off, switch off HTML.	<ul style="list-style-type: none"> <li>■ Disable</li> <li>■ Enable</li> </ul>

### Function range of "Web server functionality" parameter

Option	Description
Disable	<ul style="list-style-type: none"> <li>▪ The web server is completely disabled.</li> <li>▪ Port 80 is locked.</li> </ul>
Enable	<ul style="list-style-type: none"> <li>▪ The entire functionality of the web server is available.</li> <li>▪ JavaScript is used.</li> <li>▪ The password is transferred in an encrypted state.</li> <li>▪ Any change to the password is also transferred in an encrypted state.</li> </ul>

#### Enabling the web server

If the web server is disabled, it can only be re-enabled with the **Web server functionality** parameter via the following operating options:

- Via local display
- Via the "FieldCare" operating tool
- Via the "DeviceCare" operating tool

#### 7.5.6 Logging out

1. Select the **Logout** entry in the function bar.
  - ↳ The home page with the Login box appears.
2. Close the web browser.

 Once communication with the web server is established via the standard IP address 192.168.1.212, the DIP switch must be reset (from **ON** → **OFF**). This action reactivates the set IP address of the device for network communication.

### 7.6 Access to the operating menu via the operating tool

The structure of the operating menu in the operating tools is the same as for operation via the local display. The range of functions is different however.

## 7.6.1 Connecting the operating tool

### Via PROFINET with Ethernet-APL network

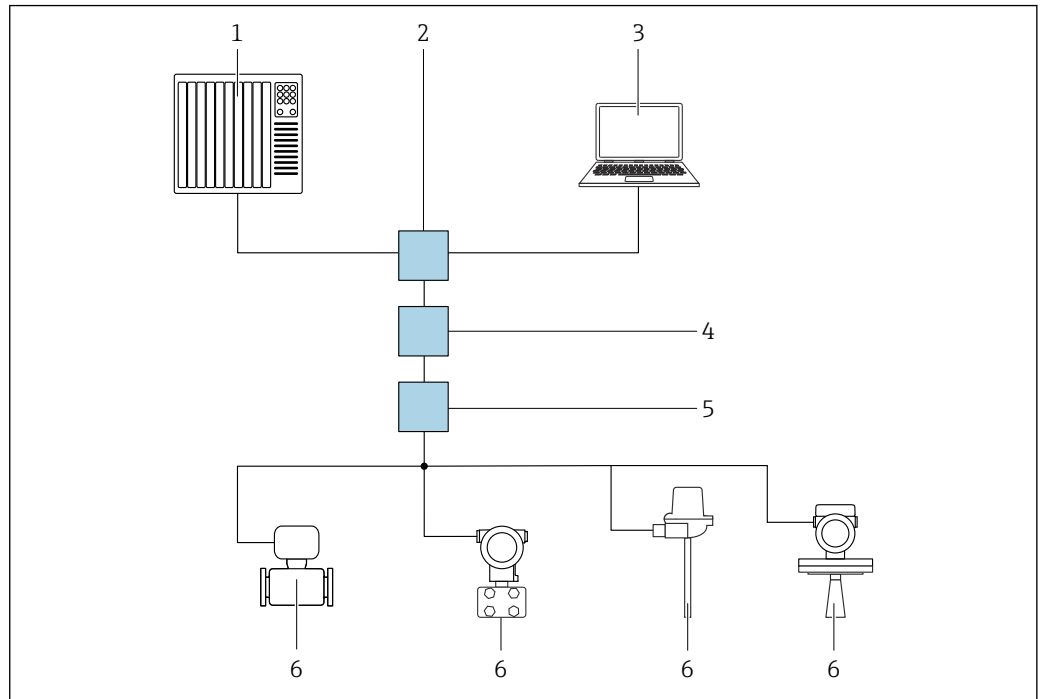

A0046097

6 Options for remote operation via PROFINET with Ethernet-APL network: star topology

- 1 Automation system, e.g. Simatic S7 (Siemens)
- 2 Ethernet switch
- 3 Computer with Web browser (e.g., Microsoft Edge) for accessing the integrated device Web server or computer with operating tool (e.g., FieldCare, DeviceCare, SIMATIC PDM) with iDTM Profinet Communication
- 4 APL power switch (optional)
- 5 APL field switch
- 6 APL field device

Call up the website via the computer in the network. The IP address of the device must be known.

The IP address can be assigned to the device in a variety of ways:

- Dynamic Configuration Protocol (DCP), factory setting  
The automation system (e.g. Siemens S7) automatically assigns the IP address to the device
  - Software addressing  
The IP address is entered via the IP address parameter
  - DIP switch for service  
The device then has the fixed IP address 192.168.1.212
- i** The IP address is only adopted following a restart.  
The IP address can now be used to establish the connection to the network

The default setting is that the device uses the Dynamic Configuration Protocol (DCP). The automation system (e.g. Siemens S7) automatically assigns the IP of the device.

### Service interface

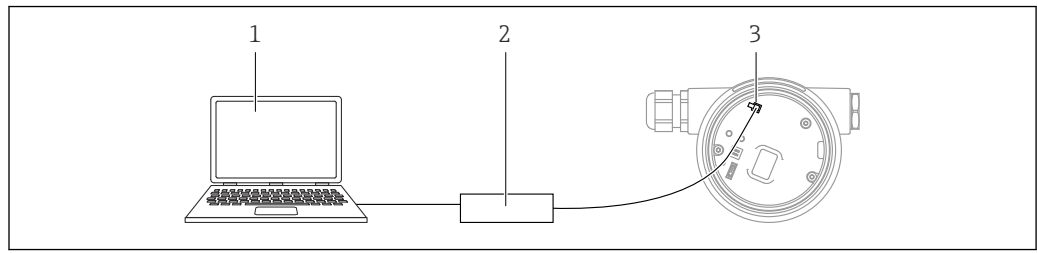

- 1 Computer with FieldCare/DeviceCare operating tool  
 2 Commubox FXA291  
 3 Service interface (CDI) of the device (= Endress+Hauser Common Data Interface)

**i** To update (flash) the device firmware, the device must be powered via the power supply terminals.

## 7.6.2 FieldCare

### Range of functions

FDT-based plant asset management tool from Endress+Hauser. FieldCare can configure all intelligent field devices in a system and helps you manage them. By using the status information, FieldCare is also a simple but effective way of checking their status and condition.

Access is via:

- CDI service interface
- PROFINET interface

Typical functions:

- Transmitter parameter configuration
- Loading and saving of device data (upload/download)
- Documentation of the measuring point
- Visualization of the measured value memory (line recorder) and event logbook

**b** For additional information about FieldCare, see Operating Instructions BA00027S and BA00059S.

## 7.6.3 DeviceCare

### Range of functions

Tool for connecting and configuring Endress+Hauser field devices

Together with the device type managers (DTMs), DeviceCare presents a convenient, comprehensive solution.

**b** For details, see Innovation Brochure IN01047S.

## 7.7 HistoROM

When replacing the electronic insert, the stored data is transferred by reconnecting the HistoROM. The device does not work without HistoROM.

The device serial number is saved in the HistoROM. The electronics serial number is saved in the electronics.

## 8 System integration

### 8.1 Overview of device description files

#### 8.1.1 Current version data for the device

Firmware version	01.01.zz	<ul style="list-style-type: none"> <li>▪ On the title page of the Operating Instructions</li> <li>▪ On the transmitter nameplate</li> <li>▪ Firmware version System → Information → Firmware version</li> </ul>
Release date of firmware version	01.2022	–
Manufacturer ID	0x11	Guidance → Commissioning → Manufacturer ID
Device ID	ID: A231	Application → PROFINET → Information → Device ID On the transmitter nameplate
Profile 4 device ID	B310	On the transmitter nameplate
Device revision	1	On the transmitter nameplate
PROFINET version	2.4x	–
Profile version	4.0x	

#### 8.1.2 Operating tools

The suitable device description file for the individual operating tools is listed in the table below, along with information on where the file can be acquired.

Operating tool via Service interface (CDI)	Sources for obtaining device descriptions
FieldCare	<ul style="list-style-type: none"> <li>▪ <a href="http://www.endress.com">www.endress.com</a> → Download Area</li> <li>▪ CD-ROM (contact Endress+Hauser)</li> <li>▪ DVD (contact Endress+Hauser)</li> </ul>
DeviceCare	<ul style="list-style-type: none"> <li>▪ <a href="http://www.endress.com">www.endress.com</a> → Download Area</li> <li>▪ CD-ROM (contact Endress+Hauser)</li> <li>▪ DVD (contact Endress+Hauser)</li> </ul>
SMT70	Use update function of handheld terminal
AMS Device Manager (Emerson Process Management)	<a href="http://www.endress.com">www.endress.com</a> → Download Area
SIMATIC PDM (Siemens)	<a href="http://www.endress.com">www.endress.com</a> → Download Area

## 8.2 Device master file (GSD)

In order to integrate field devices into a bus system, the PROFINET with Ethernet-APL system needs a description of the device parameters, such as output data, input data, data format and data volume.

These data are available in the device master file (GSD) which is provided to the automation system when the communication system is commissioned. In addition device bit maps, which appear as icons in the network structure, can also be integrated.

The device master file (GSD) is in XML format, and the file is created in the GSDML description markup language.

Download the device master file (GSD)

- Via Web server: menu path System → Device drivers
- Via [www.endress.com/download](http://www.endress.com/download)

### 8.2.1 File name of the device master file (GSD)

Example of the name of a device master file:

GSDML-V2.42-EH\_PMDXXB\_APL\_DELTABAR-20220214.xml

<b>GSDML</b>	Description language
<b>V2.42</b>	Version of the PROFINET specification
<b>EH</b>	Endress+Hauser
<b>- PMDXXB_APL_DELTABA R</b>	Instrument family
<b>20220214</b>	Date of issue (year, month, day)
<b>.xml</b>	File name extension (XML file)

### 8.3 Cyclic data transmission

#### 8.3.1 Overview of the modules

The following graphic shows which modules are available to the device for cyclic data exchange. Cyclic data exchange is performed with an automation system.

Device		Slot	Direction Data flow	Control system
Modules				
Analog input (Pressure)		1	→	PROFINET
Analog input (Scaled variable)		20	→	
Analog input (Sensor temperature)		21	→	
Analog input (Sensor pressure)		22	→	
Analog input (Electronics temperature)		23	→	
Analog input (Median of pressure signal)		24	→	
Analog input (Noise of pressure signal)		25	→	
Binary input (Heartbeat Technology)		80	→	
Binary input (SSD: Statistical Sensor Diagnostics)		81	→	
Binary output (Heartbeat Technology)		210	←	

#### BinaryInput Sensordiagnostics Slot 81

Bit	Function	Description
0	Process alert pressure	Process alert pressure detected.
1	Process alert scaled variable	Process alert scaled variable detected.
2	Process alert temperature	Process alert temperature detected.
3	Low signal noise detected	Low signal noise detected
4	High signal noise detected	High signal noise detected
5	Min signal noise detected	Min signal noise detected
6	Out of range signal detected	Out of range signal detected
7	-	-

#### 8.3.2 Description of the modules

-  The data structure is described from the perspective of the automation system:
- Input data: are sent from the device to the automation system
  - Output data: are sent from the automation system to the device

##### Analog Input module

Transmission of input variables from the device to the automation system:

Analog Input modules cyclically transmit the selected input variables, including the status, from the device to the automation system. The input variable is depicted in the first four bytes in the form of a floating point number as per the IEEE 754 standard. The fifth byte contains status information pertaining to the input variable. The "Pressure" Analog Input module in Slot 1 is contained in the pressure PA PROFILE GSD. The other Analog Input modules can only be used with the manufacturer GSD.

### Binary Output module

The Binary Output module can cyclically receive discrete output values from the automation system. The device implements an 8-bit type as described in PA PROFILE 4.0x. Of this, 1 bit is used to signal to the device that Heartbeat Verification should be started.

Bit	Function	Description
0	Start verification	Start verification
1...7	-	-

### Binary Input module

The Binary Input module can cyclically send discrete values from the device to the automation system. In the device, the status of the Heartbeat Verification is transmitted:

Bit	Function	Description
0	Status Not done	Verification not performed
1	Status Failed	Verification failed. At least one test group was outside the specifications.
2	Status Busy	Verification in progress
3	Status Done	Verification performed
4	Verification result Failed	Verification failed. At least one test group is outside the specifications.
5	Verification result Passed	The device has passed the verification. All the verified test groups met the specifications.
6	The verification result is also "Passed" if the result for an individual test group is "Failed" and the result for all other test groups is "Passed".	
7	Verification result Not done	Verification not performed

### 8.3.3 Status coding

Status	Coding (hex)	Meaning
BAD - Maintenance alarm	0x24	No measured value available, as a device error has occurred.
BAD - Process related	0x28	No measured value available, as the process conditions are not within the device's technical specification limits.
BAD - Function check	0x3C	A function check is active (e.g. cleaning or calibration)
UNCERTAIN - Initial value	0x4F	A predefined value is output until a correct measured value is available again or corrective measures have been performed that change this status.
UNCERTAIN - Maintenance demanded	0x68	Wear and tear has been detected. Maintenance is needed shortly to ensure the device remains operational. The measured value might be invalid. The use of the measured value depends on the application.
UNCERTAIN - Process related	0x78	The process conditions are not within the device's technical specification limits. This could have a negative impact on the quality and accuracy of the measured value. The use of the measured value depends on the application.
GOOD - OK	0x80	No error has been diagnosed.



Status	Coding (hex)	Meaning
GOOD - Maintenance demanded	0xA8	The measured value is valid. It is highly advisable to service the device in the near future.
GOOD - Function check	0xBC	The measured value is valid. The device performs an internal function check. The function check does not have any noticeable effect on the process.

### 8.3.4 Startup configuration

Startup configuration (NSU)	<p>The automation system adopts the configuration of the most important parameters of the device.</p> <ul style="list-style-type: none"> <li>▪ Management:             <ul style="list-style-type: none"> <li>▪ Display operation</li> <li>▪ Web server functionality</li> <li>▪ Bluetooth activation</li> <li>▪ Service CDI</li> </ul> </li> <li>▪ System units:             <ul style="list-style-type: none"> <li>▪ Pressure unit</li> <li>▪ Temperature unit</li> <li>▪ Scaled variable unit</li> </ul> </li> <li>▪ Process:             <ul style="list-style-type: none"> <li>▪ Damping</li> <li>▪ Alarm delay</li> <li>▪ Diagnostic settings</li> <li>▪ Diagnostic behavior for diverse diagnostic information</li> </ul> </li> </ul>
-----------------------------	--

## 8.4 System redundancy S2

A redundant layout with two automation systems is necessary for processes that are in continuous operation. If one system fails the second system guarantees continued, uninterrupted operation. The device supports S2 system redundancy and can communicate simultaneously with both automation systems.

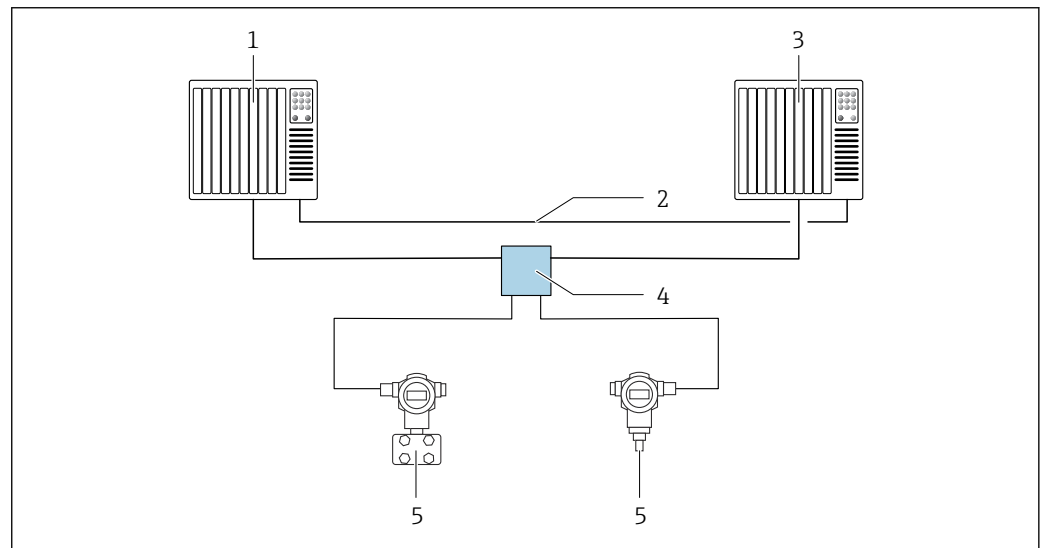

**7** Example of the layout of a redundant system (S2): star topology

- 1 Automation system 1
- 2 Synchronization of automation systems
- 3 Automation system 2
- 4 Ethernet-APL Field Switch
- 5 Device

**i** All the devices in the network must support S2 system redundancy.

## 9 Commissioning

### 9.1 Preliminaries

The measuring range and the unit in which the measured value is transmitted correspond to the data on the nameplate.

#### **⚠ WARNING**

#### **Process pressure above or below permitted maximum/minimum!**

Risk of injury if parts burst! Warnings are displayed if the pressure is too high.

- ▶ If a pressure smaller than the minimum permitted pressure or greater than the maximum permitted pressure is present at the device, a message is output.
- ▶ Only use the device within the measuring range limits!

#### 9.1.1 As-delivered state

If no customized settings were ordered:

- Calibration values defined by defined measuring cell nominal value
- DIP switch to Off position
- If Bluetooth is ordered, then Bluetooth is switched on

### 9.2 Function check

Perform a function check before putting the measuring point into operation:

- "Post-installation check" checklist (see the "Installation" section)
- "Post-connection check" checklist (see the "Electrical connection" section)

### 9.3 Establishing a connection via FieldCare and DeviceCare

#### 9.3.1 Via PROFINET protocol

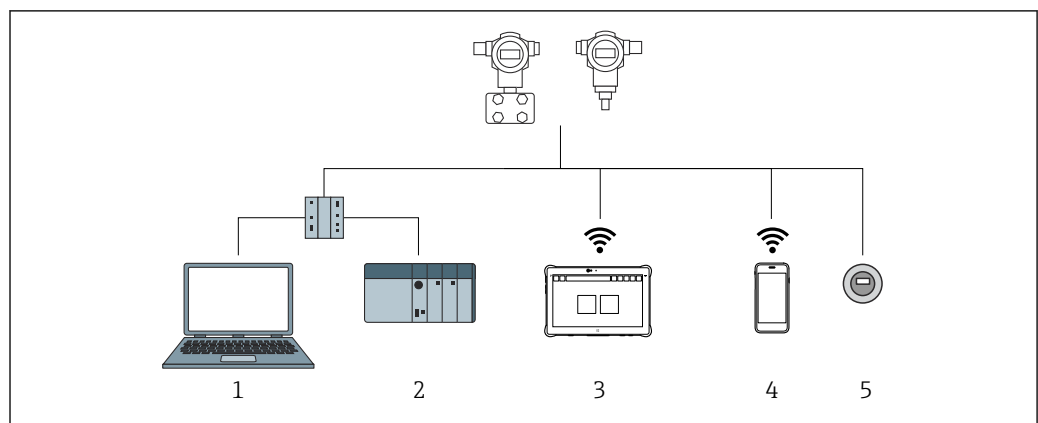

 8 Options for remote operation via PROFINET protocol

- 1 Computer with Web browser or with operating tool (e.g., DeviceCare)
- 2 Automation system
- 3 Field Xpert SMT70
- 4 Mobile handheld terminal
- 5 Local operation via display module

A0046623

### 9.3.2 FieldCare/DeviceCare via service interface (CDI)

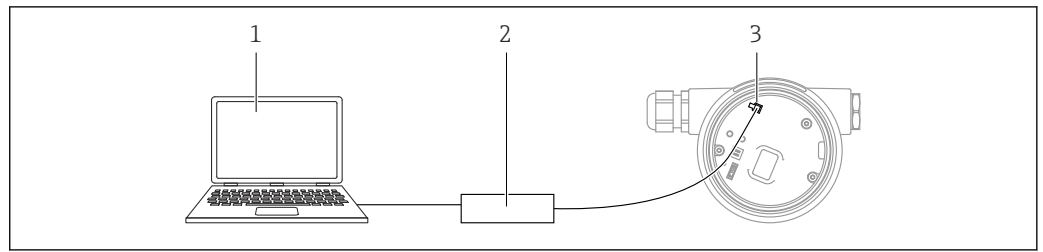

- 1 Computer with FieldCare/DeviceCare operating tool  
 2 Commubox FXA291  
 3 Service interface (CDI) of the device (= Endress+Hauser Common Data Interface)

## 9.4 Hardware settings

### 9.4.1 Setting the device name

A measuring point can be quickly identified within a plant on the basis of the **Device tag** parameter and **PROFINET device name** parameter. The **Device tag** parameter, which is specified ex works or defined when ordering, can be changed in the operating menu.

#### Configuring the "Device tag" parameter via the operating menu

The **Device tag** parameter can be adapted via the operating menu or automation system.  
 System → Device management

#### Configuring the "PROFINET device name" parameter via the operating menu

Application → PROFINET → Configuration

#### Configuring the "PROFINET device name" parameter via the automation system

The **PROFINET device name** parameter can be adapted individually via the automation system.

- i** When assigning the **PROFINET device name** parameter via the automation system:  
 assign the device name in lower case letters.

### 9.4.2 Activating the default IP address

#### Activating the default IP address via the DIP switch

The device can be set to the default IP address 192.168.1.212 via DIP switches.

1. Set DIP switch 2 on the electronic insert from **OFF** → **ON**.
2. Reconnect the device to the power supply.
  - ↳ The default IP address is used once the device is restarted.

## 9.5 Configuring the communication parameters via the software

- IP address
- Subnet mask
- Default gateway





Menu path: System → Connectivity → Ethernet

## 9.6 Setting the operating language

### 9.6.1 Local display

#### Setting the operating language

 To set the operating language, the display first needs to be unlocked:

1. Press the  key for at least 2 s.
  - ↳ A dialog box appears.
2. Unlock the display operation.
3. Select the **Language** parameter in the main menu.
4. Press the  key.
5. Select the desired language with the  or  key.
6. Press the  key.

 Display operation locks automatically:

- after 1 min on the main page if no key has been pressed
- after 10 min within the operating menu if no key has been pressed

#### Display operation - locking or unlocking

The  key must be pressed for at least 2 seconds in order to lock or unlock the optical keys. Display operation can be locked or unlocked in the dialog that appears.

Display operation locks automatically:

- After 1 minute on the main page if no key has been pressed
- After 10 minutes within the operating menu if no key has been pressed

Display operation can be disabled via software:

Menu path: System → Connectivity → Interfaces → Display operation

### 9.6.2 Web server

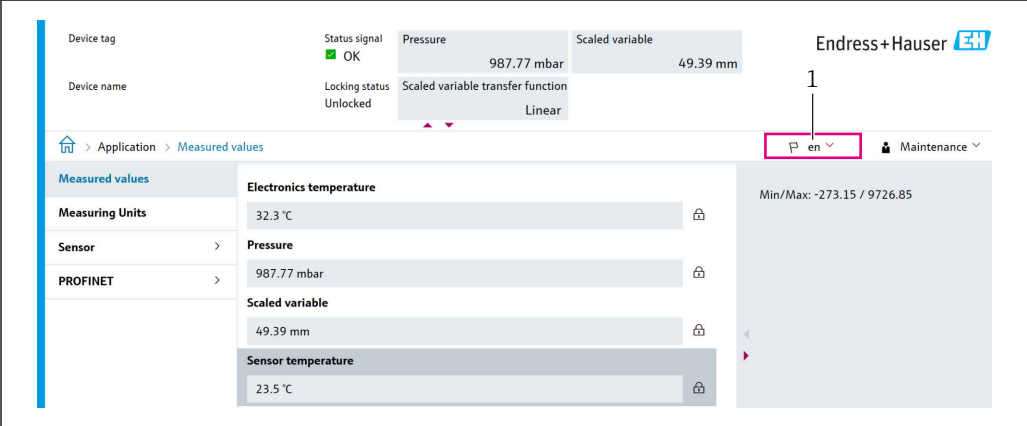

The screenshot shows the 'Measured values' page on the web server. The top navigation bar includes 'Device tag', 'Status signal' (OK), 'Pressure' (987.77 mbar), 'Scaled variable' (49.39 mm), and 'Endress+Hauser'. Below the navigation bar, there is a breadcrumb trail: 'Application > Measured values'. The main content area is divided into sections: 'Measuring Units' (32.3 °C), 'Sensor' (Pressure: 987.77 mbar), 'PROFINET', and 'Scaled variable' (49.39 mm). A 'Sensor temperature' section shows 23.5 °C. On the right side, there is a 'Maintenance' dropdown menu and a 'Min/Max: -273.15 / 9726.85' indicator. A red box highlights the language dropdown menu, which is currently set to 'en'. A small '1' is placed above the dropdown menu.

1 Language setting

### 9.6.3 Operating tool

See the description of the operating tool.

## 9.7 Configuring the device

### 9.7.1 Differential pressure measurement (e.g. flow measurement)

Before adjusting the device, the piping may need to be cleaned and filled with medium.

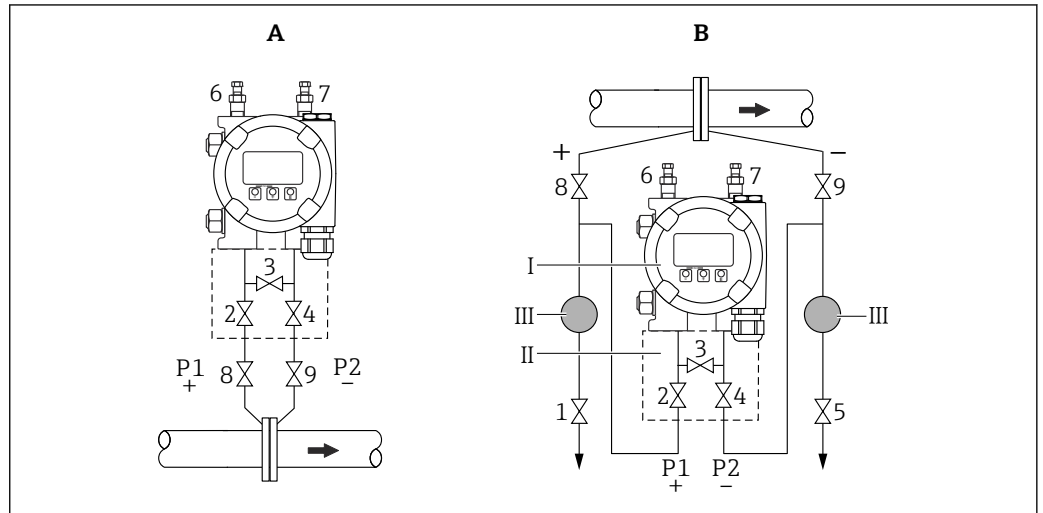

- A Preferred installation for gases  
 B Preferred installation for liquids  
 I Device  
 II Three-valve manifold  
 III Separator  
 1, 5 Drain valves  
 2, 4 Inlet valves  
 3 Equalization valve  
 6, 7 Vent valves on device  
 8, 9 Shutoff valves

1. Close 3.
2. Fill the measuring system with medium.
  - ↳ Open A, B, 2, 4. Fluid flows in.
3. Vent device.
  - ↳ Liquids: Open 6 and 7 until the system (piping, valves and side flanges) is completely filled with medium.
  - ↳ Gases: Open 6 and 7 until the system (piping, valves and side flanges) is completely filled with gas and free from condensation.
  - Close 6 and 7.

 Check the adjustment and perform again if necessary.

## 9.7.2 Level measurement

### Open vessel

Before adjusting the device, the piping may need to be cleaned and filled with medium.

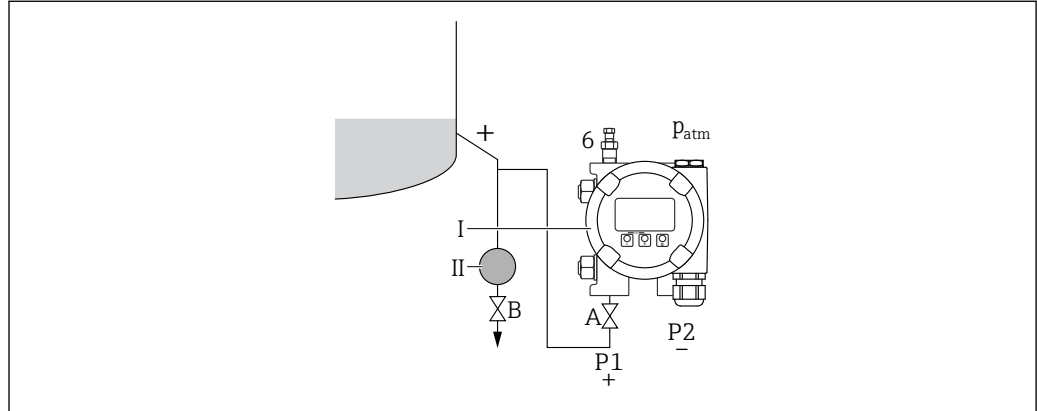

A0030038

- I* Device
- II* Separator
- 6* Vent valve on device
- A* Shutoff valve
- B* Drain valve

1. Fill the vessel to above the lower tapping point.
2. Fill the measuring system with medium.
  - ↳ Open A (shutoff valve).
3. Vent device.
  - ↳ Open 6 until the system (piping, valve and side flange) is completely filled with medium.

### Closed vessel

Before adjusting the device, the piping may need to be cleaned and filled with medium.

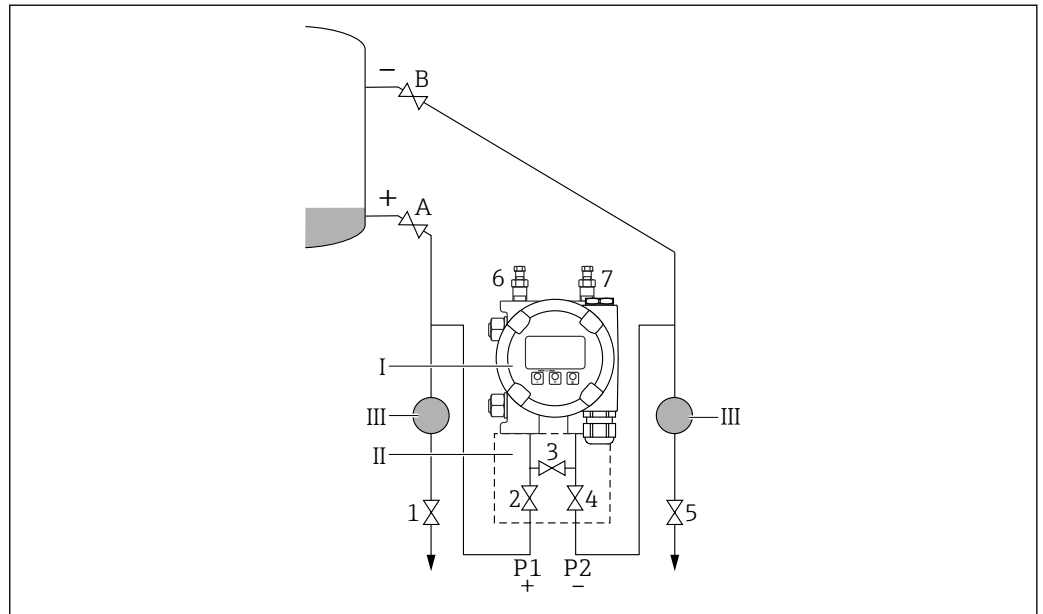

- I Device
- II Three-valve manifold
- III Separator
- 1, 5 Drain valves
- 2, 4 Inlet valves
- 3 Equalization valve
- 6, 7 Vent valves on device
- A, B Shutoff valves

1. Fill the vessel to above the lower tapping point.
2. Fill the measuring system with medium.
  - ↳ Close 3 (separate high-pressure side and low-pressure side).  
Open A and B (shutoff valves).
3. Vent high-pressure side (empty low-pressure side if necessary).
  - ↳ Open 2 and 4 (introduce fluid on high-pressure side).  
Open 6 until the system (piping, valve and side flange) is completely filled with medium.  
Open 7 until the system (piping, valve and side flange) is completely empty.

### Closed vessel with superimposed vapor

Before adjusting the device, the piping may need to be cleaned and filled with medium.

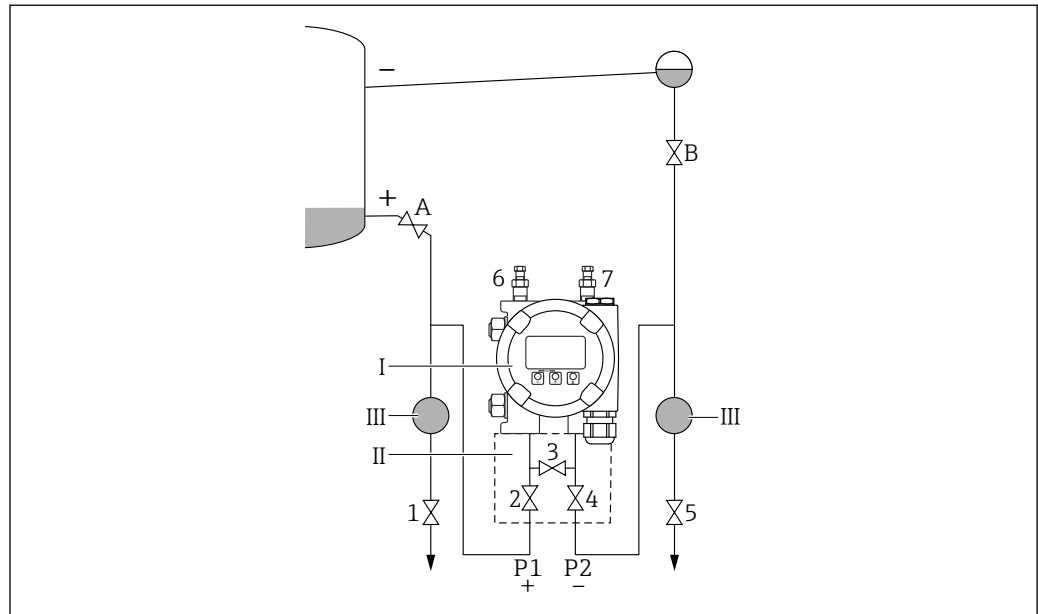

- I Device  
 II Three-valve manifold  
 III Separator  
 1, 5 Drain valves  
 2, 4 Inlet valves  
 3 Equalization valve  
 6, 7 Vent valves on device  
 A, B Shutoff valves

1. Fill the vessel to above the lower tapping point.
2. Fill the measuring system with medium.
  - ↳ Open A and B (shutoff valves).  
Fill the negative pressure piping to the height of the condensate trap.
3. Vent device.
  - ↳ Open 2 and 4 (introduce fluid).  
Open 6 and 7 until the system (piping, valve and side flange) is completely filled with medium.

### 9.7.3 Commissioning with keys on the electronic insert

The following functions are possible via the keys on the electronic insert:

- Position adjustment (zero point correction)
  - The orientation of the device may cause a pressure shift
  - This pressure shift can be corrected by a position adjustment
- Resetting the device

#### Carrying out position adjustment

1. Device installed in desired position and no pressure applied.
2. Press the "Zero" key for at least 3 s.
3. When the LED flashes twice, the pressure present has been accepted for position adjustment.

#### Resetting the device

- ▶ Press and hold the "Zero" key for at least 12 seconds.



### 9.7.4 Commissioning with the Commissioning wizard

In the Web server, SmartBlue and on the display, the **Commissioning** wizard is available to guide the user through the initial commissioning steps.

1. Connect the device to the Web server.
  2. Open the device in the Web server.
    - ↳ The dashboard (homepage) of the device is displayed:
  3. In the **Guidance** menu, click the **Commissioning** wizard to open the wizard.
  4. Enter the appropriate value in each parameter or select the appropriate option. These values are written directly to the device.
  5. Click "Next" to go to the next page.
  6. Once all the pages have been completed, click "End" to close the **Commissioning** wizard.
-  If the **Commissioning** wizard is cancelled before all the necessary parameters have been configured, the device may be in an undefined state. In such situations, it is advisable to reset the device to the factory default settings.

**Example: Outputting of the pressure value at the current output**

**i** Pressure and temperature units are converted automatically. Other units are not converted.

In the following example, the pressure value should be measured in a tank and output on the current output. The maximum pressure of 450 mbar (6.75 psi) corresponds to the 20 mA current. The 4 mA current corresponds to a pressure of 50 mbar (0.75 psi).

Prerequisites:

- Measured variable in direct proportion to the pressure
- Due to the orientation of the device, there may be pressure shifts in the measured value (when the vessel is empty or partly filled, the measured value is not zero)  
Perform a position adjustment if necessary
- In the **Assign PV** parameter, the **Pressure** option must be selected (factory setting)  
Display: In the **Guidance** menu **Commissioning** wizard, keep pressing the  $\oplus$  key until you reach the **Assign PV** parameter. Press the  $\boxtimes$  key to confirm, select the **Pressure** option and press  $\boxtimes$  to confirm.

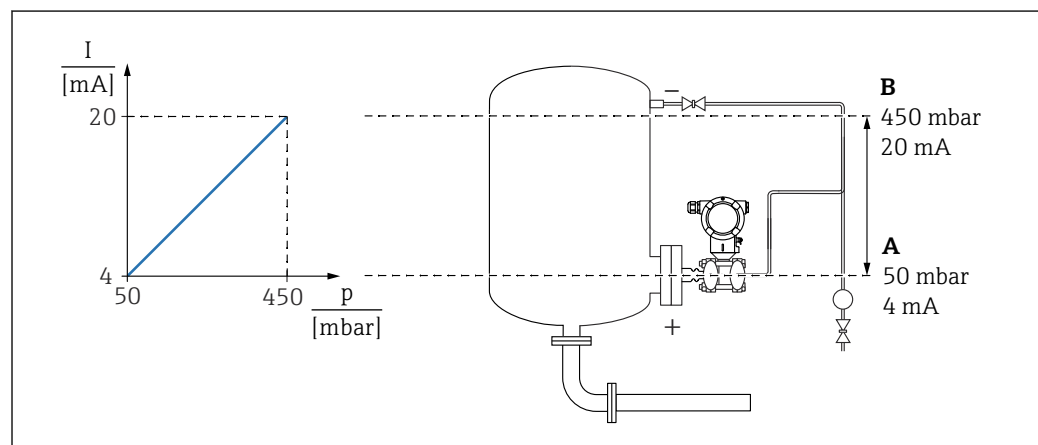

A0039096

- A Lower range value output  
B Upper range value output

Adjustment:

1. Enter the pressure value for the 4 mA current via the **Lower range value output** parameter (50 mbar (0.75 psi)).
2. Enter the pressure value for the 20 mA current via the **Upper range value output** parameter (450 mbar (6.75 psi))

Result: The measuring range is set to 4 to 20 mA.

### 9.7.5 Linearization

In the following example, the volume in a tank with a conical outlet should be measured in  $\text{m}^3$ .

Prerequisites:

- Points for linearization table are known.
- Level calibration is performed.
- Linearization characteristic must continually increase or decrease.

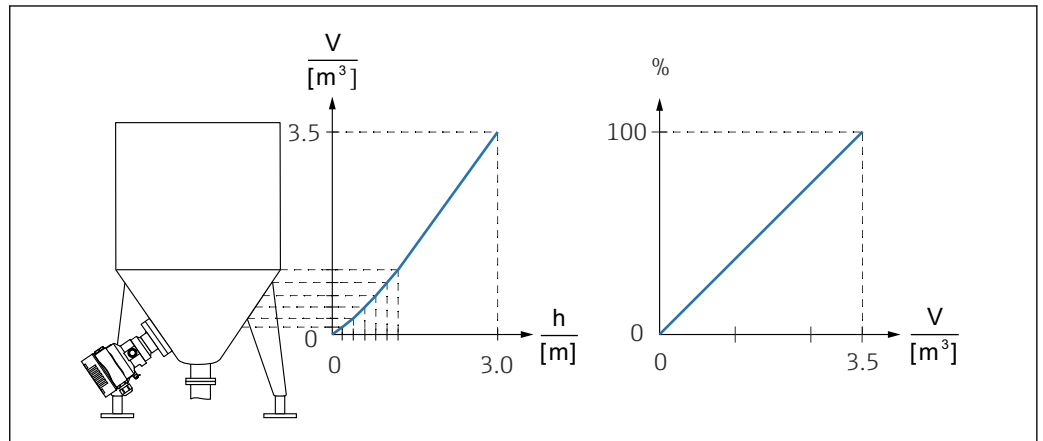

A0046625

1. The scaled variable is communicated via PROFINET in the "Analog Input Scaled Variable" module in slot 20 (0x1000). To use a linearized value, use the "Analog Input Scaled Variable" module.
2. The linearization table can be opened via the **Go to linearization table** parameter **Table** option.
  - ↳ Menu path: Application → Sensor → Scaled variable → Scaled variable transfer function
3. Enter the desired table values.
4. The table is activated once all the points in the table have been entered.
5. Activate the table using the **Activate table** parameter.

Result:

The measured value after linearization is displayed.

- i** Error message F435 "Linearization" and the alarm current appear as long as the table is being entered and until the table is activated.
  - The 0% value is defined by the smallest point in the table.
  - The 100% value is defined by the largest point in the table.

## 9.8 "Simulation" submenu

With the **Simulation** submenu, the pressure and diagnostic events can be simulated.

Menu path: Diagnostics → Simulation

## 9.9 Protecting settings from unauthorized access

### 9.9.1 Hardware locking or unlocking

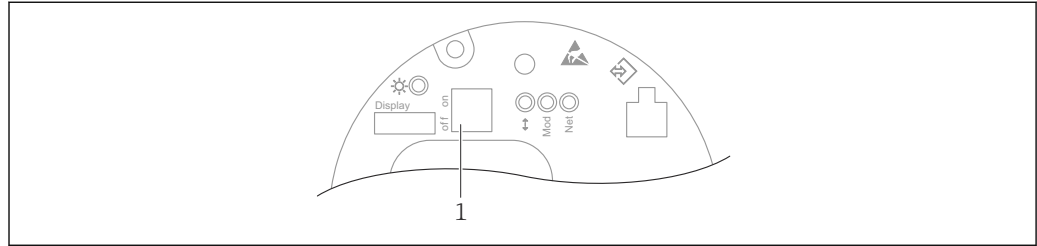

A0047196

1 DIP switch for locking and unlocking the device

DIP switch 1 on the electronic insert is used to lock or unlock operation.

If operation is locked via the DIP switch, you can only unlock operation again via the DIP switch.

If operation is locked via the operating menu, you can only unlock operation again via the operating menu.

If operation is locked via the DIP switch, the key symbol  appears on the local display.

### Sealing the device

The housing cover is designed to be sealed for use in custody transfer.

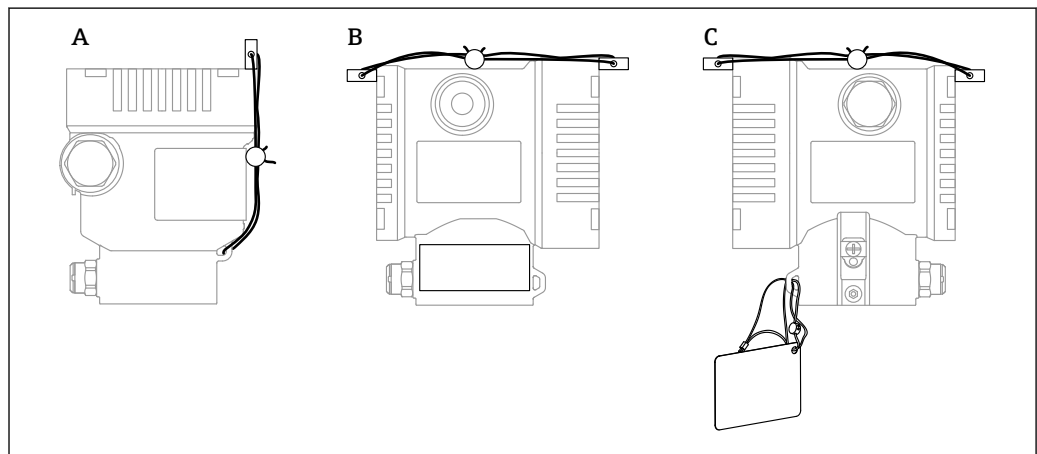

A0038742

A Single compartment housing

B Dual compartment housing

### 9.9.2 Display operation - locking or unlocking

The  key must be pressed for at least 2 seconds in order to lock or unlock the optical keys. Display operation can be locked or unlocked in the dialog that appears.

Display operation locks automatically:

- After 1 minute on the main page if no key has been pressed
- After 10 minutes within the operating menu if no key has been pressed

Display operation can be disabled via software:

Menu path: System → Connectivity → Interfaces → Display operation

### 9.9.3 Software locking or unlocking

 If operation is locked by means of the DIP switch, you can only unlock operation again by means of the DIP switch.

#### Locking via password in display / FieldCare / DeviceCare / SmartBlue / web server

Access to the device configuration can be locked by assigning a password. The user role is set to **Maintenance** option when the device is delivered to the customer. The device can be fully configured with the **Maintenance** option user role. Afterwards, access to the configuration can be locked by assigning a password. The lock sets the **Maintenance** option to the **Operator** option. The configuration can be accessed by entering the password.

The password is defined under:

**System** menu **User management** submenu

The user role can be changed from **Maintenance** option to **Operator** option under:

System → User management

#### Disabling the lock via the display / FieldCare / DeviceCare / SmartBlue / web server

Once the password is entered, you can enable the configuration of the device as an **Operator** option by entering the password. The user role then changes to **Maintenance** option.

The password can be deleted if necessary in the **User management** submenu: System → User management

## 10 Operation

### 10.1 Reading off the device locking status

Displaying active write protection:

- In the **Locking status** parameter
  - Menu path of local display: at the top operating level
  - Menu path of operating tool: System → Device management
- In the operating tool (FieldCare/DeviceCare) in the DTM header
- In the Web server in the DTM header

### 10.2 Reading off measured values

Many measured values can be read off in the header of the Web server.

All the measured values can be read off using the **Measured values** submenu.

#### Navigation

"Application" menu → Measured values

### 10.3 Adapting the device to process conditions

The following are available for this purpose:

- Basic settings using the **Guidance** menu
- Advanced settings using the **Diagnostics** menu, **Application** menu and **System** menu

### 10.3.1 Sensor calibration <sup>1)</sup>

In the course of their life cycle, pressure sensors **can** deviate, or drift, <sup>2)</sup> from the original pressure characteristic curve. This deviation depends on the operating conditions and can be corrected in the **Sensor calibration** submenu.

Set the value of the zero point shift to 0.00 before the Sensor calibration. Application  
→ Sensor → Sensor calibration → Zero adjustment offset

1. Apply the lower pressure value (value measured with pressure reference) to the device. Enter this pressure value in the **Lower sensor trim** parameter. Application  
→ Sensor → Sensor calibration → Lower sensor trim
  - ↳ The value entered causes a parallel shift of the pressure characteristic in relation to the current Sensor calibration.
2. Apply the upper pressure value (value measured with pressure reference) to the device. Enter this pressure value in the **Upper sensor trim** parameter. Application  
→ Sensor → Sensor calibration → Upper sensor trim
  - ↳ The value entered causes a change in the slope of the current Sensor calibration.

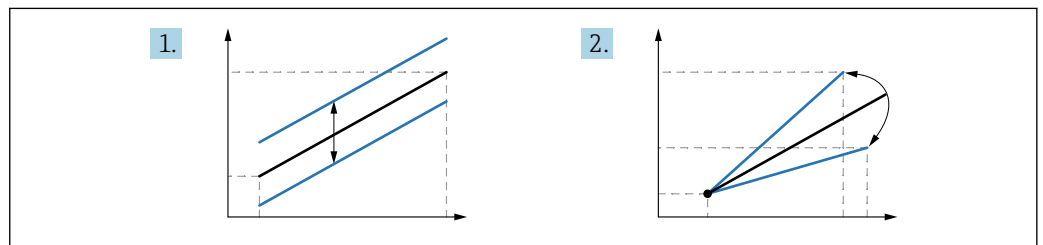

A0052045

**i** The accuracy of the pressure reference determines the accuracy of the device. The pressure reference must be more accurate than the device.

1) Not possible with display.

2) Deviations caused by physical factors are also known as "Sensor drift".

# 11 Diagnosis and troubleshooting

## 11.1 General troubleshooting

### 11.1.1 General errors

#### Device not responding

- Possible cause: Supply voltage does not match the specification on the nameplate  
Remedial action: Apply the correct voltage
- Possible cause: The polarity of the supply voltage is wrong  
Remedial action: Correct the polarity
- Possible cause: The cables do not contact the terminals properly  
Remedial action: Check the electrical contact between cables and correct if necessary
- Possible cause: Load resistance too high  
Remedial action: Increase the supply voltage to reach the minimum terminal voltage

#### No values visible on the display

- Possible cause: Graphic display is set too bright or too dark  
Remedial action: Increase or decrease the contrast with the **Contrast display** parameter  
Navigation path: System → Display → Contrast display
- Possible cause: The plug of the display cable is not connected correctly  
Remedial action: Connect the plug correctly
- Possible cause: Display is defective  
Remedial action: Replace the display

#### Display cannot be operated

Display cannot be operated

Possible cause: Operation is disabled for security reasons

#### Web server not available

Web server not available

Possible cause: The Web server is disabled for security reasons

#### Communication via CDI interface not working

- Possible cause: Wrong setting of the COM port on the computer  
Remedial action: Check the setting of the COM port on the computer and correct it if necessary
- CDI interface not available  
Possible cause: The CDI interface is disabled for security reasons.



### 11.1.2 Additional tests

If no clear cause of the error can be identified or the source of the problem can be both the device and the application, the following additional tests can be performed:

1. Check the digital pressure value (display, PROFINET, ..).
2. Check that the device concerned is functioning correctly. Replace the device if the digital value does not correspond to the expected pressure value.
3. Switch on the simulation and check the measured value in Pressure AI, Slot 1/Subslot 1. Replace the main electronics if the displayed value does not correspond to the simulated value.

## 11.2 Diagnostics information via LED

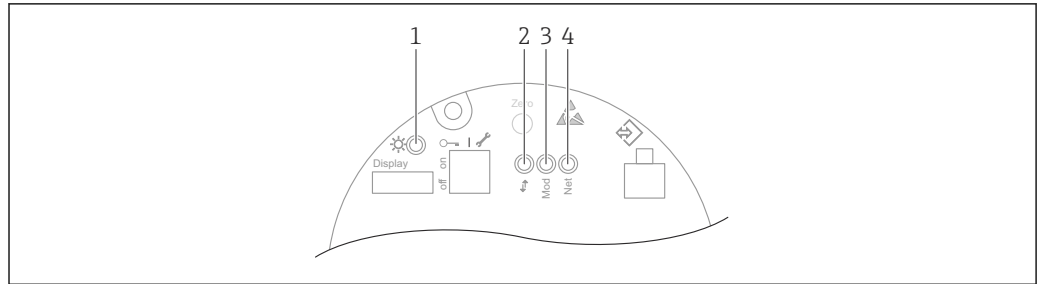

A0046179

Item	LED	Meaning
1	Off	No power
	LED flashes green	<ul style="list-style-type: none"> <li>Device commissioning until measured value available</li> <li>Device reset across all customer interfaces</li> </ul>
	LED permanently lit green	Everything OK
	LED off briefly	Key operation
2	Off	No electricity or Ethernet Link
	LED permanently lit yellow	Connection established
	LED flashing yellow	<ul style="list-style-type: none"> <li>After every data request from host: OFF/ON</li> <li>Self-test during start-up <sup>1)</sup></li> </ul>
3	Off	No power
	LED permanently lit green	Everything OK
	LED flashes red	"Warning"-type diagnostic active
	LED permanently lit red	"Alarm"-type diagnostic active
	LED flashes green and red alternately	Self-test during start-up <sup>2)</sup>
4	Off	No power or IP address not available
	LED flashes green	IP address configured but no connection established
	LED permanently lit green	<ul style="list-style-type: none"> <li>Profinet: The device has at least one established IO application relationship</li> <li>CIP: An IP address is configured, at least one CIP connection (any transport class) is established and an Exclusive Owner connection has no timeout</li> </ul>
	LED flashes red	Communication error between device and controller
	LED permanently lit red	CIP: Duplicate IP
	LED flashes green and red alternately	Self-test during start-up <sup>2)</sup>

- 1) LED is lit yellow for 0.25 seconds, switches off and remains in this state until the power-up test is completed.
- 2) LED is lit green for 0.25 seconds, is then lit red for 0.25 seconds, switches off and remains in this state until the power-up test is completed.

## 11.3 Diagnostic information on local display

### 11.3.1 Diagnostic message

#### Measured value display and diagnostic message in alarm condition

Faults detected by the device's self-monitoring system are displayed as a diagnostic message in alternation with the unit.

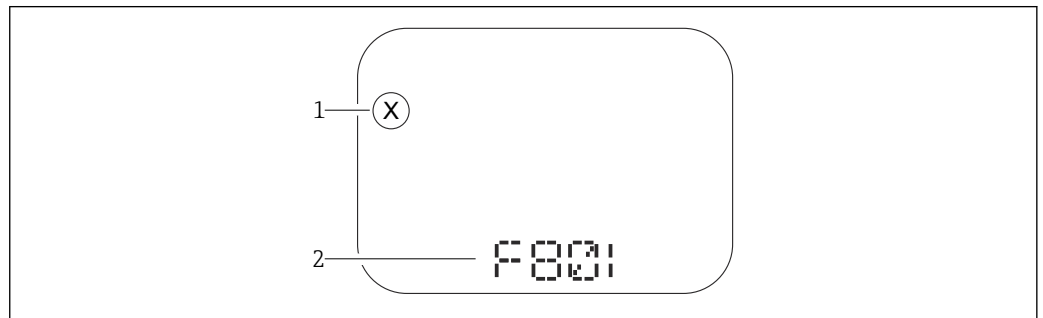

A0043759

- 1 Status signal
- 2 Status symbol with diagnostic event

Faults detected by the device's self-monitoring system are displayed as a diagnostic message in alternation with the measured value display.

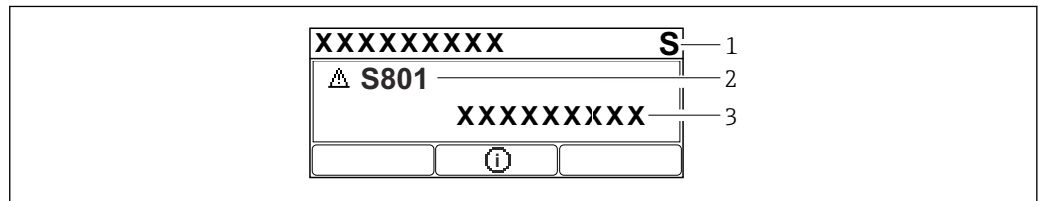

A0043103

- 1 Status signal
- 2 Status symbol with diagnostic event
- 3 Event text

#### Status signals

*F*

##### "Failure (F)" option

A device error has occurred. The measured value is no longer valid.

*C*

##### "Function check (C)" option

The device is in the service mode (e.g. during a simulation).

*S*

##### "Out of specification (S)" option

The device is being operated:

- Outside of its technical specifications (e.g. during startup or a cleaning)
- Outside of the configuration performed by the user (e.g. level outside configured span)

*M*

##### "Maintenance required (M)" option

Maintenance required. The measured value remains valid.

**Diagnostic event and event text**

The fault can be identified by means of the diagnostic event. The event text helps you by providing information about the fault. In addition, the corresponding status symbol is displayed in front of the diagnostic event.

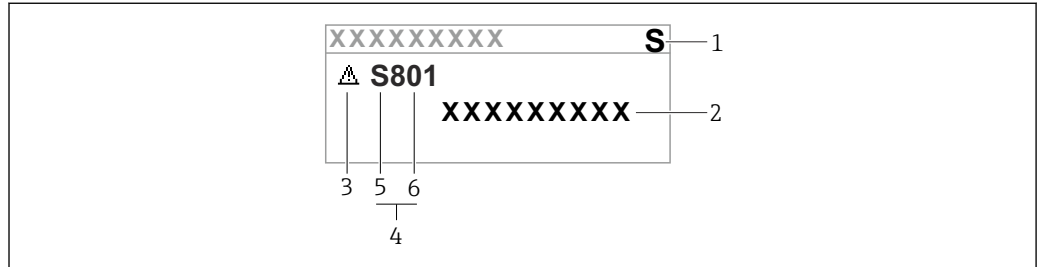

A0038013

- 1 Status signal
- 2 Event text
- 3 Status symbol
- 4 Diagnostic event
- 5 Status signal
- 6 Event number

If two or more diagnostic events occur simultaneously, only the diagnostic message with the highest priority is shown.

**"Active diagnostics" parameter**

Key

Opens the message about the remedial measures.

Key

Acknowledge warnings.

Key

Back to operating menu.

## 11.4 Diagnostic information in the Web browser

### 11.4.1 Diagnostic options

Any faults detected by the device are displayed in the header of the Web browser once the user has logged on.

In addition, diagnostic events that have occurred can be displayed in the **Diagnostics** menu.

**Status signals**

The status signals provide information on the state and reliability of the device by categorizing the cause of the diagnostic information (diagnostic event).

Symbol	Meaning
	<b>Failure</b> A device error has occurred Measured value is no longer valid
	<b>Function check</b> Device is in the service mode (e.g. during a simulation)

Symbol	Meaning
	<b>Out of specification</b> Device is being operated outside its technical specification limits (e.g. outside the process temperature range)
	<b>Maintenance required</b> Maintenance is required The measured value remains valid

The status signals are categorized in accordance with VDI/VDE 2650 and NAMUR Recommendation NE 107.

**Diagnostic information**

Devices without a display: The fault can be identified using the diagnostic information. The short text helps you by providing information about the fault. In addition, the corresponding symbol for the diagnostic behavior is displayed in front of the diagnostic information on the local display.

Devices with a display:

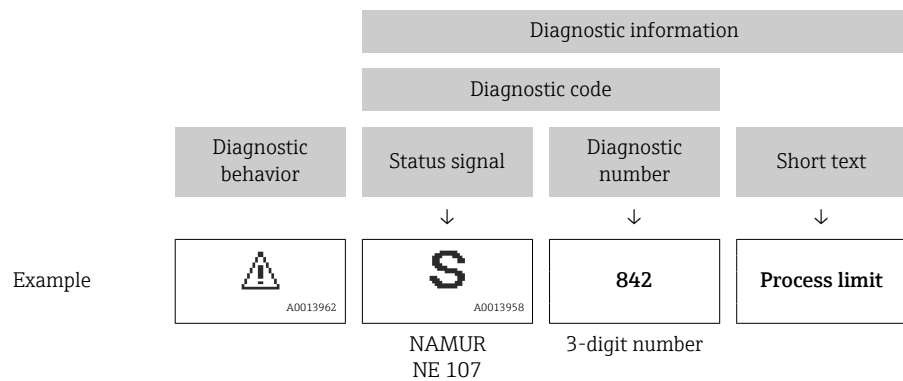

**11.4.2 Calling up remedial measures**

Remedial measures are provided for each diagnostic event to ensure that problems can be rectified quickly. These measures are displayed in red along with the diagnostic event and the related diagnostic information.

**11.5 Diagnostic list**

All the diagnostic messages that are currently queued can be displayed in the **Diagnostic list** submenu.

**Navigation path**

Diagnostics → Diagnostic list

Diagnostic number	Short text	Remedy instructions	Status signal [from the factory]	Diagnostic behavior [from the factory]
<b>Diagnostic of sensor</b>				
062	Sensor connection faulty	Check sensor connection	F	Alarm
081	Sensor initialization faulty	1. Restart device 2. Contact service	F	Alarm
100	Sensor error	1. Restart the device 2. Contact Endress+Hauser Service	F	Alarm

Diagnostic number	Short text	Remedy instructions	Status signal [from the factory]	Diagnostic behavior [from the factory]
101	Sensor temperature	1. Check process temperature 2. Check ambient temperature	F	Alarm
102	Sensor incompatible error	1. Restart device 2. Contact service	F	Alarm
<b>Diagnostic of electronic</b>				
232	Real time clock defective	Replace main electronics	M	Warning
242	Firmware incompatible	1. Check software 2. Flash or change main electronic module	F	Alarm
252	Module incompatible	1. Check if correct electronic module is plugged 2. Replace electronic module	F	Alarm
263	Incompatibility detected	Check electronic module type	M	Warning
270	Main electronics defective	Replace main electronics	F	Alarm
272	Main electronics faulty	1. Restart device 2. Contact service	F	Alarm
273	Main electronics defective	Replace main electronics	F	Alarm
282	Data storage inconsistent	Restart device	F	Alarm
283	Memory content inconsistent	1. Restart device 2. Contact service	F	Alarm
287	Memory content inconsistent	1. Restart device 2. Contact service	M	Warning
331	Firmware update failed	1. Update firmware of device 2. Restart device	M	Warning
332	Writing in HistoROM backup failed	1. Replace user interface board 2. Ex d/XP: replace transmitter	F	Alarm
387	HistoROM data faulty	Contact service organization	F	Alarm
388	Electronics and HistoROM defective	1. Restart device 2. Replace electronics and HistoROM 3. Contact service	F	Alarm
<b>Diagnostic of configuration</b>				
410	Data transfer failed	1. Retry data transfer 2. Check connection	F	Alarm
412	Processing download	Download active, please wait	S	Warning
435	Linearization faulty	Check data points and min span	F	Alarm
436	Date/time incorrect	Check date and time settings.	M	Warning <sup>1)</sup>
437	Configuration incompatible	1. Update firmware 2. Execute factory reset	F	Alarm
438	Dataset different	1. Check dataset file 2. Check device parameterization 3. Download new device parameterization	M	Warning
484	Failure mode simulation active	Deactivate simulation	C	Alarm
485	Process variable simulation active	Deactivate simulation	C	Warning

Diagnostic number	Short text	Remedy instructions	Status signal [from the factory]	Diagnostic behavior [from the factory]
495	Diagnostic event simulation active	Deactivate simulation	S	Warning
500	Process alert pressure	1. Check process pressure 2. Check configuration of process alert	C	Warning <sup>1)</sup>
501	Process alert scaled variable	1. Check process conditions 2. Check scaled variable configuration	C	Warning <sup>1)</sup>
502	Process alert temperature	1. Check process temperature 2. Check configuration of process alert	C	Warning <sup>1)</sup>
<b>Diagnostic of process</b>				
801	Supply voltage too low	Increase supply voltage	S	Warning
802	Supply voltage too high	Decrease supply voltage	S	Warning
811	APL connection faulty	Connect field device only to APL spur port	F	Alarm
822	Sensor temperature out of range	1. Check process temperature 2. Check ambient temperature	S	Warning
825	Electronics temperature	1. Check ambient temperature 2. Check process temperature	S	Warning
841	Operating range	1. Check the process pressure 2. Check the sensor range	S	Warning <sup>1)</sup>
900	High signal noise detected	1. Check impulse line 2. Check valve position 3. Check process	S	Warning <sup>1)</sup>
901	Low signal noise detected	1. Check impulse line 2. Check valve position 3. Check process	S	Warning <sup>1)</sup>
902	Min signal noise detected	1. Check impulse line 2. Check valve position 3. Check process	S	Warning <sup>1)</sup>
906	Out of range signal detected	1. Process Information. No action 2. Rebuild baseline 3. Adapt signal range thresholds	S	Warning <sup>1)</sup>

1) Diagnostic behavior can be changed.

## 11.6 Event logbook

### 11.6.1 Event history

The **Event list** submenu provides a chronological overview of the event messages that have occurred<sup>3)</sup>.

#### Navigation path

Diagnostics → Event logbook

A maximum of 100 event messages can be displayed in chronological order.

3) If operating via FieldCare, the event list can be displayed with the "Event List/HistoROM" function in FieldCare.

The event history includes entries for:

- Diagnostic events
- Information events

In addition to the operating time when the event occurred, each event is also assigned a symbol that indicates whether the event has occurred or is finished:

- Diagnostic event
  - ☺: Occurrence of the event
  - ☹: End of the event
- Information event
  - ☺: Occurrence of the event

## 11.6.2 Filtering the event logbook

Filters can be used to determine which category of event messages is displayed in the **Event list** submenu.

### Navigation path

Diagnostics → Event logbook

## 11.6.3 Overview of information events

Info number	Info name
I1000	----- (Device ok)
I1079	Sensor changed
I1089	Power on
I1090	Configuration reset
I1091	Configuration changed
I11036	Date/time set successfully
I11074	Device verification active
I1110	Write protection switch changed
I1151	History reset
I1154	Reset terminal voltage min/max
I1155	Reset electronics temperature
I1157	Memory error event list
I1256	Display: access status changed
I1264	Safety sequence aborted
I1335	Firmware changed
I1397	Fieldbus: access status changed
I1398	CDI: access status changed
I1440	Main electronic module changed
I1444	Device verification passed
I1445	Device verification failed
I1461	Sensor verification failed
I1512	Download started
I1513	Download finished
I1514	Upload started
I1515	Upload finished
I1551	Assignment error fixed



Info number	Info name
I1552	Failed: Main electronic verification
I1554	Safety sequence started
I1555	Safety sequence confirmed
I1556	Safety mode off
I1663	Power off
I1666	Clock synchronized
I1712	New flash file received
I1956	Reset

#### 11.6.4 Overview of information events

Info number	Info name
I1000	----- (Device ok)
I1079	Sensor changed
I1089	Power on
I1090	Configuration reset
I1091	Configuration changed
I11036	Date/time set successfully
I11074	Device verification active
I1110	Write protection switch changed
I1151	History reset
I1154	Reset terminal voltage min/max
I1155	Reset electronics temperature
I1157	Memory error event list
I1256	Display: access status changed
I1264	Safety sequence aborted
I1335	Firmware changed
I1397	Fieldbus: access status changed
I1398	CDI: access status changed
I1440	Main electronic module changed
I1444	Device verification passed
I1445	Device verification failed
I1461	Sensor verification failed
I1512	Download started
I1513	Download finished
I1514	Upload started
I1515	Upload finished
I1551	Assignment error fixed
I1552	Failed: Main electronic verification
I1554	Safety sequence started
I1555	Safety sequence confirmed
I1556	Safety mode off
I1663	Power off

Info number	Info name
I1666	Clock synchronized
I1712	New flash file received
I1956	Reset

## 11.7 Resetting the device

### 11.7.1 Reset password via operating tool

Enter a code to reset the current 'Maintenance' password.  
The code is delivered by your local support.

Navigation: System → User management → Reset password → Reset password

Reset password

 For details see the "Description of device parameters" documentation.

### 11.7.2 Reset device via operating tool

Reset the device configuration - either entirely or in part - to a defined state

Navigation: System → Device management → Reset device

Reset device parameter

 For details see the "Description of device parameters" documentation.

### 11.7.3 Resetting the device via keys on the electronic insert

#### Resetting the password

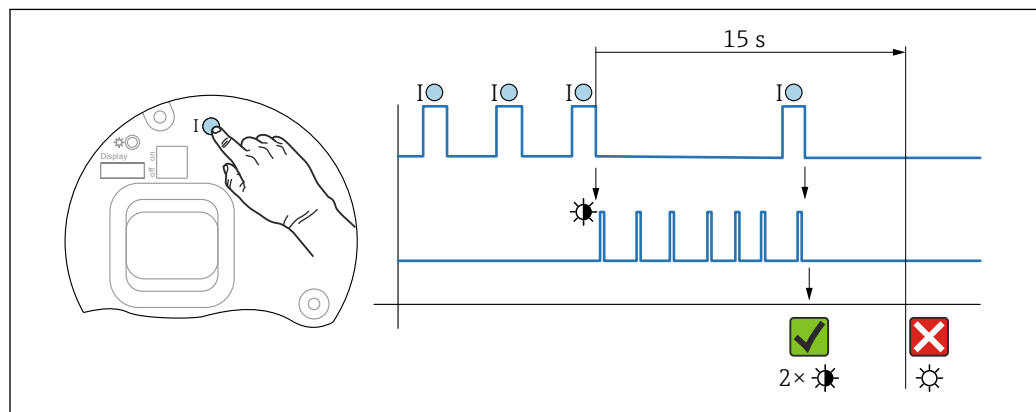

 9 Sequence - resetting the password

#### Deleting/resetting the password

1. Press operating key **I** three times.
  - ↳ The Reset Password function is started, the LED flashes.
2. Press operating key **I** once within 15 s.
  - ↳ The password is reset, the LED flashes briefly.

If operating key **I** is not pressed within 15 s, the action is canceled and the LED is no longer lit.

### Resetting the device to the factory setting

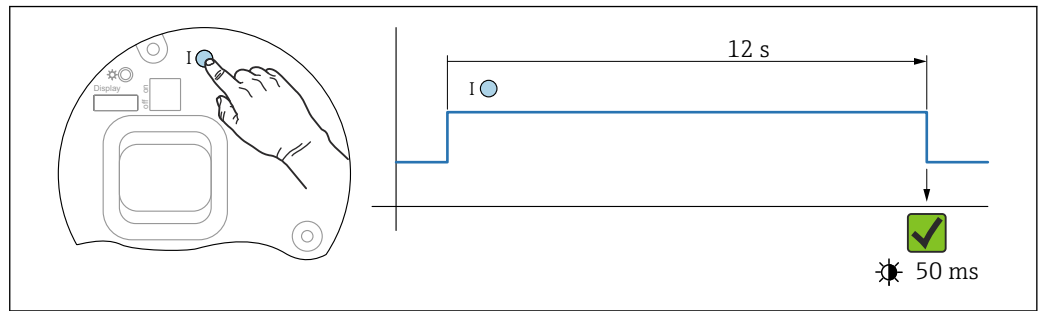

10 Sequence - factory setting

A0050015

### Resetting the device to the factory setting

- ▶ Press operating key **I** for at least 12 s.
  - ↳ Device data are reset to the factory setting, the LED flashes briefly.

## 11.8 Firmware history

- i** The firmware version can explicitly be ordered via the product structure. This makes it possible to ensure the compatibility of the firmware version with an existing or planned system integration.

### 11.8.1 Version 01.00.zz

Original software

### 11.8.2 Version 01.01.zz

- Heartbeat Technology extended functionality
- HART condensed status

## 12 Maintenance

### 12.1 Maintenance work

This chapter describes the maintenance of physical device components.

#### 12.1.1 Flushing rings

 The use of flushing rings allows the membrane to be cleaned without removing the device from the process.

For more information: contact the Endress+Hauser sales office.

#### 12.1.2 Exterior cleaning

##### Notes on cleaning

- The cleaning agents used should not corrode the surfaces and the seals
- Mechanical damage to the membrane, e.g. due to sharp objects, must be avoided
- Observe the degree of protection of the device

## 13 Repair

### 13.1 General information

#### 13.1.1 Repair concept

Under the Endress+Hauser repair concept, devices have a modular design and repairs are carried out by Endress+Hauser Service or by properly trained customers.

Spare parts are grouped into logical kits with the associated replacement instructions.

For more information on service and spare parts contact Endress+Hauser Service.

#### 13.1.2 Repair of Ex-certified devices

##### **WARNING**

##### **Incorrect repair can compromise electrical safety!**

Explosion Hazard!

- ▶ Repairs to Ex-certified devices must be carried out by Endress+Hauser Service or by specialist personnel according to national regulations.
- ▶ Relevant standards and national regulations on hazardous areas, safety instructions and certificates must be observed.
- ▶ Use only original Endress+Hauser spare parts.
- ▶ Please note the device designation on the nameplate. Only identical parts may be used as replacements.
- ▶ Carry out repairs according to the instructions.
- ▶ Only the Endress+Hauser service team is permitted to modify a certified device and convert it to another certified version.

### 13.2 Spare parts

- Some replaceable device components are identified by a spare part nameplate. This contains information about the spare part.
- All the spare parts for the measuring device, along with the order code, are listed in the *Device Viewer* ([www.endress.com/deviceviewer](http://www.endress.com/deviceviewer)) and can be ordered. If available, users can also download the associated Installation Instructions.

-  Device serial number:
  - Located on the device and spare part nameplate.
  - Can be read out via the device software.

### 13.3 Return

The device must be returned in the event of a factory calibration, or if the wrong device has been ordered or delivered.

As an ISO-certified company and also due to legal regulations, Endress+Hauser is obliged to follow certain procedures when handling any returned products that have been in contact with medium. To ensure swift, safe and professional device returns, please read the return procedures and conditions on the Endress+Hauser website <http://www.endress.com/support/return-material>.

- ▶ Select country.
  - ↳ The website of the responsible sales office opens with all the relevant information relating to returns.
- 1. If the desired country is not listed:
  - Click on the "Choose your location" link.
    - ↳ An overview of Endress+Hauser sales offices and representatives opens.
- 2. Contact the Endress+Hauser sales organization responsible for your area.

### 13.4 Disposal



If required by the Directive 2012/19/EU on waste electrical and electronic equipment (WEEE), the product is marked with the depicted symbol in order to minimize the disposal of WEEE as unsorted municipal waste. Do not dispose of products bearing this marking as unsorted municipal waste. Instead, return them to the manufacturer for disposal under the applicable conditions.

## 14 Accessories

### 14.1 Device-specific accessories

#### 14.1.1 Mechanical accessories

- Mounting bracket for housing
- Flushing rings
- Weather protection covers

 For technical data (e.g. materials, dimensions or order numbers), see the accessory document SD01553P.

#### 14.1.2 Plug connectors

- Plug connector M12 90 deg, IP67 5m cable, union nut, Cu Sn/Ni
- Plug connector M12, IP67 union nut, Cu Sn/Ni
- Plug connector M12, 90 deg IP67 union nut, Cu Sn/Ni

 The IP protection classes are only maintained if the dummy cap is used or the cable is connected.

#### 14.1.3 Weld-in accessory

 For details, refer to TI00426F/00/EN "Weld-in adapters, process adapters and flanges".

### 14.2 Device Viewer

All the spare parts for the device, along with the order code, are listed in the *Device Viewer* ([www.endress.com/deviceviewer](http://www.endress.com/deviceviewer)).

## 15 Technical data

### 15.1 Output

Output signal	<b>PROFINET with Ethernet-APL</b> 10BASE-T1L, 2-wire 10 Mbit
Signal on alarm	Signal on alarm in accordance with NAMUR recommendation NE 43. PROFINET with Ethernet-APL: <ul style="list-style-type: none"> <li>■ According to "Application layer protocol for decentralized periphery", Version 2.4</li> <li>■ Diagnostics according to PROFINET PA Profile 4.02</li> </ul>
Damping	A damping affects all outputs (output signal, display). Damping can be enabled as follows: <ul style="list-style-type: none"> <li>■ Via the onsite display, Bluetooth, handheld terminal or PC with operating program, continuous from 0 to 999 seconds</li> <li>■ Factory setting: 1 s</li> </ul>
Ex connection data	See the separate technical documentation (Safety Instructions (XA)) on <a href="http://www.endress.com/download">www.endress.com/download</a> .
Linearization	The device's linearization function allows the user to convert the measured value to any units of height or volume. User-defined linearization tables of up to 32 value pairs can be entered if necessary.

Protocol-specific data

**PROFINET with Ethernet-APL**

<b>Protocol</b>	Application layer protocol for decentral device periphery and distributed automation, Version 2.4
<b>Communication type</b>	Ethernet Advanced Physical Layer 10BASE-T1L
<b>Conformance Class</b>	Conformance Class B
<b>Netload Class</b>	Netload Class II
<b>Baud rates</b>	Automatic 10 Mbit/s with full-duplex detection
<b>Cycle times</b>	From 32 ms
<b>Polarity</b>	Auto-polarity for automatic correction of crossed TxD and RxD pairs
<b>Media Redundancy Protocol (MRP)</b>	Yes
<b>System redundancy support</b>	System redundancy S2 (2 AR with 1 NAP)
<b>Device profile</b>	Application interface identifier 0xB310 Generic device
<b>Manufacturer ID</b>	0x11
<b>Device type ID</b>	A231
<b>Device description files (GSD, FDI, DTM, DD)</b>	Information and files available at: <ul style="list-style-type: none"> <li>■ <a href="http://www.endress.com">www.endress.com</a> On the product page for the device: Documents/Software → Device drivers</li> <li>■ <a href="http://www.profibus.org">www.profibus.org</a></li> </ul>



<b>Supported connections</b>	<ul style="list-style-type: none"> <li>▪ 2 x AR (IO Controller AR)</li> <li>▪ 1 x AR (IO-Supervisor Device AR connection allowed)</li> <li>▪ 1 x Input CR (Communication Relation)</li> <li>▪ 1 x Output CR (Communication Relation)</li> <li>▪ 1 x Alarm CR (Communication Relation)</li> </ul>
<b>Configuration options for device</b>	<ul style="list-style-type: none"> <li>▪ Manufacturer-specific software (FieldCare, DeviceCare)</li> <li>▪ Web browser</li> <li>▪ Device master file (GSD), can be read out via the integrated Web server of the device</li> <li>▪ DIP switch for setting the service IP address</li> </ul>
<b>Configuration of the device name</b>	<ul style="list-style-type: none"> <li>▪ DCP protocol</li> <li>▪ Process Device Manager (PDM)</li> <li>▪ Integrated Web server</li> </ul>
<b>Supported functions</b>	<ul style="list-style-type: none"> <li>▪ Identification &amp; maintenance Simple device identification via: <ul style="list-style-type: none"> <li>▪ Control system</li> <li>▪ Nameplate</li> </ul> </li> <li>▪ Measured value status The process variables are communicated with a measured value status</li> <li>▪ Blinking feature via the local display for simple device identification and assignment</li> <li>▪ Device operation via operating tools (e.g., FieldCare, DeviceCare, SIMATIC PDM)</li> </ul>
<b>System integration</b>	<p>For information on system integration, see  Operating Instructions</p> <ul style="list-style-type: none"> <li>▪ Cyclic data transmission</li> <li>▪ Overview and description of the modules</li> <li>▪ Status coding</li> <li>▪ Startup configuration</li> <li>▪ Factory setting</li> </ul>

## 15.2 Environment

Ambient temperature range	<p>The following values apply up to a process temperature of +85 °C (+185 °F). At higher process temperatures, the permitted ambient temperature is reduced.</p> <ul style="list-style-type: none"> <li>■ Without segment display or graphic display: <ul style="list-style-type: none"> <li>■ Standard: -40 to +85 °C (-40 to +185 °F)</li> <li>■ Optionally available: -50 to +85 °C (-58 to +185 °F) with restricted operating life and performance</li> <li>■ Optionally available: -54 to +85 °C (-65 to +185 °F); below -50 °C (-58 °F): devices can be permanently damaged</li> </ul> </li> <li>■ With segment display or graphic display: -40 to +85 °C (-40 to +185 °F) with limitations in optical properties such as display speed and contrast. Can be used without limitations up to -20 to +60 °C (-4 to +140 °F)</li> </ul> <p>Segment display: up to -50 to +85 °C (-58 to +185 °F) with restricted operating life and performance</p> <ul style="list-style-type: none"> <li>■ Devices with PVC-coated capillary armor: -25 to +80 °C (-13 to +176 °F)</li> <li>■ Separate housing: -20 to +60 °C (-4 to +140 °F)</li> </ul> <p>Applications with very high temperatures: use either a diaphragm seal on one side with a temperature isolator, or a diaphragm seal on one side or both sides with a capillary. Use a mounting bracket!</p> <p>If vibrations additionally occur in the application: use a device with a capillary.</p>
	<p><b>Hazardous area</b></p> <ul style="list-style-type: none"> <li>■ For devices for use in hazardous areas, see the Safety Instructions, Installation Drawing or Control Drawing</li> <li>■ Devices that have the most common explosion protection certificates (e.g. ATEX/ IEC Ex, etc.) can be used in explosive atmospheres with an ambient temperature of -54 to +85 °C (-65 to +185 °F) (optionally available). The functionality of the explosion protection Ex ia is guaranteed for ambient temperatures to -50 °C (-58 °F) (optionally available).</li> </ul> <p>At temperatures ≤ -50 °C (-58 °F), explosion protection is guaranteed by the housing in the case of flameproof enclosure (Ex d) type of protection. The functionality of the transmitter cannot be fully guaranteed. The Ex ia capability can no longer be guaranteed.</p>
Storage temperature	<ul style="list-style-type: none"> <li>■ Without LCD display: <ul style="list-style-type: none"> <li>■ Standard: -40 to +90 °C (-40 to +194 °F)</li> <li>■ Optionally available: -50 to +90 °C (-58 to +194 °F) with restricted operating life and performance</li> <li>■ Optionally available: -54 to +90 °C (-65 to +194 °F); below -50 °C (-58 °F): Ex d devices can be permanently damaged</li> </ul> </li> <li>■ With LCD display: -40 to +85 °C (-40 to +185 °F)</li> <li>■ Separate housing: -40 to +60 °C (-40 to +140 °F)</li> </ul> <p>With M12 plug, elbowed: -25 to +85 °C (-13 to +185 °F)</p> <p>Devices with PVC-coated capillary armor: -25 to +90 °C (-13 to +194 °F)</p>
Operating altitude	Up to 5 000 m (16 404 ft) above sea level.
Climate class	<p>Class 4K4H (air temperature: -20 to +55 °C (-4 to +131 °F), relative humidity: 4 to 100 %) satisfied as per DIN EN 60721-3-4.</p> <p>Condensation is possible.</p>

Atmosphere	<p><b>Operation in very corrosive environment</b></p> <p>For corrosive environments (e.g. maritime environment / coastal areas), Endress+Hauser recommends the use of a PVC-coated capillary armor or a PTFE capillary armor for capillaries and the stainless steel housing. The transmitter can be additionally protected by a special coating (<b>Technical Special Product (TSP)</b>).</p>
Degree of protection	<p>Test as per IEC 60529 and NEMA 250-2014</p> <p><b>Housing and process connection</b></p> <p>IP66/68, TYPE 4X/6P (IP68: (1.83 mH<sub>2</sub>O for 24 h))</p> <p><b>Cable entries</b></p> <ul style="list-style-type: none"> <li>■ Gland M20, plastic, IP66/68 TYPE 4X/6P</li> <li>■ Gland M20, brass nickel plated, IP66/68 TYPE 4X/6P</li> <li>■ Gland M20, 316L, IP66/68 TYPE 4X/6P</li> <li>■ Thread M20, IP66/68 TYPE 4X/6P</li> <li>■ Thread G1/2, IP66/68 TYPE 4X/6P If the G1/2 thread is selected, the device is delivered with an M20 thread as standard and a G1/2 adapter is included with the delivery, along with the corresponding documentation</li> <li>■ Thread NPT1/2, IP66/68 TYPE 4X/6P</li> <li>■ Dummy plug transport protection: IP22, TYPE 2</li> <li>■ Plug HAN7D, 90 deg. IP65 NEMA Type 4X</li> <li>■ Plug M12 When housing is closed and connecting cable is plugged in: IP66/67 NEMA Type 4X When housing is open or connecting cable is not plugged in: IP20, NEMA Type 1</li> </ul> <p><b>NOTICE</b></p> <p><b>Plug M12 and plug HAN7D: incorrect mounting can invalidate the IP protection class!</b></p> <ul style="list-style-type: none"> <li>▶ The degree of protection only applies if the connecting cable used is plugged in and screwed tight.</li> <li>▶ The degree of protection only applies if the connecting cable used is specified according to IP67 NEMA Type 4X.</li> <li>▶ The IP protection classes are only maintained if the dummy cap is used or the cable is connected.</li> </ul> <p><b>Process connection and process adapter when using the separate housing</b></p> <p><i>FEP cable</i></p> <ul style="list-style-type: none"> <li>■ IP69 (on sensor side)</li> <li>■ IP66 TYPE 4/6P</li> <li>■ IP68 (1.83 mH<sub>2</sub>O for 24 h) TYPE 4/6P</li> </ul> <p><i>PE cable</i></p> <ul style="list-style-type: none"> <li>■ IP69 (on sensor side)</li> <li>■ IP66 TYPE 4/6P</li> <li>■ IP68 (1.83 mH<sub>2</sub>O for 24 h) TYPE 4/6P</li> </ul>
Electromagnetic compatibility (EMC)	<ul style="list-style-type: none"> <li>■ Electromagnetic compatibility as per EN 61326 series and NAMUR recommendation EMC (NE21)</li> <li>■ With regard to the safety function (SIL), the requirements of EN 61326-3-x are satisfied</li> <li>■ Maximum deviation with interference influence: &lt; 0.5% of span with full measuring range (TD 1:1)</li> </ul>

For more details refer to the EU Declaration of Conformity.

### 15.3 Process

Process temperature range

**NOTICE**

The permitted process temperature depends on the process connection, the ambient temperature and the type of approval.

- ▶ All the temperature data in this document must be taken into consideration when selecting the device.

#### Diaphragm seal fill fluid

Fill fluid	$P_{abs} = 0.05 \text{ bar (0.725 psi)}^{1)}$	$P_{abs} \geq 1 \text{ bar (14.5 psi)}^{2)}$
Silicone oil	-40 to +180 °C (-40 to +356 °F)	-40 to +250 °C (-40 to +482 °F)
High-temperature oil	-20 to +200 °C (-4 to +392 °F)	-20 to +400 °C (-4 to +752 °F) <sup>3) 4) 5)</sup>
Low-temperature oil	-70 to +120 °C (-94 to +248 °F)	-70 to +180 °C (-94 to +356 °F)
Vegetable oil	-10 to +160 °C (+14 to +320 °F)	-10 to +220 °C (+14 to +428 °F)
Inert oil	-40 to +100 °C (-40 to +212 °F)	-40 to +175 °C (-40 to +347 °F) <sup>6) 7)</sup>

- 1) Permitted temperature range at  $p_{abs} = 0.05 \text{ bar (0.725 psi)}$  (observe temperature limits of the device and the system!)
- 2) Permitted temperature range at  $p_{abs} \geq 1 \text{ bar (14.5 psi)}$  (observe temperature limits of the device and the system!)
- 3) 325 °C (617 °F) at  $\geq 1 \text{ bar (14.5 psi)}$  absolute pressure
- 4) 350 °C (662 °F) at  $\geq 1 \text{ bar (14.5 psi)}$  absolute pressure (max. 200 hours)
- 5) 400 °C (752 °F) at  $\geq 1 \text{ bar (14.5 psi)}$  absolute pressure (max. 10 hours)
- 6) 150 °C (302 °F) at  $\geq 1 \text{ bar (14.5 psi)}$  absolute pressure
- 7) 175 °C (347 °F) at  $\geq 1 \text{ bar (14.5 psi)}$  absolute pressure (max. 200 hours)

Fill fluid	Density <sup>1)</sup> kg/m <sup>3</sup>
Silicone oil	970
High-temperature oil	995
Low-temperature oil	940
Vegetable oil	920
Inert oil	1900

- 1) Density of the diaphragm seal fill fluid at 20 °C (68 °F).

The calculation of the operating temperature range of a diaphragm seal system depends on the fill fluid, capillary length and capillary internal diameter, process temperature and oil volume of the diaphragm seal. Detailed calculations, e.g. for temperature ranges, negative pressure and temperature ranges, are done separately in the Applicator "[Sizing Diaphragm Seal](#)".



A0038925

**Oxygen applications (gaseous)**

Oxygen and other gases can react explosively to oils, grease and plastics. The following precautions must be taken:

- All components of the system, such as devices, must be cleaned in accordance with national requirements.
- Depending on the materials used, a certain maximum temperature and a maximum pressure must not be exceeded for oxygen applications.

The cleaning of the device (not accessories) is provided as an optional service.

- $p_{max}$ : PN of the flange, max. 80 bar (1 200 psi)
- $T_{max}$ : 60 °C (140 °F)

**Seals**

Seal on the LP side (-)	Temperature	Pressure specifications
FKM	-20 to +85 °C (-4 to +185 °F)	-
FKM Cleaned of oil and grease	-10 to +85 °C (+14 to +185 °F)	-
FKM Cleaned for oxygen service	-10 to +60 °C (+14 to +140 °F)	-
FFKM	-10 to +85 °C (+14 to +185 °F)	MWP: 160 bar (2 320 psi)
	-25 to +85 °C (-13 to +185 °F)	MWP: 100 bar (1 450 psi)
EPDM	-40 to +85 °C (-40 to +185 °F)	-
PTFE	-40 to +85 °C (-40 to +185 °F)	PN > 160 bar (2 320 psi) Minimum process temperature: -20 °C (-4 °F)
PTFE Cleaned for oxygen applications	-20 to +60 °C (-4 to +140 °F)	PN > 160 bar (2 320 psi) Minimum process temperature: -20 °C (-4 °F)

- Diaphragm seal and capillary welded: Pay attention to the temperature application limits of the fill fluid
- PMD78B generally OPL on one side 160 bar (2 320 psi), on both sides 240 bar (3 480 psi)  
Lower temperatures on request

Process temperature range (temperature at transmitter)

**Diaphragm seal on one side with temperature isolator**

- Dependent on design (see "Design" section)
- Dependent on diaphragm seal and fill fluid: -70 to +400 °C (-94 to +752 °F)
- Observe the temperature application limits of the fill fluid.
- Observe the maximum gauge pressure and maximum temperature
- Pay attention to the process temperature range of the seal

Design:

- Transmitter horizontal, temperature isolator long: 400 °C (752 °F)
- Transmitter vertical, temperature isolator long: 300 °C (572 °F)
- Transmitter horizontal, temperature isolator short: 200 °C (392 °F)
- Transmitter vertical, temperature isolator short: 200 °C (392 °F)

**Diaphragm seal on one side or both sides with capillary**

- Depends on diaphragm seal and fill fluid: -70 °C (-94 °F) up to +400 °C (+752 °F)
- A4 screws of process connection, threaded separator:  $T_{min}$  -60 °C (-76 °F)
- Observe the maximum gauge pressure and maximum temperature

**Diaphragm seal with tantalum membrane**

-70 to +300 °C (-94 to +572 °F)

**Devices with PTFE-coated diaphragm seal membrane**

The anti-stick coating has very good anti-friction properties and protects the membrane against abrasive media.

**NOTICE****Destruction of the device due to incorrect use of PTFE coating!**

- The PTFE coating used is designed to protect the unit against abrasion. It does not provide protection against corrosive media.

Area of application of the 0.25 mm (0.01 in) PTFE foil on AISI 316L (1.4404/1.4435) membrane, see the following graphic:

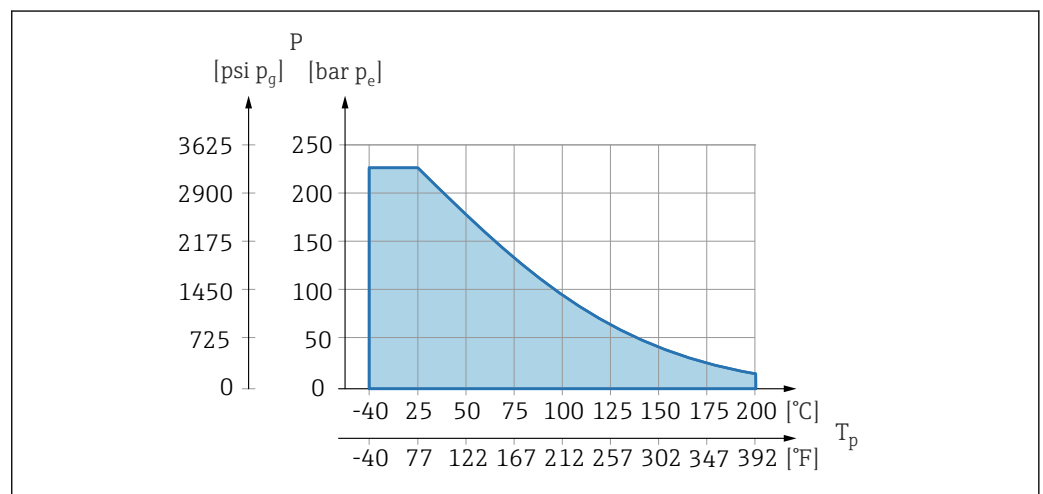

A0045213

- i** For vacuum applications:  $p_{abs} \leq 1$  bar (14.5 psi) to 0.05 bar (0.725 psi) to max. +150 °C (302 °F).

If a PTFE coating has been selected, a conventional membrane is always delivered.

Diaphragm seal capillary armor

Process temperature depending on the ambient temperature.

- 316L: No restrictions
- PTFE: No restrictions
- PVC: See the following diagram

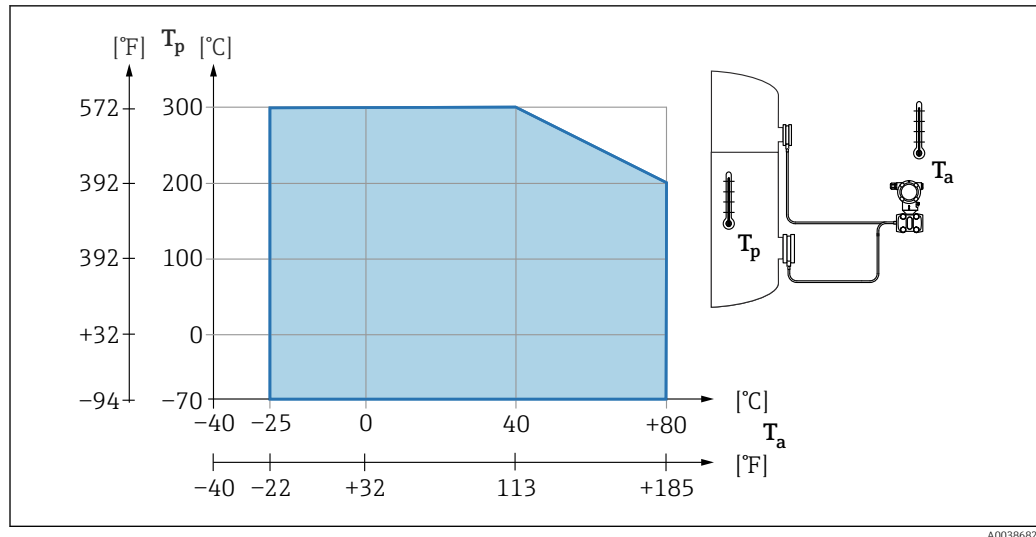

Process pressure range

**Pressure specifications**



The maximum pressure for the device depends on the lowest-rated component with regard to pressure (components are: process connection, optional mounted parts or accessories).

- ▶ Only operate the device within the specified limits for the components!
- ▶ MWP (maximum working pressure): The MWP is specified on the nameplate. This value refers to a reference temperature of +20 °C (+68 °F) and may be applied to the device for an unlimited time. Note temperature dependence of MWP. For flanges, refer to the following standards for the permitted pressure values at higher temperatures: EN 1092-1 (with regard to their stability/temperature property, the materials 1.4435 and 1.4404 are grouped together under EN 1092-1; the chemical composition of the two materials can be identical.), ASME B 16.5a, JIS B 2220 (the latest version of the standard applies in each case). MWP data that deviate from this are provided in the relevant sections of the Technical Information.
- ▶ The overpressure limit is the maximum pressure a device may be subjected to during a test. It is greater than the maximum working pressure by a certain factor. This value refers to a reference temperature of +20 °C (+68 °F).
- ▶ The Pressure Equipment Directive (2014/68/EU) uses the abbreviation "PS". The abbreviation "PS" corresponds to the MWP (maximum working pressure) of the device.
- ▶ In the case of measuring cell range and process connection combinations where the overpressure limit (OPL) of the process connection is smaller than the nominal value of the measuring cell, the device is set at the factory, at the very maximum, to the OPL value of the process connection. If the entire measuring cell range must be used, select a process connection with a higher OPL value (1.5 x PN; MWP = PN).
- ▶ Oxygen applications: do not exceed values for  $P_{max}$  and  $T_{max}$ .

**Burst pressure**

As of the specified burst pressure, the complete destruction of the pressure-bearing parts and/or a device leak must be expected. It is therefore imperative to avoid such operating conditions by carefully planning and sizing your facility.

Thermal insulation

**Thermal insulation when mounting with a temperature isolator**

The device may only be insulated up to a certain height. The maximum permitted insulation height applies to an insulation material with a thermal conductivity  $\leq 0.04 \text{ W}/(\text{m} \times \text{K})$  and to the maximum permitted ambient temperature and process temperature. The data were determined under the application "quiescent air".



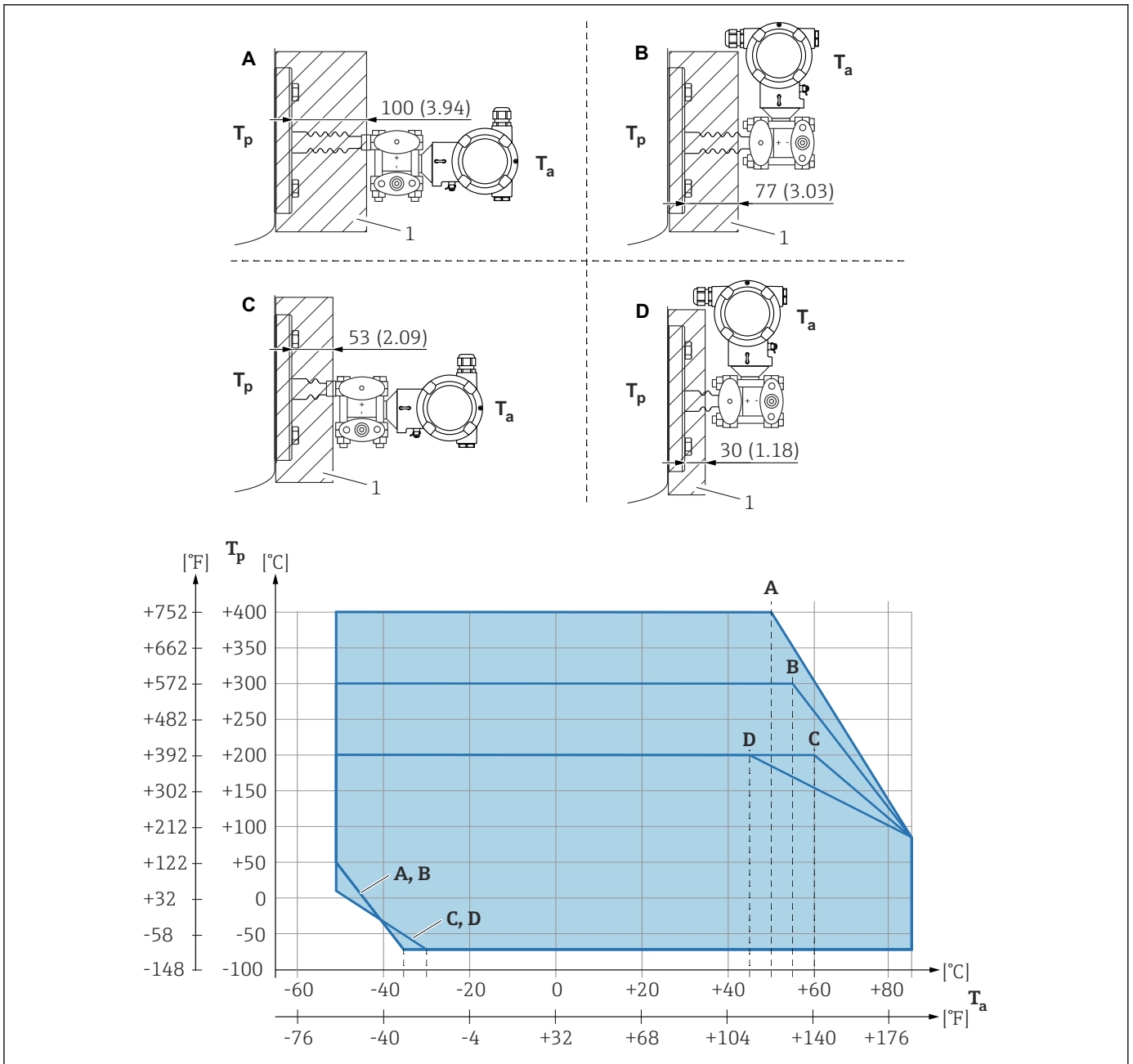

A0039331

- 1 Insulation material
- A Transmitter horizontal, temperature isolator long
- B Transmitter vertical, temperature isolator long
- C Transmitter horizontal, temperature isolator short
- D Transmitter vertical, temperature isolator short

Without insulation, the ambient temperature decreases by 5 K.

Item	$T_a$ <sup>1)</sup>	$T_p$ <sup>2)</sup>
A	50 °C (122 °F)	400 °C (752 °F)
	85 °C (185 °F)	85 °C (185 °F) <sup>3)</sup>
	-50 °C (-58 °F)	50 °C (122 °F)
	-35 °C (-31 °F)	-70 °C (-94 °F)
B	55 °C (131 °F)	300 °C (572 °F) <sup>3)</sup>
	85 °C (185 °F)	85 °C (185 °F)

Item	T <sub>a</sub> <sup>1)</sup>	T <sub>p</sub> <sup>2)</sup>
	-50 °C (-58 °F)	50 °C (122 °F)
	-35 °C (-31 °F)	-70 °C (-94 °F)
<b>C</b>	60 °C (140 °F)	200 °C (392 °F) <sup>3)</sup>
	85 °C (185 °F)	85 °C (185 °F)
	-50 °C (-58 °F)	10 °C (50 °F)
	-30 °C (-22 °F)	-70 °C (-94 °F)
<b>D</b>	67 °C (153 °F)	200 °C (392 °F) <sup>3)</sup>
	85 °C (185 °F)	85 °C (185 °F)
	-50 °C (-58 °F)	10 °C (50 °F)
	-30 °C (-22 °F)	-70 °C (-94 °F)

- 1) Maximum ambient temperature at transmitter
- 2) Maximum process temperature
- 3) Process temperature: max. +400 °C (+752 °F), depending on the fill fluid used.

**Thermal Range Expander**

The device may only be insulated up to a certain height. The maximum permitted insulation height applies to an insulation material with a thermal conductivity  $\leq 0.04 \text{ W}/(\text{m} \times \text{K})$  and to the maximum permitted ambient temperature and process temperature. The data were determined under the application "quiescent air".

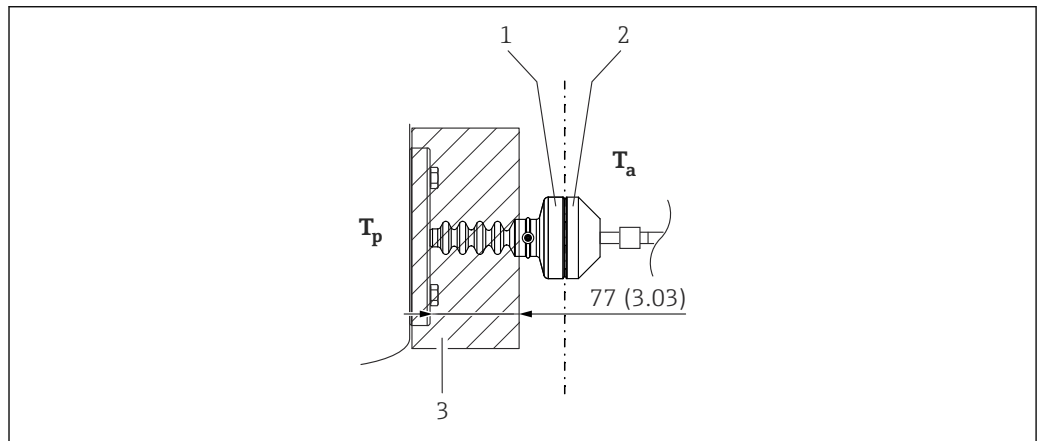

A0054921

- 1 Primary chamber
- 2 Secondary chamber
- 3 Insulation material

Without insulation, the ambient temperature decreases by 5 K.

Ultrapure gas applications Endress+Hauser also offers devices for special applications, such as for ultrapure gas, that are cleaned of oil and grease. No special restrictions regarding the process conditions apply to these devices.

Hydrogen applications A **gold-coated** metallic membrane offers universal protection against hydrogen diffusion, both in gas applications and in applications with water-based solutions.

# Index

## Symbols

"Device ID" parameter . . . . .	45
"Device revision" parameter . . . . .	45
"Firmware version" parameter . . . . .	45
"Manufacturer ID" parameter . . . . .	45

## A

Access authorization to parameters	
Read access . . . . .	35
Write access . . . . .	35
Access code . . . . .	35
Incorrect input . . . . .	35
APL integration . . . . .	45

## B

Bluetooth® wireless technology . . . . .	37
--	----

## C

CE mark (Declaration of Conformity) . . . . .	9
Cleaning . . . . .	76
Cyclic data transmission . . . . .	47

## D

Declaration of Conformity . . . . .	9
Device description files . . . . .	45
Device documentation	
Supplementary documentation . . . . .	7
Device locking, status . . . . .	62
Device master file	
GSD . . . . .	45
Device usage	
see Intended use	
Device Viewer . . . . .	77
DeviceCare . . . . .	44
Device description file . . . . .	45
Diagnosis	
Symbols . . . . .	67
Diagnostic event . . . . .	68
Diagnostic events . . . . .	66, 67
Diagnostic information	
Design, description . . . . .	69
Web browser . . . . .	68
Diagnostic list . . . . .	69
Diagnostic message . . . . .	67
Display values	
For locking status . . . . .	62
Disposal . . . . .	78

## E

Event history . . . . .	71
Event text . . . . .	68
Events list . . . . .	71
Exterior cleaning . . . . .	76

## F

FieldCare . . . . .	44
Device description file . . . . .	45

Function . . . . .	44
Filtering the event logbook . . . . .	72
Firmware	
Release date . . . . .	45

## I

Intended use . . . . .	8
------------------------	---

## L

Local display	
see Diagnostic message	
see In alarm condition	

## M

Maintenance . . . . .	76
-----------------------	----

## N

Nameplate . . . . .	15
---------------------	----

## O

Operating elements	
Diagnostic message . . . . .	68
Operation . . . . .	62
Operational safety . . . . .	8

## P

Product safety . . . . .	9
PROFINET protocol . . . . .	50

## R

Read access . . . . .	35
Reading off measured values . . . . .	62
Repair concept . . . . .	77
Requirements concerning the staff . . . . .	8

## S

Safety Instructions	
Basic . . . . .	8
Service interface (CDI) . . . . .	44, 51
Settings	
Adapting the device to process conditions . . . . .	62
Software release . . . . .	45
Spare parts . . . . .	77
Nameplate . . . . .	77
Status signals . . . . .	67, 68
Submenu	
Events list . . . . .	71
Interfaces . . . . .	41
Measured values . . . . .	62
System redundancy S2 . . . . .	49

## T

Troubleshooting . . . . .	64
Turning the display module . . . . .	27

**U**

Using the devices

Borderline cases . . . . .	8
Incorrect use . . . . .	8

**V**

Version data for the device . . . . .	45
---------------------------------------	----

**W**

Workplace safety . . . . .	8
Write access . . . . .	35









[www.addresses.endress.com](http://www.addresses.endress.com)

---