

Reduce complexity, achieve simplicity.

iTHERM ModuLine – easily configurable
to your needs.



iTHERM ModuLine

Our offering covers the right solution for every application **from basic functionality to high-end performance** with advanced safety features. It is differentiated by **easy selection and configuration, global availability** and short delivery times which together with our customer-oriented service and project support ensures lower cost over the entire life cycle.









Portfolio overview thermometers

Our **iTHERM ModuLine family** is the latest generation of modular thermometers for industrial applications. Innovative technologies provide added values, and certifications according to international standards complete the offering.

Portfolio description

- Variety of sensor designs - best possible measurement performance for any application
- Thermometers with or without transmitter
- Thermometers with or without display
- Threaded, compression fitted, flanged process connections



Thermowell	Direct contact – without thermowell			Welded thermowell		Barstock thermowell		
Model	TM101	TM111	TM112	TM121	TM131	TM151	TM152	
Product website								
Design	Metric			Imperial	Metric			Imperial
								
Segment	FLEX	FLEX		FLEX	FLEX			
Communication standards	4-20 mA, HART, IO-Link	4-20 mA, HART, PROFINET over Ethernet-APL, FOUNDATION Fieldbus, IO-Link, PROFIBUS PA		4-20 mA, HART, IO-Link	4-20 mA, HART, PROFINET over Ethernet-APL, FOUNDATION Fieldbus, IO-Link, PROFIBUS PA			
Features	Best price/performance ratio	iTHERM StrongSens iTHERM QuickSens		Best price/performance ratio	iTHERM StrongSens iTHERM QuickSens iTHERM QuickNeck QuickLink Dual Seal Dual compartment housing	iTHERM StrongSens iTHERM QuickSens iTHERM QuickNeck iTHERM TwistWell QuickSleeve Dual Seal Dual compartment housing		
Approvals/certificates	-	ATEX/IECEX Ex ia, Ex nA, Ex ec, Ex tc, Ex ta/tb, Ex db; CSA C/US IS, NI, XP, DIP; INMETRO Ex ia, Ex d; NEPSI Ex ia, Ex d, Ex tD; UK Ex ia, Ex nA		-	ATEX/IECEX Ex ia, Ex nA, Ex ec, Ex tc, Ex ta/tb, Ex db; CSA C/US IS, NI, XP, DIP; INMETRO Ex ia, Ex d; NEPSI Ex ia, Ex d, Ex tD; UK Ex ia, Ex nA; SIL 2/SC 3; DNV			
Temperature range	TC: -270 to +650 °C (-454 to 1202 °F) RTD: -50 to +200 °C (-58 to +392 °F)	TC: -270 to +1100 °C (-454 to +2012 °F) RTD: -200 to +600 °C (-328 to +1112 °F)		TC: -270 to +650 °C (-454 to +1202 °F) RTD: -50 to +200 °C (-58 to +392 °F)	TC: -270 to +1100 °C (-454 to +2012 °F) RTD: -200 to +600 °C (-328 to +1112 °F)			

Portfolio overview thermowells

Combined, our **iTHERM ModuLine thermometers and thermowells** form the perfect unit for industrial applications.

Portfolio description

- Wide range of industrial process connections – e.g. threaded, flanged, weld-in, socket weld, compression fitting...
- Wide choice of materials
- With or without extension neck
- Designs according to DIN 43772, ASME B40.9 or NAMUR NE 170

Type	Barstock thermowell			Welded industrial thermowell
Model	TT151	TT152	TT511	TT131
Product website				
Design	Metric		Imperial	
				
Segment	F L E X			
Thermowell design	DIN, ASME		ASME	Van Stone
Process connection	Flange, weld-in, threaded			Lap-joint flange
Material	316, 316L, 316Ti, 347, 310 Alloys 600, C276, 10CrMo9-10, 13CrMo4-5, 16Mo3 A105, C22.8 Duplex S32205, Titan Gr.2			1.4401, 1.4571
Innovations	iTHERM TwistWell			-
Suitable for	TM131, TM151	TM152	TM131, TM151	TM131

Stainless steel: 316, 316L, 316Ti, 321, Alloy446
nickel-based materials: AlloyC276, Alloy600,
jackets in Tantalum and PTFE

QuickLink
iTHERM QuickNeck

Unmatched simplicity

We have successfully streamlined the Endress+Hauser **industrial modular thermometer portfolio** from more than 50 to just **7 product roots** in the iTHERM ModuLine product family.

This consolidation allows for **easy configuration to suit different applications and local requirements**. In addition, we can help you **simplify your inventory and material handling processes**, while ensuring consistent quality - all from a single source.



Global availability

- Sales and support
- Documentation for installation, troubleshooting, maintenance
- Certificates, approvals, tests, calibration options

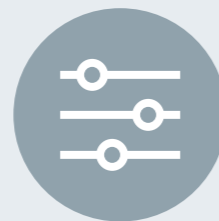

Ease of selection

- Quick and easy configuration
- Reduced number of order codes
- From basic to advanced products
- For standard or demanding applications



Wide selection

- Assembly
- Thermowells
- Temperature transmitter
- Sensor designs
- Process connections
- Materials
- Mechanical and sensor innovations



iTEMP temperature transmitters

- All common communication protocols
- Optional Bluetooth® connectivity



Reduced life cycle costs

- Streamlined stockkeeping
- Simplified material handling processes

Increased efficiency

Our unique sensor technologies and thermowell designs help **improve process efficiency by enabling faster reactions to temperature changes.**

Whether using barstock / welded thermowell or direct-contact thermometers, our solutions provide accurate, long-term stable temperature measurements in any application.

QuickLink

Pipe thermowell with patented design to control the process at peak efficiency and performance

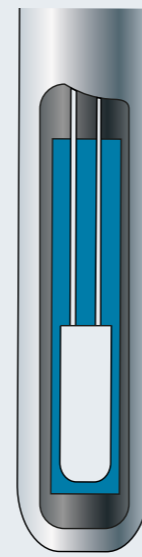

Up to
5x
faster response times

- Optimized thermal coupling between insert and thermowell
- Applicable with replaceable standard inserts Ø 6 mm (0.25 inches)
- For temperatures up to 400 °C (752 °F)

QuickSleeve

Insert for fast response times in combination with barstock thermowells

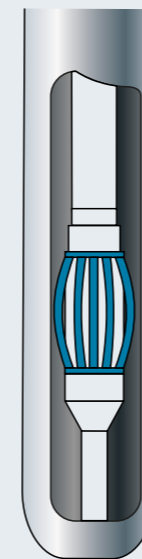

Up to
2x
faster response times

- Bridging the usual airgap between insert & barstock thermowells for optimized thermal coupling
- Suitable for bore Ø 6,5 and 7 mm (0.26 inches)
- For temperatures up to 400 °C (752 °F)

iTHERM QuickSens

Insert for fastest response times



T90 =
1.5s

- Pt100 thinfilm sensor
- Sensor-on-tip technology
- Minimum immersion length can be reduced by > 70% (20-30 mm (0.78-1.18 inches))
- Measuring range from -50 to +200 °C (-58 to 392 °F)

Enhanced safety

Process conditions in demanding applications require robust solutions to **reduce the risk of unexpected incidents and potential safety issues for plant and personnel.**

Our patented robust sensor / specially designed thermowell prevent sensor damage / thermowell breakage, ensuring long-term durability.

Additionally, a second process barrier can add an extra layer of protection by sealing the system and prevents leakage of hazardous media.

iTHERM StrongSens

Insert with highest vibration resistance

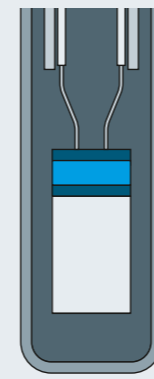

>60g
vibration
resistance

- Highly robust
- Suitable for applications in hazardous areas
- Ceramic-encapsulated Pt100 thinfilm RTD
- Long lifetime and plant availability
- Suitable for e.g. turbines, compressors

iTHERM TwistWell

Barstock thermowell with helix design for high velocity applications

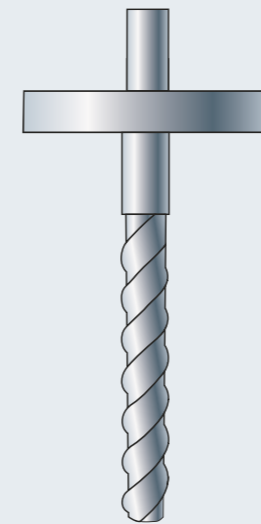

>90%
reduction of
vortex induced
vibrations

- Static loads can be calculated acc. ASME PTC 19.3 TW
- Easy installation for all nozzle sizes starting from 1" / DN25
- Effectiveness of the design verified by an independent 3rd party agency

Dual Seal

Pressure-triggered safety valve for critical applications

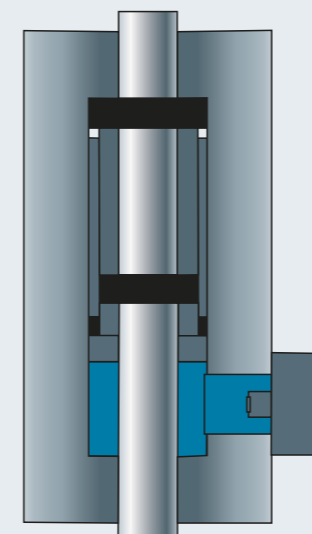

100%
leakage
detection

- Second process barrier for the case of thermowell failure / rupture
- Health monitoring & signal to PLC in case of activation
- Additional health information from measurement device
- Immediate sealing for containment of hazardous media

Effortless handling

Our patented iTHERM QuickNeck **boosts productivity by minimizing maintenance downtime.** It streamlines manual temperature sensor recalibration, offering a fast, tool-free solution that enhances efficiency and reduces risks.

iTHERM QuickNeck

Divisible extension neck with tool-free quick release

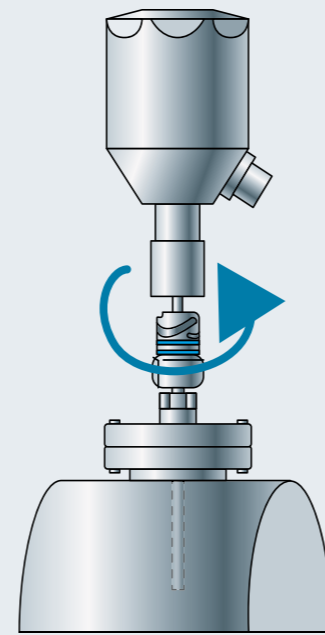

More than
50%
cost + time
savings

- Removal of insert without any tools
- Terminal head can remain closed, connection cables remain connected
- No risk of water ingress, mechanical damage or wiring errors

Perfect fit

Whatever the industry or application, iTEMP temperature transmitters **fit perfectly into iTHERM ModuLine thermometers.** Unique features and worldwide approvals allow for optimal selection according to the existing or desired system environment.

iTEMP temperature transmitter

The perfect solution for your measuring point

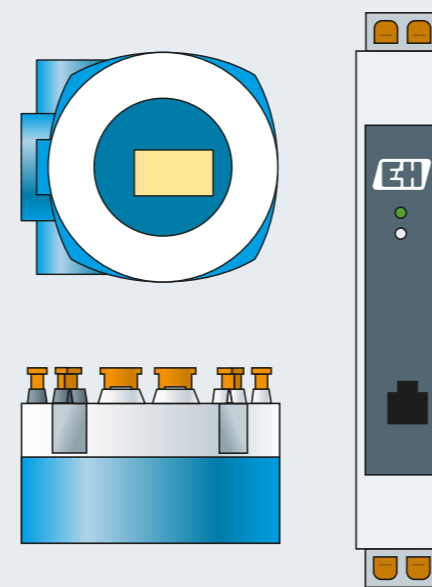

10
transmitters to
cover all needs

- All common communication protocols
- Optional Bluetooth® technology
- Plug-in display unit (TID10) for head transmitters
- Housing types: head transmitter, field transmitter or DIN rail
- Advanced diagnostics
 - Sensor break, open-circuit, short-cut detection
 - Corrosion monitoring
 - Sensor drift detection
 - Sensor back up function



Industry focus

Our iTHERM ModuLine portfolio of **basic and advanced modular temperature assemblies** is designed for customers in the **chemical, oil & gas and power & energy industries** where applications require reliable temperature measurements that are accurate, stable and offer valuable additional information with the goal to improve process control, increase uptime and plant safety.





Thermal power plant: main steam temperature

Main steam is being produced in the boiler and is fed to the turbine, where it is used to run the turbine. Temperature is the key parameter to increase efficiency.

In this application, sensors have to cope with high temperatures and pressures. Temperature sensors must have a high accuracy and a fast response time due to material stress limits.

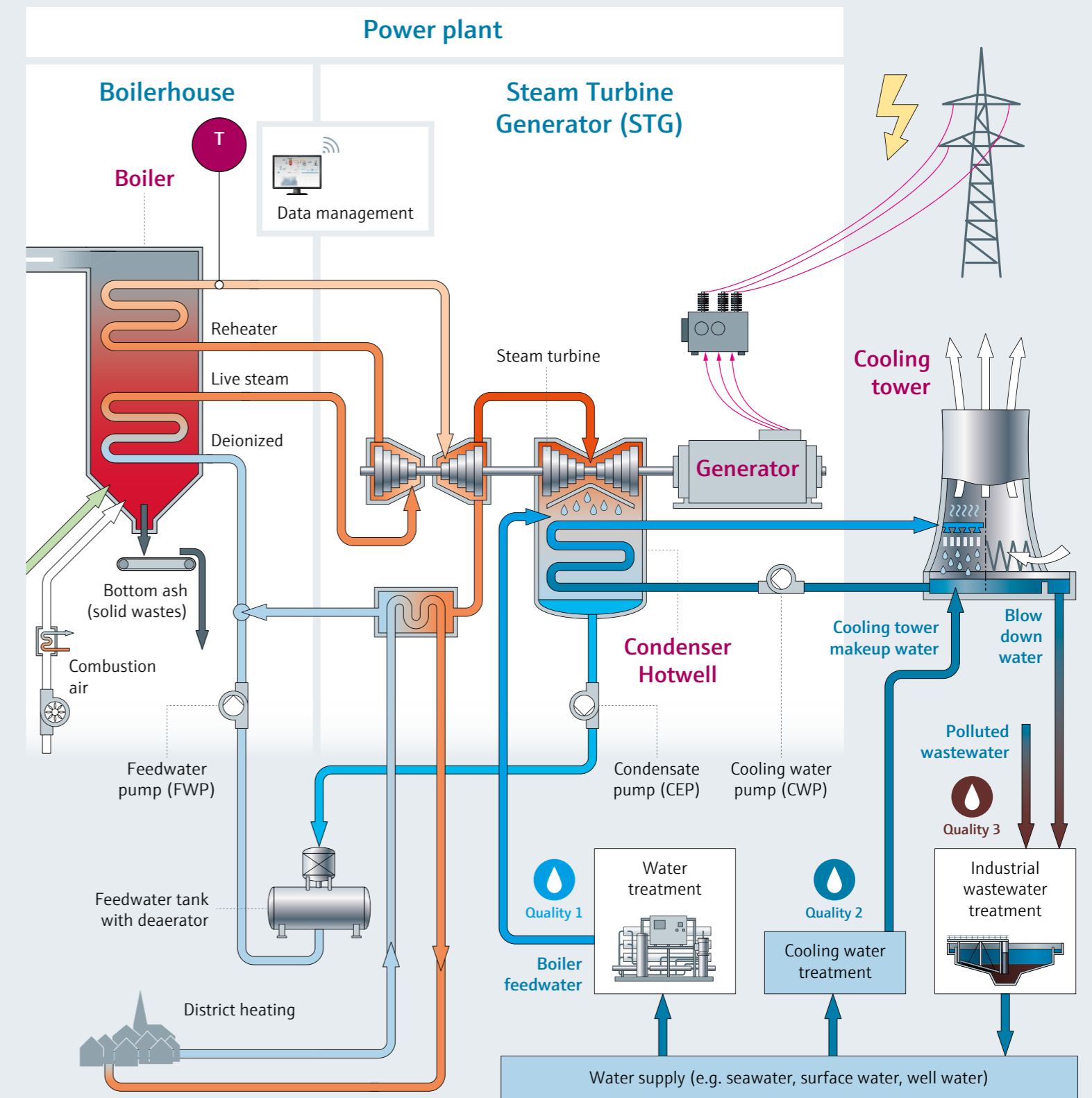

Your challenge

Measuring task: temperature measurement

Measuring point: main steam

Medium: steam

Process temperature: 625 °C (1.157 °F)

Specific challenges: pressure up to 300 bar (4.350 psi)

Our answer

iTHERM ModuLine TM151 / TM152 is the metric / imperial version of our thermometer with barstock thermowell, specially designed for applications with pressures up to 500 bar (7.251 psi).

This innovative sensor offers a high measuring range, wide range of materials, improved ease of maintenance and fits for use in explosion proof areas.

Sludge treatment optimization: digester temperature

Under anaerobic conditions, special bacteria break down organic substances from the primary and waste activated sludge to produce biogas. The result is a reduction in sludge volume and its stabilization. Retention times of 2-3 weeks are common at temperatures of 30-50 °C (86-122 °F), while continuous sludge circulation is important. The process offers opportunities for heat recovery and energy recovery of biogas.

Temperature is one of the most important factors influencing bacterial activity. Digesters are often operated at 30-40 °C (86-104 °F), where so-called mesophilic bacteria are at their most active. Incoming sludge is preheated in a heat exchanger. When using biogas, heat demand is not usually a limiting factor, as the biogas process produces enough heat to supply the digesters.

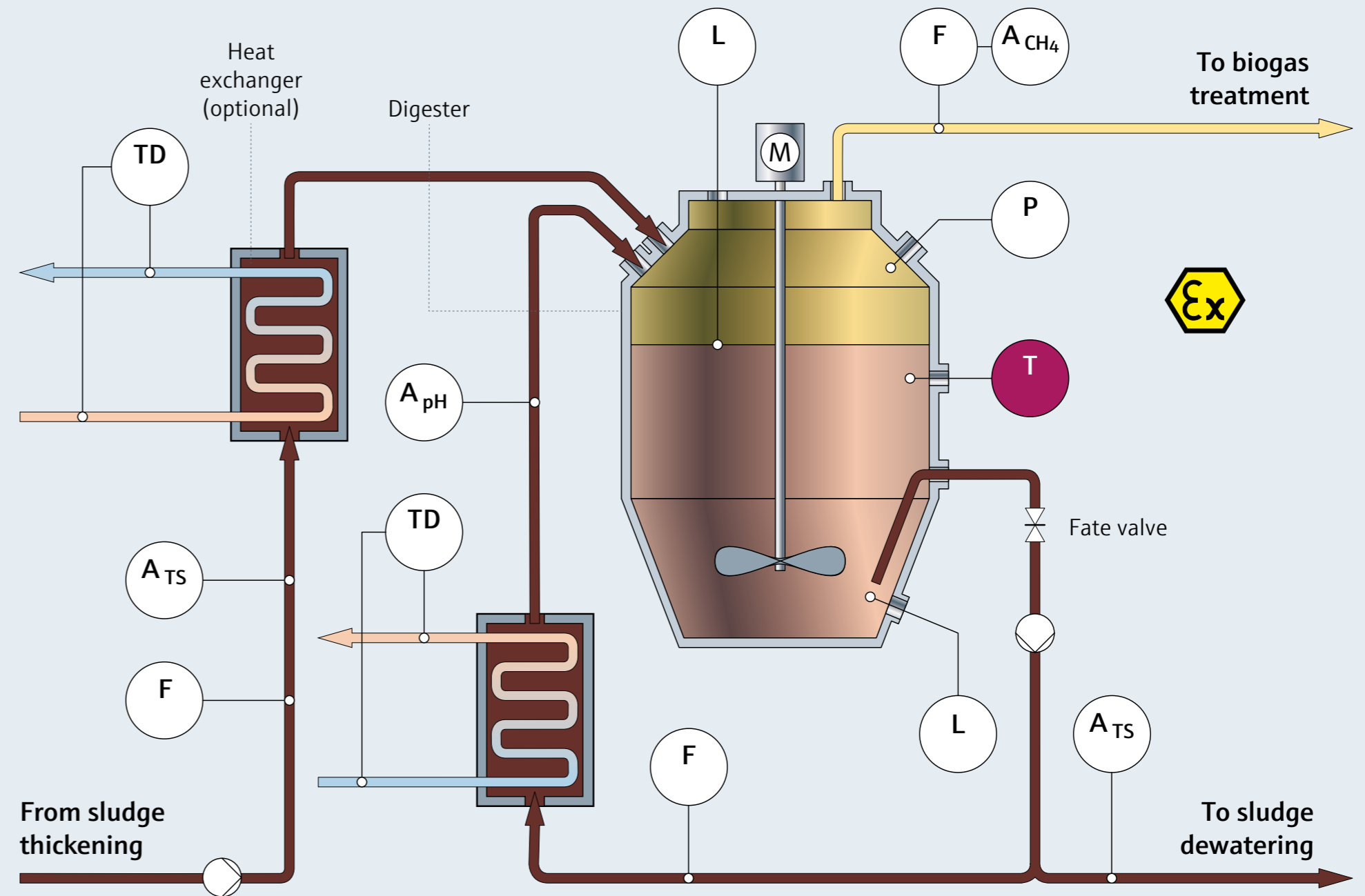

Your challenge

Measuring task: temperature measurement

Measuring point: temperature in the digester

Medium: sludge

Process temperature: 30 to 50 °C (86 to 122 °F)

Specific challenges:

- Resistance to H₂S
- Optional Ex-certificate (ATEX zone 1)

Our answer

iTHERM ModuLine TM151 / TM152 is the metric / imperial version of our thermometer with barstock thermowell.

This innovative sensor offers a high variety of suitable materials (e.g. for H₂S resistance), high performance sensor elements, improved ease of maintenance and fits for use in explosion proof area.

Safety and efficiency improvement in CCUS processes

Several approaches are used to separate CO₂ from gas streams or emissions produced by processes using fossil fuels. The separation of CO₂ is necessary to meet the stringent requirements in terms of maximum allowable concentrations of CO₂ emitted to achieve the ultimate goal of zero emissions. **The captured CO₂ will also need to be transported, injected, and stored for reuse.**

- The most common approaches:
- **Absorption** – CO₂ gas is chemically absorbed in a liquid solvent.
 - **Adsorption** – CO₂ gas is captured in a specific medium such as an adsorbent bed of porous particles.
 - **Membrane separation** and other processes based on cryogenics or chemical looping.

Throughout the CO₂ capture, utilization, and storage (CCUS) process, several utilities are used and temperature is one of the key measurements to monitor and to control all the operating conditions **where mixtures and pure CO₂ are processed in liquid, gaseous or dual phases.**

The demanding requirements of each process phase are set to ensure that the utilities operate with the best separation efficiency and with the highest level of safety to obtain the expected purity and quality of CO₂. Temperature is again the fundamental parameter in achieving these objectives.

Your challenge

Measuring task: temperature measurement

Measuring point: pipelines and utilities like condenser, reboiler, reflux drum, heat exchanger, compressor, stripping tower

Medium: gaseous, liquid or two-phase fluids of various compositions, saturated steam

Process temperature: -50 to 350 °C (-58 to 662 °F)

Specific challenges: minimally invasive instruments with corrosion resistant wetted materials for hazardous environments

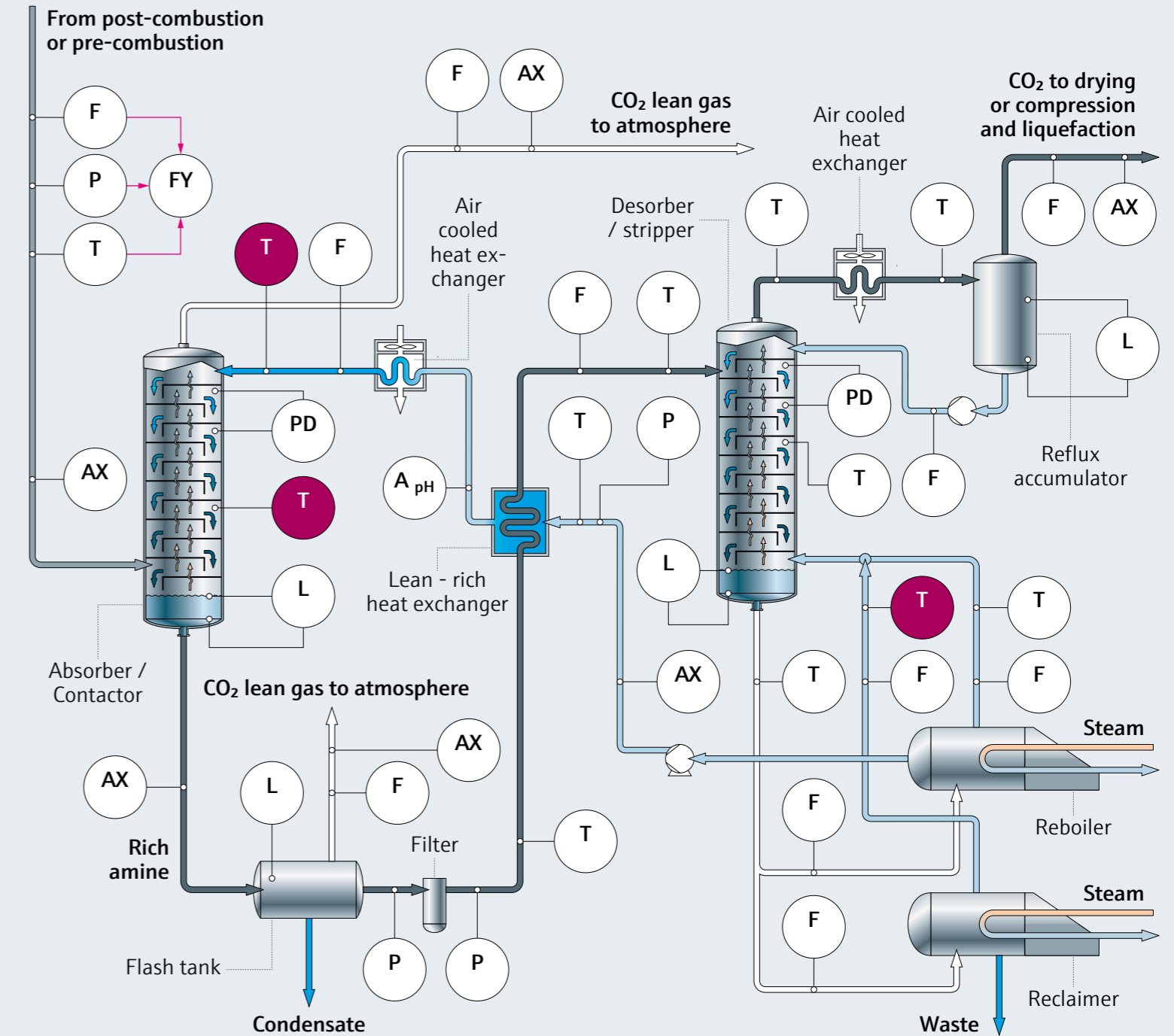

Our answer

Thanks to the wide range of configurations for iTHERM ModuLine products, high accuracy and fastest response times are achievable. TM151 and TM152 are ideal for contact measurement with short immersion lengths and barstock thermowell, capable of withstanding the speed and chemical aggressiveness of process fluids like CO₂-rich solvents. Alternatively, for precise delta measurements between small outlet and inlet pipes, such as in a heat exchanger, reliable direct contact measurement can be achieved with TM111 or TM112.



Operational expenditures in distillation

Distillation is the process of separating mixtures of liquids into their basic components by acting on the boiling points. It involves several units such as a distillation column, reboiler, condenser and reflux drum (separator). The distillation process is one of the most energy consuming processes due to the significant amount of heat that must be transferred to extract the vapors from the liquid mixture and to operate the condensers, separators and pumps.

Distillation efficiency depends on several parameters such as column size, height/diameter ratio, materials used, internal design and, most importantly,

feed composition and heat distribution and exchange in several steps inside and outside the column.

The efficiency of the distillation column and the long-term ability of all the other auxiliaries to operate in stable conditions are the key challenges in extracting the most elementary compounds from the mixture, especially when they differ by a small delta boiling temperature. Another challenge is to quickly reach a new optimized efficiency of the whole process, in case the composition of the feedstock may change, to always guarantee the best quality of the obtained fractions.

Your challenge

Measuring task: temperature measurement

Measuring point: column feed lines, outlet lines, reboiler and condenser inlets and outlets, reflux feed lines

Medium: gaseous, liquid or two-phase fluids with various composition, saturated or superheated steam

Process temperature: 250 to 450 °C (482 to 842 °F)

Specific challenges: accurate and fast response time even with turbulent and fast-moving fluids in hazardous environments

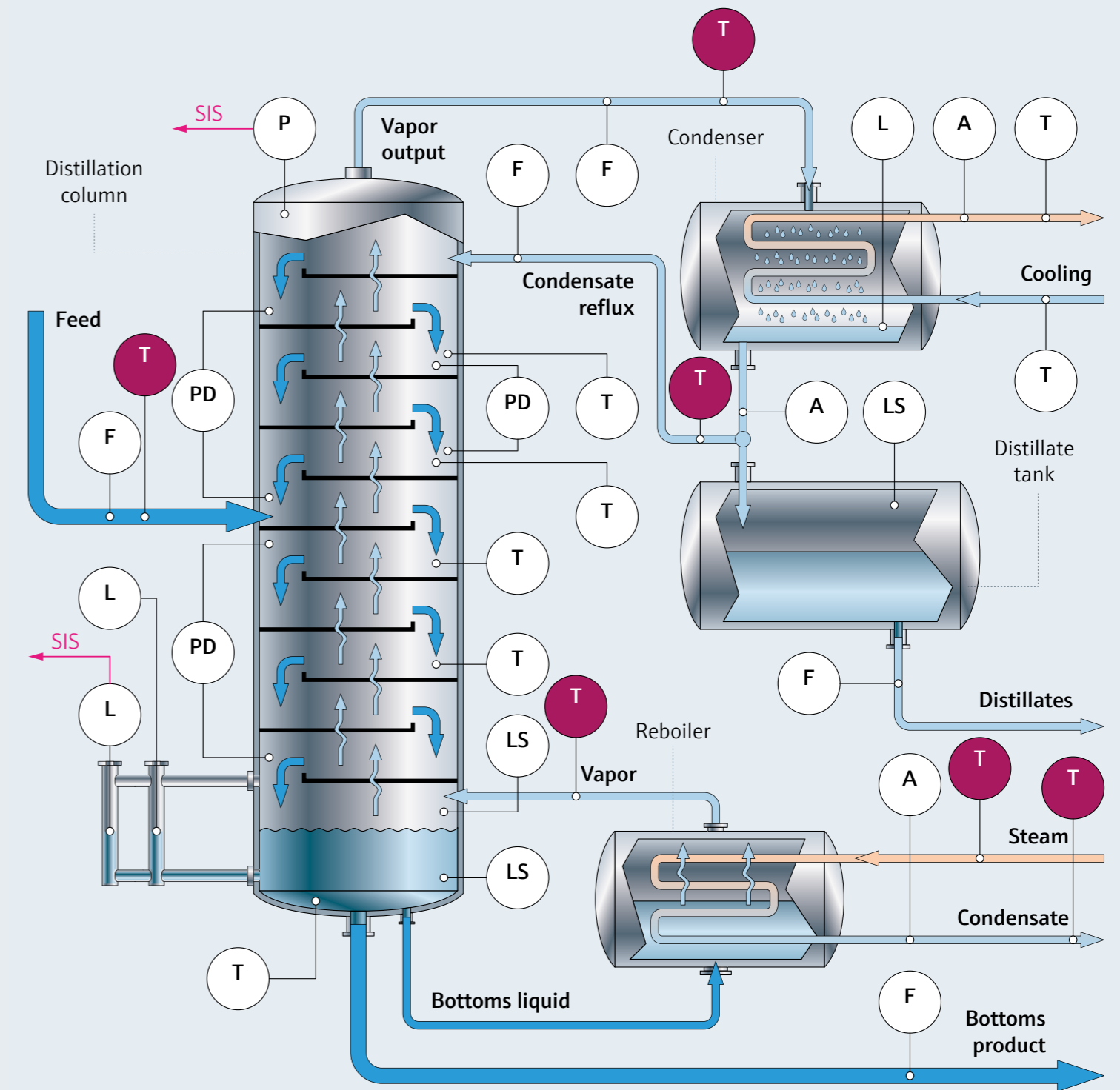

Our answer

iTHERM ModuLine TM151 / TM152 and TM111 / TM112 offer a wide range of configurations, providing high accuracy and fast response time combined with excellent mechanical and corrosion resistance.

These products perform well under a wide range of process conditions, allowing accurate measurement of multiple boiling points. This capability helps to identify and separate mixed fluids based on their specific energy content, even when they have minor variations in density and vapor pressure.



Related offering

The combination of our **iTHERM ModuLine thermometers with temperature transmitters** makes the features available for all systems and applications.

Our **system products** like process indicators or active barriers offer additional comfort and safety.

iTEMP temperature transmitters

- Large selection of models, housings and approvals
- DIN rail transmitters, head transmitters and field transmitters
- Secure Bluetooth® interface option for remote parametrization
- Seamless system integration with common communication protocols
- Digitization with Ethernet-APL and IO-Link technology



System products

- Solutions for your measuring loop
- Everything you need from a single source
- Power supplies, signal conditioning, process indicators, overvoltage protection, data managers, energy managers





Thermometer portfolio

Our expansive portfolio offers globally available, standardized thermometers for industrial and hygienic applications across all industries.

As a full-range supplier for temperature measurement, we unite all competencies under one roof – from sensors and electronics to complete assemblies and customized solutions.

Thermometer portfolio

- Compact and modular thermometers for industrial or hygienic applications across all industries
- Expansive, globally available portfolio offers of standardized thermometers, or customized solutions
- Temperature switches, high temperature thermometers, surface thermometers, cable probes and multipoint thermometers



iTHERM SurfaceLine TM611

- Non-invasive surface thermometer for demanding applications
- No process opening required, no leakage risk
- Measurement accuracy and response time comparable with invasive measurements
- International approvals and certificates
- All common communication protocols



People for Process Automation



Visit us on social media