

# Installation Instructions

## **Terminal module**

Gammapilot, Liquiphant, Micropilot, Prothermo  
Cerabar, Deltabar, Prowirl L



# 1 Intended use

- A defective unit can only be replaced with a functioning unit of the same type.
- Use only original parts from Endress+Hauser.
- In the W@M Device Viewer, check if the spare part is suitable for the existing device.

 In some devices, an overview of spare parts is provided inside the device. If the spare part set is listed in the overview, it is not necessary to check the Device Viewer.

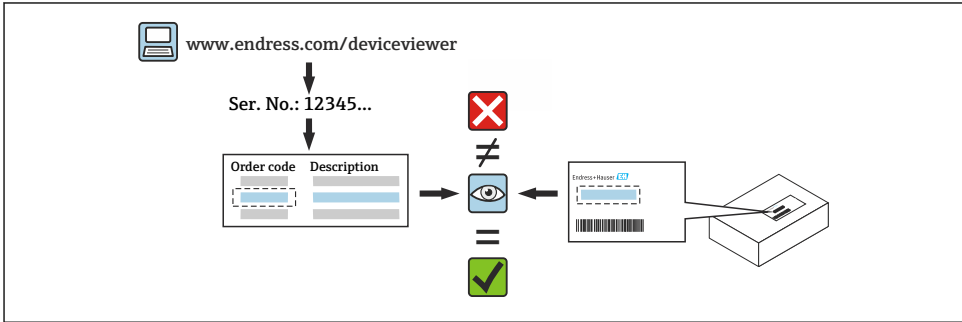

# 2 Personnel authorized to carry out repairs

Technical staff must comply with the following requirements for repair, mounting, electrical installation and commissioning of the devices:

- Be trained in instrument safety.
- Be familiar with the individual operating conditions of the devices.
- In the case of Ex-certified devices, they must also be trained in explosion protection.

 Technical staff carrying out work are responsible for ensuring that the work is carried out safely and to the required quality standard. They must also guarantee the safety of the device following repair.

# 3 Safety instructions

- Observe the Operating Instructions for the device.
- Comply with national regulations regarding mounting, electrical installation, commissioning, maintenance and repair.
- Device is live! Risk of fatal injury from electric shock. Open the device only when the device is deenergized.
- For devices intended for use in hazardous locations, please observe the instructions in the Ex documentation (XA).
- In the case of devices in safety-related applications in accordance with IEC 61508 or IEC 61511: Commission in accordance with Operating Instructions after repair.

- Before removing the device: set the process to a safe state and purge the pipe of dangerous process substances.
- Risk of burns from hot surfaces! Before commencing work: allow the system and device to cool down to a touchable temperature.
- In the case of devices in custody transfer, the custody transfer status no longer applies once the seal has been removed.
- Risk of damaging electronic components! Ensure that the working environment is protected against electrostatic discharge.
- After removing the electronics compartment cover: risk of electric shock due to removal of contact protection! Switch the device off before removing internal covers.
- Modifications to the device are not permitted.
- Only open the housing for a short period. Avoid ingress of foreign bodies, moisture or contaminants.
- Replace defective seals only with original seals from Endress+Hauser.
- If threads are damaged or defective, the device must be repaired.
- Do not lubricate threads (e.g. of electronics compartment cover and connection compartment cover).
- If spacing is reduced or the dielectric strength of the device cannot be guaranteed during repair work: Perform a test on completion of the work (e.g. high-voltage test in accordance with the manufacturer's specifications).
- Service connector:
  - Do not connect in potentially explosive atmospheres.
  - Only connect to Endress+Hauser service devices.
- Observe the instructions for transporting and returning the device outlined in the Operating Instructions.

 For information on service and spare parts, contact your Endress+Hauser sales center.

## 4 Tool list

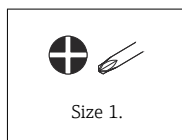
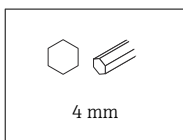

## 5 Housing version

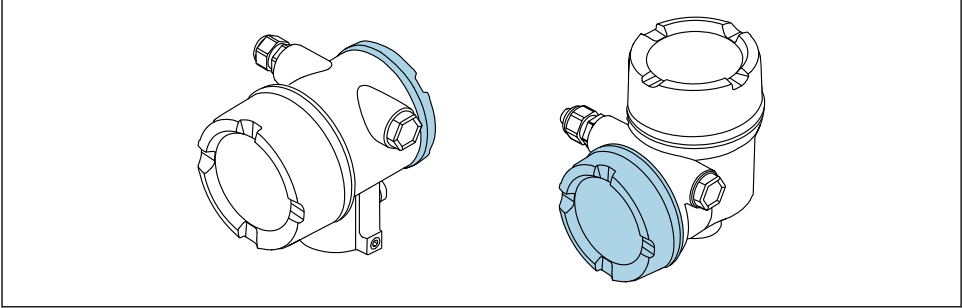

1 Installation positions

## 6 Removal

### 6.1 Removing the cover

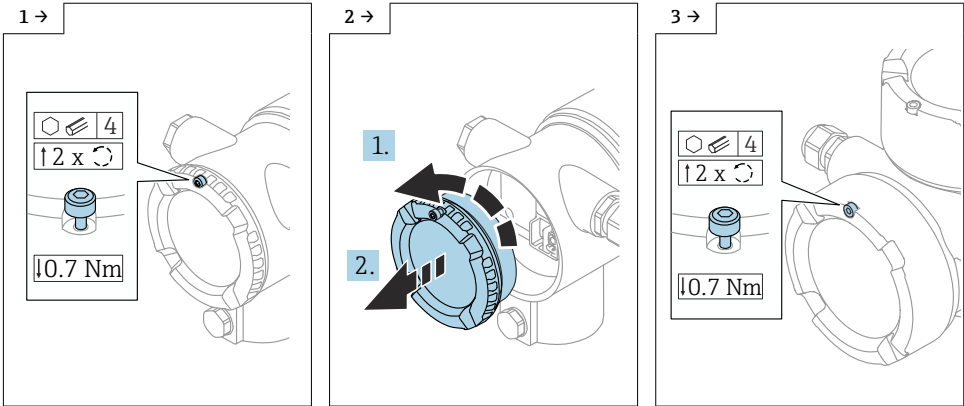

► Optional: L-shaped housing with display in the connection compartment

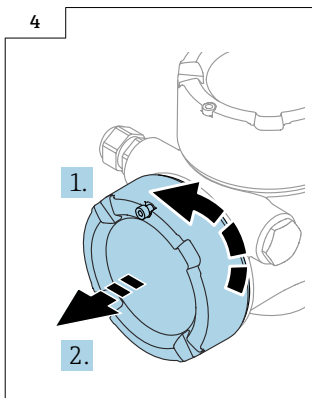

## 6.2 Optional: Removing the display module

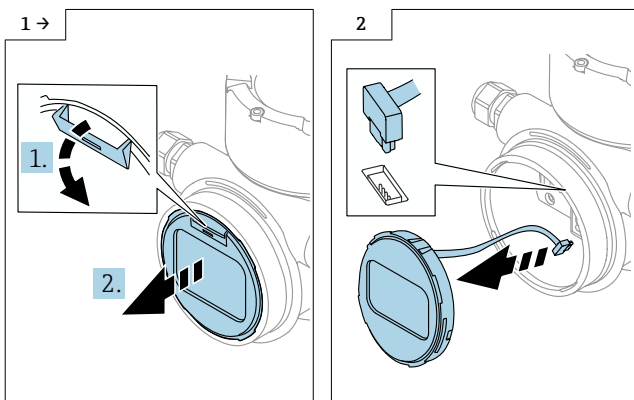

- ▶ L-shaped housing with display in the connection compartment

## 6.3 Disassembling the terminal module

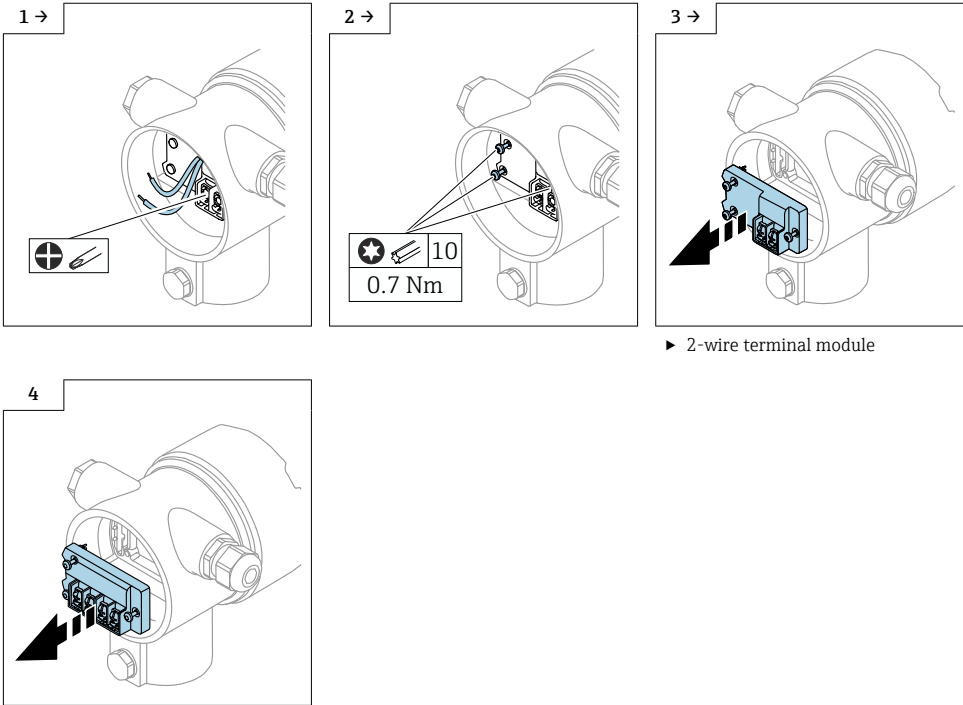

▶ 2-wire terminal module

- ▶ Optional:
- ▶ 4 - wire terminal module

## 7 Reassembling the terminal module

Installation is performed by following the removal procedure in reverse order.



For devices with a cover locking, please note the following:

The securing screw must not protrude over the lower edge of the cover. Pay attention to the position of the securing screw before and while screwing down the cover.

## 8 Disposal



If required by the Directive 2012/19/EU on waste electrical and electronic equipment (WEEE), the product is marked with the depicted symbol in order to minimize the disposal of WEEE as unsorted municipal waste. Do not dispose of products bearing this marking as unsorted municipal waste. Instead, return them to the manufacturer for disposal under the applicable conditions.



71697117

[www.addresses.endress.com](http://www.addresses.endress.com)

---