

# Brief Operating Instructions

## Proline 500 – digital

### PROFIBUS DP

Transmitter with Coriolis sensor

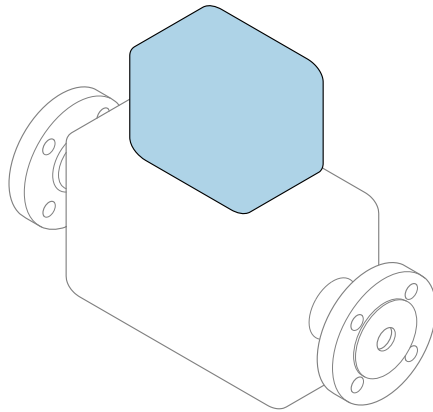

These instructions are Brief Operating Instructions; they are **not** a substitute for the Operating Instructions pertaining to the device.

#### **Transmitter Brief Operating Instructions**

Contain information about the transmitter.

Sensor Brief Operating Instructions →  3



A0023555

## Brief Operating Instructions for the device

The device consists of a transmitter and a sensor.

The process of commissioning these two components is described in two separate manuals:

- Sensor Brief Operating Instructions
- Transmitter Brief Operating Instructions

Please refer to both Brief Operating Instructions when commissioning the device as the contents of the manuals complement one another:

### Sensor Brief Operating Instructions

The Sensor Brief Operating Instructions are aimed at specialists with responsibility for installing the measuring device.

- Incoming acceptance and product identification
- Storage and transport
- Installation

### Transmitter Brief Operating Instructions

The Transmitter Brief Operating Instructions are aimed at specialists with responsibility for commissioning, configuring and parameterizing the measuring device (until the first measured value).

- Product description
- Installation
- Electrical connection
- Operation options
- System integration
- Commissioning
- Diagnostic information

## Additional device documentation



These Brief Operating Instructions are the **Transmitter Brief Operating Instructions**.

The "Sensor Brief Operating Instructions" are available via:

- Internet: [www.endress.com/deviceviewer](http://www.endress.com/deviceviewer)
- Smart phone/tablet: *Endress+Hauser Operations App*

Detailed information about the device can be found in the Operating Instructions and the other documentation:

- Internet: [www.endress.com/deviceviewer](http://www.endress.com/deviceviewer)
- Smart phone/tablet: *Endress+Hauser Operations App*





# Table of contents

<b>1</b>	<b>About this document</b>	<b>5</b>
1.1	Symbols used	5
<b>2</b>	<b>Basic safety instructions</b>	<b>7</b>
2.1	Requirements for the personnel	7
2.2	Designated use	7
2.3	Workplace safety	8
2.4	Operational safety	8
2.5	Product safety	9
2.6	IT security	9
2.7	Device-specific IT security	9
<b>3</b>	<b>Product description</b>	<b>10</b>
<b>4</b>	<b>Installation</b>	<b>11</b>
4.1	Post mounting	11
4.2	Wall mounting	12
4.3	Transmitter post-installation check	12
<b>5</b>	<b>Electrical connection</b>	<b>13</b>
5.1	Connection conditions	13
5.2	Connecting the measuring device	18
5.3	Hardware settings	25
5.4	Ensuring potential equalization	28
5.5	Ensuring the degree of protection	28
5.6	Post-connection check	29
<b>6</b>	<b>Operation options</b>	<b>30</b>
6.1	Overview of operation options	30
6.2	Structure and function of the operating menu	31
6.3	Access to the operating menu via the local display	32
6.4	Access to the operating menu via the operating tool	35
6.5	Access to the operating menu via the Web server	35
<b>7</b>	<b>System integration</b>	<b>35</b>
<b>8</b>	<b>Commissioning</b>	<b>36</b>
8.1	Function check	36
8.2	Setting the operating language	36
8.3	Configuring the measuring device	37
8.4	Protecting settings from unauthorized access	37
<b>9</b>	<b>Diagnostic information</b>	<b>37</b>











# 1 About this document

## 1.1 Symbols used





### 1.1.1 Safety symbols

Symbol	Meaning
	<b>DANGER!</b> This symbol alerts you to a dangerous situation. Failure to avoid this situation will result in serious or fatal injury.
	<b>WARNING!</b> This symbol alerts you to a dangerous situation. Failure to avoid this situation can result in serious or fatal injury.
	<b>CAUTION!</b> This symbol alerts you to a dangerous situation. Failure to avoid this situation can result in minor or medium injury.
	<b>NOTE!</b> This symbol contains information on procedures and other facts which do not result in personal injury.

### 1.1.2 Symbols for certain types of information





Symbol	Meaning	Symbol	Meaning
	<b>Permitted</b> Procedures, processes or actions that are permitted.		<b>Preferred</b> Procedures, processes or actions that are preferred.
	<b>Forbidden</b> Procedures, processes or actions that are forbidden.		<b>Tip</b> Indicates additional information.
	Reference to documentation		Reference to page
	Reference to graphic		Series of steps
	Result of a step		Visual inspection

### 1.1.3 Electrical symbols





Symbol	Meaning	Symbol	Meaning
	Direct current		Alternating current
	Direct current and alternating current		<b>Ground connection</b> A grounded terminal which, as far as the operator is concerned, is grounded via a grounding system.

Symbol	Meaning
	<p><b>Protective Earth (PE)</b>                      A terminal which must be connected to ground prior to establishing any other connections.</p> <p>The ground terminals are situated inside and outside the device:</p> <ul style="list-style-type: none"> <li>▪ Inner ground terminal: Connects the protective earth to the mains supply.</li> <li>▪ Outer ground terminal: Connects the device to the plant grounding system.</li> </ul>





### 1.1.4 Communication symbols

Symbol	Meaning	Symbol	Meaning
	<p><b>Wireless Local Area Network (WLAN)</b>                      Communication via a wireless, local network.</p>		<p><b>LED</b>                      Light emitting diode is off.</p>
	<p><b>LED</b>                      Light emitting diode is on.</p>		<p><b>LED</b>                      Light emitting diode is flashing.</p>

### 1.1.5 Tool symbols

Symbol	Meaning	Symbol	Meaning
	Torx screwdriver		Flat blade screwdriver
	Cross-head screwdriver		Allen key
	Open-ended wrench		

### 1.1.6 Symbols in graphics

Symbol	Meaning	Symbol	Meaning
1, 2, 3,...	Item numbers		Series of steps
A, B, C, ...	Views	A-A, B-B, C-C, ...	Sections
	Hazardous area		Safe area (non-hazardous area)
	Flow direction		

## 2 Basic safety instructions

### 2.1 Requirements for the personnel

The personnel must fulfill the following requirements for its tasks:

- ▶ Trained, qualified specialists must have a relevant qualification for this specific function and task.
- ▶ Are authorized by the plant owner/operator.
- ▶ Are familiar with federal/national regulations.
- ▶ Before starting work, read and understand the instructions in the manual and supplementary documentation as well as the certificates (depending on the application).
- ▶ Follow instructions and comply with basic conditions.

### 2.2 Designated use

#### Application and media

- The measuring device described in these Brief Operating Instructions is intended only for flow measurement of liquids and gases.
- The measuring device described in these Brief Operating Instructions is intended only for flow measurement of liquids.

Depending on the version ordered, the measuring device can also measure potentially explosive, flammable, poisonous and oxidizing media.

Measuring devices for use in hazardous areas, in hygienic applications or where there is an increased risk due to process pressure, are labeled accordingly on the nameplate.

To ensure that the measuring device remains in proper condition for the operation time:

- ▶ Keep within the specified pressure and temperature range.
- ▶ Only use the measuring device in full compliance with the data on the nameplate and the general conditions listed in the Operating Instructions and supplementary documentation.
- ▶ Based on the nameplate, check whether the ordered device is permitted for the intended use in the hazardous area (e.g. explosion protection, pressure vessel safety).
- ▶ Use the measuring device only for media to which the process-wetted materials are sufficiently resistant.
- ▶ If the ambient temperature of the measuring device is outside the atmospheric temperature, it is absolutely essential to comply with the relevant basic conditions as specified in the device documentation.
- ▶ Protect the measuring device permanently against corrosion from environmental influences.

#### Incorrect use

Non-designated use can compromise safety. The manufacturer is not liable for damage caused by improper or non-designated use.

#### WARNING

#### **Danger of breakage due to corrosive or abrasive fluids and ambient conditions!**

- ▶ Verify the compatibility of the process fluid with the sensor material.
- ▶ Ensure the resistance of all fluid-wetted materials in the process.
- ▶ Keep within the specified pressure and temperature range.

**NOTICE****Verification for borderline cases:**

- ▶ For special fluids and fluids for cleaning, Endress+Hauser is glad to provide assistance in verifying the corrosion resistance of fluid-wetted materials, but does not accept any warranty or liability as minute changes in the temperature, concentration or level of contamination in the process can alter the corrosion resistance properties.

**Residual risks****⚠ WARNING**

**The electronics and the medium may cause the surfaces to heat up. This presents a burn hazard!**

- ▶ For elevated fluid temperatures, ensure protection against contact to prevent burns.

*Only applies for Proline Promass A, E, F, O, X and Cubemass C*

**⚠ WARNING**

**Danger of housing breaking due to measuring tube breakage!**

If a measuring tube ruptures, the pressure inside the sensor housing will rise according to the operating process pressure.

- ▶ Use a rupture disk.

**⚠ WARNING**

**Danger from medium escaping!**

For device versions with a rupture disk: medium escaping under pressure can cause injury or material damage.

- ▶ Take precautions to prevent injury and material damage if the rupture disk is actuated.

## 2.3 Workplace safety

For work on and with the device:

- ▶ Wear the required personal protective equipment according to federal/national regulations.

For welding work on the piping:

- ▶ Do not ground the welding unit via the measuring device.

If working on and with the device with wet hands:

- ▶ Due to the increased risk of electric shock, gloves must be worn.

## 2.4 Operational safety

Risk of injury.

- ▶ Operate the device in proper technical condition and fail-safe condition only.
- ▶ The operator is responsible for interference-free operation of the device.



## 2.5 Product safety

This measuring device is designed in accordance with good engineering practice to meet state-of-the-art safety requirements, has been tested, and left the factory in a condition in which it is safe to operate.

It meets general safety standards and legal requirements. It also complies with the EU directives listed in the device-specific EU Declaration of Conformity. Endress+Hauser confirms this by affixing the CE mark to the device.

## 2.6 IT security

Our warranty is valid only if the device is installed and used as described in the Operating Instructions. The device is equipped with security mechanisms to protect it against any inadvertent changes to the settings.

IT security measures, which provide additional protection for the device and associated data transfer, must be implemented by the operators themselves in line with their security standards.

## 2.7 Device-specific IT security

The device offers a range of specific functions to support protective measures on the operator's side. These functions can be configured by the user and guarantee greater in-operation safety if used correctly.



For detailed information on device-specific IT security, see the Operating Instructions for the device.

### 2.7.1 Access via service interface (CDI-RJ45)

The device can be connected to a network via the service interface (CDI-RJ45). Device-specific functions guarantee the secure operation of the device in a network.

The use of relevant industrial standards and guidelines that have been defined by national and international safety committees, such as IEC/ISA62443 or the IEEE, is recommended. This includes organizational security measures such as the assignment of access authorization as well as technical measures such as network segmentation.

### 3 Product description

The measuring system consists of a Proline 500 - digital transmitter and a Proline Promass or Cubemass Coriolis sensor.

The transmitter and sensor are mounted in physically separate locations. They are interconnected by a connecting cable.

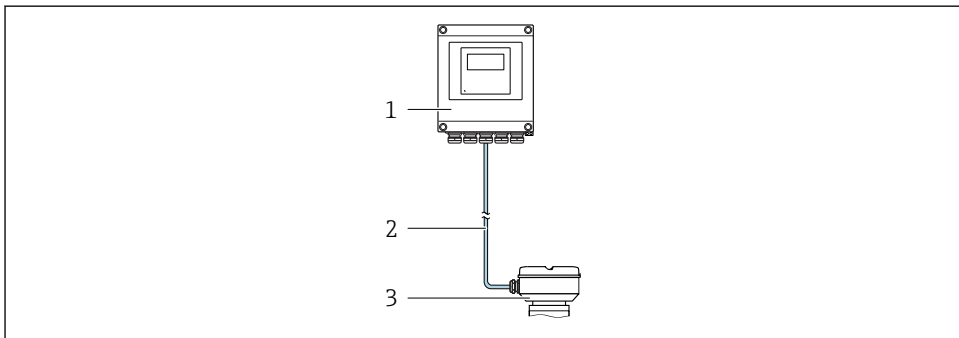

- 1 Transmitter
- 2 Connecting cable: cable, separate, standard
- 3 Sensor connection housing with integrated ISEM (intelligent sensor electronics module)



For detailed information on the product description, see the Operating Instructions for the device

## 4 Installation



For detailed information about mounting the sensor, see the Sensor Brief Operating Instructions → 3

### CAUTION

#### Ambient temperature too high!

Danger of electronics overheating and housing deformation.

- ▶ Do not exceed the permitted maximum ambient temperature .
- ▶ If operating outdoors: Avoid direct sunlight and exposure to weathering, particularly in warm climatic regions.

### CAUTION

#### Excessive force can damage the housing!

- ▶ Avoid excessive mechanical stress.

### 4.1 Post mounting

#### WARNING

#### Excessive tightening torque applied to the fixing screws!

Risk of damaging the plastic transmitter.

- ▶ Tighten the fixing screws as per the tightening torque: 2 Nm (1.5 lbf ft)

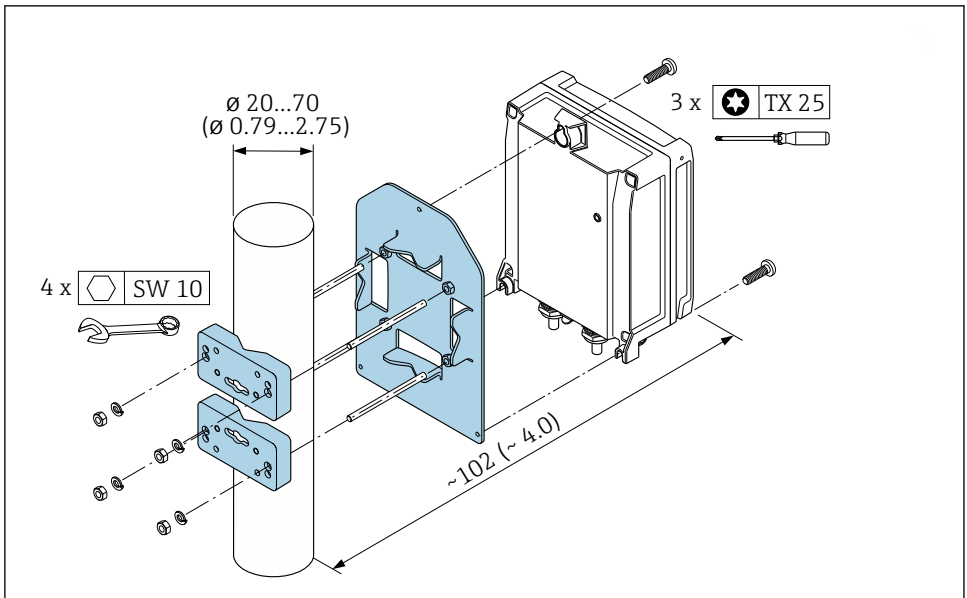

A0029051

1 Engineering unit mm (in)

## 4.2 Wall mounting

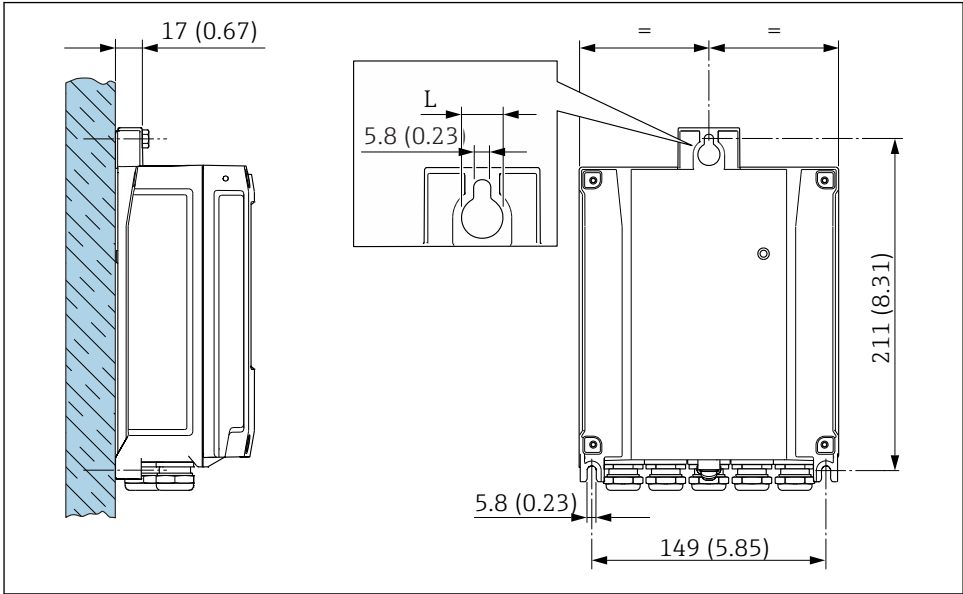

A0029054

2 Engineering unit mm (in)

*L* Depends on order code for "Transmitter housing"

Order code for "Transmitter housing"

- Option **A**, aluminum coated:  $L = 14 \text{ mm (0.55 in)}$
- Option **D**, polycarbonate:  $L = 13 \text{ mm (0.51 in)}$

## 4.3 Transmitter post-installation check

The post-installation check must always be performed after the following tasks:

Mounting the transmitter housing:

- Post mounting
- Wall mounting

Is the device undamaged (visual inspection)?	<input type="checkbox"/>
Post mounting: Have the fixing screws been tightened with the correct tightening torque?	<input type="checkbox"/>
Wall mounting: Are the securing screws tightened securely?	<input type="checkbox"/>

## 5 Electrical connection

### NOTICE

**The measuring device does not have an internal circuit breaker.**

- ▶ For this reason, assign the measuring device a switch or power-circuit breaker so that the power supply line can be easily disconnected from the mains.
- ▶ Although the measuring device is equipped with a fuse, additional overcurrent protection (maximum 10 A) should be integrated into the system installation.

### 5.1 Connection conditions

#### 5.1.1 Required tools

- For cable entries: Use corresponding tools
- For securing clamp: Allen key 3 mm
- Wire stripper
- When using stranded cables: crimper for wire end ferrule
- For removing cables from terminal: Flat blade screwdriver  $\leq 3$  mm (0.12 in)

#### 5.1.2 Connecting cable requirements

The connecting cables provided by the customer must fulfill the following requirements.

#### Electrical safety

In accordance with applicable federal/national regulations.

#### Protective ground cable

Cable  $\geq 2.08$  mm<sup>2</sup> (14 AWG)

The grounding impedance must be less than 1  $\Omega$ .

#### Permitted temperature range

- The installation guidelines that apply in the country of installation must be observed.
- The cables must be suitable for the minimum and maximum temperatures to be expected.

#### Power supply cable

Standard installation cable is sufficient.

#### Cable diameter

- Cable glands supplied:  
M20  $\times$  1.5 with cable  $\varnothing$  6 to 12 mm (0.24 to 0.47 in)
- Spring-loaded terminals: Suitable for strands and strands with ferrules.  
Conductor cross-section 0.2 to 2.5 mm<sup>2</sup> (24 to 12 AWG).

## Signal cable

### *PROFIBUS DP*

The IEC 61158 standard specifies two types of cable (A and B) for the bus line which can be used for every transmission rate. Cable type A is recommended.



For detailed information about the specification of the connecting cable, see the Operating Instructions for the device.



For further information on planning and installing PROFIBUS networks see:

Operating Instructions "PROFIBUS DP/PA: Guidelines for planning and commissioning" (BA00034S)

### *Current output 0/4 to 20 mA*

Standard installation cable is sufficient.

### *Pulse/frequency/switch output*

Standard installation cable is sufficient.

### *Relay output*

Standard installation cable is sufficient.

### *Current input 0/4 to 20 mA*

Standard installation cable is sufficient.

### *Status input*

Standard installation cable is sufficient.

### 5.1.3 Connecting cable

#### Non-hazardous area, Ex Zone 2, Class I, Division 2

##### Standard cable

A standard cable can be used as the connecting cable.

<b>Standard cable</b>	4 cores (2 pairs); pair-stranded with common shield
<b>Shielding</b>	Tin-plated copper-braid, optical cover $\geq 85\%$
<b>Loop resistance</b>	Power supply line (+, -): maximum 10 $\Omega$
<b>Cable length</b>	Maximum 300 m (1 000 ft), see the following table.

Cross-section	Cable length
0.34 mm <sup>2</sup> (AWG 22)	80 m (270 ft)
0.50 mm <sup>2</sup> (AWG 20)	120 m (400 ft)
0.75 mm <sup>2</sup> (AWG 18)	180 m (600 ft)
1.00 mm <sup>2</sup> (AWG 17)	240 m (800 ft)
1.50 mm <sup>2</sup> (AWG 15)	300 m (1 000 ft)

#### Hazardous area, Ex Zone 1, Class I, Division 1

##### Standard cable

A standard cable can be used as the connecting cable.

<b>Standard cable</b>	4, 6, 8 cores (2, 3, 4 pairs); pair-stranded with common shield
<b>Shielding</b>	Tin-plated copper-braid, optical cover $\geq 85\%$
<b>Capacitance C</b>	Maximum 760 nF IIC, maximum 4.2 $\mu$ F IIB
<b>Inductance L</b>	Maximum 26 $\mu$ H IIC, maximum 104 $\mu$ H IIB
<b>Inductance/resistance ratio (L/R)</b>	Maximum 8.9 $\mu$ H/ $\Omega$ IIC, maximum 35.6 $\mu$ H/ $\Omega$ IIB (e.g. in accordance with IEC 60079-25)
<b>Loop resistance</b>	Power supply line (+, -): maximum 5 $\Omega$
<b>Cable length</b>	Maximum 150 m (500 ft), see the following table.

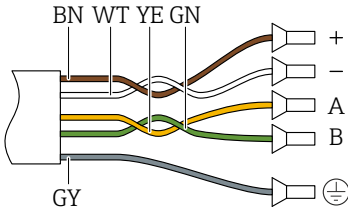
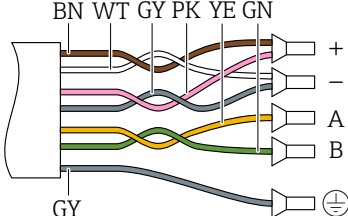
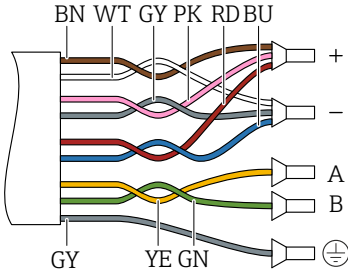
Cross-section	Cable length	Termination
<p>2 x 2 x 0.50 mm<sup>2</sup> (AWG 22)</p>	<p>50 m (165 ft)</p>	 <ul style="list-style-type: none"> <li>■ +, - = 0.5 mm<sup>2</sup></li> <li>■ A, B = 0.5 mm<sup>2</sup></li> </ul>
<p>3 x 2 x 0.50 mm<sup>2</sup> (AWG 22)</p>	<p>100 m (330 ft)</p>	 <ul style="list-style-type: none"> <li>■ +, - = 1.0 mm<sup>2</sup></li> <li>■ A, B = 0.5 mm<sup>2</sup></li> </ul>
<p>4 x 2 x 0.50 mm<sup>2</sup> (AWG 22)</p>	<p>150 m (500 ft)</p>	 <ul style="list-style-type: none"> <li>■ +, - = 1.5 mm<sup>2</sup></li> <li>■ A, B = 0.5 mm<sup>2</sup></li> </ul>

### 5.1.4 Terminal assignment

#### Transmitter: supply voltage, input/outputs

The terminal assignment of the inputs and outputs depends on the individual order version of the device. The device-specific terminal assignment is documented on an adhesive label in the terminal cover.



Supply voltage		Input/output 1		Input/output 2		Input/output 3		Input/output 4	
1 (+)	2 (-)	26 (B)	27 (A)	24 (+)	25 (-)	22 (+)	23 (-)	20 (+)	21 (-)
Device-specific terminal assignment: adhesive label in terminal cover.									

### Transmitter and sensor connection housing: connecting cable

The sensor and transmitter, which are mounted in separate locations, are interconnected by a connecting cable. The cable is connected via the sensor connection housing and the transmitter housing.



Terminal assignment and connection of the connecting cable → 18.

#### 5.1.5 Preparing the measuring device

Carry out the steps in the following order:

1. Mount the sensor and transmitter.
2. Connection housing, sensor: Connect connecting cable.
3. Transmitter: Connect connecting cable.
4. Transmitter: Connect signal cable and cable for supply voltage.

#### NOTICE

##### Insufficient sealing of the housing!

Operational reliability of the measuring device could be compromised.

► Use suitable cable glands corresponding to the degree of protection.

1. Remove dummy plug if present.
2. If the measuring device is supplied without cable glands:  
Provide suitable cable gland for corresponding connecting cable.
3. If the measuring device is supplied with cable glands:  
Observe requirements for connecting cables → 13.

## 5.2 Connecting the measuring device

### NOTICE

#### Limitation of electrical safety due to incorrect connection!

- ▶ Have electrical connection work carried out by appropriately trained specialists only.
- ▶ Observe applicable federal/national installation codes and regulations.
- ▶ Comply with local workplace safety regulations.
- ▶ Always connect the protective ground cable ⊕ before connecting additional cables.
- ▶ For use in potentially explosive atmospheres, observe the information in the device-specific Ex documentation.

### 5.2.1 Connecting the connecting cable

#### ⚠ WARNING

#### Risk of damaging the electronic components!

- ▶ Connect the sensor and transmitter to the same potential equalization.
- ▶ Only connect the sensor to a transmitter with the same serial number.
- ▶ Ground the connection housing of the sensor via the external screw terminal.

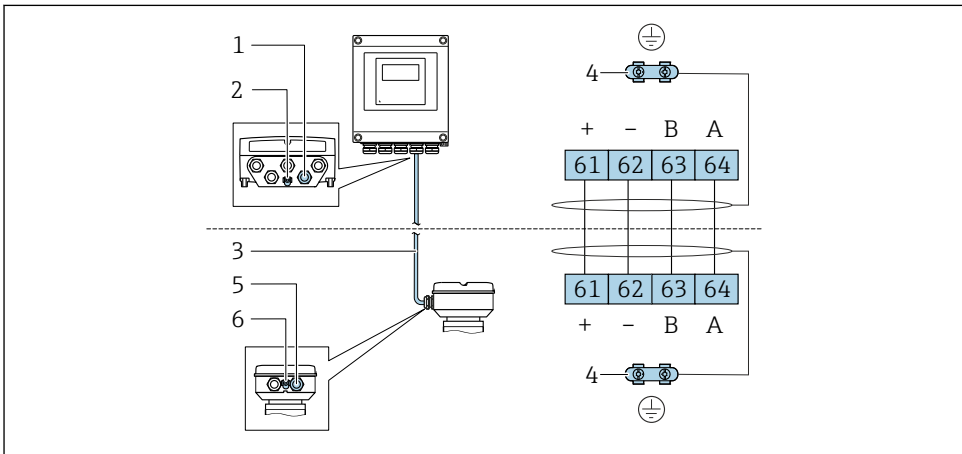

#### Connecting cable terminal assignment



A0028198

- 1 Cable entry for cable on transmitter housing
- 2 Protective earth (PE)
- 3 Connecting cable ISEM communication
- 4 Grounding via ground connection; on device plug versions grounding is through the plug itself
- 5 Cable entry for cable or connection of device plug on sensor connection housing
- 6 Protective earth (PE)

## Connecting the connecting cable to the sensor connection housing

Connection via terminals with order code for "Housing"		Available for sensor
Option A "Aluminum, coated"	→  20	<ul style="list-style-type: none"> <li>■ Promass A, E, F, H, I, O, P, Q, S</li> <li>■ CubemassC</li> </ul>
Option B "Stainless"	→  21	<ul style="list-style-type: none"> <li>■ Promass A, E, F, H, I, O, P, Q, S</li> <li>■ CubemassC</li> </ul>
Option L "Cast, stainless"	→  20	<ul style="list-style-type: none"> <li>■ Promass F, H, I, O, Q, X</li> <li>■ CubemassC</li> </ul>

Connection via connectors with order code for "Sensor connection housing"		Available for sensor
Option C "Ultra-compact hygienic, stainless"	→  22	<ul style="list-style-type: none"> <li>■ Promass A, E, F, H, I, O, P, Q, S</li> <li>■ CubemassC</li> </ul>

## Connecting the connecting cable to the transmitter

The cable is connected to the transmitter via terminals →  23.

## Connecting the sensor connection housing via terminals

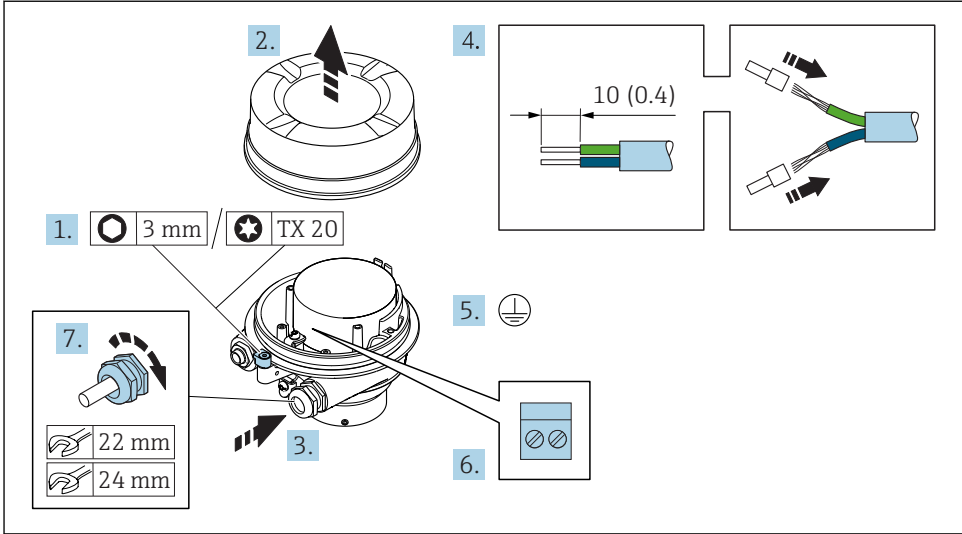

A0029616

1. Loosen the securing clamp of the housing cover.
2. Unscrew the housing cover.
3. Push the cable through the cable entry . To ensure tight sealing, do not remove the sealing ring from the cable entry.
4. Strip the cable and cable ends. In the case of stranded cables, fit ferrules.
5. Connect the protective ground.
6. Connect the cable in accordance with the connecting cable terminal assignment → 18.
7. Firmly tighten the cable glands.
  - ↳ This concludes the process for connecting the connecting cable.

### **⚠ WARNING**

#### **Housing degree of protection voided due to insufficient sealing of the housing.**

- ▶ Screw in the thread on the cover without using any lubricant. The thread on the cover is coated with a dry lubricant.

8. Screw on the housing cover.
9. Tighten the securing clamp of the housing cover.

## Connecting the sensor connection housing via terminals

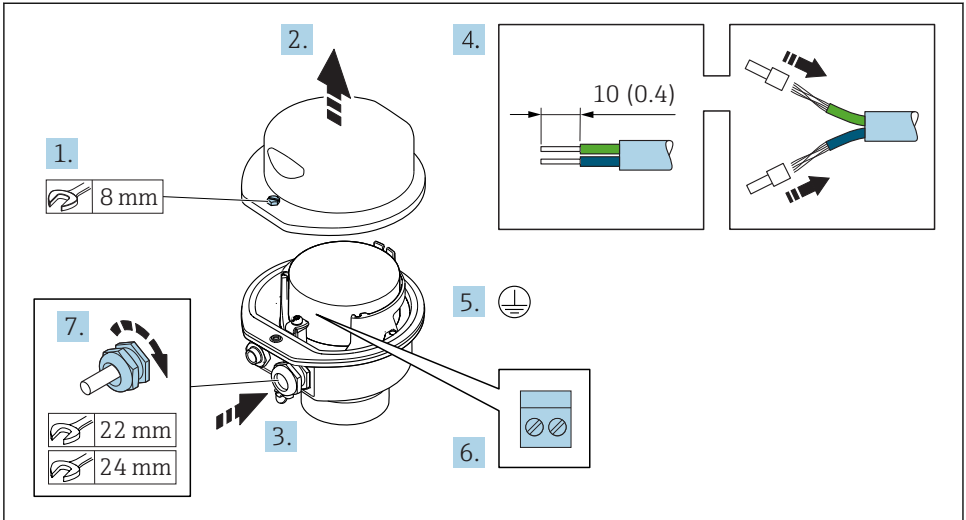

A0029613

1. Release the securing screw of the housing cover.
2. Open the housing cover.
3. Push the cable through the cable entry . To ensure tight sealing, do not remove the sealing ring from the cable entry.
4. Strip the cable and cable ends. In the case of stranded cables, fit ferrules.
5. Connect the protective ground.
6. Connect the cable in accordance with the connecting cable terminal assignment  
→ 18.
7. Firmly tighten the cable glands.  
↳ This concludes the process for connecting the connecting cable.
8. Close the housing cover.
9. Tighten the securing screw of the housing cover.

## Connecting the sensor connection housing via the connector

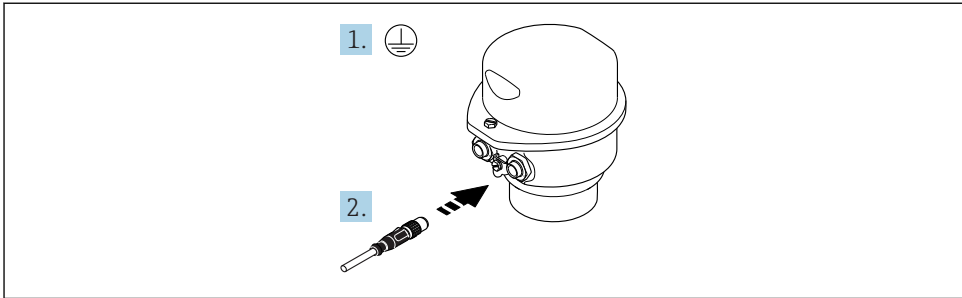

A0029615

1. Connect the protective ground.
2. Connect the connector.

## Connecting the connecting cable to the transmitter

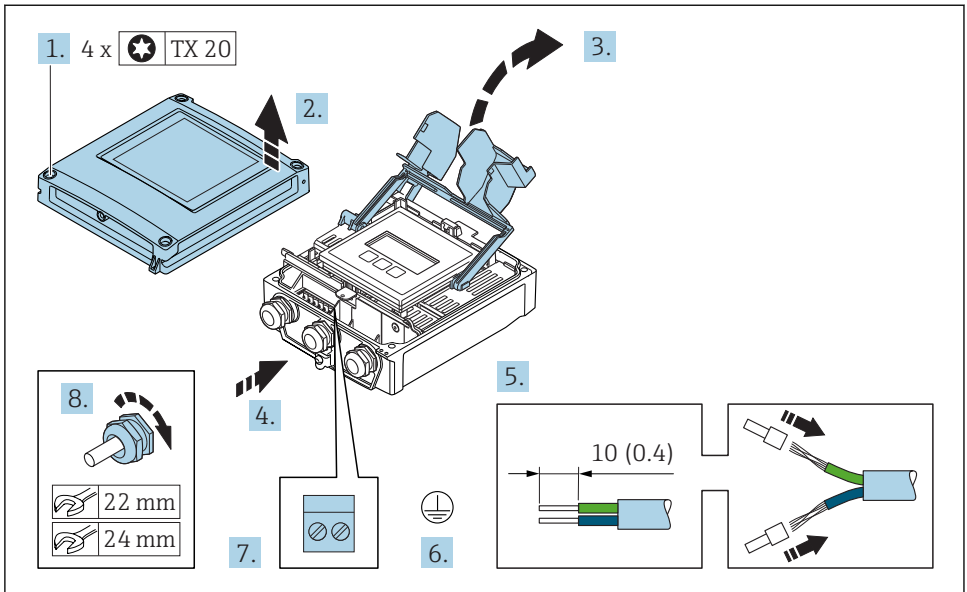

A0029597

1. Loosen the 4 fixing screws on the housing cover.
2. Open the housing cover.
3. Fold open the terminal cover.
4. Push the cable through the cable entry . To ensure tight sealing, do not remove the sealing ring from the cable entry.
5. Strip the cable and cable ends. In the case of stranded cables, fit ferrules.
6. Connect the protective ground.
7. Connect the cable in accordance with the connecting cable terminal assignment → 18.
8. Firmly tighten the cable glands.
  - ↳ This concludes the process for connecting the connecting cable.
9. Close the housing cover.
10. Tighten the securing screw of the housing cover.
11. After connecting the connecting cable:
  - Connect the signal cable and the supply voltage cable → 24.

## 5.2.2 Connecting the signal cable and the supply voltage cable

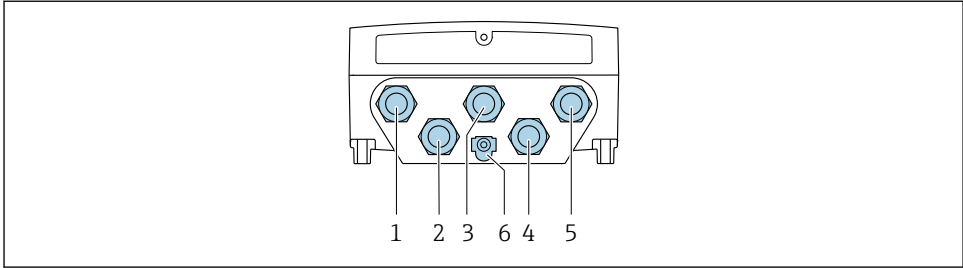

A0028200

- 1 Terminal connection for supply voltage
- 2 Terminal connection for signal transmission, input/output
- 3 Terminal connection for signal transmission, input/output
- 4 Terminal connection for connecting cable between sensor and transmitter
- 5 Terminal connection for signal transmission, input/output; optional: connection for external WLAN antenna
- 6 Protective earth (PE)

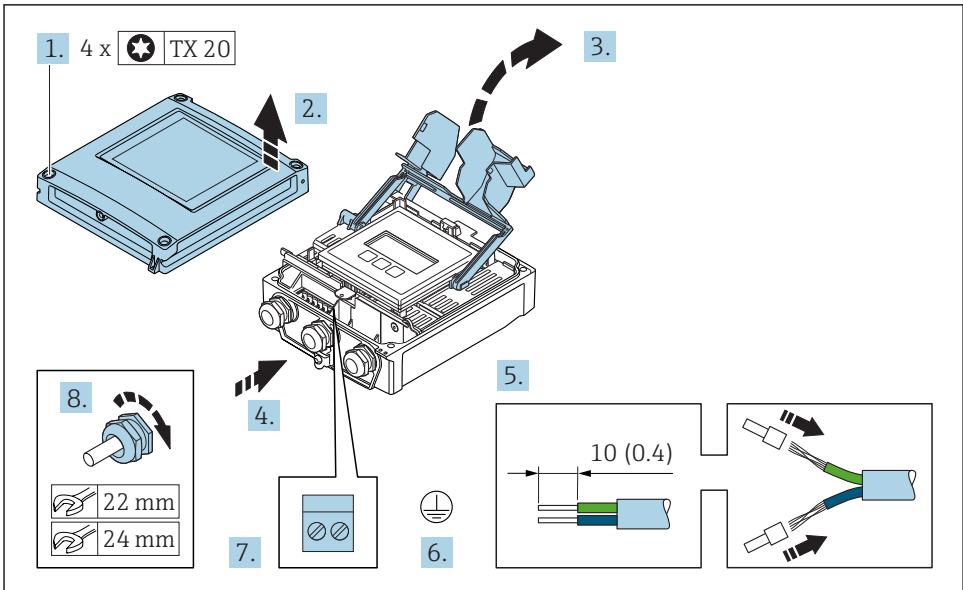

A0029597

1. Loosen the 4 fixing screws on the housing cover.
2. Open the housing cover.
3. Fold open the terminal cover.



4. Push the cable through the cable entry . To ensure tight sealing, do not remove the sealing ring from the cable entry.
5. Strip the cable and cable ends. In the case of stranded cables, fit ferrules.
6. Connect the protective ground.
7. Connect the cable in accordance with the terminal assignment .
  - ↳ **Signal cable terminal assignment:** The device-specific terminal assignment is documented on an adhesive label in the terminal cover.
  - Supply voltage terminal assignment:** Adhesive label in the terminal cover or .
8. Firmly tighten the cable glands.
  - ↳ This concludes the cable connection process.
9. Close the terminal cover.
10. Close the housing cover.

**⚠ WARNING**

**Housing degree of protection may be voided due to insufficient sealing of the housing.**

- ▶ Screw in the screw without using any lubricant.

**⚠ WARNING**

**Excessive tightening torque applied to the fixing screws!**

Risk of damaging the plastic transmitter.

- ▶ Tighten the fixing screws as per the tightening torque: 2 Nm (1.5 lbf ft)

11. Tighten the 4 fixing screws on the housing cover.

## 5.3 Hardware settings

### 5.3.1 Setting the device address

The address must always be configured for a PROFIBUS DP/PA device. The valid address range is between 1 and 126. In a PROFIBUS DP/PA network, each address can only be assigned once. If an address is not configured correctly, the device is not recognized by the master. All measuring devices are delivered from the factory with the device address 126 and with the software addressing method.

## Hardware addressing

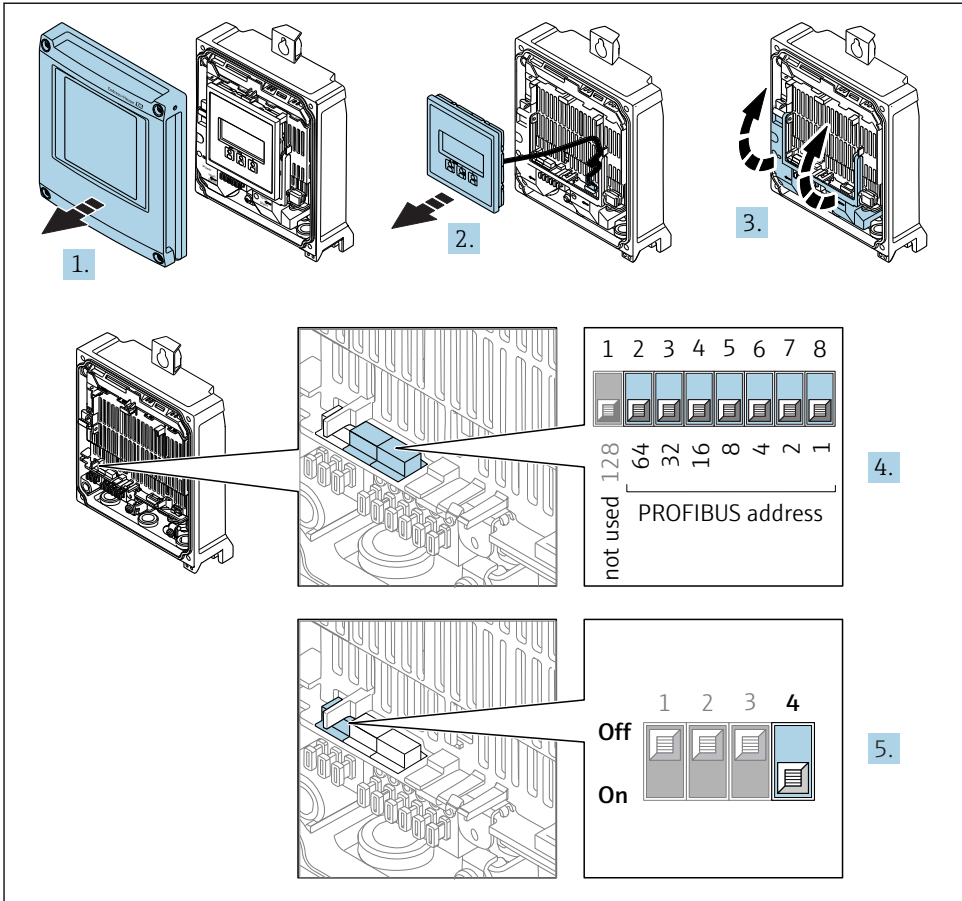

A0029679

1. Open the housing cover.
2. Remove the display module.
3. Fold open the terminal cover.
4. Set the desired device address using the DIP switches.
5. To switch addressing from software addressing to hardware addressing: set the DIP switch to **On**.
  - ↳ The change of device address takes effect after 10 seconds. The device is restarted.

## Software addressing

- ▶ To switch addressing from hardware addressing to software addressing: set DIP switch No. 4 to **Off**.
  - ↳ The device address configured in the **Device address** parameter takes effect after 10 seconds. The device is restarted.

### 5.3.2 Activating the terminating resistor

To avoid incorrect communication transmission caused by impedance mismatch, terminate the PROFIBUS DP cable correctly at the start and end of the bus segment.

- If the device is operated with a baud rate of 1.5 Mbaud and under:  
For the last transmitter on the bus, terminate by setting DIP switch 3 (bus termination) to ON.
- For baud rates > 1.5 Mbaud:  
Due to the capacitance load of the user and the line reflections generated as a result, ensure that an external bus terminator is used.

**i** It is generally advisable to use an external bus terminator as the entire segment can fail if a device that is terminated internally is defective.

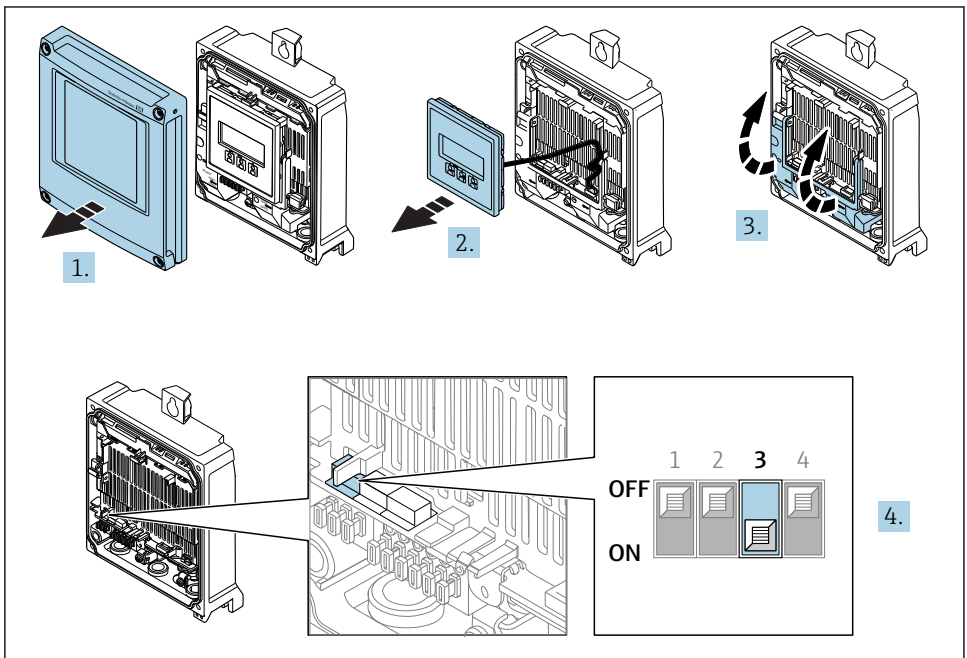

A0029675

1. Open the housing cover.
2. Remove the display module.
3. Fold open the terminal cover.

4. Set DIP switch No. 3 to **ON**.

### 5.3.3 Activating the default IP address

The default IP address 192.168.1.212 can be activated by DIP switch.

Risk of electric shock when opening the transmitter housing.

- ▶ Before opening the transmitter housing:
- ▶ Disconnect the device from the power supply.

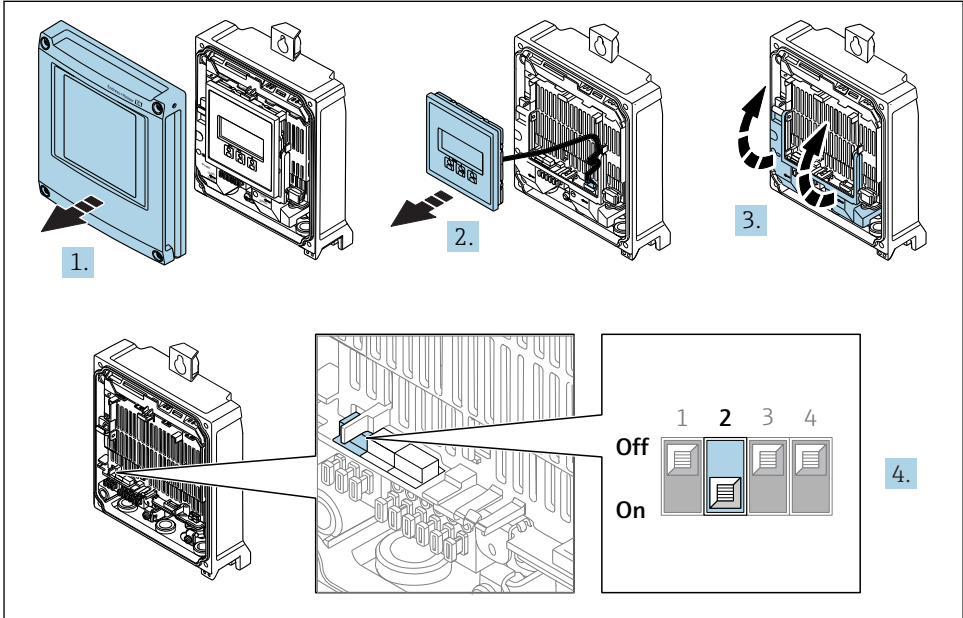

A0034500

- ▶ Set DIP switch No. 2 on the I/O electronics module from **OFF** → **ON**.

## 5.4 Ensuring potential equalization

### 5.4.1 Requirements

No special measures for potential equalization are required.



For devices intended for use in hazardous locations, please observe the guidelines in the Ex documentation (XA).

## 5.5 Ensuring the degree of protection

The measuring device fulfills all the requirements for the IP66/67 degree of protection, Type 4X enclosure.

To guarantee IP66/67 degree of protection, Type 4X enclosure, carry out the following steps after the electrical connection:

1. Check that the housing seals are clean and fitted correctly.
2. Dry, clean or replace the seals if necessary.
3. Tighten all housing screws and screw covers.
4. Firmly tighten the cable glands.
5. To ensure that moisture does not enter the cable entry:  
Route the cable so that it loops down before the cable entry ("water trap").

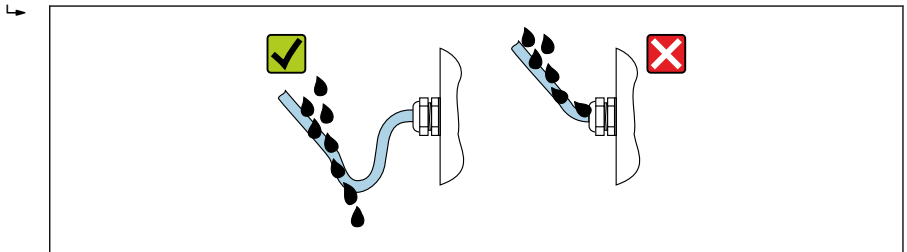

A0029278

6. Insert dummy plugs into unused cable entries.

## 5.6 Post-connection check

Are cables or the device undamaged (visual inspection)?	<input type="checkbox"/>
Do the cables used meet the requirements?	<input type="checkbox"/>
Do the cables have adequate strain relief?	<input type="checkbox"/>
Are all the cable glands installed, firmly tightened and leak-tight? Cable run with "water trap" → 28?	<input type="checkbox"/>

## 6 Operation options

### 6.1 Overview of operation options

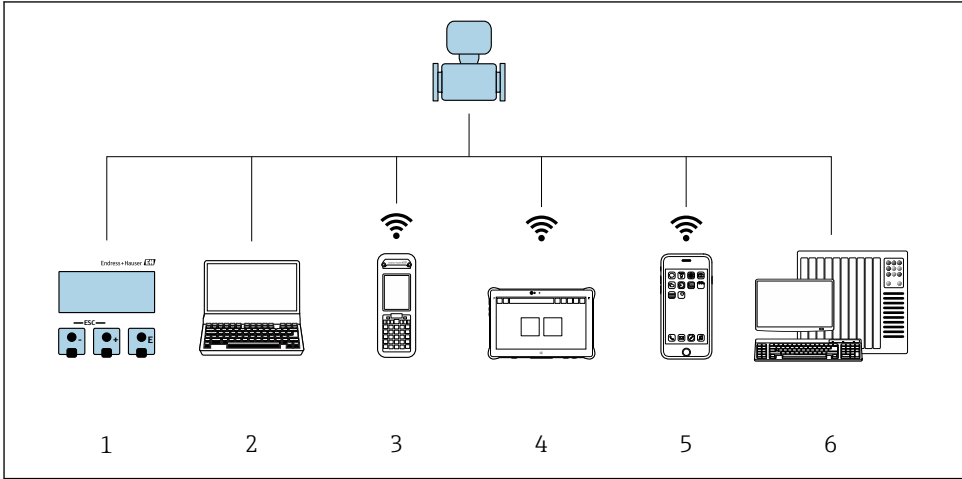

A0034513

- 1 Local operation via display module
- 2 Computer with Web browser (e.g. Internet Explorer) or with operating tool (e.g. FieldCare, DeviceCare, AMS Device Manager, SIMATIC PDM)
- 3 Field Xpert SFX350 or SFX370
- 4 Field Xpert SMT70
- 5 Mobile handheld terminal
- 6 Control system (e.g. PLC)

## 6.2 Structure and function of the operating menu

### 6.2.1 Structure of the operating menu

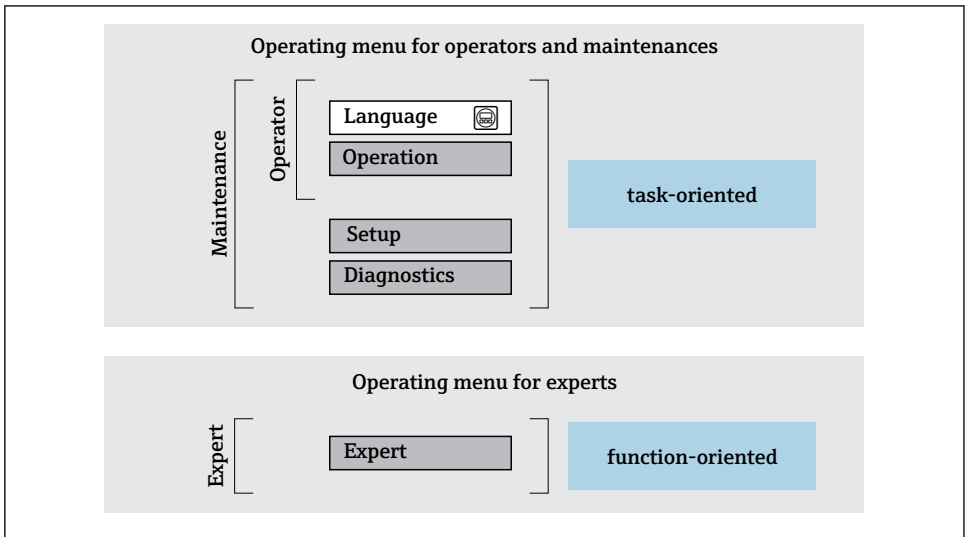

A0014058-EN

 3 Schematic structure of the operating menu

### 6.2.2 Operating philosophy

The individual parts of the operating menu are assigned to certain user roles (operator, maintenance etc.). Each user role contains typical tasks within the device lifecycle.



For detailed information on the operating philosophy, see the Operating Instructions for the device.

### 6.3 Access to the operating menu via the local display

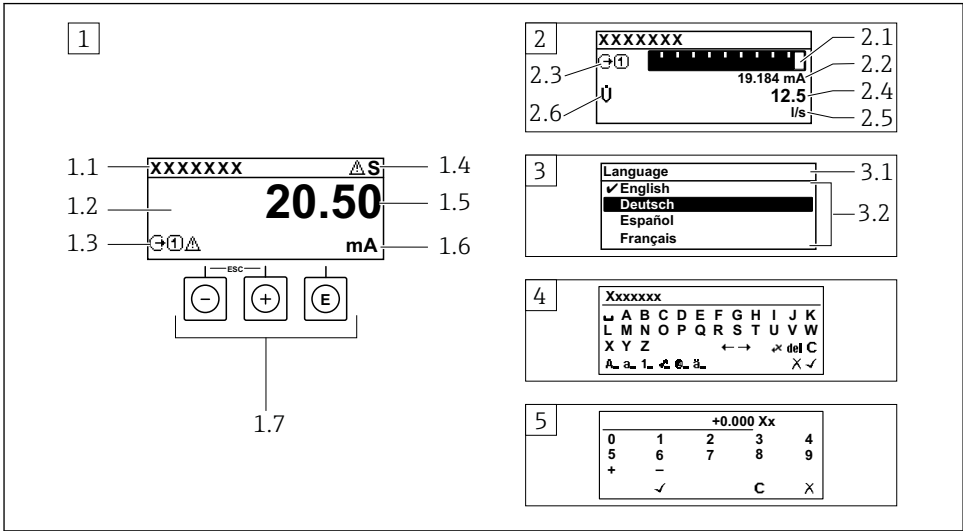

A0014013

- 1 Operational display with measured value shown as "1 value, max." (example)
  - 1.1 Device tag
  - 1.2 Display area for measured values (4-line)
  - 1.3 Explanatory symbols for measured value: Measured value type, measuring channel number, symbol for diagnostic behavior
  - 1.4 Status area
  - 1.5 Measured value
  - 1.6 Unit for the measured value
  - 1.7 Operating elements
- 2 Operational display with measured value shown as "1 bar graph + 1 value" (example)
  - 2.1 Bar graph display for measured value 1
  - 2.2 Measured value 1 with unit
  - 2.3 Explanatory symbols for measured value 1: measured value type, measuring channel number
  - 2.4 Measured value 2
  - 2.5 Unit for measured value 2
  - 2.6 Explanatory symbols for measured value 2: measured value type, measuring channel number
- 3 Navigation view: picklist of a parameter
  - 3.1 Navigation path and status area
  - 3.2 Display area for navigation: ✓ designates the current parameter value
- 4 Editing view: text editor with input mask
- 5 Editing view: numeric editor with input mask



### 6.3.1 Operational display

Explanatory symbols for the measured value	Status area
<ul style="list-style-type: none"> <li>▪ Depends on the device version, e.g.:                             <ul style="list-style-type: none"> <li>- : Volume flow</li> <li>- : Mass flow</li> <li>- : Density</li> <li>- : Conductivity</li> <li>- : Temperature</li> </ul> </li> <li>▪ : Totalizer</li> <li>▪ : Output</li> <li>▪ : Input</li> <li>▪  ... : Measurement channel number <sup>1)</sup></li> <li>▪ Diagnostic behavior <sup>2)</sup> <ul style="list-style-type: none"> <li>- : Alarm</li> <li>- : Warning</li> </ul> </li> </ul>	<p>The following symbols appear in the status area of the operational display at the top right:</p> <ul style="list-style-type: none"> <li>▪ Status signals                             <ul style="list-style-type: none"> <li>- <b>F</b>: Failure</li> <li>- <b>C</b>: Function check</li> <li>- <b>S</b>: Out of specification</li> <li>- <b>M</b>: Maintenance required</li> </ul> </li> <li>▪ Diagnostic behavior                             <ul style="list-style-type: none"> <li>- : Alarm</li> <li>- : Warning</li> </ul> </li> <li>▪ : Locking (locked via hardware))</li> <li>▪ : Communication via remote operation is active.</li> </ul>







- 1) If there is more than one channel for the same measured variable type (totalizer, output etc.).
- 2) For a diagnostic event that concerns the displayed measured variable.

### 6.3.2 Navigation view





Status area	Display area
<p>The following appears in the status area of the navigation view in the top right corner:</p> <ul style="list-style-type: none"> <li>▪ In the submenu                             <ul style="list-style-type: none"> <li>- The direct access code for the parameter you are navigating to (e.g. 0022-1)</li> <li>- If a diagnostic event is present, the diagnostic behavior and status signal</li> </ul> </li> <li>▪ In the wizard                             <ul style="list-style-type: none"> <li>- If a diagnostic event is present, the diagnostic behavior and status signal</li> </ul> </li> </ul>	<ul style="list-style-type: none"> <li>▪ Icons for menus                             <ul style="list-style-type: none"> <li>- : Operation</li> <li>- : Setup</li> <li>- : Diagnostics</li> <li>- : Expert</li> </ul> </li> <li>▪ : Submenus</li> <li>▪ : Wizards</li> <li>▪ : Parameters within a wizard</li> <li>▪ : Parameter locked</li> </ul>

### 6.3.3 Editing view

Text editor	Correction symbols under
Confirms selection.	Clears all entered characters.
Exits the input without applying the changes.	Moves the input position one position to the right.
Clears all entered characters.	Moves the input position one position to the left.
Switches to the selection of the correction tools.	Deletes one character immediately to the left of the input position.
Toggle <ul style="list-style-type: none"> <li>▪ Between upper-case and lower-case letters</li> <li>▪ For entering numbers</li> <li>▪ For entering special characters</li> </ul>	

Numeric editor	
 Confirms selection.	 Moves the input position one position to the left.
 Exits the input without applying the changes.	 Inserts decimal separator at the input position.
 Inserts minus sign at the input position.	 Clears all entered characters.

### 6.3.4 Operating elements

Keys and meaning
<p> <b>Enter key</b></p> <p><i>With an operational display</i> Pressing the key briefly opens the operating menu.</p> <p><i>In a menu, submenu</i></p> <ul style="list-style-type: none"> <li>▪ Pressing the key briefly:                     <ul style="list-style-type: none"> <li>– Opens the selected menu, submenu or parameter.</li> <li>– Starts the wizard.</li> <li>– If help text is open:                             <ul style="list-style-type: none"> <li>– Closes the help text of the parameter.</li> </ul> </li> </ul> </li> <li>▪ Pressing the key for 2 s in the case of a parameter: If present, opens the help text for the function of the parameter.</li> </ul> <p><i>With a wizard:</i> Opens the editing view of the parameter.</p> <p><i>With a text and numeric editor</i></p> <ul style="list-style-type: none"> <li>▪ Press the key briefly: confirm your selection.</li> <li>▪ Press the key for 2 s: confirm the entry.</li> </ul>
<p> <b>Minus key</b></p> <ul style="list-style-type: none"> <li>▪ <i>In a menu, submenu:</i> Moves the selection bar upwards in a picklist.</li> <li>▪ <i>With a wizard:</i> Confirms the parameter value and goes to the previous parameter.</li> <li>▪ <i>With a text and numeric editor:</i> Moves the cursor position to the left.</li> </ul>
<p> <b>Plus key</b></p> <ul style="list-style-type: none"> <li>▪ <i>In a menu, submenu:</i> Moves the selection bar downwards in a picklist.</li> <li>▪ <i>With a wizard:</i> Confirms the parameter value and goes to the next parameter.</li> <li>▪ <i>With a text and numeric editor:</i> Moves the cursor position to the right.</li> </ul>
<p>+ <b>Escape key combination (press keys simultaneously)</b></p> <p><i>In a menu, submenu</i></p> <ul style="list-style-type: none"> <li>▪ Pressing the key briefly:                     <ul style="list-style-type: none"> <li>– Exits the current menu level and takes you to the next higher level.</li> <li>– If help text is open, closes the help text of the parameter.</li> </ul> </li> <li>▪ Pressing the key for 2 s in the case of a parameter: Returns you to the operational display ("home position").</li> </ul> <p><i>With a wizard:</i> Exits the wizard and takes you to the next higher level.</p> <p><i>With a text and numeric editor:</i> Closes the editor view without applying any changes.</p>

**Keys and meaning** **Minus/Enter key combination (press the keys simultaneously)**

*With an operational display:*

- If keypad lock is active:  
Press the key for 3 s: Deactivates the keypad lock.
- If keypad lock is not active:  
Press the key for 3 s: Opens the context menu including the option for activating the keypad lock.

**6.3.5 Further information**

For further information on the following topics, see the Operating Instructions for the device

- Calling up help text
- User roles and related access authorization
- Disabling write protection via access code
- Enabling and disabling the keypad lock

**6.4 Access to the operating menu via the operating tool**

The operating menu can also be accessed via the FieldCare and DeviceCare operating tools. See the Operating Instructions for the device.

**6.5 Access to the operating menu via the Web server**

The operating menu can also be accessed via the Web server. See the Operating Instructions for the device.

**7 System integration**

For detailed information on system integration, see the Operating Instructions for the device.

- Overview of device description files:
  - Current version data for the device
  - Operating tools
- Device master file (GSD)
  - Manufacturer-specific GSD
  - Profile GSD
- Compatibility with previous model
- Using the GSD modules of the previous model
- Cyclic data transmission
  - Block model
  - Description of the modules

## 8 Commissioning

### 8.1 Function check

Before commissioning the measuring device:

- ▶ Make sure that the post-installation and post-connection checks have been performed.
- "Post-installation check" checklist →  12
- "Post-connection check" checklist →  29

### 8.2 Setting the operating language

Factory setting: English or ordered local language

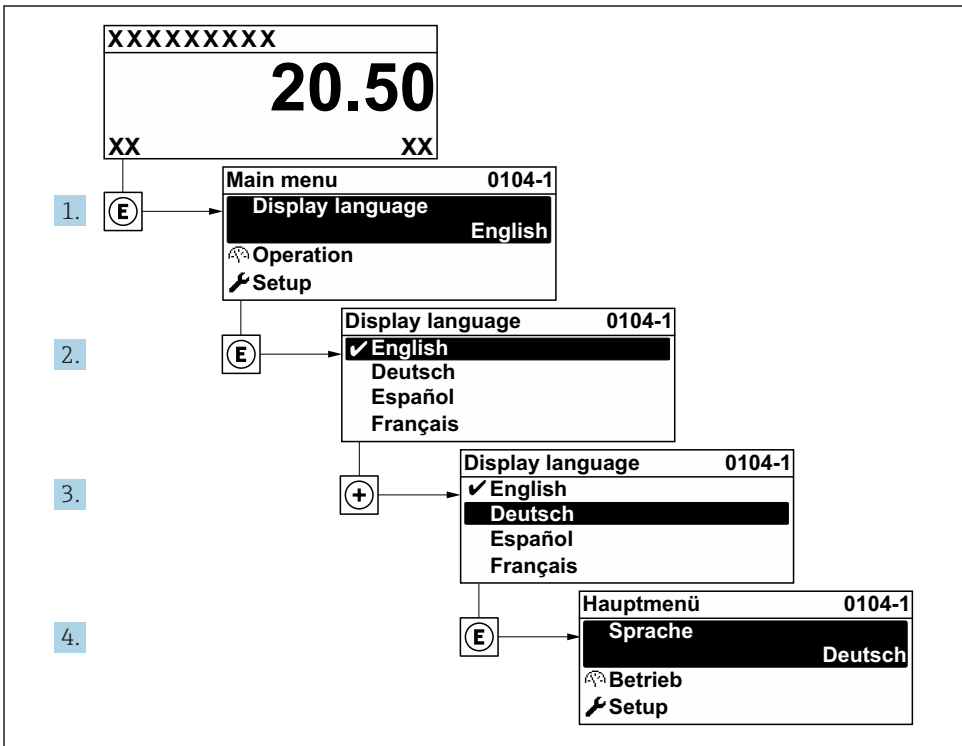

A0029420

 4 Taking the example of the local display

## 8.3 Configuring the measuring device

The **Setup** menu with its submenus and guided wizards is used for fast commissioning of the device. They contain all the parameters required for configuration, such as for measurement or communication.



Depending on the device version, not all submenus and parameters are available in every device. The selection can vary depending on the order code.

Example: Available submenus, wizards	Meaning
System units	Configure the units for all measured values
Medium selection	Define the medium
User interface	Configure the display format on the local display
Low flow cut off	Set the low flow cut off
Partially filled pipe detection	Configure partial and empty pipe detection
Advanced setup	Additional parameters for configuration: <ul style="list-style-type: none"> <li>▪ Calculated process variables</li> <li>▪ Sensor adjustment</li> <li>▪ Totalizer</li> <li>▪ User interface</li> <li>▪ WLAN settings</li> <li>▪ Data backup</li> <li>▪ Administration</li> </ul>

## 8.4 Protecting settings from unauthorized access

The following write protection options exist in order to protect the configuration of the measuring device from unintentional modification:

- Protect access to parameters via access code
- Protect access to local operation via key locking
- Protect access to measuring device via write protection switch



For detailed information on protecting the settings against unauthorized access, see the Operating Instructions for the device.

## 9 Diagnostic information

Faults detected by the self-monitoring system of the measuring device are displayed as a diagnostic message in alternation with the operational display. The message about remedial measures can be called up from the diagnostic message, and contains important information on the fault.

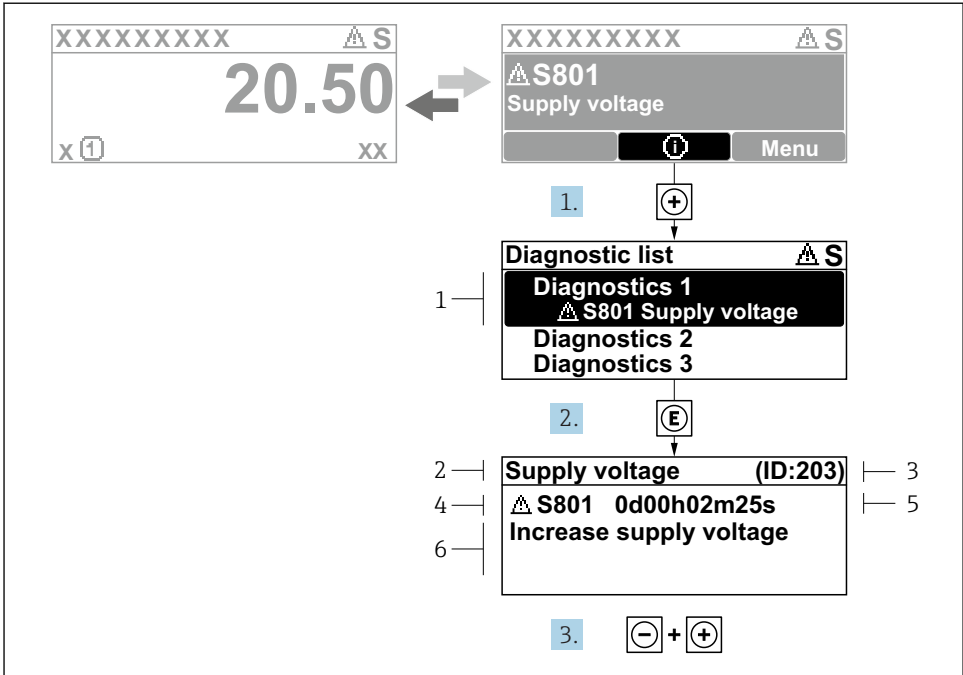

A0029431-EN

5 Message about remedial measures

- 1 Diagnostic information
- 2 Short text
- 3 Service ID
- 4 Diagnostic behavior with diagnostic code
- 5 Operation time of occurrence
- 6 Remedial measures

1. The user is in the diagnostic message.  
Press **+** (ⓘ symbol).  
↳ The **Diagnostic list** submenu opens.
2. Select the desired diagnostic event with **+** or **-** and press **E** .  
↳ The message about the remedial measures opens.
3. Press **-** + **+** simultaneously.  
↳ The message about the remedial measures closes.



[www.addresses.endress.com](http://www.addresses.endress.com)

---