

# Safety Instructions

## Micropilot

### FMR50/51/52/53/54/56/57

PROFIBUS PA, FOUNDATION Fieldbus

Control Drawing IS



Document: XA01118F-B  
Safety instructions for electrical apparatus for explosion-hazardous areas → 3

Document: XA01118F-B  
Temperature tables → 15

Document: XA01118F-B  
Attachment: Nameplate view → 67

---

# Micropilot FMR50/51/52/53/54/56/57

PROFIBUS PA, FOUNDATION Fieldbus

## Table of contents

Associated documentation . . . . .	4
Manufacturer's certificates . . . . .	4
Manufacturer address . . . . .	4
Extended order code . . . . .	4
Combined type of protection (Approval code, 8A) . . . . .	8
Safety instructions: General . . . . .	8
Safety instructions: Special conditions . . . . .	9
Safety instructions: Installation . . . . .	10
Intrinsic safety . . . . .	11
Class I, Div. 2, Groups A-D . . . . .	12
Process seals . . . . .	13
Temperature tables . . . . .	13
Connection data . . . . .	13

**Associated documentation** This document is an integral part of the following Operating Instructions:

PROFIBUS PA

- BA01124F/00 (FMR50)
- BA01125F/00 (FMR51, FMR52)
- BA01126F/00 (FMR53, FMR54)
- BA01127F/00 (FMR56, FMR57)

FOUNDATION Fieldbus

- BA01120F/00 (FMR50)
- BA01121F/00 (FMR51, FMR52)
- BA01122F/00 (FMR53, FMR54)
- BA01123F/00 (FMR56, FMR57)

**Manufacturer's certificates** **FM C/US certificate**

Certificate number:

- FM19.US0045X
- FM19.CA0023X

**Manufacturer address** Endress+Hauser SE+Co. KG  
Hauptstraße 1  
79689 Maulburg, Germany  
Address of the manufacturing plant: See nameplate.

**Extended order code** The extended order code is indicated on the nameplate, which is affixed to the device in such a way that it is clearly visible. Additional information about the nameplate is provided in the associated Operating Instructions.

#### Structure of the extended order code

FMR5x	–	*****	+	A*B*C*D*E*F*G*..
<i>(Device type)</i>		<i>(Basic specifications)</i>		<i>(Optional specifications)</i>

\* = Placeholder

At this position, an option (number or letter) selected from the specification is displayed instead of the placeholders.

#### *Basic specifications*

The features that are absolutely essential for the device (mandatory features) are specified in the basic specifications. The number of positions depends on the number of features available. The selected option of a feature can consist of several positions.

#### *Optional specifications*

The optional specifications describe additional features for the device (optional features). The number of positions depends on the number of features available. The features have a 2-digit structure to aid identification (e.g. JA). The first digit (ID) stands for the feature group and consists of a number or a letter (e.g. J = Test, Certificate). The second digit constitutes the value that stands for the feature within the group (e.g. A = 3.1 material (wetted parts), inspection certificate).

More detailed information about the device is provided in the following tables. These tables describe the individual positions and IDs in the extended order code which are relevant to hazardous locations.

**Extended order code: Micropilot**

The following specifications reproduce an extract from the product structure and are used to assign:

- This documentation to the device (using the extended order code on the nameplate).
- The device options cited in the document.

*Device type*

FMR50, FMR51, FMR52, FMR53, FMR54, FMR56, FMR57

*Basic specifications*

Position 1, 2 (Approval)		
Selected option		Description
FMR5x	FA	FM C/US IS Cl. I, Div. 1, Groups A-D
	FB	FM C/US IS Cl. I, II, III, Div. 1, Groups A-G; Cl. I, Zone 0, AEx ia/Ex ia IIC; NI Cl. I, Div. 2, Groups A-D
	8A	FM/CSA IS+XP-IS Cl. I, II, III, Div. 1, Groups A-G, AIS Cl. I, II, III, Div. 1, Groups A-G

Position 3 (Power Supply, Output)		
Selected option		Description
FMR5x	E	2-wire, FOUNDATION Fieldbus, switch output (PFS)
	G	2-wire, PROFIBUS PA, switch output (PFS)

Position 4 (Display, Operation)		
Selected option		Description
FMR5x	A	Without, via communication
	C	SD02, 4-line, push buttons + data backup function
	E	SD03, 4-line, illum., touch control + data backup function
	L <sup>1)</sup>	Prepared for display FHX50 + M12 connection
	M <sup>1)</sup>	Prepared for display FHX50 + custom connection
	N <sup>2)</sup>	Prepared for display FHX50 + NPT1/2"

- 1) In connection with Position 5 (Housing) = A: Observe the specifications in the "Overvoltage protection" and "Temperature tables" chapters!
- 2) Only in connection with Position 5 (Housing) = B, C

Position 5 (Housing)		
Selected option		Description
FMR5x	A <sup>1)</sup>	GT19 dual compartment, plastic PBT
	C	GT20 dual compartment, Alu, coated
FMR51-54 FMR57	B	GT18 dual compartment, 316L

- 1) Only in connection with Position 1, 2 (Approval) = FA

Position 7, 8 (Antenna)		
Selected option		Description
FMR50	BM	Horn 40 mm/1½", PVDF encapsulated, -40...130°C
	BN	Horn 80 mm/3", PP cladde, -40...80°C
	BR	Horn 100 mm/4", PP cladde, -40...80°C
FMR51	Bx	Horn (different sizes)
FMR52	BO	Horn 50 mm/2", -40...200°C <sup>1)</sup> , -196...200°C <sup>2)</sup> , flush mount
	BP	Horn 80 mm/3", -40...200°C <sup>1)</sup> , -196...200°C <sup>2)</sup> , flush mount
FMR53	Cx	Rod (different sizes)
FMR54	Ax	Without Horn
	Bx	Horn (different sizes)
	Dx	Planar (different sizes)
FMR56	BN	Horn 80 mm/3", PP cladde, -40...80°C
	BR	Horn 100 mm/4", PP cladde, -40...80°C
FMR57	Bx	Horn (different sizes)
	Fx	Parabolic (different sizes)

1) In connection with Position 5 (Housing) = A

2) Only in connection with Position 5 (Housing) = B, C

Position 9, 10 (Seal)		
Selected option		Description
FMR51	A5	Viton GLT, -40...150°C
	C1	Kalrez, -20...150°C
	D2	Graphite, -196...450°C (HT)
	D3	Graphite, -40...250°C (XT)
FMR54	A7	Viton, -20...150°C (Planar)
	A8	Viton, -40...200°C
	B4	EPDM, -40...150°C
	C2	Kalrez, -20...200°C, conductive media max. 150°C
	D1	Graphite, -196...280°C (XT)
	D2	Graphite, -196...400°C (HT)
FMR57	A6	Viton GLT, -40...200°C
	D4	Graphite, -40...400°C (HT)

Position 11-13 (Process Connection)		
Selected option		Description
FMR51-54 FMR57	Axx Cxx Kxx	Flange (different sizes)
FMR50	GGF RGF	Thread, PVDF
	UAE	Mounting bracket
	XRO	Connection, without flange/mounting bracket
	XxG	Slip on flange (different sizes)

Position 11-13 (Process Connection)		
Selected option		Description
FMR51	Pxx	Flange (different sizes)
	Rxx	Thread
	Txx	Tri-Clamp
FMR52	Mxx	Slotted-nut
	Txx	Tri-Clamp
FMR53	RxJ	Thread, 316L
	RxF	Thread, PVDF
FMR56	UAE	Mounting bracket
	XR0	Connection, without flange/mounting bracket
	XxG	Slip on flange (different sizes)
FMR57	RxJ	Thread, 316L
	XxJ	Align. device (different sizes)

Position 14 (Air Purge Connection)		
Selected option		Description
FMR57	1	G1/4
	2	NPT1/4

#### Optional specifications

ID Jx (Test, Certificate)		
Selected option		Description
FMR51 <sup>1)</sup> FMR52 FMR54 <sup>2)</sup>	JN <sup>3)</sup>	Ambient temperature transmitter -50°C

- 1) Only in connection with Position 9, 10 (Seal) = D2
- 2) Only in connection with Position 9, 10 (Seal) = D1, D2
- 3) Only in connection with Position 5 (Housing) = B, C

ID Nx, Ox (Accessory Mounted)		
Selected option		Description
FMR5x	NA	Overvoltage protection
FMR51	OM OU OV	Antenna extension (different sizes)
	OW	Horn protection, PTFE, no airpurge possible
FMR54	OM ON OR OS	Antenna extension (different sizes)
	OP OT	Antenna extension (different sizes)
	OW	Horn protection, PTFE, no airpurge possible

**Combined type of protection (Approval code, 8A)**

Devices with approval code "8A" are suitable for installation with explosion protection type of Intrinsic Safety or Explosionproof.

- Before initial commissioning, specify the type of protection.
- It is not permitted to change the type of protection after initial commissioning as this can jeopardize the explosion protection.

For aluminum housings:

Void out the explosion protection that is not used on the nameplate.

For stainless steel housings:

Using a striking tool, mark the explosion protection used, or void out the explosion protection that is not used.

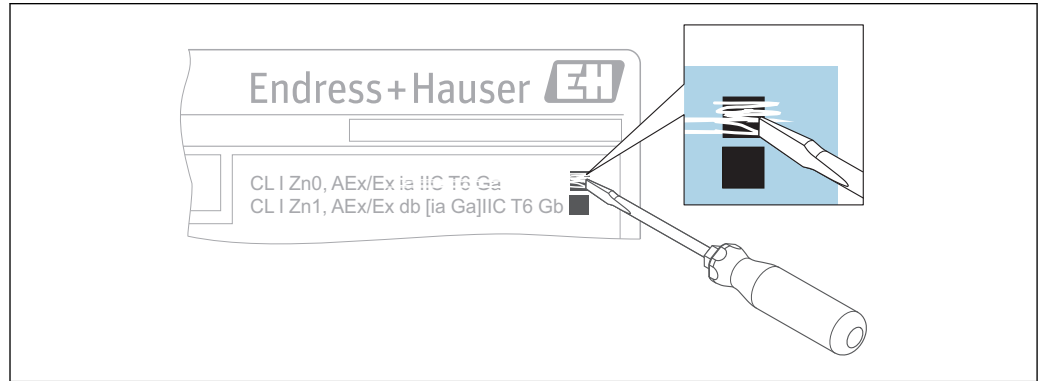

A003253

1

**i** It is critical to observe and follow the correct instructions for installation depending on the type of protection used. Refer to the following table for reference to the correct installation instructions.

Type of protection	Agency approval	Control Drawing no. / Document no.
Intrinsic Safety	CSA	XA01114F
	FM	XA01118F
Explosionproof	CSA	XA01115F
	FM	XA01119F

Class I, Division 2 installation:

References in this manual to Class I, Division 2 installation are not applicable for devices with the combined type of protection. For installation in Class I, Division 2, these devices must be installed per the applicable Division 1 intrinsic safety or explosionproof requirements.

**Safety instructions: General**

- Staff must meet the following conditions for mounting, electrical installation, commissioning and maintenance of the device:
  - Be suitably qualified for their role and the tasks they perform
  - Be trained in explosion protection
  - Be familiar with national regulations
- Install the device according to the manufacturer's instructions and national regulations.
- Do not operate the device outside the specified electrical, thermal and mechanical parameters.
- Only use the device in media to which the wetted materials have sufficient durability.



- Avoid electrostatic charging:
  - Of plastic surfaces (e.g. housing, sensor element, special varnishing, attached additional plates, ..)
  - Of isolated capacities (e.g. isolated metallic plates)
- Modifications to the device can affect the explosion protection and must be carried out by staff authorized to perform such work by Endress+Hauser.
- Refer to the temperature tables for the relationship between the permitted ambient temperature for the sensor and/or transmitter, depending on the range of application and the temperature class.

**Safety instructions:**  
**Special conditions**

Permitted ambient temperature range at the electronics housing:  
 $-40\text{ °C} \leq T_a \leq +80\text{ °C}$

*Optional specification, ID Jx (Test, Certificate) = JN*

Permitted ambient temperature range at the electronics housing:  
 $-50\text{ °C} \leq T_a \leq +80\text{ °C}$

- Observe the information in the temperature tables.
- Use supply wires suitable for 20 K above the ambient temperature.
- In the case of process connections made of polymeric material or with polymeric coatings, avoid electrostatic charging of the plastic surfaces.
- In the event of additional or alternative special varnishing on the housing or other metal parts:
  - Observe the danger of electrostatic charging and discharge.
  - Do not rub surfaces with a dry cloth.

*Basic specification, Position 5 (Housing) = A*

Avoid electrostatic charging of the housing (e.g. friction, cleaning, maintenance, strong medium flow).

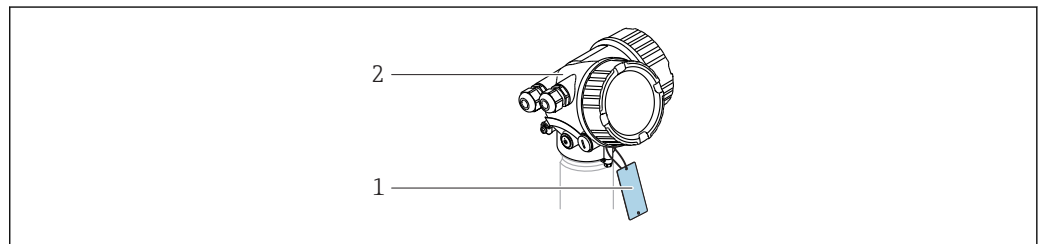

A0032146

■ 2

1 *Isolated capacitance:*

*with one metal plate:  $\leq 3\text{ pF}$  (permitted for Class I, II, III, Division 1, Division 2 and Class I, Zone 0, Zone 1)*

*with two to three metal plates:  $\leq 10\text{ pF}$  (not permitted for Class I, Zone 0 and for Equipment Group IIC)*

2 *Housing*

*Basic specification, Position 5 (Housing) = C*

In Zone 0, avoid sparks caused by impact and friction.

*Device type FMR50, FMR52, FMR53, FMR54 (planar, enamel), FMR56*

An antenna coated with non-conductive material can be used if avoiding electrostatic charging (e.g. through friction, cleaning, maintenance, strong medium flow).

*Device type FMR51, FMR57 and Optional specification, ID Nx, Ox (Accessory Mounted) = OW*

An antenna coated with non-conductive material can be used if avoiding electrostatic charging (e.g. through friction, cleaning, maintenance, strong medium flow).

*Device type FMR57 and Basic specification, Position 11-13 (Process Connection) = Xxj*

- Changing the position of the alignment device must be impossible:
  - After the alignment of the antenna via the pivot bracket
  - After tightening of the clamping flange
  - After setting the damping ring (torque 15 Nm)
- Degree of protection IP67 must be fulfilled.

Device type FMR57 and Basic specification, Position 14 (Air Purge Connection) = 1, 2

- If equipment with Ga/Gb or Da/Db is required: In the closed state the minimum degree of protection of the installation must be IP67.
- After removing the air purge connection: Lock the opening with a suitable plug.
  - Torque: 6-7 Nm
  - For Da/Db: thread engagement > 5 turns
- Degree of protection IP67 must be fulfilled.

Device type FMR51, FMR54, FMR57 and Optional specification, ID Nx, Ox (Accessory Mounted) = OM, ON, OR, OS, OU, OV, OP, OT

Avoid contact between sensor and tank wall. Take into account tank fittings and flow conditions (avoid sparks caused by impact and friction).

### Safety instructions: Installation

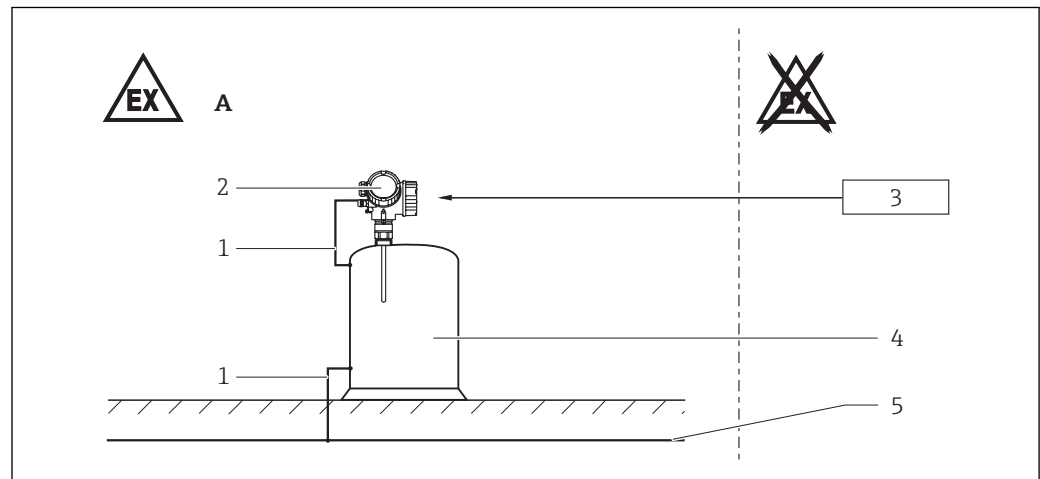

A0022629



- A Class I, Div. 1 or 2, Groups A, B, C, D; Class II, Div. 1, Groups E, F, G; Zone 0 or Zone 1
- 1 Potential equalization line
- 2 Electronic insert
- 3 Certified associated apparatus
- 4 Tank; Class I, Div. 1 or 2, Groups A, B, C, D; Class II, Div. 1, Groups E, F, G; Zone 0 or Zone 1
- 5 Potential equalization

- After aligning (rotating) the housing, retighten the fixing screw (see Operating Instructions).
- Install the device to exclude any mechanical damage or friction during the application. Pay particular attention to flow conditions and tank fittings.
- Continuous service temperature of the connecting cable:  $-40\text{ °C}$  to  $\geq +85\text{ °C}$ ; in accordance with the range of service temperature taking into account additional influences of the process conditions ( $T_{a,\min}$ ), ( $T_{a,\max} + 20\text{ K}$ ).

Optional specification, ID Jx (Test, Certificate) = JN

Continuous service temperature of the connecting cable:  $-50\text{ °C}$  to  $\geq +85\text{ °C}$ ; in accordance with the range of service temperature taking into account additional influences of the process conditions ( $T_{a,\min}$ ), ( $T_{a,\max} + 20\text{ K}$ ).

Basic specification, Position 4 (Display, Operation) = N

Observe national regulations and standards for conduit systems.

**Intrinsic safety**

Intrinsically safe, Class I, Div. 1, Groups A, B, C, D, Class II, Div. 1, Groups E, F, G, Class III Class I, Zone 0 or Zone 1, AEx ia IIC/Ex ia IIC

**General**

- Control room equipment may not use or generate over 250 V<sub>rms</sub>.
- Install as per National Electrical Code (NFPA70) or Canadian Electrical Code, Part I (C22.1), as applicable.
- WARNINGS: Substitution of components may impair intrinsic safety.
- Always follow the installation drawing provided by the associated apparatus manufacturer. The configuration of the associated apparatus must be approved for the country in use.
- When prepared for use with an approved remote display FHX50, remote display is intrinsically safe suitable for Class I, Division 1/Zone 0 locations and connection between transmitter housing and remote display is intrinsically safe field wiring.

For Class II and III

Keep covers tight unless power has been switched off.

**FISCO Installation (terminals 1 and 2)**

The FISCO concept allows interconnection of intrinsically safe apparatus to associated apparatus not specifically examined in such combination. The criteria for interconnection is that the voltage ( $U_i$ ), the current ( $I_i$ ) and the power ( $P_i$ ) which intrinsically safe apparatus can receive and remain intrinsically safe, considering faults, must be equal or greater than the voltage ( $U_o$ ), the current ( $I_o$ ) and the power ( $P_o$ ) levels which can be delivered by the associated apparatus, considering faults and applicable factors. In addition, the maximum unprotected capacitance ( $C_i$ ) and inductance ( $L_i$ ) of each apparatus (other than the termination) connected to the fieldbus must be less than or equal to 5 nF and 10  $\mu$ H respectively.

For transmitter parameters: See "Connection data" section.

In each segment only one active device, normally the associated apparatus, is allowed to provide the necessary energy for the fieldbus system. The voltage  $U_o$  of the associated apparatus has to be limited to the range of 14 to 24 V<sub>DC</sub>. All other equipment connected to the bus cable has to be passive, meaning that they are not allowed to provide energy to the system, except to a leakage current of 50  $\mu$ A for each connected device. Separately powered equipment needs a galvanic isolation to assure that the intrinsically safe fieldbus circuit remains passive.

The cable used to interconnect the devices needs to have the parameters in the following range:

- Loop resistance, R: 15 to 150  $\Omega$ /km
- Inductance per unit length, L: 0.4 to 1 mH/km
- Capacitance per unit length, C: 80 to 200 nF/km
- $C = C_{\text{line/line}} + 0.5 C_{\text{line/screen}}$ , if both lines are floating, or  
 $C = C_{\text{line/line}} + C_{\text{line/screen}}$ , if the screen is connected to one line
- Length of spur cable: 30 m
- Length of trunk cable: 1 km
- Length of splice: 1 m

At each end of the trunk cable an approved infallible line termination with the following parameters is suitable:

- R = 90 to 100  $\Omega$
- C = 0 to 2.2  $\mu$ F

One of the allowed terminations might already be integrated in the associated apparatus.

The number of passive devices connected to the bus segment is not limited due to I.S. reasons. If the above rules are respected, up to a total length of 1 000 m (sum of the length of trunk cable and all spur cables), the inductance and capacitance of the cable will not impair the intrinsic safety of the installation.

**Entity installation (terminals 1, 2 and 3, 4)**

- Use an intrinsic safety barrier or other associated equipment that is approved for the country in use and satisfies the following conditions:  $U_o (V_{oc}) \leq U_i (V_{max})$ ,  $I_o (I_{sc}) \leq I_i (I_{max})$ ,  $C_o (C_a) \geq C_i + C_{cable}$ ,  $L_o (L_a) \geq L_i + L_{cable}$  and  $P_o \leq P_i$ .
- For transmitter parameters: See "Connection data" section.

**Class I, Div. 2, Groups A-D**

The following instructions apply only for *Device type FMR5x, Basic specification, Position 1, 2 (Approval) = FB*

*Device type FMR5x, Basic specification, Position 1, 2 (Approval) = FA and 8A* are not marked for use in Class I, Division 2; however, these devices are suitable for this application when installed using the intrinsic safety instructions for Class I, Division 1.

**Nonincendive Field Wiring (NIFW) installation**

- The Nonincendive Field Wiring circuit concept allows interconnection of nonincendive field wiring apparatus with associated nonincendive field wiring apparatus or associated apparatus not specifically examined in combination as a system using any of the wiring methods permitted for unclassified locations, when the following conditions are met:  $V_{\max} \geq V_{oc}$ ,  $C_a \geq C_i + C_{cable}$ ,  $L_a \geq L_i + L_{cable}$ .
- For transmitter parameters: See "Connection data" section.
- The transmitter provides a current controlled circuit; therefore, the parameter  $I_{\max}$  is not required and needs not to be aligned with  $I_{sc}$  of the associated nonincendive field wiring apparatus or associated apparatus.
- Control room equipment may not use or generate over 250 V<sub>rms</sub>.
- Install as per National Electrical Code (NFPA70) or Canadian Electrical Code, Part I (C22.1), as applicable.
- WARNINGS: Substitution of components may impair suitability for Class I, Div. 2.
- Always follow the installation drawing provided by the associated apparatus manufacturer. The configuration of the associated apparatus must be approved for the country in use.
- Antenna is intrinsically safe, AEx ia/Ex ia, and suitable for installation in Class I, II, III, Division 1 or Class I, Zone 0/1.
- When prepared for use with an approved remote display FHX50, remote display is intrinsically safe suitable for Class I, Division 1/Zone 0 locations and connection between transmitter housing and remote display is intrinsically safe field wiring.

**Standard Wiring installation (only for NPT conduit entries)**

- Install as per National Electrical Code (NFPA70) or Canadian Electrical Code, Part I (C22.1), as applicable.
- Using wiring methods appropriate for the location.
- Associated apparatus not required.
- For the maximum supply voltage: See "Connection data" section.
- WARNINGS: Explosion hazard - Do not disconnect equipment unless power has been switched off or the area is known to be non-hazardous.
- WARNINGS: Substitution of components may impair suitability for Class I, Div. 2.
- Antenna is intrinsically safe, AEx ia/Ex ia, and suitable for installation in Class I, II, III, Division 1 or Class I, Zone 0/1.
- When prepared for use with an approved remote display FHX50, remote display is intrinsically safe suitable for Class I, Division 1/Zone 0 locations and connection between transmitter housing and remote display is intrinsically safe field wiring.

**Process seals**

The following device types are Dual Seal devices per ANSI/ISA 12.27.01 and do not require the use of an external secondary process seal.

Device type	Basic specification, Position 1, 2 (Approval)	MWP <sup>1)</sup>	Method of annunciation
FMR53 FMR54	8A	12 bar	Process fluid leakage through vent located in electronics compartment.
FMR50-52 FMR56 FMR57	8A	40 bar	When using the remote display FHX50: Leakage may also occur from the vent located in the remote display housing. No maintenance of annunciator necessary.

1) Maximum Working Pressure for the Dual Seal rating.  
This value may be a value less than the MWP for the device.

 Verify the chemical compatibility of the process seal specified on the nameplate in first position with the process fluid (see field "Mat." on the nameplate).

*Basic specification, Position 4 (Display, Operation) = L M, N and a cable provided by customer, gland M16 or thread NPT1/2*

To prevent possible leakage of process fluids in an area classified as non-hazardous, the FHX50 must be installed in the hazardous location when used with a device with a Dual Seal rating.

**Temperature tables**

→  16

**Connection data**

*Optional specification, ID Nx (Accessory Mounted) = NA (Overvoltage protection Type OVP20)*  
When using the internal overvoltage protection: No changes to the connection values.

*Basic specification, Position 3 (Power Supply, Output) = E, G*  
IS, Class I, II, III, Div. 1; Class I, Zone 0, AEx ia/Ex ia

Terminal 1 (+), 2 (-)		Terminal 3 (+), 4 (-)
FISCO:	Entity:	Entity:
U <sub>i</sub> = 17.5 V	U <sub>i</sub> = 30 V	U <sub>i</sub> = 30 V
I <sub>i</sub> = 550 mA	I <sub>i</sub> = 300 mA	I <sub>i</sub> = 300 mA
P <sub>i</sub> = 5.5 W	P <sub>i</sub> = 1.2 W	P <sub>i</sub> = 1 W
effective inner inductance L <sub>i</sub> = 10 µH		effective inner inductance L <sub>i</sub> = 0
effective inner capacitance C <sub>i</sub> = 5 nF		effective inner capacitance C <sub>i</sub> = 6 nF

NIFW: Class I, Div. 2

Terminal 1 (+), 2 (-)		Terminal 3 (+), 4 (-)
FISCO/FNICO:	Entity:	Entity:
U <sub>i</sub> = 17.5 V	U <sub>i</sub> = 32 V	U <sub>i</sub> = 35 V
I <sub>i</sub> = not applicable (current-controlled circuit)	I <sub>i</sub> = 15 mA	I <sub>i</sub> = 300 mA
		P <sub>i</sub> = 1 W
effective inner inductance L <sub>i</sub> = 10 µH		effective inner inductance L <sub>i</sub> = 0
effective inner capacitance C <sub>i</sub> = 5 nF		effective inner capacitance C <sub>i</sub> = 6 nF

Class I, Div. 2

Terminal 1 (+), 2 (-)	Terminal 3 (+), 4 (-)
Input voltage = 32 V Input current = 25 mA	Input voltage = 35 V Input current = 46 mA

The power consumption of I/O modules with passive PFS output can be limited for certain applications.

- Recommended: Power consumption = 1 W. This is obtained for a supply voltage at the terminals of 27 V<sub>DC</sub>.
- For higher supply voltages (U<sub>max</sub>): Insert a serial resistance (R<sub>V</sub>) in order to limit the power consumption, see table below.

**Table for the PFS serial resistance (R<sub>V</sub>):**

Power consumption	1.0 W
Total power consumption	1.88 W
Internal resistance R <sub>I</sub>	760 Ω

U <sub>max</sub> [V]	R <sub>V</sub> min
35	205 Ω
34	177 Ω
33	150 Ω
32	122 Ω
31	95 Ω
30	67 Ω
29	39 Ω
28	12 Ω
27	0 Ω

 For values associated with a higher or lower internal power consumption please contact Endress+Hauser.

### Service interface (CDI)

Taking the following values into consideration, the device can be connected to the certified Endress+Hauser FXA291 service tool or a similar interface:

Service interface													
U <sub>i</sub> = 7.3 V effective inner inductance L <sub>i</sub> = negligible effective inner capacitance C <sub>i</sub> = negligible													
U <sub>o</sub> = 7.3 V I <sub>o</sub> = 100 mA P <sub>o</sub> = 160 mW													
L <sub>o</sub> (mH) =	5.00	2.00	1.00	0.50	0.20	0.10	0.05	0.02	0.01	0.005	0.002	0.001	
C <sub>o</sub> (μF) =	0.73	1.20	1.60	2.00	2.60	3.20	4.00	5.50	7.30	10.00	12.70	12.70	

### Remote display interface

- Devices with *Basic specification, Position 4 (Display, Operation) = L, M, N* can be connected to the approved Endress+Hauser remote display FHX50.
- Refer to Safety Instructions XA01096F for additional installation instructions.

# Micropilot FMR50/51/52/53/54/56/57

PROFIBUS PA, FOUNDATION Fieldbus

## Table of contents

Notes on the structure .....	16
Example diagrams of possible deratings .....	20
Compact; 1 channel .....	21
Compact; 2 channels .....	37
Class II, III, Division 1; 1 channel .....	66
Class II, III, Division 1; 2 channels .....	66

## Notes on the structure

## Extract from the extended order code

## Device type

FMR50, FMR51, FMR52, FMR53, FMR54, FMR56, FMR57

## Basic specifications

Position 1, 2 (Approval)		
Selected option		Description
FMR5x	FA	FM C/US IS Cl. I, Div. 1, Groups A-D
	FB	FM C/US IS Cl. I, II, III, Div. 1, Groups A-G; Cl. I, Zone 0, AEx ia/Ex ia IIC; NI Cl. I, Div. 2, Groups A-D
	8A	FM/CSA IS+XP-IS Cl. I, II, III, Div. 1, Groups A-G, AIS Cl. I, II, III, Div. 1, Groups A-G

Position 3 (Power Supply, Output)		
Selected option		Description
FMR5x	E	2-wire, FOUNDATION Fieldbus, switch output (PFS)
	G	2-wire, PROFIBUS PA, switch output (PFS)

Position 5 (Housing)		
Selected option		Description
FMR5x	A <sup>1)</sup>	GT19 dual compartment, plastic PBT
	C	GT20 dual compartment, Alu, coated
FMR51-54 FMR57	B	GT18 dual compartment, 316L

1) Only in connection with Position 1, 2 (Approval) = FA

Position 7, 8 (Antenna)		
Selected option		Description
FMR50	BM	Horn 40 mm/1½", PVDF encapsulated, -40...130°C
	BN	Horn 80 mm/3", PP cladded, -40...80°C
	BR	Horn 100 mm/4", PP cladded, -40...80°C
FMR51	Bx	Horn (different sizes)
FMR52	BO	Horn 50 mm/2", -40...200°C <sup>1)</sup> , -196...200°C <sup>2)</sup> , flush mount
	BP	Horn 80 mm/3", -40...200°C <sup>1)</sup> , -196...200°C <sup>2)</sup> , flush mount
FMR53	Cx	Rod (different sizes)
FMR54	Ax	Without Horn
	Bx	Horn (different sizes)
	Dx	Planar (different sizes)
FMR56	BN	Horn 80 mm/3", PP cladded, -40...80°C
	BR	Horn 100 mm/4", PP cladded, -40...80°C

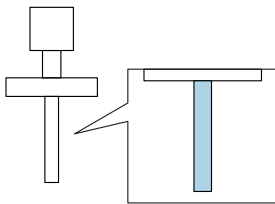

Position 7, 8 (Antenna)		
Selected option		Description
FMR57	Bx	Horn (different sizes)
	Fx	Parabolic (different sizes)
 Shown in the temperature tables exemplary as follows:		

- 1) In connection with Position 5 (Housing) = A
- 2) Only in connection with Position 5 (Housing) = B, C

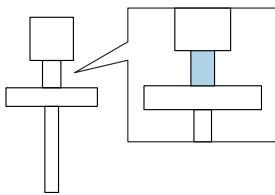
Position 9, 10 (Seal)		
Selected option		Description
FMR51	A5	Viton GLT, -40...150°C
	C1	Kalrez, -20...150°C
	D2	Graphite, -196...450°C (HT)
	D3	Graphite, -40...250°C (XT)
FMR54	A7	Viton, -20...150°C (Planar)
	A8	Viton, -40...200°C
	B4	EPDM, -40...150°C
	C2	Kalrez, -20...200°C, conductive media max. 150°C
	D1	Graphite, -196...280°C (XT)
	D2	Graphite, -196...400°C (HT)
FMR57	A6	Viton GLT, -40...200°C
	D4	Graphite, -40...400°C (HT)
 Shown in the temperature tables exemplary as follows:		

Position 11-13 (Process Connection)		
Selected option		Description
FMR51-54 FMR57	Axx Cxx Kxx	Flange (different sizes)
FMR50	GGF RGF	Thread, PVDF
	UAE	Mounting bracket
	XR0	Connection, without flange/mounting bracket
	XxG	Slip on flange (different sizes)

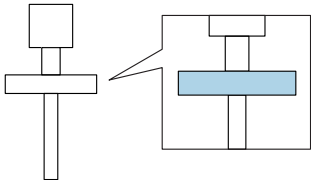
Position 11-13 (Process Connection)		
Selected option		Description
FMR51	Pxx	Flange (different sizes)
	Rxx	Thread
	Txx	Tri-Clamp
FMR52	Mxx	Slotted-nut
	Txx	Tri-Clamp
FMR53	Rxj	Thread, 316L
	RxF	Thread, PVDF
FMR56	UAE	Mounting bracket
	XRO	Connection, without flange/mounting bracket
	XxG	Slip on flange (different sizes)
FMR57	Rxj	Thread, 316L
	Xxj	Align. device (different sizes)
 Shown in the temperature tables exemplary as follows:		

#### Optional specifications

ID Jx (Test, Certificate)		
Selected option		Description
FMR51 <sup>1)</sup> FMR52 FMR54 <sup>2)</sup>	JN <sup>3)</sup>	Ambient temperature transmitter -50°C

- 1) Only in connection with Position 9, 10 (Seal) = D2
- 2) Only in connection with Position 9, 10 (Seal) = D1, D2
- 3) Only in connection with Position 5 (Housing) = B, C

#### General notes

 *Optional specification, ID Nx, Ox (Accessory Mounted) = NA*  
(Overvoltage protection Type OVP20)

When using the internal overvoltage protection: Reduce the admissible ambient temperature at the housing by 5 K.

*Basic specification, Position 5 (Housing) = A*

When using the remote display FHX50: Reduce the admissible ambient temperature at the housing by 3 K.

 Observe the permitted temperature range at the antenna.

**Description notes**

 Unless otherwise indicated, the positions always refer to the basic specification.

1st column: Position 5 (Housing) = A, B, ...

2nd column: Position 3 (Power Supply, Output) = A, B, ..

- (1): 1 channel used
- (2): 2 channels used

3rd column: Temperature classes T6 (85 °C) to T1 (450 °C)

Column P1 to P6: Position (temperature value) on the axes of the derating

- $T_a$ : Ambient temperature in °C
- $T_p$ : Process temperature in °C

 Column P6 is only relevant for version B of the derating.

→  20

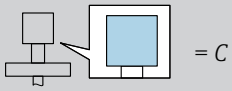
	(1)	P1		P2		P3		P4		P5		P6		
		$T_p$	$T_a$	$T_p$	$T_a$	$T_p$	$T_a$	$T_p$	$T_a$	$T_p$	$T_a$	$T_p$	$T_a$	
	E, G	T6	-40	60	60	60	85	53	85	-40	-40	-40	-	-
		T5	-40	75	75	75	100	68	100	-40	-40	-40	-	-
		T4	-40	80	80	80	135	67	135	-40	-40	-40	-	-
		T3	-40	80	80	80	200	51	200	-40	-40	-40	-	-

A0038026-EN

Class II, III, Division 1

1st column: Position 5 (Housing) = A, B, ...

2nd column: Position 3 (Power Supply, Output) = A, B, ..

- (1): 1 channel used
- (2): 2 channels used

3rd column: Temperature values

	(1)	
	E, G	$T = T_a + 10 \text{ K}$

A0039400-EN

  $T_a$ : Ambient temperature in °C

Example diagrams  
of possible deratings

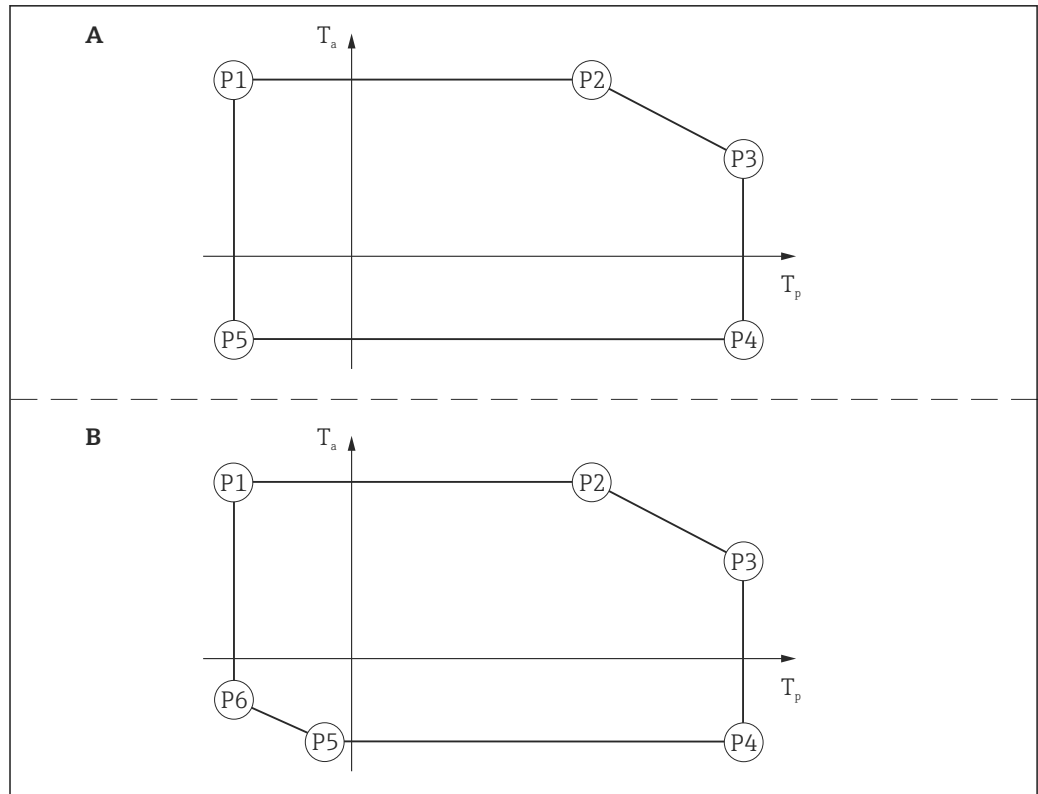

A0022717

4

**Compact; 1 channel**

Position 3 (Power Supply, Output) = E, G: 1 channel used

Page references to the temperature tables of the respective device types: See the following list.

- FMR50 → 21
- FMR51 → 22
- FMR52 → 25
- FMR53 → 27
- FMR54 → 29
- FMR56 → 34
- FMR57 → 35

 Explosion protection: IS / AEx ia/Ex ia or Division 2 (NIFW and standard wiring)

Antenna: Class I, Zone 0 / Class I, Division 1 or Division 2;

Electronics housing: Class I, Zone 1 / Class I, Division 1 or Division 2

**FMR50**

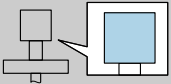
 = A	(1)		P1		P2		P3		P4		P5		P6	
			T <sub>p</sub>	T <sub>a</sub>	T <sub>p</sub>	T <sub>a</sub>	T <sub>p</sub>	T <sub>a</sub>	T <sub>p</sub>	T <sub>a</sub>	T <sub>p</sub>	T <sub>a</sub>	T <sub>p</sub>	T <sub>a</sub>
E, G	T6		-40	58	58	58	80	55	80	-40	-40	-40	-	-

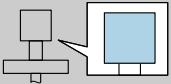
 = C	(1)		P1		P2		P3		P4		P5		P6	
			T <sub>p</sub>	T <sub>a</sub>	T <sub>p</sub>	T <sub>a</sub>	T <sub>p</sub>	T <sub>a</sub>	T <sub>p</sub>	T <sub>a</sub>	T <sub>p</sub>	T <sub>a</sub>	T <sub>p</sub>	T <sub>a</sub>
E, G	T6		-40	60	60	60	80	58	80	-40	-40	-40	-	-

 Explosion protection: IS / AEx ia/Ex ia or Division 2 (NIFW and standard wiring)

Antenna: Class I, Zone 0 / Class I, Division 1 or Division 2;

Electronics housing: Class I, Zone 1 / Class I, Division 1 or Division 2

### FMR51

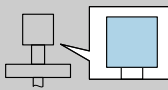
 = A	(1)	P1		P2		P3		P4		P5		P6		
		T <sub>p</sub>	T <sub>a</sub>	T <sub>p</sub>	T <sub>a</sub>	T <sub>p</sub>	T <sub>a</sub>	T <sub>p</sub>	T <sub>a</sub>	T <sub>p</sub>	T <sub>a</sub>	T <sub>p</sub>	T <sub>a</sub>	
	E, G	T6	-40	60	60	60	85	49	85	-40	-40	-40	-	-
		T5	-40	74	74	74	100	64	100	-40	-40	-40	-	-
		T4	-40	74	74	74	135	58	135	-40	-40	-40	-	-
		T3 <sup>1)</sup>	-40	74	74	74	150	55	150	-40	-40	-40	-	-

1) Functional: Maximum permissible process temperature

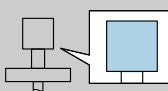
 = B	(1)	P1		P2		P3		P4		P5		P6		
		T <sub>p</sub>	T <sub>a</sub>	T <sub>p</sub>	T <sub>a</sub>	T <sub>p</sub>	T <sub>a</sub>	T <sub>p</sub>	T <sub>a</sub>	T <sub>p</sub>	T <sub>a</sub>	T <sub>p</sub>	T <sub>a</sub>	
	E, G	T6	-40	60	60	60	85	54	85	-40	-40	-40	-	-
		T5	-40	75	75	75	100	69	100	-40	-40	-40	-	-
		T4	-40	80	81	80	135	69	135	-40	-40	-40	-	-
		T3 <sup>1)</sup>	-40	80	81	80	150	66	150	-40	-40	-40	-	-

1) Functional: Maximum permissible process temperature

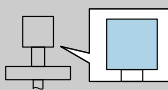
 = C	(1)	P1		P2		P3		P4		P5		P6		
		T <sub>p</sub>	T <sub>a</sub>	T <sub>p</sub>	T <sub>a</sub>	T <sub>p</sub>	T <sub>a</sub>	T <sub>p</sub>	T <sub>a</sub>	T <sub>p</sub>	T <sub>a</sub>	T <sub>p</sub>	T <sub>a</sub>	
	E, G	T6	-40	60	60	60	85	55	85	-40	-40	-40	-	-
		T5	-40	75	75	75	100	70	100	-40	-40	-40	-	-
		T4	-40	80	81	80	135	71	135	-40	-40	-40	-	-
		T3 <sup>1)</sup>	-40	80	81	80	150	68	150	-40	-40	-40	-	-

1) Functional: Maximum permissible process temperature

**FMR51**

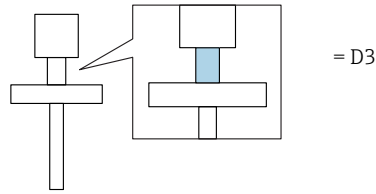

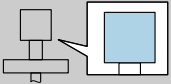
 = A	(1)		P1		P2		P3		P4		P5		P6	
			T <sub>p</sub>	T <sub>a</sub>	T <sub>p</sub>	T <sub>a</sub>	T <sub>p</sub>	T <sub>a</sub>	T <sub>p</sub>	T <sub>a</sub>	T <sub>p</sub>	T <sub>a</sub>	T <sub>p</sub>	T <sub>a</sub>
	E, G	T6	-40	60	60	60	85	54	85	-40	-40	-40	-	-
		T5	-40	74	74	74	100	69	100	-40	-40	-40	-	-
		T4	-40	74	74	74	135	64	135	-40	-40	-40	-	-
		T3	-40	74	74	74	200	55	200	-40	-40	-40	-	-
		T2 <sup>1)</sup>	-40	74	74	74	250	44	250	-40	-40	-40	-	-

1) Functional: Maximum permissible process temperature

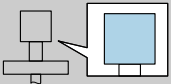
 = B	(1)		P1		P2		P3		P4		P5		P6	
			T <sub>p</sub>	T <sub>a</sub>	T <sub>p</sub>	T <sub>a</sub>	T <sub>p</sub>	T <sub>a</sub>	T <sub>p</sub>	T <sub>a</sub>	T <sub>p</sub>	T <sub>a</sub>	T <sub>p</sub>	T <sub>a</sub>
	E, G	T6	-40	60	60	60	85	57	85	-40	-40	-40	-	-
		T5	-40	75	75	75	100	72	100	-40	-40	-40	-	-
		T4	-40	80	81	80	135	75	135	-40	-40	-40	-	-
		T3	-40	80	81	80	200	68	200	-40	-40	-40	-	-
		T2 <sup>1)</sup>	-40	80	81	80	250	63	250	-40	-40	-40	-	-

1) Functional: Maximum permissible process temperature

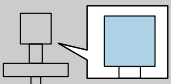
 = C	(1)		P1		P2		P3		P4		P5		P6	
			T <sub>p</sub>	T <sub>a</sub>	T <sub>p</sub>	T <sub>a</sub>	T <sub>p</sub>	T <sub>a</sub>	T <sub>p</sub>	T <sub>a</sub>	T <sub>p</sub>	T <sub>a</sub>	T <sub>p</sub>	T <sub>a</sub>
	E, G	T6	-40	60	60	60	85	58	85	-40	-40	-40	-	-
		T5	-40	75	75	75	100	73	100	-40	-40	-40	-	-
		T4	-40	80	81	80	135	76	135	-40	-40	-40	-	-
		T3	-40	80	81	80	200	71	200	-40	-40	-40	-	-
		T2 <sup>1)</sup>	-40	80	81	80	250	67	250	-40	-40	-40	-	-

1) Functional: Maximum permissible process temperature

FMR51

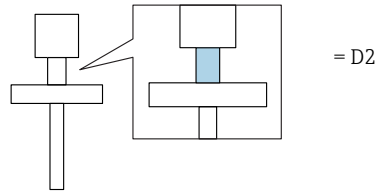

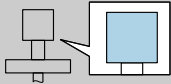
 = A	(1)	P1		P2		P3		P4		P5		P6		
		T <sub>p</sub>	T <sub>a</sub>	T <sub>p</sub>	T <sub>a</sub>	T <sub>p</sub>	T <sub>a</sub>	T <sub>p</sub>	T <sub>a</sub>	T <sub>p</sub>	T <sub>a</sub>	T <sub>p</sub>	T <sub>a</sub>	
	E, G	T6	-196	60	60	60	85	52	85	-40	-40	-40	-196	9
		T5	-196	74	74	74	100	67	100	-40	-40	-40	-196	9
		T4	-196	74	74	74	135	62	135	-40	-40	-40	-196	9
		T3	-196	74	74	74	200	49	200	-40	-40	-40	-196	9

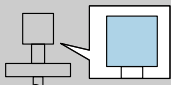
 = B	(1)	P1		P2		P3		P4		P5		P6		
		T <sub>p</sub>	T <sub>a</sub>	T <sub>p</sub>	T <sub>a</sub>	T <sub>p</sub>	T <sub>a</sub>	T <sub>p</sub>	T <sub>a</sub>	T <sub>p</sub>	T <sub>a</sub>	T <sub>p</sub>	T <sub>a</sub>	
	E, G	T6	-196	60	60	60	85	56	85	-40 -50 <sup>1)</sup>	-40 -50 <sup>1)</sup>	-40 -50 <sup>1)</sup>	-196	-15
		T5	-196	75	75	75	100	71	100	-40 -50 <sup>1)</sup>	-40 -50 <sup>1)</sup>	-40 -50 <sup>1)</sup>	-196	-15
		T4	-196	80	81	80	135	73	135	-40 -50 <sup>1)</sup>	-40 -50 <sup>1)</sup>	-40 -50 <sup>1)</sup>	-196	-15
		T3	-196	80	81	80	200	64	200	-40 -50 <sup>1)</sup>	-40 -50 <sup>1)</sup>	-40 -50 <sup>1)</sup>	-196	-15
		T2	-196	80	81	80	300	50	300	-40 -50 <sup>1)</sup>	-40 -50 <sup>1)</sup>	-40 -50 <sup>1)</sup>	-196	-15

1) Only in connection with Optional specification, ID Jx (Test, Certificate) = JN

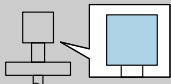
 = C	(1)	P1		P2		P3		P4		P5		P6		
		T <sub>p</sub>	T <sub>a</sub>	T <sub>p</sub>	T <sub>a</sub>	T <sub>p</sub>	T <sub>a</sub>	T <sub>p</sub>	T <sub>a</sub>	T <sub>p</sub>	T <sub>a</sub>	T <sub>p</sub>	T <sub>a</sub>	
	E, G	T6	-196	60	60	60	85	57	85	-40 -50 <sup>1)</sup>	-40 -50 <sup>1)</sup>	-40 -50 <sup>1)</sup>	-196	-20 -28 <sup>1)</sup>
		T5	-196	75	75	75	100	72	100	-40 -50 <sup>1)</sup>	-40 -50 <sup>1)</sup>	-40 -50 <sup>1)</sup>	-196	-20 -28 <sup>1)</sup>
		T4	-196	80	81	80	135	75	135	-40 -50 <sup>1)</sup>	-40 -50 <sup>1)</sup>	-40 -50 <sup>1)</sup>	-196	-20 -28 <sup>1)</sup>
		T3	-196	80	81	80	200	68	200	-40 -50 <sup>1)</sup>	-40 -50 <sup>1)</sup>	-40 -50 <sup>1)</sup>	-196	-20 -28 <sup>1)</sup>
		T2	-196	80	81	80	300	57	300	-40 -50 <sup>1)</sup>	-40 -50 <sup>1)</sup>	-40 -50 <sup>1)</sup>	-196	-20 -28 <sup>1)</sup>
		T1	-196	80	81	80	450	39	450	-40 -50 <sup>1)</sup>	-40 -50 <sup>1)</sup>	-40 -50 <sup>1)</sup>	-196	-20 -28 <sup>1)</sup>

1) Only in connection with Optional specification, ID Jx (Test, Certificate) = JN



 Explosion protection: IS / AEx ia/Ex ia or Division 2 (NIFW and standard wiring)

Antenna: Class I, Zone 0 / Class I, Division 1 or Division 2;

Electronics housing: Class I, Zone 1 / Class I, Division 1 or Division 2

**FMR52**

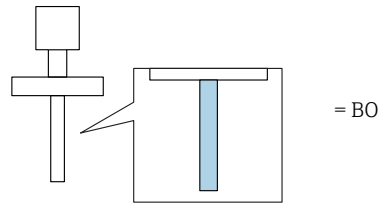

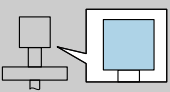
 = A	(1)	P1		P2		P3		P4		P5		P6		
		T <sub>p</sub>	T <sub>a</sub>	T <sub>p</sub>	T <sub>a</sub>	T <sub>p</sub>	T <sub>a</sub>	T <sub>p</sub>	T <sub>a</sub>	T <sub>p</sub>	T <sub>a</sub>	T <sub>p</sub>	T <sub>a</sub>	
	E, G	T6	-40	60	60	60	85	51	85	-40	-40	-40	-	-
		T5	-40	74	74	74	100	66	100	-40	-40	-40	-	-
		T4	-40	74	74	74	135	60	135	-40	-40	-40	-	-
		T3	-40	74	74	74	200	42	200	-40	-40	-40	-	-

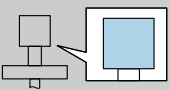
 = B	(1)	P1		P2		P3		P4		P5		P6		
		T <sub>p</sub>	T <sub>a</sub>	T <sub>p</sub>	T <sub>a</sub>	T <sub>p</sub>	T <sub>a</sub>	T <sub>p</sub>	T <sub>a</sub>	T <sub>p</sub>	T <sub>a</sub>	T <sub>p</sub>	T <sub>a</sub>	
	E, G	T6	-196	60	60	60	85	55	85	-40 -50 <sup>1)</sup>	-40 -50 <sup>1)</sup>	-40 -50 <sup>1)</sup>	-196	-3
		T5	-196	75	75	75	100	70	100	-40 -50 <sup>1)</sup>	-40 -50 <sup>1)</sup>	-40 -50 <sup>1)</sup>	-196	-3
		T4	-196	80	81	80	135	71	135	-40 -50 <sup>1)</sup>	-40 -50 <sup>1)</sup>	-40 -50 <sup>1)</sup>	-196	-3
		T3	-196	80	81	80	200	60	200	-40 -50 <sup>1)</sup>	-40 -50 <sup>1)</sup>	-40 -50 <sup>1)</sup>	-196	-3

1) Only in connection with Optional specification, ID Jx (Test, Certificate) = JN

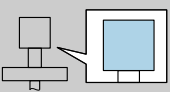
 = C	(1)	P1		P2		P3		P4		P5		P6		
		T <sub>p</sub>	T <sub>a</sub>	T <sub>p</sub>	T <sub>a</sub>	T <sub>p</sub>	T <sub>a</sub>	T <sub>p</sub>	T <sub>a</sub>	T <sub>p</sub>	T <sub>a</sub>	T <sub>p</sub>	T <sub>a</sub>	
	E, G	T6	-196	60	60	60	85	56	85	-40 -50 <sup>1)</sup>	-40 -50 <sup>1)</sup>	-40 -50 <sup>1)</sup>	-196	-14
		T5	-196	75	75	75	100	71	100	-40 -50 <sup>1)</sup>	-40 -50 <sup>1)</sup>	-40 -50 <sup>1)</sup>	-196	-14
		T4	-196	80	81	80	135	73	135	-40 -50 <sup>1)</sup>	-40 -50 <sup>1)</sup>	-40 -50 <sup>1)</sup>	-196	-14
		T3	-196	80	81	80	200	64	200	-40 -50 <sup>1)</sup>	-40 -50 <sup>1)</sup>	-40 -50 <sup>1)</sup>	-196	-14

1) Only in connection with Optional specification, ID Jx (Test, Certificate) = JN

FMR52

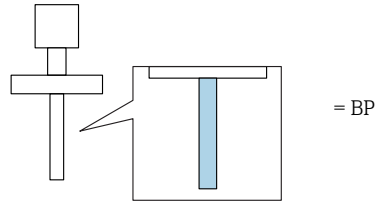

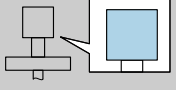
 = A	(1)	P1		P2		P3		P4		P5		P6		
		T <sub>p</sub>	T <sub>a</sub>	T <sub>p</sub>	T <sub>a</sub>	T <sub>p</sub>	T <sub>a</sub>	T <sub>p</sub>	T <sub>a</sub>	T <sub>p</sub>	T <sub>a</sub>	T <sub>p</sub>	T <sub>a</sub>	
	E, G	T6	-40	60	60	60	85	49	85	-40	-40	-40	-	-
		T5	-40	74	74	74	100	64	100	-40	-40	-40	-	-
		T4	-40	74	74	74	135	59	135	-40	-40	-40	-	-
		T3	-40	74	74	74	200	36	200	-40	-40	-40	-	-

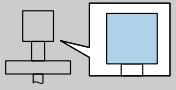
 = B	(1)	P1		P2		P3		P4		P5		P6		
		T <sub>p</sub>	T <sub>a</sub>	T <sub>p</sub>	T <sub>a</sub>	T <sub>p</sub>	T <sub>a</sub>	T <sub>p</sub>	T <sub>a</sub>	T <sub>p</sub>	T <sub>a</sub>	T <sub>p</sub>	T <sub>a</sub>	
	E, G	T6	-196	60	60	60	85	54	85	-40 -50 <sup>1)</sup>	-40 -50 <sup>1)</sup>	-40 -50 <sup>1)</sup>	-196	10
		T5	-196	75	75	75	100	69	100	-40 -50 <sup>1)</sup>	-40 -50 <sup>1)</sup>	-40 -50 <sup>1)</sup>	-196	10
		T4	-196	80	81	80	135	69	135	-40 -50 <sup>1)</sup>	-40 -50 <sup>1)</sup>	-40 -50 <sup>1)</sup>	-196	10
		T3	-196	80	81	80	200	56	200	-40 -50 <sup>1)</sup>	-40 -50 <sup>1)</sup>	-40 -50 <sup>1)</sup>	-196	10

1) Only in connection with Optional specification, ID Jx (Test, Certificate) = JN

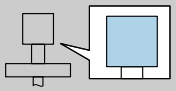
 = C	(1)	P1		P2		P3		P4		P5		P6		
		T <sub>p</sub>	T <sub>a</sub>	T <sub>p</sub>	T <sub>a</sub>	T <sub>p</sub>	T <sub>a</sub>	T <sub>p</sub>	T <sub>a</sub>	T <sub>p</sub>	T <sub>a</sub>	T <sub>p</sub>	T <sub>a</sub>	
	E, G	T6	-196	60	60	60	85	55	85	-40 -50 <sup>1)</sup>	-40 -50 <sup>1)</sup>	-40 -50 <sup>1)</sup>	-196	-8
		T5	-196	75	75	75	100	70	100	-40 -50 <sup>1)</sup>	-40 -50 <sup>1)</sup>	-40 -50 <sup>1)</sup>	-196	-8
		T4	-196	80	81	80	135	72	135	-40 -50 <sup>1)</sup>	-40 -50 <sup>1)</sup>	-40 -50 <sup>1)</sup>	-196	-8
		T3	-196	80	81	80	200	61	200	-40 -50 <sup>1)</sup>	-40 -50 <sup>1)</sup>	-40 -50 <sup>1)</sup>	-196	-8

1) Only in connection with Optional specification, ID Jx (Test, Certificate) = JN

 Explosion protection: IS / AEx ia/Ex ia or Division 2 (NIFW and standard wiring)

Antenna: Class I, Zone 0 / Class I, Division 1 or Division 2;

Electronics housing: Class I, Zone 1 / Class I, Division 1 or Division 2

**FMR53**

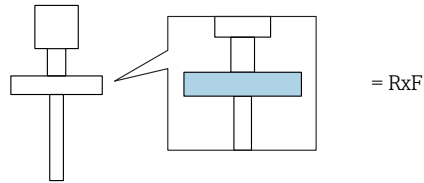

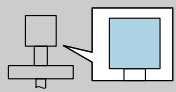
 = A	(1)		P1		P2		P3		P4		P5		P6	
			T <sub>p</sub>	T <sub>a</sub>	T <sub>p</sub>	T <sub>a</sub>	T <sub>p</sub>	T <sub>a</sub>	T <sub>p</sub>	T <sub>a</sub>	T <sub>p</sub>	T <sub>a</sub>	T <sub>p</sub>	T <sub>a</sub>
	E, G	T6	-40	58	58	58	80	55	80	-40	-40	-40	-	-

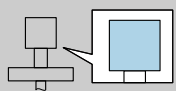
 = B, C	(1)		P1		P2		P3		P4		P5		P6	
			T <sub>p</sub>	T <sub>a</sub>	T <sub>p</sub>	T <sub>a</sub>	T <sub>p</sub>	T <sub>a</sub>	T <sub>p</sub>	T <sub>a</sub>	T <sub>p</sub>	T <sub>a</sub>	T <sub>p</sub>	T <sub>a</sub>
	E, G	T6	-40	60	60	60	80	58	80	-40	-40	-40	-	-

## FMR53

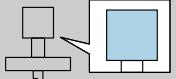
 = A	(1)	P1		P2		P3		P4		P5		P6		
		T <sub>p</sub>	T <sub>a</sub>	T <sub>p</sub>	T <sub>a</sub>	T <sub>p</sub>	T <sub>a</sub>	T <sub>p</sub>	T <sub>a</sub>	T <sub>p</sub>	T <sub>a</sub>	T <sub>p</sub>	T <sub>a</sub>	
	E, G	T6	-40	60	60	60	85	48	85	-40	-40	-40	-	-
		T5	-40	74	74	74	100	63	100	-40	-40	-40	-	-
		T4	-40	74	74	74	135	58	135	-40	-40	-40	-	-
		T3 <sup>1)</sup>	-40	74	74	74	150	54	150	-40	-40	-40	-	-

1) Functional: Maximum permissible process temperature

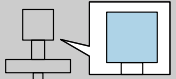
 = B	(1)	P1		P2		P3		P4		P5		P6		
		T <sub>p</sub>	T <sub>a</sub>	T <sub>p</sub>	T <sub>a</sub>	T <sub>p</sub>	T <sub>a</sub>	T <sub>p</sub>	T <sub>a</sub>	T <sub>p</sub>	T <sub>a</sub>	T <sub>p</sub>	T <sub>a</sub>	
	E, G	T6	-40	60	60	60	85	53	85	-40	-40	-40	-	-
		T5	-40	75	75	75	100	68	100	-40	-40	-40	-	-
		T4	-40	80	81	80	135	68	135	-40	-40	-40	-	-
		T3 <sup>1)</sup>	-40	80	81	80	150	65	150	-40	-40	-40	-	-

1) Functional: Maximum permissible process temperature

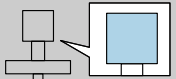
 = C	(1)	P1		P2		P3		P4		P5		P6		
		T <sub>p</sub>	T <sub>a</sub>	T <sub>p</sub>	T <sub>a</sub>	T <sub>p</sub>	T <sub>a</sub>	T <sub>p</sub>	T <sub>a</sub>	T <sub>p</sub>	T <sub>a</sub>	T <sub>p</sub>	T <sub>a</sub>	
	E, G	T6	-40	60	60	60	85	54	85	-40	-40	-40	-	-
		T5	-40	75	75	75	100	70	100	-40	-40	-40	-	-
		T4	-40	80	81	80	135	70	135	-40	-40	-40	-	-
		T3 <sup>1)</sup>	-40	80	81	80	150	67	150	-40	-40	-40	-	-

1) Functional: Maximum permissible process temperature

 Explosion protection: IS / AEx ia/Ex ia or Division 2 (NIFW and standard wiring)

Antenna: Class I, Zone 0 / Class I, Division 1 or Division 2;

Electronics housing: Class I, Zone 1 / Class I, Division 1 or Division 2

**FMR54**

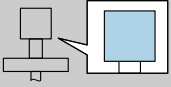
 = A	(1)	P1		P2		P3		P4		P5		P6		
		T <sub>p</sub>	T <sub>a</sub>	T <sub>p</sub>	T <sub>a</sub>	T <sub>p</sub>	T <sub>a</sub>	T <sub>p</sub>	T <sub>a</sub>	T <sub>p</sub>	T <sub>a</sub>	T <sub>p</sub>	T <sub>a</sub>	
	E, G	T6	-40	60	60	60	85	48	85	-40	-40	-40	-	-
		T5	-40	74	74	74	100	63	100	-40	-40	-40	-	-
		T4	-40	74	74	74	135	57	135	-40	-40	-40	-	-

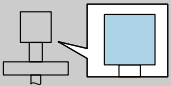
 = B	(1)	P1		P2		P3		P4		P5		P6		
		T <sub>p</sub>	T <sub>a</sub>	T <sub>p</sub>	T <sub>a</sub>	T <sub>p</sub>	T <sub>a</sub>	T <sub>p</sub>	T <sub>a</sub>	T <sub>p</sub>	T <sub>a</sub>	T <sub>p</sub>	T <sub>a</sub>	
	E, G	T6	-40	60	60	60	85	53	85	-40	-40	-40	-	-
		T5	-40	75	75	75	100	68	100	-40	-40	-40	-	-
		T4	-40	80	81	80	135	67	135	-40	-40	-40	-	-
		T3	-40	80	81	80	200	52	200	-40	-40	-40	-	-

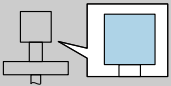
 = C	(1)	P1		P2		P3		P4		P5		P6		
		T <sub>p</sub>	T <sub>a</sub>	T <sub>p</sub>	T <sub>a</sub>	T <sub>p</sub>	T <sub>a</sub>	T <sub>p</sub>	T <sub>a</sub>	T <sub>p</sub>	T <sub>a</sub>	T <sub>p</sub>	T <sub>a</sub>	
	E, G	T6	-40	60	60	60	85	54	85	-40	-40	-40	-	-
		T5	-40	75	75	75	100	69	100	-40	-40	-40	-	-
		T4	-40	80	81	80	135	70	135	-40	-40	-40	-	-
		T3	-40	80	81	80	200	57	200	-40	-40	-40	-	-

FMR54

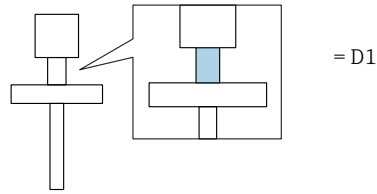

= A	(1)	P1		P2		P3		P4		P5		P6		
		T <sub>p</sub>	T <sub>a</sub>	T <sub>p</sub>	T <sub>a</sub>	T <sub>p</sub>	T <sub>a</sub>	T <sub>p</sub>	T <sub>a</sub>	T <sub>p</sub>	T <sub>a</sub>	T <sub>p</sub>	T <sub>a</sub>	
	E, G	T6	-196	60	60	60	85	51	85	-40	-40	-40	-196	18
		T5	-196	74	74	74	100	66	100	-40	-40	-40	-196	18
		T4	-196	74	74	74	135	61	135	-40	-40	-40	-196	18
		T3	-196	74	74	74	200	42	200	-40	-40	-40	-196	18

= B	(1)	P1		P2		P3		P4		P5		P6		
		T <sub>p</sub>	T <sub>a</sub>	T <sub>p</sub>	T <sub>a</sub>	T <sub>p</sub>	T <sub>a</sub>	T <sub>p</sub>	T <sub>a</sub>	T <sub>p</sub>	T <sub>a</sub>	T <sub>p</sub>	T <sub>a</sub>	
	E, G	T6	-196	60	60	60	85	55	85	-40 -50 <sup>1)</sup>	-40 -50 <sup>1)</sup>	-40 -50 <sup>1)</sup>	-196	-4
		T5	-196	75	75	75	100	70	100	-40 -50 <sup>1)</sup>	-40 -50 <sup>1)</sup>	-40 -50 <sup>1)</sup>	-196	-4
		T4	-196	80	81	80	135	71	135	-40 -50 <sup>1)</sup>	-40 -50 <sup>1)</sup>	-40 -50 <sup>1)</sup>	-196	-4
		T3	-196	80	81	80	200	60	200	-40 -50 <sup>1)</sup>	-40 -50 <sup>1)</sup>	-40 -50 <sup>1)</sup>	-196	-4
		T2 <sup>2)</sup>	-196	80	81	80	280	46	280	-40 -50 <sup>1)</sup>	-40 -50 <sup>1)</sup>	-40 -50 <sup>1)</sup>	-196	-4

- 1) Only in connection with Optional specification, ID Jx (Test, Certificate) = JN
- 2) Functional: Maximum permissible process temperature

= C	(1)	P1		P2		P3		P4		P5		P6		
		T <sub>p</sub>	T <sub>a</sub>	T <sub>p</sub>	T <sub>a</sub>	T <sub>p</sub>	T <sub>a</sub>	T <sub>p</sub>	T <sub>a</sub>	T <sub>p</sub>	T <sub>a</sub>	T <sub>p</sub>	T <sub>a</sub>	
	E, G	T6	-196	60	60	60	85	56	85	-40 -50 <sup>1)</sup>	-40 -50 <sup>1)</sup>	-40 -50 <sup>1)</sup>	-196	-15
		T5	-196	75	75	75	100	71	100	-40 -50 <sup>1)</sup>	-40 -50 <sup>1)</sup>	-40 -50 <sup>1)</sup>	-196	-15
		T4	-196	80	81	80	135	73	135	-40 -50 <sup>1)</sup>	-40 -50 <sup>1)</sup>	-40 -50 <sup>1)</sup>	-196	-15
		T3	-196	80	81	80	200	64	200	-40 -50 <sup>1)</sup>	-40 -50 <sup>1)</sup>	-40 -50 <sup>1)</sup>	-196	-15
		T2 <sup>2)</sup>	-196	80	81	80	280	53	280	-40 -50 <sup>1)</sup>	-40 -50 <sup>1)</sup>	-40 -50 <sup>1)</sup>	-196	-15

- 1) Only in connection with Optional specification, ID Jx (Test, Certificate) = JN
- 2) Functional: Maximum permissible process temperature

**FMR54**

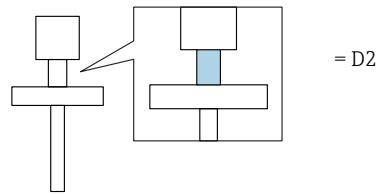

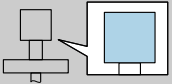
 = A	(1)	P1		P2		P3		P4		P5		P6		
		T <sub>p</sub>	T <sub>a</sub>	T <sub>p</sub>	T <sub>a</sub>	T <sub>p</sub>	T <sub>a</sub>	T <sub>p</sub>	T <sub>a</sub>	T <sub>p</sub>	T <sub>a</sub>	T <sub>p</sub>	T <sub>a</sub>	
	E, G	T6	-196	60	60	60	85	52	85	-40	-40	-40	-196	11
		T5	-196	74	74	74	100	67	100	-40	-40	-40	-196	11
		T4	-196	74	74	74	135	62	135	-40	-40	-40	-196	11
		T3	-196	74	74	74	200	47	200	-40	-40	-40	-196	11

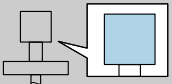
 = B	(1)	P1		P2		P3		P4		P5		P6		
		T <sub>p</sub>	T <sub>a</sub>	T <sub>p</sub>	T <sub>a</sub>	T <sub>p</sub>	T <sub>a</sub>	T <sub>p</sub>	T <sub>a</sub>	T <sub>p</sub>	T <sub>a</sub>	T <sub>p</sub>	T <sub>a</sub>	
	E, G	T6	-196	60	60	60	85	56	85	-40 -50 <sup>1)</sup>	-40 -50 <sup>1)</sup>	-40 -50 <sup>1)</sup>	-196	-13
		T5	-196	75	75	75	100	71	100	-40 -50 <sup>1)</sup>	-40 -50 <sup>1)</sup>	-40 -50 <sup>1)</sup>	-196	-13
		T4	-196	80	81	80	135	73	135	-40 -50 <sup>1)</sup>	-40 -50 <sup>1)</sup>	-40 -50 <sup>1)</sup>	-196	-13
		T3	-196	80	81	80	200	63	200	-40 -50 <sup>1)</sup>	-40 -50 <sup>1)</sup>	-40 -50 <sup>1)</sup>	-196	-13
		T2	-196	80	81	80	300	48	300	-40 -50 <sup>1)</sup>	-40 -50 <sup>1)</sup>	-40 -50 <sup>1)</sup>	-196	-13
		T1 <sup>2)</sup>	-196	80	81	80	400	31	400	-40 -50 <sup>1)</sup>	-40 -50 <sup>1)</sup>	-40 -50 <sup>1)</sup>	-196	-13

1) Only in connection with Optional specification, ID Jx (Test, Certificate) = JN  
 2) Functional: Maximum permissible process temperature

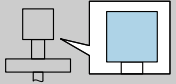
 = C	(1)	P1		P2		P3		P4		P5		P6		
		T <sub>p</sub>	T <sub>a</sub>	T <sub>p</sub>	T <sub>a</sub>	T <sub>p</sub>	T <sub>a</sub>	T <sub>p</sub>	T <sub>a</sub>	T <sub>p</sub>	T <sub>a</sub>	T <sub>p</sub>	T <sub>a</sub>	
	E, G	T6	-196	60	60	60	85	57	85	-40 -50 <sup>1)</sup>	-40 -50 <sup>1)</sup>	-40 -50 <sup>1)</sup>	-196	-19 -26 <sup>1)</sup>
		T5	-196	75	75	75	100	72	100	-40 -50 <sup>1)</sup>	-40 -50 <sup>1)</sup>	-40 -50 <sup>1)</sup>	-196	-19 -26 <sup>1)</sup>
		T4	-196	80	81	80	135	74	135	-40 -50 <sup>1)</sup>	-40 -50 <sup>1)</sup>	-40 -50 <sup>1)</sup>	-196	-19 -26 <sup>1)</sup>
		T3	-196	80	81	80	200	67	200	-40 -50 <sup>1)</sup>	-40 -50 <sup>1)</sup>	-40 -50 <sup>1)</sup>	-196	-19 -26 <sup>1)</sup>
		T2	-196	80	81	80	300	55	300	-40 -50 <sup>1)</sup>	-40 -50 <sup>1)</sup>	-40 -50 <sup>1)</sup>	-196	-19 -26 <sup>1)</sup>
		T1 <sup>2)</sup>	-196	80	81	80	400	42	400	-40 -50 <sup>1)</sup>	-40 -50 <sup>1)</sup>	-40 -50 <sup>1)</sup>	-196	-19 -26 <sup>1)</sup>

1) Only in connection with Optional specification, ID Jx (Test, Certificate) = JN

2) Functional: Maximum permissible process temperature



**FMR54**

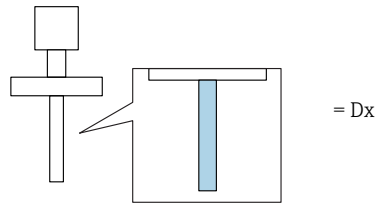

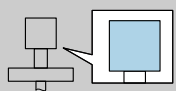
 = A	(1)	P1		P2		P3		P4		P5		P6		
		T <sub>p</sub>	T <sub>a</sub>	T <sub>p</sub>	T <sub>a</sub>	T <sub>p</sub>	T <sub>a</sub>	T <sub>p</sub>	T <sub>a</sub>	T <sub>p</sub>	T <sub>a</sub>	T <sub>p</sub>	T <sub>a</sub>	
	E, G	T6	-40	60	60	60	85	50	85	-40	-40	-40	-	-
		T5	-40	74	74	74	100	65	100	-40	-40	-40	-	-
		T4	-40	74	74	74	135	60	135	-40	-40	-40	-	-
		T3 <sup>1)</sup>	-40	74	74	74	150	57	150	-40	-40	-40	-	-

1) Functional: Maximum permissible process temperature

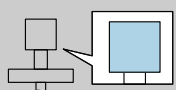
 = B	(1)	P1		P2		P3		P4		P5		P6		
		T <sub>p</sub>	T <sub>a</sub>	T <sub>p</sub>	T <sub>a</sub>	T <sub>p</sub>	T <sub>a</sub>	T <sub>p</sub>	T <sub>a</sub>	T <sub>p</sub>	T <sub>a</sub>	T <sub>p</sub>	T <sub>a</sub>	
	E, G	T6	-40	60	60	60	85	55	85	-40	-40	-40	-	-
		T5	-40	75	75	75	100	70	100	-40	-40	-40	-	-
		T4	-40	80	81	80	135	71	135	-40	-40	-40	-	-
		T3 <sup>1)</sup>	-40	80	81	80	150	68	150	-40	-40	-40	-	-

1) Functional: Maximum permissible process temperature

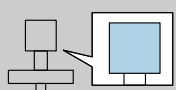
 = C	(1)	P1		P2		P3		P4		P5		P6		
		T <sub>p</sub>	T <sub>a</sub>	T <sub>p</sub>	T <sub>a</sub>	T <sub>p</sub>	T <sub>a</sub>	T <sub>p</sub>	T <sub>a</sub>	T <sub>p</sub>	T <sub>a</sub>	T <sub>p</sub>	T <sub>a</sub>	
	E, G	T6	-40	60	60	60	85	56	85	-40	-40	-40	-	-
		T5	-40	75	75	75	100	71	100	-40	-40	-40	-	-
		T4	-40	80	81	80	135	73	135	-40	-40	-40	-	-
		T3 <sup>1)</sup>	-40	80	81	80	150	71	150	-40	-40	-40	-	-

1) Functional: Maximum permissible process temperature

 Explosion protection: IS / AEx ia/Ex ia or Division 2 (NIFW and standard wiring)

Antenna: Class I, Zone 0 / Class I, Division 1 or Division 2;

Electronics housing: Class I, Zone 1 / Class I, Division 1 or Division 2

**FMR56**

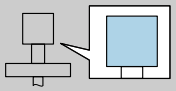
 = A	(1)		P1		P2		P3		P4		P5		P6	
			T <sub>p</sub>	T <sub>a</sub>	T <sub>p</sub>	T <sub>a</sub>	T <sub>p</sub>	T <sub>a</sub>	T <sub>p</sub>	T <sub>a</sub>	T <sub>p</sub>	T <sub>a</sub>	T <sub>p</sub>	T <sub>a</sub>
	E, G	T6	-40	58	58	58	80	55	80	-40	-40	-40	-	-

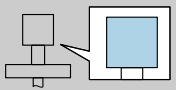
 = C	(1)		P1		P2		P3		P4		P5		P6	
			T <sub>p</sub>	T <sub>a</sub>	T <sub>p</sub>	T <sub>a</sub>	T <sub>p</sub>	T <sub>a</sub>	T <sub>p</sub>	T <sub>a</sub>	T <sub>p</sub>	T <sub>a</sub>	T <sub>p</sub>	T <sub>a</sub>
	E, G	T6	-40	60	60	60	80	58	80	-40	-40	-40	-	-

 Explosion protection: IS / AEx ia/Ex ia or Division 2 (NIFW and standard wiring)

Antenna: Class I, Zone 0 / Class I, Division 1 or Division 2;

Electronics housing: Class I, Zone 1 / Class I, Division 1 or Division 2

**FMR57**

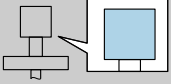
 = A	(1)	P1		P2		P3		P4		P5		P6		
		T <sub>p</sub>	T <sub>a</sub>	T <sub>p</sub>	T <sub>a</sub>	T <sub>p</sub>	T <sub>a</sub>	T <sub>p</sub>	T <sub>a</sub>	T <sub>p</sub>	T <sub>a</sub>	T <sub>p</sub>	T <sub>a</sub>	
	E, G	T6	-40	60	60	60	85	53	85	-40	-40	-40	-	-
		T5	-40	74	74	74	100	68	100	-40	-40	-40	-	-
		T4	-40	74	74	74	135	63	135	-40	-40	-40	-	-
		T3	-40	74	74	74	200	53	200	-40	-40	-40	-	-

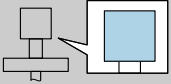
 = B	(1)	P1		P2		P3		P4		P5		P6		
		T <sub>p</sub>	T <sub>a</sub>	T <sub>p</sub>	T <sub>a</sub>	T <sub>p</sub>	T <sub>a</sub>	T <sub>p</sub>	T <sub>a</sub>	T <sub>p</sub>	T <sub>a</sub>	T <sub>p</sub>	T <sub>a</sub>	
	E, G	T6	-40	60	60	60	85	56	85	-40	-40	-40	-	-
		T5	-40	75	75	75	100	71	100	-40	-40	-40	-	-
		T4	-40	80	81	80	135	74	135	-40	-40	-40	-	-
		T3	-40	80	81	80	200	66	200	-40	-40	-40	-	-

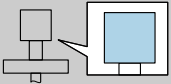
 = C	(1)	P1		P2		P3		P4		P5		P6		
		T <sub>p</sub>	T <sub>a</sub>	T <sub>p</sub>	T <sub>a</sub>	T <sub>p</sub>	T <sub>a</sub>	T <sub>p</sub>	T <sub>a</sub>	T <sub>p</sub>	T <sub>a</sub>	T <sub>p</sub>	T <sub>a</sub>	
	E, G	T6	-40	60	60	60	85	57	85	-40	-40	-40	-	-
		T5	-40	75	75	75	100	72	100	-40	-40	-40	-	-
		T4	-40	80	81	80	135	75	135	-40	-40	-40	-	-
		T3	-40	80	81	80	200	69	200	-40	-40	-40	-	-

**FMR57**

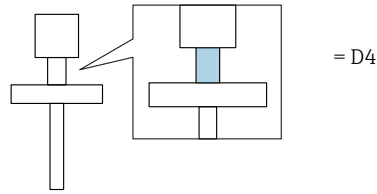

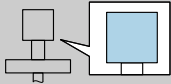
 = A	(1)	P1		P2		P3		P4		P5		P6		
		T <sub>p</sub>	T <sub>a</sub>	T <sub>p</sub>	T <sub>a</sub>	T <sub>p</sub>	T <sub>a</sub>	T <sub>p</sub>	T <sub>a</sub>	T <sub>p</sub>	T <sub>a</sub>	T <sub>p</sub>	T <sub>a</sub>	
	E, G	T6	-40	58	58	58	85	54	85	-40	-40	-40	-	-
		T5	-40	73	73	73	100	69	100	-40	-40	-40	-	-
		T4	-40	74	74	74	135	65	135	-40	-40	-40	-	-
		T3	-40	74	74	74	200	57	200	-40	-40	-40	-	-
		T2	-40	74	74	74	300	37	300	-40	-40	-40	-	-

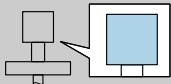
 = B	(1)	P1		P2		P3		P4		P5		P6		
		T <sub>p</sub>	T <sub>a</sub>	T <sub>p</sub>	T <sub>a</sub>	T <sub>p</sub>	T <sub>a</sub>	T <sub>p</sub>	T <sub>a</sub>	T <sub>p</sub>	T <sub>a</sub>	T <sub>p</sub>	T <sub>a</sub>	
	E, G	T6	-40	60	60	60	85	57	85	-40	-40	-40	-	-
		T5	-40	75	75	75	100	72	100	-40	-40	-40	-	-
		T4	-40	80	81	80	135	76	135	-40	-40	-40	-	-
		T3	-40	80	81	80	200	70	200	-40	-40	-40	-	-
		T2	-40	80	81	80	300	61	300	-40	-40	-40	-	-
		T1 <sup>1)</sup>	-40	80	81	80	400	51	400	-40	-40	-40	-	-

1) Functional: Maximum permissible process temperature

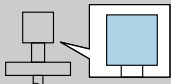
 = C	(1)	P1		P2		P3		P4		P5		P6		
		T <sub>p</sub>	T <sub>a</sub>	T <sub>p</sub>	T <sub>a</sub>	T <sub>p</sub>	T <sub>a</sub>	T <sub>p</sub>	T <sub>a</sub>	T <sub>p</sub>	T <sub>a</sub>	T <sub>p</sub>	T <sub>a</sub>	
	E, G	T6	-40	60	60	60	85	58	85	-40	-40	-40	-	-
		T5	-40	75	75	75	100	73	100	-40	-40	-40	-	-
		T4	-40	80	81	80	135	77	135	-40	-40	-40	-	-
		T3	-40	80	81	80	200	72	200	-40	-40	-40	-	-
		T2	-40	80	81	80	300	65	300	-40	-40	-40	-	-
		T1 <sup>1)</sup>	-40	80	81	80	400	58	400	-40	-40	-40	-	-

1) Functional: Maximum permissible process temperature

**Compact; 2 channels**

Position 3 (Power Supply, Output) = E, G: 2 channels used

Page references to the temperature tables of the respective device types: See the following list.

- FMR50 → 37
- FMR51 → 38
- FMR52 → 44
- FMR53 → 48
- FMR54 → 52
- FMR56 → 60
- FMR57 → 62

 Explosion protection: IS / AEx ia/Ex ia

Antenna: Class I, Zone 0 / Class I, Division 1;  
 Electronics housing: Class I, Zone 1 / Class I, Division 1

**FMR50**

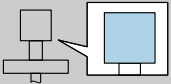
 = A	(2)		P1		P2		P3		P4		P5		P6	
			T <sub>p</sub>	T <sub>a</sub>	T <sub>p</sub>	T <sub>a</sub>	T <sub>p</sub>	T <sub>a</sub>	T <sub>p</sub>	T <sub>a</sub>	T <sub>p</sub>	T <sub>a</sub>	T <sub>p</sub>	T <sub>a</sub>
E, G	T6	-40	51	51	51	80	47	80	-40	-40	-40	-	-	

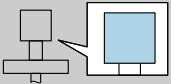
 = C	(2)		P1		P2		P3		P4		P5		P6	
			T <sub>p</sub>	T <sub>a</sub>	T <sub>p</sub>	T <sub>a</sub>	T <sub>p</sub>	T <sub>a</sub>	T <sub>p</sub>	T <sub>a</sub>	T <sub>p</sub>	T <sub>a</sub>	T <sub>p</sub>	T <sub>a</sub>
E, G	T6	-40	57	57	57	80	55	80	-40	-40	-40	-	-	

 Explosion protection: Division 2 (NIFW and standard wiring)

Antenna: Class I, Zone 0 / Class I, Division 1 or Division 2;  
 Electronics housing: Class I, Division 2

**FMR50**

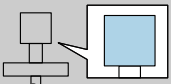
 = C	(2)		P1		P2		P3		P4		P5		P6	
			T <sub>p</sub>	T <sub>a</sub>	T <sub>p</sub>	T <sub>a</sub>	T <sub>p</sub>	T <sub>a</sub>	T <sub>p</sub>	T <sub>a</sub>	T <sub>p</sub>	T <sub>a</sub>	T <sub>p</sub>	T <sub>a</sub>
E, G	T6	-40	60	60	60	80	58	80	-40	-40	-40	-	-	

 Explosion protection: IS / AEx ia/Ex ia

Antenna: Class I, Zone 0 / Class I, Division 1;

Electronics housing: Class I, Zone 1 / Class I, Division 1

### FMR51

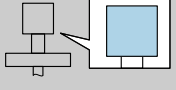
 = A	(2)	P1		P2		P3		P4		P5		P6		
		T <sub>p</sub>	T <sub>a</sub>	T <sub>p</sub>	T <sub>a</sub>	T <sub>p</sub>	T <sub>a</sub>	T <sub>p</sub>	T <sub>a</sub>	T <sub>p</sub>	T <sub>a</sub>	T <sub>p</sub>	T <sub>a</sub>	
	E, G	T6	-40	51	51	51	85	43	85	-40	-40	-40	-	-
		T5	-40	56	56	56	100	45	100	-40	-40	-40	-	-
		T4	-40	56	56	56	135	37	135	-40	-40	-40	-	-
		T3 <sup>1)</sup>	-40	56	56	56	150	33	150	-40	-40	-40	-	-

1) Functional: Maximum permissible process temperature

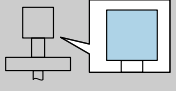
 = B	(2)	P1		P2		P3		P4		P5		P6		
		T <sub>p</sub>	T <sub>a</sub>	T <sub>p</sub>	T <sub>a</sub>	T <sub>p</sub>	T <sub>a</sub>	T <sub>p</sub>	T <sub>a</sub>	T <sub>p</sub>	T <sub>a</sub>	T <sub>p</sub>	T <sub>a</sub>	
	E, G	T6	-40	57	57	57	85	51	85	-40	-40	-40	-	-
		T5	-40	72	72	72	100	66	100	-40	-40	-40	-	-
		T4	-40	76	76	76	135	63	135	-40	-40	-40	-	-
		T3 <sup>1)</sup>	-40	76	76	76	150	60	150	-40	-40	-40	-	-

1) Functional: Maximum permissible process temperature

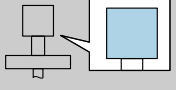
 = C	(2)	P1		P2		P3		P4		P5		P6		
		T <sub>p</sub>	T <sub>a</sub>	T <sub>p</sub>	T <sub>a</sub>	T <sub>p</sub>	T <sub>a</sub>	T <sub>p</sub>	T <sub>a</sub>	T <sub>p</sub>	T <sub>a</sub>	T <sub>p</sub>	T <sub>a</sub>	
	E, G	T6	-40	57	57	57	85	52	85	-40	-40	-40	-	-
		T5	-40	72	72	72	100	67	100	-40	-40	-40	-	-
		T4	-40	76	76	76	135	65	135	-40	-40	-40	-	-
		T3 <sup>1)</sup>	-40	76	76	76	150	63	150	-40	-40	-40	-	-

1) Functional: Maximum permissible process temperature

**FMR51**

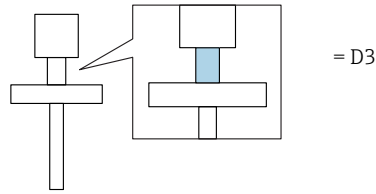

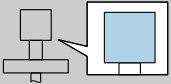
 = A	(2)	P1		P2		P3		P4		P5		P6		
		T <sub>p</sub>	T <sub>a</sub>	T <sub>p</sub>	T <sub>a</sub>	T <sub>p</sub>	T <sub>a</sub>	T <sub>p</sub>	T <sub>a</sub>	T <sub>p</sub>	T <sub>a</sub>	T <sub>p</sub>	T <sub>a</sub>	
	E, G	T6	-40	51	51	51	85	46	85	-40	-40	-40	-	-
		T5	-40	56	56	56	100	50	100	-40	-40	-40	-	-
		T4	-40	56	56	56	135	45	135	-40	-40	-40	-	-
		T3	-40	56	56	56	200	35	200	-40	-40	-40	-	-

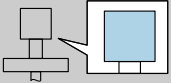
 = B	(2)	P1		P2		P3		P4		P5		P6		
		T <sub>p</sub>	T <sub>a</sub>	T <sub>p</sub>	T <sub>a</sub>	T <sub>p</sub>	T <sub>a</sub>	T <sub>p</sub>	T <sub>a</sub>	T <sub>p</sub>	T <sub>a</sub>	T <sub>p</sub>	T <sub>a</sub>	
	E, G	T6	-40	57	57	57	85	54	85	-40	-40	-40	-	-
		T5	-40	72	72	72	100	69	100	-40	-40	-40	-	-
		T4	-40	76	76	76	135	69	135	-40	-40	-40	-	-
		T3	-40	76	76	76	200	62	200	-40	-40	-40	-	-
		T2 <sup>1)</sup>	-40	76	76	76	250	57	250	-40	-40	-40	-	-

1) Functional: Maximum permissible process temperature

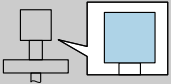
 = C	(2)	P1		P2		P3		P4		P5		P6		
		T <sub>p</sub>	T <sub>a</sub>	T <sub>p</sub>	T <sub>a</sub>	T <sub>p</sub>	T <sub>a</sub>	T <sub>p</sub>	T <sub>a</sub>	T <sub>p</sub>	T <sub>a</sub>	T <sub>p</sub>	T <sub>a</sub>	
	E, G	T6	-40	57	57	57	85	55	85	-40	-40	-40	-	-
		T5	-40	72	72	72	100	70	100	-40	-40	-40	-	-
		T4	-40	76	76	76	135	71	135	-40	-40	-40	-	-
		T3	-40	76	76	76	200	65	200	-40	-40	-40	-	-
		T2 <sup>1)</sup>	-40	76	76	76	250	61	250	-40	-40	-40	-	-

1) Functional: Maximum permissible process temperature

FMR51

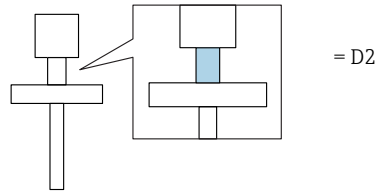

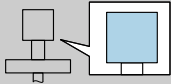
 = A	(2)	P1		P2		P3		P4		P5		P6		
		T <sub>p</sub>	T <sub>a</sub>	T <sub>p</sub>	T <sub>a</sub>	T <sub>p</sub>	T <sub>a</sub>	T <sub>p</sub>	T <sub>a</sub>	T <sub>p</sub>	T <sub>a</sub>	T <sub>p</sub>	T <sub>a</sub>	
	E, G	T6	-196	51	51	51	85	45	85	-40	-40	-40	-196	9
		T5	-196	56	56	56	100	48	100	-40	-40	-40	-196	9
		T4	-196	56	56	56	135	42	135	-40	-40	-40	-196	9
		T3	-196	56	56	56	200	30	200	-40	-40	-40	-196	9

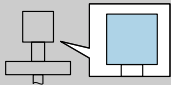
 = B	(2)	P1		P2		P3		P4		P5		P6		
		T <sub>p</sub>	T <sub>a</sub>	T <sub>p</sub>	T <sub>a</sub>	T <sub>p</sub>	T <sub>a</sub>	T <sub>p</sub>	T <sub>a</sub>	T <sub>p</sub>	T <sub>a</sub>	T <sub>p</sub>	T <sub>a</sub>	
	E, G	T6	-196	57	57	57	85	54	85	-40 -50 <sup>1)</sup>	-40 -50 <sup>1)</sup>	-40 -50 <sup>1)</sup>	-196	-15
		T5	-196	72	72	72	100	69	100	-40 -50 <sup>1)</sup>	-40 -50 <sup>1)</sup>	-40 -50 <sup>1)</sup>	-196	-15
		T4	-196	76	76	76	135	67	135	-40 -50 <sup>1)</sup>	-40 -50 <sup>1)</sup>	-40 -50 <sup>1)</sup>	-196	-15
		T3	-196	76	76	76	200	59	200	-40 -50 <sup>1)</sup>	-40 -50 <sup>1)</sup>	-40 -50 <sup>1)</sup>	-196	-15
		T2	-196	76	76	76	300	45	300	-40 -50 <sup>1)</sup>	-40 -50 <sup>1)</sup>	-40 -50 <sup>1)</sup>	-196	-15

1) Only in connection with Optional specification, ID Jx (Test, Certificate) = JN

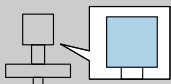
 = C	(2)	P1		P2		P3		P4		P5		P6		
		T <sub>p</sub>	T <sub>a</sub>	T <sub>p</sub>	T <sub>a</sub>	T <sub>p</sub>	T <sub>a</sub>	T <sub>p</sub>	T <sub>a</sub>	T <sub>p</sub>	T <sub>a</sub>	T <sub>p</sub>	T <sub>a</sub>	
	E, G	T6	-196	57	57	57	85	54	85	-40 -50 <sup>1)</sup>	-40 -50 <sup>1)</sup>	-40 -50 <sup>1)</sup>	-196	-20 -28 <sup>1)</sup>
		T5	-196	72	72	72	100	69	100	-40 -50 <sup>1)</sup>	-40 -50 <sup>1)</sup>	-40 -50 <sup>1)</sup>	-196	-20 -28 <sup>1)</sup>
		T4	-196	76	76	76	135	69	135	-40 -50 <sup>1)</sup>	-40 -50 <sup>1)</sup>	-40 -50 <sup>1)</sup>	-196	-20 -28 <sup>1)</sup>
		T3	-196	76	76	76	200	62	200	-40 -50 <sup>1)</sup>	-40 -50 <sup>1)</sup>	-40 -50 <sup>1)</sup>	-196	-20 -28 <sup>1)</sup>
		T2	-196	76	76	76	300	51	300	-40 -50 <sup>1)</sup>	-40 -50 <sup>1)</sup>	-40 -50 <sup>1)</sup>	-196	-20 -28 <sup>1)</sup>
		T1	-196	76	76	76	450	35	450	-40 -50 <sup>1)</sup>	-40 -50 <sup>1)</sup>	-40 -50 <sup>1)</sup>	-196	-20 -28 <sup>1)</sup>

1) Only in connection with Optional specification, ID Jx (Test, Certificate) = JN



 Explosion protection: Division 2 (NIFW and standard wiring)

Antenna: Class I, Zone 0 / Class I, Division 1 or Division 2;  
 Electronics housing: Class I, Division 2

**FMR51**

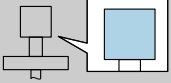
 = B	(2)	P1		P2		P3		P4		P5		P6		
		T <sub>p</sub>	T <sub>a</sub>	T <sub>p</sub>	T <sub>a</sub>	T <sub>p</sub>	T <sub>a</sub>	T <sub>p</sub>	T <sub>a</sub>	T <sub>p</sub>	T <sub>a</sub>	T <sub>p</sub>	T <sub>a</sub>	
	E, G	T6	-40	60	60	60	85	54	85	-40	-40	-40	-	-
		T5	-40	75	75	75	100	69	100	-40	-40	-40	-	-
		T4	-40	76	76	76	135	63	135	-40	-40	-40	-	-
		T3 <sup>1)</sup>	-40	76	76	76	150	60	150	-40	-40	-40	-	-

1) Functional: Maximum permissible process temperature

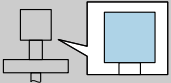
 = C	(2)	P1		P2		P3		P4		P5		P6		
		T <sub>p</sub>	T <sub>a</sub>	T <sub>p</sub>	T <sub>a</sub>	T <sub>p</sub>	T <sub>a</sub>	T <sub>p</sub>	T <sub>a</sub>	T <sub>p</sub>	T <sub>a</sub>	T <sub>p</sub>	T <sub>a</sub>	
	E, G	T6	-40	60	60	60	85	55	85	-40	-40	-40	-	-
		T5	-40	75	75	75	100	70	100	-40	-40	-40	-	-
		T4	-40	76	76	76	135	65	135	-40	-40	-40	-	-
		T3 <sup>1)</sup>	-40	76	76	76	150	63	150	-40	-40	-40	-	-

1) Functional: Maximum permissible process temperature

FMR51

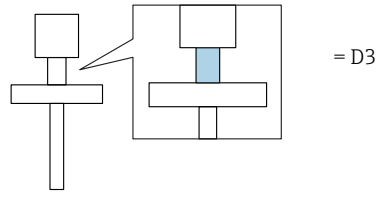

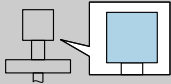
 = B	(2)	P1		P2		P3		P4		P5		P6		
		T <sub>p</sub>	T <sub>a</sub>	T <sub>p</sub>	T <sub>a</sub>	T <sub>p</sub>	T <sub>a</sub>	T <sub>p</sub>	T <sub>a</sub>	T <sub>p</sub>	T <sub>a</sub>	T <sub>p</sub>	T <sub>a</sub>	
	E, G	T6	-40	60	60	60	85	57	85	-40	-40	-40	-	-
		T5	-40	75	75	75	100	72	100	-40	-40	-40	-	-
		T4	-40	76	76	76	135	69	135	-40	-40	-40	-	-
		T3	-40	76	76	76	200	62	200	-40	-40	-40	-	-
		T2 <sup>1)</sup>	-40	76	76	76	250	57	250	-40	-40	-40	-	-

1) Functional: Maximum permissible process temperature

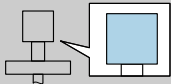
 = C	(2)	P1		P2		P3		P4		P5		P6		
		T <sub>p</sub>	T <sub>a</sub>	T <sub>p</sub>	T <sub>a</sub>	T <sub>p</sub>	T <sub>a</sub>	T <sub>p</sub>	T <sub>a</sub>	T <sub>p</sub>	T <sub>a</sub>	T <sub>p</sub>	T <sub>a</sub>	
	E, G	T6	-40	60	60	60	85	58	85	-40	-40	-40	-	-
		T5	-40	75	75	75	100	73	100	-40	-40	-40	-	-
		T4	-40	76	76	76	135	71	135	-40	-40	-40	-	-
		T3	-40	76	76	76	200	65	200	-40	-40	-40	-	-
		T2 <sup>1)</sup>	-40	76	76	76	250	61	250	-40	-40	-40	-	-

1) Functional: Maximum permissible process temperature

**FMR51**

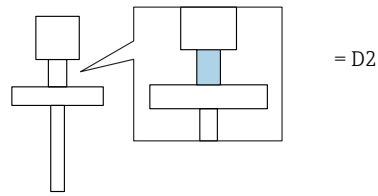

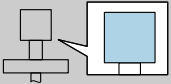
 = B	(2)	P1		P2		P3		P4		P5		P6		
		T <sub>p</sub>	T <sub>a</sub>	T <sub>p</sub>	T <sub>a</sub>	T <sub>p</sub>	T <sub>a</sub>	T <sub>p</sub>	T <sub>a</sub>	T <sub>p</sub>	T <sub>a</sub>	T <sub>p</sub>	T <sub>a</sub>	
	E, G	T6	-196	60	60	60	85	56	85	-40	-40	-40	-196	-15
		T5	-196	75	75	75	100	71	100	-40	-40	-40	-196	-15
		T4	-196	76	76	76	135	67	135	-40	-40	-40	-196	-15
		T3	-196	76	76	76	200	59	200	-40	-40	-40	-196	-15
		T2	-196	76	76	76	300	45	300	-40	-40	-40	-196	-15

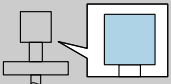
 = C	(2)	P1		P2		P3		P4		P5		P6		
		T <sub>p</sub>	T <sub>a</sub>	T <sub>p</sub>	T <sub>a</sub>	T <sub>p</sub>	T <sub>a</sub>	T <sub>p</sub>	T <sub>a</sub>	T <sub>p</sub>	T <sub>a</sub>	T <sub>p</sub>	T <sub>a</sub>	
	E, G	T6	-196	60	60	60	85	57	85	-40	-40	-40	-196	-20
		T5	-196	75	75	75	100	72	100	-40	-40	-40	-196	-20
		T4	-196	76	76	76	135	69	135	-40	-40	-40	-196	-20
		T3	-196	76	76	76	200	62	200	-40	-40	-40	-196	-20
		T2	-196	76	76	76	300	51	300	-40	-40	-40	-196	-20
		T1	-196	76	76	76	450	35	450	-40	-40	-40	-196	-20

 Explosion protection: IS / AEx ia/Ex ia

Antenna: Class I, Zone 0 / Class I, Division 1;  
 Electronics housing: Class I, Zone 1 / Class I, Division 1

**FMR52**

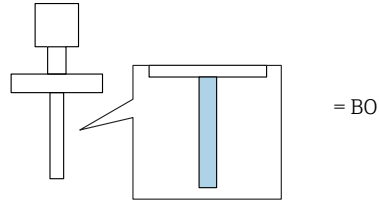

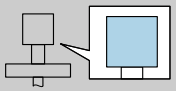
 = A	(2)	P1		P2		P3		P4		P5		P6		
		T <sub>p</sub>	T <sub>a</sub>	T <sub>p</sub>	T <sub>a</sub>	T <sub>p</sub>	T <sub>a</sub>	T <sub>p</sub>	T <sub>a</sub>	T <sub>p</sub>	T <sub>a</sub>	T <sub>p</sub>	T <sub>a</sub>	
	E, G	T6	-40	51	51	51	85	44	85	-40	-40	-40	-	-
		T5	-40	56	56	56	100	47	100	-40	-40	-40	-	-
		T4	-40	56	56	56	135	39	135	-40	-40	-40	-	-

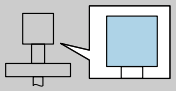
 = B	(2)	P1		P2		P3		P4		P5		P6		
		T <sub>p</sub>	T <sub>a</sub>	T <sub>p</sub>	T <sub>a</sub>	T <sub>p</sub>	T <sub>a</sub>	T <sub>p</sub>	T <sub>a</sub>	T <sub>p</sub>	T <sub>a</sub>	T <sub>p</sub>	T <sub>a</sub>	
	E, G	T6	-196	57	57	57	85	53	85	-40 -50 <sup>1)</sup>	-40 -50 <sup>1)</sup>	-40 -50 <sup>1)</sup>	-196	-3
		T5	-196	72	72	72	100	68	100	-40 -50 <sup>1)</sup>	-40 -50 <sup>1)</sup>	-40 -50 <sup>1)</sup>	-196	-3
		T4	-196	76	76	76	135	65	135	-40 -50 <sup>1)</sup>	-40 -50 <sup>1)</sup>	-40 -50 <sup>1)</sup>	-196	-3
		T3	-196	76	76	76	200	54	200	-40 -50 <sup>1)</sup>	-40 -50 <sup>1)</sup>	-40 -50 <sup>1)</sup>	-196	-3

1) Only in connection with Optional specification, ID Jx (Test, Certificate) = JN

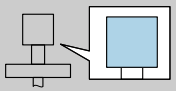
 = C	(2)	P1		P2		P3		P4		P5		P6		
		T <sub>p</sub>	T <sub>a</sub>	T <sub>p</sub>	T <sub>a</sub>	T <sub>p</sub>	T <sub>a</sub>	T <sub>p</sub>	T <sub>a</sub>	T <sub>p</sub>	T <sub>a</sub>	T <sub>p</sub>	T <sub>a</sub>	
	E, G	T6	-196	57	57	57	85	53	85	-40 -50 <sup>1)</sup>	-40 -50 <sup>1)</sup>	-40 -50 <sup>1)</sup>	-196	-14
		T5	-196	72	72	72	100	68	100	-40 -50 <sup>1)</sup>	-40 -50 <sup>1)</sup>	-40 -50 <sup>1)</sup>	-196	-14
		T4	-196	76	76	76	135	67	135	-40 -50 <sup>1)</sup>	-40 -50 <sup>1)</sup>	-40 -50 <sup>1)</sup>	-196	-14
		T3	-196	76	76	76	200	58	200	-40 -50 <sup>1)</sup>	-40 -50 <sup>1)</sup>	-40 -50 <sup>1)</sup>	-196	-14

1) Only in connection with Optional specification, ID Jx (Test, Certificate) = JN

**FMR52**

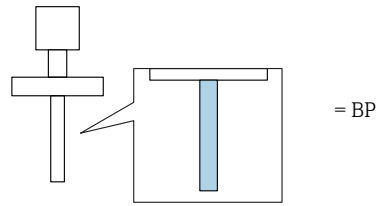

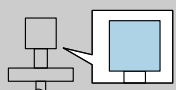
 = A	(2)		P1		P2		P3		P4		P5		P6	
			T <sub>p</sub>	T <sub>a</sub>	T <sub>p</sub>	T <sub>a</sub>	T <sub>p</sub>	T <sub>a</sub>	T <sub>p</sub>	T <sub>a</sub>	T <sub>p</sub>	T <sub>a</sub>	T <sub>p</sub>	T <sub>a</sub>
	E, G	T6	-40	51	51	51	85	43	85	-40	-40	-40	-	-
		T5	-40	56	56	56	100	46	100	-40	-40	-40	-	-
		T4	-40	56	56	56	135	37	135	-40	-40	-40	-	-

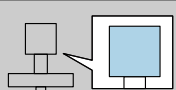
 = B	(2)		P1		P2		P3		P4		P5		P6	
			T <sub>p</sub>	T <sub>a</sub>	T <sub>p</sub>	T <sub>a</sub>	T <sub>p</sub>	T <sub>a</sub>	T <sub>p</sub>	T <sub>a</sub>	T <sub>p</sub>	T <sub>a</sub>	T <sub>p</sub>	T <sub>a</sub>
	E, G	T6	-196	57	57	57	85	52	85	-40 -50 <sup>1)</sup>	-40 -50 <sup>1)</sup>	-40 -50 <sup>1)</sup>	-196	10
		T5	-196	72	72	72	100	67	100	-40 -50 <sup>1)</sup>	-40 -50 <sup>1)</sup>	-40 -50 <sup>1)</sup>	-196	10
		T4	-196	76	76	76	135	63	135	-40 -50 <sup>1)</sup>	-40 -50 <sup>1)</sup>	-40 -50 <sup>1)</sup>	-196	10
		T3	-196	76	76	76	200	50	200	-40 -50 <sup>1)</sup>	-40 -50 <sup>1)</sup>	-40 -50 <sup>1)</sup>	-196	10

1) Only in connection with Optional specification, ID Jx (Test, Certificate) = JN

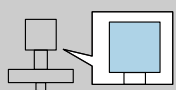
 = C	(2)		P1		P2		P3		P4		P5		P6	
			T <sub>p</sub>	T <sub>a</sub>	T <sub>p</sub>	T <sub>a</sub>	T <sub>p</sub>	T <sub>a</sub>	T <sub>p</sub>	T <sub>a</sub>	T <sub>p</sub>	T <sub>a</sub>	T <sub>p</sub>	T <sub>a</sub>
	E, G	T6	-196	57	57	57	85	53	85	-40 -50 <sup>1)</sup>	-40 -50 <sup>1)</sup>	-40 -50 <sup>1)</sup>	-196	-8
		T5	-196	72	72	72	100	68	100	-40 -50 <sup>1)</sup>	-40 -50 <sup>1)</sup>	-40 -50 <sup>1)</sup>	-196	-8
		T4	-196	76	76	76	135	66	135	-40 -50 <sup>1)</sup>	-40 -50 <sup>1)</sup>	-40 -50 <sup>1)</sup>	-196	-8
		T3	-196	76	76	76	200	55	200	-40 -50 <sup>1)</sup>	-40 -50 <sup>1)</sup>	-40 -50 <sup>1)</sup>	-196	-8

1) Only in connection with Optional specification, ID Jx (Test, Certificate) = JN

 Explosion protection: Division 2 (NIFW and standard wiring)

Antenna: Class I, Zone 0 / Class I, Division 1 or Division 2;  
 Electronics housing: Class I, Division 2

**FMR52**

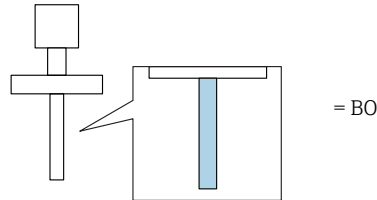

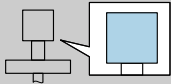
 = B	(2)	P1		P2		P3		P4		P5		P6		
		T <sub>p</sub>	T <sub>a</sub>	T <sub>p</sub>	T <sub>a</sub>	T <sub>p</sub>	T <sub>a</sub>	T <sub>p</sub>	T <sub>a</sub>	T <sub>p</sub>	T <sub>a</sub>	T <sub>p</sub>	T <sub>a</sub>	
	E, G	T6	-196	60	60	60	85	55	85	-40	-40	-40	-196	-3
		T5	-196	75	75	75	100	70	100	-40	-40	-40	-196	-3
		T4	-196	76	76	76	135	65	135	-40	-40	-40	-196	-3
		T3	-196	76	76	76	200	54	200	-40	-40	-40	-196	-3

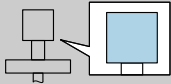
 = C	(2)	P1		P2		P3		P4		P5		P6		
		T <sub>p</sub>	T <sub>a</sub>	T <sub>p</sub>	T <sub>a</sub>	T <sub>p</sub>	T <sub>a</sub>	T <sub>p</sub>	T <sub>a</sub>	T <sub>p</sub>	T <sub>a</sub>	T <sub>p</sub>	T <sub>a</sub>	
	E, G	T6	-196	60	60	60	85	56	85	-40	-40	-40	-196	-14
		T5	-196	75	75	75	100	71	100	-40	-40	-40	-196	-14
		T4	-196	76	76	76	135	67	135	-40	-40	-40	-196	-14
		T3	-196	76	76	76	200	58	200	-40	-40	-40	-196	-14

**FMR52**

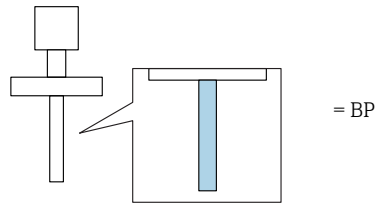

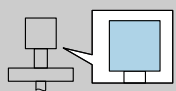
 = B	(2)	P1		P2		P3		P4		P5		P6		
		T <sub>p</sub>	T <sub>a</sub>	T <sub>p</sub>	T <sub>a</sub>	T <sub>p</sub>	T <sub>a</sub>	T <sub>p</sub>	T <sub>a</sub>	T <sub>p</sub>	T <sub>a</sub>	T <sub>p</sub>	T <sub>a</sub>	
	E, G	T6	-196	60	60	60	85	54	85	-40	-40	-40	-196	10
		T5	-196	75	75	75	100	69	100	-40	-40	-40	-196	10
		T4	-196	76	76	76	135	63	135	-40	-40	-40	-196	10
		T3	-196	76	76	76	200	50	200	-40	-40	-40	-196	10

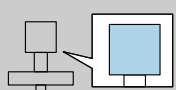
 = C	(2)	P1		P2		P3		P4		P5		P6		
		T <sub>p</sub>	T <sub>a</sub>	T <sub>p</sub>	T <sub>a</sub>	T <sub>p</sub>	T <sub>a</sub>	T <sub>p</sub>	T <sub>a</sub>	T <sub>p</sub>	T <sub>a</sub>	T <sub>p</sub>	T <sub>a</sub>	
	E, G	T6	-196	60	60	60	85	55	85	-40	-40	-40	-196	-8
		T5	-196	75	75	75	100	70	100	-40	-40	-40	-196	-8
		T4	-196	76	76	76	135	66	135	-40	-40	-40	-196	-8
		T3	-196	76	76	76	200	55	200	-40	-40	-40	-196	-8

 Explosion protection: IS / AEx ia/Ex ia

Antenna: Class I, Zone 0 / Class I, Division 1;

Electronics housing: Class I, Zone 1 / Class I, Division 1

**FMR53**

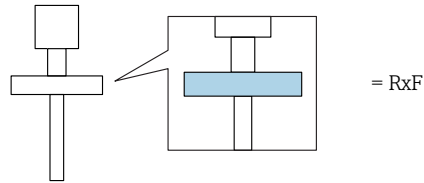

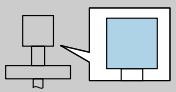
 = A	(2)		P1		P2		P3		P4		P5		P6	
			T <sub>p</sub>	T <sub>a</sub>	T <sub>p</sub>	T <sub>a</sub>	T <sub>p</sub>	T <sub>a</sub>	T <sub>p</sub>	T <sub>a</sub>	T <sub>p</sub>	T <sub>a</sub>	T <sub>p</sub>	T <sub>a</sub>
	E, G	T6	-40	51	51	51	80	47	80	-40	-40	-40	-	-

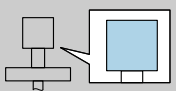
 = B, C	(2)		P1		P2		P3		P4		P5		P6	
			T <sub>p</sub>	T <sub>a</sub>	T <sub>p</sub>	T <sub>a</sub>	T <sub>p</sub>	T <sub>a</sub>	T <sub>p</sub>	T <sub>a</sub>	T <sub>p</sub>	T <sub>a</sub>	T <sub>p</sub>	T <sub>a</sub>
	E, G	T6	-40	57	57	57	80	55	80	-40	-40	-40	-	-

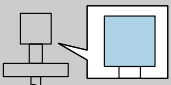

**FMR53**

 = A	(2)		P1		P2		P3		P4		P5		P6	
			T <sub>p</sub>	T <sub>a</sub>	T <sub>p</sub>	T <sub>a</sub>	T <sub>p</sub>	T <sub>a</sub>	T <sub>p</sub>	T <sub>a</sub>	T <sub>p</sub>	T <sub>a</sub>	T <sub>p</sub>	T <sub>a</sub>
	E, G	T6	-40	51	51	51	85	42	85	-40	-40	-40	-	-
		T5	-40	56	56	56	100	45	100	-40	-40	-40	-	-
		T4	-40	56	56	56	135	36	135	-20	-40	-40	-	-
		T3 <sup>1)</sup>	-40	56	56	56	150	32	150	-20	-40	-40	-	-

1) Functional: Maximum permissible process temperature

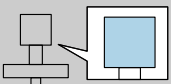
 = B	(2)		P1		P2		P3		P4		P5		P6	
			T <sub>p</sub>	T <sub>a</sub>	T <sub>p</sub>	T <sub>a</sub>	T <sub>p</sub>	T <sub>a</sub>	T <sub>p</sub>	T <sub>a</sub>	T <sub>p</sub>	T <sub>a</sub>	T <sub>p</sub>	T <sub>a</sub>
	E, G	T6	-40	57	57	57	85	51	85	-40	-40	-40	-	-
		T5	-40	72	72	72	100	66	100	-40	-40	-40	-	-
		T4	-40	76	76	76	135	62	135	-40	-40	-40	-	-
		T3 <sup>1)</sup>	-40	76	76	76	150	58	150	-40	-40	-40	-	-

1) Functional: Maximum permissible process temperature

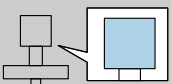
 = C	(2)		P1		P2		P3		P4		P5		P6	
			T <sub>p</sub>	T <sub>a</sub>	T <sub>p</sub>	T <sub>a</sub>	T <sub>p</sub>	T <sub>a</sub>	T <sub>p</sub>	T <sub>a</sub>	T <sub>p</sub>	T <sub>a</sub>	T <sub>p</sub>	T <sub>a</sub>
	E, G	T6	-40	57	57	57	85	52	85	-40	-40	-40	-	-
		T5	-40	72	72	72	100	67	100	-40	-40	-40	-	-
		T4	-40	76	76	76	135	64	135	-40	-40	-40	-	-
		T3 <sup>1)</sup>	-40	76	76	76	150	62	150	-40	-40	-40	-	-

1) Functional: Maximum permissible process temperature

**i** Explosion protection: Division 2 (NIFW and standard wiring)

Antenna: Class I, Zone 0 / Class I, Division 1 or Division 2;  
 Electronics housing: Class I, Division 2

**FMR53**

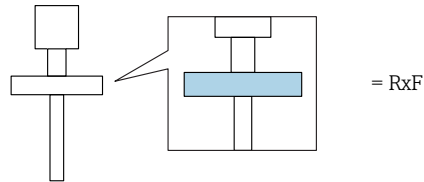

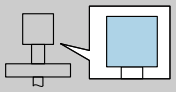
 = B, C	(2)		P1		P2		P3		P4		P5		P6	
			T <sub>p</sub>	T <sub>a</sub>	T <sub>p</sub>	T <sub>a</sub>	T <sub>p</sub>	T <sub>a</sub>	T <sub>p</sub>	T <sub>a</sub>	T <sub>p</sub>	T <sub>a</sub>	T <sub>p</sub>	T <sub>a</sub>
	E, G	T6	-40	60	60	60	80	58	80	-40	-40	-40	-	-

**FMR53**

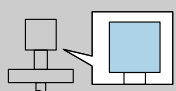
 = B	(2)		P1		P2		P3		P4		P5		P6	
			T <sub>p</sub>	T <sub>a</sub>	T <sub>p</sub>	T <sub>a</sub>	T <sub>p</sub>	T <sub>a</sub>	T <sub>p</sub>	T <sub>a</sub>	T <sub>p</sub>	T <sub>a</sub>	T <sub>p</sub>	T <sub>a</sub>
	E, G	T6	-40	60	60	60	85	53	85	-40	-40	-40	-	-
		T5	-40	75	75	75	100	68	100	-40	-40	-40	-	-
		T4	-40	76	76	76	135	62	135	-40	-40	-40	-	-
		T3 <sup>1)</sup>	-40	76	76	76	150	58	150	-40	-40	-40	-	-

1) Functional: Maximum permissible process temperature

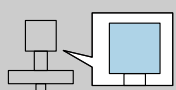
 = C	(2)		P1		P2		P3		P4		P5		P6	
			T <sub>p</sub>	T <sub>a</sub>	T <sub>p</sub>	T <sub>a</sub>	T <sub>p</sub>	T <sub>a</sub>	T <sub>p</sub>	T <sub>a</sub>	T <sub>p</sub>	T <sub>a</sub>	T <sub>p</sub>	T <sub>a</sub>
	E, G	T6	-40	60	60	60	85	54	85	-40	-40	-40	-	-
		T5	-40	75	75	75	100	69	100	-40	-40	-40	-	-
		T4	-40	76	76	76	135	64	135	-40	-40	-40	-	-
		T3 <sup>1)</sup>	-40	76	76	76	150	62	150	-40	-40	-40	-	-

1) Functional: Maximum permissible process temperature

 Explosion protection: IS / AEx ia/Ex ia

Antenna: Class I, Zone 0 / Class I, Division 1;

Electronics housing: Class I, Zone 1 / Class I, Division 1

#### FMR54

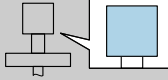
 = A	(2)	P1		P2		P3		P4		P5		P6		
		T <sub>p</sub>	T <sub>a</sub>	T <sub>p</sub>	T <sub>a</sub>	T <sub>p</sub>	T <sub>a</sub>	T <sub>p</sub>	T <sub>a</sub>	T <sub>p</sub>	T <sub>a</sub>	T <sub>p</sub>	T <sub>a</sub>	
	E, G	T6	-40	51	51	51	85	42	85	-40	-40	-40	-	-
		T5	-40	56	56	56	100	45	100	-40	-40	-40	-	-
		T4	-40	56	56	56	135	35	135	-40	-40	-40	-	-

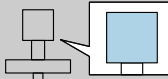
 = B	(2)	P1		P2		P3		P4		P5		P6		
		T <sub>p</sub>	T <sub>a</sub>	T <sub>p</sub>	T <sub>a</sub>	T <sub>p</sub>	T <sub>a</sub>	T <sub>p</sub>	T <sub>a</sub>	T <sub>p</sub>	T <sub>a</sub>	T <sub>p</sub>	T <sub>a</sub>	
	E, G	T6	-40	57	57	57	85	51	85	-40	-40	-40	-	-
		T5	-40	72	72	72	100	66	100	-40	-40	-40	-	-
		T4	-40	76	76	76	135	61	135	-40	-40	-40	-	-
		T3	-40	76	76	76	200	45	200	-40	-40	-40	-	-

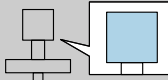
 = C	(2)	P1		P2		P3		P4		P5		P6		
		T <sub>p</sub>	T <sub>a</sub>	T <sub>p</sub>	T <sub>a</sub>	T <sub>p</sub>	T <sub>a</sub>	T <sub>p</sub>	T <sub>a</sub>	T <sub>p</sub>	T <sub>a</sub>	T <sub>p</sub>	T <sub>a</sub>	
	E, G	T6	-40	57	57	57	85	52	85	-40	-40	-40	-	-
		T5	-40	72	72	72	100	67	100	-40	-40	-40	-	-
		T4	-40	76	76	76	135	64	135	-40	-40	-40	-	-
		T3	-40	76	76	76	200	51	200	-40	-40	-40	-	-

**FMR54**

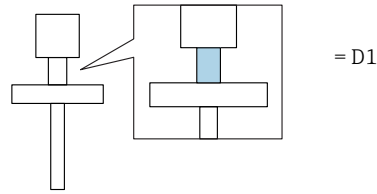

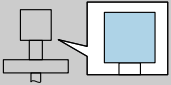
 = A	(2)	P1		P2		P3		P4		P5		P6		
		T <sub>p</sub>	T <sub>a</sub>	T <sub>p</sub>	T <sub>a</sub>	T <sub>p</sub>	T <sub>a</sub>	T <sub>p</sub>	T <sub>a</sub>	T <sub>p</sub>	T <sub>a</sub>	T <sub>p</sub>	T <sub>a</sub>	
	E, G	T6	-196	51	51	51	85	44	85	-40	-40	-40	-196	18
		T5	-196	56	56	56	100	47	100	-40	-40	-40	-196	18
		T4	-196	56	56	56	135	40	135	-40	-40	-40	-196	18

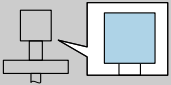
 = B	(2)	P1		P2		P3		P4		P5		P6		
		T <sub>p</sub>	T <sub>a</sub>	T <sub>p</sub>	T <sub>a</sub>	T <sub>p</sub>	T <sub>a</sub>	T <sub>p</sub>	T <sub>a</sub>	T <sub>p</sub>	T <sub>a</sub>	T <sub>p</sub>	T <sub>a</sub>	
	E, G	T6	-196	57	57	57	85	53	85	-40 -50 <sup>1)</sup>	-40 -50 <sup>1)</sup>	-40 -50 <sup>1)</sup>	-196	-4
		T5	-196	72	72	72	100	68	100	-40 -50 <sup>1)</sup>	-40 -50 <sup>1)</sup>	-40 -50 <sup>1)</sup>	-196	-4
		T4	-196	76	76	76	135	65	135	-40 -50 <sup>1)</sup>	-40 -50 <sup>1)</sup>	-40 -50 <sup>1)</sup>	-196	-4
		T3	-196	76	76	76	200	54	200	-40 -50 <sup>1)</sup>	-40 -50 <sup>1)</sup>	-40 -50 <sup>1)</sup>	-196	-4
		T2 <sup>2)</sup>	-196	76	76	76	280	41	280	-40 -50 <sup>1)</sup>	-40 -50 <sup>1)</sup>	-40 -50 <sup>1)</sup>	-196	-4

- 1) Only in connection with Optional specification, ID Jx (Test, Certificate) = JN
- 2) Functional: Maximum permissible process temperature

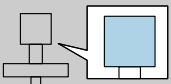
 = C	(2)	P1		P2		P3		P4		P5		P6		
		T <sub>p</sub>	T <sub>a</sub>	T <sub>p</sub>	T <sub>a</sub>	T <sub>p</sub>	T <sub>a</sub>	T <sub>p</sub>	T <sub>a</sub>	T <sub>p</sub>	T <sub>a</sub>	T <sub>p</sub>	T <sub>a</sub>	
	E, G	T6	-196	57	57	57	85	54	85	-40 -50 <sup>1)</sup>	-40 -50 <sup>1)</sup>	-40 -50 <sup>1)</sup>	-196	-15
		T5	-196	72	72	72	100	69	100	-40 -50 <sup>1)</sup>	-40 -50 <sup>1)</sup>	-40 -50 <sup>1)</sup>	-196	-15
		T4	-196	76	76	76	135	67	135	-40 -50 <sup>1)</sup>	-40 -50 <sup>1)</sup>	-40 -50 <sup>1)</sup>	-196	-15
		T3	-196	76	76	76	200	59	200	-40 -50 <sup>1)</sup>	-40 -50 <sup>1)</sup>	-40 -50 <sup>1)</sup>	-196	-15
		T2 <sup>2)</sup>	-196	76	76	76	280	48	280	-40 -50 <sup>1)</sup>	-40 -50 <sup>1)</sup>	-40 -50 <sup>1)</sup>	-196	-15

- 1) Only in connection with Optional specification, ID Jx (Test, Certificate) = JN
- 2) Functional: Maximum permissible process temperature

**FMR54**

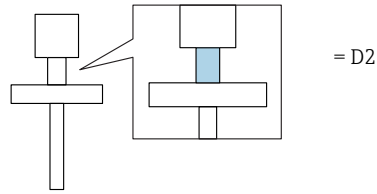

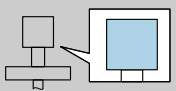
 = A	(2)	P1		P2		P3		P4		P5		P6		
		T <sub>p</sub>	T <sub>a</sub>	T <sub>p</sub>	T <sub>a</sub>	T <sub>p</sub>	T <sub>a</sub>	T <sub>p</sub>	T <sub>a</sub>	T <sub>p</sub>	T <sub>a</sub>	T <sub>p</sub>	T <sub>a</sub>	
	E, G	T6	-196	51	51	51	85	45	85	-40	-40	-40	-196	11
		T5	-196	56	56	56	100	48	100	-40	-40	-40	-196	11
		T4	-196	56	56	56	135	41	135	-40	-40	-40	-196	11

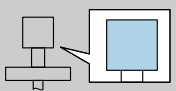
 = B	(2)	P1		P2		P3		P4		P5		P6		
		T <sub>p</sub>	T <sub>a</sub>	T <sub>p</sub>	T <sub>a</sub>	T <sub>p</sub>	T <sub>a</sub>	T <sub>p</sub>	T <sub>a</sub>	T <sub>p</sub>	T <sub>a</sub>	T <sub>p</sub>	T <sub>a</sub>	
	E, G	T6	-196	57	57	57	85	53	85	-40 -50 <sup>1)</sup>	-40 -50 <sup>1)</sup>	-40 -50 <sup>1)</sup>	-196	-13
		T5	-196	72	72	72	100	68	100	-40 -50 <sup>1)</sup>	-40 -50 <sup>1)</sup>	-40 -50 <sup>1)</sup>	-196	-13
		T4	-196	76	76	76	135	67	135	-40 -50 <sup>1)</sup>	-40 -50 <sup>1)</sup>	-40 -50 <sup>1)</sup>	-196	-13
		T3	-196	76	76	76	200	57	200	-40 -50 <sup>1)</sup>	-40 -50 <sup>1)</sup>	-40 -50 <sup>1)</sup>	-196	-13
		T2	-196	76	76	76	300	43	300	-40 -50 <sup>1)</sup>	-40 -50 <sup>1)</sup>	-40 -50 <sup>1)</sup>	-196	-13

1) Only in connection with Optional specification, ID Jx (Test, Certificate) = JN

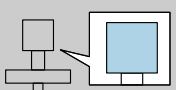
 = C	(2)	P1		P2		P3		P4		P5		P6		
		T <sub>p</sub>	T <sub>a</sub>	T <sub>p</sub>	T <sub>a</sub>	T <sub>p</sub>	T <sub>a</sub>	T <sub>p</sub>	T <sub>a</sub>	T <sub>p</sub>	T <sub>a</sub>	T <sub>p</sub>	T <sub>a</sub>	
	E, G	T6	-196	57	57	57	85	54	85	-40 -50 <sup>1)</sup>	-40 -50 <sup>1)</sup>	-40 -50 <sup>1)</sup>	-196	-19 -26 <sup>1)</sup>
		T5	-196	72	72	72	100	69	100	-40 -50 <sup>1)</sup>	-40 -50 <sup>1)</sup>	-40 -50 <sup>1)</sup>	-196	-19 -26 <sup>1)</sup>
		T4	-196	76	76	76	135	69	135	-40 -50 <sup>1)</sup>	-40 -50 <sup>1)</sup>	-40 -50 <sup>1)</sup>	-196	-19 -26 <sup>1)</sup>
		T3	-196	76	76	76	200	61	200	-40 -50 <sup>1)</sup>	-40 -50 <sup>1)</sup>	-40 -50 <sup>1)</sup>	-196	-19 -26 <sup>1)</sup>
		T2	-196	76	76	76	300	49	300	-40 -50 <sup>1)</sup>	-40 -50 <sup>1)</sup>	-40 -50 <sup>1)</sup>	-196	-19 -26 <sup>1)</sup>
		T1 <sup>2)</sup>	-196	76	76	76	400	38	400	-40 -50 <sup>1)</sup>	-40 -50 <sup>1)</sup>	-40 -50 <sup>1)</sup>	-196	-19 -26 <sup>1)</sup>

1) Only in connection with Optional specification, ID Jx (Test, Certificate) = JN

2) Functional: Maximum permissible process temperature

**FMR54**

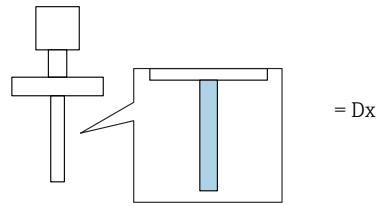

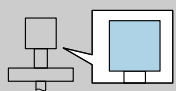
 = A	(2)	P1		P2		P3		P4		P5		P6		
		T <sub>p</sub>	T <sub>a</sub>	T <sub>p</sub>	T <sub>a</sub>	T <sub>p</sub>	T <sub>a</sub>	T <sub>p</sub>	T <sub>a</sub>	T <sub>p</sub>	T <sub>a</sub>	T <sub>p</sub>	T <sub>a</sub>	
	E, G	T6	-40	51	51	51	85	44	85	-40	-40	-40	-	-
		T5	-40	56	56	56	100	47	100	-40	-40	-40	-	-
		T4	-40	56	56	56	135	39	135	-40	-40	-40	-	-
		T3 <sup>1)</sup>	-40	56	56	56	150	36	150	-40	-40	-40	-	-

1) Functional: Maximum permissible process temperature

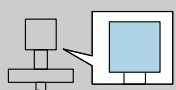
 = B	(2)	P1		P2		P3		P4		P5		P6		
		T <sub>p</sub>	T <sub>a</sub>	T <sub>p</sub>	T <sub>a</sub>	T <sub>p</sub>	T <sub>a</sub>	T <sub>p</sub>	T <sub>a</sub>	T <sub>p</sub>	T <sub>a</sub>	T <sub>p</sub>	T <sub>a</sub>	
	E, G	T6	-40	57	57	57	85	52	85	-40	-40	-40	-	-
		T5	-40	72	72	72	100	67	100	-40	-40	-40	-	-
		T4	-40	76	76	76	135	65	135	-40	-40	-40	-	-
		T3 <sup>1)</sup>	-40	76	76	76	150	62	150	-40	-40	-40	-	-

1) Functional: Maximum permissible process temperature

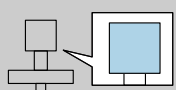
 = C	(2)	P1		P2		P3		P4		P5		P6		
		T <sub>p</sub>	T <sub>a</sub>	T <sub>p</sub>	T <sub>a</sub>	T <sub>p</sub>	T <sub>a</sub>	T <sub>p</sub>	T <sub>a</sub>	T <sub>p</sub>	T <sub>a</sub>	T <sub>p</sub>	T <sub>a</sub>	
	E, G	T6	-40	57	57	57	85	53	85	-40	-40	-40	-	-
		T5	-40	72	72	72	100	68	100	-40	-40	-40	-	-
		T4	-40	76	76	76	135	67	135	-40	-40	-40	-	-
		T3 <sup>1)</sup>	-40	76	76	76	150	65	150	-40	-40	-40	-	-

1) Functional: Maximum permissible process temperature

 Explosion protection: Division 2 (NIFW and standard wiring)

Antenna: Class I, Zone 0 / Class I, Division 1 or Division 2;  
Electronics housing: Class I, Division 2

#### FMR54

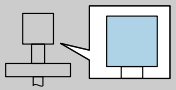
 = B	(2)	P1		P2		P3		P4		P5		P6		
		T <sub>p</sub>	T <sub>a</sub>	T <sub>p</sub>	T <sub>a</sub>	T <sub>p</sub>	T <sub>a</sub>	T <sub>p</sub>	T <sub>a</sub>	T <sub>p</sub>	T <sub>a</sub>	T <sub>p</sub>	T <sub>a</sub>	
	E, G	T6	-40	60	60	60	85	53	85	-40	-40	-40	-	-
		T5	-40	75	75	75	100	68	100	-40	-40	-40	-	-
		T4	-40	76	76	76	135	61	135	-40	-40	-40	-	-
		T3	-40	76	76	76	200	45	200	-40	-40	-40	-	-

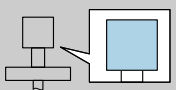
 = C	(2)	P1		P2		P3		P4		P5		P6		
		T <sub>p</sub>	T <sub>a</sub>	T <sub>p</sub>	T <sub>a</sub>	T <sub>p</sub>	T <sub>a</sub>	T <sub>p</sub>	T <sub>a</sub>	T <sub>p</sub>	T <sub>a</sub>	T <sub>p</sub>	T <sub>a</sub>	
	E, G	T6	-40	60	60	60	85	54	85	-40	-40	-40	-	-
		T5	-40	75	75	75	100	69	100	-40	-40	-40	-	-
		T4	-40	76	76	76	135	64	135	-40	-40	-40	-	-
		T3	-40	76	76	76	200	51	200	-40	-40	-40	-	-



**FMR54**

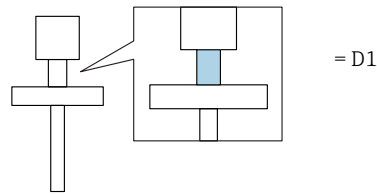

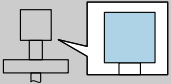
 = B	(2)	P1		P2		P3		P4		P5		P6		
		T <sub>p</sub>	T <sub>a</sub>	T <sub>p</sub>	T <sub>a</sub>	T <sub>p</sub>	T <sub>a</sub>	T <sub>p</sub>	T <sub>a</sub>	T <sub>p</sub>	T <sub>a</sub>	T <sub>p</sub>	T <sub>a</sub>	
	E, G	T6	-196	60	60	60	85	55	85	-40	-40	-40	-196	-4
		T5	-196	75	75	75	100	70	100	-40	-40	-40	-196	-4
		T4	-196	76	76	76	135	65	135	-40	-40	-40	-196	-4
		T3	-196	76	76	76	200	54	200	-40	-40	-40	-196	-4
		T2 <sup>1)</sup>	-196	76	76	76	280	41	280	-40	-40	-40	-196	-4

1) Functional: Maximum permissible process temperature

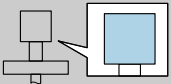
 = C	(2)	P1		P2		P3		P4		P5		P6		
		T <sub>p</sub>	T <sub>a</sub>	T <sub>p</sub>	T <sub>a</sub>	T <sub>p</sub>	T <sub>a</sub>	T <sub>p</sub>	T <sub>a</sub>	T <sub>p</sub>	T <sub>a</sub>	T <sub>p</sub>	T <sub>a</sub>	
	E, G	T6	-196	60	60	60	85	56	85	-40	-40	-40	-196	-15
		T5	-196	75	75	75	100	71	100	-40	-40	-40	-196	-15
		T4	-196	76	76	76	135	67	135	-40	-40	-40	-196	-15
		T3	-196	76	76	76	200	59	200	-40	-40	-40	-196	-15
		T2 <sup>1)</sup>	-196	76	76	76	280	48	280	-40	-40	-40	-196	-15

1) Functional: Maximum permissible process temperature

**FMR54**

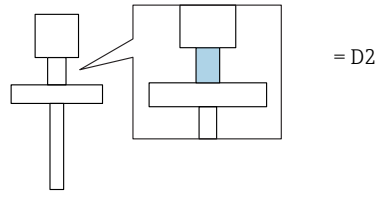

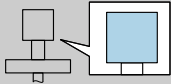
 = B	(2)	P1		P2		P3		P4		P5		P6		
		T <sub>p</sub>	T <sub>a</sub>	T <sub>p</sub>	T <sub>a</sub>	T <sub>p</sub>	T <sub>a</sub>	T <sub>p</sub>	T <sub>a</sub>	T <sub>p</sub>	T <sub>a</sub>	T <sub>p</sub>	T <sub>a</sub>	
	E, G	T6	-196	60	60	60	85	56	85	-40	-40	-40	-196	-13
		T5	-196	75	75	75	100	71	100	-40	-40	-40	-196	-13
		T4	-196	76	76	76	135	67	135	-40	-40	-40	-196	-13
		T3	-196	76	76	76	200	57	200	-40	-40	-40	-196	-13
		T2	-196	76	76	76	300	43	300	-40	-40	-40	-196	-13

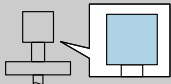
 = C	(2)	P1		P2		P3		P4		P5		P6		
		T <sub>p</sub>	T <sub>a</sub>	T <sub>p</sub>	T <sub>a</sub>	T <sub>p</sub>	T <sub>a</sub>	T <sub>p</sub>	T <sub>a</sub>	T <sub>p</sub>	T <sub>a</sub>	T <sub>p</sub>	T <sub>a</sub>	
	E, G	T6	-196	60	60	60	85	57	85	-40	-40	-40	-196	-19
		T5	-196	75	75	75	100	72	100	-40	-40	-40	-196	-19
		T4	-196	76	76	76	135	69	135	-40	-40	-40	-196	-19
		T3	-196	76	76	76	200	61	200	-40	-40	-40	-196	-19
		T2	-196	76	76	76	300	49	300	-40	-40	-40	-196	-19
		T1 <sup>1)</sup>	-196	76	76	76	400	38	400	-40	-40	-40	-196	-19

1) Functional: Maximum permissible process temperature

**FMR54**

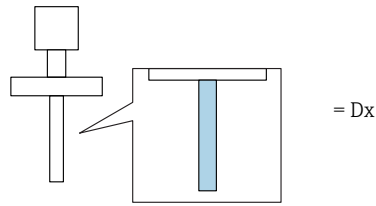

	(2)	P1		P2		P3		P4		P5		P6		
		T <sub>p</sub>	T <sub>a</sub>	T <sub>p</sub>	T <sub>a</sub>	T <sub>p</sub>	T <sub>a</sub>	T <sub>p</sub>	T <sub>a</sub>	T <sub>p</sub>	T <sub>a</sub>	T <sub>p</sub>	T <sub>a</sub>	
	E, G	T6	-40	60	60	60	85	55	85	-40	-40	-40	-	-
		T5	-40	75	75	75	100	70	100	-40	-40	-40	-	-
		T4	-40	76	76	76	135	65	135	-40	-40	-40	-	-
		T3 <sup>1)</sup>	-40	76	76	76	150	62	150	-40	-40	-40	-	-

1) Functional: Maximum permissible process temperature

	(2)	P1		P2		P3		P4		P5		P6		
		T <sub>p</sub>	T <sub>a</sub>	T <sub>p</sub>	T <sub>a</sub>	T <sub>p</sub>	T <sub>a</sub>	T <sub>p</sub>	T <sub>a</sub>	T <sub>p</sub>	T <sub>a</sub>	T <sub>p</sub>	T <sub>a</sub>	
	E, G	T6	-40	60	60	60	85	56	85	-40	-40	-40	-	-
		T5	-40	75	75	75	100	71	100	-40	-40	-40	-	-
		T4	-40	76	76	76	135	67	135	-40	-40	-40	-	-
		T3 <sup>1)</sup>	-40	76	76	76	150	65	150	-40	-40	-40	-	-

1) Functional: Maximum permissible process temperature

 Explosion protection: IS / AEx ia/Ex ia

Antenna: Class I, Zone 0 / Class I, Division 1;

Electronics housing: Class I, Zone 1 / Class I, Division 1

**FMR56**

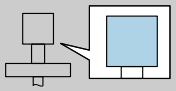
 = A	(2)		P1		P2		P3		P4		P5		P6	
			T <sub>p</sub>	T <sub>a</sub>	T <sub>p</sub>	T <sub>a</sub>	T <sub>p</sub>	T <sub>a</sub>	T <sub>p</sub>	T <sub>a</sub>	T <sub>p</sub>	T <sub>a</sub>	T <sub>p</sub>	T <sub>a</sub>
	E, G	T6	-40	51	51	51	80	47	80	-40	-40	-40	-	-

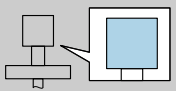
 = C	(2)		P1		P2		P3		P4		P5		P6	
			T <sub>p</sub>	T <sub>a</sub>	T <sub>p</sub>	T <sub>a</sub>	T <sub>p</sub>	T <sub>a</sub>	T <sub>p</sub>	T <sub>a</sub>	T <sub>p</sub>	T <sub>a</sub>	T <sub>p</sub>	T <sub>a</sub>
	E, G	T6	-40	57	57	57	80	55	80	-40	-40	-40	-	-

 Explosion protection: Division 2 (NIFW and standard wiring)

Antenna: Class I, Zone 0 / Class I, Division 1 or Division 2;  
 Electronics housing: Class I, Division 2

**FMR56**

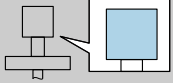
 = C	(2)		P1		P2		P3		P4		P5		P6	
			T <sub>p</sub>	T <sub>a</sub>	T <sub>p</sub>	T <sub>a</sub>	T <sub>p</sub>	T <sub>a</sub>	T <sub>p</sub>	T <sub>a</sub>	T <sub>p</sub>	T <sub>a</sub>	T <sub>p</sub>	T <sub>a</sub>
	E, G	T6	-40	60	60	60	80	58	80	-40	-40	-40	-	-

 Explosion protection: IS / AEx ia/Ex ia

Antenna: Class I, Zone 0 / Class I, Division 1;

Electronics housing: Class I, Zone 1 / Class I, Division 1

### FMR57

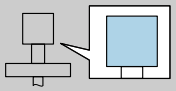
 = A	(2)	P1		P2		P3		P4		P5		P6		
		T <sub>p</sub>	T <sub>a</sub>	T <sub>p</sub>	T <sub>a</sub>	T <sub>p</sub>	T <sub>a</sub>	T <sub>p</sub>	T <sub>a</sub>	T <sub>p</sub>	T <sub>a</sub>	T <sub>p</sub>	T <sub>a</sub>	
	E, G	T6	-40	51	51	51	85	46	85	-40	-40	-40	-	-
		T5	-40	56	56	56	100	49	100	-40	-40	-40	-	-
		T4	-40	56	56	56	135	43	135	-40	-40	-40	-	-
		T3	-40	56	56	56	200	33	200	-40	-40	-40	-	-

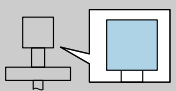
 = B	(2)	P1		P2		P3		P4		P5		P6		
		T <sub>p</sub>	T <sub>a</sub>	T <sub>p</sub>	T <sub>a</sub>	T <sub>p</sub>	T <sub>a</sub>	T <sub>p</sub>	T <sub>a</sub>	T <sub>p</sub>	T <sub>a</sub>	T <sub>p</sub>	T <sub>a</sub>	
	E, G	T6	-40	57	57	57	85	54	85	-40	-40	-40	-	-
		T5	-40	72	72	72	100	69	100	-40	-40	-40	-	-
		T4	-40	76	76	76	135	68	135	-40	-40	-40	-	-
		T3	-40	76	76	76	200	61	200	-40	-40	-40	-	-

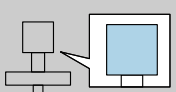
 = C	(2)	P1		P2		P3		P4		P5		P6		
		T <sub>p</sub>	T <sub>a</sub>	T <sub>p</sub>	T <sub>a</sub>	T <sub>p</sub>	T <sub>a</sub>	T <sub>p</sub>	T <sub>a</sub>	T <sub>p</sub>	T <sub>a</sub>	T <sub>p</sub>	T <sub>a</sub>	
	E, G	T6	-40	57	57	57	85	55	85	-40	-40	-40	-	-
		T5	-40	72	72	72	100	70	100	-40	-40	-40	-	-
		T4	-40	76	76	76	135	70	135	-40	-40	-40	-	-
		T3	-40	76	76	76	200	64	200	-40	-40	-40	-	-

**FMR57**

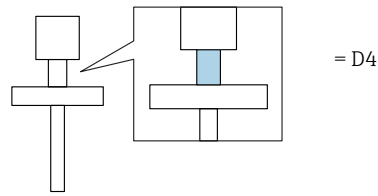

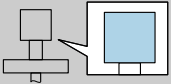
 = A	(2)	P1		P2		P3		P4		P5		P6		
		T <sub>p</sub>	T <sub>a</sub>	T <sub>p</sub>	T <sub>a</sub>	T <sub>p</sub>	T <sub>a</sub>	T <sub>p</sub>	T <sub>a</sub>	T <sub>p</sub>	T <sub>a</sub>	T <sub>p</sub>	T <sub>a</sub>	
	E, G	T6	-40	51	51	51	85	47	85	-40	-40	-40	-	-
		T5	-40	56	56	56	100	50	100	-40	-40	-40	-	-
		T4	-40	56	56	56	135	46	135	-40	-40	-40	-	-
		T3	-40	56	56	56	200	37	200	-40	-40	-40	-	-

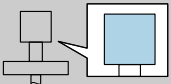
 = B	(2)	P1		P2		P3		P4		P5		P6		
		T <sub>p</sub>	T <sub>a</sub>	T <sub>p</sub>	T <sub>a</sub>	T <sub>p</sub>	T <sub>a</sub>	T <sub>p</sub>	T <sub>a</sub>	T <sub>p</sub>	T <sub>a</sub>	T <sub>p</sub>	T <sub>a</sub>	
	E, G	T6	-40	57	57	57	85	55	85	-40	-40	-40	-	-
		T5	-40	72	72	72	100	70	100	-40	-40	-40	-	-
		T4	-40	76	76	76	135	70	135	-40	-40	-40	-	-
		T3	-40	76	76	76	200	64	200	-40	-40	-40	-	-
		T2	-40	76	76	76	300	55	300	-40	-40	-40	-	-
		T1 <sup>1)</sup>	-40	76	76	76	400	46	400	-40	-40	-40	-	-

1) Functional: Maximum permissible process temperature

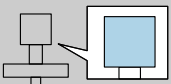
 = C	(2)	P1		P2		P3		P4		P5		P6		
		T <sub>p</sub>	T <sub>a</sub>	T <sub>p</sub>	T <sub>a</sub>	T <sub>p</sub>	T <sub>a</sub>	T <sub>p</sub>	T <sub>a</sub>	T <sub>p</sub>	T <sub>a</sub>	T <sub>p</sub>	T <sub>a</sub>	
	E, G	T6	-40	57	57	57	85	55	85	-40	-40	-40	-	-
		T5	-40	72	72	72	100	70	100	-40	-40	-40	-	-
		T4	-40	76	76	76	135	71	135	-40	-40	-40	-	-
		T3	-40	76	76	76	200	67	200	-40	-40	-40	-	-
		T2	-40	76	76	76	300	60	300	-40	-40	-40	-	-
		T1 <sup>1)</sup>	-40	76	76	76	400	52	400	-40	-40	-40	-	-

1) Functional: Maximum permissible process temperature

 Explosion protection: Division 2 (NIFW and standard wiring)

Antenna: Class I, Zone 0 / Class I, Division 1 or Division 2;  
Electronics housing: Class I, Division 2

### FMR57

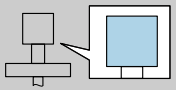
 = B	(2)	P1		P2		P3		P4		P5		P6		
		T <sub>p</sub>	T <sub>a</sub>	T <sub>p</sub>	T <sub>a</sub>	T <sub>p</sub>	T <sub>a</sub>	T <sub>p</sub>	T <sub>a</sub>	T <sub>p</sub>	T <sub>a</sub>	T <sub>p</sub>	T <sub>a</sub>	
	E, G	T6	-40	60	60	60	85	56	85	-40	-40	-40	-	-
		T5	-40	75	75	75	100	71	100	-40	-40	-40	-	-
		T4	-40	76	76	76	135	68	135	-40	-40	-40	-	-
		T3	-40	76	76	76	200	61	200	-40	-40	-40	-	-

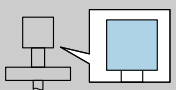
 = C	(2)	P1		P2		P3		P4		P5		P6		
		T <sub>p</sub>	T <sub>a</sub>	T <sub>p</sub>	T <sub>a</sub>	T <sub>p</sub>	T <sub>a</sub>	T <sub>p</sub>	T <sub>a</sub>	T <sub>p</sub>	T <sub>a</sub>	T <sub>p</sub>	T <sub>a</sub>	
	E, G	T6	-40	60	60	60	85	57	85	-40	-40	-40	-	-
		T5	-40	75	75	75	100	72	100	-40	-40	-40	-	-
		T4	-40	76	76	76	135	70	135	-40	-40	-40	-	-
		T3	-40	76	76	76	200	64	200	-40	-40	-40	-	-



**FMR57**

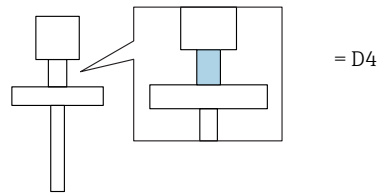

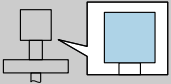
 = B	(2)	P1		P2		P3		P4		P5		P6		
		T <sub>p</sub>	T <sub>a</sub>	T <sub>p</sub>	T <sub>a</sub>	T <sub>p</sub>	T <sub>a</sub>	T <sub>p</sub>	T <sub>a</sub>	T <sub>p</sub>	T <sub>a</sub>	T <sub>p</sub>	T <sub>a</sub>	
	E, G	T6	-40	60	60	60	85	57	85	-40	-40	-40	-	-
		T5	-40	75	75	75	100	72	100	-40	-40	-40	-	-
		T4	-40	76	76	76	135	70	135	-40	-40	-40	-	-
		T3	-40	76	76	76	200	64	200	-40	-40	-40	-	-
		T2	-40	76	76	76	300	55	300	-40	-40	-40	-	-
		T1 <sup>1)</sup>	-40	76	76	76	400	46	400	-40	-40	-40	-	-

1) Functional: Maximum permissible process temperature

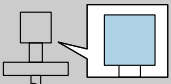
 = C	(2)	P1		P2		P3		P4		P5		P6		
		T <sub>p</sub>	T <sub>a</sub>	T <sub>p</sub>	T <sub>a</sub>	T <sub>p</sub>	T <sub>a</sub>	T <sub>p</sub>	T <sub>a</sub>	T <sub>p</sub>	T <sub>a</sub>	T <sub>p</sub>	T <sub>a</sub>	
	E, G	T6	-40	60	60	60	85	58	85	-40	-40	-40	-	-
		T5	-40	75	75	75	100	73	100	-40	-40	-40	-	-
		T4	-40	76	76	76	135	71	135	-40	-40	-40	-	-
		T3	-40	76	76	76	200	67	200	-40	-40	-40	-	-
		T2	-40	76	76	76	300	60	300	-40	-40	-40	-	-
		T1 <sup>1)</sup>	-40	76	76	76	400	52	400	-40	-40	-40	-	-

1) Functional: Maximum permissible process temperature

**Class II, III, Division 1;  
1 channel**

*Position 3 (Power Supply, Output) = E, G: 1 channel used*

**FMR5x**

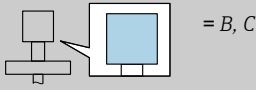
	(1)	
	E, G	$T = T_a + 6 \text{ K}$

**Class II, III, Division 1;  
2 channels**

*Position 3 (Power Supply, Output) = E, G: 2 channels used*

**FMR5x**

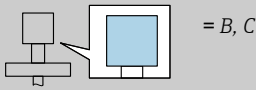
	(2)	
	E, G	$T = T_a + 12 \text{ K}$

# Micropilot FMR50/51/52/53/54/56/57

PROFIBUS PA, FOUNDATION Fieldbus

## Table of contents

Attachment: Nameplate view . . . . . 68

Attachment: Nameplate view

The diagrams show three variations of the nameplate for the Micropilot FMR50/51/52 series. Each nameplate includes the following information:

- Order code:** 8
- Ser. no.:** xxxxxxxx
- Ext. ord. cd.:** FMR5x-FAbcdeffgghhh
- Switch output:** 23, 25
- Temperature ratings:** Tp max = 12 MWP: 13; 21 Ln = ; 78 Ta > 60 °C; (Ta + 20 K)
- Material:** 15
- Manufacturer:** Endress+Hauser
- IP Rating:** IP68/66 Type 4X / 6P Encl.
- Standards:** FM19.US0045X, FM19.CA0023X, CRN OF18572.5C
- IS Classification:** IS CL I, DIV 1, GP A,B,C,D T6...T1
- Warnings:** See warning sign fixed to the enclosure. Voir plaque d'avertissement fixée au boîtier.
- Part Number:** XA01118F
- Date:** JJJJ-MM

The three diagrams differ in their IS classification and additional standards:

- Top Diagram (FMR50):** IS CL I, DIV 1, GP A,B,C,D T6...T1
- Middle Diagram (FMR51):** IS CL I, II, III, DIV 1, GP A-G T6...T1; NI CL I, DIV 2, GP A,B,C,D T6...T1; CL I, Zn 0, AEx/Ex ia IIC T6...T1 Ga
- Bottom Diagram (FMR52):** CRN OF18572.5C, 151079 CSA 14.2675458; IS CL I, II, III, DIV 1, GP A-G T6...T1; XP-IS CL I, DIV 1, GP A-D T6...T1; DIP-IS CL II, III, DIV 1, GP E-G T6...T1; AIS CL I, II, III, DIV 1, GP A-G [Exia]; FM19.US0045X, FM19.CA0023X

Each diagram also includes a warning label with the following text:

**WARNINGS:** Potential electrostatic charging hazard - see instructions. Substitution of components may impair suitability for hazardous locations.

**AVERTISSEMENTS:** Risque potentiel de décharges électrostatiques - voir consignes. La substitution de composants peut compromettre l'adaptabilité aux emplacements dangereux.

A0037144

Field no.	Order code FMR5x-aabcdeffgghh +options	Contents	Comment
3	-	Made in Germany, 79689 Maulburg	Depending on production plant
		Assembled in USA	
		Assembled in India	
6	-	+##****#	<b>+options</b> added to Order Code (multiple options may be added; options relevant to approval are included below)
8	-	Ident.-No.	Individual no. for identically configured devices
12	-	Actual process temperature	Depends on options ff, gg and hhh
13	-	Permissible pressure (process): bar or psi	Depends on antenna type FMR5x and process connection (options hhh)
15	-	Process wetted materials	Depends on options ff, gg and hhh
21	e = A,B,I,M	M20x1,5 / M16x1,5	Cable Entry
	e = C	G ½ / M16x1,5	
	e = D	NPT ½ / M16x1,5	
23	b = E,G	-	Electrical Ratings (fieldbus connection)
25	b = E	FOUNDATION Fieldbus	Fieldbus protocol
	b = G	PROFIBUS PA (MBP)	
52	FMR50 FMR51 FMR52 FMR56 FMR57	Dual Seal	Dual Seal rating (MWP ...) required only when permissible pressure (Field 13) > 12 bar (174 psi). Use same units as Field 13.
	FMR53 FMP54	Dual Seal (MWP: 12 bar (174 psi))	
63, 64	-	(checkbox)	First installation checkbox
78	-	T <sub>a</sub> : -40 to +80 °C	Ambient temperature range
	<b>+options = JN</b>	T <sub>a</sub> : -50 to +80 °C	



---



[www.addresses.endress.com](http://www.addresses.endress.com)

---