

Instrucțiuni de utilizare **Soliphant M FTM52**

RO- Detector de nivel punctual

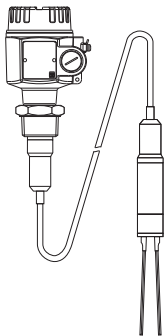

ro - Cuprins

Note privind siguranța	3
Manevrare	4
Identificarea dispozitivului	6
Note privind montarea	10
Sistem de măsurare	12
Selectarea lungimii lamelor vibrante	15
Modul protecție intrinsecă	19
Diagnosticare	24
Referințe la simbolism	26
Conexiuni	27
Întreținere	48
Date tehnice	49
Accesorii	50
Depanare	52
Piese de schimb	53
Reparații	56
Documentație suplimentară	57



Atenție!

= interzis;

duce la utilizare incorectă
sau distrugere.

ro - Note privind siguranța

Soliphant M FTM52 este proiectat pentru detectarea limitei de nivel în substanțele solide în vrac. În caz de utilizare incorectă, este posibil să apară pericole legate de aplicație.

Detectorul limitei de nivel poate fi instalat, conectat, pus în funcțiune, operat și întreținut

numai de către personal

calificat și autorizat, cu

respectarea strictă a acestor instrucțiuni de operare, a standardelor în vigoare, a dispozițiilor legale și, unde este cazul, a certificatului.

Instalați un întrerupător de alimentare ușor accesibil în apropierea dispozitivului.

Marcați întrerupătorul de rețea ca separator pentru dispozitiv.

ro - Manevrare

Nu țineți de lamele vibrante

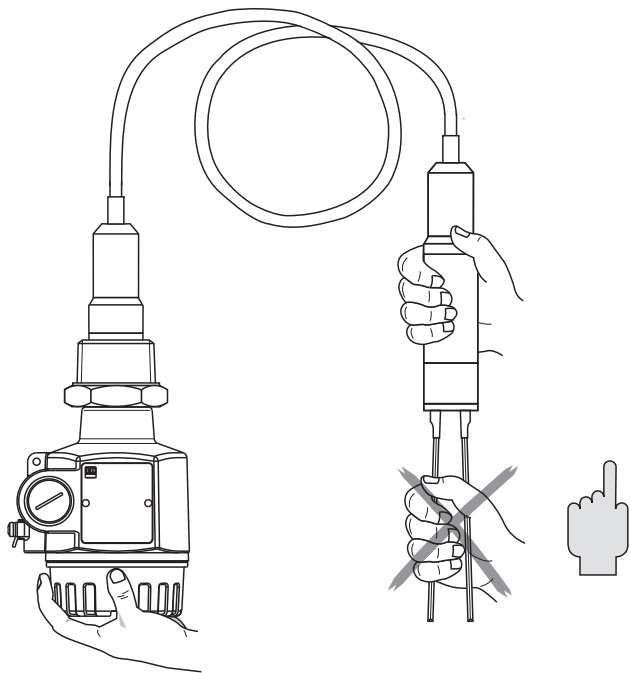

ro - Nu îndoiți
Nu scurțați
Nu lungiți

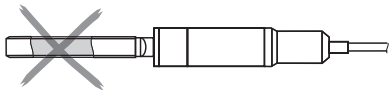
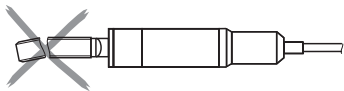
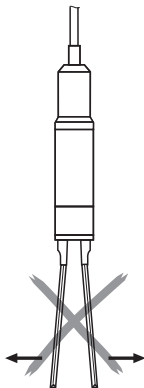
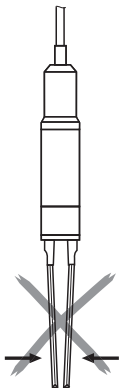



ENDRESS+HAUSER
SOLIPHANT M

Cod de comandă

FTM52-#####

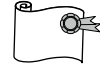

A	*1	CSA General Purpose, CSA CUS
C		FM DIP-AIS Cl. II, III, Div. 1, Gr. E-G +
D		CSA DIP Cl. II, III, Div. 1+2, Gr. E-G
E		IEC Ex iaD A20
F		FM IS Cl. I, II, III, Div. 1, Gr. A-G + NI +
F		CSA IS Cl. I, II, III, Div. 1+2, Gr. A-G
G		IEC Ex ID [iaD] A21
H		FM XP-AIS Cl. I, Div. 1, Gr. A-D +
H		CSA XP Cl. I, Div. 1+2, Gr. A-D
K		IEC Ex d IIC T6 Ga/Gb
L		IEC Ex de IIC T6 Ga/Gb
M		INMETRO Ex tb IIIC Da/Db
P		INMETRO Ex d IIC T6-T2 Ga/Gb, Ex Ia/Ib IIIC Da/Db
Q		INMETRO Ex de IIC T6-T2 Ga/Gb, Ex Ia/Ib IIIC Da/Db
R		EAC Ex de IIC T6 Ga/Gb, Ex t IIC Da/Db
S		TIIS Ex d IIC T3
U		Zonă care nu prezintă pericol + marcaj EAC
V		EAC Ex d IIC T6 Ga/Gb, Ex t IIIC Da
W		EAC Ex Ia IIIC Da/Db, Ex Ia IIC T6 Ga/Gb
X		NEPSI Ex Ia IIC T6
Z		NEPSI Ex d [Ia] IIC T6
8		NEPSI DIP
Y	*2	
1		ATEX II 1 D, 1/2 GD, 1/3 GD Ex Ia IIC T6
2		ATEX II 1/2 D Ex ID
3		ATEX II 3 D, ATEX II 3 G EEx nA/nL/nC
4		ATEX II 1/3 D Ex ID
5		ATEX II 1 D, ATEX II 1/2 G Ex de [Ia] IIC T6
6		ATEX II 1 D, ATEX II 1/2 G Ex d [Ia] IIC T6
7		ATEX II 1 D, II 1 G Ex Ia T6 (XA)

AF	2", 150 lbs, RF, ANSI B16.5
AG	3", 150 lbs, RF, ANSI B16.5
AH	4", 150 lbs, RF, ANSI B16.5
B3	DN50, PN25/40 A, EN1092-1 (DIN2527 B)
B5	DN80, PN10/16 A, EN1092-1 (DIN2527 B)
BT	DN100, PN10/16 A, EN1092-1 (DIN2527 B)
GG	EN10226, R 1½
GJ	ANSI, NPT 1½, d = 1.67"
GK	ANSI, NPT 1¼, d = 1.38"

GX	ANSI, NPT 1½, d = 1.38" --> ISA
KF	10K 50, RF, JIS B2220
KG	10K 80, RF, JIS B2220
KH	10K 100, RF, JIS B2220
TD	Tri-Clamp ISO2852, DN40-51 (2")
YY	*2
A	PTFE->316L; Lamelă vibrantă acopentă
2	316L; Ra ≤ 3,2 µm/granulație 80, .1
5	316L; Ra ≤ 0,8 µm/granulație 180; Lamelă vibrantă șlefuită
9	*2
B mm; min. 10 g/l (0,7 lbs)
C mm; min. 50 g/l (3 lbs)
F in; min. 10 g/l (0,7 lbs)
G in; min. 50 g/l (3 lbs)
Y	*2
1	FEM51; 19...253 V AC
2	FEM52; PNP 10... 55 V DC
4	FEM54; DPDT, 19...253 V AC / 55 V DC
5	FEM55; 8/16 mA, 11... 36 V DC
7	FEM57; PFM
8	FEM58; NAMUR + Buton test
9	*2



A Compact
D 6 m > ³
E 20 ft > *₃
G 6 m,
Blindat > ³
H 20 ft, *
Blindat > ³
Y ²
*

H T13, Aluminii, IP66/68 NEMA4X,
Compartiment de conexiune separat
Y ²
1 #16, Poliester, IP66/67 NEMA4X +
Capac transparent
3 F17, Aluminii, IP66/67 NEMA4 X
5 F13, Aluminii, IP66/68 NEMA4 X
7 F15, 316L, IP66/67 NEMA4X

1 Fișă M12
2 M20
3 NPT 1/2
4 G 1/2
7 NPT 3/4
9 ²
*

A ¹
G #Capac de sticlă
R SIL, ⁴,
Capac de sticlă
S SIL, ⁴
Y ²
*

A #1
Y #2

- *1 Fără
- *2 Altele
- *3 Carcasă separată
- *4 Declarație de conformitate

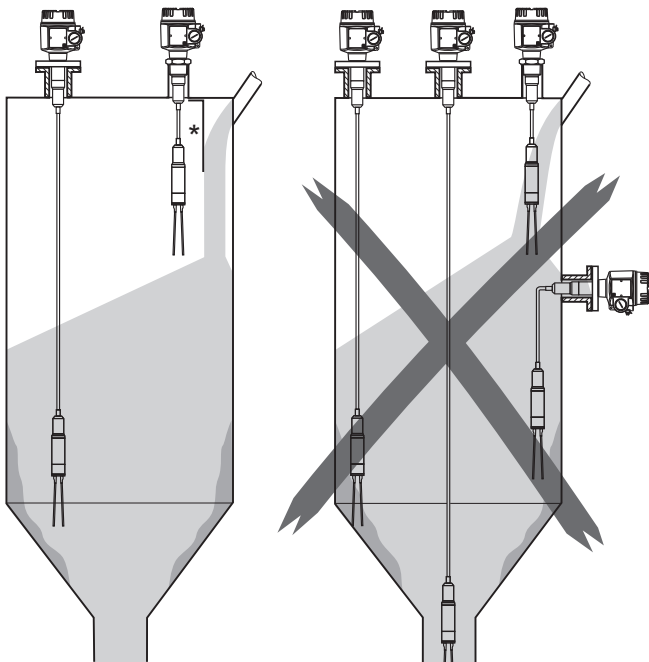

* Placă reglatoare de debit

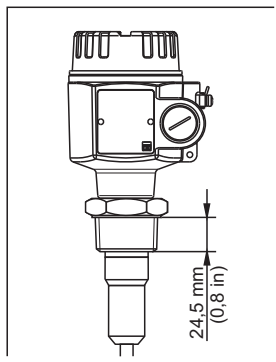
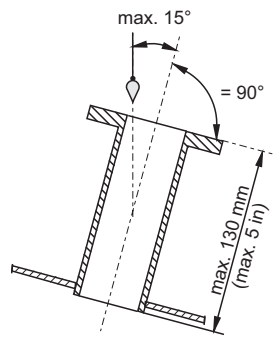
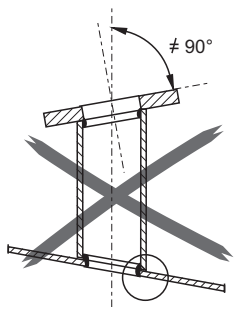
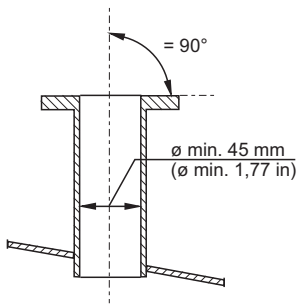

ro - Sistem de măsurare
pentru conexiune prin unitatea
de comutare

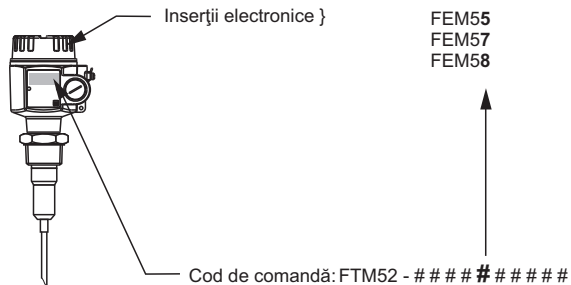

ro - Sistem de măsurare
pentru conexiune prin unitatea
de comutare

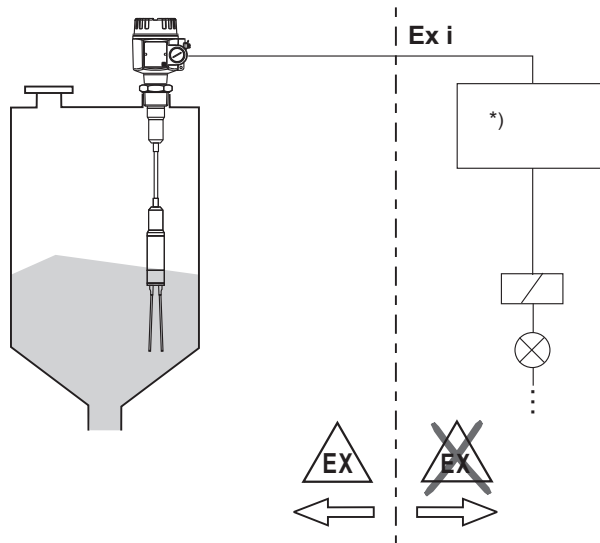

*) Unitate de comutare, PLC, amplificator de izolare, cuplaj de segment

ro - Sistem de măsurare
pentru racord direct

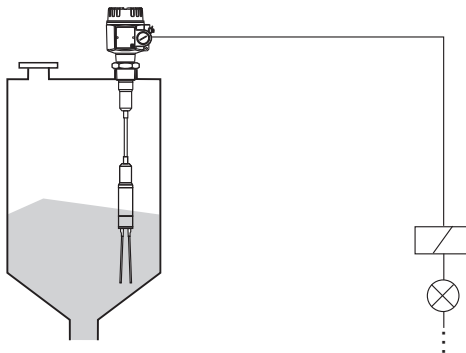
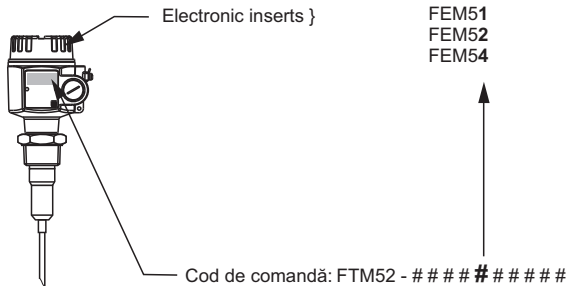

Masă specifică în vrac cu lamelă vibrantă standard

$\geq 10 \text{ g/l}$ ($\geq 0.7 \text{ lbs}$)

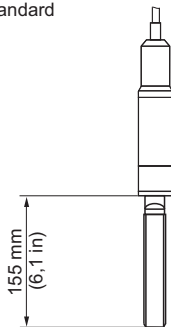

Masă specifică în vrac cu lamelă vibrantă scurtă

$\geq 50 \text{ g/l}$ ($\geq 3 \text{ lbs}$)

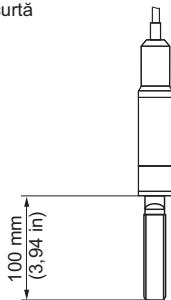

ro - Selectarea lungimii lamelor vibrante
în funcție de masa specifică
în vrac

ro - Luați în calcul acumulările.
Este posibil ca lamela vibrantă
să nu intre în contact cu
acumulările din rezervor.

* Respectați distanța!

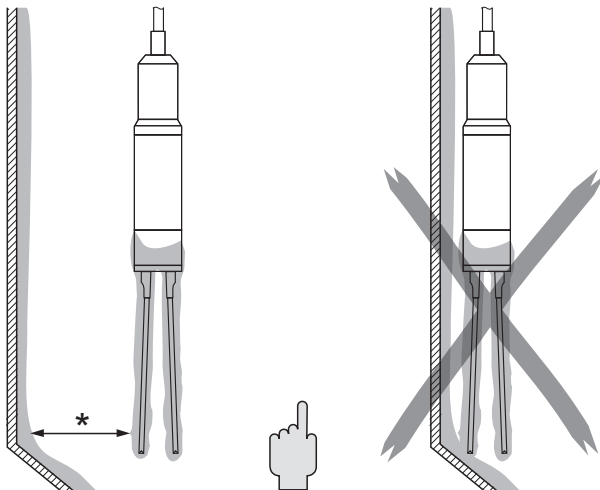

1.

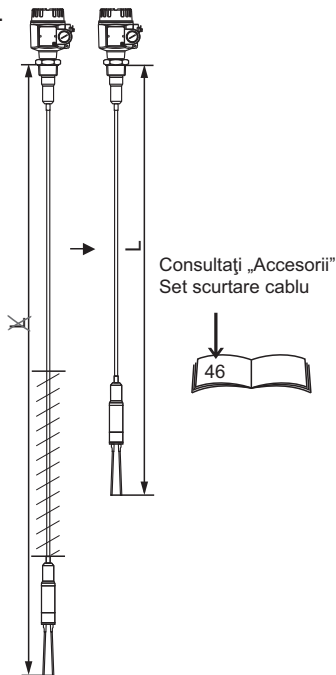

2.

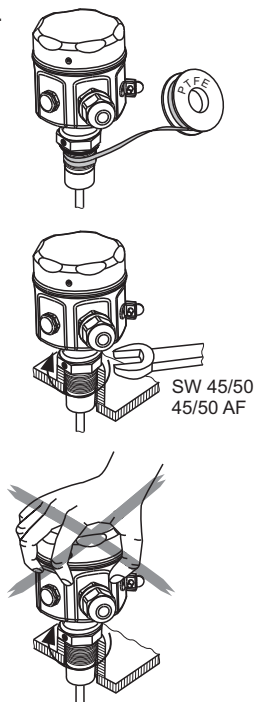

- ro - 1. Scurtați cablul dacă este necesar.
2. Înfiletați Soliphant în conexiunea de proces.
- Nu** utilizați carcasa pentru a roti.

ro - Orientarea presgarniturii
de cablu

Cuplu

F16:
0,6 Nm (0,4425 lbf ft)

F15, F17, F13, T13:
0,9 Nm (0,6638 lbf ft)

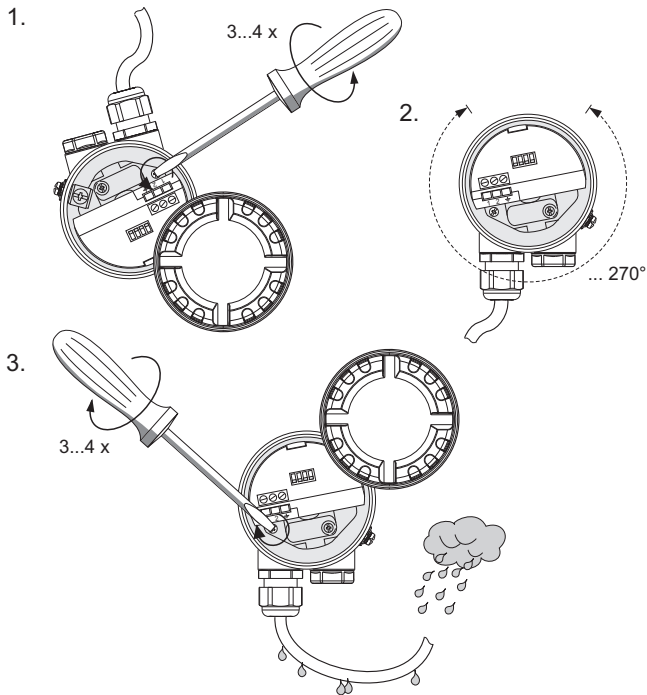

ro - Mod protecție intrinsecă
MIN/MAX

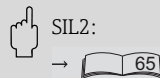
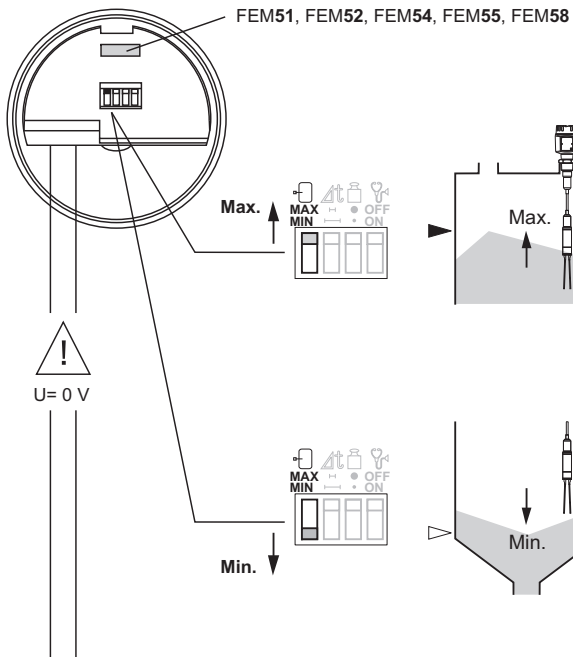

ro - Autotest
FEM57
(consultați pagina 41, 42 și
unitatea de comutare pentru
secvență)

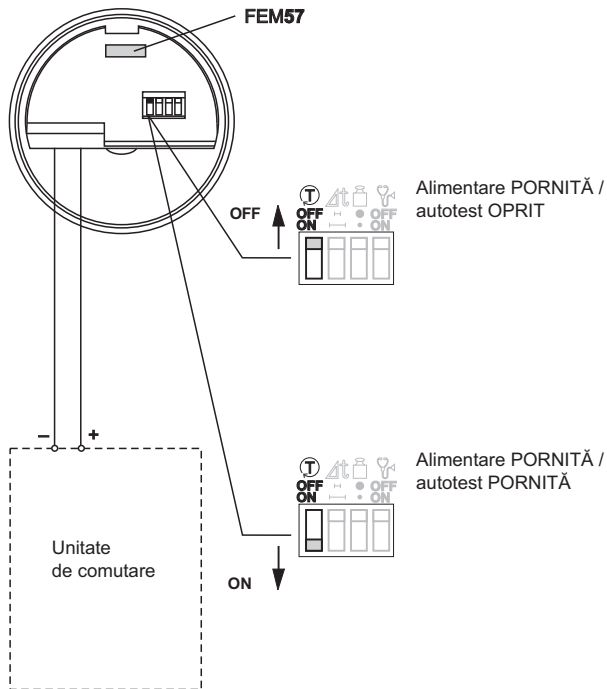

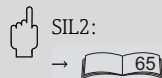
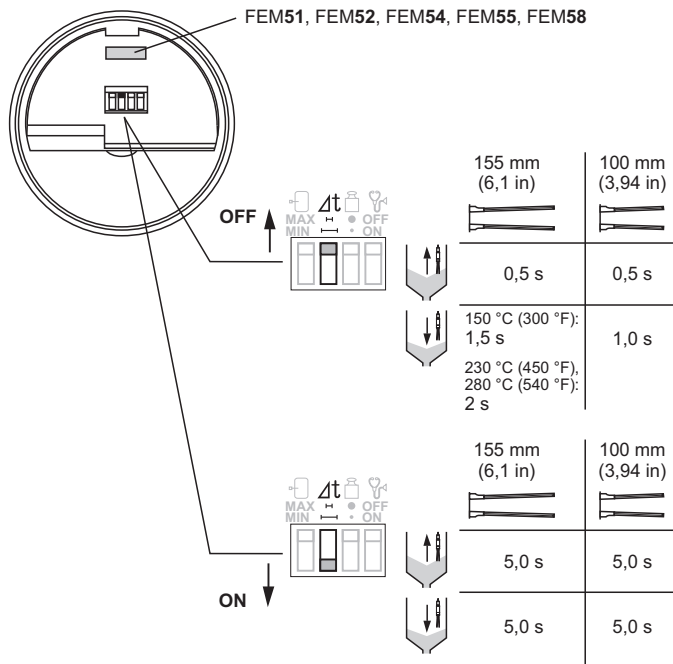

ro - Masa specifică a solidelor.
Masă specifică în vrac măsurată
în g/l.
Pentru **lamele vibrante**
standard.

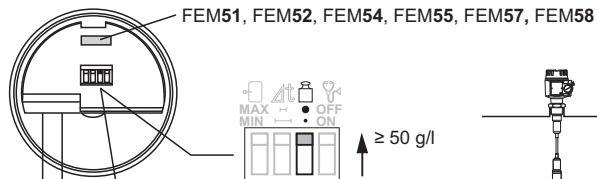

1 l = 50 g
(1 ft³ = 3 lbs)

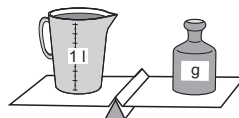

1 l = 10 g
(1 ft³ = 0,7 lbs)

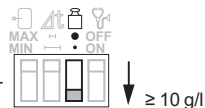

U = 0 V

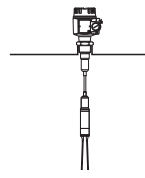
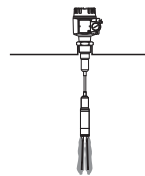

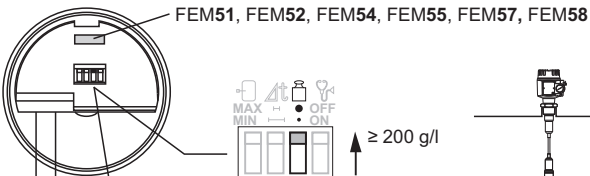

1 l = 200 g
(1 ft³ = 12 lbs)

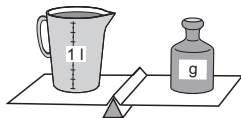



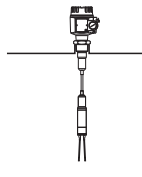
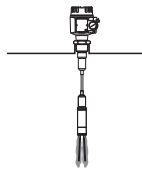
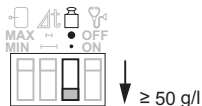













1 l = 50 g
(1 ft³ = 3 lbs)



ro - Masa specifică a solidelor.
Masă specifică în vrac măsurată
în g/l.
Pentru lamele vibrante scurte.



	Acumulări 	Abraziune 
		
		
		
		
		

Referințe la simbolism





Eroare electronică

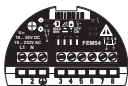

Semnale LED roșu (eroare)



Inserție electronică FEL58
(NAMUR)

LED-uri

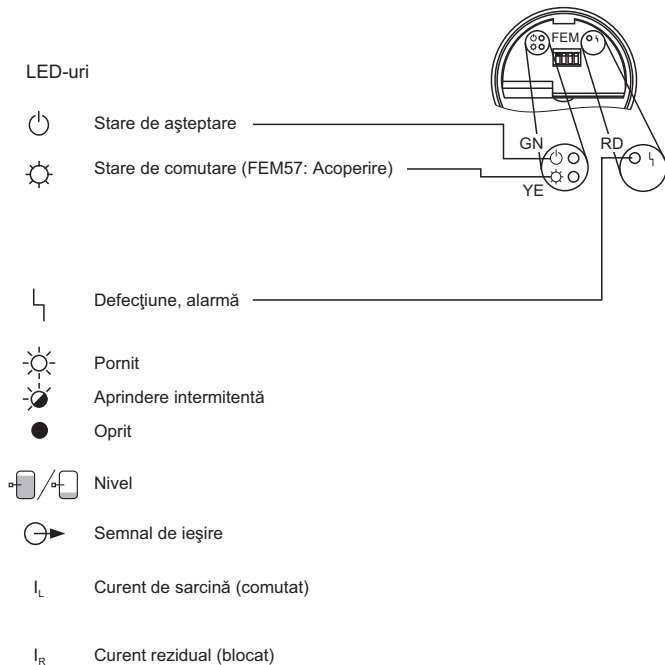



Respectați reglementările naționale!

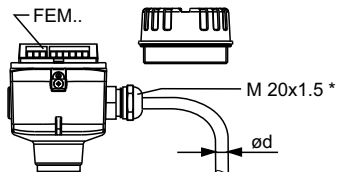

max. 2,5 mm²
(max. AWG 14)

max. 4 mm²
(max. AWG 12)

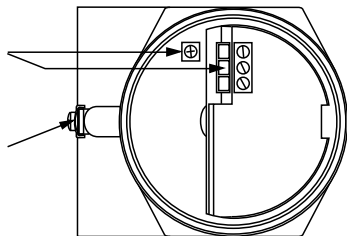

3 mm

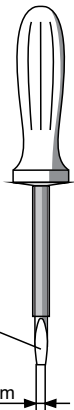

ro - Conexiuni

*Intrare de cablu

Alamă placată cu nichel:

ø = 7...10,5 mm (0,28...0,41 in)

Plastic:

ø = 5...10 mm (0,2...0,38 in)

Oțel inoxidabil:

ø = 7...12 mm (0,28...0,47 in)

$t \geq T_{amb} + 15 K$

ro - Conexiuni FEM51
 Conexiune c.a. două cabluri

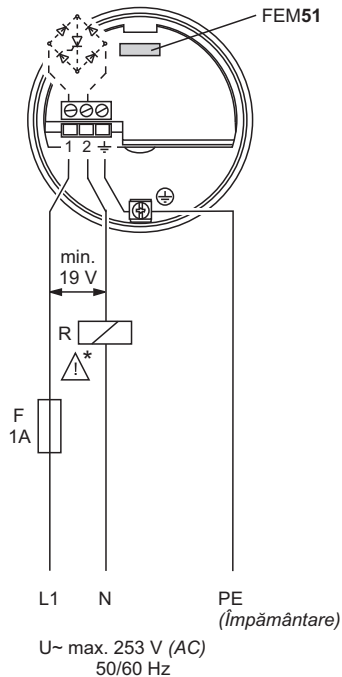







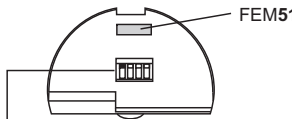

















* Sarcina externă R **trebuie** să fie conectată



$I_{L,max.}$	1.5 A	
$I_{L,max.}$	350 mA	
	max. 89 VA / 253 V	
	max. 8,4 VA / 24 V	
	max. 2,5 VA / 253 V (10 mA)	
	max. 0,5 VA / 24 V (20 mA)	



		 FEM51	GN	YE	RD
MAX		1 $\xrightarrow{I_L}$ 2 $\xleftarrow{\Delta U}$			
		1 $\xrightarrow{I_R}$ 2			
MIN		1 $\xrightarrow{I_L}$ 2 $\xleftarrow{\Delta U}$			
		1 $\xrightarrow{I_R}$ 2			
*1		1 $\xrightarrow{I_L / I_R}$ 2			
*2		1 $\xrightarrow{I_R}$ 2			

*1 Necesită întreținere

*2 Eroare instrument

$$\Delta U_{FEM51} = \text{max. } 12 \text{ V}$$

ro - Conexiuni FEM52
Presgarnitură cablu

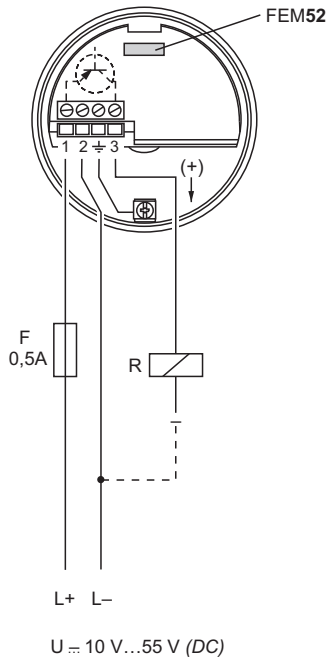



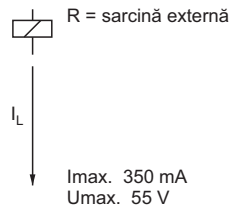



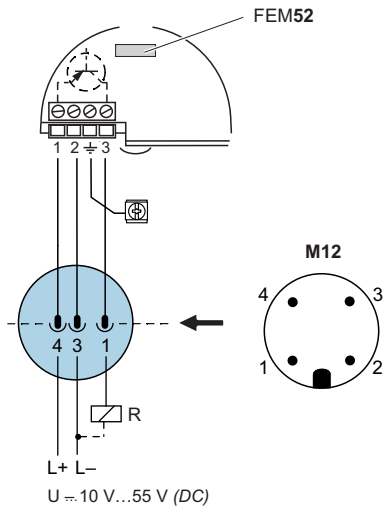

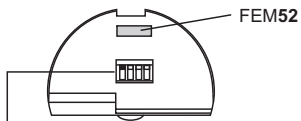



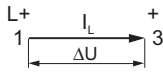



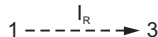



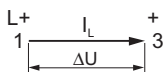



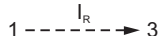

Și pentru module DI
EN 61131-2

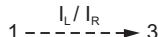

ro - Conexiuni FEM52
Fișă M12





		 FEM52	GN	YE	RD
MAX					
					
MIN					
					
*1					
*2					

*1 Necesită întreținere

*2 Eroare instrument

$\Delta U_{FEM52} = \text{max. } 3 \text{ V}$

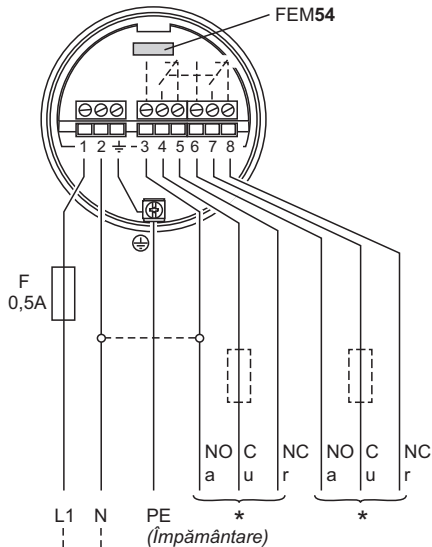

L1 N PE
(Împământare)









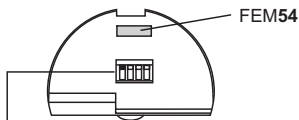



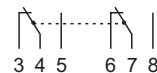



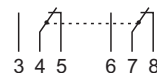



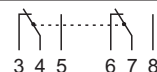



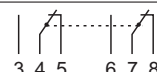

U_{\sim} 19...253 V (AC)

L+ L-
 U_{\dots} 19... 55 V (DC)

$\left\{ \begin{array}{l} U_{\sim} \text{ max. } 253 \text{ V, } I_{\sim} \text{ max. } 6 \text{ A} \\ P_{\sim} \text{ max. } 1500 \text{ VA, } \cos \varphi = 1 \\ * \ P_{\sim} \text{ max. } 750 \text{ VA, } \cos \varphi > 0,7 \\ I_{\dots} \text{ max. } 6 \text{ A, } U_{\dots} < 30 \text{ V} \\ I_{\dots} \text{ max. } 0,2 \text{ A, } U_{\dots} < 125 \text{ V} \end{array} \right.$

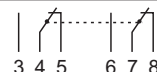
ro - Conexiuni FEM54
Conexiune universală
Ieşire releu



		 FEM54	GN	YE	RD
MAX					
					
MIN					
					
*1					
*2					

*1 Necesită întreținere

*2 Eroare instrument

ro - Conexiuni FEM55
 Presgarnitură cablu
 Ieșire 8/16 mA

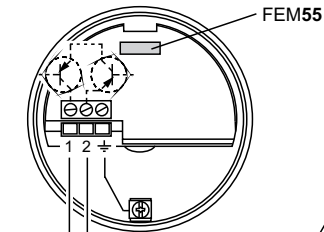

Ex ia



Utilizați numai unități
 de alimentare cu separație
 galvanică sigură
 (de ex., SELV)!

de ex., module PLC, AI



4...20 mA
 EN 61131-2

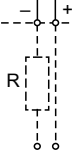

$$R_{\max} = \frac{U - 11 \text{ V}}{16,8 \text{ mA}}$$

U_{nom} 11...36 B (DC)







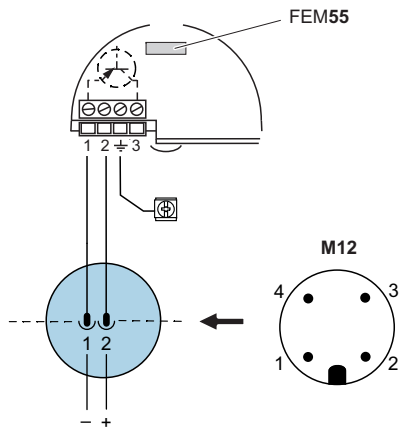





















U_{nom} 11...35 B (DC)*

* Locație umedă.

ro - Conexiuni FEM55
Fișă M12





		FEM55	GN	YE	RD
MAX		+ 2 $\xrightarrow{\sim 16 \text{ mA}}$ 1			
		+ 2 $\xrightarrow{\sim 8 \text{ mA}}$ 1			
MIN		+ 2 $\xrightarrow{\sim 16 \text{ mA}}$ 1			
		+ 2 $\xrightarrow{\sim 8 \text{ mA}}$ 1			
*1		+ 2 $\xrightarrow{8/16 \text{ mA}}$ 1			
		 *3 3,6 mA			
*2		+ 2 $\xrightarrow{3,6 \text{ mA}}$ 1			

*1 Necesită întreținere

*2 Eroare instrument

*3 → 

ro - Conexiuni FEM57
 Presgarnitură cablu
 Ieșire PFM

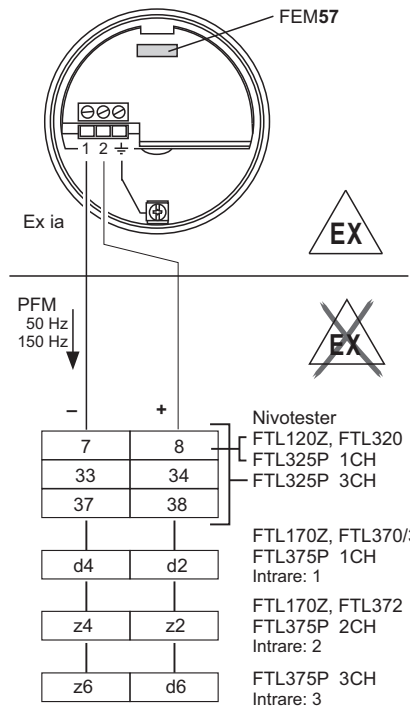

Observați funcția!



ro - Conexiuni FEM57
Fișă M12

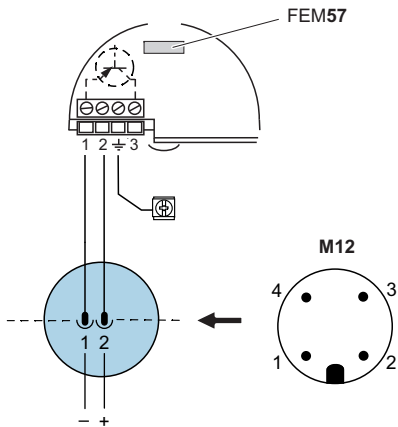









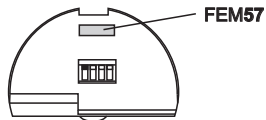

















ro - Funcție FEM57

*1 Necesită întreținere

*2 Eroare instrument

*3 → 



		 FEM57	GN	YE	RD
		150 Hz 			
		50 Hz 			
*1		150 Hz 			
		 *3 0 Hz 			
*2		0 Hz _____			

Comportament la pornire

→ 

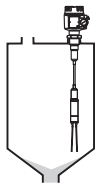

+

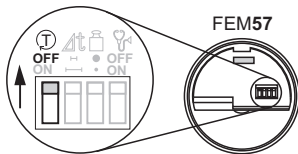

ro - Comportament la pornire
Autotest (OPRIT)

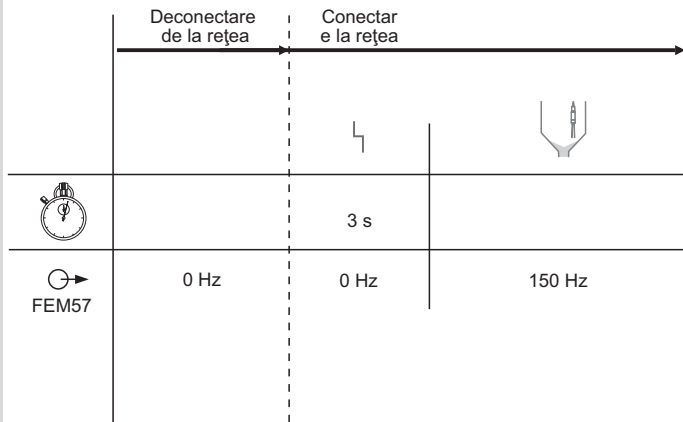

ro - Comportament la pornire
Autotest (PORNIT)

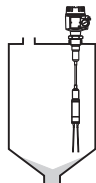

+

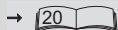
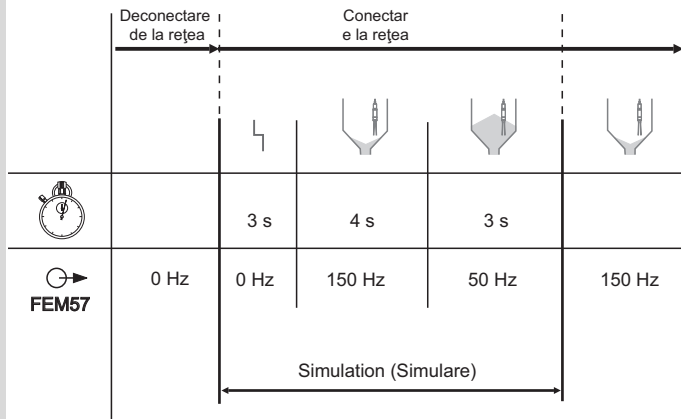
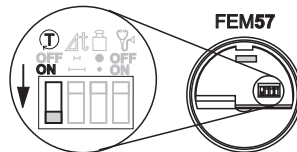



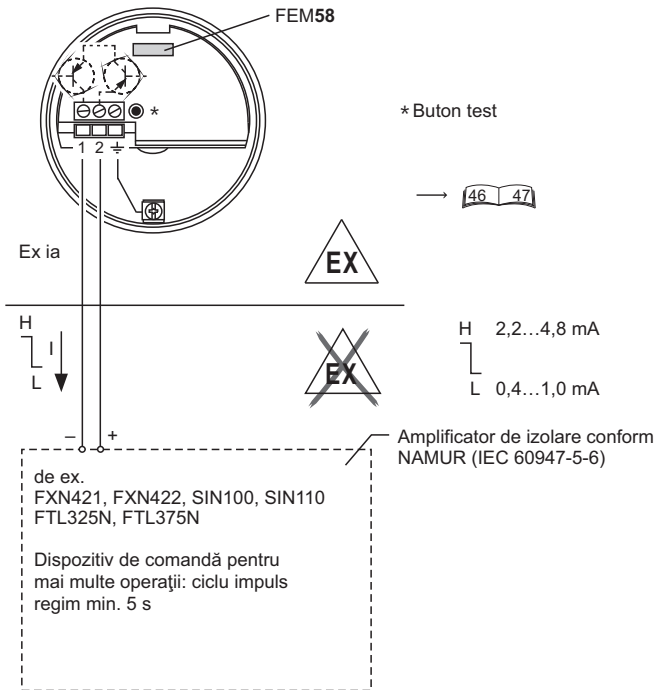



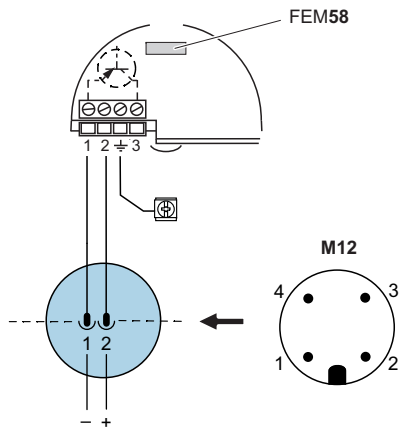

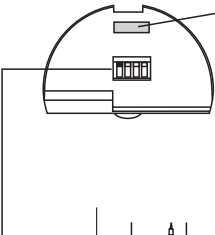

















ro - Conexiuni FEM58
 Presgarnitură cablu
 Ieșire NAMUR H-L
 > 2,2 mA / < 1,0 mA



ro - Conexiuni FEM58
Fișă M12





		 FEM58	GN	YE	RD
MAX		$\begin{matrix} + \\ 2 \end{matrix} \xrightarrow{2,2 \dots 4,8 \text{ mA}} 1$			
		$\begin{matrix} + \\ 2 \end{matrix} \xrightarrow{0,4 \dots 1,0 \text{ mA}} 1$			
MIN		$\begin{matrix} + \\ 2 \end{matrix} \xrightarrow{2,2 \dots 4,8 \text{ mA}} 1$			
		$\begin{matrix} + \\ 2 \end{matrix} \xrightarrow{0,4 \dots 1,0 \text{ mA}} 1$			
*1		$\begin{matrix} + \\ 2 \end{matrix} \xrightarrow{0,4 \dots 4,8 \text{ mA}} 1$			
*2		$\begin{matrix} + \\ 2 \end{matrix} \xrightarrow{0,4 \dots 1,0 \text{ mA}} 1$			

*1 Necesită întreținere

*2 Eroare instrument

ro - Buton test de funcționare
 FEM58
 Mod protecție intrinsecă MAX



1. Funcționare normală

GN YE RD



+ 2,2...
 4,8 mA → 1

GN YE RD



+ 0,4...
 1,0 mA → 1

2. Apăsați butonul test



GN YE RD



+ 0 mA → 1

GN YE RD



+ 0 mA → 1

3. Eliberați butonul test după ~3s de funcționare normală



GN YE RD



+ 2,2...
 4,8 mA → 1

GN YE RD



+ 0,4...
 1,0 mA → 1

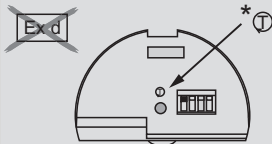

MIN



ro - Buton test de funcționare
FEM58
Mod protecție intrinsecă MIN

1. Funcționare normală

GN YE RD
 ●
1 Hz
+ 2,2...
2 4,8 mA → 1

GN YE RD
 ● ●
1 Hz
+ 0,4...
2 1,0 mA → 1

2. Apăsați butonul test



GN YE RD
● ● ●
+ 0 mA
2 -----> 1

GN YE RD
● ● ●
+ 0 mA
2 -----> 1

3. Eliberați butonul test
după ~3s de funcționare
normală



GN YE RD
 ●
1 Hz
+ 2,2...
2 4,8 mA → 1

GN YE RD
 ● ●
1 Hz
+ 0,4...
2 1,0 mA → 1

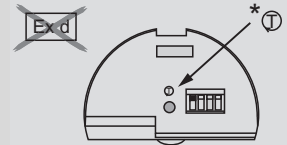

ro - Întreținere

Eliminare încrustare groasă

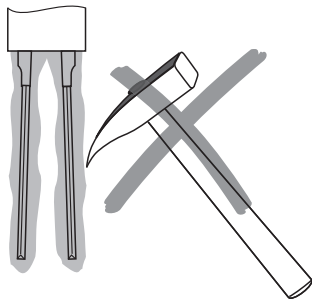
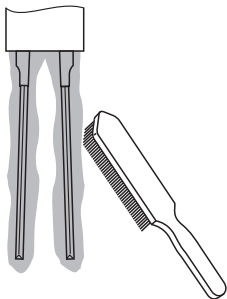

A **nu** se utiliza pentru urcare!

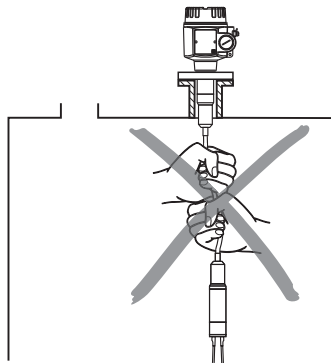

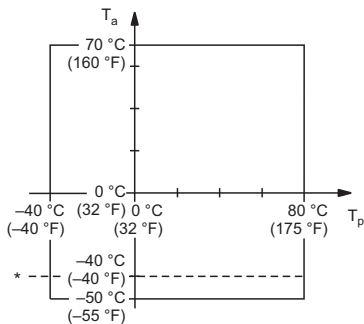
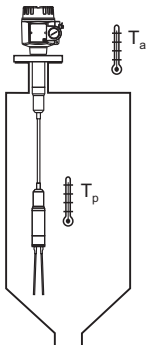

* Pentru carcasă F16

MWP = 2 bar (30 psi);

MWP = 6 bar (85 psi)

→ Ex d, Ex de, FM/CSA XP



Conexiune de proces

Masă specifică în vrac



ro - Date tehnice

Temperatură ambiantă T_a

Temperatură de proces T_p

Presiune de lucru max. MWP

ro - Accesorii

Carcasă de protecție
pentru carcasă F13 și F17
71040497

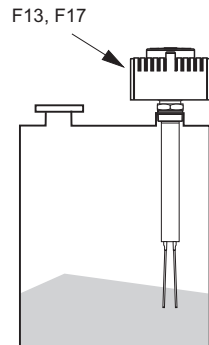
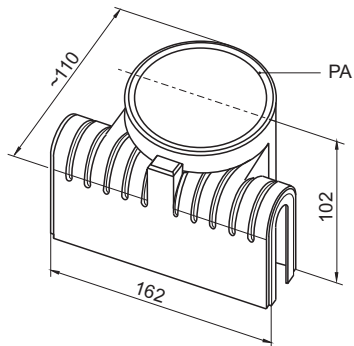

ro - Set scurtare cablu
52024632

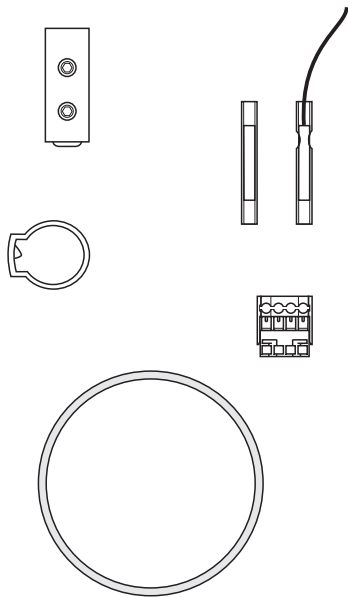

ro - Depanare

Cauză	Nu comută	Comutare incorectă	Comutare defectuoasă sporadică	Afișaj întreținere	Afișaj eroare instrument
Fără tensiune de alimentare	Verificați tensiunea de alimentare				
Inversarea polarității	Verificați alocarea bornelor				
Scurtcircuit la ieșire				Verificați alocarea bornelor	
Linie de semnal defectuoasă	Verificați linia de semnal				
Este selectat mod protecție intrinsecă incorect		Setați MAX pentru protecție la umplerea excesivă, MIN pentru protecție împotriva funcționării în gol			
Interferență radio extremă			Utilizați un cablu ecranat		
Apă în carcasă			Curățați capacul și intrările de cablu și strângeți-le bine		
FEM51: Menținerea curentului releului utilizat la o intensitate prea scăzută		Utilizați un releu adecvat sau solicitați MVT 2Y1278 ca opțiune			
Masă specifică în vrac prea scăzută	Adaptați la o masă specifică în vrac mai mică		Adaptați la o masă specifică în vrac mai mică		
Vibrații externe extreme			Reglați întârzierea comutării la 5 s		
Acumulări			Adaptați la o masă specifică în vrac mai mare	Eliminarea acumulărilor	
Insertie electronică incorectă					Schimbare insertie electronică
Abraziune					Schimbare senzor
Nicio conexiune la senzor					Schimbare senzor

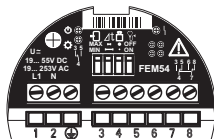







FEM51	52026497
FEM52	52026498
FEM54	52026499
FEM55	52026500
FEM57	52026501
FEM58	52026502

Specificație privind instalarea: În timpul instalării, țineți cont că este posibil ca inserțiile electronice FEM57 și FEM58 care sunt alimentate de circuite fără protecție intrinsecă să **nu** fie interconectate mai mult cu circuite cu protecție intrinsecă.

ro - Piese de schimb

Inserții electronice

ro - Capace carcasă,
garnituri

Material carcasă/capac	Garnituri	Număr de piesă
F16 / PA12	EPDM *	52025790
F13, F17 / Alu 	 EPDM *	52027693
F13, F17 / Alu	 EPDM *	52002699
F13 / Alu	 EPDM *	52002698
F15 / 316L	VMQ/PTFE	52027000
F15 / 316L	VMQ/PTFE	52027708
Cod de comandă FTM5# - ##### ↓ D, 2, 3, 4		
F15 / 316L 	VMQ/PTFE	52027002
F15 / 316L 	VMQ/PTFE	52027709
Cod de comandă FTM5# - ##### ↓ D, 2, 3, 4		
T13 / Alu	EPDM *	52006903
T13 / Alu 	EPDM *	52007103

* Utilizați numai lubrifianți
adecvați

Senzorul de schimb FTM52X poate fi comandat prin departamentul de service Endress+Hauser!

ro - Senzor de schimb

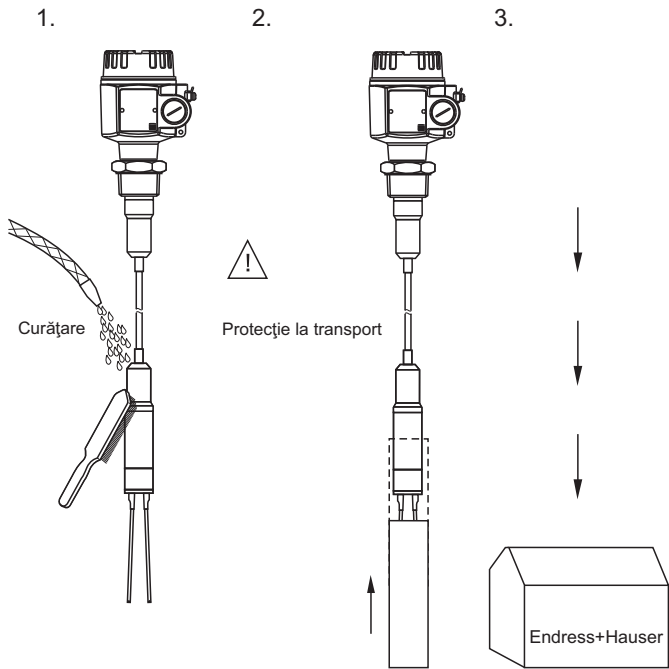

Informații tehnice

TI00392F Soliphant M FTM50, FTM51, FTM52

Instrucțiuni de utilizare

KA00231F Soliphant M FTM52

Scurtarea cablului

KA00264F Soliphant M FTM50, FTM51, FTM52

Carcasă separată: Instrucțiuni pentru montare și scurtare
(Pe partea carcasei)

KA00265F Soliphant M FTM50, FTM51, FTM52

Carcasă separată și tub blindat: Instrucțiuni pentru montare
și scurtare (Pe partea carcasei)

KA00273F Soliphant M FTM50, FTM51, FTM52

Carcasă separată: Demontarea și montarea senzorului

ro - Documentație
suplimentară

Note privind siguranța
Certificate

ATEX II	Ex i	1D, 1/2D, 1G, 1/2G	XA00305F
ATEX II	Ex d/Ex de/Ex t	1/2G,1D, 1/2D	XA00306F
ATEX II	Ex t	1/2D, 1/3D	XA00307F
ATEX II	Ex i (X)	1D, 1G	XA00319F
ATEX II	Ex t, Ex n	3D, 3G	XA00331F
NEPSI	Ex t		XA00393F
NEPSI	Ex ia		XA00394F
NEPSI	Ex d, Ex t		XA00395F
IECEX	Ex ia		XA00391F
IECEX	Ex t		XA00392F
IECEX	Ex d, Ex de, Ex t		XA00633F
INMETRO	Ex t		XA01336F
INMETRO	Ex d, Ex de, Ex t		XA01354F
EAC	Ex d,Ex t	Ga/Gb, Da/Db	XA01590F
FM	IS, NI		XA01337F
CSA	IS, NI		XA01248F
CSA	XP, DIP		XA01042F

Siguranță funcțională

Soliphant M + FEM51	SD00203F
Soliphant M + FEM52	SD00204F
Soliphant M + FEM54	SD00205F
Soliphant M + FEM55	SD00208F
Soliphant M + FEM57 + Nivotester FTL325P	SD00207F
Soliphant M + FEM58	SD00206F



71460306

www.endress.com/worldwide
