

Technical Information

CA76NA

Analyzer for sodium



Application

The CA76NA analyzer monitors:

- The water/steam circuit in power stations
- The condensate for values that indicate ruptures in the system
- Demineralization systems
- Steam purity
- Cation and mixed bed exchanger

Your benefits

- Reduce operating costs due to low consumption of DIPA reagent ¹⁾ and standard solution
- Automatic three-point calibration, adjustable time interval
- Control and monitoring of the configurable pH value
- Automatic temperature compensation
- Galvanically isolated signal outputs
- Pressure regulator and easy-to-clean preliminary filter per channel
- Optimized investment costs: One Analyzer for up to 6 sampling channels
- Additional connection for the measurement of a laboratory sample
- Automatic regeneration of sodium electrode
- Optional PROFIBUS connection

1) Consumption of DIPA reagent depends greatly on the pH value and temperature of the medium.

Table of contents

Function and system design	3
Measuring principle	3
Sodium	3
Equipment architecture	4
Input	6
Measured variables	6
Measuring range	6
Types of input	6
Hose specification	6
Output	6
Output signal	6
Load	7
Relay outputs	7
Response time	7
Protocol-specific data	8
Power supply	8
Supply voltage	8
Power consumption	8
Performance characteristics	9
Maximum measured error	9
Repeatability	9
Environment	9
Ambient temperature	9
Storage temperature	9
Humidity	9
Degree of protection	9
Electromagnetic compatibility	9
Electrical safety	9
Pollution degree	9
Process	9
Sample conditioning	9
Mechanical construction	10
Dimensions	10
Weight	11
Certificates and approvals	11
Ordering information	12
Product page	12
Product Configurator	12
Scope of delivery	12
Accessories	12
Device-specific accessories	12

Function and system design

Measuring principle

The analyzer measures the concentration of dissolved sodium ions.

Sodium measurement is potentiometric using ion-selective glass electrodes.

An advanced Nernst equation describes in principal the processes at the ion-selective glass membrane:

$$U_i = U_0 + \frac{2.303 RT}{F} \cdot \log (a_{\text{Na}^+} + \sum K_{\text{Na}^+} \cdot a_x^{1/z_x})$$

A0034599

U_i	Measured value in mV
U_0	Standard potential
R	Relative gas constant (8.3143 J/molK)
T	Temperature [K]
F	Faraday constant (26.803 Ah)
a_{Na^+}	Activity of Na^+ ions
K_{Na^+}	Selectivity coefficient
a_x	Activity of interference ion
z_x	Value of interference ion



The slope of the Nernst equation ($2.303RT/F$) is known as the **Nernst factor** and has a value of 59.16 mV/px at 25 °C.

The pH electrode has 2 specific functions:

- It serves as the reference point for the sodium electrode.
- It measures the pH value of the sample.

To also be able to measure Na^+ in very low concentrations, the Ag^+ and H^+ activity must be well below the Na^+ concentration to be measured. In this case, the pH value present must be more than 10.8. The device is set to a pH target value of 11.00 as standard to sufficiently safeguard the set pH value.

The pH value of the sample is increased to 11.0 by adding an alkalization reagent, e.g. diisopropylamine.

The sensitivity of the measuring arrangement to interference ions is according to the following rule:

$\text{Ag}^+ \gg \text{H}^+ \gg \text{Na}^+ > \text{Li}^+ > \text{K}^+$

Sodium

Sodium measurement is very important in the water/steam circuit of power stations for two reasons:

- Sodium plays a major role in corrosion
- The measurement of sodium enables fast leak detection, e.g. in the condenser or in the event of a ruptured cation or mixed bed filter.

Therefore, more attention is paid to sodium measurement in the revised VGB Guideline (S-006 / S-010).

For a measurement without the influence of hydronium ions, the sample is conditioned to a pH value of pH 11 +/- 0.2 pH. The measurement is potentiometric using a special electrode system comprising an Na-sensitive electrode in conjunction with an Ag/AgCl reference electrode:

Ag/AgCl(S) – buffer – Na^+ -sensitive glass membrane - alkalized measuring solution - diaphragm - KCl electrolyte gel - AgCl(S)/Ag.

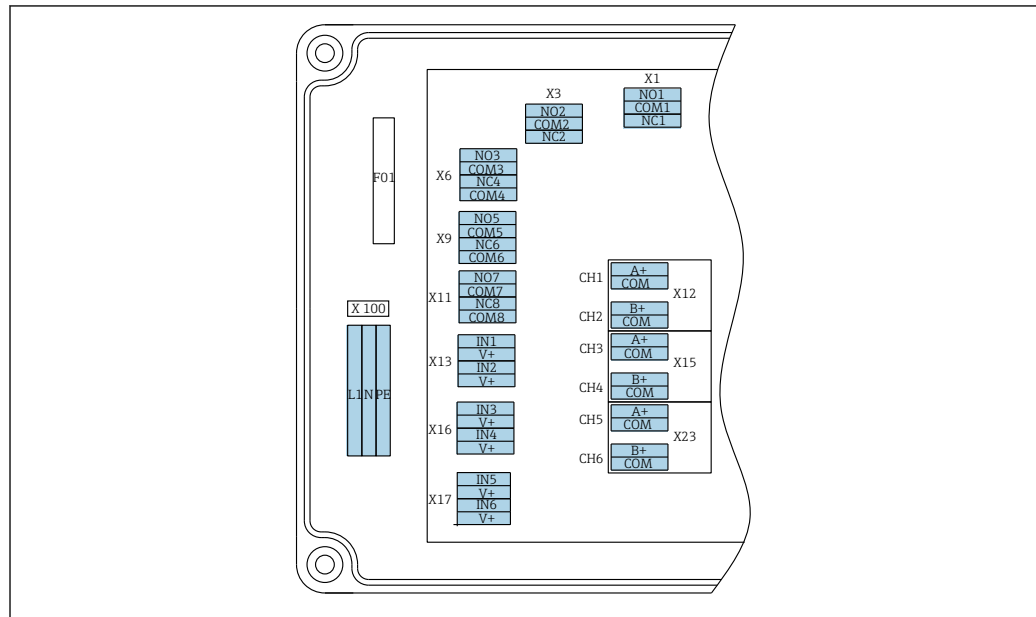

A0039459

L1	N	PE	NO1	COM1	NC1	NO2	COM2	NC2	A+	COM	B+	COM	A+	COM	B+	COM	A+	COM	B+	COM
X100 Power supply 100 to 240 V AC, 50/60 Hz			X1 Relay 1 Alarm			X3 Relay 2 Warning			X12A 4 to 20 mA Channel 1		X12B 4 to 20 mA Channel 2		X15A 4 to 20 mA Channel 3		X15B 4 to 20 mA Channel 4		X23A 4 to 20 mA Channel 5		X23B 4 to 20 mA Channel 6	

Mains voltage

Multi-range power unit for 100 to 240 V AC



The analyzer is fitted with a fuse, T 1.25 A, for the 215 to 240 V AC voltage level. If the analyzer is operated with 100 to 130 V AC, replace the fuse with the T 2.5 A fuse supplied. The fuse is located in the cover of the electronics unit.

Analog outputs

- X12: current output, channel 1 + 2
- X15: current output, channel 3 + 4
- X23: current output, channel 5 + 6

Digital outputs

- X1: relay, 1 alarm
 - Open contact on error: COM-NO
 - Closed contact on error: COM-NC
- X3: relay 2, warning
 - Open contact on error: COM-NC
 - Closed contact on error: COM-NO

Terminal diagram with PROFIBUS

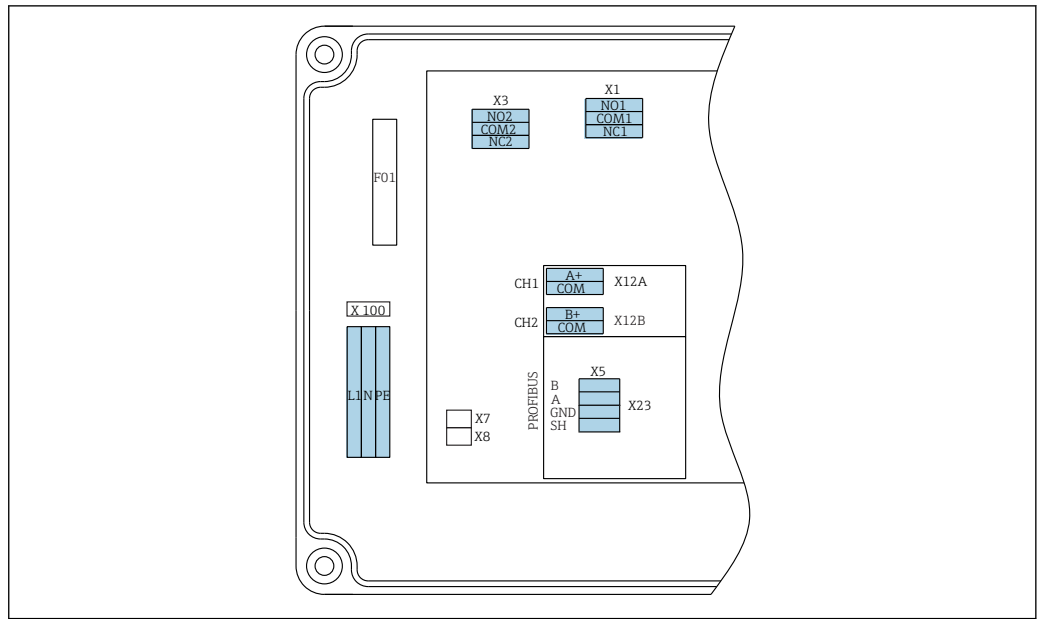

A0041292

L1	N	PE	NO1	CO M1	NC1	NO2	CO M2	NC2	A+	CO M	B+	CO M	B	A	GND	SH
X100 Power supply 100 to 240 V AC, 50/60 Hz			X1 Relay 1 Alarm			X3 Relay 2 Warning			X12A 4 to 20 mA Channel 1		X12B 4 to 20 mA Channel 2		PROFIBUS cable (internal)			

Mains voltage

Multi-range power unit for 100 to 240 V AC

Analog outputs

X12: current output, channel 1 + 2

Digital outputs

- X1: relay 1, alarms
 - Open contact on error: COM-NO
 - Closed contact on error: COM-NC
- X3: relay 2, warnings
 - Open contact on error: COM-NC
 - Closed contact on error: COM-NO

If the CA76NA is the last device in the bus segment, the two jumpers must be set to X7 and X8 on the PROFIBUS interface card to incorporate the terminating resistors. If the analyzer is not the last device in the bus segment, the jumpers must be removed from X7 and X8 on the PROFIBUS interface card.

M12 socket

PROFIBUS is connected to an external M12 socket.

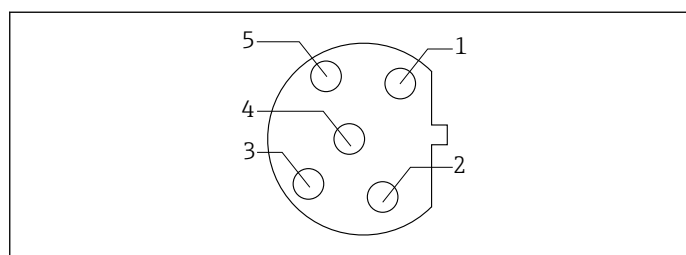

A0041351

1 Pin assignment 5-pin, b-coded

Flow diagram

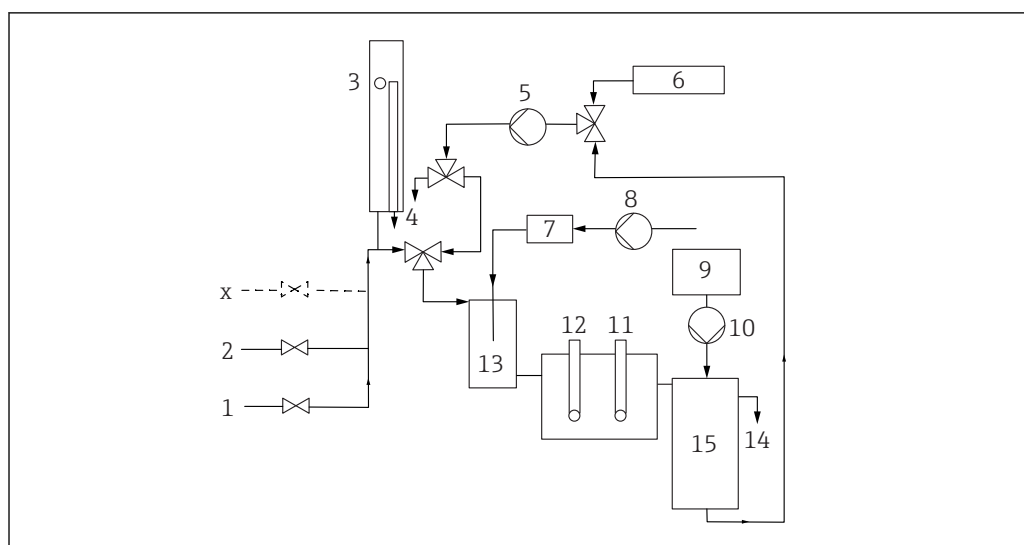

A0033198

2 Analyzer CA76NA, flow diagram

1	Valve 1	8	Alkalization pump
2	Valve 2	9	Standard solution
x	Valves 3 to 6	10	Standard solution pump
3	Overflow vessel with level monitor	11	pH electrode
4	Outputs	12	Sodium electrode
5	Circuit pump	13	Alkalization vessel
6	Lab sample	14	Output
7	Alkalization reagent	15	Supply vessel for standard solution (for calibration)

Input

Measured variables	Na [$\mu\text{g/l}$, ppb]
Measuring range	0.1 to 2000 $\mu\text{g/l}$ (ppb) Na 2001 to 9999 $\mu\text{g/l}$ (ppb) Na
Types of input	1-6 measuring channels

Hose specification	Supply of medium
	<ul style="list-style-type: none"> ■ PE or PTFE hose with defined outer diameter of 6 mm at quick-action coupling ■ Minimum hose length: 200 mm (7.87 in)
	Medium outlet
	<ul style="list-style-type: none"> ■ Outlet of sample conditioning unit: hose 8 x 11 mm ■ Outflow from overflow vessel: hose measuring 8 x 5 mm ■ General outlet: hose measuring 12 x 16 mm

Output

Output signal	Depending on version: Up to 6 x 4 to 20 mA
----------------------	---

PROFIBUS DP	
Signal encoding	EIA/TIA-485, PROFIBUS DP-compliant acc. to IEC 61158
Data transmission rate	9.6 kbit/s – 12 Mbit/s
Galvanic isolation	Yes
Connectors	M12 socket as per IEC 61072-2-101, 5-pin, b-coded

For version with PROFIBUS DP:
Maximum of two analog outputs for outputting the measured value

Load

Max. 500 Ω

Relay outputs

Relay

- 1 relay for alarms
- 1 relay for warnings

Relay types

Changeover contact

Relay switching capacity

Switching voltage	Load (max.)	Switching cycles (min.)
250 V AC, $\cos\Phi = 0,8 \dots 1$	0,1 A	1.000.000
	0,5 A	200.000
	3 A	300.000
115 V AC, $\cos\Phi = 0,8 \dots 1$	0,1 A	1.000.000
	0,5 A	200.000
	3 A	30.000
24 V DC, L/R = 0 ... 15 ms	0,5 A	200.000
	3 A	30.000

Response time

0.1 to 2000 µg/l (ppb)	180 seconds (95 %) within a calibration interval of 72 hours
2001 to 9999 µg/l (ppb)	600 seconds (95 %) within a calibration interval of 72 hours

Protocol-specific data

Manufacturer ID	11 _h
Device type	1571D _h
Device database files (GSD files)	www.endress.com/profibus Device Integration Manager DIM
Output values	Status and measured values
Input variables	Remote control: measurement, calibration and regeneration of the analysis function
Supported features	<ul style="list-style-type: none"> ▪ PROFIBUS DP (DP-V0, cyclic data exchange), baud rate: 9.6 kbit/s – 12 Mbit/s ▪ PROFIBUS device address configured via onsite operation or PROFIBUS Service "Set_Slave_Add" ▪ GSD

Power supply

Supply voltage

- 100 to 240 V AC (fuse must be replaced)
- 50 or 60 Hz
- Battery-free parameter backup

 The analyzer is fitted with a fuse, T 1.25 A, for the 215 to 240 V AC voltage level. If the analyzer is operated with 100 to 130 V AC, replace the fuse with the T 2.5 A fuse supplied. The fuse is located in the cover of the electronics unit.

Power consumption

40 VA

Performance characteristics

Maximum measured error	0.1 to 2000 µg/l (ppb)	±2 % of measured value; ±2 µg/l (ppb) (under reference conditions)
	2001 to 9999 µg/l (ppb)	±5 % of measured value; ±5 µg/l (ppb) (under reference conditions)
Repeatability	0.1 to 2000 µg/l (ppb)	±2 % of display value; ±2 µg/l (ppb) (under reference conditions)
	2001 to 9999 µg/l (ppb)	±5 % of display value; ±5 µg/l (ppb) (under reference conditions)

Environment

Ambient temperature 5 to 45 °C (41 to 113 °F)

Storage temperature 0 to 50 °C (32 to 122 °F)

Alkalization reagent and electrodes

Store the alkalization reagent and electrodes at temperatures above +5 °C (41 °F).

Humidity 30 ... 95 %

Degree of protection IP54 complete panel assembly
IP65 electronics unit

Electromagnetic compatibility Interference emission and interference immunity as per EN 61326-1:2013, Class A for Industry

Electrical safety According to EN/IEC 61010-1:2010, Class I equipment
Low voltage: overvoltage category II
For installations up to 2000 m (6500 ft) above MSL

Pollution degree The product is suitable for pollution degree 2. Pollution degree 1 applies within the electronics unit.

Process

Sample conditioning	Sample temperature	+10 to +40 °C (+50 to +104 °F)
	Supply pressure	1.0 to 5.0 bar (14.5 to 72.5 psi)
	Sample flow rate	10 to 15 l/h (2.64 to 3.96 gal/hr)
	Sample supply	<ul style="list-style-type: none"> ▪ 1 to 6 input channels with pressure regulator (regulates pressure to approx. 0.8 bar (11.6 psi)) ▪ additional lab sample ▪ pH regulation to pH 11

Mechanical construction

Dimensions

i Mounting materials to secure the analyzer to the wall (screws, wall plugs) are not included in the delivery. The mounting materials must be provided by the customer onsite.

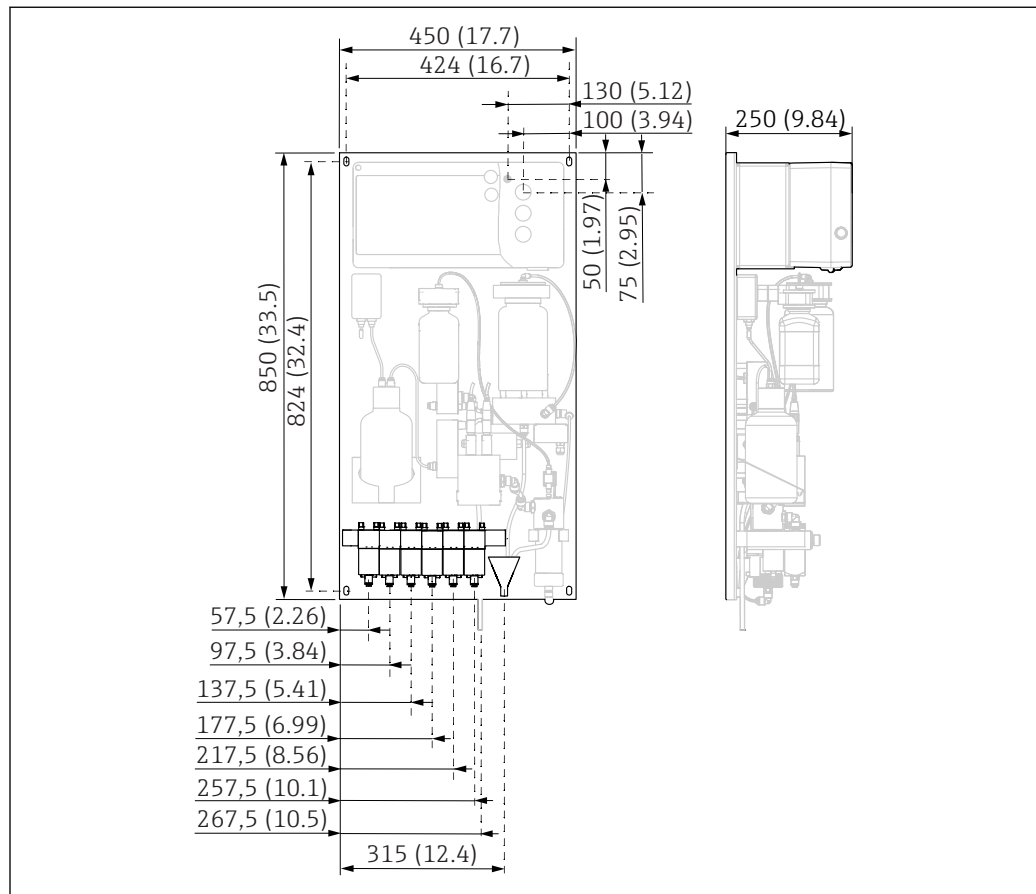

A0039005

3 Analyzer CA76NA, dimensions in mm (in)

Spacing requirements when mounting

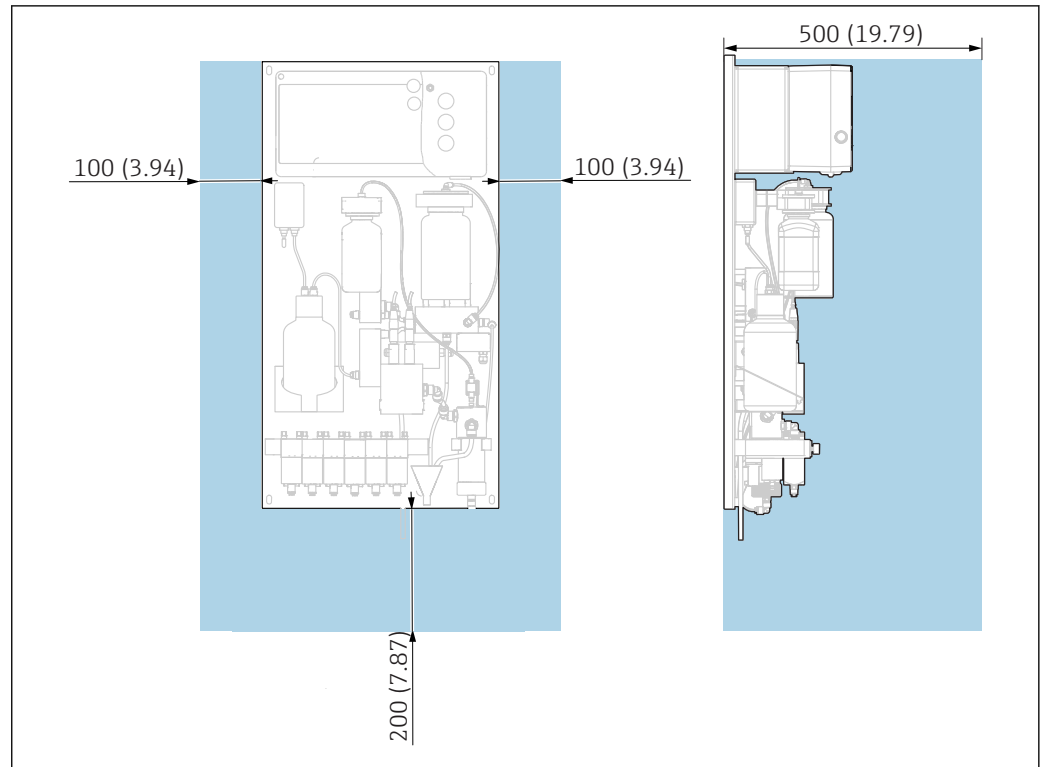

4 Analyzer CA76NA, spacing requirements in mm (in)

A0039006

- Comply with the spacing requirements when mounting .

Weight

Approx. 30 kg (66.15 lbs)

Certificates and approvals

The product meets the requirements of the harmonized European standards. As such, it complies with the legal specifications of the EU directives. The manufacturer confirms successful testing of the product by affixing to it the **CE** mark.

Ordering information

Product page

www.endress.com/ca76na

Product Configurator

On the product page there is a **Configure** button to the right of the product image.

1. Click this button.
 - ↳ The Configurator opens in a separate window.
2. Select all the options to configure the device in line with your requirements.
 - ↳ In this way, you receive a valid and complete order code for the device.
3. Export the order code as a PDF or Excel file. To do so, click the appropriate button on the right above the selection window.

 For many products you also have the option of downloading CAD or 2D drawings of the selected product version. Click the **CAD** tab for this and select the desired file type using picklists.

Scope of delivery

The scope of delivery comprises:

- 1 analyzer
- 1 print version of the Brief Operating Instructions in the language ordered

 The sodium electrode, pH electrode, standard solution and alkalization reagent are not included in the delivery for the analyzer.

Before commissioning the analyzer, order the sodium electrode, pH electrode and standard solution as a "starter kit" accessory.

Purchase alkalization reagent separately (recommended: diisopropylamine (DIPA), > 99.0 % (GC), in a bottle made from a solid material, e.g. glass.

Accessories

The following are the most important accessories available at the time this documentation was issued.

- ▶ For accessories not listed here, please contact your Service or Sales Center.

Device-specific accessories

Starter kit

 Due to customs regulations, check with your local Sales Center regarding availability.

 The sodium electrode, pH electrode and standard solution are not included in the delivery for the analyzer.

Before commissioning the analyzer, order the sodium electrode, pH electrode and standard solution as a "starter kit" accessory.

- pH electrode
- Sodium electrode
- Standard solution

Order No. 71358762

Electrode kit

- Sodium electrode
- pH electrode

Order No. 71371663

PROFIBUS upgrade kit for CA76NA

 Analyzers with software version V2.13 or higher can be upgraded to PROFIBUS.

PROFIBUS DP upgrade

Order No. 71439722

Sodium electrode for CA76NA

Sodium electrode

Order No. 71358110

pH electrode for CA76NA

pH electrode

Order No. 71358111

Consumables for CA76NA

Alkalization reagent



Purchase alkalization reagent separately (recommended: diisopropylamine (DIPA), > 99.0 % (GC), in a bottle made from a solid material, e.g. glass).

Sodium standard solution

Standard solution 5100 µg/l (ppb) Na, 500 ml (16.9 fl.oz)

Order No. 71358761

Other accessories

Threaded adapter for alkalization bottle GL45 IG / S40 AG

Order No. 71358132



www.addresses.endress.com
