

Safety Instructions

Gammapilot M FMG60

4-20 mA HART

Ex d e [ia Ga] IIC T5/T6 Gb

Ex d [ia Ga] IIC T5/T6 Gb



Document: XA00536F-F

Safety instructions for electrical apparatus for explosion-hazardous areas → 3

Gammapilot M FMG60

4-20 mA HART

Table of contents

Associated documentation	4
Supplementary documentation	4
Manufacturer's certificates	4
Manufacturer address	4
Extended order code	4
Safety instructions: General	6
Safety instructions: Special conditions	6
Safety instructions: Installation	6
Temperature tables	9
Connection data	10

Associated documentation	This document is an integral part of the following Operating Instructions: BA00236F/00										
Supplementary documentation	Explosion-protection brochure: CP00021Z/11 The Explosion-protection brochure is available: <ul style="list-style-type: none"> ■ In the download area of the Endress+Hauser website: www.endress.com -> Downloads -> Media Type: Documentation -> Documentation Type: Brochures and catalogs -> Text Search: CP00021Z ■ On the CD for devices with CD-based documentation 										
Manufacturer's certificates	NEPSI Declaration of Conformity Certificate number: GYJ20.1026X Affixing the certificate number certifies conformity with the following standards (depending on the device version): <ul style="list-style-type: none"> ■ GB3836.1-2010 ■ GB3836.2-2010 ■ GB3836.3-2010 ■ GB3836.4-2010 ■ GB3836.20-2010 										
Manufacturer address	Endress+Hauser SE+Co. KG Hauptstraße 1 79689 Maulburg, Germany Address of the manufacturing plant: See nameplate.										
Extended order code	The extended order code is indicated on the nameplate, which is affixed to the device in such a way that it is clearly visible. Additional information about the nameplate is provided in the associated Operating Instructions. Structure of the extended order code <table border="0" style="margin-left: 40px;"> <tr> <td style="text-align: center;">FMG60</td> <td style="text-align: center;">-</td> <td style="text-align: center;">*****</td> <td style="text-align: center;">+</td> <td style="text-align: center;">A*B*C*D*E*F*G*..</td> </tr> <tr> <td style="text-align: center;"><i>(Device type)</i></td> <td></td> <td style="text-align: center;"><i>(Basic specifications)</i></td> <td></td> <td style="text-align: center;"><i>(Optional specifications)</i></td> </tr> </table> <p>* = Placeholder At this position, an option (number or letter) selected from the specification is displayed instead of the placeholders.</p> <p><i>Basic specifications</i></p> <p>The features that are absolutely essential for the device (mandatory features) are specified in the basic specifications. The number of positions depends on the number of features available. The selected option of a feature can consist of several positions.</p> <p><i>Optional specifications</i></p> <p>The optional specifications describe additional features for the device (optional features). The number of positions depends on the number of features available. The features have a 2-digit structure to aid identification (e.g. JA). The first digit (ID) stands for the feature group and consists of a number or a letter (e.g. J = Test, Certificate). The second digit constitutes the value that stands for the feature within the group (e.g. A = 3.1 material (wetted parts), inspection certificate).</p>	FMG60	-	*****	+	A*B*C*D*E*F*G*..	<i>(Device type)</i>		<i>(Basic specifications)</i>		<i>(Optional specifications)</i>
FMG60	-	*****	+	A*B*C*D*E*F*G*..							
<i>(Device type)</i>		<i>(Basic specifications)</i>		<i>(Optional specifications)</i>							

More detailed information about the device is provided in the following tables. These tables describe the individual positions and IDs in the extended order code which are relevant to hazardous locations.

Extended order code: Gammapilot M



The following specifications reproduce an extract from the product structure and are used to assign:

- This documentation to the device (using the extended order code on the nameplate).
- The device options cited in the document.

Device type

FMG60

Basic specifications

Position 1 (Approval)		
Selected option		Description
FMG60	C	NEPSI Ex d e [ia Ga] IIC T5/T6 Gb
	D	NEPSI Ex d [ia Ga] IIC T5/T6 Gb

Position 2 (Power Supply)		
Selected option		Description
FMG60	1	90-253 VAC
	2	18-35 VDC

Position 3 (Connect. Power Supply; Connect. Output)		
Selected option		Description
FMG60	B	Ex e; Ex ia
	C	Ex e; Ex e
	D	Ex d (XP); Ex d (XP)
	E	Ex d (XP); Ex ia (IS)

Position 4 (Output)		
Selected option		Description
FMG60	1	4-20 mA HART

Position 5 (Scintillator; Measuring Range)		
Selected option		Description
FMG60	A-D	NaJ-Crystal
	G-T	PVT

Optional specifications

No options specific to hazardous locations are available.

Safety instructions: General

- Comply with the installation and safety instructions in the Operating Instructions.
- For installation, use and maintenance of the device, users must also observe the requirements stated in the Operating Instructions and the standards:
 - GB 50257-2014: "Code for construction and acceptance of electric device for explosion atmospheres and fire hazard electrical equipment installation engineering".
 - GB 3836.13-2013: "Explosive atmospheres, Part 13: Equipment repair, overhaul and reclamation".
 - GB/T 3836.15-2017: "Explosive atmospheres, Part 15: Electrical installations design, selection and erection".
 - GB/T 3836.16-2017: "Explosive atmospheres, Part 16: Electrical installations inspection and maintenance".
 - GB/T 3836.18-2017: "Explosive atmospheres, Part 18: Intrinsically safe electrical systems".
- Staff must meet the following conditions for mounting, electrical installation, commissioning and maintenance of the device:
 - Be suitably qualified for their role and the tasks they perform
 - Be trained in explosion protection
 - Be familiar with national regulations
- Install the device according to the manufacturer's instructions and national regulations.
- Do not operate the device outside the specified electrical, thermal and mechanical parameters.
- Avoid electrostatic charging:
 - Of plastic surfaces (e.g. housing, sensor element, special varnishing, attached additional plates, ..)
 - Of isolated capacities (e.g. isolated metallic plates)

**Safety instructions:
Special conditions**

In the event of additional or alternative special varnishing on the housing or other metal parts:

- Observe the danger of electrostatic charging and discharge.
- Do not rub surfaces with a dry cloth.
- Do not install in the vicinity of processes generating strong electrostatic charges.

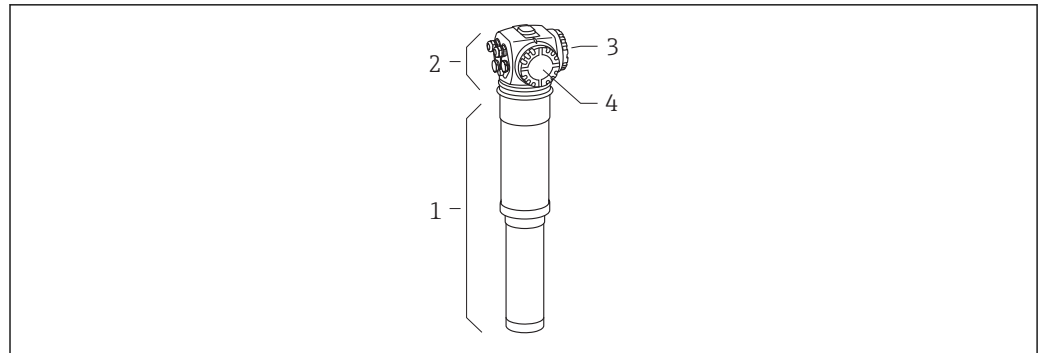
**Safety instructions:
Installation**

A0031753

 1

- 1 Pipe housing
- 2 Compartment housing
- 3 Terminal compartment A
- 4 Terminal compartment B

Circuit 4...20 mA/HART (active) in type of protection Intrinsic safety (Ex ia)

Basic specification, Position 3 (Connect. Power Supply; Connect. Output) = B, E

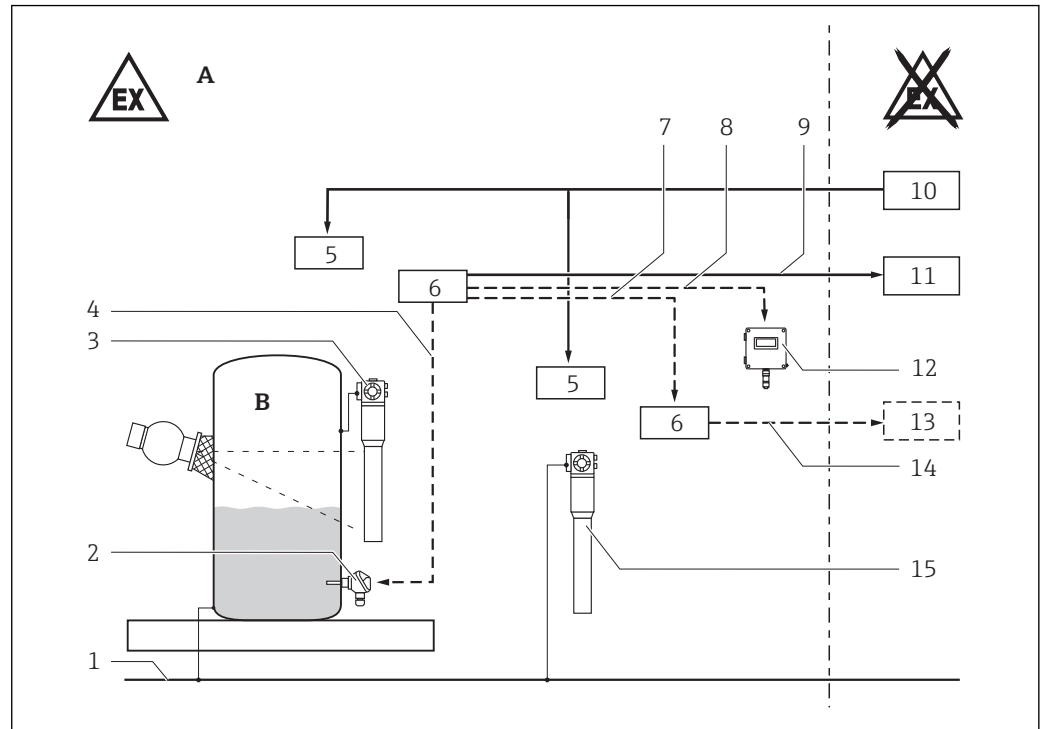

A0031754

2

- A Zone 1 or Zone 2
- B Zone 0, Zone 1 or Zone 2
- 1 Local potential equalization line
- 2 PT100; approved Ex ia equipment
- 3 Gammapilot with NaJ crystal scintillator, PVT plastic scintillator
- 4 [Ex ia] circuit
- 5 Terminal compartment A (Ex d or Ex e)
- 6 Terminal compartment B (Ex i)
- 7 [Ex ia] circuit; Cascade in, out
- 8 [Ex ia] circuit
- 9 Communication: 4...20 mA/HART active [Ex ia]
- 10 Power supply
- 11 Certified associated apparatus
- 12 Remote display FHX40
- 13 Certified associated apparatus
- 14 Communication: 4...20 mA/HART active [Ex ia]
- 15 Gammapilot with NaJ crystal scintillator, PVT plastic scintillator

Circuit 4...20 mA/HART (active) in type of protection Increased safety (Ex e) or Flameproof enclosure (Ex d)

Basic specification, Position 3 (Connect. Power Supply; Connect. Output) = C, D

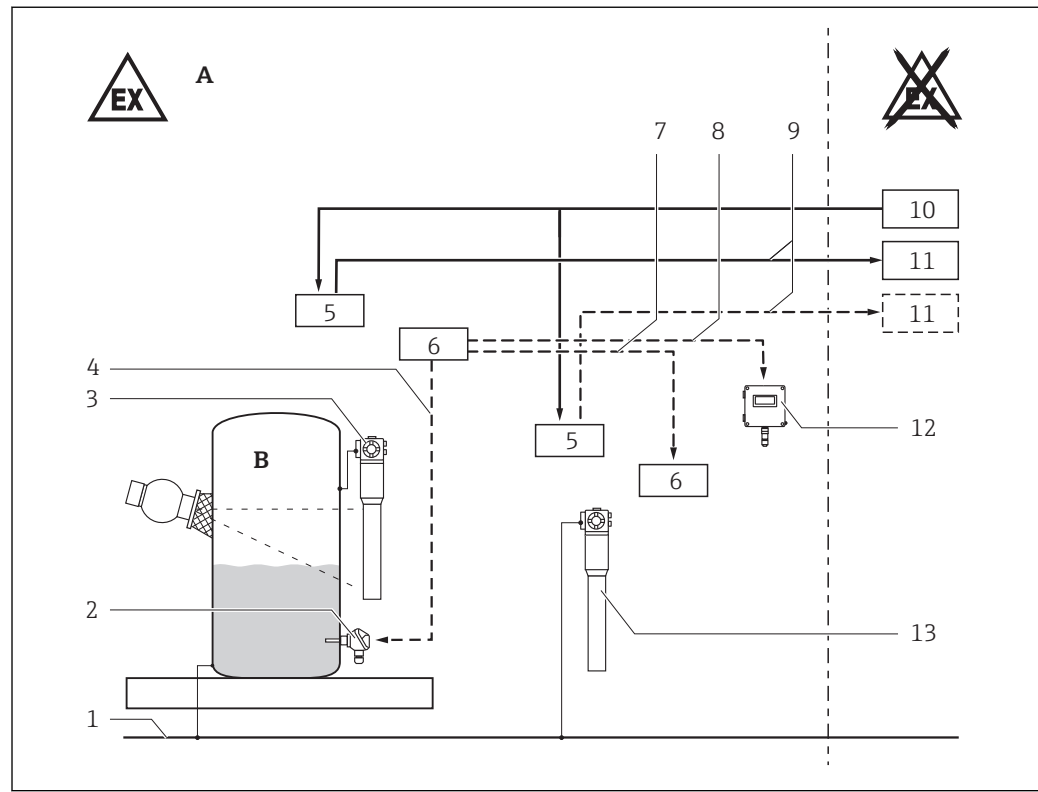

3

- A Zone 1 or Zone 2
 B Zone 0, Zone 1 or Zone 2
 1 Local potential equalization line
 2 PT100; approved Ex ia equipment
 3 Gammapilot with NaJ crystal scintillator, PVT plastic scintillator
 4 [Ex ia] circuit
 5 Terminal compartment A (Ex d or Ex e)
 6 Terminal compartment B (Ex i)
 7 [Ex ia] circuit; Cascade in, out
 8 [Ex ia] circuit
 9 Communication: 4...20 mA/HART active
 10 Power supply
 11 E.g. transmitter
 12 Remote display FHX40
 13 Gammapilot with NaJ crystal scintillator, PVT plastic scintillator

- To maintain the ingress protection of the housing IP66/67: Install the housing cover, cable glands and blind plugs correctly.
- Cable glands as well as sealing plugs of the terminal compartment A must not be exchanged with those of the terminal compartment B.
- Do not open the terminal compartment A when energized.
- In an explosive atmosphere: Minimum waiting time before opening the terminal compartment A after switching off the power supply: 3 minutes.
- Before operation:
 - Screw in the cover all the way.
 - Tighten the securing clamp on the cover.
- Continuous service temperature of the connecting cable: $\geq T_a + 20 \text{ K}$.

The safety screws at the pipe housing must not be loosened:

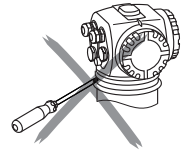

A0031759

When using the water cooling

To avoid damages at the detector or at the cooling jacket if the cooling water freezes: Empty cooling jacket or protect against freezing.

Intrinsic safety

- Observe the pertinent guidelines when interconnecting intrinsically safe circuits.
- The intrinsically-safe input circuits are galvanically isolated from other circuits up to a peak value of the nominal voltage of 375 V.
- The intrinsically safe circuits of the device are isolated from ground and have a dielectric strength of at least 500 V_{rms}.
- When the device is connected to an intrinsically safe circuit Ex ib, the type of protection changes to Ex ib. Do not operate the temperature sensor in Zone 0 if the device is connected to an intrinsically safe circuit of Category Ex ib.
- When the device is connected to an intrinsically safe circuit Ex ic, the type of protection changes to Ex ic. Do not operate the temperature sensor in Zone 0 or Zone 1 if the device is connected to an intrinsically safe circuit of Category Ex ic.
- Do not interconnect the 4...20 mA/HART signal circuits of the devices of a cascade set.

Increased safety (Ex e)

- Only use suitable certified Ex e cable glands providing an ingress protection of at least IP66/67. The cable glands must be suitable for the intended ambient temperature range.
- Replace cable glands and sealing plugs only with identical parts.

Flameproof enclosure (Ex d)

- Connect the device:
 - Using suitable cable and wire entries of protection type "Flameproof Enclosure (Ex d)".
 - Using piping systems of protection type "Flameproof Enclosure (Ex d)".
- Seal unused entry glands with approved Ex d sealing plugs.

Safety instructions: Ex d joints

If required or if in doubt: ask manufacturer for specifications.

Potential equalization

Integrate the device into the local potential equalization.

Temperature tables

Temperature class
T6 or T5

Basic specification, Position 5 (Scintillator; Measuring Range) = A-D, G-T

Ambient temperature T_a (ambient)	
Detector without water cooling or detector with water cooling out of operation: ■ Devices with Naj crystal scintillator: ■ Devices with PVT plastic scintillator:	Temperature class T6 $-40\text{ °C} \leq T_a \leq +60\text{ °C}$ $-40\text{ °C} \leq T_a \leq +60\text{ °C}$
Detector with water cooling in operation: At the pipe housing (within the water cooling): ■ Devices with Naj crystal scintillator: ■ Devices with PVT plastic scintillator: At the compartment housing:	Temperature class T6 or T5 $-40\text{ °C} \leq T_a \leq +60\text{ °C}$ $-40\text{ °C} \leq T_a \leq +60\text{ °C}$ $-40\text{ °C} \leq T_a \leq +75\text{ °C}$ (T6) $-40\text{ °C} \leq T_a \leq +80\text{ °C}$ (T5)

Type of protection	
Power supply circuit (Terminal compartment A)	Ex e or Ex d
Signal circuits (Terminal compartment B)	Ex ia

Connection data

- Tightening torque of the terminal screws: max. 0.4 Nm.
- Strip the insulation of the connection wires with suitable length. Bare parts of the wires must not emerge from the terminal.
- Ensure that the wires are securely clamped.

Terminal compartment A

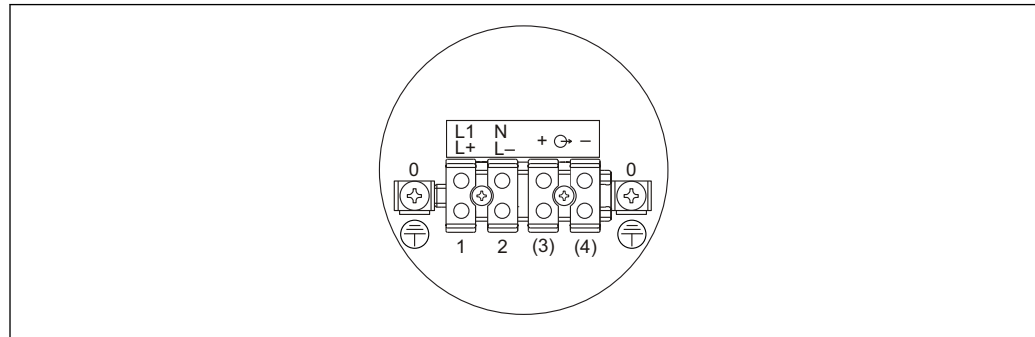

Increased safety (Ex e) or Flameproof enclosure (Ex d)



A0031763

4

Power supply circuit		
Basic specification, Position 2 (Power Supply) = 1	L1 N	$U_e = 90\text{ to }253\text{ V}_{AC}, 50/60\text{ Hz}, 8.5\text{ VA}$
Basic specification, Position 2 (Power Supply) = 2	L+ L-	$U_e = 18\text{ to }35\text{ V}_{DC}, 3.5\text{ W}$ $U_m = 253\text{ V}_{AC}$

Signal circuit		
Basic specification, Position 3 (Connect. Power Supply; Connect. Output) = B, E	 + -	not connected
Basic specification, Position 3 (Connect. Power Supply; Connect. Output) = C, D	 + -	4...20 mA/HART (active) $U_m = 253 V_{AC}$ The detector ensures galvanic isolation up to a maximum of 253 V _{AC} between the signal circuit and any other circuit.



Terminal compartment B

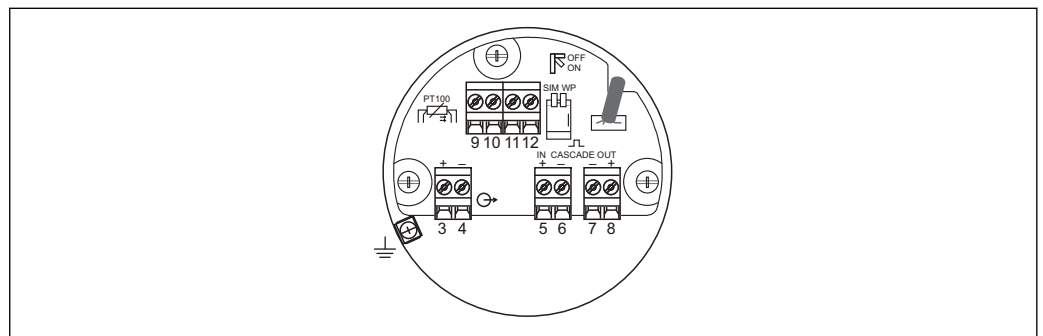

Intrinsic safety (Ex ia)



A0031764

5

Signal circuit			Ex ia IIC	Ex ia IIB	Ex ib IIC	Ex ib IIB
4...20 mA/ HART (active) ¹⁾	 + -	$U_o = 21.2 V$ $I_o = 92 mA$ $P_o = 479 mW$ $R_i = 235 \Omega$ $C_i = 13.4 nF$ $L_i = 0$ Characteristic curve: linear $U_i = 30 V$ $I_i = 13 mA$ $P_i = 390 mW$	$C_o = 156 nF$ at $L_o = 0.15 mH$ $C_o = 116 nF$ at $L_o = 1 mH$	$C_o = 886 nF$ at $L_o = 0.15 mH$ $C_o = 686 nF$ at $L_o = 1 mH$	$C_o = 169 nF$ $L_o = 4 mH$	$C_o = 1.2 \mu F$ $L_o = 15 mH$
PT100		$U_o = 8.4 V$ $I_o = 8.3 mA$ $P_o = 17.5 mW$ $R_i = 1012 \Omega$ $C_i = 0$ $L_i = 0$ Characteristic curve: linear	$C_o = 1200 nF$ at $L_o = 1 mH$ $C_o = 1800 nF$ at $L_o = 0.15 mH$	$C_o = 6 \mu F$ at $L_o = 1 mH$ $C_o = 5.2 \mu F$ at $L_o = 2 mH$	$C_o = 5.2 \mu F$ $L_o = 400 mH$	$C_o = 43 \mu F$ $L_o = 400 mH$
Cascade out ²⁾	 - +	$U_o = 8.4 V$ $I_o = 19.2 mA$ $P_o = 40.3 mW$ $R_i = 439 \Omega$ $C_i = 5.3 nF$ $L_i = 67 \mu H$ Characteristic curve: linear	$C_o = 5.1 \mu F$ $L_o = 69 mH$	$C_o = 42 \mu F$ $L_o = 199 mH$	$C_o = 5.1 \mu F$ $L_o = 69 mH$	$C_o = 42 \mu F$ $L_o = 199 mH$

Signal circuit			Ex ia IIC	Ex ia IIB	Ex ib IIC	Ex ib IIB
Cascade in ³⁾	 + -	$U_i = 8.4 \text{ V}$ $I_i = 19.2 \text{ mA}$ $P_i = 40.3 \text{ mW}$ $C_i = 0$ $L_i = 67 \text{ }\mu\text{H}$				
Connection for FHX40		$U_o = 4.7 \text{ V}$ $I_o = 37.7 \text{ mA}$ $P_o = 44.3 \text{ mW}$ $R_i = 125 \text{ }\Omega$ $C_i = 12.7 \text{ nF}$ $L_i = 0$ Characteristic curve: linear	For connection to the approved display FHX40 with associated cable (IECEx TUN 04.0011) in type of protection intrinsic safety Ex ia IIC. Observe associated Safety Instructions! $C_o = 150 \text{ }\mu\text{F}$ $L_o = 25 \text{ mH}$			

- 1) Only available at Basic specification, Position 3 (Connect. Power Supply; Connect. Output) = B, E
- 2) Only for connection to FMG60 signal circuit Cascade in
- 3) Only for connection to FMG60 signal circuit Cascade out



www.addresses.endress.com
