

Instrucțiuni de operare **Liquiphant S FTL70, FTL71**

Comutator de nivel punctual

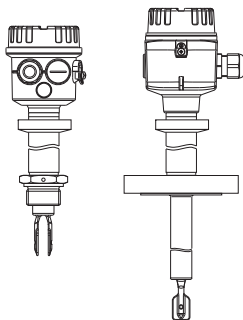

RO- Cuprins

Informații privind siguranța	3
Manevrarea	4
Identificarea dispozitivului	6
Aplicația	12
Sistemul de măsurare	13
Instalarea	17
Configurarea	26
Semnalele luminoase	30
Conexiunile	31
Întreținerea, curățarea	52
Date tehnice	53
Accesoriile	55
Depanarea	58
Piese de schimb	60
Reparațiile	61
Documentația suplimentară	62



Atenție!

= interzis;
duce la funcționare
incorectă sau distrugere.

RO- Informații privind siguranța

Liquiphant S FTL70, FTL71 este conceput pentru detectarea nivelului punctual din lichide.

În caz de utilizare incorectă, este posibilă apariția unor pericole privind aplicația.

Comutatorul limitei de nivel Liquiphant S FTL70, FTL71 poate fi instalat, conectat, pus în funcțiune, operat și întreținut

numai de către personal calificat și autorizat, cu respectarea strictă a acestor instrucțiuni de operare, a standardelor în vigoare, a dispozițiilor legale și, unde este cazul, a certificatului.

Instalați un întrerupător de alimentare ușor accesibil în apropierea dispozitivului.

Marcați întrerupătorul de alimentare ca separator pentru dispozitiv.

RO- Manevrarea

Țineți dispozitivul de
distanțierul de temperatură,
flanșă sau tubul prelungitor.

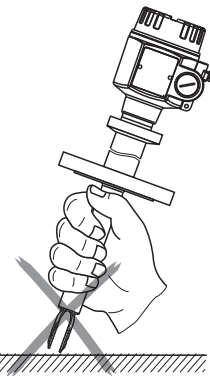
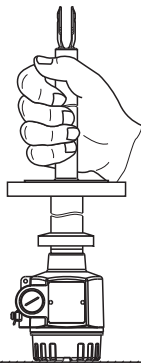
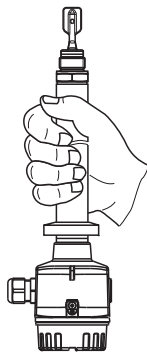

RO- Nu îndoiți
Nu scurțați
Nu lungiți

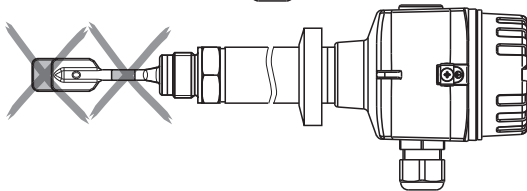
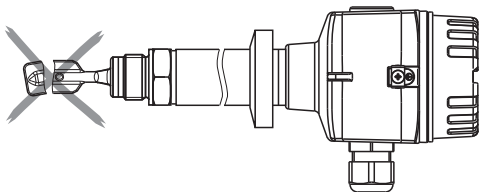
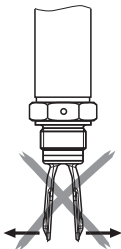
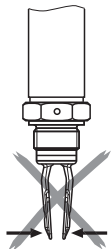

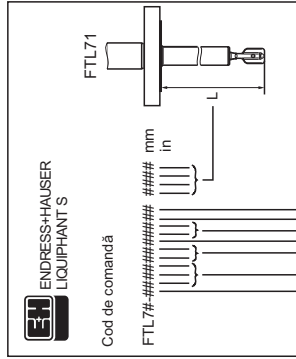

EH
ENDRESS+HAUSER
LIQUIPHANT S

FTL71

Cod de comandă

FTL71#-#####

mm

in

L

*¹

- | | |
|---|--|
| A | ATEX II 3 G, EEx nC II T6, WHG |
| B | ATEX II 3 D T85°C ³ |
| C | ATEX II 3 G, EEx nA II T6, WHG |
| | ATEX II 3 D T85°C ³ |
| D | * ¹ WHG |
| E | ATEX II 1/2 G, EEx de IIC T6, WHG |
| F | ATEX II 1/2 G, EEx Ia IIC T6, WHG |
| | ATEX II 1/2 D T80°C ³ |
| L | ATEX II 1/2 G, EEx d IIC T6, WHG |
| M | NEPSI Ex Ia IIC T6 |
| N | NEPSI Ex d IIC T6 |
| P | FM, IS, Cl. I, II, III, Div. 1, Gr. A-G |
| Q | FM, XP, Cl. I, II, III, Div. 1, Gr. B-G, E5 => Gr. A-G |
| R | FM, NI, Cl. I, Div. 2, Gr. A-D |
| S | CSA, IS, Cl. I, II, III, Div. 1, Gr. A-G |
| T | CSA, XP, Cl. I, II, III, Div. 1, Gr. A-G |
| U | Utilizare generală CSA |
| V | TIIS Ex Ia IIC T2 |
| W | TIIS Ex d IIC T2 |
| Y | |

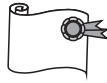

KA173

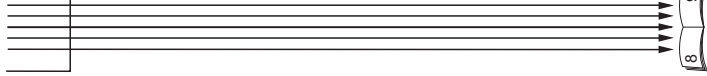

A##	B##	C##	D##	K##	Flanșe												
GE2	GE5	GE6	GF2	GF5	GF6	GM2	GM5	GM6	GN2	GN5	GN6	GQ2	GQ5	GQ6	GR2	GR5	GR6
R 3/4,	R 3/4,	R 3/4,	R 1,	R 1,	R 1,	NPT 3/4,	NPT 3/4,	NPT 3/4,	NPT 1,	NPT 1,	NPT 1,	G 3/4,	G 3/4,	G 3/4,	G 1,	G 1,	G 1,
DIN 2999, 316L	DIN 2999, AlloyC4	DIN 2999, AlloyC22	DIN 2999, 316L	DIN 2999, AlloyC4	DIN 2999, AlloyC22	ANSI, 316L	ANSI, AlloyC4	ANSI, AlloyC22	ANSI, 316L	ANSI, AlloyC4	ANSI, AlloyC22	ISO 228, 316L	ISO 228, AlloyC4	ISO 228, AlloyC22	ISO 228, 316L	ISO 228, AlloyC4	ISO 228, AlloyC22



YY9

*¹ fără

*² altele

*³ nevalid pentru PBT



ENDRESS+HAUSER
LIQUIPHANT S

Cod de comandă

FTL7######

mm
in

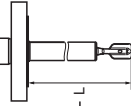

FTL71

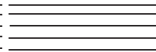
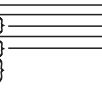

FTL70:

AB ²

316L*, 318L**, Ra < 3,2 µm/80 grit

AE ²

AlloyC4+**, Ra < 3,2 µm/80 grit

FTL71:

BB ²

.....mm, 316L*, 318L**, Ra < 3,2 µm/80 grit

BE ²

.....mm, AlloyC4+**, Ra < 3,2 µm/80 grit

CB ²

.....in, 316L*, 318L**, Ra < 3,2 µm/80 grit

CE ²

.....in, AlloyC4+**, Ra < 3,2 µm/80 grit

YY ²

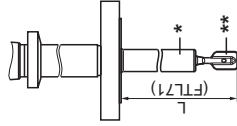

FEL50A, PROFIBUS PA

FEL51, 19...253 V AC

FEL52, 10... 55 V DC, PNP

FEL54, 19...253 V AC, 19...55 V DC, DPDT

FEL55, 11... 36 V DC, 8/16 mA

FEL56, NAMUR, L-H

FEL57, PFM

FEL58, NAMUR, H-L

+ Buton testare

9 ²

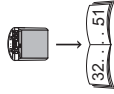

32...51



E1	F27,	Nema 6P, NPT ¾
E4	F16,	Nema 4x, NPT ½
E5	F13/17,	Nema 4x, NPT ¾
E6	F15,	Nema 4x, NPT ½
F1	F27,	IP68, G ½ A
F4	F16,	IP66, G ½ A
F5	F13/17,	IP66, G ½ A
F6	F15,	IP66, G ½ A
G1	F27,	IP68, M20
G4	F16,	IP66, M20
G5	F13/17,	IP66, M20
G6	F15,	IP66, M20
N4	F16,	IP66, M12, PA
N5	F13/17,	IP66, M12, PA
N6	F15,	IP66, M12, PA
Y9	*1	
#7	Aluminiu/Separat	



F16 (PBT)



F13/17 (Alu)
F27 (316L)



F15 (316L)



KA173

A	*1	
C	EN 10204 - 3.1,	316L/318L
N	EN 10204 - 3.1, NACE MR0175, 316L	
S	Certificat maritim GL/ABS	
Y	*2	

L	230 °C (L _T ~ 160 mm)
N	280 °C (L _T ~ 200 mm)
Y	*2

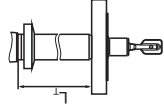

*1 fără
*2 altele

ANSI B16.5

AB2	1¼", 300 lbs, RF, 316/316L
AC2	1½", 150 lbs, RF, 316/316L
AD2	1½", 300 lbs, RF, 316/316L
AE2	2", 150 lbs, RF, 316/316L
AE5	2", 150 lbs, AlloyC4 > 1.4462
AE6	2", 150 lbs, AlloyC22 > 1.4462
AF2	2", 300 lbs, RF, 316/316L
AF5	2", 300 lbs, AlloyC4 > 1.4462
AF6	2", 300 lbs, AlloyC22 > 1.4462
AG2	2", 600 lbs, RF, 316/316L
AG5	2", 600 lbs, AlloyC4 > 1.4462
AG6	2", 600 lbs, AlloyC22 > 1.4462
AL2	3", 150 lbs, RF, 316/316L
AM2	3", 300 lbs, RF, 316/316L
AN2	3", 600 lbs, RF, 316/316L
AN6	3", 600 lbs, AlloyC4 > 1.4462
AP2	4", 150 lbs, RF, 316/316L
AQ2	4", 300 lbs, RF, 316/316L
AR2	4", 600 lbs, RF, 316/316L
A82	1", 150 lbs, RF, 316/316L

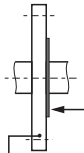
**EN 1092-1**

BB2	DN32, PN25/40 A, 316L
BD2	DN40, PN25/40 A, 316L
BG2	DN50, PN25/40 A, 316L
BI2	DN50, PN63 A, 316L
BJ2	DN50, PN100 A, 316L
BK2	DN65, PN25/40 A, 316L
BN2	DN80, PN25/40 A, 316L
BR2	DN100, PN25/40 A, 316L
BU2	DN100, PN63 A, 316L
B02	DN80, PN63 A, 316TI
B12	DN80, PN100 A, 316L
B82	DN25, PN25/40 A, 316L

CF2	DN50,	PN10/16 B1, 316L
CG2	DN50,	PN25/40 B1, 316L
CG5	DN50,	PN25/40, AlloyC4 > 1.4462
CG6	DN50,	PN25/40, AlloyC22 > 1.4462
C12	DN50,	PN63 B2, 316L
C15	DN50,	PN63, AlloyC4 > 1.4462
C16	DN50,	PN63, AlloyC22 > 1.4462
CJ2	DN50,	PN100 B2, 316L
CM2	DN80,	PN10/16 B1, 316L
CN2	DN80,	PN25/40 B1, 316L
CN5	DN80,	PN25/40, AlloyC4 > 1.4462
CN6	DN80,	PN25/40, AlloyC22 > 1.4462
CQ2	DN100,	PN10/16 B1, 316L
CU2	DN100,	PN63 B2, 316L
CU5	DN100,	PN63, AlloyC4 > 1.4462
CU6	DN100,	PN63, AlloyC22 > 1.4462
C02	DN80,	PN63 B2, 316L
C05	DN80,	PN63, AlloyC4 > 1.4462
C06	DN80,	PN63, AlloyC22 > 1.4462
C12	DN80,	PN100 B2, 316L
C82	DN25,	PN25/40 B1, 316L
C85	DN25,	PN25/40, AlloyC4 > 1.4462
C86	DN25,	PN25/40, AlloyC22 > 1.4462
DG2	DN50,	PN40 B1, 316L
DN2	DN80,	PN40 B1, 316L
D82	DN25,	PN40 B1, 316L

JIS B2220

KF2	20K 50, RF,	316L
KF5	20K 50, RF,	AlloyC4 > 316L
KF6	20K 50, RF,	AlloyC22 > 316L

RO- Aplicația

Detectarea nivelului punctual în
fluide

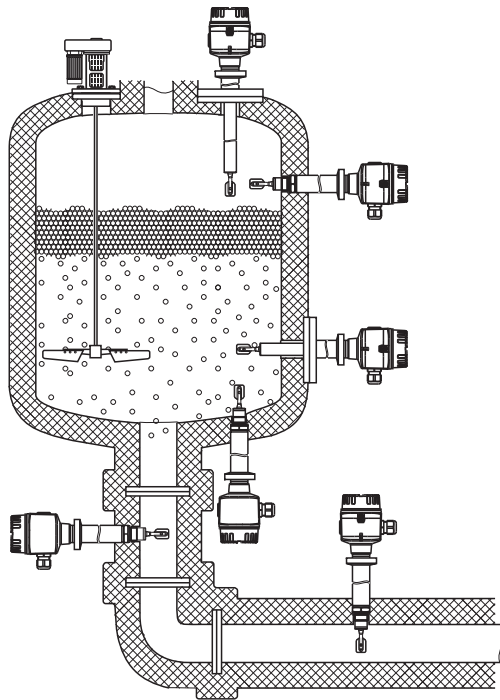

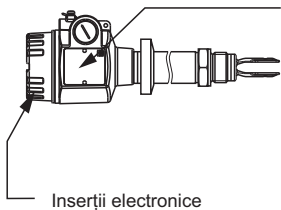

Cod de comandă:
FTL7# - # ### # # # # #

FEL51
FEL52
FEL54

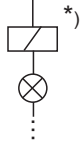
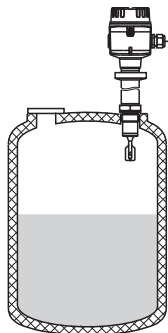

*) Sarcină externă

RO- Sistem de măsurare
pentru conectare directă

RO- Sistem de măsurare

pentru conexiune prin unitatea
de comutare

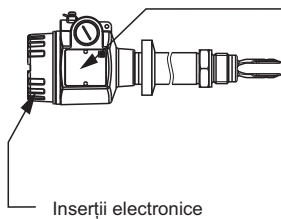

Insertii electronice

Cod de comandă:
FTL7# - # ### # # # #

FEL55
FEL56
FEL57
FEL58

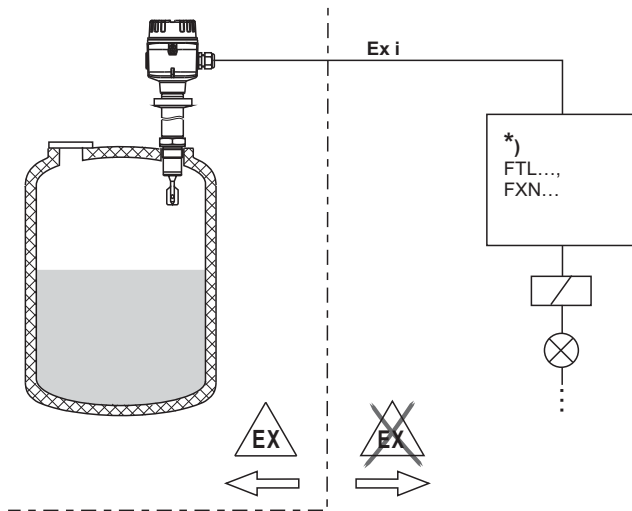

*) Unitate de comutare, PLC, amplificator de izolare

RO- Sistem de măsurare
pentru conexiune la
PROFIBUS PA

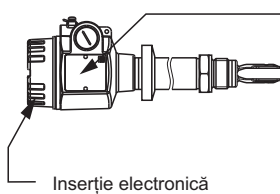

Cod de comandă:
FTL7# - # ### ## # ## ##

FEL50A

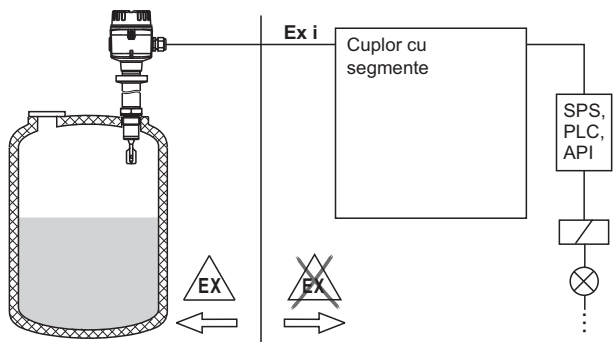

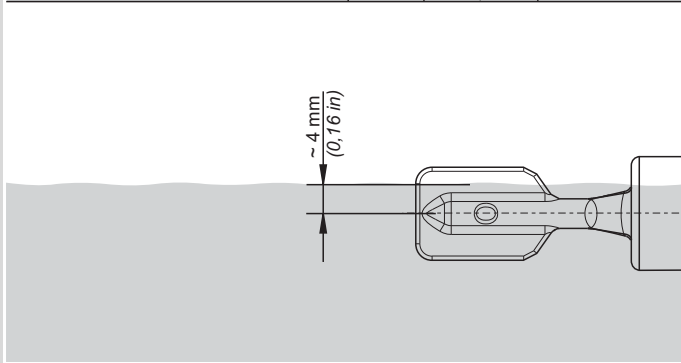
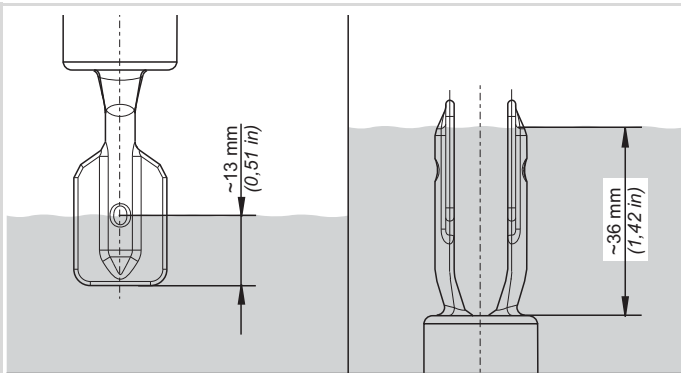

RO- Instalarea

Punctul de comutare depinde de poziția de montare

RO- Exemple de montare
ca funcție a vâscozității
lichidului ν

$\nu = 0 \dots 2000 \text{ mm}^2/\text{s}$
($\nu = 0 \dots 2000 \text{ cSt}$)

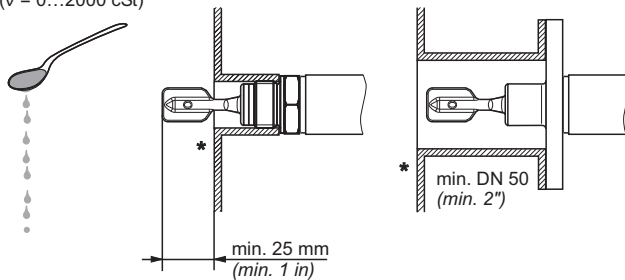

$\nu = 0 \dots 10000 \text{ mm}^2/\text{s}$
($\nu = 0 \dots 10000 \text{ cSt}$)

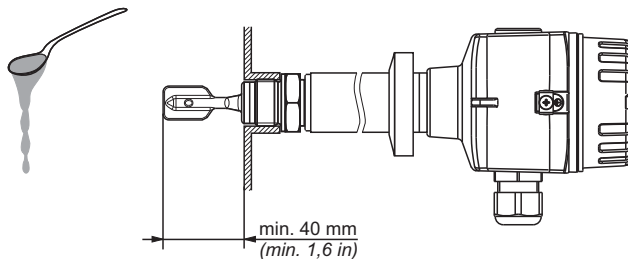

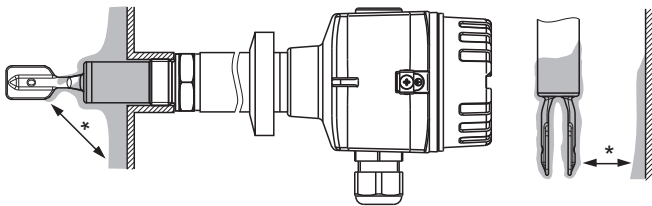

* Distanță!

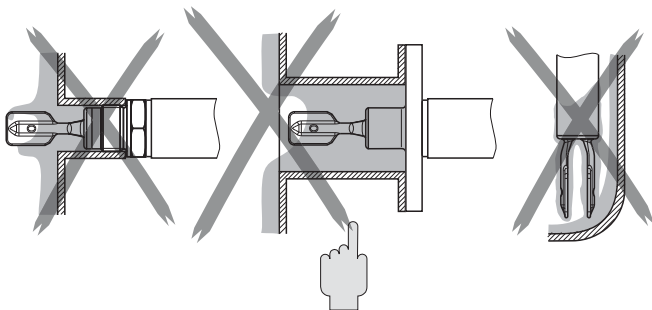

RO- Luați în calcul acumulările.
Fura nu trebuie să intre în contact
cu acumulările.

RO- În cazul susținerii forțelor
dinamice

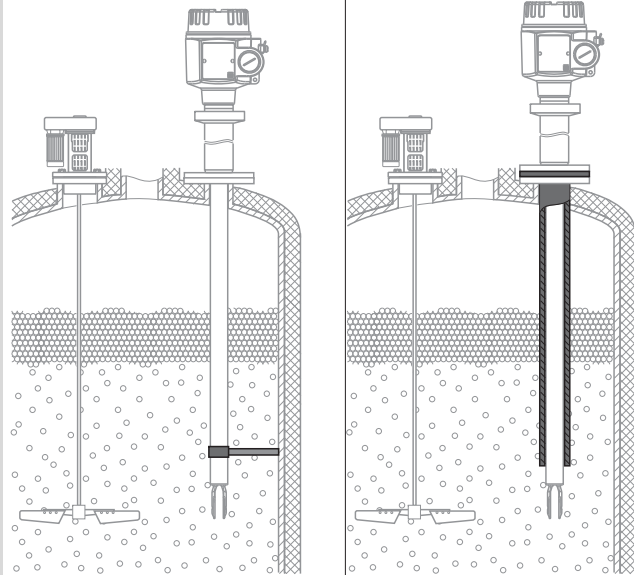

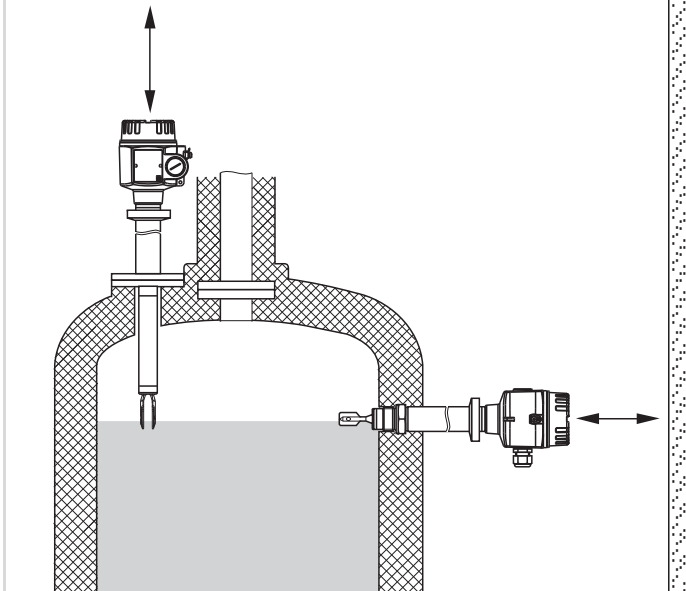

RO- Orientarea dinților furcii:
Marcaj deasupra sau dedesubt

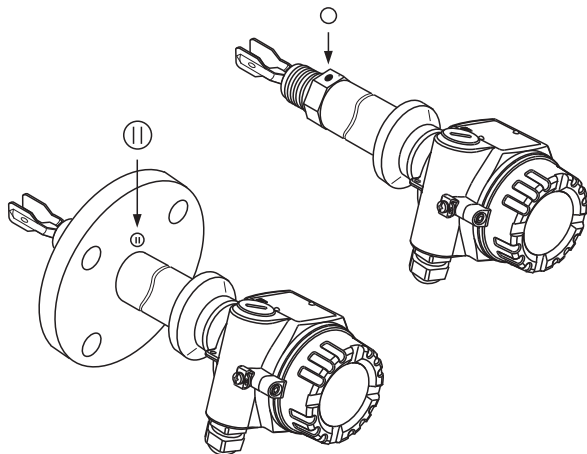
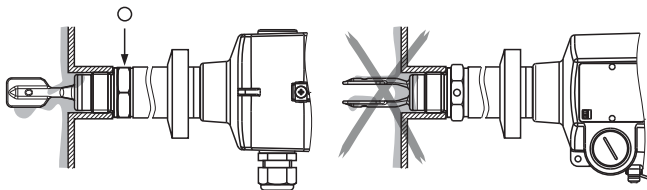

G ¾, 32 mm (1¼")*
G 1, 41 mm (1½")*

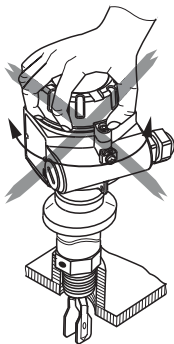
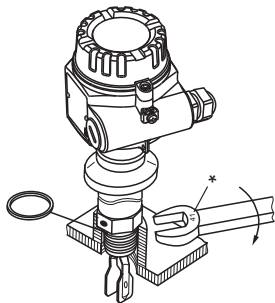

NPT ¾, R ¾, G ¾, 32 mm (1¼")*
NPT 1, R 1, G 1, 41 mm (1½")*

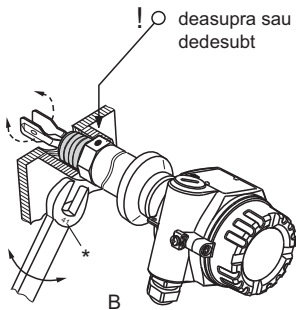
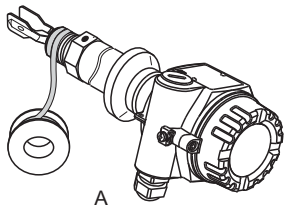

RO- Înfiletați Liquiphant în
conexiunea de proces.
Nu utilizați carcasa pentru a roti.

RO- Orientarea în conducte:
Marcaj în direcția de curgere

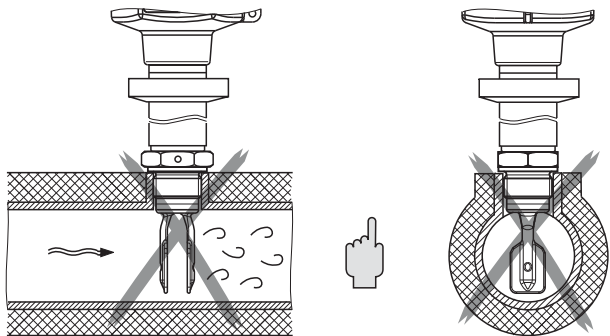
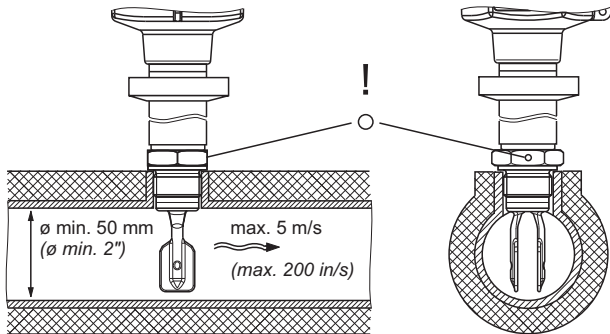

F15, F27

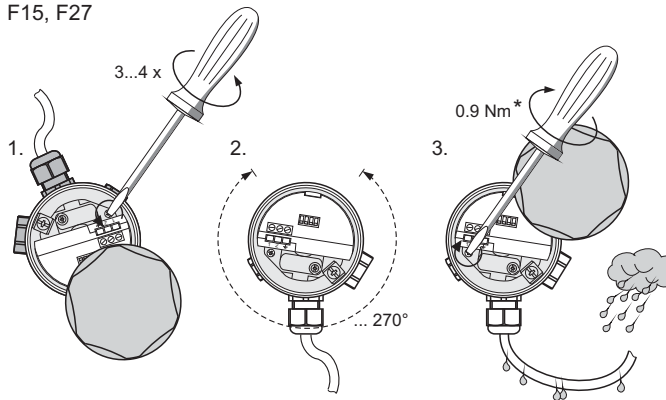

RO- Orientarea presgarniturii de cablu

F16, F13, F17

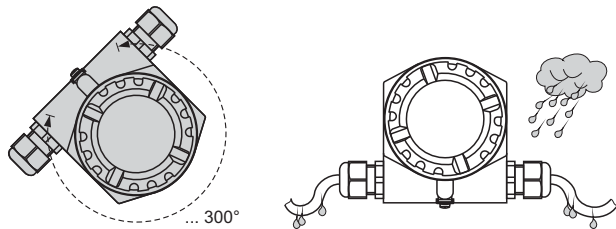

* Cuplu

RO- Configurarea

Mod protecție intrinsecă
minim/maxim

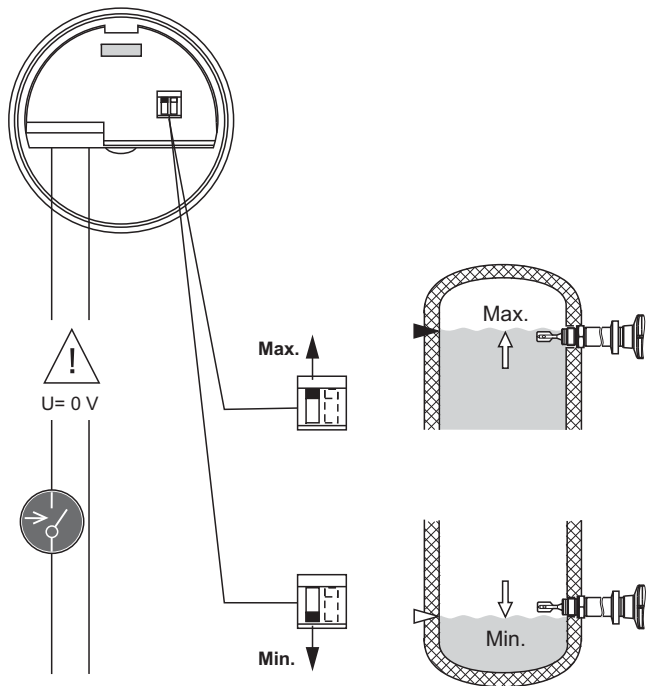

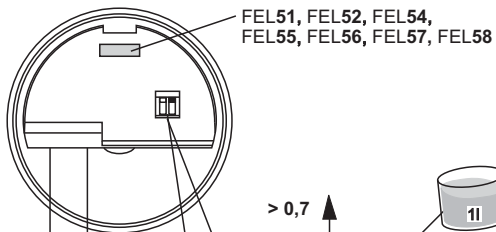

Standard

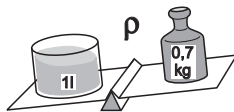

1 l (1 dm³) = min. 0,7 kg
 (1 gal. brit. = min. 7,0 lbs)
 (1 gal. SUA = min. 5,9 lbs)



U= 0 V



(ρ 0,5...0,7)

de exemplu, propan

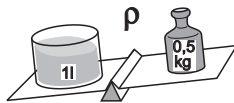

1 l (1 dm³) = 0,5...0,7 kg
 (1 gal. brit. = 5,0...0,7 lbs)
 (1 gal. SUA = 4,2...5,9 lbs)

RO- Densitatea lichidelor.

Densitatea ρ măsurată în g/cm³
 sau în kg/l.

RO- Autotestare FEL57
(consultați pagina 44, 45 și
unitatea de comutare pentru
secvență)

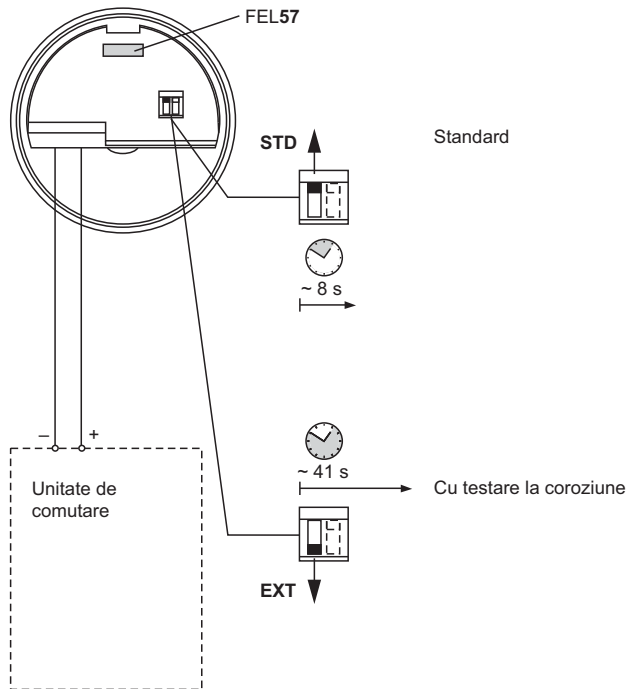

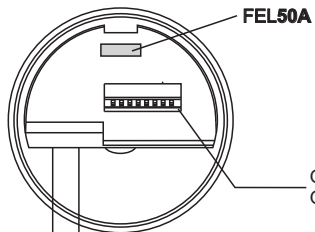

ON	1	2	4	8	16	32	64	SW
OFF	0	0	0	0	0	0	0	HW
	1	2	3	4	5	6	7	8

Exemplu:

$$2 + 8 = 10 = \text{Adresă}$$

RO- Setarea adresei dispozitivului
(Setarea parametrilor,
consultați BA141F)

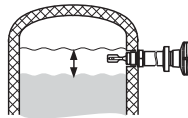

Nivel variabil

LED-uri



Stare de așteptare



Stare de comutare



FEL57, FEL50A: Acoperire



activat



se aprinde intermitent



stins



Semnal de ieșire



Defecțiune

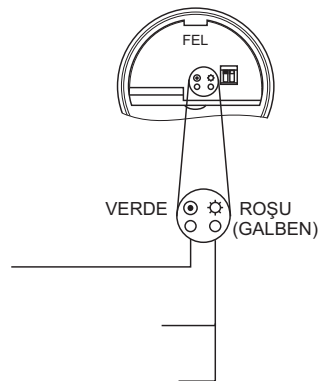



Respectați reglementările naționale!

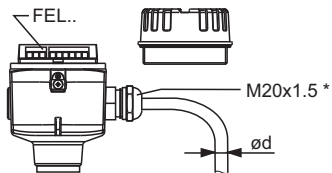

max. 2,5 mm²
(max. AWG 14)

max. 4 mm²
(max. AWG 12)

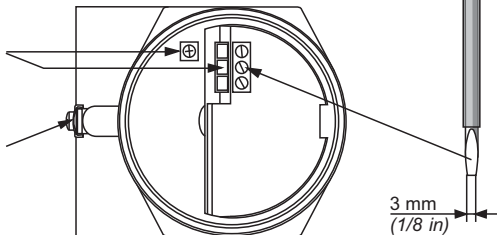

RO- Conexiuni

*Intrare de cablu

Alamă placată cu nichel:

Ød = 7...10,5 mm (0,28...0,41 in)

Plastic:

Ød = 5...10 mm (0,2...0,38 in)

Oțel inoxidabil:

Ød = 7...12 mm (0,28...0,47 in)

RO- Conexiuni FEL51
 Conexiune c.a. două cabluri

 Distrugere

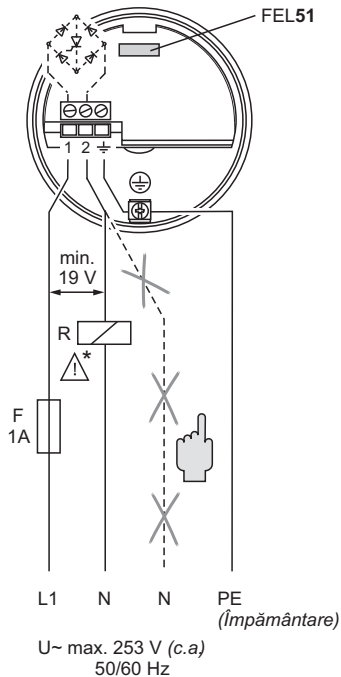

 * Sarcina externă R **trebuie să fie conectată**

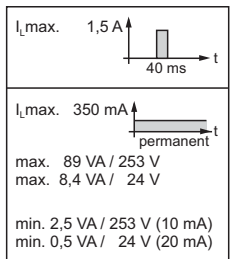

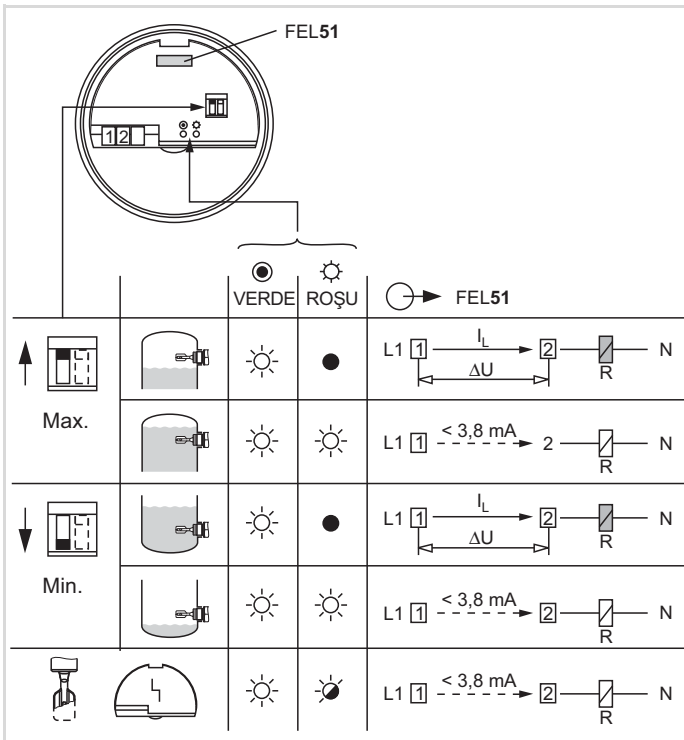
 $\Delta U_{FEL51} \text{ max. } 12 \text{ V}$

RO- Conexiuni FEL52
Conexiune c.c. (PNP)

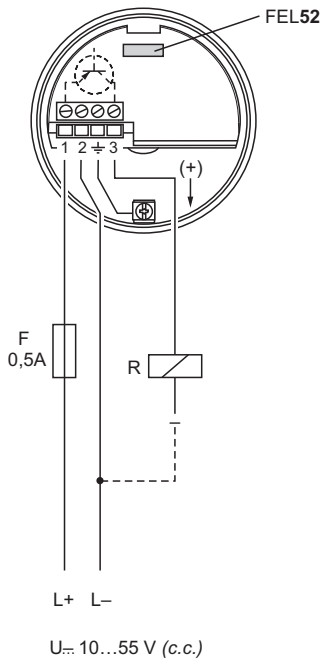

și pentru module DI
EN 61131-2

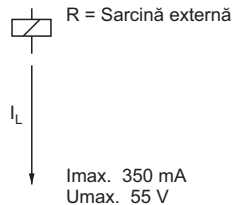

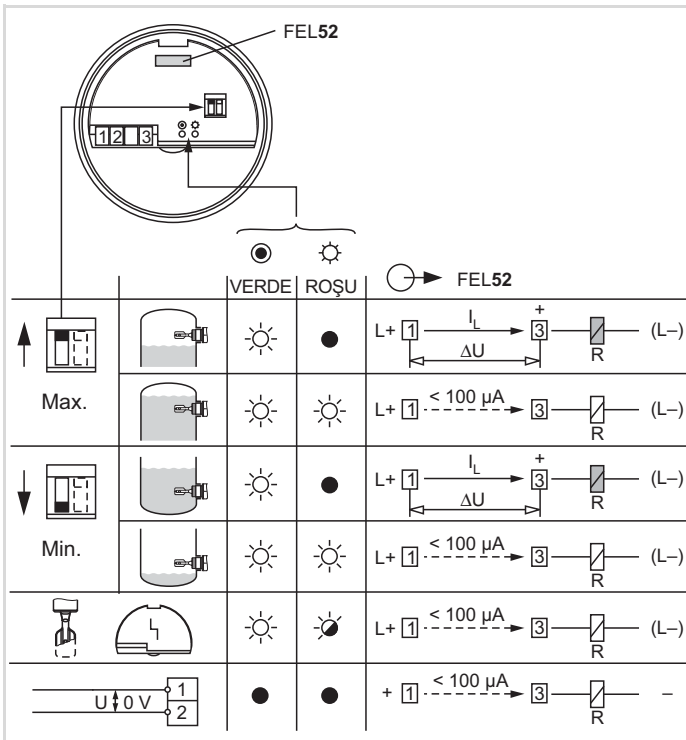
 $\Delta U_{FEL52} \text{ max. } 3 \text{ V}$

RO- Conexiuni FEL54
 Conexiune universală
 Ieșire releu

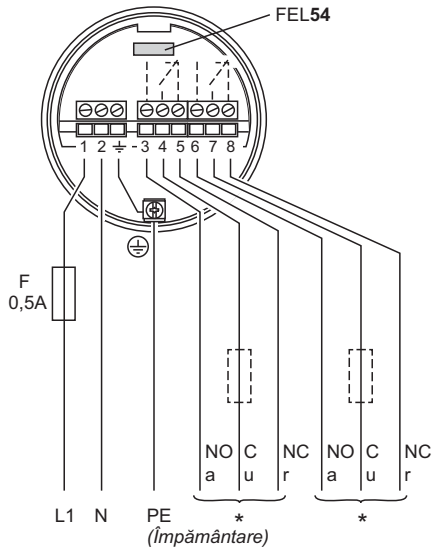

$U \sim 19 \dots 253 \text{ V (c.a.)}$

$U_{\text{=}} 19 \dots 55 \text{ V (c.c.)}$
 L+ L-

$\left\{ \begin{array}{l} U \sim \text{max. } 253 \text{ V, } I \sim \text{max. } 6 \text{ A} \\ P \sim \text{max. } 1500 \text{ VA, } \cos \varphi = 1 \\ * P \sim \text{max. } 750 \text{ VA, } \cos \varphi > 0.7 \\ I_{\text{=}} \text{max. } 6 \text{ A, } U_{\text{=}} < 30 \text{ V} \\ I_{\text{=}} \text{max. } 0,2 \text{ A, } U_{\text{=}} < 125 \text{ V} \end{array} \right.$

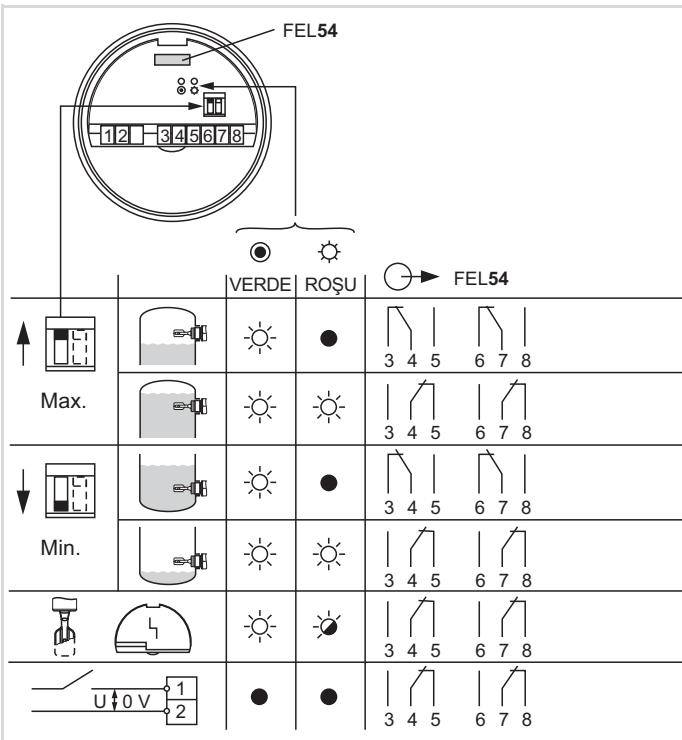

RO- Conexiuni FEL55

Ieșire 8/16 mA

* Locație umedă.

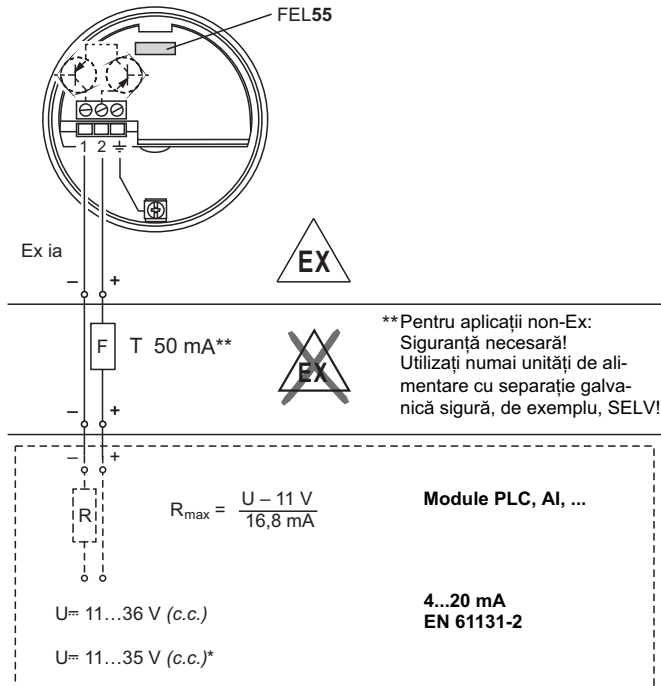

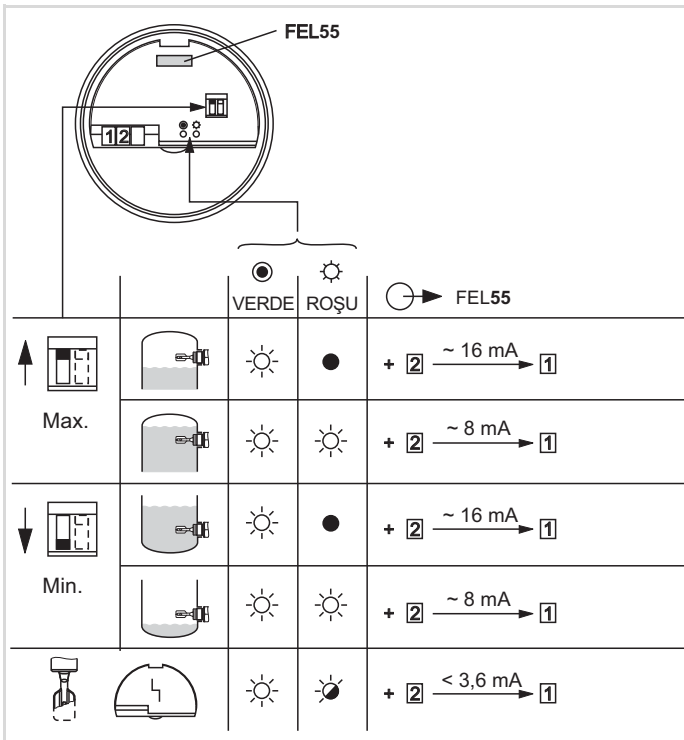

RO- Conexiuni FEL56
Ieşire NAMUR L-H
< 1,0 mA / > 2,2 mA

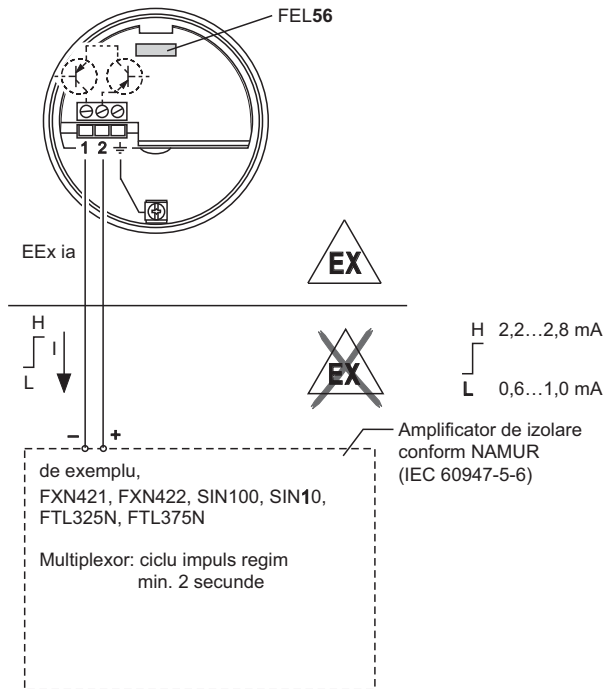

Alimentare cu energie electrică
c.c.: 8,2 V +/- 20%

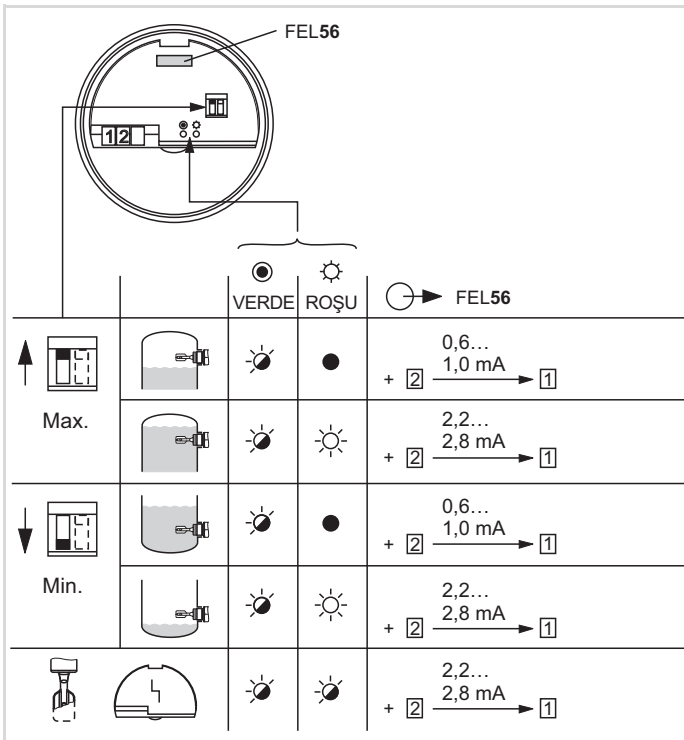

RO- Conexiuni FEL 57
 Ieşire PFM
 150 Hz / 50 Hz

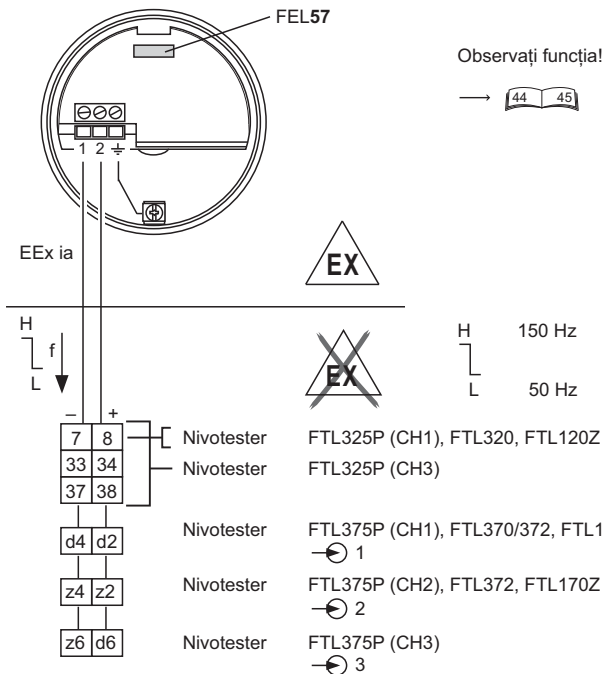

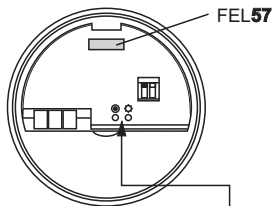

	● VERDE	⚙️ GALBEN	⊙ → FEL57
	☀️	☀️	
	☀️	●	
	☀️	◐	
	●	●	

* Comportament la pornire



RO- Comportament la pornire Autotestare (STD)

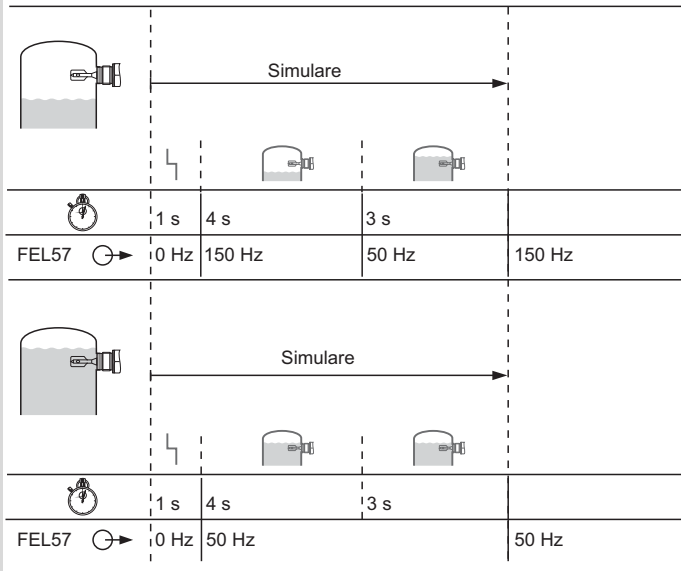
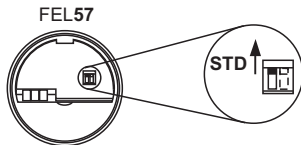

FEL57

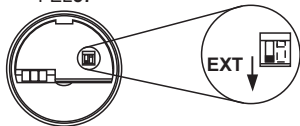

RO- Comportament la pornire
Autotestare (EXT)

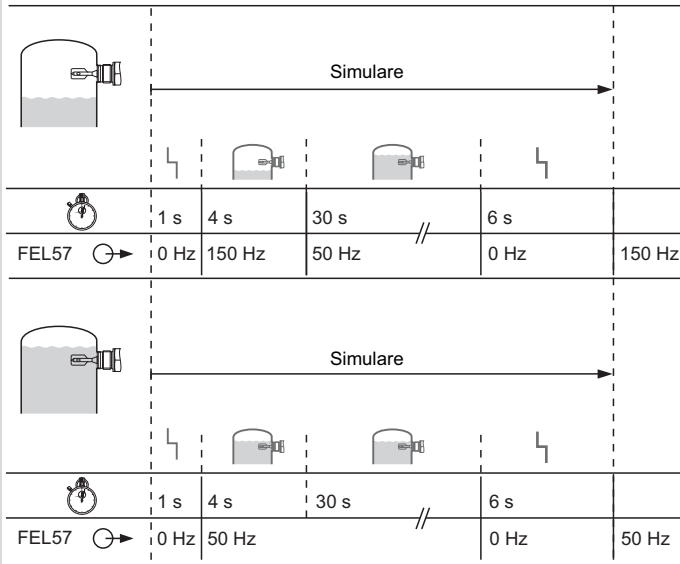

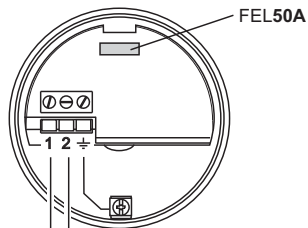



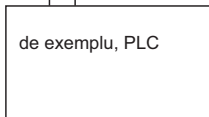
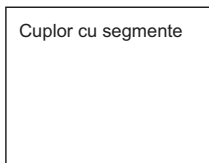



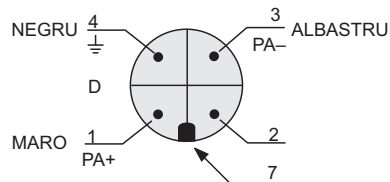



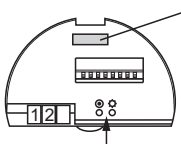
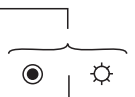









PA- PA+
 U... 9...32 V (c.c.)



Racord M12

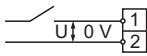

Racord dispozitiv de pe carcasă (tată)

				
				Semnal magistrală PA
neinversat				OUT_D = 0
				OUT_D = 1
inversat				OUT_D = 0
				OUT_D = 1
			-	Comunicație
		-		Stare, consultați BA141F
				../..

RO- Conexiuni FEL58
Ieşire NAMUR H-L
> 2,2 mA / < 1,0 mA

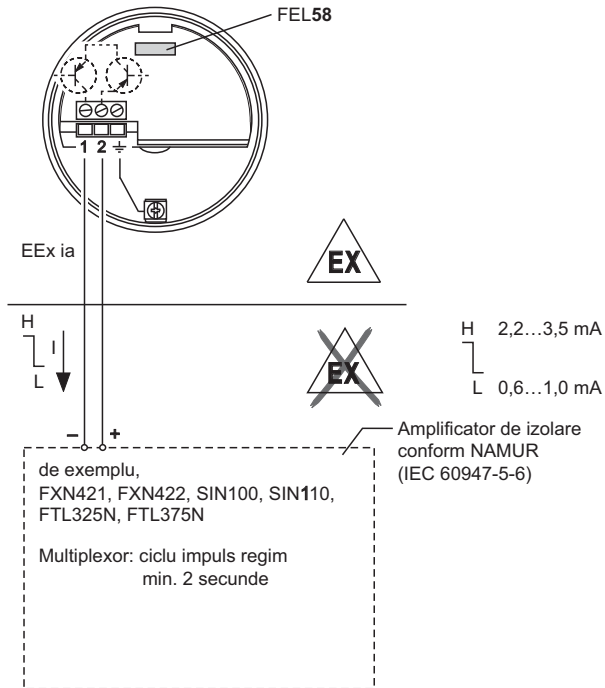

Alimentare cu energie electrică
c.c.: 8,2 V +/- 20%

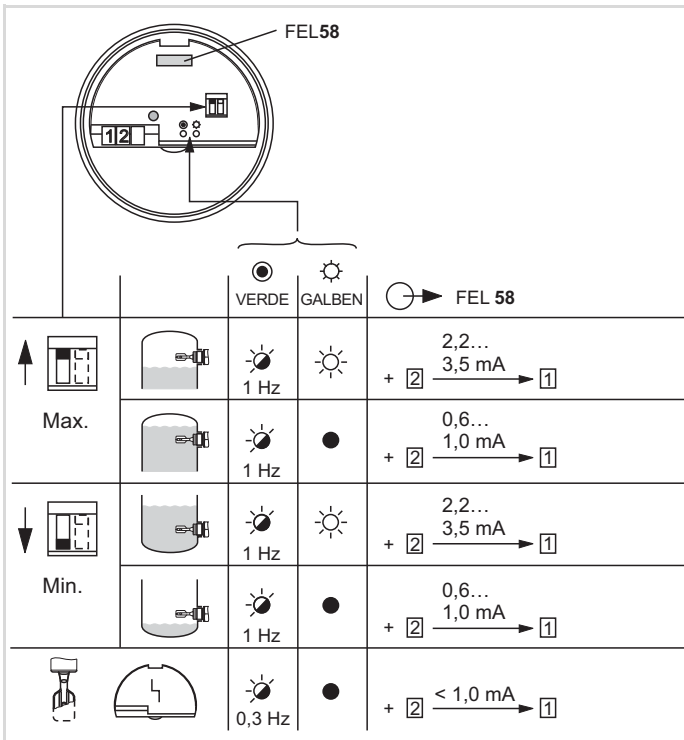

RO- Buton test de funcționare FEL58
Mod protecție intrinsecă MAX

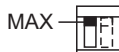
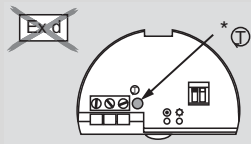

1. Funcționare normală



VERDE GALBEN



1 Hz

+ 2.2...
3.5 mA → 1

VERDE GALBEN



1 Hz

+ 0.6...
1.0 mA → 1

2. Apăsați butonul de testare



VERDE GALBEN



+ 0 mA → 1

VERDE GALBEN



+ 0 mA → 1

3. Eliberați butonul de testare după ~2 secunde de funcționare normală



VERDE GALBEN



1 Hz

+ 2.2...
3.5 mA → 1

















VERDE GALBEN



1 Hz

+ 0.6...
1.0 mA → 1

RO- Buton test de funcționare FEL58
Mod protecție intrinsecă MIN

<p>MIN </p>		
<p>1. Funcționare normală</p>	<p>VERDE GALBEN</p> <p> </p> <p>1 Hz</p> <p>+ 2,2... 2 3,5 mA → 1</p>	<p>VERDE GALBEN</p> <p> </p> <p>1 Hz</p> <p>+ 0,6... 2 1,0 mA → 1</p>
<p>2. Apăsați butonul de testare</p> <p>>3 s </p>	<p>VERDE GALBEN</p> <p> </p> <p>+ 0 mA 2 -----> 1</p>	<p>VERDE GALBEN</p> <p> </p> <p>+ 0 mA 2 -----> 1</p>
<p>3. Eliberați butonul de testare după ~2 secunde de funcționare normală</p> <p></p>	<p>VERDE GALBEN</p> <p> </p> <p>1 Hz</p> <p>+ 2,2... 2 3,5 mA → 1</p>	<p>VERDE GALBEN</p> <p> </p> <p>1 Hz</p> <p>+ 0,6... 2 1,0 mA → 1</p>

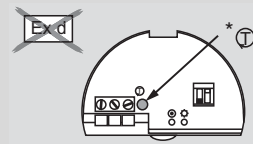

RO- Întreținerea, curățarea

Eliminare încrustare groasă

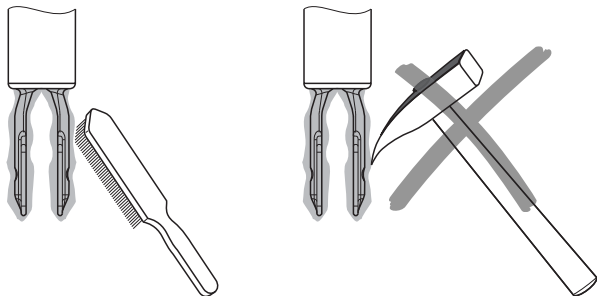

**Nu utilizați pe
post de treaptă!**

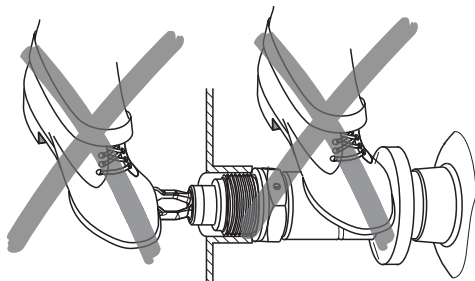

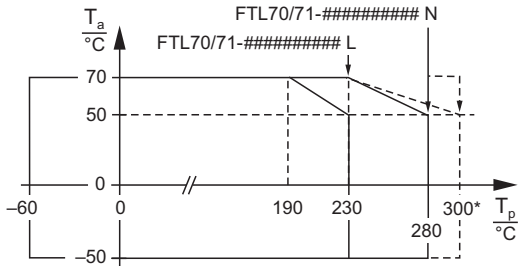
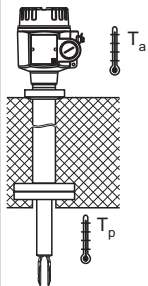
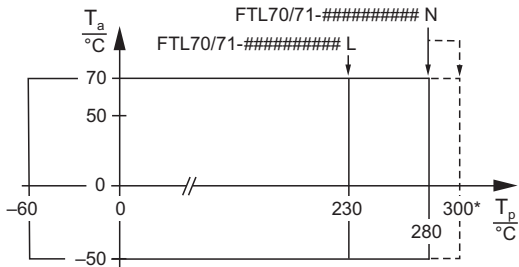
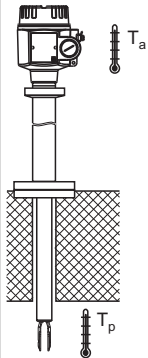

RO- Date tehnice

Temperatură ambiantă T_a

Temperatură de proces T_p

max. 50 h
acumulată

$x^{\circ}\text{C} = (1,8x + 32)^{\circ}\text{F}$

Presiune de proces $* p_e$ }  Conexiune de proces/Accesorii

$p_e = \text{max. } 100 \text{ bar (1450 psi) } *$

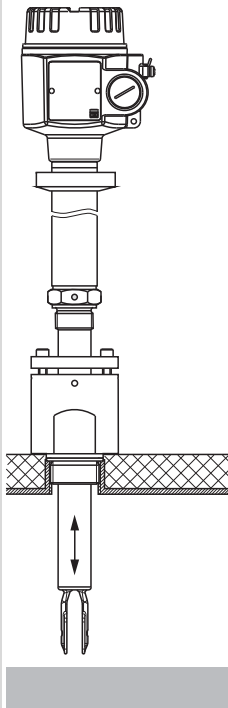

G 1

1.4435 (AISI 316L)
52003663

AlloyC4: 52003664
AlloyC22: 71118691

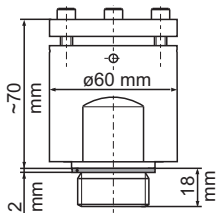

NPT 1 - 11½

1.4435 (AISI 316L)
52003667

AlloyC4: 52003668
AlloyC22: 71118694

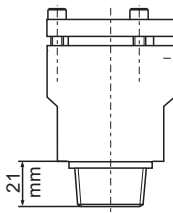

G 1½

1.4435 (AISI 316L)
52003665

AlloyC4: 52003666
AlloyC22: 71118693

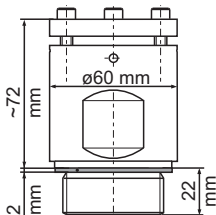

NPT 1½ - 11½

1.4435 (AISI 316L)
52003669

AlloyC4: 52003670
AlloyC22: 71118695

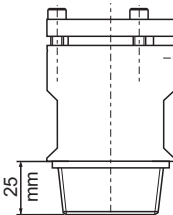

RO- Accesorii

Manșoane culisante presiune
înaltă

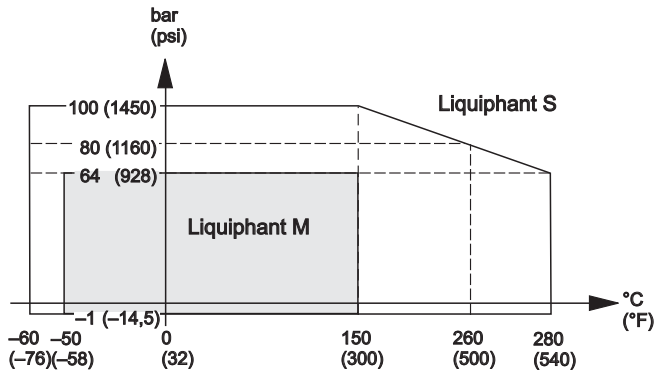

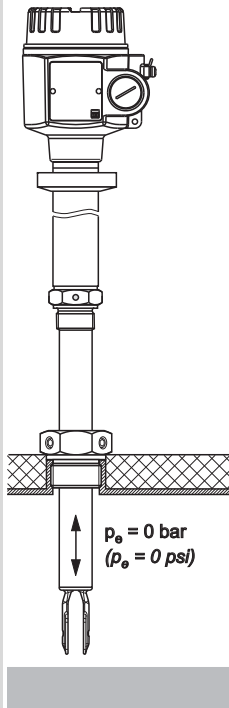

G 1
52003978

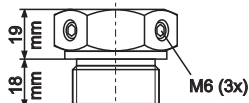

NPT 1 - 11½
52003979

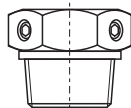

G 1½
52003980

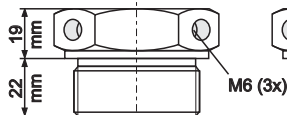

NPT 1½ - 11½
52003981

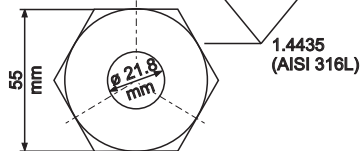
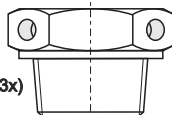

RO- Manșoane culisante
pentru funcționare
depresurizată

consultați:
KA00151F (G 1, NPT 1)
KA00152F (G 1½, NPT 1½)

100 mm = 3,94 in

Defecțiune	Cauză	Remediere
Nu comută	Fără alimentare cu energie electrică	Verificați alimentarea cu energia electrică
	Linie de semnal defectuoasă	Verificați linia de semnal
	Inserție electronică defectă - FEL51 conectat direct la L1 și N	Schimb - conectați întotdeauna FEL51 printr-o sarcină externă
	Densitate prea scăzută a lichidului	Setați densitatea la $> 0,5$ la inserția electronică
	Furcă acoperită de cruste	Curățați furca
	Furcă corodată (Indicația de pe FEL: se aprinde intermitent în roșu/galben, FEL58: se aprinde intermitent în verde 0,3 Hz)	Schimbați furca și conexiunea de proces
	FEL51: Rezistența internă a releului conectat este prea mare	Releu adecvat conectat
	FEL51: Curentul de menținere al releului conectat este prea scăzut	Rezistor conectat în paralel cu releul
	FEL54: Contacte sudate împreună (după scurtcircuit)	Schimbați FEL54; introduceți siguranța în circuitul de contact
Comut incorect	Mod protecție intrinsecă min./max. setat greșit	Setați modul corect la inserția electronică
Comutare defec- tuoasă sporadică	Spumă densă și grea, condiții foarte turbulente, lichid spumant	Montare Liquiphant în bypass
	RFI extrem	Utilizați un cablu ecranat
	Vibrații extreme	Decuplați, umeziți, răsuciți furca la 90°
	Apă în carcasă	Înfiletați ferm capacul și presgarnitura cablului
	FEL52: Ieșire supraîncărcată	Reduceți a încărca, capacitanța (cablului)
Comută incorect după căderea de tensiune	FEL57, comportament în timpul testării de pornire (testare funcțională)	Urmăriți comportamentul de comutare al FEL57; după căderea de tensiune, blocați sistemul de comandă a instalației timp de 45 de secunde

RO- Supliment privind depanarea

Dacă comportamentul de comutare al furcii este anormal, frecvența furcii poate fi măsurată la pinul 4 al prizei de diagnoză.

Cu inserțiile electronice FEL51/52/54/55/56/57/58

aceasta este o vibrație sinusoidală a cărei amplitudine permite determinarea stării furcii.

Cu FEL50A, este posibilă numai măsurarea frecvenței furcii datorită semnalului cu impulsuri dreptunghiulare.

RO- Piesele de schimb

Insertii electronice



FEL51	52002304
FEL52	52002305
FEL54	52002306
FEL55	52002307
FEL56	52002308
FEL57	52002309
FEL58	52006454
FEL50A	52010527

Specificație privind instalarea: În timpul instalării, țineți cont de faptul că resursele electrice (insertiile electronice) care sunt alimentate de circuite fără protecție intrinsecă nu mai pot fi interconectate cu circuite cu protecție intrinsecă.

RO- Repararea la Endress+Hauser

1.

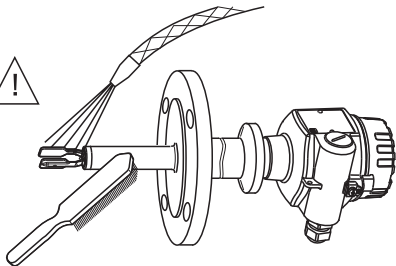

curățare

2.

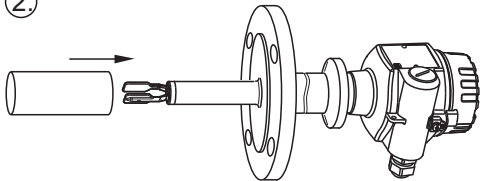

Protecția în
timpul
transportului

3.

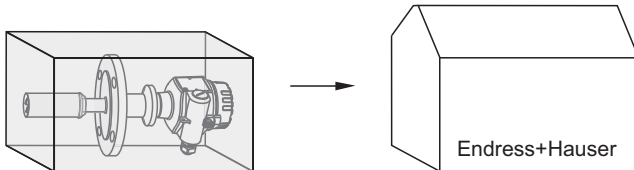

Endress+Hauser

Informații tehnice

TI00354F Liquiphant FTL70, FTL71
 TI00426F Adaptor sudat, nivel și presiune

Instrucțiuni de operare

BA00141F FEL50A, PROFIBUS PA

Informații privind siguranța

XA00031F	CE Ex	II 1/2 G,	Ex d	IIC/IIB
XA00063F	CE Ex	II 1/2 G, II 1/2 D,	Ex ia/ib	IIC/IIB
XA00064F	CE Ex	II 1 G,	Ex ia	IIC/IIB
XA00108F	CE Ex	II 1/2 G,	Ex de	IIC/IIB
XA00113F	CE Ex	II 1/2 G,	Ex ia/ib	IIC
XA00114F	CE Ex	II 1/2 G,	Ex d	IIC
XA00115F	CE Ex	II 1/2 G,	Ex de	IIC
XA00154F	CE Ex	II 1/2 G, II 1/2 D,	Ex ia/ib	IIC/IIB
XA00158F	CE Ex	II 1/2 G,	Ex ia/ib	IIC
XA00159F	CE Ex	II 1 G,	Ex ia	IIC/IIB
XA00182F	CE Ex	II 3 G, II 3 D,	Ex nA/nC	IIC/IIIC



71482867

www.endress.com/worldwide
