

Safety Instructions

Micropilot

FMR60, FMR62, FMR67

4-20 mA HART

Ex ia IIC T6...T1 Ga

Ex ia IIC T6...T1 Ga/Gb

Document: XA01631F-B

Safety instructions for electrical apparatus for explosion-hazardous areas →  3

Document: XA01631F-B

Temperature tables →  13



Micropilot FMR60, FMR62, FMR67

4-20 mA HART

Table of contents

Associated documentation	4
Supplementary documentation	4
Manufacturer's certificates	4
Manufacturer address	4
Extended order code	4
Safety instructions: General	7
Safety instructions: Special conditions	8
Safety instructions: Installation	9
Safety instructions: Zone 0	10
Temperature tables	10
Connection data	10

Associated documentation	<p>This document is an integral part of the following Operating Instructions:</p> <ul style="list-style-type: none"> ■ BA01618F/00 (FMR60) ■ BA01619F/00 (FMR62) ■ BA01620F/00 (FMR67) 										
Supplementary documentation	<p>Special Documentation for cable gland M20 Ex d: SD02550F/00</p> <p>Explosion-protection brochure: CP00021Z/11</p> <p>The Explosion-protection brochure is available:</p> <ul style="list-style-type: none"> ■ In the download area of the Endress+Hauser website: www.endress.com -> Downloads -> Brochures and Catalogs -> Text Search: CP00021Z ■ On the CD for devices with CD-based documentation 										
Manufacturer's certificates	<p>Certificate of Conformity</p> <p>Certificate number: CML 18JPN1094X</p> <p>Affixing the certificate number certifies conformity with the following standards (depending on the device version):</p> <ul style="list-style-type: none"> ■ JNIO SH-TR-46-1 : 2015 ■ JNIO SH-TR-46-6 : 2015 ■ IEC 60079-26 : 2014 										
Manufacturer address	<p>Endress+Hauser SE+Co. KG Hauptstraße 1 79689 Maulburg, Germany Address of the manufacturing plant: See nameplate.</p>										
Extended order code	<p>The extended order code is indicated on the nameplate, which is affixed to the device in such a way that it is clearly visible. Additional information about the nameplate is provided in the associated Operating Instructions.</p> <p>Structure of the extended order code</p> <table border="0" style="margin-left: 40px;"> <tr> <td style="text-align: center;">FMR6x</td> <td style="text-align: center;">-</td> <td style="text-align: center;">*****</td> <td style="text-align: center;">+</td> <td style="text-align: center;">A*B*C*D*E*F*G*..</td> </tr> <tr> <td style="text-align: center;"><i>(Device type)</i></td> <td></td> <td style="text-align: center;"><i>(Basic specifications)</i></td> <td></td> <td style="text-align: center;"><i>(Optional specifications)</i></td> </tr> </table> <p>* = Placeholder At this position, an option (number or letter) selected from the specification is displayed instead of the placeholders.</p> <p><i>Basic specifications</i></p> <p>The features that are absolutely essential for the device (mandatory features) are specified in the basic specifications. The number of positions depends on the number of features available. The selected option of a feature can consist of several positions.</p> <p><i>Optional specifications</i></p> <p>The optional specifications describe additional features for the device (optional features). The number of positions depends on the number of features available. The features have a 2-digit structure to aid identification (e.g. JA). The first digit (ID) stands for the feature group and consists of a number or a letter (e.g. J = Test, Certificate). The second digit constitutes the value that stands for the feature within the group (e.g. A = 3.1 material (wetted parts), inspection certificate).</p>	FMR6x	-	*****	+	A*B*C*D*E*F*G*..	<i>(Device type)</i>		<i>(Basic specifications)</i>		<i>(Optional specifications)</i>
FMR6x	-	*****	+	A*B*C*D*E*F*G*..							
<i>(Device type)</i>		<i>(Basic specifications)</i>		<i>(Optional specifications)</i>							

More detailed information about the device is provided in the following tables. These tables describe the individual positions and IDs in the extended order code which are relevant to hazardous locations.

Extended order code: Micropilot



The following specifications reproduce an extract from the product structure and are used to assign:

- This documentation to the device (using the extended order code on the nameplate).
- The device options cited in the document.

Device type

FMR60, FMR62, FMR67

Basic specifications

Position 1, 2 (Approval)		
Selected option		Description
FMR6x	JA	JPN Ex ia IIC T6...T1 Ga
	JB	JPN Ex ia IIC T6...T1 Ga/Gb

Position 3 (Power Supply; Output)		
Selected option		Description
FMR6x	A	2-wire, 4-20 mA HART
	B	2-wire, 4-20 mA HART, switch output (PFS)
	C	2-wire, 4-20 mA HART, 4...20 mA

Position 4 (Display; Operation)		
Selected option		Description
FMR6x	A	Without, via communication
	C	SD02, 4-line, push buttons + data backup function
	E	SD03, 4-line, illum., touch control + data backup function
	L ¹⁾	Prepared for display FHX50 + M12 connection
	M ¹⁾	Prepared for display FHX50 + custom connection
	N ²⁾	Prepared for display FHX50 + NPT1/2"

- 1) In connection with Position 5 (Housing) = A: Observe the specifications in the "Overvoltage protection" and "Temperature tables" chapters!
- 2) Only in connection with Position 5 (Housing) = B, C

Position 5 (Housing)		
Selected option		Description
FMR6x	A	GT19 dual compartment, plastic PBT
	C	GT20 dual compartment, Alu, coated
FMR62 FMR67	B	GT18 dual compartment, 316L

Position 7, 8 (Antenna)		
Selected option		Description
FMR60	GA	Drip-off, PTFE DN50
FMR62	GE	Integrated, PEEK, 3/4"
	GF	Integrated, PEEK, 1-1/2"
	GM	PTFE cladded flush mount DN50
	GN	PTFE cladded flush mount DN80
FMR67	GA	Drip-off, PTFE DN50
	GP	PTFE flush mount DN80

Position 9, 10 (Seal)		
Selected option		Description
FMR60	A3	FKM Viton GLT, -40...80°C/-40...176°F
	A4	FKM Viton GLT, -40...130°C/-40...266°F
	C1	FFKM Kalrez, -20...150°C/-4...302°F
	B4	EPDM, -40...150°C/-40...302°F
FMR62	A5	FKM Viton GLT, -40...150°C/-40...302°F
	A6	FKM Viton GLT, -40...200°C/-40...392°F
	C1	FFKM Kalrez, -20...150°C/-4...302°F
	C2	FFKM Kalrez, -20...200°C/-4...392°F
	F5	PTFE cladded, -40...150°C/-40...302°F
	F6	PTFE cladded, -40...200°C/-40...392°F
FMR67	A3	FKM Viton GLT, -40...80°C/-40...176°F
	A5	FKM Viton GLT, -40...150°C/-40...302°F
	A6	FKM Viton GLT, -40...200°C/-40...392°F

Position 11-13 (Process Connection)		
Selected option		Description
FMR60	GGJ	Thread ISO228 G1-1/2, 316L
	RGJ	Thread ANSI MNPT1-1/2, 316L
	XxG	Flange (different sizes), PP
	XxJ	Flange (different sizes), 316L
FMR62	AxK	Flange (different sizes), PTFE>316/316L
	CxK	Flange (different sizes), PTFE>316L
	GxJ	Thread ISO (different sizes), 316L
	KxK	Flange (different sizes), PTFE>316L
	MxK	Slotted-nut (different sizes), PTFE>316L
	RxJ	Thread ANSI (different sizes), 316L
	TxK	Tri-Clamp (different sizes), PTFE>316L

Position 11-13 (Process Connection)		
Selected option		Description
FMR67	AxJ	Flange (different sizes), 316/316L
	CxJ	Flange (different sizes), 316L
	GGJ	Thread ISO228 G1-1/2, 316L
	KxJ	Flange (different sizes), 316L
	RGJ	Thread ANSI MNPT1-1/2, 316L
	XxA	Align. device (different sizes)
	XxG	Flange (different sizes), PP
	XxJ	Flange (different sizes), 316L

Position 14 (Air Purge Connection)		
Selected option		Description
FMR67	A ¹⁾	W/o
	1 ²⁾	G1/4
	2 ²⁾	NPT1/4
	3 ¹⁾	Adapter G1/4
	4 ¹⁾	Adapter NPT1/4

- 1) Only in connection with Position 7, 8 (Antenna) = GA
 2) Only in connection with Position 7, 8 (Antenna) = GP

Optional specifications

ID Nx (Accessory Mounted)		
Selected option		Description
FMR6x	NA	Overvoltage protection
	NF ¹⁾	Bluetooth

- 1) Only in connection with Position 4 (Display, Operation) = C, E

Safety instructions: General

- Staff must meet the following conditions for mounting, electrical installation, commissioning and maintenance of the device:
 - Be suitably qualified for their role and the tasks they perform
 - Be trained in explosion protection
 - Be familiar with national regulations
- Install the device according to the manufacturer's instructions and national regulations.
- Do not operate the device outside the specified electrical, thermal and mechanical parameters.
- Only use the device in media to which the wetted materials have sufficient durability.
- Avoid electrostatic charging:
 - Of plastic surfaces (e.g. housing, sensor element, special varnishing, attached additional plates, ..)
 - Of isolated capacities (e.g. isolated metallic plates)
- Modifications to the device can affect the explosion protection and must be carried out by staff authorized to perform such work by Endress+Hauser.
- Refer to the temperature tables for the relationship between the permitted ambient temperature for the sensor and/or transmitter, depending on the range of application and the temperature class.

**Safety instructions:
Special conditions**

Permitted ambient temperature range at the electronics housing:
 $-40\text{ °C} \leq T_a \leq +80\text{ °C}$

- Observe the information in the temperature tables.
- In the case of process connections made of polymeric material or with polymeric coatings, avoid electrostatic charging of the plastic surfaces.
- To avoid electrostatic charging: Do not rub surfaces with a dry cloth.
- In the event of additional or alternative special varnishing on the housing or other metal parts or for adhesive plates:
 - Observe the danger of electrostatic charging and discharge.
 - Do not install in the vicinity of processes ($\leq 0.5\text{ m}$) generating strong electrostatic charges.
- Avoid electrostatic charging of the sensor (e.g. do not rub dry and install outside the filling flow).

Basic specification, Position 5 (Housing) = A

Avoid electrostatic charging of the housing (e.g. friction, cleaning, maintenance, strong medium flow).

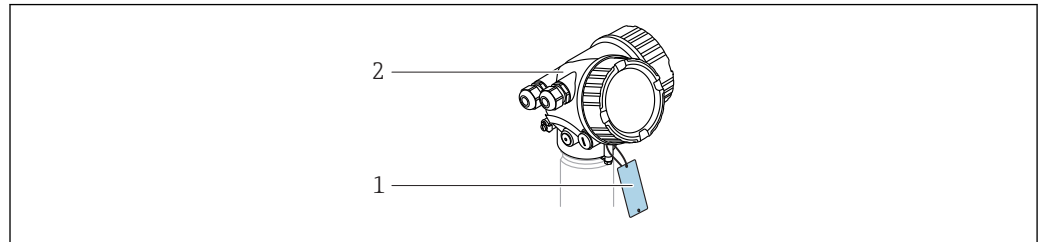

A0032146

1

- 1 *Isolated capacitance:*
 with one metal plate: $\leq 3\text{ pF}$ (permitted in all areas for Equipment Groups II and III)
 with two to three metal plates: $\leq 10\text{ pF}$ (not permitted in Zone 0 and for Equipment Group IIC)
- 2 *Housing*

Basic specification, Position 5 (Housing) = C

In Zone 0, avoid sparks caused by impact and friction.

Device type FMR67 and Basic specification, Position 11-13 (Process Connection) = XxA

- In Zone 0, avoid sparks caused by impact and friction.
- Changing the position of the alignment device must be impossible:
 - After the alignment of the antenna via the pivot bracket
 - After tightening of the clamping flange
 - After setting the damping ring (torque 10 to 11 Nm)
- Degree of protection IP67 must be fulfilled.

Device type FMR67 and Basic specification, Position 14 (Air Purge Connection) = 1, 2

- If equipment with Ga/Gb or Da/Db is required: In the closed state the minimum degree of protection of the installation must be IP67.
- After removing the air purge connection: Lock the opening with a suitable plug.
 - Torque: 6-7 Nm
 - For Da/Db: thread engagement > 5 turns
- Degree of protection IP67 must be fulfilled.

Safety instructions: Installation

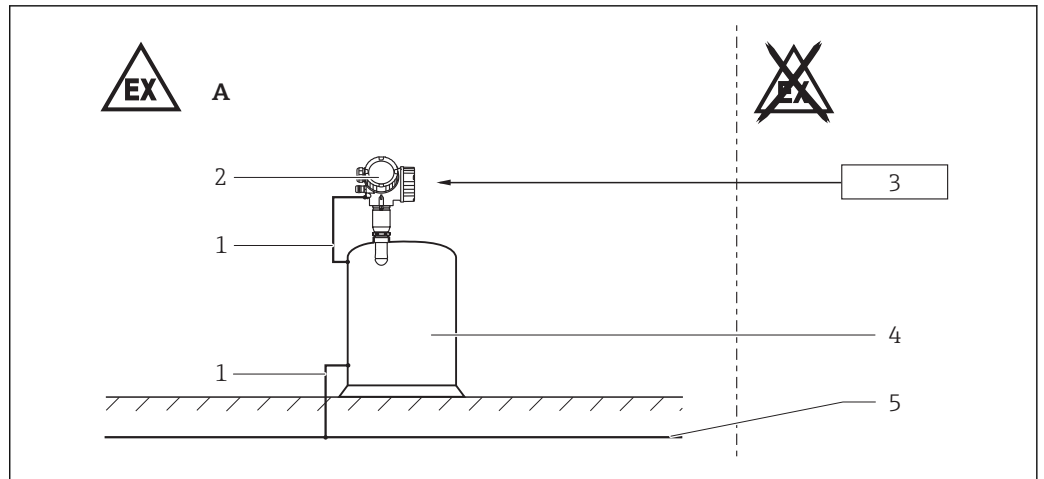

2

- A Zone 0, Zone 1
 1 Potential equalization line
 2 Electronic insert
 3 Certified associated apparatus
 4 Tank; Zone 0, Zone 1
 5 Potential equalization

- After aligning (rotating) the housing, retighten the fixing screw (see Operating Instructions).
- Install the device to exclude any mechanical damage or friction during the application. Pay particular attention to flow conditions and tank fittings.
- Continuous service temperature of the connecting cable: -40 °C to $\geq +85\text{ °C}$; in accordance with the range of service temperature taking into account additional influences of the process conditions ($T_{a,\min}$), ($T_{a,\max} + 20\text{ K}$).

Basic specification, Position 4 (Display, Operation) = N

Observe the requirements according to IEC/EN 60079-14 for conduit systems and the wiring- and installation instructions of the suitable Safety Instructions (XA). In addition, observe national regulations and standards for conduit systems.

Intrinsic safety

- The device is only suitable for connection to certified, intrinsically safe equipment with explosion protection Ex ia / Ex ib.
- The intrinsically safe input power circuit of the device is isolated from ground. If the device is only equipped with one input, the dielectric strength of the input is at least $500\text{ V}_{\text{rms}}$. If the device is equipped with more than one input, the dielectric strength of each individual input to ground is at least $500\text{ V}_{\text{rms}}$, and the dielectric strength of the inputs vis-à-vis one another is also at least $500\text{ V}_{\text{rms}}$.
- Observe the pertinent guidelines when interconnecting intrinsically safe circuits.
- The device can be connected to the Endress+Hauser FXA291 service tool: refer to the Operating Instructions and specifications in the "Overvoltage protection" chapter.
- The device can be equipped with the Bluetooth® module: refer to the Operating Instructions and specifications in the "Bluetooth® module" chapter.

Basic specification, Position 3 (Power Supply, Output) = A

When the device is connected to certified intrinsically safe circuits of Category Ex ib for Equipment Groups IIC and IIB, the type of protection changes to Ex ib IIC and Ex ib IIB. Do not operate the antenna in Zone 0 if connecting to an intrinsically safe circuit of Category Ex ib.

Basic specification, Position 3 (Power Supply, Output) = B, C

When the intrinsically safe Ex ia circuits of the device are connected to certified intrinsically safe circuits of Category Ex ib for Equipment Groups IIC or IIB, the type of protection changes to Ex ib [ia] IIC or Ex ib [ia] IIB. Regardless of the power supply, all the internal circuits correspond to Ex ia IIC type of protection (e.g. service interface, external display, sensor).

Potential equalization

Integrate the device into the local potential equalization.

Overvoltage protection

- If an overvoltage protection against atmospheric over voltages is required: no other circuits may leave the housing during normal operation without additional measures.
- For installations which require overvoltage protection to comply with national regulations or standards, install the device using overvoltage protection (e.g. HAW56x from Endress+Hauser).
- Observe the safety instructions of the overvoltage protection.

*Optional specification, ID Nx (Accessory Mounted) = NA
(Overvoltage protection Type OVP10 and Type OVP20)*

The intrinsically safe input power circuit of the device is isolated from ground. If the device is only equipped with one input, the dielectric strength of the input is at least $290 V_{\text{rms}}$. If the device is equipped with more than one input, the dielectric strength of each individual input to ground is at least $290 V_{\text{rms}}$, and the dielectric strength of the inputs vis-à-vis one another is also at least $290 V_{\text{rms}}$.

Bluetooth® module

Optional specification, ID Nx (Accessory Mounted) = NF

- With Bluetooth® module installed: Use of external hardware not allowed (e.g. external display, service interface).
- The intrinsically safe input power circuit of the Bluetooth® module is isolated from ground.

Safety instructions: Zone 0

- In the event of potentially explosive vapor/air mixtures, only operate the device under atmospheric conditions.
 - Temperature: -20 to $+60$ °C
 - Pressure: 80 to 110 kPa (0.8 to 1.1 bar)
 - Air with normal oxygen content, usually 21 % (V/V)
- If no potentially explosive mixtures are present, or if additional protective measures have been taken, the device may also be operated under non-atmospheric conditions in accordance with the manufacturer's specifications.
- Associated devices with galvanic isolation between the intrinsically safe and non-intrinsically safe circuits are preferred.
- Only use the device in media to which the silicone rubber potting compound of the electronic insert and the housing made of PBT, aluminum or 316L have sufficient durability.
- If there is a risk of dangerous potential differences within Zone 0 (e.g. through the occurrence of atmospheric electricity), implement suitable measures for intrinsically safe circuits in Zone 0.

Temperature tables

→  14

Connection data

*Optional specification, ID Nx (Accessory Mounted) = NA
(Overvoltage protection Type OVP10 and Type OVP20)*

When using the internal overvoltage protection: No changes to the connection values.

Optional specification, ID Nx (Accessory Mounted) = NF

When using the Bluetooth® module: No changes to the connection values.

Ex ia

Power supply and signal circuit with protection type: intrinsic safety Ex ia IIC, Ex ia IIB.

Basic specification, Position 3 (Power Supply, Output) = A

Terminal 1 (+), 2 (-)
Power supply
$U_i = 30$ V
$I_i = 300$ mA
$P_i = 1$ W
effective inner inductance $L_i = 0$
effective inner capacitance $C_i = 12$ nF

Basic specification, Position 3 (Power Supply, Output) = B

Terminal 1 (+), 2 (-)	Terminal 3 (+), 4 (-)
Power supply $U_i = 30\text{ V}$ $I_i = 300\text{ mA}$ $P_i = 1\text{ W}$ effective inner inductance $L_i = 0$ effective inner capacitance $C_i = 5\text{ nF}$	Switch output (PFS) $U_i = 30\text{ V}$ $I_i = 300\text{ mA}$ $P_i = 1\text{ W}$ effective inner inductance $L_i = 0$ effective inner capacitance $C_i = 6\text{ nF}$

Basic specification, Position 3 (Power Supply, Output) = C

Terminal 1 (+), 2 (-)	Terminal 3 (+), 4 (-)
Power supply $U_i = 30\text{ V}$ $I_i = 300\text{ mA}$ $P_i = 1\text{ W}$ effective inner inductance $L_i = 0$ effective inner capacitance $C_i = 30\text{ nF}$	Output 4 to 20 mA $U_i = 30\text{ V}$ $I_i = 300\text{ mA}$ $P_i = 1\text{ W}$ effective inner inductance $L_i = 0$ effective inner capacitance $C_i = 30\text{ nF}$

Service interface (CDI)

Taking the following values into consideration, the device can be connected to the certified Endress+Hauser FXA291 service tool or a similar interface:

Service interface														
$U_i = 7.3\text{ V}$ effective inner inductance $L_i = \text{negligible}$ effective inner capacitance $C_i = \text{negligible}$														
$U_o = 7.3\text{ V}$ $I_o = 60\text{ mA}$ $P_o = 110\text{ mW}$														
$L_o\text{ (mH)} =$	5.00	2.00	1.00	0.50	0.20	0.15	0.10	0.05	0.02	0.01	0.005	0.002	0.001	
$C_o\text{ (}\mu\text{F)}^{1) =}$	0.73	1.20	1.60	2.00	2.60	-	3.20	4.00	5.50	7.30	10.00	12.70	12.70	
$C_o\text{ (}\mu\text{F)}^{2) =}$	-	0.49	0.90	1.40	-	2.00	-	-	-	-	-	-	-	

- 1) Values according to PTB "ispark" program
- 2) Values according to IEC/EN 60079-25, Annex C



Micropilot FMR60, FMR62, FMR67

4-20 mA HART

Table of contents

Notes on the structure	14
Example diagrams of possible deratings	16
Zone 0	17
Zone 0, Zone 1	18
Zone 1	19

Notes on the structure

Extract from the extended order code

Device type

FMR60, FMR62, FMR67

Basic specifications

Position 1, 2 (Approval)		
Selected option		Description
FMR6x	JA	JPN Ex ia IIC T6...T1 Ga
	JB	JPN Ex ia IIC T6...T1 Ga/Gb

Position 5 (Housing)		
Selected option		Description
FMR6x	A	GT19 dual compartment, plastic PBT
	C	GT20 dual compartment, Alu, coated
FMR62 FMR67	B	GT18 dual compartment, 316L

Position 7, 8 (Antenna)		
Selected option		Description
FMR60	GA	Drip-off, PTFE DN50
FMR62	GE	Integrated, PEEK, 3/4"
	GF	Integrated, PEEK, 1-1/2"
	GM	PTFE cladded flush mount DN50
	GN	PTFE cladded flush mount DN80
FMR67	GA	Drip-off, PTFE DN50
	GP	PTFE flush mount DN80

 Shown in the temperature tables exemplary as follows:

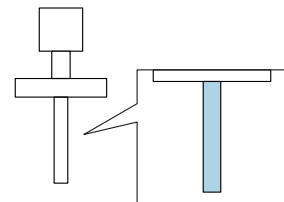

Position 9, 10 (Seal)		
Selected option		Description
FMR60	A3	FKM Viton GLT, -40...80°C/-40...176°F
	A4	FKM Viton GLT, -40...130°C/-40...266°F
	C1	FFKM Kalrez, -20...150°C/-4...302°F
	B4	EPDM, -40...150°C/-40...302°F

Position 9, 10 (Seal)		
Selected option		Description
FMR62	A5	FKM Viton GLT, -40...150°C/-40...302°F
	A6	FKM Viton GLT, -40...200°C/-40...392°F
	C1	FFKM Kalrez, -20...150°C/-4...302°F
	C2	FFKM Kalrez, -20...200°C/-4...392°F
	F5	PTFE cladded, -40...150°C/-40...302°F
	F6	PTFE cladded, -40...200°C/-40...392°F
FMR67	A3	FKM Viton GLT, -40...80°C/-40...176°F
	A5	FKM Viton GLT, -40...150°C/-40...302°F
	A6	FKM Viton GLT, -40...200°C/-40...392°F

i Shown in the temperature tables exemplary as follows:

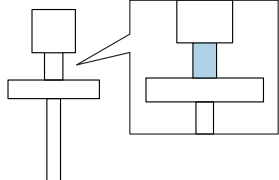

General notes

- i** *Optional specification, ID Nx, Ox (Accessory Mounted) = NA (Overvoltage protection Type OVP10 and Type OVP20)*
When using the internal overvoltage protection: Reduce the admissible ambient temperature at the housing by 2 K.
Basic specification, Position 5 (Housing) = A
When using the remote display FHX50: Reduce the admissible ambient temperature at the housing by 3 K.
- i** Observe the permitted temperature range at the antenna.

Description notes

- i** Unless otherwise indicated, the positions always refer to the basic specification.
1st column: Position 5 (Housing) = A, B, ...
2nd column: Temperature classes T6 (85 °C) to T1 (450 °C)
Column P1 to P5: Position (temperature value) on the axes of the derating
 - T_a: Ambient temperature in °C
 - T_p: Process temperature in °C
- i** Column P2+ is only relevant for version B of the derating.
→ 16

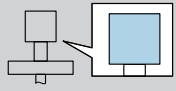
 = C		P1		P2		P2+		P3		P4		P5	
		T _p	T _a	T _p	T _a	T _p	T _a	T _p	T _a	T _p	T _a	T _p	T _a
	T6	-40	51	51	51	-	-	85	45	85	-40	-40	-40
	T5	-40	64	64	64	-	-	100	58	100	-40	-40	-40
	T4	-40	64	64	64	-	-	135	52	135	-40	-40	-40

A0031752-EN

Example diagrams
of possible deratings

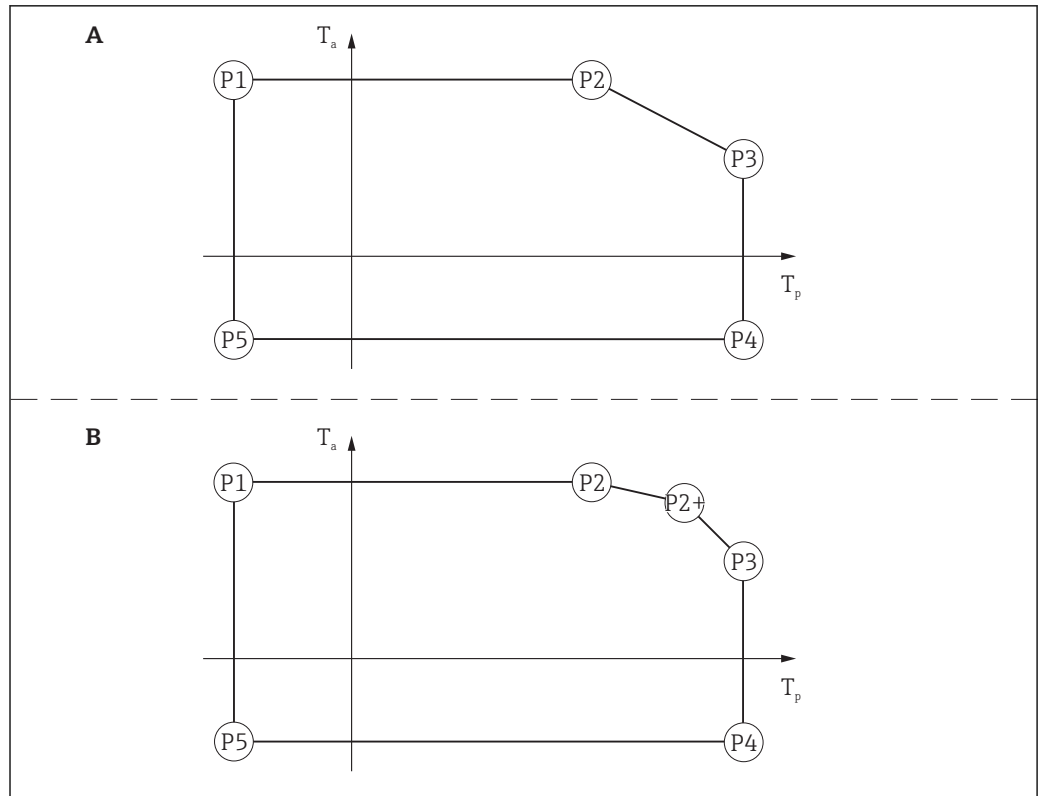

A0031943

3

Zone 0

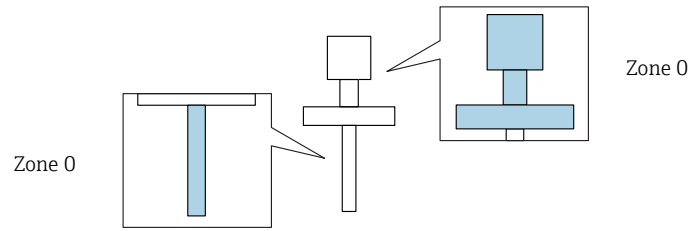

FMR6x

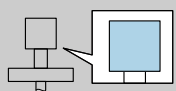
 = A		P1		P2		P2+		P3		P4		P5	
		T _p	T _a	T _p	T _a	T _p	T _a	T _p	T _a	T _p	T _a	T _p	T _a
	T6	-20	31	31	31	-	-	60	23	60	-20	-20	-20
	T5	-20	43	43	43	-	-	60	38	60	-20	-20	-20
	T4	-20	56	56	56	-	-	60	55	60	-20	-20	-20
	T3	-20	56	56	56	-	-	60	55	60	-20	-20	-20

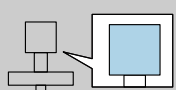
 = B, C		P1		P2		P2+		P3		P4		P5	
		T _p	T _a	T _p	T _a	T _p	T _a	T _p	T _a	T _p	T _a	T _p	T _a
	T6	-20	39	39	39	-	-	60	34	60	-20	-20	-20
	T5	-20	51	51	51	-	-	60	49	60	-20	-20	-20
	T4	-20	60	60	60	-	-	60	60	60	-20	-20	-20
	T3	-20	60	60	60	-	-	60	60	60	-20	-20	-20

Zone 0, Zone 1

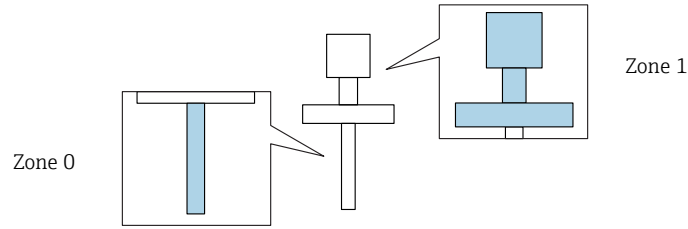

FMR6x

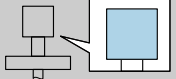
 = A		P1		P2		P2+		P3		P4		P5	
		T _p	T _a	T _p	T _a	T _p	T _a	T _p	T _a	T _p	T _a	T _p	T _a
	T6	-20	43	43	43	-	-	60	38	60	-20	-20	-20
	T5	-20	56	56	56	-	-	60	55	60	-20	-20	-20
	T4	-20	56	56	56	-	-	60	55	60	-20	-20	-20
	T3	-20	56	56	56	-	-	60	55	60	-20	-20	-20

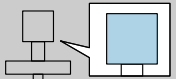
 = B, C		P1		P2		P2+		P3		P4		P5	
		T _p	T _a	T _p	T _a	T _p	T _a	T _p	T _a	T _p	T _a	T _p	T _a
	T6	-20	51	51	51	-	-	60	49	60	-20	-20	-20
	T5	-20	64	60	64	-	-	60	64	60	-20	-20	-20
	T4	-20	64	60	64	-	-	60	64	60	-20	-20	-20
	T3	-20	64	60	64	-	-	60	64	60	-20	-20	-20

Zone 1

Page references to the temperature tables of the respective device types: See the following list.

- FMR60 → 19
- FMR62 → 23
- FMR67 → 27

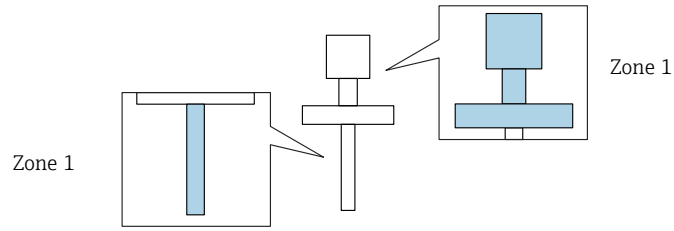

FMR60

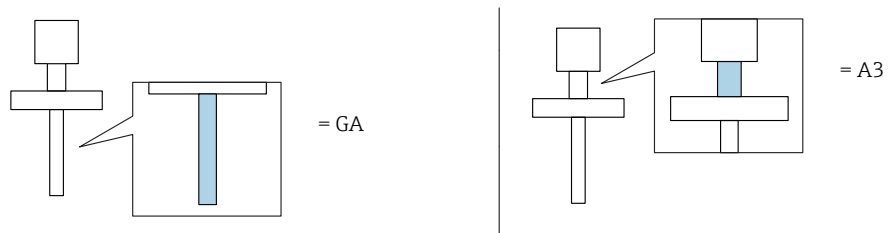

	T6	P1		P2		P2+		P3		P4		P5	
		T _p	T _a	T _p	T _a	T _p	T _a	T _p	T _a	T _p	T _a	T _p	T _a
		-40	43	43	43	-	-	80	32	80	-40	-40	-40

	T6	P1		P2		P2+		P3		P4		P5	
		T _p	T _a	T _p	T _a	T _p	T _a	T _p	T _a	T _p	T _a	T _p	T _a
		-40	51	51	51	-	-	80	47	80	-40	-40	-40

FMR60

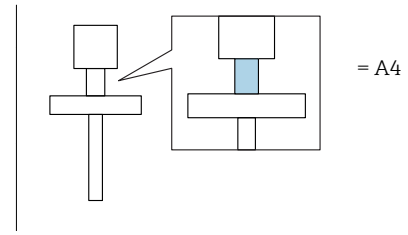
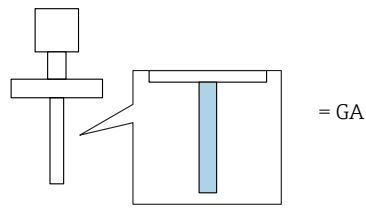

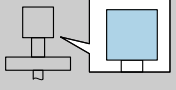
 = A		P1		P2		P2+		P3		P4		P5	
		T _p	T _a	T _p	T _a	T _p	T _a	T _p	T _a	T _p	T _a	T _p	T _a
	T6	-40	43	43	43	79	33	85	25	85	-40	-40	-40
	T5	-40	56	56	56	96	45	100	40	100	-40	-40	-40
	T4	-40	56	56	56	117	39	130	22	130	-40	-40	-40

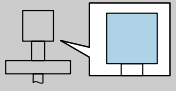
 = C		P1		P2		P2+		P3		P4		P5	
		T _p	T _a	T _p	T _a	T _p	T _a	T _p	T _a	T _p	T _a	T _p	T _a
	T6	-40	51	51	51	-	-	85	46	85	-40	-40	-40
	T5	-40	64	64	64	-	-	100	59	100	-40	-40	-40
	T4	-40	64	64	64	-	-	130	54	130	-40	-40	-40

FMR60

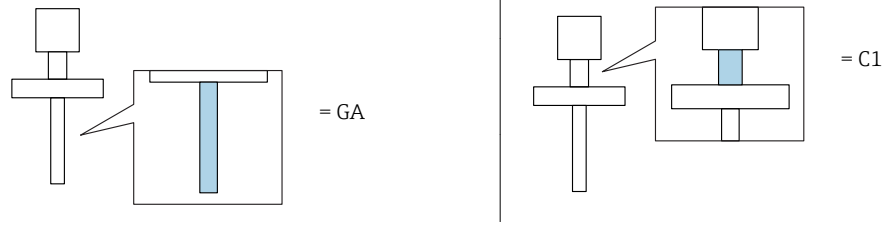

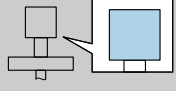
 = A		P1		P2		P2+		P3		P4		P5	
		T _p	T _a	T _p	T _a	T _p	T _a	T _p	T _a	T _p	T _a	T _p	T _a
	T6	-20	43	43	43	79	33	85	25	85	-20	-20	-20
	T5	-20	56	56	56	96	45	100	40	100	-20	-20	-20
	T4	-20	56	56	56	117	39	135	15	135	-20	-20	-20

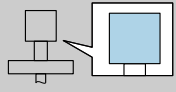
 = C		P1		P2		P2+		P3		P4		P5	
		T _p	T _a	T _p	T _a	T _p	T _a	T _p	T _a	T _p	T _a	T _p	T _a
	T6	-20	51	51	51	-	-	85	46	85	-20	-20	-20
	T5	-20	64	64	64	-	-	100	59	100	-20	-20	-20
	T4	-20	64	64	64	-	-	135	54	135	-20	-20	-20
	T3	-20	64	64	64	-	-	150	50	150	-20	-20	-20

FMR60

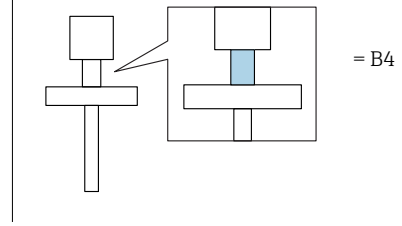
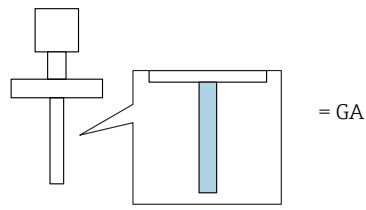

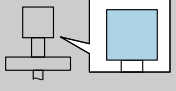
 = A		P1		P2		P2+		P3		P4		P5	
		T _p	T _a	T _p	T _a	T _p	T _a	T _p	T _a	T _p	T _a	T _p	T _a
	T6	-40	43	43	43	79	33	85	25	85	-40	-40	-40
	T5	-40	56	56	56	96	45	100	40	100	-40	-40	-40
	T4	-40	56	56	56	117	39	135	15	135	-40	-40	-40

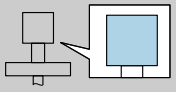
 = C		P1		P2		P2+		P3		P4		P5	
		T _p	T _a	T _p	T _a	T _p	T _a	T _p	T _a	T _p	T _a	T _p	T _a
	T6	-40	51	51	51	-	-	85	46	85	-40	-40	-40
	T5	-40	64	64	64	-	-	100	59	100	-40	-40	-40
	T4	-40	64	64	64	-	-	135	54	135	-40	-40	-40
	T3	-40	64	64	64	-	-	150	50	150	-40	-40	-40

FMR62

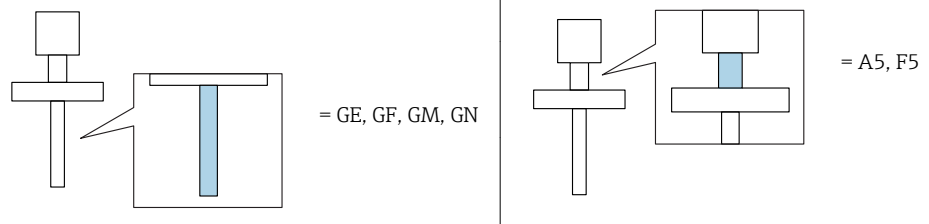

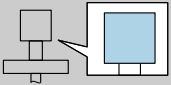
 = A		P1		P2		P2+		P3		P4		P5	
		T _p	T _a	T _p	T _a	T _p	T _a	T _p	T _a	T _p	T _a	T _p	T _a
	T6	-40	43	43	43	-	-	85	34	85	-40	-40	-40
	T5	-40	56	56	56	-	-	100	46	100	-40	-40	-40
	T4	-40	56	56	56	-	-	135	38	135	-40	-40	-40
	T3	-40	56	56	56	134	39	150	24	150	-40	-40	-40

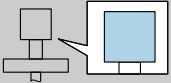
 = B		P1		P2		P2+		P3		P4		P5	
		T _p	T _a	T _p	T _a	T _p	T _a	T _p	T _a	T _p	T _a	T _p	T _a
	T6	-40	51	51	51	-	-	85	45	85	-40	-40	-40
	T5	-40	64	64	64	-	-	100	58	100	-40	-40	-40
	T4	-40	64	64	64	-	-	135	52	135	-40	-40	-40
	T3	-40	64	64	64	-	-	150	47	150	-40	-40	-40

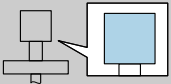
 = C		P1		P2		P2+		P3		P4		P5	
		T _p	T _a	T _p	T _a	T _p	T _a	T _p	T _a	T _p	T _a	T _p	T _a
	T6	-40	51	51	51	-	-	85	47	85	-40	-40	-40
	T5	-40	64	64	64	-	-	100	60	100	-40	-40	-40
	T4	-40	64	64	64	-	-	135	56	135	-40	-40	-40
	T3	-40	64	64	64	-	-	150	54	150	-40	-40	-40

FMR62

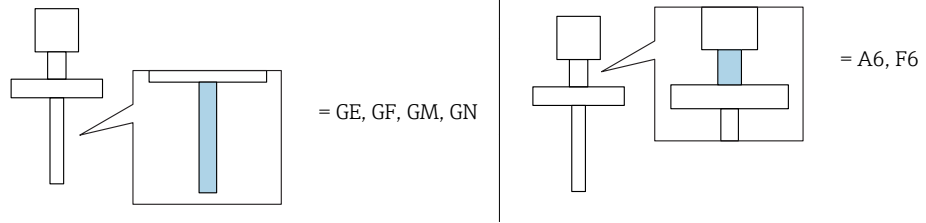

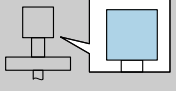
 = A		P1		P2		P2+		P3		P4		P5	
		T _p	T _a	T _p	T _a	T _p	T _a	T _p	T _a	T _p	T _a	T _p	T _a
	T6	-40	43	43	43	-	-	85	38	85	-40	-40	-40
	T5	-40	56	56	56	-	-	100	51	100	-40	-40	-40
	T4	-40	56	56	56	-	-	135	47	135	-40	-40	-40
	T3	-40	56	56	56	-	-	200	40	200	-40	-40	-40

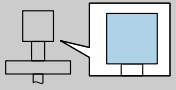
 = B, C		P1		P2		P2+		P3		P4		P5	
		T _p	T _a	T _p	T _a	T _p	T _a	T _p	T _a	T _p	T _a	T _p	T _a
	T6	-40	51	51	51	-	-	85	48	85	-40	-40	-40
	T5	-40	64	64	64	-	-	100	61	100	-40	-40	-40
	T4	-40	64	64	64	-	-	135	58	135	-40	-40	-40
	T3	-40	64	64	64	-	-	200	53	200	-40	-40	-40

FMR62

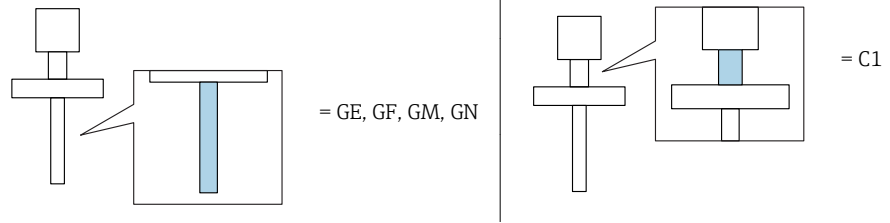

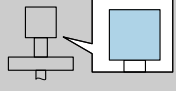
 = A		P1		P2		P2+		P3		P4		P5	
		T _p	T _a	T _p	T _a	T _p	T _a	T _p	T _a	T _p	T _a	T _p	T _a
	T6	-20	43	43	43	-	-	85	34	85	-20	-20	-20
	T5	-20	56	56	56	-	-	100	46	100	-20	-20	-20
	T4	-20	56	56	56	-	-	135	38	135	-20	-20	-20
	T3	-20	56	56	56	134	39	150	24	150	-20	-20	-20

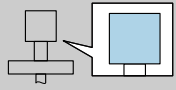
 = B		P1		P2		P2+		P3		P4		P5	
		T _p	T _a	T _p	T _a	T _p	T _a	T _p	T _a	T _p	T _a	T _p	T _a
	T6	-20	51	51	51	-	-	85	45	85	-20	-20	-20
	T5	-20	64	64	64	-	-	100	58	100	-20	-20	-20
	T4	-20	64	64	64	-	-	135	52	135	-20	-20	-20
	T3	-20	64	64	64	-	-	150	47	150	-20	-20	-20

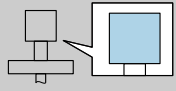
 = C		P1		P2		P2+		P3		P4		P5	
		T _p	T _a	T _p	T _a	T _p	T _a	T _p	T _a	T _p	T _a	T _p	T _a
	T6	-20	51	51	51	-	-	85	47	85	-20	-20	-20
	T5	-20	64	64	64	-	-	100	60	100	-20	-20	-20
	T4	-20	64	64	64	-	-	135	56	135	-20	-20	-20
	T3	-20	64	64	64	-	-	150	54	150	-20	-20	-20

FMR62

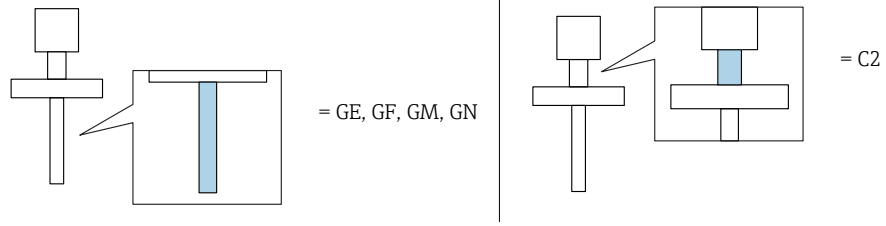

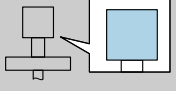
 = A		P1		P2		P2+		P3		P4		P5	
		T _p	T _a	T _p	T _a	T _p	T _a	T _p	T _a	T _p	T _a	T _p	T _a
	T6	-20	43	43	43	-	-	85	38	85	-20	-20	-20
	T5	-20	56	56	56	-	-	100	51	100	-20	-20	-20
	T4	-20	56	56	56	-	-	135	47	135	-20	-20	-20
	T3	-20	56	56	56	-	-	200	40	200	-20	-20	-20

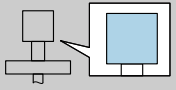
 = B, C		P1		P2		P2+		P3		P4		P5	
		T _p	T _a	T _p	T _a	T _p	T _a	T _p	T _a	T _p	T _a	T _p	T _a
	T6	-20	51	51	51	-	-	85	48	85	-20	-20	-20
	T5	-20	64	64	64	-	-	100	61	100	-20	-20	-20
	T4	-20	64	64	64	-	-	135	58	135	-20	-20	-20
	T3	-20	64	64	64	-	-	200	53	200	-20	-20	-20

FMR67

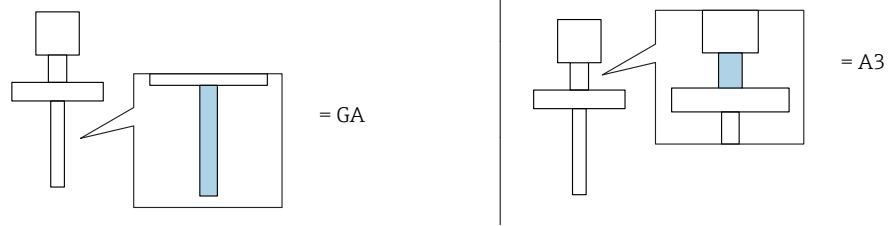

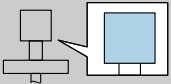
 = A	T6	P1		P2		P2+		P3		P4		P5	
		T _p	T _a	T _p	T _a	T _p	T _a	T _p	T _a	T _p	T _a	T _p	T _a
	T6	-40	43	43	43	-	-	80	32	80	-40	-40	-40

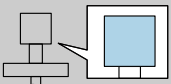
 = B	T6	P1		P2		P2+		P3		P4		P5	
		T _p	T _a	T _p	T _a	T _p	T _a	T _p	T _a	T _p	T _a	T _p	T _a
	T6	-40	51	51	51	-	-	80	43	80	-40	-40	-40

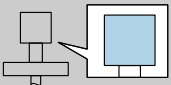
 = C	T6	P1		P2		P2+		P3		P4		P5	
		T _p	T _a	T _p	T _a	T _p	T _a	T _p	T _a	T _p	T _a	T _p	T _a
	T6	-40	51	51	51	-	-	80	47	80	-40	-40	-40

FMR67

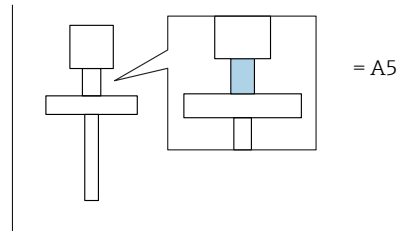
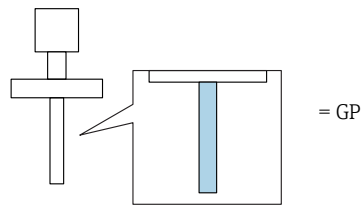

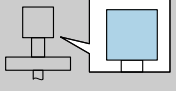
 = A		P1		P2		P2+		P3		P4		P5	
		T _p	T _a	T _p	T _a	T _p	T _a	T _p	T _a	T _p	T _a	T _p	T _a
	T6	-40	43	43	43	-	-	85	34	85	-40	-40	-40
	T5	-40	56	56	56	-	-	100	46	100	-40	-40	-40
	T4	-40	56	56	56	-	-	135	38	135	-40	-40	-40
	T3	-40	56	56	56	134	39	150	24	150	-40	-40	-40

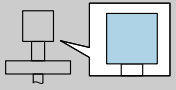
 = B		P1		P2		P2+		P3		P4		P5	
		T _p	T _a	T _p	T _a	T _p	T _a	T _p	T _a	T _p	T _a	T _p	T _a
	T6	-40	51	51	51	-	-	85	45	85	-40	-40	-40
	T5	-40	64	64	64	-	-	100	58	100	-40	-40	-40
	T4	-40	64	64	64	-	-	135	52	135	-40	-40	-40
	T3	-40	64	64	64	-	-	150	47	150	-40	-40	-40

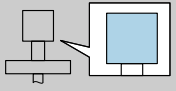
 = C		P1		P2		P2+		P3		P4		P5	
		T _p	T _a	T _p	T _a	T _p	T _a	T _p	T _a	T _p	T _a	T _p	T _a
	T6	-40	51	51	51	-	-	85	47	85	-40	-40	-40
	T5	-40	64	64	64	-	-	100	60	100	-40	-40	-40
	T4	-40	64	64	64	-	-	135	56	135	-40	-40	-40
	T3	-40	64	64	64	-	-	150	54	150	-40	-40	-40

FMR67

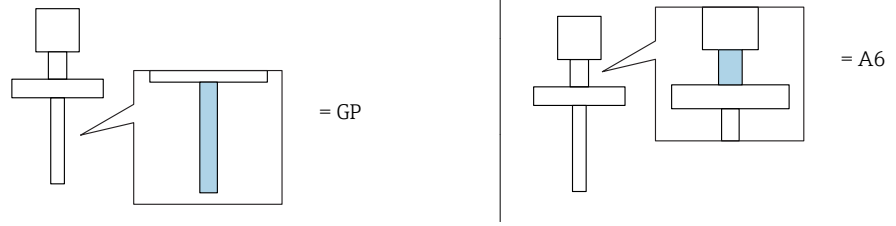

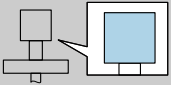
 = A		P1		P2		P2+		P3		P4		P5	
		T _p	T _a	T _p	T _a	T _p	T _a	T _p	T _a	T _p	T _a	T _p	T _a
	T6	-40	43	43	43	-	-	85	38	85	-40	-40	-40
	T5	-40	56	56	56	-	-	100	51	100	-40	-40	-40
	T4	-40	56	56	56	-	-	135	47	135	-40	-40	-40
	T3	-40	56	56	56	-	-	200	40	200	-40	-40	-40

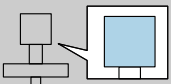
 = B, C		P1		P2		P2+		P3		P4		P5	
		T _p	T _a	T _p	T _a	T _p	T _a	T _p	T _a	T _p	T _a	T _p	T _a
	T6	-40	51	51	51	-	-	85	48	85	-40	-40	-40
	T5	-40	64	64	64	-	-	100	61	100	-40	-40	-40
	T4	-40	64	64	64	-	-	135	58	135	-40	-40	-40
	T3	-40	64	64	64	-	-	200	53	200	-40	-40	-40



71486812

www.addresses.endress.com
