

Safety Instructions

Micropilot

FMR50/51/52/53/54/56/57

PROFIBUS PA, FOUNDATION Fieldbus

ATEX: II 1 G Ex ia IIC T6...T1 Ga
II 1/2 G Ex ia IIC T6...T1 Ga/Gb
IECEX: Ex ia IIC T6...T1 Ga
Ex ia IIC T6...T1 Ga/Gb



DE Dokument: XA00685F-E
Sicherheitshinweise für elektrische Betriebsmittel für explosionsgefährdete Bereiche → 5

EN Document: XA00685F-E
Safety instructions for electrical apparatus for explosion-hazardous areas → 15

FR Document: XA00685F-E
Conseils de sécurité pour matériels électriques destinés aux zones explosibles → 25

-- Document: XA00685F-E
Temperaturtabellen / Temperature tables / Tableaux des températures → 35

- BG - Правила за техниката на безопасност за електрически средства за производство във взривоопасни зони. Ако не разбирате езика на това ръководство има възможност да си поръчате при нас едно ръководство, преведено на езика на Вашата страна.
- ЕС декларация за съответствие**
Производителят Endress+Hauser декларира с това заявление за съответствие и с предявяването на сертификата CE, че този продукт отговаря на изискванията на съответните европейски директиви. Прилаганите директиви, норми и документи са указани в заявлението за съответствие.
- CS - Bezpečnostní pokyny pro elektrické přístroje v místech s nebezpečím výbuchu. Pokud nemáte možnost přečíst si tento návod, můžete si u nás objednat návod přeložený do svého jazyka.
- EU prohlášení o shodě**
Společnost Endress+Hauser prohlašuje prostřednictvím tohoto prohlášení a použitím značky CE, že tento výrobek vyhovuje příslušným evropským směrnicím. Zmíněné směrnice, normy a dokumenty jsou uvedeny v Prohlášení o shodě.
- DA - Sikkerhedsforskrifter for elektriske apparater certificeret til brug i eksplosionsfarlige områder. Hvis du ikke forstår denne manual, kan en oversat kopi af den på dit eget sprog bestilles fra os.
- EU-overensstemmelseserklæring**
Med denne overensstemmelseserklæring og tilføjelsen af CE-mærket sikrer producenten Endress+Hauser, at produktet er i overensstemmelse med relevante europæiske direktiver. Dokumentation for overensstemmelsen gives i de anførte direktiver, standarder og dokumenter.
- EL - Οδηγίες ασφαλείας ηλεκτρικών συσκευών για επικίνδυνες για έκρηξη περιοχές. Σε περίπτωση που δεν μπορείτε να διαβάσετε αυτές τις οδηγίες, τότε μπορείτε να παραγγείλετε ένα αντίστοιχο μεταφρασμένο στη γλώσσα σας.
- Δήλωση συμμόρφωσης ΕΕ**
Με αυτή τη δήλωση πιστότητας και την τοποθέτηση του σήματος CE ο κατασκευαστής Endress+Hauser δηλώνει, ότι αυτό το προϊόν συμμορφώνεται με τις ευρωπαϊκές οδηγίες που πρέπει να εφαρμοστούν. Οι οδηγίες, τα πρότυπα και τα έγγραφα που εφαρμόστηκαν αναφέρονται στη δήλωση πιστότητας.
- ES - Instrucciones de seguridad de aparatos eléctricos homologados para su utilización en áreas expuestas a riesgos de deflagración. Si no entiende este manual, puede pedir un ejemplar en su idioma.
- Declaración UE de conformidad**
Por la presente declaración y la inclusión de la marca CE, el fabricante Endress+Hauser, declara que el producto cumple con las directivas europeas pertinentes. Las directivas, normas y documentos de aplicación se indican en la declaración de conformidad.
- ET - Ohutusjuhised plahvatusohtlikus keskkonnas kasutatavate elektriseadmete kohta. Kui Te ei saa käesolevat juhendist aru, võite meilt tellida Teie riigikeelde tõlgitud juhendi.
- EL i vastavusdeklaratsioon**
Tootja Endress+Hauser kinnitab juurdelisat vastavusdeklaratsiooni esitamise ja CE-märgise kandmisega tootele, et käesolev toode vastab kohaldatavate Euroopa Liidu direktiivide nõuetele. Kohaldatavad direktiivid, standardid ja dokumendid on ära toodud vastavusdeklaratsioonis.
- FI - Turvallisuusohjeita sähkölaitteille, jotka on vahvistettu käytettäväksi räjähdysvaarallisilla alueilla. Jos et ymmärrä tätä käsikirjaa, voit tilata meiltä käännöksen omalla kansallisella kielelläsi.
- EU-vaatimustenmukaisuusvakuutus**
Valmistaja Endress+Hauser vakuuttaa täällä vaatimustenmukaisuustodistuksella ja CE-merkin kiinnittämisellä, että tämä tuote täyttää sovellettavien EU-direktiivien määräykset. Ovellettavat direktiivit, normit ja dokumentit on merkitty vaatimustenmukaisuustodistukseen.
- HR - Sigurnosni naputci za elektromaterijal u sredini u kojoj prijetei opasnost od eksplozije. Ako Vam nije moguće čitati ovaj naputak, onda imate mogućnost da kod nas naručite naputak sastavljen na Vašem materinskom jeziku.
- EU izjava o skladnosti**
Dobavljač Endress+Hauser jamči ovom izjavom i stavljanjem oznake CE da ovaj proizvod udovoljava zahtjevima europskih direktiva koje su na snazi. U izjavi o usuglašenosti se navode direktive, norme i dokumenti koji su nasnazi.
- HU - Biztonsági információk robbanásveszélyes területre való elektromos eszközökhöz. Amennyiben nem tudja elolvasni ezt az útmutatót, akkor megrendelheti az Ön anyanyelvére lefordítva is.
- EU-megfelelőségi nyilatkozat**
Az Endress+Hauser mint gyártó jelen megfeleléségi nyilatkozattal és a CE-jelzés felhelyezésével kijelenti, hogy ez a termék megfelel az alkalmazandó európai irányelveknek. Az alkalmazott irányelvek, szabványok és dokumentumok a megfeleléségi nyilatkozatban fel vannak tüntetve.
- IT - Istruzioni di sicurezza per apparecchiature elettriche certificate per l'utilizzo in aree con pericolo di esplosione. Se il presente manuale non risulta comprensibile potete ordinarne una copia tradotta nella vostra lingua.
- Dichiarazione di conformità UE**
Con questa dichiarazione e con l'applicazione del marchio CE, il costruttore Endress+Hauser, assicura che il prodotto è conforme alle direttive europee vigenti. Prova della conformità è fornita dall'osservanza delle direttive, delle norme e dei documenti elencati.
- LT - Elektros įrenginio saugumo nurodymai, susiję su sprogimo zonomis. Jeigu negalite perskaityti šios instrukcijos, kreipkitės į mus, kad užsisakytumėte į jūsų gimtąją kalbą išverstą instrukciją.
- ES atitikties deklaracija**
Gamintojas Endress+Hauser šia atitikties deklaracija ir CE ženkliniu patvirtina, kad gaminyas atitinka taikytinas ES direktyvas. Taikomos direktyvos, normos ir dokumentai yra pateikiam atitikties deklaracijoje.
- LV - Drošības norādījumi elektrisko darba instrumentu lietošanai apgabalos, kas pakļauti sprādzienbīstamībai. Ja Jums nav iespēju izlasīt šos norādījumus, Jūs varat pasūtīt pie mums tulkojumu Jūsu valsts valodā.
- ES atbilstības deklarācija**
Ražotājs Endress+Hauser ar šo atbilstības apliecinājumu un CE zīmola lietojumu apstiprina, ka produkts izgatavots saskaņā ar atbilstošajām Eiropas vadlīnijām. Piemērotās vadlīnijas, normas un dokumenti atrunāti atbilstības apliecinājumā.
- NL - Veiligheidsinstructies voor elektrisch materieel in explosiegevaarlijke omgeving. Wanneer u deze handleiding niet kunt lezen, kunt u een in uw landstaal vertaalde handleiding bij ons bestellen.
- EU-conformiteitsverklaring**
De leverancier Endress+Hauser waarborgt met deze verklaring en het aanbrengen van het CE-teken, dat dit product overeenstemt met de geldende Europese richtlijnen. De geldende richtlijnen, normen en documenten zijn aangegeven in de conformiteitsverklaring.
- PL - Wskazówki dot. bezpieczeństwa dla urządzeń elektrycznych stosowanych w obszarze zagrożonym wybuchem. Jeśli niniejsza instrukcja napisana jest w języku, którym się nie posługujesz, możesz zamówić u nas przetłumaczony dokument.
- Deklaracja zgodności UE**
Producent Endress+Hauser w niniejszej deklaracji zgodności wraz z nadaniem znaku CE oświadcza, że produkt ten jest zgodny z obowiązującą Europejską Dyrektywą. Zastosowane wytyczne, normy oraz dokumenty podane są w deklaracji zgodności.
- PT - Instruções de segurança para dispositivos eléctricos certificados para utilização em áreas de risco de incêndio. Se não compreender este manual, pode encomendar-nos directamente uma cópia na sua língua.
- Declaração UE de conformidade**
Com esta declaração de conformidade e a aplicação da marca CE, o fabricante Endress+Hauser, garante que o produto obedece às directivas europeias a aplicar. As directivas, normas e documentos são apresentadas na declaração de conformidade.
- RO - Indicații de siguranță pentru mijloacele de producție electrice pentru zonele periclitate de explozie. Dacă nu puteți citi aceste instrucțiuni, atunci puteți comanda la noi instrucțiunile traduse în limba țării dumneavoastră.
- Declarația UE de conformitate**
Producătorul Endress+Hauser declară prin declarația de conformitate alăturată și prin aplicarea semnului CE că acest produs corespunde directivelor europene aplicabile. Directivele, normele aplicate și documentele sunt menționate în declarația de conformitate.
- SK - Bezpečnostné pokyny pre elektrické zariadenie prevádzkované v priestoroch s nebezpečenstvom výbuchu. Ak nemáte možnosť prečítať si tento návod, môžete si u nás objednať návod preložený do svojho jazyka.
- EU vyhlásenie o zhode**
Spoločnosť Endress+Hauser vyhlasuje prostredníctvom tohto vyhlásenia o konformite a použitím značky CE, že tento výrobok vyhovuje príslušným európskym smerniciam. Zmieňované smernice, normy a dokumenty sú uvedené vo Vyhlásení o konformite.
- SL - Varnostni napotki glede električne opreme, namenjene za uporabo v eksplozivnih območjih. Če teh navodil ne morete razumeti, lahko pri nas naročite prevod v vaš jezik.
- Izjava EU o skladnosti**
Proizvajalec Endress+Hauser s to izjavo o skladnosti in navedbo oznake CE izjavlja, da je ta izdelek skladen s predpisanimi evropskimi smernicami. Upoštevane smernice, standardi in dokumenti so navedeni v izjavi o skladnosti.
- SV - Säkerhetsföreskrifter för elektrisk utrustning certifierad för användning i explosionsfarliga områden. Om du inte förstår denna manual, kan en översatt kopia på ditt eget språk beställas från oss.
- EU-försäkran om överensstämmelse**
Endress+Hauser försäkrar med vidstående försäkran om överensstämmelse och med CE-märkningen att denna produkt överensstämmer med de tillämpbara europeiska riktlinjerna. De tillämpade riktlinjerna, normerna och dokumenten anges i försäkran om överensstämmelse.

EU-Konformitätserklärung
EU-Declaration of Conformity
Déclaration UE de Conformité

Endress+Hauser 
 People for Process Automation



Company	Endress+Hauser SE+Co. KG, Hauptstraße 1, 79689 Maulburg					
	erklärt als Hersteller in alleiniger Verantwortung, dass das Produkt declares as manufacturer under sole responsibility, that the product déclare sous sa seule responsabilité en qualité de fabricant que le produit					
Product	Micropilot FMR50, FMR51, FMR52, FMR53, FMR54, FMR56, FMR57					
Regulations	den folgenden Europäischen Richtlinien entspricht: conforms to following European Directives: est conforme aux prescriptions des Directives Européennes suivantes :					
	ATEX	2014/34/EU	(L96/309)			
	RED	2014/53/EU	(L153/62)			
	RoHS	2011/65/EU	(L174/88)			
Standards	angewandte harmonisierte Normen oder normative Dokumente: applied harmonized standards or normative documents: normes harmonisées ou documents normatifs appliqués :					
	EN 300328-V2.1.1	(2016)	EN 60079-1	(2014)	EN IEC 60079-0	(2018)
	EN 301489-1 V2.1.1	(2017)	EN 60079-11	(2012)	EN IEC 63000	(2018)
	EN 301489-17 V3.1.1	(2017)	EN 60079-15	(2010)		
	EN 302372-V2.1.1	(2016)	EN 60079-26	(2015)		
	EN 302729-V2.1.1	(2016)	EN 60079-31	(2014)		
	EN 61010-1	(2010)				
	EN 61326-1	(2013)				
	EN 61326-2-3	(2013)				
	EN 61326-2-5	(2013)				
	EN 62311	(2008)				
	mit / with / avec Bluetooth: EN 300328-V2.1.1, EN 301489-1 V2.1.1, EN 301489-17 V3.1.1, EN 62311					
Certification	EG-Baumusterprüfbescheinigung Nr. EC-Type Examination Certificate No. Numéro de l'attestation d'examen CE de typ			PTB 12 ATEX 2018 X		
	Ausgestellt von/issued by/délivré par Qualitätssicherung Quality assurance Système d'assurance qualité			PTB Braunschweig (0102) TÜV Nord CERT (GmbH) (0044)		

Maulburg, 28.11.2020
 Endress+Hauser SE+Co. KG

 i.V. Dr. Arno Götz
 Abteilungsleiter Produktsicherheit
 Department Manager Product Safety
 Responsable de certification

EG_12 021-i



Micropilot FMR50/51/52/53/54/56/57

PROFIBUS PA, FOUNDATION Fieldbus

Inhaltsverzeichnis

Zugehörige Dokumentation	6
Ergänzende Dokumentation	6
Herstellerbescheinigungen	6
Herstelleradresse	6
Weitere Normen	6
Erweiterter Bestellcode	6
Sicherheitshinweise: Allgemein	10
Sicherheitshinweise: Besondere Bedingungen	10
Sicherheitshinweise: Installation	12
Sicherheitshinweise: Zone 0	14
Temperaturtabellen	14
Anschlusswerte	14

Zugehörige Dokumentation	<p>Dieses Dokument ist fester Bestandteil der folgenden Betriebsanleitungen:</p> <p>PROFIBUS PA</p> <ul style="list-style-type: none">▪ BA01124F/00 (FMR50)▪ BA01125F/00 (FMR51, FMR52)▪ BA01126F/00 (FMR53, FMR54)▪ BA01127F/00 (FMR56, FMR57) <p>FOUNDATION Fieldbus</p> <ul style="list-style-type: none">▪ BA01120F/00 (FMR50)▪ BA01121F/00 (FMR51, FMR52)▪ BA01122F/00 (FMR53, FMR54)▪ BA01123F/00 (FMR56, FMR57)
Ergänzende Dokumentation	<p>Explosionsschutz-Broschüre: CP00021Z/11</p> <p>Die Explosionsschutz-Broschüre ist verfügbar:</p> <ul style="list-style-type: none">▪ Im Download-Bereich der Endress+Hauser Internetseite: www.endress.com -> Downloads -> Broschüren und Kataloge -> Textsuche: CP00021Z▪ Bei Geräten mit Dokumentation auf CD: Auf der CD
Herstellerbescheinigungen	<p>EU-Konformitätserklärung</p> <p>→  3</p> <p>EU-Baumusterprüfbescheinigung</p> <p>Zertifikatsnummer: PTB 12 ATEX 2018 X</p> <p>Liste der angewendeten Standards: Siehe EU-Konformitätserklärung.</p> <p>IEC-Konformitätserklärung</p> <p>Zertifikatsnummer: IECEX PTB 12.0044 X</p> <p>Das Anbringen der Zertifikatsnummer bescheinigt die Konformität mit den folgenden Normen (abhängig von der Geräteausführung):</p> <ul style="list-style-type: none">▪ IEC 60079-0 : 2017▪ IEC 60079-11 : 2011 + Corr. 1: 2012▪ IEC 60079-26 : 2014
Herstelleradresse	<p>Endress+Hauser SE+Co. KG Hauptstraße 1 79689 Maulburg, Deutschland Adresse des Fertigungswerks: Siehe Typenschild.</p>
Weitere Normen	<p>Für die fachgerechte Installation sind unter anderem die folgende Normen in ihrer aktuellen Version zu beachten:</p> <ul style="list-style-type: none">▪ IEC/EN 60079-14: "Explosionsgefährdete Bereiche - Teil 14: Projektierung, Auswahl und Errichtung elektrischer Anlagen"▪ EN 1127-1: "Explosionsfähige Atmosphären - Explosionsschutz - Teil 1: Grundlagen und Methodik"
Erweiterter Bestellcode	<p>Der erweiterte Bestellcode (Extended order code) wird auf dem Typenschild dargestellt, das auf dem Gerät gut sichtbar angebracht ist. Weitere Informationen zum Typenschild: Siehe Betriebsanleitung.</p>

Position 4 (Anzeige, Bedienung)		
Gewählte Option		Beschreibung
FMR5x	A	Ohne, via Kommunikation
	C	SD02, 4-zeilig, Drucktasten + Datensicherungsfunktion
	E	SD03, 4-zeilig, beleuchtet, Touch Control + Datensicherungsfunktion
	L ^{1) 2)}	Vorbereitet für Anzeige FHX50 + M12 Anschluss
	M ^{1) 2)}	Vorbereitet für Anzeige FHX50 + kundenseitiger Anschluss
	N ^{1) 3)}	Vorbereitet für Anzeige FHX50 + NPT1/2"

- 1) FHX50 ist zugelassen nach DEK12.0046X resp. DEKRA 12ATEX0151X.
- 2) In Zusammenhang mit Position 5 (Gehäuse) = A: Angaben in den Kapiteln "Überspannungsschutz" und "Temperaturtabellen" beachten!
- 3) Nur in Zusammenhang mit Position 5 (Gehäuse) = B, C

Position 5 (Gehäuse)		
Gewählte Option		Beschreibung
FMR5x	A	GT19 Zweikammer, Kunststoff PBT
	C	GT20 Zweikammer, Alu beschichtet
FMR51-54 FMR57	B	GT18 Zweikammer, 316L

Position 7, 8 (Antenne)		
Gewählte Option		Beschreibung
FMR50	BM	Horn 40 mm/1½", PVDF gekapselt, -40...130°C
	BN	Horn 80 mm/3", PP plattiert, -40...80°C
	BR	Horn 100 mm/4", PP plattiert, -40...80°C
FMR51	Bx	Horn (verschiedene Größen)
FMR52	BO	Horn 50 mm/2", -40...200°C ¹⁾ , -196...200°C ²⁾ , frontbündig
	BP	Horn 80 mm/3", -40...200°C ¹⁾ , -196...200°C ²⁾ , frontbündig
FMR53	Cx	Stab (verschiedene Größen)
FMR54	Ax	Ohne Horn
	Bx	Horn (verschiedene Größen)
	Dx	Planar (verschiedene Größen)
FMR56	BN	Horn 80 mm/3", PP plattiert, -40...80°C
	BR	Horn 100 mm/4", PP plattiert, -40...80°C
FMR57	Bx	Horn (verschiedene Größen)
	Fx	Parabol (verschiedene Größen)

- 1) In Zusammenhang mit Position 5 (Gehäuse) = A
- 2) Nur in Zusammenhang mit Position 5 (Gehäuse) = B, C

Position 9, 10 (Dichtung)		
Gewählte Option		Beschreibung
FMR51	A5	Viton GLT, -40...150°C
	C1	Kalrez, -20...150°C
	D2	Graphit, -196...450°C (HT)
	D3	Graphit, -40...250°C (XT)
FMR54	A7	Viton, -20...150°C (Planar)
	A8	Viton, -40...200°C
	B4	EPDM, -40...150°C
	C2	Kalrez, -20...200°C, leitfähige Medien max. 150°C
	D1	Graphit, -196...280°C (XT)
	D2	Graphit, -196 to 400 °C (HT)
FMR57	A6	Viton GLT, -40...200°C
	D4	Graphit, -40...400°C (HT)

Position 11-13 (Prozessanschluss)		
Gewählte Option		Beschreibung
FMR51-54 FMR57	Axx Cxx Kxx	Flansch (verschiedene Größen)
FMR50	GGF RGF	Gewinde, PVDF
	UAE	Montagebügel
	XR0	Montagevorrichtung, ohne Flansch/Montagebügel
	XxG	Überwurfflansch (verschiedene Größen)
FMR51	Pxx	Flansch (verschiedene Größen)
	Rxx	Gewinde
	Txx	Tri-Clamp
FMR52	Mxx	Nutmutter
	Txx	Tri-Clamp
FMR53	RxJ	Gewinde, 316L
	RxF	Gewinde, PVDF
FMR56	UAE	Montagebügel
	XR0	Montagevorrichtung, ohne Flansch/Montagebügel
	XxG	Überwurfflansch (verschiedene Größen)
FMR57	RxJ	Gewinde, 316L
	XxJ	Ausrichtvorr. (verschiedene Größen)

Position 14 (Spülluftanschluss)		
Gewählte Option		Beschreibung
FMR57	1	G1/4
	2	NPT1/4

Optionale Spezifikationen

Kennung Jx (Test, Zeugnis)		
Gewählte Option		Beschreibung
FMR51 ¹⁾ FMR52 FMR54 ²⁾	JN ³⁾	Transmitter für Umgebungstemperatur -50°C

- 1) Nur in Zusammenhang mit Position 9, 10 (Dichtung) = D2
 2) Nur in Zusammenhang mit Position 9, 10 (Dichtung) = D1, D2
 3) Nur in Zusammenhang mit Position 5 (Gehäuse) = B, C

ID Nx, Ox (Zubehör montiert)		
Gewählte Option		Beschreibung
FMR5x	NA	Überspannungsschutz
FMR51	OM OU OV	Antennenverlängerung (verschiedene Größen)
	OW	Hornschutz, PTFE, keine Spülluft möglich
FMR54	OM	Antennenverlängerung (verschiedene Größen)
	ON	
	OR	
	OS	
FMR57	OP OT	Antennenverlängerung (verschiedene Größen)
	OW	Hornschutz, PTFE, keine Spülluft möglich

**Sicherheitshinweise:
Allgemein**

- Das Personal muss für Montage, elektrische Installation, Inbetriebnahme und Wartung des Geräts folgende Bedingungen erfüllen:
 - Verfügt über Qualifikation, die seiner Funktion und Tätigkeit entspricht
 - Ist ausgebildet im Explosionsschutz
 - Ist vertraut mit den nationalen Vorschriften
- Gerät gemäß Herstellerangaben und nationaler Vorschriften installieren.
- Gerät nicht außerhalb der elektrischen, thermischen und mechanischen Kenngrößen betreiben.
- Gerät nur für Messstoffe einsetzen, gegen die die prozessberührenden Materialien hinreichend beständig sind.
- Elektrostatische Aufladung vermeiden:
 - Von Kunststoffflächen (z.B. Gehäuse, Sensorelement, Sonderlackierung, angehängte Zusatzschilder, ..)
 - Von isolierten Kapazitäten (z.B. isolierte metallische Schilder)
- Veränderungen am Gerät können den Explosionsschutz beeinträchtigen und müssen von Endress+Hauser autorisiertem Personal durchgeführt werden.
- Den Zusammenhang zwischen zulässiger Umgebungstemperatur für den Messaufnehmer und/oder Messumformer in Abhängigkeit des Einsatzbereiches und der Temperaturklasse den Temperaturtabellen entnehmen.

Sicherheitshinweise: Besondere Bedingungen

Zulässiger Umgebungstemperaturbereich am Elektronikgehäuse:
 $-40\text{ °C} \leq T_a \leq +80\text{ °C}$

Optionale Spezifikation, Kennung Jx (Test, Zeugnis) = JN

Zulässiger Umgebungstemperaturbereich am Elektronikgehäuse:
 $-50\text{ °C} \leq T_a \leq +80\text{ °C}$

- Angaben aus den Temperatortabellen beachten.
- Bei Prozessanschlüssen aus Kunststoff oder bei Kunststoffbeschichtungen: Elektrostatische Aufladung der Kunststoffflächen vermeiden.
- Zur Vermeidung elektrostatischer Aufladung: Oberflächen nicht trocken reiben.
- Bei zusätzlicher oder alternativer Sonderlackierung des Gehäuses oder anderer metallener Oberflächen oder bei geklebten Schildern:
 - Gefahr von elektrostatischer Auf- und Entladung beachten.
 - Nicht in der Nähe von Prozessen installieren ($\leq 0,5$ m), in denen starke elektrostatische Aufladungen entstehen.

Grundspezifikation, Position 5 (Gehäuse) = A

Elektrostatische Aufladung des Gehäuses (z.B. durch Reibung, Reinigung, Wartung, starke Messstoffströme) vermeiden.

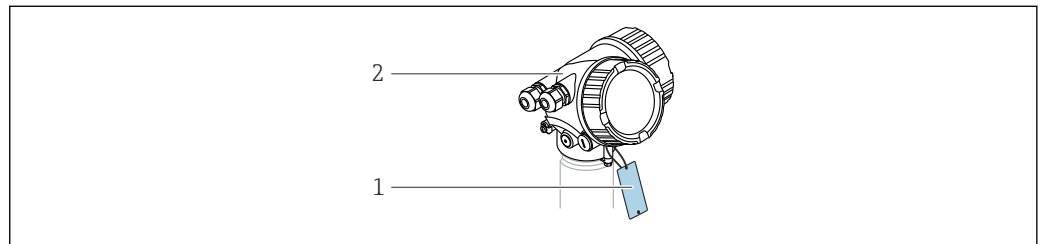

A0032146

1

1 Isolierte Kapazität:

mit einem Metallschild: ≤ 3 pF (geeignet in allen Zonen für Gerätegruppe II und III)

mit zwei bis drei Metallschildern: ≤ 10 pF (nicht geeignet in Zone 0 und für Explosionsgruppe IIC)

2 Gehäuse

Grundspezifikation, Position 5 (Gehäuse) = C

In Zone 0: Reib- und Schlagfunken vermeiden.

Gerätetyp FMR50, FMR52, FMR53, FMR54 (Planar, Email), FMR56

Wenn elektrostatische Aufladungen (z.B. durch Reibung, Reinigung, Wartung, starke Messstoffströme) vermieden werden: Antenne einsetzbar, die mit nicht leitenden Kunststoffen beschichtet ist.

Gerätetyp FMR51, FMR57 und Optionale Spezifikation, Kennung Nx, Ox (Zubehör montiert) = OW

Wenn elektrostatische Aufladungen (z.B. durch Reibung, Reinigung, Wartung, starke Messstoffströme) vermieden werden: Antenne einsetzbar, die mit nicht leitenden Kunststoffen beschichtet ist.

Gerätetyp FMR57 und Grundspezifikation, Position 11-13 (Prozessanschluss) = XxJ

- Das Verstellen der Position der Ausrichtvorrichtung darf nicht mehr möglich sein:
 - Nach Ausrichtung der Antenne mittels Schwenkhalterung
 - Nach Verschraubung des Spannflansches
 - Nach Festsetzen des Klemmrings (Anzugsdrehmoment 15 Nm)
- Schutzart IP67 einhalten.

Gerätetyp FMR57 und Grundspezifikation, Position 14 (Spülluftanschluss) = 1, 2

- Betriebsmittel mit Ga/Gb oder Da/Db erforderlich: Installation muss im geschlossenen Zustand mindestens Schutzart IP67 aufweisen.
- Nach entfernen des Spülluftanschlusses: Öffnung mit geeignetem Verschlussstopfen verschließen.
 - Anzugsdrehmoment: 6-7 Nm
 - Bei Da/Db: Gewinde in Eingriff > 5
- Schutzart IP67 einhalten.

Gerätetyp FMR51, FMR54, FMR57 und Optionale Spezifikation, Kennung Nx, Ox (Zubehör montiert)

= OM, ON, OR, OS, OU, OV, OP, OT

Anstoßen des Sensors an die Behälterwand vermeiden. Behältereinbauten und Strömungsverhältnisse beachten (Reib- und Schlagfunken vermeiden).

Sicherheitshinweise: Installation

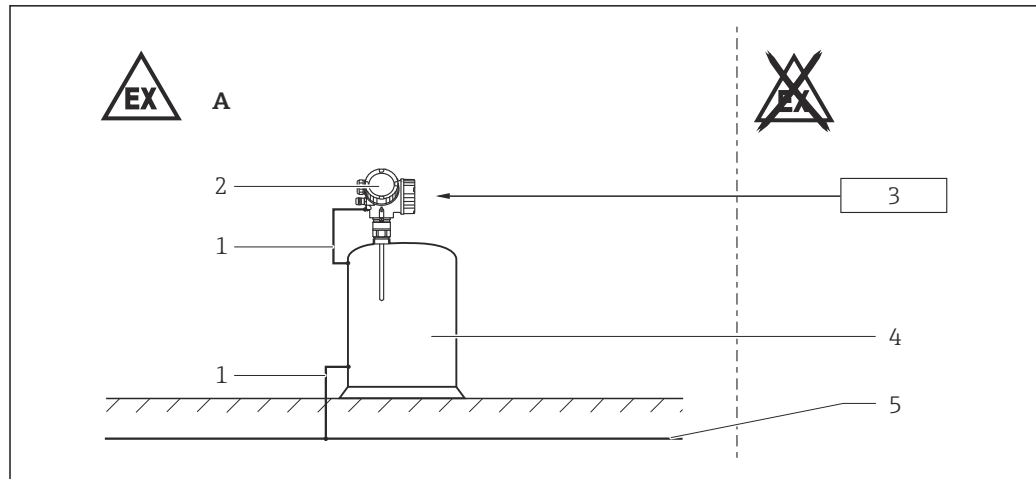

A0022629

2

- A Zone 0, Zone 1
 1 Potentialausgleichsleitung
 2 Elektronikeinsatz
 3 Bescheinigtes zugehöriges Betriebsmittel
 4 Behälter; Zone 0, Zone 1
 5 Potentialausgleich

- Nach einer Gehäuse-Ausrichtung (Verdrehen): Arretierschraube wieder fest anziehen (siehe Betriebsanleitung).
- Gerät so montieren, dass mechanische Beschädigung oder Reibung in der Anwendung ausgeschlossen sind. Besonders auf Strömungsverhältnisse und Behältereinbauten achten.
- Dauergebrauchstemperatur des Anschlusskabels: $-40\text{ °C} \dots \geq +85\text{ °C}$; mindestens aber entsprechend dem Einsatztemperaturbereich der Anwendung zuzüglich der Berücksichtigung von Prozessbedingungen ($T_{a,\min}$), ($T_{a,\max} + 20\text{ K}$).

Optionale Spezifikation, Kennung Jx (Test, Zeugnis) = JN

Dauergebrauchstemperatur des Anschlusskabels: $-50\text{ °C} \dots \geq +85\text{ °C}$; mindestens aber entsprechend dem Einsatztemperaturbereich der Anwendung zuzüglich der Berücksichtigung von Prozessbedingungen ($T_{a,\min}$), ($T_{a,\max} + 20\text{ K}$).

Grundspezifikation, Position 4 (Anzeige, Bedienung) = N

Anforderungen gemäß IEC/EN60079-14 für Rohrleitungssysteme und Verdrahtungs- und Installationsanweisungen der entsprechenden "Safety Instructions" (XA) beachten. Zusätzlich die nationale Vorschriften und Normen für Rohrleitungssysteme berücksichtigen.

Eigensicherheit

- Das Gerät ist ausschließlich für den Anschluss an bescheinigte eigensichere Betriebsmittel der Zündschutzart Ex ia / Ex ib geeignet.
- Der eigensichere Eingangsstromkreis des Geräts ist erdfrei. Seine Spannungsfestigkeit von min. $500\text{ V}_{\text{eff}}$ ist bei einem Eingang gegen Erde ausgeführt und bei mehreren Eingängen auch untereinander.
- Regeln für die Zusammenschaltung von eigensicheren Stromkreisen beachten.
- Das Gerät kann an das Endress+Hauser Servicetool FXA291 angeschlossen werden; Betriebsanleitung und Angaben in dem Kapitel "Überspannungsschutz" berücksichtigen.
- Beim Zusammenschalten der eigensicheren Ex ia-Stromkreise des Geräts mit bescheinigten eigensicheren Ex ib-Stromkreisen mit Explosionsgruppe IIC oder IIB: Zündschutzart ändert sich in Ex ib [ia] IIC oder Ex ib [ia] IIB. Unabhängig von der Versorgung entsprechen alle internen Stromkreise der Zündschutzart Ex ia IIC (z.B. Service Interface, externes Display, Messaufnehmer).

Potentialausgleich

- Gerät in den örtlichen Potentialausgleich einbeziehen.
- Erdung des Schirms: Siehe folgende Zeichnung.

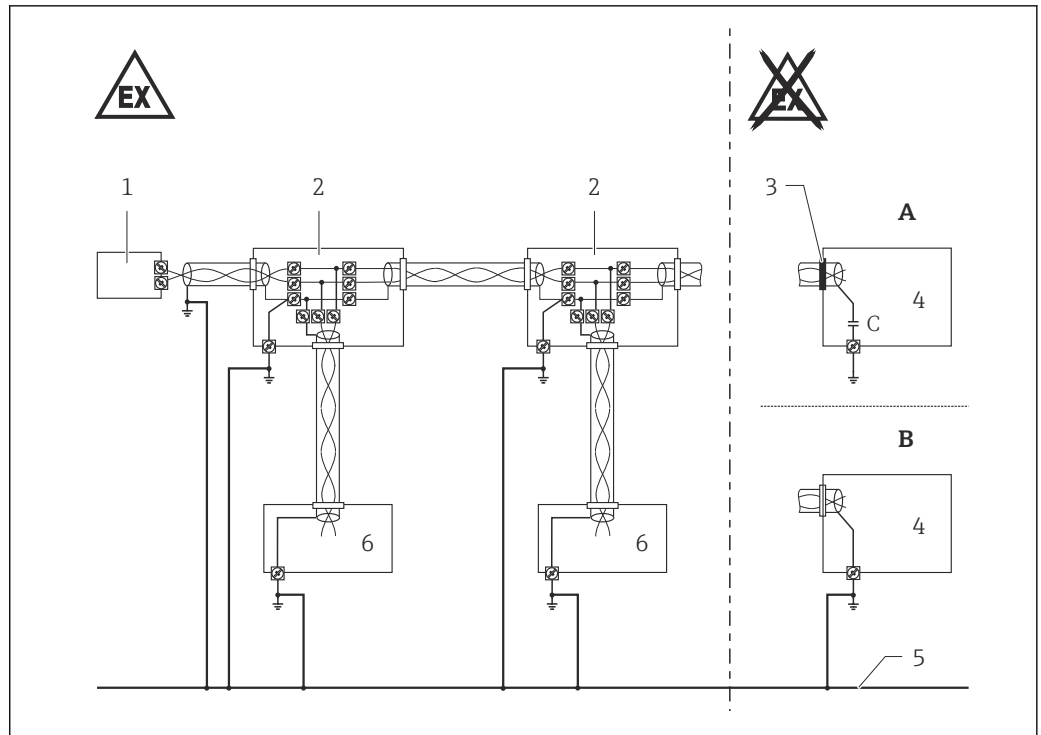

A0022352

3

A Version 1: Kleine Kondensatoren verwenden (z.B. 1 nF, 1 500 V Spannungsfestigkeit, Keramik). Die gesamte Kapazität, die am Schirm angeschlossen ist, darf 10 nF nicht überschreiten.

B Version 2

1 Abschlusswiderstand

2 Verteiler/T-Box

3 Schirm isoliert

4 Speisegerät/Segmentkoppler

5 Potentialausgleich (in hohem Grade sichergestellt)

6 Feldgerät

Überspannungsschutz

- Ist ein Überspannungsschutz gegen atmosphärische Überspannungen erforderlich: Ohne zusätzliche Maßnahmen sind keine anderen Stromkreise, die das Gehäuse verlassen, während des normalen Betriebs erlaubt.
- Bei Installationen, die gemäß nationaler Vorschriften oder Normen einen Überspannungsschutz benötigen: Gerät unter Verwendung eines Überspannungsschutzes installieren (z.B. HAW56x von Endress+Hauser).
- Sicherheitshinweise des Überspannungsschutzes beachten.

Optionale Spezifikation, Kennung Nx, Ox (Zubehör montiert) = NA
(Überspannungsschutz Typ OVP20)

Der eigensichere Eingangsstromkreis des Geräts ist erdfrei. Seine Spannungsfestigkeit von min. 290 V_{eff} ist bei einem Eingang gegen Erde ausgeführt und bei mehreren Eingängen auch untereinander.

Sicherheitshinweise: Zone 0

- Bei explosionsfähigen Dampf-Luft-Gemischen: Gerät nur unter atmosphärischen Bedingungen betreiben.
 - Temperatur: -20 ... +60 °C
 - Druck: 80 ... 110 kPa (0,8 ... 1,1 bar)
 - Luft mit normalem Sauerstoffgehalt, üblicherweise 21 % (V/V)
- Wenn keine explosionsfähigen Gemische vorliegen oder Zusatzmaßnahmen getroffen sind: Gerät gemäß seiner Herstellerspezifikation auch außerhalb der atmosphärischen Bedingungen betreibbar.
- Zugehörige Geräte mit galvanischer Trennung zwischen eigensicheren und nicht eigensicheren Stromkreisen bevorzugen.
- Gerät nur für Messstoffe einsetzen, gegen die die Vergussmasse des Elektronikensatzes aus Silikonkautschuk und das Gehäuse aus PBT, Alu oder 316L hinreichend beständig sind.
- Wenn das Risiko gefährlicher Potentialdifferenzen innerhalb Zone 0 besteht (z.B. durch Auftreten atmosphärischer Elektrizität): Geeignete Maßnahmen für eigensichere Stromkreise in Zone 0 treffen.

Temperaturtabellen→  36**Anschlusswerte**

Optionale Spezifikation, Kennung Nx, Ox (Zubehör montiert) = NA
(Überspannungsschutz Typ OVP20)

Bei Verwendung eines internen Überspannungsschutzes: Keine Änderung der Anschlusswerte.

Ex ia

Versorgungs- und Signalstromkreis in Zündschutzart: Eigensicherheit Ex ia IIC, Ex ia IIB.

Grundspezifikation, Position 3 (Hilfsenergie, Ausgang) = E, G

Klemme 1 (+), 2 (-)		Klemme 3 (+), 4 (-)
FISCO	Entity	Schaltausgang (PFS)
$U_i = 17,5 \text{ V}$	$U_i = 30 \text{ V}$	$U_i = 30 \text{ V}$
$I_i = 550 \text{ mA}$	$I_i = 300 \text{ mA}$	$I_i = 300 \text{ mA}$
$P_i = 5,5 \text{ W}$	$P_i = 1,2 \text{ W}$	$P_i = 1 \text{ W}$
wirksame innere Induktivität $L_i = 10 \mu\text{H}$		wirksame innere Induktivität $L_i = 0$
wirksame innere Kapazität $C_i = 5 \text{ nF}$		wirksame innere Kapazität $C_i = 6 \text{ nF}$

Service Interface (CDI)

Unter Berücksichtigung der folgenden Werte ist das Gerät an das zugelassene Endress+Hauser Servicetool FXA291 oder an ein vergleichbares Interface anschließbar:

Service-Schnittstelle													
$U_i = 7,3 \text{ V}$													
wirksame innere Induktivität $L_i = \text{vernachlässigbar}$													
wirksame innere Kapazität $C_i = \text{vernachlässigbar}$													
$U_o = 7,3 \text{ V}$													
$I_o = 100 \text{ mA}$													
$P_o = 160 \text{ mW}$													
$L_o \text{ (mH)} =$	5,00	2,00	1,00	0,50	0,20	0,15	0,10	0,05	0,02	0,01	0,005	0,002	0,001
$C_o \text{ (}\mu\text{F)}^{1)} =$	0,73	1,20	1,60	2,00	2,60	-	3,20	4,00	5,50	7,30	10,00	12,70	12,70
$C_o \text{ (}\mu\text{F)}^{2)} =$	-	0,49	0,90	1,40	-	2,00	-	-	-	-	-	-	-

1) Werte nach PTB "ispark"-Programm

2) Werte nach IEC/EN 60079-25, Anhang C

Micropilot FMR50/51/52/53/54/56/57

PROFIBUS PA, FOUNDATION Fieldbus

Table of contents

Associated documentation	16
Supplementary documentation	16
Manufacturer's certificates	16
Manufacturer address	16
Other standards	16
Extended order code	16
Safety instructions: General	20
Safety instructions: Special conditions	20
Safety instructions: Installation	22
Safety instructions: Zone 0	24
Temperature tables	24
Connection data	24

Associated documentation	<p>This document is an integral part of the following Operating Instructions:</p> <p>PROFIBUS PA</p> <ul style="list-style-type: none"> ■ BA01124F/00 (FMR50) ■ BA01125F/00 (FMR51, FMR52) ■ BA01126F/00 (FMR53, FMR54) ■ BA01127F/00 (FMR56, FMR57) <p>FOUNDATION Fieldbus</p> <ul style="list-style-type: none"> ■ BA01120F/00 (FMR50) ■ BA01121F/00 (FMR51, FMR52) ■ BA01122F/00 (FMR53, FMR54) ■ BA01123F/00 (FMR56, FMR57)
Supplementary documentation	<p>Explosion-protection brochure: CP00021Z/11</p> <p>The Explosion-protection brochure is available:</p> <ul style="list-style-type: none"> ■ In the download area of the Endress+Hauser website: www.endress.com -> Downloads -> Brochures and Catalogs -> Text Search: CP00021Z ■ On the CD for devices with CD-based documentation
Manufacturer's certificates	<p>EU Declaration of Conformity</p> <p>→  3</p> <p>EU type-examination certificate</p> <p>Certificate number: PTB 12 ATEX 2018 X</p> <p>List of applied standards: See EU Declaration of Conformity.</p> <p>IEC Declaration of Conformity</p> <p>Certificate number: IECEX PTB 12.0044 X</p> <p>Affixing the certificate number certifies conformity with the following standards (depending on the device version):</p> <ul style="list-style-type: none"> ■ IEC 60079-0 : 2017 ■ IEC 60079-11 : 2011 + Corr. 1: 2012 ■ IEC 60079-26 : 2014
Manufacturer address	<p>Endress+Hauser SE+Co. KG Hauptstraße 1 79689 Maulburg, Germany</p> <p>Address of the manufacturing plant: See nameplate.</p>
Other standards	<p>Among other things, the following standards shall be observed in their current version for proper installation:</p> <ul style="list-style-type: none"> ■ IEC/EN 60079-14: "Explosive atmospheres - Part 14: Electrical installations design, selection and erection" ■ EN 1127-1: "Explosive atmospheres - Explosion prevention and protection - Part 1: Basic concepts and methodology"
Extended order code	<p>The extended order code is indicated on the nameplate, which is affixed to the device in such a way that it is clearly visible. Additional information about the nameplate is provided in the associated Operating Instructions.</p>

Position 4 (Display, Operation)		
Selected option		Description
FMR5x	A	Without, via communication
	C	SD02, 4-line, push buttons + data backup function
	E	SD03, 4-line, illum., touch control + data backup function
	L ^{1) 2)}	Prepared for display FHX50 + M12 connection
	M ^{1) 2)}	Prepared for display FHX50 + custom connection
	N ^{1) 3)}	Prepared for display FHX50 + NPT1/2"

- 1) FHX50 is approved according to DEK12.0046X or DEKRA 12ATEX0151X.
- 2) In connection with Position 5 (Housing) = A: Observe the specifications in the "Overvoltage protection" and "Temperature tables" chapters!
- 3) Only in connection with Position 5 (Housing) = B, C

Position 5 (Housing)		
Selected option		Description
FMR5x	A	GT19 dual compartment, plastics PBT
	C	GT20 dual compartment, Alu coated
FMR51-54 FMR57	B	GT18 dual compartment, 316L

Position 7, 8 (Antenna)		
Selected option		Description
FMR50	BM	Horn 40 mm/1½", PVDF encapsulated, -40...130°C
	BN	Horn 80 mm/3", PP cladde, -40...80°C
	BR	Horn 100 mm/4", PP cladde, -40...80°C
FMR51	Bx	Horn (different sizes)
FMR52	BO	Horn 50 mm/2", -40...200°C ¹⁾ , -196...200°C ²⁾ , flush mount
	BP	Horn 80 mm/3", -40...200°C ¹⁾ , -196...200°C ²⁾ , flush mount
FMR53	Cx	Rod (different sizes)
FMR54	Ax	Without Horn
	Bx	Horn (different sizes)
	Dx	Planar (different sizes)
FMR56	BN	Horn 80 mm/3", PP cladde, -40...80°C
	BR	Horn 100 mm/4", PP cladde, -40...80°C
FMR57	Bx	Horn (different sizes)
	Fx	Parabolic (different sizes)

- 1) In connection with Position 5 (Housing) = A
- 2) Only in connection with Position 5 (Housing) = B, C

Position 9, 10 (Seal)		
Selected option		Description
FMR51	A5	Viton GLT, -40...150°C
	C1	Kalrez, -20...150°C
	D2	Graphite, -196...450°C (HT)
	D3	Graphite, -40...250°C (XT)
FMR54	A7	Viton, -20...150°C (Planar)
	A8	Viton, -40...200°C
	B4	EPDM, -40...150°C
	C2	Kalrez, -20...200°C, conductive media max. 150°C
	D1	Graphite, -196...280°C (XT)
	D2	Graphite, -196 to 400 °C (HT)
FMR57	A6	Viton GLT, -40...200°C
	D4	Graphite, -40...400°C (HT)

Position 11-13 (Process Connection)		
Selected option		Description
FMR51-54 FMR57	Axx Cxx Kxx	Flange (different sizes)
FMR50	GGF RGF	Thread, PVDF
	UAE	Mounting bracket
	XR0	Connection, without flange/mounting bracket
	XxG	Slip on flange (different sizes)
FMR51	Pxx	Flange (different sizes)
	Rxx	Thread
	Txx	Tri-Clamp
FMR52	Mxx	Slotted-nut
	Txx	Tri-Clamp
FMR53	RxJ	Thread, 316L
	RxF	Thread, PVDF
FMR56	UAE	Mounting bracket
	XR0	Connection, without flange/mounting bracket
	XxG	Slip on flange (different sizes)
FMR57	RxJ	Thread, 316L
	Xxj	Align. device (different sizes)

Position 14 (Air Purge Connection)		
Selected option		Description
FMR57	1	G1/4
	2	NPT1/4

Optional specifications

ID Jx (Test, Certificate)		
Selected option		Description
FMR51 ¹⁾ FMR52 FMR54 ²⁾	JN ³⁾	Ambient temperature transmitter -50°C

- 1) Only in connection with Position 9, 10 (Seal) = D2
 2) Only in connection with Position 9, 10 (Seal) = D1, D2
 3) Only in connection with Position 5 (Housing) = B, C

ID Nx, Ox (Accessory Mounted)		
Selected option		Description
FMR5x	NA	Overvoltage protection
FMR51	OM OU OV	Antenna extension (different sizes)
	OW	Horn protection, PTFE, no airpurge possible
FMR54	OM	Antenna extension (different sizes)
	ON	
	OR	
	OS	
FMR57	OP OT	Antenna extension (different sizes)
	OW	Horn protection, PTFE, no airpurge possible

Safety instructions: General

- Staff must meet the following conditions for mounting, electrical installation, commissioning and maintenance of the device:
 - Be suitably qualified for their role and the tasks they perform
 - Be trained in explosion protection
 - Be familiar with national regulations
- Install the device according to the manufacturer's instructions and national regulations.
- Do not operate the device outside the specified electrical, thermal and mechanical parameters.
- Only use the device in media to which the wetted materials have sufficient durability.
- Avoid electrostatic charging:
 - Of plastic surfaces (e.g. housing, sensor element, special varnishing, attached additional plates, ..)
 - Of isolated capacities (e.g. isolated metallic plates)
- Modifications to the device can affect the explosion protection and must be carried out by staff authorized to perform such work by Endress+Hauser.
- Refer to the temperature tables for the relationship between the permitted ambient temperature for the sensor and/or transmitter, depending on the range of application and the temperature class.

**Safety instructions:
Special conditions**

Permitted ambient temperature range at the electronics housing:
 $-40\text{ °C} \leq T_a \leq +80\text{ °C}$

Optional specification, ID Jx (Test, Certificate) = JN

Permitted ambient temperature range at the electronics housing:
 $-50\text{ °C} \leq T_a \leq +80\text{ °C}$

- Observe the information in the temperature tables.
- In the case of process connections made of polymeric material or with polymeric coatings, avoid electrostatic charging of the plastic surfaces.
- To avoid electrostatic charging: Do not rub surfaces with a dry cloth.
- In the event of additional or alternative special varnishing on the housing or other metal parts or for adhesive plates:
 - Observe the danger of electrostatic charging and discharge.
 - Do not install in the vicinity of processes (≤ 0.5 m) generating strong electrostatic charges.

Basic specification, Position 5 (Housing) = A

Avoid electrostatic charging of the housing (e.g. friction, cleaning, maintenance, strong medium flow).

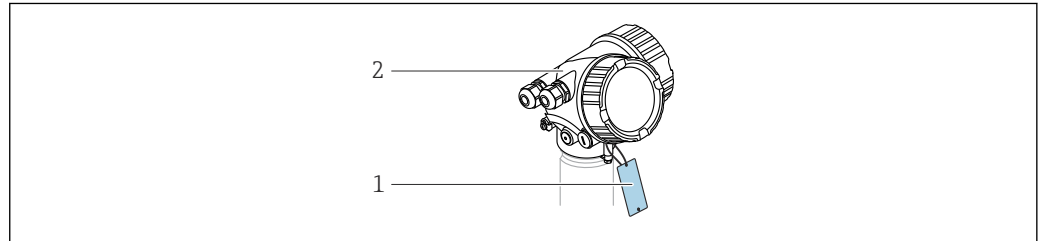

A0032146

4

- 1 *Isolated capacitance:*
 - with one metal plate: ≤ 3 pF (permitted in all areas for Equipment Groups II and III)
 - with two to three metal plates: ≤ 10 pF (not permitted in Zone 0 and for Equipment Group IIC)
- 2 *Housing*

Basic specification, Position 5 (Housing) = C

In Zone 0, avoid sparks caused by impact and friction.

Device type FMR50, FMR52, FMR53, FMR54 (planar, enamel), FMR56

An antenna coated with non-conductive material can be used if avoiding electrostatic charging (e.g. through friction, cleaning, maintenance, strong medium flow).

Device type FMR51, FMR57 and Optional specification, ID Nx, Ox (Accessory Mounted) = OW

An antenna coated with non-conductive material can be used if avoiding electrostatic charging (e.g. through friction, cleaning, maintenance, strong medium flow).

Device type FMR57 and Basic specification, Position 11-13 (Process Connection) = Xxj

- Changing the position of the alignment device must be impossible:
 - After the alignment of the antenna via the pivot bracket
 - After tightening of the clamping flange
 - After setting the damping ring (torque 15 Nm)
- Degree of protection IP67 must be fulfilled.

Device type FMR57 and Basic specification, Position 14 (Air Purge Connection) = 1, 2

- If equipment with Ga/Gb or Da/Db is required: In the closed state the minimum degree of protection of the installation must be IP67.
- After removing the air purge connection: Lock the opening with a suitable plug.
 - Torque: 6-7 Nm
 - For Da/Db: thread engagement > 5 turns
- Degree of protection IP67 must be fulfilled.

Device type FMR51, FMR54, FMR57 and Optional specification, ID Nx, Ox (Accessory Mounted) = OM, ON, OR, OS, OU, OV, OP, OT

Avoid contact between sensor and tank wall. Take into account tank fittings and flow conditions (avoid sparks caused by impact and friction).

Safety instructions: Installation

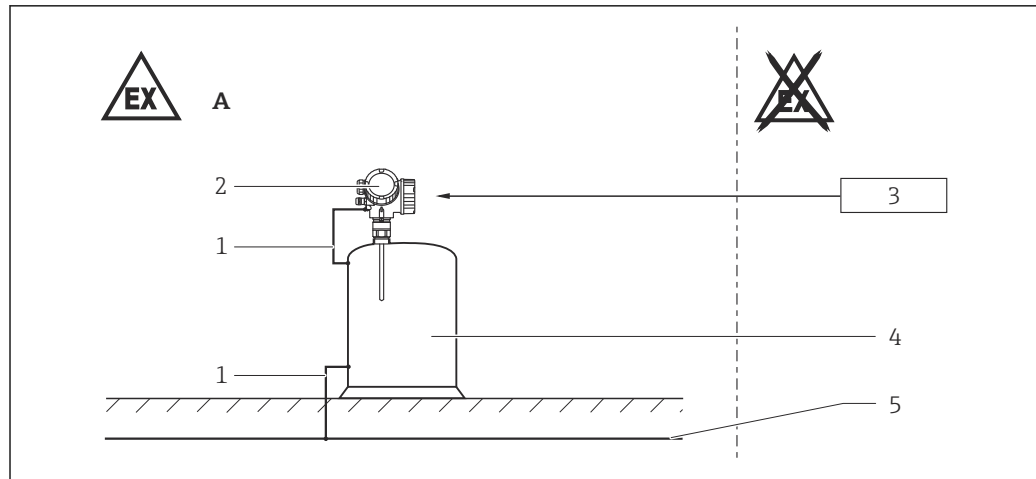

A0022629

5

- A Zone 0, Zone 1
 1 Potential equalization line
 2 Electronic insert
 3 Certified associated apparatus
 4 Tank; Zone 0, Zone 1
 5 Potential equalization

- After aligning (rotating) the housing, retighten the fixing screw (see Operating Instructions).
- Install the device to exclude any mechanical damage or friction during the application. Pay particular attention to flow conditions and tank fittings.
- Continuous service temperature of the connecting cable: -40 °C to $\geq +85\text{ °C}$; in accordance with the range of service temperature taking into account additional influences of the process conditions ($T_{a,\min}$), ($T_{a,\max} + 20\text{ K}$).

Optional specification, ID Jx (Test, Certificate) = JN

Continuous service temperature of the connecting cable: -50 °C to $\geq +85\text{ °C}$; in accordance with the range of service temperature taking into account additional influences of the process conditions ($T_{a,\min}$), ($T_{a,\max} + 20\text{ K}$).

Basic specification, Position 4 (Display, Operation) = N

Observe the requirements according to IEC/EN 60079-14 for conduit systems and the wiring- and installation instructions of the suitable Safety Instructions (XA). In addition, observe national regulations and standards for conduit systems.

Intrinsic safety

- The device is only suitable for connection to certified, intrinsically safe equipment with explosion protection Ex ia / Ex ib.
- The intrinsically safe input power circuit of the device is isolated from ground. If the device is only equipped with one input, the dielectric strength of the input is at least $500\text{ V}_{\text{rms}}$. If the device is equipped with more than one input, the dielectric strength of each individual input to ground is at least $500\text{ V}_{\text{rms}}$, and the dielectric strength of the inputs vis-à-vis one another is also at least $500\text{ V}_{\text{rms}}$.
- Observe the pertinent guidelines when interconnecting intrinsically safe circuits.
- The device can be connected to the Endress+Hauser FXA291 service tool: refer to the Operating Instructions and specifications in the "Overvoltage protection" chapter.
- When the intrinsically safe Ex ia circuits of the device are connected to certified intrinsically safe circuits of Category Ex ib for Equipment Groups IIC or IIB, the type of protection changes to Ex ib [ia] IIC or Ex ib [ia] IIB. Regardless of the power supply, all the internal circuits correspond to Ex ia IIC type of protection (e.g. service interface, external display, sensor).

Potential equalization

- Integrate the device into the local potential equalization.
- Grounding the screen, see the following figure.

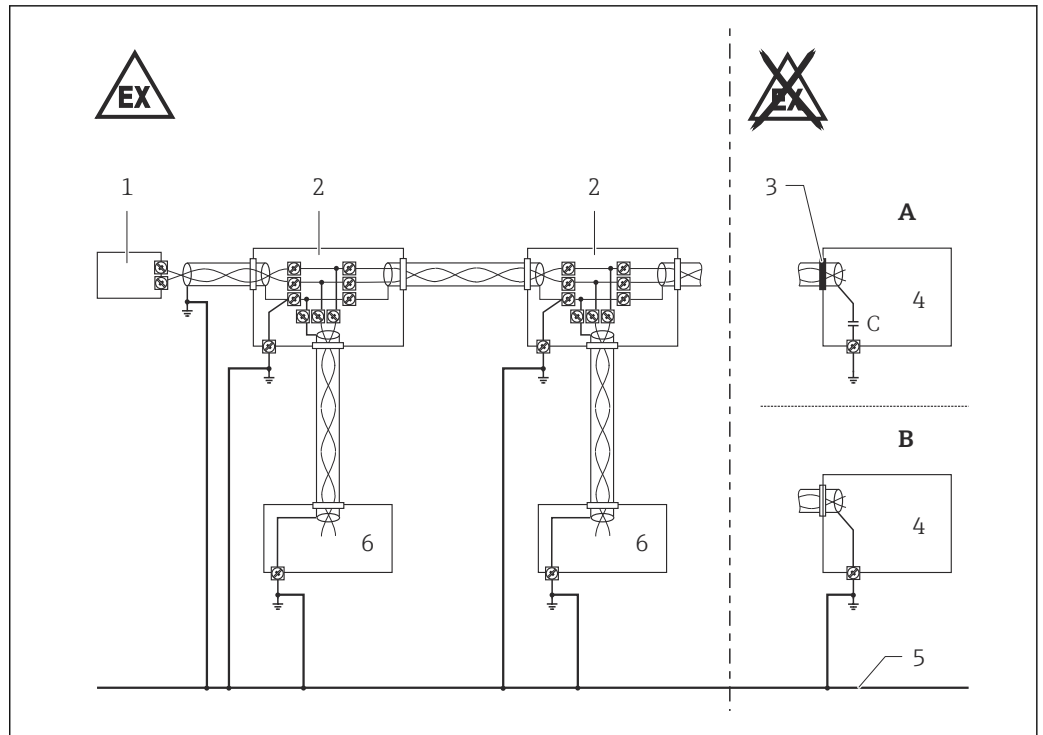

A0022352

6

- A Version 1: Use small capacitors (e.g. 1 nF, 1 500 V dielectric strength, ceramic). Total capacitance connected to the screen may not exceed 10 nF.
- B Version 2
- 1 Terminating resistor
- 2 Distributor/T box
- 3 Screen insulated
- 4 Supply unit/Segment coupler
- 5 Potential equalization (secured in high degree)
- 6 Field device

Overvoltage protection

- If an overvoltage protection against atmospheric over voltages is required: no other circuits may leave the housing during normal operation without additional measures.
- For installations which require overvoltage protection to comply with national regulations or standards, install the device using overvoltage protection (e.g. HAW56x from Endress+Hauser).
- Observe the safety instructions of the overvoltage protection.

Optional specification, ID Nx, Ox (Accessory Mounted) = NA (Overvoltage protection Type OVP20)
 The intrinsically safe input power circuit of the device is isolated from ground. If the device is only equipped with one input, the dielectric strength of the input is at least 290 V_{rms}. If the device is equipped with more than one input, the dielectric strength of each individual input to ground is at least 290 V_{rms}, and the dielectric strength of the inputs vis-à-vis one another is also at least 290 V_{rms}.

Safety instructions: Zone 0

- In the event of potentially explosive vapor/air mixtures, only operate the device under atmospheric conditions.
 - Temperature: -20 to +60 °C
 - Pressure: 80 to 110 kPa (0.8 to 1.1 bar)
 - Air with normal oxygen content, usually 21 % (V/V)
- If no potentially explosive mixtures are present, or if additional protective measures have been taken, the device may also be operated under non-atmospheric conditions in accordance with the manufacturer's specifications.
- Associated devices with galvanic isolation between the intrinsically safe and non-intrinsically safe circuits are preferred.
- Only use the device in media to which the silicone rubber potting compound of the electronic insert and the housing made of PBT, aluminum or 316L have sufficient durability.
- If there is a risk of dangerous potential differences within Zone 0 (e.g. through the occurrence of atmospheric electricity), implement suitable measures for intrinsically safe circuits in Zone 0.

Temperature tables

→ 40

Connection data

Optional specification, ID Nx, Ox (Accessory Mounted) = NA (Overvoltage protection Type OVP20)
 When using the internal overvoltage protection: No changes to the connection values.

Ex ia

Power supply and signal circuit with protection type: intrinsic safety Ex ia IIC, Ex ia IIB.

Basic specification, Position 3 (Power Supply, Output) = E, G

Terminal 1 (+), 2 (-)		Terminal 3 (+), 4 (-)
FISCO	Entity	Switch output (PFS)
$U_i = 17.5\text{ V}$	$U_i = 30\text{ V}$	$U_i = 30\text{ V}$
$I_i = 550\text{ mA}$	$I_i = 300\text{ mA}$	$I_i = 300\text{ mA}$
$P_i = 5.5\text{ W}$	$P_i = 1.2\text{ W}$	$P_i = 1\text{ W}$
effective inner inductance $L_i = 10\text{ }\mu\text{H}$		effective inner inductance $L_i = 0$
effective inner capacitance $C_i = 5\text{ nF}$		effective inner capacitance $C_i = 6\text{ nF}$

Service interface (CDI)

Taking the following values into consideration, the device can be connected to the certified Endress+Hauser FXA291 service tool or a similar interface:

Service interface														
$U_i = 7.3\text{ V}$ effective inner inductance $L_i = \text{negligible}$ effective inner capacitance $C_i = \text{negligible}$														
$U_o = 7.3\text{ V}$ $I_o = 100\text{ mA}$ $P_o = 160\text{ mW}$														
$L_o\text{ (mH)} =$	5.00	2.00	1.00	0.50	0.20	0.15	0.10	0.05	0.02	0.01	0.005	0.002	0.001	
$C_o\text{ (}\mu\text{F)}^{1) =}$	0.73	1.20	1.60	2.00	2.60	-	3.20	4.00	5.50	7.30	10.00	12.70	12.70	
$C_o\text{ (}\mu\text{F)}^{2) =}$	-	0.49	0.90	1.40	-	2.00	-	-	-	-	-	-	-	

1) Values according to PTB "ispark" program
 2) Values according to IEC/EN 60079-25, Annex C

Micropilot FMR50/51/52/53/54/56/57

PROFIBUS PA, FOUNDATION Fieldbus

Sommaire

Documentation correspondante	26
Documentation complémentaire	26
Certificats constructeur	26
Adresse du fabricant	26
Autres normes	26
Référence de commande étendue	26
Conseils de sécurité : Généralités	30
Conseils de sécurité : Conditions particulières	30
Conseils de sécurité : Installation	32
Conseils de sécurité : Zone 0	34
Tableaux des températures	34
Valeurs de raccordement	34

Documentation correspondante

Le présent document fait partie intégrante des manuels de mise en service suivants :

PROFIBUS PA

- BA01124F/00 (FMR50)
- BA01125F/00 (FMR51, FMR52)
- BA01126F/00 (FMR53, FMR54)
- BA01127F/00 (FMR56, FMR57)

FOUNDATION Fieldbus

- BA01120F/00 (FMR50)
- BA01121F/00 (FMR51, FMR52)
- BA01122F/00 (FMR53, FMR54)
- BA01123F/00 (FMR56, FMR57)

Documentation complémentaire

Brochure sur la protection contre les explosions : CP00021Z/11

La brochure sur la protection contre les explosions est disponible :

- Dans la zone de téléchargement sur le site Internet Endress+Hauser :
www.endress.com -> Télécharger -> Brochures et catalogues -> Recherche de texte : CP00021Z
- Pour les appareils avec documentation sur CD : Sur le CD

Certificats constructeur**Déclaration UE de conformité**

→  3

Attestation d'examen UE de type

Numéro de certificat :

PTB 12 ATEX 2018 X

Liste des normes appliquées : Voir la Déclaration UE de conformité.

Déclaration CEI de conformité

Numéro de certificat :

IECEX PTB 12.0044 X

En apposant le numéro de certificat, on certifie la conformité aux normes suivantes (en fonction de l'exécution de l'appareil) :

- IEC 60079-0 : 2017
- IEC 60079-11 : 2011 + Corr. 1: 2012
- IEC 60079-26 : 2014

Adresse du fabricant

Endress+Hauser SE+Co. KG

Hauptstraße 1

79689 Maulburg, Allemagne

Adresse du site de production : Voir plaque signalétique.

Autres normes

Pour une installation conforme, il convient, entre autres, de respecter les normes suivantes dans leur version actuelle :

- IEC/EN 60079-14 : "Atmosphères explosives - Partie 14 : Conception, sélection et construction des installations électriques"
- EN 1127-1 : "Atmosphères explosives - Prévention de l'explosion et protection contre l'explosion - Partie 1 : Notions fondamentales et méthodologie"

Référence de commande étendue

La référence de commande étendue (Extended order code) est indiquée sur la plaque signalétique qui est apposée de façon bien visible sur l'appareil. Pour plus d'informations sur la plaque signalétique : Voir manuel de mise en service correspondant.

Structure de la référence de commande étendue

FMR5x – ***** + A*B*C*D*E*F*G*..
(Type d'appareil) *(Spécifications de base)* *(Spécifications optionnelles)*

* = Caractère de remplacement
 Position pour une option sélectionnée dans la spécification (chiffre ou lettre).

Spécifications de base

Les caractéristiques indispensables pour l'appareil sont définies dans les spécifications de base. Le nombre de positions dépend du nombre de caractéristiques disponibles, l'option choisie pour une caractéristique pouvant être composée de plusieurs positions.

Spécifications optionnelles

Les caractéristiques additionnelles de l'appareil sont décrites dans les spécifications optionnelles. Le nombre de positions dépend du nombre de caractéristiques disponibles. Afin d'identifier les caractéristiques, elles sont composées de deux caractères (par ex. JA). La première position (identifiant), qui correspond à un groupe de caractéristiques (par ex. J = Test, certificat) se compose d'un chiffre ou d'une lettre. La deuxième position représente la valeur qui correspond à la caractéristique au sein du groupe (par ex. A = Matériau 3.1 (en contact avec le produit), certificat de réception).

Pour plus d'informations sur l'appareil, voir les tableaux suivants. Chaque caractère Ex ou chaque identifiant de la référence de commande étendue est décrit ici.

Référence de commande étendue : Micropilot

 Les indications suivantes représentent un extrait de la structure du produit et permettent l'affectation :

- De cette documentation à l'appareil (à l'aide de la référence de commande étendue sur la plaque signalétique).
- Des options d'appareil indiquées dans le document.

Type d'appareil

FMR50, FMR51, FMR52, FMR53, FMR54, FMR56, FMR57

Spécifications de base

Position 1, 2 (Agrément)		
Option sélectionnée		Description
FMR5x	BA	ATEX II 1 G Ex ia IIC T6...T1 Ga
	BB	ATEX II 1/2 G Ex ia IIC T6...T1 Ga/Gb
	IA	IECEX Ex ia IIC T6...T1 Ga
	IB	IECEX Ex ia IIC T6...T1 Ga/Gb

Position 3 (Alimentation, sortie)		
Option sélectionnée		Description
FMR5x	E	2-fils, FOUNDATION Fieldbus, sortie tout ou rien (PFS)
	G	2-fils, PROFIBUS PA, sortie tout ou rien (PFS)

Position 4 (Affichage, configuration)		
Option sélectionnée		Description
FMR5x	A	Sans, via communication
	C	SD02, 4-lignes, boutons-poussoirs + fonction de sauvegarde des données
	E	SD03, 4-lignes, rétroéclairé, touches optiques + fonction de sauvegarde des données
	L ^{1) 2)}	Prêt pour affichage FHX50 + M12 raccordement
	M ^{1) 2)}	Prêt pour affichage FHX50 + raccordement spécifique client
	N ^{1) 3)}	Prêt pour affichage FHX50 + NPT1/2"

- 1) FHX50 est agréé selon DEK12.0046X ou DEKRA 12ATEX0151X.
- 2) En combinaison avec Position 5 (Boîtier) = A : respecter les indications des chapitres "Parafoudre" et "Tableaux des températures" !
- 3) Seulement en combinaison avec Position 5 (Boîtier) = B, C

Position 5 (Boîtier)		
Option sélectionnée		Description
FMR5x	A	GT19 double compartiment, plastique PBT
	C	GT20 double compartiment, alu revêtu
FMR51-54 FMR57	B	GT18 double compartiment, 316L

Position 7, 8 (Antenne)		
Option sélectionnée		Description
FMR50	BM	Cornet 40 mm/1½", enrobé PVDF, -40...130°C
	BN	Cornet 80 mm/3", PP plaqué, -40...80°C
	BR	Cornet 100 mm/4", PP plaqué, -40...80°C
FMR51	Bx	Cornet (différentes tailles)
FMR52	BO	Cornet 50 mm/2", -40...200°C ¹⁾ , -196...200°C ²⁾ , affleurant
	BP	Cornet 80 mm/3", -40...200°C ¹⁾ , -196...200°C ²⁾ , affleurant
FMR53	Cx	Tige (différentes tailles)
FMR54	Ax	Sans cornet
	Bx	Cornet (différentes tailles)
	Dx	Planar (différentes tailles)
FMR56	BN	Cornet 80 mm/3", PP plaqué, -40...80°C
	BR	Cornet 100 mm/4", PP plaqué, -40...80°C
FMR57	Bx	Cornet (différentes tailles)
	Fx	Parabolique (différentes tailles)

- 1) En combinaison avec Position 5 (Boîtier) = A
- 2) Seulement en combinaison avec Position 5 (Boîtier) = B, C

Position 9, 10 (Joint)		
Option sélectionnée		Description
FMR51	A5	Viton GLT, -40...150°C
	C1	Kalrez, -20...150°C
	D2	Graphite, -196...450°C (HT)
	D3	Graphite, -40...250°C (XT)
FMR54	A7	Viton, -20...150°C (Planar)
	A8	Viton, -40...200°C
	B4	EPDM, -40...150°C
	C2	Kalrez, -20...200°C, produit conducteur max. 150°C
	D1	Graphite, -196...280°C (XT)
	D2	Graphite, -196 to 400 °C (HT)
FMR57	A6	Viton GLT, -40...200°C
	D4	Graphite, -40...400°C (HT)

Position 11-13 (Raccordement process)		
Option sélectionnée		Description
FMR51-54 FMR57	Axx Cxx Kxx	Bride (différentes tailles)
FMR50	GGF RGF	Filet., PVDF
	UAE	Étrier de fixation
	XR0	Système de montage utilisateur, sans bride/étrier de fixation
	XxG	Bride tournante (différentes tailles)
FMR51	Pxx	Bride (différentes tailles)
	Rxx	Filet.
	Txx	Tri-Clamp
FMR52	Mxx	Écrou fou
	Txx	Tri-Clamp
FMR53	RxJ	Filet., 316L
	RxF	Filet., PVDF
FMR56	UAE	Étrier de fixation
	XR0	Système de montage utilisateur, sans bride/étrier de fixation
	XxG	Bride tournante (différentes tailles)
FMR57	RxJ	Filet., 316L
	XxJ	Disp.orientation (différentes tailles)

Position 14 (Raccord air comprimé)		
Option sélectionnée		Description
FMR57	1	G1/4
	2	NPT1/4

Spécifications optionnelles

Identifiant Jx (Test, Certificat)		
Option sélectionnée		Description
FMR51 ¹⁾ FMR52 FMR54 ²⁾	JN ³⁾	Transmetteur de température ambiante -50°C

- 1) Seulement en combinaison avec Position 9, 10 (Joint) = D2
 2) Seulement en combinaison avec Position 9, 10 (Joint) = D1, D2
 3) Seulement en combinaison avec Position 5 (Boîtier) = B, C

ID Nx, Ox (Accessoire monté)		
Option sélectionnée		Description
FMR5x	NA	Parafoudre
FMR51	OM OU OV	Extension antenne (différentes tailles)
	OW	
FMR54	OM	Extension antenne (différentes tailles)
	ON	
	OR	
	OS	
FMR57	OP	Extension antenne (différentes tailles)
	OT	
	OW	Protection du cornet, PTFE, pas de purge d'air possible

Conseils de sécurité :
Généralités

- Le personnel réalisant le montage, l'installation électrique, la mise en service et la maintenance de l'appareil doit remplir les conditions suivantes :
 - Disposer de la qualification correspondant à ses fonctions et à ses activités
 - Être formé sur la protection contre les explosions
 - Être informé sur les directives nationales en vigueur
- Installer l'appareil d'après les instructions du fabricant et les directives nationales en vigueur.
- Ne pas utiliser l'appareil en dehors des limites nominales électriques, thermiques et mécaniques.
- N'utiliser l'appareil que dans des produits contre lesquels les matériaux en contact sont suffisamment résistants.
- Éviter le chargement électrostatique :
 - De surfaces synthétiques (par ex. boîtier, élément sensible, vernis spécial, plaques additionnelles attachées...)
 - De capacités isolées (par ex. plaques métalliques isolées)
- La modification de l'appareil peut altérer la protection contre les risques d'explosion et ne peut, par conséquent, être réalisée que par du personnel Endress+Hauser habilité.
- La relation entre la température ambiante admissible pour le capteur et/ou le transmetteur en fonction du domaine d'application et de la classe de température est à déduire des tableaux des températures.

Conseils de sécurité :
Conditions particulières

Gamme de température ambiante admissible au boîtier de l'électronique :
 $-40\text{ °C} \leq T_a \leq +80\text{ °C}$

Spécifications optionnelles, Identifiant Jx (Test, certificat) = JN

Gamme de température ambiante admissible au boîtier de l'électronique :
 $-50\text{ °C} \leq T_a \leq +80\text{ °C}$

- Tenir compte des données dans les tableaux de température.
- En cas de raccords process en matière synthétique ou avec revêtements synthétiques : Eviter le chargement électrostatique des surfaces synthétiques.
- Pour éviter toute chargement électrostatique : Ne pas frotter les surfaces avec un chiffon sec.
- En cas de vernis spécial supplémentaire ou alternatif du boîtier ou d'autres surfaces métalliques ou en cas de plaques adhésives :
 - Prendre en compte un risque de charge ou de décharge électrostatique.
 - Ne pas installer à proximité de process ($\leq 0,5$ m) générant de fortes charges électrostatiques.

Spécifications de base, Position 5 (Boîtier) = A

Eviter le chargement électrostatique du boîtier (par ex. friction, nettoyage, maintenance, forts courants de produit).

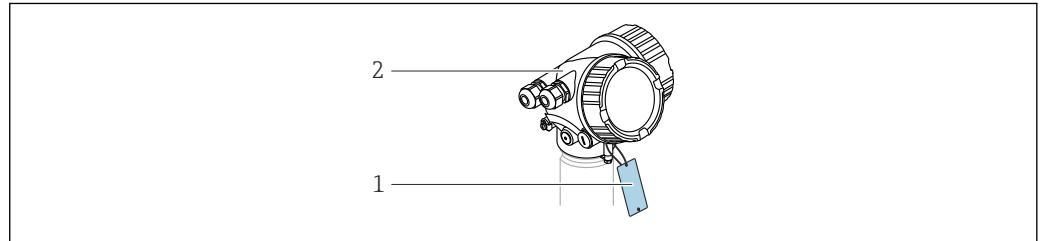

A0032146

7

1 Capacité isolée :

avec une plaque métallique : ≤ 3 pF (autorisé en toutes zones pour groupes d'équipements II et III)
avec deux ou trois plaques métalliques : ≤ 10 pF (non autorisé en zone 0 et groupe d'explosion IIC)

2 Boîtier

Spécifications de base, Position 5 (Boîtier) = C

En zone 0 : Eviter les étincelles dues aux frottements ou aux chocs.

Type d'appareil FMR50, FMR52, FMR53, FMR54 (planar, émail), FMR56

Si tout chargement électrostatique (par ex. friction, nettoyage, maintenance, forts courants de produit) est évité : Possibilité d'utiliser une antenne revêtue de matière synthétique non conductrice.

Type d'appareil FMR51, FMR57 et Spécifications optionnelles, Identifiant Nx, Ox (Accessoire monté) = OW

Si tout chargement électrostatique (par ex. friction, nettoyage, maintenance, forts courants de produit) est évité : Possibilité d'utiliser une antenne revêtue de matière synthétique non conductrice.

Type d'appareil FMR57 et Spécifications de base, Position 11-13 (Raccordement process) = Xxj

- Le réglage de la position du dispositif d'orientation ne doit plus être possible :
 - Après l'alignement de l'antenne au moyen du support pivotant
 - Après avoir vissé la bride de serrage
 - Après avoir réglé la bague de serrage (couple de serrage 15 Nm)
- Respecter l'indice de protection IP67.

Type d'appareil FMR57 et Spécifications de base, Position 14 (Raccord air comprimé) = 1, 2

- Matériel avec Ga/Gb ou Da/Db nécessaire : En position fermée, l'installation doit avoir un indice de protection d'au moins IP67.
- Après avoir retiré le raccord d'air de purge : Fermer l'ouverture avec un bouchon d'étanchéité adapté.
 - Couple de serrage: 6-7 Nm
 - Pour Da/Db : engagement du filetage > 5
- Respecter l'indice de protection IP67.

Type d'appareil FMR51, FMR54, FMR57 et Spécifications optionnelles, Identifiant Nx, Ox (Accessoire monté) = OM, ON, OR, OS, OU, OV, OP, OT

Eviter tout contact entre le capteur et la paroi de la cuve. Tenir compte des éléments internes à la cuve et des conditions d'écoulement (éviter les étincelles dues aux frottements et aux chocs).

Conseils de sécurité : Installation

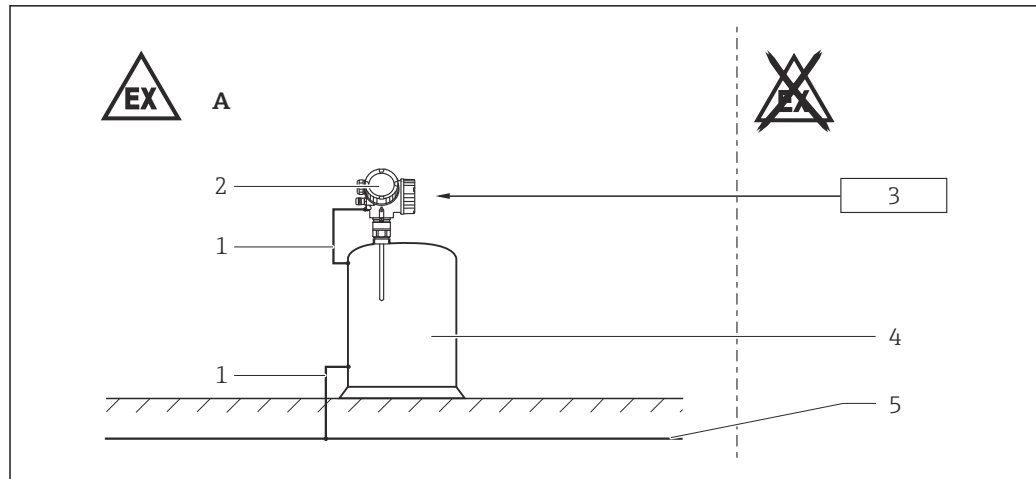

A0022629

8

- A Zone 0, Zone 1
 1 Ligne d'équipotentialité
 2 Electronique
 3 Matériel électrique associé certifié
 4 Cuve ; Zone 0, Zone 1
 5 Compensation de potentiel

- Après l'orientation du boîtier (rotation) : Serrer fortement les vis de verrouillage (voir manuel de mise en service).
- Monter l'appareil de manière à ce que les dommages mécaniques ou frottements soient exclus au cours de l'application. Tenir notamment compte des conditions d'écoulement et des éléments internes au réservoir.
- Température en régime continu du câble de raccordement : $-40\text{ °C} \geq +85\text{ °C}$; toutefois en tenant compte au minimum de la gamme de température de service de l'application ainsi que des conditions de process ($T_{a,\min}$), ($T_{a,\max} + 20\text{ K}$).

Spécifications optionnelles, Identifiant Jx (Test, certificat) = JN

Température en régime continu du câble de raccordement : $-50\text{ °C} \geq +85\text{ °C}$; toutefois en tenant compte au minimum de la gamme de température de service de l'application ainsi que des conditions de process ($T_{a,\min}$), ($T_{a,\max} + 20\text{ K}$).

Spécifications de base, Position 4 (Affichage, configuration) = N

Respecter les exigences selon IEC/EN 60079-14 pour les systèmes de conduites ainsi que les instructions de raccordement et de montage contenues dans les "Safety Instructions" (XA). En outre, respecter les réglementations et normes nationales relatives aux systèmes de conduites.

Sécurité intrinsèque

- L'appareil doit impérativement être raccordé à une installation certifiée du mode de protection Ex ia / Ex ib.
- Le circuit d'entrée à sécurité intrinsèque de l'appareil est isolé de la terre. Pour une entrée, sa tenue diélectrique est de min. $500\text{ V}_{\text{eff}}$ par rapport à la terre, pour plusieurs entrées, c'est également le cas les unes par rapport aux autres.
- Respecter les règles en matière d'interconnexion de circuits à sécurité intrinsèque.
- L'appareil peut être raccordé au service tool FXA291 Endress+Hauser ; tenir compte des instructions du manuel de mise en service et des indications du chapitre "Parafoudre".
- En cas de connexion des circuits à sécurité intrinsèque Ex ia de l'appareil à des circuits à sécurité intrinsèque Ex ib avec groupe d'explosion IIC ou IIB : Le mode de protection se modifie comme suit : Ex ib |ia| IIC ou Ex ib |ia| IIB. Indépendamment de l'alimentation, tous les circuits internes ont le mode de protection Ex ia IIC (par ex. interface service, afficheur externe, capteur).

Compensation de potentiel

- Intégrer l'appareil dans la compensation de potentiel locale.
- Mise à la terre du blindage : Voir graphique suivant.

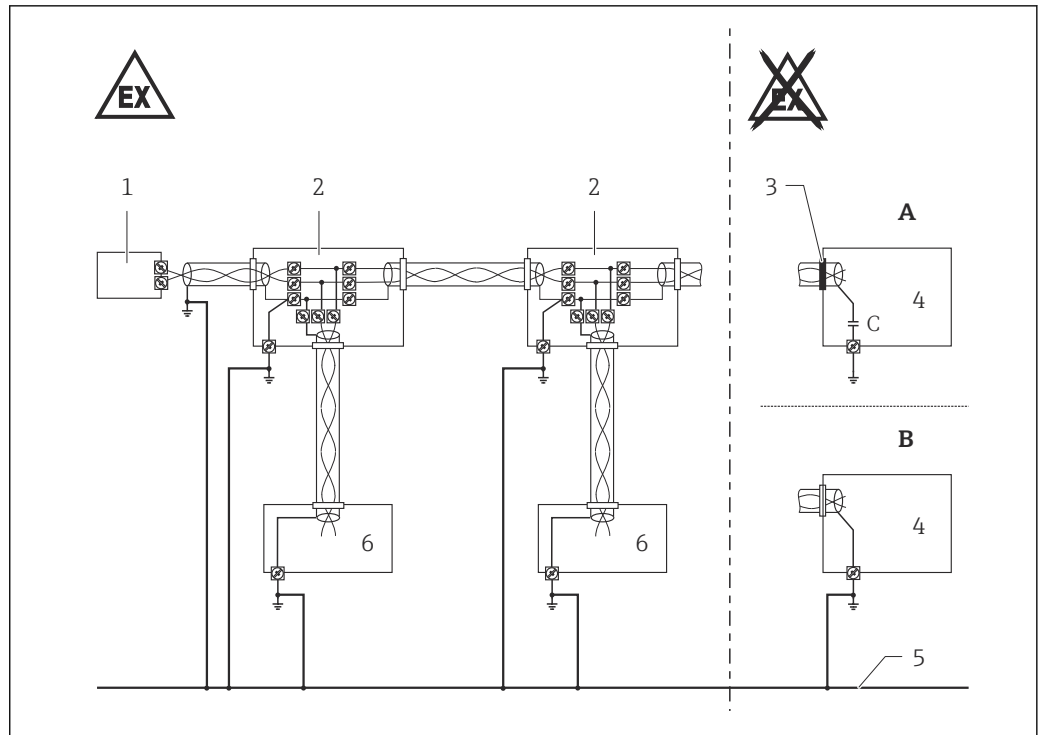

A0022352

9

- A Version 1: Utiliser de petits condensateurs (par ex. 1 nF, 1 500 V tenue diélectrique, céramique). La capacité totale raccordée au blindage ne doit pas dépasser 10 nF.
- B Version 2
- 1 Résistance de terminaison
- 2 Boîte de jonction
- 3 Blindage isolé
- 4 Alimentation/Coupleur de segments
- 5 Compensation de potentiel (largement assurée)
- 6 Appareil de terrain

Parafoudre

- Si un parafoudre est nécessaire pour la protection contre les surtensions atmosphériques : aucun autre circuit ne peut quitter le boîtier pendant le fonctionnement normal sans mesures supplémentaires.
- Pour les installations qui, conformément à des directives ou normes nationales nécessitent un parafoudre : Installer l'appareil avec un tel dispositif (par ex. HAW56x d'Endress+Hauser).
- Tenir compte des conseils de sécurité du parafoudre.

Spécifications optionnelles, Identifiant Nx, Ox (Accessoire monté) = NA (Parafoudre type OVP20)

Le circuit d'entrée à sécurité intrinsèque de l'appareil est isolé de la terre. Pour une entrée, sa tenue diélectrique est de min. 290 V_{eff} par rapport à la terre, pour plusieurs entrées, c'est également le cas les unes par rapport aux autres.

Conseils de sécurité : Zone 0

- En cas de mélanges explosifs vapeur-air : N'utiliser l'appareil que sous des conditions atmosphériques.
 - Température : -20 ... +60 °C
 - Pression : 80 ... 110 kPa (0,8 ... 1,1 bar)
 - Air avec concentration normale en oxygène, généralement 21 % (V/V)
- En l'absence de mélange explosif ou si des mesures complémentaires ont été prises : Appareil utilisable selon les spécifications du fabricant même en dehors des conditions atmosphériques.
- Préférer les appareils associés avec séparation galvanique entre les circuits avec et sans sécurité intrinsèque.
- N'utiliser l'appareil que dans des produits contre lesquels la masse de surmoulage de l'électronique en caoutchouc siliconé et le boîtier en PBT, alu ou inox 316L sont suffisamment résistants.
- En cas de risque de différences de potentiel dangereuses en zone 0 (par ex. dues à la présence d'électricité atmosphérique) : Prendre des mesures appropriées pour les circuits à sécurité intrinsèque en zone 0.

Tableaux des températures→  44**Valeurs de raccordement**

Spécifications optionnelles, Identifiant Nx, Ox (Accessoire monté) = NA (Parafoudre type OVP20)
 En cas d'utilisation d'un parafoudre interne : pas de changement des valeurs de raccordement.

Ex ia

Circuit d'alimentation et de signal en mode de protection : Sécurité intrinsèque Ex ia IIC, Ex ia IIB.

Spécifications de base, Position 3 (Alimentation, sortie) = E, G

Borne 1 (+), 2 (-)		Borne 3 (+), 4 (-)
FISCO	Entity	Sortie tout ou rien (PFS)
$U_i = 17,5 \text{ V}$	$U_i = 30 \text{ V}$	$U_i = 30 \text{ V}$
$I_i = 550 \text{ mA}$	$I_i = 300 \text{ mA}$	$I_i = 300 \text{ mA}$
$P_i = 5,5 \text{ W}$	$P_i = 1,2 \text{ W}$	$P_i = 1 \text{ W}$
inductance interne $L_i = 10 \text{ } \mu\text{H}$		inductance interne $L_i = 0$
capacité interne $C_i = 5 \text{ nF}$		capacité interne $C_i = 6 \text{ nF}$

Interface service (CDI)

En tenant compte des valeurs suivantes, l'appareil peut être raccordé au service tool FXA291 Endress+Hauser agréé ou à une interface comparable :

Interface de service														
$U_i = 7,3 \text{ V}$ inductance interne $L_i =$ négligeable capacité interne $C_i =$ négligeable														
$U_o = 7,3 \text{ V}$ $I_o = 100 \text{ mA}$ $P_o = 160 \text{ mW}$														
$L_o \text{ (mH)} =$	5,00	2,00	1,00	0,50	0,20	0,15	0,10	0,05	0,02	0,01	0,005	0,002	0,001	
$C_o \text{ (}\mu\text{F)}^{1) =}$	0,73	1,20	1,60	2,00	2,60	-	3,20	4,00	5,50	7,30	10,00	12,70	12,70	
$C_o \text{ (}\mu\text{F)}^{2) =}$	-	0,49	0,90	1,40	-	2,00	-	-	-	-	-	-	-	-

1) Valeurs selon PTB "ispark" programme

2) Valeurs selon IEC/EN 60079-25, Annexe C

Micropilot FMR50/51/52/53/54/56/57

PROFIBUS PA, FOUNDATION Fieldbus

Table of contents

Erläuterungen zum Aufbau	36
Notes on the structure	40
Explications concernant la structure	44
Beispiel-Diagramme möglicher Deratings / Example diagrams of possible deratings / Exemple de diagrammes de déclassements possibles	48
Zone 0: 1 channel	49
Zone 0: 2 channels	50
Zone 0, Zone 1: 1 channel	51
Zone 0, Zone 1: 2 channels	52
Zone 1: 1 channel	53
Zone 1: 2 channels	71

Erläuterungen zum Aufbau **Auszug aus dem erweiterten Bestellcode***Gerätetyp*

FMR50, FMR51, FMR52, FMR53, FMR54, FMR56, FMR57

Grundspezifikationen

Position 1, 2 (Zulassung)		
Gewählte Option		Beschreibung
FMR5x	BA	ATEX II 1 G Ex ia IIC T6...T1 Ga
	BB	ATEX II 1/2 G Ex ia IIC T6...T1 Ga/Gb
	IA	IECEX Ex ia IIC T6...T1 Ga
	IB	IECEX Ex ia IIC T6...T1 Ga/Gb

Position 3 (Hilfsenergie, Ausgang)		
Gewählte Option		Beschreibung
FMR5x	E	2-Draht, FOUNDATION Fieldbus, Schaltausgang (PFS)
	G	2-Draht, PROFIBUS PA, Schaltausgang (PFS)

Position 5 (Gehäuse)		
Gewählte Option		Beschreibung
FMR5x	A	GT19 Zweikammer, Kunststoff PBT
	C	GT20 Zweikammer, Alu beschichtet
FMR51-54 FMR57	B	GT18 Zweikammer, 316L

Position 7, 8 (Antenne)		
Gewählte Option		Beschreibung
FMR50	BM	Horn 40 mm/1½", PVDF gekapselt, -40...130°C
	BN	Horn 80 mm/3", PP plattiert, -40...80°C
	BR	Horn 100 mm/4", PP plattiert, -40...80°C
FMR51	Bx	Horn (verschiedene Größen)
FMR52	BO	Horn 50 mm/2", -40...200°C ¹⁾ , -196...200°C ²⁾ , frontbündig
	BP	Horn 80 mm/3", -40...200°C ¹⁾ , -196...200°C ²⁾ , frontbündig
FMR53	Cx	Stab (verschiedene Größen)
FMR54	Ax	Ohne Horn
	Bx	Horn (verschiedene Größen)
	Dx	Planar (verschiedene Größen)
FMR56	BN	Horn 80 mm/3", PP plattiert, -40...80°C
	BR	Horn 100 mm/4", PP plattiert, -40...80°C

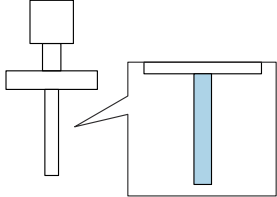
Position 7, 8 (Antenne)		
Gewählte Option		Beschreibung
FMR57	Bx	Horn (verschiedene Größen)
	Fx	Parabol (verschiedene Größen)
 In den Temperaturtabellen beispielhaft dargestellt wie folgt:		

- 1) In Zusammenhang mit Position 5 (Gehäuse) = A
- 2) Nur in Zusammenhang mit Position 5 (Gehäuse) = B, C

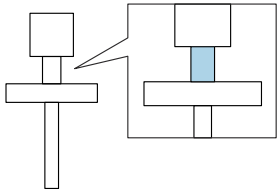
Position 9, 10 (Dichtung)		
Gewählte Option		Beschreibung
FMR51	A5	Viton GLT, -40...150°C
	C1	Kalrez, -20...150°C
	D2	Graphit, -196...450°C (HT)
	D3	Graphit, -40...250°C (XT)
FMR54	A7	Viton, -20...150°C (Planar)
	A8	Viton, -40...200°C
	B4	EPDM, -40...150°C
	C2	Kalrez, -20...200°C, leitfähige Medien max. 150°C
	D1	Graphit, -196...280°C (XT)
	D2	Graphit, -196...400°C (HT)
FMR57	A6	Viton GLT, -40...200°C
	D4	Graphit, -40...400°C (HT)
 In den Temperaturtabellen beispielhaft dargestellt wie folgt:		

Position 11-13 (Prozessanschluss)		
Gewählte Option		Beschreibung
FMR51-54 FMR57	Axx Cxx Kxx	Flansch (verschiedene Größen)
FMR50	GGF RGF	Gewinde, PVDF
	UAE	Montagebügel
	XR0	Montagevorrichtung, ohne Flansch/Montagebügel
	XxG	Überwurfflansch (verschiedene Größen)

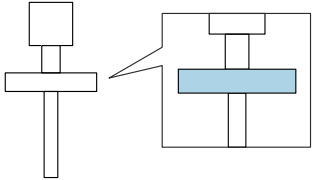
Position 11-13 (Prozessanschluss)		
Gewählte Option		Beschreibung
FMR51	Pxx	Flansch (verschiedene Größen)
	Rxx	Gewinde
	Txx	Tri-Clamp
FMR52	Mxx	Nutmutter
	Txx	Tri-Clamp
FMR53	Rxj	Gewinde, 316L
	RxF	Gewinde, PVDF
FMR56	UAE	Montagebügel
	XRO	Montagevorrichtung, ohne Flansch/Montagebügel
	XxG	Überwurfflansch (verschiedene Größen)
FMR57	Rxj	Gewinde, 316L
	Xxj	Ausrichtvorr. (verschiedene Größen)
 In den Temperaturtabellen beispielhaft dargestellt wie folgt:		

Optionale Spezifikationen

Kennung Jx (Test, Zeugnis)		
Gewählte Option		Beschreibung
FMR51 ¹⁾ FMR52 FMR54 ²⁾	JN ³⁾	Transmitter für Umgebungstemperatur -50°C

- 1) Nur in Zusammenhang mit Position 9, 10 (Dichtung) = D2
- 2) Nur in Zusammenhang mit Position 9, 10 (Dichtung) = D1, D2
- 3) Nur in Zusammenhang mit Position 5 (Gehäuse) = B, C

Allgemeine Hinweise

 *Optionale Spezifikation, Kennung Nx, Ox (Zubehör montiert) = NA (Überspannungsschutz Typ OVP20)*

Bei Verwendung eines internen Überspannungsschutzes: Zulässige Umgebungstemperatur am Gehäuse um 5 K reduzieren.

Grundspezifikation, Position 5 (Gehäuse) = A

Bei Verwendung einer abgesetzten Anzeige FHX50: Zulässige Umgebungstemperatur am Gehäuse um 3 K reduzieren.

 Zulässigen Temperaturbereich an der Antenne beachten.

Darstellungshinweise



 Wenn nicht anders angegeben, beziehen sich die Positionen immer auf die Grundspezifikation.

- 1. Spalte: Position 5 (Gehäuse) = A, B, ...
- 2. Spalte: Position 3 (Hilfsenergie, Ausgang) = A, B, ..
 - (1): 1 Kanal benutzt
 - (2): 2 Kanäle benutzt
- 3. Spalte: Temperaturklassen T6 (85 °C) bis T1 (450 °C)

Spalte P1 bis P6: Position (Temperaturwert) auf den Achsen des Deratings

- T_a: Umgebungstemperatur in °C
- T_p: Prozesstemperatur in °C

 Spalte P6 ist nur bei Version B des Deratings relevant.

→  10,  48

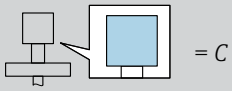
	(1)	P1		P2		P3		P4		P5		P6		
		T _p	T _a	T _p	T _a	T _p	T _a	T _p	T _a	T _p	T _a	T _p	T _a	
	E, G	T6	-40	60	60	60	85	53	85	-40	-40	-40	-	-
		T5	-40	75	75	75	100	68	100	-40	-40	-40	-	-
		T4	-40	80	80	80	135	67	135	-40	-40	-40	-	-
		T3	-40	80	80	80	200	51	200	-40	-40	-40	-	-

A0038026-DE

Notes on the structure

Extract from the extended order code

Device type

FMR50, FMR51, FMR52, FMR53, FMR54, FMR56, FMR57

Basic specifications

Position 1, 2 (Approval)		
Selected option		Description
FMR5x	BA	ATEX II 1 G Ex ia IIC T6...T1 Ga
	BB	ATEX II 1/2 G Ex ia IIC T6...T1 Ga/Gb
	IA	IECEX Ex ia IIC T6...T1 Ga
	IB	IECEX Ex ia IIC T6...T1 Ga/Gb

Position 3 (Power Supply, Output)		
Selected option		Description
FMR5x	E	2-wire, FOUNDATION Fieldbus, switch output (PFS)
	G	2-wire, PROFIBUS PA, switch output (PFS)

Position 5 (Housing)		
Selected option		Description
FMR5x	A	GT19 dual compartment, plastics PBT
	C	GT20 dual compartment, Alu coated
FMR51-54 FMR57	B	GT18 dual compartment, 316L

Position 7, 8 (Antenna)		
Selected option		Description
FMR50	BM	Horn 40 mm/1½", PVDF encapsulated, -40...130°C
	BN	Horn 80 mm/3", PP cladded, -40...80°C
	BR	Horn 100 mm/4", PP cladded, -40...80°C
FMR51	Bx	Horn (different sizes)
FMR52	BO	Horn 50 mm/2", -40...200°C ¹⁾ , -196...200°C ²⁾ , flush mount
	BP	Horn 80 mm/3", -40...200°C ¹⁾ , -196...200°C ²⁾ , flush mount
FMR53	Cx	Rod (different sizes)
FMR54	Ax	Without Horn
	Bx	Horn (different sizes)
	Dx	Planar (different sizes)
FMR56	BN	Horn 80 mm/3", PP cladded, -40...80°C
	BR	Horn 100 mm/4", PP cladded, -40...80°C

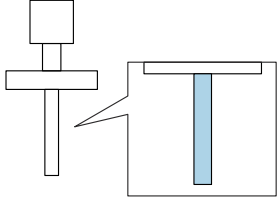
Position 7, 8 (Antenna)		
Selected option		Description
FMR57	Bx	Horn (different sizes)
	Fx	Parabolic (different sizes)
 Shown in the temperature tables exemplary as follows:		

- 1) In connection with Position 5 (Housing) = A
- 2) Only in connection with Position 5 (Housing) = B, C

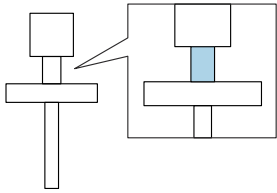
Position 9, 10 (Seal)		
Selected option		Description
FMR51	A5	Viton GLT, -40...150°C
	C1	Kalrez, -20...150°C
	D2	Graphite, -196...450°C (HT)
	D3	Graphite, -40...250°C (XT)
FMR54	A7	Viton, -20...150°C (Planar)
	A8	Viton, -40...200°C
	B4	EPDM, -40...150°C
	C2	Kalrez, -20...200°C, conductive media max. 150°C
	D1	Graphite, -196...280°C (XT)
	D2	Graphite, -196...400°C (HT)
FMR57	A6	Viton GLT, -40...200°C
	D4	Graphite, -40...400°C (HT)
 Shown in the temperature tables exemplary as follows:		

Position 11-13 (Process Connection)		
Selected option		Description
FMR51-54 FMR57	Axx Cxx Kxx	Flange (different sizes)
FMR50	GGF RGF	Thread, PVDF
	UAE	Mounting bracket
	XR0	Connection, without flange/mounting bracket
	XxG	Slip on flange (different sizes)

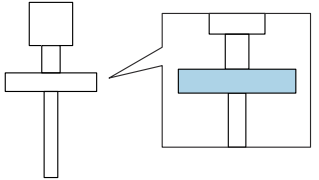
Position 11-13 (Process Connection)		
Selected option		Description
FMR51	Pxx	Flange (different sizes)
	Rxx	Thread
	Txx	Tri-Clamp
FMR52	Mxx	Slotted-nut
	Txx	Tri-Clamp
FMR53	Rxj	Thread, 316L
	RxF	Thread, PVDF
FMR56	UAE	Mounting bracket
	XRO	Connection, without flange/mounting bracket
	XxG	Slip on flange (different sizes)
FMR57	Rxj	Thread, 316L
	Xxj	Align. device (different sizes)
 Shown in the temperature tables exemplary as follows:		

Optional specifications

ID Jx (Test, Certificate)		
Selected option		Description
FMR51 ¹⁾ FMR52 FMR54 ²⁾	JN ³⁾	Ambient temperature transmitter -50°C

- 1) Only in connection with Position 9, 10 (Seal) = D2
- 2) Only in connection with Position 9, 10 (Seal) = D1, D2
- 3) Only in connection with Position 5 (Housing) = B, C

General notes

 *Optional specification, ID Nx, Ox (Accessory Mounted) = NA*
(Overvoltage protection Type OVP20)

When using the internal overvoltage protection: Reduce the admissible ambient temperature at the housing by 5 K.

Basic specification, Position 5 (Housing) = A

When using the remote display FHX50: Reduce the admissible ambient temperature at the housing by 3 K.

 Observe the permitted temperature range at the antenna.

Description notes

 Unless otherwise indicated, the positions always refer to the basic specification.

1st column: Position 5 (Housing) = A, B, ...

2nd column: Position 3 (Power Supply, Output) = A, B, ..



- (1): 1 channel used
- (2): 2 channels used

3rd column: Temperature classes T6 (85 °C) to T1 (450 °C)

Column P1 to P6: Position (temperature value) on the axes of the derating

- T_a: Ambient temperature in °C
- T_p: Process temperature in °C

 Column P6 is only relevant for version B of the derating.

→  10,  48

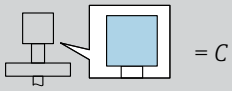
	(1)	P1		P2		P3		P4		P5		P6		
		T _p	T _a	T _p	T _a	T _p	T _a	T _p	T _a	T _p	T _a	T _p	T _a	
	E, G	T6	-40	60	60	60	85	53	85	-40	-40	-40	-	-
		T5	-40	75	75	75	100	68	100	-40	-40	-40	-	-
		T4	-40	80	80	80	135	67	135	-40	-40	-40	-	-
		T3	-40	80	80	80	200	51	200	-40	-40	-40	-	-

A0038026-EN

Explications concernant la structure

Extrait du référence de commande étendue

Type d'appareil

FMR50, FMR51, FMR52, FMR53, FMR54, FMR56, FMR57

Spécifications de base

Position 1, 2 (Agrément)		
Option sélectionnée		Description
FMR5x	BA	ATEX II 1 G Ex ia IIC T6...T1 Ga
	BB	ATEX II 1/2 G Ex ia IIC T6...T1 Ga/Gb
	IA	IECEX Ex ia IIC T6...T1 Ga
	IB	IECEX Ex ia IIC T6...T1 Ga/Gb

Position 3 (Alimentation, sortie)		
Option sélectionnée		Description
FMR5x	E	2-fils, FOUNDATION Fieldbus, sortie tout ou rien (PFS)
	G	2-fils, PROFIBUS PA, sortie tout ou rien (PFS)

Position 5 (Boîtier)		
Option sélectionnée		Description
FMR5x	A	GT19 double compartiment, plastique PBT
	C	GT20 double compartiment, alu revêtu
FMR51-54 FMR57	B	GT18 double compartiment, 316L

Position 7, 8 (Antenne)		
Option sélectionnée		Description
FMR50	BM	Cornet 40 mm/1½", enrobé PVDF, -40...130°C
	BN	Cornet 80 mm/3", PP plaqué, -40...80°C
	BR	Cornet 100 mm/4", PP plaqué, -40...80°C
FMR51	Bx	Cornet (différentes tailles)
FMR52	BO	Cornet 50 mm/2", -40...200°C ¹⁾ , -196...200°C ²⁾ , affleurant
	BP	Cornet 80 mm/3", -40...200°C ¹⁾ , -196...200°C ²⁾ , affleurant
FMR53	Cx	Tige (différentes tailles)
FMR54	Ax	Sans cornet
	Bx	Cornet (différentes tailles)
	Dx	Planar (différentes tailles)
FMR56	BN	Cornet 80 mm/3", PP plaqué, -40...80°C
	BR	Cornet 100 mm/4", PP plaqué, -40...80°C

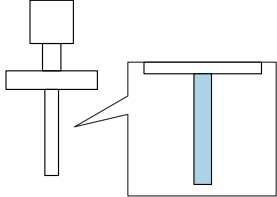
Position 7, 8 (Antenne)		
Option sélectionnée		Description
FMR57	Bx	Cornet (différentes tailles)
	Fx	Parabolique (différentes tailles)
<p> Représenté dans les tableaux de température à titre d'exemple de la façon suivante :</p>		
		

- 1) En combinaison avec Position 5 (Boîtier) = A
- 2) Seulement en combinaison avec Position 5 (Boîtier) = B, C

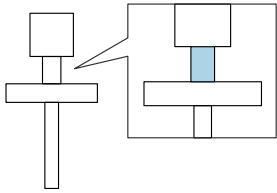
Position 9, 10 (Joint)		
Option sélectionnée		Description
FMR51	A5	Viton GLT, -40...150°C
	C1	Kalrez, -20...150°C
	D2	Graphite, -196...450°C (HT)
	D3	Graphite, -40...250°C (XT)
FMR54	A7	Viton, -20...150°C (Planar)
	A8	Viton, -40...200°C
	B4	EPDM, -40...150°C
	C2	Kalrez, -20...200°C, produit conducteur max. 150°C
	D1	Graphite, -196...280°C (XT)
	D2	Graphite, -196...400°C (HT)
FMR57	A6	Viton GLT, -40...200°C
	D4	Graphite, -40...400°C (HT)
<p> Représenté dans les tableaux de température à titre d'exemple de la façon suivante :</p>		
		

Position 11-13 (Raccordement process)		
Option sélectionnée		Description
FMR51-54 FMR57	Axx	Bride (différentes tailles)
	Cxx	
	Kxx	
FMR50	GGF	Filet., PVDF
	RGF	
	UAE	Étrier de fixation
	XR0	Système de montage utilisateur, sans bride/étrier de fixation
	XxG	Bride tournante (différentes tailles)

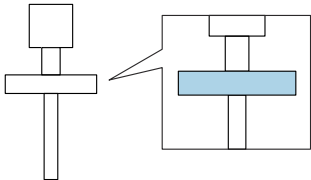
Position 11-13 (Raccordement process)		
Option sélectionnée	Description	
FMR51	Pxx	Bride (différentes tailles)
	Rxx	Filet.
	Txx	Tri-Clamp
FMR52	Mxx	Écrou fou
	Txx	Tri-Clamp
FMR53	Rxj	Filet., 316L
	RxF	Filet., PVDF
FMR56	UAE	Étrier de fixation
	XRO	Système de montage utilisateur, sans bride/étrier de fixation
	XxG	Bride tournante (différentes tailles)
FMR57	Rxj	Filet., 316L
	Xxj	Disp.orientation (différentes tailles)
<p> Représenté dans les tableaux de température à titre d'exemple de la façon suivante :</p> 		

Spécifications optionnelles

Identifiant Jx (Test, Certificat)		
Option sélectionnée	Description	
FMR51 ¹⁾ FMR52 FMR54 ²⁾	JN ³⁾	Transmetteur de température ambiante -50°C

- 1) Seulement en combinaison avec Position 9, 10 (Joint) = D2
- 2) Seulement en combinaison avec Position 9, 10 (Joint) = D1, D2
- 3) Seulement en combinaison avec Position 5 (Boîtier) = B, C

Généralités

 *Spécifications optionnelles, Identifiant Nx, Ox (Accessoire monté) = NA (Parafoudre type OVP20)*
En cas d'utilisation d'un parafoudre interne : réduire la température ambiante admissible au boîtier de 5 K.

Spécifications de base, Position 5 (Boîtier) = A

En cas d'utilisation d'un afficheur déporté FHX50 : réduire la température ambiante admissible au boîtier de 3 K.

 Tenir compte de la gamme de température admissible à l'antenne.

Remarques concernant la présentation

 Sauf indication contraire, les positions se réfèrent toujours aux spécifications de base.

1ère colonne : Position 5 (Boîtier) = A, B, ...

2e colonne : Position 3 (Alimentation, sortie) = A, B, ..



- (1) : 1 voie utilisée
- (2) : 2 voies utilisées

3e colonne : Classes de température T6 (85 °C) à T1 (450 °C)

Colonnes P1 à P6 : Position (valeur de température) sur l'axe du déclassement

- T_a : Température ambiante en °C
- T_p : Température de process en °C

 La colonne P6 ne s'applique qu'à la version B du déclassement.

→  10,  48

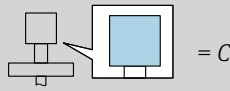
	(1)	P1		P2		P3		P4		P5		P6		
		T _p	T _a	T _p	T _a	T _p	T _a	T _p	T _a	T _p	T _a	T _p	T _a	
	E, G	T6	-40	60	60	60	85	53	85	-40	-40	-40	-	-
		T5	-40	75	75	75	100	68	100	-40	-40	-40	-	-
		T4	-40	80	80	80	135	67	135	-40	-40	-40	-	-
		T3	-40	80	80	80	200	51	200	-40	-40	-40	-	-

A0038026-FR

Beispiel-Diagramme
 möglicher Deratings /
 Example diagrams
 of possible deratings /
 Exemple de diagrammes
 de déclassements possibles

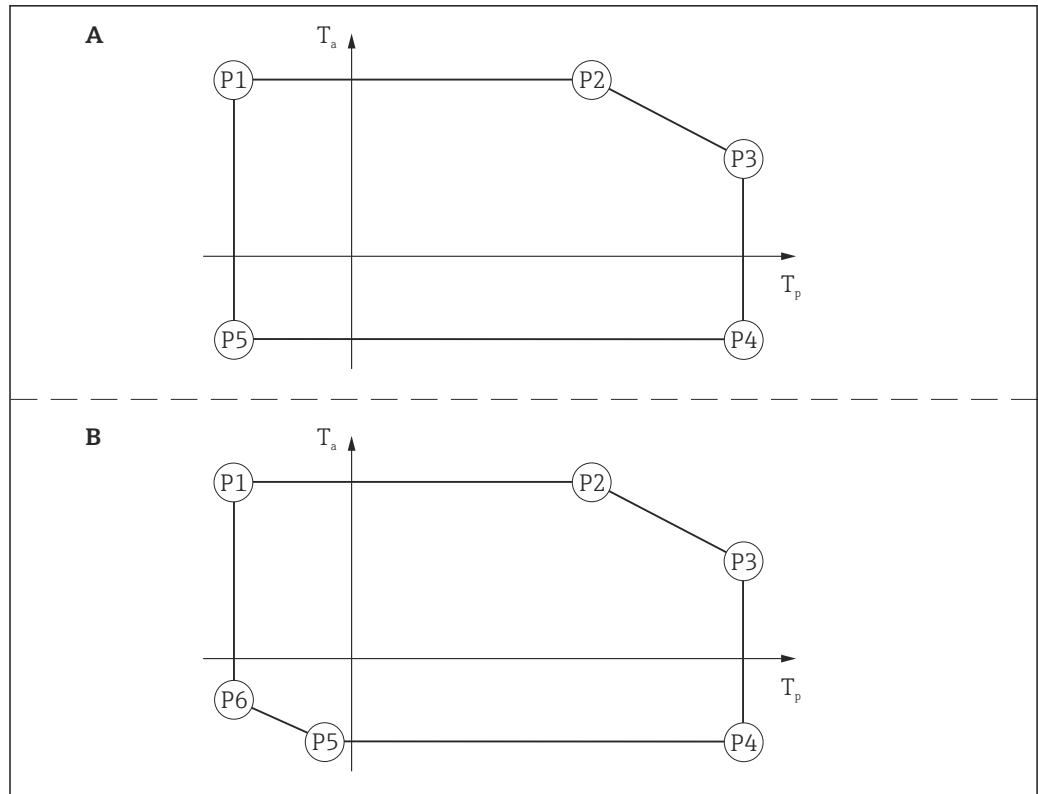

A0022717

Zone 0: 1 channel

DE
 Position 3 (Hilfsenergie, Ausgang) = E, G: 1 Kanal benutzt

EN
 Position 3 (Power Supply, Output) = E, G: 1 channel used

FR
 Position 3 (Alimentation, sortie) = E, G : 1 voie utilisée

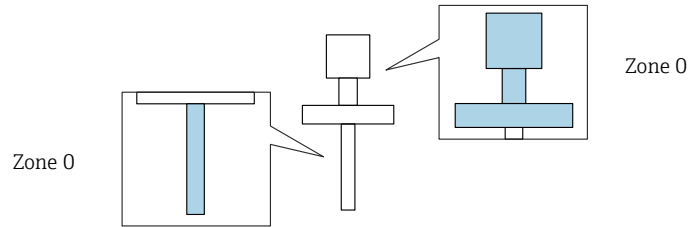

FMR5x

	(1)	P1		P2		P3		P4		P5		P6	
		T _p	T _a	T _p	T _a	T _p	T _a	T _p	T _a	T _p	T _a	T _p	T _a
E, G	T6	-20	48	48	48	60	42	60	-20	-20	-20	-	-
	T5	-20	58	58	58	60	57	60	-20	-20	-20	-	-
	T4	-20	60	60	60	60	60	60	-20	-20	-20	-	-

	(1)	P1		P2		P3		P4		P5		P6	
		T _p	T _a	T _p	T _a	T _p	T _a	T _p	T _a	T _p	T _a	T _p	T _a
E, G	T6	-20	48	48	48	60	45	60	-20	-20	-20	-	-
	T5	-20	60	60	60	60	60	60	-20	-20	-20	-	-

Zone 0: 2 channels

DE

Position 3 (Hilfsenergie, Ausgang) = E, G: 2 Kanäle benutzt

EN

Position 3 (Power Supply, Output) = E, G: 2 channels used

FR

Position 3 (Alimentation, sortie) = E, G : 2 voies utilisées

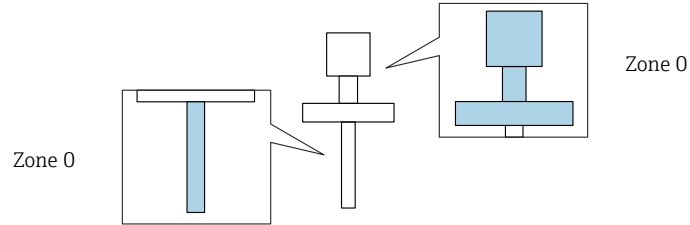

FMR5x

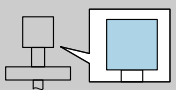
 = A	(2)	P1		P2		P3		P4		P5		P6		
		T _p	T _a	T _p	T _a	T _p	T _a	T _p	T _a	T _p	T _a	T _p	T _a	
	E, G	T6	-20	39	39	39	60	34	60	-20	-20	-20	-	-
		T5	-20	51	51	51	60	49	60	-20	-20	-20	-	-
		T4	-20	56	56	56	60	55	60	-20	-20	-20	-	-

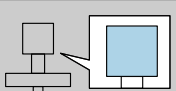
 = B, C	(2)	P1		P2		P3		P4		P5		P6		
		T _p	T _a	T _p	T _a	T _p	T _a	T _p	T _a	T _p	T _a	T _p	T _a	
	E, G	T6	-20	45	45	45	60	42	60	-20	-20	-20	-	-
		T5	-20	57	57	57	60	57	60	-20	-20	-20	-	-
		T4	-20	60	60	60	60	60	60	-20	-20	-20	-	-

Zone 0, Zone 1: 1 channel

DE

Position 3 (Hilfsenergie, Ausgang) = E, G: 1 Kanal benutzt

EN

Position 3 (Power Supply, Output) = E, G: 1 channel used

FR

Position 3 (Alimentation, sortie) = E, G : 1 voie utilisée

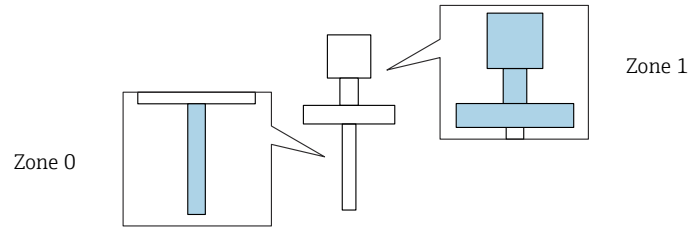

FMR5x

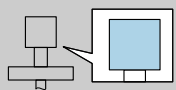
 = A	(1)		P1		P2		P3		P4		P5		P6	
			T _p	T _a	T _p	T _a	T _p	T _a	T _p	T _a	T _p	T _a	T _p	T _a
	E, G	T6	-20	58	58	58	58	58	58	-40	-20	-40	-	-
		T5	-20	73	60	73	60	73	60	-40	-20	-40	-	-
		T4	-20	74	60	74	60	74	60	-40	-20	-40	-	-

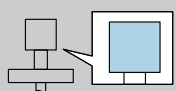
 = B, C	(1)		P1		P2		P3		P4		P5		P6	
			T _p	T _a	T _p	T _a	T _p	T _a	T _p	T _a	T _p	T _a	T _p	T _a
	E, G	T6	-20	60	60	60	60	60	60	-40 -50 ¹⁾	-20	-40 -50 ¹⁾	-	-
		T5	-20	75	60	75	60	75	60	-40 -50 ¹⁾	-20	-40 -50 ¹⁾	-	-
		T4	-20	80	60	80	60	80	60	-40 -50 ¹⁾	-20	-40 -50 ¹⁾	-	-

1) Nur in Zusammenhang mit Optionale Spezifikation, Kennung Jx (Test, Zeugnis) = JN /
 Only in connection with Optional specification, ID Jx (Test, Certificate) = JN /
 Seulement en combinaison avec Spécification optionnelle, Identifiant Jx (Test, certificat) = JN

Zone 0, Zone 1: 2 channels

DE

Position 3 (Hilfsenergie, Ausgang) = E, G: 2 Kanäle benutzt

EN

Position 3 (Power Supply, Output) = E, G: 2 channels used

FR

Position 3 (Alimentation, sortie) = E, G : 2 voies utilisées

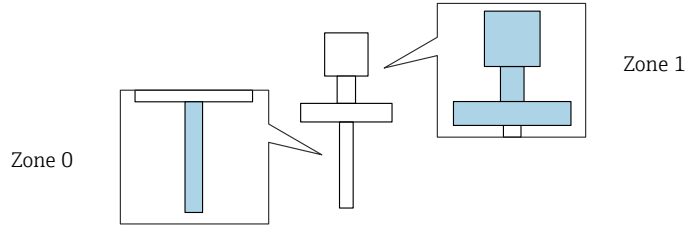

FMR5x

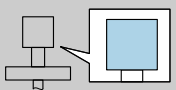
 = A	(2)	P1		P2		P3		P4		P5		P6	
		T _p	T _a	T _p	T _a	T _p	T _a	T _p	T _a	T _p	T _a	T _p	T _a
E, G	T6	-20	51	51	51	60	49	60	-40	-20	-40	-	-
	T5	-20	56	56	56	60	55	60	-40	-20	-40	-	-

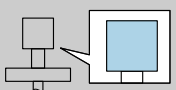
 = B, C	(2)	P1		P2		P3		P4		P5		P6	
		T _p	T _a	T _p	T _a	T _p	T _a	T _p	T _a	T _p	T _a	T _p	T _a
E, G	T6	-20	57	57	57	57	57	57	-40 -50 ¹⁾	-20	-40 -50 ¹⁾	-	-
	T5	-20	72	60	72	60	72	60	-40 -50 ¹⁾	-20	-40 -50 ¹⁾	-	-
	T4	-20	76	60	76	60	76	60	-40 -50 ¹⁾	-20	-40 -50 ¹⁾	-	-

1) Nur in Zusammenhang mit Optionale Spezifikation, Kennung Jx (Test, Zeugnis) = JN /
 Only in connection with Optional specification, ID Jx (Test, Certificate) = JN /
 Seulement en combinaison avec Spécification optionnelle, Identifiant Jx (Test, certificat) = JN

Zone 1: 1 channel

DE

Position 3 (Hilfsenergie, Ausgang) = E, G: 1 Kanal benutzt

Seitenverweise zu den Temperaturtabellen des jeweiligen Gerätetyps: Siehe folgende Auflistung.

EN

Position 3 (Power Supply, Output) = E, G: 1 channel used

Page references to the temperature tables of the respective device types: See the following list.

FR

Position 3 (Alimentation, sortie) = E, G : 1 voie utilisée

Renvois aux tables de température du type d'appareil concerné : Voir liste ci-dessous.

- FMR50 → 53
- FMR51 → 54
- FMR52 → 58
- FMR53 → 60
- FMR54 → 62
- FMR56 → 68
- FMR57 → 69

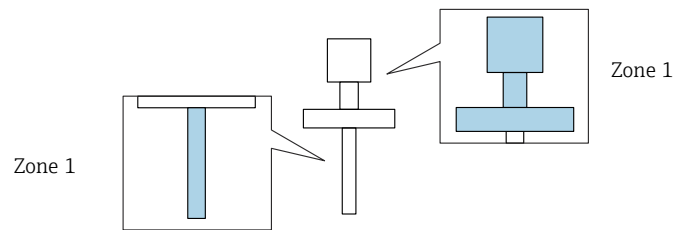

FMR50

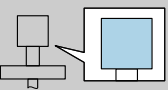
 = A	(1)		P1		P2		P3		P4		P5		P6	
			T _p	T _a	T _p	T _a	T _p	T _a	T _p	T _a	T _p	T _a	T _p	T _a
	E, G	T6	-40	58	58	58	80	55	80	-40	-40	-40	-	-

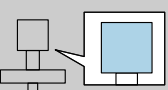
 = C	(1)		P1		P2		P3		P4		P5		P6	
			T _p	T _a	T _p	T _a	T _p	T _a	T _p	T _a	T _p	T _a	T _p	T _a
	E, G	T6	-40	60	60	60	80	58	80	-40	-40	-40	-	-

FMR51

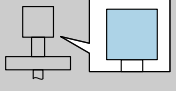
 = A	(1)	P1		P2		P3		P4		P5		P6		
		T _p	T _a	T _p	T _a	T _p	T _a	T _p	T _a	T _p	T _a	T _p	T _a	
	E, G	T6	-40	60	60	60	85	49	85	-40	-40	-40	-	-
		T5	-40	74	74	74	100	64	100	-40	-40	-40	-	-
		T4	-40	74	74	74	135	58	135	-40	-40	-40	-	-
		T3 ¹⁾	-40	74	74	74	150	55	150	-40	-40	-40	-	-

1) Funktional: Maximal zulässige Prozesstemperatur / Functional: Max. permissible process temperature /
Fonctionnel : Température de process admissible max.

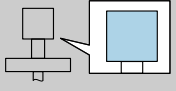
 = B	(1)	P1		P2		P3		P4		P5		P6		
		T _p	T _a	T _p	T _a	T _p	T _a	T _p	T _a	T _p	T _a	T _p	T _a	
	E, G	T6	-40	60	60	60	85	54	85	-40	-40	-40	-	-
		T5	-40	75	75	75	100	69	100	-40	-40	-40	-	-
		T4	-40	80	81	80	135	69	135	-40	-40	-40	-	-
		T3 ¹⁾	-40	80	81	80	150	66	150	-40	-40	-40	-	-

1) Funktional: Maximal zulässige Prozesstemperatur / Functional: Max. permissible process temperature /
Fonctionnel : Température de process admissible max.

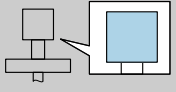
 = C	(1)	P1		P2		P3		P4		P5		P6		
		T _p	T _a	T _p	T _a	T _p	T _a	T _p	T _a	T _p	T _a	T _p	T _a	
	E, G	T6	-40	60	60	60	85	55	85	-40	-40	-40	-	-
		T5	-40	75	75	75	100	70	100	-40	-40	-40	-	-
		T4	-40	80	81	80	135	71	135	-40	-40	-40	-	-
		T3 ¹⁾	-40	80	81	80	150	68	150	-40	-40	-40	-	-

1) Funktional: Maximal zulässige Prozesstemperatur / Functional: Max. permissible process temperature /
Fonctionnel : Température de process admissible max.

FMR51

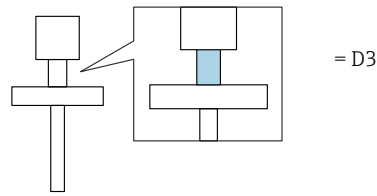

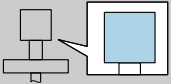
 = A	(1)	P1		P2		P3		P4		P5		P6		
		T _p	T _a	T _p	T _a	T _p	T _a	T _p	T _a	T _p	T _a	T _p	T _a	
	E, G	T6	-40	60	60	60	85	54	85	-40	-40	-40	-	-
		T5	-40	74	74	74	100	69	100	-40	-40	-40	-	-
		T4	-40	74	74	74	135	64	135	-40	-40	-40	-	-
		T3	-40	74	74	74	200	55	200	-40	-40	-40	-	-
		T2 ¹⁾	-40	74	74	74	250	44	250	-40	-40	-40	-	-

1) Funktional: Maximal zulässige Prozesstemperatur / Functional: Max. permissible process temperature /
Fonctionnel : Température de process admissible max.

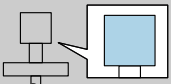
 = B	(1)	P1		P2		P3		P4		P5		P6		
		T _p	T _a	T _p	T _a	T _p	T _a	T _p	T _a	T _p	T _a	T _p	T _a	
	E, G	T6	-40	60	60	60	85	57	85	-40	-40	-40	-	-
		T5	-40	75	75	75	100	72	100	-40	-40	-40	-	-
		T4	-40	80	81	80	135	75	135	-40	-40	-40	-	-
		T3	-40	80	81	80	200	68	200	-40	-40	-40	-	-
		T2 ¹⁾	-40	80	81	80	250	63	250	-40	-40	-40	-	-

1) Funktional: Maximal zulässige Prozesstemperatur / Functional: Max. permissible process temperature /
Fonctionnel : Température de process admissible max.

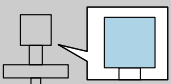
 = C	(1)	P1		P2		P3		P4		P5		P6		
		T _p	T _a	T _p	T _a	T _p	T _a	T _p	T _a	T _p	T _a	T _p	T _a	
	E, G	T6	-40	60	60	60	85	58	85	-40	-40	-40	-	-
		T5	-40	75	75	75	100	73	100	-40	-40	-40	-	-
		T4	-40	80	81	80	135	76	135	-40	-40	-40	-	-
		T3	-40	80	81	80	200	71	200	-40	-40	-40	-	-
		T2 ¹⁾	-40	80	81	80	250	67	250	-40	-40	-40	-	-

1) Funktional: Maximal zulässige Prozesstemperatur / Functional: Max. permissible process temperature /
Fonctionnel : Température de process admissible max.

FMR51

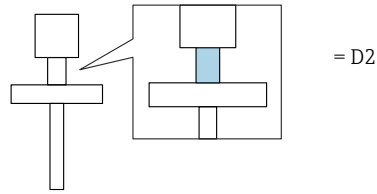

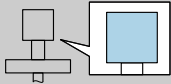
 = A	(1)	P1		P2		P3		P4		P5		P6		
		T _p	T _a	T _p	T _a	T _p	T _a	T _p	T _a	T _p	T _a	T _p	T _a	
	E, G	T6	-196	60	60	60	85	52	85	-40	-40	-40	-196	9
		T5	-196	74	74	74	100	67	100	-40	-40	-40	-196	9
		T4	-196	74	74	74	135	62	135	-40	-40	-40	-196	9
		T3	-196	74	74	74	200	49	200	-40	-40	-40	-196	9

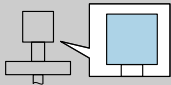
 = B	(1)	P1		P2		P3		P4		P5		P6		
		T _p	T _a	T _p	T _a	T _p	T _a	T _p	T _a	T _p	T _a	T _p	T _a	
	E, G	T6	-196	60	60	60	85	56	85	-40 -50 ¹⁾	-40 -50 ¹⁾	-40 -50 ¹⁾	-196	-15
		T5	-196	75	75	75	100	71	100	-40 -50 ¹⁾	-40 -50 ¹⁾	-40 -50 ¹⁾	-196	-15
		T4	-196	80	81	80	135	73	135	-40 -50 ¹⁾	-40 -50 ¹⁾	-40 -50 ¹⁾	-196	-15
		T3	-196	80	81	80	200	64	200	-40 -50 ¹⁾	-40 -50 ¹⁾	-40 -50 ¹⁾	-196	-15
		T2	-196	80	81	80	300	50	300	-40 -50 ¹⁾	-40 -50 ¹⁾	-40 -50 ¹⁾	-196	-15

1) Nur in Zusammenhang mit Optionale Spezifikation, Kennung Jx (Test, Zeugnis) = JN /
 Only in connection with Optional specification, ID Jx (Test, Certificate) = JN /
 Seulement en combinaison avec Spécification optionnelle, Identifiant Jx (Test, certificat) = JN

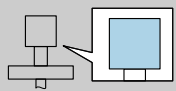
	(1)	P1		P2		P3		P4		P5		P6		
		T _p	T _a	T _p	T _a	T _p	T _a	T _p	T _a	T _p	T _a	T _p	T _a	
	E, G	T6	-196	60	60	60	85	57	85	-40 -50 ¹⁾	-40 -50 ¹⁾	-40 -50 ¹⁾	-196	-20 -28 ¹⁾
		T5	-196	75	75	75	100	72	100	-40 -50 ¹⁾	-40 -50 ¹⁾	-40 -50 ¹⁾	-196	-20 -28 ¹⁾
		T4	-196	80	81	80	135	75	135	-40 -50 ¹⁾	-40 -50 ¹⁾	-40 -50 ¹⁾	-196	-20 -28 ¹⁾
		T3	-196	80	81	80	200	68	200	-40 -50 ¹⁾	-40 -50 ¹⁾	-40 -50 ¹⁾	-196	-20 -28 ¹⁾
		T2	-196	80	81	80	300	57	300	-40 -50 ¹⁾	-40 -50 ¹⁾	-40 -50 ¹⁾	-196	-20 -28 ¹⁾
		T1	-196	80	81	80	450	39	450	-40 -50 ¹⁾	-40 -50 ¹⁾	-40 -50 ¹⁾	-196	-20 -28 ¹⁾

- 1) Nur in Zusammenhang mit Optionale Spezifikation, Kennung Jx (Test, Zeugnis) = JN /
 Only in connection with Optional specification, ID Jx (Test, Certificate) = JN /
 Seulement en combinaison avec Spécification optionnelle, Identifiant Jx (Test, certificat) = JN

FMR52

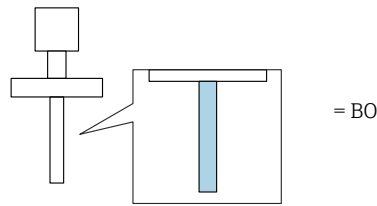

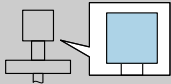
 = A	(1)	P1		P2		P3		P4		P5		P6		
		T _p	T _a	T _p	T _a	T _p	T _a	T _p	T _a	T _p	T _a	T _p	T _a	
	E, G	T6	-40	60	60	60	85	51	85	-40	-40	-40	-	-
		T5	-40	74	74	74	100	66	100	-40	-40	-40	-	-
		T4	-40	74	74	74	135	60	135	-40	-40	-40	-	-
		T3	-40	74	74	74	200	42	200	-40	-40	-40	-	-

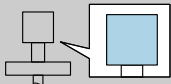
 = B	(1)	P1		P2		P3		P4		P5		P6		
		T _p	T _a	T _p	T _a	T _p	T _a	T _p	T _a	T _p	T _a	T _p	T _a	
	E, G	T6	-196	60	60	60	85	55	85	-40 -50 ¹⁾	-40 -50 ¹⁾	-40 -50 ¹⁾	-196	-3
		T5	-196	75	75	75	100	70	100	-40 -50 ¹⁾	-40 -50 ¹⁾	-40 -50 ¹⁾	-196	-3
		T4	-196	80	81	80	135	71	135	-40 -50 ¹⁾	-40 -50 ¹⁾	-40 -50 ¹⁾	-196	-3
		T3	-196	80	81	80	200	60	200	-40 -50 ¹⁾	-40 -50 ¹⁾	-40 -50 ¹⁾	-196	-3

1) Nur in Zusammenhang mit Optionale Spezifikation, Kennung Jx (Test, Zeugnis) = JN /
 Only in connection with Optional specification, ID Jx (Test, Certificate) = JN /
 Seulement en combinaison avec Spécification optionnelle, Identifiant Jx (Test, certificat) = JN

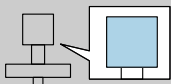
 = C	(1)	P1		P2		P3		P4		P5		P6		
		T _p	T _a	T _p	T _a	T _p	T _a	T _p	T _a	T _p	T _a	T _p	T _a	
	E, G	T6	-196	60	60	60	85	56	85	-40 -50 ¹⁾	-40 -50 ¹⁾	-40 -50 ¹⁾	-196	-14
		T5	-196	75	75	75	100	71	100	-40 -50 ¹⁾	-40 -50 ¹⁾	-40 -50 ¹⁾	-196	-14
		T4	-196	80	81	80	135	73	135	-40 -50 ¹⁾	-40 -50 ¹⁾	-40 -50 ¹⁾	-196	-14
		T3	-196	80	81	80	200	64	200	-40 -50 ¹⁾	-40 -50 ¹⁾	-40 -50 ¹⁾	-196	-14

1) Nur in Zusammenhang mit Optionale Spezifikation, Kennung Jx (Test, Zeugnis) = JN /
 Only in connection with Optional specification, ID Jx (Test, Certificate) = JN /
 Seulement en combinaison avec Spécification optionnelle, Identifiant Jx (Test, certificat) = JN

FMR52

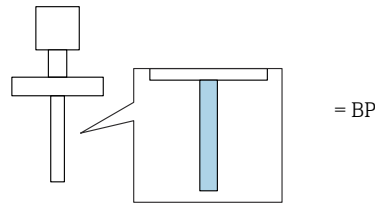

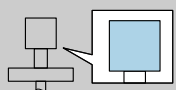
 = A	(1)	P1		P2		P3		P4		P5		P6		
		T _p	T _a	T _p	T _a	T _p	T _a	T _p	T _a	T _p	T _a	T _p	T _a	
	E, G	T6	-40	60	60	60	85	49	85	-40	-40	-40	-	-
		T5	-40	74	74	74	100	64	100	-40	-40	-40	-	-
		T4	-40	74	74	74	135	59	135	-40	-40	-40	-	-
		T3	-40	74	74	74	200	36	200	-40	-40	-40	-	-

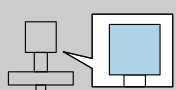
 = B	(1)	P1		P2		P3		P4		P5		P6		
		T _p	T _a	T _p	T _a	T _p	T _a	T _p	T _a	T _p	T _a	T _p	T _a	
	E, G	T6	-196	60	60	60	85	54	85	-40 -50 ¹⁾	-40 -50 ¹⁾	-40 -50 ¹⁾	-196	10
		T5	-196	75	75	75	100	69	100	-40 -50 ¹⁾	-40 -50 ¹⁾	-40 -50 ¹⁾	-196	10
		T4	-196	80	81	80	135	69	135	-40 -50 ¹⁾	-40 -50 ¹⁾	-40 -50 ¹⁾	-196	10
		T3	-196	80	81	80	200	56	200	-40 -50 ¹⁾	-40 -50 ¹⁾	-40 -50 ¹⁾	-196	10

- 1) Nur in Zusammenhang mit Optionale Spezifikation, Kennung Jx (Test, Zeugnis) = JN /
 Only in connection with Optional specification, ID Jx (Test, Certificate) = JN /
 Seulement en combinaison avec Spécification optionnelle, Identifiant Jx (Test, certificat) = JN

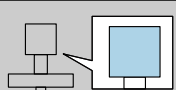
 = C	(1)	P1		P2		P3		P4		P5		P6		
		T _p	T _a	T _p	T _a	T _p	T _a	T _p	T _a	T _p	T _a	T _p	T _a	
	E, G	T6	-196	60	60	60	85	55	85	-40 -50 ¹⁾	-40 -50 ¹⁾	-40 -50 ¹⁾	-196	-8
		T5	-196	75	75	75	100	70	100	-40 -50 ¹⁾	-40 -50 ¹⁾	-40 -50 ¹⁾	-196	-8
		T4	-196	80	81	80	135	72	135	-40 -50 ¹⁾	-40 -50 ¹⁾	-40 -50 ¹⁾	-196	-8
		T3	-196	80	81	80	200	61	200	-40 -50 ¹⁾	-40 -50 ¹⁾	-40 -50 ¹⁾	-196	-8

- 1) Nur in Zusammenhang mit Optionale Spezifikation, Kennung Jx (Test, Zeugnis) = JN /
 Only in connection with Optional specification, ID Jx (Test, Certificate) = JN /
 Seulement en combinaison avec Spécification optionnelle, Identifiant Jx (Test, certificat) = JN

FMR53

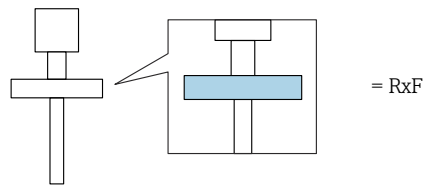

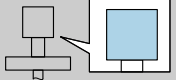
 = A	(1)		P1		P2		P3		P4		P5		P6	
			T _p	T _a	T _p	T _a	T _p	T _a	T _p	T _a	T _p	T _a	T _p	T _a
	E, G	T6	-40	58	58	58	80	55	80	-40	-40	-40	-	-

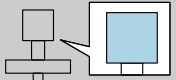
 = B, C	(1)		P1		P2		P3		P4		P5		P6	
			T _p	T _a	T _p	T _a	T _p	T _a	T _p	T _a	T _p	T _a	T _p	T _a
	E, G	T6	-40	60	60	60	80	58	80	-40	-40	-40	-	-

FMR53

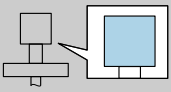
 = A	(1)	P1		P2		P3		P4		P5		P6		
		T _p	T _a	T _p	T _a	T _p	T _a	T _p	T _a	T _p	T _a	T _p	T _a	
	E, G	T6	-40	60	60	60	85	48	85	-40	-40	-40	-	-
		T5	-40	74	74	74	100	63	100	-40	-40	-40	-	-
		T4	-40	74	74	74	135	58	135	-40	-40	-40	-	-
		T3 ¹⁾	-40	74	74	74	150	54	150	-40	-40	-40	-	-

1) Funktional: Maximal zulässige Prozesstemperatur / Functional: Max. permissible process temperature /
Fonctionnel : Température de process admissible max.

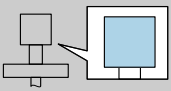
 = B	(1)	P1		P2		P3		P4		P5		P6		
		T _p	T _a	T _p	T _a	T _p	T _a	T _p	T _a	T _p	T _a	T _p	T _a	
	E, G	T6	-40	60	60	60	85	53	85	-40	-40	-40	-	-
		T5	-40	75	75	75	100	68	100	-40	-40	-40	-	-
		T4	-40	80	81	80	135	68	135	-40	-40	-40	-	-
		T3 ¹⁾	-40	80	81	80	150	65	150	-40	-40	-40	-	-

1) Funktional: Maximal zulässige Prozesstemperatur / Functional: Max. permissible process temperature /
Fonctionnel : Température de process admissible max.

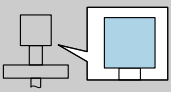
 = C	(1)	P1		P2		P3		P4		P5		P6		
		T _p	T _a	T _p	T _a	T _p	T _a	T _p	T _a	T _p	T _a	T _p	T _a	
	E, G	T6	-40	60	60	60	85	54	85	-40	-40	-40	-	-
		T5	-40	75	75	75	100	70	100	-40	-40	-40	-	-
		T4	-40	80	81	80	135	70	135	-40	-40	-40	-	-
		T3 ¹⁾	-40	80	81	80	150	67	150	-40	-40	-40	-	-

1) Funktional: Maximal zulässige Prozesstemperatur / Functional: Max. permissible process temperature /
Fonctionnel : Température de process admissible max.

FMR54

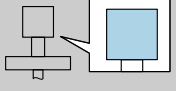
 = A	(1)	P1		P2		P3		P4		P5		P6		
		T _p	T _a	T _p	T _a	T _p	T _a	T _p	T _a	T _p	T _a	T _p	T _a	
	E, G	T6	-40	60	60	60	85	48	85	-40	-40	-40	-	-
		T5	-40	74	74	74	100	63	100	-40	-40	-40	-	-
		T4	-40	74	74	74	135	57	135	-40	-40	-40	-	-

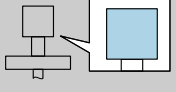
 = B	(1)	P1		P2		P3		P4		P5		P6		
		T _p	T _a	T _p	T _a	T _p	T _a	T _p	T _a	T _p	T _a	T _p	T _a	
	E, G	T6	-40	60	60	60	85	53	85	-40	-40	-40	-	-
		T5	-40	75	75	75	100	68	100	-40	-40	-40	-	-
		T4	-40	80	81	80	135	67	135	-40	-40	-40	-	-
		T3	-40	80	81	80	200	52	200	-40	-40	-40	-	-

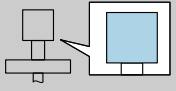
 = C	(1)	P1		P2		P3		P4		P5		P6		
		T _p	T _a	T _p	T _a	T _p	T _a	T _p	T _a	T _p	T _a	T _p	T _a	
	E, G	T6	-40	60	60	60	85	54	85	-40	-40	-40	-	-
		T5	-40	75	75	75	100	69	100	-40	-40	-40	-	-
		T4	-40	80	81	80	135	70	135	-40	-40	-40	-	-
		T3	-40	80	81	80	200	57	200	-40	-40	-40	-	-

FMR54

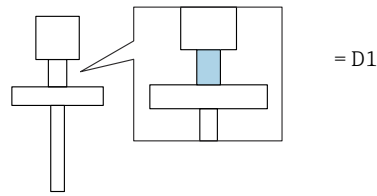

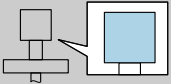
 = A	(1)		P1		P2		P3		P4		P5		P6	
			T _p	T _a	T _p	T _a	T _p	T _a	T _p	T _a	T _p	T _a	T _p	T _a
	E, G	T6	-196	60	60	60	85	51	85	-40	-40	-40	-196	18
		T5	-196	74	74	74	100	66	100	-40	-40	-40	-196	18
		T4	-196	74	74	74	135	61	135	-40	-40	-40	-196	18
		T3	-196	74	74	74	200	42	200	-40	-40	-40	-196	18

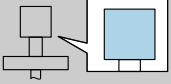
 = B	(1)		P1		P2		P3		P4		P5		P6	
			T _p	T _a	T _p	T _a	T _p	T _a	T _p	T _a	T _p	T _a	T _p	T _a
	E, G	T6	-196	60	60	60	85	55	85	-40 -50 ¹⁾	-40 -50 ¹⁾	-40 -50 ¹⁾	-196	-4
		T5	-196	75	75	75	100	70	100	-40 -50 ¹⁾	-40 -50 ¹⁾	-40 -50 ¹⁾	-196	-4
		T4	-196	80	81	80	135	71	135	-40 -50 ¹⁾	-40 -50 ¹⁾	-40 -50 ¹⁾	-196	-4
		T3	-196	80	81	80	200	60	200	-40 -50 ¹⁾	-40 -50 ¹⁾	-40 -50 ¹⁾	-196	-4
		T2 ²⁾	-196	80	81	80	280	46	280	-40 -50 ¹⁾	-40 -50 ¹⁾	-40 -50 ¹⁾	-196	-4

- 1) Nur in Zusammenhang mit Optionale Spezifikation, Kennung Jx (Test, Zeugnis) = JN /
Only in connection with Optional specification, ID Jx (Test, Certificate) = JN /
Seulement en combinaison avec Spécification optionnelle, Identifiant Jx (Test, certificat) = JN
- 2) Funktional: Maximal zulässige Prozesstemperatur / Functional: Max. permissible process temperature /
Fonctionnel : Température de process admissible max.

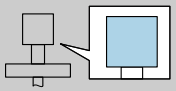
 = C	(1)	P1		P2		P3		P4		P5		P6		
		T _p	T _a	T _p	T _a	T _p	T _a	T _p	T _a	T _p	T _a	T _p	T _a	
	E, G	T6	-196	60	60	60	85	56	85	-40 -50 ¹⁾	-40 -50 ¹⁾	-40 -50 ¹⁾	-196	-15
		T5	-196	75	75	75	100	71	100	-40 -50 ¹⁾	-40 -50 ¹⁾	-40 -50 ¹⁾	-196	-15
		T4	-196	80	81	80	135	73	135	-40 -50 ¹⁾	-40 -50 ¹⁾	-40 -50 ¹⁾	-196	-15
		T3	-196	80	81	80	200	64	200	-40 -50 ¹⁾	-40 -50 ¹⁾	-40 -50 ¹⁾	-196	-15
		T2 ²⁾	-196	80	81	80	280	53	280	-40 -50 ¹⁾	-40 -50 ¹⁾	-40 -50 ¹⁾	-196	-15

- 1) Nur in Zusammenhang mit Optionale Spezifikation, Kennung Jx (Test, Zeugnis) = JN /
 Only in connection with Optional specification, ID Jx (Test, Certificate) = JN /
 Seulement en combinaison avec Spécification optionnelle, Identifiant Jx (Test, certificat) = JN
- 2) Funktional: Maximal zulässige Prozesstemperatur / Functional: Max. permissible process temperature /
 Fonctionnel : Température de process admissible max.

FMR54

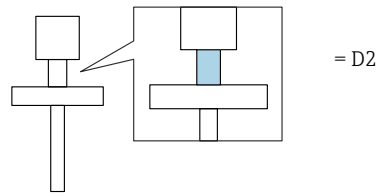

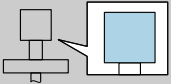
 = A	(1)	P1		P2		P3		P4		P5		P6		
		T _p	T _a	T _p	T _a	T _p	T _a	T _p	T _a	T _p	T _a	T _p	T _a	
	E, G	T6	-196	60	60	60	85	52	85	-40	-40	-40	-196	11
		T5	-196	74	74	74	100	67	100	-40	-40	-40	-196	11
		T4	-196	74	74	74	135	62	135	-40	-40	-40	-196	11
		T3	-196	74	74	74	200	47	200	-40	-40	-40	-196	11

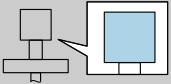
 = B	(1)	P1		P2		P3		P4		P5		P6		
		T _p	T _a	T _p	T _a	T _p	T _a	T _p	T _a	T _p	T _a	T _p	T _a	
	E, G	T6	-196	60	60	60	85	56	85	-40 -50 ¹⁾	-40 -50 ¹⁾	-40 -50 ¹⁾	-196	-13
		T5	-196	75	75	75	100	71	100	-40 -50 ¹⁾	-40 -50 ¹⁾	-40 -50 ¹⁾	-196	-13
		T4	-196	80	81	80	135	73	135	-40 -50 ¹⁾	-40 -50 ¹⁾	-40 -50 ¹⁾	-196	-13
		T3	-196	80	81	80	200	63	200	-40 -50 ¹⁾	-40 -50 ¹⁾	-40 -50 ¹⁾	-196	-13
		T2	-196	80	81	80	300	48	300	-40 -50 ¹⁾	-40 -50 ¹⁾	-40 -50 ¹⁾	-196	-13
		T1 ²⁾	-196	80	81	80	400	31	400	-40 -50 ¹⁾	-40 -50 ¹⁾	-40 -50 ¹⁾	-196	-13

- 1) Nur in Zusammenhang mit Optionale Spezifikation, Kennung Jx (Test, Zeugnis) = JN /
Only in connection with Optional specification, ID Jx (Test, Certificate) = JN /
Seulement en combinaison avec Spécification optionnelle, Identifiant Jx (Test, certificat) = JN
- 2) Funktional: Maximal zulässige Prozesstemperatur / Functional: Max. permissible process temperature /
Fonctionnel : Température de process admissible max.

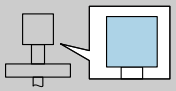
 = C	(1)	P1		P2		P3		P4		P5		P6		
		T _p	T _a	T _p	T _a	T _p	T _a	T _p	T _a	T _p	T _a	T _p	T _a	
	E, G	T6	-196	60	60	60	85	57	85	-40 -50 ¹⁾	-40 -50 ¹⁾	-40 -50 ¹⁾	-196	-19 -26 ¹⁾
		T5	-196	75	75	75	100	72	100	-40 -50 ¹⁾	-40 -50 ¹⁾	-40 -50 ¹⁾	-196	-19 -26 ¹⁾
		T4	-196	80	81	80	135	74	135	-40 -50 ¹⁾	-40 -50 ¹⁾	-40 -50 ¹⁾	-196	-19 -26 ¹⁾
		T3	-196	80	81	80	200	67	200	-40 -50 ¹⁾	-40 -50 ¹⁾	-40 -50 ¹⁾	-196	-19 -26 ¹⁾
		T2	-196	80	81	80	300	55	300	-40 -50 ¹⁾	-40 -50 ¹⁾	-40 -50 ¹⁾	-196	-19 -26 ¹⁾
		T1 ²⁾	-196	80	81	80	400	42	400	-40 -50 ¹⁾	-40 -50 ¹⁾	-40 -50 ¹⁾	-196	-19 -26 ¹⁾

- 1) Nur in Zusammenhang mit Optionale Spezifikation, Kennung Jx (Test, Zeugnis) = JN /
 Only in connection with Optional specification, ID Jx (Test, Certificate) = JN /
 Seulement en combinaison avec Spécification optionnelle, Identifiant Jx (Test, certificat) = JN
- 2) Funktional: Maximal zulässige Prozesstemperatur / Functional: Max. permissible process temperature /
 Fonctionnel : Température de process admissible max.

FMR54

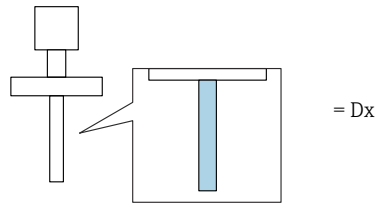

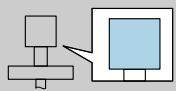
 = A	(1)	P1		P2		P3		P4		P5		P6		
		T _p	T _a	T _p	T _a	T _p	T _a	T _p	T _a	T _p	T _a	T _p	T _a	
	E, G	T6	-40	60	60	60	85	50	85	-40	-40	-40	-	-
		T5	-40	74	74	74	100	65	100	-40	-40	-40	-	-
		T4	-40	74	74	74	135	60	135	-40	-40	-40	-	-
		T3 ¹⁾	-40	74	74	74	150	57	150	-40	-40	-40	-	-

1) Funktional: Maximal zulässige Prozesstemperatur / Functional: Max. permissible process temperature /
Fonctionnel : Température de process admissible max.

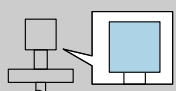
 = B	(1)	P1		P2		P3		P4		P5		P6		
		T _p	T _a	T _p	T _a	T _p	T _a	T _p	T _a	T _p	T _a	T _p	T _a	
	E, G	T6	-40	60	60	60	85	55	85	-40	-40	-40	-	-
		T5	-40	75	75	75	100	70	100	-40	-40	-40	-	-
		T4	-40	80	81	80	135	71	135	-40	-40	-40	-	-
		T3 ¹⁾	-40	80	81	80	150	68	150	-40	-40	-40	-	-

1) Funktional: Maximal zulässige Prozesstemperatur / Functional: Max. permissible process temperature /
Fonctionnel : Température de process admissible max.

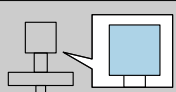
 = C	(1)	P1		P2		P3		P4		P5		P6		
		T _p	T _a	T _p	T _a	T _p	T _a	T _p	T _a	T _p	T _a	T _p	T _a	
	E, G	T6	-40	60	60	60	85	56	85	-40	-40	-40	-	-
		T5	-40	75	75	75	100	71	100	-40	-40	-40	-	-
		T4	-40	80	81	80	135	73	135	-40	-40	-40	-	-
		T3 ¹⁾	-40	80	81	80	150	71	150	-40	-40	-40	-	-

1) Funktional: Maximal zulässige Prozesstemperatur / Functional: Max. permissible process temperature /
Fonctionnel : Température de process admissible max.

FMR56

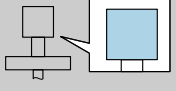
 = A	(1)		P1		P2		P3		P4		P5		P6	
			T _p	T _a	T _p	T _a	T _p	T _a	T _p	T _a	T _p	T _a	T _p	T _a
	E, G	T6	-40	58	58	58	80	55	80	-40	-40	-40	-	-

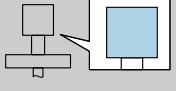
 = C	(1)		P1		P2		P3		P4		P5		P6	
			T _p	T _a	T _p	T _a	T _p	T _a	T _p	T _a	T _p	T _a	T _p	T _a
	E, G	T6	-40	60	60	60	80	58	80	-40	-40	-40	-	-

FMR57

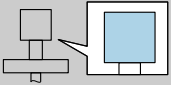
 = A	(1)	P1		P2		P3		P4		P5		P6		
		T _p	T _a	T _p	T _a	T _p	T _a	T _p	T _a	T _p	T _a	T _p	T _a	
	E, G	T6	-40	60	60	60	85	53	85	-40	-40	-40	-	-
		T5	-40	74	74	74	100	68	100	-40	-40	-40	-	-
		T4	-40	74	74	74	135	63	135	-40	-40	-40	-	-
		T3	-40	74	74	74	200	53	200	-40	-40	-40	-	-

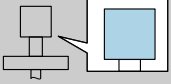
 = B	(1)	P1		P2		P3		P4		P5		P6		
		T _p	T _a	T _p	T _a	T _p	T _a	T _p	T _a	T _p	T _a	T _p	T _a	
	E, G	T6	-40	60	60	60	85	56	85	-40	-40	-40	-	-
		T5	-40	75	75	75	100	71	100	-40	-40	-40	-	-
		T4	-40	80	81	80	135	74	135	-40	-40	-40	-	-
		T3	-40	80	81	80	200	66	200	-40	-40	-40	-	-

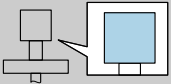
 = C	(1)	P1		P2		P3		P4		P5		P6		
		T _p	T _a	T _p	T _a	T _p	T _a	T _p	T _a	T _p	T _a	T _p	T _a	
	E, G	T6	-40	60	60	60	85	57	85	-40	-40	-40	-	-
		T5	-40	75	75	75	100	72	100	-40	-40	-40	-	-
		T4	-40	80	81	80	135	75	135	-40	-40	-40	-	-
		T3	-40	80	81	80	200	69	200	-40	-40	-40	-	-

FMR57

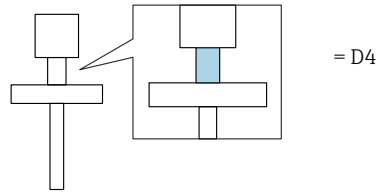

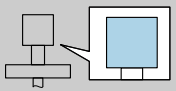
 = A	(1)	P1		P2		P3		P4		P5		P6		
		T _p	T _a	T _p	T _a	T _p	T _a	T _p	T _a	T _p	T _a	T _p	T _a	
	E, G	T6	-40	58	58	58	85	54	85	-40	-40	-40	-	-
		T5	-40	73	73	73	100	69	100	-40	-40	-40	-	-
		T4	-40	74	74	74	135	65	135	-40	-40	-40	-	-
		T3	-40	74	74	74	200	57	200	-40	-40	-40	-	-
		T2	-40	74	74	74	300	37	300	-40	-40	-40	-	-

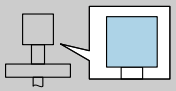
 = B	(1)	P1		P2		P3		P4		P5		P6		
		T _p	T _a	T _p	T _a	T _p	T _a	T _p	T _a	T _p	T _a	T _p	T _a	
	E, G	T6	-40	60	60	60	85	57	85	-40	-40	-40	-	-
		T5	-40	75	75	75	100	72	100	-40	-40	-40	-	-
		T4	-40	80	81	80	135	76	135	-40	-40	-40	-	-
		T3	-40	80	81	80	200	70	200	-40	-40	-40	-	-
		T2	-40	80	81	80	300	61	300	-40	-40	-40	-	-
		T1 ¹⁾	-40	80	81	80	400	51	400	-40	-40	-40	-	-

1) Funktional: Maximal zulässige Prozesstemperatur / Functional: Max. permissible process temperature /
Fonctionnel : Température de process admissible max.

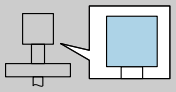
 = C	(1)	P1		P2		P3		P4		P5		P6		
		T _p	T _a	T _p	T _a	T _p	T _a	T _p	T _a	T _p	T _a	T _p	T _a	
	E, G	T6	-40	60	60	60	85	58	85	-40	-40	-40	-	-
		T5	-40	75	75	75	100	73	100	-40	-40	-40	-	-
		T4	-40	80	81	80	135	77	135	-40	-40	-40	-	-
		T3	-40	80	81	80	200	72	200	-40	-40	-40	-	-
		T2	-40	80	81	80	300	65	300	-40	-40	-40	-	-
		T1 ¹⁾	-40	80	81	80	400	58	400	-40	-40	-40	-	-

1) Funktional: Maximal zulässige Prozesstemperatur / Functional: Max. permissible process temperature /
Fonctionnel : Température de process admissible max.

Zone 1: 2 channels

DE

Position 3 (Hilfsenergie, Ausgang) = E, G: 2 Kanäle benutzt

Seitenverweise zu den Temperaturtabellen des jeweiligen Gerätetyps: Siehe folgende Auflistung.

EN

Position 3 (Power Supply, Output) = E, G: 2 channels used

Page references to the temperature tables of the respective device types: See the following list.

FR

Position 3 (Alimentation, sortie) = E, G : 2 voies utilisées

Renvois aux tables de température du type d'appareil concerné : Voir liste ci-dessous.

- FMR50 → 71
- FMR51 → 72
- FMR52 → 76
- FMR53 → 78
- FMR54 → 80
- FMR56 → 86
- FMR57 → 87

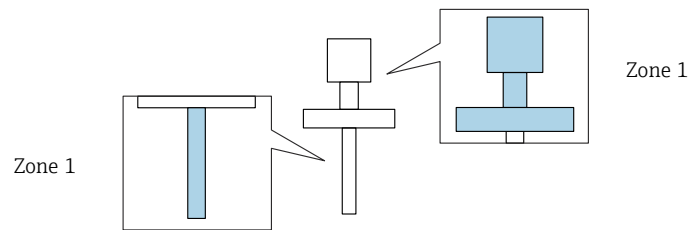

FMR50

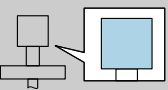
 = A	(2)		P1		P2		P3		P4		P5		P6	
			T _p	T _a	T _p	T _a	T _p	T _a	T _p	T _a	T _p	T _a	T _p	T _a
	E, G	T6	-40	51	51	51	80	47	80	-40	-40	-40	-	-

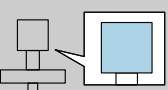
 = C	(2)		P1		P2		P3		P4		P5		P6	
			T _p	T _a	T _p	T _a	T _p	T _a	T _p	T _a	T _p	T _a	T _p	T _a
	E, G	T6	-40	57	57	57	80	55	80	-40	-40	-40	-	-

FMR51

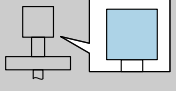
 = A	(2)	P1		P2		P3		P4		P5		P6		
		T _p	T _a	T _p	T _a	T _p	T _a	T _p	T _a	T _p	T _a	T _p	T _a	
	E, G	T6	-40	51	51	51	85	43	85	-40	-40	-40	-	-
		T5	-40	56	56	56	100	45	100	-40	-40	-40	-	-
		T4	-40	56	56	56	135	37	135	-40	-40	-40	-	-
		T3 ¹⁾	-40	56	56	56	150	33	150	-40	-40	-40	-	-

1) Funktional: Maximal zulässige Prozesstemperatur / Functional: Max. permissible process temperature /
Fonctionnel : Température de process admissible max.

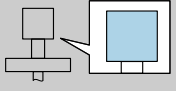
 = B	(2)	P1		P2		P3		P4		P5		P6		
		T _p	T _a	T _p	T _a	T _p	T _a	T _p	T _a	T _p	T _a	T _p	T _a	
	E, G	T6	-40	57	57	57	85	51	85	-40	-40	-40	-	-
		T5	-40	72	72	72	100	66	100	-40	-40	-40	-	-
		T4	-40	76	76	76	135	63	135	-40	-40	-40	-	-
		T3 ¹⁾	-40	76	76	76	150	60	150	-40	-40	-40	-	-

1) Funktional: Maximal zulässige Prozesstemperatur / Functional: Max. permissible process temperature /
Fonctionnel : Température de process admissible max.

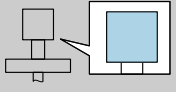
 = C	(2)	P1		P2		P3		P4		P5		P6		
		T _p	T _a	T _p	T _a	T _p	T _a	T _p	T _a	T _p	T _a	T _p	T _a	
	E, G	T6	-40	57	57	57	85	52	85	-40	-40	-40	-	-
		T5	-40	72	72	72	100	67	100	-40	-40	-40	-	-
		T4	-40	76	76	76	135	65	135	-40	-40	-40	-	-
		T3 ¹⁾	-40	76	76	76	150	63	150	-40	-40	-40	-	-

1) Funktional: Maximal zulässige Prozesstemperatur / Functional: Max. permissible process temperature /
Fonctionnel : Température de process admissible max.

FMR51

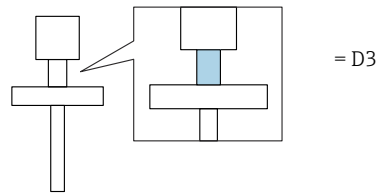

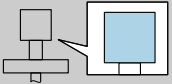
 = A	(2)	P1		P2		P3		P4		P5		P6		
		T _p	T _a	T _p	T _a	T _p	T _a	T _p	T _a	T _p	T _a	T _p	T _a	
	E, G	T6	-40	51	51	51	85	46	85	-40	-40	-40	-	-
		T5	-40	56	56	56	100	50	100	-40	-40	-40	-	-
		T4	-40	56	56	56	135	45	135	-40	-40	-40	-	-
		T3	-40	56	56	56	200	35	200	-40	-40	-40	-	-

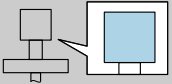
 = B	(2)	P1		P2		P3		P4		P5		P6		
		T _p	T _a	T _p	T _a	T _p	T _a	T _p	T _a	T _p	T _a	T _p	T _a	
	E, G	T6	-40	57	57	57	85	54	85	-40	-40	-40	-	-
		T5	-40	72	72	72	100	69	100	-40	-40	-40	-	-
		T4	-40	76	76	76	135	69	135	-40	-40	-40	-	-
		T3	-40	76	76	76	200	62	200	-40	-40	-40	-	-
		T2 ¹⁾	-40	76	76	76	250	57	250	-40	-40	-40	-	-

1) Funktional: Maximal zulässige Prozesstemperatur / Functional: Max. permissible process temperature /
Fonctionnel : Température de process admissible max.

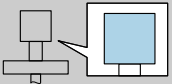
 = C	(2)	P1		P2		P3		P4		P5		P6		
		T _p	T _a	T _p	T _a	T _p	T _a	T _p	T _a	T _p	T _a	T _p	T _a	
	E, G	T6	-40	57	57	57	85	55	85	-40	-40	-40	-	-
		T5	-40	72	72	72	100	70	100	-40	-40	-40	-	-
		T4	-40	76	76	76	135	71	135	-40	-40	-40	-	-
		T3	-40	76	76	76	200	65	200	-40	-40	-40	-	-
		T2 ¹⁾	-40	76	76	76	250	61	250	-40	-40	-40	-	-

1) Funktional: Maximal zulässige Prozesstemperatur / Functional: Max. permissible process temperature /
Fonctionnel : Température de process admissible max.

FMR51

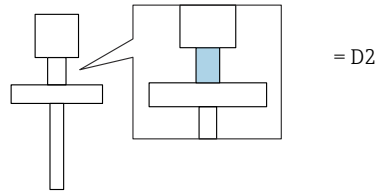

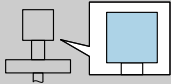
 = A	(2)	P1		P2		P3		P4		P5		P6		
		T _p	T _a	T _p	T _a	T _p	T _a	T _p	T _a	T _p	T _a	T _p	T _a	
	E, G	T6	-196	51	51	51	85	45	85	-40	-40	-40	-196	9
		T5	-196	56	56	56	100	48	100	-40	-40	-40	-196	9
		T4	-196	56	56	56	135	42	135	-40	-40	-40	-196	9
		T3	-196	56	56	56	200	30	200	-40	-40	-40	-196	9

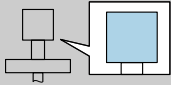
 = B	(2)	P1		P2		P3		P4		P5		P6		
		T _p	T _a	T _p	T _a	T _p	T _a	T _p	T _a	T _p	T _a	T _p	T _a	
	E, G	T6	-196	57	57	57	85	54	85	-40 -50 ¹⁾	-40 -50 ¹⁾	-40 -50 ¹⁾	-196	-15
		T5	-196	72	72	72	100	69	100	-40 -50 ¹⁾	-40 -50 ¹⁾	-40 -50 ¹⁾	-196	-15
		T4	-196	76	76	76	135	67	135	-40 -50 ¹⁾	-40 -50 ¹⁾	-40 -50 ¹⁾	-196	-15
		T3	-196	76	76	76	200	59	200	-40 -50 ¹⁾	-40 -50 ¹⁾	-40 -50 ¹⁾	-196	-15
		T2	-196	76	76	76	300	45	300	-40 -50 ¹⁾	-40 -50 ¹⁾	-40 -50 ¹⁾	-196	-15

1) Nur in Zusammenhang mit Optionale Spezifikation, Kennung Jx (Test, Zeugnis) = JN /
 Only in connection with Optional specification, ID Jx (Test, Certificate) = JN /
 Seulement en combinaison avec Spécification optionnelle, Identifiant Jx (Test, certificat) = JN

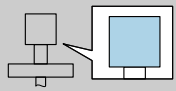
	(2)	P1		P2		P3		P4		P5		P6		
		T _p	T _a	T _p	T _a	T _p	T _a	T _p	T _a	T _p	T _a	T _p	T _a	
	E, G	T6	-196	57	57	57	85	54	85	-40 -50 ¹⁾	-40 -50 ¹⁾	-40 -50 ¹⁾	-196	-20 -28 ¹⁾
		T5	-196	72	72	72	100	69	100	-40 -50 ¹⁾	-40 -50 ¹⁾	-40 -50 ¹⁾	-196	-20 -28 ¹⁾
		T4	-196	76	76	76	135	69	135	-40 -50 ¹⁾	-40 -50 ¹⁾	-40 -50 ¹⁾	-196	-20 -28 ¹⁾
		T3	-196	76	76	76	200	62	200	-40 -50 ¹⁾	-40 -50 ¹⁾	-40 -50 ¹⁾	-196	-20 -28 ¹⁾
		T2	-196	76	76	76	300	51	300	-40 -50 ¹⁾	-40 -50 ¹⁾	-40 -50 ¹⁾	-196	-20 -28 ¹⁾
		T1	-196	76	76	76	450	35	450	-40 -50 ¹⁾	-40 -50 ¹⁾	-40 -50 ¹⁾	-196	-20 -28 ¹⁾

1) Nur in Zusammenhang mit Optionale Spezifikation, Kennung Jx (Test, Zeugnis) = JN /
 Only in connection with Optional specification, ID Jx (Test, Certificate) = JN /
 Seulement en combinaison avec Spécification optionnelle, Identifiant Jx (Test, certificat) = JN

FMR52

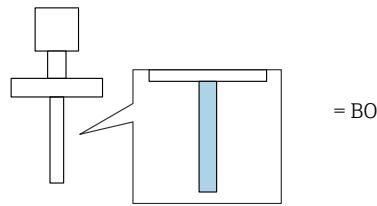

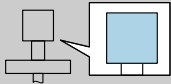
 = A	(2)	P1		P2		P3		P4		P5		P6		
		T _p	T _a	T _p	T _a	T _p	T _a	T _p	T _a	T _p	T _a	T _p	T _a	
	E, G	T6	-40	51	51	51	85	44	85	-40	-40	-40	-	-
		T5	-40	56	56	56	100	47	100	-40	-40	-40	-	-
		T4	-40	56	56	56	135	39	135	-40	-40	-40	-	-

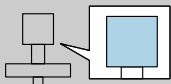
 = B	(2)	P1		P2		P3		P4		P5		P6		
		T _p	T _a	T _p	T _a	T _p	T _a	T _p	T _a	T _p	T _a	T _p	T _a	
	E, G	T6	-196	57	57	57	85	53	85	-40 -50 ¹⁾	-40 -50 ¹⁾	-40 -50 ¹⁾	-196	-3
		T5	-196	72	72	72	100	68	100	-40 -50 ¹⁾	-40 -50 ¹⁾	-40 -50 ¹⁾	-196	-3
		T4	-196	76	76	76	135	65	135	-40 -50 ¹⁾	-40 -50 ¹⁾	-40 -50 ¹⁾	-196	-3
		T3	-196	76	76	76	200	54	200	-40 -50 ¹⁾	-40 -50 ¹⁾	-40 -50 ¹⁾	-196	-3

1) Nur in Zusammenhang mit Optionale Spezifikation, Kennung Jx (Test, Zeugnis) = JN /
 Only in connection with Optional specification, ID Jx (Test, Certificate) = JN /
 Seulement en combinaison avec Spécification optionnelle, Identifiant Jx (Test, certificat) = JN

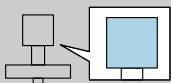
 = C	(2)	P1		P2		P3		P4		P5		P6		
		T _p	T _a	T _p	T _a	T _p	T _a	T _p	T _a	T _p	T _a	T _p	T _a	
	E, G	T6	-196	57	57	57	85	53	85	-40 -50 ¹⁾	-40 -50 ¹⁾	-40 -50 ¹⁾	-196	-14
		T5	-196	72	72	72	100	68	100	-40 -50 ¹⁾	-40 -50 ¹⁾	-40 -50 ¹⁾	-196	-14
		T4	-196	76	76	76	135	67	135	-40 -50 ¹⁾	-40 -50 ¹⁾	-40 -50 ¹⁾	-196	-14
		T3	-196	76	76	76	200	58	200	-40 -50 ¹⁾	-40 -50 ¹⁾	-40 -50 ¹⁾	-196	-14

1) Nur in Zusammenhang mit Optionale Spezifikation, Kennung Jx (Test, Zeugnis) = JN /
 Only in connection with Optional specification, ID Jx (Test, Certificate) = JN /
 Seulement en combinaison avec Spécification optionnelle, Identifiant Jx (Test, certificat) = JN

FMR52

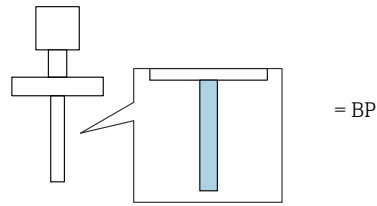

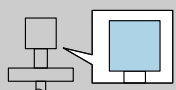
 = A	(2)	P1		P2		P3		P4		P5		P6		
		T _p	T _a	T _p	T _a	T _p	T _a	T _p	T _a	T _p	T _a	T _p	T _a	
	E, G	T6	-40	51	51	51	85	43	85	-40	-40	-40	-	-
		T5	-40	56	56	56	100	46	100	-40	-40	-40	-	-
		T4	-40	56	56	56	135	37	135	-40	-40	-40	-	-

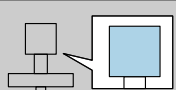
 = B	(2)	P1		P2		P3		P4		P5		P6		
		T _p	T _a	T _p	T _a	T _p	T _a	T _p	T _a	T _p	T _a	T _p	T _a	
	E, G	T6	-196	57	57	57	85	52	85	-40 -50 ¹⁾	-40 -50 ¹⁾	-40 -50 ¹⁾	-196	10
		T5	-196	72	72	72	100	67	100	-40 -50 ¹⁾	-40 -50 ¹⁾	-40 -50 ¹⁾	-196	10
		T4	-196	76	76	76	135	63	135	-40 -50 ¹⁾	-40 -50 ¹⁾	-40 -50 ¹⁾	-196	10
		T3	-196	76	76	76	200	50	200	-40 -50 ¹⁾	-40 -50 ¹⁾	-40 -50 ¹⁾	-196	10

- 1) Nur in Zusammenhang mit Optionale Spezifikation, Kennung Jx (Test, Zeugnis) = JN /
 Only in connection with Optional specification, ID Jx (Test, Certificate) = JN /
 Seulement en combinaison avec Spécification optionnelle, Identifiant Jx (Test, certificat) = JN

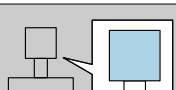
 = C	(2)	P1		P2		P3		P4		P5		P6		
		T _p	T _a	T _p	T _a	T _p	T _a	T _p	T _a	T _p	T _a	T _p	T _a	
	E, G	T6	-196	57	57	57	85	53	85	-40 -50 ¹⁾	-40 -50 ¹⁾	-40 -50 ¹⁾	-196	-8
		T5	-196	72	72	72	100	68	100	-40 -50 ¹⁾	-40 -50 ¹⁾	-40 -50 ¹⁾	-196	-8
		T4	-196	76	76	76	135	66	135	-40 -50 ¹⁾	-40 -50 ¹⁾	-40 -50 ¹⁾	-196	-8
		T3	-196	76	76	76	200	55	200	-40 -50 ¹⁾	-40 -50 ¹⁾	-40 -50 ¹⁾	-196	-8

- 1) Nur in Zusammenhang mit Optionale Spezifikation, Kennung Jx (Test, Zeugnis) = JN /
 Only in connection with Optional specification, ID Jx (Test, Certificate) = JN /
 Seulement en combinaison avec Spécification optionnelle, Identifiant Jx (Test, certificat) = JN

FMR53

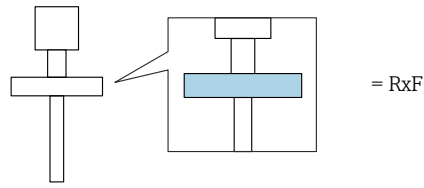

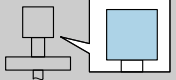
 = A	(2)		P1		P2		P3		P4		P5		P6	
			T _p	T _a	T _p	T _a	T _p	T _a	T _p	T _a	T _p	T _a	T _p	T _a
	E, G	T6	-40	51	51	51	80	47	80	-40	-40	-40	-	-

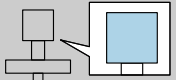
 = B, C	(2)		P1		P2		P3		P4		P5		P6	
			T _p	T _a	T _p	T _a	T _p	T _a	T _p	T _a	T _p	T _a	T _p	T _a
	E, G	T6	-40	57	57	57	80	55	80	-40	-40	-40	-	-

FMR53

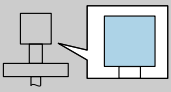
 = A	(2)	P1		P2		P3		P4		P5		P6		
		T _p	T _a	T _p	T _a	T _p	T _a	T _p	T _a	T _p	T _a	T _p	T _a	
	E, G	T6	-40	51	51	51	85	42	85	-40	-40	-40	-	-
		T5	-40	56	56	56	100	45	100	-40	-40	-40	-	-
		T4	-40	56	56	56	135	36	135	-20	-40	-40	-	-
		T3 ¹⁾	-40	56	56	56	150	32	150	-20	-40	-40	-	-

1) Funktional: Maximal zulässige Prozesstemperatur / Functional: Max. permissible process temperature /
 Fonctionnel : Température de process admissible max.

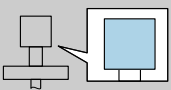
 = B	(2)	P1		P2		P3		P4		P5		P6		
		T _p	T _a	T _p	T _a	T _p	T _a	T _p	T _a	T _p	T _a	T _p	T _a	
	E, G	T6	-40	57	57	57	85	51	85	-40	-40	-40	-	-
		T5	-40	72	72	72	100	66	100	-40	-40	-40	-	-
		T4	-40	76	76	76	135	62	135	-40	-40	-40	-	-
		T3 ¹⁾	-40	76	76	76	150	58	150	-40	-40	-40	-	-

1) Funktional: Maximal zulässige Prozesstemperatur / Functional: Max. permissible process temperature /
 Fonctionnel : Température de process admissible max.

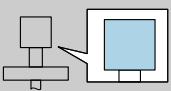
 = C	(2)	P1		P2		P3		P4		P5		P6		
		T _p	T _a	T _p	T _a	T _p	T _a	T _p	T _a	T _p	T _a	T _p	T _a	
	E, G	T6	-40	57	57	57	85	52	85	-40	-40	-40	-	-
		T5	-40	72	72	72	100	67	100	-40	-40	-40	-	-
		T4	-40	76	76	76	135	64	135	-40	-40	-40	-	-
		T3 ¹⁾	-40	76	76	76	150	62	150	-40	-40	-40	-	-

1) Funktional: Maximal zulässige Prozesstemperatur / Functional: Max. permissible process temperature /
 Fonctionnel : Température de process admissible max.

FMR54

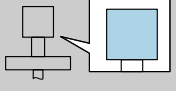
 = A	(2)	P1		P2		P3		P4		P5		P6		
		T _p	T _a	T _p	T _a	T _p	T _a	T _p	T _a	T _p	T _a	T _p	T _a	
	E, G	T6	-40	51	51	51	85	42	85	-40	-40	-40	-	-
		T5	-40	56	56	56	100	45	100	-40	-40	-40	-	-
		T4	-40	56	56	56	135	35	135	-40	-40	-40	-	-

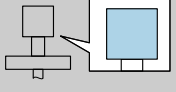
 = B	(2)	P1		P2		P3		P4		P5		P6		
		T _p	T _a	T _p	T _a	T _p	T _a	T _p	T _a	T _p	T _a	T _p	T _a	
	E, G	T6	-40	57	57	57	85	51	85	-40	-40	-40	-	-
		T5	-40	72	72	72	100	66	100	-40	-40	-40	-	-
		T4	-40	76	76	76	135	61	135	-40	-40	-40	-	-
		T3	-40	76	76	76	200	45	200	-40	-40	-40	-	-

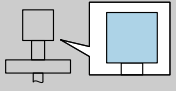
 = C	(2)	P1		P2		P3		P4		P5		P6		
		T _p	T _a	T _p	T _a	T _p	T _a	T _p	T _a	T _p	T _a	T _p	T _a	
	E, G	T6	-40	57	57	57	85	52	85	-40	-40	-40	-	-
		T5	-40	72	72	72	100	67	100	-40	-40	-40	-	-
		T4	-40	76	76	76	135	64	135	-40	-40	-40	-	-
		T3	-40	76	76	76	200	51	200	-40	-40	-40	-	-

FMR54

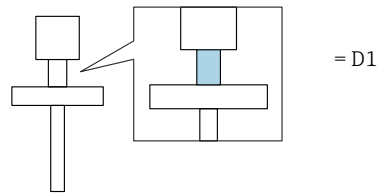

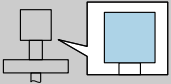
 = A	(2)	P1		P2		P3		P4		P5		P6		
		T _p	T _a	T _p	T _a	T _p	T _a	T _p	T _a	T _p	T _a	T _p	T _a	
	E, G	T6	-196	51	51	51	85	44	85	-40	-40	-40	-196	18
		T5	-196	56	56	56	100	47	100	-40	-40	-40	-196	18
		T4	-196	56	56	56	135	40	135	-40	-40	-40	-196	18

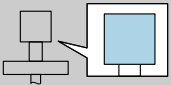
 = B	(2)	P1		P2		P3		P4		P5		P6		
		T _p	T _a	T _p	T _a	T _p	T _a	T _p	T _a	T _p	T _a	T _p	T _a	
	E, G	T6	-196	57	57	57	85	53	85	-40 -50 ¹⁾	-40 -50 ¹⁾	-40 -50 ¹⁾	-196	-4
		T5	-196	72	72	72	100	68	100	-40 -50 ¹⁾	-40 -50 ¹⁾	-40 -50 ¹⁾	-196	-4
		T4	-196	76	76	76	135	65	135	-40 -50 ¹⁾	-40 -50 ¹⁾	-40 -50 ¹⁾	-196	-4
		T3	-196	76	76	76	200	54	200	-40 -50 ¹⁾	-40 -50 ¹⁾	-40 -50 ¹⁾	-196	-4
		T2 ²⁾	-196	76	76	76	280	41	280	-40 -50 ¹⁾	-40 -50 ¹⁾	-40 -50 ¹⁾	-196	-4

- 1) Nur in Zusammenhang mit Optionale Spezifikation, Kennung Jx (Test, Zeugnis) = JN /
Only in connection with Optional specification, ID Jx (Test, Certificate) = JN /
Seulement en combinaison avec Spécification optionnelle, Identifiant Jx (Test, certificat) = JN
- 2) Funktional: Maximal zulässige Prozesstemperatur / Functional: Max. permissible process temperature /
Fonctionnel : Température de process admissible max.

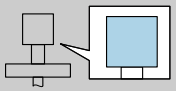
 = C	(2)	P1		P2		P3		P4		P5		P6		
		T _p	T _a	T _p	T _a	T _p	T _a	T _p	T _a	T _p	T _a	T _p	T _a	
	E, G	T6	-196	57	57	57	85	54	85	-40 -50 ¹⁾	-40 -50 ¹⁾	-40 -50 ¹⁾	-196	-15
		T5	-196	72	72	72	100	69	100	-40 -50 ¹⁾	-40 -50 ¹⁾	-40 -50 ¹⁾	-196	-15
		T4	-196	76	76	76	135	67	135	-40 -50 ¹⁾	-40 -50 ¹⁾	-40 -50 ¹⁾	-196	-15
		T3	-196	76	76	76	200	59	200	-40 -50 ¹⁾	-40 -50 ¹⁾	-40 -50 ¹⁾	-196	-15
		T2 ²⁾	-196	76	76	76	280	48	280	-40 -50 ¹⁾	-40 -50 ¹⁾	-40 -50 ¹⁾	-196	-15

- 1) Nur in Zusammenhang mit Optionale Spezifikation, Kennung Jx (Test, Zeugnis) = JN /
 Only in connection with Optional specification, ID Jx (Test, Certificate) = JN /
 Seulement en combinaison avec Spécification optionnelle, Identifiant Jx (Test, certificat) = JN
- 2) Funktional: Maximal zulässige Prozesstemperatur / Functional: Max. permissible process temperature /
 Fonctionnel : Température de process admissible max.

FMR54

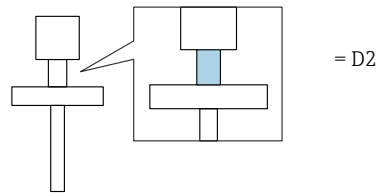

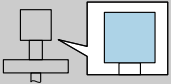
 = A	(2)	P1		P2		P3		P4		P5		P6		
		T _p	T _a	T _p	T _a	T _p	T _a	T _p	T _a	T _p	T _a	T _p	T _a	
	E, G	T6	-196	51	51	51	85	45	85	-40	-40	-40	-196	11
		T5	-196	56	56	56	100	48	100	-40	-40	-40	-196	11
		T4	-196	56	56	56	135	41	135	-40	-40	-40	-196	11

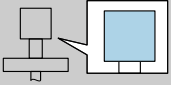
 = B	(2)	P1		P2		P3		P4		P5		P6		
		T _p	T _a	T _p	T _a	T _p	T _a	T _p	T _a	T _p	T _a	T _p	T _a	
	E, G	T6	-196	57	57	57	85	53	85	-40 -50 ¹⁾	-40 -50 ¹⁾	-40 -50 ¹⁾	-196	-13
		T5	-196	72	72	72	100	68	100	-40 -50 ¹⁾	-40 -50 ¹⁾	-40 -50 ¹⁾	-196	-13
		T4	-196	76	76	76	135	67	135	-40 -50 ¹⁾	-40 -50 ¹⁾	-40 -50 ¹⁾	-196	-13
		T3	-196	76	76	76	200	57	200	-40 -50 ¹⁾	-40 -50 ¹⁾	-40 -50 ¹⁾	-196	-13
		T2	-196	76	76	76	300	43	300	-40 -50 ¹⁾	-40 -50 ¹⁾	-40 -50 ¹⁾	-196	-13

1) Nur in Zusammenhang mit Optionale Spezifikation, Kennung Jx (Test, Zeugnis) = JN /
 Only in connection with Optional specification, ID Jx (Test, Certificate) = JN /
 Seulement en combinaison avec Spécification optionnelle, Identifiant Jx (Test, certificat) = JN

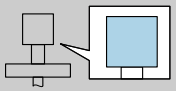
 = C	(2)	P1		P2		P3		P4		P5		P6		
		T _p	T _a	T _p	T _a	T _p	T _a	T _p	T _a	T _p	T _a	T _p	T _a	
	E, G	T6	-196	57	57	57	85	54	85	-40 -50 ¹⁾	-40 -50 ¹⁾	-40 -50 ¹⁾	-196	-19 -26 ¹⁾
		T5	-196	72	72	72	100	69	100	-40 -50 ¹⁾	-40 -50 ¹⁾	-40 -50 ¹⁾	-196	-19 -26 ¹⁾
		T4	-196	76	76	76	135	69	135	-40 -50 ¹⁾	-40 -50 ¹⁾	-40 -50 ¹⁾	-196	-19 -26 ¹⁾
		T3	-196	76	76	76	200	61	200	-40 -50 ¹⁾	-40 -50 ¹⁾	-40 -50 ¹⁾	-196	-19 -26 ¹⁾
		T2	-196	76	76	76	300	49	300	-40 -50 ¹⁾	-40 -50 ¹⁾	-40 -50 ¹⁾	-196	-19 -26 ¹⁾
		T1 ²⁾	-196	76	76	76	400	38	400	-40 -50 ¹⁾	-40 -50 ¹⁾	-40 -50 ¹⁾	-196	-19 -26 ¹⁾

- 1) Nur in Zusammenhang mit Optionale Spezifikation, Kennung Jx (Test, Zeugnis) = JN /
 Only in connection with Optional specification, ID Jx (Test, Certificate) = JN /
 Seulement en combinaison avec Spécification optionnelle, Identifiant Jx (Test, certificat) = JN
- 2) Funktional: Maximal zulässige Prozesstemperatur / Functional: Max. permissible process temperature /
 Fonctionnel : Température de process admissible max.

FMR54

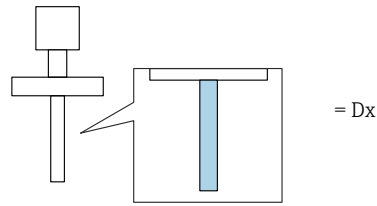

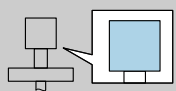
 = A	(2)	P1		P2		P3		P4		P5		P6		
		T _p	T _a	T _p	T _a	T _p	T _a	T _p	T _a	T _p	T _a	T _p	T _a	
	E, G	T6	-40	51	51	51	85	44	85	-40	-40	-40	-	-
		T5	-40	56	56	56	100	47	100	-40	-40	-40	-	-
		T4	-40	56	56	56	135	39	135	-40	-40	-40	-	-
		T3 ¹⁾	-40	56	56	56	150	36	150	-40	-40	-40	-	-

1) Funktional: Maximal zulässige Prozesstemperatur / Functional: Max. permissible process temperature /
Fonctionnel : Température de process admissible max.

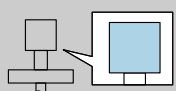
 = B	(2)	P1		P2		P3		P4		P5		P6		
		T _p	T _a	T _p	T _a	T _p	T _a	T _p	T _a	T _p	T _a	T _p	T _a	
	E, G	T6	-40	57	57	57	85	52	85	-40	-40	-40	-	-
		T5	-40	72	72	72	100	67	100	-40	-40	-40	-	-
		T4	-40	76	76	76	135	65	135	-40	-40	-40	-	-
		T3 ¹⁾	-40	76	76	76	150	62	150	-40	-40	-40	-	-

1) Funktional: Maximal zulässige Prozesstemperatur / Functional: Max. permissible process temperature /
Fonctionnel : Température de process admissible max.

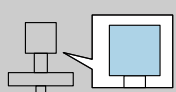
 = C	(2)	P1		P2		P3		P4		P5		P6		
		T _p	T _a	T _p	T _a	T _p	T _a	T _p	T _a	T _p	T _a	T _p	T _a	
	E, G	T6	-40	57	57	57	85	53	85	-40	-40	-40	-	-
		T5	-40	72	72	72	100	68	100	-40	-40	-40	-	-
		T4	-40	76	76	76	135	67	135	-40	-40	-40	-	-
		T3 ¹⁾	-40	76	76	76	150	65	150	-40	-40	-40	-	-

1) Funktional: Maximal zulässige Prozesstemperatur / Functional: Max. permissible process temperature /
Fonctionnel : Température de process admissible max.

FMR56

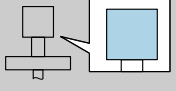
 = A	(2)		P1		P2		P3		P4		P5		P6	
			T _p	T _a	T _p	T _a	T _p	T _a	T _p	T _a	T _p	T _a	T _p	T _a
	E, G	T6	-40	51	51	51	80	47	80	-40	-40	-40	-	-

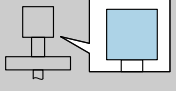
 = C	(2)		P1		P2		P3		P4		P5		P6	
			T _p	T _a	T _p	T _a	T _p	T _a	T _p	T _a	T _p	T _a	T _p	T _a
	E, G	T6	-40	57	57	57	80	55	80	-40	-40	-40	-	-

FMR57

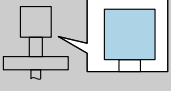
 = A	(2)	P1		P2		P3		P4		P5		P6		
		T _p	T _a	T _p	T _a	T _p	T _a	T _p	T _a	T _p	T _a	T _p	T _a	
	E, G	T6	-40	51	51	51	85	46	85	-40	-40	-40	-	-
		T5	-40	56	56	56	100	49	100	-40	-40	-40	-	-
		T4	-40	56	56	56	135	43	135	-40	-40	-40	-	-
		T3	-40	56	56	56	200	33	200	-40	-40	-40	-	-

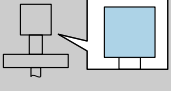
 = B	(2)	P1		P2		P3		P4		P5		P6		
		T _p	T _a	T _p	T _a	T _p	T _a	T _p	T _a	T _p	T _a	T _p	T _a	
	E, G	T6	-40	57	57	57	85	54	85	-40	-40	-40	-	-
		T5	-40	72	72	72	100	69	100	-40	-40	-40	-	-
		T4	-40	76	76	76	135	68	135	-40	-40	-40	-	-
		T3	-40	76	76	76	200	61	200	-40	-40	-40	-	-

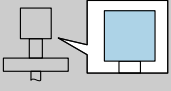
 = C	(2)	P1		P2		P3		P4		P5		P6		
		T _p	T _a	T _p	T _a	T _p	T _a	T _p	T _a	T _p	T _a	T _p	T _a	
	E, G	T6	-40	57	57	57	85	55	85	-40	-40	-40	-	-
		T5	-40	72	72	72	100	70	100	-40	-40	-40	-	-
		T4	-40	76	76	76	135	70	135	-40	-40	-40	-	-
		T3	-40	76	76	76	200	64	200	-40	-40	-40	-	-

FMR57

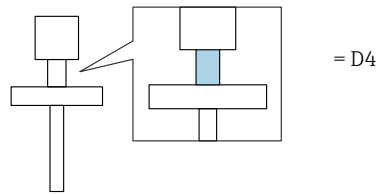

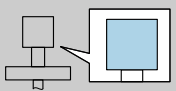
 = A	(2)	P1		P2		P3		P4		P5		P6		
		T _p	T _a	T _p	T _a	T _p	T _a	T _p	T _a	T _p	T _a	T _p	T _a	
	E, G	T6	-40	51	51	51	85	47	85	-40	-40	-40	-	-
		T5	-40	56	56	56	100	50	100	-40	-40	-40	-	-
		T4	-40	56	56	56	135	46	135	-40	-40	-40	-	-
		T3	-40	56	56	56	200	37	200	-40	-40	-40	-	-

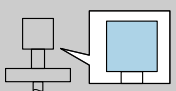
 = B	(2)	P1		P2		P3		P4		P5		P6		
		T _p	T _a	T _p	T _a	T _p	T _a	T _p	T _a	T _p	T _a	T _p	T _a	
	E, G	T6	-40	57	57	57	85	55	85	-40	-40	-40	-	-
		T5	-40	72	72	72	100	70	100	-40	-40	-40	-	-
		T4	-40	76	76	76	135	70	135	-40	-40	-40	-	-
		T3	-40	76	76	76	200	64	200	-40	-40	-40	-	-
		T2	-40	76	76	76	300	55	300	-40	-40	-40	-	-
		T1 ¹⁾	-40	76	76	76	400	46	400	-40	-40	-40	-	-

1) Funktional: Maximal zulässige Prozesstemperatur / Functional: Max. permissible process temperature /
Fonctionnel : Température de process admissible max.

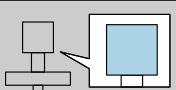
 = C	(2)	P1		P2		P3		P4		P5		P6		
		T _p	T _a	T _p	T _a	T _p	T _a	T _p	T _a	T _p	T _a	T _p	T _a	
	E, G	T6	-40	57	57	57	85	55	85	-40	-40	-40	-	-
		T5	-40	72	72	72	100	70	100	-40	-40	-40	-	-
		T4	-40	76	76	76	135	71	135	-40	-40	-40	-	-
		T3	-40	76	76	76	200	67	200	-40	-40	-40	-	-
		T2	-40	76	76	76	300	60	300	-40	-40	-40	-	-
		T1 ¹⁾	-40	76	76	76	400	52	400	-40	-40	-40	-	-

1) Funktional: Maximal zulässige Prozesstemperatur / Functional: Max. permissible process temperature /
Fonctionnel : Température de process admissible max.





www.addresses.endress.com
