

# Safety Instructions

## Micropilot

### FMR60, FMR62, FMR67

4-20 mA HART

Ex ia/db [ia Ga] IIC T6...T1 Ga/Gb



Document: XA01624F-B

Safety instructions for electrical apparatus for explosion-hazardous areas →  3

Document: XA01624F-B

Temperature tables →  13

---

# Micropilot FMR60, FMR62, FMR67

4-20 mA HART

## Table of contents

Associated documentation . . . . .	4
Supplementary documentation . . . . .	4
Manufacturer's certificates . . . . .	4
Manufacturer address . . . . .	4
Extended order code . . . . .	4
Safety instructions: General . . . . .	7
Safety instructions: Special conditions . . . . .	7
Safety instructions: Installation . . . . .	8
Safety instructions: Ex d joints . . . . .	9
Safety instructions: Zone 0 . . . . .	9
Temperature tables . . . . .	9
Connection data . . . . .	9

<b>Associated documentation</b>	<p>This document is an integral part of the following Operating Instructions:</p> <ul style="list-style-type: none"> <li>■ BA01618F/00 (FMR60)</li> <li>■ BA01619F/00 (FMR62)</li> <li>■ BA01620F/00 (FMR67)</li> </ul>										
<b>Supplementary documentation</b>	<p>Explosion-protection brochure: CP00021Z/11</p> <p>The Explosion-protection brochure is available:</p> <ul style="list-style-type: none"> <li>■ In the download area of the Endress+Hauser website:  <a href="http://www.endress.com">www.endress.com</a> -&gt; Downloads -&gt; Brochures and Catalogs -&gt; Text Search: CP00021Z</li> <li>■ On the CD for devices with CD-based documentation</li> </ul>										
<b>Manufacturer's certificates</b>	<p><b>KC Declaration of Conformity</b></p> <p>Certificate number: 17-KA4BO-0405X</p> <p>Affixing the certificate number certifies conformity with the following standards (depending on the device version):</p> <ul style="list-style-type: none"> <li>■ IEC 60079-0 : 2017</li> <li>■ IEC 60079-1 : 2014</li> <li>■ IEC 60079-11 : 2011</li> <li>■ IEC 60079-26 : 2014</li> </ul>										
<b>Manufacturer address</b>	<p>Endress+Hauser SE+Co. KG Hauptstraße 1 79689 Maulburg, Germany Address of the manufacturing plant: See nameplate.</p>										
<b>Extended order code</b>	<p>The extended order code is indicated on the nameplate, which is affixed to the device in such a way that it is clearly visible. Additional information about the nameplate is provided in the associated Operating Instructions.</p> <p><b>Structure of the extended order code</b></p> <table border="0" style="margin-left: 40px;"> <tr> <td style="text-align: center;">FMR6x</td> <td style="text-align: center;">-</td> <td style="text-align: center;">*****</td> <td style="text-align: center;">+</td> <td style="text-align: center;">A*B*C*D*E*F*G*..</td> </tr> <tr> <td style="text-align: center;"><i>(Device type)</i></td> <td></td> <td style="text-align: center;"><i>(Basic specifications)</i></td> <td></td> <td style="text-align: center;"><i>(Optional specifications)</i></td> </tr> </table> <p>* = Placeholder At this position, an option (number or letter) selected from the specification is displayed instead of the placeholders.</p> <p><i>Basic specifications</i></p> <p>The features that are absolutely essential for the device (mandatory features) are specified in the basic specifications. The number of positions depends on the number of features available. The selected option of a feature can consist of several positions.</p> <p><i>Optional specifications</i></p> <p>The optional specifications describe additional features for the device (optional features). The number of positions depends on the number of features available. The features have a 2-digit structure to aid identification (e.g. JA). The first digit (ID) stands for the feature group and consists of a number or a letter (e.g. J = Test, Certificate). The second digit constitutes the value that stands for the feature within the group (e.g. A = 3.1 material (wetted parts), inspection certificate).</p>	FMR6x	-	*****	+	A*B*C*D*E*F*G*..	<i>(Device type)</i>		<i>(Basic specifications)</i>		<i>(Optional specifications)</i>
FMR6x	-	*****	+	A*B*C*D*E*F*G*..							
<i>(Device type)</i>		<i>(Basic specifications)</i>		<i>(Optional specifications)</i>							

More detailed information about the device is provided in the following tables. These tables describe the individual positions and IDs in the extended order code which are relevant to hazardous locations.

**Extended order code: Micropilot**



The following specifications reproduce an extract from the product structure and are used to assign:

- This documentation to the device (using the extended order code on the nameplate).
- The device options cited in the document.

*Device type*

FMR60, FMR62, FMR67

*Basic specifications*

Position 1, 2 (Approval)		
Selected option		Description
FMR6x	KC	KC Ex ia/db [ia Ga] IIC T6...T1 Ga/Gb

Position 3 (Power Supply, Output)		
Selected option		Description
FMR6x	A	2-wire, 4-20 mA HART
	B	2-wire, 4-20 mA HART, switch output (PFS)
	C	2-wire, 4-20 mA HART, 4...20 mA

Position 4 (Display, Operation)		
Selected option		Description
FMR6x	A	Without, via communication
	C	SD02, 4-line, push buttons + data backup function
	E	SD03, 4-line, illum., touch control + data backup function
	L	Prepared for display FHX50 + M12 connection
	M	Prepared for display FHX50 + custom connection
	N	Prepared for display FHX50 + NPT1/2"

Position 5 (Housing)		
Selected option		Description
FMR62 FMR67	B	GT18 dual compartment, 316L
FMR6x	C	GT20 dual compartment, Alu, coated

Position 7, 8 (Antenna)		
Selected option		Description
FMR60	GA	Drip-off, PTFE DN50
FMR62	GE	Integrated, PEEK, 3/4"
	GF	Integrated, PEEK, 1-1/2"
	GM	PTFE cladded flush mount DN50
	GN	PTFE cladded flush mount DN80
FMR67	GA	Drip-off, PTFE DN50
	GP	PTFE flush mount DN80

Position 9, 10 (Seal)		
Selected option		Description
FMR60	A3	FKM Viton GLT, -40...80°C/-40...176°F
	A4	FKM Viton GLT, -40...130°C/-40...266°F
	C1	FFKM Kalrez, -20...150°C/-4...302°F
	B4	EPDM, -40...150°C/-40...302°F
FMR62	A5	FKM Viton GLT, -40...150°C/-40...302°F
	A6	FKM Viton GLT, -40...200°C/-40...392°F
	C1	FFKM Kalrez, -20...150°C/-4...302°F
	C2	FFKM Kalrez, -20...200°C/-4...392°F
	F5	PTFE cladded, -40...150°C/-40...302°F
	F6	PTFE cladded, -40...200°C/-40...392°F
FMR67	A3	FKM Viton GLT, -40...80°C/-40...176°F
	A5	FKM Viton GLT, -40...150°C/-40...302°F
	A6	FKM Viton GLT, -40...200°C/-40...392°F

Position 11-13 (Process Connection)		
Selected option		Description
FMR60	GGJ	Thread ISO228 G1-1/2, 316L
	RGJ	Thread ANSI MNPT1-1/2, 316L
	XxG	Flange (different sizes), PP
	XxJ	Flange (different sizes), 316L
FMR62	AxK	Flange (different sizes), PTFE>316/316L
	CxK	Flange (different sizes), PTFE>316L
	GxJ	Thread ISO (different sizes), 316L
	KxK	Flange (different sizes), PTFE>316L
	MxK	Slotted-nut (different sizes), PTFE>316L
	RxJ	Thread ANSI (different sizes), 316L
	TxK	Tri-Clamp (different sizes), PTFE>316L

Position 11-13 (Process Connection)		
Selected option		Description
FMR67	AxJ	Flange (different sizes), 316/316L
	CxJ	Flange (different sizes), 316L
	GGJ	Thread ISO228 G1-1/2, 316L
	KxJ	Flange (different sizes), 316L
	RGJ	Thread ANSI MNPT1-1/2, 316L
	XxA	Align. device (different sizes)
	XxG	Flange (different sizes), PP
	XxJ	Flange (different sizes), 316L

Position 14 (Air Purge Connection)		
Selected option		Description
FMR67	A <sup>1)</sup>	W/o
	1 <sup>2)</sup>	G1/4
	2 <sup>2)</sup>	NPT1/4
	3 <sup>1)</sup>	Adapter G1/4
	4 <sup>1)</sup>	Adapter NPT1/4

- 1) Only in connection with Position 7, 8 (Antenna) = GA
- 2) Only in connection with Position 7, 8 (Antenna) = GP

*Optional specifications*

ID Nx (Accessory Mounted)		
Selected option		Description
FMR6x	NF <sup>1)</sup>	Bluetooth

- 1) Only in connection with Position 4 (Display, Operation) = C, E

**Safety instructions: General**

- Staff must meet the following conditions for mounting, electrical installation, commissioning and maintenance of the device:
  - Be suitably qualified for their role and the tasks they perform
  - Be trained in explosion protection
  - Be familiar with national regulations
- Install the device according to the manufacturer's instructions and national regulations.
- Do not operate the device outside the specified electrical, thermal and mechanical parameters.
- Only use the device in media to which the wetted materials have sufficient durability.
- Avoid electrostatic charging:
  - Of plastic surfaces (e.g. housing, sensor element, special varnishing, attached additional plates, ..)
  - Of isolated capacities (e.g. isolated metallic plates)
- Modifications to the device can affect the explosion protection and must be carried out by staff authorized to perform such work by Endress+Hauser.
- Refer to the temperature tables for the relationship between the permitted ambient temperature for the sensor and/or transmitter, depending on the range of application and the temperature class.

**Safety instructions: Special conditions**

Permitted ambient temperature range at the electronics housing:  
 $-40\text{ °C} \leq T_a \leq +80\text{ °C}$

- Observe the information in the temperature tables.
- In the case of process connections made of polymeric material or with polymeric coatings, avoid electrostatic charging of the plastic surfaces.
- To avoid electrostatic charging: Do not rub surfaces with a dry cloth.
- In the event of additional or alternative special varnishing on the housing or other metal parts or for adhesive plates:
  - Observe the danger of electrostatic charging and discharge.
  - Do not install in the vicinity of processes ( $\leq 0.5$  m) generating strong electrostatic charges.
- Avoid electrostatic charging of the sensor (e.g. do not rub dry and install outside the filling flow).

*Device type FMR67 and Basic specification, Position 11-13 (Process Connection) = XxA*

- In Zone 0, avoid sparks caused by impact and friction.
- Changing the position of the alignment device must be impossible:
  - After the alignment of the antenna via the pivot bracket
  - After tightening of the clamping flange
  - After setting the damping ring (torque 10 to 11 Nm)
- Degree of protection IP67 must be fulfilled.

*Device type FMR67 and Basic specification, Position 14 (Air Purge Connection) = 1, 2*

- If equipment with Ga/Gb or Da/Db is required: In the closed state the minimum degree of protection of the installation must be IP67.
- After removing the air purge connection: Lock the opening with a suitable plug.
  - Torque: 6-7 Nm
  - For Da/Db: thread engagement  $> 5$  turns
- Degree of protection IP67 must be fulfilled.

#### Safety instructions: Installation

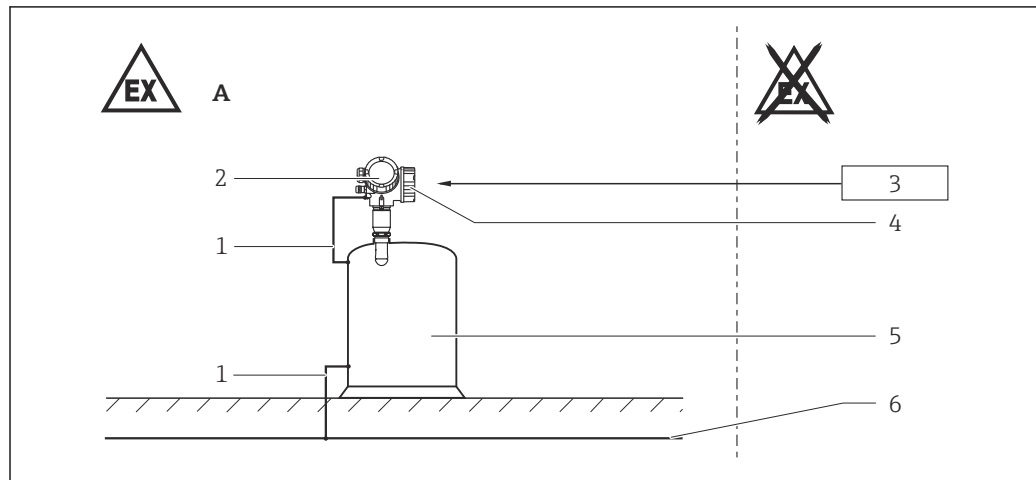

A0031947

#### 1

- A Zone 1
- 1 Potential equalization line
- 2 Electronics compartment Ex ia; Electronic insert
- 3 Power supply
- 4 Connection compartment Ex db
- 5 Tank; Zone 0, Zone 1
- 6 Potential equalization

- After aligning (rotating) the housing, retighten the fixing screw (see Operating Instructions).
- Install the device to exclude any mechanical damage or friction during the application. Pay particular attention to flow conditions and tank fittings.
- In potentially explosive atmospheres:
  - Do not disconnect the electrical connection of the power supply circuit when energized.
  - Do not open the connection compartment cover.
- Only use certified cable entries suitable for the application. Observe national regulations and standards. Accordingly, the connection terminal does not include any ignition sources.
- When operating the transmitter housing at an ambient temperature under  $-20$  °C, use appropriate cables and cable entries permitted for this application.
- When connecting through a conduit entry approved for this purpose, mount the associated sealing unit directly at the housing.



- Seal unused entry glands with approved sealing plugs that correspond to the type of protection. The plastic transport sealing plug does not meet this requirement and must therefore be replaced during installation.
- Before operation:
  - Screw in the cover all the way.
  - Tighten the securing clamp on the cover.
- Continuous service temperature of the connecting cable:  $-40\text{ °C}$  to  $\geq +85\text{ °C}$ ; in accordance with the range of service temperature taking into account additional influences of the process conditions ( $T_{a,\min}$ ), ( $T_{a,\max} + 20\text{ K}$ ).

*Basic specification, Position 4 (Display, Operation) = N*

Observe the requirements according to IEC/EN 60079-14 for conduit systems and the wiring- and installation instructions of the suitable Safety Instructions (XA). In addition, observe national regulations and standards for conduit systems.

Explosion protection "Flameproof enclosure Ex db"

Flameproof equipment with G threaded entry holes is not intended for new installations but only for replacement of equipment in existing installations. Application of this equipment shall comply with the local installation requirements.

#### Intrinsic safety

- The device can be connected to the Endress+Hauser FXA291 service tool: refer to the Operating Instructions.
- The device can be equipped with the Bluetooth® module: refer to the Operating Instructions and specifications in the "Bluetooth® module" chapter.

#### Potential equalization

Integrate the device into the local potential equalization.

#### Bluetooth® module

*Optional specification, ID Nx (Accessory Mounted) = NF*

- With Bluetooth® module installed: Use of external hardware not allowed (e.g. external display, service interface).
- The intrinsically safe input power circuit of the Bluetooth® module is isolated from ground.

#### Safety instructions: Ex d joints

- If required or if in doubt: ask manufacturer for specifications.
- Flameproof joints are not intended to be repaired.

#### Safety instructions: Zone 0

- In the event of potentially explosive vapor/air mixtures, only operate the device under atmospheric conditions.
  - Temperature:  $-20$  to  $+60\text{ °C}$
  - Pressure: 80 to 110 kPa (0.8 to 1.1 bar)
  - Air with normal oxygen content, usually 21 % (V/V)
- If no potentially explosive mixtures are present, or if additional protective measures have been taken, the device may also be operated under non-atmospheric conditions in accordance with the manufacturer's specifications.

#### Temperature tables

→  14

#### Connection data

*Optional specification, ID Nx (Accessory Mounted) = NF*

When using the Bluetooth® module: No changes to the connection values.

**Connection compartment Ex db***Basic specification, Position 3 (Power Supply, Output) = A*

Terminal 1 (+), 2 (-)
Power supply
$U_N = 35 \text{ V}_{\text{DC}}$
$U_m = 250 \text{ V}$
$I_N = 4 \text{ to } 20 \text{ mA}$
$I_{\text{max}} = 22 \text{ mA}$
$P_N = 0.7 \text{ W}$

*Basic specification, Position 3 (Power Supply, Output) = B*

The power consumption of I/O modules with passive PFS output can be limited for certain applications.

- Recommended: Power consumption = 1 W. This is obtained for a supply voltage at the terminals of  $27 \text{ V}_{\text{DC}}$ .
- For higher supply voltages ( $U_{\text{max}}$ ): Insert a serial resistance ( $R_V$ ) in order to limit the power consumption, see table below.

**Table for the PFS serial resistance ( $R_V$ ):**

Power consumption	1.0 W
Total power consumption	1.88 W
Internal resistance $R_i$	760 $\Omega$

$U_{\text{max}}$ [V]	$R_V$ min
35	205 $\Omega$
34	177 $\Omega$
33	150 $\Omega$
32	122 $\Omega$
31	95 $\Omega$
30	67 $\Omega$
29	39 $\Omega$
28	12 $\Omega$
27	0 $\Omega$

 For values associated with a higher or lower internal power consumption please contact Endress+Hauser.

Terminal 1 (+), 2 (-)	Terminal 3 (+), 4 (-)
Power supply	Switch output (PFS)
$U_N = 35 \text{ V}_{\text{DC}}$	$U_N = 35 \text{ V}_{\text{DC}}$
$U_m = 250 \text{ V}$	$U_m = 250 \text{ V}$
$I_N = 4 \text{ to } 20 \text{ mA}$	$P_N = 0.7 \text{ W}$
$I_{\text{max}} = 22 \text{ mA}$	
$P_N = 0.7 \text{ W}$	

Basic specification, Position 3 (Power Supply, Output) = C

Terminal 1 (+), 2 (-)	Terminal 3 (+), 4 (-)
Power supply $U_N = 30 V_{DC}$ $U_m = 250 V$ $I_N = 4 \text{ to } 20 \text{ mA}$ $I_{max} = 22 \text{ mA}$ $P_N = 0.7 W$	Output 4 to 20 mA $U_N = 30 V_{DC}$ $U_m = 250 V$ $I_N = 4 \text{ to } 20 \text{ mA}$ $I_{max} = 22 \text{ mA}$ $P_N = 0.7 W$

### Electronics compartment Ex ia

#### Service interface (CDI)

Taking the following values into consideration, the device can be connected to the certified Endress+Hauser FXA291 service tool or a similar interface:

Service interface														
$U_i = 7.3 V$ effective inner inductance $L_i = \text{negligible}$ effective inner capacitance $C_i = \text{negligible}$														
$U_o = 7.3 V$ $I_o = 60 \text{ mA}$ $P_o = 110 \text{ mW}$														
$L_o \text{ (mH)} =$	5.00	2.00	1.00	0.50	0.20	0.15	0.10	0.05	0.02	0.01	0.005	0.002	0.001	
$C_o \text{ (}\mu\text{F)}^{1) =}$	0.73	1.20	1.60	2.00	2.60	-	3.20	4.00	5.50	7.30	10.00	12.70	12.70	
$C_o \text{ (}\mu\text{F)}^{2) =}$	-	0.49	0.90	1.40	-	2.00	-	-	-	-	-	-	-	

- 1) Values according to PTB "ispark" program
- 2) Values according to IEC/EN 60079-25, Annex C

---

# Micropilot FMR60, FMR62, FMR67

4-20 mA HART

## Table of contents

Notes on the structure .....	14
Example diagrams of possible deratings .....	16
Zone 0, Zone 1 .....	17
Zone 1 .....	18

## Notes on the structure

## Extract from the extended order code

## Device type

FMR60, FMR62, FMR67

## Basic specifications

Position 1, 2 (Approval)		
Selected option		Description
FMR6x	KC	KC Ex ia/db [ia Ga] IIC T6...T1 Ga/Gb

Position 5 (Housing)		
Selected option		Description
FMR62	B	GT18 dual compartment, 316L
FMR67		
FMR6x	C	GT20 dual compartment, Alu, coated

Position 7, 8 (Antenna)		
Selected option		Description
FMR60	GA	Drip-off, PTFE DN50
FMR62	GE	Integrated, PEEK, 3/4"
	GF	Integrated, PEEK, 1-1/2"
	GM	PTFE cladded flush mount DN50
	GN	PTFE cladded flush mount DN80
FMR67	GA	Drip-off, PTFE DN50
	GP	PTFE flush mount DN80

 Shown in the temperature tables exemplary as follows:

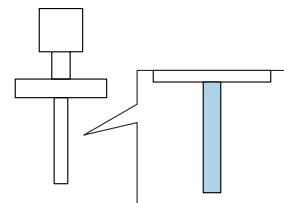

Position 9, 10 (Seal)		
Selected option		Description
FMR60	A3	FKM Viton GLT, -40...80°C/-40...176°F
	A4	FKM Viton GLT, -40...130°C/-40...266°F
	C1	FFKM Kalrez, -20...150°C/-4...302°F
	B4	EPDM, -40...150°C/-40...302°F
FMR62	A5	FKM Viton GLT, -40...150°C/-40...302°F
	A6	FKM Viton GLT, -40...200°C/-40...392°F
	C1	FFKM Kalrez, -20...150°C/-4...302°F
	C2	FFKM Kalrez, -20...200°C/-4...392°F
	F5	PTFE cladded, -40...150°C/-40...302°F
	F6	PTFE cladded, -40...200°C/-40...392°F

Position 9, 10 (Seal)		
Selected option		Description
FMR67	A3	FKM Viton GLT, -40...80°C/-40...176°F
	A5	FKM Viton GLT, -40...150°C/-40...302°F
	A6	FKM Viton GLT, -40...200°C/-40...392°F

 Shown in the temperature tables exemplary as follows:

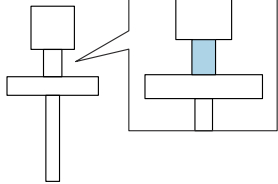

**General notes**

 Observe the permitted temperature range at the antenna.

**Description notes**

 Unless otherwise indicated, the positions always refer to the basic specification.

1st column: Position 5 (Housing) = A, B, ...

2nd column: Temperature classes T6 (85 °C) to T1 (450 °C)

Column P1 to P5: Position (temperature value) on the axes of the derating

- T<sub>a</sub>: Ambient temperature in °C
- T<sub>p</sub>: Process temperature in °C

 Column P2+ is only relevant for version B of the derating.

→  16

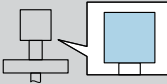
 = C		P1		P2		P2+		P3		P4		P5	
		T <sub>p</sub>	T <sub>a</sub>	T <sub>p</sub>	T <sub>a</sub>	T <sub>p</sub>	T <sub>a</sub>	T <sub>p</sub>	T <sub>a</sub>	T <sub>p</sub>	T <sub>a</sub>	T <sub>p</sub>	T <sub>a</sub>
	T6	-40	51	51	51	-	-	85	45	85	-40	-40	-40
	T5	-40	64	64	64	-	-	100	58	100	-40	-40	-40
	T4	-40	64	64	64	-	-	135	52	135	-40	-40	-40

A0031752-EN

Example diagrams  
of possible deratings

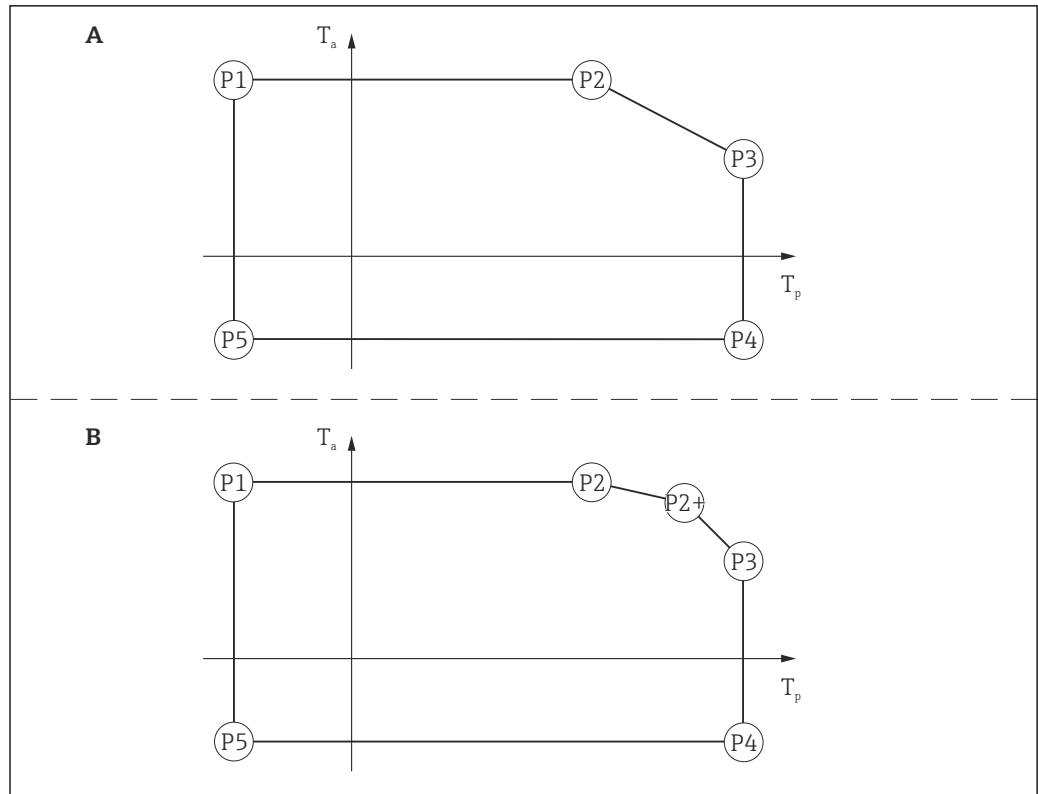

A0031943

2



Zone 0, Zone 1

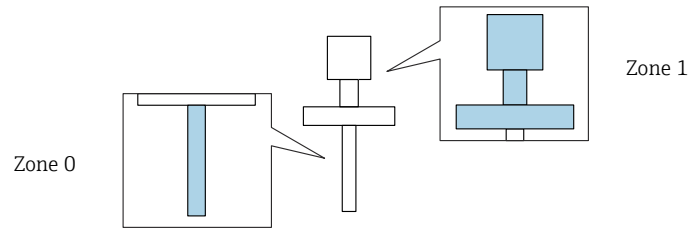

FMR6x

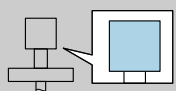
 = B, C		P1		P2		P2+		P3		P4		P5	
		T <sub>p</sub>	T <sub>a</sub>	T <sub>p</sub>	T <sub>a</sub>	T <sub>p</sub>	T <sub>a</sub>	T <sub>p</sub>	T <sub>a</sub>	T <sub>p</sub>	T <sub>a</sub>	T <sub>p</sub>	T <sub>a</sub>
	T6	-20	51	51	51	-	-	60	49	60	-20	-20	-20
	T5	-20	64	60	64	-	-	60	64	60	-20	-20	-20
	T4	-20	64	60	64	-	-	60	64	60	-20	-20	-20
	T3	-20	64	60	64	-	-	60	64	60	-20	-20	-20

**Zone 1** Page references to the temperature tables of the respective device types: See the following list.

- FMR60 → 18
- FMR62 → 20
- FMR67 → 22

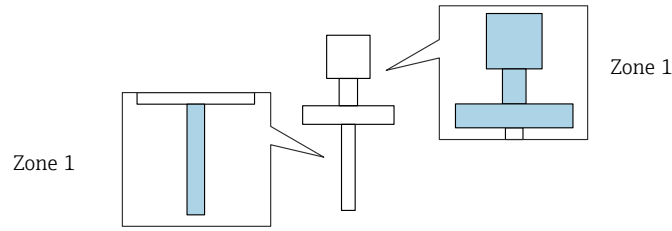

**FMR60**

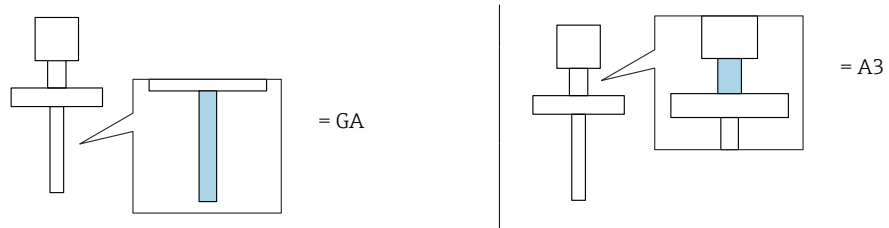

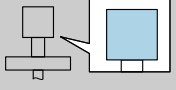
 = C		P1		P2		P2+		P3		P4		P5	
		T <sub>p</sub>	T <sub>a</sub>	T <sub>p</sub>	T <sub>a</sub>	T <sub>p</sub>	T <sub>a</sub>	T <sub>p</sub>	T <sub>a</sub>	T <sub>p</sub>	T <sub>a</sub>	T <sub>p</sub>	T <sub>a</sub>
	T6	-40	51	51	51	-	-	80	47	80	-40	-40	-40

**FMR60**

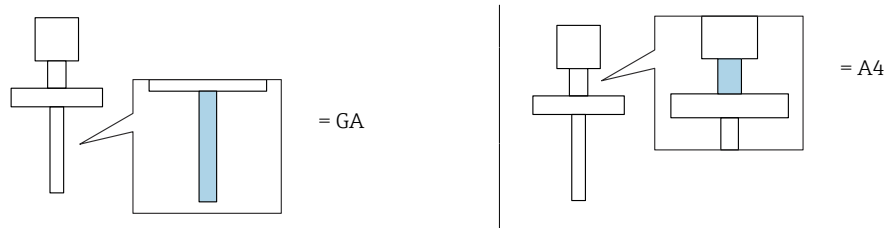

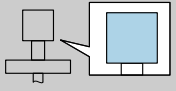
 = C		P1		P2		P2+		P3		P4		P5	
		T <sub>p</sub>	T <sub>a</sub>	T <sub>p</sub>	T <sub>a</sub>	T <sub>p</sub>	T <sub>a</sub>	T <sub>p</sub>	T <sub>a</sub>	T <sub>p</sub>	T <sub>a</sub>	T <sub>p</sub>	T <sub>a</sub>
	T6	-40	51	51	51	-	-	85	46	85	-40	-40	-40
	T5	-40	64	64	64	-	-	100	59	100	-40	-40	-40
	T4	-40	64	64	64	-	-	130	54	130	-40	-40	-40

**FMR60**

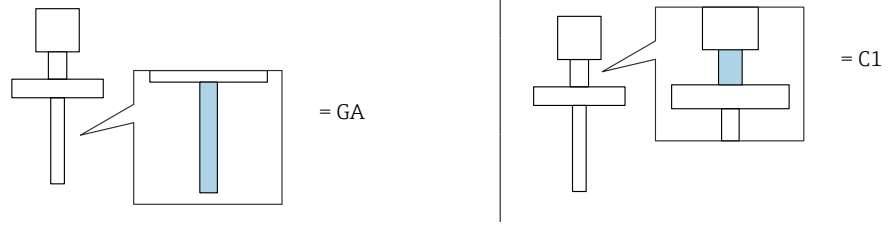

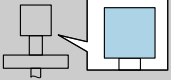
 = C		P1		P2		P2+		P3		P4		P5	
		T <sub>p</sub>	T <sub>a</sub>	T <sub>p</sub>	T <sub>a</sub>	T <sub>p</sub>	T <sub>a</sub>	T <sub>p</sub>	T <sub>a</sub>	T <sub>p</sub>	T <sub>a</sub>	T <sub>p</sub>	T <sub>a</sub>
	T6	-20	51	51	51	-	-	85	46	85	-20	-20	-20
	T5	-20	64	64	64	-	-	100	59	100	-20	-20	-20
	T4	-20	64	64	64	-	-	135	54	135	-20	-20	-20
	T3	-20	64	64	64	-	-	150	50	150	-20	-20	-20

**FMR60**

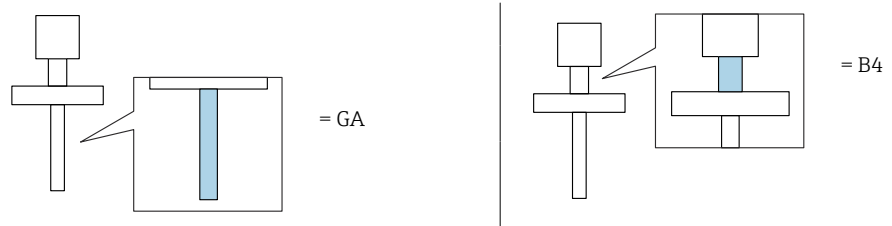

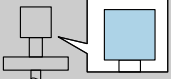
 = C		P1		P2		P2+		P3		P4		P5	
		T <sub>p</sub>	T <sub>a</sub>	T <sub>p</sub>	T <sub>a</sub>	T <sub>p</sub>	T <sub>a</sub>	T <sub>p</sub>	T <sub>a</sub>	T <sub>p</sub>	T <sub>a</sub>	T <sub>p</sub>	T <sub>a</sub>
	T6	-40	51	51	51	-	-	85	46	85	-40	-40	-40
	T5	-40	64	64	64	-	-	100	59	100	-40	-40	-40
	T4	-40	64	64	64	-	-	135	54	135	-40	-40	-40
	T3	-40	64	64	64	-	-	150	50	150	-40	-40	-40

**FMR62**

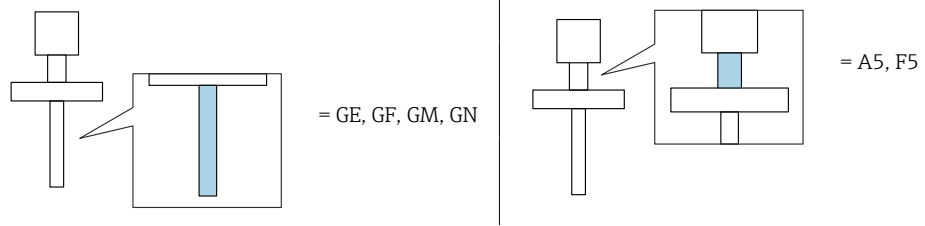

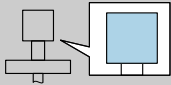
 = B		P1		P2		P2+		P3		P4		P5	
		T <sub>p</sub>	T <sub>a</sub>	T <sub>p</sub>	T <sub>a</sub>	T <sub>p</sub>	T <sub>a</sub>	T <sub>p</sub>	T <sub>a</sub>	T <sub>p</sub>	T <sub>a</sub>	T <sub>p</sub>	T <sub>a</sub>
	T6	-40	51	51	51	-	-	85	45	85	-40	-40	-40
	T5	-40	64	64	64	-	-	100	58	100	-40	-40	-40
	T4	-40	64	64	64	-	-	135	52	135	-40	-40	-40
	T3	-40	64	64	64	-	-	150	47	150	-40	-40	-40

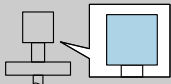
 = C		P1		P2		P2+		P3		P4		P5	
		T <sub>p</sub>	T <sub>a</sub>	T <sub>p</sub>	T <sub>a</sub>	T <sub>p</sub>	T <sub>a</sub>	T <sub>p</sub>	T <sub>a</sub>	T <sub>p</sub>	T <sub>a</sub>	T <sub>p</sub>	T <sub>a</sub>
	T6	-40	51	51	51	-	-	85	47	85	-40	-40	-40
	T5	-40	64	64	64	-	-	100	60	100	-40	-40	-40
	T4	-40	64	64	64	-	-	135	56	135	-40	-40	-40
	T3	-40	64	64	64	-	-	150	54	150	-40	-40	-40

**FMR62**

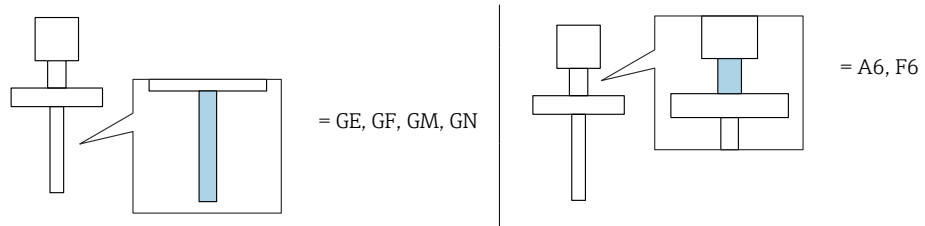

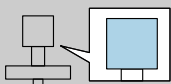
 = B, C		P1		P2		P2+		P3		P4		P5	
		T <sub>p</sub>	T <sub>a</sub>	T <sub>p</sub>	T <sub>a</sub>	T <sub>p</sub>	T <sub>a</sub>	T <sub>p</sub>	T <sub>a</sub>	T <sub>p</sub>	T <sub>a</sub>	T <sub>p</sub>	T <sub>a</sub>
	T6	-40	51	51	51	-	-	85	48	85	-40	-40	-40
	T5	-40	64	64	64	-	-	100	61	100	-40	-40	-40
	T4	-40	64	64	64	-	-	135	58	135	-40	-40	-40
	T3	-40	64	64	64	-	-	200	53	200	-40	-40	-40

**FMR62**

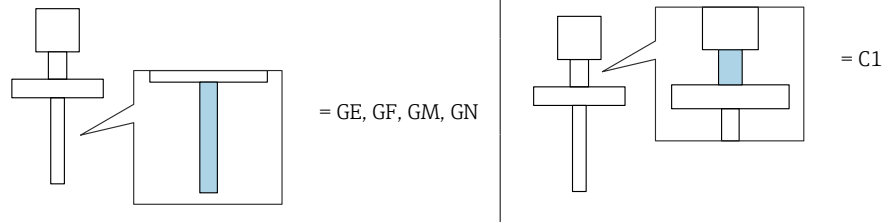

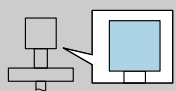
 = B		P1		P2		P2+		P3		P4		P5	
		T <sub>p</sub>	T <sub>a</sub>	T <sub>p</sub>	T <sub>a</sub>	T <sub>p</sub>	T <sub>a</sub>	T <sub>p</sub>	T <sub>a</sub>	T <sub>p</sub>	T <sub>a</sub>	T <sub>p</sub>	T <sub>a</sub>
	T6	-20	51	51	51	-	-	85	45	85	-20	-20	-20
	T5	-20	64	64	64	-	-	100	58	100	-20	-20	-20
	T4	-20	64	64	64	-	-	135	52	135	-20	-20	-20
	T3	-20	64	64	64	-	-	150	47	150	-20	-20	-20

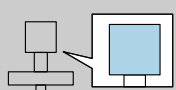
 = C		P1		P2		P2+		P3		P4		P5	
		T <sub>p</sub>	T <sub>a</sub>	T <sub>p</sub>	T <sub>a</sub>	T <sub>p</sub>	T <sub>a</sub>	T <sub>p</sub>	T <sub>a</sub>	T <sub>p</sub>	T <sub>a</sub>	T <sub>p</sub>	T <sub>a</sub>
	T6	-20	51	51	51	-	-	85	47	85	-20	-20	-20
	T5	-20	64	64	64	-	-	100	60	100	-20	-20	-20
	T4	-20	64	64	64	-	-	135	56	135	-20	-20	-20
	T3	-20	64	64	64	-	-	150	54	150	-20	-20	-20

**FMR62**

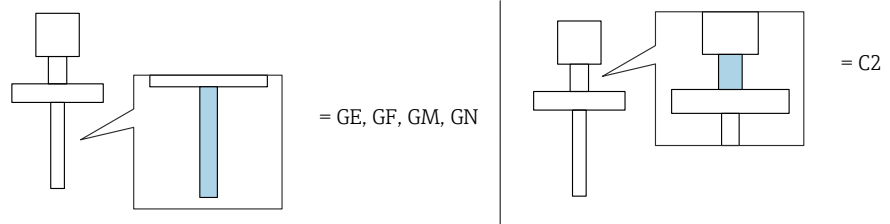

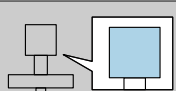
 = B, C		P1		P2		P2+		P3		P4		P5	
		T <sub>p</sub>	T <sub>a</sub>	T <sub>p</sub>	T <sub>a</sub>	T <sub>p</sub>	T <sub>a</sub>	T <sub>p</sub>	T <sub>a</sub>	T <sub>p</sub>	T <sub>a</sub>	T <sub>p</sub>	T <sub>a</sub>
	T6	-20	51	51	51	-	-	85	48	85	-20	-20	-20
	T5	-20	64	64	64	-	-	100	61	100	-20	-20	-20
	T4	-20	64	64	64	-	-	135	58	135	-20	-20	-20
	T3	-20	64	64	64	-	-	200	53	200	-20	-20	-20

**FMR67**

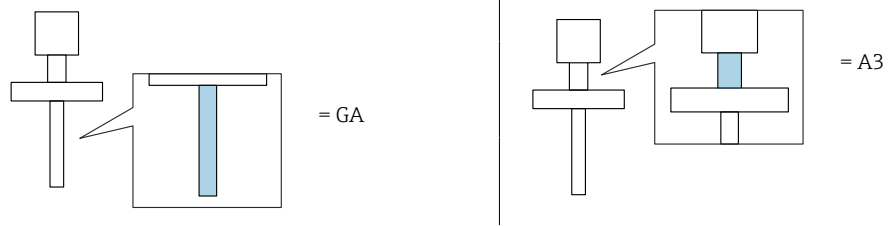

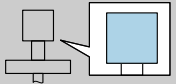
 = B		P1		P2		P2+		P3		P4		P5	
		T <sub>p</sub>	T <sub>a</sub>	T <sub>p</sub>	T <sub>a</sub>	T <sub>p</sub>	T <sub>a</sub>	T <sub>p</sub>	T <sub>a</sub>	T <sub>p</sub>	T <sub>a</sub>	T <sub>p</sub>	T <sub>a</sub>
	T6	-40	51	51	51	-	-	80	43	80	-40	-40	-40

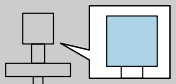
 = C		P1		P2		P2+		P3		P4		P5	
		T <sub>p</sub>	T <sub>a</sub>	T <sub>p</sub>	T <sub>a</sub>	T <sub>p</sub>	T <sub>a</sub>	T <sub>p</sub>	T <sub>a</sub>	T <sub>p</sub>	T <sub>a</sub>	T <sub>p</sub>	T <sub>a</sub>
	T6	-40	51	51	51	-	-	80	47	80	-40	-40	-40

**FMR67**

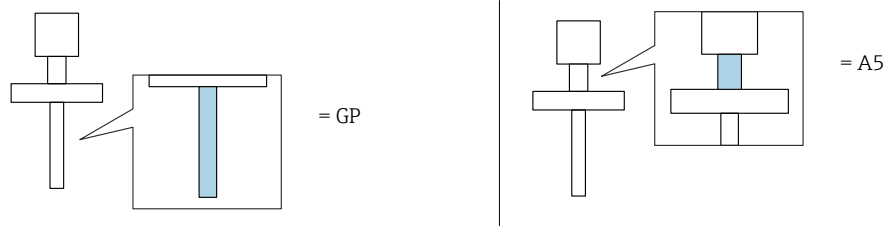

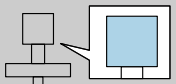
 = B		P1		P2		P2+		P3		P4		P5	
		T <sub>p</sub>	T <sub>a</sub>	T <sub>p</sub>	T <sub>a</sub>	T <sub>p</sub>	T <sub>a</sub>	T <sub>p</sub>	T <sub>a</sub>	T <sub>p</sub>	T <sub>a</sub>	T <sub>p</sub>	T <sub>a</sub>
	T6	-40	51	51	51	-	-	85	45	85	-40	-40	-40
	T5	-40	64	64	64	-	-	100	58	100	-40	-40	-40
	T4	-40	64	64	64	-	-	135	52	135	-40	-40	-40
	T3	-40	64	64	64	-	-	150	47	150	-40	-40	-40

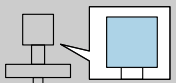
 = C		P1		P2		P2+		P3		P4		P5	
		T <sub>p</sub>	T <sub>a</sub>	T <sub>p</sub>	T <sub>a</sub>	T <sub>p</sub>	T <sub>a</sub>	T <sub>p</sub>	T <sub>a</sub>	T <sub>p</sub>	T <sub>a</sub>	T <sub>p</sub>	T <sub>a</sub>
	T6	-40	51	51	51	-	-	85	47	85	-40	-40	-40
	T5	-40	64	64	64	-	-	100	60	100	-40	-40	-40
	T4	-40	64	64	64	-	-	135	56	135	-40	-40	-40
	T3	-40	64	64	64	-	-	150	54	150	-40	-40	-40

**FMR67**

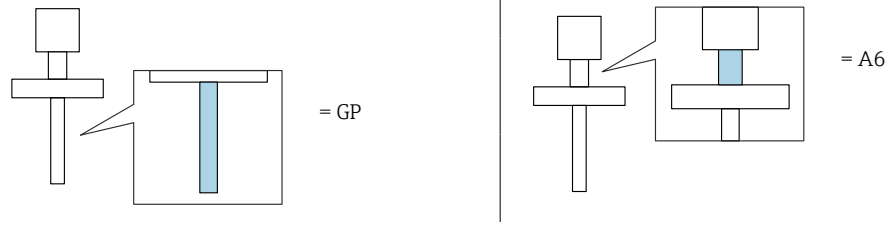

		P1		P2		P2+		P3		P4		P5	
		T <sub>p</sub>	T <sub>a</sub>	T <sub>p</sub>	T <sub>a</sub>	T <sub>p</sub>	T <sub>a</sub>	T <sub>p</sub>	T <sub>a</sub>	T <sub>p</sub>	T <sub>a</sub>	T <sub>p</sub>	T <sub>a</sub>
	T6	-40	51	51	51	-	-	85	48	85	-40	-40	-40
	T5	-40	64	64	64	-	-	100	61	100	-40	-40	-40
	T4	-40	64	64	64	-	-	135	58	135	-40	-40	-40
	T3	-40	64	64	64	-	-	200	53	200	-40	-40	-40



71501072

[www.addresses.endress.com](http://www.addresses.endress.com)

---