

Operating Instructions

Temperature switch OTR31, OTR35

For safe measurement, monitoring and control of
process temperatures

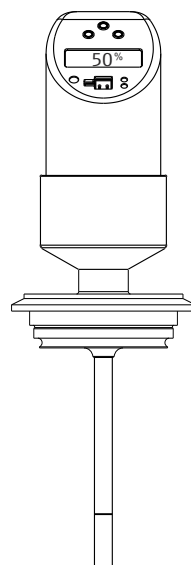
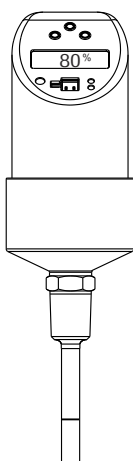

Table of contents

1	About this document	4	10	Accessories	28
1.1	Document function	4	10.1	Device-specific accessories	28
1.2	Symbols used	4	10.2	Communication-specific accessories ...	30
2	Basic safety instructions	6	11	Technical data	31
2.1	Requirements for the personnel	6	11.1	Input	31
2.2	Intended use	6	11.2	Output	32
2.3	Workplace safety	6	11.3	Power supply	33
2.4	Operational safety	6	11.4	Output	33
2.5	Product safety	7	11.5	Environment	33
2.6	IT security	7	11.6	Process	34
3	Incoming acceptance and product identification	7	11.7	Mechanical construction	37
3.1	Incoming acceptance	7	11.8	Certificates and approvals	40
3.2	Product identification	8			
3.3	Nameplate	8			
3.4	Name and address of manufacturer	8			
3.5	Certificates and approvals	9			
3.6	Hygiene standard	9			
3.7	Storage and transport	9			
4	Mounting	9			
4.1	Mounting requirements	9			
4.2	Mounting the device	10			
5	Electrical connection	12			
5.1	Connecting requirements	12			
6	Operating options	15			
6.1	Local operation	15			
6.2	Access to the operating menu via the operating tool	24			
7	Diagnostics and troubleshooting	25			
7.1	General troubleshooting	25			
7.2	Firmware history	26			
8	Maintenance	26			
8.1	Cleaning	27			
9	Repair	27			
9.1	Disposal	27			

1 About this document

1.1 Document function

These Operating Instructions contain all the information that is required in various phases of the life cycle of the device: from product identification, incoming acceptance and storage, to mounting, connection, operation and commissioning through to troubleshooting, maintenance and disposal.

1.2 Symbols used

1.2.1 Safety symbols

DANGER

This symbol alerts you to a dangerous situation. Failure to avoid this situation will result in serious or fatal injury.

WARNING

This symbol alerts you to a dangerous situation. Failure to avoid this situation can result in serious or fatal injury.





CAUTION

This symbol alerts you to a dangerous situation. Failure to avoid this situation can result in minor or medium injury.













NOTICE

This symbol contains information on procedures and other facts which do not result in personal injury.



1.2.2 Electrical symbols

Symbol	Meaning
	Direct current
	Alternating current
	Direct current and alternating current
	Ground connection A grounded terminal which, as far as the operator is concerned, is grounded via a grounding system.
	Protective Earth (PE) A terminal which must be connected to ground prior to establishing any other connections. The ground terminals are situated inside and outside the device: <ul style="list-style-type: none"> ■ Inner ground terminal: Connects the protective earth to the mains supply. ■ Outer ground terminal: Connects the device to the plant grounding system.

1.2.3 Symbols for certain types of information

Symbol	Meaning
	Permitted Procedures, processes or actions that are permitted.
	Preferred Procedures, processes or actions that are preferred.
	Forbidden Procedures, processes or actions that are forbidden.
	Tip Indicates additional information.
	Reference to documentation
	Reference to page
	Reference to graphic
	Notice or individual step to be observed
	Series of steps
	Result of a step
	Help in the event of a problem
	Visual inspection

1.2.4 Symbols in graphics

Symbol	Meaning	Symbol	Meaning
1, 2, 3,...	Item numbers		Series of steps
A, B, C, ...	Views	A-A, B-B, C-C, ...	Sections
	Hazardous area		Safe area (non-hazardous area)

2 Basic safety instructions

2.1 Requirements for the personnel

The personnel for installation, commissioning, diagnostics and maintenance must fulfill the following requirements:

- ▶ Trained, qualified specialists must have a relevant qualification for this specific function and task.
- ▶ Are authorized by the plant owner/operator.
- ▶ Are familiar with federal/national regulations.
- ▶ Before starting work, read and understand the instructions in the manual and supplementary documentation as well as the certificates (depending on the application).
- ▶ Follow instructions and comply with basic conditions.

The operating personnel must fulfill the following requirements:

- ▶ Are instructed and authorized according to the requirements of the task by the facility's owner-operator.
- ▶ Follow the instructions in this manual.

2.2 Intended use

The device is a temperature switch for monitoring, displaying and controlling process temperatures. The device is designed to meet state-of-the-art safety requirements and complies with applicable standards and EC regulations. The device can, however, be a source of danger if used incorrectly or for anything other than the purpose for which it was intended.

The manufacturer is not liable for damage caused by using the device incorrectly or for purposes for which it was not intended.

2.3 Workplace safety

For work on and with the device:

- ▶ Wear the required personal protective equipment according to federal/national regulations.

If working on and with the device with wet hands:

- ▶ Due to the increased risk of electric shock, gloves must be worn.

2.4 Operational safety

The measuring system meets the general safety requirements according to EN 61010-1 and the EMC requirements according to IEC/EN 61326 in addition to NAMUR recommendations NE 21, NE 43 and NE 53.

- Functional safety:
The device has been developed according to the IEC 61508 and IEC 61511-1 (FDIS) standards. The device version with a PNP switch output and additional analog output is fitted with mechanisms for error detection and prevention within the electronics and software.
- Hazardous area:
The device is not approved for use in hazardous areas.

Risk of injury!

- ▶ Operate the device in proper technical condition and fail-safe condition only.
- ▶ The operator is responsible for interference-free operation of the device.

Modifications to the device

Unauthorized modifications to the device are not permitted and can lead to unforeseeable dangers:

- ▶ If modifications are nevertheless required, consult with the manufacturer.

Repair

To ensure continued operational safety and reliability:

- ▶ Carry out repairs on the device only if they are expressly permitted.
- ▶ Observe federal/national regulations pertaining to the repair of an electrical device.
- ▶ Use only original spare parts and accessories from the manufacturer.

2.5 Product safety

This measuring device is designed in accordance with good engineering practice to meet state-of-the-art safety requirements, has been tested, and left the factory in a condition in which it is safe to operate.

It meets general safety standards and legal requirements. It also complies with the EC directives listed in the device-specific EC Declaration of Conformity. The manufacturer confirms this by affixing the CE mark to the device.

2.6 IT security

Our warranty is valid only if the device is installed and used as described in the Operating Instructions. The device is equipped with security mechanisms to protect it against any inadvertent changes to the settings.

IT security measures, which provide additional protection for the device and associated data transfer, must be implemented by the operators themselves in line with their security standards.

3 Incoming acceptance and product identification

3.1 Incoming acceptance

Proceed as follows on receipt of the device:

1. Check whether the packaging is intact.
2. If damage is discovered:
Report all damage immediately to the manufacturer.
3. Do not install damaged material, as the manufacturer cannot otherwise guarantee compliance with the safety requirements and cannot be held responsible for the consequences that may result.

- 4. Compare the scope of delivery to the contents of the order.
- 5. Remove all the packaging material used for transportation.

3.2 Product identification

The device can be identified in the following ways:
Nameplate specifications

3.3 Nameplate

The nameplate illustrated below is designed to help users identify specific product information, such as the serial number, design, variables, configuration and device approvals:

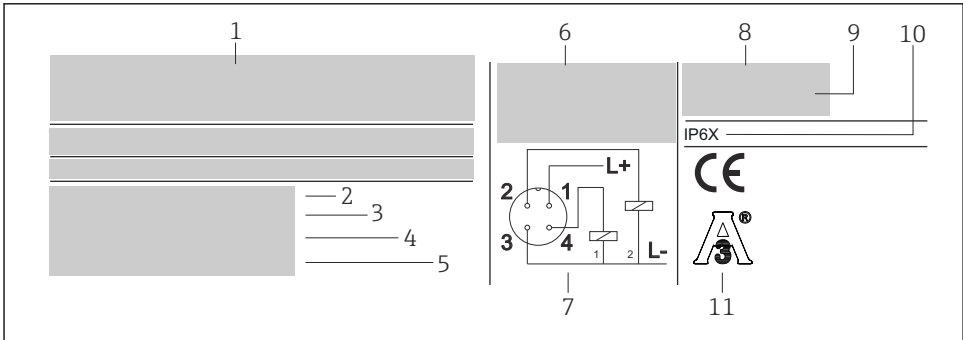

A0008138

1 Nameplate for device identification

- 1 Manufacturer's details
- 2 Order code
- 3 Serial number
- 4 Tag number
- 5 Release number
- 6 Connection data
- 7 Connection diagram
- 8 Measuring range
- 9 Ambient temperature
- 10 Degree of protection
- 11 Approvals

i Compare and check the data on the nameplate of the device against the requirements of the measurement point.

3.4 Name and address of manufacturer



Name of manufacturer:	Endress+Hauser Wetzer GmbH + Co. KG
Address of manufacturer:	Obere Wank 1, D-87484 Nesselwang or www.endress.com

3.5 Certificates and approvals

3.5.1 CE mark

The product meets the requirements of the harmonized European standards. As such, it complies with the legal specifications of the EC directives. The manufacturer confirms successful testing of the product by affixing to it the CE-mark.

3.6 Hygiene standard

- EHEDG certification, TYPE EL CLASS I. Permitted process connections in accordance with EHEDG, see 'Process connections' section →  37
- 3-A Authorization No. 1144. 3-A Sanitary Standard. Permitted process connections in accordance with 3-A, see also "Process connections" section →  37
- FDA-compliant

3.7 Storage and transport





Pack the device so that it is reliably protected against impact when it is stored (and transported). The original packaging offers the best protection.

Storage temperature	-40 to +85 °C (-40 to +185 °F)
---------------------	--------------------------------

4 Mounting

4.1 Mounting requirements



Do not turn the device into the process connection thread at the housing. Always install the device at the hexagonal screw of the sensor module (→  2,  10, item 1). using a suitable open-ended wrench (see table →  38).



Self-draining in the process must be guaranteed. If there is an opening to detect leaks at the process connection, this opening must be at the lowest possible point.

4.2 Mounting the device

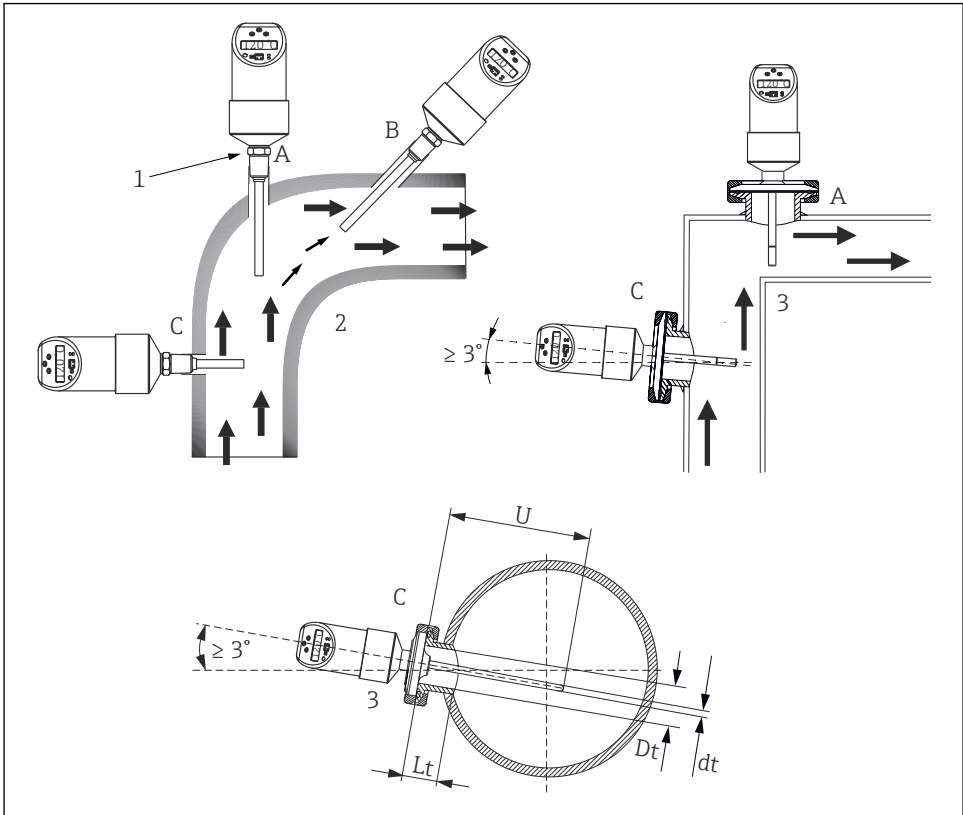

A0011644

2 Installation options for temperature monitoring in pipelines

- 1 Hexagonal screw of sensor module
- 2 Temperature switch
- 3 Temperature switch for use in hygienic processes

4.2.1 General installation instructions

- Installation at elbows, against the direction of flow (A).
- Installation in smaller pipes, inclined against the direction of flow (B).
- Installation perpendicular to the direction of flow (C).
Installation of hygiene version at a min. angle of 3° to guarantee self-draining.
- The local display can be rotated electronically by 180° : "Local operation", → 15.
- The housing can be rotated up to 310° .

Ambient temperature range

T_a	-40 to +85 °C (-40 to +185 °F)
-------	--------------------------------

4.2.2 Installation instructions when installing in hygienic processes

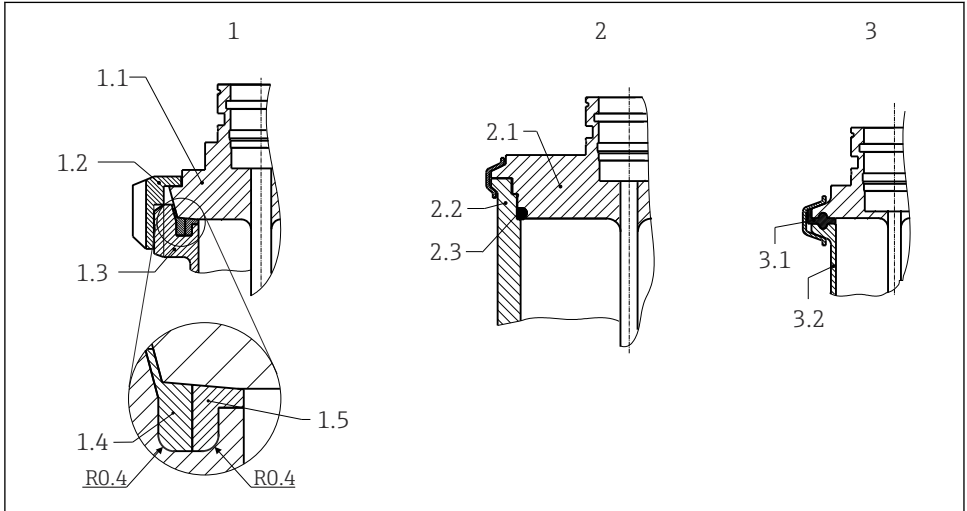

A0044659

3 Detailed installation instructions for hygiene-compliant installation

- 1 Milk pipe connection according to DIN 11851 (PL, PG, PH connection), only in conjunction with EHEDG-certified and self-centering sealing ring
 - 1.1 Sensor with milk pipe connection
 - 1.2 Groove slip-on nut
 - 1.3 Counterpart connection
 - 1.4 Centering ring
 - 1.5 Sealing ring
- 2 Varivent® and APV-Inline (LB, LL, HL connection)
 - 2.1 Sensor with Varivent® connection
 - 2.2 Counterpart connection
 - 2.3 O-ring
- 3 Clamp according to ISO 2852 (DB, DL connection), EHEDG certified only in conjunction with seal according to EHEDG position paper
 - 3.1 Molded seal
 - 3.2 Counterpart connection



The requirements of the EHEDG and the 3-A Sanitary Standard must be adhered to.
 Installation instruction EHEDG/cleanability: $Lt \leq (Dt-dt)$
 Installation instruction 3-A/cleanability: $Lt \leq 2(Dt-dt)$

In the case of weld-in connections, exercise the necessary degree of care when performing the welding work on the process side:

1. Use suitable welding material.
2. Flush-weld or weld with welding radius ≥ 3.2 mm (0.13 in).
3. Avoid crevices, folds or gaps.
4. Ensure the surface is mechanically polished, $R_a \leq 0.76$ μm (30 μin).

Pay attention to the following when installing the thermometer to ensure that the cleanability is not affected:

1. The installed sensor is suitable for CIP (cleaning in place). Cleaning is carried out in combination with tubing/piping or tank/vessel. In the case of internal tank fixtures using process connection nozzles, it is important to ensure that the cleaning assembly sprays this area directly so that it is cleaned properly.
2. The Varivent® connections enable flush-mounted installation.

NOTICE

The following action must be taken if a sealing ring (O-ring) or seal fails:

- ▶ The thermometer must be removed.
- ▶ The thread and the O-ring joint/sealing surface must be cleaned.
- ▶ The sealing ring or seal must be replaced.
- ▶ CIP must be performed after installation.

5 Electrical connection

5.1 Connecting requirements

5.1.1 DC voltage version with M12x1 connector

 According to the 3-A Sanitary Standard and EHEDG electrical connecting cables must be smooth, corrosion-resistant and easy to clean.

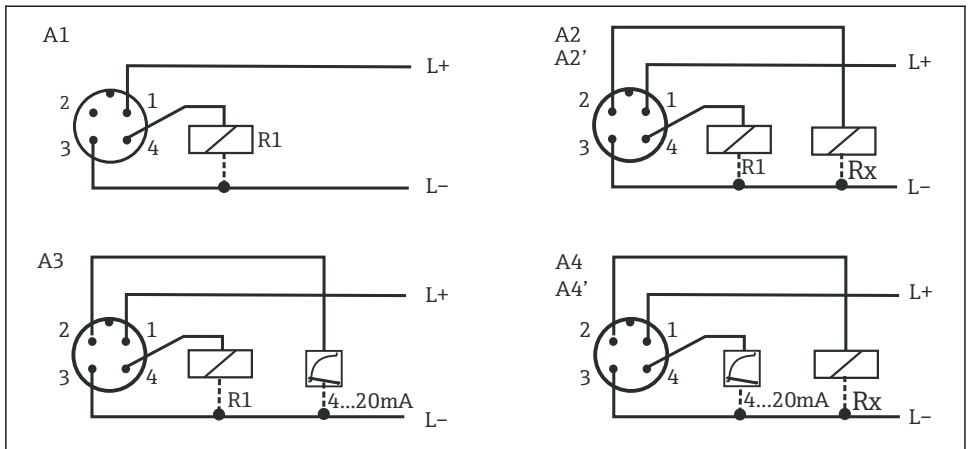

A0043603

4 Pin assignment on M12x1 connector

Item no.	Output setting
A1	1x PNP switch output
A2	2 x PNP switch output R1 and m (R2)
A2'	2x PNP switch output R1 and m (diagnostics/NC contact for "DESINA" setting)
A3	1x PNP switch output and 1x analog output (4 to 20 mA)
A4	1x analog output (4 to 20 mA) and 1x PNP switch output m (R2)
A4'	1x analog output (4 to 20 mA) and 1x PNP switch output m (diagnostics/NC contact with "DESINA" setting)

⚠ WARNING

Observe the following to avoid damaging the analog input of a PLC:

- ▶ Do not connect the active PNP switch output of the device to the 4 to 20 mA input of a PLC.

DESINA: distributed and standardized installation technology for machine tools and manufacturing systems, → 15.

R2 = diagnostics/NC contact (for more information on DESINA, see www.desina.de)

5.1.2 DC voltage version with valve connector

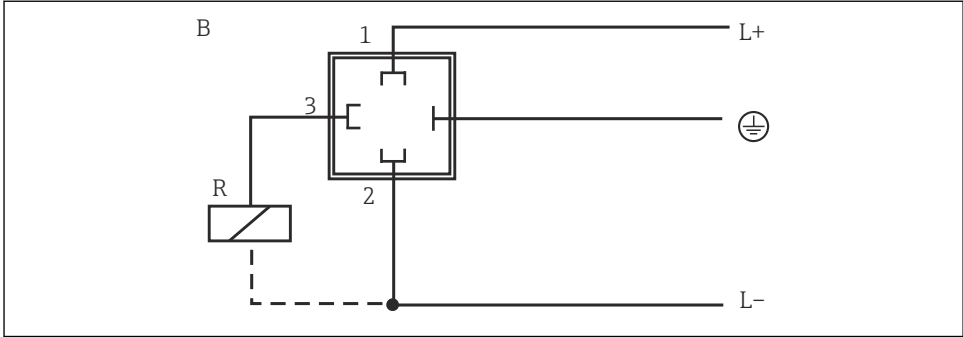

A0035798

Item no.	Output setting
B	1x PNP switch output

6 Operating options

6.1 Local operation

The device is operated via three keys. The digital display and the light emitting diodes (LED) assist navigation through the operating menu.

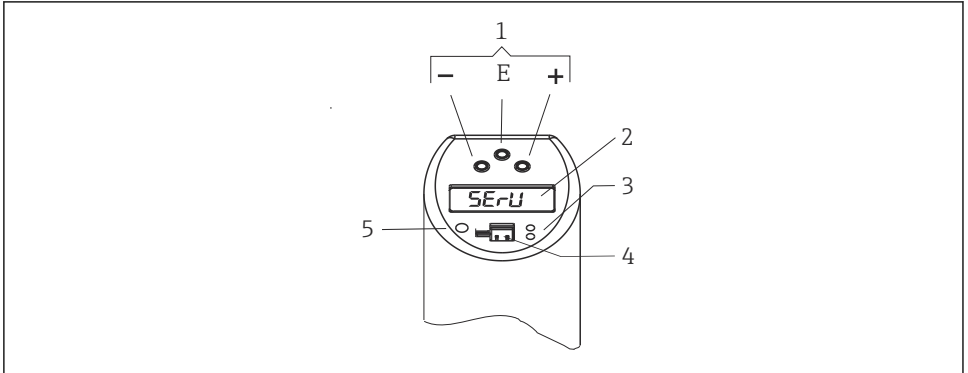

A0044663

5 Position of the operating elements and possibilities for display

- 1 Operating keys
- 2 Digital display: illuminated white (= ok); red (= alarm/error)
- 3 Yellow LED for switching states: LED on = switch closed; LED off = switch open
- 4 Communication jack for PC configuration
- 5 LED for status display: green = OK; red = error/fault; flashing red/green = warning



To prevent damage to the keys, do not operate them with a pointed object!

6.1.1 Navigation in the operating menu

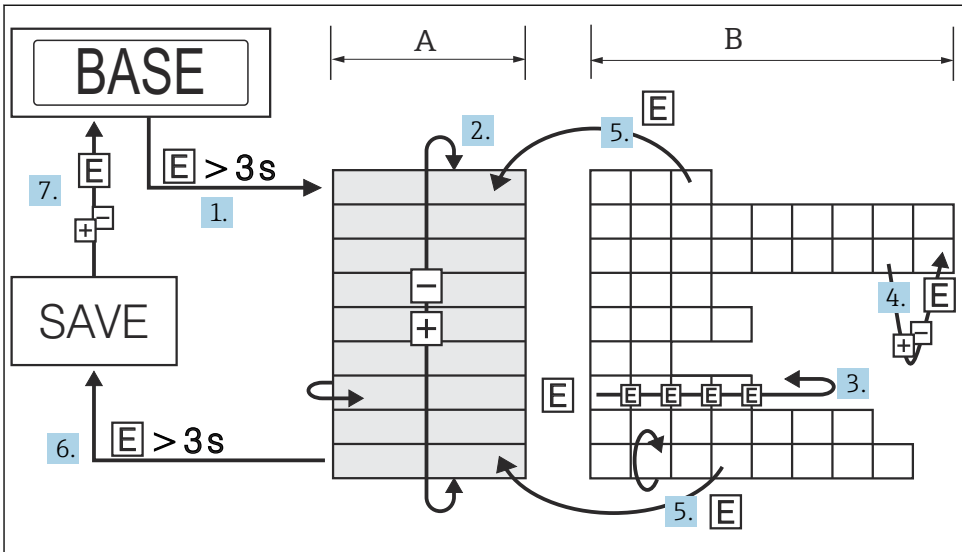

A0035802

6 Navigation in the operating menu

- A Function group selection
B Function selection

1. To enter the operating menu, press the E key for longer than 3 s.
2. Select the "Function group" with the + or – key.
3. Select the "Function" with the E key.
4. If software locking is enabled, it must be disabled before making entries or changes. Enter and change the parameters with the + or – key.
5. Press the E key to return to "Function".
6. Press the E repeatedly to return to "Function group" until the relevant function group is reached.
7. To return to the measuring position (Home), press the E key for longer than 3 s.
8. To display the prompt to save data (press + or – to select the option "YES" or "NO"), confirm with the E key.

i If "YES" is selected when asked to save the data, changes are made to the parameter settings.

6.1.2 Structure of the operating menu for 1x or 2x switch output

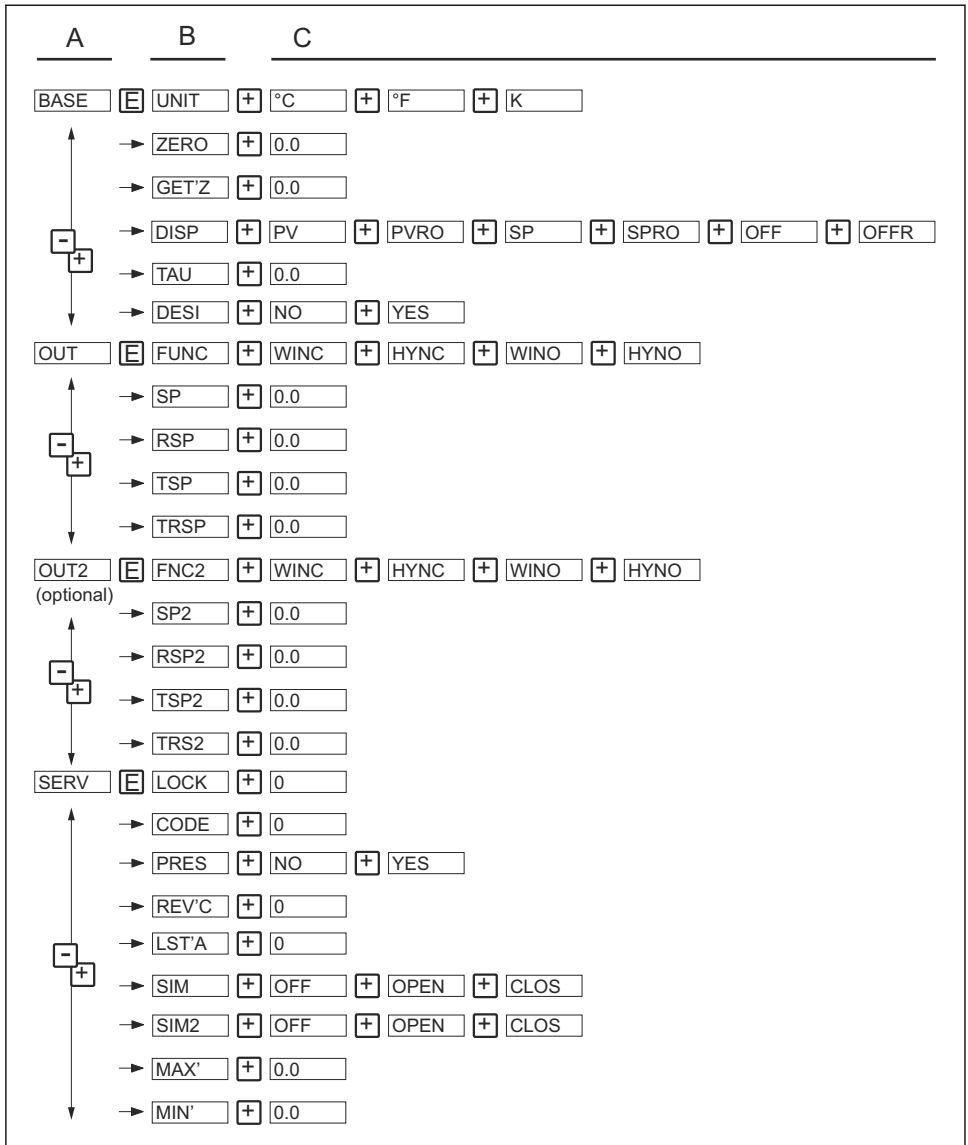

A0009102

7 Operating menu: A function groups, B functions, C settings

6.1.3 Structure of the operating menu for 1x switch output and 1x analog output4 to 20 mA

For devices with an analog output, both output 1 and output 2 can be configured as an analog output. It is also possible to configure output 1 and output 2 as a switch output.

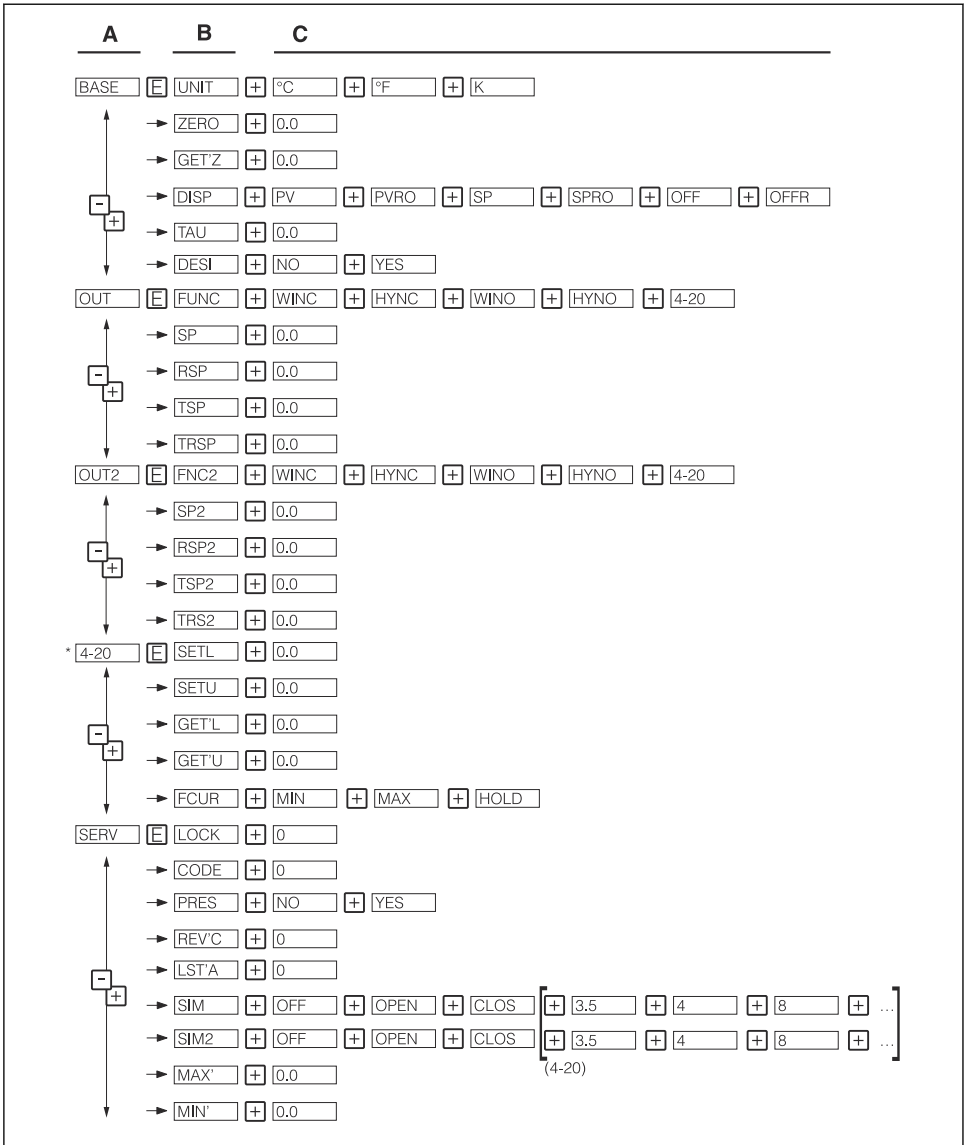

A0008103

8 Operating menu: A function groups, B functions, C settings

i The function group 4-20 is available only if the 4 to 20 mA analog output (4-20) is selected under FUNC or FNC2 in function group OUT or OUT2.

6.1.4 Basic settings

Function group	Function		Settings	Description
BASE	UNIT	Technical unit	°C °F K	Select unit on display: °C, °F, K factory setting: °C
	ZERO	Zero point configuration	0.0	Position adjustment: within ±10 °C/K (18 °F) of the upper sensor limit
	GETZ	Zero point adoption	0.0	No settings possible (not available in the PC software)
	DISP	Display	PV PVRO SP SPRO OFF OFFR	PV: Display measured value PVRO: Display of measured value rotated by 180° SP: Display set switch point SPRO: Display of set switch point rotated by 180° OFF: Display off OFFR: Display off rotated by 180° Factory setting: current measured value (PV)
	TAU	Damping: display value, output signal	0.0	Damping of measured value or display value and output: 0 (no damping) or 9 to 40 s (in increments of 1 s) Factory setting: 0 s
BASE	DESI	DESINA	NO YES	The PIN assignment of the M12 connector is in accordance with the guidelines of DESINA. Factory setting: NO  DESINA can be selected only if output 1 and 2 are selected.

6.1.5 Output setting - 1x or 2x switch output

■ Hysteresis function

The hysteresis function enables two-point control via a hysteresis. Depending on the temperature T, the hysteresis can be set via the switch point SP and the switchback point RSP.

■ Window function

The window function allows a process temperature range to be monitored.

■ NO contact or NC contact

This switch function is freely selectable.

- **Delay times for switch point SP and switchback point RSP can be configured in increments of 1 s.**

This makes it possible to filter out undesired temperature peaks of short duration or of high frequency.

- **Factory setting (if no customer-specific setting is ordered)**

Switch point SP1: 45 °C (113 °F); switchback point RSP1: 44.5 °C (112.1 °F)

Switch point SP2: 55 °C (131 °F); switchback point RSP2: 54.5 °C (130.1 °F)

- **Range of adjustment**

LRL = Lower Range Limit

URL = Upper Range Limit

LRV = Lower Range Value

URV = Upper Range Value

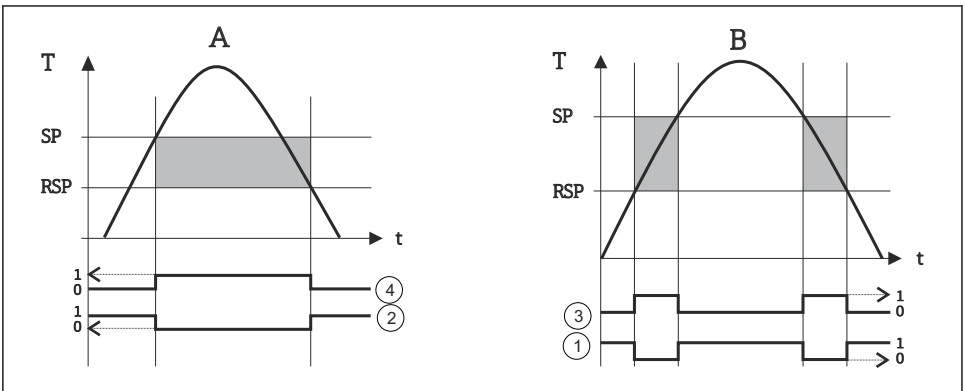

A0023240

9 Switch point functions

A Hysteresis function

B Window function

1 Window - NC contact

2 Hysteresis - NC contact

3 Window - NO contact

4 Hysteresis - NO contact

SP Switch point

RSP Switchback point

Function group	Function		Settings	Description	
OUT Output 1 OUT2 Output 2, optional	FUNC FNC2	Switching characteristics	WINC HYNC WINO HYNO	WINC: Window/NC contact HYNC: Hysteresis/NC contact WINO: Window/NO contact HYNO: Hysteresis/NO contact Factory setting: HYNO	
		SP SP2	Switch point value	0.0	Switch point -49.5 to 150 °C (-57.1 to 302 °F) in increments of 0.1 °C/°F
		RSP RSP2	Switchback point value	0.0	Switchback point -50 to 149 °C (-58 to 300 °F) in increments of 0.1 °C/°F
OUT Output 1 OUT2 Output 2, optional	TSP TSP2	Switch point delay	0.0	Delay time 0 to 99 s in increments of 0.1 s Factory setting: 0 s	
		TRSP TRSP2	Switchback point delay	0.0	Delay time 0 to 99 s in increments of 0.1 s Factory setting: 0 s
Minimum difference between SP and RSP: 0.5 °C/K (0.9 °F)					

6.1.6 Setting for output - 1x switch output and 1x analog output 4 to 20 mA

Function group	Function		Settings	Description	
OUT Output 1 OUT2 Output 2	FUNC FNC2	Switching characteristics	WINC HYNC WINO HYNO 4-20	WINC: Window/NC contact HYNC: Hysteresis/NC contact WINO: Window/NO contact HYNO: Hysteresis/NO contact 4-20: Analog output Factory setting: HYNO	
		SP SP2	Switch point value	0.0	Switch point -49.5 to 150 °C (-57.1 to 302 °F) in increments of 0.1 °C/°F
		RSP RSP2	Switchback point value	0.0	Switchback point -50 to 149 °C (-58 to 300 °F) in increments of 0.1 °C/°F
		TSP TSP2	Switch point delay	0.0	Delay time 0 to 99 s in increments of 0.1 s Factory setting: 0 s
OUT Output 1 OUT2 Output 2	TRSP TRSP2	Switchback point delay	0.0	Delay time 0 to 99 s in increments of 0.1 s Factory setting: 0 s	
Minimum difference between SP and RSP: 0.5 °C/K (0.9 °F)					

Function group	Function		Settings	Description
4-20 Analog output	SETL	Value for 4 mA (LRV)	0.0	-50 to 130 °C (-58 to 266 °F) Lower range value in increments of 0.1 °C/°F Factory setting: 0.0 °C (32 °F)
	SETU	Value for 20 mA (URV)	0.0	-30 to 150 °C (-22 to 302 °F) Upper range value in increments of 0.1 °C/°F Factory setting: 150 °C (302 °F)
	GETL	Temperature applied for 4 mA (LRV)	0.0	Accept temperature value as lower range value (not via PC software)
	GETU	Temperature applied for 20 mA (URV)	0.0	Accept temperature value as upper range value (not via PC software)
	FCUR	Failure current	MIN MAX HOLD	Current value in the event of an error: MIN = ≤ 3.6 mA MAX = ≥ 21.0 mA HOLD = last current value Factory setting: MAX
Minimum difference between SETL and SETU: 20 °C/K (36 °F)				



The function group 4-20 is available only if the 4 to 20 mA analog output (4-20) is selected under FUNC or FNC2 in function group OUT or OUT2.

6.1.7 Setting the service functions

Function group	Function		Settings	Description
SERV Service functions	LOCK	Locking code	0	Enter the locking code to enable the device.
	CODE	Change locking code	0	Freely selectable numerical code 1 to 9999. 0 = no locking; A locking code that has already been assigned can only be changed by first entering the old code to enable the device.
	PRES	Reset	NO YES	Resets all entries to the factory setting
	REV`C	Revision counter	0	Increases by 1 with each configuration
	LST`A	Last device status	0	Displays the last device status to occur ≠ 0
	SIM SIM2 (if output 2 is available)	Simulation Output 1 or 2	OFF OPEN CLOS 3.5 (if analog output is available)	OFF: no simulation OPEN: switch output open CLOS: switch output closed 3.5: simulation values for analog output in mA (3.5/4.0/8.0/12.0/ 16.0/20.0/21.7)
	MAX`	Max. indicator	0.0	Display max. measured process value
	MIN`	Min. indicator	0.0	Display min. measured process value

6.2 Access to the operating menu via the operating tool

The device can be operated using the configuration software. This requires a configuration kit as a connection between the USB port of the PC and the device.

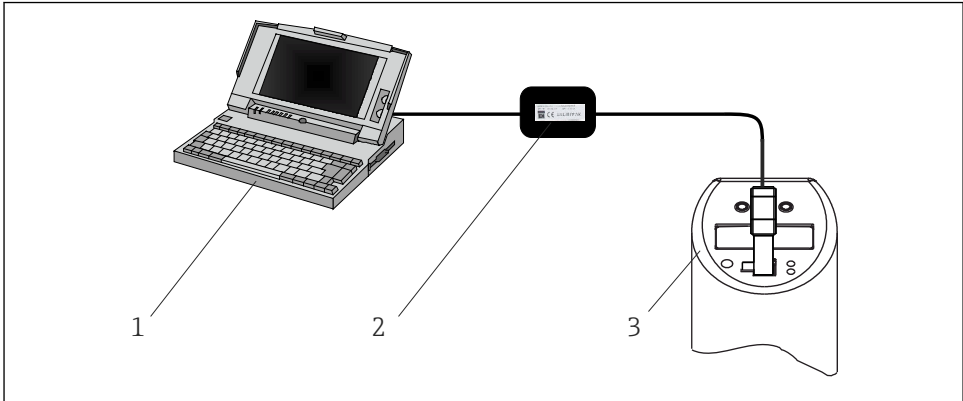

A0008072

10 Operation with PC

- 1 PC with configuration software
- 2 Configuration kit with USB port
- 3 Temperature switch

6.2.1 Additional operating options

In addition to the operating options listed in the previous "Local operation" section, further information about the temperature switch is available via the configuration software:

Function group	Description
SERV	Number of switch changes, output 1
	Number of switch changes, output 2
	Device status
INFO	Tagging, 18-digit
	Order code
	Device serial number
	Sensor serial number
	Electronics serial number
	Displays overall version
	Hardware version
	Software version

7 Diagnostics and troubleshooting

7.1 General troubleshooting

If an error occurs in the device, the color of the status LED changes from green to red and the lighting of the digital display from white to red. A flashing red/green status LED signals a warning. The display shows:

- An E-code in the event of errors
The measured value is uncertain if an error occurs.
- A W-code in the event of warnings
The measured value is reliable if warnings occur.

Code	Description	Remedial action
E011	Device configuration is incorrect	Perform device reset → 15
E012	Measurement error or medium temperature outside the measurable range	Check the medium temperature; return the device to the manufacturer if necessary
E019	Power supply out of specification	Check operating voltage and set to a valid value
E015	Memory error	Return device to manufacturer
E020		
E021		
E022	Power is only supplied to the device via the communication interface (measurement is disabled)	Check operating voltage
E025	Switching contact 1 is not open even though it should be	Switching contact is defective, return to manufacturer
E026	Switching contact 2 is not open even though it should be	Switching contact is defective, return to manufacturer
E040	VCC (controller voltage) is outside the operating range	Return device to manufacturer
E042	Output current can no longer be generated (only for 4 to 20 mA output, e.g. load too high at analog output or open analog output)	Check load; switch off analog output
E044	Output current drifts too much (± 0.5 mA)	Return device to manufacturer

Code	Description	Remedial action
W107	Simulation active	Switch off output simulation for output 1 and 2
W202	Measured value is outside the sensor range	Operate device in the specified measuring range
W209	Device starting up	
W210	Configuration changed (warning code is displayed for approx. 15 s)	
W212	Sensor signal is outside the permitted range	Operate device in the specified measuring range
W250	Number of max. switching cycles exceeded	Replace device

Code	Description	Remedial action
W270	Short-circuit and overload at output 1	Check output wiring Increase the load resistance at switch output 1
W280	Short-circuit and overload at output 2	Check output wiring Increase the load resistance at switch output 2

7.2 Firmware history

7.2.1 Release

The release number on the nameplate and in the Operating Instructions indicates the device release: XX.YY.ZZ (example 01.02.01).

XX	<ul style="list-style-type: none"> ▪ Change to main version ▪ No longer compatible ▪ The device and Operating Instructions change
YY	<ul style="list-style-type: none"> ▪ Change to functionality and operation ▪ Compatible ▪ No changes to the Operating Instructions
ZZ	<ul style="list-style-type: none"> ▪ Fixes and internal changes ▪ No changes to the Operating Instructions

7.2.2 Software history

Date	Software version	Software modifications	Documentation	Material number
09.2018	01.02	-	BA002290/09/EN/ 14.18	71415688
04.2014	01.02	-	BA002290/09/EN/ 13.14	71252257
02.2006	01.02	-	BA2290/09/EN/ 06.09	71098141

8 Maintenance

Buildup on the sensor negatively affects measurement accuracy

- ▶ Check the sensor for buildup at regular intervals.

CAUTION

Damage to the device.

- ▶ Ensure that the process is unpressurized before you remove the device.
- ▶ Do not twist the device out of the process connection thread at the housing.
- ▶ Always use a suitable open-ended wrench to remove the device →  38.

8.1 Cleaning

The device must be cleaned whenever necessary. Cleaning can also be done when the device is installed (e.g. CIP Cleaning in Place / SIP Sterilization in Place). When cleaning the device, care must be taken to ensure that it is not damaged.

NOTICE

Avoid damage to the device and the system

- ▶ Pay attention to the specific IP code when cleaning.

9 Repair

Repairs are not envisaged for the device.

9.1 Disposal

The device contains electronic components and must, therefore, be disposed of as electronic waste in the event of disposal. When disposing, comply with national disposal regulations, and separate and recycle the device components based on the materials.

10 Accessories

10.1 Device-specific accessories

10.1.1 Welding boss with sealing taper

- Collar welding boss movable with sealing taper, washer and pressure screw $G\frac{1}{2}$ "
- Material of parts in contact with the process: 316L, PEEK,
- Max. process pressure 10 bar (145 psi)
- Order number with pressure screw 51004751
- Order number without pressure screw 51004752

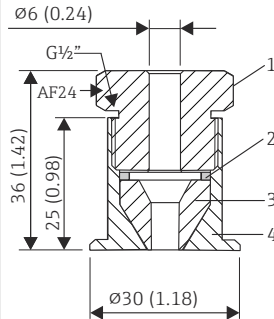

A0020709-EN

11 Dimensions in mm (in)

- 1 Pressure screw, 303/304
- 2 Washer, 303/304
- 3 Sealing taper, PEEK
- 4 Collar welding boss, 316L

10.1.2 Collar welding boss

- Collar welding boss movable with sealing taper and washer
- Material of parts in contact with the process: 316L, PEEK
- Max. process pressure 10 bar (145 psi)
- Order number without pressure screw: 51004752

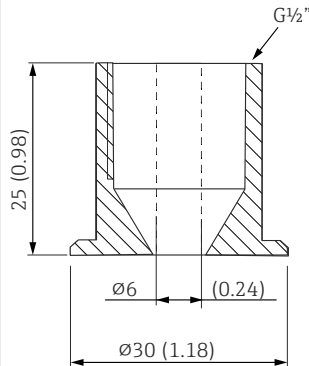

A0020710

12 Dimensions in mm (in)

10.1.3 Compression fitting

- Movable clamping ring, various process connections
- Material of compression fitting and parts in contact with the process: 316L
- Order number: TA50-..... (depending on the process connection)

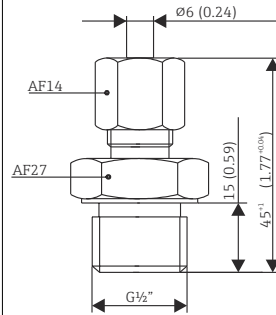

A0020174-EN

13 Dimensions in mm (in)

Version	F in mm (in)		L ~ in mm (in)	C in mm (in)	B in mm (in)	Clamping ring material	Max. process temperature	Max. process pressure
TA50	G $\frac{1}{2}$ "	SW/AF 27	47 (1.85)	-	15 (0.6)	SS316 ¹⁾	800 °C (1472 °F)	40 bar at 20 °C (580 psi at 68 °F)
						PTFE ²⁾	200 °C (392 °F)	5 bar at 20 °C (72.5 psi at 68 °F)
	G $\frac{3}{4}$ "	SW/AF 32	63 (2.48)	-	20 (0.8)	SS316 ¹⁾	800 °C (1472 °F)	40 bar at 20 °C (580 psi at 68 °F)
						PTFE ²⁾	200 °C (392 °F)	5 bar at 20 °C (72.5 psi at 68 °F)
	G1"	SW/AF 41	65 (2.56)	-	25 (0.98)	SS316 ¹⁾	800 °C (1472 °F)	40 bar at 20 °C (580 psi at 68 °F)
						PTFE ²⁾	200 °C (392 °F)	5 bar at 20 °C (72.5 psi at 68 °F)
NPT $\frac{1}{2}$ "	SW/AF 22	50 (1.97)	-	20 (0.8)	SS316 ¹⁾	800 °C (1472 °F)	40 bar at 20 °C (580 psi at 68 °F)	

Version	F in mm (in)		L ~ in mm (in)	C in mm (in)	B in mm (in)	Clamping ring material	Max. process temperature	Max. process pressure
	R½"	SW/AF 22	52 (2.05)	-	20 (0.8)	PTFE ²⁾	200 °C (392 °F)	5 bar at 20 °C (72.5 psi at 68 °F)
	R¾"	SW/AF 27	52 (2.05)	-	20 (0.8)	PTFE ²⁾	200 °C (392 °F)	5 bar at 20 °C (72.5 psi at 68 °F)

- 1) SS316 clamping ring; can only be used once. Once released the compression fitting cannot be repositioned on the thermowell. Fully adjustable immersion length on initial installation
- 2) PTFE/Elastosil® clamping ring; reusable; once loosened, the compression fitting can be moved up or down on the thermowell. Fully adjustable immersion length

10.2 Communication-specific accessories

10.2.1 Coupling; connecting cable

- Coupling M12x1; straight
- Connection to M12x1 housing connector
- Materials: body PA, coupling nut CuZn, nickel-plated
- Degree of protection (connected): IP 67
- Order number: 52006263

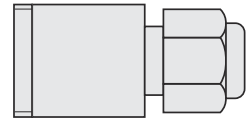
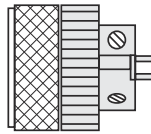

A0035843

- M12x1 coupling; elbowed, for termination of connecting cable by user
- Connection to M12x1 housing connector
- Materials: body PBT/PA,
- Cap-nut GD-Zn, nickel-plated
- Degree of protection (connected): IP 67
- Order number: 51006327

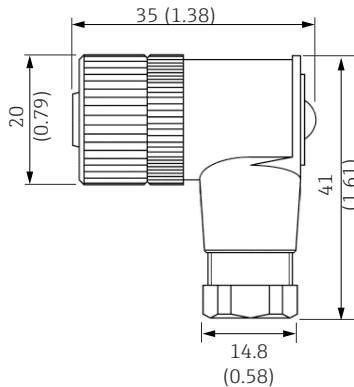

14 Dimensions in mm (in)

A0020722

- PVC cable (terminated), 4 x 0.34 mm² with M12x1 coupling, elbowed, screw plug, length 5 m (16.4 ft)
- Degree of protection: IP67
- Order number: 51005148

Core colors:

- 1 = BN brown
- 2 = WH white
- 3 = BU blue
- 4 = BK black

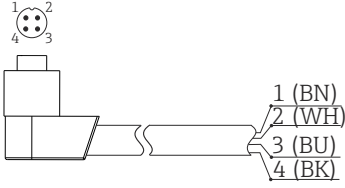

A0020723

- PVC cable, 4x 0.34 mm² with M12x1 coupling, with LED, elbowed,
- 316L screw plug, length 5 m (16.4 ft), specially for hygiene applications,
- Degree of protection (connected): IP69K
- Order number: 52018763

Display:

- gn: device is operational
- ye1: switch status 1
- ye2: switch status 2

 Not suitable for 4 to 20 mA analog output!

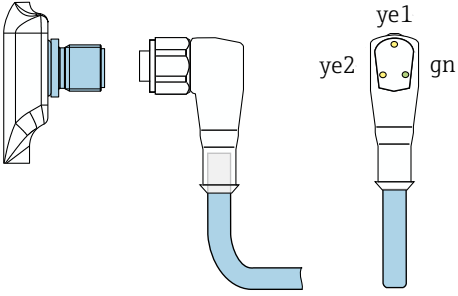

A0035844

10.2.2 Configuration kit

- Configuration kit for PC-programmable transmitters;
Configuration software and interface cable for PC with USB port and 4-pin post connector
- Intrinsically safe configuration kit with interface cable for PC with USB port. Intrinsically safe CDI interface (Common Data Interface) for transmitters with 4-pin post connector. Requires FDT/DTM configuration software.

11 Technical data

11.1 Input

11.1.1 Measured variable

Temperature (temperature-linear transmission behavior)

11.1.2 Measuring range

Designation	Measuring range limits	Min. Span
Pt100 as per IEC 60751	-50 to +150 °C (-58 to +302 °F) -50 to +200 °C (-58 to +392 °F) with extension neck	20 K (36 °F)
Sensor current: ≤ 0.6 mA		

11.2 Output

11.2.1 Output signal

DC voltage version (short-circuit proof version):

- 1x PNP switch output
- 2x PNP switch outputs
- 1x PNP switch output or one PNP switch output and 4 to 20 mA output, active

11.2.2 Signal on alarm

- Analog output: ≤ 3.6 mA or ≥ 21.0 mA (if setting is ≥ 21.0 mA, output is ≥ 21.5 mA)
- Switch outputs: in safe state (switch open)

11.2.3 Load

Max. $(V_{\text{power supply}} - 6.5 \text{ V}) / 0.022 \text{ A}$ (current output)

11.2.4 Range of adjustment

Switch output	Switch point (SP) and switchback point (RSP) in 0.1 °C (0.18 °F) increments. Minimum difference between SP and RSP: 0.5 °C (0.8 °F)
Analog output (if available)	Lower range value (LRV) and upper range value (URV) can be configured as required within the sensor range Min. Span 20 K (36 °F)
Damping	Can be configured as required: 0 to 40 s in increments of 0.1 s
Unit	°C, °F, K

11.2.5 Switching capacity

DC voltage version:

Switch status ON	$I_a \leq 250 \text{ mA}$
Switch status OFF	$I_a \leq 1 \text{ mA}$
Switching cycles	$> 10,000,000$
Voltage drop PNP	$\leq 2 \text{ V}$
Overload protection	Switching current checked automatically; switched off in event of overcurrent, switching current checked again every 0.5 s; max. capacitive load: 14 μF for max. supply voltage (without resistive load); periodic disconnection from a protective circuit in event of overcurrent ($f = 2 \text{ Hz}$) and "Warning" displayed

11.2.6 Inductive load

To prevent electrical interference, only operate an inductive load (relays, contactors, solenoid valves) with a direct protective circuit (free-wheeling diode or capacitor).

11.3 Power supply

11.3.1 Supply voltage

DC voltage version: 12 to 30 V_{DC} (reverse polarity protection)

Behavior in case of overvoltage (> 30 V)

- The device works continuously up to 34 V_{DC} without any damage
- No damage in the event of transient overvoltage up to 1 kV (according to EN 61000-4-5)
- If the supply voltage is exceeded, the specified characteristics are no longer guaranteed

Behavior in the event of undervoltage

If the supply voltage falls below the minimum value, the device switches off in a defined manner (status is the same as for not supplied with power = switch open).



The device may be powered only by a power supply unit that operates using a limited energy circuit in accordance with UL/EN/IEC 61010-1, Section 9.4 and the requirements in Table 18.

11.3.2 Current consumption

without load < 60 mA with reverse polarity protection

11.4 Output

11.4.1 Switching capacity

- Switch status ON: $I_a \leq 250 \text{ mA}$
- Switch status OFF: $I_a \leq 1 \text{ mA}$
- Switching cycles: > 10,000,000
- Voltage drop PNP: $\leq 2 \text{ V}$
- Overload protection
Automatic load testing of switching current; output is switched off in case of overcurrent, the switching current is tested again every 0.5 s; max. capacitance load: 14 μF at max. supply voltage (without resistive load).

11.4.2 Load

Max. $(V_{\text{supply}} - 6.5 \text{ V}) / 0.022 \text{ A}$

11.4.3 Signal on alarm

- Analog output: can be set to $\leq 3.6 \text{ mA}$ ('MIN') or $\geq 21.0 \text{ mA}$ ('MAX')¹⁾
- Switch outputs: in safe state (switch open)

11.5 Environment

- Orientation: No restrictions. However, self-draining in the process must be guaranteed. If there is an opening to detect leaks at the process connection, this opening must be at the lowest possible point.
- Any position-dependent zero shift can be corrected; Offset: $\pm 20\%$ URL

1) Guaranteed output value at 'MAX' setting: $\geq 21.6 \text{ mA}$.

11.5.1 Ambient temperature range

-40 to +85 °C (-40 to +185 °F)

11.5.2 Storage temperature

-40 to +85 °C (-40 to +185 °F)

11.5.3 Operating altitude

Up to 4000 m (13 123.36 ft) above sea level

11.5.4 Degree of protection

IP65	M16 x 1.5 or NPT ½", valve connector
IP66	M12 x 1 connector

11.5.5 Shock resistance

50 g as per DIN IEC 68-2-27 (11 ms)

11.5.6 Vibration resistance

- 20 g as per DIN IEC 68-2-6 (10-2000 Hz)
- 4 g as per marine approval

11.5.7 Electromagnetic compatibility (EMC)

CE conformity

Electromagnetic compatibility in accordance with all the relevant requirements of the IEC/EN 61326 series and NAMUR Recommendation EMC (NE21). For details refer to the EU Declaration of Conformity.

Maximum measured error <1% of measuring range.

Interference immunity as per IEC/EN 61326 series, industrial requirements.

Interference emission to IEC/EN 61326 - series, electrical equipment Class B.

11.5.8 Electrical safety

- Protection class III
- Overvoltage category II
- Pollution level 2

11.6 Process

11.6.1 Process temperature range

-50 to +150 °C (-58 to +302 °F) (or -50 to +200 °C (-58 to 392 °F) with extension neck).

Restrictions depending on process connection and ambient temperature:

- No restriction with compression fitting (see Accessories, order no. 51004751, 51004753) and extension neck length min. 20 mm (0.79 in)
- with process connection:

Max. ambient temperature	Max. process temperature
up to 25 °C (77 °F)	No restrictions
up to 40 °C (104 °F)	135 °C (275 °F)
up to 60 °C (140 °F)	120 °C (248 °F)
up to 85 °C (185 °F)	100 °C (212 °F)

11.6.2 Process pressure range

Maximum permitted process pressure depending on the insertion length

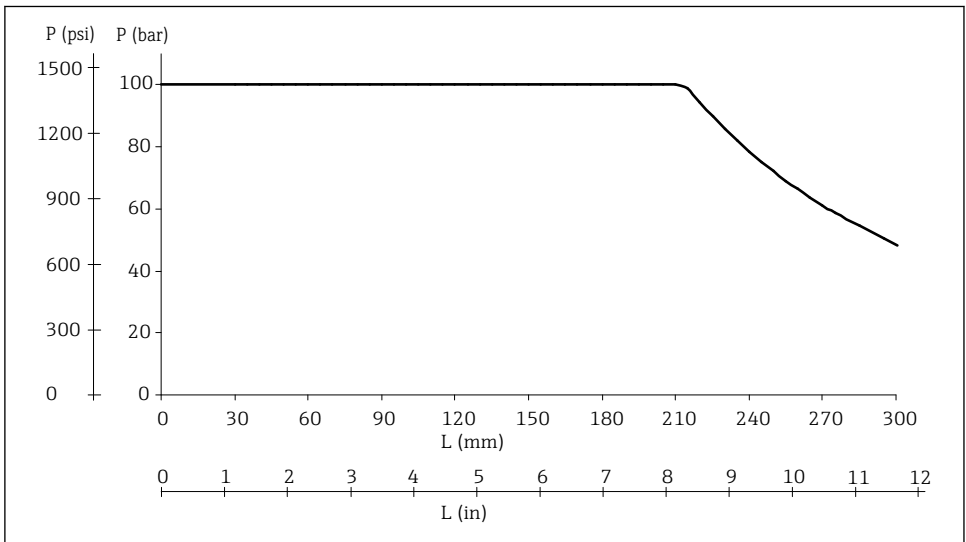

A0008063

15 Maximum permitted process pressure

L Insertion length

p Process pressure

The diagram takes into consideration not only the overpressure but also the compressive load caused by flow, wherein a safety factor of 1.9 has been applied for operation with flow. Due to the increased bending stress caused by flow, the maximum permitted static operating pressure is lower in the case of longer insertion lengths.

This calculation is based on the maximum permitted flow velocity for the respective insertion length (see diagram below).



The maximum process pressure for the conical metal-metal process connection for hygienic processes (MB option) for the device is 1.6 MPa = 16 bar (232 psi).

Permitted flow velocity depending on the insertion length

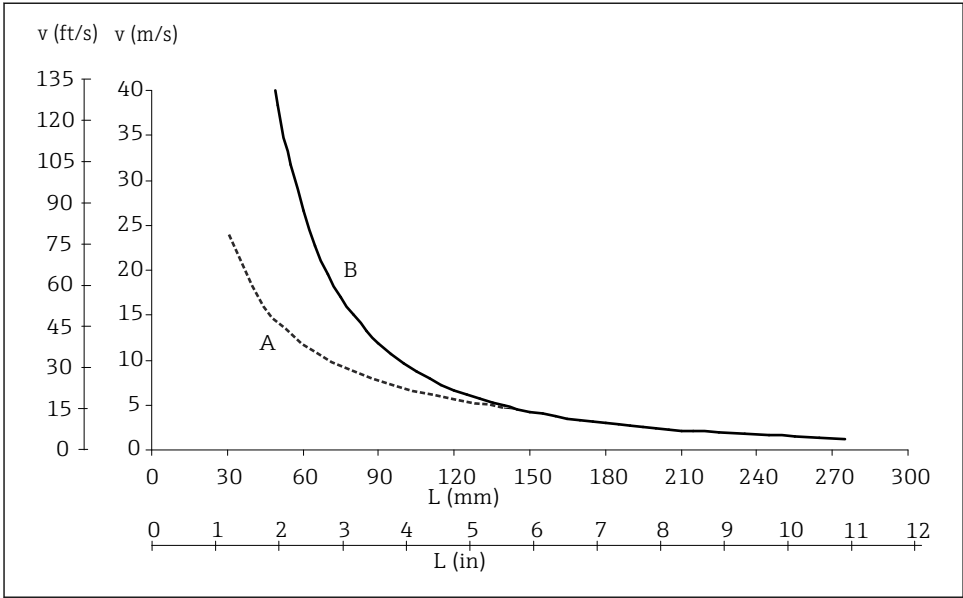

A0008065

16 Permitted flow velocity

- A Water
- B Air
- L Insertion length, during flow
- v Flow velocity

The permitted flow velocity is the minimum defined by the resonance velocity (resonance distance 80%) and stress or buckling caused by flow, which would lead to failure of the thermometer tube or to the safety factor (1.9) being exceeded. The calculation was performed for the specified limit operating conditions of 200 °C (392 °F) and ≤ 100 bar (1 450 psi) process pressure.

11.7 Mechanical construction

11.7.1 Design, dimensions

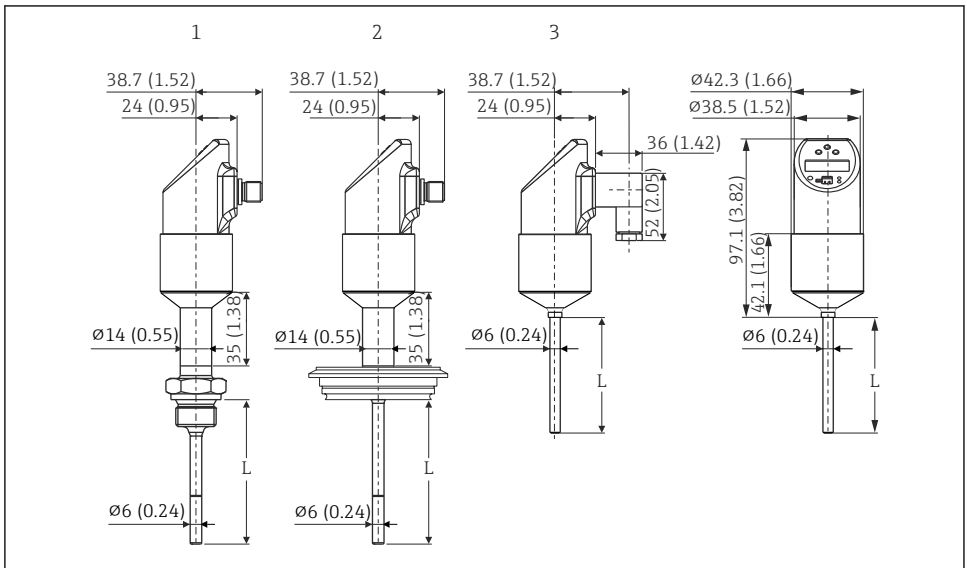

A0023233

All dimensions in mm (in)

- 1 Temperature switch with extension neck and M12x1 connector according to IEC 60947-5-2
 - 2 Temperature switch (hygiene version) with extension neck and M12x1 connector according to IEC 60947-5-2
 - 3 Valve connector M16x1.5 or NPT½" as per DIN 43650A/ISO 4400
- L Insertion length

11.7.2 Design, dimensions of process connections

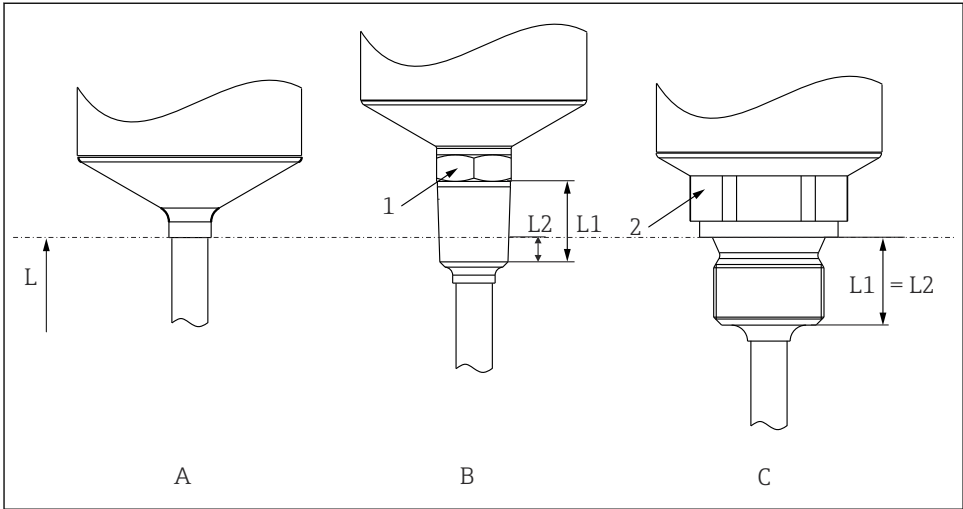

A0007101

17 Process connection versions

L Insertion length

Item No.	Version	Thread length L ₁	Screw-in length L ₂
A	Without process connection. Suitable welding bosses and compression fittings. → 28	-	-
B	Threaded process connection: <ul style="list-style-type: none"> ■ ANSI NPT ¼" (1 = AF14) ■ ANSI NPT ½" (1 = AF27) 	<ul style="list-style-type: none"> ■ 14.3 mm (0.56 in) ■ 19 mm (0.75 in) 	<ul style="list-style-type: none"> ■ 5.8 mm (0.23 in) ■ 8.1 mm (0.32 in)
C	Threaded process connection, inches, cylindrical as per ISO 228: <ul style="list-style-type: none"> ■ G¼" (2 = AF14) ■ G½" (2 = AF27) 	<ul style="list-style-type: none"> ■ 12 mm (0.47 in) ■ 14 mm (0.55 in) 	-

11.7.3 Hygienic design, dimensions of process connections

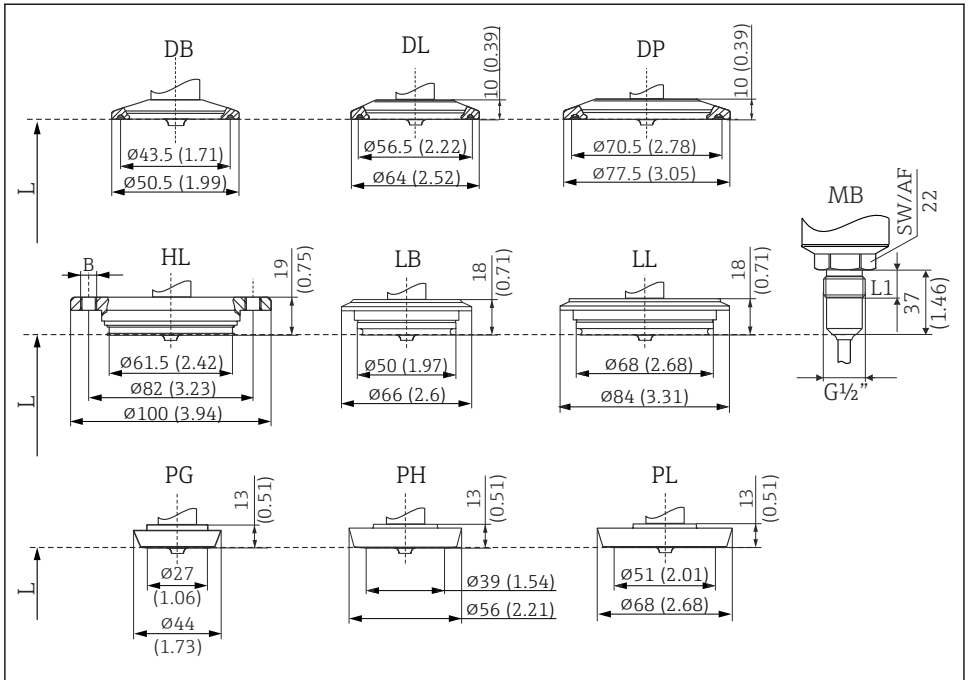

A0023235

18 Process connection versions

All dimensions in mm (in).

L Insertion length L

Item no.	Process connection versions, hygiene version	Hygiene standard
DB	Clamp 1" to 1½" (ISO 2852) or DN 25 to DN 40 (DIN 32676)	3-A marked and EHEDG certified (combined with Combift seal).
DL	Clamp 2" (ISO 2852) or DN 50 (DIN 32676)	
DP	Clamp 2½" (ISO 2852)	
HL	APV Inline, DN50, PN40, 316L, B = bores 6 x ø8.6 mm (0.34 in) + 2 x M8 thread	With 3-A symbol and EHEDG certification
LB	Varivent ¹⁾ F DN25-32, PN 40	
LL	Varivent ¹⁾ N DN40-162, PN 40	
MB	Metal sealing system for hygienic processes, G½" thread, thread length L1 = 14 mm (0.55 in). Suitable welding boss available as an accessory.	-
PG	DIN 11851, DN25, PN40 (including coupling nut)	3-A marked and EHEDG certified (only in combination with self-centering seal according to EHEDG position paper)

Item no.	Process connection versions, hygiene version	Hygiene standard
PH	DIN 11851, DN40, PN40 (including coupling nut)	
PL	DIN 11851, DN50, PN40 (including coupling nut)	

1) Varivent® process connections are suitable for installation in VARINLINE® housing connection flanges.



The VARINLINE® housing connection flange is suitable for welding into the conical or torispherical head in tanks or vessels with a small diameter (≤ 1.6 m (5.25 ft)) and up to a wall thickness of 8 mm (0.31 in). The Varivent type F cannot be used for installations in pipes in combination with the VARINLINE housing connection flange.

11.7.4 Weight

approx. 300 g (10.58 oz), depends on process connection and sensor length

11.7.5 Materials

- Process connection AISI 316L
Surfaces in contact with the process in hygienic version with surface quality $R_a \leq 0.76 \mu\text{m}$ (30 μin)
- Coupling nut AISI 304
- AISI 316L housing, with surface quality $R_a \leq 0.76 \mu\text{m}$ (30 μin)
O-ring between housing and sensor module: EPDM
- Electrical connection
 - M12 connector, exterior AISI 316L, interior polyamide (PA)
 - Valve connector, polyamide (PA)
 - M12 connector, exterior 316L
 - Cable sheath polyurethane (PUR)
 - O-ring between electrical connection and housing: FKM
- Display, polycarbonate PC-FR (Lexan®)
Seal between display and housing: SEBS THERMOPLAST K®
Keys, polycarbonate PC-FR (Lexan®)

11.8 Certificates and approvals

11.8.1 CE mark

The product meets the requirements of the harmonized European standards. As such, it complies with the legal specifications of the EC directives. The manufacturer confirms successful testing of the product by affixing to it the CE-mark.

11.8.2 Other standards and guidelines

- IEC 60529:
Degrees of protection provided by enclosures (IP code)
- IEC/EN 61010-1:
Protection Measures for Electrical Equipment for Measurement, Control, Regulation and Laboratory Procedures
- IEC/EN 61326 series:
Electromagnetic compatibility (EMC requirements)
- NAMUR:
International user association of automation technology in process industries
(www.namur.de)
- NEMA:
United States National Electrical Manufacturers Association.

11.8.3 UL approval

More information under UL Product iq™, search for keyword "E225237")

11.8.4 Hygiene standard

- EHEDG certification, type EL CLASS I. EHEDG certified/tested process connections →  37
- 3-A Authorization No. 1144, 3-A Sanitary Standard 74-07. Listed process connections
→  37
- FDA-compliant

11.8.5 Materials in contact with food/product (FCM)

The materials of the thermometer in contact with food/product (FCM) comply with the following European regulations:

- (EC) No. 1935/2004, Article 3, Paragraph 1, Articles 5 and 17 on materials and articles intended to come into contact with food.
- (EC) No. 2023/2006 on good manufacturing practice (GMP) for materials and articles intended to come into contact with food.
- (EC) No. 10/2011 on plastic materials and articles intended to come into contact with food.
- All surfaces in contact with the medium are free from materials derived from bovine animals or other livestock (ADI/TSE)

11.8.6 Material certification

The material certificate 3.1 (according to standard EN 10204) can be requested separately. The "short form" certificate includes a simplified declaration with no enclosures of documents related to the materials used in the construction of the single sensor and guarantees the traceability of the materials through the identification number of the thermometer. The data related to the origin of the materials can subsequently be requested by the client if necessary.



71509927