

# Special Documentation Proline Promag 400 PROFIBUS DP

Heartbeat Verification + Monitoring application package





## Table of contents

<b>1</b>	<b>Certification</b> .....	<b>4</b>
<b>2</b>	<b>About this document</b> .....	<b>5</b>
2.1	Document function .....	5
2.2	Content and scope .....	5
2.3	Symbols .....	5
2.4	Documentation .....	6
2.5	Registered trademarks .....	6
<b>3</b>	<b>Product features and availability</b> .....	<b>7</b>
3.1	Product features .....	7
3.2	Availability of the application package .....	7
<b>4</b>	<b>System integration</b> .....	<b>9</b>
4.1	Performing the verification and creating a verification report .....	9
4.2	Automated data exchange .....	10
4.3	Data exchange performed by the user (asset management system) .....	11
4.4	Data management .....	11
<b>5</b>	<b>Heartbeat Verification</b> .....	<b>18</b>
5.1	Performance characteristics .....	18
5.2	Commissioning .....	18
5.3	Operation .....	19
<b>6</b>	<b>Heartbeat Monitoring</b> .....	<b>39</b>
6.1	Operation .....	39
<b>7</b>	<b>Build-up detection using the Build- up index</b> .....	<b>41</b>
7.1	General principles .....	41
7.2	Description of the Build-up index parameters ..	45
7.3	Application examples .....	46

# 1 Certification

BESCHEINIGUNG ◆ ATTESTATION ◆ 証明書 ◆ СВИДЕТЕЛЬСТВО ◆ CONSTANCIA ◆ ATTESTAZIONE



Industrie Service

## ATTESTATION

The Certification Body of  
TÜV SÜD Industrie Service GmbH  
Business Area Plant Engineering

certifies that the product

### Proline Promag 400 with Heartbeat Technology™

manufactured by

**Endress + Hauser AG**  
**Kägenstraße 7**  
**4153 Reinach BL**  
**Switzerland**

complies with the following requirements:

Heartbeat Technology™ is a test method integrated in the measuring device for the diagnostics and verification of flowmeters when used in a particular application throughout the useful lifetime of the measuring device. Testing is based on internal factory-traceable references which are redundantly reproduced in the device. Heartbeat Technology™ includes Heartbeat Diagnostics and Heartbeat Verification.

**Test specifications:**

DIN EN IEC 61508-2:2011-02, Appendix C  
DIN EN IEC 61508-3:2011-02, Section 6  
DIN EN ISO 9001:2008, (Section 7.6 a), Control of monitoring and measuring equipment

**Test results:**

Heartbeat Verification verifies the function of Proline Promag 400 on demand within the specified measuring tolerance with a total test coverage ("TTC") of TTC > 94%.

Heartbeat Technology™ complies with the requirements for traceable verification according to DIN EN ISO 9001:2008 – Section 7.6 a) "Control of monitoring and measuring equipment". In accordance with this standard, the user is responsible for providing a definition of the verification interval that satisfies the particular requirements.

This Attestation is based on report no.: TR.2065342.010.15 dated July 31, 2015.  
Attestation no.: PC/209/03/144/10/15

Munich, July 31, 2015

  
Jörg Steimer  
Certification Body Plant Engineering



  
Gerhard Klein  
Dept Risk Management

TÜV SÜD Industrie Service GmbH · Certification Body Plant Engineering · Westendstraße 199 · 80686 Munich · Germany



**i Requirements according to DIN EN ISO 9001**

All products with Heartbeat Technology™, which meet the requirements of traceable verification according to DIN EN ISO 9001:2008 – Clause 7.6 a) «Control of monitoring and measuring devices», also meet the comparable requirement for traceable verification as per ISO 9001:2015, Clause 7.1.5/7.1.5.2 a) "Monitoring and measuring resources".

## 2 About this document

### 2.1 Document function

This manual is a Special Documentation and does not replace the Operating Instructions included in the scope of supply. It is a part of the Operating Instructions and serves as a reference for using the Heartbeat Technology function integrated in the measuring device.

### 2.2 Content and scope

This document contains descriptions of the additional parameters and technical data of the application package and detailed explanations regarding:

- Application-specific parameters
- Advanced technical specifications

### 2.3 Symbols

#### 2.3.1 Safety symbols

##### DANGER

This symbol alerts you to a dangerous situation. Failure to avoid this situation will result in serious or fatal injury.

##### WARNING

This symbol alerts you to a dangerous situation. Failure to avoid this situation can result in serious or fatal injury.









##### CAUTION





This symbol alerts you to a dangerous situation. Failure to avoid this situation can result in minor or medium injury.

##### NOTICE

This symbol contains information on procedures and other facts which do not result in personal injury.

#### 2.3.2 Symbols for certain types of information

Symbol	Meaning
	<b>Permitted</b> Procedures, processes or actions that are permitted.
	<b>Preferred</b> Procedures, processes or actions that are preferred.
	<b>Forbidden</b> Procedures, processes or actions that are forbidden.
	<b>Tip</b> Indicates additional information.
	Reference to documentation
	Reference to page
	Reference to graphic
	Notice or individual step to be observed
	Series of steps

Symbol	Meaning
	Result of a step
 A0028662	Operation via local display
 A0028663	Operation via operating tool
 A0028665	Write-protected parameter

### 2.3.3 Symbols in graphics

Symbol	Meaning
1, 2, 3 ...	Item numbers
A, B, C, ...	Views
A-A, B-B, C-C, ...	Sections

## 2.4 Documentation

 For an overview of the scope of the associated Technical Documentation, refer to the following:

- *W@M Device Viewer* ([www.endress.com/deviceviewer](http://www.endress.com/deviceviewer)): Enter the serial number from the nameplate
- *Endress+Hauser Operations App*: Enter the serial number from the nameplate or scan the matrix code on the nameplate

This documentation is an integral part of the following Operating Instructions:

Measuring device	Documentation code
Promag D 400	BA01232D
Promag L 400	BA01233D
Promag W 400	BA01234D

 This Special Documentation is available:  
In the Download Area of the Endress+Hauser Internet site: [www.endress.com](http://www.endress.com) → Downloads

## 2.5 Registered trademarks

**PROFIBUS®**

Registered trademark of the PROFIBUS User Organization, Karlsruhe, Germany

## 3 Product features and availability

### 3.1 Product features

Heartbeat Technology offers diagnostic functionality through continuous self-monitoring, the transmission of additional measured variables to an external Condition Monitoring system and the in-situ verification of flowmeters in the application.

The test scope achieved using these diagnostic and verification tests is referred to as the **Total Test Coverage** (TTC). The TTC is calculated using the following formula for random errors (calculation based on FMEDA as per IEC 61508):

$$TTC = (\lambda_{TOT} - \lambda_{du}) / \lambda_{TOT}$$

$\lambda_{TOT}$ : Rate of all theoretically possible failures

$\lambda_{du}$ : Rate of dangerous undetected failures

Only the dangerous undetected failures are not diagnosed by the device diagnostics. If these failures occur, they can distort the measured value that is displayed or interrupt the output of measured values.

Heartbeat Technology checks the device function within the specified measuring tolerance with a defined TTC.

 The current value for the TTC depends on the configuration and integration of the measuring device. The values indicated above were determined under the following conditions:

- Simulation operation not active
- Settings for diagnostic behavior correspond to factory settings

### 3.2 Availability of the application package

The application package can be ordered together with the device or can be activated subsequently with an activation code. Detailed information on the order code is available via the Endress+Hauser website [www.endress.com](http://www.endress.com) or from your local Endress+Hauser Sales Center.

#### Promag 400: Devices with generation index B

Devices with generation index B (5X4B, see the order code on the transmitter nameplate) can be retrofitted with Heartbeat Technology by replacing the transmitter with generation index C (5X4C).

Contact your Endress+Hauser service organization.

#### 3.2.1 Order code

If ordering directly with the device or subsequently as a retrofit kit:

The availability of the application package can be checked as follows:

- Order code with breakdown of the device features on the delivery note
- Call up the Device Viewer via the website [www.endress.com/deviceviewer](http://www.endress.com/deviceviewer): enter the serial number from the nameplate and check whether the feature is displayed
- In the operating menu Expert → System → Administration : The **Software option overview** parameter indicates whether the application package is enabled

### 3.2.2 Activation

The **Heartbeat Verification + Monitoring** application package must be enabled in the device if the package is ordered subsequently as a retrofit kit. The retrofit kit contains an activation code that must be entered via the operating menu:

Expert → System → Administration

- ▶ Enter the activation code.
  - ↳ The application package is available.  
The **Software option overview** parameter displays the packages that are currently activated.

### 3.2.3 Access

Heartbeat Technology is compatible with all the system integration options. Interfaces with digital communication are required to access the data saved in the device. The speed of data transmission depends on the type of communication interface used.



## 4 System integration

The **Heartbeat Technology** features are available via the local display module and the digital interfaces. The features can be used both via an asset management system and via the automation infrastructure (e.g. PLC).

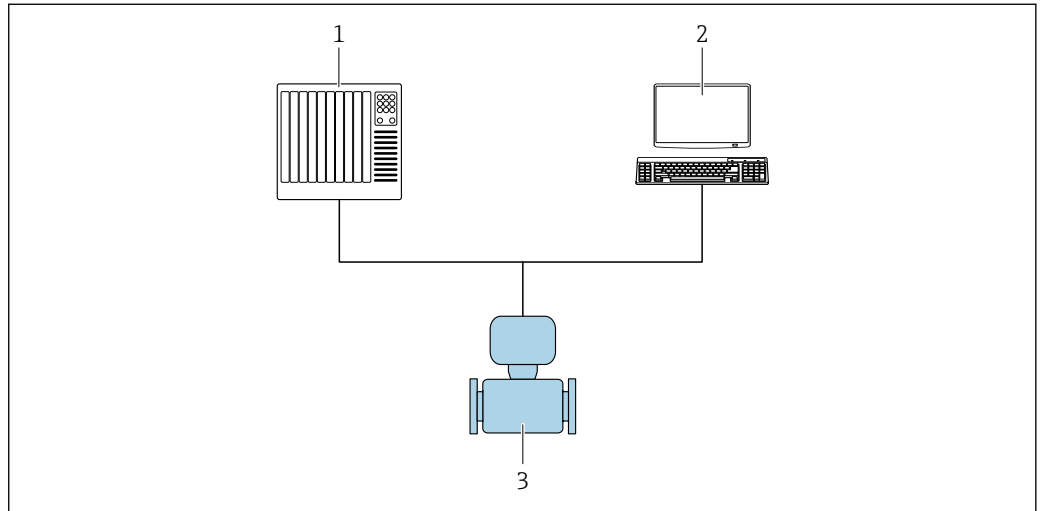

A0020248

1 General layout

- 1 PLC
- 2 Asset management system
- 3 Measuring device

### 4.1 Performing the verification and creating a verification report

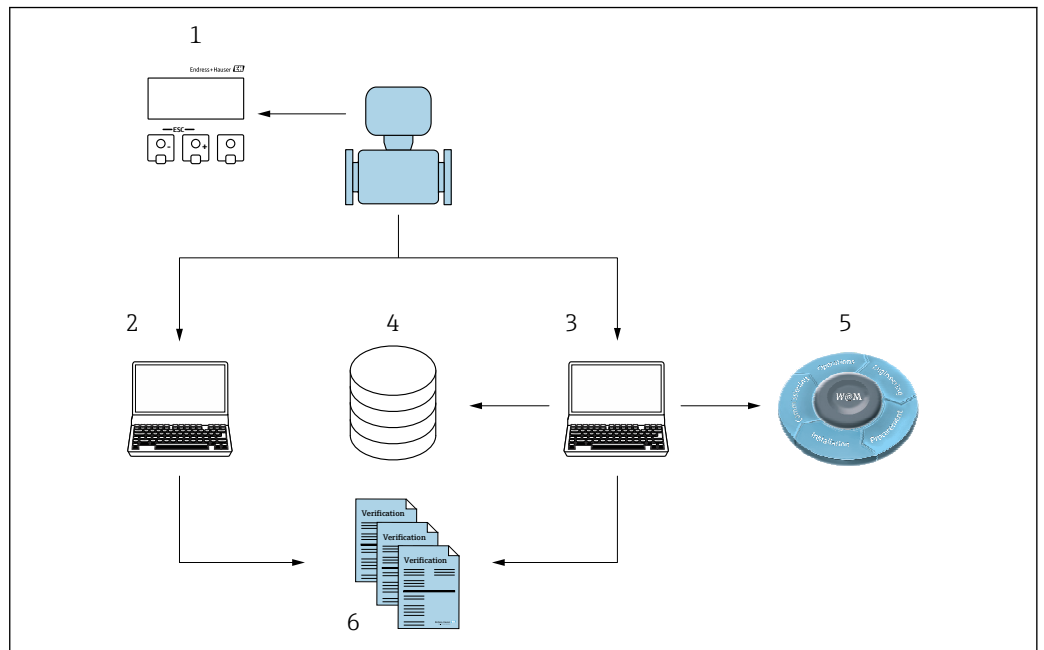

A0031421

- 1 Local display
- 2 Web browser
- 3 FieldCare
- 4 Data archive in the device
- 5 W@M Portal
- 6 Verification report

Run the **Heartbeat Verification** via one of the following interfaces:

- System integration interface of a higher-level system
- Local display
- WLAN interface
- CDI-RJ45 service interface (CDI: Common Data Interface)

The device must be accessed externally from a higher-level system via the system integration interface in order to start a verification and signal the verification result (Passed oder Failed). It is not possible to start the verification via an external status signal and relay the results to a higher-level system via the status output.

The detailed results of the verification (8 data records) are saved in the device and provided in the form of a verification report.

Verification reports can be created using the device DTM and the Web server integrated in the measuring device or the FieldCare plant asset management software from Endress+Hauser.

With the Flow Verification DTM, FieldCare also offers the possibility of data management and of archiving the verification results to create traceable documentation.

The Flow Verification DTM also enables trend analysis – i.e. the ability to monitor, compare and track the verification results of all the verifications performed on the device. This can be used for assessment purposes, e.g. to be able to extend recalibration intervals.

Data exchange can take place automatically or be triggered by a user.

## 4.2 Automated data exchange

- Instrument check via self-monitoring
- Start verification and verification status

The verification function integrated in the measuring device can be activated by a control system and the results can be checked.



For more information on "System integration", see the Operating Instructions (documentation code)

The following procedure must be implemented for this purpose:

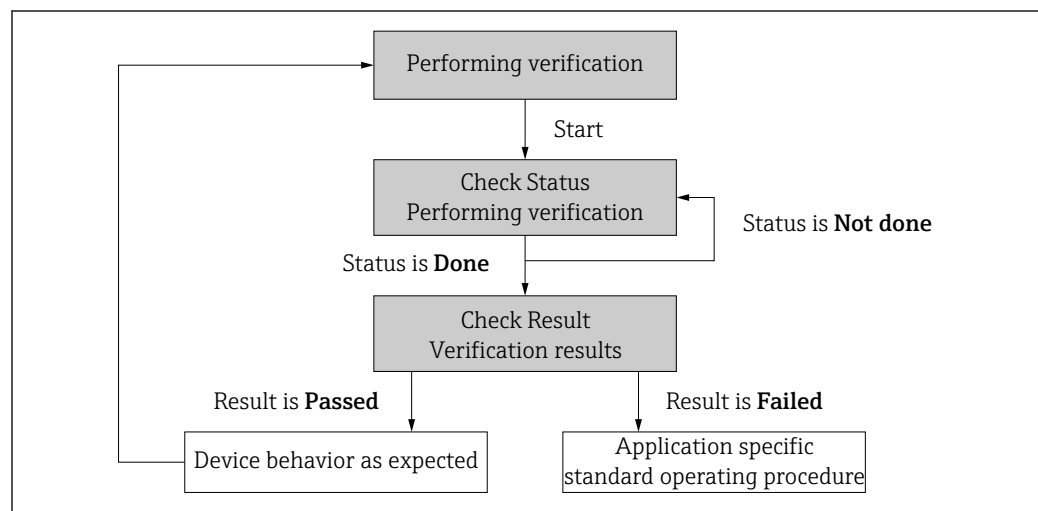

A0020258-EN

Verification result: The overall result of the verification is indicated in the **Overall result** parameter. Different, application-specific measures must be performed by system routines depending on the result, e.g. a "Maintenance Required" alert is triggered if the result is **Failed**.

## 4.3 Data exchange performed by the user (asset management system)

### Heartbeat Monitoring

The user can read the monitoring measured variables in the operating menu.

### Heartbeat Verification

- Start of verification
- Upload, archive and document the verification results including detailed results

## 4.4 Data management

The results of a **Heartbeat Verification** are saved as a non-volatile parameter set in the measuring device memory:

- Availability of 8 storage locations for parameter data sets
- New verification results overwrite old data following the FIFO <sup>1)</sup> principle

The results can be documented in the form of a verification report using the web server integrated in the measuring device or the Endress+Hauser asset management software FieldCare.

FieldCare also offers additional capabilities with the Flow Verification DTM:

- Archiving of verification results
- Export of data from these archives
- Trend analysis of verification results (line recorder function)

### 4.4.1 Data management via Web browser

Thanks to the integrated Web server the device can be operated and configured via a Web browser. In addition, it is possible to query the results of the verification and create a verification report.

### Printing a verification report

A verification report is created in PDF format.

 Prerequisite: A verification has already been performed.

User interface in the Web browser following login:

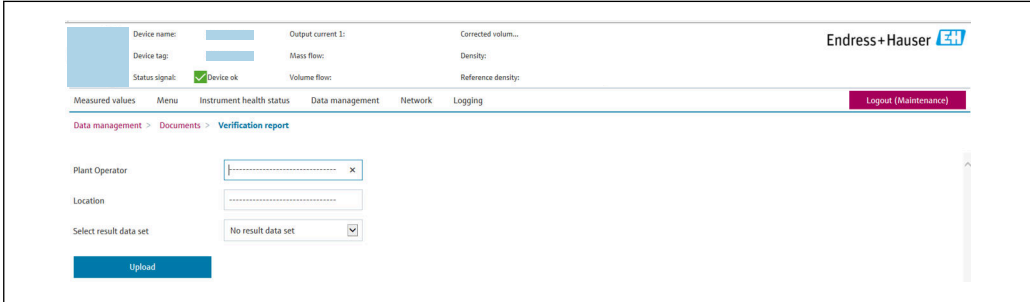

A0031439

1. Click the navigation buttons **Data management** → **Documents** → **Verification report**.
  - ↳ The input area for downloading verification reports is displayed.
2. Enter the necessary information in the **Plant operator** and **Location** fields.
  - ↳ The information entered here appears in the verification report.

1) First In – First Out







3. Select the result data set.
  - ↳ A result data set is indicated as a time stamp in the drop-down list. If no verification has been performed, the message "No result data set" is displayed here.
4. Click **Upload**.
  - ↳ The Web server generates a verification report in PDF format.

#### 4.4.2 Data management via Flow Verification DTM

A special DTM (Flow Verification DTM) is available for **Heartbeat Verification**. The Flow Verification DTM offers advanced capabilities for managing and visualizing the results.

##### Basic functions

The following basic functions are available:

	Read data records from the device
	Create a new archive
	Open saved archive files
	Save data sets to an existing archive file or initial saving of data sets to a new archive file
	Save the data sets under a new file name; a new archive file is created in this case
	Create a verification report in PDF format

##### Header

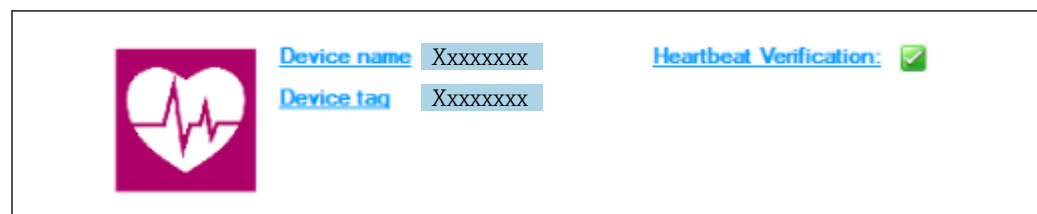

A0031425

- Top display area of the DTM
- Contains the following information:
  - Measuring device
  - Device tag
- Indicates whether verification is active:

##### Reading out data

Start uploading the data from the measuring device to the asset management software.

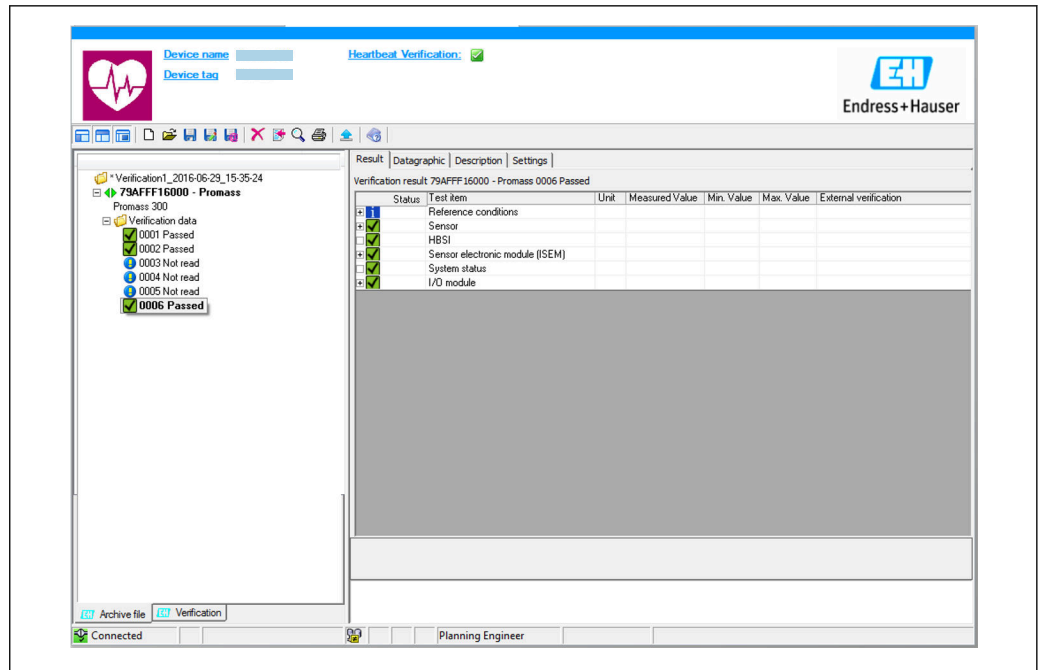

A0031426

## 2 Sample graphic

- ▶ Click an individual data set.
  - ↳ Selected data sets, which are saved in the measuring device, are transmitted to the asset management software and visualized.

### Verification results

Details for the verification results are displayed in the data area.

The data area is split into 3 tabs:

- Result – status, test group and detailed results including limit values
- Data graphic – visualization of results as a trend curve
- Description – additional descriptions and information entered by the user

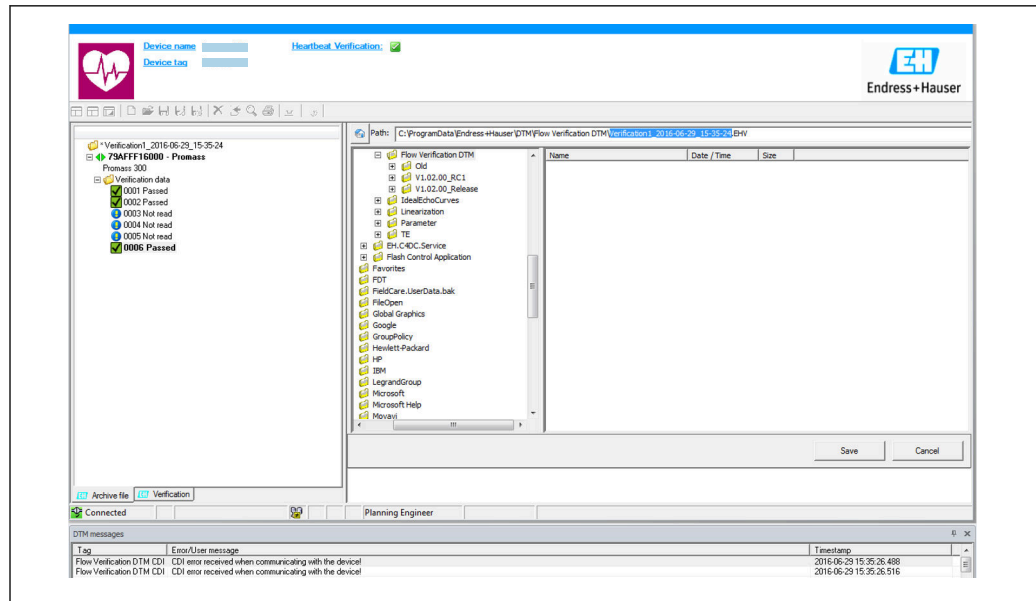

### Saving to an archive file

Save the data to an archive after upload.



A0031427

### 3 Sample graphic

- ▶ Click the icons  or .
- ↳ A file with the extension ".EHV" is generated. This file is used to archive the data. It can be read and interpreted by every asset management system with an installed Flow Verification DTM and is therefore also suitable for analysis by a third party (e.g. Endress+Hauser service organization).

### Opening the archive file

Open archive files already available.

- ▶ Click the  icon.
- ↳ The archive data are uploaded to the Flow Verification DTM.

### Configuring visualization and trending

The verification data can be visualized in the Graphic tab in the data area. The data saved in the archive are visualized as a graph over time. For this purpose, any of the data available can be selected.

### Selecting the measured variables

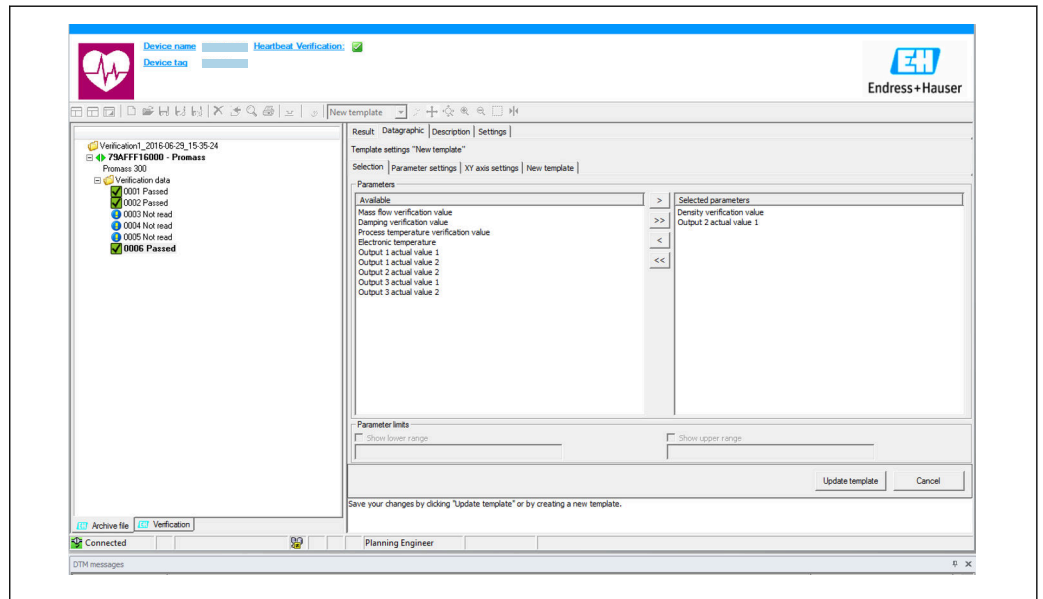

A0031430

#### 4 Sample graphic

- ▶ Select the measured variables using the list displayed.

### Visualizing a graph

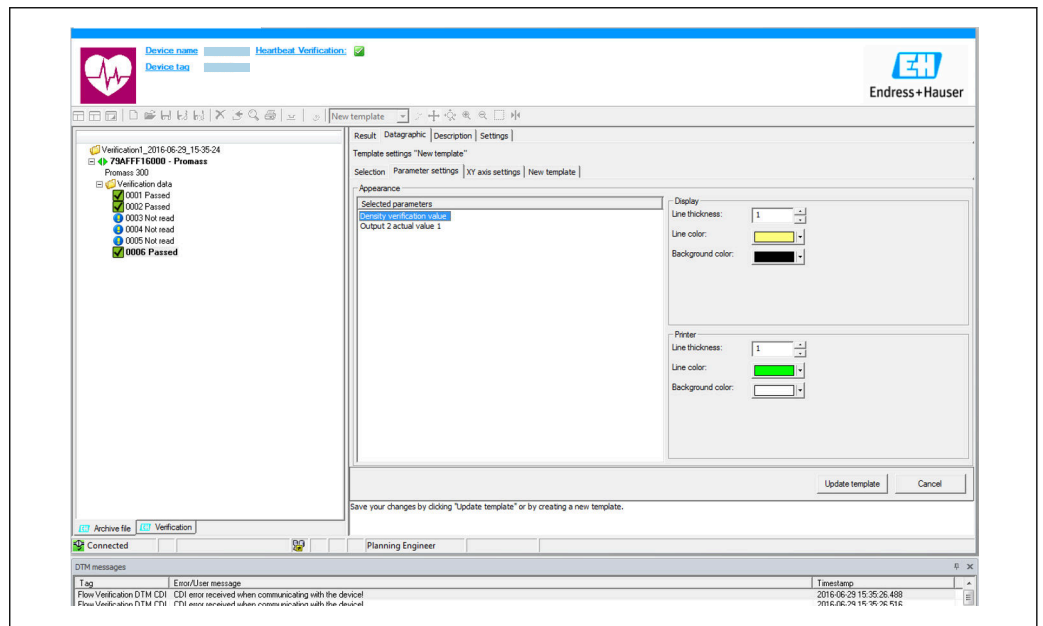

A0031430

#### 5 Sample graphic

- ▶ Assign properties for visualization of the graph.

## Configuring the Y-axis

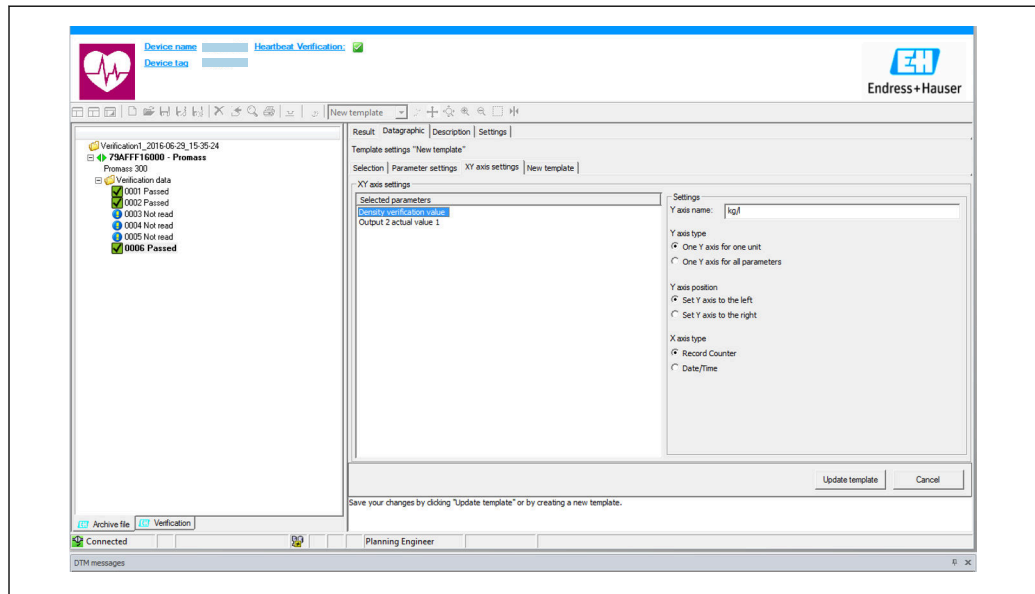

A0031434

### 6 Sample graphic

- Assign the measured variables of the Y-axis.

## Updating template or creating new template

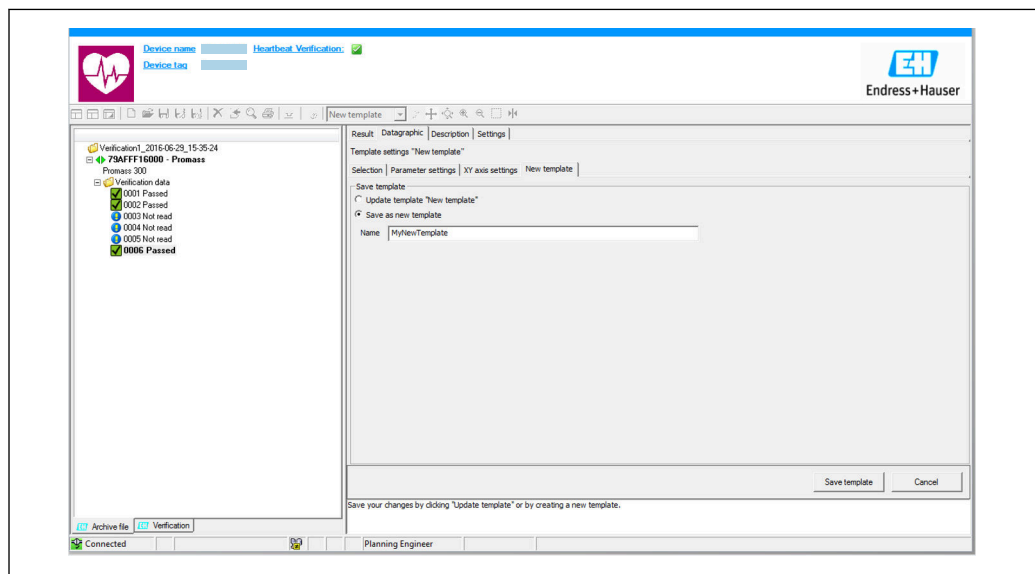

A0031437

### 7 Sample graphic

- Add a selected parameter configuration to the template or save under a new template name.



## Showing the visualization trend

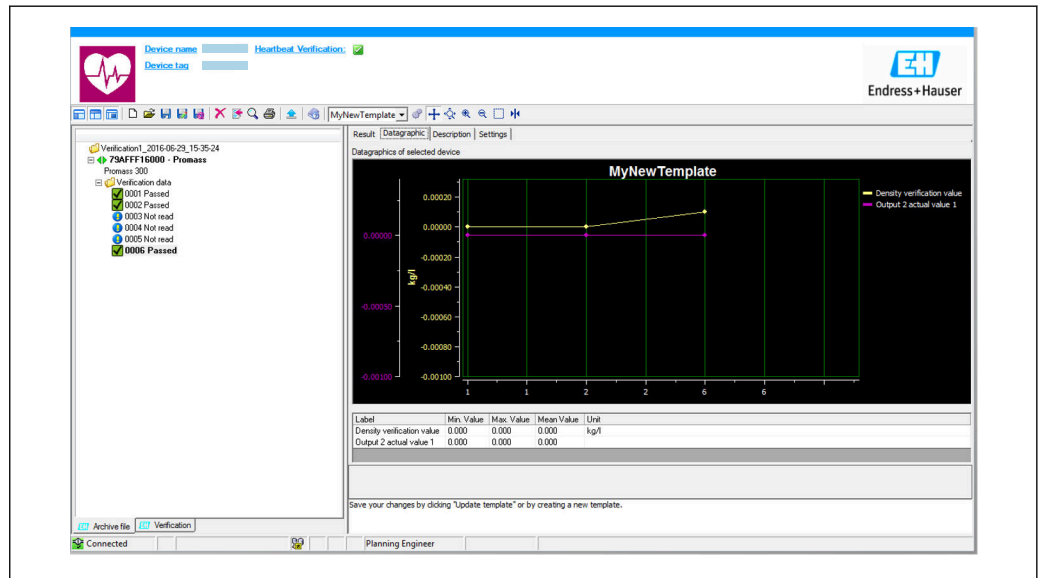

A0031438

### 8 Sample graphic

- ▶ Display the template.
  - ↳ The template shows the data in chronological order. The data points are referenced by the verification ID (X-axis), the Y-axis displays the parameters defined in the configuration.

## Creating a verification report



1. Click the  icon.
2. Select the data set.
  - ↳ A verification report is generated.

## 5 Heartbeat Verification

Heartbeat Verification checks the device function within the specified measuring tolerance on demand. The result of the verification is "Passed" or "Failed".

The verification data are saved in the device and, optionally, are archived on a PC with the FieldCare asset management software. A verification report is generated automatically on the basis of these data to ensure the traceable documentation of the verification results.

Heartbeat Technology offers two ways to perform Heartbeat Verification:

- Standard verification →  20  
Verification is performed by the device without manual checking of external measured variables.
- Extended verification →  23  
Verification also includes the entry of external measured variables.

### 5.1 Performance characteristics

**Heartbeat Verification** is performed on demand and supplements permanent self-monitoring with further checks (coil circuit measurement, shot control circuit, electrode signal integrity).



Standard verification and extended verification support verification of the reference voltage.

The verification is based on references that are incorporated in the measuring device, traceable from the factory and redundant in the device. **Heartbeat Verification** confirms on demand the device function with the total test coverage (TTC).

Assessed by an independent body: **Heartbeat Technology** meets the requirement for traceable verification according to DIN EN ISO 9001: 2015 Chapter 7.1.5.2 a) Control of monitoring and measuring equipment.

### 5.2 Commissioning

The configuration (factory reference) required as part of **Heartbeat Verification** is recorded during calibration at the factory and is permanently stored in the measuring device. When verifying in the application, the current situation of the measuring device is compared against this factory reference.

 Recommendation: Perform initial verification when commissioning the device (and all other verifications in the life cycle) under process or reference conditions. →  11.

The results are saved as an initial situation in the measuring device life cycle up until the 8th verification; from the 9th verification onwards an upload using the verification DTM is recommended.

#### 5.2.1 Recording reference data

It is possible to manually record reference data relating to the operator and the location. These reference data appear on the verification report.

##### Navigation

"Setup" menu → Advanced setup → Heartbeat setup → Heartbeat base settings

##### Navigation

"Expert" menu → Diagnostics → Heartbeat → Heartbeat base settings

▶ Heartbeat base settings

Plant operator	→ ⓘ 19
Location	→ ⓘ 19
Partially filled pipe	→ ⓘ 19

**Parameter overview with brief description**

Parameter	Description	User entry / Selection	Factory setting
Plant operator	Enter the plant operator.	Max. 32 characters such as letters, numbers or special characters (e.g. @, %, /)	–
Location	Enter the location.	Max. 32 characters such as letters, numbers or special characters (e.g. @, %, /)	–
Partially filled pipe	Indicate, if the measuring tube is partially filled during the verification process in order to avoid evaluating the EPD electrode cable.	<ul style="list-style-type: none"> <li>▪ No</li> <li>▪ Yes</li> </ul>	No

## 5.3 Operation

### 5.3.1 General information

 The **Heartbeat Verification** function can be used without restriction on a custody-transfer (CT) measuring device in the custody transfer mode.

**Initial verification**

- ▶ When commissioning the measuring device:  
Perform an initial verification to save the results as an initial situation in the life cycle of the measuring device. From the ninth verification onwards, an upload using the Verification DTM is recommended.

Initial verification can be performed in 2 ways:

- Standard verification → ⓘ 20
- Extended verification → ⓘ 23

**Device behavior and interpretation**

*Result "Passed"*

All test results are within the specifications.

If the calibration factor and the zero point match the factory settings, there is a high degree of certainty that the measuring device complies with the specification for flow.

Verification generally delivers the result Passed in most applications.

*Result "Failed"*

One or more test results are outside the specifications.

If the result of the verification is "Failed", take the following measures:

1. Establish defined and stable process conditions.
  - ↳ Ensure a constant process temperature.  
Avoid wet gases, pulsating flow, pressure shock and very high flow rates.

2. Repeat verification.
  - ↳ Repeat verification "Passed"
 

If the result of the second verification is "Passed", the result of the first verification can be ignored. In order to identify possible deviations, compare the current process conditions with the process conditions of a previous verification.

If the result of the verification is "Failed" again, take the following measures:

1. Take remedial action on the basis of the verification results and the diagnostic information of the measuring device.
  - ↳ The cause of the error can be narrowed down if the test group that "Failed" the verification is identified.
2. Provide Endress+Hauser Service with the verification result with the current process conditions.
3. Check the calibration or calibrate the measuring device.
  - ↳ The calibration has the advantage that the "as found" measuring device state is recorded and the actual measured error is determined.



### 5.3.2 Standard verification

Standard verification is performed automatically by the device and without manual checking of external measured variables.

#### Diagnostic behavior

The device signals that standard verification is being performed: **△C302 Device verification in progress** diagnostic message

- Factory setting for diagnostic behavior: warning
  - The device continues to measure.
  - The last good value is output intermittently for 10 seconds.
  - All the measured values are counted up on the totalizers during the verification.
  - Test duration: Approximately 60 seconds.
-  ▪ The diagnostic behavior can be changed by the user if necessary:  
Expert → System → Diagnostic handling → Diagnostic behavior  
If **Alarm** is selected as the diagnostic behavior, the output of measured values is interrupted in the event of an error and the signal outputs and totalizers adopt the defined alarm condition.
- A category is assigned to the diagnostic message of the outputs in the **Diagnostic configuration** submenu.  
Expert → Communication → Diagnostic configuration  
If the device does not have outputs, they are output as an error. To prevent an error from being output, assign the **No effect (N)** option to any outputs that are not present on the device.

 For detailed information on diagnostics and troubleshooting and for diagnostic information and associated remedial measures, see the Operating Instructions →  6.

#### Performing standard verification

##### Before verification starts

-  The date and time are saved with the current operating time and the verification results and also appear in the verification report.

The **Year** parameter, **Month**, **Day**, **Hour**, **AM/PM** and **Minute** are used to manually record the data at the time of verification.

1. Enter date and time.

### Select the verification mode

2. In the **Verification mode** parameter, select the **Standard verification** option.

### Starting the verification test





3. In the **Start verification** parameter, select the **Start** option.
  - ↳ While the verification is being performed, the progress of the verification is indicated as a % (bar graph indicator) in the **Progress** parameter.

### Displaying the verification status and result

The current status of the standard verification is indicated in the **Status** parameter (→  23):

- **Done**  
The verification test is finished.
- **Busy**  
The verification test is running.
- **Not done**  
A verification has not yet been performed on this measuring device.
- **Failed**  
A precondition for performing the verification has not been met; verification cannot start (e.g. due to unstable process parameters) →  19.





The result of the verification is displayed in the **Overall result** parameter (→  23):









- **Passed**  
All the verification tests were successful.
  - **Not done**  
A verification has not yet been performed on this measuring device.
  - **Failed**  
One or more verification tests were not successful →  19.
-  The overall result of the last verification can always be accessed in the menu.
- **Navigation:**  
Diagnostics → Heartbeat Technology → Verification results
  - Detailed information on the result of the verification (test groups and test status) is also provided in the verification report in addition to the overall result →  31.
  - If the device does not pass the verification, the results are saved nonetheless and indicated in the verification report.
  - This helps users to perform a targeted search for the cause of the error →  19.

### "Performing verification" submenu







#### Navigation



"Diagnostics" menu → Heartbeat Technology → Performing verification

► Performing verification	
Year	→  22
Month	→  22
Day	→  22
Hour	→  22
AM/PM	→  22

Minute	→  22
Verification mode	→  23
External device information	→  28
Start verification	→  23
Progress	→  23
Measured values	→  28
Output values	→  28
Status	→  23
Overall result	→  23

### Parameter overview with brief description

Parameter	Prerequisite	Description	User entry / Selection / User interface	Factory setting
Year	 Can be edited if Heartbeat Verification is not active.	Entry for date and time (field 1): enter the year verification is performed.	9 to 99	10
Month	 Can be edited if Heartbeat Verification is not active.	Entry for date and time (field 2): enter the month verification is performed.	<ul style="list-style-type: none"> <li>▪ January</li> <li>▪ February</li> <li>▪ March</li> <li>▪ April</li> <li>▪ May</li> <li>▪ June</li> <li>▪ July</li> <li>▪ August</li> <li>▪ September</li> <li>▪ October</li> <li>▪ November</li> <li>▪ December</li> </ul>	January
Day	 Can be edited if Heartbeat Verification is not active.	Entry for date and time (field 3): enter the day verification is performed.	1 to 31 d	1 d
Hour	 Can be edited if Heartbeat Verification is not active.	Entry for date and time (field 4): enter the hour verification is performed.	0 to 23 h	12 h
AM/PM	 Can be edited if Heartbeat Verification is not active.  The <b>dd.mm.yy hh:mm am/pm</b> option or the <b>mm/dd/yy hh:mm am/pm</b> option is selected in the <b>Date/time format</b> parameter (2812).	Entry for date and time (field 5): enter the morning or afternoon.	<ul style="list-style-type: none"> <li>▪ AM</li> <li>▪ PM</li> </ul>	AM
Minute	 Can be edited if Heartbeat Verification is not active.	Entry for date and time (field 6): enter the minute verification is performed.	0 to 59 min	0 min

Parameter	Prerequisite	Description	User entry / Selection / User interface	Factory setting
Verification mode	 Can be edited if Heartbeat Verification is not active.	Select the verification mode. Standard verification Verification is performed automatically by the device and without manual checking of external measured variables.	<ul style="list-style-type: none"> <li>■ Standard verification</li> <li>■ Extended verification</li> </ul>	Standard verification
Start verification	–	Start the verification. Start the verification with the <b>Start</b> option.	<ul style="list-style-type: none"> <li>■ Cancel</li> <li>■ Start</li> </ul>	Cancel
Progress	–	Shows the progress of the process.	0 to 100 %	0 %
Status	–	Displays the current status of the verification.	<ul style="list-style-type: none"> <li>■ Done</li> <li>■ Busy</li> <li>■ Failed</li> <li>■ Not done</li> </ul>	–
Verification result	–	Displays the overall result of the verification.  Detailed description of the classification of the results: →  30	<ul style="list-style-type: none"> <li>■ Not supported</li> <li>■ Passed</li> <li>■ Not done</li> <li>■ Failed</li> </ul>	–

### 5.3.3 Extended verification

#### Extended verification measured variables

Device reference voltage

The device uses an internal reference voltage. The actual value of the reference voltages can be accessed at the sensor electronic module (ISEM). The measured values of both test points are entered at the device.

#### Measuring equipment requirements

*Recommendations for the measuring equipment*

DC current measuring uncertainty	±0.2 %
DC current resolution	10 µA
DC voltage measuring uncertainty	±0.1 %
DC voltage resolution	1 mV
Frequency measuring uncertainty	±0.1 %
Frequency resolution	1 Hz
Temperature coefficient	0.0075 %/°C

#### Connecting the measuring equipment in the measuring circuit

*Extended verification via reference voltage*



**Danger to persons from non-approved equipment in the hazardous area!**

- ▶ Only use intrinsically safe measuring equipment in hazardous zones.

**⚠ WARNING****Risk of electric shock! Components carry dangerous voltages!**

- ▶ Only properly trained specialist staff may perform electrical connection work.
- ▶ Observe applicable federal/national installation codes and regulations.
- ▶ Comply with local workplace safety regulations.
- ▶ Do not open the measuring device while it is connected to the supply voltage.

The connection for measuring the reference voltage is established via the sensor electronics module (ISEM).

1.

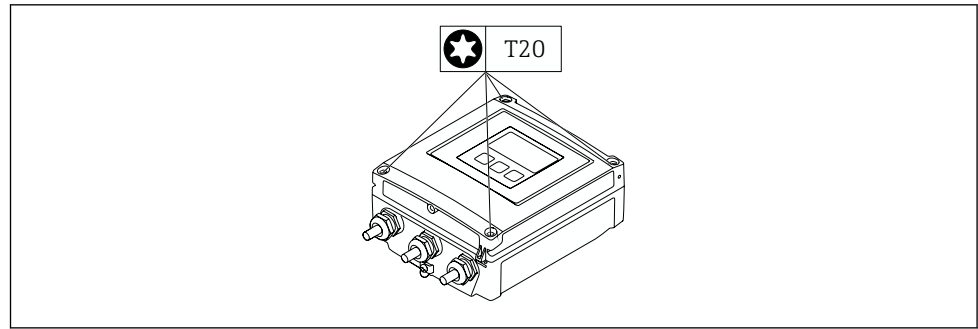

A0021571

Loosen the 4 fixing screws on the housing cover.

2.

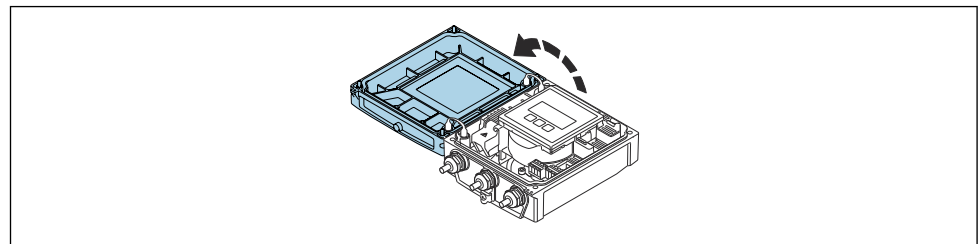

A0021572

Open the housing cover.

3.

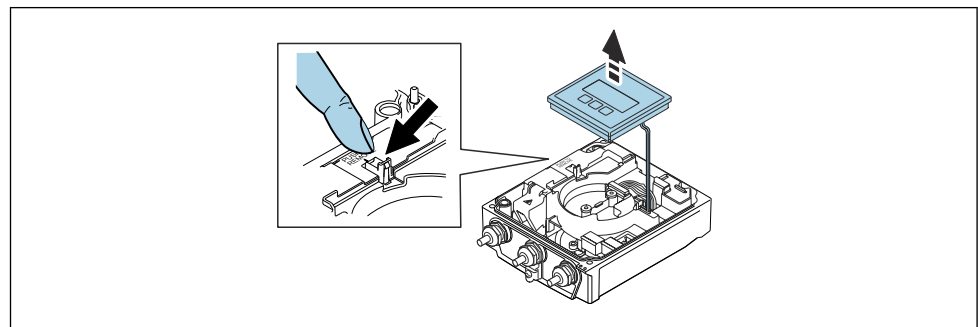

A0046553

Lift the display module.

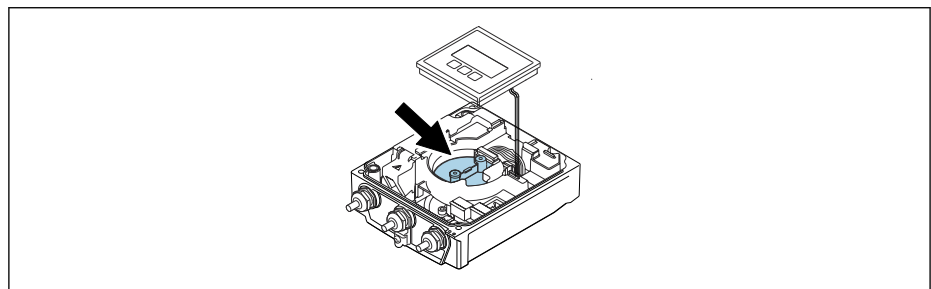

- ↳ The sensor electronics module (ISEM) is located under the display module.



A0046561



4. The external reference voltage can be measured via the GND and REF terminals of the sensor electronics module (ISEM).

 For detailed information on the **External reference voltage 1** parameter →  26

### Performing extended verification

A full standard verification is performed in the course of the verification. The validity of the entered and measured values of the outputs is checked. Additional standard verification of the outputs does not take place.

#### NOTICE

**Extended verification is not possible if no connection has been established and the ammeter is looped in during verification.**

- ▶ Establish a connection before extended verification starts.
- ▶ Loop in ammeter before extended verification starts.

### Before verification starts

 The date and time are saved with the current operating time and the verification results and also appear in the verification report.

The **Year** parameter, **Month**, **Day**, **Hour**, **AM/PM** and **Minute** are used to manually record the data at the time of verification.

1. Enter date and time.



### Select the verification mode

2. In the **Verification mode** parameter, select the **Extended verification** option.

### Further parameter settings

3. In the **External device information** parameter, enter a unique ID (e.g. serial number) of the measuring equipment used (max. 32 characters).
4. In the **Start verification** parameter, select one of the options available (e.g. the **Output 1 low value** option).
5. In the **Measured values** parameter, enter the value shown on the external measuring equipment.
6. Repeat steps 4 and 5 until all the output options are checked.
7. Adhere to the sequence indicated and enter the measured values.

The duration of the process and number of outputs depend on the device configuration.

The value displayed in the **Output values** parameter (→  28) shows the value simulated by the device at the selected output →  23

### Starting the verification test





8. In the **Start verification** parameter, select the **Start** option.
  - ↳ While the verification is being performed, the progress of the verification is indicated as a % (bar graph indicator) in the **Progress** parameter.

### Displaying the verification status and result

The current status of the standard verification is indicated in the **Status** parameter (→  23):

- Done  
The verification test is finished.
- Busy  
The verification test is running.
- Not done  
A verification has not yet been performed on this measuring device.
- Failed  
A precondition for performing the verification has not been met; verification cannot start (e.g. due to unstable process parameters) →  19.









The result of the verification is displayed in the **Overall result** parameter (→  23):

- Passed  
All the verification tests were successful.
  - Not done  
A verification has not yet been performed on this measuring device.
  - Failed  
One or more verification tests were not successful →  19.
-  ■ The overall result of the last verification can always be accessed in the menu.
- Navigation:  
Diagnostics → Heartbeat Technology → Verification results
  - Detailed information on the result of the verification (test groups and test status) is also provided in the verification report in addition to the overall result →  31.
  - If the device does not pass the verification, the results are saved nonetheless and indicated in the verification report.
  - This helps users to perform a targeted search for the cause of the error →  19.

### "Performing verification" submenu

#### Navigation





"Diagnostics" menu → Heartbeat Technology → Performing verification

▶ Performing verification	
Year	→  27
Month	→  27
Day	→  27
Hour	→  27
AM/PM	→  27
Minute	→  27
Verification mode	→  27
External device information	→  28
External reference voltage 1	→  28

Start verification	→  28
Progress	→  28
Status	→  28
Verification result	→  28

**Parameter overview with brief description**

Parameter	Prerequisite	Description	User entry / Selection / User interface	Factory setting
Year	Can be edited if Heartbeat Verification is not active.	Entry for date and time (field 1): enter the year verification is performed.	9 to 99	10
Month	Can be edited if Heartbeat Verification is not active.	Entry for date and time (field 2): enter the month verification is performed.	<ul style="list-style-type: none"> <li>▪ January</li> <li>▪ February</li> <li>▪ March</li> <li>▪ April</li> <li>▪ May</li> <li>▪ June</li> <li>▪ July</li> <li>▪ August</li> <li>▪ September</li> <li>▪ October</li> <li>▪ November</li> <li>▪ December</li> </ul>	January
Day	Can be edited if Heartbeat Verification is not active.	Entry for date and time (field 3): enter the day verification is performed.	1 to 31 d	1 d
Hour	Can be edited if Heartbeat Verification is not active.	Entry for date and time (field 4): enter the hour verification is performed.	0 to 23 h	12 h
AM/PM	Can be edited if Heartbeat Verification is not active.  The <b>dd.mm.yy hh:mm am/pm</b> option or the <b>mm/dd/yy hh:mm am/pm</b> option is selected in the <b>Date/time format</b> parameter (2812).	Entry for date and time (field 5): enter the morning or afternoon.	<ul style="list-style-type: none"> <li>▪ AM</li> <li>▪ PM</li> </ul>	AM
Minute	Can be edited if Heartbeat Verification is not active.	Entry for date and time (field 6): enter the minute verification is performed.	0 to 59 min	0 min
Verification mode	Can be edited if Heartbeat Verification is not active.	Select the verification mode.  Extended verification Standard verification is extended by the additional entry of external measured variables: <b>Measured values</b> parameter.	Extended verification	Standard verification

Parameter	Prerequisite	Description	User entry / Selection / User interface	Factory setting
External device information	With the following conditions: <ul style="list-style-type: none"> <li>▪ The <b>Extended verification</b> option is selected in the <b>Verification mode</b> parameter.</li> <li>▪ Can be edited if the verification status is not active.</li> </ul>	Record measuring equipment for extended verification.	Free text entry	–
External reference voltage 1	–	Use this function to enter the reference voltage.  The external reference voltage can be measured at the GND and REF terminals.	Signed floating-point number	2.5 V
Start verification	–	Start the verification. To carry out a complete verification, select the selection parameters individually. Once the external measured values have been recorded, verification is started using the <b>Start</b> option.	<ul style="list-style-type: none"> <li>▪ Cancel</li> <li>▪ Start</li> </ul>	Cancel
Progress	–	Shows the progress of the process.	0 to 100 %	0 %
Measured values	In the <b>Start verification</b> parameter (→  23), one of the following options is selected: <ul style="list-style-type: none"> <li>▪ Output 1 low value</li> <li>▪ Output 1 high value</li> <li>▪ Output 2 low value</li> <li>▪ Output 2 high value</li> <li>▪ Frequency output 1</li> <li>▪ Pulse output 1</li> </ul>	Displays the references for the external measured variables. <ul style="list-style-type: none"> <li>▪ Current output: Output current in [mA]</li> <li>▪ Pulse/frequency output: Output frequency in [Hz]</li> </ul>	Signed floating-point number	0
Output values	–	Displays the references for the external measured variables. Pulse/frequency output: Output frequency in [Hz].	Signed floating-point number	0
Status	–	Displays the current status of the verification.	<ul style="list-style-type: none"> <li>▪ Done</li> <li>▪ Busy</li> <li>▪ Failed</li> <li>▪ Not done</li> </ul>	–
Verification result	–	Displays the overall result of the verification.  Detailed description of the classification of the results: →  30	<ul style="list-style-type: none"> <li>▪ Not supported</li> <li>▪ Passed</li> <li>▪ Not done</li> <li>▪ Failed</li> </ul>	–

### 5.3.4 Verification results

Access to the verification results:

In the operating menu via the local display, operating tool or Web browser

- Diagnostics → Heartbeat Technology → Verification results
- Expert → Diagnostics → Heartbeat Technology → Verification results

#### Navigation



"Diagnostics" submenu → Heartbeat → Verification results





**Navigation**

"Expert" menu → Diagnostics → Heartbeat → Verification results

► Verification results		
Date/time (manually recorded)		→ ⓘ 29
Verification ID		→ ⓘ 29
Operating time		→ ⓘ 29
Verification result		→ ⓘ 29
Sensor		→ ⓘ 29
Sensor electronic module (ISEM)		→ ⓘ 29
I/O module		→ ⓘ 30
System status		→ ⓘ 30

**Parameter overview with brief description**

Parameter	Prerequisite	Description	User interface	Factory setting
Date/time (manually recorded)	The verification has been performed.	Date and time.	dd.mmmm.yyyy; hh:mm	1 January 2010; 12:00
Verification ID	The verification has been performed.	Displays consecutive numbering of the verification results in the measuring device.	0 to 65535	0
Operating time	The verification has been performed.	Indicates how long the device has been in operation up to the verification.	Days (d), hours (h), minutes (m), seconds (s)	-
Verification result	-	Displays the overall result of the verification.  Detailed description of the classification of the results: → ⓘ 30	<ul style="list-style-type: none"> <li>▪ Not supported</li> <li>▪ Passed</li> <li>▪ Not done</li> <li>▪ Failed</li> </ul>	-
Sensor	In the <b>Overall result</b> parameter, the <b>Failed</b> option was displayed.	Displays the result for the sensor.  Detailed description of the classification of the results: → ⓘ 30	<ul style="list-style-type: none"> <li>▪ Not supported</li> <li>▪ Passed</li> <li>▪ Not done</li> <li>▪ Failed</li> </ul>	Not done
Sensor electronic module (ISEM)	In the <b>Overall result</b> parameter, the <b>Failed</b> option was displayed.	Displays the result for the sensor electronics module (ISEM).  Detailed description of the classification of the results: → ⓘ 30	<ul style="list-style-type: none"> <li>▪ Not supported</li> <li>▪ Passed</li> <li>▪ Not done</li> <li>▪ Failed</li> </ul>	Not done

Parameter	Prerequisite	Description	User interface	Factory setting
I/O module	In the <b>Overall result</b> parameter, the <b>Failed</b> option was displayed.	Displays the result for I/O module monitoring of the I/O module. <ul style="list-style-type: none"> <li>For pulse output: Accuracy of pulses (for external verification only)</li> <li>For frequency output: Accuracy of frequency (for external verification only)</li> </ul>  Detailed description of the classification of the results: →  30	<ul style="list-style-type: none"> <li>Not supported</li> <li>Passed</li> <li>Not done</li> <li>Failed</li> </ul>	Not done
System status	In the <b>Overall result</b> parameter, the <b>Failed</b> option was displayed.	Displays the system condition. Tests the measuring device for active errors.  Detailed description of the classification of the results: →  30	<ul style="list-style-type: none"> <li>Not supported</li> <li>Passed</li> <li>Not done</li> <li>Failed</li> </ul>	Not done

## Classification of results

### Individual results

Result	Description
Failed	At least one individual test in the test group was outside the specifications.
Not used	The result is used for internal purposes.
Passed	All individual tests in the test group complied with the specifications. The result is also "Passed" if the result of an individual test is "Check not done" and the result of all other tests is "Passed".
Not done	No test has been performed for this test group.

### Overall results

Result	Description
Failed	At least one test group was outside the specifications.
Not used	The result is used for internal purposes.
Passed	All verified test groups complied with the specifications (result "Passed"). The overall result is also "Passed" if the result for an individual test group is "Check not done" and the result for all other test groups is "Passed".
Not done	No verification was performed for any of the test groups (result for all test groups is "Check not done").

 If a result is classified as **Check not done**, the output concerned has not been used.

 **Heartbeat Verification** confirms the device function within the specified measuring tolerance on demand. Based on redundant references in the device which are traceable from the factory, **Heartbeat Technology** meets all the requirements concerning traceable device verification according to DIN ISO 9001: 2015 Chapter 7.1.5.2 a).

### Test groups

Test group	Description
Sensor	Electrical components of the sensor (signals, circuits and cables)
Sensor electronics module (ISEM)	Electronics module for activating and converting the sensor signals

Test group	Description
I/O module	Results of all the input and output modules installed on the measuring device.
System condition	Test for active measuring device errors of "alarm"-type diagnostic behavior

For more information on the test groups and individual tests .



The results for a test group (e.g. sensor) contain the result of several individual tests. All the individual tests must be passed for the test group to pass.

The same applies to the overall result: All the test groups must pass for the overall result to be "passed". Information on the individual tests is provided in the verification report and the detailed verification results which can be accessed with the Flow Verification DTM.

### 5.3.5 Detailed verification results

The process conditions at the time of verification and the individual test group results can be accessed with the Flow Verification DTM.

- Process conditions: "VerificationDetailedResults → VerificationActualProcessConditions"
- Verification results: "VerificationDetailedResults → VerificationSensorResults"

#### Process conditions

To increase the comparability of the results, the process conditions that apply at the time of verification are recorded and documented as process conditions on the last page of the verification report.



Process conditions	Description
Verification value volume flow	Current measured value for volume flow
Verification value conductivity	Current measured value for medium conductivity (if switched on)
Current potential difference	Current measured value for potential difference
Current potential of electrode 1	Current measured value for potential of electrode 1
Current potential of electrode 2	Current measured value for potential of electrode 2
Current potential of pipe GND electrode	Current measured value for potential of pipe GND electrode
Electronic temperature	Current measured value for the electronic temperature in the transmitter

#### Individual test group results

The individual test group results listed below provide information on the results of the individual tests within a test group.

##### Sensor

Parameter/individual test	Description	Result/limit value	Interpretation/cause/remedial measures
Rise time symmetry	Monitoring of symmetry in the exciter circuit for coil current shot times while both field polarities are changed.	No value range <ul style="list-style-type: none"> <li>▪ Passed</li> <li>▪ Failed</li> <li>▪ Not done</li> </ul>	<ul style="list-style-type: none"> <li>▪ EMC interference</li> <li>▪ Defective H-bridge in the amplifier</li> </ul>
Holding voltage symmetry	Monitoring of symmetry in holding voltages of exciter circuit for setting the coil current for both field polarities.	No value range <ul style="list-style-type: none"> <li>▪ Passed</li> <li>▪ Failed</li> <li>▪ Not done</li> </ul>	<ul style="list-style-type: none"> <li>▪ EMC interference</li> <li>▪ Defective H-bridge in the amplifier</li> </ul>

Parameter/individual test	Description	Result/limit value	Interpretation/cause/remedial measures
Coil current loss	Monitoring of the coil current path for leak current. Comparison of incoming and outgoing currents.	No value range <ul style="list-style-type: none"> <li>■ Passed</li> <li>■ Failed</li> <li>■ Not done</li> </ul>	Sensor short-circuit. Check entire sensor system: <ul style="list-style-type: none"> <li>▶ Check for moisture (e.g. condensation)</li> <li>▶ Check for faulty sensor and cable connections or interfaces</li> <li>▶ Check coils</li> <li>▶ Checking the insulation resistance</li> </ul>
Coil current stability	Monitoring the correct adjustment of the coil current.	No value range <ul style="list-style-type: none"> <li>■ Passed</li> <li>■ Failed</li> <li>■ Not done</li> </ul>	EMC interference
Coil resistance	Monitoring of the coil resistance.	No value range <ul style="list-style-type: none"> <li>■ Passed</li> <li>■ Failed</li> <li>■ Not done</li> </ul>	<ul style="list-style-type: none"> <li>■ Faulty connections: check the outer connection parts, clamp connections and connecting cables</li> <li>■ Process temperature too high</li> <li>■ Coil in the sensor is defective</li> </ul>
Electrode circuit 1	Monitoring of the impedance in electrode circuit 1.	No value range <ul style="list-style-type: none"> <li>■ Passed</li> <li>■ Failed</li> <li>■ Not done</li> </ul>	Electrode cable defective  The test is not performed if the measuring tube is empty Status indicated: "Not done"
Electrode circuit 2	Monitoring of the impedance in electrode circuit 2.	No value range <ul style="list-style-type: none"> <li>■ Passed</li> <li>■ Failed</li> <li>■ Not done</li> </ul>	Electrode cable defective  The test is not performed if the measuring tube is empty Status indicated: "Not done"
EPD electrode circuit	Monitoring of the impedance in the EPD circuit.	No value range <ul style="list-style-type: none"> <li>■ Passed</li> <li>■ Failed</li> <li>■ Not done</li> </ul>	EPD cable defective  The test is not performed if the measuring tube is empty Status indicated: "Not done"

*Sensor electronics module (ISEM)*

Parameter/individual test	Description	Result/limit value	Interpretation/cause/remedial measures
Supply voltage	All the relevant supply voltages are checked. Monitoring of the supply voltage for the sensor electronics module guarantees that the system is functioning correctly.	No value range <ul style="list-style-type: none"> <li>■ Passed</li> <li>■ Failed</li> <li>■ Not done</li> </ul>	Sensor electronics module (ISEM) defective <ul style="list-style-type: none"> <li>▶ Replace sensor electronics module (ISEM)</li> </ul>
External reference voltage	Monitoring of reference voltages in flowmeter circuit and exciter circuit.	No value range <ul style="list-style-type: none"> <li>■ Passed</li> <li>■ Failed</li> <li>■ Not done</li> </ul>	
Linearity and reference voltage	<ul style="list-style-type: none"> <li>■ Monitoring of flowmeter circuit with regard to gain and linearity.</li> <li>■ Monitoring of reference voltages in flowmeter circuit and exciter circuit</li> </ul>	No value range <ul style="list-style-type: none"> <li>■ Passed</li> <li>■ Failed</li> <li>■ Not done</li> </ul>	Sensor electronics module (ISEM) defective <ul style="list-style-type: none"> <li>▶ Replace sensor electronics module (ISEM)</li> </ul>
Offset electrode signal amplifier	Monitoring of flow measurement amplifier with regard to zero point.	No value range <ul style="list-style-type: none"> <li>■ Passed</li> <li>■ Failed</li> <li>■ Not done</li> </ul>	Sensor electronics module (ISEM) defective <ul style="list-style-type: none"> <li>▶ Replace sensor electronics module (ISEM)</li> </ul>
Hold voltage feedback	The configured hold voltage is fed back to ensure the secure and constant functioning of the hold voltage.	No value range <ul style="list-style-type: none"> <li>■ Passed</li> <li>■ Failed</li> <li>■ Not done</li> </ul>	Sensor electronics module (ISEM) defective <ul style="list-style-type: none"> <li>▶ Replace sensor electronics module (ISEM)</li> </ul>
Overvoltage feedback	The overvoltage is fed back to ensure the secure and constant functioning of the overvoltage.	No value range <ul style="list-style-type: none"> <li>■ Passed</li> <li>■ Failed</li> <li>■ Not done</li> </ul>	Sensor electronics module (ISEM) defective



Parameter/individual test	Description	Result/limit value	Interpretation/cause/remedial measures
Electronic current loss	Monitoring of the coil current path for leak current.	No value range <ul style="list-style-type: none"> <li>■ Passed</li> <li>■ Failed</li> <li>■ Not done</li> </ul>	Sensor electronics module (ISEM) defective
Coil current measurement	Monitoring of low-side current measurement.	No value range <ul style="list-style-type: none"> <li>■ Passed</li> <li>■ Failed</li> <li>■ Not done</li> </ul>	Sensor electronics module (ISEM) defective
Overvoltage circuit	Monitoring of overvoltage.	No value range <ul style="list-style-type: none"> <li>■ Passed</li> <li>■ Failed</li> <li>■ Not done</li> </ul>	Sensor electronics module (ISEM) defective
Electrode signal integrity	Monitoring of input stage, sensor and electrode cable.	No value range <ul style="list-style-type: none"> <li>■ Passed</li> <li>■ Failed</li> <li>■ Not done</li> </ul>	One of the electrode signals is missing. This can be due to the following: <ul style="list-style-type: none"> <li>■ Sensor electronics module (ISEM) defective</li> <li>■ Faulty connection to the sensor</li> <li>■ Electrode short-circuit or open circuit</li> <li>■ Sensor defective</li> </ul>

*System condition*

Parameter/individual test	Description	Result/limit value	Interpretation/cause/remedial measures
System condition	System condition monitoring	No value range <ul style="list-style-type: none"> <li>■ Passed</li> <li>■ Failed</li> <li>■ Not done</li> </ul>	<b>Causes</b> System error during verification  <b>Corrective action</b> <ul style="list-style-type: none"> <li>▶ Check diagnostic event in the <b>Event logbook</b> submenu.</li> </ul>

*I/O modules*

Parameter/individual test	Description	Result/limit value	Interpretation/cause/remedial measures
Output 1 to n	Check of all the input and output modules installed at the measuring device → 18	No value range <ul style="list-style-type: none"> <li>■ Passed</li> <li>■ Failed</li> <li>■ Not done</li> </ul> <p> Limit values</p>	<b>Causes</b> <ul style="list-style-type: none"> <li>■ Output values out of specification</li> <li>■ I/O modules defective</li> </ul> <b>Corrective action</b> <ul style="list-style-type: none"> <li>▶ Check cabling.</li> <li>▶ Check connections.</li> <li>▶ Check load (current output).</li> <li>▶ Replace I/O module.</li> </ul>

### 5.3.6 Verification report

The results of the verification can be documented in the form of a verification report via the web server or FieldCare operating tool →  11. The verification report is created on the basis of the data records saved in the measuring device after verification. As the verification results are automatically and uniquely identified with a verification ID and the operating time, they are suitable for the traceable documentation of the verification of flowmeters.

#### First page: identification → 9, 35

Measuring point identification, identification of the verification results and confirmation of completion:

- System operator
  - Customer reference
- Device information
  - Information on the place of operation (tag) and the current configuration of the measuring point
  - Management of the information in the device
  - Display on the verification report
- Calibration
  - Information on the calibration factor and zero point setting for the sensor
  - These values must correspond to those from the last calibration or repeat calibration in order to comply with factory specifications
- Verification information
  - The operating time and verification ID are used to uniquely assign the verification results for the traceable documentation of the verification
  - Storage and display of the manual date and time entry as well as the current operating time in the device
  - Verification mode: standard verification or extended verification
- Overall verification result
  - Overall result of the verification passed if all of the individual results are passed

#### Second page: test results

Details on the individual results for all test groups:

- System operator
- Test groups →  31
  - Sensor
  - Sensor electronics module (ISEM)
  - System condition
  - I/O module

#### Third page (and subsequent pages): measured values and visualization

Numerical values and graphic presentation of all the values recorded:

- System operator
- Test object
- Unit
- Current: measured value
- Min.: lower limit
- Max.: upper limit
- Visualization: graphic presentation of the measured value, within the lower and upper limits.

#### Last page: process conditions

Information on the process conditions that applied during the verification:

- Volume flow
- Conductivity
- Electronics temperature
- Current potential difference
- Current potential of electrode 1

- Current potential of electrode 2
- Current potential of pipe GND electrode
- Build-up index value (only with the Heartbeat Verification + Monitoring application package)

As a prerequisite for the validity of the verification report, the **Heartbeat Verification** feature must be activated on the measuring device concerned and must have been performed by an operator tasked to carry out this job by the customer. Alternatively, an Endress+Hauser service technician or a service provider authorized by Endress+Hauser can be tasked with performing the verification.

Verification report



Endress+Hauser 

People for Process Automation

**Plant operator:**

---

**Device information**

Location	Location 14
Device tag	M-745
Module name	ProXXX
Nominal diameter	DNxx
Device name	ProXXX
Order code	XXXXXX-XXX
Serial number	1234567890
Firmware version	01.01.00



**Calibration**

Calibration factor	2.10
Compensated calibration factor	10

**Verification information**

Operating time (counter)	12d15h32min12s
Date/time (manually recorded)	02.10.2017/12:00
Verification ID	17
Verification mode	Extended verification

**Overall verification result\***

<input checked="" type="checkbox"/> Passed	Details see next page
--	-----------------------

\*Result of the complete device functionality test via Heartbeat Technology

**Confirmation**

Heartbeat Verification verifies the function of the flowmeter within the specified measuring tolerance, over the useful lifetime of the device, with a total test coverage > 94 %, and complies with the requirements for traceable verification according to DIN EN ISO 9001:2008 – Section 7.6 a. (attested by TÜV-SÜD Industrieservices GmbH)

**Notes**

---

Date

Operator's signature



Inspector's signature



www.endress.com

Device DTM

Page 1

A0031154-EN

 9 Example of a verification report (Page 1: identification →  34)

 Individual test groups and description of individual tests: →  31

Endress+Hauser

35

## Verification report



**Endress+Hauser**  
People for Process Automation

---

### Plant operator

**Device identification and verification identification**

Serial number	452633345
Device tag	M-745
Verification ID	17



<b>Sensor</b>	<input checked="" type="checkbox"/> <b>Passed</b>
Shot time symmetry	<input checked="" type="checkbox"/> Passed
Hold voltage symmetry	<input checked="" type="checkbox"/> Passed
Coil current loss	<input checked="" type="checkbox"/> Passed
Coil current offset	<input checked="" type="checkbox"/> Passed
Coil resistance value	<input checked="" type="checkbox"/> Passed
E1 electrode cable	<input checked="" type="checkbox"/> Passed
E 2 electrode cable	<input checked="" type="checkbox"/> Passed
EPD electrode cable	<input checked="" type="checkbox"/> Passed
<b>Sensor electronic module (ISEM)</b>	<input checked="" type="checkbox"/> <b>Passed</b>
Supply voltage	<input checked="" type="checkbox"/> Passed
Internal voltages	<input checked="" type="checkbox"/> Passed
External reference voltage	<input checked="" type="checkbox"/> Passed
Linearity and reference voltage	<input checked="" type="checkbox"/> Passed
Offset-Electrode control circuit	<input checked="" type="checkbox"/> Passed
Hold voltage feedback	<input checked="" type="checkbox"/> Passed
Shot voltage feedback	<input checked="" type="checkbox"/> Passed
Electronic current loss	<input checked="" type="checkbox"/> Passed
Coil circuit measurement	<input checked="" type="checkbox"/> Passed
Shot control circuit	<input checked="" type="checkbox"/> Passed
Electrode signal integrity	<input checked="" type="checkbox"/> Passed
<b>System status</b>	<input checked="" type="checkbox"/> <b>Passed</b>
<b>I/O module</b>	<input checked="" type="checkbox"/> <b>Passed</b>
Input/output 1	<input checked="" type="checkbox"/> Passed*
Input/output 2	<input checked="" type="checkbox"/> Passed*
Input/output 3	<input checked="" type="checkbox"/> Passed*

\*External verification

**Information about the external verification**

Fluke 2354, Cal: 10.05.2019

www.endress.com
Device DTM
Page 2

A0042232-EN

 10 Example of a verification report (Page 2: test results →  34)

 Comments from the person carrying out the verification appear in the "Information about the External Verification" field. It is also recommended for information on the type and serial number of the external testing device used to carry out the external verification.

 Data administration with Web server and FieldCare (Flow Verification DTM): →  11

## Verification report



**Endress+Hauser**  
People for Process Automation

---

**Plant operator:**

---

**Device identification and verification identification**

Serial number	1234567890
Device tag	M-745
Verification ID	17



---

Test item	Unit	Actual	Min.	Max.	Visualization
<b>Sensor</b>					
Shot time symmetry deviation		0.9997	0.9000	1.1000	□□□□■□□□□□
Hold voltage symmetry deviation		1.0000	0.9000	1.1000	□□□□■□□□□□
Coil current loss deviation	%	0.0000	-10.000	10.0000	□□□□■□□□□□
Coil current offset	%	-0.02	-0.1	0.1	□□□□■□□□□□
Coil current deviation	%	0.00	-0.1	0.1	□□□□■□□□□□
Coil resistance value	Ohm	85.9	50.0	240.0	■□□□□□□□□□
E1 electrode impedance	Ohm	100.00			□□□□□□□□□□
E2 electrode impedance	Ohm	100.00			□□□□□□□□□□
EPD electrode impedance	Ohm	100.00			□□□□□□□□□□
E1/E2 electrode impedance on E1	Ohm	100.00			□□□□□□□□□□
E1/E2 electrode impedance on E2	Ohm	100.00			□□□□□□□□□□
<b>Sensor electronic module (ISEM)</b>					
Supply voltage 30.0 V	V	30.0	27.000	35.000	□□□■□□□□□□
External reference voltage 1	V	0.0			□□□□□□□□□□
Linearity and reference voltage 1		1.0000	0.9900	1.01000	□□□□■□□□□□
Linearity and reference voltage 2		1.0000	0.9900	1.01000	□□□□■□□□□□
Measuring point offset		0.0000	-100.0000	100.0000	□□□□■□□□□□
Hold voltage feedback value	%	-5.65	-10.0	10.0	□□□□■□□□□□
Shot voltage feedback value	%	0.0021	-20.0	20.0	□□□□■□□□□□
Electronic current loss deviation	%	0.00	-10.000	10.0000	□□□□■□□□□□
Coil circuit value	%	-0.28	-1.0	1.0	□□□■□□□□□□
Shot control circuit value	%	0.00	-10.0	10.0	□□□□■□□□□□
Electrode signal integrity deviation	%	0.00	-40.0	40.0	□□□□■□□□□□
<b>I/O module</b>					
Output 1 value 1		0.0000	0.0000	0.0000	□□□□□□□□□□
Output 2 value 1		0.0000	0.0000	0.0000	□□□□□□□□□□
Output 3 value 2		0.0000	0.0000	0.0000	□□□□□□□□□□

www.endress.com

Verification DTM

11 Example of a verification report (Page 3: measured values and visualization → 34)

### 5.3.7 Interpreting and using the verification results

**Heartbeat Verification** uses the self-monitoring function of the Proline flowmeters to check the measuring device functionality. During the verification process, the system checks whether the measuring device components comply with the factory specifications. Both the sensor and the electronics modules are included in the tests.

Compared to flow calibration, which incorporates the entire measuring device and assesses the flow measuring performance directly (primary measured variable), **Heartbeat Verification** checks the function of the measuring chain from the sensor to the outputs.

Here, the function checks device-internal parameters that are correlated with flow measurement (secondary measured variables, comparative values). The check is based on reference values that were recorded during the factory calibration.

If a verification is passed, this confirms that the comparison values that are checked are within the factory specification and that the measuring device is working correctly. At the same time, zero point and calibration factor of the sensor are documented and traceable in the verification report. To ensure that the measuring device complies with the factory specification, these values must match those of the last calibration or repeated calibration.



-  Confirmation of compliance with the flow specifications with a total test coverage of 100 % is only possible by verifying the primary measured variable (flow) by recalibrating or by proving the value.
- **Heartbeat Verification** confirms the device function within the specified measuring tolerance on demand.

#### Recommended course of action if the result of a verification is "Failed"

If the result of a verification is **Failed**, it is advisable to begin by repeating the verification.

This applies in particular if the individual tests of the **Sensor** test group are concerned, as a process-related influence is then possible.



Ideally, ensure defined and stable process conditions in order to rule out process-specific influences as much as possible. When repeating the verification, it is advisable to compare the current process conditions to those of the previous verification in order to identify any deviations.

-  The process conditions of the previous verification are documented on the last page of the verification report or can be accessed using the Flow Verification DTM →  31.

Stabilize or stop flow, ensure that process temperature is stable, drain the sensor if possible.

#### *Additional remedial measures if the result of a verification is "Failed"*

- Calibrate the measuring device  
The calibration has the advantage that the "as found" measuring device state is recorded and the actual measured error is determined.
- Direct remedial measures  
Take remedial action on the basis of the verification results and the diagnostic information of the measuring device. Narrow down the possible cause of the error by identifying the test group that **failed** the verification.

-  For detailed information on diagnostics and troubleshooting and for diagnostic information and associated remedial measures, see the Operating Instructions →  6.

## 6 Heartbeat Monitoring

With Heartbeat Monitoring, additional measured values are output continuously and monitored in an external Condition Monitoring system so that changes to the measuring device and in the process can be detected at an early stage. The measured variables can be interpreted in a Condition Monitoring system. The information obtained in this way helps users to control measures concerning maintenance or process optimization. Possible applications of Condition Monitoring include the detection of the formation of build-up or wear as a result of corrosion.

### 6.1 Operation

The benefits of **Heartbeat Monitoring** are in direct correlation with the recorded data selection and their interpretation. Good data interpretation is critical for deciding whether a problem has occurred and when and how maintenance should be scheduled or performed (good knowledge of the application is required). The elimination of process effects that cause misleading warnings or interpretation must also be ensured. For this reason it is important to compare the recorded data against a process reference.

Heartbeat Monitoring enables additional monitoring values to be displayed in continuous operation mode.

focuses on measured variables which indicate a change in the performance of the measuring device brought about by process-related influences. There are two difference categories of process-specific influences:

- Temporary process-specific influences that impact the measuring function directly and therefore result in a higher level of measuring uncertainty than would normally be expected (e.g. measurement of multiphase fluids). These process-specific influences generally do not affect the integrity of the device but do impact measuring performance temporarily.
- Process-related influences which only impact the integrity of the sensor over the medium term but which also bring about a gradual change in the measuring performance (e.g. abrasion, corrosion or the formation of build-up in the sensor). These influences also affect the integrity of the device on the long term.

Devices with **Heartbeat Monitoring** offer a range of parameters that are particularly suitable for monitoring specific, application-related influences. These target applications are:

- Fluids containing magnetite
- Multi-phase fluids (gas content in liquid fluids)
- Applications in which the sensor is exposed to a programmed amount of wear
- Applications with cathodic protection systems
- Applications with pipes that are not grounded
- Applications in which build-up can form.

The results of must always be interpreted in the context of the application.

#### 6.1.1 Overview of the monitoring parameters

This section describes the interpretation of certain monitoring parameters in connection with the process and the application.

Monitoring parameter	Possible reasons for deviation
Noise	A change can be an indicator of multi-phase fluids (gas content in liquid fluids or a change in the solids content of the fluid) or changing electrical conductivity. This value allows conclusions to be drawn about the process.
Coil current shot time	At constant process temperatures, a change can indicate a possible build-up of magnetite or an increase in the magnetite content of the medium. Strong external magnetic fields influence this value too.

Monitoring parameter	Possible reasons for deviation
Reference electrode potential against PE	This diagnostic value describes the voltage between the fluid and the protective ground. This value is of significance if the measuring device with the reference electrode contacting the fluid is disconnected from the protective ground.
Build-up index value	Detection and monitoring of an even coating forming on the inside of the measuring tube.

### Navigation

"Diagnostics" menu → Heartbeat → Monitoring results

► Monitoring results	
Noise	→ 40
Coil current shot time	→ 40
Reference electrode potential against PE	→ 40
Build-up index	→ 40

### Parameter overview with brief description

Parameter	Description	User interface	Factory setting
Noise	Indicates the degree to which the differential signal from both measuring electrodes is dispersed.	0 to $3.0 \cdot 10^{+38} \mu\text{V}$	–
Coil current shot time	Indicates the rise time of the coil current for the buildup of the magnetic field.	2 to 500 ms	–
Reference electrode potential against PE	Displays the voltage of the reference electrode in relation to the potential of the measuring tube.	–30 to +30 V	–
Build-up index	Shows current build-up measured value.	0.0 to 100.0 %	0.0 %



## 7 Build-up detection using the Build-up index



Build-up detection is only available:

- In conjunction with the Promag W sensor
- In the **compact version** of the device (transmitter and sensor form a single mechanical unit)
- For additional prerequisites for the optimum and reliable use of the build-up detection function, see → 43

Build-up detection is part of Heartbeat Monitoring. It is used to detect and monitor an even coating forming on the inside of the measuring tube.

Build-up detection makes it possible to:

- Draw conclusions regarding accuracy
- Avoid process disruptions
- Identify and control necessary cleaning intervals early on

Build-up is understood to be an even coating that forms over the entire inner wall of the measuring tube and increases in the course of the process. The time required for build-up to form varies. Depending on the process and medium, build-up can form within just a few hours or only after a few months.

Build-up detection is particularly suitable for processes in which an even coating forms, e.g:

- Heating circuits with magnetite deposits
- Sugar refining processes with oxalates
- Dairy and food processing with protein or sugar deposits
- Iron clogging in drinking water and water processes

### 7.1 General principles

#### 7.1.1 Build-up and deposits

The build-up detection function is designed to detect and monitor the formation of an even coating and **cannot** be used for the detection of deposits at the bottom of a measuring tube.

Coating (build-up)	Deposits
12 <i>Build-up formed on the inside of the inner wall of the measuring tube</i>	13 <i>Deposits on the bottom of the measuring tube</i>

#### 7.1.2 Operating principle

The electrical conductivity values of the flowing medium and the build-up differ from one another. By analyzing the distribution of electrical conductivity within the measuring tube, it is possible to detect the formation of build-up.

The distribution of electrical conductivity in the cleaned measuring tube serves as the reference situation. In this state, a reference value is calibrated and the value of 0% is assigned to the Build-up index value before the device is delivered.

Build-up detection using the Build-up index assesses the difference between the conductivity of the flowing medium and the conductivity of the build-up. If the thickness of the build-up increases, the Build-up index value also increases. This effect is used to track the formation of build-up or cleaning progress.

### Evaluation of build-up formation

For a comparative assessment, it is important to note that if build-up has already formed in the pipe, a change in the conductivity of the flowing medium can also cause a change in the Build-up index value. Build-up formation should therefore always be assessed at a constant medium conductivity.

### Build-up index value

The formation of build-up is indicated as a percentage in the Build-up index value parameter. The higher the percentage value, the thicker the layer of build-up.

Build-up index value = 0%

- No build-up present
- Measuring tube as-delivered state (initial value)
- Measuring tube was cleaned thoroughly after formation of build-up

Build-up index value = 100%

- Value for the maximum measurable build-up thickness
- The thickness of the build-up at 100% varies depending on the process
- 100% does **not** indicate a clogged measuring tube

The percentage indicated in the Build-up index value parameter does not provide direct information about the absolute thickness or the composition of the build-up. Therefore, to make optimum use of the build-up detection function with the Build-up index, it is necessary to first compare the formation of build-up in the process, as known from experience, with the associated Build-up index value. The aim is to determine the Build-up index value at the time the cleaning is usually performed.

On the basis of the Build-up index value during cleaning, it is possible to make a valid assessment of the condition inside the measuring tube and to plan the cleaning using the Build-up limit and Build-up limit hysteresis parameters.

In addition, conclusions about possible effects on neighboring processes can be drawn from the Build-up index value.

### Interval for build-up detection

The interval for recording the Build-up index value can be specified in the Build-up index parameter.

- If it is known, from experience, that build-up is formed quickly, a short interval should be selected (**Fast** option). This option is also suitable for cleaning processes with a short monitoring duration of approx. 5 to 20 minutes.
- A longer interval, e.g. one measurement per minute or less, suffices for build-up that forms slowly over several months (**Slow** option).

The Fast, Standard and Slow options each differ from one another by a time factor of 10.

Example for the measuring interval with DN 25 nominal diameter:

- **Fast** option: Every 6 seconds
- **Standard** option: Every 60 seconds
- **Slow** option: Every 600 seconds

### Displaying the "Build-up detected" diagnostic information

Use the Build-up limit and Build-up limit hysteresis parameters to define a range for the thickness of the build-up in which the "Build-up detected" diagnostic information is output.

- i
  - If the value for the build-up detection hysteresis is higher than the Build-up limit, the "Build-up detected" diagnostic information is only reset once the measuring tube has been cleaned and the device is restarted.
  - If the "Build-up detected" diagnostic information is displayed for an empty measuring tube, this can be avoided by activating empty pipe detection: Setup → Empty pipe detection

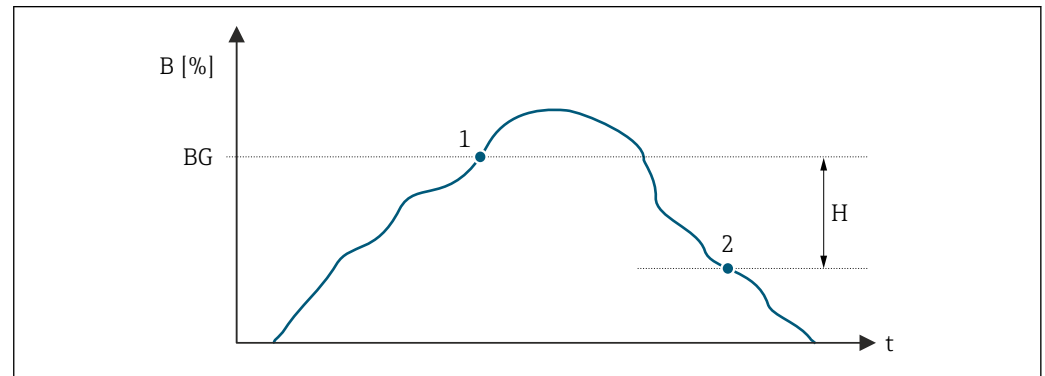

- B* Build-up index value [%]
- t* Time
- BG* Build-up limit [%]
- 1* Diagnostics information switch-on point
- H* Build-up limit hysteresis [%]
- 2* Diagnostics information switch-off point

### 7.1.3 Prerequisites

The following conditions must be met to ensure the optimum and reliable use of the build-up detection function.

#### Device version

Build-up detection is only available:

- In conjunction with the Promag W sensor
- In the **compact version** of the device (transmitter and sensor form a single mechanical unit)

#### Potential equalization

Potential equalization must be ensured in line with the operational environment of the measuring device in the plant.

- i
 For more information on ensuring potential equalization, see the Operating Instructions → 6.

#### Conductivity measurement

Build-up detection is only available if conductivity measurement is activated: Expert → Sensor → Process parameters → Conductivity measurement



**Installation**

- Vertical orientation (preferable)
- Mount the device downstream of assemblies such as valves, T-sections or pumps
- Observe inlet and outlet runs

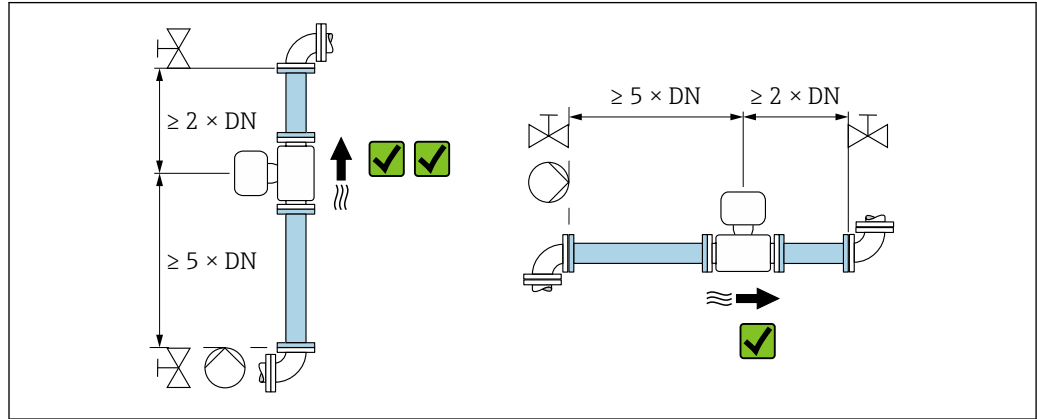
 For devices with the order code for "Design", option C, H, I, no inlet or outlet runs need to be considered.



A0046360

 For more information on installation, see the Operating Instructions →  6.

## 7.2 Description of the Build-up index parameters

### Navigation

"Expert" menu → Sensor → Process parameters → Build-up index

► Build-up index	
Build-up detection	→ 45
Build-up detection damping	→ 45
Build-up index	→ 45
Build-up limit	→ 45
Build-up limit hysteresis	→ 45

### Parameter overview with brief description

Parameter	Description	Selection / User entry / User interface	Factory setting
Build-up detection	Select mode for build-up index.	<ul style="list-style-type: none"> <li>■ Off</li> <li>■ Slow</li> <li>■ Standard</li> <li>■ Fast</li> </ul>	Off
Build-up detection damping	Enter damping value for build-up index. Damping value: <ul style="list-style-type: none"> <li>■ 0 = minimum damping</li> <li>■ 15 = maximum damping</li> </ul> The damping value should only be increased if the measured value is unstable.	0 to 15	0
Build-up index	Shows current build-up measured value.	0.0 to 100.0 %	0.0 %
Build-up limit	Enter limit value for the build-up index.	0 to 100 %	50 %
Build-up limit hysteresis	Enter hysteresis for build-up limit value. If the value for build-up detection hysteresis is higher than the Build-up limit, the "Build-up detected" diagnostic information is not reset until the measuring tube has been cleaned and a restart has been performed.	0 to 100 %	20 %

## 7.3 Application examples

**i** The following application examples show how differently build-up forms in various processes. While the values indicated cannot be applied directly on a one-to-one basis, they do provide an indication of behavior in similar processes.

### 7.3.1 Water application

Application	Water supply
Type of build-up	Iron clogging
Monitoring duration	12 months
Build-up detection	Standard (one measurement per minute)
Nominal diameter of measuring tube	DN 100
Build-up formed	9 mm
Analysis	

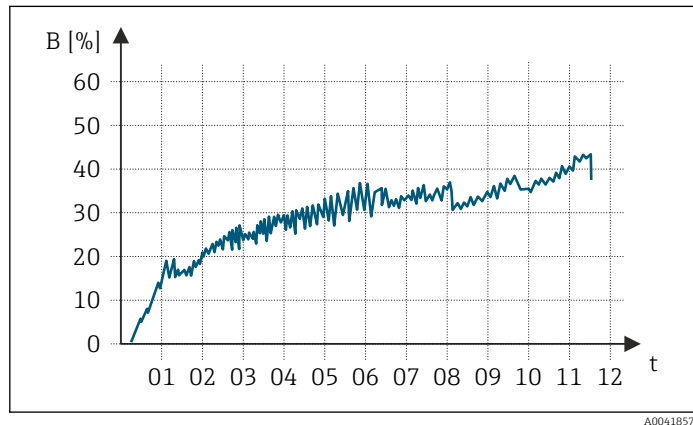

*B* Build-up index value [%]  
*t* Time [months]

- Build-up index value:
- 0 to 5% : no build-up present
  - > 5% : build-up is detected

### 7.3.2 Application in the food industry: sugar

Application	Sugar refinery
Type of build-up	Oxalates in sugar beet juice
Monitoring duration	4 months
Build-up detection	Standard (one measurement per minute)
Nominal diameter of measuring tube	DN 100
Build-up formed	4 to 8 mm
Analysis	

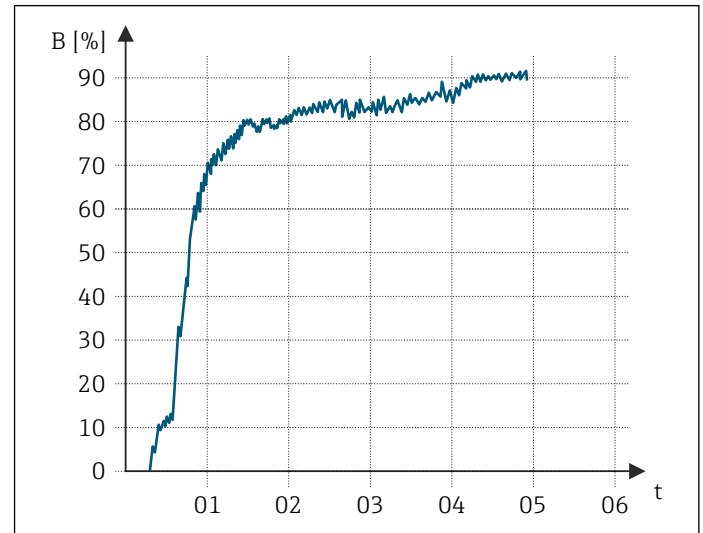

A0041868

$B$  Build-up index value [%]  
 $t$  Time [months]

Build-up index value:  
 ■ 0 to 5% : no build-up present  
 ■ > 5% : build-up is detected

### 7.3.3 Application in the food industry: whey protein

Application	Food processing facility
Type of build-up	Whey protein
Monitoring duration	1 day
Build-up detection	Standard (one measurement per minute)
Measuring tube nominal diameter	DN 25
Build-up formed	3-4 mm



[www.addresses.endress.com](http://www.addresses.endress.com)

---