

Safety Instructions

Micropilot NMR81, NMR84

Ex ia/db IIC Ga/Gb
Ex db [ia Ga] IIC Gb



Micropilot NMR81, NMR84

Table of contents

About this document	4
Associated documentation	4
Supplementary documentation	4
Manufacturer's certificates	4
Manufacturer address	4
Other standards	5
Extended order code	5
Safety instructions: General	9
Safety instructions: Special conditions	9
Safety instructions: Installation	10
Safety instructions: Zone 0	11
Temperature tables	12
Connection data	21

About this document

This document has been translated into several languages. Legally determined is solely the English source text.

Associated documentation

This document is an integral part of the following Operating Instructions:

- BA01450G/00 (NMR81)
- BA01453G/00 (NMR84)

Supplementary documentation

Explosion-protection brochure: CP00021Z/11

The Explosion-protection brochure is available:

- In the download area of the Endress+Hauser website:
www.endress.com -> Downloads -> Brochures and Catalogs -> Text Search: CP00021Z
- On the CD for devices with CD-based documentation

Manufacturer's certificates**KC Declaration of Conformity**

Certificate number:

- 16-KA4BO-0520X (NMR81)
- 16-KA4BO-0521X (NMR84)

Affixing the certificate number certifies conformity with the following standards (depending on the device version):

- IEC 60079-0 : 2017
- IEC 60079-1 : 2014
- IEC 60079-11 : 2012
- IEC 60079-26 : 2014
- IEC 60529 : 2013
- UL 122701 (2017)

Manufacturer address

Endress+Hauser SE+Co. KG
Hauptstraße 1
79689 Maulburg, Germany

Address of the manufacturing plant: See nameplate.

Other standards

Among other things, the following standards shall be observed in their current version for proper installation:

- IEC/EN 60079-14: "Explosive atmospheres - Part 14: Electrical installations design, selection and erection"
- EN 1127-1: "Explosive atmospheres - Explosion prevention and protection - Part 1: Basic concepts and methodology"

Extended order code

The extended order code is indicated on the nameplate, which is affixed to the device in such a way that it is clearly visible. Additional information about the nameplate is provided in the associated Operating Instructions.

Structure of the extended order code

NMR8x	-	*****	+	A*B*C*D*E*F*G*..
<i>(Device type)</i>		<i>(Basic specifications)</i>		<i>(Optional specifications)</i>

* = Placeholder

At this position, an option (number or letter) selected from the specification is displayed instead of the placeholders.

Basic specifications

The features that are absolutely essential for the device (mandatory features) are specified in the basic specifications. The number of positions depends on the number of features available.

The selected option of a feature can consist of several positions.

Optional specifications

The optional specifications describe additional features for the device (optional features). The number of positions depends on the number of features available. The features have a 2-digit structure to aid identification (e.g. JA). The first digit (ID) stands for the feature group and consists of a number or a letter (e.g. J = Test, Certificate). The second digit constitutes the value that stands for the feature within the group (e.g. A = 3.1 material (wetted parts), inspection certificate).

More detailed information about the device is provided in the following tables. These tables describe the individual positions and IDs in the extended order code which are relevant to hazardous locations.

Extended order code: Micropilot



The following specifications reproduce an extract from the product structure and are used to assign:

- This documentation to the device (using the extended order code on the nameplate).
- The device options cited in the document.

Device type

NMR81, NMR84

Basic specifications

Position 1, 2 (Approval)		
Selected option		Description
NMR81	KE	KC Ex ia/db IIC T4...T1 Ga/Gb KC Ex db [ia Ga] IIC T4...T1 Gb
NMR8x	KC	KC Ex ia/db IIC T6...T1 Ga/Gb KC Ex db [ia Ga] IIC T6...T1 Gb

Position 4 (Power supply, Display)		
Selected option		Description
NMR8x	B	85-264VAC; LCD + operation
	D	52-75VAC; LCD + operation
	E	19-64VDC; LCD + operation

Position 5, 6 (Primary Output)		
Selected option		Description
NMR8x	A1	Modbus RS485
	B1	V1
	C1	WM550
	E1	4-20 mA HART Ex d/XP
	H1	4-20 mA HART Ex i/IS

Position 7, 8 (Secondary I/O Analogue)		
Selected option		Description
NMR8x	A1	Ex d/XP, 1x 4-20 mA HART, 1x RTD input
	A2	Ex d/XP, 2x 4-20 mA HART, 2x RTD input
	B1	Ex i/IS, 1x 4-20 mA HART, 1x RTD input
	B2	Ex i/IS, 2x 4-20 mA HART, 2x RTD input
	C2	1x Ex i/IS 4-20 mA HART, 2x RTD input + 1x Ex d/XP 4-20 mA HART
	X0	Not selected

Position 9, 10 (Secondary I/O Digital Ex d/XP)		
Selected option		Description
NMR8x	A1	2x relay + 2x module discrete
	A2	4x relay + 4x module discrete
	A3	6x relay + 6x module discrete
	B1	Modbus RS485
	B2	Modbus RS485 + 2x relay + 2x module discrete
	B3	Modbus RS485 + 4x relay + 4x module discrete
	C1	V1
	C2	V1 + 2x relay + 2x module discrete
	C3	V1 + 4x relay + 4x module discrete
	E1	WM550
	E2	WM550 + 2x relay + 2x module discrete
	E3	WM550 + 4x relay + 4x module discrete
	X0	Not selected

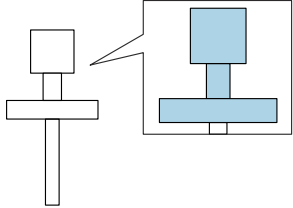
Position 11, 12 (Housing)		
Selected option	Description	
NMR8x	AC	Transmitter Alu, coated, process 316/316L
	BC	Transmitter + process 316/316L
<p> Shown in the temperature tables exemplary as follows:</p> 		

Position 14, 15 (Antenna)		
Selected option	Description	
NMR81	AB	50 mm/2"
	AC	80 mm/3"
	AD	100 mm/4", align. device
NMR84	BD	Planar 100 mm/4"
	BF	Planar 150 mm/6"
	BG	Planar 200 mm/8"
	BH	Planar 250 mm/10"
	BJ	Planar 300 mm/12"

Position 16, 17 (Process Sealing)		
Selected option	Description	
NMR81	B1	FKM GLT, -40...200 °C/-40...392 °F
	B2	FFKM, -20...200 °C/-4...392 °F
	B3	FKM -10...200°C / 14...392°F, FDA conf.
NMR84	B1	FKM GLT, -40...150 °C/-40...302 °F
	B2	FFKM, -20...150 °C/-4...302 °F
NMR8x	A1	HNBR -30...150 °C/-22...302 °F

Optional specifications

No options specific to hazardous locations are available.

Safety instructions:
General

- Staff must meet the following conditions for mounting, electrical installation, commissioning and maintenance of the device:
 - Be suitably qualified for their role and the tasks they perform
 - Be trained in explosion protection
 - Be familiar with national regulations
- Install the device according to the manufacturer's instructions and national regulations.
- Do not operate the device outside the specified electrical, thermal and mechanical parameters.
- Only use the device in media to which the wetted materials have sufficient durability.
- Avoid electrostatic charging:
 - Of plastic surfaces (e.g. enclosure, sensor element, special varnishing, attached additional plates, ..)
 - Of isolated capacities (e.g. isolated metallic plates)
- Refer to the temperature tables for the relationship between the permitted ambient temperature for the sensor and/or transmitter, depending on the range of application and the temperature class.
- Modifications to the device can affect the explosion protection and must be carried out by staff authorized to perform such work by Endress+Hauser.

Safety instructions:
Special conditions

- Permitted ambient temperature range at the electronics enclosure:
→  12, "Temperature tables".
- Observe the information in the temperature tables.
 - For ambient and process temperature range refer to XA01579G.
 - An antenna coated with non-conductive material can be used if avoiding electrostatic charging (e.g. through friction, cleaning, maintenance, strong medium flow).
 - In the case of process connections made of polymeric material or with polymeric coatings, avoid electrostatic charging of the plastic surfaces.
 - In the event of additional or alternative special varnishing on the enclosure or other metal parts:
 - Observe the danger of electrostatic charging and discharge.
 - Do not rub surfaces with a dry cloth.
 - Flamepath joints are not for repair. Contact the manufacturer.
 - Use heat resisting cables rated $\geq 85\text{ °C}$ for $T_a > 50\text{ °C}$.
 - Precautions shall be taken to minimize the risk from electrostatic discharge of non-metallic labels and isolated metal tags applied to the enclosure.
 - To maintain the ingress protection ratings (IP66/68), teflon tape or pipe dope is required for blanking plugs.
 - Ex db certified seals are required within 50 mm (2 in) on all used enclosure entries.

Safety instructions: Installation

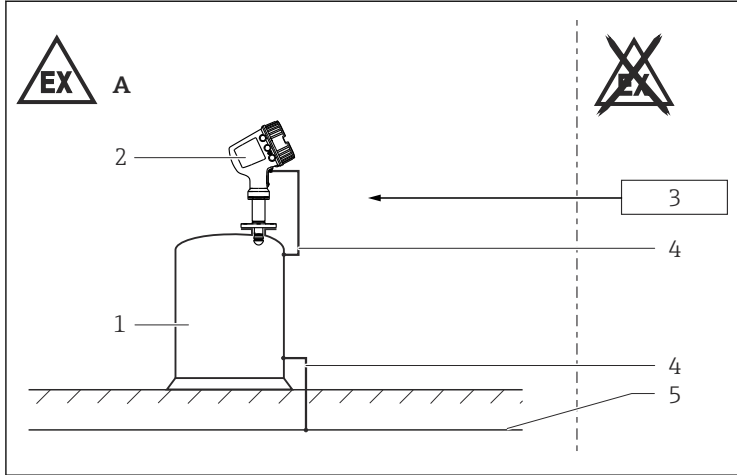

A0032009



- 1 Zone 1
 1 Tank; Zone 0, Zone 1
 2 Connection and electronics compartment Ex db
 3 Power supply
 4 Potential equalization line
 5 Potential equalization

- Install the device to exclude any mechanical damage or friction during the application. Pay particular attention to flow conditions and tank fittings.
- In potentially explosive atmospheres:
 - Do not disconnect the electrical connection of the power supply circuit when energized.
 - Do not open the connection compartment cover.
- Only use certified cable entries suitable for the application. Observe national regulations and standards. Accordingly, the connection terminal does not include any ignition sources.
- When operating the transmitter enclosure at an ambient temperature under $-20\text{ }^{\circ}\text{C}$, use appropriate cables and cable entries permitted for this application.
- Seal unused entry glands with approved sealing plugs that correspond to the type of protection. The plastic transport sealing plug does not meet this requirement and must therefore be replaced during installation.
- Before operation:
 - Screw in the cover all the way.
 - Tighten the securing clamp on the cover.

Process sealing

The following device types are single process seal devices (Single Process Seal) per UL 122701 (2017) / PD IEC/TS60079-40 and do not require the use of an external secondary process seal (Add-on Secondary Process Seal).

Device type	Maximum Working Pressure (MWP) for Single Process Seal
NMR81	1.6 MPa (16 bar) or 1.6 MPa (16 bar) limited up to 170 °C (see nameplate)
NMR84	2.5 MPa (25 bar)

Potential equalization

Integrate the device into the local potential equalization.

Overvoltage protection

Overvoltage protection against atmospheric overvoltages.

The following Terminal outputs / configurations need no separate external overvoltage protection measures:

Position	Terminal
Power supply	G
HART interface	E
external Display	F

- Device configuration:
 - *Basic specification, Position 5, 6* = A1, B1, C1, E1, H1
 - *Basic specification, Position 7, 8* = A1, A2, B1, B2, C2, X0
 - *Basic specification, Position 9, 10* = B1, C1, E1, X0
- All other configurations must be protected by separate additional measures to comply national regulations and standards.
- Observe the safety instructions of the overvoltage protection.

Safety instructions: Zone 0

- In the event of potentially explosive vapor/air mixtures, only operate the device under atmospheric conditions.
 - Temperature: -20 to +60 °C
 - Pressure: 80 to 110 kPa (0.8 to 1.1 bar)
 - Air with normal oxygen content, usually 21 % (V/V)
- If no potentially explosive mixtures are present, or if additional protective measures have been taken, the device may also be operated under non-atmospheric conditions in accordance with the manufacturer's specifications.

Temperature tables



- Observe the permitted temperature range at the antenna.
- Observe the sealing restrictions: see *Basic specification, Position 16, 17.*
- For configurations other than listed: use configuration 1.

Configuration of electronics:

	1 (worst case)	2 (best case)	3	4	5
Enclosure	X	X	X	X	X
Slot A - IOM_D	X		X	X	X
Slot B - IOM_D	X				
Slot B - IOM_A (Ex ia)			X		X
Slot C - IOM_A (Ex ia)	X				
Slot D - IOM_D	X				X
PS_LV_DC	X	X	X	X	X
MB	X	X	X	X	X
ExLi	X	X	X	X	X

Description notes



Unless otherwise indicated, the positions always refer to the basic specification.

1st column: Configuration of electronics = 1, 2, ..

2nd column: Temperature classes T6 (85 °C) to T1 (450 °C)

Column P1 to P5: Position (temperature value) on the axes of the derating

- T_a: Ambient temperature in °C
- T_p: Process temperature in °C

Example table

2		P1		P2		P3		P4		P5	
		T _p	T _a	T _p	T _a	T _p	T _a	T _p	T _a	T _p	T _a
	T6	-40	60	60	60	85	51	85	-40	-40	-40
	T5	-40	60	60	60	100	46	100	-40	-40	-40
	T4	-40	60	60	60	135	58	135	-40	-40	-40
	T3...T1	-40	60	60	60	200	54	200	-40	-40	-40

Example diagrams of possible deratings

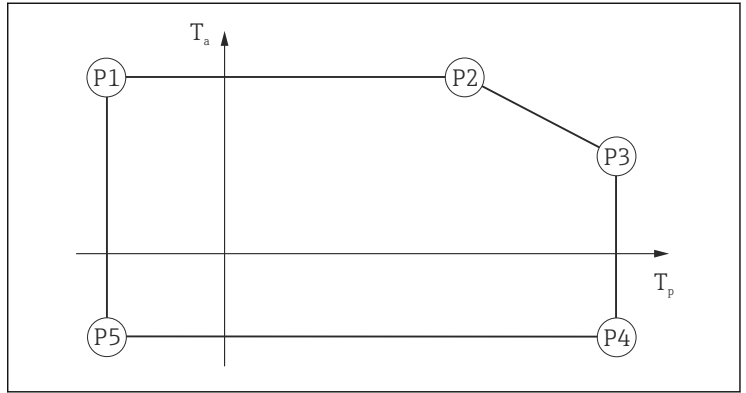

A0033052

2

NMR81

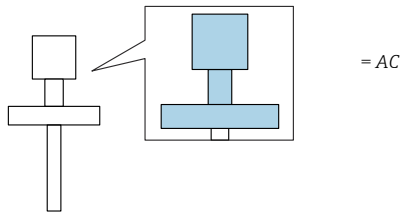

1		P1		P2		P3		P4		P5	
		T _p	T _a	T _p	T _a	T _p	T _a	T _p	T _a	T _p	T _a
	T6	-40	55	55	55	85	51	85	-40	-40	-40
	T5	-40	55	55	55	100	46	100	-40	-40	-40
	T4	-40	55	55	55	135	50	135	-40	-40	-40
	T3...T1	-40	55	55	55	200	47	200	-40	-40	-40

2		P1		P2		P3		P4		P5	
		T _p	T _a	T _p	T _a	T _p	T _a	T _p	T _a	T _p	T _a
	T6	-40	60	60	60	85	51	85	-40	-40	-40
	T5	-40	60	60	60	100	46	100	-40	-40	-40
	T4	-40	60	60	60	135	58	135	-40	-40	-40
	T3...T1	-40	60	60	60	200	54	200	-40	-40	-40

3		P1		P2		P3		P4		P5	
		T _p	T _a	T _p	T _a	T _p	T _a	T _p	T _a	T _p	T _a
	T6	-40	58	58	58	85	51	85	-40	-40	-40
	T5	-40	58	58	58	100	46	100	-40	-40	-40
	T4	-40	58	58	58	135	54	135	-40	-40	-40
	T3...T1	-40	58	58	58	200	51	200	-40	-40	-40

4		P1		P2		P3		P4		P5	
		T _p	T _a	T _p	T _a	T _p	T _a	T _p	T _a	T _p	T _a
	T6	-40	60	60	60	85	51	85	-40	-40	-40
	T5	-40	60	60	60	100	46	100	-40	-40	-40
	T4	-40	60	60	60	135	56	135	-40	-40	-40
	T3...T1	-40	60	60	60	200	53	200	-40	-40	-40

5		P1		P2		P3		P4		P5	
		T _p	T _a	T _p	T _a	T _p	T _a	T _p	T _a	T _p	T _a
	T6	-40	55	55	55	85	51	85	-40	-40	-40
	T5	-40	55	55	55	100	46	100	-40	-40	-40
	T4	-40	55	55	55	135	52	135	-40	-40	-40
	T3...T1	-40	55	55	55	200	49	200	-40	-40	-40

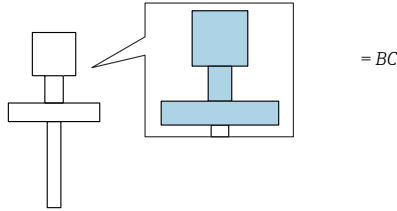

1		P1		P2		P3		P4		P5	
		T _p	T _a	T _p	T _a	T _p	T _a	T _p	T _a	T _p	T _a
	T6	-40	43	43	43	85	40	85	-40	-40	-40
	T5	-40	43	43	43	100	37	100	-40	-40	-40
	T4	-40	43	43	43	135	37	135	-40	-40	-40
	T3...T1	-40	43	43	43	200	32	200	-40	-40	-40

2		P1		P2		P3		P4		P5	
		T _p	T _a	T _p	T _a	T _p	T _a	T _p	T _a	T _p	T _a
	T6	-40	55	55	55	85	46	85	-40	-40	-40
	T5	-40	55	55	55	100	38	100	-40	-40	-40
	T4	-40	55	55	55	135	52	135	-40	-40	-40
	T3...T1	-40	55	55	55	200	46	200	-40	-40	-40

3		P1		P2		P3		P4		P5	
		T _p	T _a	T _p	T _a	T _p	T _a	T _p	T _a	T _p	T _a
	T6	-40	50	50	50	85	45	85	-40	-40	-40
	T5	-40	50	50	50	100	38	100	-40	-40	-40
	T4	-40	50	50	50	135	45	135	-40	-40	-40
	T3...T1	-40	50	50	50	200	40	200	-40	-40	-40

4		P1		P2		P3		P4		P5	
		T _p	T _a	T _p	T _a	T _p	T _a	T _p	T _a	T _p	T _a
	T6	-40	53	53	53	85	46	85	-40	-40	-40
	T5	-40	53	53	53	100	38	100	-40	-40	-40
	T4	-40	53	53	53	135	46	135	-40	-40	-40
	T3...T1	-40	53	53	53	200	43	200	-40	-40	-40

5		P1		P2		P3		P4		P5	
		T _p	T _a	T _p	T _a	T _p	T _a	T _p	T _a	T _p	T _a
	T6	-40	45	45	45	85	44	85	-40	-40	-40
	T5	-40	45	45	45	100	38	100	-40	-40	-40
	T4	-40	45	45	45	135	40	135	-40	-40	-40
	T3...T1	-40	45	45	45	200	36	200	-40	-40	-40

NMR84

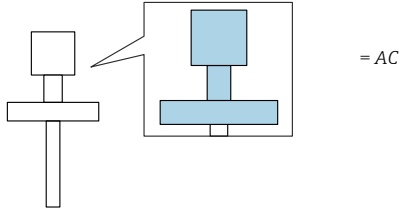

1		P1		P2		P3		P4		P5	
		T _p	T _a	T _p	T _a	T _p	T _a	T _p	T _a	T _p	T _a
	T6	-40	55	55	55	85	52	85	-40	-40	-40
	T5	-40	55	55	55	100	52	100	-40	-40	-40
	T4	-40	55	55	55	135	49	135	-40	-40	-40
	T3...T1	-40	55	55	55	150	49	150	-40	-40	-40

2		P1		P2		P3		P4		P5	
		T _p	T _a	T _p	T _a	T _p	T _a	T _p	T _a	T _p	T _a
	T6	-40	60	60	60	85	60	85	-40	-40	-40
	T5	-40	60	60	60	100	59	100	-40	-40	-40
	T4	-40	60	60	60	135	56	135	-40	-40	-40
	T3...T1	-40	60	60	60	150	56	150	-40	-40	-40

3		P1		P2		P3		P4		P5	
		T _p	T _a	T _p	T _a	T _p	T _a	T _p	T _a	T _p	T _a
	T6	-40	58	58	58	85	55	85	-40	-40	-40
	T5	-40	58	58	58	100	55	100	-40	-40	-40
	T4	-40	58	58	58	135	53	135	-40	-40	-40
	T3...T1	-40	58	58	58	150	53	150	-40	-40	-40

4		P1		P2		P3		P4		P5	
		T _p	T _a	T _p	T _a	T _p	T _a	T _p	T _a	T _p	T _a
	T6	-40	60	60	60	85	57	85	-40	-40	-40
	T5	-40	60	60	60	100	57	100	-40	-40	-40
	T4	-40	60	60	60	135	54	135	-40	-40	-40
	T3...T1	-40	60	60	60	150	54	150	-40	-40	-40

5		P1		P2		P3		P4		P5	
		T _p	T _a	T _p	T _a	T _p	T _a	T _p	T _a	T _p	T _a
	T6	-40	55	55	55	85	55	85	-40	-40	-40
	T5	-40	55	55	55	100	54	100	-40	-40	-40
	T4	-40	55	55	55	135	51	135	-40	-40	-40
	T3...T1	-40	55	55	55	150	51	150	-40	-40	-40

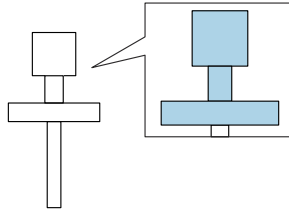

= BC

1		P1		P2		P3		P4		P5	
		T _p	T _a	T _p	T _a	T _p	T _a	T _p	T _a	T _p	T _a
	T6	-40	43	43	43	85	39	85	-40	-40	-40
	T5	-40	43	43	43	100	39	100	-40	-40	-40
	T4	-40	43	43	43	135	36	135	-40	-40	-40
	T3...T1	-40	43	43	43	150	36	150	-40	-40	-40

2		P1		P2		P3		P4		P5	
		T _p	T _a	T _p	T _a	T _p	T _a	T _p	T _a	T _p	T _a
	T6	-40	55	55	55	85	55	85	-40	-40	-40
	T5	-40	55	55	55	100	54	100	-40	-40	-40
	T4	-40	55	55	55	135	51	135	-40	-40	-40
	T3...T1	-40	55	55	55	150	51	150	-40	-40	-40

3		P1		P2		P3		P4		P5	
		T _p	T _a	T _p	T _a	T _p	T _a	T _p	T _a	T _p	T _a
	T6	-40	50	50	50	85	47	85	-40	-40	-40
	T5	-40	50	50	50	100	47	100	-40	-40	-40
	T4	-40	50	50	50	135	44	135	-40	-40	-40
	T3...T1	-40	50	50	50	150	44	150	-40	-40	-40

4		P1		P2		P3		P4		P5	
		T _p	T _a	T _p	T _a	T _p	T _a	T _p	T _a	T _p	T _a
	T6	-40	53	53	53	85	50	85	-40	-40	-40
	T5	-40	53	53	53	100	50	100	-40	-40	-40
	T4	-40	53	53	53	135	46	135	-40	-40	-40
	T3...T1	-40	53	53	53	150	46	150	-40	-40	-40

5		P1		P2		P3		P4		P5	
		T _p	T _a	T _p	T _a	T _p	T _a	T _p	T _a	T _p	T _a
	T6	-40	45	45	45	85	43	85	-40	-40	-40
	T5	-40	45	45	45	100	43	100	-40	-40	-40
	T4	-40	45	45	45	135	39	135	-40	-40	-40
	T3...T1	-40	45	45	45	150	39	150	-40	-40	-40

Connection data Connection compartment Ex db

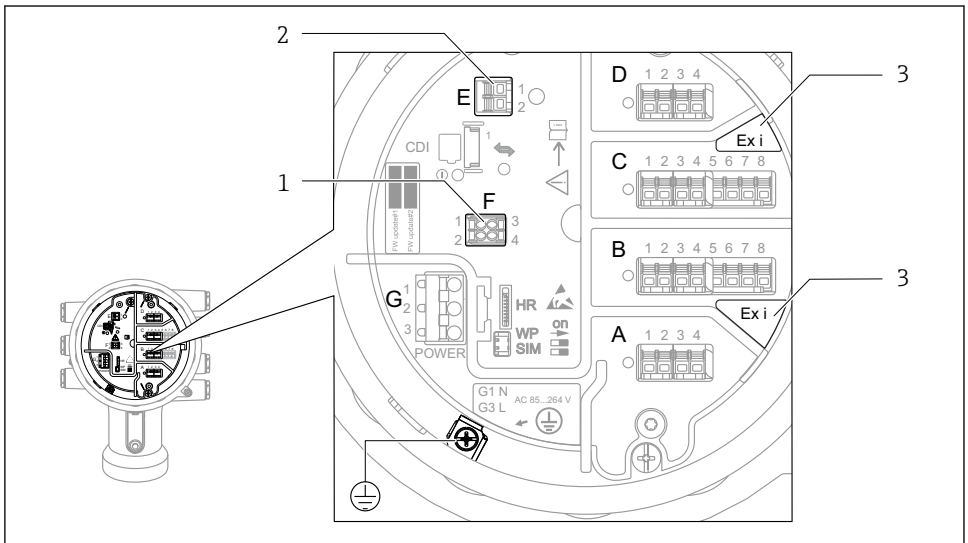

A0032010

 3

- 1 Connection for external display Ex i
- 2 Connection for HART interface Ex i
- 3 only when "Analog Ex i" installed

Detailed configuration information located at the display holder.

Example for lettering:

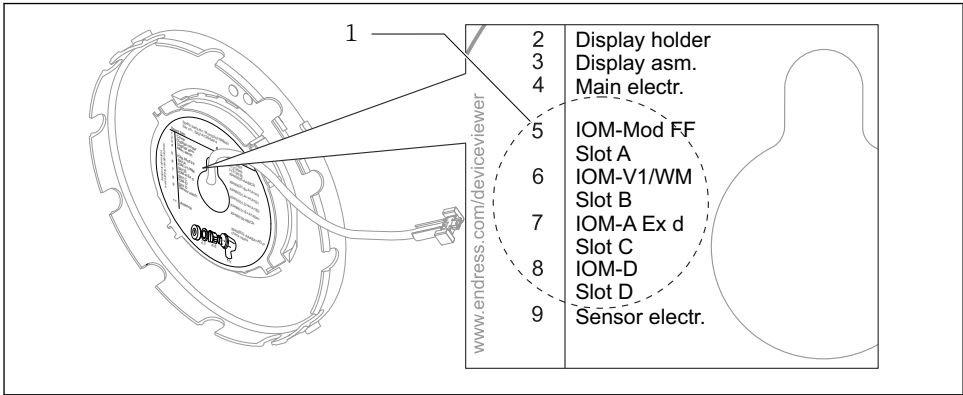

A0032011



1 Area device configuration



For detailed information see Operating Instructions.



Assignment of the terminals see designation of front plane.

TRC[01], type Power supply

Basic specification, Position 4 = B

Terminal	G	CDI
	G1: N G2: not connected G3: L	plug connected
Designation	Power / Mains	Local LCD, CDI (internal)
non-Ex (functional)	$U_N = 85 \text{ to } 264 \text{ V}_{AC}$, 50/60 Hz $P_N = 28.8 \text{ VA}$	$U_N = 3.3 \text{ V}_{DC}$ $P_N = 41 \text{ mW}$

TRC[02], type Power supply

Basic specification, Position 4 = D

Terminal	G	CDI
	G1: N G2: not connected G3: L	plug connected
Designation	Power / Mains	Local LCD, CDI (internal)
non-Ex (functional)	$U_N = 52 \text{ to } 75 \text{ V}_{AC}$, 50/60 Hz $P_N = 21.6 \text{ VA}$	$U_N = 3.3 \text{ V}_{DC}$ $P_N = 41 \text{ mW}$

TRC[03], type Power supply

Basic specification, Position 4 = E

Terminal	G	CDI
	G1: L+ G2: not connected G3: L-	plug connected
Designation	Power / Mains	Local LCD, CDI (internal)
non-Ex (functional)	$U_N = 19 \text{ to } 64 \text{ V}_{DC}$ $P_N = 13.6 \text{ W}$	$U_N = 3.3 \text{ V}_{DC}$ $P_N = 41 \text{ mW}$

TRC[10], type Main board

Terminal	E	F
	E1: H+ E2: H-	F1: Vcc F2: A F3: B F4: gnd
Designation	4-20 mA HART	Remote display
Ex [ia]	$U_o = 29 \text{ V}$ $I_o = 110 \text{ mA}$ $P_o = 700 \text{ mW}$ $C_o = 65 \text{ nF}$ $L_o = 2.9 \text{ mH}$	$U_o = 3.9 \text{ V}$ $I_o = 500 \text{ mA}$ $P_o = 230 \text{ mW}$ $C_o = 99 \text{ }\mu\text{F}$ $L_o = 140 \text{ }\mu\text{H}$
non-Ex (functional)	$U_N = 24 \text{ V}_{DC}$ $P_N \leq 426 \text{ mW}$	$U_N = 3.3 \text{ V}_{DC}$ $P_N = 41 \text{ mW}$

TRC[32], type "Modbus" module; optional

Terminal	Slot A through slot D	
	1: S Cable shielding; capacitive connected to earth 2: 0V Common reference 3: B- Non-inverting signal line 4: A+ Inverting signal line	
Designation	Modbus-Slave	FOUNDATION Fieldbus
non-Ex (functional)	$U_N = 12 V_{DC}$ $P_N \leq 12 \text{ mW}$ $U_M = 250 \text{ V}$	Currently not supported

TRC[33], type "V1" module; optional

Terminal	Slot A through slot D	
	1: S Cable shielding; capacitive connected to earth 2: not connected 3: B- Signal - 4: A+ Signal +	
Designation	V1-Slave	WM550
non-Ex (functional)	$U_N = 24 V_{DC}$ $P_N \leq 414 \text{ mW}$ $U_M = 250 \text{ V}$	Currently not supported

TRC[20], type "Analog module" (Ex i); 4-20 mA HART; optional

Terminal	Slot B or slot C	
Operation mode: <ul style="list-style-type: none"> ■ 4 to 20 mA output or HART slave + 4 to 20 mA output or ■ 4 to 20 mA input or HART master + 4 to 20 mA input or ■ HART master 	4-wire RTD connection: Terminal 5 through 8	Terminal active use: 2: H- 3: H+
	3-wire RTD connection: Terminal 5, 6 and 8	Terminal passive use: 1: H- 2: H+
Designation	24 V + RTD	4-20 mA HART
Ex [ia]	Terminals 4-5 (24 V): $U_o = 29\text{ V}$ $I_o = 108\text{ mA}$ $P_o = 776\text{ mW}$ $C_o = 63\text{ nF}$ $L_o = 3.0\text{ mH}$	Terminals 2-3 (Active): $U_o = 29\text{ V}$ $I_o = 106\text{ mA}$ $P_o = 760\text{ mW}$ $C_o = 63\text{ nF}$ $L_o = 3.1\text{ mH}$
	Terminals 5-8 (RTD): $U_o = 29\text{ V}$ $I_o = 36\text{ mA}$ $P_o = 263\text{ mW}$ $C_o = 64\text{ nF}$ $L_o = 26\text{ mH}$	Terminals 1-2 (Passive): $U_i = 29\text{ V}$ $I_i = 106\text{ mA}$ $P_i = 760\text{ mW}$ $C_i = 11\text{ nF}$ $L_i = 0$
non-Ex (functional)	Terminals 4-5 (24 V): $U_N = 24\text{ V}_{DC}$ $P_N \leq 600\text{ mW}$	Terminals 2-3 (Active): $U_N = 24\text{ V}_{DC}$ $P_N \leq 540\text{ mW}$
	Terminals 5-8 (RTD): $I_N = 400\text{ }\mu\text{A}_{DC}$ $P_N \leq 160\text{ }\mu\text{W}$	Terminals 1-2 (Passive): $U_N = 29\text{ V}_{DC}$ $P_N \leq 653\text{ mW}$

TRC[21], type "Analog module" (Ex d); 4-20 mA HART; optional

Terminal	Slot B or slot C	
Operation mode: <ul style="list-style-type: none"> ▪ 4 to 20 mA output or HART slave + 4 to 20 mA output or ▪ 4 to 20 mA input or HART master + 4 to 20 mA input or ▪ HART master 	4-wire RTD connection: Terminal 5 through 8 3-wire RTD connection: Terminal 5, 6 and 8 2-wire RTD connection: Terminal 5 and 8	Terminal active use: 2: H- 3: H+ Terminal passive use: 1: H- 2: H+
Designation	24 V + RTD	4-20 mA HART
non-Ex (functional)	Terminals 4-5 (24 V): not used	Terminals 2-3 (Active): $U_N = 24 V_{DC}$ $P_N \leq 540 mW$ $U_M = 250 V$
	Terminals 5-8 (RTD): $I_N = 400 \mu A_{DC}$ $P_N \leq 160 \mu W$ $U_M = 250 V$	Terminals 1-2 (Passive): $U_N = 29 V_{DC}$ $P_N \leq 653 mW$ $U_M = 250 V$

TRC[31], type "Digital"; optional

Terminal	Slot A through slot D	
Operation mode: <ul style="list-style-type: none"> ▪ disabled ▪ passive output ▪ passive input ▪ active input 	Installed in slot A: 1: A1-1 2: A1-2 3: A2-1 4: A2-2	
	Installed in slot B: 1: B1-1 2: B1-2 3: B2-1 4: B2-2	
	Installed in slot C: 1: C1-1 2: C1-2 3: C2-1 4: C2-2	
	Installed in slot D: 1: D1-1 2: D1-2 3: D2-1 4: D2-2	
Designation	Relay / Digital Input/Output 1	Relay / Digital Input/Output 2
non-Ex (functional)	Relay: $U_N = 250 V_{AC/DC}$ $I_N \leq 2 A$	Relay: $U_N = 250 V_{AC/DC}$ $I_N \leq 2 A$
	Digital Input: $U_N = 5 \text{ to } 230 V_{AC/DC}$ $U_M = 250 V$	Digital Input: $U_N = 5 \text{ to } 230 V_{AC/DC}$ $U_M = 250 V$



71547856

www.addresses.endress.com
