

Safety Instructions

Levelflex FMP50-FMP55

PROFIBUS PA, FOUNDATION Fieldbus

0/1 Ex ia IIC T6...T1 Ga/Gb X

0/1 Ex ia/db [ia Ga] IIC T6...T1 Ga/Gb X



Levelflex FMP50-FMP55

PROFIBUS PA, FOUNDATION Fieldbus

Table of contents

About this document	4
Associated documentation	4
Supplementary documentation	4
General notes: Combined approval	4
Manufacturer's certificates	5
Manufacturer address	5
Extended order code	5
Safety instructions: General	9
Safety instructions: Special conditions	9
Safety instructions: Installation	10
Safety instructions: Zone 0	15
Temperature tables	15
Connection data	17

About this document

This document has been translated into several languages. Legally determined is solely the English source text.

Associated documentation

This document is an integral part of the following Operating Instructions:

PROFIBUS PA

- BA01005F/00 (FMP50)
- BA01006F/00 (FMP51, FMP52, FMP54)
- BA01007F/00 (FMP53)
- BA01008F/00 (FMP55)

FOUNDATION Fieldbus

- BA01051F/00 (FMP50)
- BA01052F/00 (FMP51, FMP52, FMP54)
- BA01053F/00 (FMP53)
- BA01054F/00 (FMP55)

Supplementary documentation

Explosion protection brochure: CP00021Z

The Explosion-protection brochure is available:

- In the download area of the Endress+Hauser website:
www.endress.com -> Downloads -> Brochures and Catalogs -> Text Search: CP00021Z
- On the CD for devices with CD-based documentation

**General notes:
Combined approval**

The device is suitable for installation with explosion protection "Intrinsic safety Ex ia" or "Flameproof enclosure Ex db".

- Before initial commissioning, specify the type of protection.
- It is not permitted to change the type of protection after initial commissioning as this can jeopardize the explosion protection.

For aluminum enclosures:

Void out the explosion protection that is not used on the nameplate.

For stainless steel enclosures:

Using a striking tool, mark the explosion protection used, or void out the explosion protection that is not used.

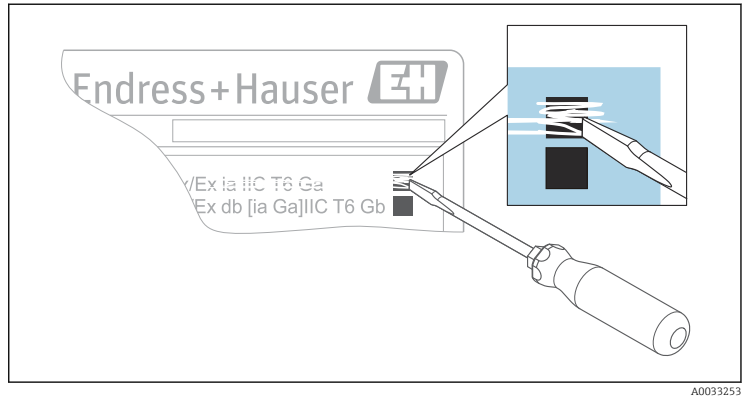

-  Depending on the type of protection used: Observe the safety instructions for installation with explosion protection "Intrinsic safety Ex ia" or "Flameproof enclosure Ex db".

Manufacturer's certificates

Certificate of Conformity TP TC 012/2011

Inspection authority:
LLC NANIO CCVE (ООО «НАНИО ЦСВЭ»)

Certificate number:
EAЭC RU C-DE.AA87.B.00973/22

Affixing the certificate number certifies conformity with the following standards (depending on the device version):

- GOST 31610.0-2014 (IEC 60079-0:2011)
- GOST IEC 60079-1-2013
- GOST 31610.11-2014 (IEC 60079-11:2011)
- GOST 31610.26-2016/IEC 60079-26:2014

Manufacturer address

Endress+Hauser SE+Co. KG
Hauptstraße 1
79689 Maulburg, Germany
Address of the manufacturing plant: See nameplate.

Extended order code

The extended order code is indicated on the nameplate, which is affixed to the device in such a way that it is clearly visible. Additional

information about the nameplate is provided in the associated Operating Instructions.

Structure of the extended order code

FMP5x	-	*****	+	A*B*C*D*E*F*G*..
<i>(Device type)</i>		<i>(Basic specifications)</i>		<i>(Optional specifications)</i>

* = Placeholder

At this position, an option (number or letter) selected from the specification is displayed instead of the placeholders.

Basic specifications

The features that are absolutely essential for the device (mandatory features) are specified in the basic specifications. The number of positions depends on the number of features available. The selected option of a feature can consist of several positions.

Optional specifications

The optional specifications describe additional features for the device (optional features). The number of positions depends on the number of features available. The features have a 2-digit structure to aid identification (e.g. JA). The first digit (ID) stands for the feature group and consists of a number or a letter (e.g. J = Test, Certificate). The second digit constitutes the value that stands for the feature within the group (e.g. A = 3.1 material (wetted parts), inspection certificate).

More detailed information about the device is provided in the following tables. These tables describe the individual positions and IDs in the extended order code which are relevant to hazardous locations.

Extended order code: Levelflex



The following specifications reproduce an extract from the product structure and are used to assign:

- This documentation to the device (using the extended order code on the nameplate).
- The device options cited in the document.

Device type

FMP50, FMP51, FMP52, FMP53, FMP54, FMP55

Basic specifications

Position 1, 2 (Approval)		
Selected option		Description
FMP5x	G4	EAC 0/1 Ex ia IIC T6...T1 Ga/Gb X EAC 0/1 Ex ia/db [ia Ga] IIC T6...T1 Ga/Gb X

Position 3 (Power Supply, Output)		
Selected option		Description
FMP5x	E	2-wire, FOUNDATION Fieldbus, switch output (PFS)
	G	2-wire, PROFIBUS PA, switch output (PFS)

Position 4 (Display, Operation)		
Selected option		Description
FMP5x	A	Without, via communication
	C	SD02, 4-line, push buttons + data backup function
	E	SD03, 4-line, illum., touch control + data backup function
	L	Prepared for display FHX50 + M12 connection
	M	Prepared for display FHX50 + custom connection
	N	Prepared for display FHX50 + NPT1/2"

Position 5 (Housing)		
Selected option		Description
FMP51 FMP52 FMP54 FMP55	B	GT18 dual compartment, 316L
FMP5x	C	GT20 dual compartment, Alu coated

Position 9, 10 (Seal)		
Selected option		Description
FMP50	A1	Viton, -20...80 °C
FMP51	A4	Viton, -30...150 °C
	B3	EPDM, -40...120 °C
	C3	Kalrez, -20...200 °C
	E1	FVMQ, -50...150 °C

Position 9, 10 (Seal)		
Selected option		Description
FMP53	AD	FKM, FDA, USP Cl. VI, -10...150 °C
	B5	EPDM, FDA, USP Cl. VI, -20...130 °C
	C4	Kalrez, FDA, USP Cl. VI, -20...150 °C
FMP54	D1	Graphite, -196...280 °C (XT)
	D2	Graphite, -196...450 °C (HT)

 Shown in the temperature tables exemplary as follows:

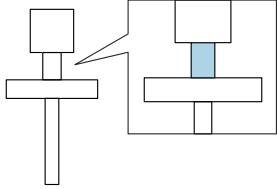

Optional specifications

ID Jx (Test, Certificate)		
Selected option		Description
FMP51 ¹⁾ FMP54	JN	Ambient temperature transmitter -50 °C

1) Only in connection with Position 9, 10 = E1

ID Mx (Probe Design)		
Selected option		Description
FMP5x	MB	Sensor remote, 3 m/9 ft cable, detachable + mounting bracket
FMP53	MA	Sensor compact, detachable
FMP50-54	MC	Sensor remote, 6 m/18 ft cable, detachable + mounting bracket
	MD	Sensor remote, 9 m/27 ft cable, detachable + mounting bracket

ID Nx, Ox (Accessory Mounted)		
Selected option		Description
FMP51 FMP52 FMP55	NC	Gas-tight feed through

Safety instructions:
General

- Staff must meet the following conditions for mounting, electrical installation, commissioning and maintenance of the device:
 - Be suitably qualified for their role and the tasks they perform
 - Be trained in explosion protection
 - Be familiar with national regulations
- Install the device according to the manufacturer's instructions and national regulations.
- Do not operate the device outside the specified electrical, thermal and mechanical parameters.
- Only use the device in media to which the wetted materials have sufficient durability.
- Avoid electrostatic charging:
 - Of plastic surfaces (e.g. enclosure, sensor element, special varnishing, attached additional plates, ..)
 - Of isolated capacities (e.g. isolated metallic plates)
- Alterations to the device can affect the explosion protection and must be carried out by staff authorized to perform such work by Endress+Hauser.
- Refer to the temperature tables for the relationship between the permitted ambient temperature for the sensor and/or transmitter, depending on the range of application and the temperature class.
- When replacing the probe electronics or opening the connection between the remote cable and the probe, a jumper plug must be used or a short-circuit must be established between the probe contact and the potential equalization conductor to avoid electrostatically charging the probe.

Safety instructions:
Special conditions

Permitted ambient temperature range at the electronics enclosure:
 $-40\text{ °C} \leq T_a \leq +80\text{ °C}$

Optional specification, ID Jx = JN

Permitted ambient temperature range at the electronics enclosure:
 $-50\text{ °C} \leq T_a \leq +80\text{ °C}$

- Observe the information in the temperature tables.
- In the case of process connections made of polymeric material or with polymeric coatings, avoid electrostatic charging of the plastic surfaces.
- To avoid electrostatic charging: Do not rub surfaces with a dry cloth.
- In the event of additional or alternative special varnishing on the enclosure or other metal parts or for adhesive plates:
 - Observe the danger of electrostatic charging and discharge.
 - Do not install in the vicinity of processes ($\leq 0.5\text{ m}$) generating strong electrostatic charges.
- Secure probes against swinging: e.g. by fixing them to the wall or floor or by installing them in the ground tube.

Device type FMP52, FMP55 and Device type FMP5x with non-conductive plastic coated probes

A probe coated with non-conductive material can be used if avoiding electrostatic charging (e.g. through friction, cleaning, maintenance, strong medium flow).

Safety instructions: Installation



Explosion protection "Intrinsic safety Ex ia"

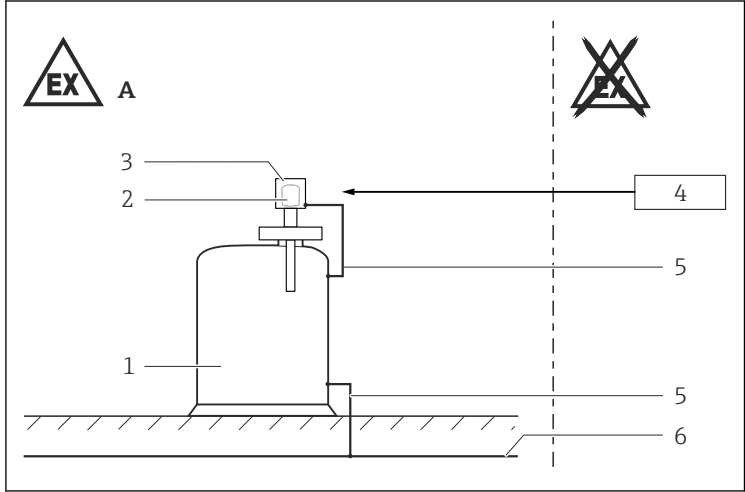

A0025536

- A Zone 1
 1 Tank; Zone 0, Zone 1
 2 Electronic insert
 3 Enclosure
 4 Certified associated apparatus
 5 Potential equalization line
 6 Potential equalization

- After aligning (rotating) the enclosure, retighten the fixing screw (see Operating Instructions).
- Install the device to exclude any mechanical damage or friction during the application. Pay particular attention to flow conditions and tank fittings.
- Continuous service temperature of the connecting cable: -40 °C to $\geq +85\text{ °C}$; in accordance with the range of service temperature taking into account additional influences of the process conditions ($T_{a,\min}$), ($T_{a,\max} + 20\text{ K}$).

Optional specification, ID Jx = JN

Continuous service temperature of the connecting cable:

-50 °C to $\geq +85\text{ °C}$; in accordance with the range of service temperature

taking into account additional influences of the process conditions ($T_{a,\min}$), ($T_{a,\max} + 20$ K).

Basic specification, Position 4 = N

Observe the requirements according to IEC/EN 60079-14 for conduit systems and the wiring- and installation instructions of the suitable Safety Instructions (XA). In addition, observe national regulations and standards for conduit systems.

Intrinsic safety

- The device is only suitable for connection to certified, intrinsically safe equipment with explosion protection Ex ia / Ex ib.
- The intrinsically safe input power circuit of the device is isolated from ground. If the device is only equipped with one input, the dielectric strength of the input is at least $500 V_{\text{rms}}$. If the device is equipped with more than one input, the dielectric strength of each individual input to ground is at least $500 V_{\text{rms}}$, and the dielectric strength of the inputs vis-à-vis one another is also at least $500 V_{\text{rms}}$.
- Observe the pertinent guidelines when interconnecting intrinsically safe circuits.
- The device can be connected to the Endress+Hauser FXA291 service tool: refer to the Operating Instructions and specifications in the "Overvoltage protection" chapter.
- When the intrinsically safe Ex ia circuits of the device are connected to certified intrinsically safe circuits of Category Ex ib for Equipment Groups IIC or IIB, the type of protection changes to Ex ib [ia] IIC or Ex ib [ia] IIB. Regardless of the power supply, all the internal circuits correspond to Ex ia IIC type of protection (e.g. service interface, external display, sensor).

Potential equalization

- Integrate the device into the local potential equalization.
- Grounding the screen, see the following figure.

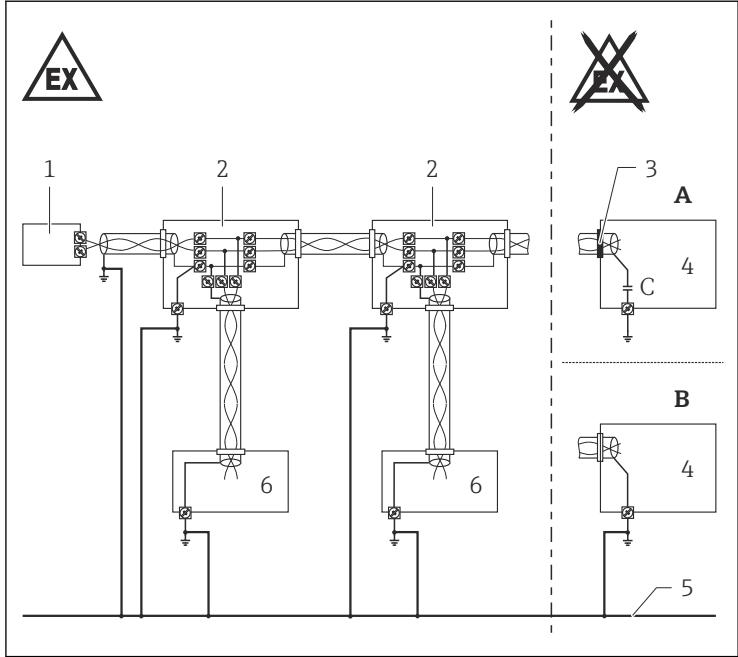

A0022352

- A Version 1: Use small capacitors (e.g. 1 nF, 1 500 V dielectric strength, ceramic). Total capacitance connected to the screen may not exceed 10 nF.
- B Version 2
- 1 Terminating resistor
 - 2 Distributor/T box
 - 3 Screen insulated
 - 4 Supply unit/Segment coupler
 - 5 Potential equalization (secured in high degree)
 - 6 Field device

Overvoltage protection

- If an overvoltage protection against atmospheric over voltages is required: no other circuits may leave the enclosure during normal operation without additional measures.
- For installations which require overvoltage protection to comply with national regulations or standards, install the device using overvoltage protection (e.g. HAW56x from Endress+Hauser).
- Observe the safety instructions of the overvoltage protection.



Explosion protection "Flameproof enclosure Ex db"

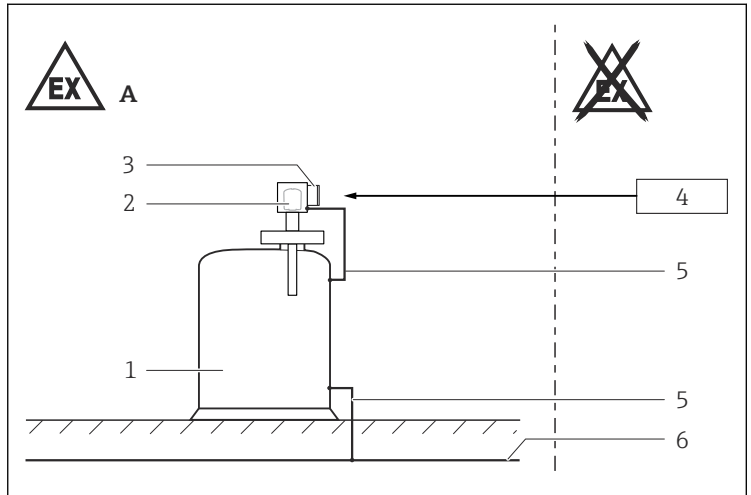

A0025537

- A Zone 1
- 1 Tank; Zone 0, Zone 1
- 2 Electronics compartment Ex ia; Electronic insert
- 3 Connection compartment Ex db
- 4 Power supply
- 5 Potential equalization line
- 6 Potential equalization

- After aligning (rotating) the enclosure, retighten the fixing screw (see Operating Instructions).
- Install the device to exclude any mechanical damage or friction during the application. Pay particular attention to flow conditions and tank fittings.
- In potentially explosive atmospheres:
 - Do not disconnect the electrical connection of the power supply circuit when energized.
 - Do not open the connection compartment cover.
- Only use certified cable entries suitable for the application. Observe national regulations and standards. Accordingly, the connection terminal does not include any ignition sources.
- When operating the transmitter enclosure at an ambient temperature under $-20\text{ }^{\circ}\text{C}$, use appropriate cables and cable entries permitted for this application.
- When connecting through a conduit entry approved for this purpose, mount the associated sealing unit directly at the enclosure.

- Seal unused entry glands with approved sealing plugs that correspond to the type of protection. The plastic transport sealing plug does not meet this requirement and must therefore be replaced during installation.
- Before operation:
 - Screw in the cover all the way.
 - Tighten the securing clamp on the cover.
- Continuous service temperature of the connecting cable:
–40 °C to $\geq +85$ °C; in accordance with the range of service temperature taking into account additional influences of the process conditions ($T_{a,min}$), ($T_{a,max} + 20$ K).
- Flameproof equipment with G threaded entry holes is not intended for new installations but only for replacement of equipment in existing installations. Application of this equipment shall comply with the local installation requirements.

Optional specification, ID Jx = JN

Continuous service temperature of the connecting cable:

–50 °C to $\geq +85$ °C; in accordance with the range of service temperature taking into account additional influences of the process conditions ($T_{a,min}$), ($T_{a,max} + 20$ K).

Basic specification, Position 4 = N

Observe the requirements according to IEC/EN 60079-14 for conduit systems and the wiring- and installation instructions of the suitable Safety Instructions (XA). In addition, observe national regulations and standards for conduit systems.

Intrinsic safety

The device can be connected to the Endress+Hauser FXA291 service tool: refer to the Operating Instructions.

Potential equalization

Integrate the device into the local potential equalization.

Safety instructions:

Zone 0



Explosion protection "Intrinsic safety Ex ia"

- In the event of potentially explosive vapor/air mixtures, only operate the device under atmospheric conditions.
 - Temperature: -20 to +60 °C
 - Pressure: 80 to 110 kPa (0.8 to 1.1 bar)
 - Air with normal oxygen content, usually 21 % (V/V)
- If no potentially explosive mixtures are present, or if additional protective measures have been taken, the device may also be operated under non-atmospheric conditions in accordance with the manufacturer's specifications.
- Associated devices with galvanic isolation between the intrinsically safe and non-intrinsically safe circuits are preferred.
- If there is a risk of dangerous potential differences within Zone 0 (e.g. through the occurrence of atmospheric electricity), implement suitable measures for intrinsically safe circuits in Zone 0.



Explosion protection "Flameproof enclosure Ex db"

- In the event of potentially explosive vapor/air mixtures, only operate the device under atmospheric conditions.
 - Temperature: -20 to +60 °C
 - Pressure: 80 to 110 kPa (0.8 to 1.1 bar)
 - Air with normal oxygen content, usually 21 % (V/V)
- If no potentially explosive mixtures are present, or if additional protective measures have been taken, the device may also be operated under non-atmospheric conditions in accordance with the manufacturer's specifications.

Temperature tables

→ Safety Instructions: XA02257F/00



The Safety Instructions for temperature tables are available:
 In the download area of the Endress+Hauser website:
www.endress.com -> Downloads ->
 Manuals and Datasheets ->
 Type: Ex Safety Instructions (XA) -> Text Search: ...



Observe the permitted temperature range at the probe.



Basic specification, Position 3 = E, G

Deratings are based on a power consumption of 1 W (PFS);
 → 18.

Explanation of how to use the temperature tables

i Unless otherwise indicated, the positions always refer to the basic specification.

1st column: Position 5 = A, B, ...

2nd column: Position 3 = A, B, ..

- (1): 1 channel used
- (2): 2 channels used

3rd column: Temperature classes T6 (85 °C) to T1 (450 °C)

Column P1 to P6: Position (temperature value) on the axes of the derating

- T_a: Ambient temperature in °C
- T_p: Process temperature in °C

i Column P6 is only relevant for version B of the derating.

Example table

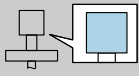
 = C	(1)	P1		P2		P3		P4		P5		P6		
		T _p	T _a	T _p	T _a	T _p	T _a	T _p	T _a	T _p	T _a	T _p	T _a	
	E, G	T6	-40	60	60	60	85	54	85	-40	-40	-40	-	-
		T5	-40	75	75	75	100	69	100	-40	-40	-40	-	-
		T4	-40	80	80	80	135	72	135	-40	-40	-40	-	-

Example diagrams of possible deratings

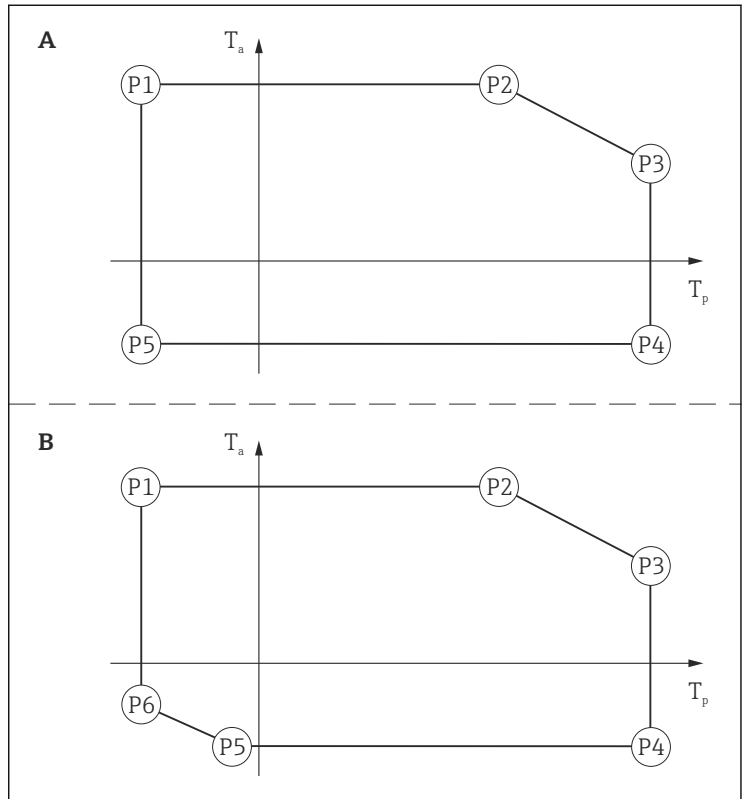

A0022717

Connection data

Ex ia



Explosion protection "Intrinsic safety Ex ia"

Power supply and signal circuit with protection type: intrinsic safety
Ex ia IIC, Ex ia IIB.

Basic specification, Position 3 = E, G

Terminal 1 (+), 2 (-)		Terminal 3 (+), 4 (-)
FISCO	Entity	Switch output (PFS)
$U_i = 17.5 \text{ V}$	$U_i = 30 \text{ V}$	$U_i = 30 \text{ V}$
$I_i = 550 \text{ mA}$	$I_i = 300 \text{ mA}$	$I_i = 300 \text{ mA}$
$P_i = 5.5 \text{ W}$	$P_i = 1.2 \text{ W}$	$P_i = 1 \text{ W}$
effective inner inductance $L_i = 10 \text{ } \mu\text{H}$		effective inner inductance $L_i = 0$
effective inner capacitance $C_i = 5 \text{ nF}$		effective inner capacitance $C_i = 6 \text{ nF}$

Service interface (CDI)

Taking the following values into consideration, the device can be connected to the certified Endress+Hauser FXA291 service tool or a similar interface:

Service interface													
$U_i = 7.3 \text{ V}$ effective inner inductance $L_i = \text{negligible}$ effective inner capacitance $C_i = \text{negligible}$													
$U_o = 7.3 \text{ V}$ $I_o = 100 \text{ mA}$ $P_o = 160 \text{ mW}$													
$L_o \text{ (mH)} =$	5.00	2.00	1.00	0.50	0.20	0.15	0.10	0.05	0.02	0.01	0.005	0.002	0.001
$C_o \text{ (}\mu\text{F)}^{1) =}$	0.73	1.20	1.60	2.00	2.60	-	3.20	4.00	5.50	7.30	10.00	12.70	12.70
$C_o \text{ (}\mu\text{F)}^{2) =}$	-	0.49	0.90	1.40	-	2.00	-	-	-	-	-	-	-

- 1) Values according to PTB "ispark" program
- 2) Values according to IEC/EN 60079-25, Annex C or equivalent national standards

Connection compartment Ex db

Explosion protection "Flameproof enclosure Ex db"

Basic specification, Position 3 = E, G

The power consumption of I/O modules with passive PFS output can be limited for certain applications.

- Recommended: Power consumption = 1 W. This is obtained for a supply voltage at the terminals of 27 V_{DC} .
- For higher supply voltages (U_{max}): Insert a serial resistance (R_V) in order to limit the power consumption, see table below.

Table for the PFS serial resistance (R_V):

Power consumption	1.0 W
Total power consumption	1.88 W
Internal resistance R_i	760 Ω

U_{max} [V]	R_V min
35	205 Ω
34	177 Ω
33	150 Ω
32	122 Ω
31	95 Ω
30	67 Ω
29	39 Ω
28	12 Ω
27	0 Ω



For values associated with a higher or lower internal power consumption please contact Endress+Hauser.

Terminal 1 (+), 2 (-)	Terminal 3 (+), 4 (-)
Power supply $U_N = 32 V_{DC}$ $U_m = 250 V$	Switch output (PFS) $U_N = 35 V_{DC}$ $U_m = 250 V$

Electronics compartment Ex ia

Service interface (CDI)

Taking the following values into consideration, the device can be connected to the certified Endress+Hauser FXA291 service tool or a similar interface:

Service interface													
$U_i = 7.3 \text{ V}$ effective inner inductance $L_i = \text{negligible}$ effective inner capacitance $C_i = \text{negligible}$													
$U_o = 7.3 \text{ V}$ $I_o = 100 \text{ mA}$ $P_o = 160 \text{ mW}$													
$L_o \text{ (mH)} =$	5.00	2.00	1.00	0.50	0.20	0.15	0.10	0.05	0.02	0.01	0.005	0.002	0.001
$C_o \text{ (}\mu\text{F)}^{1) =}$	0.73	1.20	1.60	2.00	2.60	-	3.20	4.00	5.50	7.30	10.00	12.70	12.70
$C_o \text{ (}\mu\text{F)}^{2) =}$	-	0.49	0.90	1.40	-	2.00	-	-	-	-	-	-	-

- 1) Values according to PTB "ispark" program
- 2) Values according to IEC/EN 60079-25, Annex C or equivalent national standards



71587305

www.addresses.endress.com
