

专用文档 显示单元 A400/A401/A402/ A406/A407

带 Bluetooth 蓝牙接口的显示单元

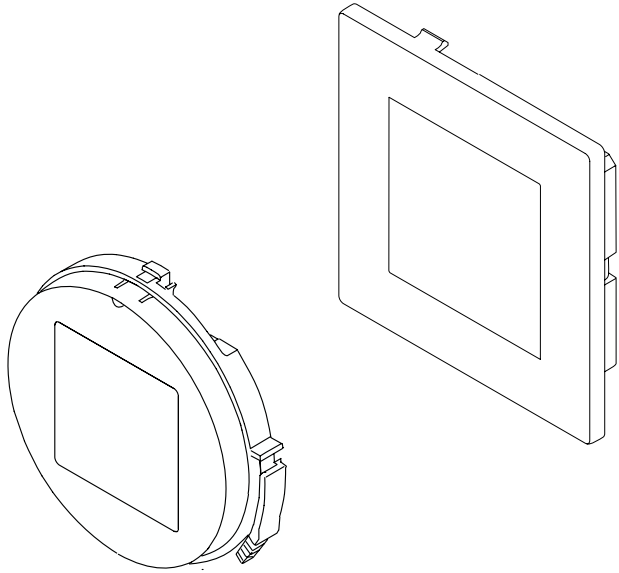

1 文档信息

1.1 文档功能



本文档是《操作手册》的组成部分，可在使用带 Bluetooth 蓝牙接口的显示单元时作为参考。

支持的变送器

- Proline 10
- Proline 800
- ICP-MS
- ICP-OES
- multiEA
- APU
- AAS
- TOC
- multiX

1.2 信息图标

1.2.1 特定信息图标

图标	说明
	提示 附加信息。
	提示信息或重要分步操作

1.3 补充文档资料

 相关技术文档范围概览，请参考 W@M 设备浏览器：

www.endress.com/deviceviewer

- ▶ 输入带蓝牙接口的显示单元所连接的设备铭牌上的序列号。

2 符合性声明

显示单元 A400/A401/A402/A406/A407 符合所有适用的 EC 准则。

3 产品描述

带 Bluetooth 蓝牙接口的显示单元允许通过 SmartBlue app 无线访问测量设备。

 带 Bluetooth 蓝牙接口的显示单元仅可连接配套专用测量设备。

4 技术参数

功能	低功耗蓝牙 (BLE)
范围	典型值: 10 m (32 ft)

5 无线电认证

5.1 巴西

5.1.1 A400、A401、A402

 <p>A0039074</p> <p>06101-21-07311</p>	<p>Este equipamento não tem direito à proteção contra interferência prejudicial e não pode causar interferência em sistemas devidamente autorizados.</p> <p>Para maiores informações, consulte o site da ANATEL www.gov.br/anatel/pt-br</p>
---	---

5.1.2 A406、A407

 <p>A0039074</p> <p>06065-21-07311</p>	<p>Este equipamento não tem direito à proteção contra interferência prejudicial e não pode causar interferência em sistemas devidamente autorizados.</p> <p>Para maiores informações, consulte o site da ANATEL www.gov.br/anatel/pt-br</p>
---	---

5.2 欧洲

设备符合欧盟无线电设备指令 RED 2014/53 的要求:

5.3 印度尼西亚

A400	A401	A402
72762/SDPPI/2021 4962	72761/SDPPI/2021 4962	72759/SDPPI/2021 4962
		
A406	A407	
72757/SDPPI/2021 4962	72756/SDPPI/2021 4962	
		

5.4 日本

Japanese Radio Law and Japanese Telecommunications Business Law Compliance.

This device is granted pursuant to the Japanese Radio Law (電波法) and the Japanese Telecommunications Business Law (電気通信事業法).

This device should not be modified (otherwise the granted designation number will become invalid).

5.5 加拿大和美国

5.5.1 English

This device complies with Part 15 of the FCC Rules and with Industry Canada licence-exempt RSS standard(s).

Operation is subject to the following two conditions:

- This device may not cause harmful interference, and
- This device must accept any interference received, including interference that may cause undesired operation.



Changes or modifications made to this equipment not expressly approved by Endress+Hauser Flowtec AG may void the to operate this equipment.



This equipment has been tested and found to comply with the limits for a Class B digital device, pursuant to Part 15 of the FCC Rules. These limits are designed to provide reasonable protection against harmful interference in a residential installation. This equipment generates, uses and can radiate radio frequency energy and, if not installed and used in accordance with the instructions, may cause harmful interference to radio communications. However, there is no guarantee that interference will not occur in a particular installation. If this equipment does cause harmful interference to radio or television reception, which can be determined by turning the equipment off and on, the user is encouraged to try to correct the interference by one or more of the following measures:

- Reorient or relocate the receiving antenna.
- Increase the separation between the equipment and receiver.
- Connect the equipment into an outlet on a circuit different from that to which the receiver is connected.
- Consult the dealer or an experienced radio/TV technician for help.



Radiofrequency radiation exposure information

This equipment complies with FCC and IC radiation exposure limits set forth for an uncontrolled environment. This equipment should be installed and operated with minimum distance of 20 cm between the radiator and your body.

This transmitter must not be co-located or operating in conjunction with any other antenna or transmitter.

5.5.2 Français

Le présent appareil est conforme aux CNR d'industrie Canada applicables aux appareils radio exempts de licence.

L'exploitation est autorisée aux deux conditions suivantes :

- L'appareil ne doit pas produire de brouillage, et
- L'utilisateur de l'appareil doit accepter tout brouillage radioélectrique subi, même si le brouillage est susceptible d'en compromettre le fonctionnement.

 Les changements ou modifications apportés à cet appareil non expressément approuvés par Endress+Hauser Flowtec AG peuvent annuler cet appareil.



Déclaration d'exposition aux radiations

Cet équipement est conforme aux limites d'exposition aux rayonnements IC établies pour un environnement non contrôlé. Cet équipement doit être installé et utilisé avec un minimum de 20 cm de distance entre la source de rayonnement et votre corps.

Ce transmetteur ne doit pas être placé au même endroit ou utilisé simultanément avec un autre transmetteur ou antenne.

5.6 墨西哥

La operación de este equipo está sujeta a las siguientes dos condiciones: (1) es posible que este equipo o dispositivo no cause interferencia perjudicial y (2) este equipo o dispositivo debe aceptar cualquier interferencia, incluyendo la que pueda causar su operación no deseada.

 	Marca: Endress+Hauser Flowtec AG
	Modelo: A400 IFT No.: RCPENA421-0333-A1
	Modelo: A401 IFT No.: RCPENA421-0333
	Modelo: A402 IFT No.: RCPENA421-0333-A2
	Modelo: A406 IFT No.: RCPENA421-0098
A0034100	Modelo: A407 IFT No.: RCPENA421-0098-A1

5.7 阿曼

OMAN - TRA
R/12929/22
D172249

5.8 韩国

5.8.1 A400、A401、A402

	제품명(모델명): Display module (A400 / A401 / A402)
	인증번호: R-R-EHF-A401
	제조사/제조국가: Endress+Hauser Flowtec AG/스위스

5.8.2 A406、A407



제품명(모델명): Display module (A406 / A407)

인증번호: R-R-EHF-A406

제조사/제조국가: Endress+Hauser Flowtec AG/스위스

5.9 新加坡

Complies with
IMDA Standards
DA108204

5.10 泰国



เครื่องวิทยุคมนาคมนี้ ได้รับยกเว้น ไม่ต้องได้รับใบอนุญาตให้มี ใช้ซึ่งเครื่องวิทยุคมนาคมหรือตั้งสถานีวิทยุคมนาคมตามประกาศ กสทช. เรื่อง เครื่องวิทยุคมนาคม และสถานีวิทยุคมนาคมที่ได้รับยกเว้นไม่ต้องได้รับใบอนุญาตวิทยุคมนาคมตามพระราชบัญญัติวิทยุคมนาคม พ.ศ. 2498



nab. | โทรคมนาคม

กำกับดูแลเพื่อประชาชน

Call Center 1200 (InSW5)

A0048466

5.11 阿拉伯联合酋长国

	<p>TRA - United Arab Emirates</p> <p>Dealer ID: DA37063/14 TA RTTE: ER95637/21 Model: A400 Type: Bluetooth</p>	
--	--	---

A0046472

	<p>TRA - United Arab Emirates</p> <p>Dealer ID: DA37063/14 TA RTTE: ER95343/21 Model: A401 Type: Bluetooth</p>	
--	--	---

A0046473

	<p>TRA - United Arab Emirates</p> <p>Dealer ID: DA37063/14 TA RTTE: ER95638/21 Model: A402 Type: Bluetooth</p>	
--	--	---

A0046474

	<p>TRA - United Arab Emirates</p> <p>Dealer ID: DA37063/14 TA RTTE: ER95344/21 Model: A406 Type: Bluetooth</p>	
--	--	---

A0046475



A0046476

5.12 其他国家

按需提供其他国家认证。

6 适用范围

6.1 非洲

埃及	纳米比亚	留尼汪
----	------	-----

6.2 亚洲

中国	塞浦路斯	埃及
格鲁吉亚	中国香港	印度
印度尼西亚	以色列	日本
马来西亚	阿曼	卡塔尔
韩国	沙特阿拉伯	新加坡
泰国	土耳其	阿拉伯联合酋长国
越南	-	-

6.3 澳大利亚和大洋洲

美属萨摩亚	澳大利亚	密克罗尼西亚
新西兰	瓦努阿图	-

6.4 欧洲

安道尔共和国	奥地利	比利时
波斯尼亚-黑塞哥维亚	保加利亚	克罗地亚

捷克	丹麦	爱沙尼亚
芬兰	法国	德国
希腊	根西岛	匈牙利
冰岛	爱尔兰	英属马恩岛
意大利	泽西岛	科索沃
拉脱维亚	列支敦斯登	立陶宛
卢森堡	马耳他	摩纳哥
黑山共和国	荷兰	北马其顿共和国
挪威	波兰	葡萄牙
罗马尼亚	圣马力诺	斯洛伐克
斯洛文尼亚	西班牙	瑞典
瑞士	土耳其	英国
梵蒂冈城	-	-

6.5 北美洲

加拿大	瓜德罗普岛	马提尼克
墨西哥	圣巴瑟米	圣马丁岛
荷属圣马丁岛	美国	-

6.6 南美洲

阿根廷	玻利维亚	巴西
智利	哥伦比亚	法属圭亚那
秘鲁	-	-



71596215

www.addresses.endress.com
