

Brief Operating Instructions

Deltabar PMD78B

Differential pressure measurement
PROFINET with Ethernet-APL



These Brief Operating Instructions are not a substitute for the Operating Instructions pertaining to the device.

Detailed information is provided in the Operating Instructions and other documentation.

Available for all device versions via:

- Internet: www.endress.com/deviceviewer
- Smartphone/tablet: Endress+Hauser Operations app

1 Associated documentation

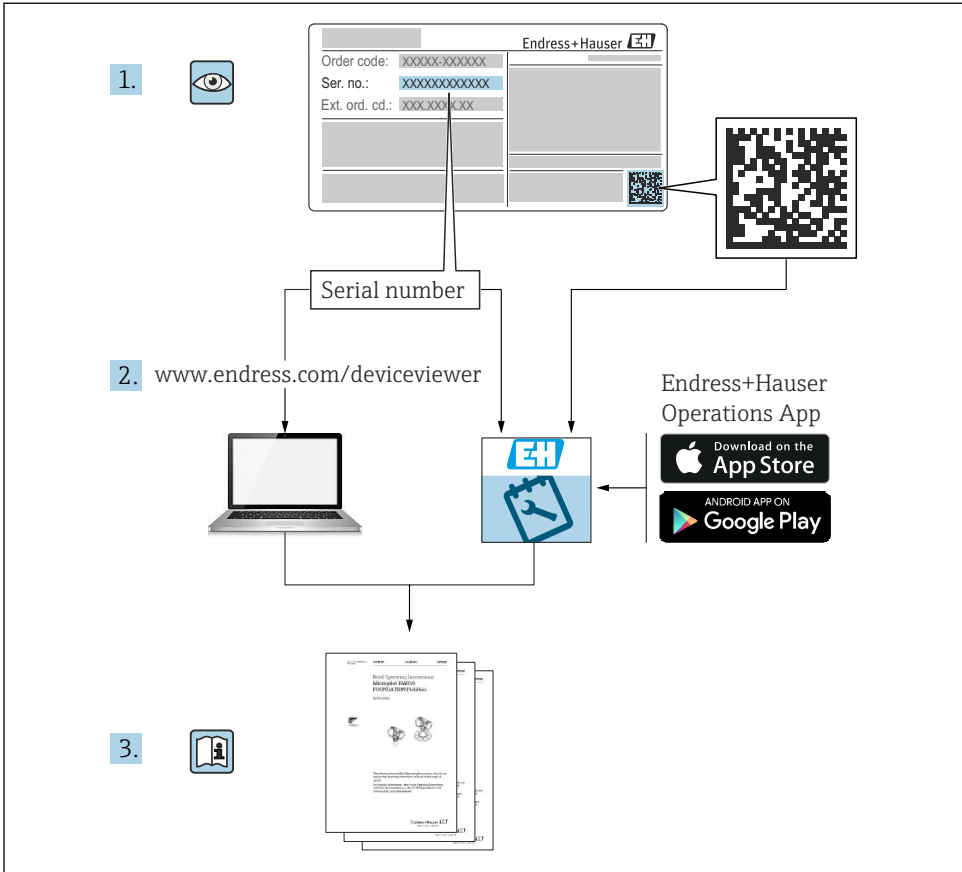

A0023555

2 About this document

2.1 Document function

The Brief Operating Instructions contain all the essential information from incoming acceptance to initial commissioning.

2.2 Symbols

2.2.1 Safety symbols

⚠ DANGER

This symbol alerts you to a dangerous situation. Failure to avoid this situation will result in serious or fatal injury.

⚠ WARNING

This symbol alerts you to a dangerous situation. Failure to avoid this situation can result in serious or fatal injury.

⚠ CAUTION

This symbol alerts you to a dangerous situation. Failure to avoid this situation can result in minor or medium injury.

NOTICE

This symbol contains information on procedures and other facts which do not result in personal injury.

2.2.2 Electrical symbols

Ground connection: \perp

Terminal for connection to the grounding system.

2.2.3 Symbols for certain types of information

Permitted: 

Procedures, processes or actions that are permitted.

Forbidden: 

Procedures, processes or actions that are forbidden.

Additional information: 

Reference to documentation: 

Reference to page: 

Series of steps: 1, 2, 3

Result of an individual step: 



2.2.4 Symbols in graphics

Item numbers: 1, 2, 3 ...

Series of steps: 1, 2, 3

Views: A, B, C, ...

2.2.5 Symbols on the device

Safety instructions:  → 

Observe the safety instructions contained in the associated Operating Instructions.

2.3 Registered trademarks

PROFINET®

Registered trademark of the PROFIBUS User Organization, Karlsruhe, Germany

3 Basic safety instructions

3.1 Requirements for the personnel

The personnel for installation, commissioning, diagnostics and maintenance must fulfill the following requirements:

- ▶ Trained, qualified specialists must have a relevant qualification for this specific function and task
- ▶ Are authorized by the plant owner/operator
- ▶ Are familiar with federal/national regulations
- ▶ Before beginning work, the specialist staff must have read and understood the instructions in the Operating Instructions and supplementary documentation as well as in the certificates (depending on the application)
- ▶ Follow instructions and comply with conditions

The operating personnel must fulfill the following requirements:

- ▶ Being instructed and authorized according to the requirements of the task by the facility's owner-operator
- ▶ Following the instructions in these Operating Instructions

3.2 Intended use

The Deltabar is a differential pressure transmitter for measuring pressure, flow, level and differential pressure.

3.2.1 Incorrect use

The manufacturer is not liable for damage caused by improper or non-intended use.

Verification for borderline cases:

- ▶ For special fluids and fluids for cleaning, Endress+Hauser is glad to provide assistance in verifying the corrosion resistance of fluid-wetted materials, but does not accept any warranty or liability.

3.3 Workplace safety

When working on and with the device:

- ▶ Wear the required personal protective equipment according to federal/national regulations.
- ▶ Switch off the supply voltage before connecting the device.

3.4 Operational safety

Risk of injury!

- ▶ Operate the device only if it is in proper technical condition, free from errors and faults.
- ▶ The operator is responsible for the interference-free operation of the device.

Modifications to the device

Unauthorized modifications to the device are not permitted and can lead to unforeseeable dangers:

- ▶ If, despite this, modifications are required, consult with Endress+Hauser.

Repair

To ensure continued operational safety and reliability:

- ▶ Carry out repairs on the device only if they are expressly permitted.
- ▶ Observe federal/national regulations pertaining to the repair of an electrical device.
- ▶ Use original spare parts and accessories from Endress+Hauser only.

Hazardous area

To eliminate the risk of danger to persons or the facility when the device is used in the approval-related area (e.g. explosion protection, pressure equipment safety):

- ▶ Check the nameplate to verify if the device ordered can be put to its intended use in the approval-related area.
- ▶ Observe the specifications in the separate supplementary documentation that is an integral part of these Instructions.

3.5 Product safety

This device is designed in accordance with good engineering practice to meet state-of-the-art safety requirements, has been tested, and left the factory in a condition in which it is safe to operate.

It meets general safety standards and legal requirements. It also complies with the EC directives listed in the device-specific EC Declaration of Conformity. Endress+Hauser confirms this by affixing the CE mark to the device.

3.6 IT security

Endress+Hauser can only provide a warranty if the device is installed and used as described in the Operating Instructions. The device is equipped with security mechanisms to protect it against any inadvertent changes to the device settings. IT security measures in line with operators' security standards and designed to provide additional protection for the device and device data transfer must be implemented by the operators themselves.

3.7 Device-specific IT security

The device offers specific functions to support protective measures by the operator. These functions can be configured by the user and guarantee greater in-operation safety if used correctly. An overview of the most important functions is provided in the following section:

- Write protection via hardware write protection switch
- Access code to change the user role (applies for operation via display, Bluetooth, or FieldCare, DeviceCare, Asset Management Tools (e.g. AMS, PDM and web server))

3.7.1 Protecting access via a password

Different passwords are available to protect write access to the parameters of the device.

Protect write access to the parameters of the device via the local display, web browser or operating tool (e.g. FieldCare, DeviceCare). Access authorization is clearly regulated through the use of a user-specific access code.

User-specific access code

Write access to the parameters of the device via the local display, web browser or operating tool (e.g. FieldCare, DeviceCare) can be protected using the editable, user-specific access code.

General notes on the use of passwords

- During commissioning, change the access code that was used when the device was delivered from the factory
- When defining and managing the access code, comply with the general rules for the generation of a secure password
- The user is responsible for managing the access code and for using the code with due care

3.7.2 Access via web server

Due to the integrated web server, the device can be operated and configured via a web browser and PROFINET with Ethernet-APL. In addition to the measured values, device status information is also displayed, allowing users to monitor the status of the device. Furthermore the device data can be managed and the network parameters can be configured.

Access to the network is required for the PROFINET with Ethernet-APL connection.

Supported functions

Data exchange between the operating unit (such as a notebook for example) and the measuring device:

- Export parameter settings (PDF file, create documentation of the measuring point configuration)
- Export the Heartbeat Technology verification report (PDF file, only available with the "Heartbeat Verification" application package)
- Download driver (GSDML) for system integration

The web server is enabled when the device is delivered. The web server can be disabled via the **Web server functionality** parameter if necessary (e.g. after commissioning).

The device and status information can be hidden on the login page. This prevents unauthorized access to the information.



Detailed information on the device parameters:

"Description of device parameters" document

4 Incoming acceptance and product identification

4.1 Incoming acceptance

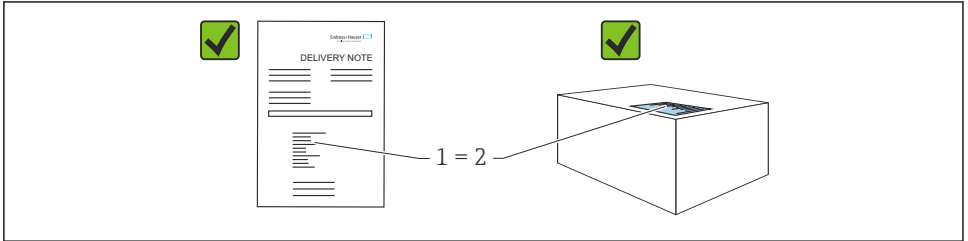

A0016870

- Is the order code on the delivery note (1) identical to the order code on the product sticker (2)?
- Are the goods undamaged?
- Do the data on the nameplate correspond to the order specifications and the delivery note?
- Is the documentation available?
- If required (see nameplate): are the Safety Instructions (XA) provided?



If you can answer "no" to any of these questions, please contact Endress+Hauser.

4.2 Storage and transport

4.2.1 Storage conditions

- Use the original packaging
- Store the device in clean and dry conditions and protect from damage caused by shocks

Storage temperature range

See Technical Information.

4.2.2 Transporting the product to the measuring point

⚠ WARNING

Incorrect transport!

Housing and membrane may become damaged, and there is a risk of injury!

- ▶ Transport the device to the measuring point in the original packaging.

⚠ WARNING

Incorrect transport!

Capillaries may become damaged, and there is a risk of injury!

- ▶ Do not use capillaries as a carrying aid for the diaphragm seals.

5 Mounting

NOTICE

The device can be damaged if handled incorrectly!

- ▶ The removal of the screws with item number (1) is not permissible under any circumstances and will void the warranty.

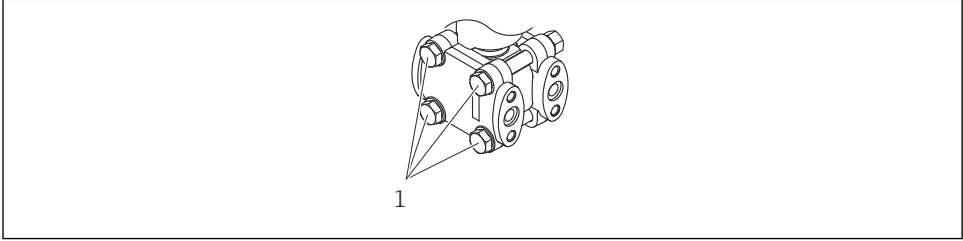

A0025336

5.1 Mounting requirements

5.1.1 General instructions

- Do not clean or touch the membrane with hard and/or pointed objects.
- Do not remove the protection on the membrane until just before installation.

Always firmly tighten the housing cover and the cable entries.

1. Counter-tighten the cable entries.
2. Tighten the coupling nut.

5.1.2 Installation instructions

- To ensure optimal readability of the local display, adjust the housing and local display
- Endress+Hauser offers a mounting bracket to mount the device on pipes or walls
- Use flushing rings for flanges, flange seals and pancake seals if buildup or clogging can be expected at the membrane
 - The flushing ring is clamped between the process connection and the flange, flange seal or pancake seal
 - Material buildup in front of the membrane is flushed away, and the pressure chamber is vented, via the two lateral flushing holes
- When measuring in media containing solids (e.g. dirty liquids), installing separators and drain valves is useful for capturing and removing sediment
- Using a valve manifold allows for easy commissioning, installation and maintenance without interrupting the process
- When mounting the device, establishing the electrical connection and during operation: prevent the penetration of moisture into the housing
- Point the cable and plug downwards as much as possible to prevent moisture from entering (e.g. rainwater or condensation)

5.1.3 Installation instructions for devices with diaphragm seals

NOTICE

Improper handling!

Damage to the device!

- ▶ The diaphragm seal and pressure transmitter form a closed, calibrated system which has been filled with diaphragm seal fill fluid. Never open any of the holes for fill fluid.
- ▶ Ensure strain relief to prevent the capillary from bending (bending radius \geq 100 mm (3.94 in)).
- ▶ Do not use capillaries as a carrying aid for the diaphragm seals.
- ▶ Observe the application limits of the fill fluid.

General information

In the case of devices with diaphragm seals and capillaries, the zero point shift caused by the hydrostatic pressure of the filling liquid column in the capillaries must be taken into account when selecting the measuring cell. Perform zero adjustment if necessary. If a measuring cell with a small measuring range is selected, a position adjustment can cause the measuring cell to go over range (position adjustment due to zero point offset, caused by the orientation of the fill fluid liquid column).

For devices with a capillary, use a suitable bracket (mounting bracket) for mounting.

When mounting, sufficient strain relief must be provided for the capillary to prevent the capillary from bending (capillary bending radius \geq 100 mm (3.94 in)).

Mount the capillary so that it is vibration-free (in order to avoid additional pressure fluctuations).

Do not mount capillaries in the vicinity of heating or cooling lines and protect them against direct sunlight.

More detailed installation instructions are provided in the Applicator "[Sizing Diaphragm Seal](#)".

Vacuum applications

In vacuum applications, mount the pressure transmitter below the diaphragm seal. This prevents additional vacuum loading of the diaphragm seal caused by the presence of fill fluid in the capillary.

If the pressure transmitter is mounted above the diaphragm seal, do not exceed the maximum height difference h_1 . The height difference h_1 is shown in the Applicator "[Sizing Diaphragm Seal](#)".

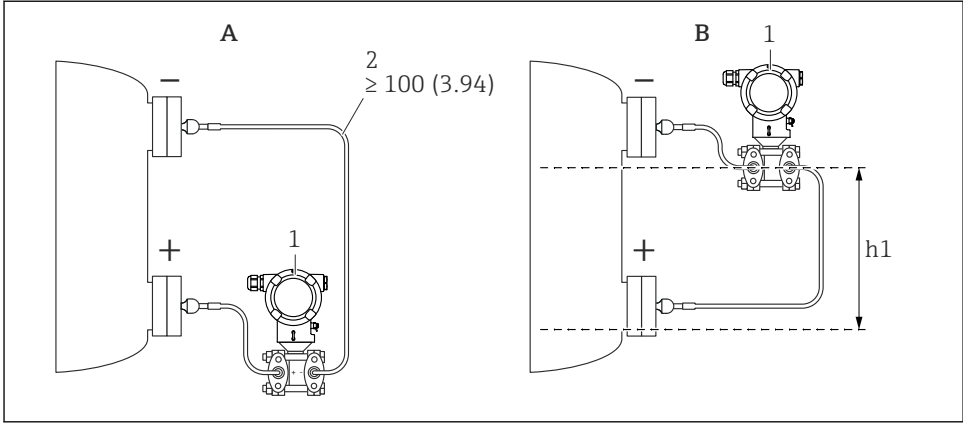

A0038720

Unit of measurement mm (in)

A Recommended installation in a vacuum application

B Installation above the lower diaphragm seal

h1 Height difference (is shown in the Applicator "Sizing Diaphragm Seal")

1 Device

2 Bending radius ≥ 100 mm (3.94 in). Ensure strain relief to prevent the capillary from bending.

The maximum height difference depends on the density of the fill fluid and the lowest absolute pressure that can ever occur at the diaphragm seal (empty vessel).

Information on cleaning

Endress+Hauser provides flushing rings as an accessory to enable the membrane to be cleaned without removing the transmitter from the process.



For more information: contact the Endress+Hauser sales office.

5.1.4 Installing pressure piping

- For recommendations for routing pressure piping, refer to DIN 19210 "Differential pressure piping for flow measurement devices" or the corresponding national or international standards
- When routing the pressure piping outdoors, ensure sufficient anti-freeze protection, e.g. by using pipe heat tracing
- Install the pressure piping with a monotonic gradient of at least 10%

5.2 Mounting the device

5.2.1 Level measurement

Level measurement in an open vessel, diaphragm seal on one side with temperature isolator

- Mount the device directly on the vessel
- The negative side is open to atmospheric pressure

Level measurement in a closed vessel, diaphragm seal on one side with temperature isolator

- Mount the device directly on the vessel
- Always connect the piping on the negative side above the maximum level

Level measurement in a closed vessel, diaphragm seal on one side or both sides with capillary

Mount the device below the lower diaphragm seal

Level measurement is only guaranteed between the upper edge of the lower diaphragm seal and the lower edge of the upper diaphragm seal.

Level measurement in a closed vessel with superimposed vapor, diaphragm seal on one side with temperature isolator

- Mount the device directly on the vessel
- Always connect the piping on the negative side above the maximum level
- The condensate trap ensures constant pressure on the negative side
- When measuring in media with solid parts (such as dirty liquids) installing separators and drain valves is useful for capturing and removing sediment

5.2.2 Differential pressure measurement

Differential pressure measurement in gases, vapors and liquids, diaphragm seal on one side or two sides with capillary

- Mount diaphragm seals with capillaries on pipes at the top or side
- In vacuum applications, mount the device below the measuring point

5.2.3 Closing the housing covers

NOTICE

Thread and housing cover damaged from dirt and fouling!

- ▶ Remove dirt (e.g. sand.) on the thread of the cover and housing.
- ▶ If you continue to encounter resistance when closing the cover, check the thread again for fouling.



Housing thread

The threads of the electronics and connection compartment can be coated with an anti-friction coating.

The following applies for all housing materials:

⊗ Do not lubricate the housing threads.

6 Electrical connection

6.1 Connecting requirements

6.1.1 Potential equalization

The protective ground on the device must not be connected. If necessary, the potential matching line can be connected to the outer ground terminal of the device before the device is connected.

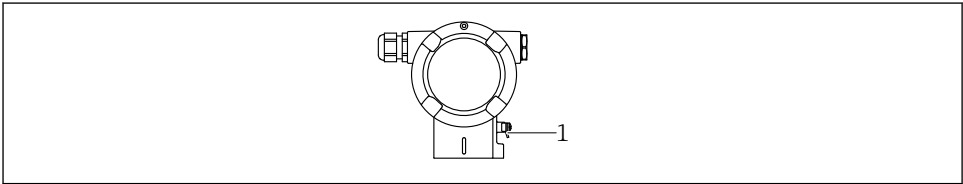

A0045412

1 Ground terminal for connecting the potential matching line

⚠ WARNING

Explosion Hazard!

- ▶ Please refer to the separate documentation on applications in hazardous areas for the safety instructions.



For optimum electromagnetic compatibility:

- Keep the potential matching line as short as possible
- Maintain a cross-section of at least 2.5 mm² (14 AWG)

6.2 Connecting the device

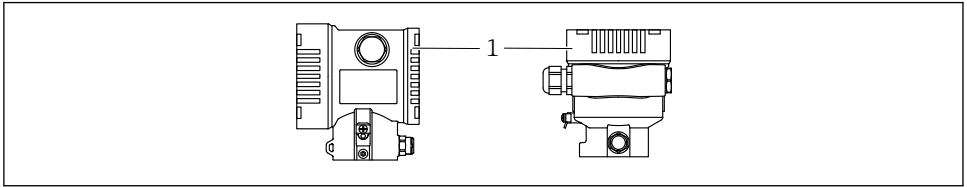

A0043806

1 Connection compartment cover



Housing thread

The threads of the electronics and connection compartment can be coated with an anti-friction coating.

The following applies for all housing materials:

✗ Do not lubricate the housing threads.

6.2.1 Supply voltage

APL power class A (9.6 to 15 V_{DC} 540 mW)



The APL field switch must be tested to ensure it meets safety requirements (e.g., PELV, SELV, Class 2) and must comply with the relevant protocol specifications.

6.2.2 Terminals

- Supply voltage and internal ground terminal: 0.5 to 2.5 mm² (20 to 14 AWG)
- External ground terminal: 0.5 to 4 mm² (20 to 12 AWG)

6.2.3 Cable specification

- Protective ground or grounding of the cable shield: rated cross-section > 1 mm² (17 AWG)
Rated cross-section of 0.5 mm² (20 AWG) to 2.5 mm² (13 AWG)
- Cable outer diameter: Ø5 to 12 mm (0.2 to 0.47 in) depends on the cable gland used (see Technical Information)

PROFINET with Ethernet-APL

The reference cable type for APL segments is fieldbus cable type A, MAU type 1 and 3 (specified in IEC 61158-2). This cable meets the requirements for intrinsically safe applications according to IEC TS 60079-47 and can also be used in non-intrinsically safe applications.

Further details are provided in the Ethernet-APL Engineering Guideline (<https://www.ethernet-apl.org>).

6.2.4 Overvoltage protection

Devices without optional overvoltage protection

Equipment from Endress+Hauser fulfills the requirements of the product standard IEC / DIN EN 61326-1 (Table 2 Industrial Environment).

Depending on the type of port (DC power supply, input/output port) different testing levels according to IEC / DIN EN 61326-1 against transient overvoltages (Surge) are applied (IEC / DIN EN 61000-4-5 Surge):

Test level on DC power ports and input / output ports is 1000 V line to earth

Devices with optional overvoltage protection

- Spark-over voltage: min. 400 V DC
- Tested according to IEC / DIN EN 60079-14 sub chapter 12.3 (IEC / DIN EN 60060-1 chapter 7)
- Nominal discharge current: 10 kA

Overvoltage category

Overvoltage category II

6.2.5 Wiring

WARNING

Supply voltage might be connected!

Risk of electric shock and/or explosion!

- ▶ If the device is used in hazardous areas, comply with national standards and the specifications in the Safety Instructions (XAs). Use the specified cable gland.
- ▶ The supply voltage must match the specifications on the nameplate.
- ▶ Switch off the supply voltage before connecting the device.
- ▶ If necessary, the potential matching line can be connected to the outer ground terminal of the transmitter before the device is connected.
- ▶ A suitable circuit breaker should be provided for the device in accordance with IEC/EN 61010.
- ▶ The cables must be adequately insulated, with due consideration given to the supply voltage and the overvoltage category.
- ▶ The connecting cables must offer adequate temperature stability, with due consideration given to the ambient temperature.
- ▶ Only operate the device with the covers closed.
- ▶ Protective circuits against reverse polarity, HF influences and overvoltage peaks are integrated.

Connect the device in the following order:

1. Release the cover lock (if provided).
2. Unscrew the cover.
3. Guide the cables into the cable glands or cable entries.
4. Connect the cables.
5. Tighten the cable glands or cable entries so that they are leak-tight. Counter-tighten the housing entry. Use a suitable tool with width across flats AF24/25 8 Nm (5.9 lbf ft) for the M20 cable gland.
6. Screw the cover securely back onto the connection compartment.

7. If fitted: tighten the screw of the cover lock using the Allen key 0.7 Nm (0.52 lbf ft) ± 0.2 Nm (0.15 lbf ft).

6.2.6 Terminal assignment

Dual compartment housing

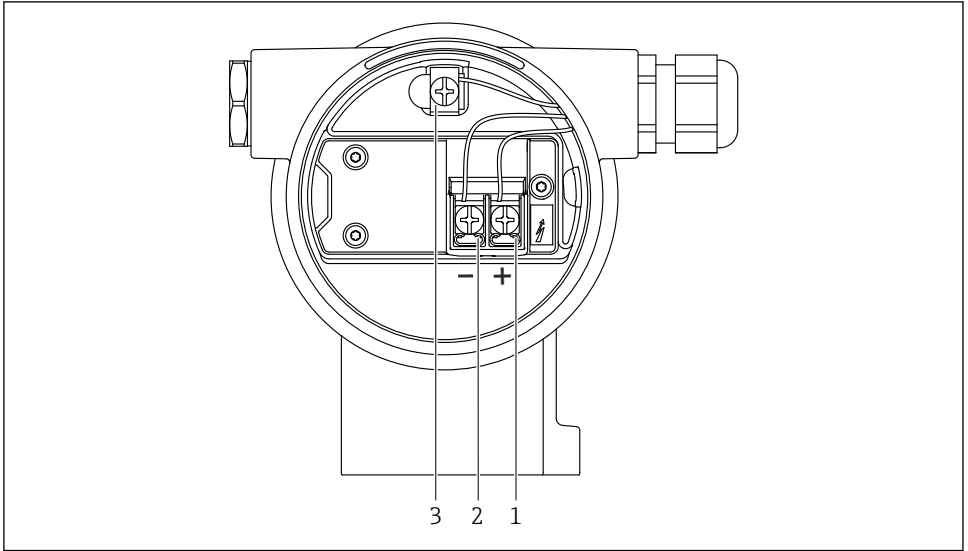

- 1 Connection terminals and ground terminal in the connection compartment

- 1 Positive terminal
2 Negative terminal
3 Internal ground terminal

6.2.7 Cable entries

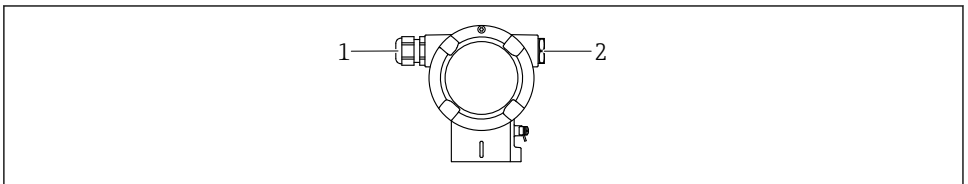

- 1 Cable entry
2 Dummy plug

The type of cable entry depends on the device version ordered.

 Always route connecting cables downwards so that moisture cannot penetrate the connection compartment.

If necessary, create a drip loop or use a weather protection cover.

6.2.8 Available device plugs

 In the case of devices with a plug, it is not necessary to open the housing for connection purposes.

Use the enclosed seals to prevent the penetration of moisture into the device.

6.3 Ensuring the degree of protection

6.3.1 Cable entries

- Gland M20, plastic, IP66/68 TYPE 4X/6P
- Gland M20, brass nickel plated, IP66/68 TYPE 4X/6P
- Gland M20, 316L, IP66/68 TYPE 4X/6P
- Thread M20, IP66/68 TYPE 4X/6P
- Thread G1/2, IP66/68 TYPE 4X/6P

If the G1/2 thread is selected, the device is delivered with an M20 thread as standard and a G1/2 adapter is included with the delivery, along with the corresponding documentation

- Thread NPT1/2, IP66/68 TYPE 4X/6P
- Dummy plug transport protection: IP22, TYPE 2
- M12 plug

When housing is closed and connecting cable is plugged in: IP66/67, NEMA Type 4X
When housing is open or connecting cable is not plugged in: IP20, NEMA Type 1

NOTICE

M12 plug and HAN7D plug: incorrect mounting can invalidate the IP protection class!

- ▶ The degree of protection only applies if the connecting cable used is plugged in and screwed tight.
- ▶ The degree of protection only applies if the connecting cable used is specified according to IP67, NEMA Type 4X.
- ▶ The IP protection classes are only maintained if the dummy cap is used or the cable is connected.

7 Operation options

7.1 Operating keys and DIP switches on the electronic insert

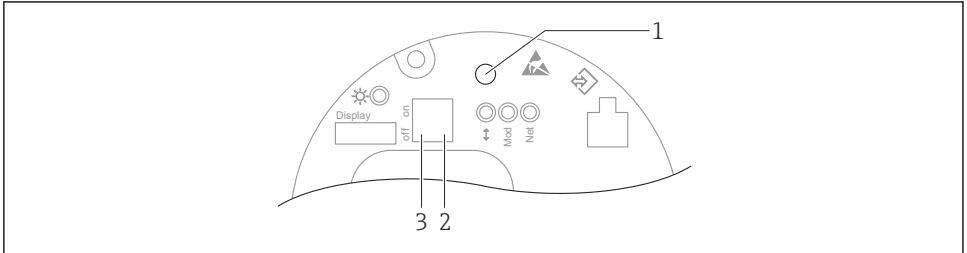

A0046061

- 1 Operating key for position adjustment (zero point correction) and device reset
- 2 DIP switch for setting the service IP address
- 3 DIP switch for locking and unlocking the device

i The setting of the DIP switches has priority over the settings made via other operation methods (e.g. FieldCare/DeviceCare).

7.2 local display

7.2.1 Device display (optional)

Functions:

- Display of measured values and fault and notice messages
- Background lighting, which switches from green to red in the event of an error
- The device display can be removed for easier operation
- In the dual compartment, L-form housing, the device display fits into both housing parts (top and side).

i The device displays are available with the additional option of Bluetooth® wireless technology.

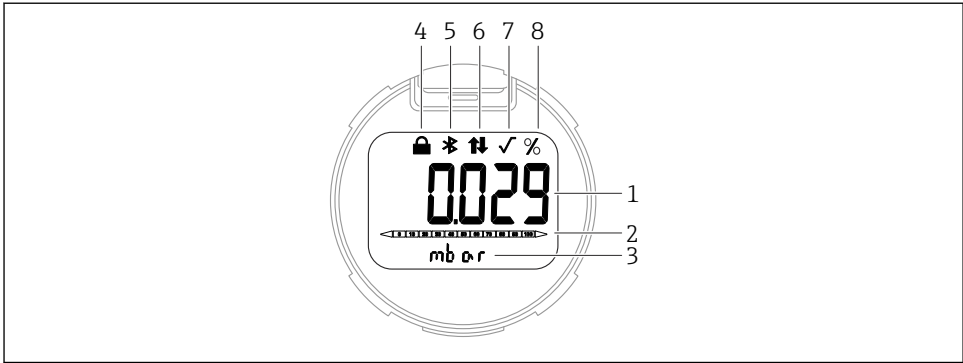

A0047143

2 Segment display

- 1 Measured value (up to 5 digits)
- 2 Bar graph (not for PROFINET with Ethernet-APL)
- 3 Unit of measured value
- 4 Locked (symbol appears when the device is locked)
- 5 Bluetooth (symbol flashes if Bluetooth connection is active)
- 6 communication via PROFINET is active
- 7 Has no function in the case of PROFINET with Ethernet-APL
- 8 Measured value output in %

The following graphics are examples. The display depends on the display settings.

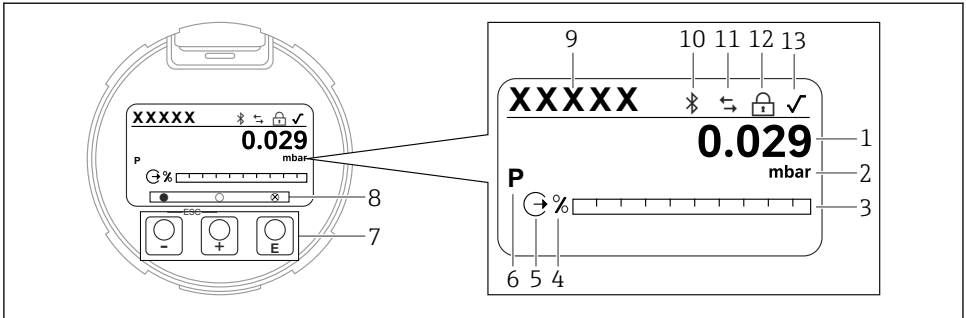

A0047141

3 Graphic display with optical operating keys.

- 1 Measured value (up to 12 digits)
- 2 Unit of measured value
- 3 Bar graph (not for PROFINET with Ethernet-APL)
- 4 Bar graph unit
- 5 Symbol for current output
- 6 Symbol for displayed measured value (e.g. p = pressure)
- 7 Optical operating keys
- 8 Symbols for key feedback. Different display symbols are possible: circle (not filled in) = key pressed briefly; circle (filled in) = key pressed for longer; circle (with X) = no operation possible due to Bluetooth connection
- 9 Device Tag
- 10 Bluetooth (symbol flashes if Bluetooth connection is active)
- 11 communication via PROFINET is active
- 12 Locked (symbol appears when the device is locked)
- 13 Symbol for square root extraction

- **+** operating key
 - Navigate down in the picklist
 - Edit the numerical values or characters within a function
- **-** operating key
 - Navigate up in the picklist
 - Edit the numerical values or characters within a function
- **⏎** operating key
 - Confirm entry
 - Jump to the next item
 - Select a menu item and activate edit mode
 - Unlock/lock the display operation
 - Press and hold the **⏎** key to display a short description of the selected parameter (if available)
- **+** key and **-** key (ESC function)
 - Exit the edit mode for a parameter without saving the changed value
 - Menu at a selection level: pressing the keys simultaneously takes the user back up a level in the menu
 - Press and hold the keys simultaneously to return to the upper level

8 Commissioning

8.1 Preliminaries

The measuring range and the unit in which the measured value is transmitted correspond to the data on the nameplate.

WARNING

Process pressure above or below permitted maximum/minimum!

Risk of injury if parts burst! Warnings are displayed if the pressure is too high.

- ▶ If a pressure smaller than the minimum permitted pressure or greater than the maximum permitted pressure is present at the device, a message is output.
- ▶ Only use the device within the measuring range limits!

8.1.1 As-delivered state

If no customized settings were ordered:

- Calibration values defined by defined measuring cell nominal value
- DIP switch to Off position
- If Bluetooth is ordered, then Bluetooth is switched on

8.2 Function check

Perform a function check before putting the measuring point into operation:





- "Post-installation check" checklist (see the "Installation" section)
- "Post-connection check" checklist (see the "Electrical connection" section)

8.3 Setting the operating language

8.3.1 Local display

Setting the operating language

 To set the operating language, the display first needs to be unlocked:

1. Press the  key for at least 2 s.
 - ↳ A dialog box appears.
2. Unlock the display operation.
3. Select the **Language** parameter in the main menu.
4. Press the  key.
5. Select the desired language with the  or  key.
6. Press the  key.

 Display operation locks automatically:

- after 1 min on the main page if no key has been pressed
- after 10 min within the operating menu if no key has been pressed

Display operation - locking or unlocking

The  key must be pressed for at least 2 seconds in order to lock or unlock the optical keys. Display operation can be locked or unlocked in the dialog that appears.

Display operation locks automatically:

- After 1 minute on the main page if no key has been pressed
- After 10 minutes within the operating menu if no key has been pressed

Display operation can be disabled via software:

Menu path: System → Connectivity → Interfaces → Display operation

8.3.2 Web server

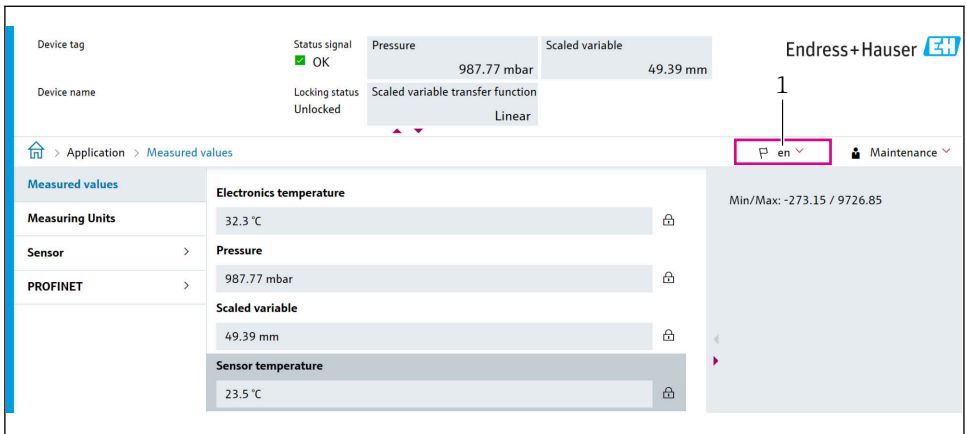

The screenshot shows a web server interface with the following elements:

- Device tag:** Status signal OK
- Device name:** Locking status Unlocked
- Pressure:** 987.77 mbar
- Scaled variable:** 49.39 mm
- Scaled variable transfer function:** Linear
- Endress+Hauser logo:** E+H
- Language dropdown:** A pink box highlights the 'P en' dropdown menu, with a '1' above it indicating a step.
- Maintenance dropdown:** A lock icon and 'Maintenance' dropdown menu.
- Measured values table:**

Measuring Units	Value	Lock
Electronics temperature	32.3 °C	🔒
Sensor	Pressure	
PROFINET	987.77 mbar	🔒
	Scaled variable	
	49.39 mm	🔒
	Sensor temperature	
	23.5 °C	🔒
- Min/Max:** -273.15 / 9726.85

A0048882

1 Language setting

8.3.3 Operating tool

See the description of the operating tool.

8.4 Configuring the measuring device

8.4.1 Commissioning with keys on the electronic insert

The following functions are possible via the keys on the electronic insert:

- Position adjustment (zero point correction)
 - The orientation of the device may cause a pressure shift
 - This pressure shift can be corrected by a position adjustment
- Resetting the device

Carrying out position adjustment

1. Device installed in desired position and no pressure applied.
2. Press the "Zero" key for at least 3 s.

3. When the LED flashes twice, the pressure present has been accepted for position adjustment.

Resetting the device

- ▶ Press and hold the "Zero" key for at least 12 seconds.



71605816

www.addresses.endress.com
