

# Functional Safety Manual

## **Liquiphant FTL62**

### **with electronic insert FEL68**

Vibronic





A0023555

## Table of contents

|          |  |           |          |  |           |
|----------|--|-----------|----------|--|-----------|
| <b>1</b> | <b>Declaration of Conformity</b> . . . . .                                     | <b>4</b>  | 5.3      | Device behavior in the event of an alarm . . . . .                                     | 13        |
| 1.1      | Safety-related characteristic values . . . . .                                 | 5         | <b>6</b> | <b>Proof testing</b> . . . . .   | <b>14</b> |
| <b>2</b> | <b>About this document</b> . . . . .   | <b>6</b>  | 6.1      | Basic test sequence . . . . .  | 15        |
| 2.1      | Document function . . . . .  | 6         | 6.2      | Test sequence A, MIN detection . . . . .   | 15        |
| 2.2      | Symbols used . . . . .   | 6         | 6.3      | Test sequence A, MAX detection . . . . .   | 16        |
| 2.2.1    | Safety symbols . . . . .   | 6         | 6.4      | Test sequence B, simulation with test button<br>or test magnet on Liquiphant . . . . . | 16        |
| 2.2.2    | Symbols for certain types of<br>information and graphics . . . . .             | 6         | 6.5      | Verification criterion . . . . .   | 17        |
| 2.3      | Supplementary device documentation . . . . .                                   | 7         | <b>7</b> | <b>Repair and error handling</b> . . . . .   | <b>17</b> |
| 2.3.1    | Further applicable documents . . . . .   | 7         | 7.1      | Maintenance . . . . .  | 17        |
| 2.3.2    | Technical Information (TI) . . . . .   | 7         | 7.2      | Repair . . . . .   | 18        |
| 2.3.3    | Brief Operating Instructions (KA) . . . . .                                    | 7         | 7.3      | Modification . . . . .   | 18        |
| 2.3.4    | Operating Instructions (BA) . . . . .  | 7         | 7.4      | Decommissioning . . . . .  | 18        |
| 2.3.5    | Safety Instructions (XA) . . . . .   | 7         | 7.5      | Disposal . . . . .   | 18        |
| <b>3</b> | <b>Design</b> . . . . .  | <b>7</b>  | 7.6      | Battery disposal . . . . .   | 19        |
| 3.1      | Permitted device types . . . . .   | 7         | <b>8</b> | <b>Appendix</b> . . . . .  | <b>19</b> |
| 3.1.1    | Order codes . . . . .  | 8         | 8.1      | Structure of the measuring system . . . . .  | 19        |
| 3.2      | Identification marking . . . . .   | 8         | 8.1.1    | System components . . . . .  | 19        |
| 3.3      | Safety function . . . . .  | 8         | 8.1.2    | Description of application as a safety<br>instrumented system . . . . .                | 19        |
| 3.4      | Basic conditions for use in safety-related<br>applications . . . . .           | 8         | 8.1.3    | Measurement function . . . . .   | 20        |
| 3.4.1    | Density of the medium . . . . .  | 9         | 8.2      | Commissioning or proof test report . . . . .   | 20        |
| 3.4.2    | Buildup: only MIN detection . . . . .  | 9         | 8.2.1    | Test Report - Page 1 - . . . . .   | 21        |
| 3.4.3    | Solid particles - heterogeneous<br>mixtures (only for MIN detection) . . . . . | 9         | 8.2.2    | Test Report - Page 2 - . . . . .   | 22        |
| 3.4.4    | Wall distance . . . . .  | 10        | 8.3      | Version history . . . . .  | 23        |
| 3.4.5    | Corrosion . . . . .  | 10        |          |  |           |
| 3.4.6    | Abrasion . . . . .   | 10        |          |  |           |
| 3.4.7    | Flow velocity . . . . .  | 10        |          |  |           |
| 3.4.8    | External vibration . . . . .   | 10        |          |  |           |
| 3.4.9    | EMC compatibility . . . . .  | 10        |          |  |           |
| 3.4.10   | Mounting with sliding sleeve . . . . .   | 10        |          |  |           |
| 3.4.11   | COM interface . . . . .  | 11        |          |  |           |
| 3.5      | Useful lifetime of electrical components . . . . .                             | 11        |          |  |           |
| <b>4</b> | <b>Commissioning (installation and<br/>configuration)</b> . . . . .            | <b>11</b> |          |  |           |
| 4.1      | Requirements for personnel . . . . .   | 11        |          |  |           |
| 4.2      | Installation . . . . .   | 11        |          |  |           |
| 4.3      | Commissioning . . . . .  | 11        |          |  |           |
| 4.4      | Operation . . . . .  | 12        |          |  |           |
| 4.5      | Parameter configuration for safety-related<br>applications . . . . .           | 12        |          |  |           |
| 4.5.1    | MIN/MAX detection mode . . . . .   | 12        |          |  |           |
| 4.5.2    | Density mode . . . . .   | 13        |          |  |           |
| <b>5</b> | <b>Operation</b> . . . . .   | <b>13</b> |          |  |           |
| 5.1      | Device behavior during power-up . . . . .                                      | 13        |          |  |           |
| 5.2      | Device behavior in safety function demand<br>mode . . . . .                    | 13        |          |  |           |

# 1 Declaration of Conformity

SIL\_00512\_01.23

**Endress+Hauser**   
People for Process Automation

## Declaration of Conformity

Functional Safety according to IEC 61508  
Based on NE 130 Form B.1

Endress+Hauser SE+Co. KG, Hauptstraße 1, 79689 Maulburg

being the manufacturer, declares that the product

### Liquiphant FTL51B / FTL62 / FTL63 / FTL64 (FEL68)

is suitable for the use in safety-instrumented systems according to IEC 61508. The instructions of the corresponding functional safety manual must be followed.

This declaration of conformity is valid for variant I: One Liquiphant with direct connection to the safety instrumented function, without a Nivotester.



A: Other safety equipment e.g. actuator/safety-related PLC

This declaration of conformity is exclusively valid for the listed products and accessories in delivery status.

Maulburg, February 3, 2023  
Endress+Hauser SE+Co. KG

i. V.

E-SIGNED by Thorsten Springmann  
on 07 February 2023 08:29:42 CET

Thorsten Springmann  
Dept. Man. R&D Devices Level Limit  
Research & Development

i. V.

E-SIGNED by Manfred Hammer  
on 07 February 2023 08:15:37 CET

Manfred Hammer  
Dept. Man. R&D Quality Management/FSM  
Research & Development

A0052149

# 1.1 Safety-related characteristic values

SIL\_00512\_01.23



| General  |   |   |   |
|--|---|---|---|
| Device designation and permissible types <sup>1)</sup>                         | Liquiphant FTL51B / FTL62 / FTL63 / FTL64 ** A8 * * * * * * * * * * + [LA] (FEL68)  |   |   |
| Safety-related output signal   | NAMUR Interface   |   |   |
| Fault signal   | 0.4 mA ... 1.0 mA   |   |   |
| Process variable/function  | Level switch for liquids  |   |   |
| Safety function(s)   | MIN / MAX   |   |   |
| Device type acc. to IEC 61508-2  | <input type="checkbox"/> Type A   | <input checked="" type="checkbox"/> Type B  |   |
| Operating mode   | <input checked="" type="checkbox"/> Low Demand Mode   | <input checked="" type="checkbox"/> High Demand Mode  |   |
| Valid hardware version   | FEL68: 01.00.ww (ww: any double number)   |   |   |
| Valid software version   | 01.01.zz (zz: any double number)  |   |   |
| Safety manual  | FTL51B: FY01000F / FTL62: FY01019F / FTL63: FY01096F / FTL64: FY01024F  |   |   |
| Type of evaluation (check only <u>one</u> box)                                 | <input checked="" type="checkbox"/>   | Complete HW/SW evaluation parallel to development incl. FMEDA and change request acc. to IEC 61508-2, 3   |   |
|  | <input type="checkbox"/>  | Evaluation of "proven in use" performance for HW/SW incl. FMEDA and change request acc. to IEC 61508-2, 3 |   |
|  | <input type="checkbox"/>  | Evaluation of HW/SW field data to verify „prior use“ acc. to IEC 61511                                    |   |
|  | <input type="checkbox"/>  | Evaluation by FMEDA acc. to IEC 61508-2 for devices w/o software  |   |
| Evaluation through – report/certificate no.                                    | TÜV Rheinland 968/FSP 1388  |   |   |
| Test documents   | Development documents   | Test reports  | Data sheets                                       |
| SIL – Integrity  |   |   |   |
| Systematic safety integrity  |   | <input type="checkbox"/> SC 2   | <input checked="" type="checkbox"/> SC 3          |
| Hardware safety integrity  | Single channel use (HFT = 0)  | <input checked="" type="checkbox"/> SIL 2 capable   | <input type="checkbox"/> SIL 3 capable            |
|  | Multi channel use (HFT ≥ 1)   | <input type="checkbox"/> SIL 2 capable  | <input checked="" type="checkbox"/> SIL 3 capable |
| FMEDA  |   |   |   |
| Safety function  | MIN   | MAX   | RANGE   |
| $\lambda_{DU}^{2),3)}$   | 34 FIT  | 19 FIT  | /   |
| $\lambda_{DD}^{2),3)}$   | 140 FIT   | 106 FIT   | /   |
| $\lambda_S^{2),3)}$  | 156 FIT   | 208 FIT   | /   |
| SFF  | 90%   | 94%   | /   |
| $PFD_{avg} (T_1 = 1 \text{ year})^3)$ (single channel architecture)            | $1.51 \cdot 10^{-4}$  | $8.35 \cdot 10^{-5}$  | /   |
| PFH  | $3.44 \cdot 10^{-8} \text{ 1/h}$  | $1.91 \cdot 10^{-8} \text{ 1/h}$  | /   |
| PTC <sup>4)</sup> A / B  | 92% / 21%   | 90% / 38%   | /   |
| Diagnostic test interval <sup>5)</sup>   | ≤ 60 s,<br>RAM check ≤ 10 min   | ≤ 60 s,<br>RAM check ≤ 10 min   | /   |
| Fault reaction time <sup>6)</sup>  | ≤ 3 s   | ≤ 3 s   | /   |
| Comments   |   |   |   |
| Please note limitation of the demand rate due to the diagnostic test interval. |   |   |   |
| Declaration  |   |   |   |
| <input checked="" type="checkbox"/>  | Our internal company quality management system ensures information on safety-related systematic faults which become evident in the future |   |   |

<sup>1)</sup> Valid order codes and order code exclusions are maintained in the E+H ordering system  
<sup>2)</sup> FIT = Failure In Time, number of failures per 10<sup>9</sup> h  
<sup>3)</sup> Valid for average ambient temperature up to +40 °C (+104 °F)  
 For continuous operation at ambient temperature close to +60 °C (+140 °F), a factor of 2.1 should be applied  
<sup>4)</sup> PTC = Proof Test Coverage  
<sup>5)</sup> All diagnostic functions are performed at least once within the diagnostic test interval  
<sup>6)</sup> Maximum time between error recognition and error response

## 2 About this document

### 2.1 Document function

This supplementary Safety Manual applies in addition to the Operating Instructions, Technical Information and ATEX Safety Instructions. The supplementary device documentation must be observed during installation, commissioning and operation. The requirements specific to the protection function are described in this safety manual.



General information on functional safety (SIL) is available at:  
[www.endress.com/SIL](http://www.endress.com/SIL)

### 2.2 Symbols used

#### 2.2.1 Safety symbols



This symbol alerts you to a dangerous situation. Failure to avoid this situation will result in serious or fatal injury.



This symbol alerts you to a dangerous situation. Failure to avoid this situation can result in serious or fatal injury.



This symbol alerts you to a dangerous situation. Failure to avoid this situation can result in minor or medium injury.



This symbol contains information on procedures and other facts which do not result in personal injury.

#### 2.2.2 Symbols for certain types of information and graphics



**Tip**  
Indicates additional information



Reference to documentation



Reference to graphic



Notice or individual step to be observed

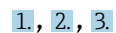

Series of steps



Result of a step

1, 2, 3, ...

Item numbers

A, B, C, ...

Views

## 2.3 Supplementary device documentation

 For an overview of the scope of the associated Technical Documentation, refer to the following:

- *Device Viewer* ([www.endress.com/deviceviewer](http://www.endress.com/deviceviewer)): Enter the serial number from the nameplate
- *Endress+Hauser Operations app*: Enter serial number from nameplate or scan matrix code on nameplate.

The following document types are available in the download area of the Endress+Hauser website ([www.endress.com/downloads](http://www.endress.com/downloads)):

### 2.3.1 Further applicable documents

- TI01539F
- BA02036F
- KA01479F
- FY01005F, Functional Safety Manual, FTL325N

### 2.3.2 Technical Information (TI)

#### Planning aid

The document contains all the technical data on the device and provides an overview of the accessories and other products that can be ordered for the device.

### 2.3.3 Brief Operating Instructions (KA)

#### Guide that takes you quickly to the 1st measured value

The Brief Operating Instructions contain all the essential information from incoming acceptance to initial commissioning.

### 2.3.4 Operating Instructions (BA)

#### Your reference guide

These Operating Instructions contain all the information that is required in various phases of the life cycle of the device: from product identification, incoming acceptance and storage, to mounting, connection, operation and commissioning through to troubleshooting, maintenance and disposal.

### 2.3.5 Safety Instructions (XA)

Depending on the approval, the following Safety Instructions (XA) are supplied with the device. They are an integral part of the Operating Instructions.

 The nameplate indicates the Safety Instructions (XA) that are relevant to the device.

## 3 Design

### 3.1 Permitted device types

The details pertaining to functional safety in this manual relate to the device versions listed below and are valid as of the specified firmware and hardware versions.

Unless otherwise specified, all subsequent versions can also be used for safety functions.

A modification process according to IEC 61508 is applied for device changes.

**Valid device versions for safety-related use:**

### **3.1.1 Order codes**

**FTL62-**

**Feature: 010 "Approval"**

Version: all

**Feature: 020 "Output"**

Version: A8 ; FEL68, 2-wire NAMUR + test button

**Feature: 030 "Display, operation"**

Version: all

**Feature: 040 "Housing; material"**

Version: all

**Feature: 050 "Electrical connection"**

Version: all

**Feature: 060 "Application"**

Version: all

**Feature: 080 "Surface finish"**

Version: all

**Feature: 085 "Probe design"**

Version: all

**Feature: 090 "Sensor length, material"**

Version: all

**Feature: 105 "Process connection, sealing surface"**

Version: all

**Feature: 110 "Process connection"**

Version: all

**Feature: 590 "Additional approval"**

Version: LA

Advanced diagnostic measures are only implemented in this version. This version must be selected for use as a safety function as per IEC 61508.

## **3.2 Identification marking**

SIL-certified devices are marked with the SIL logo  on the nameplate.

## **3.3 Safety function**

The device's safety functions are:

- Maximum level monitoring (overflow prevention, MAX detection)
- Minimum level monitoring (dry running protection, MIN detection)

## **3.4 Basic conditions for use in safety-related applications**

The measuring system must be used correctly for the specific application, taking into account the medium properties and ambient conditions. Carefully follow instructions pertaining to critical process situations and installation conditions from the Operating Instructions. The application-specific limits must be observed. The specifications in the Operating Instructions and the Technical Information must not be exceeded.



### 3.4.1 Density of the medium

Operation is only permitted with liquids:

- Depending on the configured density setting, the density of the liquid must be as follows:
  - if the switch position is > 0.7 the density must be over 0.7 g/cm<sup>3</sup> (common water- and oil-based liquids).
  - if the switch position is > 0.5 the density must be over 0.5 g/cm<sup>3</sup> (e.g., liquefied gas, isopentane, petroleum ether).
- The gas phase above the liquid may not exceed a maximum permitted density value. The maximum possible gas density depends on the temperature and the device.

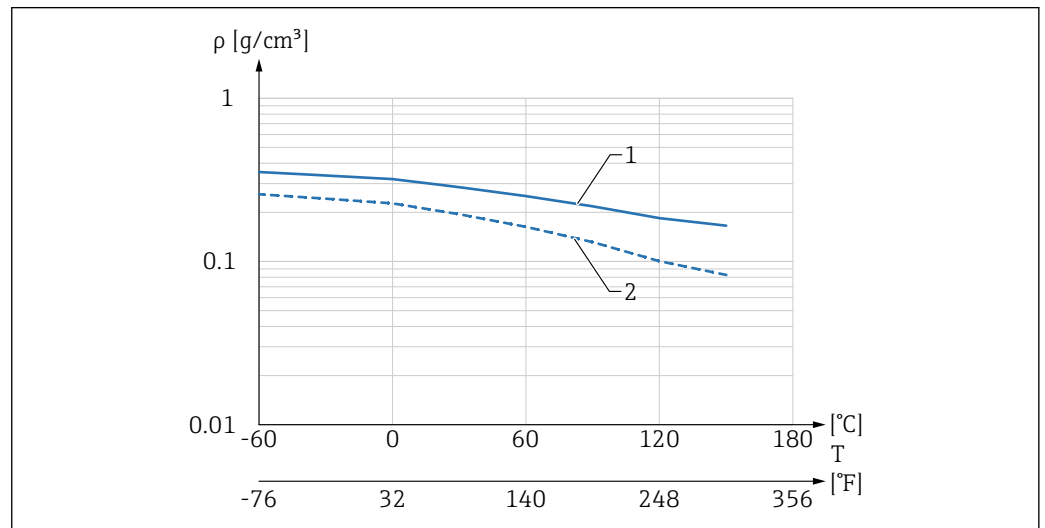

A0051630

1 ECTFE, PFA, enamel

1 Switch position for density 0.7 g/cm<sup>3</sup>

2 Switch position for density 0.5 g/cm<sup>3</sup>

**i** ECTFE up to a maximum of +120 °C (+248 °F) only

#### **CAUTION**

#### Gas density is exceeded!

The "Uncovered" state is not recognized and the "Covered" state is always reported.

- ▶ The gas density may not be exceeded.

- i**
  - There is no minimum density for the gas phase. Operation in a vacuum is permitted!
  - There is no maximum density for the liquid.
  - For more information on the levels of diagnostic coverage, refer to IEC 61508-2:2010 Appendix A.2, Comment 2 and Table A.1.

### 3.4.2 Buildup: only MIN detection

The device may only be used in media that do not tend to cause buildup.

**i** Buildup is detected with a low diagnostic coverage.

### 3.4.3 Solid particles - heterogeneous mixtures (only for MIN detection)

The medium may not contain solid particles with a diameter greater than 5 mm (0.2 in). Solid particles lodged between the tines of the tuning fork can have the effect that the

demand mode of the safety function is not detected and the device will not switch as intended.

 Lodged solid particles are detected with low diagnostic coverage.

#### 3.4.4 Wall distance

The distance between the tuning fork of the device and the wall of the vessel containing medium (e.g. tank, pipe) must be at least 10 mm (0.39 in).

#### 3.4.5 Corrosion

The device may only be used in media to which the wetted parts used are resistant. Corrosion can have the effect that the demand mode of the safety function is not detected and the device will not switch as intended.

 Corrosion is detected with low diagnostic coverage.

When using coated sensors, make sure the sensor is not damaged during installation and operation.

#### 3.4.6 Abrasion

It is not permitted to use the device with abrasive media. The removal of material from the sensor as a result of abrasion can result in sensor failure.

 Abrasion is detected with low diagnostic coverage.

#### 3.4.7 Flow velocity

In the case of flowing media, the flow velocity in the area around the tuning fork may not exceed 5 m/s. Higher flow velocities can have the effect that the demand mode is not detected and the sensor signals that it is free (uncovered).

#### 3.4.8 External vibration

In systems exposed to strong external vibrations, e.g., in the 400 to 1 200 Hz range (acceleration spectral density  $>1 \text{ (m/s}^2\text{)}^2\text{/Hz}$ ) or ultrasound with cavitation, the safety function must be verified by simulating a demand mode prior to operation. Accidental switchings may sporadically occur if a strong frequency from an external source is superimposed on the frequency of the tuning fork.

#### 3.4.9 EMC compatibility

The device is certified in accordance with IEC 61326-3-1 and is thus suitable for general industrial, safety-related applications. If the specified electromagnetic ambient conditions are exceeded, the switch status might not be reliably detected. An unshielded cable can be used between the devices in these environmental conditions. Electromagnetic interference immunity can be further improved by using shielded cables.

#### 3.4.10 Mounting with sliding sleeve

##### **NOTICE**

##### **Mechanical damage to coating**

Corrosion protection and adequate sealing are no longer guaranteed. Device could be destroyed.

- ▶ Coated sensors must not be mounted with a sliding sleeve.

### 3.4.11 COM interface

When used as a safety function, there is the option of connecting an additional module to the COM interface.

Bluetooth: BT module VU121

The module may be used for informational purposes only but not as part of the safety function. It does not have a modifying effect on the safety function.

## 3.5 Useful lifetime of electrical components

The established failure rates of electrical components apply within the useful lifetime as per IEC 61508-2:2010 section 7.4.9.5 note 3.

In accordance with DIN EN 61508-2:2011 section 7.4.9.5 (national footnote N3), appropriate measures taken by the manufacturer and operator can extend the useful lifetime.

# 4 Commissioning (installation and configuration)

## 4.1 Requirements for personnel

The personnel for installation, commissioning, diagnostics and maintenance must fulfill the following requirements:

- ▶ Trained, qualified specialists must have a relevant qualification for this specific function and task.
- ▶ Personnel must be authorized by the plant owner/operator.
- ▶ Be familiar with federal/national regulations.
- ▶ Before starting work: personnel must read and understand the instructions in the manual and supplementary documentation as well as the certificates (depending on the application).
- ▶ Personnel must follow instructions and comply with general policies.

The operating personnel must fulfill the following requirements:

- ▶ Personnel are instructed and authorized according to the requirements of the task by the facility's owner-operator.
- ▶ Personnel follow the instructions in this manual.

## 4.2 Installation

The mounting and wiring of the device and the permitted orientations are described in the Operating Instructions pertaining to the device.

 Correct installation is a prerequisite for safe operation of the device.

## 4.3 Commissioning

The commissioning of the device is described in the Operating Instructions pertaining to the device.

Prior to operating the device in a safety instrumented system, verification must be performed by carrying out a test sequence as described in **Section 6 Proof testing**.

## 4.4 Operation

The operation of the device is described in the Operating Instructions pertaining to the device.

## 4.5 Parameter configuration for safety-related applications

The device settings may not be changed if SIL operation is in progress.

### NOTICE

#### The protective function can be impaired

After commissioning the measuring system, changes to the settings can impact the protective function

- ▶ After changing the settings, perform a proof test to ensure that the safety function is working correctly

### 4.5.1 MIN/MAX detection mode

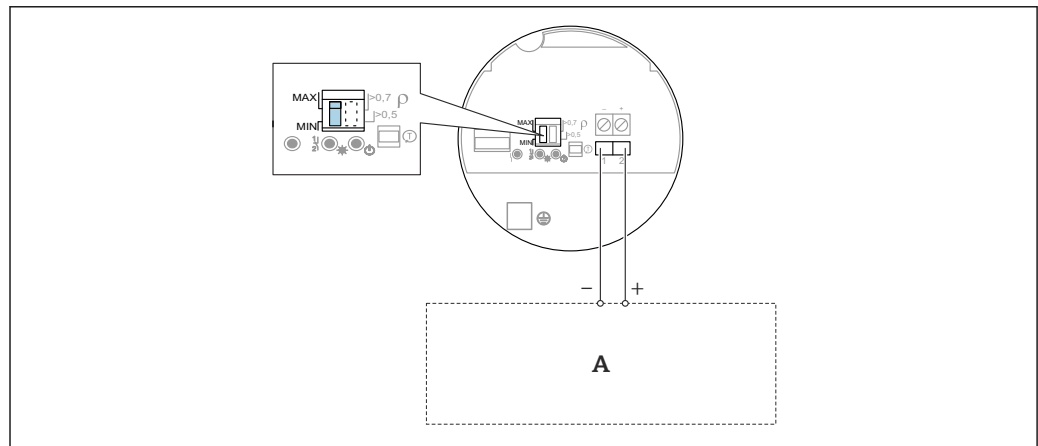

A0039188

 2 Selection of MIN/MAX detection mode

A Additional safety equipment

## 4.5.2 Density mode

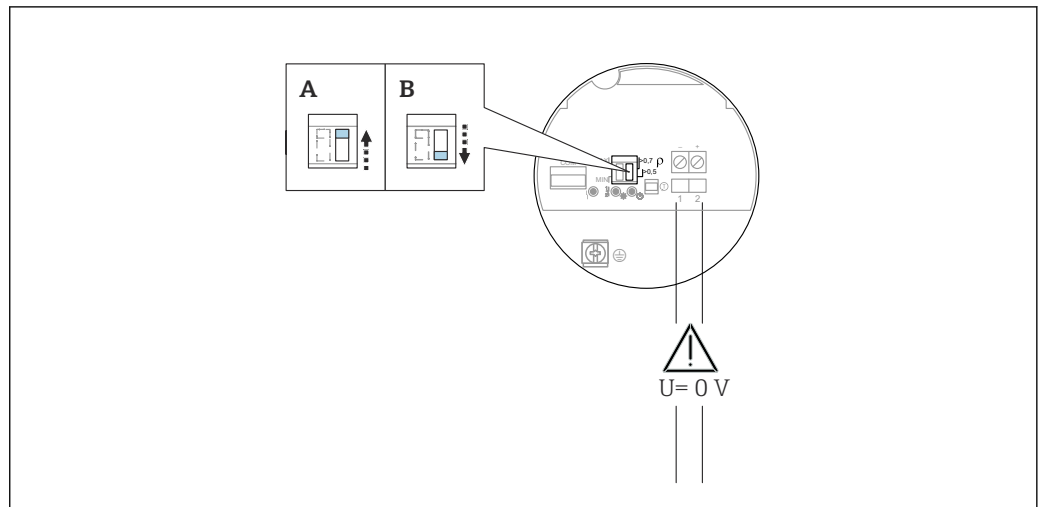

**3** Selection of density mode

A Default setting (density  $>0.7 \text{ g/cm}^3$ ); always use this setting where possible

B Special setting (density  $>0.5 \text{ g/cm}^3$ ); extremely light liquids (e.g., liquefied natural gas, isopentane, petroleum ether)

## 5 Operation

### 5.1 Device behavior during power-up

The behavior of the device when switched on is described in the relevant Operating Instructions.

### 5.2 Device behavior in safety function demand mode

The safety-related output signal consists of a current signal according to the NAMUR interface as per EN 50227 (DIN 19234; NAMUR) or IEC 60947-5-6.

- If the status is OK, the current at terminal 2 is between 2.2 to 3.8 mA
- In demand mode, or if a fault is detected in the device, this current decreases to 0.4 to 1.0 mA
- Currents  $<0.4 \text{ mA}$  or  $>3.8 \text{ mA}$  indicate a fault in the cable (short-circuit, cable open circuit or similar).

IEC 60947-5-6 defines ranges in which the switch points may be, see "Figure 3 - Control input of the switching amplifier" in the standard. Accordingly, the calculation of the safety-related characteristic values is based on the requirement that the downstream evaluation detects the following currents:

- $<0.05 \text{ mA}$  reliably detected as a cable open circuit
- $>6.6 \text{ mA}$  reliably detected as a short-circuit

### 5.3 Device behavior in the event of an alarm

The behavior of the device in the event of an alarm is described in the relevant Operating Instructions.

## 6 Proof testing

**i** The safety-related functionality of the device in the SIL mode must be verified during commissioning, when changes are made to safety-related parameters, and also at appropriate time intervals. This enables this functionality to be verified within the entire safety instrumented system. The time intervals must be specified by the operator.

### **CAUTION**

#### **The safety function is not guaranteed during a proof test**

Suitable measures must be taken to guarantee process safety during the test.

- ▶ The safety-related output signal 4 to 20 mA must not be used for the safety instrumented system during testing.
- ▶ A completed test must be documented; the reports provided in the Appendix can be used for this purpose (see Section 8.2).
- ▶ The operator specifies the test interval and this must be taken into account when determining the probability of failure  $PFD_{avg}$  of the sensor system.

**i** When using the proof-test wizard in the SmartBlue app, the correct version must be selected.

The proof test for **version I** is described below.

The other versions II to IV are described in the Functional Safety Manual for the Nivotester FTL325N.

Proof testing of the device can be performed as follows:

- Test sequence A: Approach the level, or remove and immerse in a medium of similar density and viscosity
  - Test sequence A, MIN detection
  - Test sequence A, MAX detection
- Test sequence B: Simulation using test button or test magnet on Liquiphant

**i** Note the following for the test sequences:

- A demand mode or a fault takes absolute precedence over the proof test and in the measuring system safety path. For this reason, the demand mode must first be ended or the fault rectified before the proof test can commence.
- The proof test can and may only be performed if the device status is OK.
- The status of the individual output signal is indicated by a measuring device or a downstream component of the safety path (e.g., PLC, actuator).
- The individual proof test coverages (PTC) that can be used for calculation are specified in the Declaration of Conformity.
- To monitor the safety-related output signal, it is sufficient to evaluate the response of downstream components of the safety function. If the different states are correctly identified there, the test steps are passed.

## 6.1 Basic test sequence

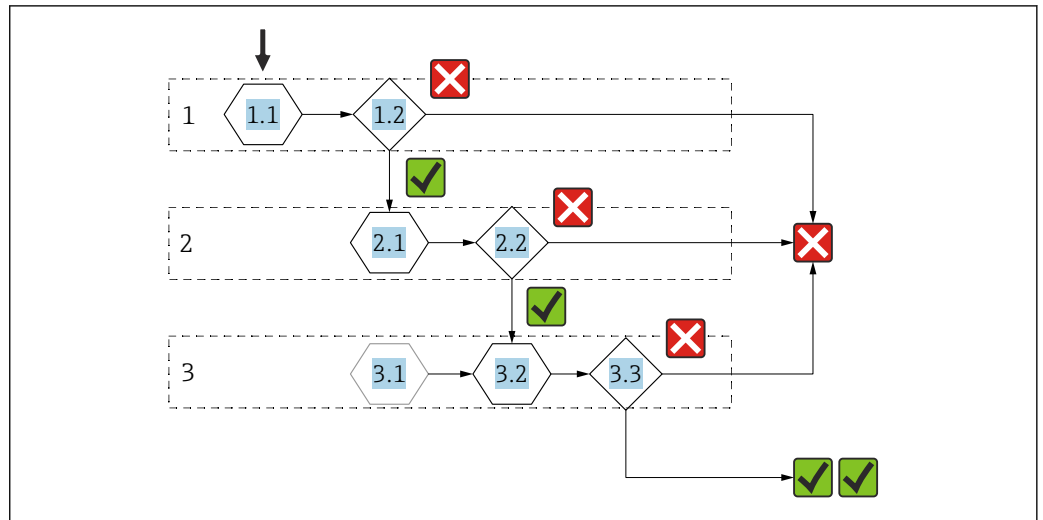

4 Basic test sequence

- 1.1 Status OK
- 1.2 Output signal for status OK?
- 2.1 Establish demand mode
- 2.2 Output signal for demand mode?
- 3.1 Re-install the sensor that was removed (optional)
- 3.2 Establish status OK
- 3.3 Output signal for status OK?

**i** The output signal can be evaluated based on the response of the following components of the safety function.

## 6.2 Test sequence A, MIN detection

- Approach the level or
- Remove and immerse in a medium of similar density and viscosity

### Step 1

1. Raise the level or immerse the tuning fork of the sensor that has been removed into the medium until the tuning fork is fully covered.
  - ↳ If it is not possible to do this with the original medium, a medium of a similar density and viscosity must be used.
2. Check if the current at terminal 2 corresponds to status OK.
  - ↳ The current must be between 2.2 to 3.8 mA.

**i** If the current does not correspond to status OK, there is an error in the safety path. The proof test has not been passed and must be aborted.

### Step 2

1. Lower the level or take the tuning fork of the sensor that has been removed out of the medium until the tuning fork is completely free.
  - ↳ Wait for the switching delay to elapse (1 s, unless ordered otherwise)
2. Check if the current at terminal 2 corresponds to demand mode.
  - ↳ The current must be between 0.4 to 1.0 mA.

**i** If the current does not correspond to demand mode, there is an error in the safety path. The proof test has not been passed and must be aborted.

## Step 3

1. Re-install the sensor that was removed (optional).
  - ↳ Wait for power-up (10 s).
2. Restore the status OK by fully covering the tuning fork.
  - ↳ Wait for the switching delay to elapse (1 s, unless ordered otherwise).
3. Check if the current at terminal 2 corresponds to status OK.
  - ↳ The current must be between 2.2 to 3.8 mA.

 If the current does not correspond to status OK, there is an error in the safety path. The proof test has not been passed and must be aborted.

### 6.3 Test sequence A, MAX detection

- Approach the level or
- Remove and immerse in a medium of similar density and viscosity

## Step 1

1. Lower the level or take the tuning fork of the sensor that has been removed out of the medium until the tuning fork is completely free.
  - ↳ If it is not possible to do this with the original medium, a medium of a similar density and viscosity must be used.
2. Check if the current at terminal 2 corresponds to status OK.
  - ↳ The current must be between 2.2 to 3.8 mA.

 If the current does not correspond to status OK, there is an error in the safety path. The proof test has not been passed and must be aborted.

## Step 2

1. Raise the level or immerse the tuning fork of the sensor that has been removed into the medium until the tuning fork is fully covered.
  - ↳ Wait for the switching delay to elapse (1 s, unless ordered otherwise)
2. Check if the current at terminal 2 corresponds to demand mode.
  - ↳ The current must be between 0.4 to 1.0 mA.

 If the current does not correspond to demand mode, there is an error in the safety path. The proof test has not been passed and must be aborted.

## Step 3

1. Re-install the sensor that was removed (optional).
  - ↳ Wait for power-up (10 s).
2. Restore the status OK by fully exposing the tuning fork.
  - ↳ Wait for the switching delay to elapse (1 s, unless ordered otherwise).
3. Check if the current at terminal 2 corresponds to status OK.
  - ↳ The current must be between 2.2 to 3.8 mA.

 If the current does not correspond to status OK, there is an error in the safety path. The proof test has not been passed and must be aborted.

### 6.4 Test sequence B, simulation with test button or test magnet on Liquiphant

No change of level in the vessel is necessary for this sequence.



Note the following for the test sequences:

**Test sequence B (simulation) is not permitted for a commissioning test.**

Step 1

- ▶ Check if the current at terminal 2 corresponds to status OK.
  - ↳ The current must be between 2.2 to 3.8 mA.

 If the current does not correspond to status OK, there is an error in the safety path. The proof test has not been passed and must be aborted.

Step 2

1. Press the test button or apply the test magnet.
  - ↳ The device restarts (3 s).  
If the button is pressed (or magnet applied) for a short period, the demand mode is maintained for 7 s afterwards.  
If the button is pressed (or magnet applied) for a longer period, the demand mode is maintained as long as the button remains pressed or the test magnet is applied.
2. Check if the current at terminal 2 corresponds to demand mode.
  - ↳ The current must be between 0.4 to 1.0 mA.

 If the current does not correspond to demand mode, there is an error in the safety path. The proof test has not been passed and must be aborted.

Step 3

1. Release the test button or remove the test magnet.
  - ↳ Wait for the switching delay to elapse (1 s, unless ordered otherwise).
2. Check if the current at terminal 2 corresponds to status OK.
  - ↳ The current must be between 2.2 to 3.8 mA.

 If the current does not correspond to status OK, there is an error in the safety path. The proof test has not been passed and must be aborted.

## 6.5 Verification criterion

**If one of the test criteria from the test sequences described above is not fulfilled, the device may no longer be used as part of a safety instrumented system.**

- The purpose of proof-testing is to detect dangerous undetected device failures ( $\lambda_{DU}$ ).
- This test does not cover the impact of systematic faults on the safety function, which must be assessed separately.
- Systematic faults can be caused, for example, by process material properties, operating conditions, build-up or corrosion.
- As part of the visual inspection, for example, ensure that all of the seals and cable entries provide adequate sealing and that the device is not visibly damaged.

# 7 Repair and error handling

## 7.1 Maintenance

Maintenance instructions and instructions regarding recalibration may be found in the Operating Instructions pertaining to the device.

 Alternative monitoring measures must be taken to ensure process safety during configuration, proof-testing and maintenance work on the device.

## 7.2 Repair

Repair means restoring functional integrity by replacing defective components.

Components may be repaired/replaced by the customer's technical staff if **genuine spare parts** from Endress+Hauser are used (they can be ordered by the end user) and the appropriate installation instructions are followed.

 A proof test must always be performed after every repair.

Spare parts are grouped into logical kits with the associated replacement instructions.

Document the repair with the following information:

- Serial number of the device
- Date of the repair
- Type of repair
- Person who performed the repair

 Installation Instructions are supplied with the original spare part and can also be accessed in the Download Area at [www.endress.com](http://www.endress.com)

Return the replaced component to Endress+Hauser for fault analysis.

When returning the defective component, always enclose the "Declaration of Hazardous Material and Decontamination" with the note "Used as SIL device in a safety instrumented system."

For information on device returns, please see:

<http://www.endress.com/support/return-material>

## 7.3 Modification

Modifications are changes to SIL devices that are already delivered or installed.

- Modifications to SIL devices are usually performed in the Endress+Hauser manufacturing center.
- Modifications to SIL devices onsite at the user's plant are possible following approval by the Endress+Hauser manufacturing center.

In this case, the modifications must be performed and documented by an Endress+Hauser service technician.

- **Modifications to SIL devices by the user are not permitted.**

## 7.4 Decommissioning

When decommissioning, the requirements according to IEC 61508-1:2010 section 7.17 must be observed.

## 7.5 Disposal



If required by the Directive 2012/19/EU on waste electrical and electronic equipment (WEEE), the product is marked with the depicted symbol in order to minimize the disposal of WEEE as unsorted municipal waste. Do not dispose of products bearing this marking as unsorted municipal waste. Instead, return them to Endress+Hauser for disposal under the applicable conditions.

## 7.6 Battery disposal

- In some countries, the end user is legally obliged to return used batteries.
- The end user can return old batteries or electronic assemblies containing these batteries free of charge to Endress+Hauser.



In accordance with German law regulating the use of batteries (BattG §17 Para Number 3), this symbol is used to denote electronic assemblies that must not be disposed of as municipal waste.

# 8 Appendix

## 8.1 Structure of the measuring system

### 8.1.1 System components

The measuring system's devices are shown in the following diagram (example).

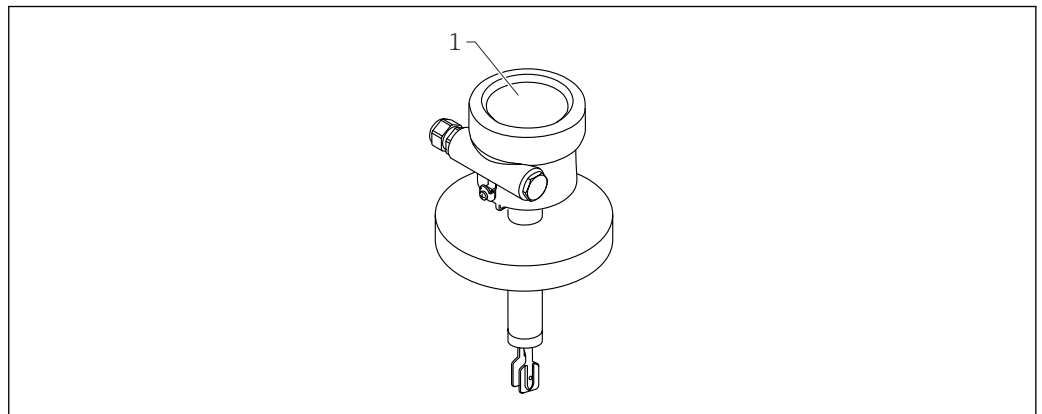

A0043444

5 System components

1 Measuring device/sensor

### 8.1.2 Description of application as a safety instrumented system

The sensor's tuning fork vibrates at its intrinsic frequency. The vibration frequency decreases as the density increases. This change in the frequency causes the current signal to change.

The switch point is in the range of the tuning fork and depends on the installation position.

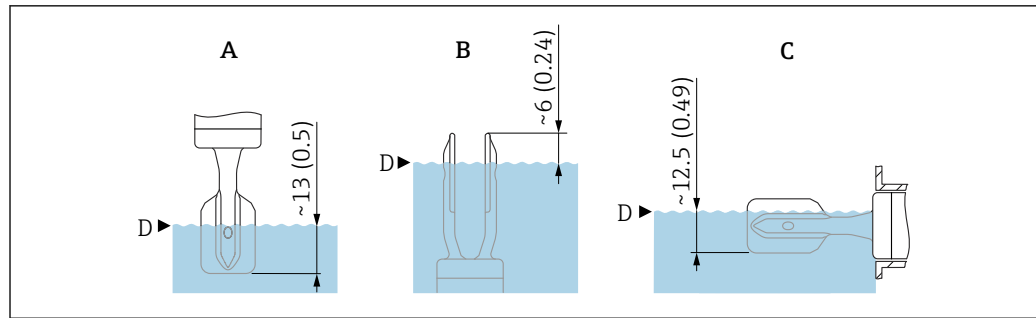

A0042269

6 Switch point depending on the installation position. Unit of measurement mm (in)

- A Installation from above
- B1 Installation from below, plastic-coated tuning fork
- B2 Installation from below, enamel-coated tuning fork
- C Installation from the side
- D Switch point

 For information on the switch point under reference operating conditions, see the Technical Information.

 Correct installation is a prerequisite for safe operation of the device.

### 8.1.3 Measurement function

Choice of operating modes:

- MIN detection

The measuring system is used to protect against a level that is too low (e.g., pump dry running protection, protection against emptying or protection against insufficient filling).

In normal operation, the tuning fork is covered by liquid and the measuring system reports the OK status. If the tuning fork is free, the device assumes the safe state and signals the demand mode.

- MAX detection

The measuring system is used to protect against a level that is too high (e.g., overflow prevention).

In normal operation, the tuning fork is not covered by liquid and the measuring system reports the OK status. If the tuning fork is covered, the device assumes the safe state and signals the demand mode.

## 8.2 Commissioning or proof test report

The following device-specific test report acts as a print/master template and can be replaced or supplemented any time by the SmartBlue app or the customer's own SIL reporting and testing system.

### 8.2.1 Test Report - Page 1 -

| Device information       |
|--------------------------|
| Facility                 |
| Measuring points/TAG No. |
| Device type/order code   |
| Serial number            |

| Verification information |
|--------------------------|
| Date/time                |
| Performed by             |

| Verification result  |
|--|
| Overall result   |
| <input type="checkbox"/> Passed <span style="margin-left: 200px;"><input type="checkbox"/> Failed</span> |

| Comment |
|---------|
|         |

|                        |
|------------------------|
| Company/contact person |
| Tester                 |

\_\_\_\_\_

Date

\_\_\_\_\_

Signature

\_\_\_\_\_

Signature of tester

## 8.2.2 Test Report - Page 2 -

| Device information       |  |
|--------------------------|--|
| Facility                 |  |
| Measuring points/TAG No. |  |
| Serial number            |  |

| Verification information |  |
|--------------------------|--|
| Date/time                |  |

| Safety function - Set point monitoring |                              |
|--|------------------------------|
| <input type="checkbox"/> MIN           | <input type="checkbox"/> MAX |

| Density range setting         |                               |
|-------------------------------|-------------------------------|
| <input type="checkbox"/> >0.7 | <input type="checkbox"/> >0.5 |

| Commissioning test - Test sequence A   |  |
|--|--|
| <input type="checkbox"/> MIN detection | <input type="checkbox"/> MAX detection |

| Proof testing  |  |
|--|--|
| <input type="checkbox"/> Test sequence A, MIN detection  |  |
| <input type="checkbox"/> Test sequence A, MAX detection  |  |
| <input type="checkbox"/> Test sequence B, simulation using test button or magnet on Liquiphant |  |

| Terminal 2, check current |               |              |                                     |                          |
|---------------------------|---------------|--------------|-------------------------------------|--------------------------|
| Test step                 | Target        | Actual value | Result                              |                          |
|                           |               |              | <input checked="" type="checkbox"/> | <input type="checkbox"/> |
| Step 1                    | 2.2 to 3.8 mA |              |                                     |                          |
| Step 2                    | 0.4 to 1.0 mA |              |                                     |                          |
| Step 3                    | 2.2 to 3.8 mA |              |                                     |                          |

## 8.3 Version history

### **FY01019F; Version: 02.23**

- Valid as of firmware version: 01.01.zz
- Valid as of hardware version: 01.00.zz
- Changes:
  - Declaration of Conformity updated
  - Adjustments to text
  - Adjustments to graphics

### **FY01019F; Version: 01.20**

- Valid as of firmware version: 01.01.zz
- Valid as of hardware version: 01.00.zz
- Changes:
  - First version



71613854

[www.addresses.endress.com](http://www.addresses.endress.com)

---