

Brief Operating Instructions

Liquiphant FTL63

Vibronic

Point level switch for liquids specifically for the food and life sciences industries



These Brief Operating Instructions are not a substitute for the Operating Instructions pertaining to the device.

Detailed information is provided in the Operating Instructions and other documentation.

Available for all device versions via:

- Internet: www.endress.com/deviceviewer
- Smartphone/tablet: Endress+Hauser Operations app

1 Associated documentation



2 About this document

2.1 Symbols

2.1.1 Safety symbols



This symbol alerts you to a dangerous situation. Failure to avoid this situation will result in serious or fatal injury.



This symbol alerts you to a dangerous situation. Failure to avoid this situation can result in serious or fatal injury.

CAUTION

This symbol alerts you to a dangerous situation. Failure to avoid this situation can result in minor or medium injury.

NOTICE

This symbol contains information on procedures and other facts which do not result in personal injury.

2.1.2 Electrical symbols

 Ground connection

Grounded clamp, which is grounded via a grounding system.

 Protective earth (PE)

Ground terminals, which must be grounded prior to establishing any other connections. The ground terminals are located on the inside and outside of the device.

2.1.3 Tool symbols

 Flat-blade screwdriver

 Allen key

 Open-ended wrench

2.1.4 Symbols for certain types of information

 Permitted

Procedures, processes or actions that are permitted.

 Forbidden

Procedures, processes or actions that are forbidden.

 Tip

Indicates additional information

 Reference to documentation

 Reference to another section

 1, 2, 3. Series of steps

2.1.5 Symbols in graphics

A, B, C ... View

1, 2, 3 ... Item numbers

 Hazardous area

 Safe area (non-hazardous area)

3 Basic safety instructions

3.1 Requirements for the personnel

The personnel must fulfill the following requirements to carry out the necessary tasks, e. g., commissioning and maintenance:

- ▶ Trained, qualified specialists must have a relevant qualification for the specific function and task
- ▶ Are authorized by the plant owner/operator
- ▶ Are familiar with federal/national regulations
- ▶ Must have read and understood the instructions in the manual and supplementary documentation
- ▶ Follow instructions and comply with conditions

3.2 Intended use

- Only use the device for liquids
- Improper use can pose hazards
- Ensure that the measuring device is free of defects while it is in operation
- Use the device only for media to which the wetted materials have an adequate level of resistance
- Do not exceed or drop below the relevant limit values for the device
 - ▣ For more details, see the Technical Documentation

3.2.1 Incorrect use

The manufacturer is not liable for damage caused by improper or non-intended use.

Residual risks

Due to heat transfer from the process, the temperature of the electronics housing and the assemblies contained therein may rise to 80 °C (176 °F) during operation.

Danger of burns from contact with surfaces!

- ▶ If necessary, ensure protection against contact to prevent burns.

For requirements concerning functional safety in accordance with IEC 61508, the associated SIL documentation must be observed.

3.3 Workplace safety

For work on and with the device:

- ▶ Wear the required personal protective equipment according to federal/national regulations.

3.4 Operational safety

Risk of injury!

- ▶ Operate the device only if it is in proper technical condition, free from errors and faults.
- ▶ The operator is responsible for ensuring the interference-free operation of the device.

Modifications to the device

Unauthorized modifications to the device are not permitted and can lead to unforeseeable dangers.

- ▶ If, despite this, modifications are required, consult with Endress+Hauser.

Repair

To ensure continued operational safety and reliability:

- ▶ Only perform repair work on the device if this is expressly permitted.
- ▶ Observe federal/national regulations pertaining to the repair of an electrical device.
- ▶ Use original spare parts and accessories from Endress+Hauser only.

Hazardous area

To eliminate danger to persons or the facility when the device is used in the hazardous area (e.g. explosion protection):

- ▶ Check the nameplate to verify whether the ordered device can be used for the intended purpose in the hazardous area.
- ▶ Observe the specifications in the separate supplementary documentation that is an integral part of this manual.

3.5 Product safety

This device is designed in accordance with good engineering practice to meet state-of-the-art safety requirements, has been tested, and left the factory in a condition in which it is safe to operate.

It meets the general safety standards and legal requirements. It also complies with the EU directives listed in the device-specific EU Declaration of Conformity. Endress+Hauser confirms this by affixing the CE mark to the device.

3.6 IT security

We only provide a warranty if the device is installed and used as described in the Operating Instructions. The device has safety mechanisms integrated to prevent users from inadvertently changing settings.

Provide additional protection for the device and data transfer to/from the device

- ▶ IT security measures defined in the plant owner/operator's own security policy must be implemented by plant owners/operators themselves.

4 Incoming acceptance and product identification

4.1 Incoming acceptance

Check the following during incoming acceptance:

- Are the order codes on the delivery note and the product sticker identical?
- Are the goods undamaged?

Do the data on the nameplate match the ordering information on the delivery note?

If required (see nameplate): are the Safety Instructions e.g. XA provided?

 If one of these conditions is not met, please contact the manufacturer's sales office.

4.2 Product identification

The device can be identified in the following ways:

- Nameplate specifications
- Extended order code with breakdown of the device features on the delivery note
- Enter serial number from nameplates in *W@M Device Viewer* www.endress.com/deviceviewer. All of the information on the measuring device is displayed along with an overview of the scope of technical documentation provided.
- Enter the serial number on the nameplate into the *Endress+Hauser Operations app* or scan the 2-D matrix code on the nameplate with the *Endress+Hauser Operations app*

4.2.1 Electronic insert

 Identify the electronic insert via the order code on the nameplate.

4.2.2 Nameplate

The information that is required by law and is relevant to the device is shown on the nameplate.

4.2.3 Manufacturer address

Endress+Hauser SE+Co. KG
Hauptstraße 1
79689 Maulburg, Germany

Place of manufacture: See nameplate.

4.3 Storage and transport

4.3.1 Storage conditions

Use original packaging.

Storage temperature

-40 to +80 °C (-40 to +176 °F)

Optional: -50 °C (-58 °F), -60 °C (-76 °F)

Transporting the device

- Transport the device to the measuring point in the original packaging
- Hold the device by the housing, temperature spacer, process connection or extension pipe
- Do not bend, shorten or extend the tuning fork

5 Mounting

Mounting instructions

- Any orientation for compact version or version with a pipe length of up to 500 mm (19.7 in) approx.
- Vertical orientation from above for device with long pipe
- Minimum distance between the tuning fork and the tank wall or pipe wall: 10 mm (0.39 in)

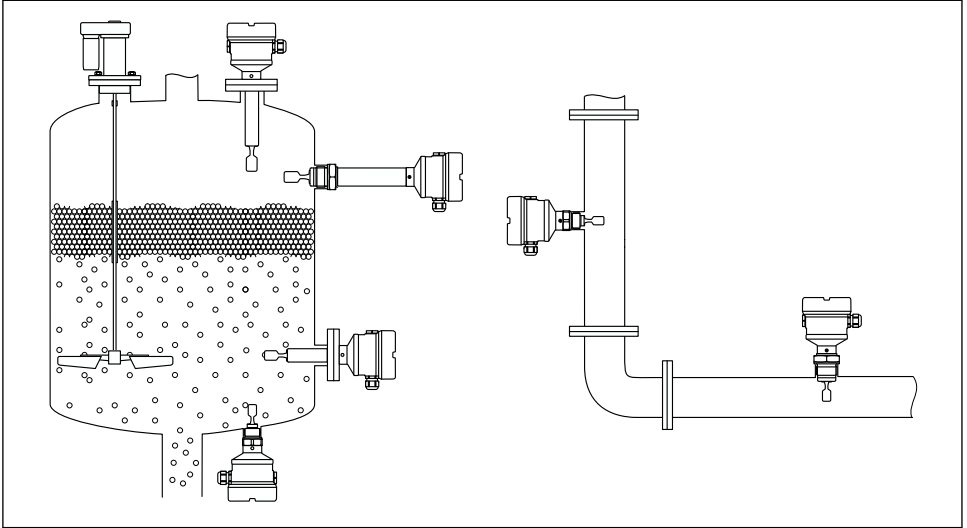

A0037879

 1 *Installation examples for a vessel, tank or pipe*

5.1 Mounting requirements

5.1.1 Take switch point into consideration

The following are typical switch points, depending on the orientation of the point level switch.

Water +23 °C (+73 °F)

-  Minimum distance between the tuning fork and the tank wall or pipe wall:
10 mm (0.39 in)

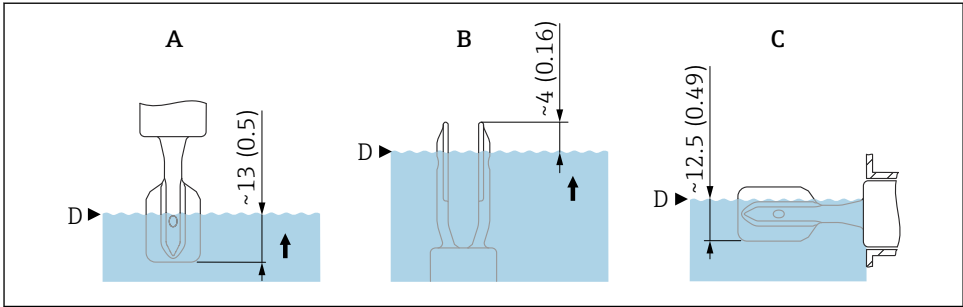

A0037915

2 Typical switch points. Unit of measurement mm (in)

- A Installation from above
- B Installation from below
- C Installation from the side
- D Switch point

5.1.2 Take viscosity into consideration

- i** Viscosity values
 - Low viscosity : < 2 000 mPa·s
 - High viscosity : > 2 000 to 10 000 mPa·s

Low viscosity

- i** It is permitted to position the tuning fork within the installation socket.

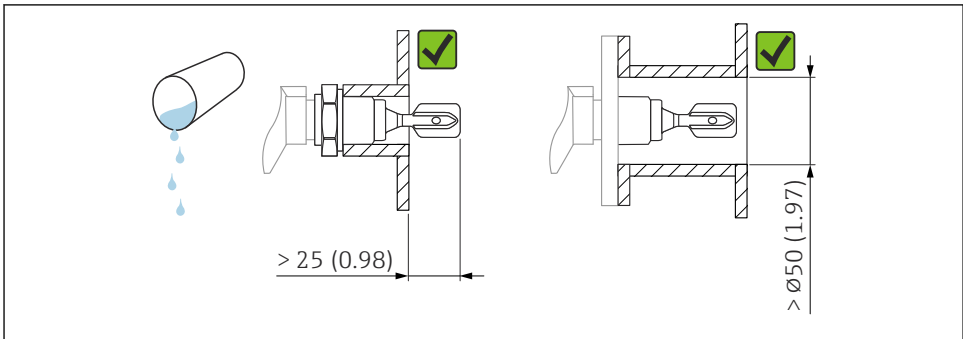

A0033297

3 Installation example for low-viscosity liquids. Unit of measurement mm (in)

High viscosity

NOTICE

Highly viscous liquids may cause switching delays.

- ▶ Make sure that the liquid can run off the tuning fork easily.
- ▶ Deburr the socket surface.



The tuning fork must be located outside the installation socket!

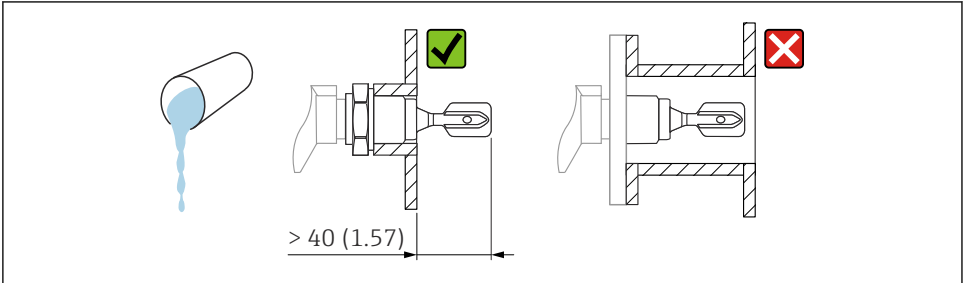

A0037348

4 Installation example for a highly viscous liquid. Unit of measurement mm (in)

5.1.3 Avoid buildup

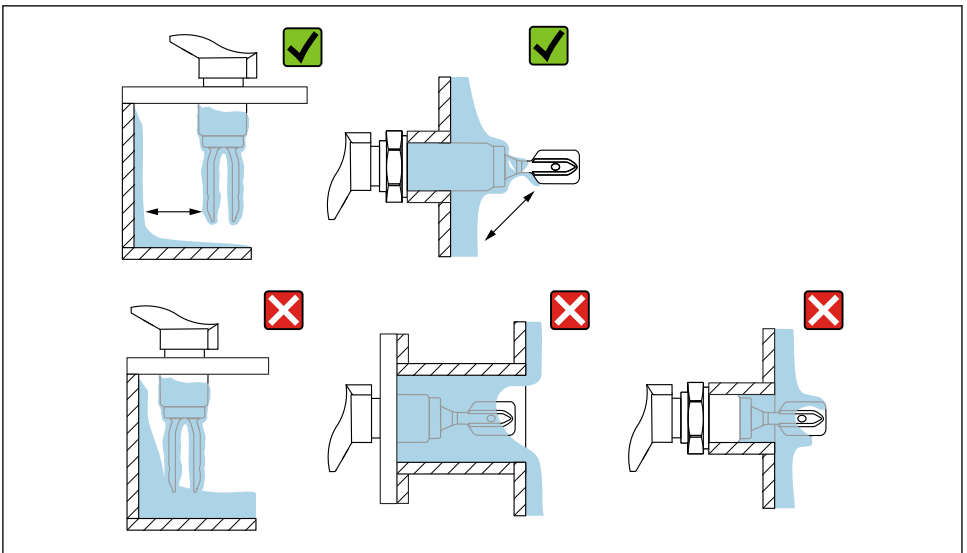

A0033239

5 Installation examples for a highly viscous process medium

5.1.4 Take clearance into consideration

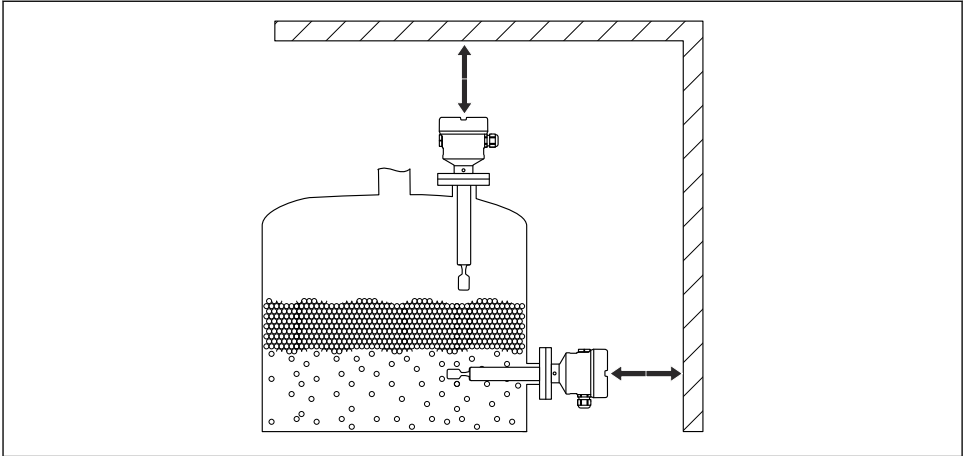

A0033236

6 Take clearance outside the tank into consideration

5.1.5 Support the device

Support the device in the event of severe dynamic load. Maximum lateral loading capacity of the pipe extensions and sensors: 75 Nm (55 lbf ft).

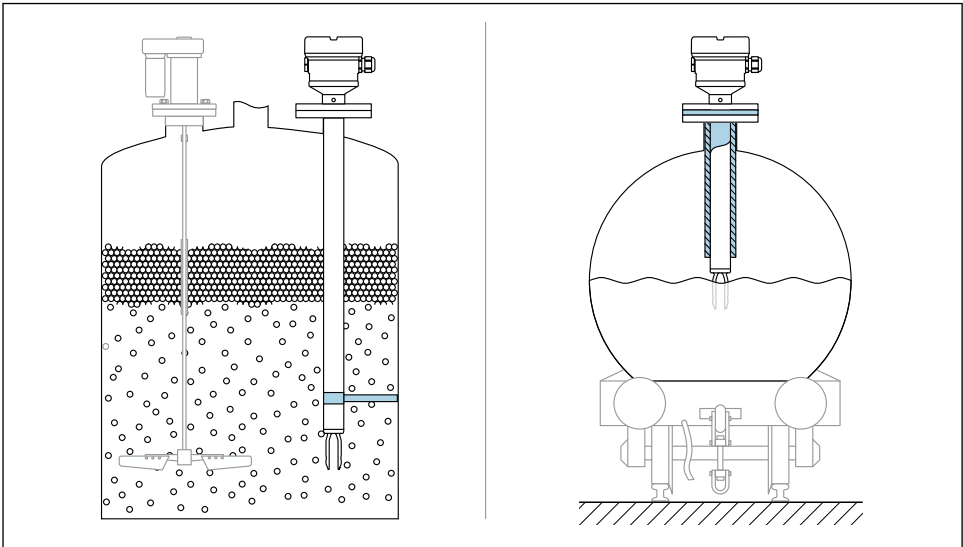

A0031874

7 Examples of support in the event of dynamic load

5.1.6 Weld-in adapter with leakage hole

Weld in the weld-in adapter in such a way that the leakage hole is pointing downwards. This enables any leaks to be detected quickly.

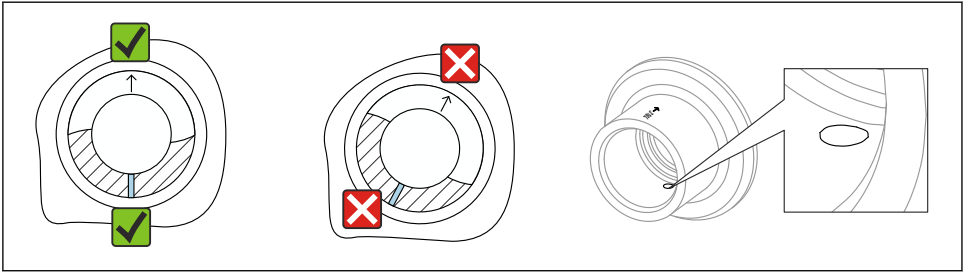

A0039230

8 Weld-in adapter with leakage hole

5.2 Mounting the device

5.2.1 Required tool

- Open-ended wrench for sensor installation
- Allen key for housing locking screw

5.2.2 Installation

Aligning the tuning fork using the marking

The tuning fork can be aligned using the marking in such a way that the medium drains off easily and buildup is avoided.

Markings are labeled on the process connection by means of:

Material specification, thread designation, circle, line or double line

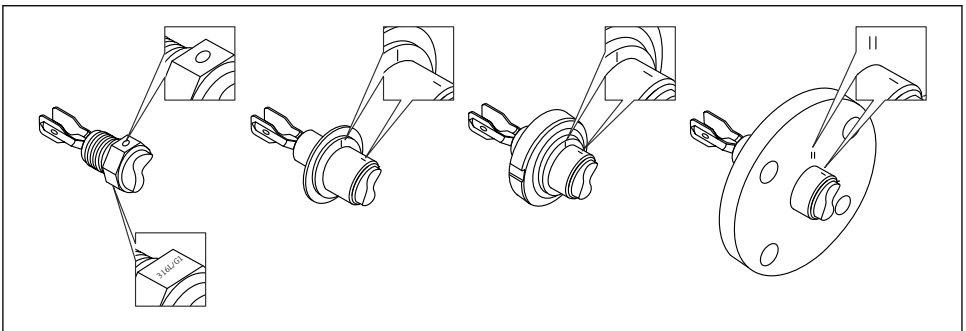

A0039125

9 Position of the tuning fork when installed horizontally in the vessel using the marking

Installing the device in piping

- Flow velocity up to 5 m/s with a viscosity of 1 mPa·s and density of 1 g/cm³ (62.4 lb/ft³) (SGU).
Check for correct functioning in the event of other process medium conditions.
- The flow will not be significantly impeded if the tuning fork is correctly aligned and the marking is pointing in the direction of flow.
- The marking is visible when installed.

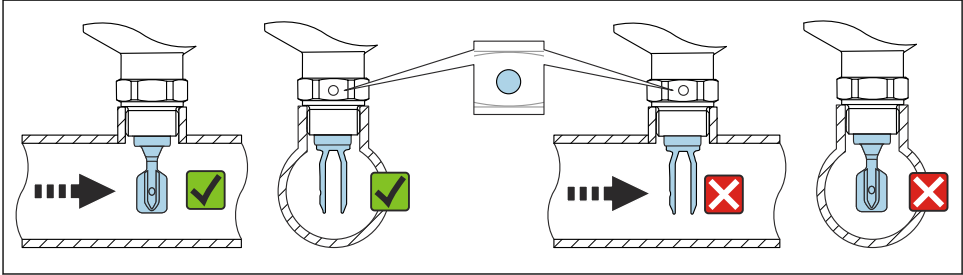

A0034851

10 Installation in pipes (take fork position and marking into consideration)

Screwing in the device

- Turn by the hex bolt only, 15 to 30 Nm (11 to 22 lbf ft)
- Do not turn at the housing!

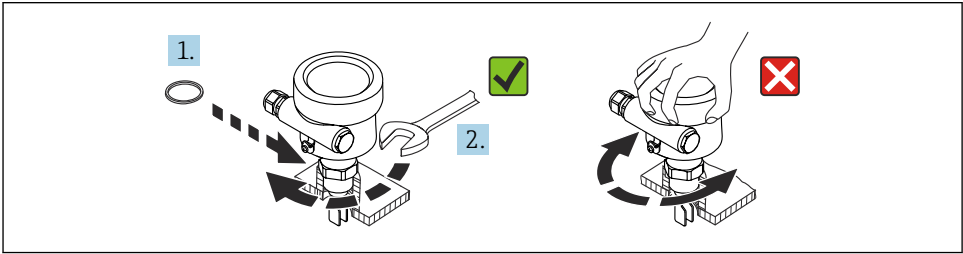

A0034852

11 Screwing in the device

Aligning the cable entry

All housings can be aligned.

Housing without locking screw

The device housing can be rotated up to 350°.

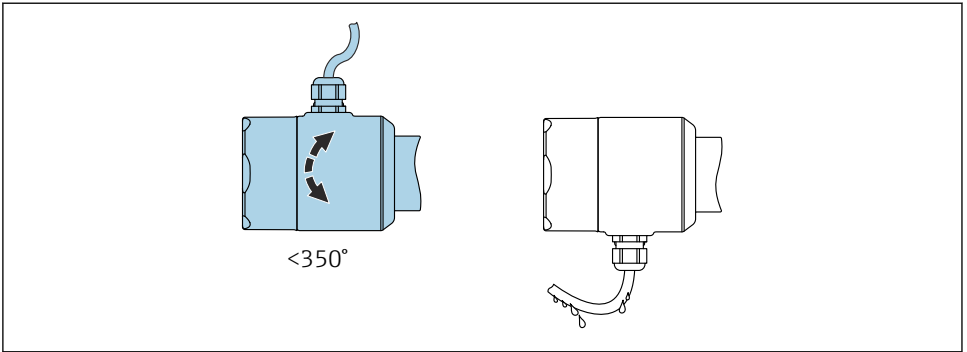

A0052359

12 Housing without locking screw with drip loop

Housing with locking screw



Housings with locking screw:

- The housing can be turned and the cable aligned by turning the locking screw.
- The locking screw is not tightened when the device is delivered.

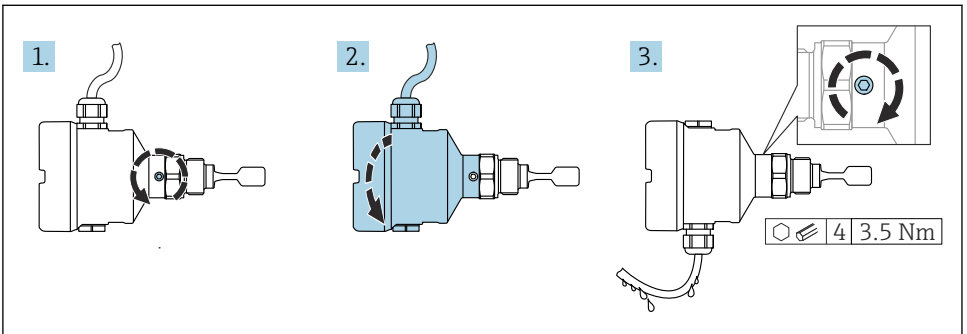

A0037347

13 Housing with external locking screw and drip loop

1. Loosen the external locking screw (maximum 1.5 turns).
2. Turn the housing, align the cable entry.
 - ↳ Avoid moisture in the housing, provide a loop to allow moisture to drain off.
3. Tighten the external locking screw.

NOTICE**The housing cannot be unscrewed fully.**

- ▶ Loosen the external locking screw by a maximum of 1.5 turns. If the screw is unscrewed too much or completely (beyond the screw anchor point), small parts (counter disk) can become loose and fall out.
- ▶ Tighten the securing screw (hexagon socket 4 mm (0.16 in)) with maximum 3.5 Nm (2.58 lbf ft)±0.3 Nm (±0.22 lbf ft).

*Closing the housing covers***NOTICE****Thread and housing cover damaged from dirt and fouling!**

- ▶ Remove dirt (e.g. sand) on the thread of the covers and housing.
- ▶ If you continue to encounter resistance when closing the cover, check the thread again for fouling.

**Housing thread**

The threads of the electronics and connection compartment can be coated with an anti-friction coating.

The following applies for all housing materials:

✘ Do not lubricate the housing threads.

6 Electrical connection

6.1 Required tool

- Screwdriver for electrical connection
- Allen key for screw of cover lock

6.2 Connecting requirements

6.2.1 Cover with securing screw

The cover is locked by a securing screw in devices for use in hazardous areas with certain explosion protection.

NOTICE**If the securing screw is not positioned correctly, the cover cannot provide secure sealing.**

- ▶ Open the cover: slacken the screw of the cover lock with a maximum of 2 turns so that the screw does not fall out. Fit the cover and check the cover seal.
- ▶ Close the cover: screw the cover securely onto the housing, making sure that the securing screw is positioned correctly. There should not be any gap between the cover and housing.

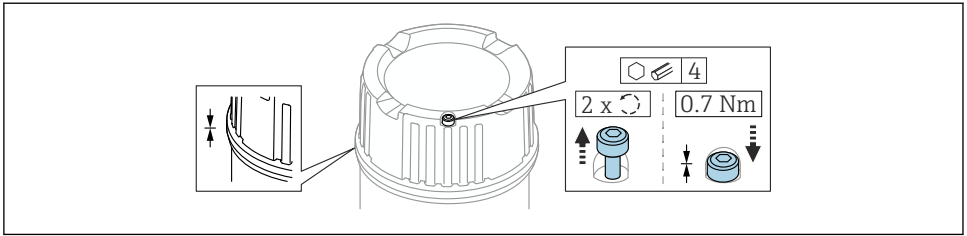

A0039520

14 Cover with securing screw

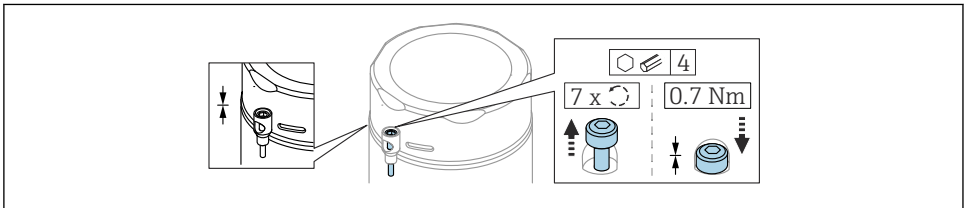

A0050983

15 Cover with securing screw; hygienic housing (only for dust explosion protection)

6.2.2 Connecting protective earth (PE)

The protective earth conductor at the device must only be connected if the device's operating voltage is $\geq 35 V_{DC}$ or $\geq 16 V_{ACeff}$.

When the device is used in hazardous areas, it must always be included in the potential equalization of the system, irrespective of the operating voltage.

i The plastic housing is available with or without an external protective earth connection (PE). If the operating voltage of the electronic insert is $< 35 V$, the plastic housing has no external protective earth connection.

6.3 Connecting the device

i Housing thread

The threads of the electronics and connection compartment can be coated with an anti-friction coating.

The following applies for all housing materials:

✗ Do not lubricate the housing threads.

6.3.1 2-wire AC (electronic insert FEL61)

- Two-wire AC version
- Switches the load directly into the power supply circuit via an electronic switch; always connect in series with a load
- Functional testing without level change
A functional test can be performed on the device using the test button on the electronic insert.

Supply voltage

$U = 19 \text{ to } 253 \text{ V}_{AC}, 50 \text{ Hz}/60 \text{ Hz}$

Residual voltage when switched through: typically 12 V



Observe the following as per IEC/EN61010-1: Provide a suitable circuit breaker for the device, and limit the current to 1 A, e.g. by installing a 1 A fuse (slow-blow) in the phase (not the neutral conductor) of the supply circuit.

Power consumption

$S \leq 2 \text{ VA}$

Current consumption

Residual current when blocked: $I \leq 3.8 \text{ mA}$

The red LED flashes in the event of an overload or short-circuit. Check for an overload or short-circuit every 5 s. The test is deactivated after 60 s.

Connectable load

- Load with a minimum holding power/rated power of 2.5 VA at 253 V (10 mA) or 0.5 VA at 24 V (20 mA)
- Load with a maximum holding power/rated power of 89 VA at 253 V (350 mA) or 8.4 VA at 24 V (350 mA)
- With overload and short-circuit protection

Behavior of output signal

- OK status: load on (switched through)
- Demand mode: load off (blocked)
- Alarm: load off (blocked)

Terminals

Terminals for cable cross-section up to 2.5 mm^2 (14 AWG). Use ferrules for the wires.

Overvoltage protection

Overvoltage category II

Terminal assignment

Always connect an external load. The electronic insert has integrated short-circuit protection.

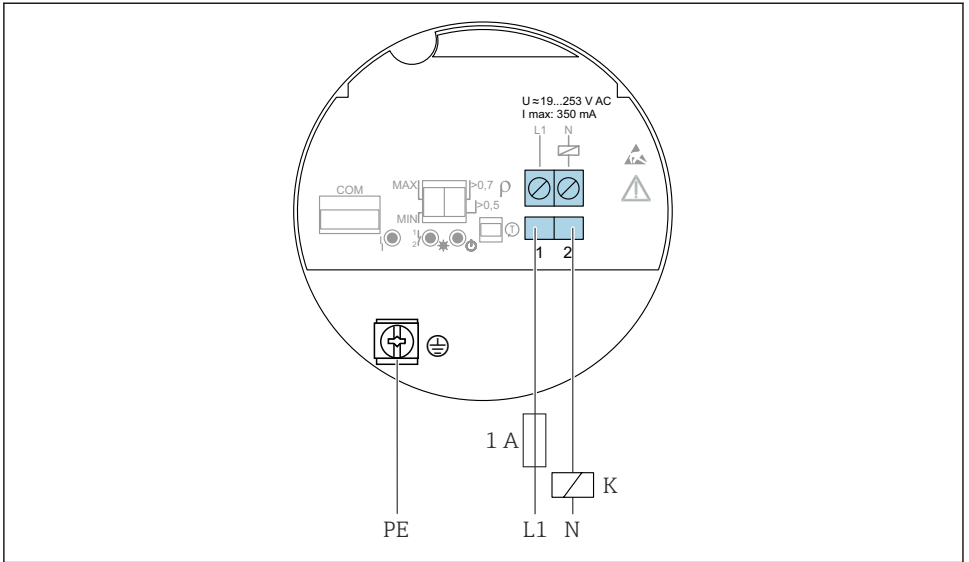

A0036060

16 2-wire AC, electronic insert FEL61

Behavior of switch output and signaling

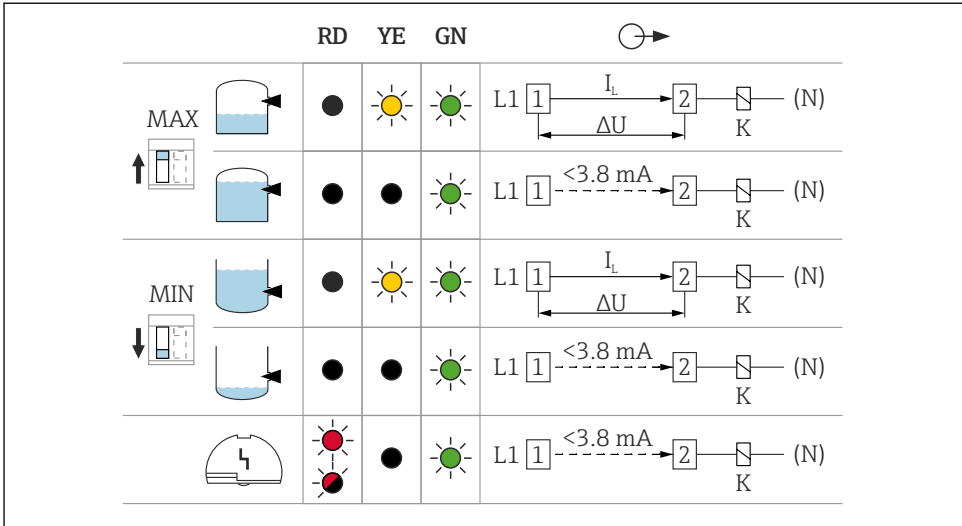

A0031901

 17 Behavior of switch output and signaling, electronic insert FEL61

MAXDIP switch for setting MAX safety mode

MIN DIP switch for setting MIN safety mode

RD LED red for warning or alarm

YE LED yellow, switch status

GN LED green, operational status, device on

I_L Load current switched through

Selection tool for relays

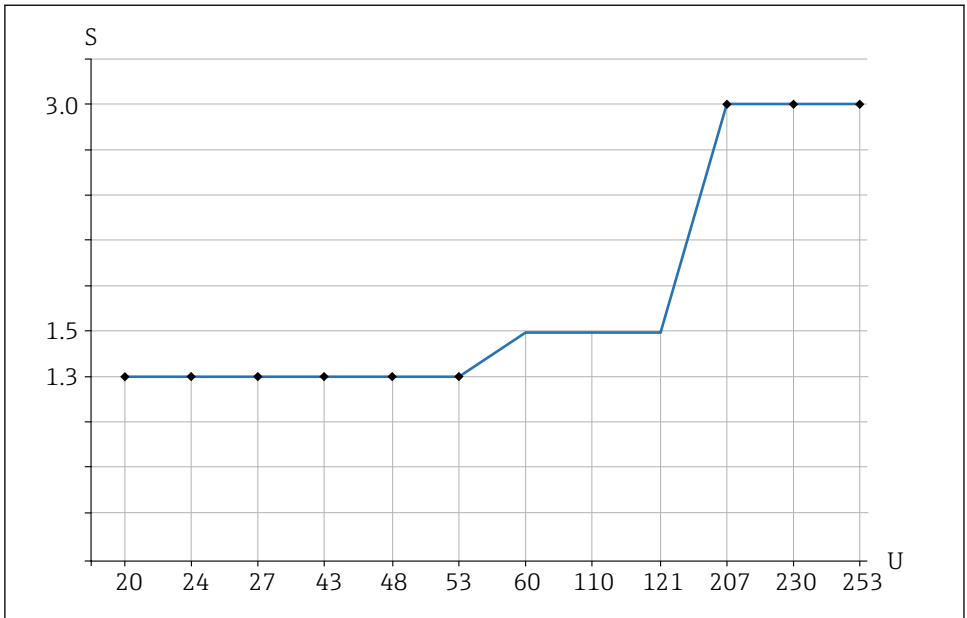

A0042052

18 Recommended minimum holding power/rated power for load

S Holding power/rated power in [VA]

U Operating voltage in [V]

AC mode

- Operating voltage: 24 V, 50 Hz/60 Hz
- Holding power/rated power: > 0.5 VA, < 8.4 VA
- Operating voltage: 110 V, 50 Hz/60 Hz
- Holding power/rated power: > 1.1 VA, < 38.5 VA
- Operating voltage: 230 V, 50 Hz/60 Hz
- Holding power/rated power: > 2.3 VA, < 80.5 VA

6.3.2 3-wire DC-PNP (electronic insert FEL62)

- Three-wire DC version
- Preferably in conjunction with programmable logic controllers (PLC), DI modules as per EN 61131-2. Positive signal at switch output of electronics module (PNP)
- Functional testing without level change

A functional test can be performed on the device using the test button on the electronic insert or using the test magnet (can be ordered as an option) with the housing closed.

Supply voltage

WARNING

Failure to use the prescribed power unit.

Risk of potentially life-threatening electric shock!

- ▶ The FEL62 may only be powered by devices with safe galvanic isolation, as per IEC 61010-1.

$$U = 10 \text{ to } 55 \text{ V}_{\text{DC}}$$



The device must be powered by a voltage supply categorized as "CLASS 2" or "SELV".



Comply with the following according to IEC/EN61010-1: provide a suitable circuit breaker for the device and limit the current to 500 mA, e.g. by installing a 0.5 A fuse (slow-blow) in the power supply circuit.

Power consumption

$$P \leq 0.5 \text{ W}$$

Current consumption

$$I \leq 10 \text{ mA (without load)}$$

The red LED flashes in the event of an overload or short-circuit. Check for an overload or short-circuit every 5 s.

Load current

$$I \leq 350 \text{ mA with overload and short-circuit protection}$$

Capacitance load

$$C \leq 0.5 \text{ } \mu\text{F at } 55 \text{ V, } C \leq 1.0 \text{ } \mu\text{F at } 24 \text{ V}$$

Residual current

$$I < 100 \text{ } \mu\text{A (for blocked transistor)}$$

Residual voltage

$$U < 3 \text{ V (for switched through transistor)}$$

Behavior of output signal

- OK status: switched through
- Demand mode: blocked
- Alarm: blocked

Terminals

Terminals for cable cross-section up to 2.5 mm² (14 AWG). Use ferrules for the wires.

Overvoltage protection

Overvoltage category I

Terminal assignment

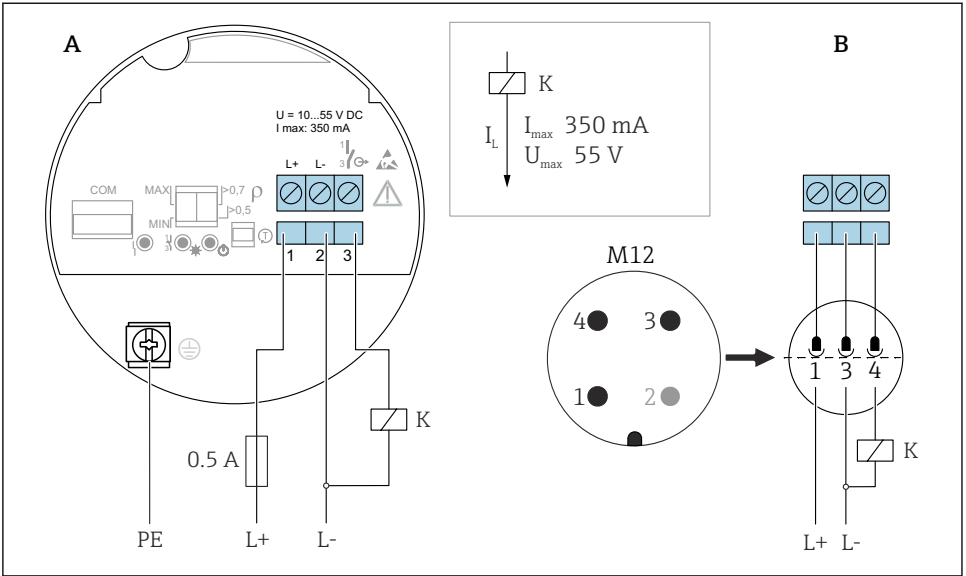

A0036061

19 3-wire DC-PNP, electronic insert FEL62

A Connection wiring with terminals

B Connection wiring with M12 plug in housing according to EN61131-2 standard

Behavior of switch output and signaling

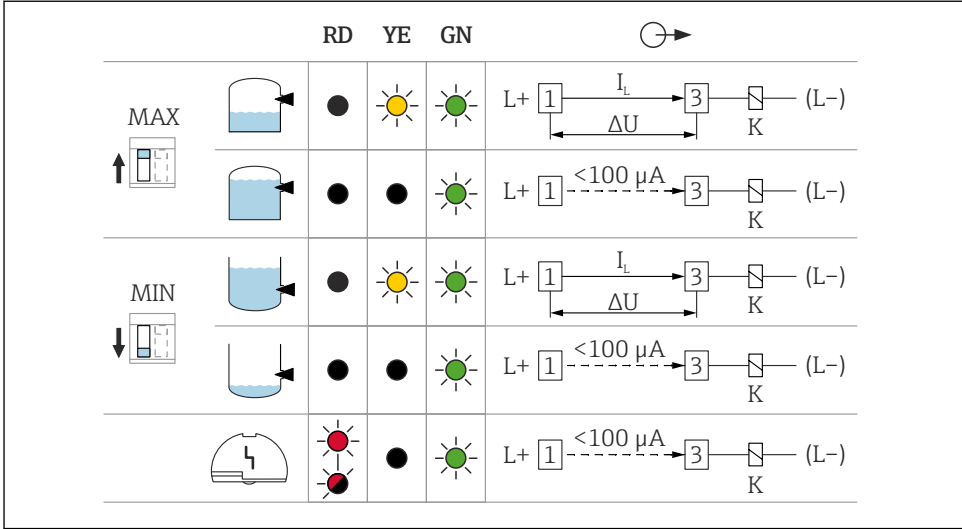

20 Behavior of switch output and signaling, electronic insert FEL62

MAXDIP switch for setting MAX safety mode

MIN DIP switch for setting MIN safety mode

RD LED red for warning or alarm

YE LED yellow, switch status

GN LED green, operational status, device on

I_L Load current switched through

6.3.3 Universal current connection with relay output (electronic insert FEL64)

- Switches the loads via 2 potential-free change-over contacts
- 2 galvanically isolated change-over contacts (DPDT), both change-over contacts switch simultaneously
- Functional testing without level change. A functional test can be performed on the device using the test button on the electronic insert or using the test magnet (can be ordered as an option) with the housing closed.

WARNING

An error at the electronic insert can cause the permitted temperature for touch-safe surfaces to be exceeded. This presents a risk of burns.

- Do not touch the electronics in the event of an error!

Supply voltage

$U = 19 \text{ to } 253 \text{ V}_{AC}, 50 \text{ Hz}/60 \text{ Hz} / 19 \text{ to } 55 \text{ V}_{DC}$



Comply with the following according to IEC/EN61010-1: provide a suitable circuit breaker for the device and limit the current to 500 mA, e.g. by installing a 0.5 A fuse (slow-blow) in the power supply circuit.

Power consumption

$S < 25 \text{ VA}, P < 1.3 \text{ W}$

Connectable load

Loads switched via 2 potential-free changeover contacts (DPDT)

- $I_{AC} \leq 6 \text{ A}, U \sim \leq \text{AC } 253 \text{ V}; P \sim \leq 1500 \text{ VA}, \cos \varphi = 1, P \sim \leq 750 \text{ VA}, \cos \varphi > 0.7$
- $I_{DC} \leq 6 \text{ A to DC } 30 \text{ V}, I_{DC} \leq 0.2 \text{ A to } 125 \text{ V}$



Additional restrictions for the connectable load depend on the selected approval. Pay attention to the information in the Safety Instructions (XA).

According to IEC 61010, the following applies: total voltage from relay outputs and power supply $\leq 300 \text{ V}$.

Use electronic insert FEL62 DC PNP for small DC load currents, e.g. for connection to a PLC.

Relay contact material: silver/nickel AgNi 90/10

When connecting a device with high inductance, provide a spark suppressor to protect the relay contact. A fine-wire fuse (depending on the connected load) protects the relay contact in the event of a short-circuit.

Both relay contacts switch simultaneously.

Behavior of output signal

- OK status: relay energized
- Demand mode: relay de-energized
- Alarm: relay de-energized

Terminals

Terminals for cable cross-section up to 2.5 mm^2 (14 AWG). Use ferrules for the wires.

Overvoltage protection

Overvoltage category II

Terminal assignment

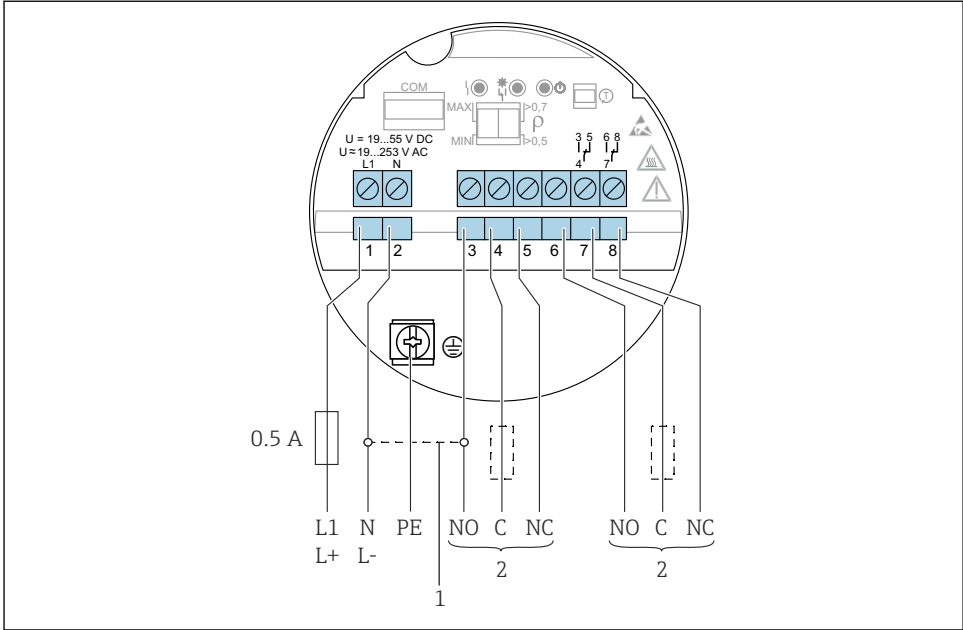















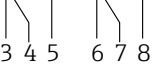



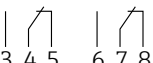







A0036062

21 Universal current connection with relay output, electronic insert FEL64

- 1 When bridged, the relay output works with NPN logic
- 2 Connectable load

Behavior of switch output and signaling

		RD	YE	GN	
MAX 					
					
MIN 					
					
					

A003513

▣ 22 Behavior of switch output and signaling, electronic insert FEL64

MAXDIP switch for setting MAX safety mode

MIN DIP switch for setting MIN safety mode

RD LED red for alarm

YE LED yellow, switch status

GN LED green, operational status, device on

6.3.4 DC connection, relay output (electronic insert FEL64 DC)

- Switches the loads via 2 potential-free change-over contacts
- 2 galvanically isolated change-over contacts (DPDT), both change-over contacts switch simultaneously
- Functional testing without level change. Functional testing of the entire device can be performed using the test button on the electronic insert or with the test magnet (can be ordered as an option) with the housing closed.

Supply voltage

$U = 9 \text{ to } 20 \text{ V}_{\text{DC}}$



The device must be powered by a voltage supply categorized as "CLASS 2" or "SELV".



Comply with the following according to IEC/EN61010-1: provide a suitable circuit breaker for the device and limit the current to 500 mA, e.g. by installing a 0.5 A fuse (slow-blow) in the power supply circuit.

Power consumption

$P < 1.0 \text{ W}$

Connectable load

Loads switched via 2 potential-free change-over contacts (DPDT)

- $I_{AC} \leq 6 \text{ A}$, $U \sim \leq \text{AC } 253 \text{ V}$; $P \sim \leq 1500 \text{ VA}$, $\cos \varphi = 1$, $P \sim \leq 750 \text{ VA}$, $\cos \varphi > 0.7$
- $I_{DC} \leq 6 \text{ A}$ to DC 30 V, $I_{DC} \leq 0.2 \text{ A}$ to 125 V



Additional restrictions for the connectable load depend on the selected approval. Pay attention to the information in the Safety Instructions (XA).

According to IEC 61010, the following applies: Total voltage from relay outputs and power supply $\leq 300 \text{ V}$

Electronic insert FEL62 DC PNP preferred for small DC load currents, e.g. connection to a PLC.

Relay contact material: silver/nickel AgNi 90/10

When connecting a device with high inductance, provide spark quenching to protect the relay contact. A fine-wire fuse (depending on the connected load) protects the relay contact in the event of a short-circuit.

Behavior of output signal

- OK status: relay energized
- Demand mode: relay de-energized
- Alarm: relay de-energized

Terminals

Terminals for cable cross-section up to 2.5 mm^2 (14 AWG). Use ferrules for the wires.

Overvoltage protection

Overvoltage category I

Terminal assignment

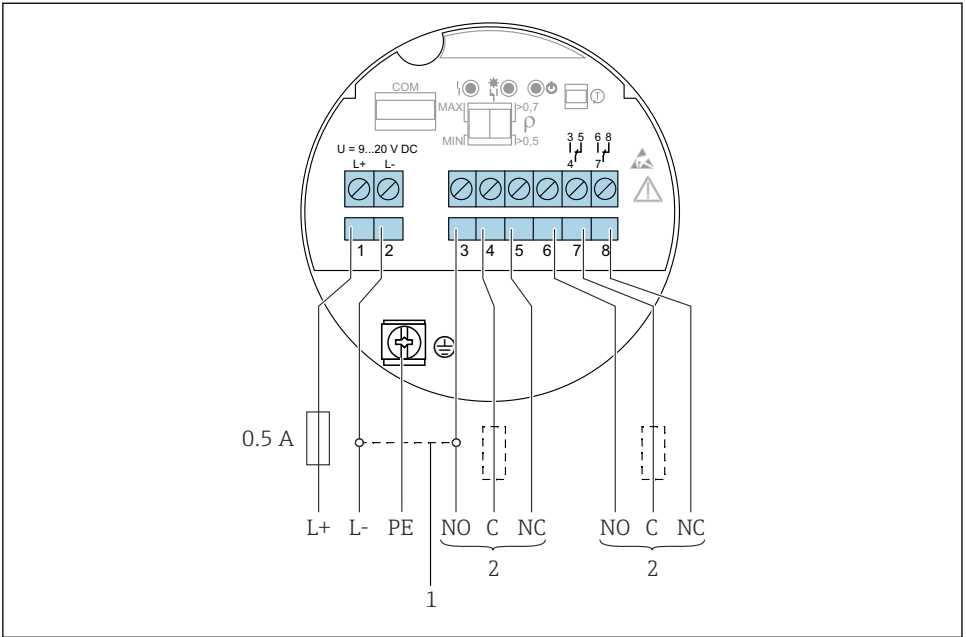

A0037685

23 DC connection with relay output, electronic insert FEL64 DC

- 1 When bridged, the relay output works with NPN logic
- 2 Connectable load

Behavior of switch output and signaling

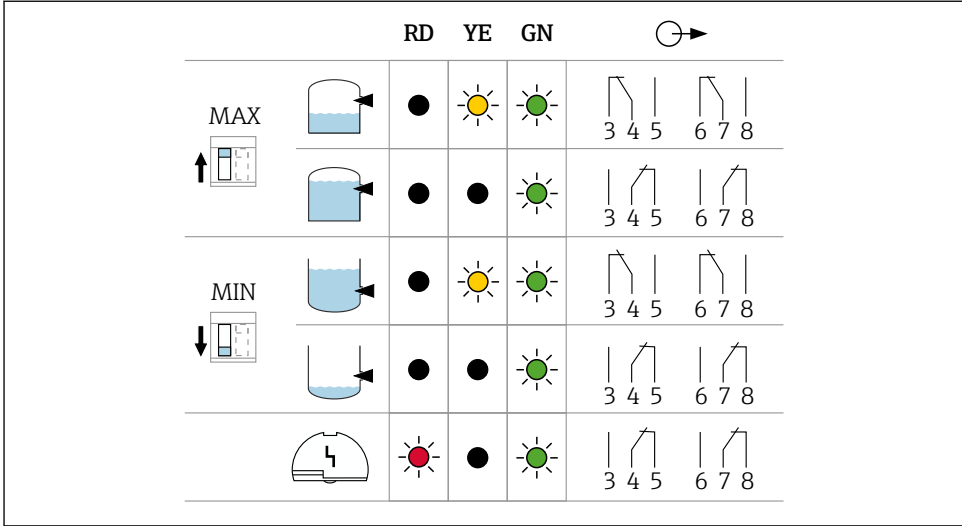

A0033513

24 Behavior of switch output and signaling, electronic insert FEL64 DC

MAXDIP switch for setting MAX safety mode

MIN DIP switch for setting MIN safety mode

RD LED red for alarm

YE LED yellow, switch status

GN LED green, operational status, device on

6.3.5 PFM output (electronic insert FEL67)

- For connection to Endress+Hauser Nivotester switching units FTL325P and FTL375P
- PFM signal transmission; pulse frequency modulation, superimposed on the power supply along the two-wire cabling
- Functional testing without level change:
 - A functional test can be performed on the device using the test button on the electronic insert.
 - The functional test can also be prompted by disconnecting the supply voltage or triggered directly by the Nivotester FTL325P and FTL375P switching unit.

Supply voltage

$U = 9.5 \text{ to } 12.5 \text{ V}_{\text{DC}}$



The device must be powered by a voltage supply categorized as "CLASS 2" or "SELV".



Comply with the following according to IEC/EN61010-1: provide a suitable circuit breaker for the device.

Power consumption

$P \leq 150$ mW with Nivotester FTL325P or FTL375P

Behavior of output signal

- OK status: MAX operating mode 150 Hz, MIN operating mode 50 Hz
- Demand mode: MAX operating mode 50 Hz, MIN operating mode 150 Hz
- Alarm: MAX/MIN operating mode 0 Hz

Terminals

Terminals for cable cross-section up to 2.5 mm^2 (14 AWG). Use ferrules for the wires.

Overvoltage protection

Overvoltage category I

Terminal assignment

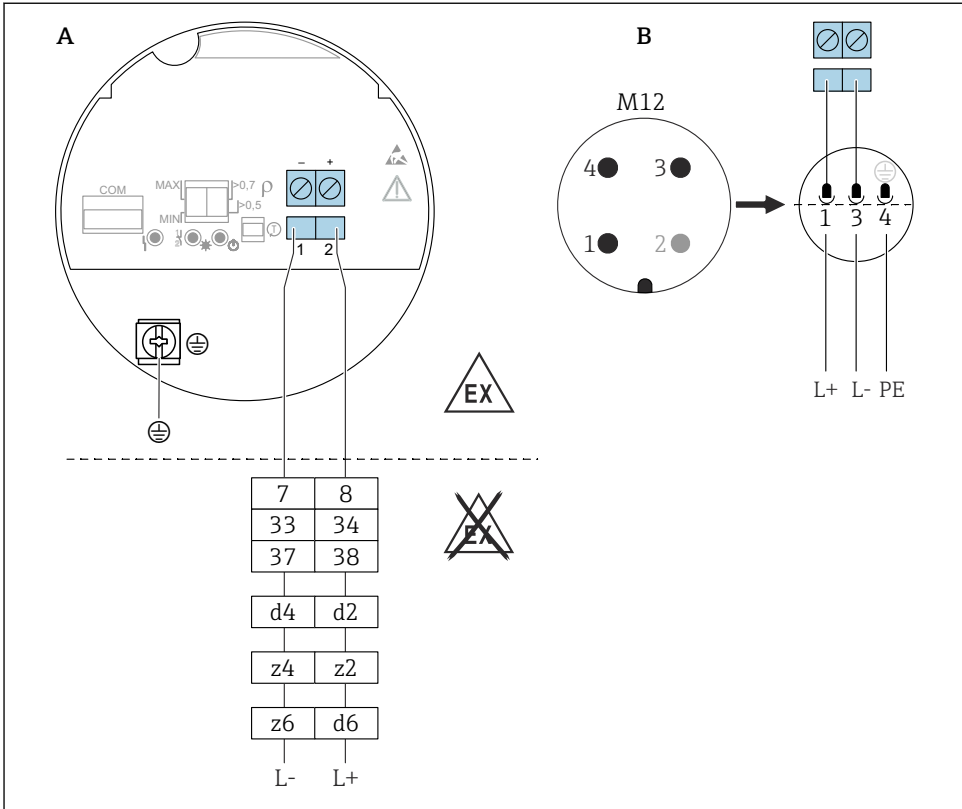

25 PFM output, electronic insert FEL67

A Connection wiring with terminals

B Connection wiring with M12 plug in housing according to EN61131-2 standard

7/ 8: Nivotester FTL325P 1 CH, FTL325P 3 CH input 1

33/ 34: Nivotester FTL325P 3 CH input 2

37/ 38: Nivotester FTL325P 3 CH input 3

d4/ d2: Nivotester FTL375P input 1

z4/ z2: Nivotester FTL375P input 2

z6/ d6: Nivotester FTL375P input 3

Connection cable

- Maximum cable resistance: 25 Ω per core
- Maximum cable capacitance: < 100 nF
- Maximum cable length: 1 000 m (3 281 ft)

Behavior of switch output and signaling

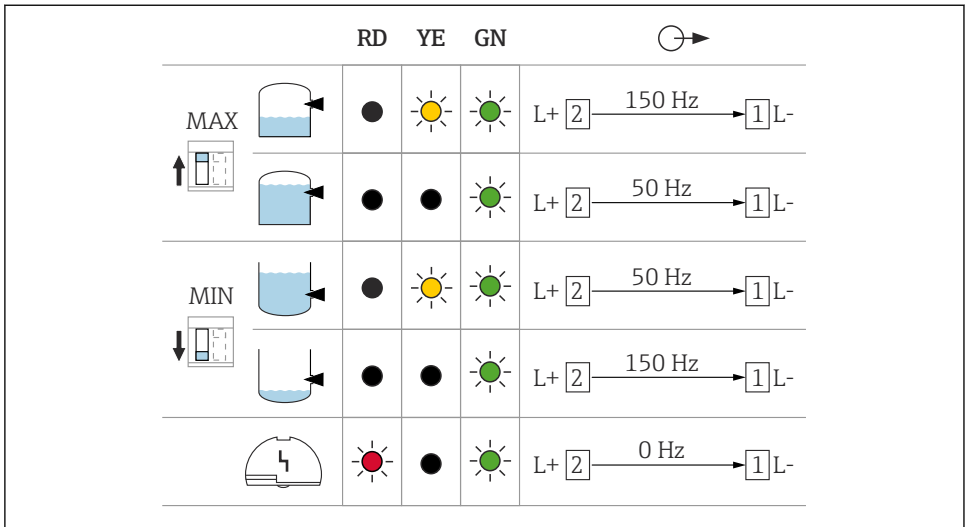

A0037696

▣ 26 Switching behavior and signaling, electronic insert FEL67

MAXDIP switch for setting MAX safety mode

MIN DIP switch for setting MIN safety mode

RD LED red for alarm

YE LED yellow, switch status

GN LED green, operational status, device on

 The switches for MAX/MIN on the electronic insert and the FTL325P switching unit must be set according to the application. Only then is it possible to perform the functional test correctly.

6.3.6 2-wire NAMUR > 2.2 mA/ < 1.0 mA (electronic insert FEL68)

- To connect to isolating amplifiers according to NAMUR (IEC 60947-5-6), e.g. Nivotester FTL325N from Endress+Hauser
- To connect to isolating amplifiers of third-party suppliers according to NAMUR (IEC 60947-5-6), a permanent power supply for the electronic insert FEL68 must be ensured.
- Signal transmission H-L edge 2.2 to 3.8 mA/ 0.4 to 1.0 mA according to NAMUR (IEC 60947-5-6) on two-wire cabling
- Functional testing without level change. A functional test can be performed on the device using the test button on the electronic insert or using the test magnet (can be ordered as an option) with the housing closed.

The functional test can also be triggered by interrupting the supply voltage or activated directly from the Nivotester FTL325N.

Supply voltage

$$U = 8.2 V_{DC} \pm 20\%$$



The device must be powered by a voltage supply categorized as "CLASS 2" or "SELV".



Comply with the following according to IEC/EN61010-1: provide a suitable circuit breaker for the device.

Power consumption

NAMUR IEC 60947-5-6

< 6 mW with $I < 1$ mA; < 38 mW with $I = 3.5$ mA

Connection data interface

NAMUR IEC 60947-5-6

Behavior of output signal

- OK status: output current 2.2 to 3.8 mA
- Demand mode: output current 0.4 to 1.0 mA
- Alarm: output current < 1.0 mA

Terminals

Terminals for cable cross-section up to 2.5 mm² (14 AWG). Use ferrules for the wires.

Overvoltage protection

Overvoltage category I

Terminal assignment

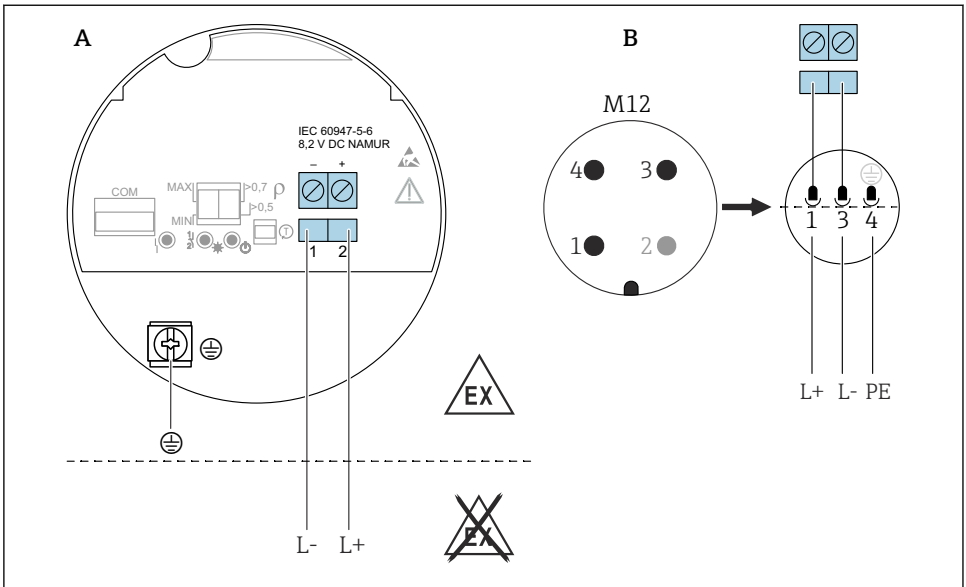

A0036066

27 2-wire NAMUR $\geq 2.2 \text{ mA}$ / $\leq 1.0 \text{ mA}$, electronic insert FEL68

A Connection wiring with terminals

B Connection wiring with M12 plug in housing according to EN61131-2 standard

Behavior of switch output and signaling

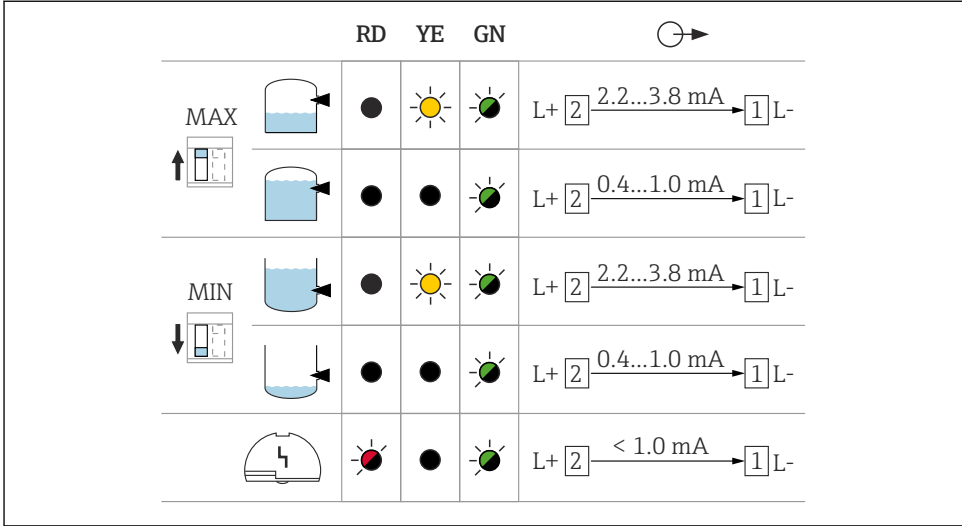

A0037694

28 Behavior of switch output and signaling, electronic insert FEL68

MAXDIP switch for setting MAX safety mode

MIN DIP switch for setting MIN safety mode

RD Red LED for alarm

YE Yellow LED, switch status

GN Green LED, operational status, device on

The Bluetooth module for use in conjunction with the electronic insert FEL68 (2-wire NAMUR) must be ordered separately with the necessary battery.

6.3.7 Bluetooth module VU121 (optional)

The Bluetooth module can be connected via the COM interface to the following electronic inserts: FEL61, FEL62, FEL64, FEL64 DC, FEL67, FEL68 (2-wire NAMUR). In conjunction with the electronic insert FEL68 (2-wire NAMUR), the Bluetooth module must be ordered separately with the necessary battery.

6.3.8 LED module VU120 (optional)

A brightly lit LED indicates the operational status (switch status or alarm status) in green, yellow or red. The LED module can be connected to the following electronic inserts: FEL62, FEL64, FEL64DC.

6.3.9 Connecting the cable

Required tools

- Flat-blade screwdriver (0.6 mm x 3.5 mm) for terminals
- Suitable tool with width across flats AF24/25 (8 Nm (5.9 lbf ft)) for M20 cable gland

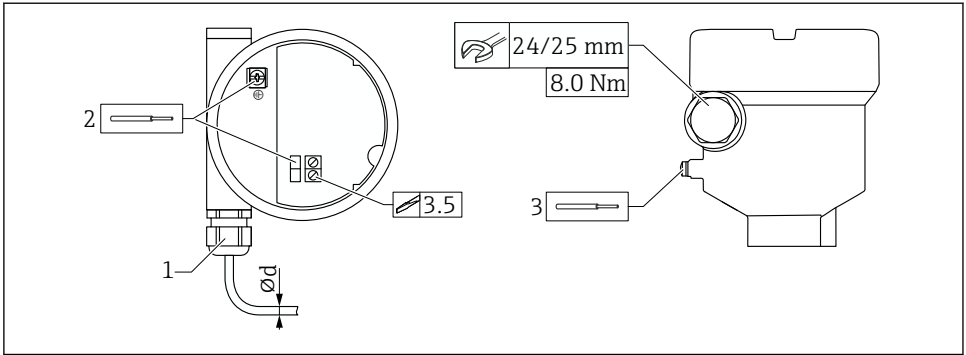

A0018023

29 Example of coupling with cable entry, electronic insert with terminals

- 1 M20 coupling (with cable entry), example
 - 2 Conductor cross-section maximum 2.5 mm^2 (AWG14), ground terminal on inside in housing + terminals on the electronics
 - 3 Conductor cross-section maximum 4.0 mm^2 (AWG12), ground terminal on outside of the housing (example: plastic housing with outer protective ground connection (PE))
- Ød Nickel-plated brass 7 to 10.5 mm (0.28 to 0.41 in),
 plastic 5 to 10 mm (0.2 to 0.38 in),
 Stainless steel 7 to 12 mm (0.28 to 0.47 in)
 stainless steel, hygienic 9 to 12 mm (0.35 to 0.47 in)



Pay attention to the following when using the M20 coupling

Following cable entry:

- Counter-tighten the coupling
- Tighten the union nut of the coupling with 8 Nm (5.9 lbf ft)
- Screw the enclosed coupling into the housing with 3.75 Nm (2.76 lbf ft)

7 Operation options

7.1 Overview of operation options

7.1.1 Operating concept

- Operation with button and DIP switches on the electronic insert
- Display with optional Bluetooth module and SmartBlue app via Bluetooth® wireless technology, see the Operating Instructions.
- Indication of operational status (switch status or alarm status) with optional LED module (signal lights visible from the outside), see the Operating Instructions.

7.2 Elements on the electronic insert

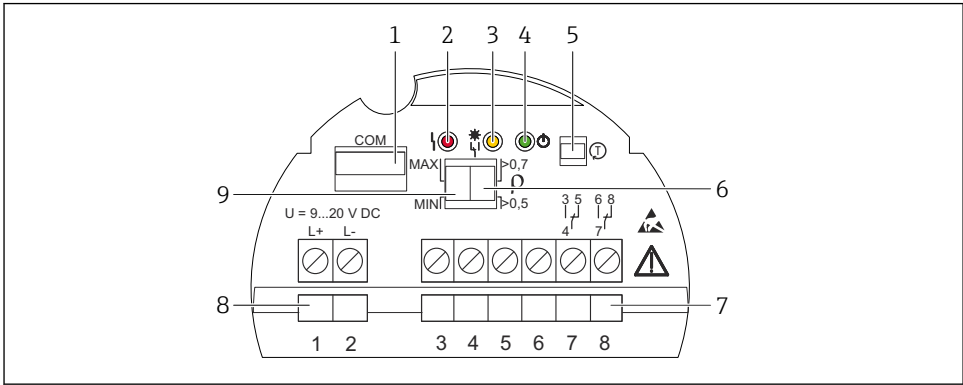

A0037705

30 Example of electronic insert FEL64DC

- 1 COM interface for additional modules (LED module, Bluetooth module)
- 2 LED, red, for warning or alarm
- 3 LED, yellow, switch status
- 4 LED, green, operational status (device is on)
- 5 Test button, activates functional test
- 6 DIP switch for setting density 0.7 or 0.5
- 7 Terminals (3 to 8), relay contact
- 8 Terminals (1 to 2), power supply
- 9 DIP switch for configuring MAX/MIN safety mode

7.3 Heartbeat diagnostics and verification with Bluetooth® wireless technology

7.3.1 Access via Bluetooth® wireless technology

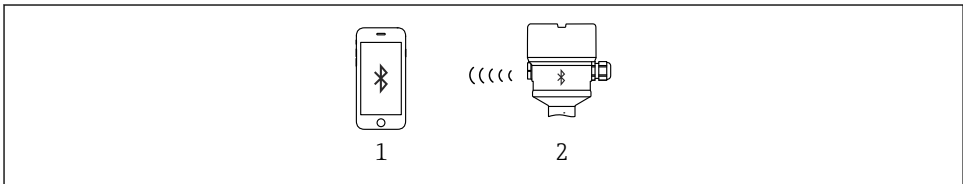

A0033411

31 Remote operation via Bluetooth® wireless technology

- 1 Smartphone or tablet with SmartBlue app
- 2 Device with optional Bluetooth module

8 Commissioning

8.1 Functional test using key on electronic insert

- The functional test must be performed in the OK state: MAX safety and sensor free or MIN safety and sensor covered.
- The LEDs flash one after another as a chaser light during the functional test.
- When performing the proof test in safety instrumented systems according to SIL or WHG: comply with the instructions in the Safety Manual.

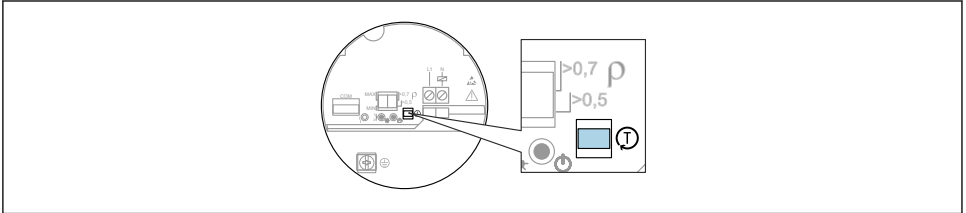

A0037132

32 Position of key for the functional test for electronic inserts FEL61/62/64/64DC/67/68

1. Make sure that no undesired switching operations are triggered!
2. Press the "T" key on the electronic insert for at least 1 s (e.g. with screwdriver).
 - ↳ The device function check is performed. The output changes from the OK state to the demand state.
 Duration of the function check: at least 10 s or if the key is pressed for > 10 s, the check lasts until the test button is released.

The device returns to normal operation if the internal test is successful.

i If the housing may not be opened during operation due to explosion protection requirements, e.g. Ex d /XP, the functional test can also be started from the outside with the test magnet (optionally available), (FEL62, FEL64, FEL64DC, FEL68).

The functional test of the PFM electronics (FEL67) and NAMUR electronics (FEL68) can be started at the Nivotester FTL325P/N.

8.2 Functional test of the electronic switch with a test magnet

Perform functional test of the electronic switch without opening the device:

- ▶ Hold the test magnet against the marking on the nameplate on the outside.
 - ↳ Simulation is possible in the case of the FEL62, FEL64, FEL64DC, FEL68 electronic inserts.

The functional test with the test magnet acts in the same way as the functional test using the test button on the electronic insert.

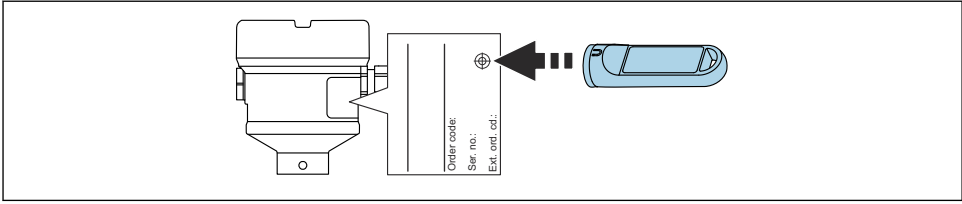

A0033419

33 Functional test with test magnet

8.3 Switching on the device

During the power-up time, the device output is in the safety-oriented state, or in the alarm state if available:

- For electronic insert FEL61, the output will be in the correct state after a maximum of 4 s following power-up.
- For electronic inserts FEL62, FEL64, FEL64DC, the output will be in the correct state after a maximum of 3 s following power-up.
- For electronic inserts FEL68 NAMUR and FEL67 PFM, a functional test is always performed upon power-up. The output will be in the correct state after a maximum of 10 s.



71624353

www.addresses.endress.com
