

Brief Operating Instructions

Flowmeter

Proline Promag H

Electromagnetic sensor



These Brief Operating Instructions are **not** a substitute for the Operating Instructions pertaining to the device.

Brief Operating Instructions Part 1 of 2: Sensor

Contain information about the sensor.

Brief Operating Instructions Part 2 of 2: Transmitter

→  3.



A0023555

Brief operating instructions Flowmeter

The device consists of a transmitter and a sensor.

The process of commissioning these two components is described in two separate manuals which together form the Brief Operating Instructions for the flowmeter:

- Brief Operating Instructions Part 1: Sensor
- Brief Operating Instructions Part 2: Transmitter

Please refer to both parts of the Brief Operating Instructions when commissioning the device, as the contents of the manuals complement one another:

Brief Operating Instructions Part 1: Sensor

The Sensor Brief Operating Instructions are aimed at specialists with responsibility for installing the measuring device.

- Incoming acceptance and product identification
- Storage and transport
- Mounting procedure

Brief Operating Instructions Part 2: Transmitter

The Transmitter Brief Operating Instructions are aimed at specialists with responsibility for commissioning, configuring and parameterizing the measuring device (until the first measured value).

- Product description
- Mounting procedure
- Electrical connection
- Operation options
- System integration
- Commissioning
- Diagnostic information

Additional device documentation



These Brief Operating Instructions are the **Brief Operating Instructions part 1: Sensor**.

The "Brief Operating Instructions part 2: Transmitter" are available via:

- Internet: www.endress.com/deviceviewer
- Smart phone/tablet: *Endress+Hauser Operations App*

Detailed information about the device can be found in the Operating Instructions and the other documentation:

- Internet: www.endress.com/deviceviewer
- Smart phone/tablet: *Endress+Hauser Operations App*

Table of contents

1	About this document	5
1.1	Symbols used	5
2	Basic safety instructions	7
2.1	Requirements for the personnel	7
2.2	Intended use	7
2.3	Workplace safety	8
2.4	Operational safety	8
2.5	Product safety	8
2.6	IT security	8
3	Incoming acceptance and product identification	9
3.1	Incoming acceptance	9
3.2	Product identification	9
4	Storage and transport	10
4.1	Storage conditions	10
4.2	Transporting the product	10
5	Mounting	12
5.1	Mounting requirements	12
5.2	Mounting the measuring instrument	19
5.3	Post-mounting check	24
6	Disposal	25
6.1	Removing the measuring device	25
6.2	Disposing of the measuring device	25

1 About this document

1.1 Symbols used

1.1.1 Safety symbols

DANGER

This symbol alerts you to a dangerous situation. Failure to avoid this situation will result in serious or fatal injury.

WARNING

This symbol alerts you to a dangerous situation. Failure to avoid this situation can result in serious or fatal injury.









CAUTION

This symbol alerts you to a dangerous situation. Failure to avoid this situation can result in minor or medium injury.





NOTICE

This symbol contains information on procedures and other facts which do not result in personal injury.

1.1.2 Symbols for certain types of information





Symbol	Meaning	Symbol	Meaning
	Permitted Procedures, processes or actions that are permitted.		Preferred Procedures, processes or actions that are preferred.
	Forbidden Procedures, processes or actions that are forbidden.		Tip Indicates additional information.
	Reference to documentation		Reference to page
	Reference to graphic	1, 2, 3...	Series of steps
	Result of a step		Visual inspection

1.1.3 Electrical symbols





Symbol	Meaning	Symbol	Meaning
	Direct current		Alternating current
	Direct current and alternating current		Ground connection A grounded terminal which, as far as the operator is concerned, is grounded via a grounding system.

Symbol	Meaning
	<p>Potential equalization connection (PE: protective earth) Ground terminals that must be connected to ground prior to establishing any other connections.</p> <p>The ground terminals are located on the interior and exterior of the device:</p> <ul style="list-style-type: none"> ▪ Interior ground terminal: potential equalization is connected to the supply network. ▪ Exterior ground terminal: device is connected to the plant grounding system.

1.1.4 Tool symbols

Symbol	Meaning	Symbol	Meaning
	Torx screwdriver		Flat-blade screwdriver
	Phillips head screwdriver		Allen key
	Open-ended wrench		

1.1.5 Symbols in graphics

Symbol	Meaning	Symbol	Meaning
1, 2, 3,...	Item numbers		Series of steps
A, B, C, ...	Views	A-A, B-B, C-C, ...	Sections
	Hazardous area		Safe area (non-hazardous area)
	Flow direction		

2 Basic safety instructions

2.1 Requirements for the personnel

The personnel must fulfill the following requirements for its tasks:

- ▶ Trained, qualified specialists must have a relevant qualification for this specific function and task.
- ▶ Are authorized by the plant owner/operator.
- ▶ Are familiar with federal/national regulations.
- ▶ Before starting work, read and understand the instructions in the manual and supplementary documentation as well as the certificates (depending on the application).
- ▶ Follow instructions and comply with basic conditions.

2.2 Intended use

Application and media

The measuring instrument is intended only for the flow measurement of liquids with a minimum conductivity of 5 $\mu\text{S}/\text{cm}$ (Promag 10, 100, 300, 500) or 20 $\mu\text{S}/\text{cm}$ (Promag 200).

Depending on the version ordered, the measuring instrument can also be used to measure potentially explosive ¹⁾, flammable, toxic and oxidizing media.

Measuring instruments for use in hazardous areas, in hygienic applications, or where there is an increased risk due to pressure, are specially labeled on the nameplate.

To ensure that the measuring instrument is in perfect condition during operation:

- ▶ Only use the measuring instrument in full compliance with the data on the nameplate and the general conditions listed in the Operating Instructions and supplementary documentation.
- ▶ Using the nameplate, check whether the ordered device is permitted for the intended use in the hazardous area (e.g. explosion protection, pressure vessel safety).
- ▶ Use the measuring instrument only for media to which the process-wetted materials are sufficiently resistant.
- ▶ Keep within the specified pressure and temperature range.
- ▶ Keep within the specified ambient temperature range.
- ▶ Protect the measuring instrument permanently against corrosion from environmental influences.

Incorrect use

Non-designated use can compromise safety. The manufacturer is not liable for damage caused by improper or non-designated use.

WARNING

Danger of breakage due to corrosive or abrasive fluids and ambient conditions!

- ▶ Verify the compatibility of the process fluid with the sensor material.
- ▶ Ensure the resistance of all fluid-wetted materials in the process.
- ▶ Keep within the specified pressure and temperature range.

1) Not applicable for IO-Link measuring instruments

NOTICE**Verification for borderline cases:**

- ▶ For special fluids and fluids for cleaning, Endress+Hauser is glad to provide assistance in verifying the corrosion resistance of fluid-wetted materials, but does not accept any warranty or liability as minute changes in the temperature, concentration or level of contamination in the process can alter the corrosion resistance properties.

Residual risks**⚠ CAUTION****Risk of hot or cold burns! The use of media and electronics with high or low temperatures can produce hot or cold surfaces on the device.**

- ▶ Mount suitable touch protection.

2.3 Workplace safety

When working on and with the device:

- ▶ Wear the required personal protective equipment as per national regulations.

2.4 Operational safety

Risk of injury!

- ▶ Operate the device in proper technical condition and fail-safe condition only.
- ▶ The operator is responsible for interference-free operation of the device.

Ambient requirements for transmitter housing made of plastic

If a plastic transmitter housing is permanently exposed to certain steam and air mixtures, this can damage the housing.

- ▶ If you are unsure, please contact your Endress+Hauser Sales Center for clarification.
- ▶ If used in an approval-related area, observe the information on the nameplate.

2.5 Product safety

This measuring device is designed in accordance with good engineering practice to meet state-of-the-art safety requirements, has been tested, and left the factory in a condition in which it is safe to operate.

It meets general safety standards and legal requirements. It also complies with the EU directives listed in the device-specific EU Declaration of Conformity. The manufacturer confirms this by affixing the CE mark to the device..

2.6 IT security

Our warranty is valid only if the product is installed and used as described in the Operating Instructions. The product is equipped with security mechanisms to protect it against any inadvertent changes to the settings.

IT security measures, which provide additional protection for the product and associated data transfer, must be implemented by the operators themselves in line with their security standards.

3 Incoming acceptance and product identification

3.1 Incoming acceptance

On receipt of the delivery:

1. Check the packaging for damage.
 - ↳ Report all damage immediately to the manufacturer.
Do not install damaged components.
2. Check the scope of delivery using the delivery note.
3. Compare the data on the nameplate with the order specifications on the delivery note.
4. Check the technical documentation and all other necessary documents, e.g. certificates, to ensure they are complete.



If one of the conditions is not satisfied, contact the manufacturer.

3.2 Product identification

The device can be identified in the following ways:

- Nameplate
- Order code with details of the device features on the delivery note
- Enter the serial numbers from the nameplates in the *Device Viewer* (www.endress.com/deviceviewer): all the information about the device is displayed.
- Enter the serial numbers from the nameplates into the *Endress+Hauser Operations app* or scan the DataMatrix code on the nameplate with the *Endress+Hauser Operations app*: all the information about the device is displayed.

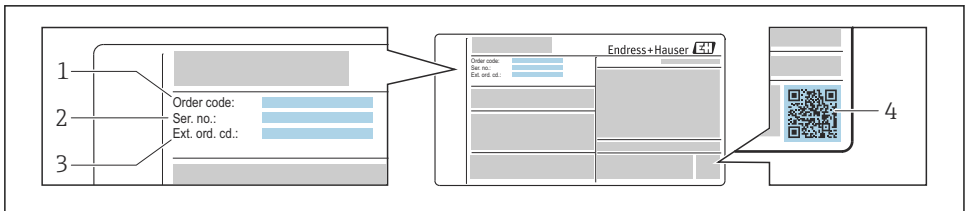

A0030196

1 Example of a nameplate

- 1 Order code
- 2 Serial number
- 3 Extended order code
- 4 2-D matrix code (QR code)



For detailed information on the data on the nameplate, see the Operating Instructions for the device.

4 Storage and transport

4.1 Storage conditions

Observe the following notes for storage:

- ▶ Store in the original packaging to ensure protection from shock.
- ▶ Do not remove protective covers or protective caps installed on process connections. They prevent mechanical damage to the sealing surfaces and contamination in the measuring tube.
- ▶ Protect from direct sunlight. Avoid unacceptably high surface temperatures.
- ▶ Select a storage location that excludes the possibility of condensation forming on the measuring device. Fungi and bacteria can damage the liner.
- ▶ Store in a dry and dust-free place.
- ▶ Do not store outdoors.

4.2 Transporting the product

Transport the measuring device to the measuring point in the original packaging.

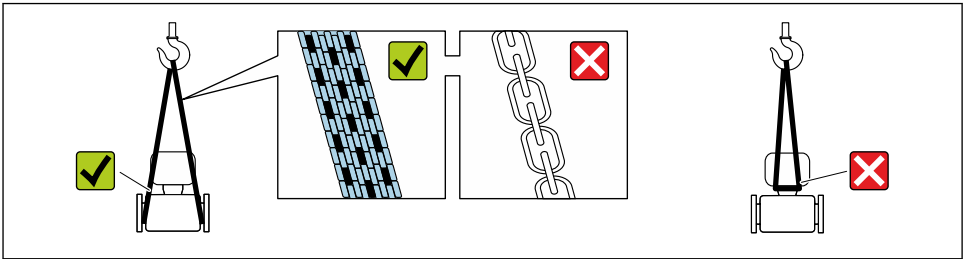

A0029252

i Do not remove protective covers or caps installed on process connections. They prevent mechanical damage to the sealing surfaces and contamination in the measuring tube.

4.2.1 Measuring devices without lifting lugs

⚠ WARNING

Center of gravity of the measuring device is higher than the suspension points of the webbing slings.

Risk of injury if the measuring device slips.

- ▶ Secure the measuring device against slipping or turning.
- ▶ Observe the weight specified on the packaging (stick-on label).

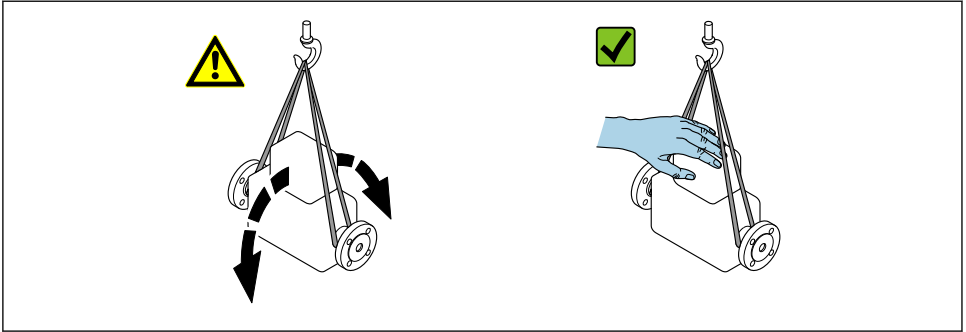

A0029214

4.2.2 Measuring devices with lifting lugs

⚠ CAUTION

Special transportation instructions for devices with lifting lugs

- ▶ Only use the lifting lugs fitted on the device or flanges to transport the device.
- ▶ The device must always be secured at two lifting lugs at least.

4.2.3 Transporting with a fork lift

If transporting in wood crates, the floor structure enables the crates to be lifted lengthwise or at both sides using a forklift.

⚠ CAUTION

Risk of damaging the magnetic coil!

- ▶ If transporting by forklift, do not lift the sensor by the metal casing.
- ▶ This would buckle the casing and damage the internal magnetic coils.

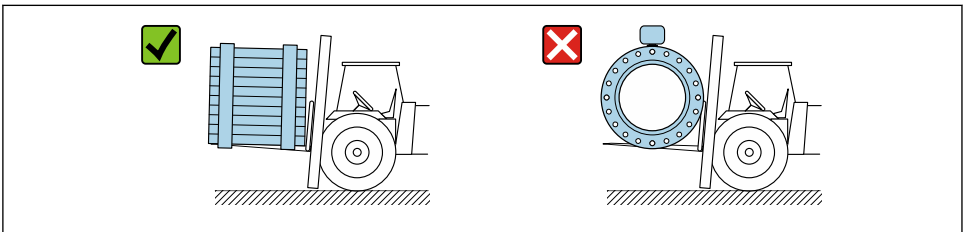

A0029319

5 Mounting

5.1 Mounting requirements

5.1.1 Mounting position

Mounting location

- Do not install the device at the highest point of the pipe.
- Do not install the device upstream from a free pipe outlet in a down pipe.

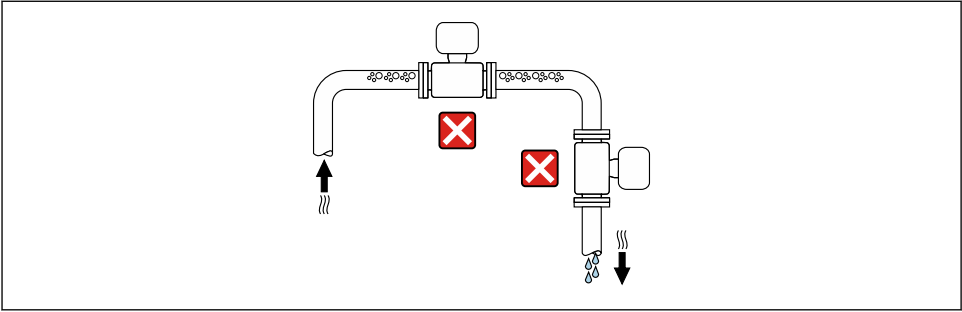

A0042131

The device should ideally be installed in an ascending pipe.

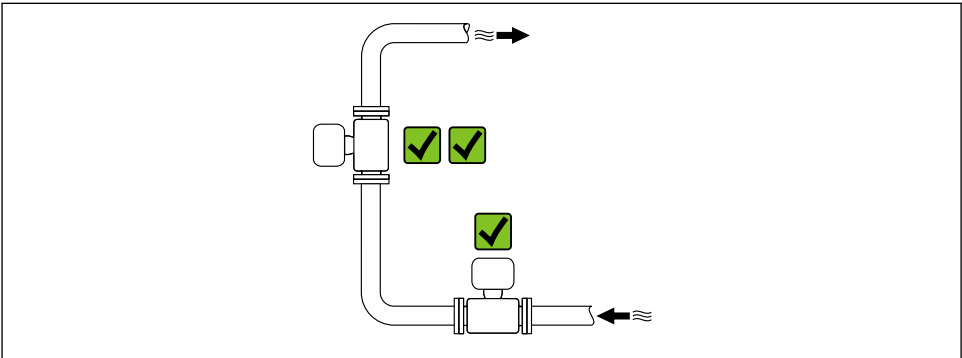

A0042317

*Installation upstream from a down pipe***NOTICE****Negative pressure in the measuring pipe can damage the liner!**

- ▶ If installing upstream of down pipes whose length $h \geq 5 \text{ m}$ (16.4 ft): install a siphon with a vent valve downstream of the device.



This arrangement prevents the flow of liquid stopping in the pipe and air entrainment.

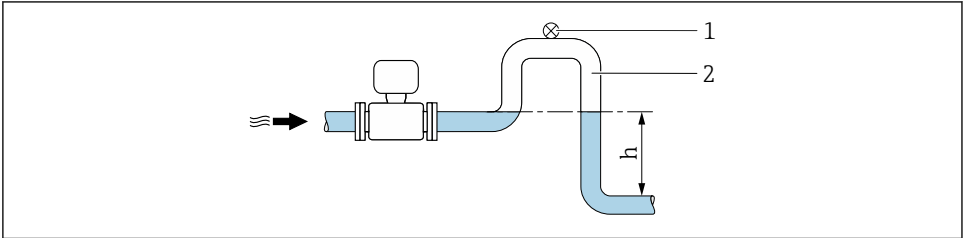

A0028981

- 1 Vent valve
- 2 Pipe siphon
- h Length of down pipe

Installation with partially filled pipes

- Partially filled pipes with a gradient require a drain-type configuration.
- The installation of a cleaning valve is recommended.

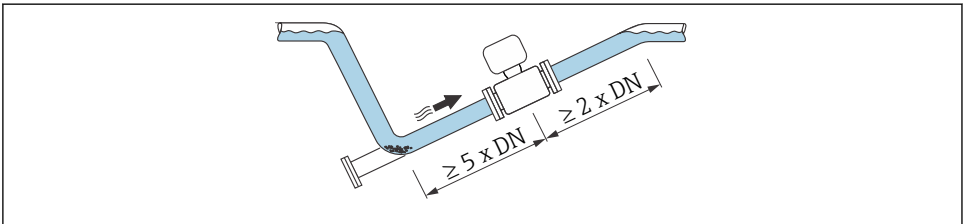

A0041088

*Installation near pumps***NOTICE****Negative pressure in the measuring tube can damage the liner!**

- ▶ In order to maintain the system pressure, install the device in the flow direction downstream from the pump.
- ▶ Install pulsation dampers if reciprocating, diaphragm or peristaltic pumps are used.

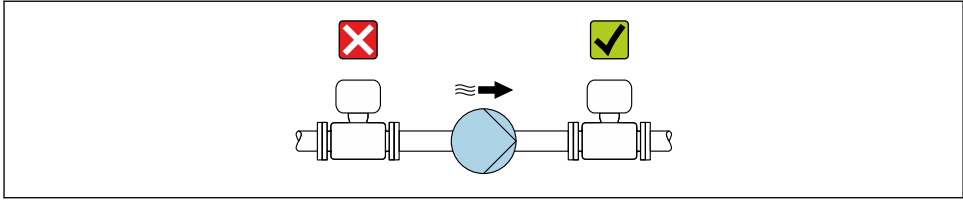

A0041083

Installation in event of pipe vibrations

A remote version is recommended in the event of strong pipe vibrations.

NOTICE

Pipe vibrations can damage the device!

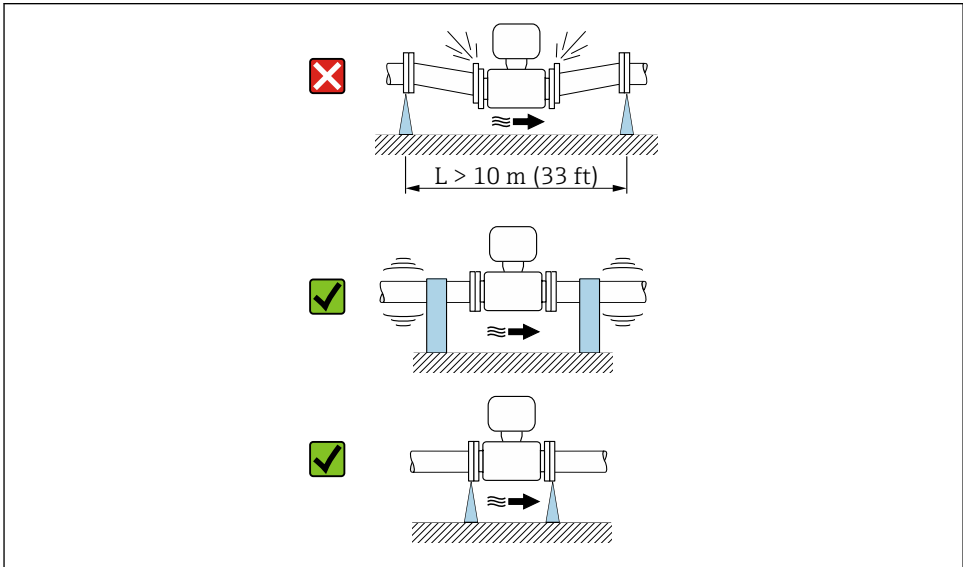

- ▶ Do not expose the device to strong vibrations.
- ▶ Support the pipe and fix it in place.
- ▶ Support the device and fix it in place.
- ▶ Mount the sensor and transmitter separately.



A0041092

Orientation

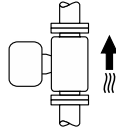
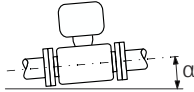
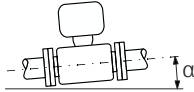
The direction of the arrow on the nameplate helps you to install the measuring device according to the flow direction.

Orientation		Recommendation
Vertical orientation	 <p style="text-align: right;">A0015591</p>	<p style="text-align: center;">☑☑</p>
Horizontal orientation	 <p style="text-align: right;">A0041328</p>	<p style="text-align: center;">☑¹⁾</p>
Horizontal orientation, transmitter at bottom	 <p style="text-align: right;">A0015590</p>	<p style="text-align: center;">☑☑^{2) 3)} ☒⁴⁾</p>
Horizontal orientation, transmitter at side	 <p style="text-align: right;">A0015592</p>	<p style="text-align: center;">☒</p>

- 1) The measuring device should be self-draining for hygiene applications. A vertical orientation is recommended for this. If only a horizontal orientation is possible, an angle of inclination $\alpha \geq 10^\circ$ is recommended.
- 2) Applications with high process temperatures may increase the ambient temperature. To maintain the maximum ambient temperature for the transmitter, this orientation is recommended.
- 3) To prevent the electronics from overheating in the event of strong heat formation (e.g. CIP or SIP cleaning process), install the device with the transmitter part pointing downwards.
- 4) With the empty pipe detection function switched on: empty pipe detection only works if the transmitter housing is pointing upwards.

Vertical

Optimum for self-emptying pipe systems and for use in conjunction with empty pipe detection.

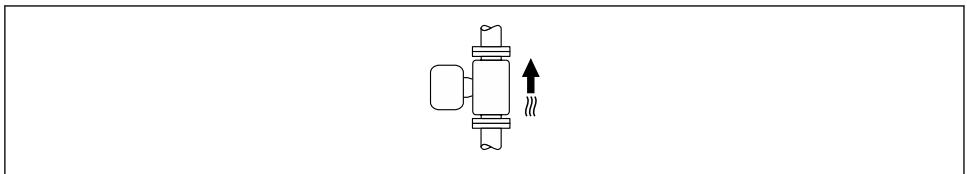

A0015591

Horizontal

- Ideally, the measuring electrode plane should be horizontal. This prevents brief insulation of the measuring electrodes by entrained air bubbles.
- Empty pipe detection only works if the transmitter housing is pointing upwards as otherwise there is no guarantee that the empty pipe detection function will actually respond to a partially filled or empty measuring tube.

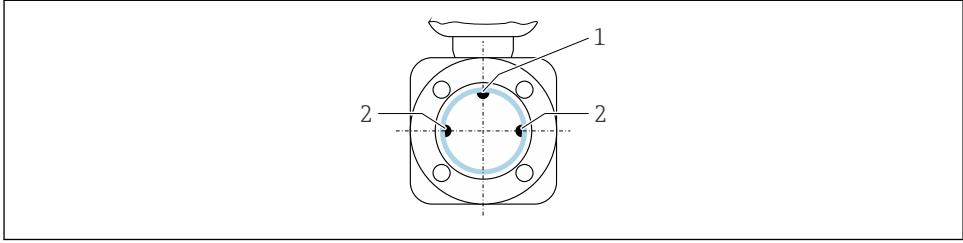

A0028998

- 1 EPD electrode for empty pipe detection, available from \geq DN 15 ($\frac{1}{2}$ ")
- 2 Measuring electrodes for signal detection

i Measuring instruments with a nominal diameter $<$ DN 15 ($\frac{1}{2}$ ") do not have an EPD electrode. In this case, empty pipe detection is performed via the measuring electrodes.

Inlet and outlet runs

Installation with inlet and outlet runs

To avoid a vacuum and to maintain the specified level of measurement accuracy, install the device upstream from assemblies that produce turbulence (e.g. valves, T-sections) and downstream from pumps.

Maintain straight, unimpeded inlet and outlet runs.

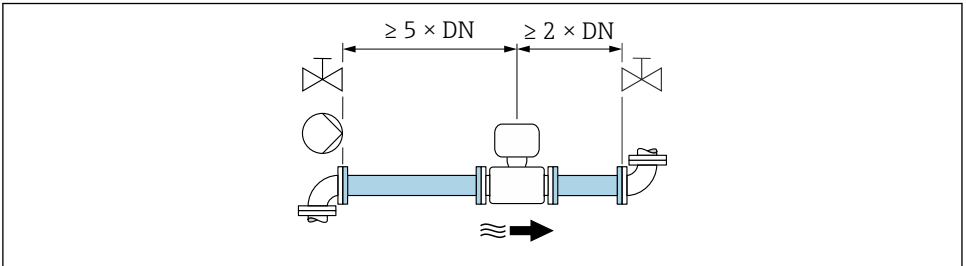

A0028997

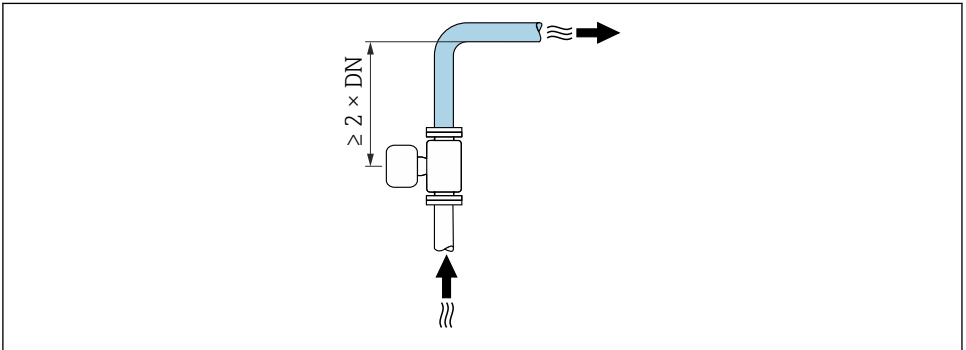

A0042132

5.1.2 Environmental and process requirements

Ambient temperature range



For detailed information on the ambient temperature range, see the Operating Instructions for the device.

If operating outdoors:

- Mount the measuring instrument in a shady location.
- Avoid direct sunlight, particularly in warm climatic regions.
- Avoid direct exposure to weather conditions.

Temperature tables²⁾

 For detailed information on the temperature tables, see the separate document entitled "Safety Instructions" (XA) for the device.

System pressure

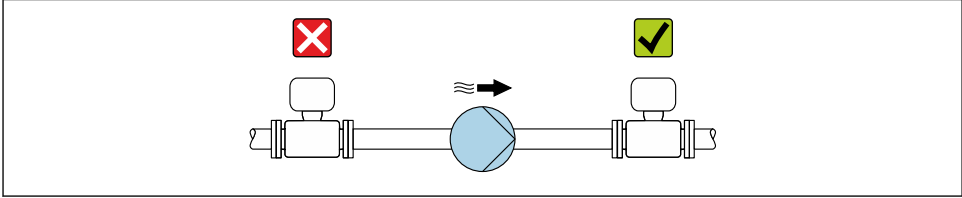

A0028777

 Furthermore, install pulse dampers if reciprocating, diaphragm or peristaltic pumps are used.

Vibrations

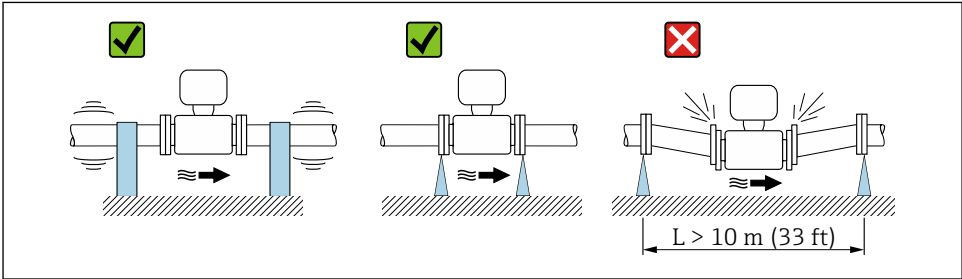

A0029004

 2 Measures to prevent vibration of the device

2) Not applicable for IO-Link measuring instruments

Adapters

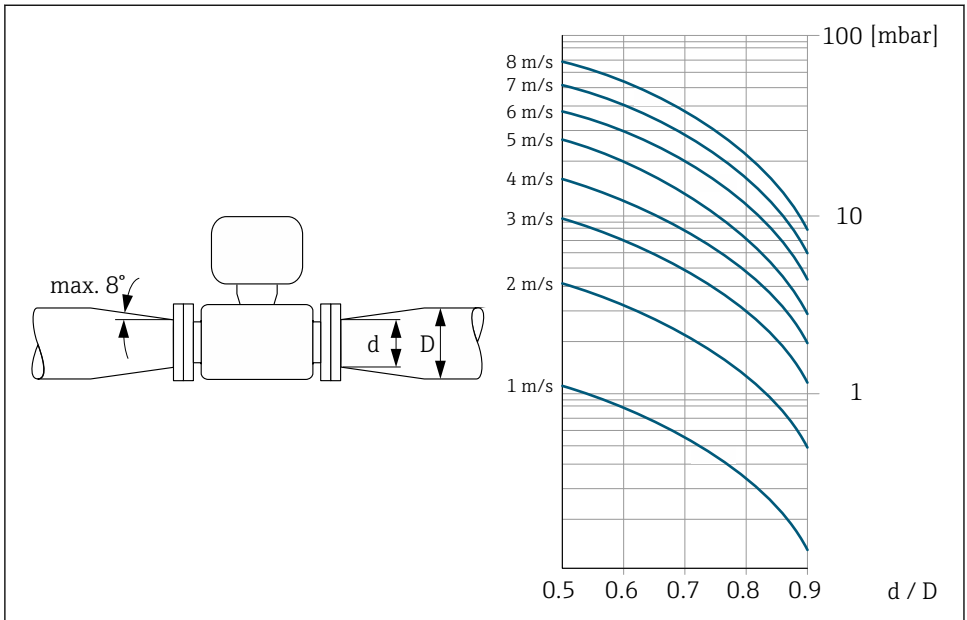

A0029002

5.2 Mounting the measuring instrument

5.2.1 Required tools

For flanges and other process connections, use an appropriate mounting tool

5.2.2 Preparing the measuring device

1. Remove all remaining transport packaging.
2. Remove any protective covers or protective caps present from the sensor.
3. Remove stick-on label on the electronics compartment cover.

5.2.3 Mounting the sensor

⚠ WARNING

An electrically conductive layer could form on the inside of the measuring tube!

Risk of measuring signal short circuit.

- ▶ Ensure that the inside diameters of the gaskets are greater than or equal to that of the process connections and piping.
- ▶ Ensure that the gaskets are clean and undamaged.
- ▶ Install the gaskets correctly.
- ▶ Do not use electrically conductive sealing compounds such as graphite.

⚠ WARNING**Danger due to improper process sealing!**

- ▶ Ensure that the inside diameters of the gaskets are greater than or equal to that of the process connections and piping.
- ▶ Ensure that the seals are clean and undamaged.
- ▶ Secure the seals correctly.

1. Ensure that the direction of the arrow on the sensor matches the flow direction of the medium.
2. To ensure compliance with device specifications, install the measuring device between the pipe flanges in a way that it is centered in the measurement section.
3. Install the measuring device or turn the transmitter housing so that the cable entries do not point upwards.

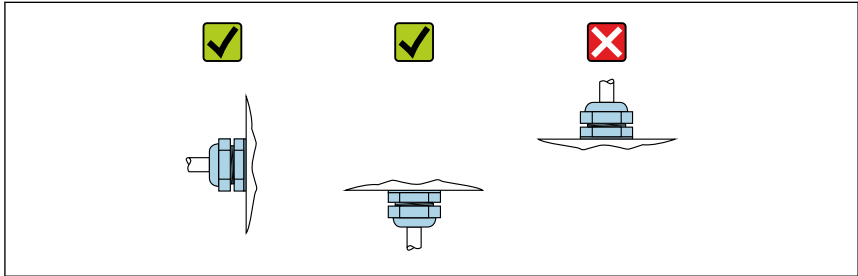

A0029263

Process connections

The sensor is supplied to order, with or without pre-installed process connections. Pre-installed process connections are firmly secured to the sensor by 4 or 6 hexagonal-headed bolts.

- i** The sensor may need to be supported or additionally secured depending on the application and pipe length. In particular, it is absolutely essential to secure the sensor additionally if plastic process connections are used. An appropriate wall mounting kit can be ordered separately as an accessory from Endress+Hauser.

Seals

- In the case of metal process connections, the screws must be tightened securely. The process connection forms a metal connection with the sensor, which ensures a defined compression of the seal.
- In the case of plastic process connections, observe the maximum torques for lubricated threads: 7 Nm (5.2 lbf ft); always insert a seal between the connection and the counterflange.
- Depending on the application, the seals should be replaced periodically, particularly if molded seals are used (aseptic version). The interval between changes depends on the frequency of the cleaning cycles, the cleaning temperature and the medium temperature. Replacement seals can be ordered as an accessory.
- For "PFA" lining: additional seals are **always** required (Promag 200).

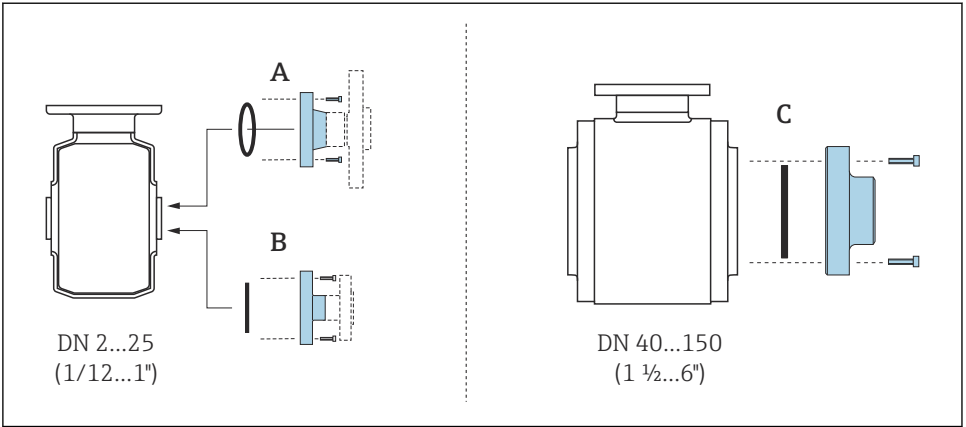

A0019804

3 Seals of process connections Promag H 10 and H 100

- A Process connections with O-ring seal
- B Process connections with aseptic molded seal, DN 2 to 25 (1/12 to 1")
- C Process connections with aseptic molded seal, DN 40 to 150 (1 1/2 to 6")

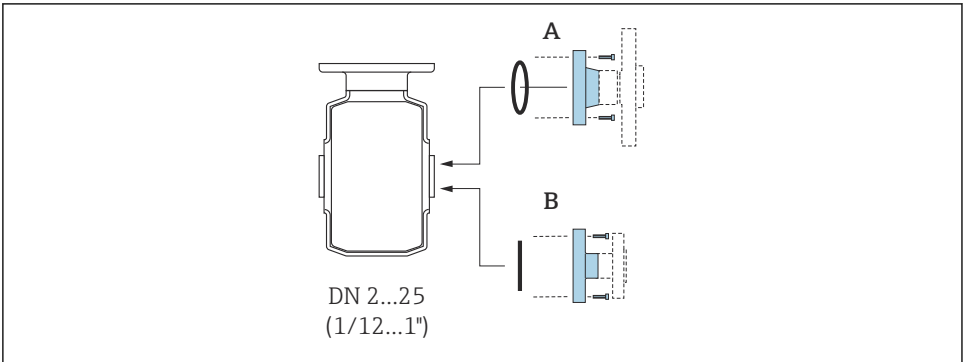

A0018782

4 Seals of process connections Promag H 200

- A Process connections with O-ring seal
- B Process connections with aseptic gasket seal

Mounting grounding rings, DN 2 to 25 (1/12 to 1")

i For information on potential equalization, see the Transmitter Brief Operating Instructions.

In the case of plastic process connections (e.g. flange connections or adhesive fittings), additional grounding rings must be used to ensure potential matching between the sensor and the fluid. If grounding rings are not installed, this can affect the measuring accuracy or cause

the destruction of the sensor as a result of the electrochemical decomposition of the electrodes.

- i
 ■ Depending on the option ordered, plastic disks are used instead of grounding rings on some process connections. These plastic disks only act as "spacers" and do not have any potential matching function. Furthermore, they also perform a significant sealing function at the sensor/process connection interface. Therefore, in the case of process connections without metal grounding rings, these plastic disks/seals should never be removed and should always be installed!
- Grounding rings can be ordered separately as an accessory from Endress+Hauser. When ordering make sure that the grounding rings are compatible with the material used for the electrodes, as otherwise there is the danger that the electrodes could be destroyed by electrochemical corrosion!
- Grounding rings, including seals, are mounted inside the process connections. This does not affect the installation length.

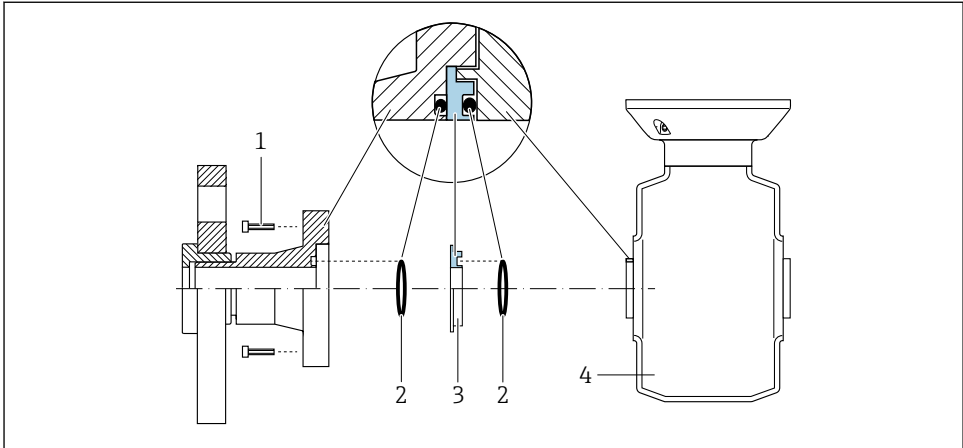

A0028971

5 Installing grounding rings

- 1 Hexagonal-headed bolts of process connection
- 2 O-ring seals
- 3 Grounding ring or plastic disk (spacer)
- 4 Sensor

1. Loosen the 4 or 6 hexagonal-headed bolts (1) and remove the process connection from the sensor (4).
2. Remove the plastic disk (3), along with the two O-ring seals (2), from the process connection.
3. Place the first O-ring seal (2) back into the groove of the process connection.
4. Fit the metal grounding ring (3) in the process connection as illustrated.
5. Place the second O-ring seal (2) into the groove of the grounding ring.

6. Mount the process connection back on the sensor. When doing so, make sure to observe the maximum screw tightening torques for lubricated threads: 7 Nm (5.2 lbf ft)

Welding the sensor into the pipe (welding connections)

WARNING



Risk of destroying the electronics!

- ▶ Make sure that the welding system is not grounded via the sensor or transmitter.
1. Tack-weld the sensor to secure it in the pipe. A suitable welding aid can be ordered separately as an accessory.
 2. Release the screws on the process connection flange and remove the sensor, along with the seal, from the pipe.
 3. Weld the process connection into the pipe.
 4. Reinstall the sensor in the pipe, and in doing so make sure that the seal is clean and in the right position.
-  If thin-walled pipes carrying food are welded correctly, the seal is not damaged by the heat even when mounted. However, it is recommended to disassemble the sensor and seal.
 - It must be possible to open the pipe by approx. 8 mm (0.31 in) for disassembly.

Cleaning with pigs

It is essential to take the internal diameters of the measuring tube and process connection into account when cleaning with pigs. All the dimensions and lengths of the sensor and transmitter are provided in the separate "Technical Information" document.

5.3 Post-mounting check

Is the device undamaged (visual inspection)?	<input type="checkbox"/>
Does the measuring device conform to the measuring point specifications? For example: <ul style="list-style-type: none"> ▪ Process temperature ▪ Pressure (refer to the "Pressure-temperature ratings" section of the "Technical Information" document). ▪ Ambient temperature ▪ Measuring range 	<input type="checkbox"/>
Has the correct orientation been selected for the sensor →  15 ? <ul style="list-style-type: none"> ▪ According to sensor type ▪ According to medium temperature ▪ According to medium properties (outgassing, with entrained solids) 	<input type="checkbox"/>
Does the arrow on the sensor nameplate match the actual direction of flow of the fluid through the piping →  15?	<input type="checkbox"/>
Are the measuring point identification and labeling correct (visual inspection)?	<input type="checkbox"/>
Is the device adequately protected against precipitation and direct sunlight?	<input type="checkbox"/>
Have the fixing screws been tightened with the correct tightening torque?	<input type="checkbox"/>

6 Disposal



If required by the Directive 2012/19/EU on waste electrical and electronic equipment (WEEE), the product is marked with the depicted symbol in order to minimize the disposal of WEEE as unsorted municipal waste. Do not dispose of products bearing this marking as unsorted municipal waste. Instead, return them to the manufacturer for disposal under the applicable conditions.

6.1 Removing the measuring device

1. Switch off the device.

WARNING

Risk of personal injury due to process conditions!

- ▶ Beware of hazardous process conditions such as pressure in the measuring device, high temperatures or aggressive media.
2. Carry out the mounting and connection steps from the "Mounting the measuring device" and "Connecting the measuring device" sections in reverse order.
 3. Observe the safety instructions.

6.2 Disposing of the measuring device

WARNING

Danger to personnel and environment from fluids that are hazardous to health.

- ▶ Ensure that the measuring device and all cavities are free of fluid residues that are hazardous to health or the environment, e.g. substances that have permeated into crevices or diffused through plastic.

Follow these instructions when disposing of the device:

- ▶ Comply with national regulations.
- ▶ Ensure proper separation and reuse of the device components.



71654757

www.addresses.endress.com
