

Safety Instructions

Rxn-41 Raman spectroscopic probe



**UK
CA**



Rxn-41 Raman spectroscopic probe





Table of Contents

1	Basic safety instruction	4
1.1	Requirements for personnel	4
1.2	Designated use	4
1.3	Workplace safety	4
1.4	Operational safety	4
1.5	Pressure safety	5
1.6	Laser safety	5
1.6.1	Maximum Permissible Exposure (MPE)	6
1.6.2	MPE for ocular exposure	6
1.6.3	MPE for skin exposure	7
1.6.4	Nominal ocular hazard distance (NOHD)	7
1.7	Service safety.....	8
1.8	Important safeguards.....	8
1.9	Product safety	8
1.9.1	CDRH and IEC compliance.....	8
1.9.2	Laser safety interlock	9
1.9.3	Hazardous area approvals.....	9
2	Certificates and approvals	11
2.1	Certificates and approvals: production center	11
2.2	Declarations of conformity: probes and optics	11
2.3	Certificates and approvals: probes and optics.....	12
2.3.1	CSA Certificate of Compliance: Raman probes.....	12
2.3.2	IECEX Certificate of Conformity: Raman probes	13
2.3.3	ATEX Certificate: Raman probes	14
2.3.4	JPex Certificate: Raman probes.....	15
2.3.5	UKCA certification	16
3	Hazardous area installation.....	17

Warnings

Structure of Information	Meaning
<p>⚠ WARNING</p> <p>Causes (/consequences) Consequences of non-compliance (if applicable) ▶ Corrective action</p>	<p>This symbol alerts you to a dangerous situation. Failure to avoid the dangerous situation can result in a fatal or serious injury.</p>
<p>⚠ CAUTION</p> <p>Causes (/consequences) Consequences of non-compliance (if applicable) ▶ Corrective action</p>	<p>This symbol alerts you to a dangerous situation. Failure to avoid this situation can result in minor or more serious injuries.</p>
<p>NOTICE</p> <p>Cause/situation Consequences of non-compliance (if applicable) ▶ Action/note</p>	<p>This symbol alerts you to situations which may result in damage to property.</p>

Symbols

Symbol	Description
	The Laser Radiation symbol is used to alert the user to the danger of exposure to hazardous visible laser radiation when using the system.
	The High Voltage symbol that alerts people to the presence of electric potential large enough to cause injury or damage. In certain industries, high voltage refers to voltage above a certain threshold. Equipment and conductors that carry high voltage warrant special safety requirements and procedures.
	The WEEE symbol indicates that the product should not be discarded as unsorted waste but must be sent to separate collection facilities for recovery and recycling.
	The CE Marking indicates conformity with health, safety, and environmental protection standards for products sold within the European Economic Area (EEA).

U.S. export compliance

The policy of Endress+Hauser is strict compliance with U.S. export control laws as detailed in the website of the [Bureau of Industry and Security](#) at the U.S. Department of Commerce. The Export Control Classification Number of this product is EAR99.

1 Basic safety instruction

1.1 Requirements for personnel

- Installation, commissioning, operation, and maintenance of the measuring system may be carried out only by specially trained technical personnel.
- The technical personnel must be authorized by the plant operator to carry out the specified activities.
- The technical personnel must have read and understood these Operating Instructions and must follow the instructions contained herein.
- Faults at the measuring point may only be rectified by properly authorized and trained personnel. Repairs not described in this document must be carried out only directly at the manufacturer's site or by the service organization.

For more assistance with taking appropriate precautions and setting the proper controls when dealing with lasers and their hazards, refer to the most current version of ANSI Z136.1 or IEC 60825-14.

1.2 Designated use

The Rxn-41 Raman spectroscopic probe is intended for liquid immersion sample analysis in a process plant setting.

Recommended applications include:

- **Chemical:** reaction monitoring, blending, feed, and final product monitoring
- **Polymer:** polymerization reaction monitoring, polymer blending
- **Pharmaceutical:** active pharmaceutical ingredient (API) reaction monitoring, crystallization, polymorph, drug substance production unit operation
- **Oil and gas:** any hydrocarbon analysis

Use of the device for any purpose other than that described poses a threat to the safety of people and of the entire measuring system and invalidates any warranty.

1.3 Workplace safety

As the user, you are responsible for complying with the following safety conditions:

- Installation guidelines
- Local standards and regulations for electromagnetic compatibility

The product has been tested for electromagnetic compatibility in accordance with the applicable international standards for industrial applications.

The electromagnetic compatibility indicated applies only to a product that has been properly connected to the analyzer.

1.4 Operational safety

Before commissioning the entire measuring point:

1. Verify that all connections are correct.
2. Ensure that electro-optical cables are undamaged.
3. Ensure fluid level is sufficient for probe immersion (if applicable).
4. Do not operate damaged products, and protect them against unintentional operation.
5. Label damaged products as defective.

During operation:

1. If faults cannot be rectified, products must be taken out of service and protected against unintentional operation.
2. When working with laser devices, always follow all local laser safety protocols which may include the use of personal protective equipment and limiting device access to authorized users.

1.5 Pressure safety

Pressure ratings are based on the referenced standards for the probe. Fittings and flanges may or may not be included in the rating depending upon the probe configuration. Furthermore, product ratings may be affected by the bolting and sealing materials and procedures.

When planning for installation of an Endress+Hauser probe into the user's piping or sampling system, it is the user's responsibility to understand the limitations of the ratings and select appropriate fittings, bolts, seals, and procedures for alignment and assembly of sealed joints.

Use of these ratings for sealed joints not conforming to the limitations, or not following accepted good practices for bolting and sealing, are the responsibility of the user.

1.6 Laser safety

The Raman Rxn analyzers use Class 3B lasers as defined in the following:

- [American National Standards Institute](#) (ANSI) Z136.1, American National Standard for Safe Use of Lasers
- [International Electrotechnical Commission](#) (IEC) 60825-14, Safety of Laser Products – Part 14: A user's guide

WARNING

Laser radiation

- ▶ Avoid exposure to beam
- ▶ Class 3B laser product

CAUTION

Laser beams can cause ignition of certain substances such as volatile organic compounds.

The two possible mechanisms for ignition are direct heating of the sample to a point causing ignition and the heating of a contaminant (such as dusts) to a critical point leading to ignition of the sample.

The laser configuration presents further safety concerns because the radiation is nearly invisible. Always be aware of the initial direction and possible scattering paths of the laser.

For 532 nm and 785 nm excitation wavelengths, use laser safety glasses with OD3 or greater.

For 993 nm excitation wavelength, use laser safety glasses with OD4 or greater.

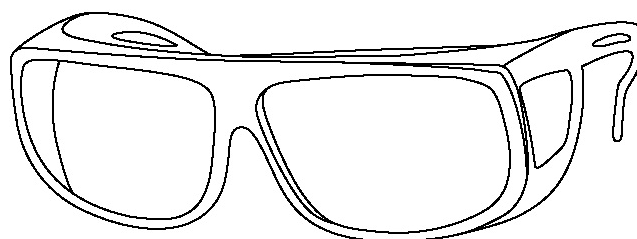

A0048421

Figure 1. Laser safety glasses

For more assistance with taking appropriate precautions and setting the proper controls when dealing with lasers and their hazards, refer to the most current version of ANSI Z136.1 or IEC 60825-14. See *MPE for ocular exposure* →  of this document for relevant parameters to enable calculation of maximum permissible exposure (MPE).

1.6.1 Maximum Permissible Exposure (MPE)

The Maximum Permissible Exposure, as defined by ANSI Z136.1, is the level of laser radiation to which an unprotected person may be exposed without adverse biological changes in the eye or skin. IEC 60825-14 expounds further defining it as, “that level of laser radiation, under normal circumstances, persons may be exposed without suffering adverse effects. The MPE levels represent the maximum level to which the eye or skin can be exposed without consequential injury immediately or after a long time and are related to the wavelength of the radiation, the pulse duration or exposure time, the tissue at risk and, for visible and near infra-red radiation in the range of 400 nm to 1,400 nm, the size of the retinal image.”

Endress+Hauser Raman instruments emit radiation at 532 nm, 785 nm, or 993 nm continuous wave (CW) with power emission < 499 mW.

The MPE is calculated using the laser wavelength (λ) in nanometers, the duration of the exposure in seconds (t), and the energy involved ($J\text{ cm}^{-2}$ or $W\text{ cm}^{-2}$).

1.6.2 MPE for ocular exposure

The ANSI Z136.1 standard provides means to perform MPE for ocular exposure. Please refer to the standard to calculate the relevant MPE levels for the case of laser exposure from the Rxn-41 probe and from the unlikely occurrence of laser exposure from a broken optical fiber. The following tables contain excerpts from the ANSI Z136.1 Standard. IEC 60825-14 will have similar tables; however, it should be noted there are differences in units of measurement between the standards. This can cause confusion when attempting to directly correlate the two standards.

MPE for ocular exposure with 532 nm laser emission

MPE for point source ocular exposure to a laser beam			
Wavelength λ (nm)	Exposure duration t (s)	MPE calculation	
		($J\cdot\text{cm}^{-2}$)	($W\cdot\text{cm}^{-2}$)
532	10^{-13} to 10^{-11}	1.0×10^{-7}	-
	10^{-11} to 5×10^{-6}	2.0×10^{-7}	-
	5×10^{-6} to 10	$1.8 t^{0.75} \times 10^{-3}$	-
	10 to 30,000	-	1×10^{-3}

MPE for ocular exposure with 785 nm or 993 nm laser emission

MPE for point source ocular exposure to a laser beam				
Wavelength λ (nm)	Exposure duration t (s)	MPE calculation		C_A
		($J\cdot\text{cm}^{-2}$)	($W\cdot\text{cm}^{-2}$)	
785 and 993	10^{-13} to 10^{-11}	$1.5 C_A \times 10^{-8}$	-	532: $C_A = 1.000$ 785: $C_A = 1.479$ 993: $C_A = 3.855$
	10^{-11} to 10^{-9}	$2.7 C_A t^{0.75}$	-	
	10^{-9} to 18×10^{-6}	$5.0 C_A \times 10^{-7}$	-	
	18×10^{-6} to 10	$1.8 C_A t^{0.75} \times 10^{-3}$	-	
	10 to 3×10^4	-	$C_A \times 10^{-3}$	

1.6.3 MPE for skin exposure

The ANSI Z136.1 standard provides means to perform MPE for skin exposure. Please refer to the standard to calculate the relevant MPE levels for the case of laser exposure from the Rxn-41 probe and from the unlikely occurrence of laser exposure from a broken optical fiber.

MPE for skin exposure with 532 nm, 785 nm, or 993 nm laser emission

MPE for skin exposure to a laser beam				
Wavelength λ (nm)	Exposure Duration t (s)	MPE Calculation		C_A
		(J·cm ⁻²)	(W·cm ⁻²)	
532, 785 and 993	10 ⁻⁹ to 10 ⁻⁷	2 $C_A \times 10^{-2}$	-	532: $C_A = 1.000$
	10 ⁻⁷ to 10	1.1 $C_A t^{0.25}$	-	785: $C_A = 1.479$
	10 to 3 x 10 ⁴	-	0.2 C_A	993: $C_A = 3.855$

1.6.4 Nominal ocular hazard distance (NOHD)

The nominal ocular hazard distance (NOHD), according to ANSI Z136.1, is, “the distance along the axis of the unobstructed beam from a laser, fiber end, or connector to the human eye beyond which the irradiance or radiant exposure does not exceed the applicable MPE.”

There are three basic scenarios that should be taken into consideration when evaluating the NOHD for using the Endress+Hauser Raman system with the Rxn-41 probe.

Scenario #1:

Normal configuration and use. When the system is set up for normal use, the collimated laser beam is focused by the probe lens as it exits the probe.

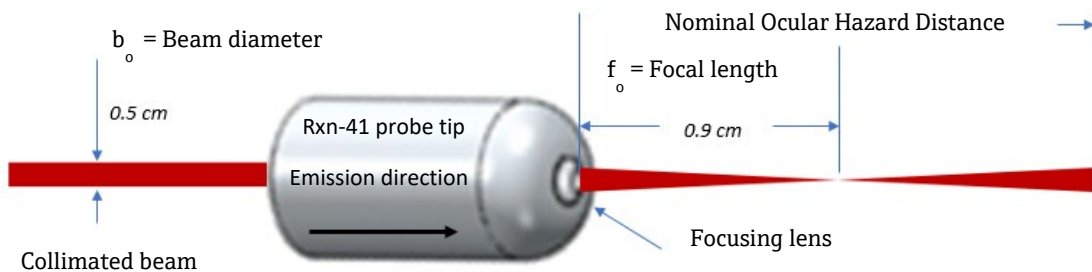

In this scenario the following equation out of ANSI Z136.1 can be used to determine the NOHD.

$$r_{NOHD} = \left(\frac{f_o}{b_o}\right) \left(\frac{4\Phi}{\pi MPE}\right)^{1/2}$$

If following the IEC 60825-14 methodology the following equation would be used.

$$r_{NOHD} = \frac{1}{\phi} \left[\frac{4 \times k \times P_o}{\pi \times MPE}\right]^5 - \frac{\alpha}{\phi}$$

- Beam divergence (ϕ) is determined by the following: $\phi = (b_o - b_1)/f_o$
- Focal point diameter is typically assumed to be 0 to 1 micron (0.0001 cm).
- The k factor is a correction factor based on the shape of the beam. The beam in this case is Gaussian in shape. Therefore, the k factor would be 1.

Scenario #2:

The fiber optic cable is severed, and the interlock circuit fails to de-energize the laser.

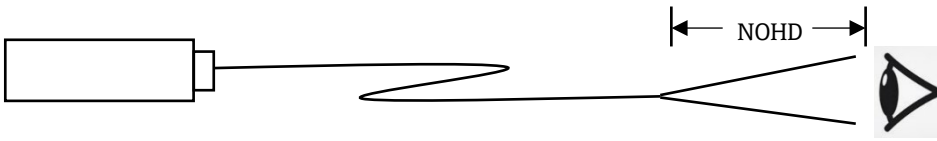

In the case the following formula would be used:

$$r_{NOHD} = \frac{1.7}{NA} \left(\frac{\varphi}{\pi MPE} \right)^{1/2}$$

Where NA is the numerical aperture of the fiber. Endress+Hauser uses fiber having a numerical aperture of 0.29.

Scenario #3:

A collimated beam is being emitted from the probe and the interlock circuit fails to de-energize the laser.

Under ANSI Z136.1 use the following formula where a is the diameter of the emerging beam at 0.5 cm:

$$r_{NOHD} = \left(\frac{1}{\varphi} \right) \left(\frac{4\varphi}{\pi MPE} - a^2 \right)^{1/2}$$

Under IEC 60825-14, the same equation would be used as when using a focusing optic substituting the 0.008 beam diameter for the calculated beam diameter:

$$r_{NOHD} = \frac{1}{\varphi} \left[\frac{4 \times k \times PO}{\pi \times MPE} \right]^5 - \frac{\alpha}{\varphi}$$

1.7 Service safety

Follow your company's safety instructions when removing a process probe from the process interface for service. Always wear proper protective equipment when servicing the equipment.

1.8 Important safeguards

- Do not use the Rxn-41 probe for anything other than its intended use.
- Do not look directly into the laser beam.
- Do not point the laser at a mirrored/shiny surface or a surface that may cause diffuse reflections. The reflected beam is as harmful as the direct beam.
- Do not leave attached and unused probes uncapped or unblocked.
- Always use a laser beam block to avoid inadvertent scatter of laser radiation.

1.9 Product safety

This product is designed to meet all current safety requirements, has been tested, and shipped from the factory in a safe operating condition. The relevant regulations and international standards have been observed. Devices connected to an analyzer must also comply with the applicable analyzer safety standards.

Endress+Hauser Raman spectroscopy systems incorporate the following safety features to conform to the United States Government requirements [21 Code of Federal Regulations \(CFR\)](#) Chapter 1, Subchapter J as administered by the [Center for Devices and Radiological Health \(CDRH\)](#) and IEC 60825-1 as administered by the [International Electrotechnical Commission](#).

1.9.1 CDRH and IEC compliance

Endress+Hauser Raman analyzers are certified by Endress+Hauser to meet CDRH and IEC 60825-1 design and manufacturing requirements.

Endress+Hauser Raman analyzers have been registered with the CDRH. Any unauthorized modifications to an existing Raman Rxn analyzer or accessory may result in hazardous radiation exposure. Such modifications may result in the system being no longer conforming to federal requirements as certified by Endress+Hauser.

1.9.2 Laser safety interlock

The Rxn-41 probe, as installed, forms part of the interlock circuit. If the fiber cable is severed, the laser will turn off within milliseconds of the breakage.

NOTICE

Handle probes and cables with care.

- ▶ Fiber cables should NOT be kinked and should be routed to maintain the minimum bend radius of 152.4 mm (6 in).
- ▶ Permanent damage may result if cables are not routed appropriately.

The interlock circuit is a low-current electrical loop. If the Rxn-41 probe is used in a hazardous classified area, the interlock circuit must pass through an intrinsically safe (IS) barrier.

The laser emission indicator is located on the probe assembly. When there is potential for the laser to be energized, the indicator light is illuminated.

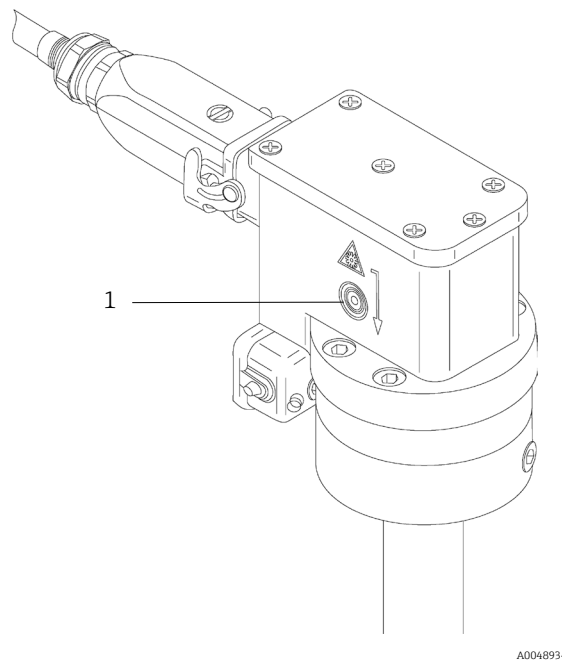

Figure 2. Location of laser interlock indicator light (1)

1.9.3 Hazardous area approvals

The Rxn-41 probe has been third-party approved for use in hazardous areas in accordance with Article 17 of Directive 2014/34/EU of the European Parliament and of the Council dated 26 February 2014. The Rxn-41 probe has been certified to the ATEX Directive for use in Europe, as well as in other countries accepting ATEX-certified equipment.



Figure 3. ATEX label for use in hazardous areas

The Rxn-41 probe has also been approved for use in hazardous areas in the United States (US) and Canada by the [Canadian Standards Association](#) when installed in accordance with the Hazardous Area Installation Drawing (4002396).

The products are eligible to bear the CSA Mark shown with adjacent indicators 'C' and 'US' for Canada and US or with adjacent indicator 'US' for US only or without either indicator for Canada only.



A0048936

Figure 4. CSA label for use in hazardous areas in the US and Canada

The Rxn-41 probe can also be marked for [International Electrotechnical Commission](#) Certification Systems for Explosive Atmospheres (IECEX) when installed in accordance with the Hazardous Area Installation Drawing (4002396).

Compliance with the Essential Health and Safety Requirements, with the exception of those listed in the schedule to this certificate, has been assured by compliance. See an exhaustive list of all appropriate certificates and approvals in *Certificates and approvals* → .

List of Applied Standards and Revision Date: Safety Certification Notification for Safety Devices No. 2021-22.

2 Certificates and approvals

Endress+Hauser offers certifications for the Rxn-41 probe to the standards below. Select the desired certification(s) and the probe or probe tag is marked accordingly.

2.1 Certificates and approvals: production center

Document	Document Number	Products/Processes	Standards/Requirements
ISO 14001:2015 and ISO 45001:2018 Declaration of Conformance	ZE4002039C/61/EN/01.21 (manufacturer)	Design and Manufacture of Raman Spectrographic Instruments including Software; Specialty Holographic Assemblies, Elements and Components	ISO 14001:2015 ISO 45001:2018
ISO 9001:2015 Certificate	Certificate Registration No. 74 300 2705	Design and Manufacture of Raman Spectrographic Instruments including Software; Specialty Holographic Assemblies, Elements and Components	ISO 9001:2015
Quality Assurance Notification (QAN) Raman Analyzers and Probes	Certificate Registr. No. 01 220 093059	Production, final inspection, and testing of Endress+Hauser Rxn2, Rxn4 and Rxn5 Analyzer Base Units and Raman Rxn-41, Rxn-40, Rxn-30, and Rxn-20 Probes. Types of protection: "d", "p", "I", "op is"	Directive 2014/34/EU Annex IV
IECEX Quality Assessment Report (QAR) Certificate	QAR Reference No. DE/TUR/QAR11.0001/05	Analyzer Base Units and Raman Rxn-40 and Rxn-30 Probes Optical Systems, Rxn5 Analyzer Base Units, Raman Rxn-40, Rxn-30, and Rxn-20 Probes Protection concept: Flameproof enclosure – Ex d; Pressurized enclosures "p"; Intrinsic safety "I"; Optical radiation "op is"	not applicable

2.2 Declarations of conformity: probes and optics

Document (Manufacturer Doc #)	Products	Regulations	Standards
EC/EU Declaration of Conformity: Probes and Optics (EU00994C/66/EN/01.22)	Probes, Probeheads, and Probehead Immersion Optics (IO) Rxn-20, Rxn-30, Rxn-41, Rxn-40	European Directives: ATEX 2014/34/EU RoHS 2011/65/EU	Applied harmonized standards or normative documents: EN 60529 2013 EN 60079-0 2018 EN 60079-11 2012 EN 60079-28 2015
Non-ATEX Declaration of Conformity: Probes and Optics (4002034)	Probes, Probeheads, Non-Contact Optics, and Probehead Immersion Optics (IO) Rxn-20, Rxn-30, Rxn-41, Rxn-40, Immersion Optics, Rxn-10 Probe, Non-Contact Optics	European Directives: PED 2014/68/EU RoHS 2011/65/EU	Applied harmonized standards or normative documents: EN 60529 2013
Supplier Declaration: Compliance to HALAL Industrial Production Standards (4004815)	Raman Probes	not applicable	CAC/GL 24-1997 General Guidelines for use of the term "HALAL"

2.3 Certificates and approvals: probes and optics

2.3.1 CSA Certificate of Compliance: Raman probes

The Rxn-41 Raman spectroscopic probe has been approved for use in hazardous areas in the United States and Canada by the [Canadian Standards Association](#) when installed in accordance with the Hazardous Area Installation Drawing (4002396).

The products are eligible to bear the CSA Mark shown with adjacent indicators 'C' and 'US' for Canada and US or with adjacent indicator 'US' for US only or without either indicator for Canada only.



Figure 5. Label showing equipment is approved for use in hazardous areas in the United States and Canada

Products:	CLASS - C225804 - PROCESS CONTROL EQUIPMENT Intrinsically Safe, Entity - For Hazardous Locations CLASS - C225884 - PROCESS CONTROL EQUIPMENT - Intrinsically Safe Entity - For Hazardous Locations - Certified to US Standards
Marking:	Ex ia op is IIA or IIB or IIB + H2 or IIC T3 or T4 Ga Class I, Division 1, Groups A, B, C, D T3/T4 Class I, Zone 0 AEx ia op is IIA or IIB or IIB + H2 or IIC T3 or T4 Ga Class I, Division 1, Groups A, B, C, D T3/T4 ambient range -20 °C to 70 °C OR Ex ia op is IIA or IIB or IIB + H2 or IIC T3 or T4 or T6 Ga Class I, Division 1, Groups A, B, C, D T3/T4/T6 Class I, Zone 0 AEx ia op is IIA or IIB or IIB + H2 or IIC T3 or T4 or T6 Ga Class I, Division 1, Groups A, B, C, D T3/T4/T6 ambient range -20 °C to 65 °C
Alternate marking when the probe window is submerged in liquid with safety interlock through level safety or similar means:	Ex ia IIA or IIB or IIC T3 or T4 Ga ambient range -20 °C to 70 °C Ex ia IIA or IIB or IIC T3 or T4 or T6 Ga ambient range -20 °C to 70 °C
Alternate marking when the probe window is not in contact with a hazardous area:	Ex ia IIC T4 Gb ambient range -20 °C to 70 °C, or Ex ia IIC T6 Gb ambient range -20 °C to 65 °C
Ambient range:	-20 °C to 70 °C Temp class T4, or -20 °C to 65 °C Temp class T6

Maximum optical power to be supplied for the probe (optical connector)

Apparatus Group	IIA		IIB Only		IIB + H ₂	IIC	
Temperature Class	T3	T4	T3	T4	T3	T4	T6
Temperature Class (°C)	<200	<135	<200	<135	<200	<135	<85
Power (mW) Rxn-41 Series Probe	150	35	35	35	35	35	15

The maximum optical power is supplied to the probe by an external controller that is not covered under the certificate. The final installation shall be subjected to acceptance of local authority having jurisdiction.

The tabulated power levels refer to surface areas not exceeding 400 mm².

Conditions of certification:

1. The fiber optic cable linking the laser output to the probe shall be installed so that the minimum bend radius specified by the cable manufacturer is not exceeded.
2. The fiber optic cable shall be installed in a manner such that the cable is not subjected to strain or pulling at the entry of the optical cable into the probe assembly.
3. Where it is necessary to monitor the process level to ensure that the optical beam is not exposed to a potentially explosive atmosphere, the devices used to monitor the level shall be intrinsically safe or classed as simple apparatus and be installed so as to provide (for EPL Ga) a fault tolerance of 2. Where the EPL required for the area of installation is lower than Ga, the reliability of the control mechanism may also be reduced. The functional safety of this arrangement has not been assessed as

part of this certification and it is the responsibility of the installer/user to ensure that an appropriate mechanism is in place, commensurate with the required EPL.

- When the probe is manufactured from titanium, the probe shall be installed so that it cannot be subjected to impact or friction.

Applicable requirements/standards:

- CSA Standard C22.2 No. 0-10 General Requirements - Canadian Electrical Code, Part II
- CAN/CSA-60079-0:18 Electrical apparatus for explosive gas atmospheres – Part 0: General requirements
- CAN/CSA-60079-11:14 Electrical apparatus for explosive gas atmospheres – Part 11: Intrinsic safety “i”
- CAN/CSA-C22.2 No. 60529:16 Degrees of protection provided by enclosures (IP Code)
- CAN/CSA-C22.2 No. 60079-28:16 Electrical apparatus for explosive gas atmospheres – Part 28: Protection of equipment and transmission systems using optical radiation
- CAN/CSA-C22.2 No. 61010-1:18 Safety requirements for electrical equipment for measurement, control, and laboratory use – Part 1: General requirements
- ANSI/UL Standard 913, 8th Ed. Intrinsically Safe Apparatus and Associated Apparatus for Use in Class I, II, and III, Division 1, Hazardous (Classified) Locations
- ANSI/UL 60079-0:2019, 7th Ed. Electrical Apparatus for Explosive Gas Atmospheres – Part 0: General Requirements
- ANSI/UL 60079-11:2013, 6th Ed. Explosive Atmospheres – Part 11: Equipment Protection by Intrinsic Safety “i”
- ANSI/UL 60079-28-2017 Electrical apparatus for explosive gas atmospheres – Part 28: Protection of equipment and transmission systems using optical radiation
- ANSI/UL 61010-1-2018 Third Edition Safety requirements for electrical equipment for measurement, control, and laboratory use – Part 1: General requirements

2.3.2 IECEx Certificate of Conformity: Raman probes

The Rxn-41 probe can also be marked for [International Electrotechnical Commission \(IEC\)](#) Certification Systems for Explosive Atmospheres when installed in accordance with the Hazardous Area Installation Drawing (4002396).

- Type of Protection:** Ex ia op is
- Marking:** Ex ia op is IIA or IIB or IIB+H2 or IIC T3 or T4 Ga ambient range -20 °C to 70 °C, or Ex ia op is IIA or IIB or IIB+H2 or IIC T3 or T4 or T6 Ga ambient range -20 °C to 65 °C
IECEX CSAE 22.0020X
- Alternate marking** when the probe window is submerged in liquid with safety interlock via level sensing or similar means: Ex ia op is IIA or IIB or IIB+H2 or IIC T3 or T4 Ga ambient range -20 °C to 70 °C, or Ex ia op is IIA or IIB or IIB+H2 or IIC T3 or T4 or T6 Ga ambient range -20 °C to 65 °C
- Alternate marking** when the probe window is not in contact with a hazardous area: Ex ia IIC T4 Gb ambient range -20 °C to 70 °C, or Ex ia IIC T6 Gb ambient range -20 °C to 65 °C
- Ambient range:** -20 °C to 70 °C Temp class T4, or -20 °C to 65 °C Temp class T6

Limits of laser power exiting the probe

Apparatus Group	IIA		IIB Only		IIB + H ₂	IIC	
	T3	T4	T3	T4	T3	T4	T6
Temperature Class	T3	T4	T3	T4	T3	T4	T6
Temperature Class (°C)	<200	<135	<200	<135	<200	<135	<85
Power (mW) Rxn-41 Series Probe	150	35	35	35	35	35	15

The tabulated power levels refer to surface areas not exceeding 400 mm².

Conditions of certification:

- The fiber optic cable linking the laser output to the probe shall be installed so that the minimum bend radius specified by the cable manufacturer is not exceeded.
- The fiber optic cable shall be installed in a manner such that the cable is not subjected to strain or pulling at the entry of the optical cable into the probe assembly.
- Where it is necessary to monitor the process level to ensure that the optical beam is not exposed to a potentially explosive atmosphere, the devices used to monitor the level shall be intrinsically safe or classed as simple apparatus and be installed to provide (for EPL Ga) a fault tolerance of 2. Where the EPL required for the area of installation is lower than Ga, the reliability of the control mechanism may also be reduced. The functional safety of this arrangement has not been assessed as

part of this certification and it is the responsibility of the installer/user to ensure that an appropriate mechanism is in place, commensurate with the required EPL.

- When the probe is manufactured from titanium, the probe shall be installed so that it cannot be subjected to impact or friction.

Applicable requirements/standards:

The equipment and any acceptable variations to it specified in the schedule of this certificate and the identified documents, was found to comply with the following standards:

- IEC 60079-0:2017 Edition:7.0 Explosive atmospheres - Part 0: Equipment - General requirements
- IEC 60079-11:2011 Edition:6.0 Explosive atmospheres - Part 11: Equipment protection by intrinsic safety "i"
- EN 60079-28:2015 Edition:2 Explosive atmospheres - Part 28: Protection of equipment and transmission systems using optical radiation

2.3.3 ATEX Certificate: Raman probes

The Rxn-41 probe has been third-party approved for use in hazardous areas in accordance with Article 17 of Directive 2014/34/EU of the European Parliament and of the Council dated 26 February 2014. The Rxn-41 probe has been certified to the ATEX Directive for use in Europe, as well as in other countries accepting ATEX-certified equipment.



Figure 6. ATEX label for use in hazardous areas

Marking:

 II 1 G Ex ia op is IIA or IIB or IIB+H2 or IIC T3 or T4 Ga ambient range -20 °C to 70 °C, or
II 1 G Ex ia op is IIA or IIB or IIB+H2 or IIC T3 or T4 or T6 Ga ambient range -20 °C to 65 °C

Alternate marking when the probe window is submerged in liquid with safety interlock via level sensing or similar means:

 II 1 G Ex ia IIA or IIB or IIB+H2 or IIC T3 or T4 Ga ambient range -20 °C to 70 °C, or
II 1 G Ex ia IIA or IIB or IIB+H2 or IIC T3 or T4 or T6 Ga ambient range -20 °C to 65 °C

Alternate marking when the probe window is not in contact with a hazardous area:

 II 2 G Ex ia IIC T4 Gb ambient range -20 °C to 70 °C, or
II 2 G Ex ia IIC T6 Gb ambient range -20 °C to 65 °C

Ambient range:

-20 °C to 70 °C Temp class T4, or -20 °C to 65 °C Temp class T6

Limits of laser power exiting the probe

Apparatus Group	IIA		IIB Only		IIB + H ₂	IIC	
	T3	T4	T3	T4	T3	T4	T6
Temperature Class	T3	T4	T3	T4	T3	T4	T6
Temperature Class (°C)	<200	<135	<200	<135	<200	<135	<85
Power (mW) Rxn-41 Series Probe	150	35	35	35	35	35	15

The tabulated power levels refer to surface areas not exceeding 400 mm².

Conditions of certification:

- The fiber optic cable linking the laser output to the Rxn-41 probe shall be installed so that the minimum bend radius specified by the cable manufacturer is not exceeded.
- The fiber optic cable shall be installed in a manner such that the cable is not subjected to strain or pulling at the entry of the optical cable into the probe assembly.
- Where it is necessary to monitor the process level to ensure that the optical beam is not exposed to a potentially explosive atmosphere, the devices used to monitor the level shall be intrinsically safe or classed as simple apparatus and be installed so as to provide (for EPL Ga/Category 1G) a fault tolerance of 2. Where the EPL required for the area of installation is lower than Ga/Category 1G, the reliability of the control mechanism may also be reduced. The functional safety of this

arrangement has not been assessed as part of this certification and it is the responsibility of the installer/user to ensure that an appropriate mechanism is in place, commensurate with the required EPL/Equipment Category.

- 4. When the probe is manufactured from titanium, the probe shall be installed so that it cannot be subjected to impact or friction.

Applicable requirements/standards:

Compliance with the relevant Essential Health and Safety Requirements has been assured by compliance with the requirements identified in the following:

- IEC 60079-0:2017 Edition:7.0 Explosive atmospheres - Part 0: Equipment - General requirements
- IEC 60079-11:2011 Edition:6.0 Explosive atmospheres - Part 11: Equipment protection by intrinsic safety "I"
- EN 60079-28:2015 Edition:2 Explosive atmospheres - Part 28: Protection of equipment and transmission systems using optical radiation

2.3.4 JPEx Certificate: Raman probes

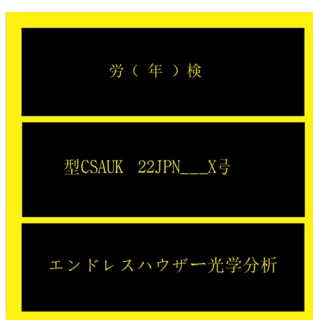

A0053030

Figure 7. JPEx product certification label

The JPEx certification number depends on the gas group and temperature class of the sample with which the probe is in contact. The relevant certification numbers for each gas group and temperature class are provided below.

Ambient range: -20 °C to 70 °C Temp class T4, or -20 °C to 65 °C Temp class T6

JPEx markings and certification numbers

Model	Marking	Certification Number
Rxn-41	Ex ia op is IIA T3 Ga Tamb -20 °C to 70 °C	CSAUK 22JPN122X
	Ex ia op is IIA T4 Ga Tamb -20 °C to 70 °C	CSAUK 22JPN123X
	Ex ia op is IIB T3 Ga Tamb -20 °C to 70 °C	CSAUK 22JPN124X
	Ex ia op is IIB T4 Ga Tamb -20 °C to 70 °C	CSAUK 22JPN125X
	Ex ia op is IIB + H2 T3 Ga Tamb -20 °C to 70 °C	CSAUK 22JPN126X
	Ex ia op is IIC T4 Ga Tamb -20 °C to 70 °C	CSAUK 22JPN127X
	Ex ia op is IIC T6 Ga Tamb -20 °C to 65 °C	CSAUK 22JPN128X

2.3.5 UKCA certification

The Rxn-41 probe has been third-party approved for use in hazardous areas in accordance with Article 17 of Directive-2014/34/EU of the European Parliament and of the Council dated 26 February 2014. The Rxn-41 probe has been certified to the ATEX Directive for use in Europe, as well as in other countries accepting ATEX-certified equipment.



Figure 8. UK product certification label

Marking:



II 1 G Ex ia op is IIA or IIB or IIB+H2 or IIC T3 or T4 Ga ambient range -20 °C to 70 °C, or
 II 1 G Ex ia op is IIA or IIB or IIB+H2 or IIC T3 or T4 or T6 Ga ambient range -20 °C to 65 °C

Alternate marking when the probe window is submerged in liquid with safety interlock via level sensing or similar means:



II 1 G Ex ia IIA or IIB or IIB+H2 or IIC T3 or T4 Ga ambient range -20 °C to 70 °C, or
 II 1 G Ex ia IIA or IIB or IIB+H2 or IIC T3 or T4 or T6 Ga ambient range -20 °C to 65 °C

Alternate marking when the probe window is not in contact with a hazardous area:



II 2 G Ex ia IIC T4 Gb ambient range -20 °C to 70 °C, or
 II 2 G Ex ia IIC T6 Gb ambient range -20 °C to 65 °C

Ambient range:

-20 °C to 70 °C Temp class T4, or -20 °C to 65 °C Temp class T6

Limits of laser power exiting the probe

Apparatus Group	IIA		IIB Only		IIB + H ₂	IIC	
Temperature Class	T3	T4	T3	T4	T3	T4	T6
Temperature Class (°C)	<200	<135	<200	<135	<200	<135	<85
Power (mW) Rxn-41 Series Probe	150	35	35	35	35	35	15

The maximum optical power is supplied to the probe by an external controller that is not covered under the certificate. The final installation shall be subjected to acceptance of local authority having jurisdiction. The tabulated power levels refer to surface areas not exceeding 400 mm².

Conditions of certification:

1. The fiber optic cable linking the laser output to the probe shall be installed so that the minimum bend radius specified by the cable manufacturer is not exceeded.
2. The fiber optic cable shall be installed in a manner such that the cable is not subjected to strain or pulling at the entry of the optical cable into the probe assembly.
3. Where it is necessary to monitor the process level to ensure that the optical beam is not exposed to a potentially explosive atmosphere, the devices used to monitor the level shall be intrinsically safe or classed as simple apparatus and be installed so as to provide (for EPL Ga/Category 1G) a fault tolerance of 2. Where the EPL required for the area of installation is lower than Ga/Category 1G, the reliability of the control mechanism may also be reduced. The functional safety of this arrangement has not been assessed as part of this certification and it is the responsibility of the installer/ user to ensure that an appropriate mechanism is in place, commensurate with the required EPL/Equipment Category.
4. When the probe is manufactured from titanium, the probe shall be installed so that it cannot be subjected to impact or friction.

Applicable requirements/standards:

Compliance with the relevant Essential Health and Safety Requirements has been assured by compliance with the requirements identified in the following:

- [IEC 60079-0:2017](#) Edition:7.0 Explosive atmospheres - Part 0: Equipment - General requirements
- [IEC 60079-11:2011](#) Edition:6.0 Explosive atmospheres - Part 11: Equipment protection by intrinsic safety "i"
- [EN 60079-28:2015](#) Edition:2 Explosive atmospheres - Part 28: Protection of equipment and transmission systems using optical radiation

3 Hazardous area installation

The Rxn-41 probe is designed for direct installation into reaction vessels or process streams. The probe must be installed according to the Hazardous Area Installation Drawing (4002396).

NOTICE

When installing the probe in situ, the user must provide the strain relief to the fiber optic cable at the probe installation location.

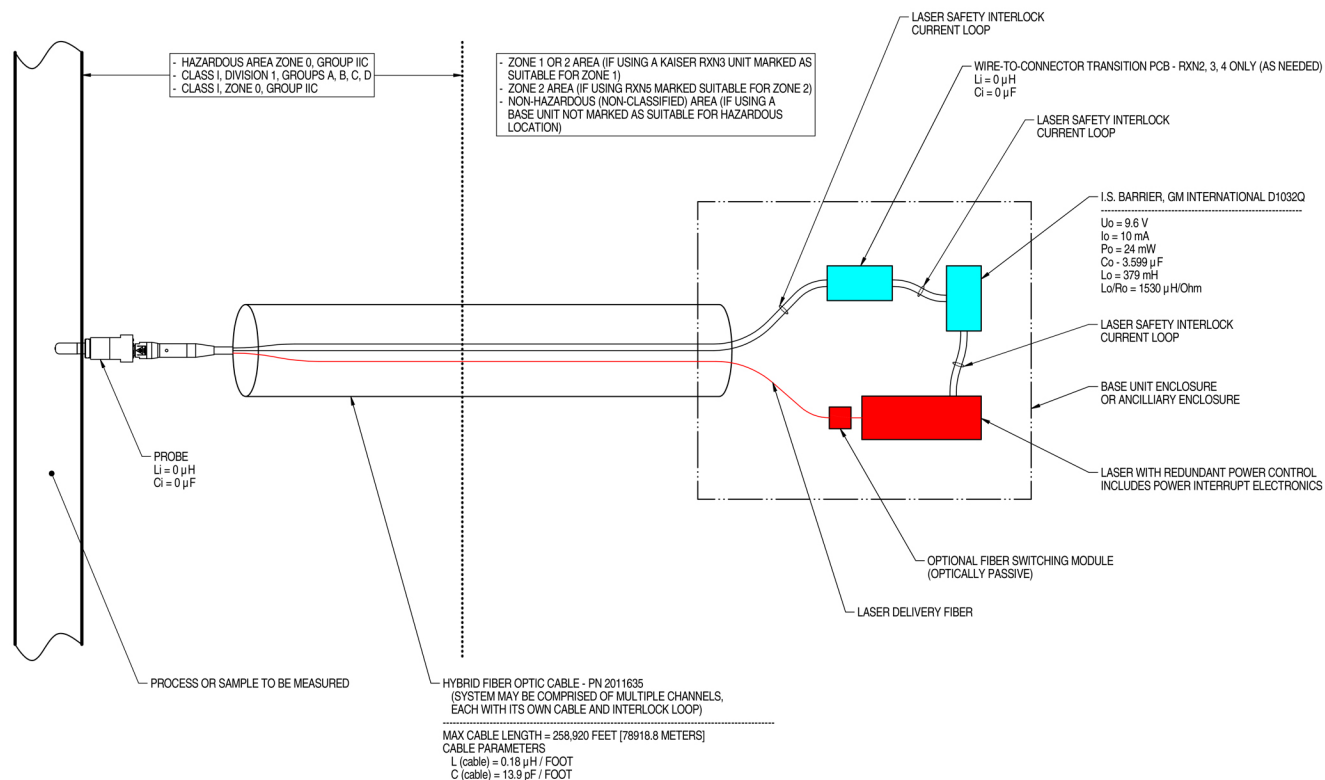

NOTES:

- CONTROL EQUIPMENT CONNECTED TO THE ASSOCIATED APPARATUS MUST NOT USE OR GENERATE MORE THAN 250 VRMS OR VDC.
- INSTALLATION IN THE U.S. SHOULD BE IN ACCORDANCE WITH ANSI/ISA RP12.6 "INSTALLATION OF INTRINSICALLY SAFE SYSTEMS FOR HAZARDOUS (CLASSIFIED) LOCATIONS" AND THE NATIONAL ELECTRICAL CODE® (ANSI/NFPA 70) SECTIONS 504 AND 505.
- INSTALLATION IN CANADA SHOULD BE IN ACCORDANCE WITH THE CANADIAN ELECTRICAL CODE, CSA C22.1, PART 18, APPENDIX J18.
- ASSOCIATED APPARATUS MANUFACTURER'S INSTALLATION DRAWING MUST BE FOLLOWED WHEN INSTALLING THIS EQUIPMENT.
- FOR U.S. INSTALLATIONS, THE PROBE MODELS RXN-30 (AIRHEAD), RXN-40 (WETHEAD) AND RXN-41 (PILOT) ARE APPROVED FOR CLASS I, ZONE 0 APPLICATIONS.
- NO REVISION TO DRAWING WITHOUT PRIOR CSA APPROVAL.
- WARNING: SUBSTITUTION OF COMPONENTS MAY IMPAIR INTRINSIC SAFETY.

A0049010

Figure 9. Hazardous Area Installation Drawing (4002396 X6)

www.addresses.endress.com
