

Operating Instructions

Memosens ISFET sensors





CPS47E, CPS77E, CPS97E

pH measurement
Sensors with Memosens 2.0 technology











1 About this document



1.1 Safety information

Structure of information	Meaning
<p> DANGER</p> <p>Causes (/consequences) If necessary, Consequences of non-compliance (if applicable)</p> <ul style="list-style-type: none"> ▶ Corrective action 	<p>This symbol alerts you to a dangerous situation. Failure to avoid the dangerous situation will result in a fatal or serious injury.</p>
<p> WARNING</p> <p>Causes (/consequences) If necessary, Consequences of non-compliance (if applicable)</p> <ul style="list-style-type: none"> ▶ Corrective action 	<p>This symbol alerts you to a dangerous situation. Failure to avoid the dangerous situation can result in a fatal or serious injury.</p>
<p> CAUTION</p> <p>Causes (/consequences) If necessary, Consequences of non-compliance (if applicable)</p> <ul style="list-style-type: none"> ▶ Corrective action 	<p>This symbol alerts you to a dangerous situation. Failure to avoid this situation can result in minor or more serious injuries.</p>
<p> NOTICE</p> <p>Cause/situation If necessary, Consequences of non-compliance (if applicable)</p> <ul style="list-style-type: none"> ▶ Action/note 	<p>This symbol alerts you to situations which may result in damage to property.</p>

1.2 Symbols

	Additional information, tips
	Permitted
	Recommended
	Not permitted or not recommended
	Reference to device documentation
	Reference to page
	Reference to graphic
	Result of an individual step

1.2.1 Symbols on the device

	Reference to device documentation
	Do not dispose of products bearing this marking as unsorted municipal waste. Instead, return them to the manufacturer for disposal under the applicable conditions.

1.3 Documentation

The following manuals which complement these Operating Instructions can be found on the product pages on the Internet:

- Technical Information for the relevant sensor
- Operating Instructions for the transmitter used

In addition to these Operating Instructions, an XA with "Safety instructions for electrical apparatus in the hazardous area" is also included with sensors for use in the hazardous area.

- ▶ Please follow instructions on use in the hazardous area carefully.



Special Documentation for hygienic applications, SD02751C



Safety instructions for electrical equipment in hazardous areas, Memosens ISFET pH sensors for ATEX and IECEx approval, XA02692C



Safety instructions for electrical equipment in hazardous areas, Memosens ISFET pH sensors for CSA C/US approval, XA02689C



Safety instructions for electrical equipment in hazardous areas, Memosens ISFET pH sensors for INMETRO approval, XA02688C



Safety instructions for electrical equipment in hazardous areas, Memosens ISFET pH sensors for JPN Ex approval, XA02690C



Safety instructions for electrical equipment in hazardous areas, Memosens ISFET pH sensors for NEPSI Ex approval, XA02691C



Safety instructions for electrical equipment in hazardous areas, Memosens ISFET pH sensors for UKCA approval, XA02647C



Safety instructions for electrical equipment in hazardous areas, Memosens ISFET pH sensors for Korea Ex approval, XA02699C

2 Basic safety instructions

2.1 Requirements for the personnel

- Installation, commissioning, operation and maintenance of the measuring system may be carried out only by specially trained technical personnel.
- The technical personnel must be authorized by the plant operator to carry out the specified activities.
- The electrical connection may be performed only by an electrical technician.
- The technical personnel must have read and understood these Operating Instructions and must follow the instructions contained therein.
- Faults at the measuring point may only be rectified by authorized and specially trained personnel.



Repairs not described in the Operating Instructions provided must be carried out only directly at the manufacturer's site or by the service organization.

2.2 Intended use

The sensors are designed for continuous measurement of the pH value in liquids.



A list of recommended applications is provided in the Technical Information for the relevant sensor.

Any use other than that intended puts the safety of people and the measuring system at risk. Therefore, any other use is not permitted.

The manufacturer is not liable for harm caused by improper or unintended use.

2.3 Workplace safety

As the user, you are responsible for complying with the following safety conditions:

- Installation guidelines
- Local standards and regulations
- Regulations for explosion protection

2.4 Operational safety

Before commissioning the entire measuring point:

1. Verify that all connections are correct.
2. Ensure that electrical cables and hose connections are undamaged.
3. Do not operate damaged products, and protect them against unintentional operation.
4. Label damaged products as defective.

During operation:

- ▶ If faults cannot be rectified,
take products out of service and protect them against unintentional operation.

2.5 Product security

2.5.1 State of the art

The product is designed to meet state-of-the-art safety requirements, has been tested, and left the factory in a condition in which it is safe to operate. The relevant regulations and international standards have been observed.

3 Incoming acceptance and product identification

3.1 Incoming acceptance

1. Verify that the packaging is undamaged.
 - ↳ Notify the supplier of any damage to the packaging.
Keep the damaged packaging until the issue has been resolved.

2. Verify that the contents are undamaged.
 - ↳ Notify the supplier of any damage to the delivery contents.
Keep the damaged goods until the issue has been resolved.
3. Check that the delivery is complete and nothing is missing.
 - ↳ Compare the shipping documents with your order.
4. Pack the product for storage and transportation in such a way that it is protected against impact and moisture.
 - ↳ The original packaging offers the best protection.
Make sure to comply with the permitted ambient conditions.

If you have any questions, please contact your supplier or your local Sales Center.

3.2 Product identification

3.2.1 Nameplate

The nameplate provides you with the following information on your device:

- Manufacturer identification
- Extended order code
- Serial number
- Safety information and warnings
- Certificate information

- ▶ Compare the information on the nameplate with the order.

3.2.2 Identifying the product

Interpreting the order code

The order code and serial number of your product can be found in the following locations:

- On the nameplate
- In the delivery papers

Obtaining information on the product

1. Go to www.endress.com.
2. Page search (magnifying glass symbol): Enter valid serial number.
3. Search (magnifying glass).
 - ↳ The product structure is displayed in a popup window.
4. Click the product overview.
 - ↳ A new window opens. Here you fill information pertaining to your device, including the product documentation.

3.2.3 Manufacturer address

Endress+Hauser Conducta GmbH+Co. KG
Dieselstraße 24
70839 Gerlingen
Germany

3.3 Storage and transport

All sensors are individually tested and supplied in individual packs. The sensors are equipped with a moistening cap with a bayonet lock. The cap contains a special liquid that prevents the sensor from drying out.

- ▶ If a moistening cap is not used to store the sensor, store the sensor in a KCl solution (3 mol/l) or buffer solution.



Do not allow the sensor to dry out, as this can result in permanent measurement errors.

Sensors must be stored in dry rooms at temperatures of 0 to 50 °C (32 to 122 °F).

NOTICE

Freezing of internal buffer and inner electrolyte!

The sensors can crack at temperatures lower than -15 °C (5 °F).

- ▶ If transporting the sensors, make sure to package them so they are appropriately protected against frost.

3.4 Scope of delivery

The scope of delivery comprises:

- Ordered version of the sensor
- Operating Instructions
- Safety instructions for the hazardous area (for sensors with Ex approval)
- Supplementary sheet for optionally ordered certificates

3.5 Certificates and approvals

Current certificates and approvals for the product are available at www.endress.com on the relevant product page:

1. Select the product using the filters and search field.
2. Open the product page.
3. Select **Downloads**.

4 Mounting

4.1 Mounting requirements

- Before screwing in the sensor, make sure the assembly thread, the O-rings and the sealing surface are clean and undamaged and that the thread runs smoothly.
- Pay attention to the installation instructions provided in the Operating Instructions of the assembly used.

- ▶ Tighten the sensor by hand with a torque of 3 Nm (2.21 lbf ft) (specification applies only if installed in Endress+Hauser assemblies).



4.1.1 Orientation

NOTICE

Open junction

Gel can escape from the sensor interior and resulting air bubbles can break the electrical contact!

- ▶ Exercise care when handling the sensor.
- ▶ Align the sensor at an optimum angle to the direction of flow.

1. Note the direction of medium flow when installing the sensor.
2. Position the ISFET chip at an angle of approx. 30 to 45 ° to the direction of flow (item 2)
→  2,  8. Use the rotatable terminal head for this purpose.

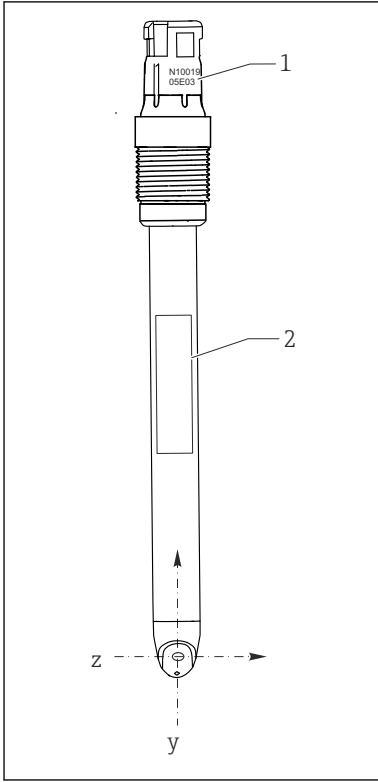

1 Sensor orientation, front view

- 1 Serial number
- 2 Nameplate

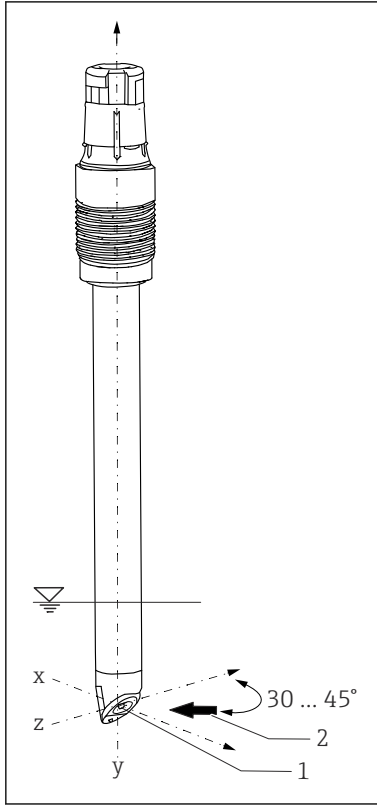

2 Sensor orientation, 3D view

- 1 ISFET chip
- 2 Direction of medium flow

When installing the sensor in an assembly, the serial number engraved on the terminal head can be used as a guide when aligning the sensor → 1, 8. The engraving is always on the same plane as the ISFET chip and the nameplate (z-y direction).

ISFET sensors are not designed for use in abrasive media.

- ▶ If these sensors are used in such applications, avoid direct flow to the chip.
 - ↳ The disadvantage is that the pH value displayed is not stable.

ISFET sensors can be installed in any position because there is no liquid internal lead. However, if installed upside down, the possibility of an air bubble in the reference system interrupting the electrical contact between the medium and the junction or reference cannot be ruled out.

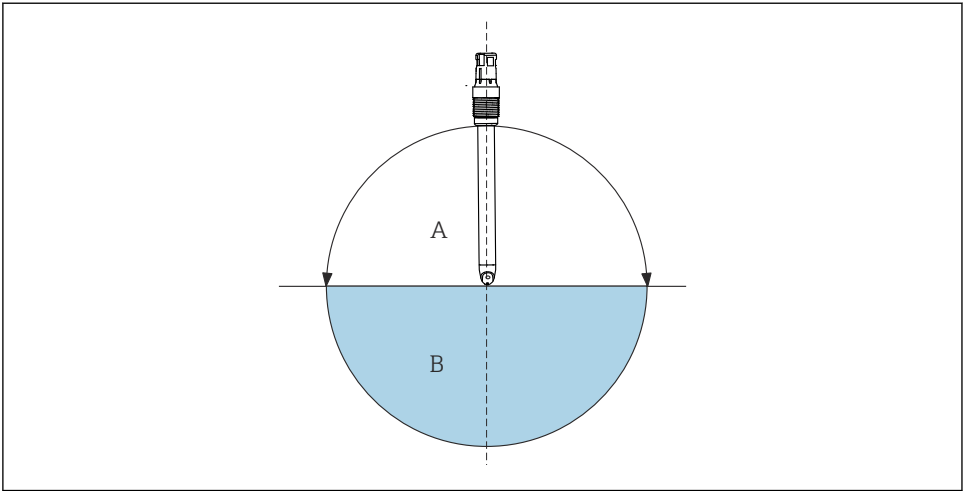

A0030407

3 *Angle of installation*

A *Recommended*

B *Permitted, pay attention to basic conditions* → 8

Basic conditions: The sensor is delivered from the factory free of air bubbles. Air bubbles occur, however, when working with a vacuum, e.g. when emptying a tank.

1. In the case of upside-down installations, in particular, make sure that the KCI supply vessel is free from air bubbles when connected.
2. Leave the installed sensor in dry conditions for a maximum of 6 hours (also applies to upside-down installation).

4.2 Post-mounting check

Put the sensor into operation only if you can answer "yes" to the following questions:

- Are the sensor and cable undamaged?
- Is the orientation correct?

5 Electrical connection

5.1 Connecting the sensor

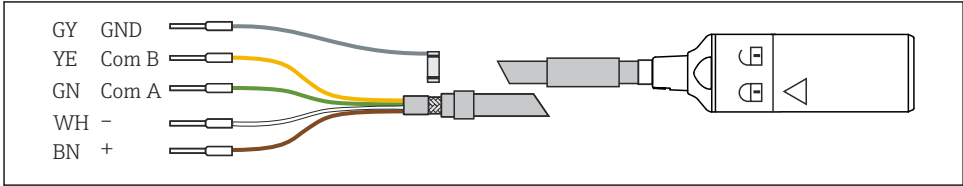

 4 *Measuring cable CYK10 or CYK20*

► Connect the Memosens measuring cable, e.g. CYK10 or CYK20, to the sensor.

 For further information on cable CYK10, see BA00118C.

6 Commissioning

6.1 Preliminaries

Before commissioning the sensor, remove the wetting cap with bayonet connector:

1.

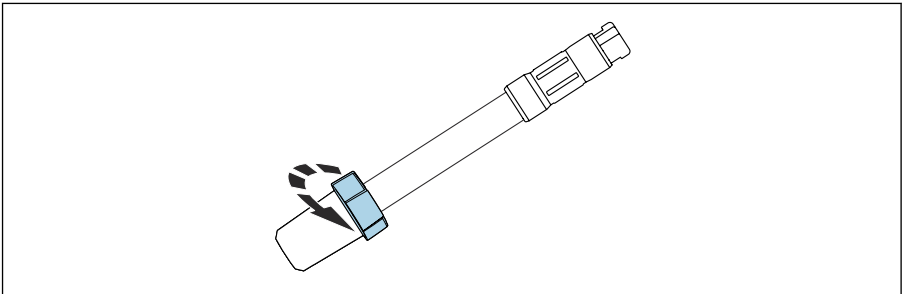

Open the connector.

2. Push the connector upwards.

3.

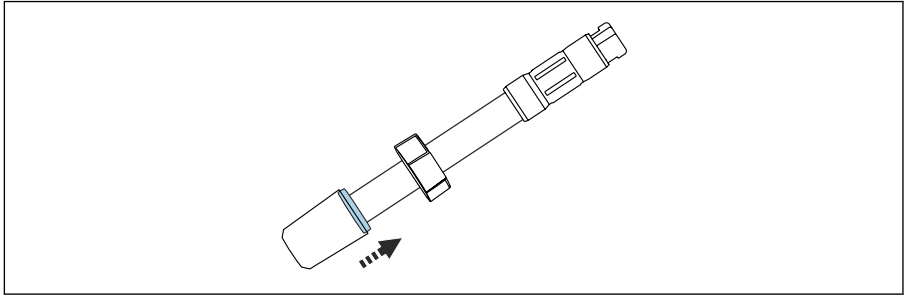

A0047391

The rubber seal, which is located under the lock, must now be pushed up slightly so that an airspace is formed.

↳ The wetting cap can be released easily and without any counterpressure.

4.

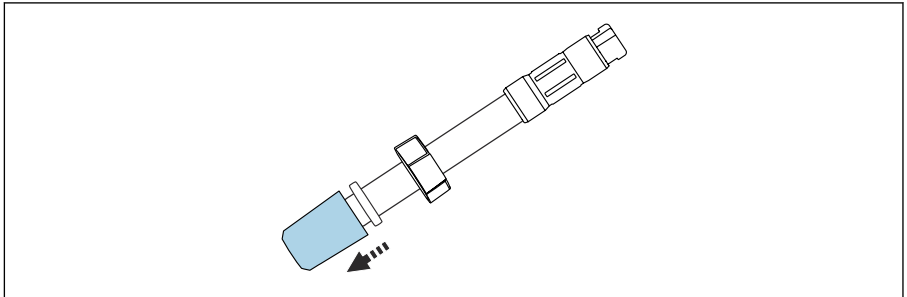

A0047206

Carefully remove the wetting cap from the sensor.

5. Remove the rubber seal and the connector from the sensor.

6.1.1 Calibration and adjustment

The frequency at which a sensor calibration or sensor inspection is performed depends on the operating conditions (fouling, chemical load).

i ISFET sensors with Memosens technology do not need to be calibrated when connected for the first time. Calibration is only required if very strict measurement accuracy requirements must be met, or if the sensor has been in storage for longer than 3 months.

Two-point calibration is required for ISFET sensors. Use quality buffers from Endress+Hauser, e.g. CPY20, for this purpose.

1. To calibrate and measure, remove the wetting cap with bayonet connector →  10.
2. If the wetting cap is no longer used to store the sensor, store the sensor in a KCl solution (3 mol/l) or buffer solution.
3. Do not store the sensor in distilled water.
4. ISFET sensors that are stored dry must be immersed in water for at least 30 minutes before use.

A closed-control loop is created when the measuring system is switched on. The measured value adjusts to the real value during this time (15 minutes at least).

This settling behavior occurs every time the film of liquid between the pH-sensitive semiconductor and the reference lead is interrupted. The settling time depends on the length of the interruption.

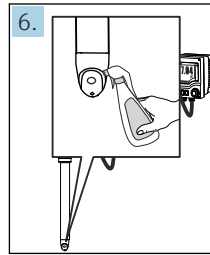
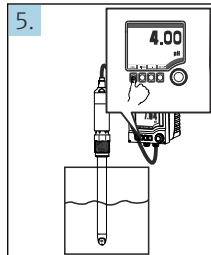
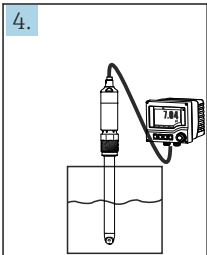
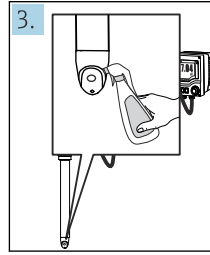
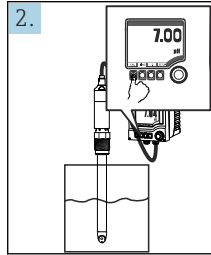
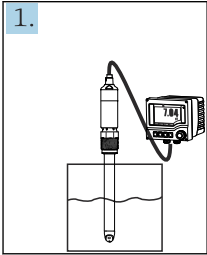

1. Immerse the sensor in a defined buffer solution (e.g. pH 7).
2. Perform the calibration at the transmitter:
 - (a) In the case of pH sensors and manual temperature compensation, set the measurement temperature. Omit this step if automatic temperature compensation (ATC) is switched on.
 - (b) Enter the pH value of the buffer solution.
 - (c) Start the calibration.
 - (d) The value is accepted once it has stabilized.
3. Rinse the sensor with distilled water. Do not dry the sensor or rub it dry!
4. Immerse the sensor in the second buffer solution (e.g. pH 4).
5. Perform the calibration at the transmitter:
 - (a) Enter the pH value of the second buffer solution.
 - (b) Start the calibration.
 - (c) The value is accepted once it has stabilized.

The device calculates the operating point and slope and displays the values. Once the adjustment values have been accepted, the device is adjusted to the new sensor.

6. Rinse the sensor with distilled water.

7 Maintenance

7.1 Maintenance tasks

7.1.1 Cleaning the sensor

WARNING

Mineral acids

Risk of serious or fatal injury from caustic burns!

- ▶ Wear goggles to protect eyes.
- ▶ Wear protective gloves and appropriate protective clothing.
- ▶ Avoid all contact with the eyes, mouth and skin.

WARNING

Thiocarbamide

Harmful if swallowed! Limited evidence of carcinogenicity! Possible risk of harm to the unborn child! Dangerous for the environment with long-term effects!

- ▶ Wear protective goggles, protective gloves and appropriate protective clothing.
- ▶ Avoid all contact with the eyes, mouth and skin.
- ▶ Avoid discharge into the environment.

NOTICE

Pressurized water can damage the seal!

- ▶ Do not direct pressurized water straight onto the chip.

8 Repair

8.1 General notes

The repair and conversion concept provides for the following:

- The product has a modular design
- Spare parts are grouped into kits which include the associated kit instructions
- Only use original spare parts from the manufacturer
- Repairs are carried out by the manufacturer's Service Department or by trained users
- Certified devices can only be converted to other certified device versions by the manufacturer's Service Department or at the factory
- Observe applicable standards, national regulations, Ex documentation (XA) and certificates

1. Carry out the repair according to the kit instructions.
2. Document the repair and conversion and enter, or have entered, in the Life Cycle Management tool (W@M).

8.2 Spare parts

Device spare parts that are currently available for delivery can be found on the website:

<https://portal.endress.com/webapp/SparePartFinder>

- ▶ Quote the serial number of the device when ordering spare parts.

8.3 Return

The product must be returned if repairs or a factory calibration are required, or if the wrong product was ordered or delivered. As an ISO-certified company and also due to legal regulations, Endress+Hauser is obliged to follow certain procedures when handling any returned products that have been in contact with medium.

To ensure the swift, safe and professional return of the device:

- ▶ Check the website www.endress.com/support/return-material for information on the procedure and general conditions.

8.4 Disposal

The device contains electronic components. The product must be disposed of as electronic waste.

- ▶ Observe the local regulations.

 If required by the Directive 2012/19/EU on waste electrical and electronic equipment (WEEE), the product is marked with the depicted symbol in order to minimize the disposal of WEEE as unsorted municipal waste. Do not dispose of products bearing this marking as unsorted municipal waste. Instead, return them to the manufacturer for disposal under the applicable conditions.



71662144

www.addresses.endress.com
