

Special Documentation

Proline Promass 500

Custody transfer
Counter for liquids other than water
HART



Table of contents

1	About this document	4
1.1	Document function	4
1.2	Using this document	4
1.3	Symbols used	4
1.4	Documentation	5
2	Basic safety instructions	5
2.1	Requirements for the personnel	5
3	Product description	6
4	Product identification	6
5	Operation and commissioning	7
5.1	Operating conditions	7
5.2	Delivery status	9
5.3	Custody transfer	9
5.4	Reading parameters relevant for custody transfer	19
5.5	Custody transfer logbook	20
5.6	Procedure for market surveillance	22
5.7	Repeated calibration due to legal metrology controls	23
5.8	Sealing	23
6	Parameters in custody transfer mode	27
6.1	Configurable parameters	27

1 About this document

1.1 Document function

This manual is Special Documentation that describes the use of the device in custody transfer measurement.

NOTICE

When installing:

- Follow the Operating Instructions for the device.

1.2 Using this document







1.2.1 Information on the document structure





For additional information regarding the arrangement of the parameters, along with a short description, according to the **Operation** menu, **Setup** menu, **Diagnostics** menu and the operating concept, see the Operating Instructions, "Supplementary device documentation" section

1.3 Symbols used

1.3.1 Symbols for certain types of information

Symbol	Meaning
	Tip Indicates additional information.
	Reference to documentation
	Reference to page
	Reference to graphic
	Notice or individual step to be observed
	Series of steps
	Result of a step

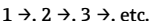
1.3.2 Symbols in graphics

Symbol	Meaning
	Item numbers
	Series of steps of individual, consecutive images
	Series of steps within an image

Symbol	Meaning
A, B, C, ...	Views
A-A, B-B, C-C, ...	Sections

1.4 Documentation

This manual is Special Documentation. It is not a substitute for the Operating Instructions supplied with the device.

For detailed information, refer to the Operating Instructions and other documentation on the CD-ROM provided or visit "www.endress.com/deviceviewer".

The Special Documentation is an integral part of the following Operating Instructions:

Measuring device	Documentation code
Promass F 500	BA01529D
Promass O 500	BA01532D
Promass Q 500	BA01534D
Promass X 500	BA01536D

2 Basic safety instructions

2.1 Requirements for the personnel

The personnel for installation, commissioning, diagnostics and maintenance must fulfill the following requirements:

- ▶ Trained, qualified specialists must have a relevant qualification for this specific function and task.
- ▶ Are authorized by the plant owner/operator.
- ▶ Are familiar with federal/national regulations.
- ▶ Before starting work, read and understand the instructions in the manual and supplementary documentation as well as the certificates (depending on the application).
- ▶ Follow instructions and comply with basic conditions.

The operating personnel must fulfill the following requirements:

- ▶ Are instructed and authorized according to the requirements of the task by the facility's owner-operator.
- ▶ Follow the instructions in this manual.

3 Product description

The measuring device has been tested in accordance with the internationally recognized OIML guidelines. It has an EU Evaluation Certificate authorizing its use in specific applications that are subject to legal metrology controls in EC type examination certificates.

The measuring device features a local display. It is used with outputs that are subject to legal metrology controls.

Measuring devices subject to legal metrology controls are protected against tampering by means of an electronic lock with Authorized user login and password and optional sealing of the transmitter or sensor. This electronic lock and optional seal may be unlocked or broken only by an authorized representative of the responsible authority for legal metrology controls. Operator seals are not subject to legal controls.

Once the measuring device has been put into operation with an electronic lock, operation is possible on a restricted basis only.

Europe

Since the European Measuring Instruments Directive 2004/22/EC came into effect on November 1, 2006 and was replaced by 2014/32/EU on April 20, 2016, counters with the relevant marking can be placed on the market across the borders of all EU member states that have ratified the requirements of Annex VII (MI-005) of the European Measuring Instruments Directive and incorporated them into national law.

The associated declaration of conformity for the measuring instrument, as per the European Measuring Instruments Directive 2014/32/EU, was made in accordance with Module B:

Type examination according to OIML R117-1:2007 and OIML R117:2019

Outside Europe

Detailed ordering information for national approvals based on OIML R117 is available from your local Endress+Hauser sales center.

4 Product identification

Measuring devices for use subject to legal metrology controls are supplied with the relevant marking.

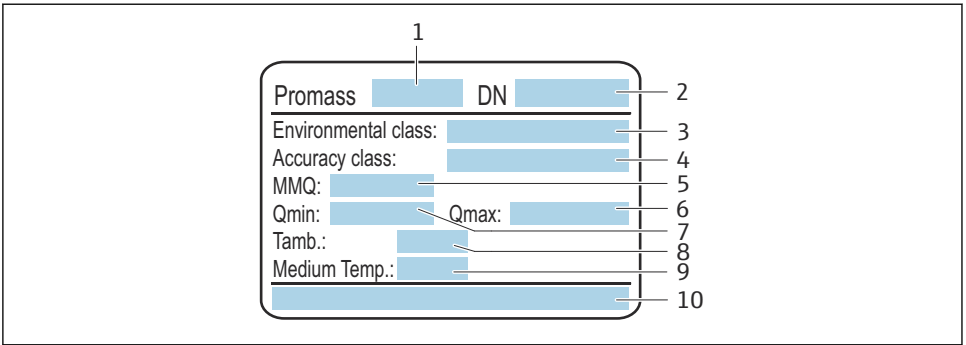

A0034714

1 Sensor nameplate, subject to mandatory verification

- 1 Name of sensor
- 2 Nominal diameter of sensor
- 3 Permitted environmental classes
- 4 Accuracy class
- 5 Minimum measured quantity
- 6 Maximum permanent flowrate Q_{max}
- 7 Minimum permanent flowrate Q_{min}
- 8 Ambient temperature
- 9 Temperature of the medium (depending on the device version ordered, the data indicated are extended by the corresponding limit values)
- 10 Number of certificate

5 Operation and commissioning

5.1 Operating conditions

The operating conditions can be found in the relevant national or EU Evaluation Certificates.

- i** An entry is generated in the custody transfer logbook each time the power supply is interrupted. Only interrupt the power supply if this is absolutely necessary. → 20
- Shielded signal cables must be used for operation.

European Measuring Instruments Directive (MID MI-005)

Measuring instrument	Medium temperature range			Maximum pressure bar(g)
	Oil and oil products, chemicals and consumable liquids Accuracy class 0.3; 0.5	Liquefied gas under pressure ≥ -10 °C (LPG, LCO ₂) Accuracy class 1.0	Liquefied carbon dioxide, cryogenic liquids, liquefied gas < -10 °C (LNG, LCO ₂) Accuracy class 1.5; 2.5	
Promass F	-10 to +200 °C (mass)	-10 to +200 °C (mass)	-200 to +90 °C (mass)	100
	-10 to +90 °C (vol/dens)	-10 to +90 °C (vol/dens)	-	

Measuring instrument	Medium temperature range			Maximum pressure bar(g)
	Oil and oil products, chemicals and consumable liquids Accuracy class 0.3; 0.5	Liquefied gas under pressure ≥ -10 °C (LPG, LCO ₂) Accuracy class 1.0	Liquefied carbon dioxide, cryogenic liquids, liquefied gas < -10 °C (LNG, LCO ₂) Accuracy class 1.5; 2.5	
Promass O	-10 to +200 °C (mass)	-10 to +200 °C (mass)	-40 to +90 °C (mass) ¹⁾	258
	-10 to +90 °C (vol/dens)	-10 to +90 °C (vol/dens)	-	
Promass Q	-10 to +200 °C (mass)	-10 to +200 °C (mass)	-200 to +90 °C (mass)	100
	-10 to +200 °C (vol/dens)	-10 to +200 °C (vol/dens)	-	
Promass X	-10 to +180 °C (mass)	-10 to +180 °C (mass)	-50 to +90 °C (mass)	100
	-10 to +90 °C (vol/dens)	-10 to +90 °C (vol/dens)	-	

1) Medium temperature range for liquefied CO₂ (LCO₂) gas, accuracy class 1.5 only

OIML R117

Measuring instrument	Medium temperature range			Maximum pressure bar(g)
	Oil and oil products, chemicals and consumable liquids Accuracy class 0.3; 0.5	Liquefied gas under pressure ≥ -10 °C (LPG, LCO ₂) Accuracy class 1.0	Liquefied carbon dioxide, cryogenic liquids, liquefied gas < -10 °C (LNG, LCO ₂) Accuracy class 1.5	
Promass F	-10 to +200 °C (mass)	-10 to +200 °C (mass)	-200 to +85 °C (mass)	100
	-10 to +90 °C (vol/dens)	-10 to +90 °C (vol/dens)	-	
Promass O	-10 to +200 °C (mass)	-10 to +200 °C (mass)	-40 to +90 °C (mass) ¹⁾	258
	-10 to +90 °C (vol/dens)	-10 to +90 °C (vol/dens)	-	
Promass Q	-10 to +200 °C (mass)	-10 to +200 °C (mass)	-200 to +90 °C (mass)	100
	-10 to +200 °C (vol/dens)	-10 to +200 °C (vol/dens)	-	
Promass X	-10 to +180 °C (mass)	-10 to +180 °C (mass)	-10 to +85 °C (mass)	100
	-10 to +90 °C (vol/dens)	-10 to +90 °C (vol/dens)	-	

1) Medium temperature range for liquefied CO₂ (LCO₂) gas

5.2 Delivery status



Europe

The measuring device is not locked when delivered. In accordance with Measuring Instruments Directive 2014/32/EU, Annex I ("Essential requirements") the system manufacturer is responsible for the correct implementation of the requirements with regard to the locking and sealing of the measuring device as part of the manufacturer's approved measuring system according to Measuring Instruments Directive 2014/32/EU, Annex VII (MI-005).



Outside Europe

The measuring device is not locked when delivered. The system operator is expected to place the measuring device on the market with the involvement of the competent national calibration authority and correctly implement the locally applicable requirements as regards the locking and sealing of the measuring device. The authorized representative of the national calibration authority is responsible for providing the necessary information in this regard.

In its condition as supplied to the customer, the parameters for custody transfer have been set to the standard values.

Custody transfer parameters	Default value
Custody transfer mode	Off
Custody transfer counter	0
Timestamp last custody transfer	0

5.3 Custody transfer



National rules or regulations must be observed when performing custody transfer.



An **authorized user login** is available: EH000 with password 177801. This **authorized user login** is the non-personalized factory login and enables the activation and deactivation of the custody transfer mode. Settings made using this login must be documented and personalized by the system operator. In addition, the responsible weights and measures services must be informed of these changes.



The locking status of the device can be read under: Operation → Locking status

5.3.1 Outputs/inputs relevant for custody transfer

For devices with the HART current output on the I/O-1 module, the outputs relevant for custody transfer are the local display, the double-pulse output for totalizing the flow, the current output I/O-1 or the current output or frequency output of the PFS module for displaying the density, the switch output, and the switch output of the PFS module for communicating the device status.

The inputs that are relevant for custody transfer for external temperature and pressure devices are the current input or the HART input.

Local display

The local display can be configured as required outside the custody transfer mode. As soon as the custody transfer mode is enabled, it is not possible to edit the local display, apart from the value for display 3. The value displayed for value 4 is overwritten and the custody transfer counter is displayed. A padlock symbol is displayed in the top right-hand corner in the custody transfer mode.

Dual-pulse output

If the approved dual-pulse output is to be used, this must be indicated by specifying the relevant code when ordering. It cannot be used with two PFS modules at a later stage.

Current output

The current output is approved to output the density of the measured medium.

Current input

The 4-20 mA current input or the digital bus is approved for active pressure and/or temperature correction.

Totalizer 3

Totalizer 3 can also be reset in the custody transfer mode in applications in which a totalizer must be reset following flow measurement.

The current flow must be less than the set low flow cutoff to be able to reset the totalizer. The reset function does not work if low flow cutoff is switched off. Totalizer 3 can be reset via the digital bus, the status input, the Web server and the local display.

PFS output

The PFS can be configured as a pulse, frequency or switch output. Pulse and frequency can only be used as an output for custody transfer if the custody transfer lock is set to "all parameters". In the case of both custody transfer locks, the switch output is disabled in the custody transfer mode and is authorized to transmit the status of the device.

Switch output

The switch output is authorized to transmit the status of the device.

5.3.2 Authorized user login



To change the measuring device to the Custody transfer mode, the non-personalized, **authorized user login** (factory login) can be used. However, the use of a personalized, **authorized user login** with associated **password** is recommended. This is available only to national market surveillance and authorized persons from the relevant centers. This **authorized user login** is comparable to a personalized sealing pliers and is used to uniquely identify the person / authority who has locked or unlocked the measuring device for custody transfer measurement.



To create an **authorized user login** with **password**, please contact your E+H sales center.

To create the **Authorized user login** parameter with **password**, the following data are required.

Required data	Example
Applicant type	<ul style="list-style-type: none"> ▪ System operator ▪ Market surveillance ▪ Approval center ▪ Endress+Hauser employee
First name	John
Surname	Smith
Company	ABC Company
Department	ABC Department
Address	Any Street 1
Country	Anywhere
City/Town	Anytown
ZIP code	123456
Telephone	123456
E-mail address	John.Smith@sample.com

- The **Authorized user login** parameter consists of five characters comprising two letters and three digits.
- For each **Authorized user login** parameter comprising five characters, a **password** is generated.
- When changes are made, the **Authorized user login** parameter is saved in the Custody transfer logbook.

5.3.3 Determining parameters locked in Custody transfer

Select the preferred write protection option for custody transfer mode.

Navigation

"Custody transfer" submenu → Custody transfer locking

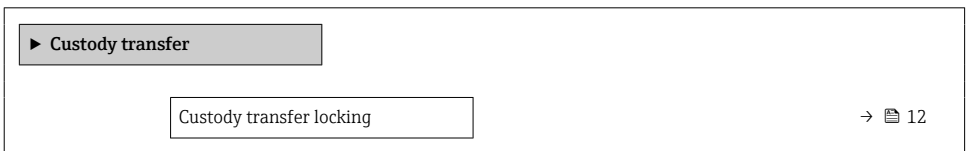

Parameter overview with brief description

Parameter	Description	Selection	Factory setting
Custody transfer locking	Indicate whether all parameters or only parameters relevant to custody transfer should be write-protected.	<ul style="list-style-type: none"> ▪ Defined parameters ▪ All parameters 	Defined parameters

5.3.4 Parameter description for Custody transfer activation

 An **authorized user login** is available: EH000 with password 177801. This **authorized user login** is the non-personalized factory login and enables the activation and deactivation of the custody transfer mode. Settings made using this login must be documented and personalized by the system operator. In addition, the responsible weights and measures services must be informed of these changes.

Navigation

"Setup" menu → Advanced setup → Custody transfer activation

▶ Custody transfer activation

Authorized user login

→  13

Password

→  13

Login state

→  13

Year

→  13

Month

→  13

Day

→  13

AM/PM

→  13

Hour



→  13

Minute

→  13

Clear custody transfer logbook

→  13

Entry 30 of custody transfer logbook	→  13
Checksum	→  13
Toggle DIP switch	→  13

Parameter overview with brief description

Parameter	Description	User entry / User interface / Selection	Factory setting
Authorized user login	Enter a specified authorized user login.	Authorized user login	EH000
Password	Enter a specified password.	0 to 999999	177 801
Login state	Display login status.	<ul style="list-style-type: none"> ■ Logged in ■ Logged out 	Logged out
Year	Enter the year.	9 to 99	10
Month	Enter the month.	<ul style="list-style-type: none"> ■ January ■ February ■ March ■ April ■ May ■ June ■ July ■ August ■ September ■ October ■ November ■ December 	January
Day	Enter the day.	1 to 31 d	1 d
AM/PM	Select AM/PM.	<ul style="list-style-type: none"> ■ AM ■ PM 	AM
Hour	Enter the hour.	0 to 23 h	12 h
Minute	Enter the minutes.	0 to 59 min	0 min
Clear custody transfer logbook	Delete custody transfer logbook selection.	<ul style="list-style-type: none"> ■ Cancel ■ Clear data 	Cancel
Entry 30 of custody transfer logbook	Display the recorded logbook entries.	0...30	0
Checksum	Shows the firmware's checksum.	Positive integer	–
Toggle DIP switch	Display the DIP switch status.	<ul style="list-style-type: none"> ■ Off ■ On 	Off

5.3.5 Setting up Custody transfer mode

The measuring device is supplied in an unlocked state. It is the responsibility of the system operator to ensure that the measuring device is put into operation in accordance with national regulations governing locking and sealing.



i If the **authorized user login** and **password** are entered via the display module, perform the following steps in the order indicated. If the **authorized user login** and **password** are entered via the web server, the device must first be opened and connected to the service interface.

i The procedure does not have a time limit.

i The measuring device can be locked only by means of the **Authorized user login** parameter with associated **password** and **DIP switch 2**. If only **DIP switch 2** is set to the **On** position, the measuring device will not switch to Custody transfer mode. A warning message is generated, which can be cleared only by resetting **DIP switch 2**.

i Use a suitable tool - preferably one with a non-metal tip - to switch the DIP switch.

Opening the measuring device and setting up custody transfer mode: Promass 500

1. Select the parameters to be locked with the **Custody transfer locking** parameter →  12.
2. Enter the **Authorized user login** parameter and **Password** parameter in the menu →  12.
3. Enter the time and date information.
4. As an option, the custody transfer logbook can be cleared.
5. Disconnect the power supply to the device.
- 6.

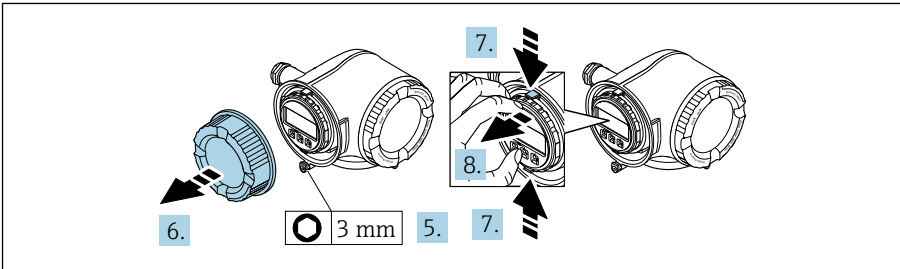

A0034738

Loosen the securing clamp of the connection compartment cover.

7. Unscrew the connection compartment cover.
8. Squeeze the tabs of the display module holder together.
9. Remove the display module holder.

10.

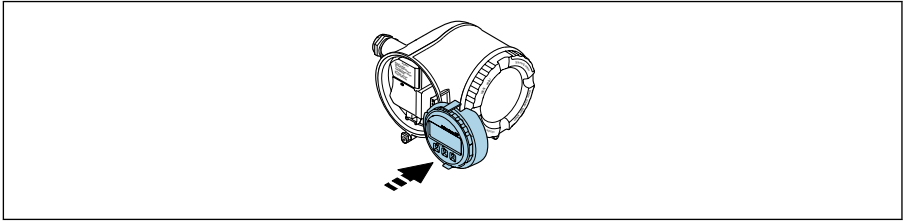

A0031375

Attach the display module to the edge of the electronics compartment.

11.

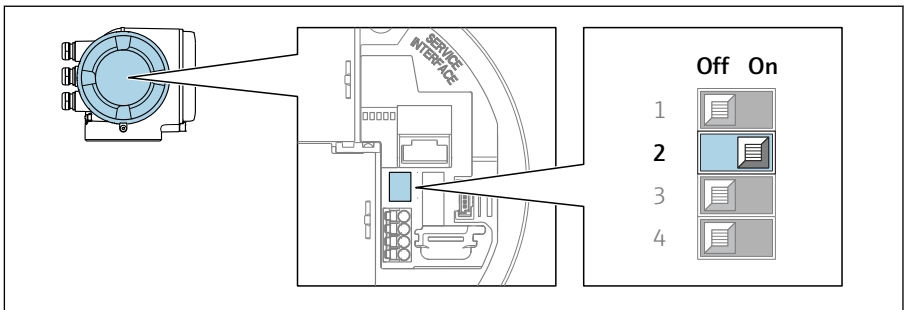

A0029631

Set **DIP switch 2** to the **On** position.

- ↳ If the measuring device was locked correctly using the **Authorized user login** parameter, **Password** parameter and **DIP switch 2**, the padlock symbol appears on the display and the internal Custody transfer counter is incremented. In addition, an entry with Timestamp (operating hours) is generated in the Custody transfer logbook. An entry is also recorded in the event logbook.

12. Follow the reverse sequence to close the measuring device, and seal if desired.
13. Reestablish the power supply.
14. A padlock symbol (🔒) appears in the header of the display.

Opening the measuring device and setting up custody transfer mode: Promass 500 digital

1. Select the parameters to be locked with the **Custody transfer locking** parameter → 📄 12.
2. Enter the **Authorized user login** parameter and **Password** parameter in the menu → 📄 12.
3. Enter the time and date information.
4. As an option, the custody transfer logbook can be cleared.

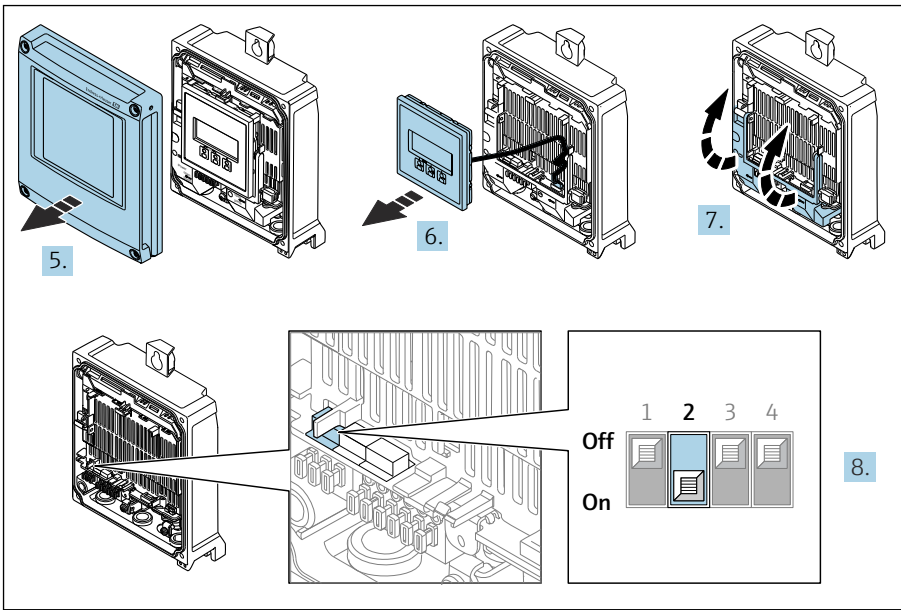

A0034739

Unscrew the cover of the transmitter.

6. Remove the display module.

7. Fold up the cover.

8. Set **DIP switch 2** to the **On** position.

↳ If the measuring device was locked correctly using the **Authorized user login** parameter, **Password** parameter and **DIP switch 2**, the padlock symbol appears on the display and the internal Custody transfer counter is incremented. In addition, an entry with Timestamp (operating hours) is generated in the Custody transfer logbook. An entry is also recorded in the event logbook.

9. A padlock symbol (🔒) appears in the header of the display.











10. Follow the reverse sequence to close the measuring device, and seal if desired.

5.3.6 Parameter description for Custody transfer deactivation

i An **authorized user login** is available: EH000 with password 177801. This **authorized user login** is the non-personalized factory login and enables the activation and deactivation of the custody transfer mode. Settings made using this login must be documented and personalized by the system operator. In addition, the responsible weights and measures services must be informed of these changes.

Navigation

"Setup" menu → Advanced setup → Custody transfer deactivation

► Custody transfer deactivation	
Authorized user login	→  17
Password	→  17
Login state	→  17
Year	→  17
Month	→  18
Day	→  18
AM/PM	→  18
Hour	→  18
Minute	→  18
Toggle DIP switch	→  18

Parameter overview with brief description

Parameter	Description	User entry / User interface / Selection	Factory setting
Authorized user login	Enter a specified authorized user login.	Authorized user login	EH000
Password	Enter a specified password.	0 to 999999	177 801
Login state	Display login status.	<ul style="list-style-type: none"> ■ Logged in ■ Logged out 	Logged out
Year	Enter the year.	9 to 99	10

Parameter	Description	User entry / User interface / Selection	Factory setting
Month	Enter the month.	<ul style="list-style-type: none"> ▪ January ▪ February ▪ March ▪ April ▪ May ▪ June ▪ July ▪ August ▪ September ▪ October ▪ November ▪ December 	January
Day	Enter the day.	1 to 31 d	1 d
AM/PM	Select AM/PM.	<ul style="list-style-type: none"> ▪ AM ▪ PM 	AM
Hour	Enter the hour.	0 to 23 h	12 h
Minute	Enter the minutes.	0 to 59 min	0 min
Toggle DIP switch	Display the DIP switch status.	<ul style="list-style-type: none"> ▪ Off ▪ On 	Off

5.3.7 Disabling Custody transfer mode

The measuring instrument can be taken out of Custody transfer mode at any time.



If the **authorized user login** and **password** are entered via the display module, perform the following steps in the order indicated. If the **authorized user login** and **password** are entered via the web server, the device must first be opened and connected to the service interface.



The procedure does not have a time limit.



Use a suitable tool - preferably one with a non-metal tip - to switch the DIP switch.

Opening the measuring device and disabling custody transfer mode

1. Break the optional sealing.
2. Enter the **Authorized user login** parameter and **Password** parameter in the menu → 12.
3. Enter the time and date information.
4. Disconnect the power supply to the device.
5. Open the measuring device as described previously.

6. Set **DIP switch 2** to the **Off** position.
 - ↳ If the measuring device was correctly unlocked using the **Authorized user login** parameter, **password** and **DIP switch 2**, the padlock symbol disappears from the display and the internal Custody transfer counter is incremented. In addition, an entry with Timestamp (operating hours) is generated in the logbook. An entry is also recorded in the event logbook. When the device is in an unlocked state, all parameters can be edited.
7. Close the measuring device as described previously.
8. Reestablish the power supply.

 Once Custody transfer mode has been disabled or the seal (subject to legal metrology controls) has been broken, the measuring device may no longer be used in custody transfer applications. If the measuring device is to be used again in custody transfer, the measuring device must be put into circulation again.

5.4 Reading parameters relevant for custody transfer

 In custody transfer mode, the following parameters can be viewed via the display or the service interface (Web server).

Navigation

"Operation" menu → Custody transfer

▶ Custody transfer	
Custody transfer mode	→ 20
Firmware version	→ 20
Checksum	→ 20
Custody transfer counter	→ 20
Custody transfer locking	→ 20
Timestamp last custody transfer	→ 20
Display test	→ 20

Parameter overview with brief description

Parameter	Description	User interface / Selection	Factory setting
Custody transfer mode	Shows if the device is in custody transfer mode.	<ul style="list-style-type: none"> ▪ Off ▪ On 	Off
Firmware version	Shows the device firmware version installed.	Character string in the format xx.yy.zz	–
Checksum	Shows the firmware's checksum.	Positive integer	–
Custody transfer counter	Indicates how often custody transfer mode has been enabled so far.	0 to 65 535	–
Custody transfer locking	Indicate whether all parameters or only parameters relevant to custody transfer should be write-protected.	<ul style="list-style-type: none"> ▪ Defined parameters ▪ All parameters 	Defined parameters
Timestamp last custody transfer	Indicates the time when the custody transfer mode was last enabled.	Days (d), hours (h), minutes (m) and seconds (s)	–
Display test	Start or cancel display test.	<ul style="list-style-type: none"> ▪ Cancel ▪ Start 	Cancel

5.4.1 Character test string

The character test string is used to test the display. When the test string is selected, the display test sequence starts and the test string is displayed with an inverted background. Once the text display is confirmed, the test string is displayed again with a non-inverted background and the display test is finished.

5.5 Custody transfer logbook

The Custody transfer logbook can be viewed on the display, via FieldCare or via the web server.

- The last entry is displayed first.
- A maximum of 30 entries can be saved in the Custody transfer logbook. If these are all in use, no further entries will be saved.











The diagnostic behavior of diagnostic number 599 "Custody transfer logbook full" determines the behavior of the device when the 30 entries are reached (factory setting: warning). The diagnostic behavior cannot be edited in the activated custody transfer mode.



For more information on adapting the diagnostic behavior, see the Operating Instructions

Navigation

"Diagnostics" menu → Custody transfer logbook

► Custody transfer logbook	
Logbook entry	→  21
Entry 30 of custody transfer logbook	→  21
Event number	→  21
Event logbook	→  21
Timestamp	→  21
Authorized user login	→  21
Totalizer value	→  21
Totalizer overflow	→  22
Date/time	→  22

Parameter overview with brief description

Parameter	Description	User entry / User interface	Factory setting
Logbook entry	Select a logbook entry.	1 to 30	1
Entry 30 of custody transfer logbook	Display the recorded logbook entries.	0...30	0
Event number	Display the event number.	Positive integer	1
Event logbook	Display the event.	-	0
Timestamp	Display the timestamp.	Date of timestamp.	0
Authorized user login	Display the specified authorized user login.	Authorized user login	EH000
Totalizer value	Display the totalizer value.	Signed floating-point number	0

Parameter	Description	User entry / User interface	Factory setting
Totalizer overflow	Display the totalizer overflow.	Signed floating-point number	0
Date/time	Display the date/time.	Date/time	0

5.5.1 Custody transfer logbook entries

The following entries are written to the custody transfer logbook. The operating time counter is saved with each entry. Additional information that is saved and useful data are listed in the "Comments" column.

Event	Description
Open the measuring device and set up Custody transfer	<ul style="list-style-type: none"> ▪ Authorized user login ▪ Value of totalizer 1 ▪ Date/time logged in the "Custody transfer activation/deactivation" menu
Disable Custody transfer mode	<ul style="list-style-type: none"> ▪ Authorized user login ▪ Value of totalizer 1 ▪ Date/time logged in the "Custody transfer activation/deactivation" menu
Clear the Custody transfer logbook	<ul style="list-style-type: none"> ▪ Authorized user login ▪ Value of totalizer 1 ▪ Date/time logged in the "Custody transfer activation/deactivation" menu. The custody transfer logbook can be cleared each time the custody transfer mode is activated or deactivated.
Determine parameters locked in Custody transfer	Entries are only generated if the device is not in the custody transfer mode. By comparing the operating time counter, it is possible to check which parameter has been changed in the event logbook.
Set up Custody transfer or power failure	Value of totalizer 1. Each power failure is recorded if the device is in the custody transfer mode.

5.5.2 Clearing the Custody transfer logbook

The Custody transfer logbook can be cleared only if you have previously logged in using an **Authorized user login** parameter and **password**.

1. In the **Custody transfer activation** wizard, log in with an **Authorized user login** parameter and **password**.
2. The **Clear custody transfer logbook** parameter is available in the **Custody transfer activation** wizard →  12.
 - ↳ If the Custody transfer logbook is cleared, this is stored as the first new entry in the custody transfer logbook.

5.6 Procedure for market surveillance

The recommended procedure for market surveillance is the comparison between the status of the custody transfer counter shown under display value 4 on the display and the last documented status of the custody transfer counter.

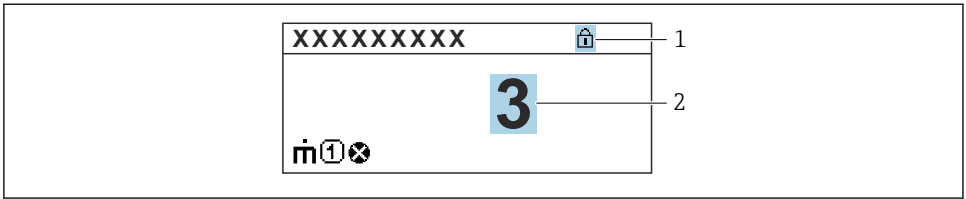

A0032467

- 1 Custody transfer lock indicator
- 2 Custody transfer counter status indicator

If the custody transfer counter status on the display and the last documented custody transfer counter status are identical, the device has not been tampered with.

However, if the two custody transfer counter statuses are not identical, the following procedure is recommended:

Retrieve the following parameters in the Custody transfer logbook:

1. **Authorized user login** parameter: Check the last authorized user login where a change was made to parameters relating to custody transfer.
2. **Event logbook** parameter: Verify changes.
3. **Totalizer value** parameter: Check the value of the totalizer at the time of the change.
4. **Timestamp** parameter: Check the operating time at which the change was made.
5. In the Event logbook, search for the entry with the applicable Timestamp in the Event logbook and verify which changes were carried out.

In this way, market surveillance can verify what was changed by whom at a particular time.

5.7 Repeated calibration due to legal metrology controls

The system operator is obliged to perform a recalibration in accordance with the relevant applicable national regulations.

5.8 Sealing



It is possible to seal the measuring device.. The seal can be applied using a sealing screw and the relevant holder on the housing. The system operator or the competent calibration authority is responsible for applying the seal.

5.8.1 Promass 500 – digital transmitter

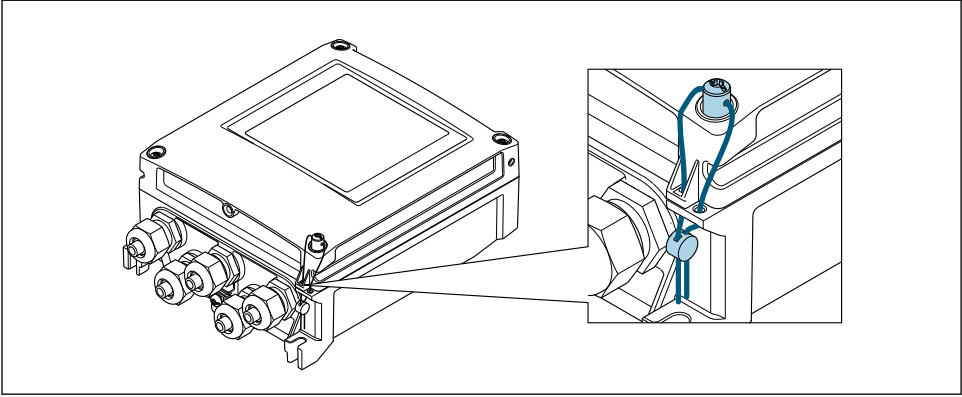
Order code for "Transmitter housing", option A "Aluminum, coated"

A0025237

1. Pull the wire through the bore in the housing and through the screw head. In doing so, ensure that the wire is taut and there is no leeway for the screw to loosen.
2. Seal the wire ends.

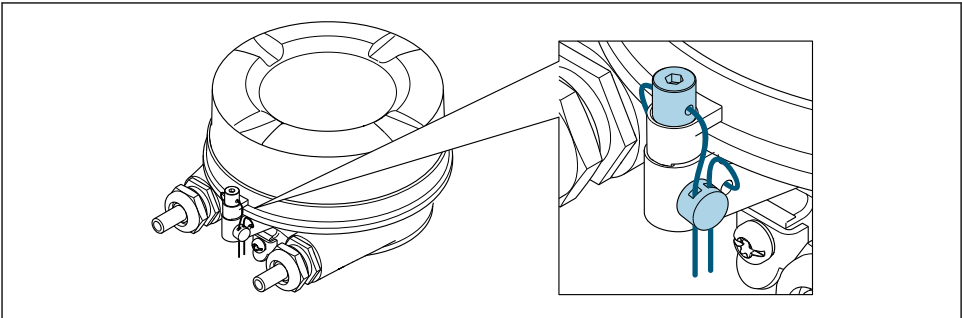

A0025239

1. Pull the wire through the bore in the housing and through the screw head. In doing so, ensure that the wire is taut and there is no leeway for the screw to loosen.
2. Seal the wire ends.

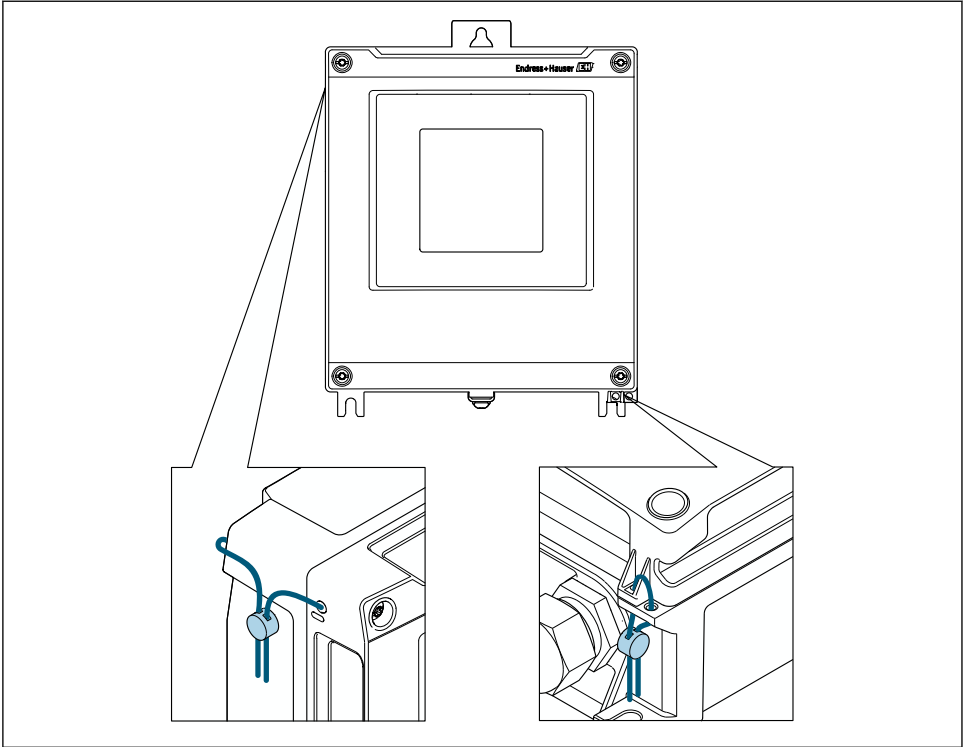
Order code for "Transmitter housing", option D "Polycarbonate"

A0041369

1. When using the display protector (order code for "Accessories", option PV "Display protector"), remove the display protector before sealing.
2. Pull the wire through holes in the housing.
3. Seal the wire ends.
4. If using the display protector, re-install the display protector after sealing.

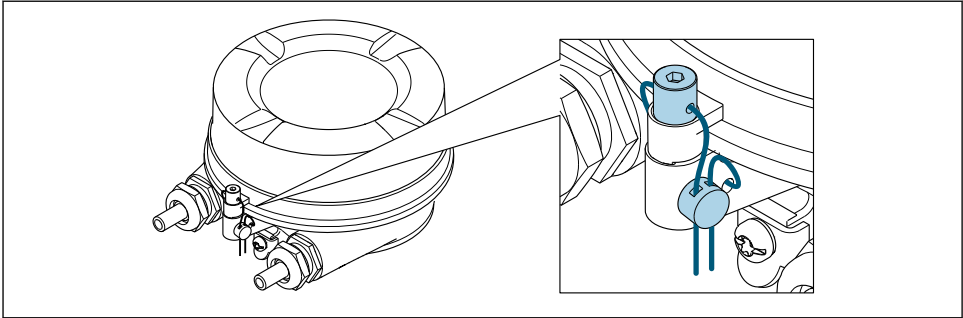

A0025239

1. Pull the wire through the bore in the housing and through the screw head. In doing so, ensure that the wire is taut and there is no leeway for the screw to loosen.
2. Seal the wire ends.

5.8.2 Promass 500 transmitter

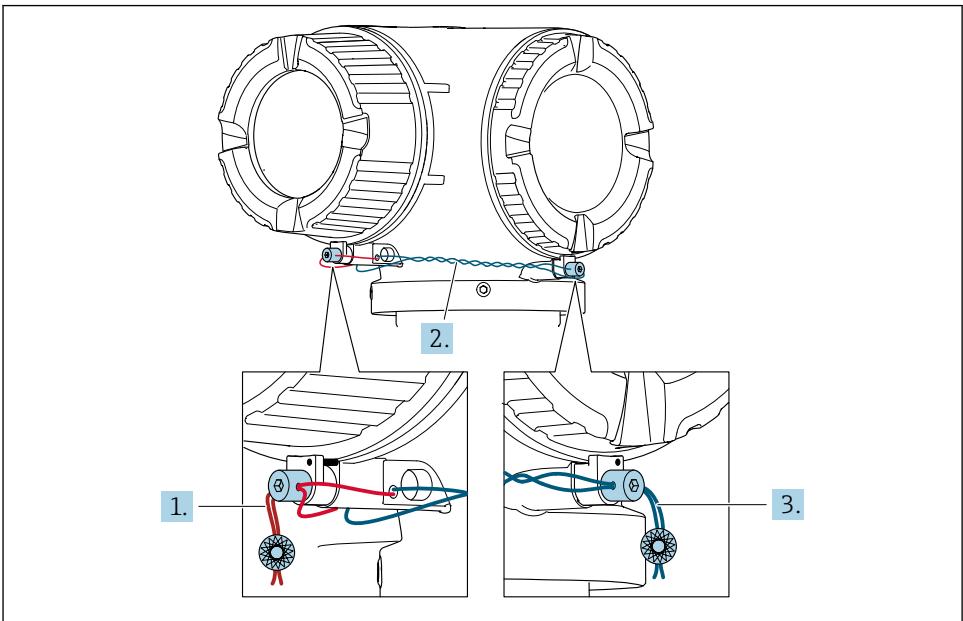

A0032276

1. Pull the wire through the bore in the housing and through the screw head. In doing so, ensure that the wire is taut and there is no leeway for the screw to loosen.
2. Pull the wire through the bore in the housing.
3. Twist the wire and guide it to the screw head.
4. Pull each of the wire ends through the screw heads and seal.

6 Parameters in custody transfer mode

Parameters that are relevant for custody transfer must be write-protected in the custody transfer mode. Three options are available for this purpose:

Write protection	Description
Hardware write protection	Sets every parameter to write-protected.
CT locking: All parameters	Locks the parameters that are relevant for custody transfer (CT) and also parameters that are predefined by Endress+Hauser and are not relevant for custody transfer.
CT locking: Defined parameters	Only locks parameters that are relevant for custody transfer.



The locking status of the device can be read under: Operation → Locking status

6.1 Configurable parameters

Description

- The parameters that are marked with  can only be edited in the custody transfer locking of **defined parameters** mode.
- The parameters that are not marked can be edited in the custody transfer locking of **all parameters** and **defined parameters** mode.
- Generally speaking, all the parameters that are not listed cannot be edited in the custody transfer mode.



For detailed information on the device parameters, see the "Description of Device Parameters" document

Navigation

"Expert" menu → Application → Custody transfer

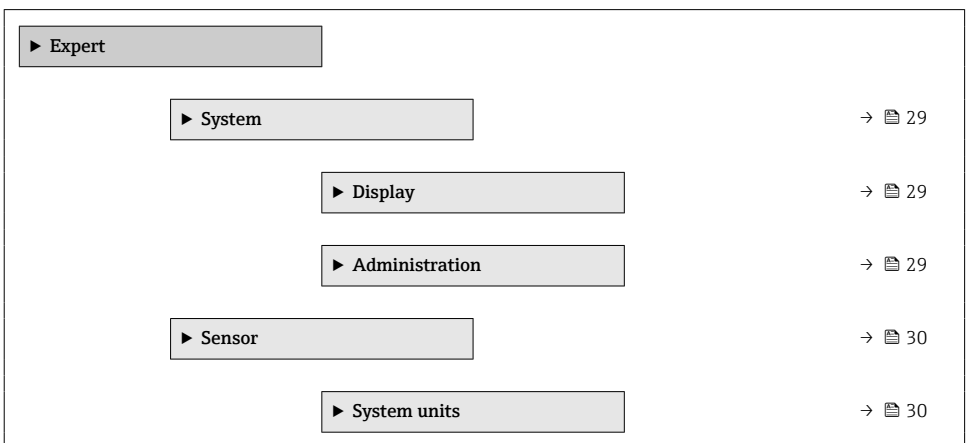

▶ Output	→ 30
▶ Pulse/frequency/switch output 1 to n	→ 30
▶ Communication	→ 31
▶ HART output	→ 31
▶ Web server	→ 33
▶ WLAN settings	→ 34
▶ OPC-UA configuration	→ 35
▶ Application	→ 36
▶ Totalizer 3	→ 36
▶ Viscosity	→ 36
▶ Concentration	→ 37
▶ Medium index	→ 39
▶ Diagnostics	→ 40
▶ Event logbook	→ 40
▶ Data logging	→ 40
▶ Heartbeat Technology	→ 41
▶ Simulation	→ 42

6.1.1 "System" submenu

"Display" submenu

Navigation

"Expert" menu → System → Display

▶ Display	
Display language	✱
Value 3 display	✱
0% bargraph value 3	✱
100% bargraph value 3	✱
Decimal places 3	✱
Header	✱
Header text	✱
Separator	✱
Contrast display	✱
Backlight	✱

"Administration" submenu

Navigation

"Expert" menu → System → Administration

▶ Administration	
▶ Define access code	

Define access code
Confirm access code
▶ Reset access code
Reset access code

6.1.2 "Sensor" submenu

"System units" submenu

Navigation

"Expert" menu → Sensor → System units

▶ System units	
Date/time format	☒

6.1.3 "Output" submenu

"Pulse/frequency/switch output 1 to n" submenu

Navigation

"Expert" menu → Output → Pulse/frequency/switch output 1 to n

▶ Pulse/frequency/switch output 1 to n	
Signal mode	☒
Assign pulse output	☒
Pulse scaling	☒
Pulse width	☒
Measuring mode	☒

Failure mode	
Assign frequency output	
Minimum frequency value	
Maximum frequency value	
Measuring value at minimum frequency	
Measuring value at maximum frequency	
Measuring mode	
Damping output	
Failure mode	
Failure frequency	
Assign flow direction check	
Invert output signal	

6.1.4 "Communication" submenu

"HART output" submenu

Navigation

"Expert" menu → Communication → HART output

▶ HART output	
▶ Configuration	
HART short tag	

Device tag 

HART address 

No. of preambles 

Fieldbus writing access 

► Burst configuration

► Burst configuration 1 to n

Burst mode 1 to n 

Burst command 1 to n 

Burst variable 0 

Burst variable 1 

Burst variable 2 

Burst variable 3 

Burst variable 4 





Burst variable 5 

Burst variable 6 

Burst variable 7 

Burst trigger mode 







Burst trigger level 

Min. update period	
Max. update period	
► Information	
HART descriptor	
HART message	
HART date code	

"Web server" submenu

Navigation















"Expert" menu → Communication → Web server

► Web server	
Web server language	
DHCP client	
IP address	
Subnet mask	
Default gateway	
Web server functionality	
Login page	

"WLAN settings" wizard

Navigation

"Expert" menu → Communication → WLAN settings

▶ WLAN settings	
WLAN	
WLAN mode	
SSID name	
Network security	
User name	
WLAN password	
WLAN IP address	
WLAN subnet mask	
WLAN passphrase	
Assign SSID name	
SSID name	
2.4 GHz WLAN channel	
Select antenna	
WLAN IP address	

"OPC-UA configuration" submenu

Navigation

"Expert" menu → Communication → OPC-UA configuration

▶ OPC-UA configuration

Activate OPC-UA function

▶ OPC-UA settings

Port

▶ OPC-UA date and time

Year

Month

Day

Hour

AM/PM

Minute

▶ OPC-UA security

Security policy

6.1.5 "Application" submenu

"Totalizer 3" submenu

Navigation

"Expert" menu → Application → Totalizer 3

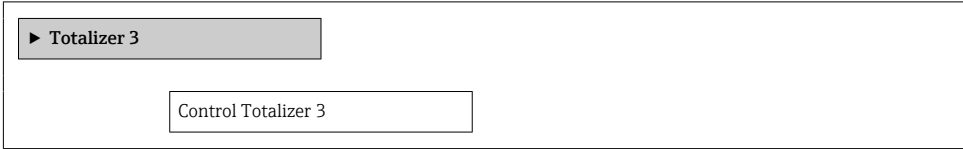





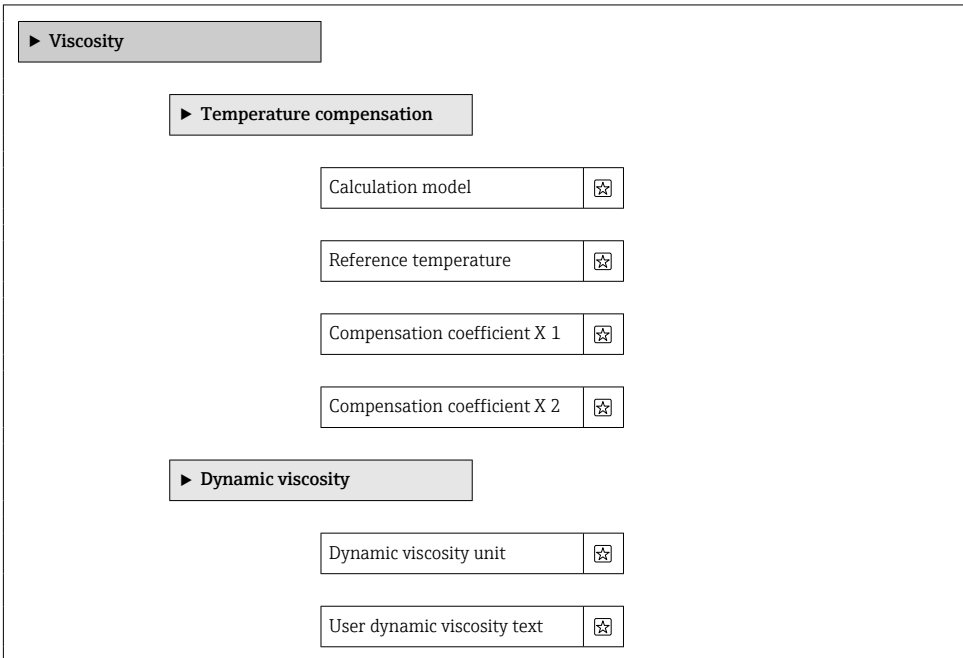

"Viscosity" submenu

Navigation

"Expert" menu → Application → Viscosity









User dynamic viscosity factor	
User dynamic viscosity offset	
► Kinematic viscosity	
Kinematic viscosity unit	
User kinematic viscosity text	
User kinematic viscosity factor	
User kinematic viscosity offset	

"Concentration" submenu

Navigation

"Expert" menu → Application → Concentration

► Concentration	
► Concentration settings	
Liquid type	
Carrier type	
Water mineral content	
Carrier reference density	
Carrier linear expansion coefficient	
Carrier square expansion coefficient	

Target reference density	
--------------------------	---

Target linear expansion coefficient	
-------------------------------------	---

Target square expansion coefficient	
-------------------------------------	---

Reference temperature expansion	
---------------------------------	---

Create coefficients for liquid type	
-------------------------------------	---

► **Concentration unit**

Concentration unit	
--------------------	---

User concentration text	
-------------------------	---

User concentration factor	
---------------------------	---

User concentration offset	
---------------------------	---

Reference temperature	
-----------------------	--

► **Concentration profile 1 to n**









Coefficients set name	
-----------------------	---

A 0	
-----	---

A 1	
-----	---

A 2	
-----	---



A 3	
-----	---

A 4	
B 1	
B 2	
B 3	
D 1	
D 2	
D 3	
D 4	
► Mineral content determination	
Control mineral content determination	

"Medium index" submenu

Navigation

"Expert" menu → Application → Medium index

► Medium index	
Cut off inhomogeneous wet gas	
Cut off inhomogeneous liquid	
Cut off suspended bubbles	

6.1.6 "Diagnostics" submenu

"Event logbook" submenu

Navigation

"Expert" menu → Diagnostics → Event logbook

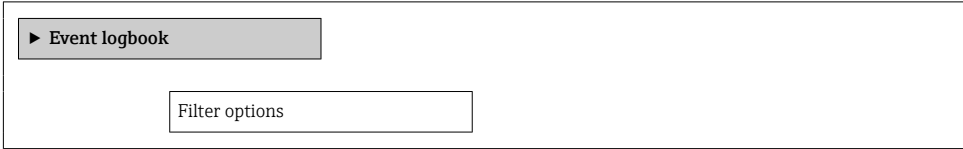

"Data logging" submenu

Navigation

"Expert" menu → Diagnostics → Data logging

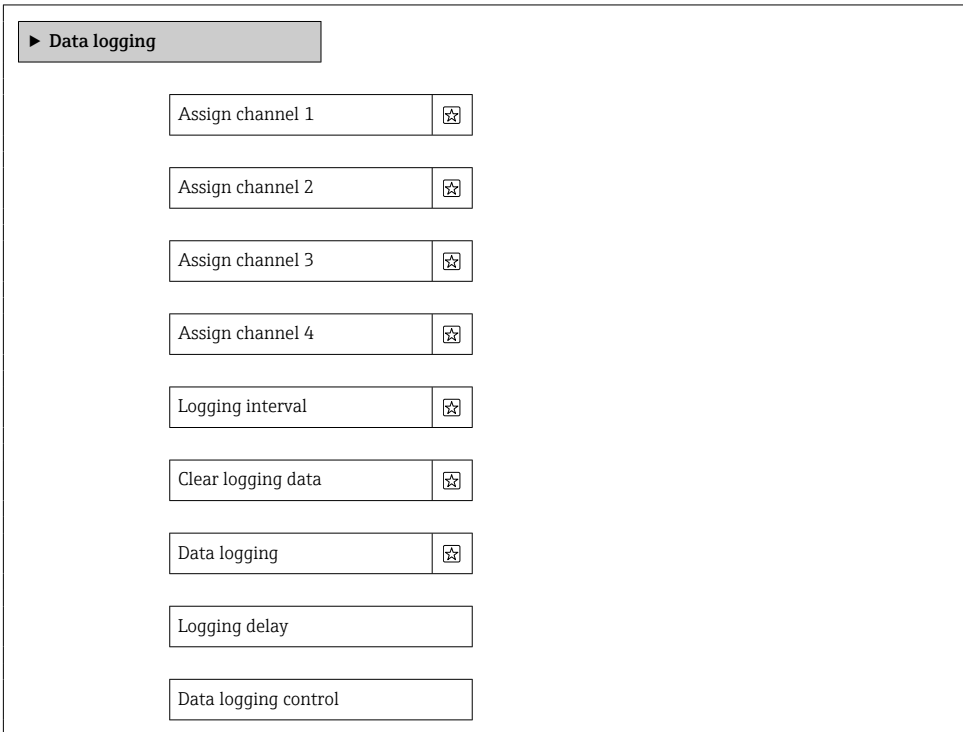

"Heartbeat Technology" submenu

Navigation

"Expert" menu → Diagnostics → Heartbeat Technology

The screenshot displays a hierarchical menu structure for 'Heartbeat Technology'. It starts with a main menu item '▶ Heartbeat Technology'. Underneath, there are three sub-sections: '▶ Heartbeat base settings', '▶ Performing verification', and '▶ Heartbeat Monitoring'. Each sub-section contains several text input fields for configuration.

- ▶ Heartbeat Technology**
 - ▶ Heartbeat base settings**
 - Plant operator
 - Location
 - ▶ Performing verification**
 - Year
 - Month
 - Day
 - Hour
 - AM/PM
 - Minute
 - External device information
 - Start verification
 - Measured values
 - ▶ Heartbeat Monitoring**
 - Activate monitoring
 - HBSI cycle time

"Simulation" submenu

Navigation

"Expert" menu → Diagnostics → Simulation

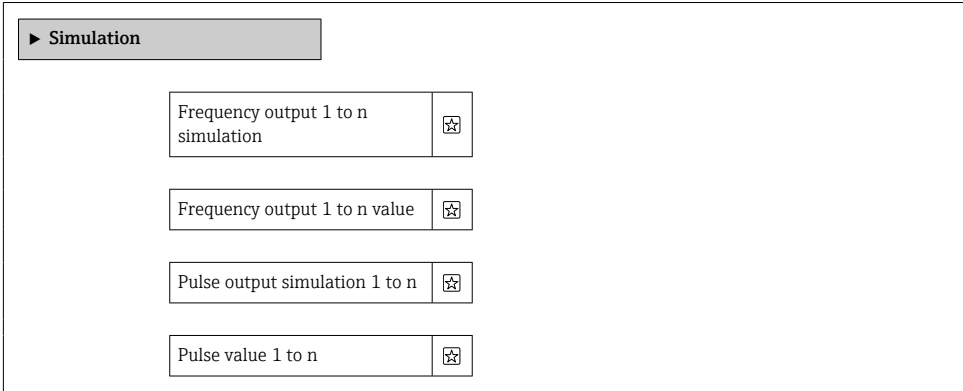



71662343

www.addresses.endress.com
