

Operating Instructions

CCS120D

Digital sensor with Memosens technology for determining total chlorine







Table of contents









1	About this document	4	10.3 Disposal	35
1.1	Safety information	4		
1.2	Symbols used	4		
2	Basic safety instructions	5		
2.1	Requirements for the personnel	5		
2.2	Intended use	5		
2.3	Workplace safety	6		
2.4	Operational safety	6		
2.5	Product security	6		
3	Product description	7		
3.1	Product design	7		
4	Incoming acceptance and product identification	11		
4.1	Incoming acceptance	11		
4.2	Product identification	11		
5	Mounting	13		
5.1	Mounting requirements	13		
5.2	Mounting the sensor	15		
5.3	Post-mounting check	21		
6	Electrical connection	23		
6.1	Connecting the sensor	23		
6.2	Ensuring the degree of protection	23		
6.3	Post-connection check	24		
7	Commissioning	25		
7.1	Installation and function check	25		
7.2	Filling the membrane cap with electrolyte	25		
7.3	Sensor polarization	25		
7.4	Calibrating the sensor	25		
8	Diagnostics and troubleshooting	27		
9	Maintenance	29		
9.1	Maintenance schedule	29		
9.2	Maintenance work	29		
10	Repair	35		
10.1	Spare parts	35		
10.2	Return	35		
			11	Accessories
			11.1	Device-specific accessories
			12	Technical data
			12.1	Input
			12.2	Performance characteristics
			12.3	Environment
			12.4	Process
			12.5	Mechanical construction
			13	Installation and operation in hazardous environment Class I Div. 2
			Index	44

1 About this document



1.1 Safety information

Structure of information	Meaning
<p> DANGER</p> <p>Causes (/consequences) If necessary, Consequences of non-compliance (if applicable)</p> <ul style="list-style-type: none"> ▶ Corrective action 	<p>This symbol alerts you to a dangerous situation. Failure to avoid the dangerous situation will result in a fatal or serious injury.</p>
<p> WARNING</p> <p>Causes (/consequences) If necessary, Consequences of non-compliance (if applicable)</p> <ul style="list-style-type: none"> ▶ Corrective action 	<p>This symbol alerts you to a dangerous situation. Failure to avoid the dangerous situation can result in a fatal or serious injury.</p>
<p> CAUTION</p> <p>Causes (/consequences) If necessary, Consequences of non-compliance (if applicable)</p> <ul style="list-style-type: none"> ▶ Corrective action 	<p>This symbol alerts you to a dangerous situation. Failure to avoid this situation can result in minor or more serious injuries.</p>
<p> NOTICE</p> <p>Cause/situation If necessary, Consequences of non-compliance (if applicable)</p> <ul style="list-style-type: none"> ▶ Action/note 	<p>This symbol alerts you to situations which may result in damage to property.</p>

1.2 Symbols used

	Additional information, tips
	Permitted
	Recommended
	Not permitted or not recommended
	Reference to device documentation
	Reference to page
	Reference to graphic
	Result of an individual step

1.2.1 Symbols on the device

	Reference to device documentation
	Minimum immersion depth
	Do not dispose of products bearing this marking as unsorted municipal waste. Instead, return them to the manufacturer for disposal under the applicable conditions.

2 Basic safety instructions

2.1 Requirements for the personnel

Installation, commissioning, operation and maintenance of the measuring system may be carried out only by specially trained technical personnel.

- ▶ The technical personnel must be authorized by the plant operator to carry out the specified activities.
- ▶ The electrical connection may be performed only by an electrical technician.
- ▶ The technical personnel must have read and understood these Operating Instructions and must follow the instructions contained therein.
- ▶ Measuring point faults may be repaired only by authorized and specially trained personnel.



Repairs not described in the Operating Instructions provided must be carried out only directly at the manufacturer's site or by the service organization.

2.2 Intended use

Drinking water and industrial water must be disinfected through the addition of appropriate disinfectants such as chlorine gas or inorganic chlorine compounds. The dosing quantity must be adapted to continuously fluctuating operating conditions. If the concentrations in the water are too low, this could jeopardize the effectiveness of the disinfection. On the other hand, concentrations which are too high can lead to signs of corrosion and have an adverse effect on taste, as well as generating unnecessary costs.

The sensor was specifically developed for this application and is designed for continuous measurement of total chlorine in water. In conjunction with measuring and control equipment, it allows optimal control of disinfection.

In this context, the following compounds are referred to collectively as total chlorine:

- Free available chlorine: hypochlorous acid (HOCl), hypochlorite ions (OCl⁻)
- Combined chlorine (chloramines)
- Organic combined chlorine, e. g. cyanuric acid derivatives

Chloride (Cl⁻) is not recorded.



The sensor is not suitable for checking the absence of chlorine.

The sensor is particularly suitable for:

- Monitoring of total chlorine content in wastewater, industrial water, process water, cooling water and pool water
- Measurement, monitoring and control of total chlorine content in fresh water and seawater during the treatment of process water, swimming pool water and whirlpool bathwater

A typical application is the disinfection of wastewater, industrial, process and cooling water with disinfectants containing chlorine, particularly at higher pH values up to 9.5. In swimming pools, the CCS120D sensor is used in combination with the CCS51D sensor for free available chlorine to monitor the amount of combined chlorine (chloramines).

Any use other than that intended puts the safety of people and the measuring system at risk. Therefore, any other use is not permitted.

The manufacturer is not liable for harm caused by improper or unintended use.

2.2.1 Hazardous environment as per cCSAus NI Cl. I, Div. 2¹⁾

- ▶ It is essential to observe and comply with the control drawing and the specified application conditions in the appendix of these Operating Instructions.

2.3 Workplace safety

As the user, you are responsible for complying with the following safety conditions:

- Installation guidelines
- Local standards and regulations

Electromagnetic compatibility

- The product has been tested for electromagnetic compatibility in accordance with the applicable international standards for industrial applications.
- The electromagnetic compatibility indicated applies only to a product that has been connected in accordance with these Operating Instructions.

2.4 Operational safety

Before commissioning the entire measuring point:

1. Verify that all connections are correct.
2. Ensure that electrical cables and hose connections are undamaged.
3. Do not operate damaged products, and protect them against unintentional operation.
4. Label damaged products as defective.

During operation:

- ▶ If faults cannot be rectified, take products out of service and protect them against unintentional operation.

2.4.1 Special instructions

- ▶ Do not operate the sensor under process conditions in which components of the electrolyte can enter the process through the membrane.

Use of the sensor for its intended purpose in liquids with a conductivity of at least 10 nS/cm can be classified as safe in terms of the application.

2.5 Product security

The product is designed to meet state-of-the-art safety requirements, has been tested, and left the factory in a condition in which it is safe to operate. The relevant regulations and international standards have been observed.

1) Only if connected to CM44x(R)-CD*

3 Product description

3.1 Product design

The sensor consists of the following functional units:

- Membrane cap (measuring chamber with membrane)
 - Separates the inner amperometric system from the medium
 - With robust PET membrane and pressure relief valve
 - Guarantees a defined and consistent electrolyte film between working electrode and membrane
- Sensor shaft with
 - Large counter electrode
 - Working electrode embedded in plastic
 - Embedded temperature sensor

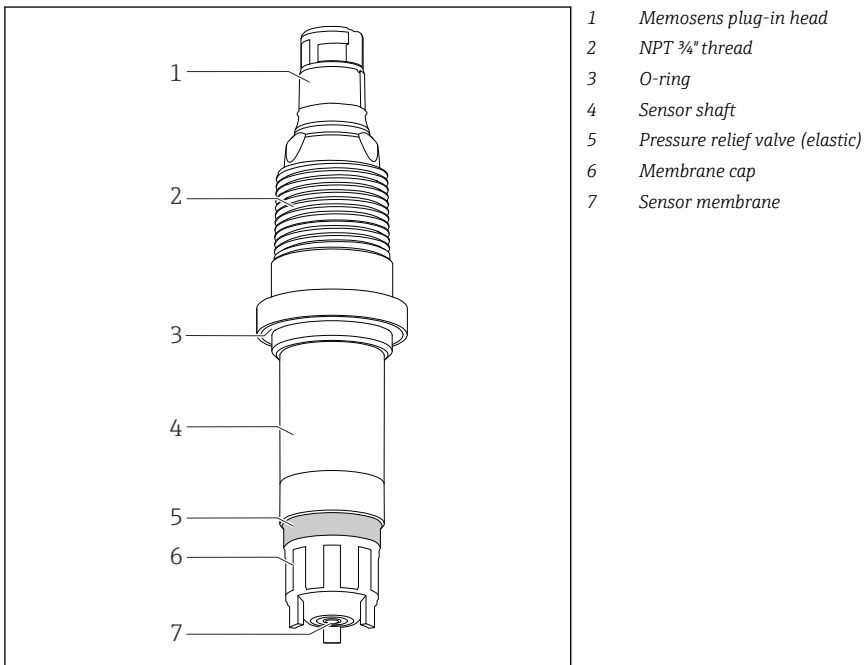

 1 Sensor structure

3.1.1 Measuring principle

Total chlorine levels are determined in accordance with the amperometric measuring principle.

In this context, the following compounds are referred to collectively as total chlorine:

- Free available chlorine: hypochlorous acid (HOCl), hypochlorite ions (OCl⁻)
- Combined chlorine (chloramines)
- Organic combined chlorine, e.g. cyanuric acid derivatives

Chloride (Cl⁻) is not recorded.

The sensor is a membrane-covered, two-electrode sensor. A platinum working electrode is used as the working electrode. A counter electrode coated in silver halide is used as the counter and reference electrode.

The membrane cap, which is filled with electrolyte, constitutes the measuring chamber. The measuring electrodes are immersed in the measuring chamber. The measuring chamber is separated from the medium by means of a microporous membrane. The chlorine compounds contained in the medium diffuse through the sensor membrane.

The constant polarization voltage present between the two electrodes causes the electrochemical reaction of the chlorine compounds at the working electrode. Electron donation at the working electrode and electron acceptance at the counter-electrode cause a current to flow. In the operational range of the sensor, this current flow is proportional to the chlorine concentration under constant conditions and is only slightly pH-dependent in the case of this sensor type. The transmitter uses the current signal to calculate the measured variable for concentration in mg/l (ppm).

3.1.2 Effects on the measured signal

pH value

pH dependency

The sensor is specified for the pH range of pH 5.5 to 9.5. The measuring signal is practically independent within this range. However, if the pH increases from pH 7 to pH 8 the measuring signal for free chlorine is reduced by 10 %.

Flow

The flow to the membrane-covered measuring cell should be at least 15 cm/s and maximum 50 cm/s. The optimum flow velocity is in the range 20 to 30 cm/s.

When using the CCA250 flow assembly, the minimum flow velocity corresponds to a volume flow of 30 l/h (7.9 gal/h) (upper edge of float at the height of the red bar mark).

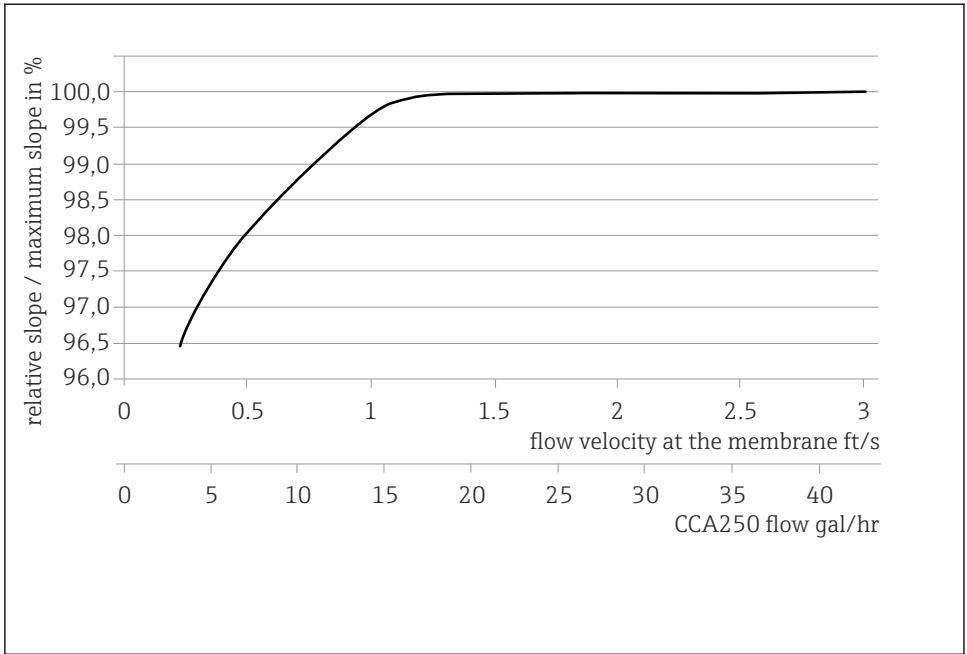

A0055815

- 2 *Correlation between slope of electrode and flow velocity at the membrane/volume flow in assembly*

At higher flow rates, the measured signal is virtually flow-independent. However, if the flow rate falls below the specified value, the measured signal depends on the flow.

Temperature

Changes in the temperature of the medium affect the measured value:

- Increases in temperature result in a higher measured value (approx. 4 % per K)
- Decreases in temperature result in a lower measured value (approx. 4 % per K)

When used with the Liquiline, the sensor enables automatic temperature compensation (ATC). Recalibration in the case of temperature changes is not necessary.

1. If automatic temperature compensation is disabled at the transmitter, the temperature must be maintained at a constant level following calibration.
2. Otherwise, recalibrate the sensor.

In the event of normal and slow changes in temperature (0.3 K / minute), the internal temperature sensor is sufficient. In the event of very rapid temperature fluctuations with high amplitude (2 K/minute), an external temperature sensor is necessary to ensure maximum measurement accuracy.

Cross-sensitivities ²⁾

Oxidants, such as bromine, iodine, ozone, chlorine dioxide, permanganate, peracetic acid and hydrogen peroxide result in higher readings than expected.

Reducing agents, such as sulfides, sulfites, thiosulfates and hydrazine, result in lower readings than expected.

2) The listed substances have been tested with different concentrations. An additive effect has not been investigated.

4 Incoming acceptance and product identification

4.1 Incoming acceptance

1. Verify that the packaging is undamaged.
 - ↳ Notify the supplier of any damage to the packaging.
Keep the damaged packaging until the issue has been resolved.
2. Verify that the contents are undamaged.
 - ↳ Notify the supplier of any damage to the delivery contents.
Keep the damaged goods until the issue has been resolved.
3. Check that the delivery is complete and nothing is missing.
 - ↳ Compare the shipping documents with your order.
4. Pack the product for storage and transportation in such a way that it is protected against impact and moisture.
 - ↳ The original packaging offers the best protection.
Make sure to comply with the permitted ambient conditions.

If you have any questions, please contact your supplier or your local Sales Center.

4.2 Product identification

4.2.1 Nameplate

The nameplate provides you with the following information on your device:

- Manufacturer identification
- Extended order code
- Serial number
- Safety information and warnings

- ▶ Compare the information on the nameplate with the order.

4.2.2 Product page

www.endress.com/ccs120d

4.2.3 Interpreting the order code

The order code and serial number of your product can be found in the following locations:

- On the nameplate
- In the delivery papers

Obtaining information on the product

1. Go to www.endress.com.
2. Page search (magnifying glass symbol): Enter valid serial number.
3. Search (magnifying glass).
 - ↳ The product structure is displayed in a popup window.

4. Click the product overview.

- ↳ A new window opens. Here you fill information pertaining to your device, including the product documentation.

4.2.4 Manufacturer's address

Endress+Hauser Conducta GmbH+Co. KG
Dieselstraße 24
70839 Gerlingen
Germany

4.2.5 Scope of delivery

The scope of delivery comprises:

- Disinfection sensor (membrane-covered)
- Bottle with electrolyte (50 ml (1.69 fl oz)) and nozzle
- Replacement membrane cap
- Operating Instructions
- Manufacturer inspection certificate

5 Mounting

5.1 Mounting requirements

5.1.1 Orientation

Do not install upside-down!

- ▶ Install the sensor in an assembly, support or appropriate process connection at an angle of at least 15° to the horizontal.
- ▶ Other angles of inclination are not permitted.
- ▶ Follow the instructions for installing the sensor in the Operating Instructions of the assembly used.

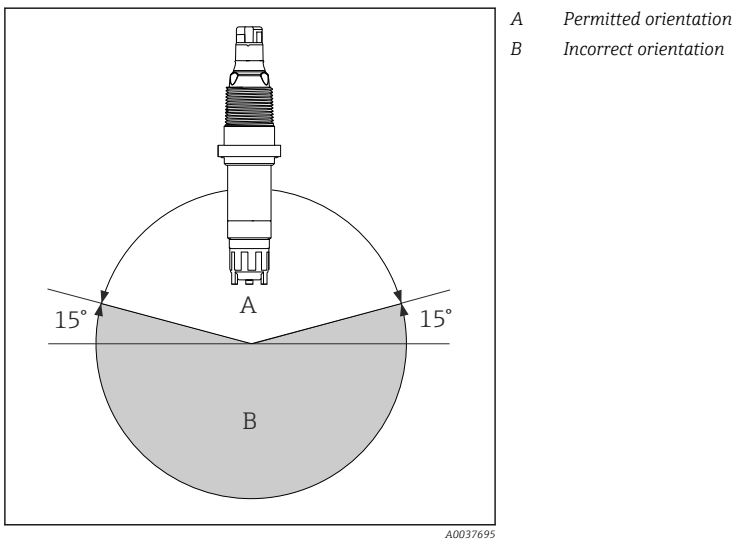

5.1.2 Immersion depth

At least 70 mm (2.76 in)

5.1.3 Dimensions

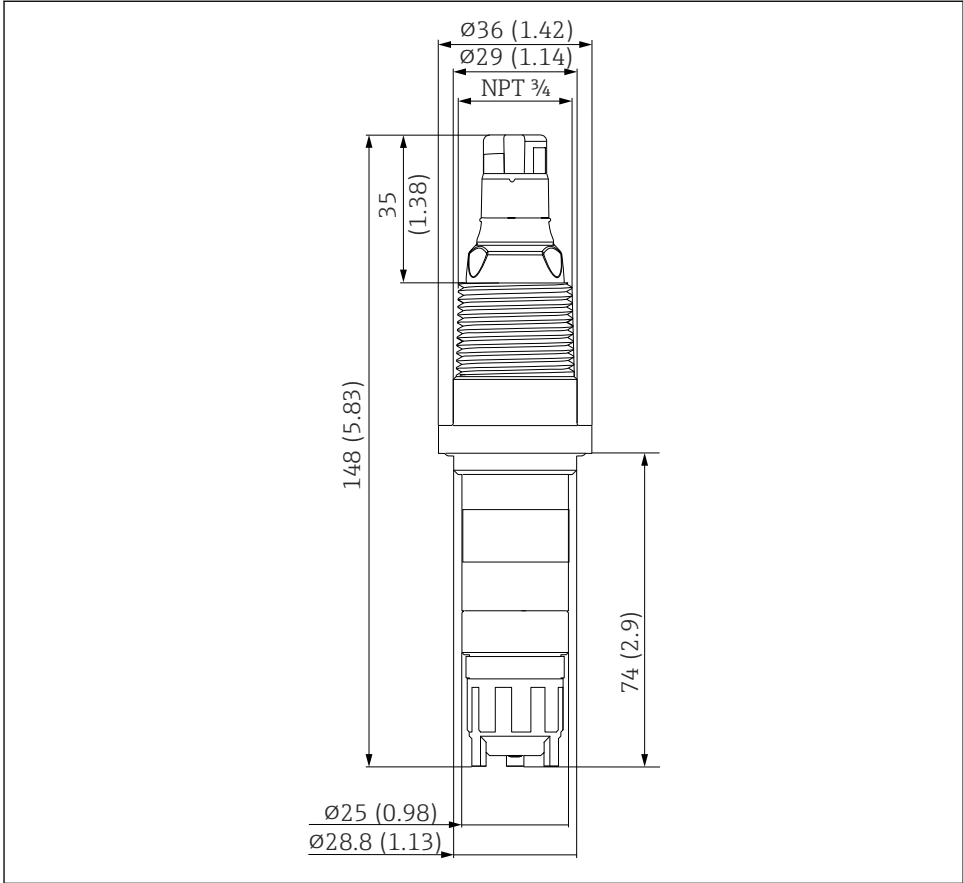

A0038260

3 Dimensions in mm (in)

5.2 Mounting the sensor

5.2.1 Measuring system

A complete measuring system comprises:

- CCS120D disinfection sensor (membrane-covered)
- Flexdip CYA112 immersion assembly
- Measuring cable CYK10, CYK20
- Transmitter, e. g. Liquiline CM44x with firmware version 01.06.08 or higher or CM44xR with firmware version 01.06.08 or higher
- Optional: extension cable CYK11
- Optional: Flowfit CCA250 flow assembly (a pH/ORP sensor can additionally be installed here)

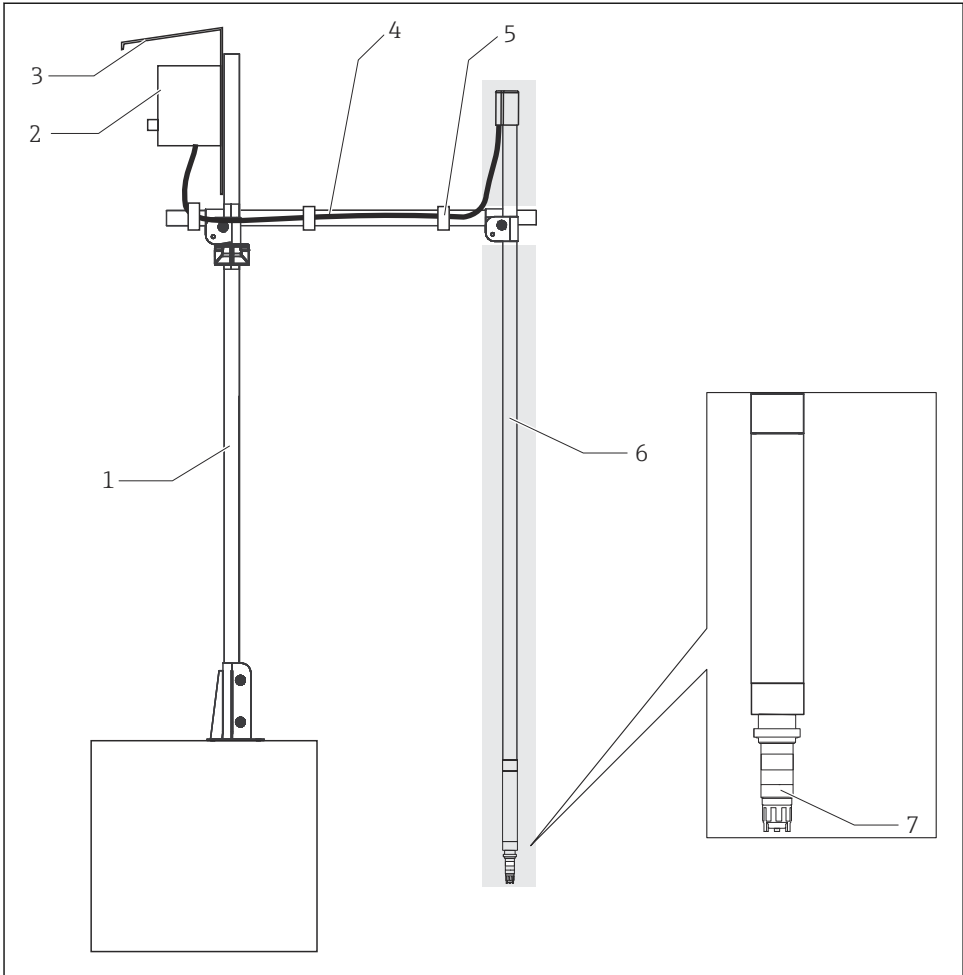

A0038294

4 Example of a measuring system

- 1 CYH112 holder, main pipe
- 2 Transmitter
- 3 Protective cover
- 4 CYH112 holder, transverse pipe
- 5 Hook-and-loop tape
- 6 CYA112 assembly (gray background)
- 7 Disinfection sensor CCS120D (membrane-covered, $\varnothing 25$ mm)

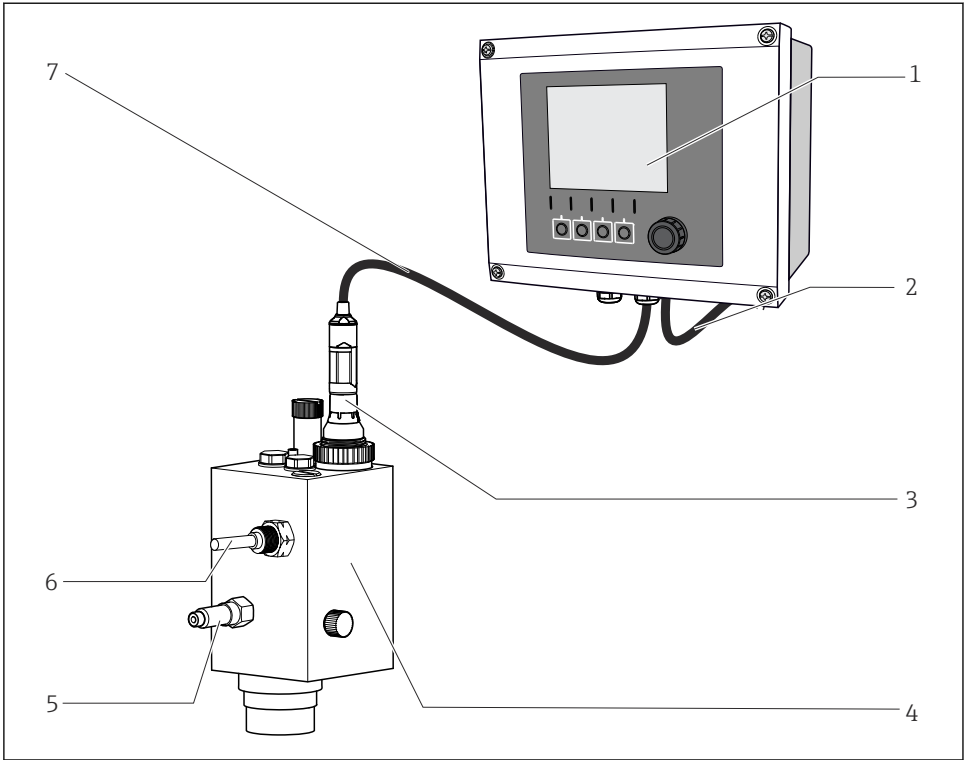

A0038946

5 Example of a measuring system

- 1 Liquiline CM44x transmitter
- 2 Power cable for transmitter
- 3 Disinfection sensor CCS120D (membrane-covered, Ø25 mm)
- 4 Flowfit CCA250 flow assembly
- 5 Inlet to Flowfit CCA250 flow assembly
- 6 Proximity switch (optional)
- 7 Measuring cable CYK10

5.2.2 Preparing the sensor

Remove protective cap from sensor

NOTICE

Vacuum causes damage to the sensor's membrane cap

► If the protective cap is attached, carefully remove it from sensor.

1. When supplied to the customer and when in storage, the sensor is fitted with a protective cap: First release just the top part of the protective cap by turning it.

↳

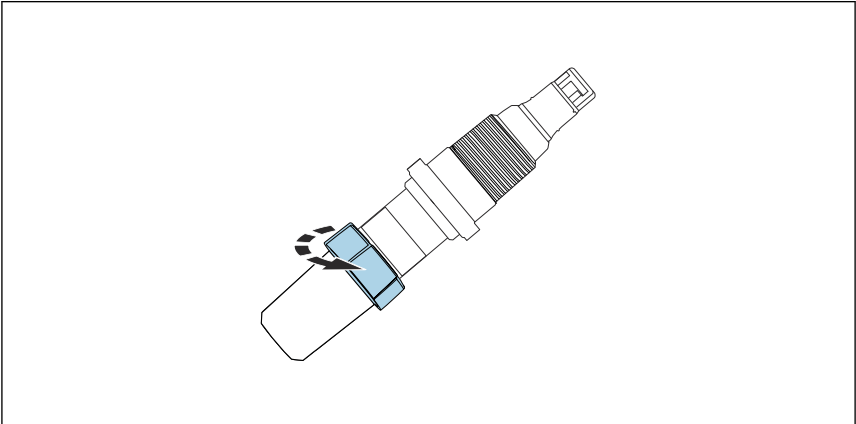

A0037884

6 Releasing top part of protective cap by turning

2. Carefully remove protective cap from sensor.

↳

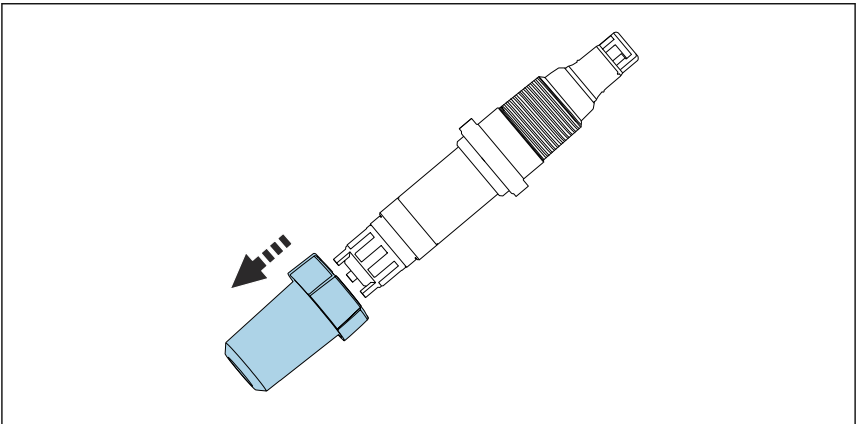

A0037885

7 Carefully remove protective cap

Filling the membrane cap with electrolyte



Please note the information on the safety data sheet to ensure safe use of the electrolyte.

NOTICE

Damage to membrane and electrodes, air bubbles

Possibility of measured errors to complete failure of the measuring point

- ▶ Avoid damage to membrane and electrodes.
- ▶ The electrolyte is chemically neutral and is not hazardous to health. Nonetheless, do not swallow it and avoid contact with eyes.
- ▶ Keep the electrolyte bottle closed after use. Do not transfer electrolyte to other vessels.
- ▶ Do not store electrolyte for longer than one year. The electrolyte must not be yellow in color. Observe the use-by date on the label.
- ▶ Avoid air bubbles when pouring electrolyte into membrane cap.
- ▶ Only use membrane cap once.
- ▶ Store the electrolyte bottle upside down (standing on its head) to ensure that the viscous electrolyte can be decanted as easily as possible with minimum bubbles. Smaller air bubbles are not a problem. Larger air bubbles rise to the upper edge of the membrane cap.

Filling the membrane cap with electrolyte



The sensor is dry when delivered from the factory. Before using the sensor, fill the membrane cap with electrolyte.

1. Open the electrolyte bottle. Screw the nozzle onto the electrolyte bottle.
2. Press out any excess air.
3. Place the electrolyte bottle on the membrane cap.
4. Using a single movement, slowly push the electrolyte into the membrane cap until it reaches the lower turn of the thread. Withdraw the electrolyte bottle smoothly.
5. Slowly screw on the membrane cap as far as the end stop. This will force excess electrolyte out at the valve and at the thread.
6. If necessary, pat the sensor and membrane cap dry using a cloth.
7. Thoroughly clean the nozzle with a clean, warm and strong jet of water to ensure that any electrolyte is removed.
8. Reset operating hours counter for electrolyte on transmitter. For detailed information, see the Operating Instructions for the transmitter.

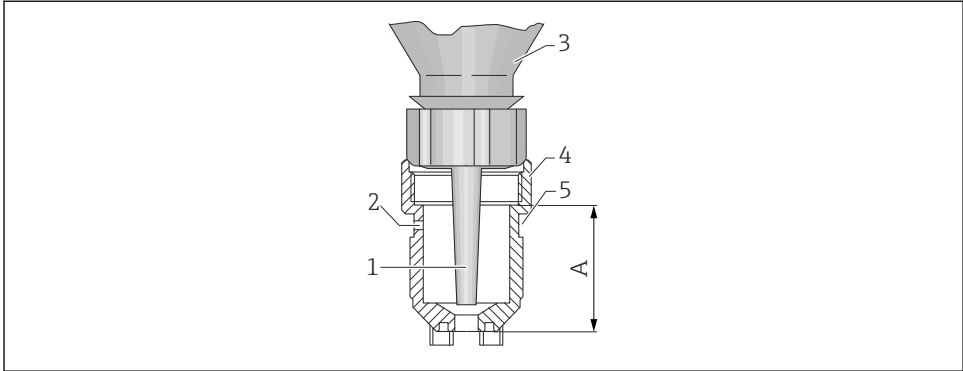

A0037963

8 Membrane cap with electrolyte bottle

- 1 Nozzle
- 2 Ventilation hole
- 3 Electrolyte bottle
- 4 Membrane cap
- 5 Hose seal
- A Electrolyte level

5.2.3 Installing the sensor in the Flowfit CYA27 assembly

The sensor can be installed in the Flowfit CYA27 flow assembly. In addition to the installation of the , this assembly also enables the simultaneous operation of several other sensors and flow monitoring.

Please note the following during installation:

- ▶ Guarantee the minimum flow to the sensor and the minimum volume flow of the assembly (5 l/h or 30 l/h).
- ▶ If the medium is fed back into an overflow basin, pipe or similar, the resulting counterpressure on the sensor may not exceed 1 bar relativ (14.5 psi relativ) (2 bar abs. (29 psi abs.)) and must remain constant.
- ▶ Avoid negative pressure at the sensor, e.g. due to medium being returned to the suction side of a pump.
- ▶ To avoid buildup, heavily contaminated water should also be filtered.

Equip sensor with adapter

The necessary adapter (clamping ring, thrust collar and O-ring) can be ordered as a mounted accessory for the sensor or as a separate accessory.

- ▶ First mount the clamping ring (1) from the sensor head towards the membrane cap, then slide the thrust collar (2) and then the O-ring (3) from the membrane cap towards the sensor head as far as the lower groove.

Install sensor in assembly

1. The assembly is supplied to the customer with a union nut screwed onto the assembly: unscrew union nut from assembly.
2. The assembly is supplied to the customer with a dummy plug inserted in the assembly: remove dummy plug and O-ring (1) from the assembly.
3. Slide the sensor with the adapter for Flowfit CYA27 into the opening in the assembly.
4. Screw the union nut onto assembly.

5.2.4 Installing the sensor in assembly CCA250

The Flowfit CCA250 flow assembly is designed for installing the sensor. It allows a pH and an ORP sensor to also be installed, in addition to the total chlorine sensor. A needle valve controls the flow rate in the range of 30 to 120 l/h (7.9 to 31.7 gal/h).

Please note the following during installation:

- ▶ The flow rate must be at least 30 l/h (7.9 gal/h). If the flow drops below this value or stops completely, this can be detected by an inductive proximity switch.
- ▶ If the medium is fed back into an overflow basin, pipe or similar, the resulting counterpressure on the sensor may not exceed 1 bar (14.5 psi)(2 bar abs. (29 psi abs.)) and must remain constant.
- ▶ Negative pressure at the sensor, e.g. due to medium being returned to the suction side of a pump, must be avoided.
- ▶ To avoid buildup, heavily contaminated water should also be filtered.



Additional installation instructions can be found in the Operating Instructions for the assembly.

5.2.5 Installing the sensor in other flow assemblies

When using other flow assembly, ensure:

- ▶ A minimum flow velocity of 15 cm/s (0.49 ft/s) must be ensured at the membrane.
- ▶ The flow direction is upwards. Transported air bubbles must be removed so that they do not collect in front of the membrane.
- ▶ The membrane must be exposed to direct flow.

5.2.6 Installing the sensor in the CYA112 immersion assembly

Alternatively, the sensor can be installed in an immersion assembly with threaded connection G1", e.g. CYA112.



Additional installation instructions can be found in the Operating Instructions for the assembly.

5.3 Post-mounting check

1. Check the membrane to ensure it is sealed and undamaged.
 - ↳ Replace if necessary.

2. Is the sensor installed in an assembly and not suspended from the cable?
 - ↳ The sensor may be installed only in an assembly or directly via the process connection.

6 Electrical connection

⚠ CAUTION

Device is live

Incorrect connection may result in injury!

- ▶ The electrical connection may be performed only by an electrical technician.
- ▶ The electrical technician must have read and understood these Operating Instructions and must follow the instructions contained therein.
- ▶ **Prior** to commencing connection work, ensure that no voltage is present on any cable.

6.1 Connecting the sensor

The electrical connection to the transmitter is performed via Memosens data cable CYK10 or measuring cable CYK20.

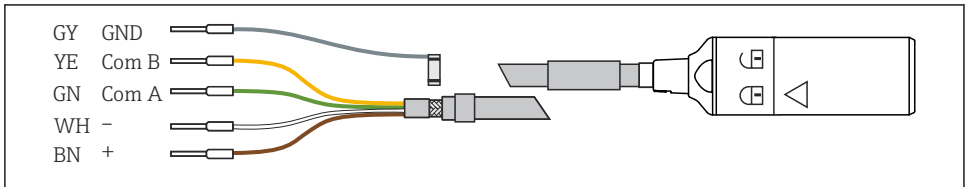

9 *Measuring cable CYK10/CYK20*

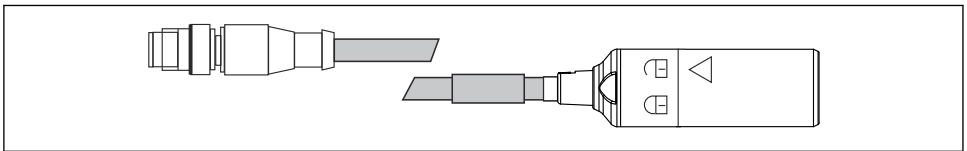

10 *CYK10 with M12 plug, electrical connection*

6.2 Ensuring the degree of protection

Only the mechanical and electrical connections which are described in these instructions, and which are necessary for the required intended use, may be established on the device delivered.

- ▶ Exercise care when carrying out the work.

Otherwise, the individual types of protection (Ingress Protection (IP), electrical safety, EMC interference immunity) agreed for this product can no longer be guaranteed due, for example, to covers being left off or cable (ends) that are loose or insufficiently secured.

6.3 Post-connection check

Device condition and specifications	Notes
Are the sensor, assembly, or cables free from damage on the outside?	Visual inspection
Electrical connection	Notes
Are the mounted cables strain-relieved and not twisted?	
Is a sufficient length of the cable cores stripped, and are the cores positioned in the terminal correctly?	Check the fit (by pulling gently)
Are all the screw terminals properly tightened?	Tighten
Are all the cable entries installed, tightened and sealed?	For lateral cable entries, make sure the cables loop downwards to allow water to drip off
Are all cable entries installed downwards or mounted laterally?	

7 Commissioning

7.1 Installation and function check

Prior to commissioning, ensure that:

- The sensor is correctly installed.
- The electrical connection is correct.
- There is sufficient electrolyte in the membrane cap and the transmitter is not displaying a warning about electrolyte depletion.



Please note the information on the safety data sheet to ensure safe use of the electrolyte.



Always keep the sensor moist after commissioning.

⚠ CAUTION

Escaping process medium

Risk of injury from high pressure, high temperatures or chemical hazards

- ▶ Before applying pressure to an assembly with cleaning system, ensure that the system has been connected correctly.
- ▶ Do not install the assembly in the process if you cannot reliably establish the correct connection.

7.2 Filling the membrane cap with electrolyte

Fill the membrane cap with electrolyte

The sensor is dry when delivered from the factory.

- ▶ Fill the membrane cap with electrolyte before commissioning the sensor → 19.

7.3 Sensor polarization

The voltage applied by the transmitter between the working electrode and counter electrode polarizes the surface of the working electrode. Therefore, after switching on the transmitter with the sensor connected, you must wait until the polarization time has elapsed before starting calibration.

Polarization time: → 39

7.4 Calibrating the sensor

Reference measurement according to the DPD method

To calibrate the measuring system, carry out a colorimetric comparison measurement according to the DPD-1/DPD-3 method. Chlorine reacts with diethyl-p-phenyldiamine (DPD) producing a red dye, the intensity of the red color being proportional to the chlorine content. Alternatively, the DPD 4 method can also be used.

Measure the intensity of the red color using a photometer, (e.g. PF-3 → 36) . The photometer indicates the chlorine content.

Prerequisites

The sensor reading is stable (no drifts or unsteady values for at least 5 minutes). This is normally guaranteed once the following preconditions have been met:

- The polarization time has fully elapsed.
- The flow is constant and within the correct range.
- The sensor and the medium are at the same temperature.
- The pH value is within the permitted range.

Zero adjustment

A zero adjustment is not required due to the zero point stability of the membrane-covered sensor.

Slope calibration



Always perform a slope calibration in the following cases:

- After replacing the membrane cap
- After replacing electrolyte

The slope of the sensor is strongly influenced by the application conditions. The interval for the slope calibration must be adjusted accordingly.

Repeat the slope calibration at regular intervals.



Recommended calibration intervals → 29



1. Ensure that the pH value and temperature of the medium are constant.
2. Take a representative sample for the DPD measurement. This must be done in close proximity to the sensor. Use the sampling tap if available.
3. Determine the chlorine content using the DPD method.
4. Enter the measured value into the transmitter (see Operating Instructions for transmitter).
5. To ensure greater accuracy, check the calibration several hours or a day later using the DPD method.

8 Diagnostics and troubleshooting

When troubleshooting, the entire measuring point must be taken into account. This comprises:

- Transmitter
- Electrical connections and lines
- Assembly
- Sensor



The possible causes of faults in the following table refer primarily to the sensor. Before commencing troubleshooting, ensure that the following operating conditions have been met:

- The chlorine content is within the measuring range of the sensor (check with the DPD-1/DPD-3 method) →  38.
- The pH value is within the pH range of the sensor →  40.
- The temperature is within the temperature range of the sensor →  39.
- The conductivity is within the conductivity range of the sensor .
- Measurement in "temperature-compensated" mode (can be configured on transmitter CM44x) or constant temperature following calibration
- Medium flow rate of at least 30 l/h (7.9 gal/h) (red bar mark when using the CCA250 flow assembly)



If the value measured by the sensor differs significantly from that of the DPD method, first consider all possible malfunctions of the photometric DPD method (see Operating Instructions for photometer). If necessary, repeat the DPD measurement several times.

Error	Possible cause	Remedy
No display, no sensor current	No supply voltage at the transmitter	▶ Establish mains connection
	Connection cable between sensor and transmitter interrupted	▶ Establish cable connection
	There is no electrolyte in the membrane cap	▶ Fill the membrane cap with fresh electrolyte →  31
	No input flow of medium	▶ Establish flow, clean filter
	Zero point has shifted	<ol style="list-style-type: none"> 1. Check condition of counter electrode. 2. Reset transmitter to factory settings.

Error	Possible cause	Remedy
Display value too high	Polarization of the sensor not yet completed	▶ Wait for polarization to be completed
	Membrane defective	▶ Replace membrane cap
	Shunt resistance (e.g. moisture contact) in the sensor shaft	▶ Remove membrane cap, rub working electrode dry. ▶ If the transmitter display does not return to zero, there is a shunt present: replace sensor.
	Foreign oxidants interfering with sensor	▶ Examine medium, check chemicals
	DPD chemicals are too old	▶ Replace DPD chemicals.
	pH value < pH 5	▶ Stay within permitted pH range (pH 5.5 to 9.5).
Display value too low	Membrane cap not screwed on fully	▶ Fill the membrane cap with fresh electrolyte →  31 ▶ Screw membrane cap on fully
	Membrane soiled	▶ Clean the membrane →  29
	Air bubble in front of membrane	▶ Release air bubble
	Air bubble between working electrode and membrane	▶ Remove membrane cap, top up electrolyte ▶ Remove air bubble by tapping on the outside of the membrane cap ▶ Screw on membrane cap
	Input flow of medium too low	▶ Establish correct flow
	Foreign oxidants interfering with DPD reference measurement	▶ Examine medium, check chemicals
	Use of organic disinfectants	▶ Use suitable agent (e.g. as per DIN 19643) (water may need to be replaced first) ▶ Use suitable reference system.
	Polarization time is too low	▶ Wait for polarization to be completed
	pH value	▶ Stay within permitted pH range (pH 5.5 to 9.5).
	There is no electrolyte in the membrane cap	▶ Fill the membrane cap with fresh electrolyte →  31
Display fluctuates considerably	Hole in membrane	▶ Replace membrane cap
	Fluid pressure variations	▶ Adjust the process

9 Maintenance



Please note the information on the safety data sheet to ensure safe use of the electrolyte.

Take all the necessary precautions in time to ensure the operational safety and reliability of the entire measuring system.

NOTICE

Effects on process and process control!

- ▶ When carrying out any work on the system, bear in mind any potential impact this could have on the process control system and the process itself.
- ▶ For your own safety, only use genuine accessories. With genuine parts, the function, accuracy and reliability are also ensured after maintenance work.

9.1 Maintenance schedule

Interval	Maintenance work
If deposits are visible on the membrane (biofilm, limescale)	Clean sensor membrane → 30
If dirt is visible on the surface of the electrode body	Clean electrode body of sensor
Recommended calibration intervals: <ul style="list-style-type: none"> ▪ Drinking water, industrial water, process water, cooling water: depending on the special conditions (1 to 4 weeks) ▪ Swimming pools: weekly ▪ Whirlpools: daily 	Sensor calibration
<ul style="list-style-type: none"> ▪ If cap is replaced ▪ If the slope is too low or too high relative to the nominal slope and the membrane cap is not visibly damaged or dirty 	Fill membrane cap with fresh electrolyte → 31
<ul style="list-style-type: none"> ▪ If there are grease/oil deposits (dark or transparent spots on the membrane) ▪ If slope is too high or too low or sensor current is very noisy ▪ If it is obvious that the sensor current is significantly dependent on the temperature (temperature compensation not working). 	Replace membrane cap → 31
In the event of visible silvery or white changes to the counter electrode (brown/gray or yellow/green discoloration is not a problem)	Regenerate sensor → 34

9.2 Maintenance work

9.2.1 Cleaning the sensor

Remove the sensor from the Flowfit CYA27 assembly

1. Remove the cable.
2. Unscrew the union nut from the assembly.

3. Pull sensor out through opening in assembly.

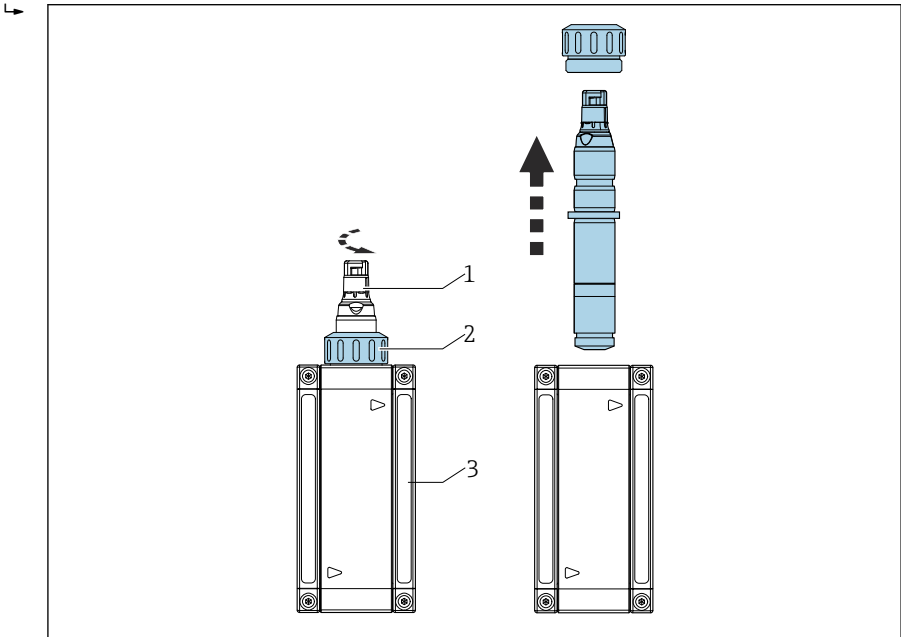

A0044654

- 1 Disinfection sensor
- 2 Union nut for securing a disinfection sensor
- 3 flow assembly

 For detailed information on "Removing the sensor from the assembly Flowfit CYA27, see the Operating Instructions for the assembly.

Removing the sensor from the assembly CCA151

1. Remove the cable.
2. Unscrew the union nut from the assembly.



3. Pull sensor out through opening in assembly.

Clean the sensor membrane

If the membrane is visibly soiled, proceed as follows:

1. Remove sensor from flow assembly.
2. Only clean membrane mechanically with a gentle jet of water.

9.2.2 Filling the membrane cap with fresh electrolyte



Please note the information on the safety data sheet to ensure safe use of the electrolyte.

NOTICE



Damage to membrane and electrodes, air bubbles

Possibility of measured errors to complete failure of the measuring point

- ▶ Avoid damage to membrane and electrodes.
- ▶ The electrolyte is chemically neutral and is not hazardous to health. Nonetheless, do not swallow it and avoid contact with eyes.
- ▶ Keep the electrolyte bottle closed after use. Do not transfer electrolyte to other vessels.
- ▶ Do not store electrolyte for longer than one year. The electrolyte must not be yellow in color. Observe the use-by date on the label.
- ▶ Avoid air bubbles when pouring electrolyte into membrane cap.
- ▶ Only use membrane cap once.

Fill the membrane cap with electrolyte →  19

9.2.3 Replacing the membrane cap

1. Remove sensor from flow assembly.
2. Remove membrane cap →  32.
3. Fill new membrane cap with fresh electrolyte →  19.
4. Check the condition of the sealing ring and check whether the sealing ring is mounted on the shaft.
5. Screw new membrane cap onto sensor shaft →  32.
6. Reset operating hours counter for membrane cap on transmitter. For detailed information, see Operating Instructions for transmitter.

Remove membrane cap

- ▶ Carefully rotate membrane cap and remove.

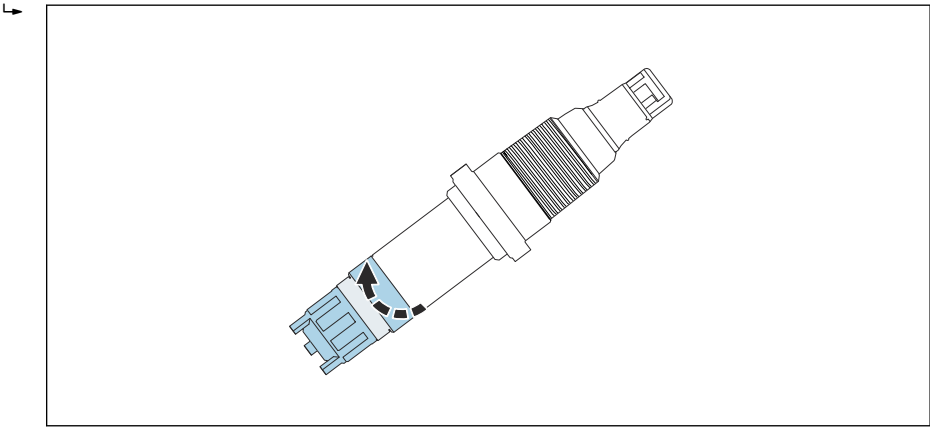

A0037888

 11 Carefully rotate membrane cap.

Screw membrane cap onto sensor

- ▶ Screw membrane cap onto sensor shaft: hold sensor by the shaft. Keep valve clear.

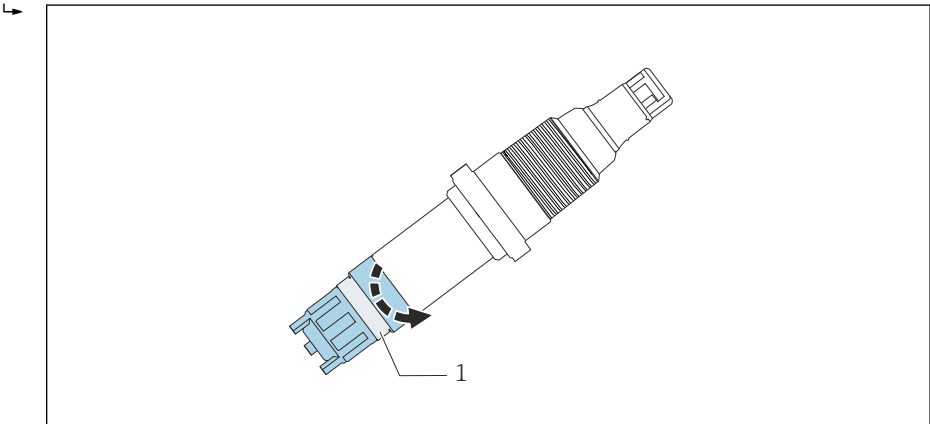

A0037889



 12 Screw on membrane cap: keep pressure relief valve clear.

1 Pressure relief valve

9.2.4 Storing the sensor

If measurement is suspended:

1. Remove the cable.
2. Remove sensor from assembly.

3. Unscrew membrane cap and dispose of it.
 4. Rinse electrodes thoroughly with clean, warm water ensuring all residue of electrolyte is removed.
 5. Allow the electrodes to dry.
 6. Screw a new membrane cap loosely onto the electrodes to protect them.
 7. Fit the protective cap on the sensor →  33.
 8. For recommissioning, follow the same procedure as for commissioning →  25.
-  Ensure that no biofouling occurs during longer interruptions to measurement. Remove continuous organic deposits such as films of bacteria from media with a high concentration of chlorine.

Fit the protective cap on the sensor

1. To keep the membrane moist after the sensor has been removed, fill the protective cap with clean water.

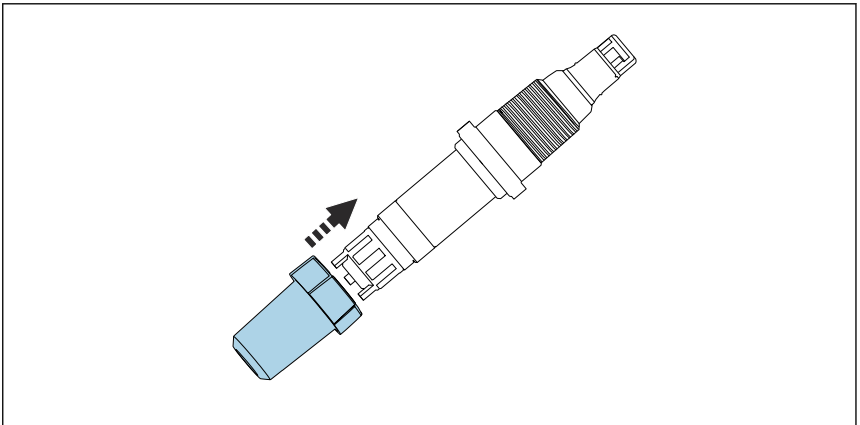

A0037886

 13 Carefully slide the protective cap onto the membrane cap.

2. Top part of protective cap is in the open position.
Carefully slide the protective cap onto the membrane cap.

- Secure protective cap by rotating the top part of the protective cap.

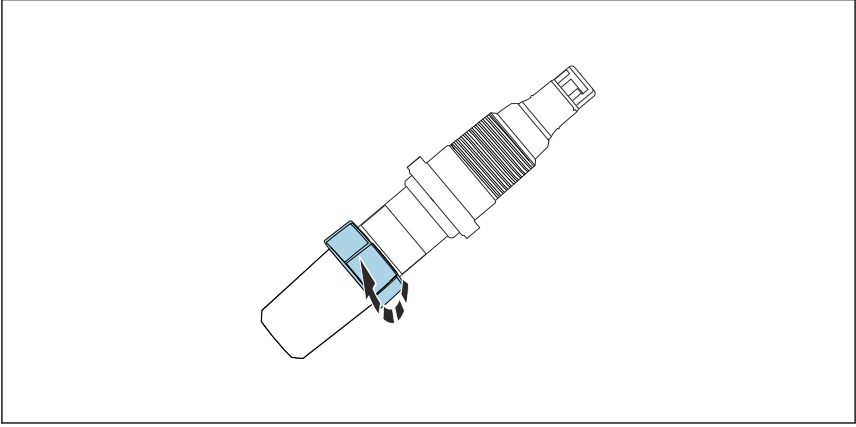

A0037887

-  14 Secure the protective cap by rotating the top part.

9.2.5 Regenerating the sensor

During measurement, the electrolyte in the sensor is gradually exhausted due to chemical reactions. The gray-brown silver halide layer that is applied to the counter electrode at the factory continues to grow during sensor operation. However, this has no effect on the reaction taking place at the working electrode.

A change in the color of the silver halide layer indicates an effect of the reaction that is taking place. Carry out a visual inspection to ensure that the gray-brown color of the counter electrode has not changed. If the color of the counter electrode has changed, e.g. if it is spotted, white or silvery, the sensor must be regenerated.

- Send the sensor to the manufacturer for regeneration.

10 Repair

10.1 Spare parts

For more detailed information on spare parts kits, please refer to the "Spare Part Finding Tool" on the Internet:

www.endress.com/spareparts_consumables

10.2 Return

The product must be returned if repairs or a factory calibration are required, or if the wrong product was ordered or delivered. As an ISO-certified company and also due to legal regulations, Endress+Hauser is obliged to follow certain procedures when handling any returned products that have been in contact with medium.

To ensure the swift, safe and professional return of the device:

- ▶ Check the website www.endress.com/support/return-material for information on the procedure and general conditions.

10.3 Disposal



If required by the Directive 2012/19/EU on waste electrical and electronic equipment (WEEE), the product is marked with the depicted symbol in order to minimize the disposal of WEEE as unsorted municipal waste. Do not dispose of products bearing this marking as unsorted municipal waste. Instead, return them to the manufacturer for disposal under the applicable conditions.

11 Accessories

The following are the most important accessories available at the time this documentation was issued.

Listed accessories are technically compatible with the product in the instructions.

1. Application-specific restrictions of the product combination are possible. Ensure conformity of the measuring point to the application. This is the responsibility of the operator of the measuring point.
2. Pay attention to the information in the instructions for all products, particularly the technical data.
3. For accessories not listed here, please contact your Service or Sales Center.

11.1 Device-specific accessories

Kit CCS120/120D, maintenance kit

- 2 x membrane caps and 1 x electrolyte 50 ml (1.69 fl.oz)
- Order number: 71412917

Kit CCS120/120D, electrolyte

- 1 × electrolyte 50 ml (1.69 fl oz)
- Order number: 71412916

Kit CCS120/120D, Viton ring set

- 2 × Viton rings
- Order number: 71105209

Memosens data cable CYK10

- For digital sensors with Memosens technology
- Product Configurator on the product page: www.endress.com/cyk10



Technical Information TI00118C

Memosens data cable CYK11

- Extension cable for digital sensors with Memosens protocol
- Product Configurator on the product page: www.endress.com/cyk11



Technical Information TI00118C

Memosens laboratory cable CYK20

- For digital sensors with Memosens technology
- Product Configurator on the product page: www.endress.com/cyk20

Flowfit CYA27

- Modular flow assembly for multiparameter measurements
- Product Configurator on the product page: www.endress.com/cya27



Technical Information TI01559C

Flowfit CCA250

- Flow assembly for disinfection and pH/ORP sensors
- Product Configurator on the product page: www.endress.com/cca250



Technical Information TI00062C

Flexdip CYA112

- Immersion assembly for water and wastewater
- Modular assembly system for sensors in open basins, channels and tanks
- Material: PVC or stainless steel
- Product Configurator on the product page: www.endress.com/cya112



Technical Information TI00432C

Photometer PF-3

- Compact hand-held photometer for determining the reference measured value
- Color-coded reagent bottles with clear dosing instructions
- Order No.: 71257946

Complete quick fastener kit for CYA112

- Adapter, inner and outer parts incl. O-rings
- Tool for mounting and disassembly
- Order No. 71093377 or mounted accessory of CYA112

COY8

Zero-point gel for oxygen and disinfection sensors

- Disinfectant-free gel for the verification, zero point calibration and adjustment of oxygen and disinfection measuring points
- Product Configurator on the product page: www.endress.com/coy8



Technical Information TI01244C

12 Technical data

12.1 Input

12.1.1 Measured variables

Total chlorine

[mg/l, µg/l, ppm, ppb]

- Free available chlorine:
 - Hypochlorous acid (HOCl)
 - Hypochlorite ions (OCl⁻)
- Combined chlorine (chloramines)
- Organically combined chlorine (e.g. cyanuric acid derivatives)

Temperature

[°C, °F]

12.1.2 Measuring range

0.1 to 10 mg/l (ppm)

The sensor is not suitable for checking the absence of chlorine.

12.1.3 Signal current

2.4 to 5.4 nA per 1 mg/l (ppm)

12.2 Performance characteristics

12.2.1 Reference conditions

Temperature 30 °C (86 °F)

pH value pH 7.2

12.2.2 Response time

T₉₀ approx. 60 s (with increasing and decreasing concentration)

12.2.3 Measured value resolution of sensor

0.01 mg/l (ppm)

12.2.4 Measurement error

$\pm 2\%$ or 200 $\mu\text{g/l}$ (ppb) of value measured (depending on which value is higher)

LOD (limit of detection) ¹⁾

0.022 mg/l (ppm)

LOQ (limit of quantification) ¹⁾

0.072 mg/l (ppm)

1) Based on ISO 15839. The measured error includes all the uncertainties of the sensor and transmitter (electrode system). It does not contain all the uncertainties caused by the reference material and adjustments that may have been performed.

12.2.5 Repeatability

0.008 mg/l (ppm)

12.2.6 Nominal slope

4 nA per 1 mg/l (ppm) (under reference operating conditions)

12.2.7 Long-term drift

$< \pm 3\%$ per month

12.2.8 Polarization time

Initial commissioning

Up to 24 h

After replacing the membrane cap

Typically 1 to 6 h

Recommissioning

Pour approx. 4 to 24 h

12.2.9 Operating time of the electrolyte

3 to 6 months (depending on water quality)

12.2.10 Operating time of membrane cap

With electrolyte

Typically 3 to 6 months, depending on water quality

Without electrolyte

> 2 years (25 °C (77 °F))

12.3 Environment**12.3.1 Ambient temperature**

5 to 45 °C (41 to 113 °F), no temperature fluctuations

12.3.2 Storage temperature

Without electrolyte

-20 to 60 °C (-4 to 140 °F)

12.3.3 Degree of protection

IP68

12.4 Process

12.4.1 Process temperature

5 to 45 °C (41 to 113 °F), no temperature fluctuations

12.4.2 Process pressure

Max. 1 bar relativ (14.5 psi relativ) (2 bar abs. (29 psi abs.)), if installed in the Flowfit CCA250 assembly

12.4.3 pH range

pH5.5 to 9.5

pH dependency: increase from pH 7 to pH 8: approx. -10 % for free chlorine

12.4.4 Conductivity

0.03 to 40 mS/cm

The sensor can also be used in media with a very low conductivity, such as demineralized water.



If the salt content is high, iodine and bromine can occur; this affects the reference value.

12.4.5 Flow

CCA250

- Optimum 40 to 60 l/h (10.6 to 15.8 gal/h)
- Minimum 30 l/h (7.9 gal/h)
- Maximum 100 l/h (26.4 gal/h)

12.4.6 Flow

- Optimum 20 to 30 cm/s
- Minimum 15 cm/s
- Maximum 50 cm/s

12.5 Mechanical construction

12.5.1 Dimensions

→  14

12.5.2 Weight

75 g (2.65 oz)

12.5.3 Materials

Sensor shaft	PVC
Membrane	PET
Membrane cap	PPE

Clamping ring	PTFE
Hose seal	Silicone
Electrode body	PMMA

12.5.4 Cable specification

max. 100 m (330 ft), incl. Cable extension

13 Installation and operation in hazardous environment Class I Div. 2

Non-sparking device for use in specified hazardous environment in accordance with:

- cCSAus Class I Div. 2
- Gas group A, B, C, D
- Temperature class T6, $-5\text{ °C (23 °F)} < T_a < 55\text{ °C (131 °F)}$
- Control drawing: 401204

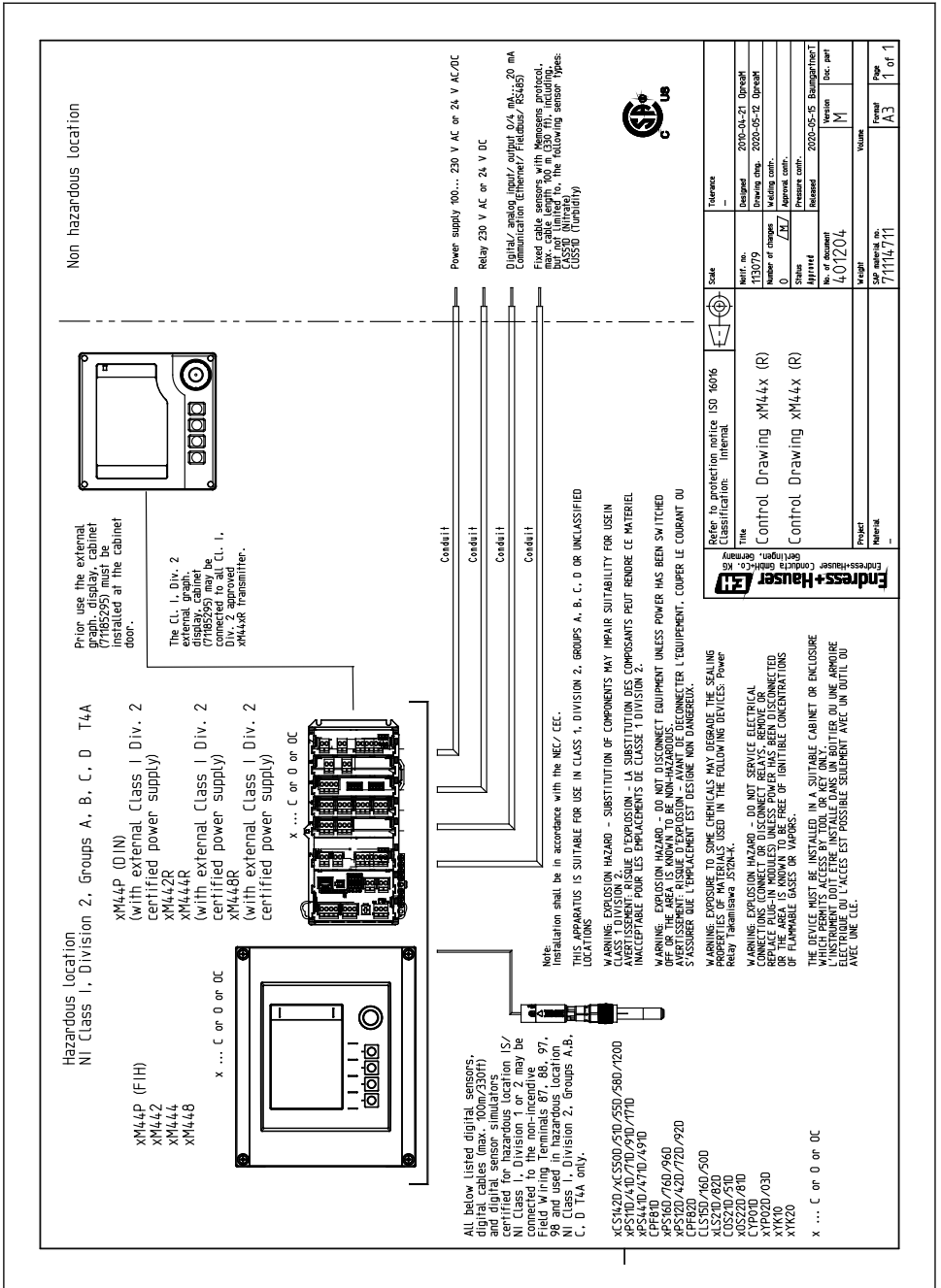

Non hazardous location

Hazardous location
NI Class I, Division 2, Groups A, B, C, D T4A

Prior use the external cabinet (7185295) must be installed at the cabinet door.
The CL 1, Div. 2 display cabinet (7185295) may be connected to all CL 1, XM44xR transmitter.

- xM44P (0IN) (with external Class I Div. 2 certified power supply)
- xM442R (with external Class I Div. 2 certified power supply)
- xM444R (with external Class I Div. 2 certified power supply)
- xM448R (with external Class I Div. 2 certified power supply)

- xM44P (FIH)
- xM442
- xM444
- xM448

x ... C or 0 or 0C

x ... C or 0 or 0C

All below listed digital, sensors, (with external Class I Div. 2) and digital sensor simulators certified for hazardous location IS/ NI Class I, Division 1 or 2 may be connected to the non-hazardous location. See also the following table: 98, 97, 98 and used in hazardous location. NI Class I, Division 2, Groups A, B, C, D T4A only.

- XC5142D/XC5500/51D/55D/56D/720D
- XP511D/41D/71D/91D/711D
- XP5441D/471D/491D
- XP510/76D/96D
- XP512D/42D/72D/92D
- CPF82D
- CL55D/16D/50D
- CL521D/91D
- CL521D/91D
- X0522D/91D
- CP101D
- XP102D/03D
- XP102D/03D
- XP12D

x ... C or 0 or 0C

- Power supply 100... 230 V AC or 24 V AC/DC
- Relay 230 V AC or 24 V DC
- Digital/ analog input/ output 0/4 mA... 20 mA Communication (Ethernet/ Profibus/ RS485)
- Fixed cable sensors with Memosens protocol, max. cable length up to 1330 ft), including, CANOPEN (Nitrado), the following sensor types: CCS50 (Nitrado), CCS50B (Nitrado)



Scale	1:1	Tolerance	—
Drawn by	13079	Designed	2020-04-21, G.rosch
Number of changes	0	Drawing date	2020-05-12, G.rosch
Status	Approved	Modifying contr.	—
Revision	401204	Approval contr.	—
Weight	711147/11	Pressure contr.	2020-05-28, Baumgartner
Project	—	Released	2020-05-28, Baumgartner
Material	—	Version	1.0
Page	1 of 1	Volume	—

Endress+Hauser
Control Drawing XM44x (R)
Control Drawing XM44x (R)

Refer to protection notice ISO 6606
Classification: Internal.
This drawing is the property of Endress+Hauser AG. All rights reserved.
Do not service electrical equipment unless power has been switched off and the area is known to be free of ignitable concentrations of flammable gases or vapors.
The device must be installed in a suitable cabinet or enclosure. The instrument must be installed in a suitable enclosure with the electrical connections.
WARNING: EXPOSURE TO SOME CHEMICALS MAY DEGRADE THE SEALING PROPERTIES OF MATERIALS USED IN THE FOLLOWING DEVICES: Power Relay (Amisawa J50H-4).
DO NOT SERVICE ELECTRICAL EQUIPMENT UNLESS POWER HAS BEEN DISCONNECTED AND THE AREA IS KNOWN TO BE FREE OF IGNITABLE CONCENTRATIONS OF FLAMMABLE GASES OR VAPORS.
The device must be installed in a suitable cabinet or enclosure. The instrument must be installed in a suitable enclosure with the electrical connections.
WARNING: EXPOSURE TO SOME CHEMICALS MAY DEGRADE THE SEALING PROPERTIES OF MATERIALS USED IN THE FOLLOWING DEVICES: Power Relay (Amisawa J50H-4).
DO NOT SERVICE ELECTRICAL EQUIPMENT UNLESS POWER HAS BEEN DISCONNECTED AND THE AREA IS KNOWN TO BE FREE OF IGNITABLE CONCENTRATIONS OF FLAMMABLE GASES OR VAPORS.

Index

A

- Accessories 36
- Ambient temperature 39

C

- Cable specification 41
- Check
 - Connection 24
 - Function 25
 - Mounting 21
- Cleaning 29
- Connection
 - Check 24
 - Ensuring the degree of protection 23

D

- Degree of protection
 - Ensuring 23
 - Technical data 39
- Device description 7
- Diagnostics 27
- Disposal 35

E

- Effect on the measured signal
 - Flow 8
 - pH value 8
 - Temperature 9
- Electrical connection 23
- Environment 39

F

- Flow 8, 40
- Flow assembly 21
- Function 7
- Function check 25

I

- Immersion assembly 21
- Incoming acceptance 11
- Intended use 5

L

- Long-term drift 39

M

- Maintenance schedule 29
- Maintenance work 29
- Materials 40
- Measured signal 8
- Measured value resolution 38
- Measured variables 38
- Measurement error 39
- Measuring principle 7
- Measuring ranges 38
- Measuring system 15
- Mounting
 - Check 21
 - Flow assembly 21
 - Immersion assembly 21
 - Orientation 13
 - Sensor 15
- Mounting instructions 13

N

- Nameplate 11
- Nominal slope 39

O

- Operating time of the electrolyte 39
- Orientation 13

P

- Performance characteristics 38
- pH range 40
- pH value 8
- Polarization time 39
- Post-installation check 25
- Process 40
- Process pressure 40
- Process temperature 40

R

- Reference conditions 38
- Regeneration 34
- Repair 35
- Repeatability 39
- Response time 38
- Return 35

S

Safety information	4
Safety instructions	5
Scope of delivery	12
Sensor	
Calibrating	25
Cleaning	29
Connecting	23
Installing	15
Polarization	25
Regenerating	34
Storing	32
Spare parts	35
Storage	32
Storage temperature	39
Symbols	4

T

Technical data	
Environment	39
Input	38
Mechanical construction	40
Performance characteristics	38
Process	40
Temperature	9
Troubleshooting	27

U

Use	5
---------------	---

W

Weight	40
------------------	----

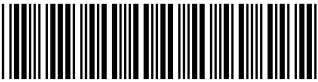

71663354

www.addresses.endress.com
