

Operating Instructions

OXY5500 gas analyzer

ATEX/IECEX/UKEX: Zone 2
cCSAus: Class I, Division 2





Table of Contents





1 About this document.....	4	5.7 Digitals menu	25
1.1 Warnings.....	4	5.8 Analog output settings (Analogues) menu.....	26
1.2 Symbols on the device.....	4	5.9 Measurement menu options.....	27
1.3 U.S. export compliance	4	5.10 Measurement settings (Meas. settings) menu options	31
2 Introduction	5	5.11 Device settings menu options.....	35
2.1 Associated documents	5	5.12 Sensor menu options	38
2.2 Who should read this manual.....	5	5.13 Purging the cylinder pressure regulators and analyzer.....	46
2.3 How to use this manual	5	5.14 Digitals menu options.....	52
2.4 General warnings and cautions	6	5.15 Analog output settings (Analogues) menu options	53
2.5 Documents provided with the OXY5500 analyzer	7	6 Modbus communication	58
2.6 Manufacturer address	7	6.1 Protocol definition	58
2.7 About the OXY5500 analyzer	7	6.2 Examples.....	67
2.8 Getting familiar with the analyzer	7	7 Appendix A: Specifications.....	69
2.9 Safety guidelines	11	7.1 Technical notes	70
3 Safety.....	12	7.2 Spare parts.....	72
3.1 Potential risks affecting personnel	12	8 Appendix B: Maintenance and troubleshooting.....	74
4 Installation.....	13	8.1 Optical output.....	74
4.1 Shipping box contents	13	8.2 Cleaning the instrument	74
4.2 Inspecting the analyzer	13	8.3 Temperature probe lifespan	74
4.3 Installing the analyzer.....	13	8.4 Fuse replacement.....	75
4.4 Required basic equipment.....	13	8.5 Replacing the electro-optical module	76
4.5 Hardware and tools for installation	14	8.6 Installing/replacing the pressure sensor	77
4.6 Analyzer mounting	14	8.7 Removing and replacing the oxygen probe.....	79
4.7 Connecting electrical power to the analyzer	15	8.8 Correcting error codes	84
4.8 Analyzer connections	17	8.9 Recommendations for correct measurement.....	84
4.9 Analog outputs/analog input connections.....	17	8.10 Performance improvement.....	85
5 Operation	20	8.11 Troubleshooting.....	85
5.1 Starting up the analyzer	20	8.12 Service	86
5.2 Operation overview	20	8.13 Packing and storage	86
5.3 Measurement menu.....	22	8.14 Storage	87
5.4 Measurement settings (Meas. settings) menu	23	8.15 Disclaimers	87
5.5 Device settings menu.....	24	8.16 Warranty.....	87
5.6 Sensor menu	24		

1 About this document

1.1 Warnings

Structure of Information	Meaning
 WARNING Causes (/consequences) Consequences of noncompliance (if applicable) ▶ Corrective action	This symbol alerts you to a dangerous situation. Failure to avoid the dangerous situation can result in a fatal or serious injury.
 CAUTION Causes (/consequences) Consequences of noncompliance (if applicable) ▶ Corrective action	This symbol alerts you to a dangerous situation. Failure to avoid this situation can result in minor or more serious injuries.
NOTICE Cause/situation Consequences of noncompliance (if applicable) ▶ Action/note	This symbol alerts you to situations which may result in damage to property.

1.2 Symbols on the device

Symbol	Description
	The High Voltage symbol that alerts people to the presence of electric potential large enough to cause injury or damage. In certain industries, high voltage refers to voltage above a certain threshold. Equipment and conductors that carry high voltage warrant special safety requirements and procedures.
	The WEEE symbol indicates that the product should not be discarded as unsorted waste but must be sent to separate collection facilities for recovery and recycling.
	The CE Marking indicates conformity with Essential Health, Safety & Environmental requirements of Directive 2014/34/EU for products sold within the European Economic Area (EEA).
	The UKCA marking indicates conformity with Essential Health, Safety & Environmental requirements of Directive UKSI 2016:1107 for products sold on the market in Great Britain (England, Wales and Scotland).

1.3 U.S. export compliance

The policy of Endress+Hauser is strict compliance with U.S. export control laws as detailed in the website of the [Bureau of Industry and Security](#) at the U.S. Department of Commerce.

2 Introduction

Endress+Hauser's OXY5500 Optical oxygen analyzer is a stand-alone device designed to detect oxygen in gases such as natural gas and air. Its design is based on fluorescence quenching technology that creates very stable, internally referenced measured values.

2.1 Associated documents

Enclosed in your analyzer system order is the product safety instruction for your reference. Please review all necessary safety instructions before installing or operating your analyzer. This document is an integral part of the complete document package, which is listed in the following table.

Part Number	Document Type	Description
BA02195C	Operating Instruction	Provides a comprehensive overview of the analyzer and step-by-step installation instructions
BA02196C	Sample Conditioning System (SCS) Operating Instruction	Commission, operation, and maintenance details for the Sample Conditioning System
SD02868C	Service Software Instruction	Instructions for operating the OXY5500 Service software to diagnose and maintain OXY5500 Optical oxygen analyzer systems
TI01656C	Technical Information	Provides technical data on the device with an overview of associated models available
XA02754C	Safety instruction	Safety instructions for the OXY5500 Optical oxygen analyzer

For additional instruction manuals, please refer to the following:

- **For custom orders:** Refer to the Endress+Hauser website (<https://endress.com/contact>) for the list of local sales channels to request order-specific documentation. Order-specific documentation is located by analyzer serial number (SN).
- **For standard orders:** Refer to the Endress+Hauser website product page to download the published manuals for the analyzer: www.endress.com.

2.2 Who should read this manual

This manual should be read and referenced by anyone installing, operating, or having direct contact with the analyzer.

2.3 How to use this manual

Take a moment to familiarize yourself with the content included in this Operating Instruction by reviewing the table of contents.

There are a number of options and accessories available for the OXY5500 analyzers. This manual has been written to address the most common options and accessories. Images, tables, and charts have been included to provide a visual understanding of the analyzer and its functions. Special symbols are also shown to provide the user with key information regarding the system configuration and/or operation. Pay close attention to this information.

2.3.1 Conventions used in this manual

In addition to the symbols and instructional information, this manual is created with "hot links" to enable the user to quickly navigate between different sections within the manual. These links include table, figure, and section references and are identified by a pointing finger cursor when rolling over the text. Simply click on the link to navigate to the associated reference.





2.4 General warnings and cautions

Instructional icons are provided in this manual to alert the user of potential hazards, important information, and valuable tips. Following are the symbols and associated warning and caution types to observe when servicing the analyzer.

2.4.1 Equipment labels

Symbol	Description
<p>WARNING - DO NOT OPEN WHEN AN EXPLOSIVE ATMOSPHERE MAY BE PRESENT.</p> <p>AVERTISSEMENT - NE PAS OUVRIIR SI UNE ATMOSPHERE EXPLOSIVE PEUT ETRE PRESENTE</p>	Follow instructions to avoid possible explosion.
<p>WARNING - POTENTIAL ELECTROSTATIC CHARGING HAZARD – SEE INSTRUCTIONS</p> <p>AVERTISSEMENT - DANGER DE CHARGE ELECTROSTATIQUE POTENTIELS - VOIR LES INSTRUCTIONS</p>	Follow instructions to avoid electrostatic discharge.
<p>WARNING - USE DAMP CLOTH TO CLEAN DISPLAY AND KEYPAD TO AVOID STATIC ELECTRICITY DISCHARGE.</p> <p>AVERTISSEMENT - AUX CHARGES ELECTROSTATIQUES. UTILISER UN CHIFFON HUMIDE POUR NETTOYER L'AFFICHEUR ET LE CLAVIER.</p>	Use appropriate tools to avoid electrostatic discharge.
<p>WARNING - EXPLOSION HAZARD – SUBSTITUTION OF COMPONENTS MAY IMPAIR SUITABILITY FOR CLASS I, DIVISION 2 OR ZONE 2</p> <p>AVERTISSEMENT - RISQUE D'EXPLOSION – LA SUBSTITUION D'E COMPOSANTSP EU TR ENDRE CE MATERIEL INACCEPTABLE POUR LES EMBLACEMENTS DE CLASSE I, DIVISION 2 ou ZONE 2</p>	Substitution of components may void certification.
<p>WARNING - EXPLOSION HAZARD - DO NOT REPLACE _____ UNLESS POWER HAS BEEN SWITCHED OFF OR THE AREA IS KNOWN TO BE NON-HAZARDOUS</p> <p>AVERTISSEMENT - RISQUE D'EXPLOSION - COUPER LE COURANT OU S'ASSURER QUE L'EMPLACEMENT EST DESIGNE NON DANGEREUX AVANT DE REMPLACER LE _____</p>	Switch off power before replacing components to avoid explosion risk.
<p>WARNING - EXPLOSION HAZARD - DO NOT DISCONNECT EQUIPMENT UNLESS POWER HAS BEEN SWITCHED OFF OR THE AREA IS KNOWN TO BE NON-HAZARDOUS</p> <p>AVERTISSEMENT - RISQUE D'EXPLOSION - AVANT DE DECONNECTER L'EQUIPEMENT, COUPER LE COURANT OU S'ASSURER QUE L'EMPLACEMENT EST DESIGNE NON DANGEREUX</p>	Switch off power before disconnecting system to avoid explosion risk.
<p>CAUTION: DO NOT OPERATE MACHINE WITH GROUNDING WIRE DISCONNECTED</p> <p>ATTENTION: NE PAS METTRE L'APPAREIL EN MARCHÉ QUAND LE CON DUCTEUR DE MISE A LA TERRE EST DEBRANCHE.</p>	Ensure grounding wire is connected at all times during operation.

2.4.2 Instructional symbols

Symbol	Description
	General notes and important information concerning the installation and operation of the analyzer.
	Failure to follow all directions may result in fire.
	Failure to follow all directions may result in damage or malfunction of the analyzer.
	Maximum voltage and current specifications for fuses.

2.5 Documents provided with the OXY5500 analyzer

Each OXY5500 analyzer shipped from the factory is packaged with documents and software that are to be used for system operation, as applicable to the system configuration. Typically, each shipment includes the following documents:

- Operating Instruction (electronic copy)
- Sample Conditioning System (SCS) Operating Instruction (electronic copy)
- OXY5500 Service Software Operating Instruction (electronic copy) (and software)
- OXY5500 Safety instruction (paper copy)
- Calibration Certificate (paper copy)

2.6 Manufacturer address

Endress+Hauser
11027 Arrow Route
Rancho Cucamonga, CA 91730
United States
www.endress.com

2.7 About the OXY5500 analyzer

The OXY5500 is a stand-alone precision oxygen analyzer enclosed in an ingress protected stainless steel case. The rugged design and low power consumption makes the OXY5500 ready for an indoor or outdoor application in Class I, Division 2, Groups A, B, C, and D, T3. In addition, the analyzer is also marked as  II 3 G, Ex ec IIC T3 Gc IP66.

The OXY5500 is designed for three types of measurement ranges: 0 to 1000 ppmv, 0 to 5% O₂, and 0 to 20% O₂. This analyzer was specifically designed for gas measurements using a flow through fiber-optic oxygen sensor mounted in a 1/4 in. compression tee. The instrument LCD and data-logger are integrated into the system. The analog outputs are programmable to provide data for oxygen and temperature. The digital interface and PC software (included) are used for internal data storage and external data logging. Complete control, including all calibration and adjustments, can be completed through the PC.

2.7.1 Temperature

Endress+Hauser's optical oxygen sensors must be used with an RTD probe (Pt100 temperature sensor) in the temperature ranges shown in *Appendix A* → . Each instrument is supplied with the RTD probe for compensation and to record temperature variations.

2.7.2 Cross-sensitivity

The sensors can be used in methanol- and ethanol-water mixtures, as well as in pure methanol and ethanol.

Endress+Hauser recommends avoiding other organic solvents, such as acetone, chloroform, or methylene chloride, which may swell the sensor matrix, rendering it unusable.

There are no cross-sensitivity issues with CO₂, H₂S, or SO₂ (ionic species) pertaining to any of the three probe types.

2.8 Getting familiar with the analyzer

The figure shows a sample OXY5500 analyzer. Signal wiring and analyzer power are connected from the right side of the analyzer (facing the unit). On the front panel of the analyzer, the LCD serves as the user interface to the analyzer. The analyzer control electronics drive the sensor, collect the signal, and provide measurement output signals.

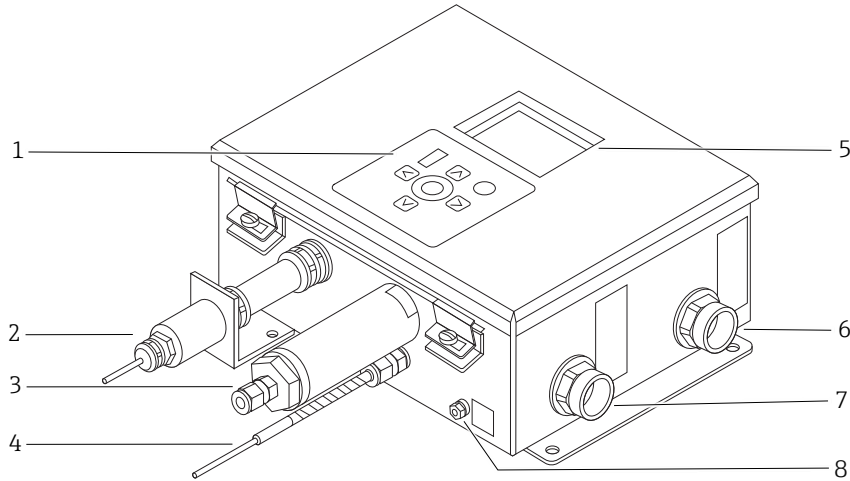

Figure 1. OXY5500 analyzer

A0056242

#	Description
1	Keypad
2	Oxygen Probe
3	Pressure Sensor (Optional)
4	RTD Probe (pt100)
5	Graphic Display
6	Signaling Port
7	Analyzer Power Port
8	Chassis Ground Stud

Inside the cabinet is the electro-optical module that provides power and other connections to the analyzer. Refer to the figure for an internal view of the analyzer.

The optional Sample Conditioning System (SCS) contains flow devices for the bypass loop and to control the flow to the oxygen sensor. A pressure reducing device is also installed to reduce and control the pressure of the sample going to the oxygen sensor. Depending on the application and/or ambient conditions, the SCS may also contain a heater and thermostat to maintain the interior of an optional enclosure at a constant temperature. Refer to the *Sample Conditioning System (SCS) operating instructions* for more information.

2.8.1 Oxygen probe

The oxygen sensor consists of a polymer optical fiber (POF) with a polished distal tip that is coated with a planar oxygen-sensitive foil. The end of the polymer optical fiber is covered with a high-grade steel tube to protect both the sensor material and the POF. Refer to the figure. Typically, the fiber is coated with an optical isolated sensor material in order to exclude ambient light from the fiber sensor spot.

2.8.1.1 Schematic drawing for the oxygen probe

Refer to Figure 5 for a schematic of the trace oxygen probe.

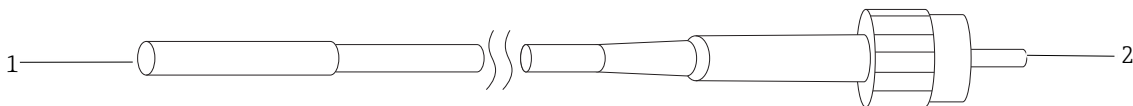

Figure 2. Trace oxygen probe schematic

A0056243

#	Description
1	Sensor spot
2	SMA connector

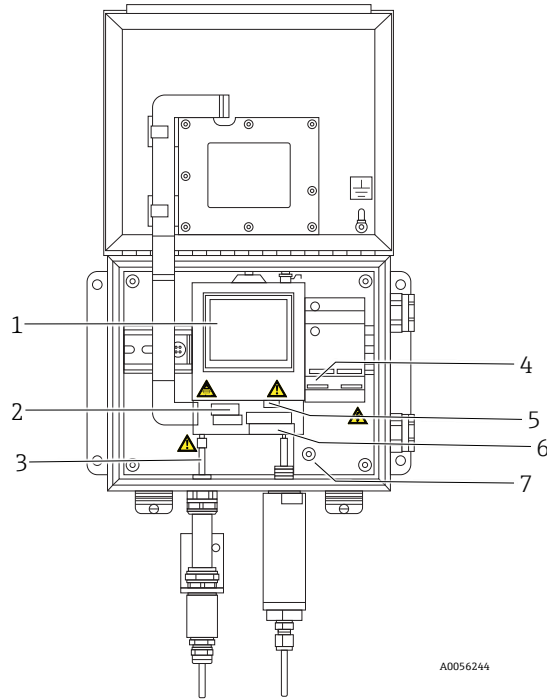

Figure 3. Inside cabinet view (AC version)

#	Description
1	Electro-optical module
2	Fuse enclosure
3	SMA connector
4	AC/DC power connection
5	RJ-45 and USB connectors
6	Relay connections
7	Protective earth ground

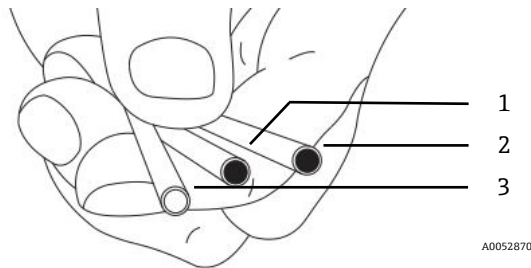

Figure 4. OXY5500 probe sensor spot

#	Description
1	OP-3
2	OP-6
3	OP-9

Endress+Hauser’s fiber-optic oxygen sensors are made with 2 mm polymer optical fibers. The sensing portion is a 4 mm stainless steel probe. As a standard, the probe is mounted in a 1/4 in. Swagelok Union Tee using a 1/4 in. x 4 mm adapter as shown in Figure 5. Please contact your sales representative for more information.

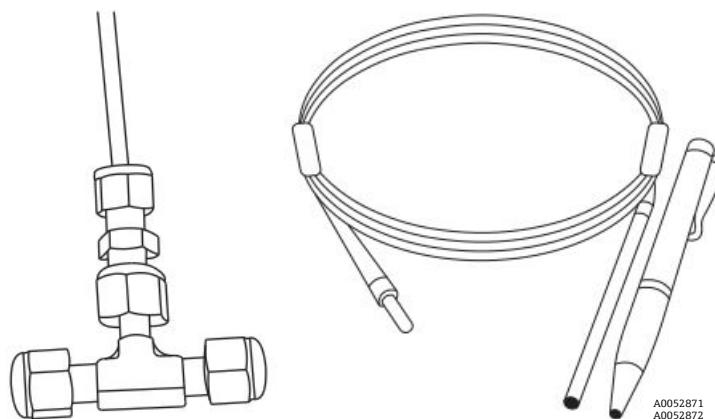

Figure 5. Standard fiber-optic oxygen sensors fittings

2.8.2 How an oxygen sensor works

The principle of measurement is based on the effect of fluorescence quenching by molecular oxygen.

Principle of fluorescence quenching by molecular oxygen (refer to Figure 6):

1. Fluorescence process in absence of oxygen:
 - **Absorption of light:** Excitation energy from the analyzer to the sensor spot.
 - **Excited state:** Sensor spot becomes excited.
 - **Emission of light:** In the absence of oxygen, the sensor spot decays to original energy state. The light emitted during decay is quantified by the analyzer.
2. Fluorescence process in the presence of oxygen:
 - **Absorption of light:** The light from an LED is absorbed by the sensor spot.
 - **Excited state:** Sensor spot becomes excited.
 - **Emission of light:** If the sensor encounters oxygen molecules, the excess energy is transferred to the molecule, decreasing, or “quenching” the fluorescence signal. The degree of quenching correlates to the oxygen partial pressure.

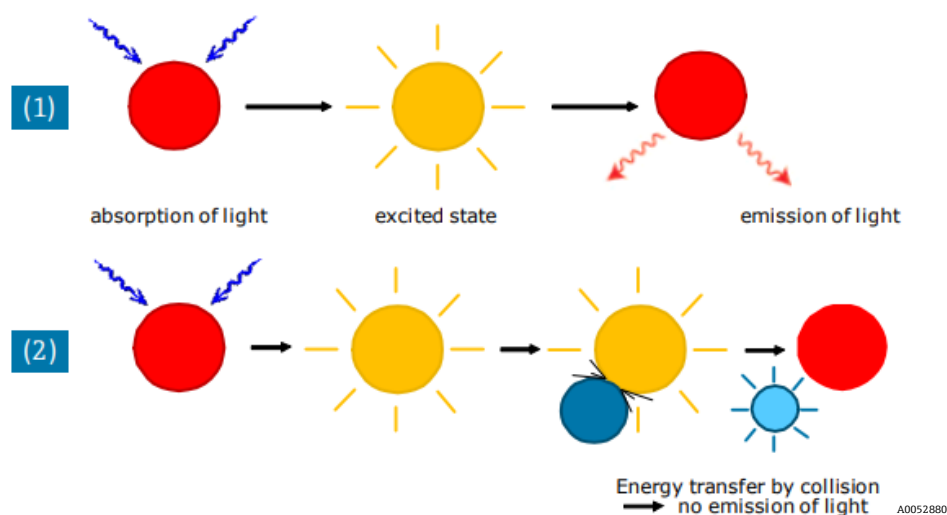



Figure 6. Principle of dynamic quenching of luminescence by molecular oxygen

2.9 Safety guidelines

NOTICE

- ▶ Please read these instructions and the *OXY5500 Safety Manual (XA02754C)* carefully before working with this instrument.

All functions of this device has been carefully tested and comply with safety requirements, prior to leaving the factory. The correct functional and operational safety of this instrument can only be ensured if the user observes the necessary safety precautions and specific guidelines presented in this manual. Refer to *Appendix A* →  and the list outlined below.

- Before connecting the device to the electrical supply network, ensure that the operating voltage stated on the power supply corresponds to the main voltage input as described in Appendix A.
- If the instrument is moved from cold to warm surroundings, condensation may form and interfere with the functioning of the system. In this event, wait until the instrument temperature reaches room temperature before putting the analyzer back into operation.
- Calibration, maintenance, and repair work must only be completed by qualified trained personnel.
- If there is any doubt as to the working condition of the analyzer, return the instrument for repair, and maintenance. Consult with *Service* → .

3 Safety

3.1 Potential risks affecting personnel

This section addresses the appropriate actions to undertake when faced with hazardous situations before or during service of the analyzer. It is not possible to list all potential hazards within this document. The user is responsible for identifying and mitigating any potential hazards present when servicing the analyzer.

NOTICE

- ▶ Technicians are expected to follow all safety protocols established by the customer that are necessary for servicing the analyzer. These may include, but are not limited to, lockout/tag-out procedures, toxic gas monitoring protocols, personal protective equipment (PPE) requirements, hot work permits, and other precautions that address safety concerns related to performing service on process equipment located in hazardous areas.

3.1.1 Mitigating risks

Refer to the instructions for each situation listed below to mitigate associated risks.

3.1.2 Electrocuting hazard

1. Shut off power at the main disconnect external to the analyzer and open the enclosure.

⚠ CAUTION

- ▶ Complete this action before performing any service that requires working near the main input power or disconnecting any wiring or other electrical components.
2. Open enclosure door.

3.1.3 Explosion hazard

Any work in a hazardous area must be carefully controlled to avoid creating any possible ignition sources (e.g., heat, arcing, sparking, etc.). All tools must be appropriate for the area and hazards present. Electrical connections must not be made or broken with power on (to avoid arcing).

3.1.4 Electrostatic discharge

Use a damp cloth to clean the display and keypad to avoid static electricity discharge.

Adhere to all warning labels to prevent damage to the unit. Refer to *General warnings and cautions* → .

4 Installation

This section describes the processes used to install and setup your OXY5500 analyzer. Once the analyzer arrives, fully examine the contents before installing the unit.

NOTICE

- ▶ Endress+Hauser Class I Division 2 analyzers use a non-incendive protection method and Zone 2 uses an increased safety ec protection method; as such, all portions of the local electrical installation codes apply. The maximum allowed inductance to resistance ratio (L/R ratio) for the field wiring interface must be less than 25 $\mu\text{H}/\Omega$.
- ▶ The safety of the analyzer is the responsibility of the installer and the organization he/she represents.

4.1 Shipping box contents

The contents of the crates should include:

- The Endress+Hauser OXY5500 analyzer
- Optional Sample Conditioning System (SCS), if applicable
- A USB flash drive or CD, which includes this manual and other system manuals, calibration certificate, and software. Refer to Documents Provided with the *OXY5500 Analyzer* → .
- One USB cable (for Service purposes)

If any of these contents are missing, refer to *Service* → .

4.2 Inspecting the analyzer

Unpack and place the unit on a flat surface. Carefully inspect all enclosures for dents, dings, or general damage. Inspect the supply and return connections for damage, such as bent tubing. Report any damage to the carrier.

CAUTION

- ▶ Avoid jolting the instrument by dropping it or banging it against a hard surface.

Each analyzer is custom configured with various accessories and options. If there is any discrepancy with your order, please contact your local sales channel.

4.2.1 Lifting/carrying the analyzer

At approximately 5.44 Kg (12 lbs) without the sample conditioning system, the OXY5500 can easily be lifted from the packaging and moved to the installation location. Take care to lift or carry the analyzer by the enclosure and not by any ancillary probes or cables or damage may occur.

If the analyzer is configured with an optional integrated sample conditioning system (SCS), two individuals may be required to lift and move the analyzer system. Refer to the OXY5500 SCS Operating Instructions (P/N BA02196C) for more information.

4.3 Installing the analyzer

Installing the analyzer is relatively easy requiring only a few steps that, when carefully followed, will ensure proper mounting and connection. This section includes information regarding:

- Hardware and Tools for Installation
- Analyzer Mounting
- Connecting Electrical Power to the Analyzer
- Analog Outputs/Analog Input Connections

4.4 Required basic equipment

The following components are shipped with the OXY5500 analyzer from the factory for installation and operation:

- Flow-through Tee fitting with probe
- Flow-through Tee fitting for temperature probe and pressure sensor (pressure sensor is optional)

4.5 Hardware and tools for installation

Depending on the particular configuration of accessories and options ordered, you may need the following hardware and tools to complete the installation process.

4.5.1 Hardware

- 1/4 in. (~6 mm) thickness Unistrut® (or equivalent) bolts and spring nuts
- Stainless steel tubing (using 1/4 in. [~6 mm] O.D. x 0.035 in. wall thickness, seamless stainless steel tubing is recommended)
- 3/4 in. conduit or appropriate Ex e M20 cable gland
- 1/4 in. (M6) screws with an appropriate screw length for wall material, e.g., concrete, drywall, etc.

4.5.2 Tools

- Drill and bits
- Tape measure
- Level
- Pencil
- Screw driver (Philips)
- Screw driver, small (Flat-head)
- Needle-nose pliers

4.6 Analyzer mounting

The OXY5500 analyzer is manufactured for wall or Unistrut® (or equivalent) metal framing installations. Depending on your application and configuration, the analyzer will come mounted on a plate or Unistrut frame. Refer to Appendix A for drawings with detailed wall mounting dimensions.

NOTICE

- ▶ When mounting the analyzer, be sure not to position the instrument so that it is difficult to operate adjacent devices. Allow 1 m (3 feet) of room in front of the analyzer and any switches.

CAUTION

- ▶ It is critical to mount the analyzer so that the supply and return lines reach the supply and return connections on the chassis while still maintaining flexibility so that the sample lines are not under excessive stress.

NOTICE

- ▶ Mounting brackets for equipment exceeding 18 kg intended for wall mounting and/or part(s) that support heavy loads must withstand four times the maximum static load.

CAUTION

- ▶ Because the breaker in the power distribution panel or switch will be the primary means of disconnecting the power from the analyzer, the power distribution panel should be located in close proximity to the equipment and within easy reach of the operator, or within 3 meters (10 feet) of the analyzer.

4.6.1 Mounting the analyzer

1. Select a suitable location to mount the analyzer. Choose a shaded area or use an optional analyzer hood (or equivalent) to minimize sun exposure.

CAUTION

- ▶ Endress+Hauser analyzers are designed for operation within the specified ambient temperature range. Refer to Appendix A. Direct sun exposure in some areas may cause the analyzer temperature to exceed the maximum range.
2. Locate the mounting holes on your unit. Refer to Figure 7 and the system drawings in *Appendix A* → .

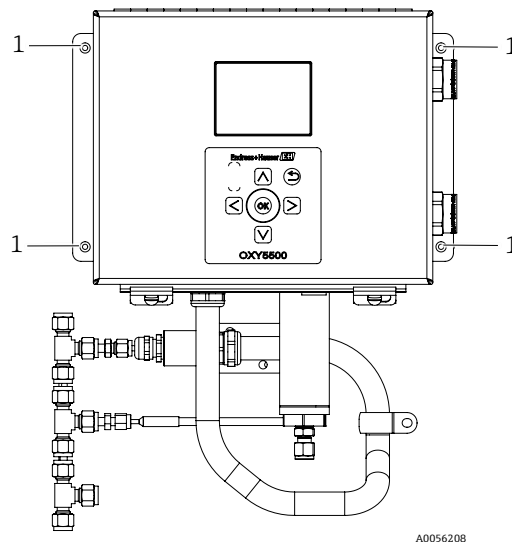

Figure 7. Analyzer mounting hole locations (1)

3. For wall installations, mark the centers of the top mounting holes.
4. Drill the appropriate size holes for the screws you are using.
5. Hold the analyzer in place and fasten with the top screws.
6. Repeat for the bottom mounting holes.

Once all four screws are tightened, the analyzer will be very secure and ready for the electrical connections.

4.7 Connecting electrical power to the analyzer

The OXY5500 is able to interface with either AC or DC power connections.

NOTICE

- ▶ The OXY5500 is available in power options of either 240 VAC or 9 to 30 VDC (CSA), or 18 to 30 VDC (IEC/ATEX/UKEX). The OXY5500 can be powered by an DC source via connection directly to the terminal of the DC/DC converter terminals. The AC powered is wired directly to the power supply mounted to the back plate.

CAUTION

- ▶ Interconnection of the analyzer enclosure must be accomplished using wiring methods approved for Class I, Division 2 or Zone 2 hazardous locations as per the Canadian Electrical Code (CEC) Appendix B or J and the National Electric Code (NEC) Article 501 or 505. The installer is responsible for complying with all local installation codes.

4.7.1 AC connection

AC power is connected to the AC Power Supply at L1, N, and GND. Refer to the figures for the Analyzer Power Port location and the wiring connection diagram.

4.7.2 DC connection

DC power is connected to the DC Power Supply at VI+ and -. Refer to Figure 1 for the Analyzer Power Port location and Figure 73 for the wiring connection diagram.

WARNING

- ▶ Hazardous voltage and risk of electric shock. Before attaching the wiring to the analyzer, make sure the main breaker/power switch is off.

CAUTION

- ▶ Careful consideration should be taken when grounding. Properly ground the unit by connecting the main ground lead to the protecting grounding stud labeled with the ground symbol. Connect the chassis ground stud to plant grounding using 6mm² or 10-gauge wire.
- ▶ Do not exceed the 36 VDC power rating or electronics will be damaged.

4.7.3 Protective chassis and ground connections

Before connecting any electrical signal or power, the protective and chassis grounds must be connected. Requirements for the protective and chassis grounds are as follows:

- The protective and chassis grounds must be of equal or greater size than any other current-carrying conductors, including the heater located in the sample conditioning system.
- The protective and chassis grounds must remain connected until all other wiring is removed.
- If the protective and chassis ground is insulated, it must use the green/yellow color.

Refer to Figure 1 and Figure 2 for the protective and chassis ground locations.

4.7.4 Connecting electrical power to the analyzer

1. Open the OXY5500 analyzer electronics enclosure door. Take care not to disturb the electrical assembly inside.

⚠ WARNING

- ▶ Hazardous voltage and risk of electric shock. Failure to properly ground the analyzer may create a high-voltage shock hazard.
2. Run conduit or armored braided cable from the power distribution panel to the conduit hub on the right side of the analyzer enclosure labeled for power input.

⚠ CAUTION

- ▶ Conduit seals or Ex e cable gland should be used where appropriate in compliance with local regulations.
 - ▶ Because the breaker in the power distribution panel or switch will be the primary means of disconnecting the power from the analyzer, the power distribution panel should be located in close proximity to the equipment and within easy reach of the operator, or within 3 meters (10 feet) of the analyzer.
 - ▶ The electrical installation to which the analyzer is connected must be protected against transients. The protective device has to be set at a level not exceeding 140% of the peak rated voltage values at the power supply terminals.
 - ▶ An approved switch or circuit breaker rated for 15 amps should be used and clearly marked as the disconnecting device for the analyzer.
3. For AC systems, pull ground, neutral (N), and L1 wires into the electronics enclosure. Refer to Figure 8. For DC systems, pull VI +, - and ground wires into the electronics enclosure. Refer to Figure 8.

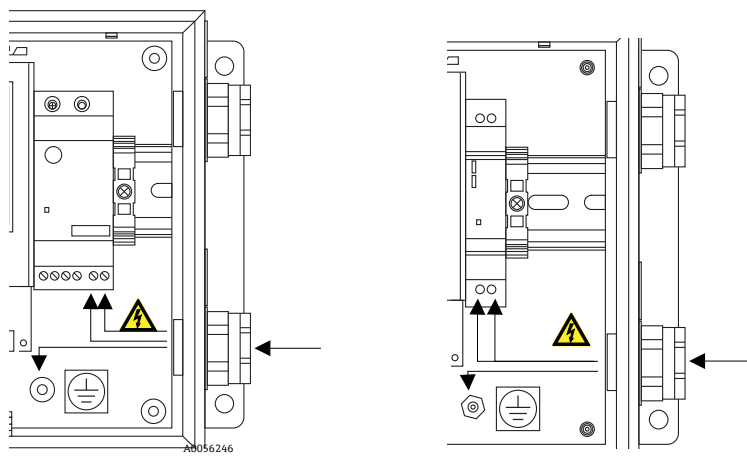

Figure 8. AC/DC power connections

4. Strip back the jacket and/or insulation of the wires just enough to connect to the power terminal block.
5. Connect the main ground wire to the protection ground terminal marked Ⓧ.
6. Close and tighten the analyzer enclosure door.

NOTICE

- ▶ Apply 2.25 nm (20 in-lbs) of torque on each bolt to ensure the door is closed properly to maintain required ingress protection.

4.8 Analyzer connections

The fiber optic oxygen cable to the SMA connector, located at the bottom of the OXY5500, will be installed at the factory. Additional connectors are available as shown in Figure 9.

NOTICE

- ▶ **RS-232/RS-485 Interface:** The unit has standard RS-232 communication via Modbus protocol. Use care in making connections as described in Modbus Communication →  to avoid communication problems and potential damage to the unit.
- ▶ **Optical Module with SMA Connector:** The optical module with SMA connector is used to connect to the oxygen probe, which is installed at the factory.
- ▶ **USB Connection:** The USB connection is for service and troubleshooting purposes only. Do not connect during normal operation. To avoid damage to the port, use only the USB Mini B cable to connect to the unit. Refer to the Service Software Operations Manual (P/N 4900002254) for system requirements.
- ▶ **Ethernet:** The unit uses standard Modbus - TCP/IP communication. Use a CAT5 (or better) cable and make connections per IEEE 802.3 standard.

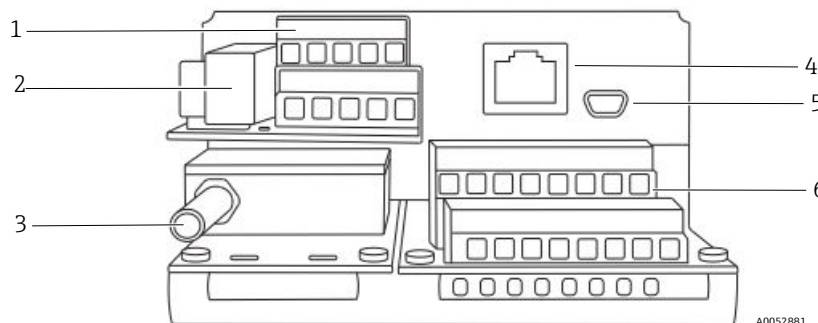

Figure 9. Analyzer connections

#	Description
1	TB1
2	Fuse Box
3	Optical module with SMA Connector
4	RJ-45
5	USB
6	TB2

4.9 Analog outputs/analog input connections

The OXY5500 is equipped with two independent analog outputs and one analog input. The 4-20 mA current loop and serial output are connected terminal blocks located inside the analyzer electronics enclosure. By default, the 4-20mA current loop analog outputs (IOUT1/IOUT2) are set to inactive.

The analog outputs are programmable to oxygen and temperature. To allow external data collection, one input port is available (i.e., external pressure sensor).

Connections can be made with customer-supplied cables for the current loop and alarms. Refer to Figure 10.

WARNING

- ▶ Hazardous voltage and risk of electric shock. The analog outputs are not protected against any input voltage. Any voltage applied to the analog outputs can cause irreversible damage to the circuit.
- ▶ Hazardous voltage and risk of electric shock. Turn off and lock out system power before opening the electronics enclosure and making any connections.

CAUTION

- ▶ Endress+Hauser Class I Division 2 analyzers use a non-incendive protection method and Zone 2 uses an increased safety ec non-arcing protection method; as such, all portions of the local electrical installation codes

apply. The maximum allowed inductance to resistance ratio (L/R ratio) for the field wiring interface must be less than 25 $\mu\text{H}/\Omega$.

NOTICE

- ▶ The 4-20 mA outputs are configured as sourcing to provide power to the loop. If a PLC/HMI is used to provide power to the loop, an isolator is necessary and must comply with the specifications provided in the table. Installation of the isolator must comply with the non-incendive or non-arcing protection method detailed in the note above.
- ▶ Certified Ex e glands and cables, or conduit seal and conduit, should be used where appropriate in compliance with local regulations.

4.9.1 Connecting the analog outputs/analog inputs

1. Disconnect power from the analyzer and open the electronics enclosure cover. Take care not to disturb the electrical assembly inside.
2. Run conduit or rated armor cable with the appropriate cable glands (minimum Exe rated) from the analog outputs/inputs receiving station to the conduit hub in the right outside corner of the electronics enclosure.
3. If using conduit, pull the customer-supplied cables for the source outputs through the conduit into the electronics enclosure.

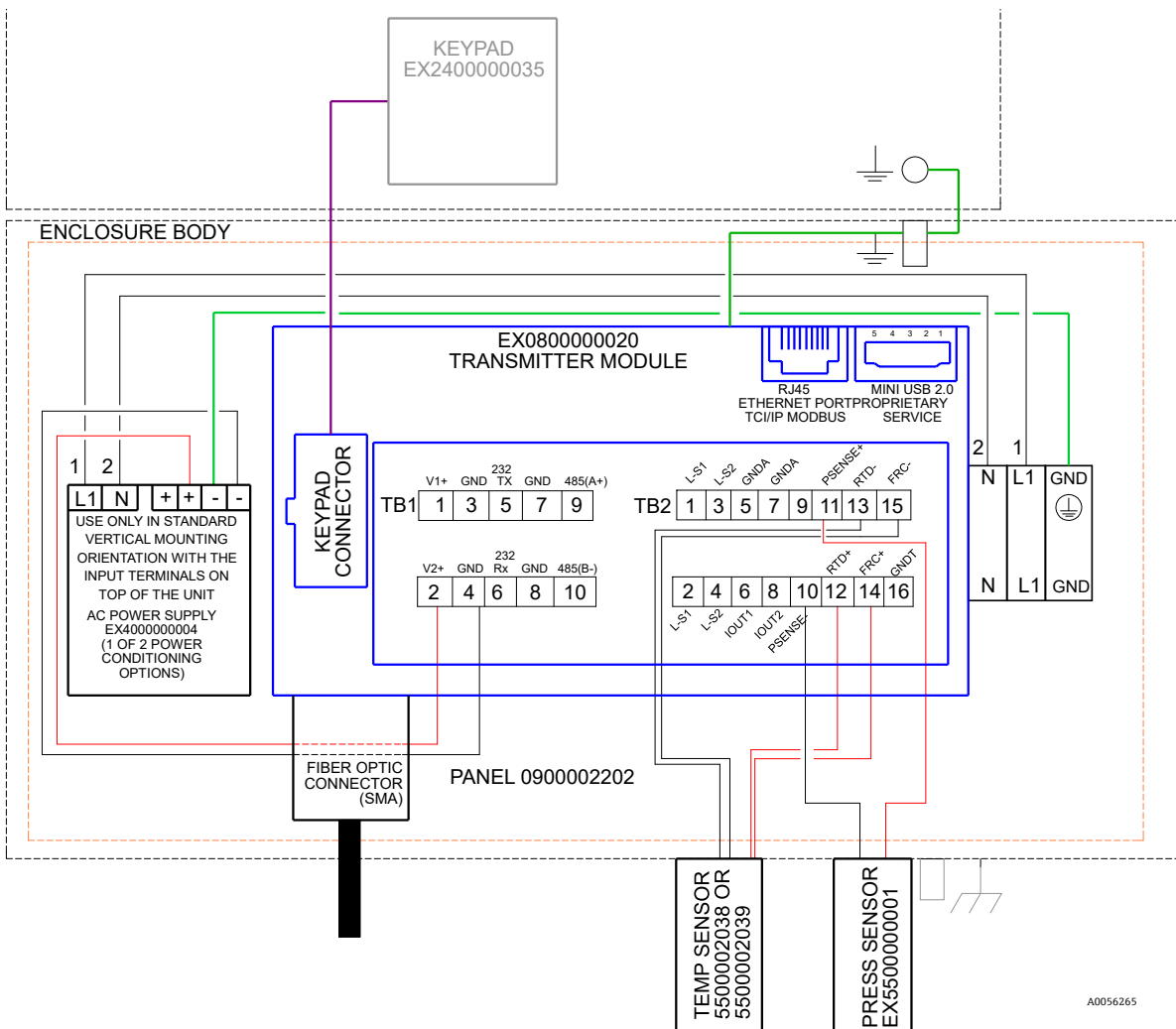

Figure 10. TB1/TB2 connections

If using rated armor cable, wires are already provided. Skip to step 4.

4. Strip back the jacket and insulation of the current loop output and serial cables just enough to connect to the mating terminal block.

5. Connect the 4-20 mA current loop IOUT1/IOUT2 output wires to terminals 6 and 8, as shown in Figure 9 and the table.
6. Connect the serial cable wires to the appropriate terminals according to the table (TB1).
7. To complete the connection, connect the other end of the current loop wires to a current loop receiver and the external serial cable to a serial port on your computer.

Pin	Label	Description	Function
1	L-S1	Relay output, switch #1 (400V/250mA; R = max 8 Ohm)	General Fault Alarm; normally closed
2	L-S1	Relay output, switch #1 (400V/250mA; R = max 8 Ohm)	
3	L-S2	Relay output, switch #2 (400V/250mA; R = max 8 Ohm)	Concentration Alarm; normally closed
4	L-S2	Relay output, switch #2 (400V/250mA; R = max 8 Ohm)	
5	GND A	Analog output #1 ground	Configurable analog output #1
6	IOUT1	Analog output #1 (4 – 20 mA); max load = 800 Ohm	
7	GND A	Analog output #2 ground	Configurable analog output #2
8	IOUT2	Analog output #2 (4 – 20 mA); max load = 800 Ohm	
9	NC	Not connected	–
10	Psense-	Analog input (4 – 20 mA); Sense (-)	Pressure sensor input
11	Psense+	Analog Input (4 – 20 mA); Sense (+) loop-power 16 to 24 VDC; max current = 32 mA	
12	RTD +	4-wire RTD Pt100; Sense (+)	Temperature probe
13	RTD -	4-wire RTD Pt100; Sense (-)	
14	FRC+	4-wire RTD Pt100; Force (+)	
15	FRC-	4-wire RTD Pt100; Force (-)	
16	GND T	RTD ground (Shield)	

Table 1. Terminal block TB2

¹ The 4-20 mA outputs are configured as sourcing to provide power to the loop. If a PLC/HMI is used to provide power to the loop, an isolator will be required.

Pin	Label	Description	Function
1	V1+	Power supply 24 VDC - Factory connection	DC power input
2	V2+	Power supply 24 VDC - Factory connection	DC power input
3	GND	Power supply GND - Factory connection	Power ground
4	GND	Power supply GND - Factory connection	Power ground
5	232TX	RS-232 transmitter output (typical signal level ± 6 V)	RS-232 signal transmit
6	232Rx	RS-232 receiver input (typical signal level ± 6 V)	RS-232 signal receive
7	GND	RS-232/RS-485 ground	RS-232/RS-485 signal ground
8	GND	RS-232/RS-485 ground	RS-232/RS-485 signal ground
9	485(A)+	RS-485 non-inverting receiver input and non-inverting driver	RS-485 signal
10	485(B)-	RS-485 inverting receiver input and inverting driver output	RS-485 signal

Table 2. Terminal block TB1

5 Operation

The instructions provided in this chapter should be used to start up, configure, and operate the OXY5500. On the face of the analyzer is an LCD with programming and data readouts. Refer to Figure 1 for an external view of the analyzer with descriptions.

5.1 Starting up the analyzer

Before powering up the OXY5500, refer to the system drawings in *Appendix A* →  to confirm the proper power connections to the power supply, temperature sensor, and oxygen sensor.

As soon as the OXY5500 is connected to the power supply, the analyzer begins running a short self-test sequence. Refer to the figure.

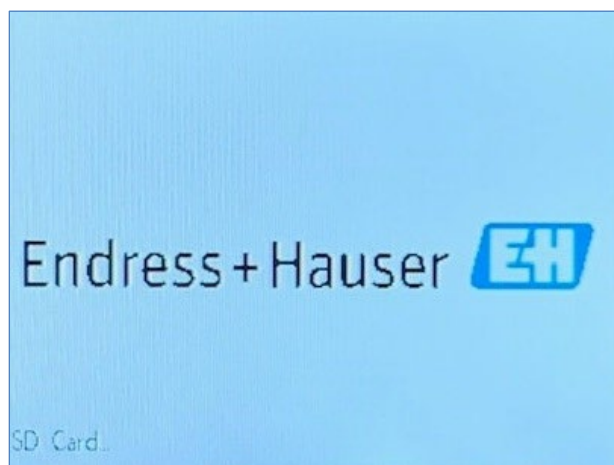

Figure 11. Initial screen - Self-check

A0052882

The display switches to the main measurement screen automatically. Refer to the figure.

To achieve a highest accuracy, the OXY5500 should be warmed up for approximately five minutes before taking a measurement.

NOTICE

- ▶ Warm-up time may be extended up to 15 minutes if the optode has been exposed to high concentrations of oxygen.

After the warm-up, complete a field calibration to achieve accurate measurements. Refer to *Performing a manual calibration (calibration using sensor values)* → .

5.2 Operation overview

The screens and menus described in this chapter are used to program and operate the OXY5500. Links have been included to assist in navigating through the instructions. Refer to *Conventions used in this manual* → , which explains hot links and how to use them. Other conventions used in this chapter to describe user actions and to assist in software or manual navigation include:

- Underlined text: Used to show clickable program buttons in the software.
- ALL CAPITAL LETTERS: Used to indicate screens or windows viewed throughout the software program.
- *Italic text*: Used to indicate software fields that can be edited.
- **Bold text**: Used to indicate links to other sections or chapters in the manual.

After the analyzer has been initialized, the MAIN MENU screen displays. Refer to Figure 12.

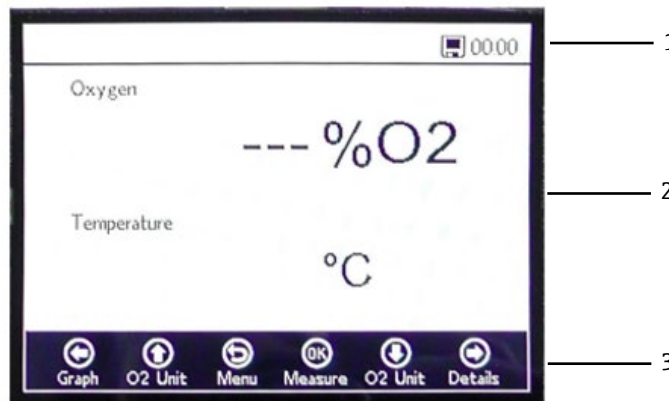

Figure 12. Main menu screen

A0052883

#	Description
1	Status bar
2	Main screen
3	Navigation bar

NOTICE

- ▶ The OXY5500 display is divided into three sections: status bar, main screen, and navigation bar.

The status bar shows:

- **Time:** The OXY5500 has a 24-hour clock setting.

The OXY5500 must be calibrated before use. Refer to *Performing a two-point calibration* →

NOTICE

- ▶ If the power to the analyzer is disabled, the Time and Date will be set to 0 on start-up. A warning message will display in the Status bar as shown in Figure 13.

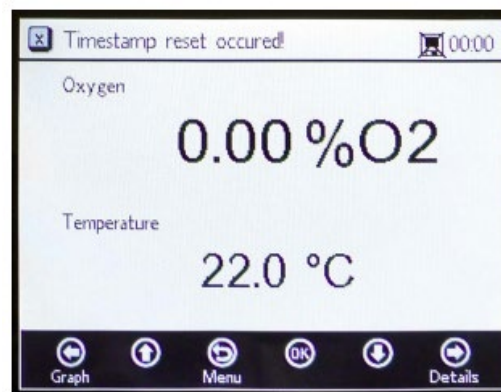

Figure 13. Warning: Timestamp reset

A0052884

Reset the Time and Date settings as shown in the *Device Settings Menu* → before starting a new measurement so that the correct time is stored in the data.

- The **Monitor** symbol in the Status bar indicates that logging is activated.
- The **Monitor (X)** symbol in the Status bar indicates that logging is not activated.

The Main screen consists of the central area of the display above the Navigation Bar and provides information about the analyzer.

The Navigation Bar is across the lower section of the display and shows the **Control** buttons used to perform actions in the analyzer.

- Click **Menu** to access the MAIN MENU screen.

Refer to Figure 14 for a view of the MENU MAP that outlines the OXY5500 software structure. This section gin with a review of the top level menu screens (shown in grey boxes in the Menu Map) and then continue with an overview of the accessible screens available from each menu screen.

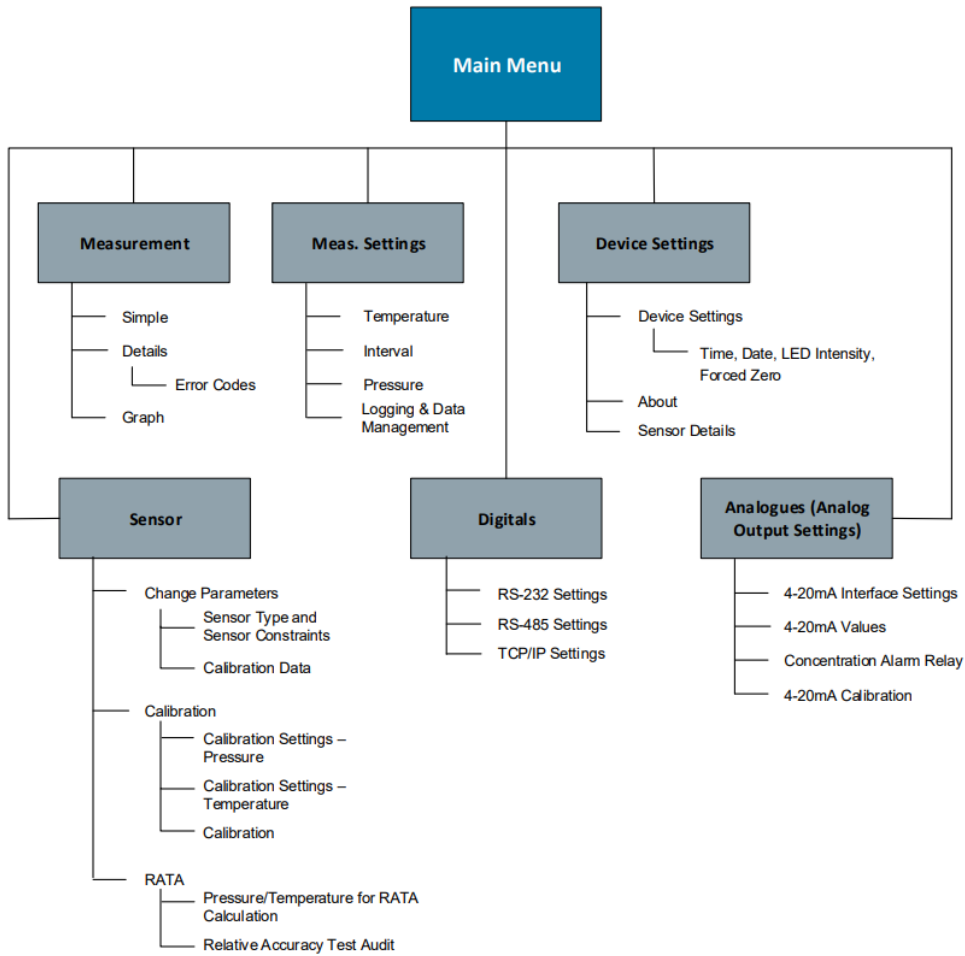

Figure 14. OXY5500 software menu map

5.3 Measurement menu

Selecting Measurement from the MAIN MENU screen displays the currently measured values and measurement settings. Refer to Figure 15.

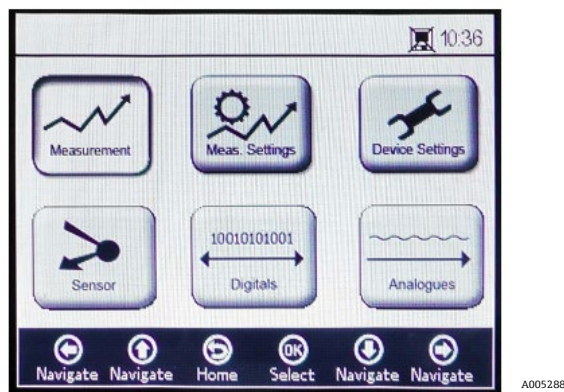



Figure 15. Main menu screen - Measurement selected

Views can be selected for simple, detailed, or graphical presentations of the measurements. Use the buttons to switch between screens. Refer to *Measurement Menu Options* → for more information on accessing screen views from this menu selection.

CAUTION

- ▶ If power to the analyzer is disabled, Time, and Date settings will be set to zero. Before starting a new measurement, reset the Time and Date in *Device settings screen* → , so that the correct measurement time is stored with the data.

5.4 Measurement settings (Meas. settings) menu

General measurement setting changes are performed in the MEASUREMENT SETTINGS menu. If the measurement settings are not changed, the settings from the last measurement will be applied.

The Measurement Settings (Meas. Settings) window is selected from the MAIN MENU screen. Refer to the figure.

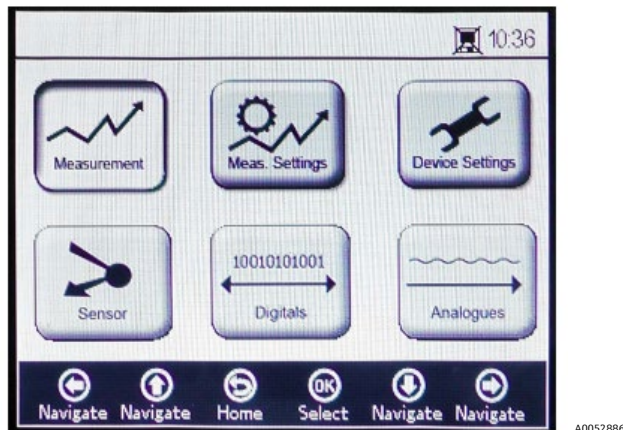

Figure 16. Main menu screen - Measurement settings selected

1. Select Meas. Settings from the MAIN MENU screen. A message window displays requiring confirmation to abort the currently running measurement. Refer to Figure 17.

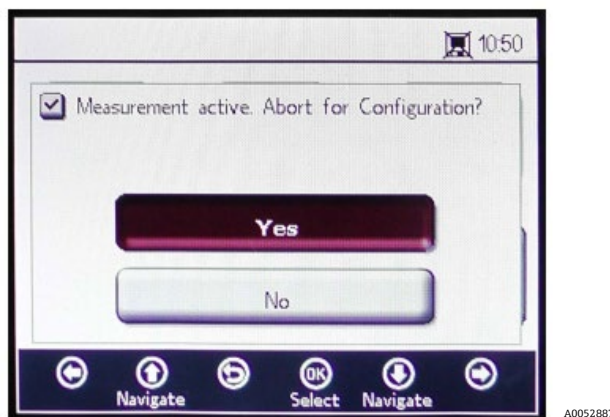
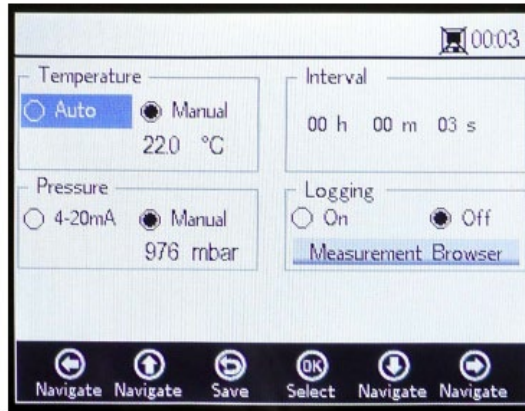

Figure 17. Message window - Stop measurements during configuration

2. Click **Yes** to stop the measurement in order to display the MEASUREMENT SETTINGS screen. Refer to Figure 18.



A0052888

Figure 18. Measurement settings screen

3. Use the **Arrow** buttons to navigate between screens.

5.4.1 To enter editing mode

1. Click **OK** to enter editing mode.
2. Change the setting or value (one digit at a time) by clicking the **Arrow** buttons.
3. Click **OK** again to save the changes.

5.4.2 To exit editing mode

1. Click **Menu** to cancel and exit.

Refer to *Measurement Settings (Meas. Settings) Menu Options* → for more information on setting temperature compensation, pressure compensation, interval or logging, and data management.

5.5 Device settings menu

Select Device Settings from the MAIN MENU screen to display the analyzer settings. Refer to Figure 19.

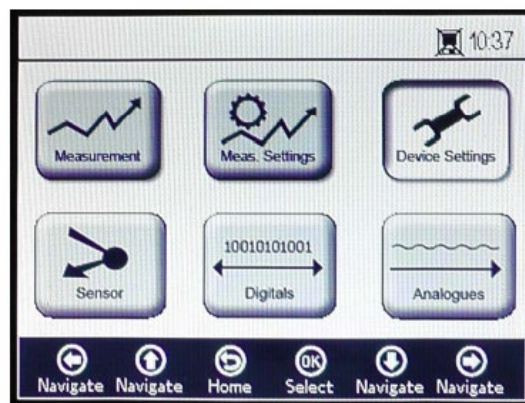

A0052889

Figure 19. Main menu screen - Device settings selected

The DEVICE SETTINGS menu is divided into three screens: DEVICE SETTINGS, SENSOR DETAILS, and ABOUT. Refer to *Device Settings Menu Options* → for more information on setting these options.

Use the **Arrow** buttons to switch between screens.

5.6 Sensor menu

Select Sensor from the MAIN MENU. Refer to Figure 20. This selection opens the SENSOR OPTIONS window.



Figure 20. Main Menu - Sensor selected

In the SENSOR OPTIONS window, the user can click the **Change Parameters** button for the connected sensor, the **Calibration** button to perform a sensor calibration, or the **Relative Accuracy Test Audit (RATA)** button. Refer to Figure 21.

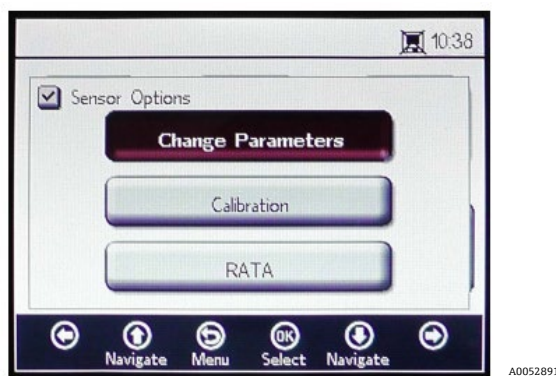

Figure 21. Sensor options

- **Up and Down Arrows:** Navigate up and down in the sensor list.
- **OK:** Select the sensor options. The display will switch to respective screens.
- **Menu Arrow:** Return to the MAIN MENU screen.

Refer to *Change parameters* → and *Calibrating the analyzer on* → for more information about these functions.

5.7 Digitals menu

From the MAIN MENU, select Digitals to change the digital connection setting of the OXY5500. Refer to Figure 22.

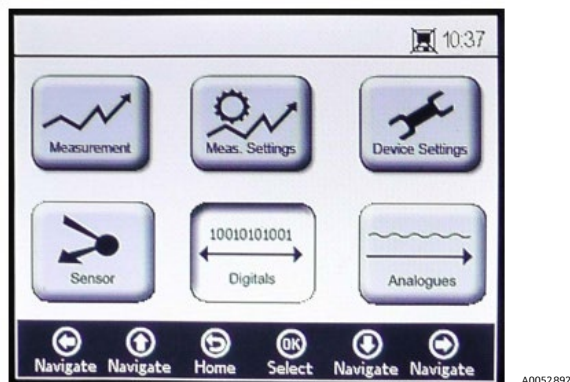

Figure 22. Main menu screen - Digitals selected

Before displaying the DIGITALS screen, a message window displays requesting confirmation to abort the currently running operation. Refer to Figure 23.

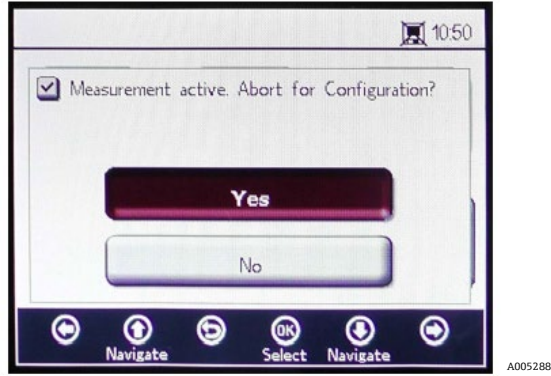

Figure 23. Message window - Stop measurements during configuration

Select **Yes** and stop the measurement to proceed with the Digitals settings.

The DIGITALS menu is divided into three screens: RS-232, RS-485, and TCP/IP settings. Refer to *Digitals Menu Options* → for more information for setting these options.

Use the **Up** and **Down Arrow** buttons to navigate between input fields.

5.7.1 To enter editing mode

1. Click **OK** to enter editing mode.
2. Change the setting or value (one digit at a time) using the **Up** and **Down Arrow** buttons.
3. Click **OK** again to save editing changes.

5.7.2 To exit the editing mode

1. Click **Menu** to cancel and exit.

5.8 Analog output settings (Analogues) menu

From the MAIN MENU, select Analogues to change the analog output settings. Refer to Figure 24.



Figure 24. Main menu screen - Analogues selected

Before displaying the ANALOGUES screen, a message window displays requesting confirmation to abort the currently running operation. Refer to Figure 25.

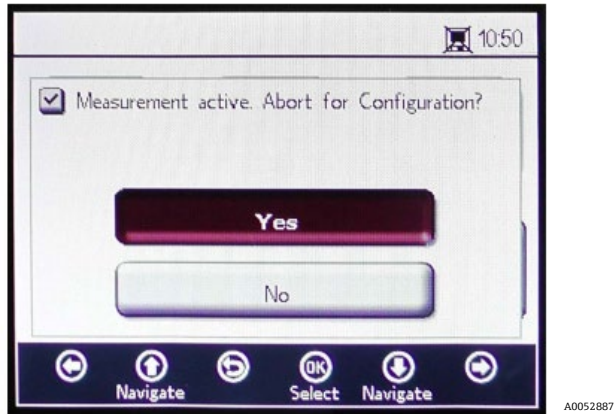

Figure 25. Message window - Stop measurements during configuration

Select **Yes** and stop the measurement to proceed with the Analog Output settings.

The ANALOGUES menu is divided into four screens: 4-20mA INTERFACE SETTINGS, 4-20mA VALUES, CONCENTRATION ALARM RELAY (LS2), and 4-20mA CALIBRATION. Refer to *Analog Output Settings (Analogues) Menu Options* →

Use the **Up** and **Down Arrow** buttons to navigate between input fields.

5.8.1 To enter editing mode

1. Click **OK** to enter editing mode.
2. Change the setting or value (one digit at a time) using the **Up** and **Down Arrow** buttons.
3. Click **OK** again to save editing changes.

5.8.2 To exit editing mode

1. Click **Menu** to cancel and exit editing mode.

CAUTION

- ▶ All changes will be applied after the next measurement period.

5.9 Measurement menu options

Selecting Measurement from the MAIN MENU will open the SIMPLE screen. The DETAILS or GRAPH screens can be selected from the SIMPLE screen.

5.9.1 Simple screen

This screen displays the oxygen and temperature values from the moment the measurement was started. Refer to Figure 26.



Figure 26. Simple measurement screen

If the measurement temperature was set manually, the temperature value is already shown before starting the measurement.

NOTICE

- ▶ In manual mode, the temperature unit can be changed. Values ranging from -99 °C to 199 °C can be input into the MEAS. SETTINGS window. Refer to *Temperature compensation* → .

If automatic temperature measurement is selected and the temperature sensor is not connected or not working properly, the display will show an error message. Refer to Figure 27.



Figure 27. Temperature sensor error message

If no sensor is connected or is not connected properly, and the signal cannot be read when measurements are started, an error message will be displayed in the status bar as shown in Figure 28.

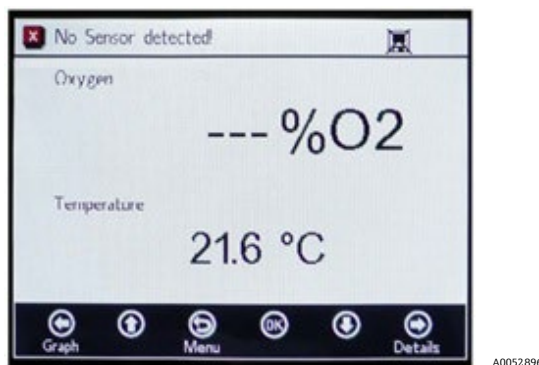



Figure 28. Error message - Sensor cannot be detected

The oxygen values are displayed in the following units:

- For OP-3 sensor: %O2
- For OP-6 sensor: %O2, ppmv
- For OP-9 sensor: ppmv

1. Click the **Up** and **Down Arrow** buttons to change the oxygen unit on the display. The last measurement value shown in the respective oxygen unit immediately. Choose one of the following options:
 - Click the **Right Arrow** to display the detailed measurement screen. Refer to *Details screen* → .
 - Click the **Left Arrow** to display the measurement graph. Refer to *Graph screen* → .
2. Click **Menu** to return to the MAIN MENU screen.

5.9.2 Details screen

The DETAILS screen gives additional information about measurement and measurement settings. Refer to Figure 29.

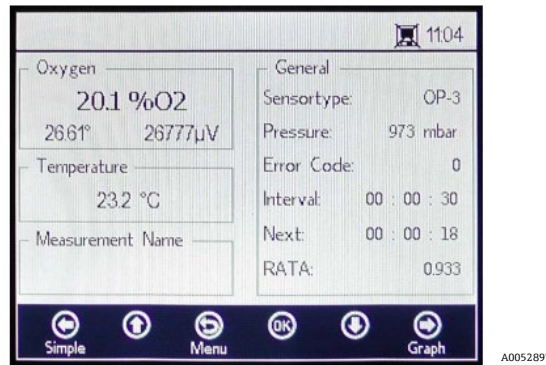



Figure 29. Details measurement screen



This screen is sectioned into boxes containing information on Oxygen, Temperature, Measurement Name, and General.

- **Oxygen:** This box displays the last measured value in the selected oxygen unit. It also shows the phase angle and amplitude values. Change the oxygen unit by clicking the button.
- **Temperature:** In this box, the current, last measured or manually set temperature value is displayed in the selected temperature unit.

NOTICE

- ▶ The temperature unit can be changed in Manual mode. Values ranging from -99 °C to 199 °C can be input into the MEAS. SETTINGS window. Refer to *Temperature compensation* → .
- **Measurement Name:** This box displays the selected measurement file in which all data is stored when logging is turned on.

NOTICE

- ▶ The measurement file can be changed in the MEAS. SETTINGS menu. Refer to *Logging and data management* → .
- **General:** Here the Sensor type of the currently connected oxygen sensor is displayed.
 - The currently measured or manually set Pressure value is also displayed in the General box. For automatic measurement, the display will show the interpreted pressure value from the 4-20mA input. If no pressure sensor is connected, the display will read 1013 mbar.
 - In the lower right of the General box, the time Interval at which the measurements are taken is displayed.
 - Next provides the time period (the countdown during a running measurement) until the next measurement.
 - The RATA is displayed at the bottom of the screen.
 - Error Codes are also displayed under the General box. Error codes are also logged together with measurement data. During error-free measurements, a 0 value will display.
- Click the **Left Arrow** to return to Simple view.
- Click the **Right Arrow** to display the measurement graph. Clicking the button will switch to the graphical presentation of the current measurements. Refer to *Graph screen* → .
- Click **Menu** to return to the MAIN MENU screen.

5.9.3 Error codes

The error code is a bit combination of multiple errors. The table shows a list of error bits. Some examples of error codes are shown below:

- **Error code: 1** = No RTD (Pt100) (bit 0)
- **Error code: 5** = No RTD (Pt100) and amplitude too low (bit 0 [2N Value 1], bit 2 [2N Value 4]=5)
- **Error code: 1024** = No pressure sensor connected (bit 10)
- **Error code: 1029** = No RTD (Pt100), amplitude too low, no pressure sensor connected (bit 0 [2N Value 1], bit 2 [2N Value 4], bit 10 [2N Value 1024] = 1029)

Bit	2N Value	Error
0	1	No RTD (Pt100)
1	2	No sensor selected
2	4	Amplitude too low
3	8	SD card defect
4	16	Reference amplitude out of range
5	32	Photo diode saturated
6	64	Signal overflow
7	128	Signal overflow
8	256	Reserved
9	512	Critical error. Refer to <i>Service</i> →  .
10	1024	No pressure sensor / pressure sensor out of range
11	2048	Reserved
12	4096	Storage space full

Table 3. Error codes

5.9.4 Graph screen

The oxygen values of the current measurement session are displayed in a graph; the last measurement value of the Current Measurement is shown at the top of the screen. Refer to Figure 30.

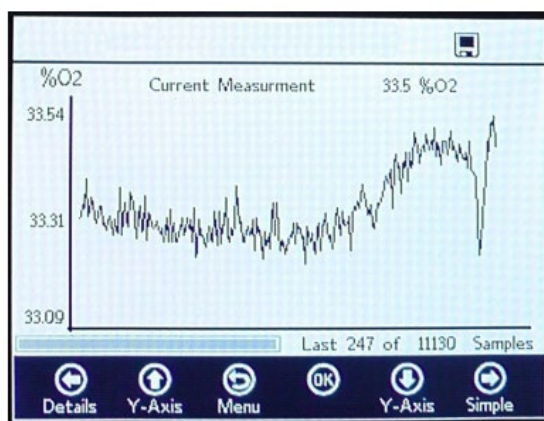

A0052898

Figure 30. Graph screen

In the lower right area of the screen, the number of measurement points of the total number of measurement points are displayed in the graph. In the lower left of the screen, a progress bar shows the progress of the data being analyzed.

NOTICE

- ▶ When large measurement files are being opened, a pop-up window will display stating, “You are about to open a very large file.” and requesting confirmation before proceeding. Select **No** to return to the currently selected measurement graph or **Yes** to show the last 248 measurement points of the currently selected measurement file.

When logging is not activated, only the currently measured oxygen values are displayed, starting at the time the GRAPH screen is opened.

1. Click the **Up** and **Down Arrows** to open the Y-Axis Setup window where the minimum and maximum values for the Y-Axis are set.
2. Select **Autoscale** or **Manual** setting of the maximum or minimum values displayed on the Y-Axis. Refer to Figure 31. Autoscale will automatically set the maximum and minimum values according to the preset measurement values.

CAUTION

- ▶ Measurement values outside the set display range will be shown as maximum or minimum values.
 - Click the **Left Arrow** to return to DETAILS view.

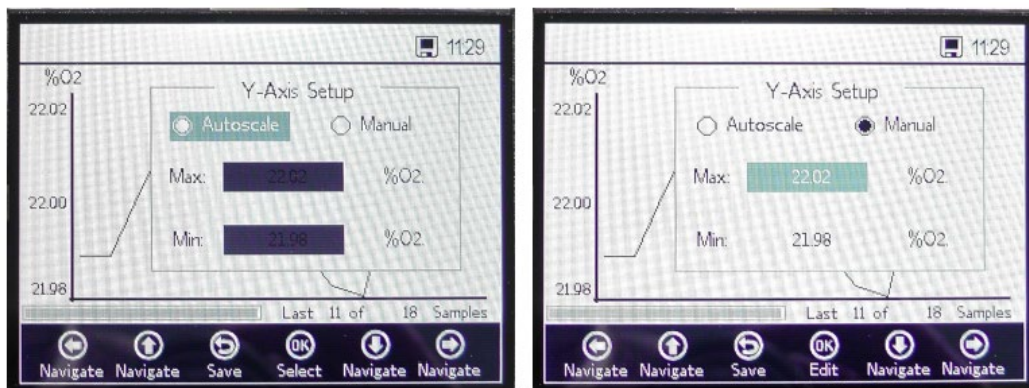

Figure 31. Y-Axis setup: Autoscale, ...and Manual setting

A0052899

- Click the **Right Arrow** to return to SIMPLE view.
- Click **Menu** to return to the MAIN MENU screen.

5.10 Measurement settings (Meas. settings) menu options

After selecting Meas. Settings from the MAIN MENU, the MEASUREMENT SETTINGS window displays. The analyzer temperature compensation, pressure compensation, interval, and logging and data management options are accessed from this screen.

5.10.1 Temperature compensation

On the MEASUREMENT SETTINGS screen, use the Navigation buttons to move to the Temperature box. Refer to Figure 32.

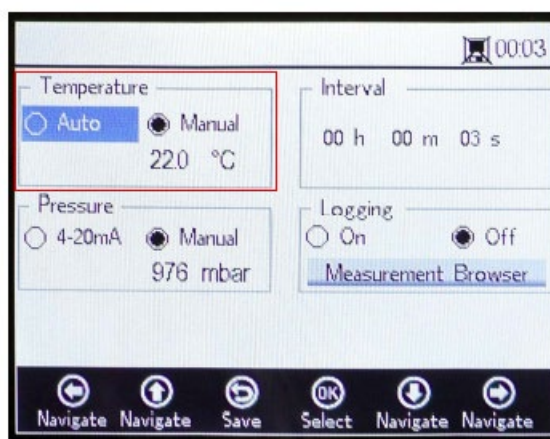

A0052900

Figure 32. Measurement settings screen - Temperature compensation

With Auto selected, the measurement temperature is determined by the RTD (Pt100) sensor.

NOTICE

- ▶ Automatically measured temperature values can be displayed in °C, °F, or K.

5.10.2 Setting the temperature compensation

1. Change the settings to the desired unit of measurement in the lower right corner of the Temperature box. Figure 32 shows the temperature set at 22.0 °C.

OR

Select **Manual** if the temperature during measurement at the oxygen sensor is known and constant throughout the measurement.

CAUTION

- ▶ Manual setting is only required if the temperature probe is not functioning properly. Refer to *Service* →  before using the Manual setting.

NOTICE

- ▶ Temperature values can be input in °C, °F, or K, in a range from -99 °C to 199 °C. Values will automatically be recalculated in the respective unit.
2. Switch to the desired temperature unit and change the temperature value in the input field to the measurement temperature.

5.10.3 Pressure compensation

On the MEASUREMENT SETTINGS screen, use the **Navigation** buttons to move to the Pressure box. Refer to Figure 33.

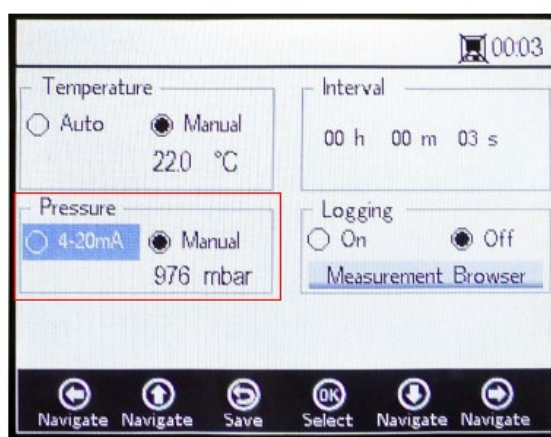

A0052901

Figure 33. Measurement settings screen - Pressure compensation

If the OXY5500 was purchased with a pressure sensor, the analyzer will be configured to use the pressure sensor from the factory. If the pressure sensor is purchased separately, refer to the following steps for configuring the pressure sensor.

5.10.4 Setting the pressure compensation

1. Select the pressure compensation mode. Click on 4-20mA for the atmospheric pressure to be measured with a connected pressure sensor. These values will be used for pressure compensation.
2. Connect a pressure sensor to the analyzer. The display will show the interpreted pressure value from the 4-20mA input. Refer to *Calibrating the input* → .

NOTICE

- ▶ If no pressure sensor is connected, the display will read 1013 mbar.

OR

1. Select **Manual** if the atmospheric pressure during measurement is known.

NOTICE

- ▶ Pressure values can be input in hPa, mbar, PSI, atm, or torr.
2. Switch to the desired pressure unit and change the pressure value in the input field.

5.10.5 Interval

On the MEASUREMENT SETTINGS screen, use the Navigation buttons to move to the Interval box and select the measurement mode. Refer to Figure 34.

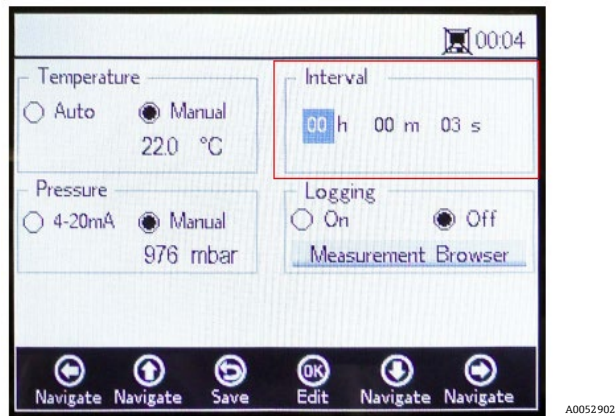

Figure 34. Measurement settings screen - Select time interval

5.10.6 Setting the interval

1. Select **Single Scan** to initiate one single measurement scan.
2. Select Interval to set a certain time interval for the measurement to be taken.
3. Insert the hours, minutes, and seconds for the interval at which measurements scans are taken.

NOTICE

- ▶ The recommended default interval value is “30 s” (30 seconds). The fastest possible interval for OP-3 is “1 s”. For OP-6 and OP-9, it is “3 s”.

CAUTION

- ▶ Interval values set to less than 30 seconds can reduce the lifespan of the probe. Please refer to *Signal drift due to photo decomposition* → for more information.

The Interval sampling rate determines the frequency for the sensor calibration. For example, a sensor with an Interval sampling rate of 30 seconds would produce 100,000 measurement points at 34.7 days. Endress+Hauser recommends 35 days as a starting point for re-calibration or as the application requires it. Refer to The table below and *Calibrating the analyzer* → .

Sampling Rate	Points	Calibration Frequency (Days)
30 seconds	100,000	34.7
1 minute	100,000	69.4
1 hour	100,000	4,166
10 hours	100,000	41,666

Table 4. Interval sampling rate/calibration frequency

5.10.7 Logging and data management

On the MEASUREMENT SETTINGS screen, use the Navigation buttons to move to the Logging box. Refer to Figure 35.

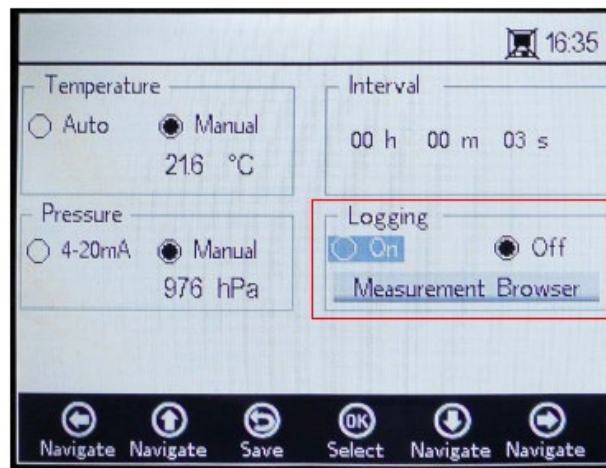

A0052903

Figure 35. Measurement settings screen - Logging

NOTICE

- ▶ In the Status bar, the symbol indicates Logging is turned off.
- Select Off if you do not want to store measurement data.
- Select On to store measurement data.

The screen will switch to the Measurement Browser automatically. A list will display showing the Measurement file name, the number of measurement Points stored in the respective file and the date the file was Last Used. Refer to Figure 36.

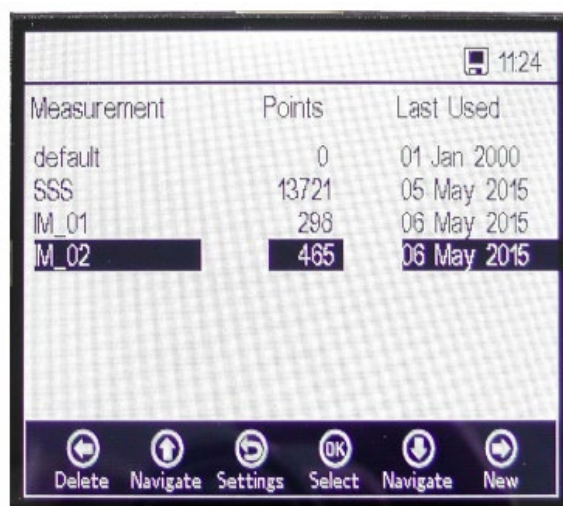

A0052904

Figure 36. Measurement browser - List of measurement files

- Use the **Up** and **Down Arrow** buttons to navigate up or down the list.
- Click **OK** to select the highlighted file. The new measurement data will be added to the existing file. The display will switch back to the measurement settings automatically.

NOTICE

- ▶ In Figure 36, the **Monitor** symbol in the Status bar shows that Logging is turned on and measurement data are going to be stored.

- Click the **Left Arrow** to delete the highlighted measurement file from the list. A window will display with the question, “Really delete this measurement?” Select **Yes** and the highlighted measurement field will be deleted.

NOTICE

- The currently activated measurement file cannot be deleted. To delete, first select another measurement file, then return to deleting the measurement file to be removed. The default measurement cannot be deleted.

Click the **Right Arrow** to create a new measurement file. A keyboard screen displays to enter the new measurement file name. Refer to Figure 37.



A0052905

Figure 37. Keyboard screen to enter measurement name

- Use the **Arrow** buttons to move across the keyboard and the **OK** button to select the respective letter or number. The new measurement name will show in the highlighted box at the bottom of the screen.

NOTICE

- To return to the measurement file list without creating a new file, click **Menu**.
- Finish typing the file name, click **Done** and **OK**. The new measurement file will display in the file list.
- To select a newly created measurement file for data storage, click **OK** a second time. The screen will switch back to the measurement settings automatically.
- Click **Menu** to save the changes and return to the MAIN MENU screen.

5.11 Device settings menu options

Click **Device Settings** on the MAIN MENU to access the DEVICE SETTINGS menu, the SENSOR DETAILS screen and the ABOUT screen.

5.11.1 Device settings screen

This screen is used to change the general settings of the OXY5500. Refer to Figure 38. Date, Time, LED Intensity (User Signal Intensity), and Forced Zero settings are saved with every measurement in the respective measurement file.

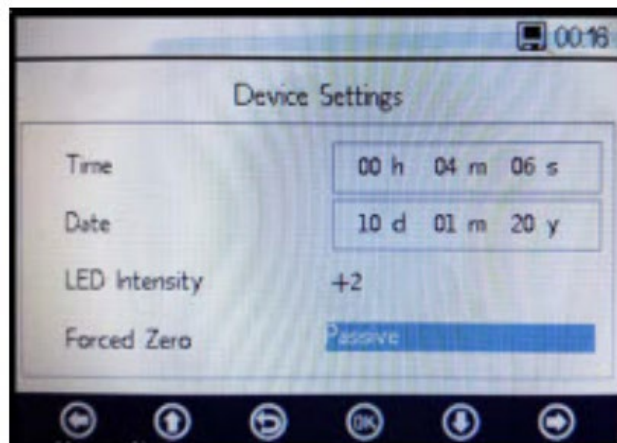

A0052906

Figure 38. Device settings screen

CAUTION

- ▶ If the power supply to the analyzer is disabled, Time and Date settings will be set to zero. Reset Time and Date before starting a new measurement so that the correct time is stored with the data.
- **Time:** Set the current time in hour (h), minute (m), and seconds (s). The OXY5500 uses 24-hour time settings.
- **Date:** Set the current date in day (d), month (m), and year (y).
- **LED Intensity/User Signal Intensity:** Adjusts the signal strength of the probe. The LED Intensity (also called User Signal Intensity) setting range is from -5 to 5, with 5 as the highest probe intensity and -5 the lowest probe intensity. The default value is 0.

5.11.2 Setting the forced zero mode

1. Click the **Forced Zero** mode field to view the drop down menu.



A0052907

Figure 39. Forced zero mode (1)

2. Select one of the forced zero modes shown in the table.

Forced Zero Settings	Negative Oxygen Value Display	Alarm Signal “Forced Zero is Active”	Forced Zero Active After Reset
Passive	yes	no	no
Active	no	no	no
Active with alarm	no	yes	no
Active stored (default setting)	no	no	yes
Active with alarm stored	no	yes	yes

Table 5. Forced zero modes

5.11.3 Forced Zero mode definitions

- **Passive mode:** Forced zero option is inactivated and negative measurement readings are shown.
- **Active mode:** In this mode, a negative value will be seen as 0% [ppm] O₂. After rebooting the device, the default mode “passive” is reactivated.
- **Active alarm:** In this mode, a negative value will be seen as 0% [ppm] O₂. An alarm signal “Forced Zero is active” is displayed at the top of the window. Refer to Figure 40. After rebooting the device, the default mode “passive” is reactivated.
- **Active stored:** In this mode, a negative value will be seen as 0% [ppm] O₂. No alarm signal is displayed when the oxygen concentration reading is negative. After rebooting the device, this mode remains active.
- **Active with alarm stored:** In this mode, a negative value will be seen as a 0% [ppm] O₂. This mode combines the functionality of modes “active alarm” and “active stored”. After rebooting this device, this mode remains active.



Figure 40. Forced Zero alarm signal

CAUTION

- ▶ The OXY5500 requires regular calibration as discussed in *Calibrating the analyzer* → . Negative oxygen values which may be due to an inaccurate calibration are not displayed when Forced Zero is active.

NOTICE

- ▶ Once the Forced Zero feature is active, the reading as described above applies to the main measurement screen and to the analog 4-20 mA output. Negative oxygen values are output as 4 mA.

5.11.4 About screen

The ABOUT screen provides the Serial Number, LED Status, and Firmware Version of the OXY5500. Refer to Figure 41.

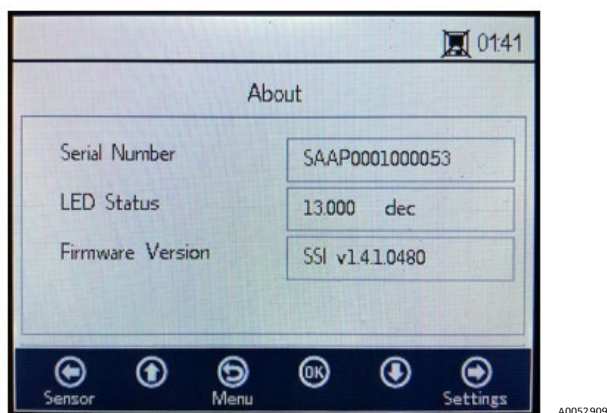



Figure 41. About screen

CAUTION

- ▶ Make sure to have the analyzer information found in the ABOUT screen before contacting *Service* → .

5.11.5 Sensor details screen

Information about the currently selected sensor is available through the SENSOR DETAILS screen. Refer to Figure 42. The sensor type is displayed at the top of the screen. Below, all calibration data and sensor constants are shown.

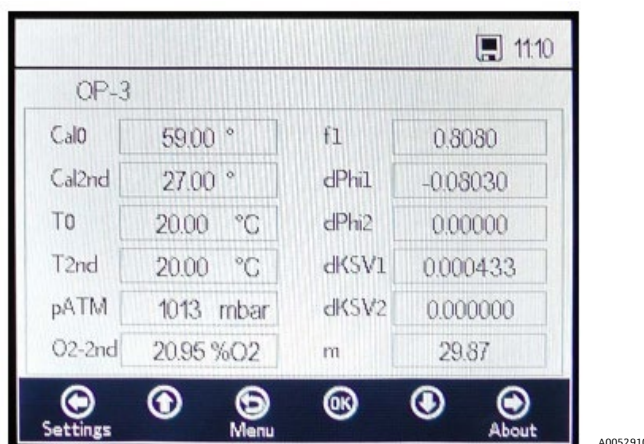

Figure 42. Sensor details screen

5.12 Sensor menu options

The option to change parameters, sensor type, or to calibrate the analyzer are accessed via the **Sensor** button on the MAIN MENU.

5.12.1 Change parameters

Clicking the **Change Parameters** button in the SENSOR menu causes a message window to display with the question to abort the currently running measurement. Refer to Figure 43.

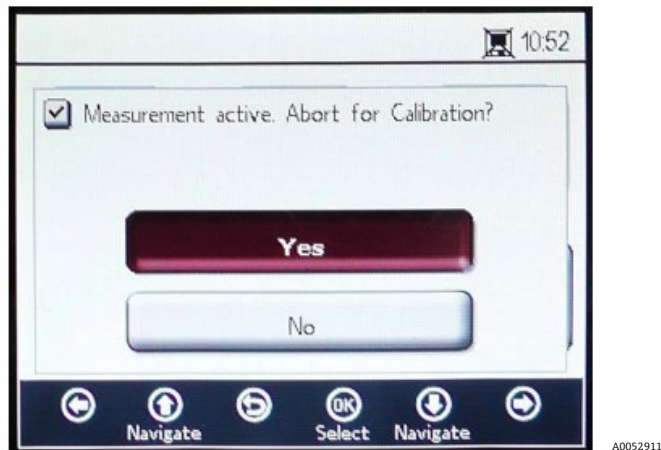

Figure 43. Message window - Stop measurements during configurations

Select **Yes** to stop the measurement in order to display the SENSOR TYPE AND SENSOR CONSTANTS window. Refer to Figure 44.

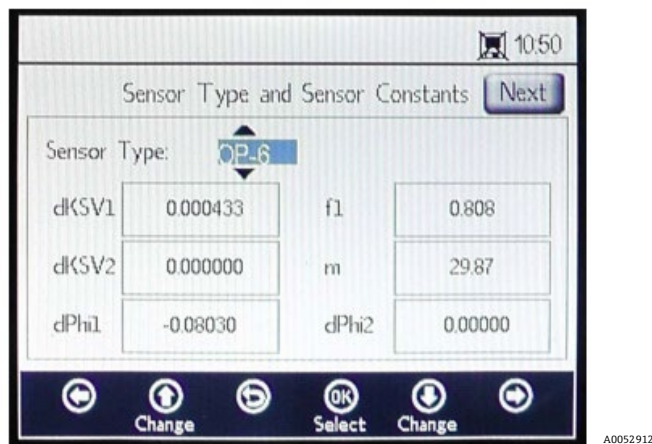

Figure 44. Sensor type and sensor constants - Sensor type menu selected for editing

Use the **Arrow** buttons to navigate between input fields.

5.12.2 To enter editing mode

1. Click **OK** to edit the highlighted field.
2. Change the setting or value (one digit at a time) by pressing the **Up** and **Down Arrow** buttons.
3. Make the desired change to an input field.
4. Click **OK** again to save the changes.

5.12.3 To exit editing mode

1. Click **Menu** to cancel and exit.

5.12.4 Changing the sensor type

If it is necessary to change the probe type in the field, change the sensor type (OP-3, OP-6, or OP-9) according to the sensor that is connected to the analyzer. The displayed sensor constants (dKSV1, dKSV2, dPhi1, dPhi2, f1, and m) will change according to the sensor type selected.

NOTICE

- The sensor constant values can also be located on the Calibration Certificate delivered with the optical oxygen sensor. Refer to the example in Figure 45.

OXY5500 Calibration Certificate

SYSTEM INFORMATION

<table border="1" style="width: 100%; border-collapse: collapse;"> <tr><td>Calibration Date</td><td>1-12-2022</td></tr> <tr><td>Optical Module S/N</td><td>SAAP0001000579</td></tr> <tr><td>OXY5500 S/N</td><td>SC009C28000</td></tr> <tr><td>SSI Sales Order No.</td><td>15451</td></tr> <tr><td>Job No.</td><td>J58595</td></tr> </table>	Calibration Date	1-12-2022	Optical Module S/N	SAAP0001000579	OXY5500 S/N	SC009C28000	SSI Sales Order No.	15451	Job No.	J58595	<table border="1" style="width: 100%; border-collapse: collapse;"> <tr><td>Sensor Type</td><td>OP-9</td><td>Range: 0 to 300 ppm</td></tr> <tr><td>Sensor S/N</td><td colspan="2">211029-006 PST9-1729-01</td></tr> <tr><td>Firmware</td><td colspan="2">SSI v1.4.1.0519</td></tr> <tr><td>SSI P/N</td><td colspan="2">OXY5500- 11011120-00000-00</td></tr> <tr><td>Tag No.</td><td colspan="2">N/A</td></tr> </table>	Sensor Type	OP-9	Range: 0 to 300 ppm	Sensor S/N	211029-006 PST9-1729-01		Firmware	SSI v1.4.1.0519		SSI P/N	OXY5500- 11011120-00000-00		Tag No.	N/A	
Calibration Date	1-12-2022																									
Optical Module S/N	SAAP0001000579																									
OXY5500 S/N	SC009C28000																									
SSI Sales Order No.	15451																									
Job No.	J58595																									
Sensor Type	OP-9	Range: 0 to 300 ppm																								
Sensor S/N	211029-006 PST9-1729-01																									
Firmware	SSI v1.4.1.0519																									
SSI P/N	OXY5500- 11011120-00000-00																									
Tag No.	N/A																									

CALIBRATION SPECIFICATIONS

<table border="1" style="width: 100%; border-collapse: collapse;"> <tr><td>Calibration Point: CAL0</td><td>ppm</td><td>0.00</td></tr> <tr><td>Calibration Point: CAL2ND</td><td>ppm</td><td>200.00</td></tr> </table>	Calibration Point: CAL0	ppm	0.00	Calibration Point: CAL2ND	ppm	200.00	<table border="1" style="width: 100%; border-collapse: collapse;"> <tr><td>User Signal Intesity</td><td>0</td></tr> <tr><td>Operating Temperature [°C]</td><td>21.22</td></tr> <tr><td>Atmospheric Pressure [mbar]</td><td>989.01</td></tr> </table>	User Signal Intesity	0	Operating Temperature [°C]	21.22	Atmospheric Pressure [mbar]	989.01
Calibration Point: CAL0	ppm	0.00											
Calibration Point: CAL2ND	ppm	200.00											
User Signal Intesity	0												
Operating Temperature [°C]	21.22												
Atmospheric Pressure [mbar]	989.01												

CALIBRATION DATA

Calibration Points	Phase Signal [°]	Valid Range [°]	Temperature [°C]	Valid Range [°C]	Amplitude [µV]	Pass / Fail
Cal0:	64.12	60.00 - 70.00	21.21	18.00 - 60.00	25738.03	PASS
Cal2nd:	34.77	32.00 - 45.00	20.92	18.00 - 60.00	14956.97	PASS

Sensor Constants: 0 to 60 °C			
F1 =	0.786	dPhi1=	-0.0035
m =	15.8	dPhi2=	-0.00038
dKSV1 =	-0.08	dKSV2 =	0

Cal Gas	Cylinder	Station
N2 (6.0)	3200152	OXY
O2 In N2	2810220	OXY

Sensor Constant Used -20 to 50 C

VALIDATION DATA

O2 Reading								
O2 ppm	Set Point	O2 ppm	Valid Range ppm	Temperature [°C]	Valid Range [°C]	Pressure [mbar]	Valid Range [mbar]	Pass-Fail
0.00		0.03	< 2.00	21.22	18.00 - 60.00	989.01	900.00 - 1025.00	PASS
200.00		200.15	190.00 - 210.00	20.99	18.00 - 60.00	989.01	900.00 - 1025.00	PASS

Analog Outputs					
Set Point [mA]	Port1 [mA]	Valid Range [mA]	Port2 [mA]	Valid Range [mA]	Pass-Fail
4.00	4.000	3.995 - 4.005	4.000	3.995 - 4.005	PASS
20.00	20.001	19.995 - 20.005	20.000	19.995 - 20.005	PASS

COMMENTS

NOTE: Calibration was performed using SpectraSensors instrumentation at ambient conditions. OXY5500 manual recommends for end users to calibrate the unit prior to use. End users to check calibration frequency based on manual recommended intervals.

Calibrated by: <u>FT20</u>	Date: <u>1-12-2022</u>
----------------------------	------------------------

Figure 45. Calibration certificate example: Calibration data and sensor constants

A0052913

5.12.5 To manually change the sensor constants values

1. Select the desired field and click **OK**.
2. Click **Next** in the upper right corner of the screen, then click **OK**.

The display will change to the CALIBRATION DATA screen. Refer to Figure 46. If a calibration was performed with a previously connected sensor, the data from that calibration is shown.

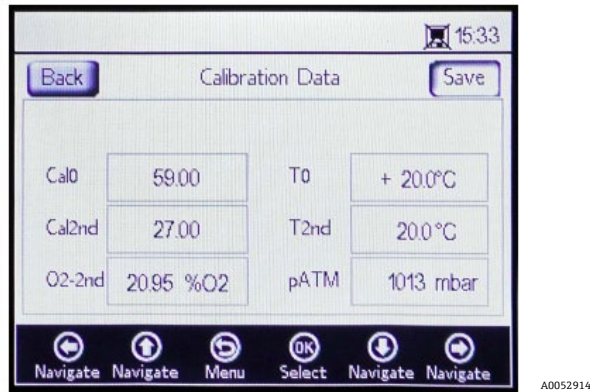



Figure 46. Calibration data screen

NOTICE

- ▶ On the Calibration Certificate → , "T0" is shown under the Calibration Data section, Temperature column as Cal0 and Cal2nd.
- ▶ On the Calibration Certificate, "pATM" is shown as "Atmospheric Pressure" under the Calibration Specifications section during Cal0 and Cal2nd.

5.12.6 Calibration

Calibration pressure and temperature are set from the CALIBRATION SETTINGS and CALIBRATION TEMPERATURE screens, as shown below.

5.12.7 Setting calibration pressure

Refer to Figure 47 for a view of the CALIBRATION SETTINGS screen. The following instructions provide setting information.

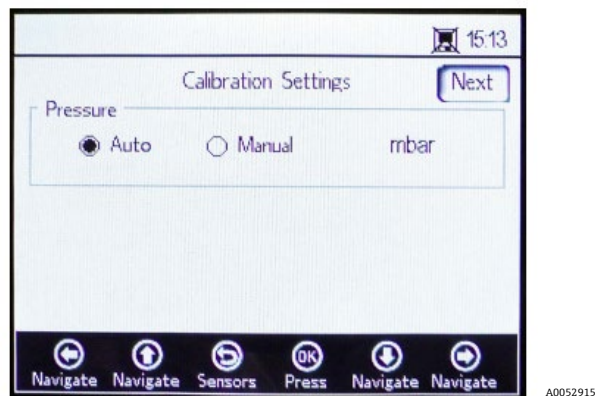

Figure 47. Calibration settings screen

Pressure:

- Select **Auto** to measure the atmospheric pressure via the 4-20mA input.
- Select **Manual** if there is no pressure sensor connected to the analyzer. Type in the current atmospheric pressure value and the respective unit (hPa, mbar, PSI, atm, or torr).
- Click **OK** to save your changes.

Click **Next** at the top right of the screen followed by **OK**.

5.12.8 Setting calibration temperature

Use the following instructions to program the analyzer for the correct calibration temperature. Refer to Figure 48.



Figure 48. Calibration temperature screen

- **T0:** Temperature at the first calibration point.
 - Select **Auto** to measure the temperature at the first calibration point with the RTD probe (Pt100 temperature sensor).
 - Select **Manual** if the first calibration point is known and remains constant through the calibration process. Temperature values can be input in °C, °F, or K. Switch to the desired temperature unit and change the temperature value in the input field.
- **T2nd:** Temperature at the second calibration point.
 - Select **Auto** at the first calibration point for automatic temperature measurement.
 - Select **Manual** to insert the changes to the calibration temperature manually.

To proceed with the calibration, click **Next** at the top right of the screen followed by **OK**.

Before starting the measurement, the OXY5500 must be calibrated. Refer to *Calibrating the analyzer* →

5.12.9 Calibrating the analyzer

Complete the calibration procedures in this section before starting the measurement. First, refer to the required equipment and materials list in The table. Figure 49 shows an illustration of the components to be used for the cylinder regulator purge process.

5.12.10 Equipment and materials

Refer to The table for a list of the materials and other equipment recommended for best results in the calibration process. Component locations are shown in Figure 49, Figure 50, and Figure 51.

Material/Equipment	Specifications	Vendor; P/N (if available)	Notes
Nitrogen gas (Cal 0)	6.0 Research grade (99.9999%)	Airgas, Inc.; P/N NI ISP 300, or equivalent	To be used for measurement ranges 0 to 100 ppmv and lower. Can also be used for OP-6 or OP-3 probe.
Nitrogen gas (Cal 0)	5.0 High purity grade (99.999%)	–	Use for calibration ranges greater than 100 ppmv. Can be used for OP-6, OP-3, or OP-9 probe, or for OP-9 probe with O2 concentrations >100 ppm
200 ppm O2 in N2 gas (Cal 2nd)	200 ppm oxygen in nitrogen	Airgas, Inc.; P/N X02NI99P15A0122, or equivalent	To be used with probe OP-9
2% O2 in N2 gas (Cal 2nd)	2% oxygen in nitrogen	Airgas, Inc.; P/N X02NI98C15A0614, or equivalent	To be used with probe OP-6
21% O2 in N2 gas (Cal 2nd)	20 to 21% oxygen from ambient air	N/A	To be used with probe OP-3
Cylinder dual stage pressure regulators	Type: High purity, dual-stage, regular, stainless steel diaphragm	Genstar Technologies; R31BQK-DIK-C580-00-DR, or equivalent	Used for N2, 200 ppm O2 in N2 and 2% in O2 in N2 (quantity 2)

Material/Equipment	Specifications	Vendor; P/N (if available)	Notes
Stainless steel tubing	3 mm (1/8 in.) tube, 316L, electro-polished, seamless	-	Used to connect the cylinders to the Cal Port (minimize length between cylinder and the OXY5500 cal port/inlet)
Three-way ball valve	0.35 Cv, 1/4 in. TF, PTFE, 316SS or 0.35 Cv, 6 mm TF, PTFE, 316SS	Swagelok; SS-42GXS4 SS-42GXS6MM	To be used to connect the N2 and O2 cylinders to the OXY5500 cal port/inlet (quantity 1)
Tube reducer	Stainless steel tube fitting, reducer, 1/8 in. x 1/4 in. tube OD or Stainless steel tube fitting, reducer, 6 mm x 3 mm tube OD	Swagelok; SS-200-R-4 SS-6M0-R-3M	(quantity 2)
Port connector	1/4 TF, OD, 316SS or 6 mm TF, OD, 316SS	Swagelok; SS-401-PC SS-6M1-PC	(quantity 2)

Table 6. Calibration materials/equipment

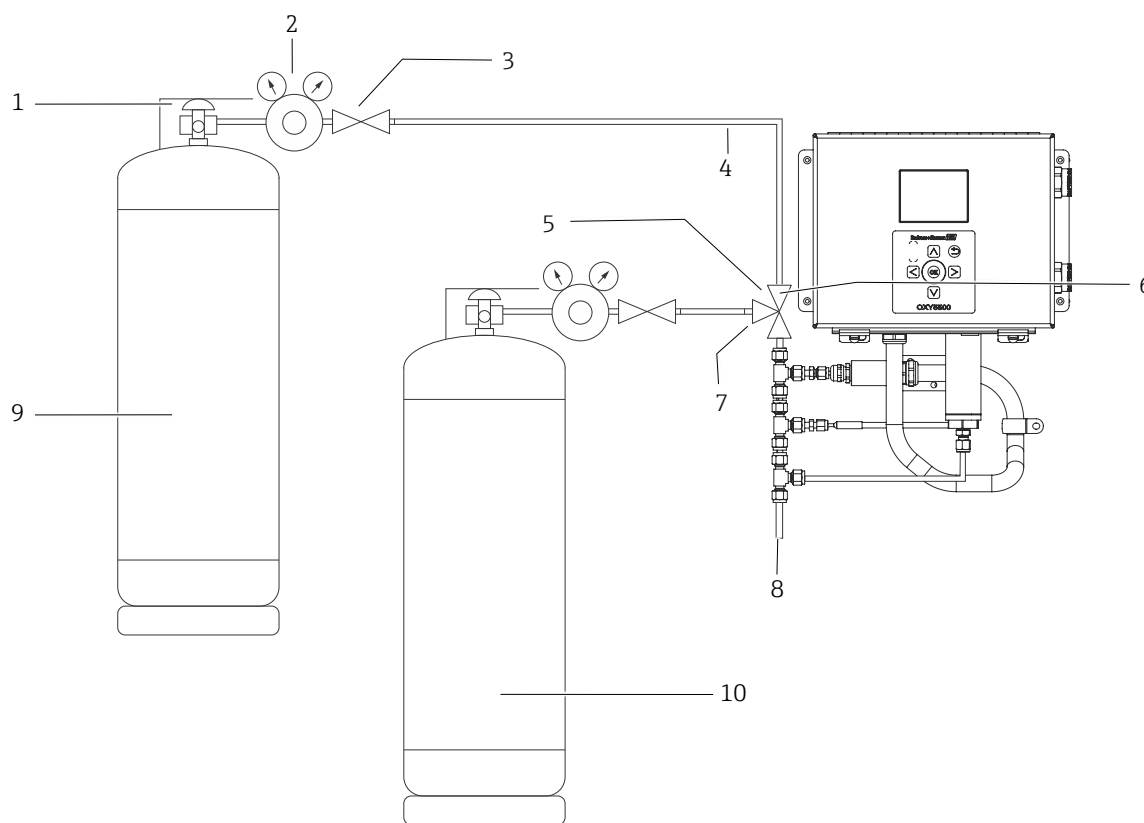

A0056248

Figure 49. General layout for cylinder and Endress+Hauser analyzer connections

#	Description
1	Cylinder valve
2	Dual stage pressure regulator
3	Shut off valve
4	Stainless steel tubing
5	Three-way ball valve
6	Port 1
7	Port 2
8	To vent
9	Cal 0
10	Cal 2nd

5.12.11 Calibration gas connections to the OXY5500 analyzer

Connecting the two calibration gas cylinders to a three-way valve will minimize the OXY5500 exposure to ambient oxygen. This process will help reduce the calibration time of the analyzer. The instruction below are for analyzers with and without integrated sample conditioning systems. If your analyzer sample conditioning system (SCS) was produced outside the Endress+Hauser factory, contact the manufacturer for details relating to the SCS connections.

This arrangement is strongly recommended for low-range calibrations (0 to 100 ppmv and lower). Higher ranges may be calibrated by connecting the N2 and the calibration gases one at a time without the three-way valve as shown in Figure 50.

5.12.12 Connecting the gas inlet for analyzers without the sample conditioning system

1. Connect the three-way valve to a port connector.
2. Connect the reducers to either side of the three-way valve.

3. Connect to the gas cylinder to the reducer on either side of the three-way valve using 3 mm (1/8 in.) stainless steel tubing.
4. Connect the OXY5500 probe to the port connector.

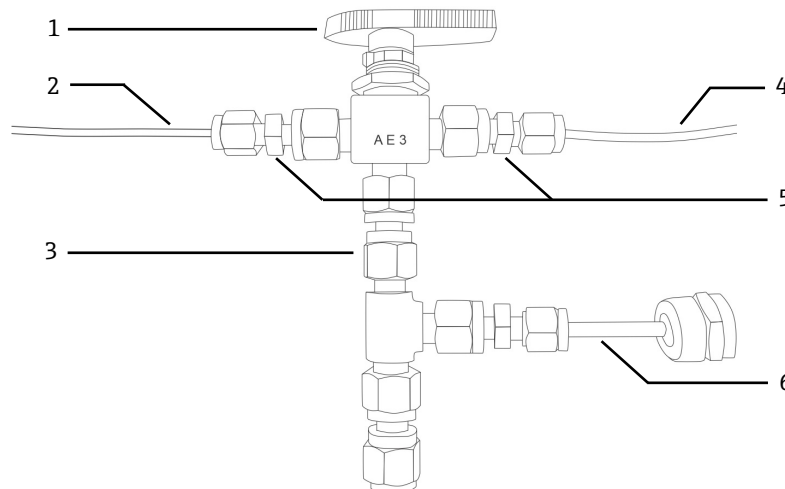

Figure 50. Gas inlet connections without SCS

#	Description
1	Three-way valve
2	Tubing to gas cylinder
3	Port connector
4	Tubing to gas cylinder
5	Reducers
6	OXY5500

5.12.13 Connecting the gas inlet for analyzers with Endress+Hauser’s sample conditioning system (SCS)

1. Attach the Port Connector to the Endress+Hauser analyzer SCS enclosure.
2. Connect the three-way valve to the port connector.
3. Connect the reducers to either side of the three-way valve.
4. Connect to the gas cylinder to the reducer on either side of the three-way valve using 3 mm (1/8 in.) stainless steel tubing.

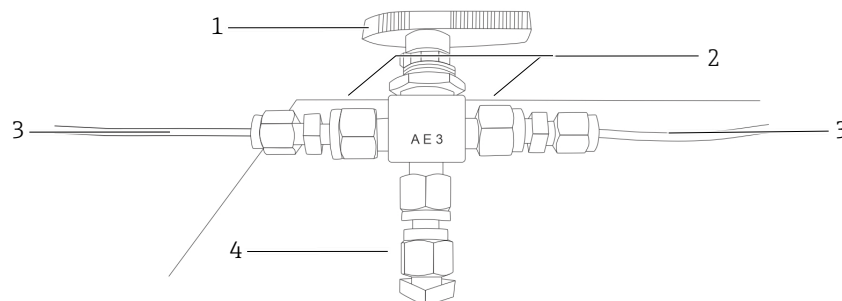

Figure 51. Gas inlet connections with SCS

#	Description
1	Three-way valve
2	Reducers
3	Tubing to gas cylinder
4	Port connector

5.13 Purging the cylinder pressure regulators and analyzer

1. Install a pressure regulator to the nitrogen (N₂) zero gas cylinder.
2. Install a pressure regulator to the O₂ calibration gas cylinder.
3. Purge the pressure regulator starting with the O₂ cylinder, then the N₂ cylinder. Allow the gas to flow into the analyzer to purge also.
4. Close the pressure regulator outlet valve and open the cylinder valve. This will pressurize the primary and secondary side of the two-stage regulator.
5. Adjust the regulation pressure to 200 KPaG (30 PSIG).
6. Close the cylinder valve and crack the dual stage pressure regulator outlet valve. Allow the gas to discharge until both the primary and secondary regulator pressure gases approach zero.
7. Close the dual stage pressure regulator outlet valve prior to releasing the last amount of gas pressure.
8. Repeat steps 1 to 7 fifteen (15) times for each regulator.

NOTICE

- ▶ For best results, discharge the regulator as much as possible without releasing all of the pressure on each purge cycle.
9. Open the cylinder valve and ensure the regulator is set to 200 KPaG (30 PSIG).
 10. Open the dual stage pressure regulator outlet valve fully. Ensure there are no restrictions on the sample return that may cause back pressure during the purge cycle.

5.13.1 Performing a manual calibration (calibration using sensor values)

If the sensor was not previously calibrated with the analyzer (e.g., sensor replacement), the calibration can be set by simply entering the values from the Calibration Certificate provided with the analyzer, without the need for calibration gases. Refer to the sample *Calibration Certificate* → . However, calibrating with gases is more accurate because it accounts for variability in the specific installation. To calibrate with gas, refer to *Performing a two-point calibration* → .

1. Change the values for Cal0, T0, Cal2nd, T2nd, and pATM according to the values shown in the Calibration Certificate. Refer to Figure 52.

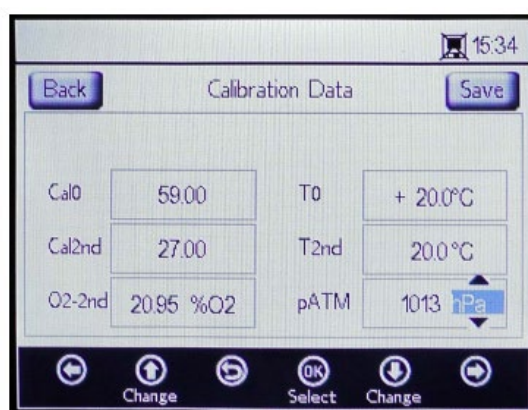

A0052918

Figure 52. Calibration data screen - Changing the pressure unit

NOTICE

- ▶ On the Calibration Certificate, “pATM” is shown as “Atmospheric Pressure” under Calibration Specifications during Cal0 and Cal2nd.
2. Change the O₂-2nd value according to the value shown below the cal2nd column.

CAUTION

- ▶ Confirm that the correct unit for the O₂-2nd and pATM values are selected.
3. Click **Save** in the upper right of the screen to store the changes and complete the manual calibration of the analyzer.

The display will automatically change to the MEASUREMENT window. If another sensor type has been selected, a message window will display stating that the sensor type change has reset RATA. Refer to *Relative accuracy test audit (RATA)* → .

5.13.2 Performing a two-point calibration

To perform a two-point calibration with the connected oxygen sensor, begin by selecting the screens below. When completed, continue with the procedure detailed in “Calibrating the analyzer” on page 53.

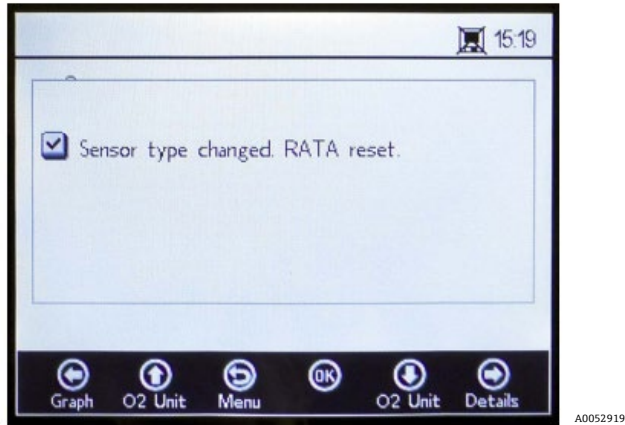

Figure 53. Message window - Sensor type change resets RATA

1. Select **Calibration** from the SENSOR OPTIONS window. Refer to Figure 54.

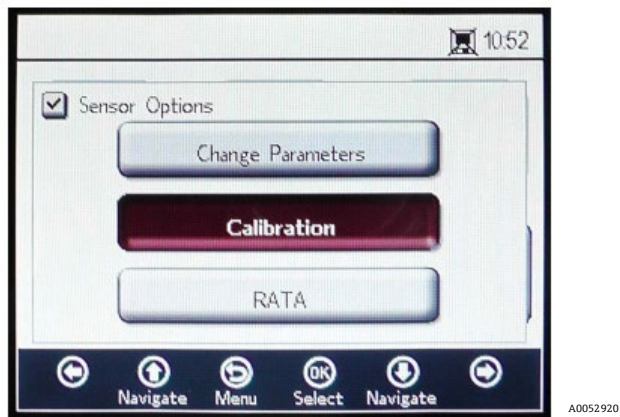

Figure 54. Calibration button in the sensor options window

2. Click **OK**.

A message window will display requesting a response to the following question, “Measurement active. Abort for Configuration?” Refer to Figure 55.

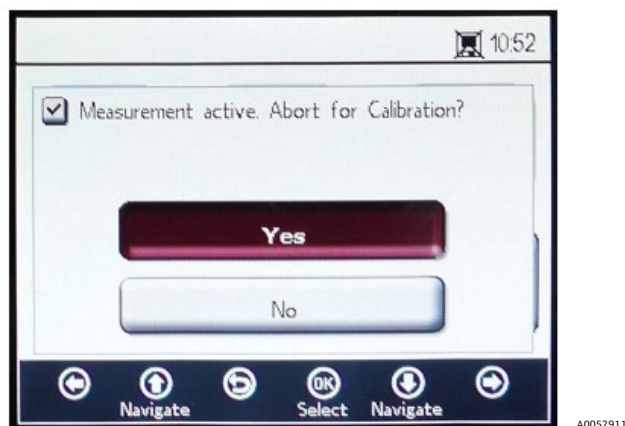

Figure 55. Message window - Stop measurements during configuration

3. Select **Yes** to stop the measurement in order to move to the CALIBRATION windows. Use the **Up** and **Down Arrow** buttons to navigate between input fields.

5.13.3 To enter editing mode

1. Click **OK**.
 - o Change the setting or value (one digit at a time) by clicking the **Up** and **Down Arrow** buttons.
 - o Make the desired change to an input field.
2. Click **OK** again to save the changes.

5.13.4 To exit editing mode

1. Click **Menu** to cancel and exit.

5.13.5 Performing pre-calibration

1. Connect the analyzer to a nitrogen (N₂) bottle.
2. Set the flow to 1.5 SLPM.
3. Confirm settings for the specified probe being used.

CAUTION

- ▶ Settings specified in the calibration certificate must be used for probes. Refer to *Calibration Certificate* → .
4. Allow nitrogen (N₂) Cal 0 gas to flow through the system for 45 to 60 minutes to purge the system. Refer to The table.

Item	OP-3	OP-6	OP-9
Cal 0	Calibration with oxygen-free environment (e.g., nitrogen).	Calibration in oxygen-free environment (nitrogen).	Calibration in oxygen-free environment (99.9999% nitrogen).
Cal 2nd	Calibration value optimal at 20.9% O ₂ in N ₂ (or ambient air).	Calibration value optimal between 1% and 2% oxygen.	Calibration value optimal between 100 to 200 ppm O ₂ in N ₂ .
Storage Stability	2 years provided the sensor material is stored in the original packaging.		

Table 7. Calibration gas specifications

In the upper section of the main screen, the Present Values measured by the OXY5500 are displayed. Refer to Figure 56.

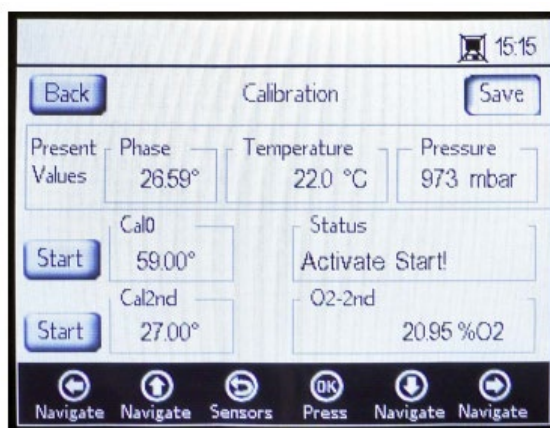

A0052921

Figure 56. Calibration screen

5.13.6 Setting the first calibration point Cal0

1. Flow Cal0 gas to sensor for the first calibration point. Refer to The table for Cal 0 gas specifications.
2. Click **Start** to the left of the Cal0 value.

The Status field will display the message 'Wait - Stabilizing!' Wait for the phase values to stabilize within ± 0.01°.

CAUTION

- ▶ Disregard the “Ready to Set Value” message.
- 3. Run zero gas until the phase is stable; within 0.01 (approximately 45 to 60 minutes).
- 4. Move the **Set** button to the left of the Cal0 value and click **OK**.

5.13.7 Setting the second calibration point Cal2nd

1. Flow Cal2nd gas to sensor for the second calibration point.
2. In the O2-2nd field, type in the oxygen value (concentration unit) of the second calibration medium.
3. Click **Start** next to the Cal2nd box.

The Status field will display the message, “Wait - Stabilizing!”. Wait for the phase values to stabilize within $\pm 0.01^\circ$.

CAUTION

- ▶ Disregard the “Ready to Set Value” message.
- 4. Click **Start** to the left of the Cal2nd value.
- 5. Click **OK**.

5.13.8 Saving the calibration values

1. Click **Save** at the upper right of the screen.
2. Click **OK** to store the calibration data for the selected sensor.

The display will switch to the measurement screen automatically.

5.13.9 Relative accuracy test audit (RATA)

RATA is accessible from the **RATA** button on the SENSOR / SENSOR OPTIONS menu screen.

5.13.10 Setting RATA

1. Select **RATA** in the SENSOR OPTIONS window. Refer to Figure 57.

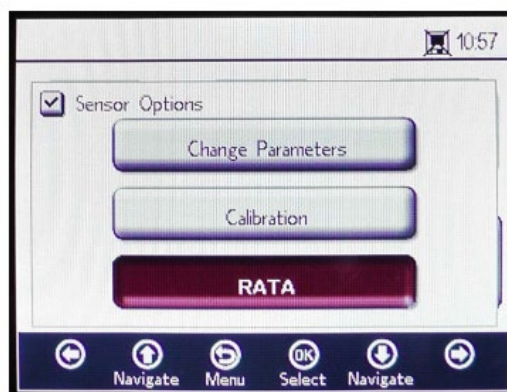

A0052922

Figure 57. Sensor options screen

2. Click **OK** to perform a Relative Accuracy Test Audit (RATA). This will open a message window with the question, “Measurement Active. Abort for calibration?” Refer to Figure 58.

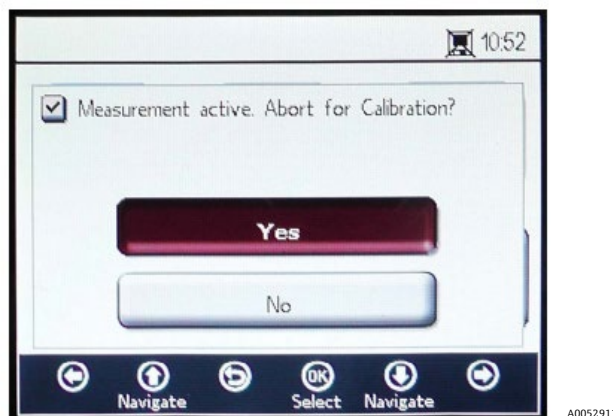

Figure 58. Message window - Stop measurements for calibration

3. Select **Yes** and stop the measurement to move to the CALIBRATION screen.
4. Use the **Up** and **Down Arrow** buttons to navigate between input fields.

5.13.11 To enter editing mode

1. Click **OK**.
2. Change the setting or value (one digit at a time) by clicking the **Up** and **Down Arrow** buttons.
3. Make the desired change to an input field.
4. Click **OK** again to save the changes.

5.13.12 To exit editing mode

1. Click **Menu** to cancel and exit.

5.13.13 Setting the pressure for RATA calculation

After stopping the currently running measurement, the PRESSURE FOR RATA CALCULATION screen displays. Refer to Figure 59.

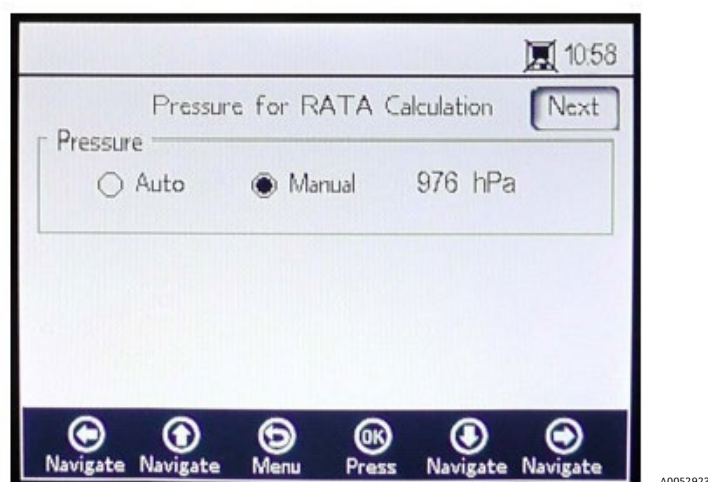

Figure 59. Pressure for RATA calculation

- Select **Auto** and the atmospheric pressure will be measured via the 4-20mA Input.
- Select **Manual** if there is no pressure sensor connected to the analyzer.
 - Type in the current atmospheric pressure value in the respective unit (hPa, mbar, PSI, atm, or torr).
 - Click **OK** to save changes.

5.13.14 Setting the temperature for RATA calculation

- Select **Auto** to measure the temperature for RATA calculation with the RTD probe (Pt100 temperature sensor).
- Select **Manual** if the temperature for RATA calculation is known. Temperature values can be input in °C, °F, or K.
 - Switch to the desired temperature unit and change the temperature value in the input field.
 - Click **OK** to save changes.

Click **Next** at the top right of the screen followed by **OK**. The screens in Figure 60 will display.

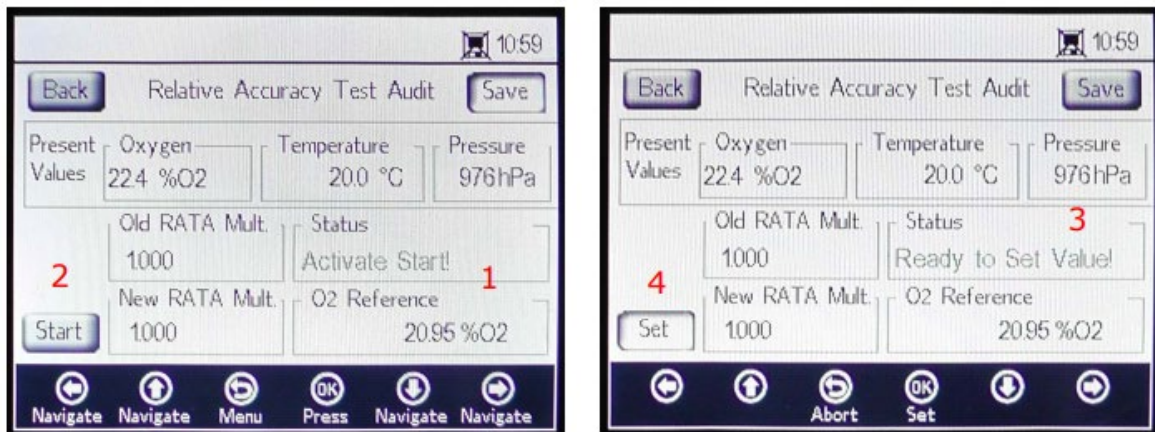

Figure 60. Relative accuracy test audit (RATA) screen

A0052924

At the top of the screen, the currently measured Oxygen, Temperature, and Pressure values are displayed. Below this, the Old RATA Mult. value is shown.

NOTICE

- ▶ If RATA has not been changed, the display will read 1.000.

5.13.15 Setting RATA reference values

1. Enter the reference oxygen value (oxygen concentration of certified test gas lead into the vessel with the oxygen sensor or the oxygen value of a reference device) in the O2 Reference field (1) at the bottom of the screen.
2. Click **Start** next to the New RATA Mult. field (2), as shown in the Status field, to display current sensor phase values. Wait while the sensor values stabilize until the Status field displays “Ready to Set Value!” (3).
3. Click the **Set** button (4) next to the New RATA Mult. field and the new value will display.

The New RATA Mult. can also be set manually. Refer to *Setting new RATA mult. manually* →

4. Click **Save** at the upper right of the screen.
5. Click **OK**.

The display will switch to the MEASUREMENT screen automatically.

NOTICE

- ▶ There is no automatic reset for RATA. This feature cannot be manually reset to ‘off’ (1).

5.13.16 Setting new RATA mult. manually

1. Navigate to the New RATA Mult. box and click **OK**.
2. Use the **Up** and **Down Arrow** buttons to change the value (between 0.001 to 9.999) one digit at a time.
3. Click **OK** again.

5.14 Digitals menu options

Set RS-232, RS-485, and TCP/IP configurations from the **Digitals** button on the MAIN MENU.

5.14.1 RS-232 settings

Use this screen to set the baud rate of the RS-232 channel. Refer to Figure 61.



A0052925

Figure 61. Digitals - RS-232 settings

- The Baudrate for the RS-232 channel can be set to 9600, 19200, 38400, 57600, or 115200.
- The ID, which is used in the Modbus communication, can be set to any value between 1 and 32.
- Parity can be set to Even, Odd, or None.

NOTICE

- ▶ Setting the Parity to “None” also sets the number of stop bits to two. Odd and Even settings will use one stop bit.

All settings are applied by clicking **Save**.

5.14.2 RS-485 settings

Use this screen to set the baud rate of the RS-485 channel. Refer to Figure 62.



A0052926

Figure 62. Digitals - RS-485 settings

- The Baudrate for the RS-485 channel can be set to 9600, 19200, 38400, 57600, or 115200.
- The ID, which is used within the Modbus communication, can be set to any value between 1 and 32.
- Parity can be set to Even, Odd, or None.

NOTICE

- ▶ Setting the Parity to “None” also sets the number of stop bits to two. Odd and Even settings will use one stop bit.

All settings are applied by clicking **Save**.

5.14.3 TCP/IP settings

Use this screen to set TCP/IP. Refer to Figure 63.

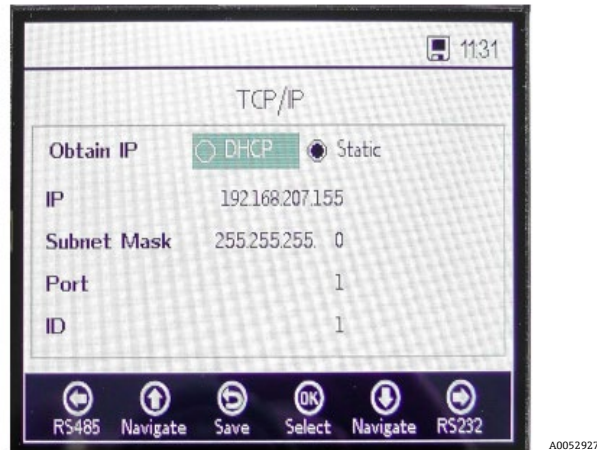

Figure 63. Digitals - TCP/IP settings

- If **DHCP** is selected, the IP and Subnet Mask will be assigned by the DHCP server and therefore are not editable.
- If **Static** is selected, the IP and Subnet Mask must be entered manually. Contact your local Network Administrator for assistance if input data needs to be confirmed.
- Port specifies the network port under which the Modbus application takes place. The default value for most Modbus applications is 502.
- The ID, which is used with the Modbus communication, can be set to any value between 1 and 32.

All settings are applied by clicking **Save**.

5.15 Analog output settings (Analogues) menu options

From the MAIN MENU, click **Analogues** to access the 4-20mA INTERFACE SETTINGS, 4-20mA VALUES, CONCENTRATION ALARM RELAY (LS2), and 4-20mA CALIBRATION screens.

5.15.1 4-20mA interface settings

The 4-20mA INTERFACE SETTINGS can be accessed through the ANALOGUES menu. When accessed, the following screen displays. Refer to Figure 64.

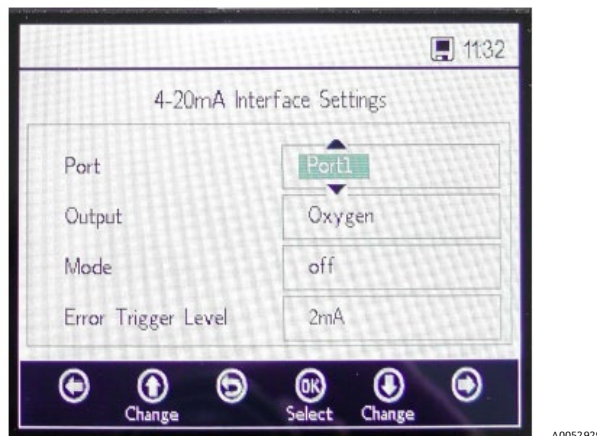

Figure 64. Analogues - 4-20mA interface settings

The Output, Mode, and Error Trigger Level settings will be applied to the selected port, which includes Port1, Port2, or the Input.

The error trigger level defines the port output in the event that the analyzer goes into an error state. No timestamp error (NTE) options exclude time stamp error caused by loss of power to the analyzer. This option is recommended for installations with unpredictable power supply to the analyzer. The Output of Port1 or Port2 can be oxygen or temperature.

The Input is always Pressure and cannot be changed.

The Mode of Port1 and Port2 can be set to one of the following:

- **Off:** No input reading or output writing.
- **Linear:** High and low value that has been set to correspond to 4mA and 20mA. Values between these two settings will be calculated linearly. Values outside this range will initiate the error trigger level.
- **Bilinear:** High, mid, and low value set to correspond to 4mA, 12mA, and 20mA respectively. This mode allows higher resolution in a certain range. Refer to Figure 65 for an example.

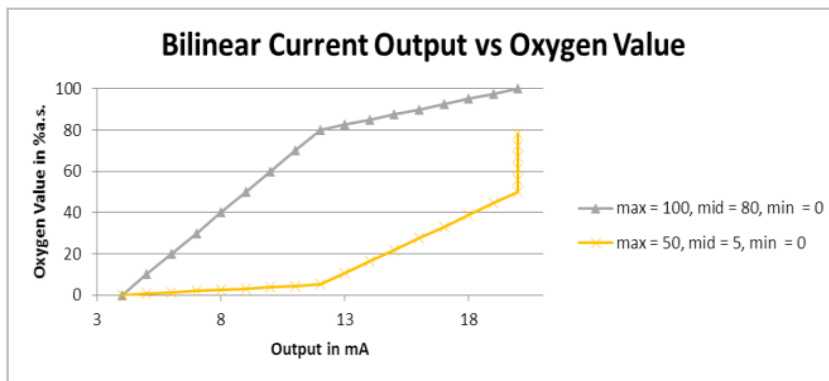

Figure 65. Bilinear current output vs oxygen value

A0052930

The first example (gray line) in Figure 65 shows high resolution in a low oxygen environment. The second example (yellow line) shows a high resolution in high oxygen environment. This also shows the behavior for measurement values that lie outside the value range (oxygen values over a maximum of 50 will be shown as 20mA).

In the event of any error, the Error Trigger Level (2mA or 22mA) will be applied to the currently selected port. For the input, any value outside the 4-20mA range will be interpreted as “not valid”.

5.15.2 4-20mA values

In the 4-20mA VALUES screen, enter the values that correspond to 4mA, 12mA, or 20mA depending on the currently selected mode.

Modes that can be selected include:

- **Off:** No values can be entered. Refer to Figure 66.
- **Linear:** The high and low value can be entered. Refer to Figure 67. The unit depends on the selected output and oxygen sensor. If the output is set to Temperature, the unit is always °C. Otherwise, the output depends on the oxygen sensor (the oxygen unit selected in the measurement screen will explicitly NOT be used):
 - OP-3: %O2
 - OP-6: %O2
 - OP-9: ppmv

The values will be used for calculating the output or input value on the next measurement.

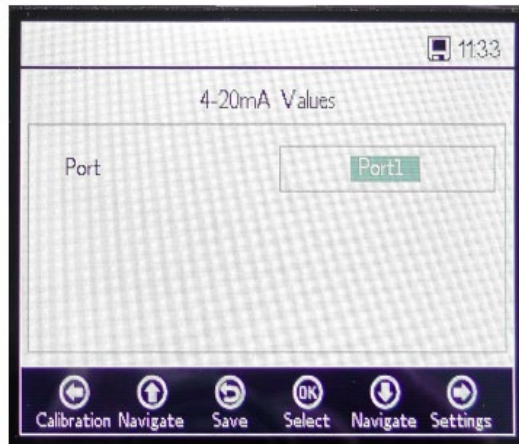

A0052931

Figure 66. Analogues - 4-20mA values for mode "Off"

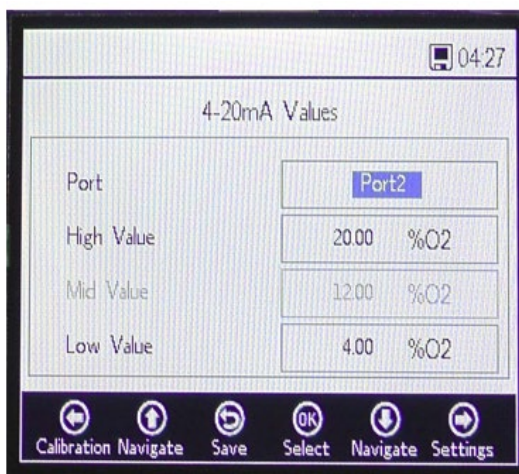

A0052932

Figure 67. 4-20mA values for mode "Linear"

- Bilinear:** The High Value, Mid Value, and Low Value can be entered. Refer to Figure 68. The units are the same as those used in Linear mode. The values will be used for calculating the output or input value on the next measurement.



A0052933

Figure 68. 4-20mA values for mode "Bilinear"

5.15.3 Concentration alarm relay

This screen is used to define the range of the concentration alarm relay (LS2). Refer to Figure 69. If the oxygen value is outside this range, the relay will be switched with low impedance and will trigger an error. Select the Alarm Low Level to enable or disable the setting.

The unit depends on the currently selected oxygen sensor:

- **OP-3:** %O₂
- **OP-6:** %O₂
- **OP-9:** ppmv



Figure 69. Analogues - Concentration alarm relay

5.15.4 4-20mA calibration

Use the 4-20mA CALIBRATION screen to calibrate the Output and Input. The analyzer is delivered in the calibrated state but can be calibrated to other devices in your measurement system.

⚠ CAUTION

- ▶ Factory calibration will be lost if the analyzer is re-calibrated.

5.15.5 Calibrating the output

Use the following procedure to calibrate the work flow for either Output 1 or Output 2. Refer to Figure 70.

1. Connect a current measurement device to the respective output. This will serve as the reference device.
2. Set the **1st Point** value to any low value, e.g., 4.00 mA. The value will be applied immediately.
Click **Apply** or enter another value.
3. Read the current value shown on the reference device, e.g., 3.90 mA.
Use the +/- symbols in the Adjust column next to the 1st Point value to adjust the values accordingly.
4. Set the **2nd Point** value to any high value, e.g., 20.00 mA. The value will be applied immediately.
Click **Apply** or enter another value.
5. Read the current value shown on the reference device, e.g., 19.54 mA.
Use the +/- symbols in the Adjust column next to the 2nd Point value to adjust the values accordingly.

Example: The analyzer shows a value of 19.54 mA and the value should be 20.00 mA. Click the button until the desired value is registered.

6. To test the calibration, apply some test points by selecting different percentage values, such as 0%, 25%, 50%, 75%, or 100%, which corresponds to 4mA, 8mA, 12mA, 16mA, and 20mA. Check the values with the reference device. If satisfied with the calibration, click **Save**.

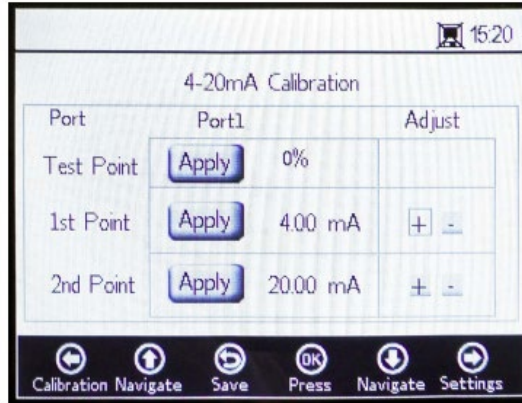

A0052935

Figure 70. Analogues - 4-20mA calibration

5.15.6 Calibrating the input

The procedure for calibrating the input is similar to the output procedure noted above. Use the following steps to calibrate the input. Refer to Figure 71.

1. Apply a low current to the OXY5500.
2. Enter this value in the Reference column in the 1st Point row.
3. Click the **Set** button next to the 1st Point when the reading is steady. The last measured value will be displayed in the top row next to the selected port.

NOTICE

- ▶ This value is the uncalibrated value that will be used as the 1st Point calibration value.

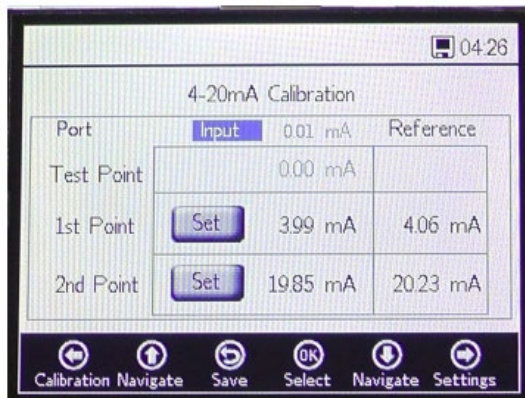

A0052936

Figure 71. Analogues - 4-20mA input calibration

4. Apply a higher value to the OXY5500.
5. Enter this value in the Reference column in the 2nd Point row.
6. Click **Set** next to the 2nd Point when the reading is steady.

NOTICE

- ▶ This value is the uncalibrated value that will be used as the 2nd Point calibration value.
7. The row Test Point displays the calibrated value, which is used for calculating the pressure value. This value should match the reference device value by less than 0.05mA.

6 Modbus communication

Modbus is a serial communications protocol published by Modicon in 1979 for use with its programmable logic controllers (PLCs). It has become a de facto standard communications protocol in industry and is now the most commonly available means of connecting industrial electronic devices. Modbus is used extensively in lieu of other communications protocols because it is openly published and royalty-free, relatively easy to deploy, and capable of moving raw bits or words without placing many restrictions on vendors.

This chapter covers the protocols, formats, and register data used to communicate with the OXY5500.

6.1 Protocol definition

6.1.1 General specification

The following general specifications apply to the Modbus protocol:

- The protocol is Modbus RTU conform.
- The protocol is a client-server arrangement with the host controller acting as the server and each individual module as a client.
- Each module on the bus needs to have a unique device ID (see register 4095).
- The device has no command buffer, so the host must always wait until the command is processed.
 - Read commands need 10ms processing time over RS-232 and RS-485 and 300ms over LAN.
 - After a write process, certain time consuming tasks are started. After a write process, a fixed timeslot of 150ms over RS-232 and RS-485 and 300ms over LAN after the transmitted response should be kept.
- RX Input Buffer is 256 bytes.
- A CRC16 error checking method is implemented. Starting value is 0xFFFF and polynomial type is 0xA001.
- Some registers are read only. When writing to those, a Modbus error 2 occurs (illegal data address). This also happens when 4 registers should be written, but the last 2 are read-only. No register will be changed afterward.
- All registers between 1023 and 5708 can be read, as there is no read-protection.

6.1.2 Function codes

Available public functions are

- **3:** Read Holding Registers
- **4:** Read Input Registers
- **16:** Write Multiple Registers

Please note that function codes 3 and 4 are fully interchangeable as they behave in the same way.

NOTICE

- ▶ Function code 16 may be used with broadcast (device ID = 0). Codes 3 and 4 may not be used with broadcast.

6.1.3 Data formats

6.1.3.1 Float

The Float refers to the floating point according to IEEE 754 (Single Precision). This format requires two registers obtaining 32 bit where each register contains the high byte in its first bit.

For example, if the float value is 20.56 (int32), represented as 0x41A47AE1 (hexaint32), it is written in two consecutive registers, where the first register is 3499. Therefore, the value must be transmitted in the following way:

Register	Value
Register 3499, high byte	0x7A
Register 3499, low byte	0xE1
Register 3500, high byte	0x41
Register 3500, low byte	0xA4

Table 8. Float values

6.1.3.2 Int32

All int32 values are 32 bit-wide integer values. The example given in the previous section applies here as well.

6.1.3.3 Character

The definition is as follows:

8 bit ASCII-Code table according to ISO-8859-1 (Latin-1 Western European)

NOTICE

- ▶ A register always holds exactly 2 characters. Unused bytes are filled with zeros (ASCII: 0x00).

6.1.3.4 Boolean

Boolean registers are 16bit int32 registers with only 0 and 1 as allowed values.

6.1.4 Error response

The error response follows the Modbus definition, but only four exception codes are implemented:

- **1 (Illegal function):** An unsupported function code was used.
- **2 (Illegal data address):** The requested register is either not available or write-protected.
- **3 (Illegal data value):** The value could not be set. The value was out of range. The last correct value will be restored.
- **6 (Slave device busy):** This code appears when there is an “active” USB connection (communication via software is active).

6.1.5 Different communication channels

The OXY5500 has multiple ways to read and set its settings and measurement values:

- Modbus Communication
 - RS-485
 - RS-232
- Ethernet
- USB Service Port
- Via keypad and LCD

All options share the same fundamental memory. Changing the settings via one communication channel will alter the expected result on another channel.

6.1.5.1 Recommendation

One channel should be used to set up the device completely. As the device will save every setting and allows immediate checking of the results, it is recommended to do this via keypad and LCD and to use the other channels as simple data-polling options.

NOTICE

- ▶ If there is a Service Software connected (via USB), the Modbus write command 16 (“Write multiple registers”) will always return error code 6.

6.1.6 Holding registers

Refer to the table for table register definitions. When reviewing the table, it is important to remember:

- The register addresses referred to in the table show the first address of multiple addresses available per register (see “Size” column for number of addresses per register). Do not add or subtract “1” from the first address register number as this could cause conflict with other register assignments.
- The analyzer does not check for correct ranges. The host must ensure that valid numbers are used. Any wrong value may lead to unexpected performance.

Register Name	Address	Size	Variable Type	Description	Write Access
Firmware Date	1023	8	Character	Firmware creation date, e.g., “2014-11-18\0\0” (November 18, 2014)	No
Firmware Version	1031	8	Character	Firmware version, e.g., „SSI v1.0.1.0287\0”	No
Serial Number	1063	8	Character	Serial number, e.g., „SAAP000000001\0\0”	No
Oxygen Unit	2089	2	Int32	The oxygen unit that displays on the LCD of the analyzer and also in measurement register 4909	Yes
Compensation Temperature	2411	2	Float	Sets the compensation temperature.	Yes
Interval Rate	3499	2	Mixed	Sets the oxygen measurement interval rate and also deactivates oxygen measurement. Range: 1 to 359999 seconds.	Yes
Device ID RS-485	4095	2	Int32	Sets the device ID that is used in Modbus RTU communication (range 1-32).	Yes
Device ID Minimum RS-485	4097	2	Int32	Device ID Address Limit: Minimum	No
Device ID Maximum RS-485	4099	2	Int32	Device ID Address Limit: Maximum	No
Baud rate RS-485	4101	2	Int32	Code for Baud rate where: 3 = 9600 4 = 19200 5 = 38400 6 = 57600 7 = 115200	Yes
Baud rate Minimum RS-485	4103	2	Int32	Minimum code for baud rate	No
Baud rate Maximum RS-485	4105	2	Int32	Maximum code for baud rate	No
Parity RS-485	4107	2	Int32	Parity for the RS-485 output where: 0x00 = Even Parity 0x01 = Odd Parity 0x02 = No Parity	Yes
Device ID RS-232	4109	2	Int32	Sets the device ID used in the Modbus RTU communication (range 1-32).	Yes
Device ID Minimum RS-232	4111	2	Int32	Device ID Address Limit: Minimum	No
Device ID Maximum RS-232	4113	2	Int32	Device ID Address Limit: Maximum	No
Baud Rate RS-232	4115	2	Int32	Code for baud rate where: 0x03 = 9600 0x04 = 19200 0x05 = 38400 0x06 = 57600 0x07 = 115200	Yes

Register Name	Address	Size	Variable Type	Description	Write Access
Baud Rate Minimum RS-232	4117	2	Int32	Minimum code for baud rate	No
Baud Rate Maximum RS-232	4119	2	Int32	Maximum code for baud rate	No
Parity RS-232	4121	2	Int32	Parity for the RS-232 output where: 0x00 = Even Parity 0x01 = Odd Parity 0x02 = No Parity2	Yes
4-20mA Port1 Output Interface	4359	2	Int32	Code for 4-20mA Port1 Output Mode where: 0x00 = Off 0x01 = Fixed 0x02 = Linear 0x04 = Bilinear	Yes
4-20mA Port1 Output Channel	4363	2	Int32	Code for 4-20mA Port1 Output Interface where: 0x01 = Oxygen 0x20 = Temperature	Yes
4-20mA Port1 Low Value	4377	2	Float	The 4mA output value.	Yes
4-20mA Port1 Mid Value	4379	2	Float	The 12mA output value, which is used in bilinear mode only.	Yes
4-20mA Port1 High Value	4381	2	Float	The 20mA output value.	Yes
4-20mA Port1 Fixed Value	4383	2	Float	In fixed output mode, this value is applied to the output. Unit is mA.	Yes
4-20mA Port1 Error Trigger Level Value	4389	2	Int32	Output current in the event of an error, where: 0x00 = 22mA 0x01 = 2mA 0x03 = 22mA NTE 0x04 = 2mA NTE	Yes
4-20mA Port1 Calibration Values	4329	8	Float	2 calibration values for a low point and a high point (each with a reference value and device output).	
4-20mA Port2 Output Interface	4945	2	Int32	Code for 4-20mA Port1 Output Mode where: 0x00 = off 0x01 = fixed 0x02 = linear 0x04 = bilinear	Yes
4-20mA Port2 Output Channel	4949	2	Int32/	Code for 4-20mA Port1 Output Interface where: 0x01 = Oxygen 0x20 = Temperature	Yes
4-20mA Port2 Low Value	4963	2	Float	The 4mA output value.	Yes
4-20mA Port2 Mid Value	4965	2	Float	The 12mA output value is only used in bilinear mode.	Yes
4-20mA Port2 High Value	4967	2	Float	The 20mA output value.	Yes
4-20mA Port2 Fixed Value	4969	2	Float	In fixed output mode, this value is applied to the output.	Yes

Register Name	Address	Size	Variable Type	Description	Write Access
4-20mA Port2 Error Trigger Level Value	4975	2	Int32	Output current in the event of an error, where: 0x00 = 22mA 0x01 = 2mA 0x03 = 22mA NTE 0x04 = 2mA NTE	Yes
4-20mA Port2 Calibration Values	4979	8	Float	Two calibration values for a low point and a high point, each with a reference value and device output.	Yes
4-20mA Input Interface	5633	2	Int32	This register is reserved for future use.	Yes
4-20mA Input Channel	5637	2	Int32	Code for 4-20mA Port1 Output Interface where: 0x02 = Pressure.3	No
4-20mA Input Low Value	5651	2	Float	The 4mA corresponding input value.	Yes
4-20mA Input Mid Value	5653	2	Float	The 12mA input value is only used in bilinear mode.	Yes
4-20mA Input High Value	5655	2	Float	The 20mA input value.	Yes
4-20mA Input Fixed Value	5657	2	Float	This register is reserved for future use.	Yes
4-20mA Input Error Trigger Level Value	5663	2	Float	This register is reserved for future use.	Yes
4-20mA Input Calibration Values	5667	8	Float	Two calibration values for a low and a high point, each with reference value and device output.	Yes
Measurement Values	4895	14	Mixed	Refer to <i>Measurement values</i> →  for details.	No
Sensor Constant f1	4911	2	Float	Sensor constant f1. Allowed range: 0.000 to 9.999	Yes
Sensor Constant dPhi1	4913	2	Float	Sensor constant dPhi1. Allowed range: -9.99999 to +9.99999	Yes
Sensor Constant dPhi2	4917	2	Float	Sensor constant dPhi2. Allowed range: -9.99999 to +9.99999	Yes
Sensor Constant dKSV1	4919	2	Float	Sensor constant dKSV1. Allowed range: -9.99999 to +9.99999	Yes
Sensor constant DKSV2	4921	2	Float	Sensor constant dKSV2. Allowed range: -9.99999 to +9.99999	Yes
Sensor Constant m	4923	2	Float	Sensor constant m. Allowed range: 0.00 to +999.99	Yes
Sensor Type	4925	2	Int32	Sensor Type where: 0x00 = OP-3 0x01 = OP-6 0x02 = OP-94	Yes
Manual Temperature Compensation	5611	1	Boolean	Activates the temperature measurement of the Pt100 sensor by setting and uses the manual temperature value by deleting this Boolean register. After writing this register, the manual temperature value has to be set (register 2411).	Yes
Cal0	5521	2	Float	Calibration value: Phase shift of low oxygen calibration point (Default: 59.9).	Yes
T0	5523	2	Float	Calibration value: Temperature at the low oxygen calibration point in °C (Default: 20.0).	Yes

Register Name	Address	Size	Variable Type	Description	Write Access
O2-2nd	5527	2	Float	Calibration value: Oxygen concentration of the high oxygen calibration point in the unit defined in register 5535 (O2-2nd Unit).	Yes
Cal-2nd	5529	2	Float	Calibration value: Phase shift of high oxygen calibration point (Default: 26.3).	Yes
T2nd	5531	2	Float	Calibration value: Temperature at the high calibration point in °C.	Yes
pATM	5533	2	Float	Calibration value: Pressure at the high oxygen calibration in mbar.	Yes
O2-2nd Unit	5535	2	Int32	The unit for the O2-2nd value, where: 0x4000.0000 = ppmv 0x0000.0010 = % O2	Yes
Ethernet Obtain IP Mode	5675	2	Int32	Activates or deactivates DHCP. Entering "1" will obtain IP automatically.	Yes
Ethernet IP	5677	8	Int32	The Ethernet IP. Each pair of registers holds one octet of the address. This register will only be used if register 5675 is set to "0" (DHCP off).	Yes
Subnet Mask	5685	8	Int32	The Subnet Mask. Each pair of registers holds one octet of the address. See "Ethernet subnet mask" on page 5-18 for details. This register will only be used if register 5675 is set to "0" (DHCP off).	Yes
Ethernet Port for Modbus	5693	2	Int32	The Ethernet Port used in the Modbus Protocol. (Default: 502)	Yes
Ethernet Modbus ID	5695	2	Int32	The Ethernet Modbus ID (range: 0 to 32).	Yes
Alarm Relay High Level	5697	2	Float	The High Level which triggers the Level Alarm Relay.	Yes
Alarm Relay Level Low	5699	2	Float	The Low Level which triggers the Level Alarm Relay.	Yes
Pressure Mode	5705	1	Boolean	Sets the measurement mode to either acquisition via 4-20mA or fixed value where: 0x00 = fixed value 0x01 = 4-20mA	Yes
Measurement Mode	5707	2	Int32	This is a bit-coded register to configure the measurement mode and to trigger the measurement start. Bit 0: Reserved. Bit 1: Read only. Set when a measurement is already active. Bit 2: Will perform a single scan.	Yes
Set Concentration Alarm Low Level	5709	2	Int32	Enables/disables the Low Level Alarm of the Concentration Alarm Relay: 0x00: Disable (Low Level is ignored) 0x01: Enable	Yes
LED Intensity	5711	2	Int32	The signal LED intensity. The allowed range is 0x00 (lowest) to 0x0A (highest)	Yes
Timestamp	8231	2	Int32	This is the current system time, defined as the number of seconds that have elapsed since 00:00:00, Thursday, 1 January 1970 (Unix time, ISO8601). NOTE: Values below 1493050000 will lead to error code "illegal value".	Yes

Table 9. Holding registers

6.1.7 Measurement control

Definition of register 5707

Start Register	Number of Registers	Reg3 / Reg4	Write Access
5707	2	Int32: Bit codes control register.	Yes

Table 10. Definition of register 5707

This register is used to activate interval measurement and also to trigger a measurement. It is bit-coded as shown in the table.

Bit	Description
0	Interval on/off (delete to turn off, set to turn on)
1	Status-Bit: Set when a measurement is currently performed. will be deleted after completing the measurement.
2	Start measurement (single scan or continuous)
3 - 31	Reserved

Table 11. Measurement control register bit definition

6.1.8 Compensation temperature

This value is used for compensation of the oxygen calculation.

Start Register	Number of Registers	Reg3 / Reg4	Write Access
2411	2	Float: Temperature value in °C	Yes

Table 12. Definition of register 2411

6.1.9 Measurement interval

The oxygen measurement interval can be set between 1 and 359999. Setting the interval to "0" will lead to Modbus error response with code 3.

The measurement values may be read any time but are updated only with the interval set in these registers. Hence, polling the measurement values in a higher rate than the measurement interval should be omitted as it leads to unnecessary traffic on the bus.

Start Register	Number of Registers	Reg3/Reg4	Write Access
3499	2	Int32: Interval value in seconds	Yes

Table 13. Definition of register 3499

6.1.10 Device ID RS-485, RS-232 and Ethernet

Sets the device ID used in the Modbus RTU communication. If a value over 32 is set, the device will reset its ID to 1, which may lead to communication errors. If no ID is set, or the ID is not known, set the ID via broadcast (ID=0).

Start Register	Number of Registers	Reg3/Reg4	Write Access
4095	2	Int32: Device ID of RS-485. Minimum 1, Maximum 32	Yes

Table 14. Definition of register 4095

Start Register	Number of Registers	Reg3/Reg4	Write Access
4109	2	Int32: Device ID of RS-232. Minimum 1, Maximum 32.	Yes

Table 15. Definition of register 4109

Start Register	Number of Registers	Reg3/Reg4	Write Access
5695	2	Int32: Device ID of Ethernet. Minimum 1, Maximum 32.	Yes

Table 16. Definition of register 5695

6.1.11 Measurement values

Start Register	# of Registers	Reg1/ Reg2	Reg3/ Reg4	Reg5/ Reg6	Reg7/ Reg8	Reg9/ Reg10	Reg11/ Reg12	Reg13/ Reg14	Write Access
4895	14	Float: Pressure in mbar	Float: Reference Amplitude in mV	Float: Oxygen Amplitude in mV	Float: Oxygen Phase shift in degrees	Float: Temperatu re in °C	Float: Oxygen Value defined in register 2089	Int32: Error Register.	No

Table 17. Definition of register 4895

NOTICE

- It is not necessary to read out all 14 registers. For simple applications, reading out registers 9 to 14 (starting with Register 4903) may be all that is required.

Bit	2N Value	Error
0	1	No RTD (Pt100)
1	2	No sensor selected
2	4	Amplitude too low
3	8	SD card defect
4	16	Reference amplitude out of range
5	32	Photo diode saturated
6	64	Signal overflow
7	128	Signal overflow
8	256	Reserved
9	512	Critical error.
10	1024	No pressure sensor / pressure sensor out of range
11	2048	Reserved
12	4096	Storage space full

Table 18. Error codes for the error register

6.1.12 4-20mA port1 calibration values

All values are transmitted in mA.

Start Register	# of Registers	Reg1/Reg2	Reg3/Reg4	Reg5/Reg6	Reg7/Reg8	Write Access
4329	8	Float: Device Value Low Point	Float: Reference Value Low Point	Float: Device Value High Point	Float: Reference Value High Point	Yes

Table 19. Definition of register 4329

6.1.13 4-20mA port2 calibration values

All values are transmitted in mA.

Start Register	# of Registers	Reg1/Reg2	Reg3/Reg4	Reg5/Reg6	Reg7/Reg8	Write Access
4979	8	Float: Device Value Low Point	Float: Reference Value Low Point	Float: Device Value High Point	Float: Reference Value High Point	Yes

Table 20. Definition of register 4979

6.1.14 4-20mA input calibration values

All values are transmitted in mA.

Start Register	# of Registers	Reg1/Reg2	Reg3/Reg4	Reg5/Reg6	Reg7/Reg8	Write Access
5667	8	Float: Device Value Low Point	Float: Reference Value Low Point	Float: Device Value High Point	Float: Reference Value High Point	Yes

Table 21. Definition of register 5667

6.1.15 Analog input and output value ranges

The values that define the range of the analog outputs/inputs (Low, Mid, and High Values of Analog Port1 and 2, and Analog Input) always use the units shown in the table.

Output	Unit	Sensor/Condition
Oxygen	% O2	OP-3
Oxygen	% O2/ppm gas	OP-6
Oxygen	ppm gas	OP-9
Temperature	°C	Always
Pressure	Mbar	Always

Table 22. Oxygen units for various output, sensor, and measurement mode configuration

NOTICE

- ▶ Endress+Hauser recommends deactivating the current measurement before changing any settings. The device will hold its last analog output value until the next measurement.

6.1.16 Ethernet IP

Start Register	# of Registers	Reg1/Reg2	Reg3/Reg4	Reg5/Reg6	Reg7/Reg8	Write Access
5677	8	Int32: Ethernet IP Octet 1	Int32: Ethernet IP Octet 2	Int32: Ethernet IP Octet 3	Int32: Ethernet IP Octet 4	Yes

Table 23. Definition of register 5677

Example:

Writing the following bytes:

0x 01 10 16 2D 00 08 10 00 C0 00 00 00 A8 00 00 00 01 00 00 00 0A 00 00 1F B1 will result in the IP 192.168.1.10

In detail:

0x 01 Slave address (int32 "01")
 0x 10 Function Code
 0x 16 2D Starting Address (5677 in int32 representation)
 0x 00 08 Quantity of registers
 0x 00 C0 00 00 Octet 1 (int32 192)
 0x 00 A8 00 00 Octet 2 (int32 168)
 0x 00 01 00 00 Octet 3 (int32 1)
 0x 00 0A 00 00 Octet 4 (int32 10)
 0x 1F B1 CRC16

6.1.17 Ethernet subnet mask

Start Register	# of Registers	Reg1/Reg2	Reg3/Reg4	Reg5/Reg6	Reg7/Reg8	Write Access
5685	8	Int32: Ethernet Subnet Mask Octet 1	Int32: Ethernet Subnet Mask Octet 2	Int32: Ethernet Subnet Mask Octet 3	Int32: Ethernet Subnet Mask Octet 4	Yes

Table 24. Definition of register 5685

6.2 Examples

6.2.1 Configuration of a continuous measurement

Precondition: Sensor is connected, and sensor constants and calibration values are already set up correctly (OP-9).

The goal for this configuration is a continuous measurement with a 1-minute interval with the pressure sensor and RTD (Pt100) are deactivated. Instead, a manual fixed value will be transmitted. Refer to the table.

Step	Description	Register(s)	Value
1	Stop the measurement, if it is running.	5707, 5708	0 (Int32)
2	Set pressure mode to "Manual".	5705	0 (Boolean)
3	Set manual pressure to "1006.23".	3147, 3148	1006.23 (Float)
4	Set temperature mode to "Manual".	5611	0 (Boolean)
5	Set manual temperature to "20.56".	2409, 2410	20.56 (Float)
6	Set the interval rate to 1 min. ("60" seconds).	3499, 3500	60 (Int32)
7	Activate the interval mode and start the continuous measurement immediately.	5707, 5708	5 (Int32 translates to 00000101 binary)
8	Read measurement control register. If bit 1 is deleted, see step 9. If bit 1 is set or the display has timed out, repeat step 7 until value shows '0' (max. 400 ms after which time-out detection should be implemented).	5707, 5708	/
9	Read out the last measurement.	4895 to 4908	Refer to the table.
10	Read out the oxygen unit.	2089, 2090	1073741824 (Int32 translates to 0x40000000 hex, meaning

Table 25. Configuration for a continuous measurement

Register 4895/4896	Register 4897/4898	Register 4899/4900	Register 4901/4902	Register 4903/4904	Register 4905/4906	Register 4907/4908
Float: Pressure in mbar	Float: Reference Amplitude mV	Float: Oxygen Amplitude in mV	Float: Oxygen Phase shift in degrees	Float: Temperature in °C	Float: Calculated Oxygen Value in unit	Int32: Error Register (refer to the table)
1006.23	35000.00 (a value between 10 and 60000)	10562.12 (Sensor and environment dependent value)	44.32 (Sensor and environment dependent value)	20.56	100 (Sensor and environment dependent value)	0 (Error code. Should be 0 if a sensor is connected)

Table 26. Reading measurement example

6.2.2 Configuration of an analog output

- **Precondition:** Sensor is connected, and sensor constants and calibration values are already set up correctly (OP-9). 4-20mA Output is already in a calibrated state.

The goal for this configuration is to set up the analog output 1 for a linear oxygen value output between 10 and 110 ppm gas, with an error level of 2mA.

Step	Description	Register(s)	Value
1	Deactivate the current measurement, otherwise the output may generate false values.	5707, 5708	0 (Int32)
2	Set the Mode to "linear".	4359, 4360	2 (Int32)
3	Set the Output to "oxygen".	4363, 4364	1 (Int32)
4	Set the Error Level to "2mA".	4389, 4390	2 (Int32)
5	Set the Low Level to "10.00".	4377, 4378	10.00 (Float)
6	Set the High Level to "110.00".	4381, 4382	110.00 (Float)

Table 27. Configuration for an analog output

NOTICE

- ▶ The oxygen value does not have to be set. This is done automatically when setting the sensor type.

6.2.3 1-Point calibration of an OP-9 sensor

- **Precondition:** Sensor is connected and put in a low oxygen environment. Sensor constants are already set correctly (OP-9).

The goal for this example is to calibrate the oxygen sensor.

Step	Description	Register(s)	Value
1	Read the current measurement values.	4899 to 4908	Refer to the able.
2	Check to confirm there are no errors, especially error bits 1, 2, 4, 5, and 6. Refer to the table. Proceed only when there are no errors present.		
3	Set the calibration values cal0 and T0.	5521 to 5524	1st Float: 66.32 2nd Float: 21.98

Table 28. 1-Point calibration of a OP-9 sensor

Register 4899/4900	Register 4901/4902	Register 4903/4904	Register 4905/4906	Register 4907/4908
Float: Oxygen Amplitude in mV	Float: Oxygen Phase shift in degrees	Float: Temperature in °C	Float: Calculated Oxygen Value in unit	Int32: Error Register. Refer to the table.
50592.62 (Sensor and environment dependent value)	66.32 (Sensor and environment dependent value)	21.98	This value can be ignored while calibration process takes place.	0 (Error code. Should be 0 if a sensor is connected)

Table 29. Measurement reading for calibration process example

7 Appendix A: Specifications

Application Data			
Target Components	O2		
Principle of Measurement	Fluorescent Quenching		
	OP-9	OP-6	OP-3
Typical Measurement Ranges	0 to 200 ppmv (default) 0-10 to 10-1,000 ppmv User setting	0 to 5 % 0-1 to 0-5 % User setting	0-20 % 0-10 to 0-20 % User setting
Lower Limit of Detection	0.5 ppmv	20 ppmv	300 ppmv
Accuracy at 20 to 25 °C	±5% of Reading	±3% of Reading	±2% of Reading
Repeatability	±1% of Reading		
Measurement Update Time	Programmable Sampling Rate (default 30 seconds)		
Temperature Range (Configurable)	1) 0 °C to 60 °C (0 °F to 140 °F) 2) -20 °C to 50 °C (-4 °F to 122 °F)		
Sample Inlet Pressure	140 to 275 KPaG (20 to 40 PSIG) to sample panel regulator		
Sample Pressure Range	800 to 1400 mbara		
Maximum Probe Pressure	275 KPaG (40 PSIG)		
Sample Flow Rate	Typical 1.0 SLPM (2.1 SCFH)		
Recommended Calibration	Two-point calibration in oxygen-free environment (nitrogen) and a second span point (cylinder gas). Validate with O2 in N2 reference (cylinder gas).		
Electrical & Communications			
Input Power (Voltage and Max. Power)	AC 108 to 253 V, 50/60 Hz; 5.3W at AC 120 V; 6.6W at AC 240 V or DC 9 to 30 V (CSA), 18 to DC 30 V (IEC/ATEX); 4.7 W at DC 24 V		
Communication	<ul style="list-style-type: none"> ▪ Analog: Qty 2) 4-20mA sourcing power outputs and (1) 4-20 mA input (sample pressure) ▪ Fieldbus: RS-232C, RS-485, Ethernet 10/100 with Modbus ▪ Output Relays: Qty (2) 250 mA max load (Concentration and Fault Alarms) USB 2.0 works with Service Software only 4 GB Internal Memory with Internal Data Logging		
LCD Display	Concentration, Temperature, Sample Rate, Data Logging, Diagnostics, plus Full Menu for Setup, Calibration, etc.		
Service Software	<ul style="list-style-type: none"> ▪ Windows software. ▪ Connected via USB port. ▪ Download data logs, trend and monitor, calibrate and troubleshoot. 		
Physical			
Enclosure Type	Type 4X and IP66 rated, 304 and 316 (optional) Stainless Steel		
Analyzer Dimensions	280 x 230 x 114 mm (11 x 9 x 4.5 in.) H X W x D (not including Sample Conditioning System)		
Controller to Probe Cable Length	0.7 m (2.3 ft.) - Standard 2.5 m (8.2 ft.) and 5.0 m (16.4 ft.) - Optional		
Weight	2.2 Kg (4.9 lbs) - analyzer without sample conditioning system 14 kg (31 lbs) - analyzer on a panel 35.4 (78 lbs) - analyzer in enclosure		
Sample Probe Construction	316 Stainless Steel		
Area Classification - Certification	CSA: Class I, Div. 2, Groups A, B, C, and D, T3, NEMA 4X ATEX/IECEX/UKEX:  II 3 G, Ex ec IIC T3 Gc IP66 NOTE: Certification applies to the analyzer only. The enclosure versions of this product are considered accessories for the product and not included as part of the certification.		

Table 30. OXY5500 analyzer specifications

CAUTION

- ▶ Probe assemblies and other such equipment required for analyzer operation must meet with all manufacturer specifications.

7.1 Technical notes

- **ANALYZER ENCLOSURE:** The enclosure and fittings are designed for IP66/Type 4X ratings. In order to maintain this rating, all connections must be made with proper hardware and adhering to suggested procedures. Use of incorrect materials can compromise the integrity of the environmental seals.

NOTICE

- ▶ For a complete listing of new or updated certificates, please visit the product page at www.endress.com.

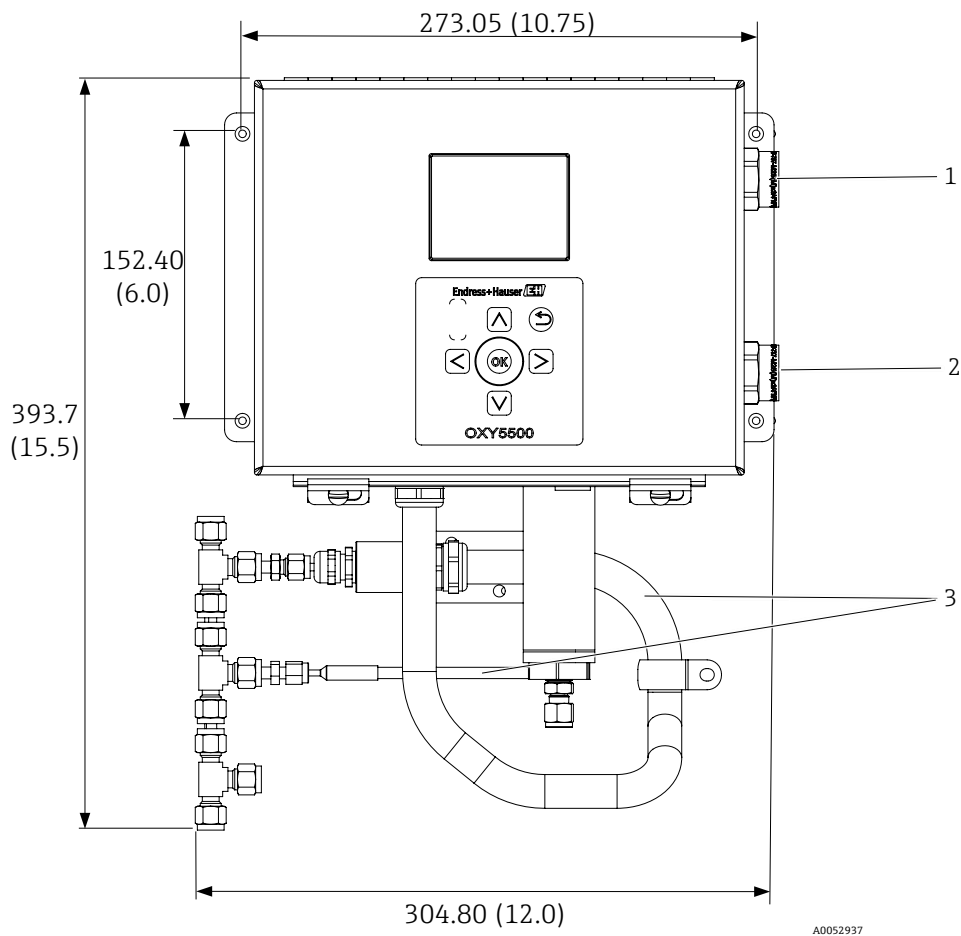

Figure 72. Outline and mounting dimensions - panel mount. Dimensions: mm(in)

#	Description
1	Communication signal connections
2	Power connections
3	Conduit and armor routing (for illustrative purposes only)

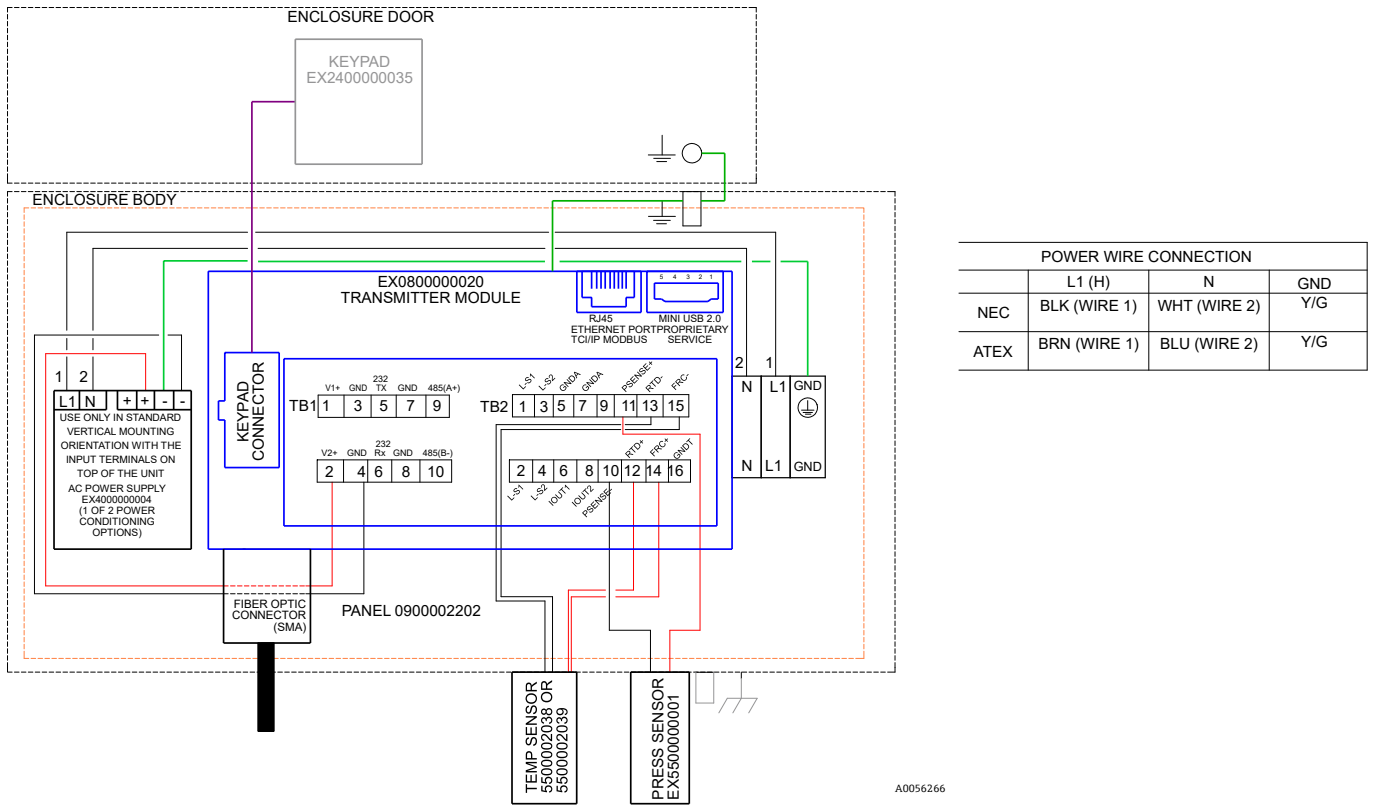

Figure 73. Interconnect diagram (AC)

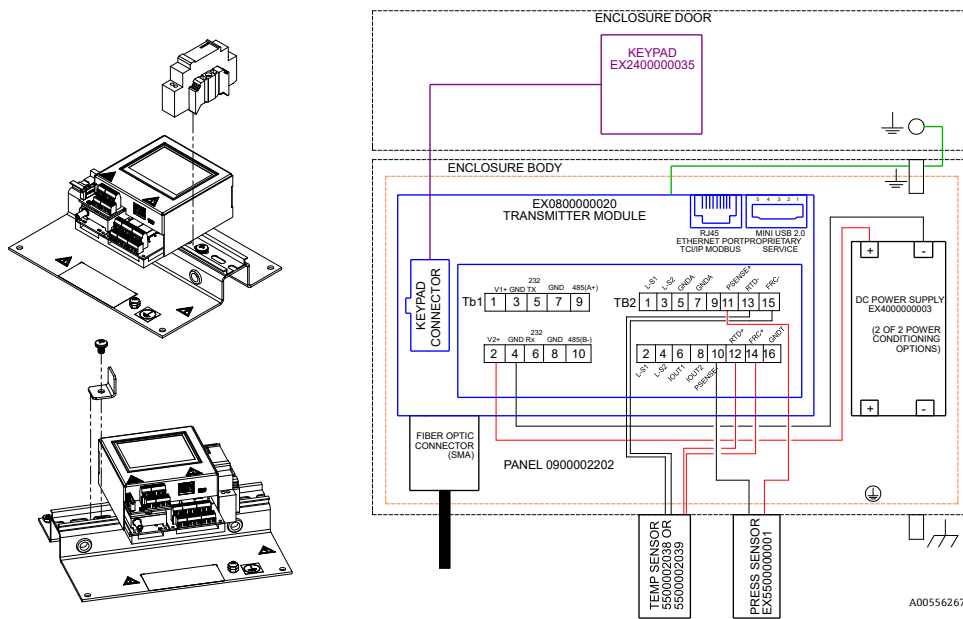

Figure 74. Interconnect diagram (DC)

7.2 Spare parts

Below is a list of spare parts for the OXY5500 Optical oxygen analyzer with recommended quantities for 2 years of operation. Not all parts listed are included on every analyzer. When ordering, please specify the system serial number to ensure that the correct parts are identified.

Part Number	Description	2 YR QTY
Electronics Assembly Components		
70157019	Window, Enclosure	–
70157020	Window Gasket, Enclosure	–
70175074	OXY5500 Display	–
70175071	Replacement Kit, Transmitter, OXY5500	–
EX4000000004	Power Supply, Module, AC 100-240 V to DC 24 V 1.3A	1
70157025	Power Supply, DC/DC Conv., 15W, 24V, DIN	1
70157026	Cartridge Fuse, 216 Series, 5 x 20mm, Fast Act 800 mA, 250V	1
70178487	Communication Board	–
Optical Fiber Probes and Installation Accessories		
70163999	Optical Fiber Assembly, OP-9 Sensor Probe, 1000ppm, 0.7 m, SMA	1
70164000	Optical Fiber Assembly, OP-9 Sensor Probe, 1000ppm, 2.5 m, SMA	1
70164001	Optical Fiber Assembly, OP-9 Sensor Probe, 1000ppm, 5.0 m, SMA	1
70164002	Optical Fiber Assembly, OP-6 Sensor Probe, 5%, 0.7 m, SMA	1
70164003	Optical Fiber Assembly, OP-6 Sensor Probe, 5%, 2.5 m, SMA	1
70164004	Optical Fiber Assembly, OP-6 Sensor Probe, 5%, 5.0 m, SMA	1
70164005	Optical Fiber Assembly, OP-3 Sensor Probe, 20%, 0.7 m, SMA	1
70164006	Optical Fiber Assembly, OP-3 Sensor Probe, 20%, 2.5 m, SMA	1
70164007	Optical Fiber Assembly, OP-3 Sensor Probe, 20%, 5.0 m, SMA	1
70164008	OXY5500 Fiber Probe Conduit Kit (all lengths) (includes all parts associated with fiber probe installation)	–
70157039	Front Ferrule, 4 mm, Teflon	–
70157040	Back Ferrule, 4 mm, Teflon	–
70157041	Tube Reducer, 4 mm TX 1/4 TSTUB, BT, SS	–
Temperature Probes and Installation Accessories		
70157042	RTD Probe, 100 W, 1/8 x 2, SS ARM, 40 in. LG	–
70157043	RTD Probe, 100 W, 1/8 x 2, SS ARM, 10 in. LG	–
70157044	Tube Reducer, 1/8 TX 1/4 TA, SS, Bored	–
70164009	OXY5500 Temperature Sensor Kit (0.7 m) (includes temperature sensor and all parts associated with installation)	–
70164010	OXY5500 RTD Probe Kit (2.5 m, 5.0 m) (includes temperature sensor and all parts associated with installation)	–
Pressure Transmitter and Installation Accessories		
70157047	Pressure Transmitter	1
70157048	Male Connector, 1/4 TFX, 1/4 MNPT, 316SS	–
70164011	OXY5500 Pressure Sensor Kit (includes pressure sensor and all parts associated with installation)	–

Part Number	Description	2 YR QTY
General		
BA02195C	OXY5500 Operating Instruction, additional copies	–
BA02196C	OXY5500 Sample Conditioning System (SCS) Operating Instruction, additional copies	–
XA02754C	OXY5500 Safety instruction, additional copies	–
SD02868C	OXY5500 Service Software Operation Instruction, additional copies	–
70157051	Cable, USB, 2.0A to Mini-B 5 Pin, 28/28 AW, 6 Ft.	–

Table 31. Replacement parts for OXY5500 analyzer

8 Appendix B: Maintenance and troubleshooting

The OXY5500 is a maintenance-free instrument, although some components may need cleaning or replacement. This chapter contains instruction for cleaning, replacement, and general troubleshooting information.

8.1 Optical output

The SMA connector is a high precision optical component. For optimal performance, keep it dry and clean. Always use the rubber cap to close the output when not in use.

8.2 Cleaning the instrument

The housing should be cleaned only with a moist cloth to avoid electro-static discharge.

8.2.1 SMA-fiber connector

The SMA-fiber connector of the sensor can be cleaned only with a lint-free cloth. The sensor tip may be rinsed only with distilled water or ethanol.

⚠ CAUTION

- ▶ Never use benzene, acetone, isopropyl alcohol, or other organic solvents to clean the sensor tip.

8.2.2 Oxygen probe

The sensor tip can be cleaned as needed. Use caution when using this cleaning procedure to avoid removing the protective coating and causing possible damage.

Tools and materials

- Ethanol (or equivalent)
- Clean container
- Lint-free wipes



NOTICE

- ▶ This procedure applies to the OP-3, OP-6, and OP-9 probes.

⚠ CAUTION

- ▶ Never use benzene, acetone, isopropyl alcohol, or other organic solvents to clean the sensor tip.

8.2.3 Cleaning the oxygen probe

1. Remove the probe from the analyzer. Refer to *Removing the oxygen probe* → .
2. Pour enough ethanol into a clean container to cover the probe tip when submerged.
3. Submerge probe tip into container with ethanol.
Leave the probe tip submerged for 5 to 30 minutes depending on amount of visible contaminant.
4. Remove probe from container.
5. Place lint-free wipe on flat surface and gently tap the probe tip against the wipe to remove excess liquid and any contaminant residue.
Repeat steps 3 to 5 if contaminant is still visible on the probe tip.
6. Replace oxygen probe in the analyzer. Refer to *Installing the new oxygen probe* → .
7. Recalibrate analyzer. Refer to *Calibrating the analyzer* → .

8.3 Temperature probe lifespan

The temperature probe is estimated to last as long as the analyzer itself, therefore does not require replacement.

8.4 Fuse replacement

Use the following instructions to replace a fuse. Refer to Figure 2 for the fuse location.

8.4.1 Replacing the fuse

1. Turn off power to the analyzer and open the enclosure door using a standard flathead screwdriver to unlatch the lock.
2. Using a flat-head screwdriver (or comparable), remove the cover from the fuse enclosure. Refer to the figure.

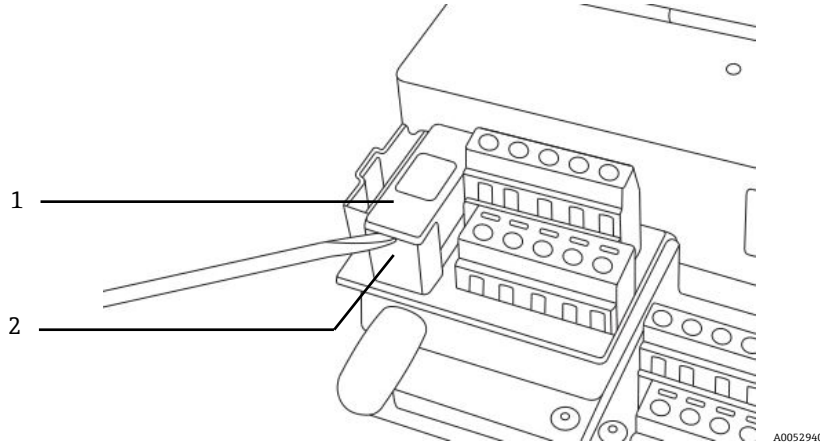

Figure 75. Removing the fuse cover

#	Description
1	Fuse cover
2	Fuse enclosure

3. Lift the fuse cover off and turn it over. The fuse is held in the slot in the cover.
4. Remove the fuse from the fuse cover. Refer to Figure 76.

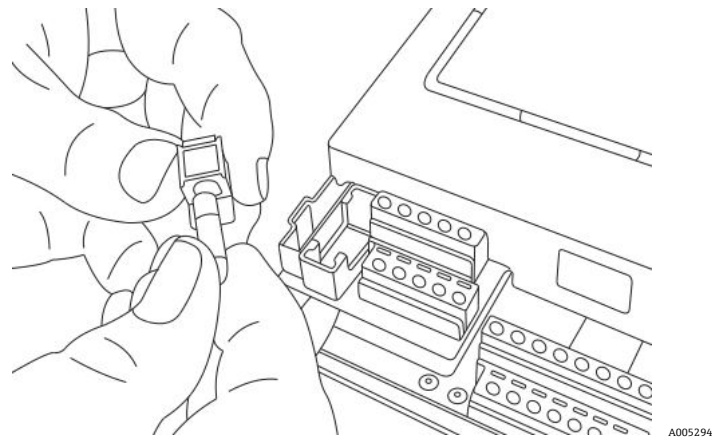

Figure 76. Removing the fuse

5. Replace the expired fuse with a new fuse.
6. Turn the fuse cover over (fuse side down) and place onto the fuse enclosure.
7. Snap fuse cover onto fuse enclosure.

CAUTION

- ▶ Use only the same type and rating of fuse for replacements. Refer to the specifications listed in the table.

Description	Rating
Cartridge fuse, 216 Series, 5 x 20 mm, Fast Act	800 mA, 250 V

Table 32. Fuse specifications

8.5 Replacing the electro-optical module

Use the following procedure to replace and install the electro-optical module in the OXY5500 analyzer.

NOTICE

- ▶ Drawings shown in this instruction are used to provide a clearer illustration of the required steps only. DO NOT REMOVE the base plate from the analyzer enclosure to complete this instruction.

8.5.1 Required tools and hardware

- Flathead screwdriver
- Philips screwdriver
- Electro-optical module (P/N EX0800000020)

8.5.2 Removing the electro-optical module

1. Turn off power to the analyzer and open the enclosure door using a standard flathead screwdriver to unlatch the lock.
2. Disconnect the ribbon cable from the keypad and set aside.
3. Disconnect the probes, power supply, and pressure sensor from the terminal blocks, as necessary. Refer to *Installation* → .
4. Insert a flathead screwdriver in the clip extension at the top of the electro-optical module as shown in Figure 77.

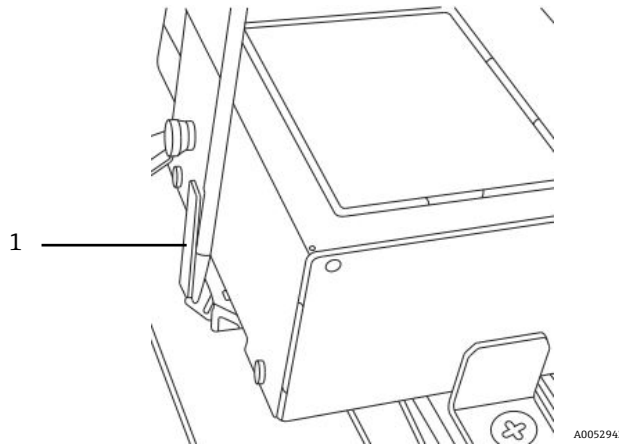

Figure 77. Inserting screwdriver into clip extension (1)

5. Press down on the corner of the electro-optical module and hold.
6. With the screwdriver, press down on the clip extension and away from the top of the module. Refer to Figure 78. The electro-optical module should pop up.

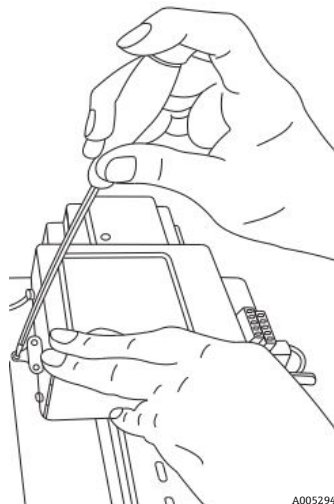

Figure 78. Disconnecting the electro-optical module from the DIN rail

7. Tilt the electro-optical module forward and lift away from the DIN rail.
8. Remove the ground cable from the module.

Using the Philips screwdriver, remove the screw and cable. Refer to Figure 79.

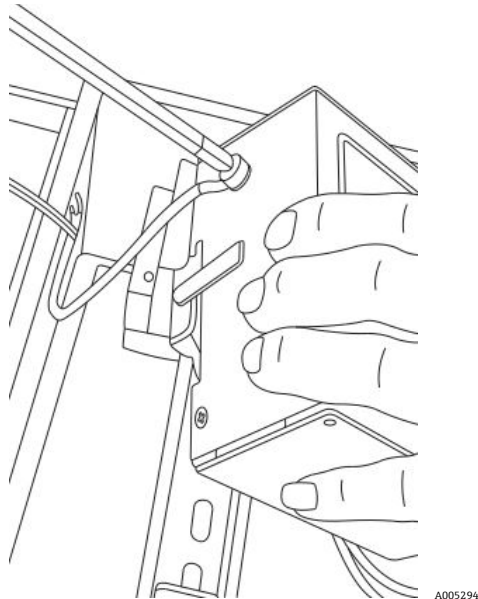

Figure 79. Removing the ground cable



9. Remove the electro-optical module from the enclosure and set aside.

8.5.3 Replacing the electro-optical module

1. Connect the ground cable to the replacement module.
2. Position the electro-optical module above the DIN rail and snap down into place.
3. Re-wire the terminal blocks as shown in Figure 73 or Figure 74.
4. Re-connect the probe.
5. Re-connect the ribbon cable to the keypad.
6. Close the analyzer enclosure door.

8.6 Installing/replacing the pressure sensor

The pressure sensor is optional on the OXY5500 analyzer. Use this procedure to install or replace the pressure sensor.

Refer to the procedure called *Installing the pressure sensor* →  and *Spare parts* →  for the pressure sensor kit part number to install this option.

8.6.1 Required tools

- Flathead screwdriver (standard size and mini)
- 9/16 in. open-ended wrench
- Adjustable wrench
- 10 in. crescent wrench

8.6.2 Removing the pressure sensor

1. Turn off the power to the analyzer and open the enclosure door using a standard flathead screwdriver to unlatch the lock.
2. With a 9/16 in. wrench, loosen the Swagelok nut closest to the pressure sensor.
3. Using the same wrench, loosen the Swagelok nut on the T-fitting. Refer to Figure 80.

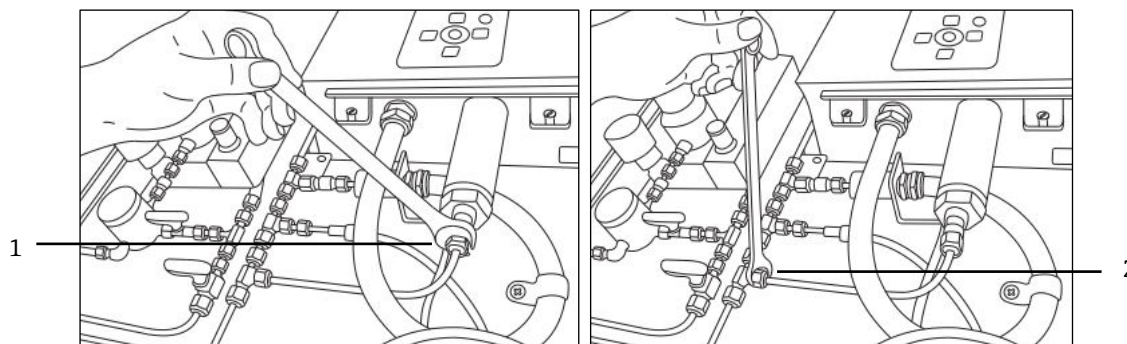

Figure 80. Removing the Swagelok nuts

A0052945
A0052946

#	Description
1	Pressure Sensor Nut
2	T-Fitting Nut

4. Remove the tubing between the pressure sensor and T-fitting. Refer to Figure 81.

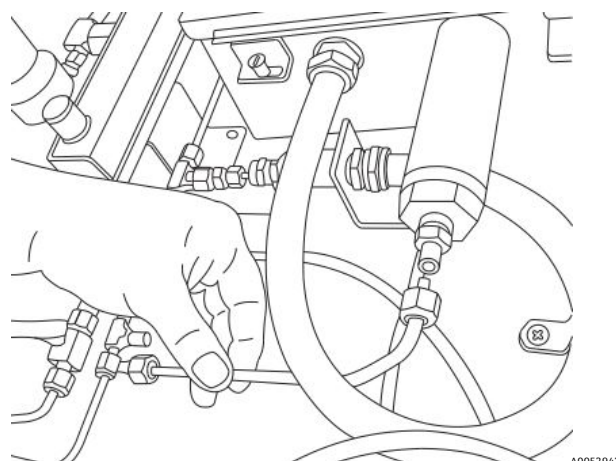

Figure 81. Removing the tubing

A0052947

5. Loosen both hinge screws from the OXY5500 analyzer enclosure and open the door.
6. Disconnect the red and black wires labeled “psens-” and “psens+” from terminal block TB2 using the mini screwdriver as shown in Figure 82.

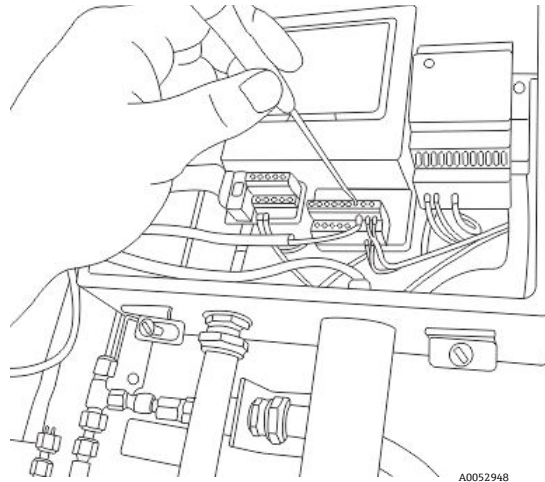

Figure 82. Removing the wiring

7. Hold the pressure sensor using the crescent wrench to secure the hex nut on the external end.
8. Loosen the panel mount nut from the pressure sensor on the inside of the enclosure with the adjustable wrench. Refer to Figure 83.

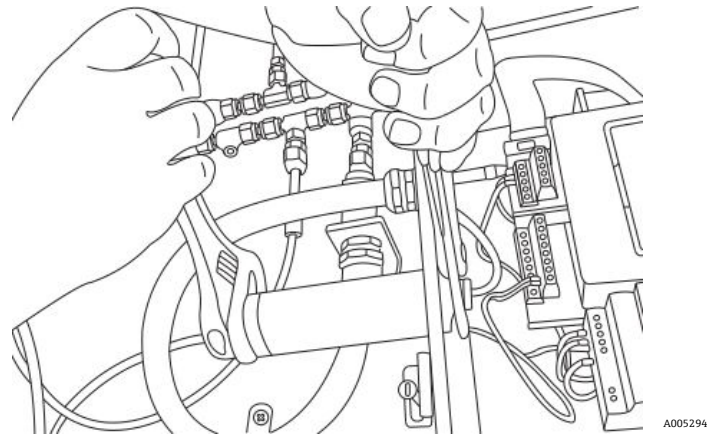

Figure 83. Removing the pressure sensor

9. Remove the panel nut with fingers and extract the pressure sensor from the enclosure. Leave the green sealing washer in place.

8.6.3 Installing the pressure sensor

1. Remove the new pressure sensor from the bag and insert into the opening with the green sealing washer with the same orientation as the one removed.
2. Secure the panel nut to the top of the pressure sensor inside the OXY5500 enclosure. Tighten the panel nut sufficiently to avoid possible leaks from entering the analyzer enclosure.
3. Connect the pressure sensor wiring as shown in Figure 73 or Figure 74.
4. Close the OXY5500 enclosure door and secure with the hinge screws.
5. Connect the pressure sensor tubing to the pressure sensor using the Swagelok nut.
6. Connect the tubing to the T-fitting using the Swagelok nut.
7. Tighten the Swagelok nuts at both ends of the tubing until tubing is secure.
8. Close the SCS enclosure cover.

8.7 Removing and replacing the oxygen probe

Use the following instructions to remove and replace an oxygen probe on the OXY5500.

8.7.1 Tools/parts

- OXY5500 replacement oxygen probe
Refer to *Spare parts* →  for a complete list of replaceable probe parts and part numbers.
- Adjustable Crescent wrench
- Philips screwdriver
- 5/32 in. Hex driver
- 7/16 in. Open-end wrench
- 1/2 in. Open-end wrench

8.7.2 Removing the oxygen probe

1. Purge the analyzer by allowing 99.9999% pure nitrogen flow through the system for 30 minutes.
2. Shut off gas flow to the analyzer.
3. Turn off power to the analyzer.
4. Loosen the enclosure screws and remove the clamps to open the enclosure door.
5. Using an adjustable wrench, loosen the cable gland cap on the panel by turning “up” toward the analyzer. Do not remove cable gland cap. Refer to Figure 84.

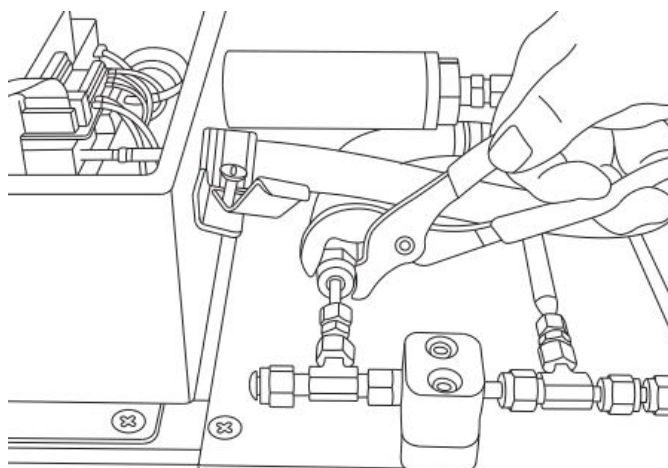

Figure 84. Loosen the cable gland cap

A0052950

6. Remove the tube nut on the panel using a 1/2 in. open-end wrench turning “down” away from the analyzer. Refer to Figure 85.

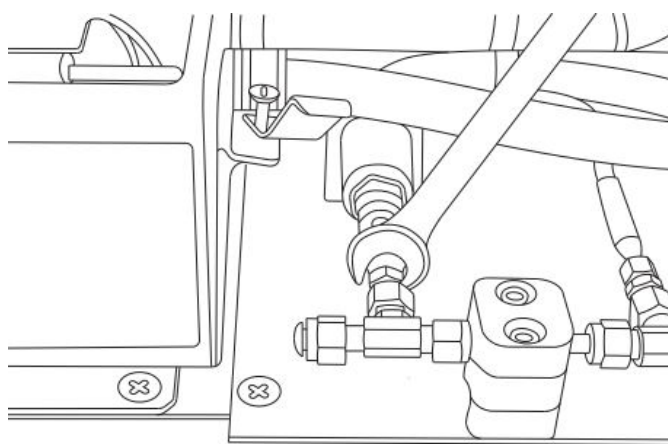

Figure 85. Remove tube nut

A0052951

7. Remove the conduit bracket screws (x2) with a 5/32 in. Hex driver. Refer to Figure 86.

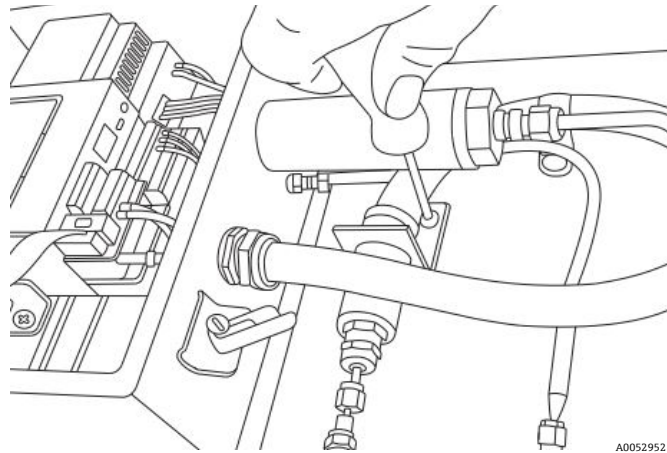

Figure 86. Remove conduit bracket

8. Remove the conduit clamp screw with a Philips screwdriver. Refer to Figure 87.

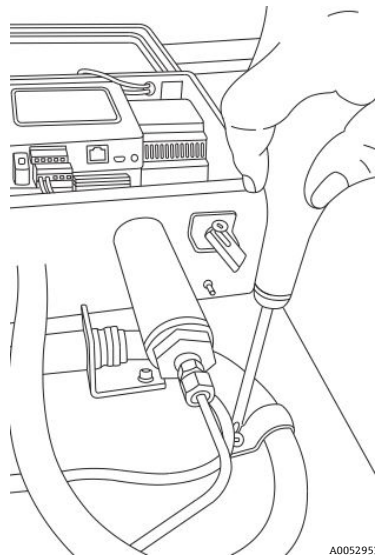

Figure 87. Remove conduit clamp

9. Turn the conduit bracket parallel to the panel and carefully disengage the probe from the Tee union (panel side). Refer to Figure 88.

⚠ CAUTION

- ▶ Take care not to disturb the temperature probe while removing the oxygen probe conduit.

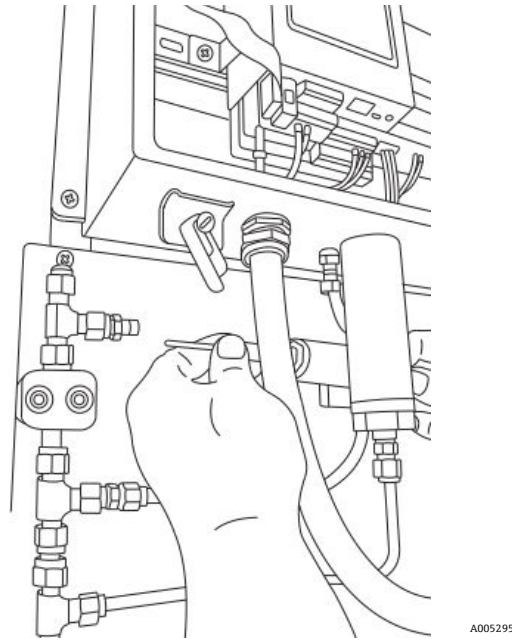

Figure 88. Remove probe from tee union (panel side)

10. Extend the probe conduit away from the panel and remove the fittings from the probe tip (panel side). Refer to Figure 89.

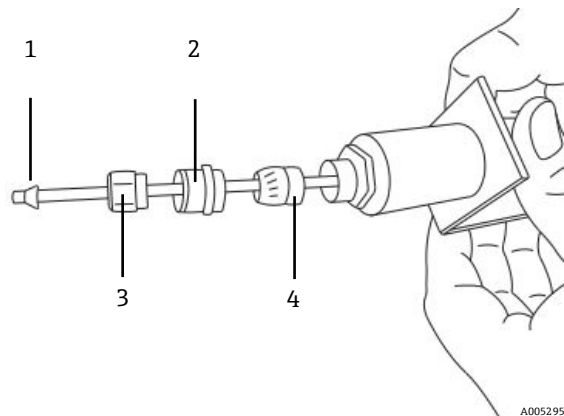

Figure 89. Fittings on oxygen probe (panel side)

#	Description
1	Plastic Ferrule
2	Cable Gland Cap
3	Tube Nut
4	Cable Gland

CAUTION

- ▶ Take care to safely set aside the tube nut, cable gland cap, and plastic ferrules for use with the replacement probe.

11. Loosen the connector nut on the probe at the SMA connector inside the analyzer enclosure. Refer to Figure 90.

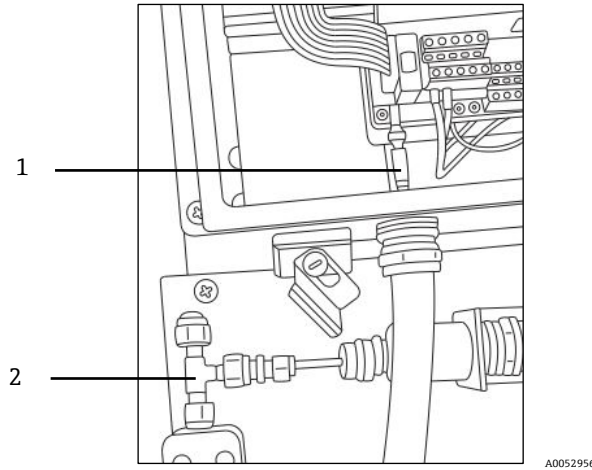

Figure 90. Remove connector nut (analyzer side)

#	Description
1	Oxygen Probe and SMA Connector Nut
2	Tee Union

12. Carefully pull the probe out through the conduit and discard.

8.7.3 Installing the new oxygen probe

1. Carefully remove the protective plunger from the end of the probe (analyzer side), taking care not to touch the optical fiber tip. Refer to Figure 91.

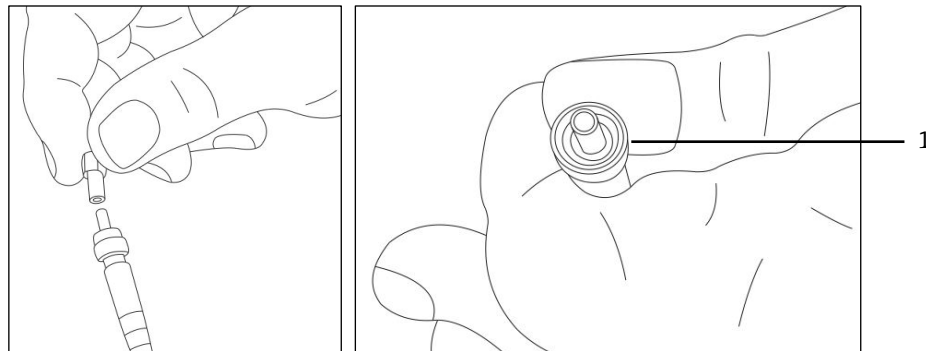

Figure 91. Preparing the new oxygen probe with the fiber optic tip (1)

2. Feed the new probe through the conduit with the SMA connector end entering first.

CAUTION

▶ Touching the optical fiber tip will cause damage to the probe.

3. Insert the probe tip into the SMA connector and tighten the connector nut. Refer to Figure 91.

CAUTION

▶ Take care not to bump the probe tip against the sides of the opening or damage will occur.

4. Remove the red safety cap from the probe tip (panel side). Refer to Figure 92.

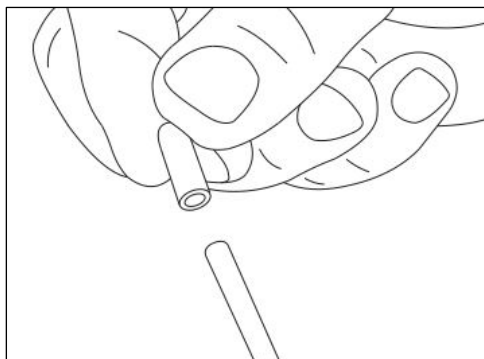

A0052959



Figure 92. Remove probe safety cap (analyzer side)

5. Re-install fittings onto probe tip (panel side).

CAUTION

- ▶ Ensure plastic ferrules are properly installed.
6. Route conduit so that probe end (panel side) is aligned with the Tee union.
 7. Insert the probe tip (panel side) into the Tee union.
 8. Connect the conduit bracket with screws (x2) using a 5/32 in. Hex driver.
 9. Connect the conduit clamp with screw using a Philips screwdriver.
 10. Tighten the tube nut on the probe tip (panel side).
 11. Secure the cable gland cap with the adjustable wrench.

CAUTION

- ▶ Do not overtighten the cable gland cap.
12. Close the analyzer enclosure cover and secure with clamps.
 13. Perform a leak test on the analyzer. Refer to *Service* → .
 14. Calibrate the analyzer. Refer to *Calibrating the analyzer* → .

8.8 Correcting error codes

If a signal overflow error is received, follow the steps below to resolve the error.

8.8.1 High signal strength: Low O₂ or no O₂ on OP-3, OP-6, or OP-9 probe

1. Decrease the LED intensity of the O₂ probe by single increments.
2. Refer to *Device settings screen* →  for more information on LED Intensity settings.

8.8.2 Low signal strength: High O₂ on OP-3, OP-6, or OP-9 probe

1. Increase the LED intensity of the O₂ probe by single increments.
2. Refer to *Device settings screen* for more information on LED Intensity settings.

8.9 Recommendations for correct measurement

Calibration of the sensor is recommended before each new application. As an alternative, the calibration values of the last measurement can be used. If temperature compensation is not used, ensure that the temperature of the sample is known and is constant during measurement. With temperature compensated measurements, the temperature sensor Pt100 (RTD probe) should be positioned as close as possible to the oxygen sensor to avoid temperature differences.

8.9.1 Signal drifts due to oxygen gradients

It is important to remember that the sensor only measures the oxygen content near its surface. The formation of a bio-film during long-term measurements, or the accumulation of other sample components like oil or solid substances, may lead to an oxygen gradient.

8.9.2 Signal drifts due to temperature gradients

A further source of imprecise measurement is insufficient temperature compensation. If temperature compensation is used, ensure that no temperature gradients exist between the oxygen sensor and the temperature sensors. If measurement is conducted without temperature compensation, bear in mind that the OXY5500 only measures correctly if the sample temperature is constant during measurement and the temperature is the same as the entry at the beginning of the measurement. A temperature measurement error of ± 0.3 °C will result in a measurement error of about $\pm 1\%$ of reading. The temperature probe provided with the unit has excellent precision, but large gas temperature gradients will result in an offset between the oxygen probe and temperature probe. To avoid an offset, ensure that the gas temperature has been stabilized prior to passing over the oxygen probe. SCS systems provided by Endress+Hauser are designed to ensure that this is not a problem.

8.9.3 Signal drift due to photo-decomposition

The oxygen-sensitive material may be subject to photo-decomposition resulting in a signal drift. Photo-decomposition takes place only during illumination of the sensor tip and depends on the intensity of the excitation light. Therefore, the excitation light should be minimized. Continuous illumination of a OP-3 oxygen sensor over a period of 24 hours may lead to a phase drift of up to $+ 0.4\%$ of reading at 20 °C. However, this effect of photo-decomposition can be minimized by changing the measuring mode to the 30-second or minute interval mode. In these modes, the software switches off the excitation light after recording the data point and switches it on after the interval chosen. Use the interval method whenever possible to increase the operational life of the sensor. Refer to the table below.

Name	Drift per 3600 Points	Drift per 50000 Points	Drift per 100000 Points
OP-3	<0.15% air-sat.	<0.15% air-sat.	<0.25% air-sat.
OP-6	<1 ppb	<2 ppb	< 3 ppb



Table 33. Sensor drift at zero reading (0 ppb) recording 3,600, 50,000 and 100,000 data points

8.10 Performance improvement

To improve the performance over past measurements, check the calibration values by using the calibration test gases for “0” (UHP nitrogen 99.9999%), and the Span test gas (100 ppm oxygen/N₂). This can be completed by using a 3-way valve connected to the test gas enabling the user to switch back and forth between bottles. This can assist in verifying proper operation.

8.11 Troubleshooting

Refer to the table for frequently asked questions related to troubleshooting the OXY5500 before contacting the service department. To contact the service department, refer to “Service” in the next section.

Indication	Suspected Cause	Solution
No Sensor detected!	Amplitude < 1000	Make sure that the SMA connector is connected properly to the connector.
Signal too low!	Amplitude < 3000	Check sensor connections or POF for any irregularities. Refer to <i>Low signal strength: High O₂ on OP-3, OP-6, or OP-9 probe</i> →  .
Signal Overflow!		Refer to <i>High signal strength: Low O₂ or no O₂ on OP-3, OP-6, or OP-9 probe</i> →  .
Critical Error 16!	Reference signal exceeds specified range	Refer to “Service”.
No Pt100!	Pt100 sensor has wrong cable or is broken	Check temperature sensor connection.
Critical Error 512!	Measurement system defect	Refer to “Service”.
SD Card Error!	SD card cannot be read or it cannot be written on	Refer to “Service”.
Pressure Sensor out of range!	Pressure sensor is either not connected or provides a current less than 4mA or higher than 20mA	Check the pressure sensor and its connection.
Flash Error!	Writing on Flash was not successful	Refer to “Service”.

Indication	Suspected Cause	Solution
Storage space full!	No more measurement files can be created and no more measurement entries can be saved.	Delete measurement files via Measurement Browser or Service Software.

Table 34. Potential instrument problems and their solutions

8.12 Service

For Service, refer to our website (<https://endress.com/contact>) for the list of local sales channels in your area.

To return the unit for service or replacement, refer to "Service repair order".

8.12.1 Before contacting tech support

Before contacting Technical Services, prepare the following information to send with your inquiry:

- Contact information
- Description of the problem or questions

Access to the information above will greatly expedite our response to your technical request.

8.12.2 Service repair order

If returning the unit is required, obtain a Service Repair Order (SRO) Number from Customer Service before returning the analyzer to the factory. Your service representative can determine whether the analyzer can be serviced on site or should be returned to the factory. All returns should be shipped to:

11027 Arrow Rte.
 Rancho Cucamonga, CA 91730-4866
 United States of America
www.endress.com

8.12.2.1 Renewity returns

Returns can also be made inside the USA through the Renewity system. From a computer, navigate to <https://endress.com/returns> and complete the online form.

8.13 Packing and storage

Endress+Hauser's OXY5500 analyzers and auxiliary equipment are shipped from the factory in appropriate packaging. Depending on the size and weight, the packaging may consist of a cardboard-skinned container or a wooden crate. All inlets and vents are capped and protected when packaged for shipment.

If the equipment is to be shipped or stored for any length of time, it should be packed in the original packaging when shipped from the factory. If the analyzer has been installed and/or operated (even for purposes of a demonstration), the system should first be decontaminated (purged with an inert gas) before powering down the analyzer.

8.13.1 Preparing the analyzer for shipment or storage

1. Shut off the process gas flow.
2. Allow all residual gas to dissipate from the lines.
3. Connect a purge supply, regulated to the specified sample supply pressure, to the sample supply port.
4. Confirm that any valves controlling the sample flow effluent to the low pressure flare or atmospheric vent are open.
5. Turn on the purge supply and purge the system to clear any residual process gases.
6. Turn off the purge supply.
7. Allow all residual gas to dissipate from the lines.
8. Close any valves controlling the sample flow effluent to the low pressure flare or atmospheric vent.
9. Disconnect power to the system.
10. Disconnect all tubing and signal connections.

11. Cap all inlets and outlets to prevent foreign material such as dust or water from entering the system).
12. Pack the equipment in the original packaging in which it was shipped, if available. If the original packaging material is no longer available, the equipment should be adequately secured to prevent excessive shock or vibration.
13. If returning the analyzer to the factory, complete the Decontamination Form provided by Endress+Hauser (refer to "Service repair order") and attach to the outside of the shipping package as instructed before shipping.

8.14 Storage

The packaged analyzer should be stored in a sheltered environment that is temperature controlled between -20 °C (4 °F) and 70 °C (158 °F) and should not be exposed to direct sun, rain, snow, condensing humidity, or corrosive environments.

8.15 Disclaimers

Endress+Hauser accepts no responsibility for consequential damages arising from the use of this equipment. Liability is limited to replacement and/or repair of defective components.

This manual contains information protected by copyright. No part of this guide may be photocopied or reproduced in any form without prior written consent from Endress+Hauser.

8.16 Warranty

For a period of 18 months from date of shipment or 12 months in operation, whichever comes first, Endress+Hauser warrants that all products sold by it must be free from defects in material and workmanship under normal use and service when correctly installed and maintained. Endress+Hauser's sole liability and Customer's sole and exclusive remedy for a breach of warranty is limited to Endress+Hauser's repair or replacement (at Endress+Hauser's sole option) of the product or part thereof which is returned at Customer's expense to Endress+Hauser's plant. This warranty must apply only if Customer notifies Endress+Hauser in writing of the defective product promptly after the discovery of the defect and within the warranty period. Products may only be returned by Customer when accompanied by a return authorization reference number (SRO) issued by Endress+Hauser. Freight expenses for products returned by Customer will be prepaid by Customer. Endress+Hauser must pay for shipment back to Customer for products repaired under warranty. For products returned for repair that are not covered under warranty, Endress+Hauser's standard repair charges must be applicable in addition to all shipping expenses.

www.addresses.endress.com
