

Operating Instructions

Cerabar PMP43

4-20mA HART

Process pressure measurement



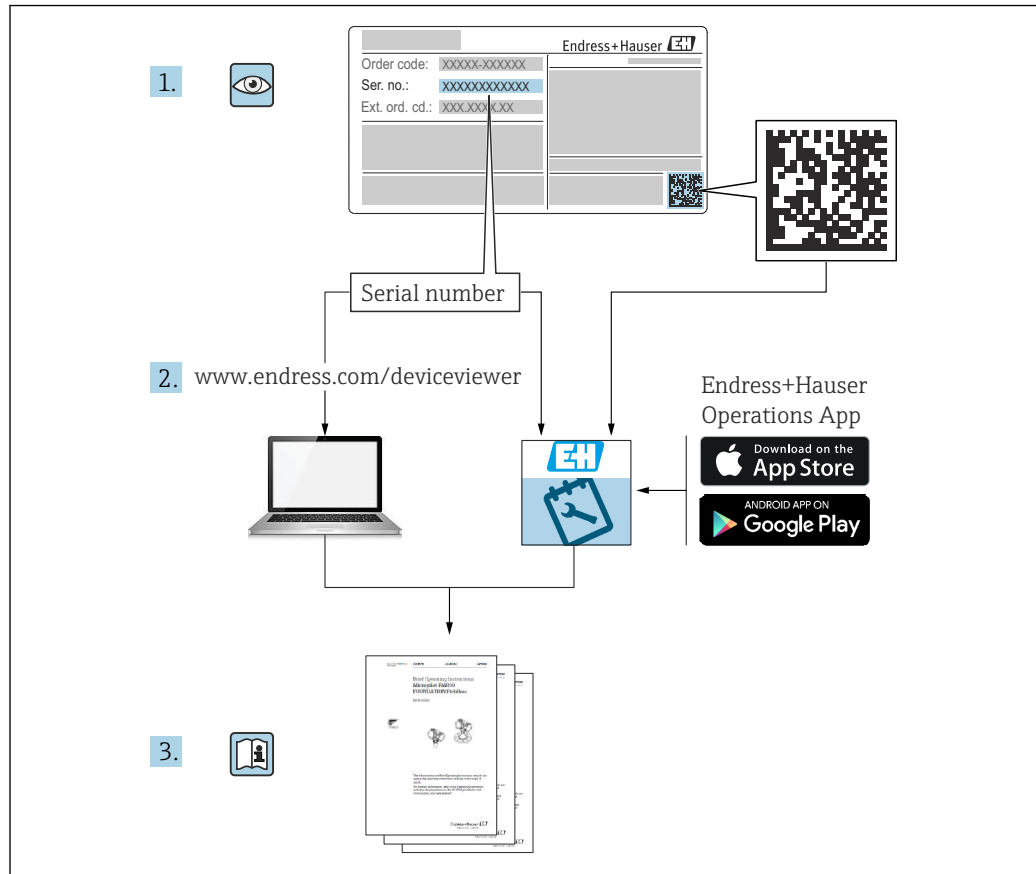

A0023555

- Make sure the document is stored in a safe place such that it is always available when working on or with the device
- Avoid danger to individuals or the facility: read the "Basic safety instructions" section carefully, as well as all other safety instructions in the document that are specific to working procedures

The manufacturer reserves the right to modify technical data without prior notice. The Endress+Hauser sales organization will supply you with current information and updates to these instructions.

Table of contents

1	About this document	5	9	Commissioning	24
1.1	Document function	5	9.1	Preliminaries	24
1.2	Symbols	5	9.2	Installation and function check	24
1.3	List of abbreviations	6	9.3	Overview of commissioning options	24
1.4	Turn down calculation	7	9.4	Commissioning via LED display operating key	24
1.5	Documentation	8	9.5	Commissioning via onsite display	25
1.6	Registered trademarks	8	9.6	Commissioning via FieldCare/DeviceCare	25
2	Basic safety instructions	8	9.7	Commissioning via additional operating tools (AMS, PDM, etc.)	26
2.1	Requirements for the personnel	8	9.8	Configuring the device address via software ..	26
2.2	Intended use	8	9.9	Configuring the operating language	26
2.3	Occupational safety	9	9.10	Configuring the device	27
2.4	Operational safety	9	9.11	Protecting settings from unauthorized access	31
2.5	Product security	9	10	Operation	31
2.6	IT security	10	10.1	Reading off the device locking status	31
2.7	Device-specific IT security	10	10.2	Reading off measured values	31
3	Product description	11	10.3	Adapting the device to process conditions	32
3.1	Product design	11	10.4	Heartbeat Technology (optional)	32
4	Incoming acceptance and product identification	11	10.5	Proof test for WHG devices (optional)	32
4.1	Incoming acceptance	11	10.6	Displaying the measured value history	32
4.2	Product identification	12	10.7	Sensor calibration	33
4.3	Storage and transport	12	11	Diagnostics and troubleshooting ...	33
5	Mounting procedure	13	11.1	General troubleshooting	33
5.1	Mounting requirements	13	11.2	Diagnostic information on operating status LED	35
5.2	Orientation	13	11.3	Diagnostic information on onsite display	36
5.3	Post-mounting checks	13	11.4	Diagnostic event in the operating tool	37
6	Electrical connection	14	11.5	Adapting the diagnostic information	37
6.1	Connecting the device	14	11.6	Pending diagnostic messages	37
6.2	Ensuring the degree of protection	16	11.7	Diagnostic list	37
6.3	Post-connection check	16	11.8	Event logbook	40
7	Operation options	16	11.9	Resetting the device	41
7.1	Overview of operation options	16	11.10	Device information	42
7.2	Structure and function of the operating menu	16	11.11	Firmware history	42
7.3	Access to operating menu via LED display	17	12	Maintenance	42
7.4	Access to operating menu via onsite display ..	19	12.1	Maintenance work	42
7.5	Onsite display, locking or unlocking procedure	20	13	Repair	43
7.6	Access to the operating menu via the operating tool	20	13.1	General notes	43
8	System integration	22	13.2	Return	43
8.1	Overview of device description files	22	13.3	Disposal	43
8.2	Measured variables via HART protocol	22	14	Accessories	44
			14.1	Device-specific accessories	44
			14.2	DeviceCare SFE100	44
			14.3	FieldCare SFE500	45
			14.4	Device Viewer	45

14.5	Field Xpert SMT70	45
14.6	Field Xpert SMT77	45
14.7	SmartBlue app	45
15	Technical data	46
15.1	Input	46
15.2	Output	47
15.3	Environment	49
15.4	Process	52
Index	54

1 About this document

1.1 Document function

These Operating Instructions contain all the information required in the various life cycle phases of the device: from product identification, incoming acceptance and storage, to installation, connection, operation and commissioning, through to troubleshooting, maintenance and disposal.

1.2 Symbols

1.2.1 Safety symbols

 DANGER

This symbol alerts you to a dangerous situation. Failure to avoid this situation will result in serious or fatal injury.

 WARNING

This symbol alerts you to a potentially dangerous situation. Failure to avoid this situation can result in serious or fatal injury.

 CAUTION

This symbol alerts you to a potentially dangerous situation. Failure to avoid this situation can result in minor or medium injury.

NOTICE

This symbol alerts you to a potentially harmful situation. Failure to avoid this situation can result in damage to the product or something in its vicinity.

1.2.2 Communication-specific symbols

Bluetooth®: 

Wireless data transmission between devices over a short distance.

1.2.3 Symbols for certain types of Information

Permitted: 

Procedures, processes or actions that are permitted.

Forbidden: 

Procedures, processes or actions that are forbidden.

Additional information: 

Reference to documentation: 

Reference to page: 

Series of steps: [1.](#), [2.](#), [3.](#)

Result of an individual step: 

1.2.4 Symbols in graphics

Item numbers: 1, 2, 3 ...

Series of steps: [1.](#), [2.](#), [3.](#)

Views: A, B, C, ...

1.3 List of abbreviations

PN

Nominal pressure

DTM

Device Type Manager

Operating tool

The term "operating tool" is used in place of the following operating software:

- FieldCare / DeviceCare, for operation via HART communication and PC
- SmartBlue app for operation using an Android or iOS smartphone or tablet

PLC

Programmable logic controller (PLC)

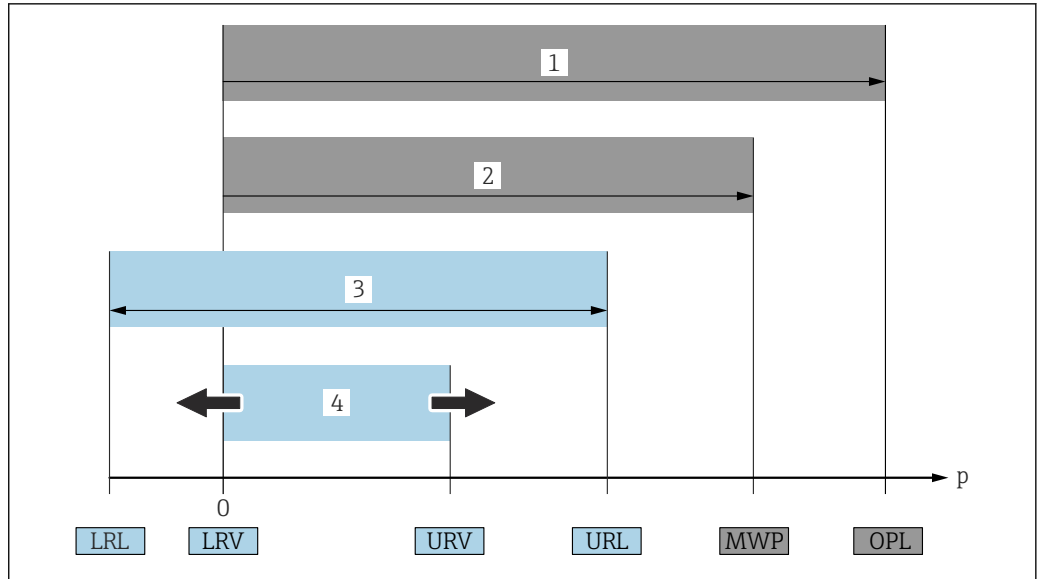

A0029505

- 1 OPL: The OPL (overpressure limit = measuring cell overload limit) for the device depends on the lowest-rated element, with regard to pressure, of the selected components, i.e. the process connection must be taken into consideration in addition to the measuring cell. Pay attention to the pressure-temperature dependency. The OPL may only be applied for a short period of time.
 - 2 MWP: The MWP (maximum working pressure) for the measuring cells depends on the lowest-rated element, with regard to pressure, of the selected components, i.e. the process connection also has to be taken into consideration besides the measuring cell. Pay attention to the pressure-temperature dependency. The maximum working pressure may be applied at the device for an unlimited period of time. The maximum working pressure can be found on the nameplate.
 - 3 The maximum measuring range corresponds to the span between the LRL and URL. This measuring range is equivalent to the maximum span that can be calibrated/adjusted.
 - 4 The calibrated/adjusted span corresponds to the span between the LRV and URV. Factory setting: 0 to URL. Other calibrated spans can be ordered as customized spans.
- p Pressure
 LRL Lower range limit
 URL Upper range limit
 LRV Lower range value
 URV Upper range value
 TD Turn down Example - see the following section.

1.4 Turn down calculation

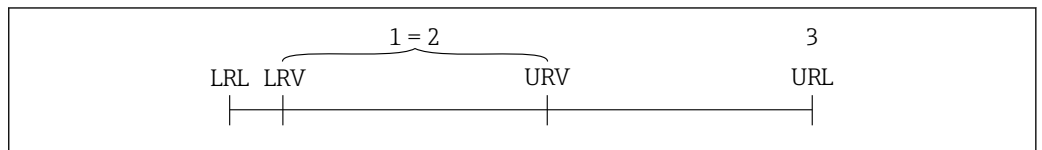

A0029545

- 1 Calibrated/adjusted span
- 2 Zero point-based span
- 3 Upper range limit

Example:

- Measuring cell: 10 bar (150 psi)
- Upper range limit (URL) = 10 bar (150 psi)
- Calibrated/adjusted span: 0 to 5 bar (0 to 75 psi)
- Lower range value (LRV) = 0 bar (0 psi)
- Upper range value (URV) = 5 bar (75 psi)

$$TD = \frac{URL}{|URV - LRV|}$$

In this example, the TD is therefore 2:1. This measuring span is based on the zero point.

1.5 Documentation

 For an overview of the scope of the associated Technical Documentation, refer to the following:

- *Device Viewer* (www.endress.com/deviceviewer): Enter the serial number from the nameplate
- *Endress+Hauser Operations app*: Enter serial number from nameplate or scan matrix code on nameplate.

1.6 Registered trademarks

Apple®

Apple, the Apple logo, iPhone, and iPod touch are trademarks of Apple Inc., registered in the U.S. and other countries. App Store is a service mark of Apple Inc.

Android®

Android, Google Play and the Google Play logo are trademarks of Google Inc.

Bluetooth®

The *Bluetooth*® word mark and logos are registered trademarks owned by the Bluetooth SIG, Inc. and any use of such marks by Endress+Hauser is under license. Other trademarks and trade names are those of their respective owners.

HART®

Registered trademark of the FieldComm Group, Austin, Texas USA

2 Basic safety instructions

2.1 Requirements for the personnel

The personnel for installation, commissioning, diagnostics and maintenance must fulfill the following requirements:

- ▶ Trained, qualified specialists must have a relevant qualification for this specific function and task.
- ▶ Are authorized by the plant owner/operator.
- ▶ Are familiar with federal/national regulations.
- ▶ Before starting work, read and understand the instructions in the manual and supplementary documentation as well as the certificates (depending on the application).
- ▶ Follow instructions and comply with basic conditions.

The operating personnel must fulfill the following requirements:

- ▶ Are instructed and authorized according to the requirements of the task by the facility's owner-operator.
- ▶ Follow the instructions in this manual.

2.2 Intended use

The Cerabar is a pressure transmitter for measuring level and pressure.

Incorrect use

The manufacturer is not liable for harm caused by improper or unintended use.

Avoid mechanical damage:

- ▶ Do not touch or clean device surfaces with pointed or hard objects.

Clarification for borderline cases:

- ▶ For special fluids and fluids for cleaning: Endress+Hauser is glad to provide assistance in verifying the corrosion resistance of fluid-wetted materials, but does not accept any warranty or liability.

Residual risks

During operation, the housing can heat up to 80 °C (176 °F) due to heat transfer from the process and power loss in the electronics. When in operation, the sensor can reach a temperature close to the medium temperature.

Danger of burns from contact with surfaces!

- ▶ In the event of elevated fluid temperatures, ensure protection against contact to prevent burns.

2.3 Occupational safety

When working on and with the device:

- ▶ Wear the required personal protective equipment as per national regulations.
- ▶ Switch off the supply voltage before connecting the device.

2.4 Operational safety

Risk of injury!

- ▶ Operate the device only if it is in proper technical condition, free from errors and faults.
- ▶ The operator is responsible for trouble-free operation of the device.

Modifications to the device

Unauthorized modifications to the device are not permitted and can lead to unforeseeable dangers:

- ▶ If modifications are nevertheless required, consult with the manufacturer.

Repair

To ensure continued operational safety and reliability:

- ▶ Only use original accessories.

Hazardous area

To eliminate the risk of danger to persons or the facility when the device is used in the approval-related area (e.g. explosion protection, pressure equipment safety):

- ▶ Check the nameplate to verify if the device ordered can be put to its intended use in the hazardous area.
- ▶ Comply with the instructions in the separate supplementary documentation, which is an integral part of this manual.

2.5 Product security

This state-of-the-art device is designed and tested in accordance with good engineering practice to meet operational safety standards. It left the factory in a condition in which it is safe to operate.

The device fulfills general safety requirements and legal requirements. It also complies with the EU directives listed in the device-specific EU declaration of conformity.

Endress+Hauser confirms this fact by affixing the CE mark to the device.

2.6 IT security

Our warranty is valid only if the product is installed and used as described in the Operating Instructions. The product is equipped with security mechanisms to protect it against any inadvertent changes to the settings.

IT security measures, which provide additional protection for the product and associated data transfer, must be implemented by the operators themselves in line with their security standards.

2.7 Device-specific IT security

The device offers specific functions to support protective measures by the operator. These functions can be configured by the user and guarantee greater in-operation safety if used correctly. The user role can be changed with an access code (applies to operation via the onsite display, Bluetooth or FieldCare, DeviceCare, asset management tools e.g. AMS, PDM).

2.7.1 Access via Bluetooth® wireless technology

Secure signal transmission via Bluetooth® wireless technology uses an encryption method tested by the Fraunhofer Institute.

- Without the SmartBlue app, the device is not visible via Bluetooth® wireless technology.
- Only one point-to-point connection is established between the device and a smartphone or tablet.
- The Bluetooth® wireless technology interface can be disabled via local operation or via SmartBlue/FieldCare/DeviceCare.

3 Product description

3.1 Product design

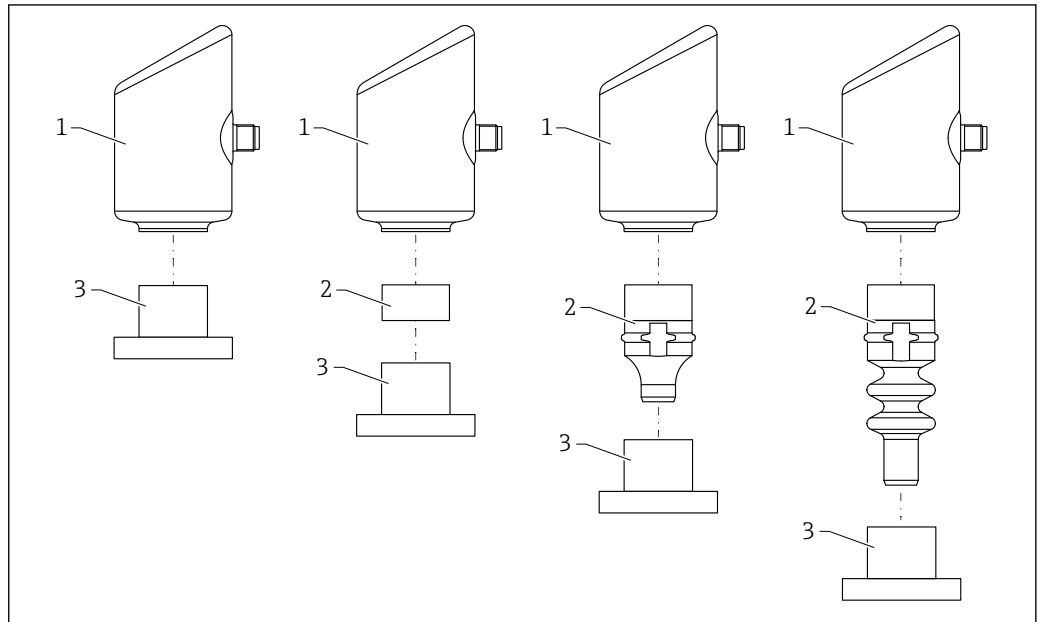

A0055927

- 1 Housing
- 2 Configuration-dependent mounted parts
- 3 Process connection

4 Incoming acceptance and product identification

4.1 Incoming acceptance

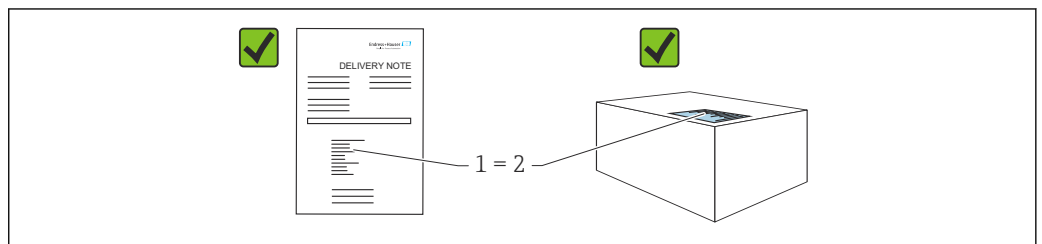

A0016870

Check the following during incoming acceptance:

- Is the order code on the delivery note (1) identical to the order code on the product sticker (2)?
- Are the goods undamaged?
- Do the data on the nameplate correspond to the order specifications and the delivery note?
- Is the documentation provided?
- If required (see nameplate), are the Safety Instructions (XA) provided?

i If one of these conditions is not met, please contact the manufacturer's sales office.

4.2 Product identification

The following options are available for identification of the device:

- Nameplate specifications
- Order code with breakdown of the device features on the delivery note
- Enter the serial numbers from the nameplates in *Device Viewer* (www.endress.com/deviceviewer): all the information about the device is displayed.

4.2.1 Nameplate

The information that is required by law and is relevant to the device is shown on the nameplate, e.g.:

- Manufacturer identification
- Order number, extended order code, serial number
- Technical data, degree of protection
- Firmware version, hardware version
- Approval-specific information
- DataMatrix code (information about the device)

Compare the data on the nameplate with your order.

4.2.2 Manufacturer address

Endress+Hauser SE+Co. KG
Hauptstraße 1
79689 Maulburg, Germany
Place of manufacture: See nameplate.

4.3 Storage and transport

4.3.1 Storage conditions

- Use the original packaging
- Store the device in clean and dry conditions and protect from damage caused by shocks

Storage temperature

-40 to +85 °C (-40 to +185 °F)

4.3.2 Transporting the product to the measuring point

WARNING

Incorrect transport!

Housing and membrane may become damaged, and there is a risk of injury!

- ▶ Transport the device to the measuring point in the original packaging.

5 Mounting procedure

5.1 Mounting requirements

5.1.1 Mounting instructions

i During installation, it is important to ensure that the sealing element used has a permanent operating temperature that corresponds to the maximum temperature of the process.

- Devices with CSA approval are intended for indoor use.
Devices are suitable for use in wet environments in accordance with IEC/EN 61010-1.
- Orient the onsite display using the operating menu to ensure optimum readability.
- The onsite display can be adapted to the light conditions (for color scheme, see  operating menu).
- The devices are mounted according to the same guidelines as manometers.
- Protect housing against impact.

5.2 Orientation

NOTICE

If a heated device is cooled during a cleaning process (e.g. by cold water), a vacuum develops for a short time. Moisture can get into the measuring cell via the pressure compensation filter (1) as a result of the vacuum. Whether or not a filter element is installed depends on the device version.

Device could be destroyed!

- ▶ Mount the device as follows.

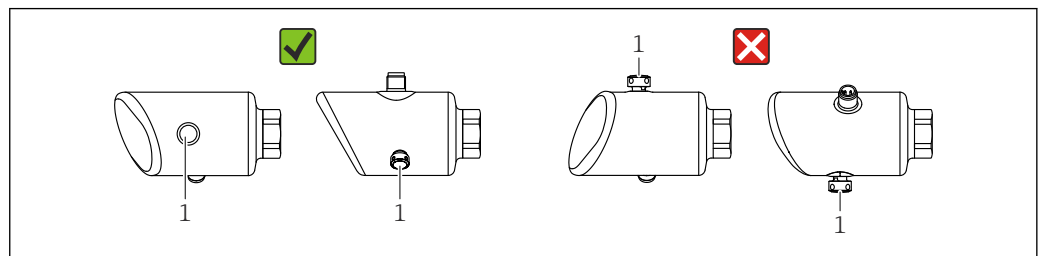

A0054016

- Keep the filter element (1) free from contamination.
- The orientation of the device depends on the measuring application.
- A position-dependent zero point shift (when the vessel is empty the measured value does not display zero) can be corrected

5.3 Post-mounting checks

- Is the device undamaged (visual inspection)?
- Are the measuring point identification and labeling correct (visual inspection)?
- Is the device properly secured?
- Is the filter element pointing downwards at an angle or to the side?
- Does the device comply with the measuring point specifications?

For example:

- Process temperature
- Pressure
- Ambient temperature

- Measuring range

6 Electrical connection

6.1 Connecting the device

6.1.1 Potential equalization

If necessary, establish potential equalization using the process connection or the grounding clamp supplied by the customer.

6.1.2 Supply voltage

12 to 30 V_{DC} on a direct current power unit

i The power unit must be safety-approved (e.g. PELV, SELV, Class 2) and must comply with the relevant protocol specifications.

For 4 to 20 mA, the same requirements apply as for HART. A galvanically isolated active barrier must be used for devices approved for use in explosion hazardous areas.

Protective circuits against reverse polarity, HF influences and overvoltage peaks are installed.

6.1.3 Power consumption

Non-hazardous area: To meet device safety specifications according to the IEC/EN 61010 standard, the installation must ensure that the maximum current is limited to 500 mA.

6.1.4 4 to 20 mA HART

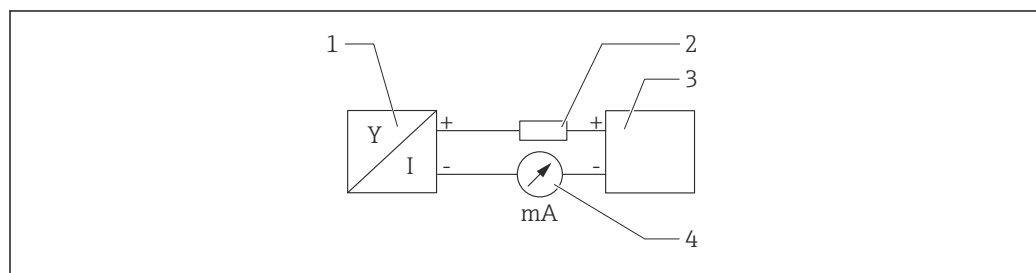

1 Block diagram of HART connection

- 1 Device with HART communication
- 2 HART communication resistor
- 3 Power supply
- 4 Multimeter or ammeter

i The HART communication resistor of 250 Ω in the signal line is always necessary in the case of a low-impedance power supply.

Take the voltage drop into consideration:

Maximum 6 V for a communication resistor of 250 Ω

6.1.5 Overvoltage protection

The device satisfies the IEC/DIN EN IEC 61326-1 product standard (Table 2 Industrial environment). Depending on the type of port (DC supply, input/output port) different test

levels against transient overvoltages (IEC/DIN EN 61000-4-5 Surge) are applied according to IEC/DIN EN 61326-1: Test level on DC power ports and input/output ports is 1 000 V line to earth.

Overvoltage protection category

According to IEC/DIN EN 61010-1, the device is intended for use in overvoltage protection category II networks.

6.1.6 Terminal assignment

⚠ WARNING

Supply voltage might be connected!

Risk of electric shock and/or explosion

- ▶ Ensure that no supply voltage is applied when connecting.
- ▶ The supply voltage must match the specifications on the nameplate.
- ▶ A suitable circuit breaker should be provided for the device in accordance with IEC/EN 61010.
- ▶ The cables must be adequately insulated, with due consideration given to the supply voltage and the overvoltage category.
- ▶ The connecting cables must offer adequate temperature stability, with due consideration given to the ambient temperature.
- ▶ Protective circuits against reverse polarity, HF influences and overvoltage peaks are installed.

⚠ WARNING

An incorrect connection compromises electrical safety!

- ▶ Non-hazardous area: To meet device safety specifications according to the IEC/EN 61010 standard, the installation must ensure that the maximum current is limited to 500 mA.
- ▶ Hazardous area: The maximum current is restricted to $I_i = 100$ mA by the transmitter power supply unit when the device is used in an intrinsically safe circuit (Ex ia).
- ▶ When using the device in hazardous areas, comply with the corresponding national standards and the information in the Safety Instructions (XAs).
- ▶ All explosion-protection information is provided in separate explosion-protection (Ex) documentation. This Ex documentation can be requested. The Ex documentation is supplied as standard with all devices approved for use in explosion hazardous areas.

Connect the device in the following order:

1. Check that the supply voltage corresponds to the supply voltage indicated on the nameplate.
2. Connect the device as indicated in the following diagram.
3. Switch on the supply voltage.

2-wire

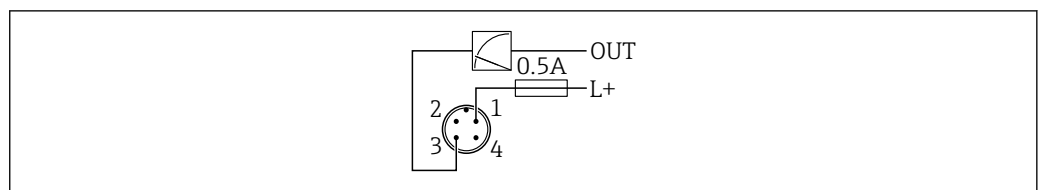

A0052662

- 1 Supply voltage L+, brown wire (BN)
- 3 OUT (L-), blue wire (BU)

6.2 Ensuring the degree of protection

For mounted M12 connecting cable: IP66/68/69, NEMA type 4X/6P

NOTICE

Loss of IP protection class due to incorrect installation!

- ▶ The degree of protection only applies if the connecting cable used is plugged in and screwed tight.
- ▶ The degree of protection only applies if the connecting cable used is specified according to the intended protection class.

6.3 Post-connection check

- Is the device or cable undamaged (visual check)?
- Does the cable used comply with the requirements?
- Is the mounted cable strain-relieved?
- Is the screw connection properly mounted?
- Does the supply voltage match the specifications on the nameplate?
- No reverse polarity, terminal assignment correct?
- If supply voltage is present: is the device ready for operation and does an indication appear on the onsite display or is the green operating status LED lit?

7 Operation options

7.1 Overview of operation options

- Operation via LED indicator operating key
- Operation via onsite display
- Operation via Bluetooth®
- Operation via Endress+Hauser operating tool
- Operation via handheld, Fieldcare, DeviceCare, AMS and PDM

7.2 Structure and function of the operating menu

The differences between the structure of the operating menus of the onsite display and the Endress+Hauser FieldCare or DeviceCare operating tools can be summarized as follows:

The onsite display has a reduced menu to configure basic settings on the device.

The complete operating menu is available via the operating tools (FieldCare, DeviceCare, SmartBlue) in order to make more complex settings on the device.

Wizards help the user to commission the various applications. The user is guided through the individual configuration steps.

7.2.1 Overview of the operating menu

"Guidance" menu

The Guidance main menu contains functions that enable the user to carry out basic tasks quickly, e.g. commissioning. This menu primarily consists of guided wizards and special functions covering multiple areas.

"Diagnostics" menu

Diagnostic information and settings as well as help for troubleshooting.

"Application" menu

Functions for detailed adjustment of the process for optimum integration of the device into the application.

"System" menu

System settings for device management, user administration or safety.

7.2.2 User roles and related access authorization

This device supports 2 user roles: **Maintenance** and **Operator**

- The **Maintenance** user role (as delivered to customer) has read/write access.
- The **Operator** user role has read access only.

The current user role is displayed in the main menu.

The device parameters can be fully configured with the **Maintenance** user role. Afterwards, access to the configuration can be locked by assigning a password. This password acts as an access code and protects device configuration from unauthorized access.

Blocking changes the **Maintenance** user role to the **Operator** user role. The configuration can be accessed again by entering the access code.

If an incorrect access code is entered, the user obtains the access rights of the **Operator** role.

Assign password, change user role:

- ▶ Navigation: System → User management

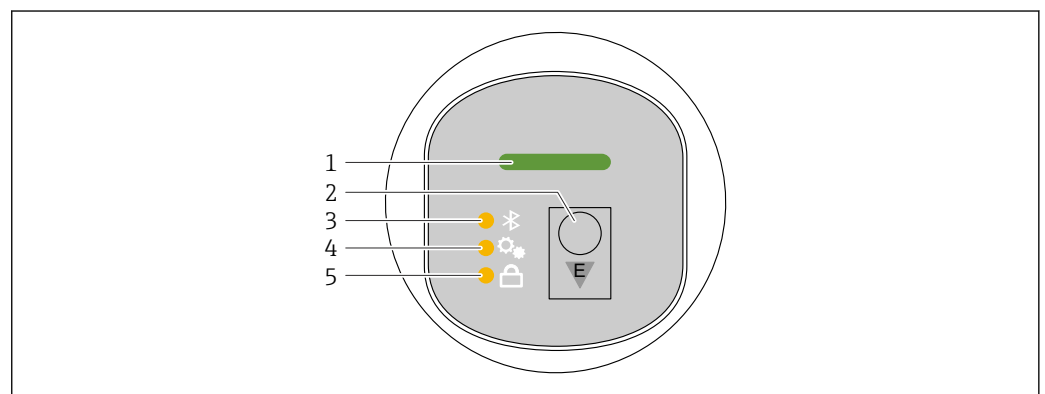
7.3 Access to operating menu via LED display**7.3.1 Overview**

- 1 Operating status LED
- 2 Operating key "E"
- 3 Bluetooth LED
- 4 Position adjustment LED
- 5 Keypad lock LED

 Operation on the LED display is not possible when the Bluetooth connection is active.

Operating status LED (1)

See diagnostic events section.

Bluetooth LED (3)

- LED lit: Bluetooth enabled
- LED not lit: Bluetooth disabled or Bluetooth option not ordered
- LED flashing: Bluetooth connection established

Keypad lock LED (5)

- LED lit: Key locked
- LED not lit: Key released

7.3.2 Operation

The device is operated by pressing operating key "E" briefly (< 2 s) or pressing and holding it (> 2 s).

Navigation

- The LED for the selected function flashes
- Press the "E" operating key briefly to switch between the functions
- Press and hold down the "E" operating key to select a particular function

Flashing behavior of LEDs (active/inactive)

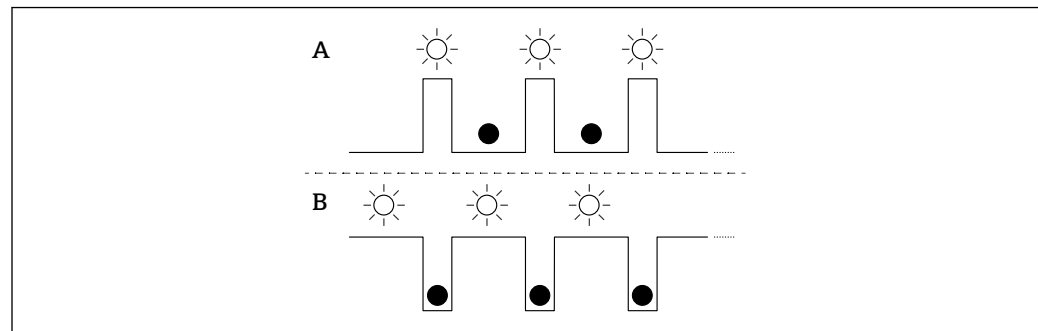

A0053175

A Function selected but not active

B Function selected and active

Disabling the keypad lock

1. Press and hold down operating key "E".
 - ↳ Bluetooth LED flashes.
2. Briefly press operating key "E" repeatedly until the keypad lock LED flashes.
3. Press and hold down operating key "E".
 - ↳ Keypad lock is disabled.

Enabling or disabling Bluetooth

1. If necessary, disable the keypad lock.
2. Repeatedly press the "E" key briefly until the Bluetooth LED flashes.
3. Press and hold down operating key "E".
 - ↳ Bluetooth is enabled (Bluetooth LED is lit) or Bluetooth is disabled (Bluetooth LED goes out).

7.4 Access to operating menu via onsite display

Functions:

- Display measured values, also fault and notice messages
- Display a symbol in the event of an error
- Electronically adjustable onsite display (automatic or manual adjustment of display in 90° increments)
 - i** The measured value display rotates automatically depending on the orientation when the device is started. ¹⁾
- Basic settings via the onsite display with touch function ²⁾
 - Locking On/Off
 - Select the operating language
 - Start the Heartbeat Verification with passed/failed feedback message on the onsite display
 - Bluetooth On/Off
 - Commissioning wizard for basic settings
 - Read the device information, such as the name, serial number and firmware version
 - Active diagnosis and status
 - Device reset
 - Invert colors for bright lighting conditions

The backlighting is reduced with lower terminal voltage.

i The following figure is an example. The display depends on the settings of the onsite display.

Optional display by swiping from left to right (see A, B and C in the following graphic). Swiping only works if the display has been ordered with touch control and the display has been unlocked beforehand.

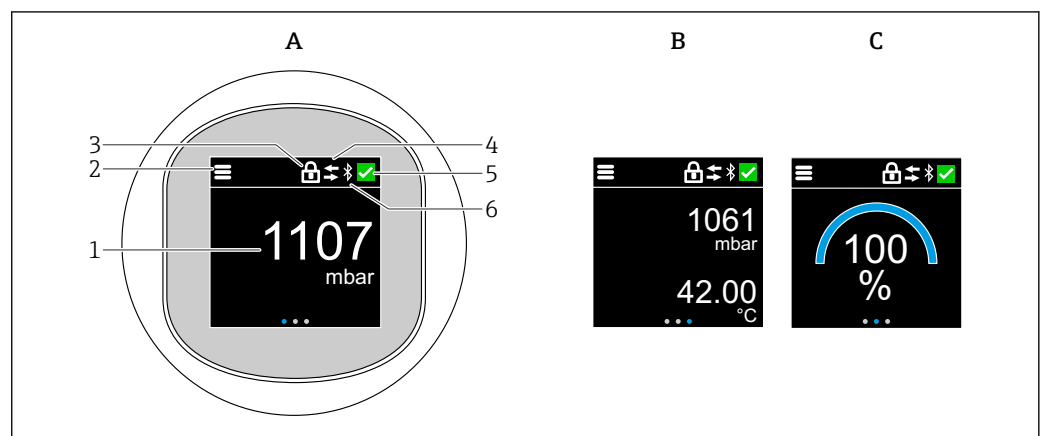

A0052427

A Standard display: 1 measured value with unit (adjustable)

B 2 measured values, each with unit (adjustable)

C Graphic measured value display in %

1 Measured value

2 Menu or home symbol

3 Locking (locking only visible if locked via "Safety mode" wizard. "Safety mode" wizard is available if WHG option or Heartbeat Verification option+Monitoring have been selected.)

4 Communication (symbol appears if communication is enabled)

5 Diagnostic symbol

6 Bluetooth (symbol flashes when Bluetooth connection is enabled)

The standard display can be permanently set via the operating menu.

1) The measured value display only rotates automatically if automatic alignment is switched on.

2) For devices without touch function, settings can be made using operating tools (FieldCare, DeviceCare, SmartBlue).

7.4.1 Operation

Navigation

Navigation by swiping with finger.

 Operation via the LED indicator is not possible if the Bluetooth connection is enabled.

Selecting option and confirming

Select the required option and confirm using the checkmark at the top right (see screens below).

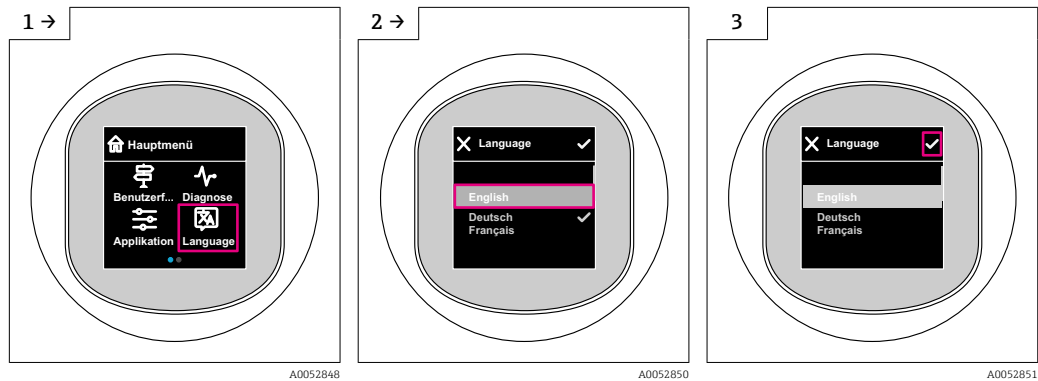

7.5 Onsite display, locking or unlocking procedure

7.5.1 Unlocking procedure

1. Tap the center of the display for the following view:

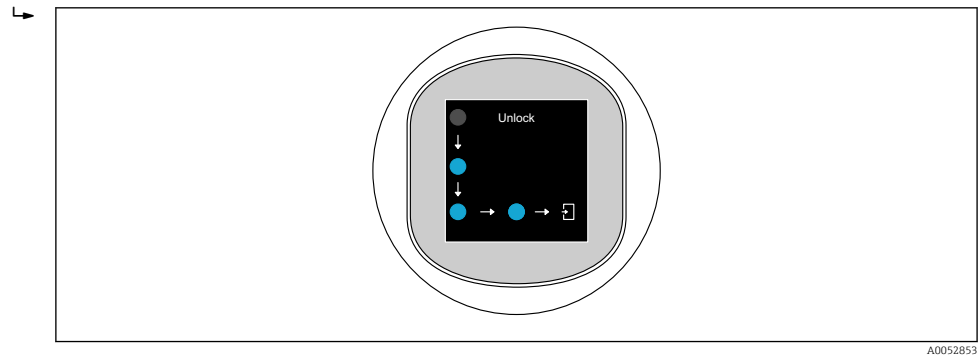

2. Use a finger to follow the arrows without interruption.
↳ The display is unlocked.

7.5.2 Locking procedure

 Operation locks automatically (except in **Safety mode** wizard):

- after 1 min on the main page
- after 10 min within the operating menu

7.6 Access to the operating menu via the operating tool

7.6.1 Connecting the operating tool

Access via the operating tool is possible:

- Via HART communication, e.g. Commubox FXA195
- Via Bluetooth (optional)

FieldCare

Function range

FDT-based plant asset management tool from Endress+Hauser. FieldCare can configure all smart field devices in a system and helps you manage them. By using the status information, FieldCare is also a simple but effective way of checking their status and condition.

Access is via digital communication (Bluetooth, HART communication)

Typical functions:

- Configuration of transmitter parameters
- Loading and saving of device data (upload/download)
- Documentation of the measuring point
- Visualization of the measured value memory (line recorder) and event logbook



For additional information on FieldCare: See Operating Instructions for FieldCare

DeviceCare

Range of functions

Tool to connect and configure Endress+Hauser field devices.



For details, see Innovation Brochure IN01047S.

FieldXpert SMT70, SMT77

The Field Xpert SMT70 tablet PC for device configuration enables mobile plant asset management in hazardous (Ex Zone 2) and non-hazardous areas. It is suitable for commissioning and maintenance staff. It manages Endress+Hauser and third-party field instruments with a digital communication interface and documents the progress of the work. The SMT70 is designed as a complete solution. It comes with a pre-installed driver library and is an easy-to-use, touch-enabled tool for managing field devices throughout their entire life cycle.



Technical Information TI01342S

The Field Xpert SMT77 tablet PC for device configuration enables mobile plant asset management in areas categorized as Ex Zone 1.



Technical Information TI01418S

7.6.2 Operation via SmartBlue App

The device can be operated and configured with the SmartBlue App.

- The SmartBlue App must be downloaded onto a mobile device for this purpose.
- For information on the compatibility of the SmartBlue App with mobile devices, see **Apple App Store (iOS devices)** or **Google Play Store (Android devices)**.
- Incorrect operation by unauthorized persons is prevented by means of encrypted communication and password encryption.
- The Bluetooth® function can be deactivated after initial device setup.





A0033202

2 QR code for free Endress+Hauser SmartBlue App

Download and installation:

1. Scan the QR code or enter **SmartBlue** in the search field of the Apple App Store (iOS) or Google Play Store (Android).
2. Install and start the SmartBlue App.
3. For Android devices: enable location tracking (GPS) (not required for iOS devices).
4. Select a device that is ready to receive from the device list displayed.

Login:

1. Enter the user name: admin
 2. Enter the initial password: serial number of the device
-  Change the password after logging in for the first time.
-  Forgotten your password? Contact Endress+Hauser Service.

8 System integration

8.1 Overview of device description files

- Manufacturer ID: 17 (0x0011)
- Device type code: 0x11C5
- HART specification: 7.6
- DD files, information and files can be found at:
 - www.endress.com
 - www.fieldcommgroup.org

8.2 Measured variables via HART protocol

The following measured values are assigned to the device variables at the factory:

Device variable	Measured value
Primary variable (PV) ¹⁾	Pressure ²⁾
Secondary variable (SV)	Sensor temperature

Device variable	Measured value
Tertiary variable (TV)	Electronics temperature
Quaternary variable (QV)	Sensor pressure ³⁾

- 1) The PV is always applied to the current output.
- 2) The pressure is the calculated signal after damping and position adjustment.
- 3) The Sensor pressure is the raw signal of the measuring cell before damping and position adjustment.

 The assignment of the measured values to the device variables can be changed in the following submenu:
Application → HART output → HART output

 In a HART Multidrop loop, only one device may use the analog current value for signal transmission. For all other devices in "**Loop current mode**" parameter, select **Disable** option.

8.2.1 Device variables and measured values

The following codes are assigned to the device variables at the factory:

 The device variables can be queried via HART[®] command 9 or 33 from a HART[®] master.

8.2.2 System units

The following table describes the supported pressure measuring units.

Index number	Description	HART unit code
0	mbar	8
1	bar	7
2	Pa	11
3	kPa	12
4	MPa	237
5	psi	6
6	torr	13
7	atm	14
8	mmH ₂ O	4
9	mmH ₂ O (4°C)	239
10	mH ₂ O	240
11	mH ₂ O (4°C)	240
10	ftH ₂ O	3
11	inH ₂ O	1
12	inH ₂ O (4°C)	238
13	mmHg	5
14	inHg	2
15	gf/cm ²	9
16	kgf/cm ²	10

9 Commissioning

9.1 Preliminaries



WARNING

Settings on the current output can result in a safety-related condition (e.g., product overflow)!

- ▶ Check current output settings.
- ▶ The setting of the current output depends on the setting in the **Assign PV** parameter.

9.2 Installation and function check

Before commissioning the measuring point, check that the post-installation and post-connection checks have been performed:

-  "Post-mounting check" section
-  "Post-connection check" section

9.3 Overview of commissioning options

- Commissioning via LED display operating key
- Commissioning via onsite display
- Commissioning with the SmartBlue app
(see  "Operation via SmartBlue app" section)
- Commissioning via FieldCare/DeviceCare/Field Xpert
- Commissioning via additional operating tools (AMS, PDM, etc.)

9.4 Commissioning via LED display operating key

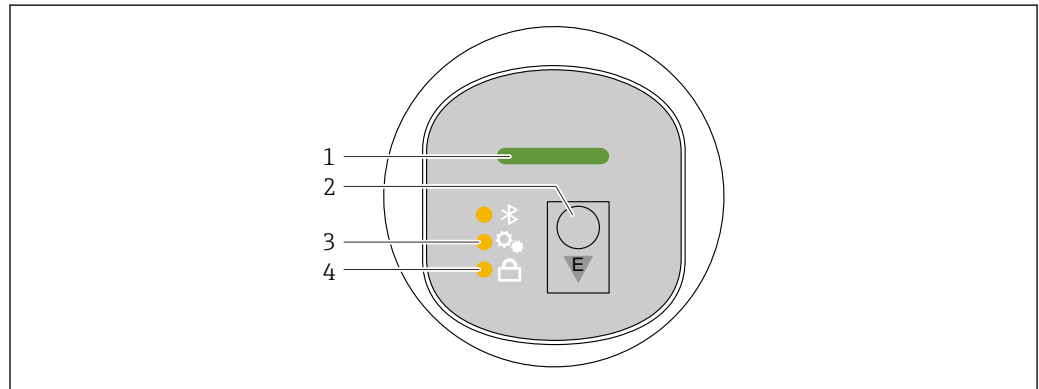

A0053357

- 1 *Operating status LED*
- 2 *Operating key "E"*
- 3 *Position adjustment LED*
- 4 *Keypad lock LED*

1. If necessary, disable the keypad lock (see  section "Access to operating menu via LED display" > "Operation").
2. Repeatedly press the "E" key briefly until the position adjustment LED flashes.
3. Press the "E" key for longer than 4 seconds.
 - ↳ Position adjustment LED is activated.
The position adjustment LED flashes during activation. The keypad lock LED and Bluetooth LED are off.

Once activated successfully, the position adjustment LED lights up continuously for 12 seconds. The keypad lock LED and Bluetooth LED are off.

If not successfully activated, the position adjustment LED, keypad lock LED and Bluetooth LED flash quickly for 12 seconds.

9.5 Commissioning via onsite display

1. If necessary, enable operation (see  section "Onsite display, locking or unlocking procedure" > "Unlocking").
2. Start **Commissioning** wizard (see graphic below).

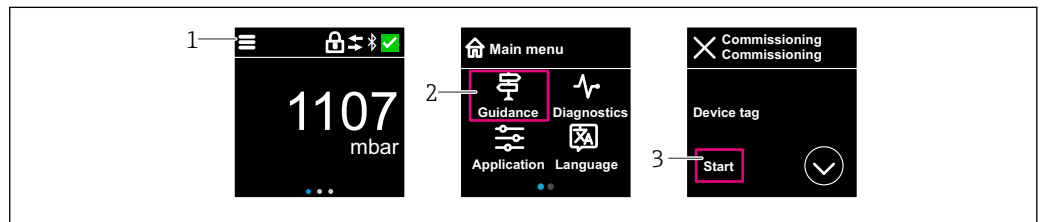

- 1 Press the menu icon.
- 2 Press "Guidance" menu.
- 3 Start "Commissioning" wizard.

9.5.1 Notes on "Commissioning" wizard

The **Commissioning** wizard enables simple, user-guided commissioning.

1. Once you have started the **Commissioning** wizard, enter the appropriate value in each parameter or select the appropriate option. These values are written directly to the device.
2. Click > to go to the next page.
3. Once all pages have been completed, click OK to close the **Commissioning** wizard.

 If the **Commissioning** wizard is canceled before all necessary parameters have been configured, the device may be in an undefined state. In such situations, it is advisable to reset the device to the factory default settings.

9.6 Commissioning via FieldCare/DeviceCare

1. Download the DTM: <http://www.endress.com/download> -> Device Driver -> Device Type Manager (DTM)
2. Update the catalog.
3. Click the **Guidance** menu and start the **Commissioning** wizard.

9.6.1 Connecting via FieldCare, DeviceCare and FieldXpert

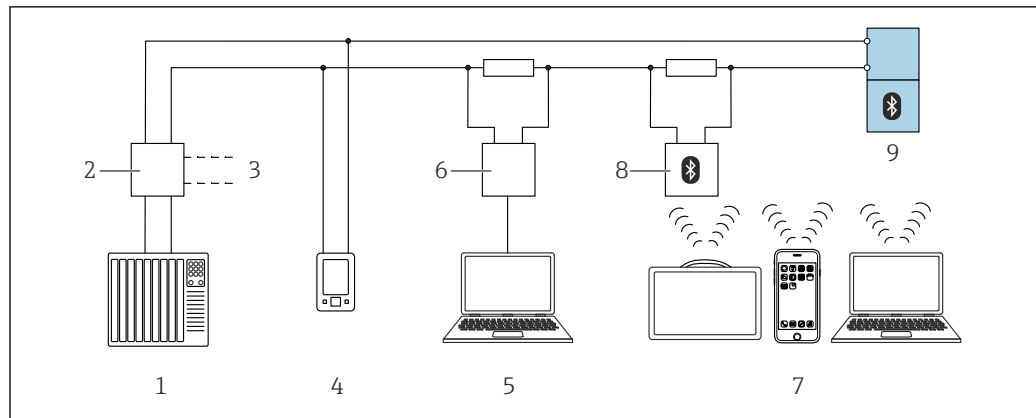

A0044334

 3 Options for remote operation via HART protocol

- 1 PLC (programmable logic controller)
- 2 Transmitter power supply unit, e.g. RN42
- 3 Connection for Commubox FXA195 and AMS Trex™ device communicator
- 4 AMS Trex™ device communicator
- 5 Computer with operating tool (e.g. DeviceCare/FieldCare, AMS Device View, SIMATIC PDM)
- 6 Commubox FXA195 (USB)
- 7 Field Xpert SMT70/SMT77, smartphone or computer with operating tool (e.g. DeviceCare/FieldCare, AMS Device View, SIMATIC PDM)
- 8 Bluetooth modem with connecting cable (e.g. VIATOR)
- 9 Transmitter

9.7 Commissioning via additional operating tools (AMS, PDM, etc.)

Download the device-specific drivers: <https://www.endress.com/en/downloads>

For more details, see the help for the relevant operating tool.

9.8 Configuring the device address via software

See "HART address" parameter

Enter the address to exchange data via the HART protocol.

- Guidance → Commissioning → HART address
- Application → HART output → Configuration → HART address
- Default HART address: 0

9.9 Configuring the operating language

9.9.1 Onsite display

Configuring the operating language

 Before you can set the operating language, you must first unlock the onsite display:

1. Open the operating menu.
2. Select the Language button.

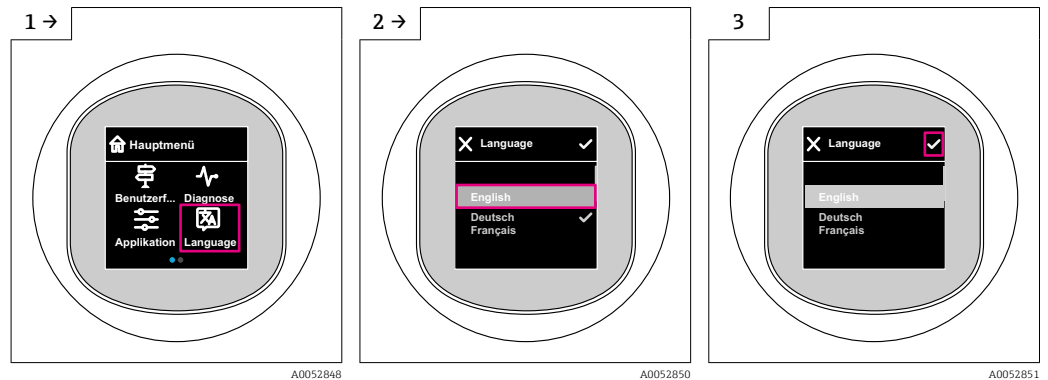

9.9.2 Operating tool

Set display language

System → Display → Language

9.10 Configuring the device

9.10.1 Application examples

WARNING

The settings of the current output are relevant for safety!

Incorrectly configuring the current output can result in an unsafe state of the application (e.g. the tank can overflow in a fill level application).

- ▶ The current output setting depends on the setting in the **Assign PV** parameter.
- ▶ After changing the **Assign PV** parameter, check the span settings (LRV and URV) and reconfigure if necessary.

Example: Outputting of the pressure value at the current output

i Pressure and temperature units are converted automatically. Other units are not converted.

In the following example, the pressure value should be measured in a tank and output on the current output. The maximum pressure of 450 mbar (6.75 psi) corresponds to the 20 mA current. The 4 mA current corresponds to a pressure of 50 mbar (0.75 psi).

Prerequisites:

- Measured variable in direct proportion to the pressure
- Due to the orientation of the device, there may be pressure shifts in the measured value (when the vessel is empty or partly filled, the measured value is not zero)
Perform a position adjustment if necessary
- In the **Assign PV** parameter, the **Pressure** option must be selected (factory setting).

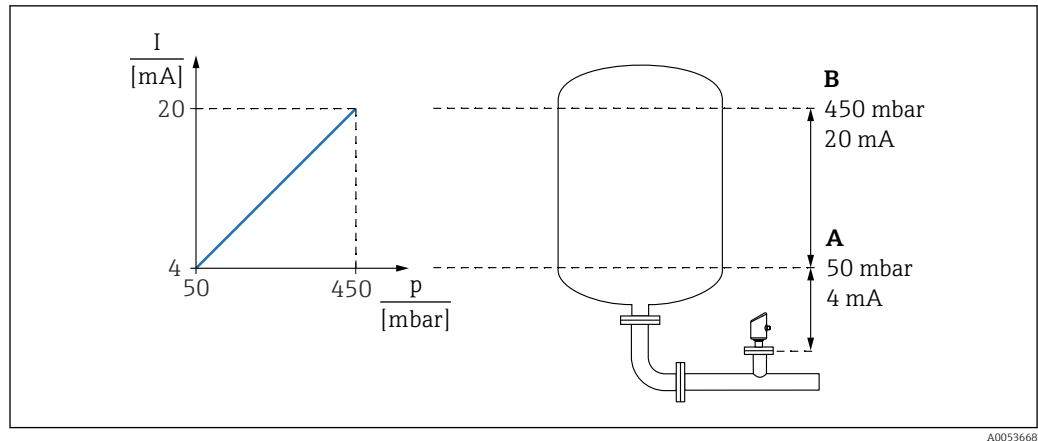

- A Lower range value output
B Upper range value output

Adjustment:

1. Using the **Lower range value output** parameter, enter the pressure value for the 4 mA current (50 mbar (0.75 psi)).
2. Using the **Upper range value output** parameter, enter the pressure value for the 20 mA current (450 mbar (6.75 psi))

Result: The measuring range is set to 4 to 20 mA.

Example: Commissioning a volume measurement in the tank

i Pressure and temperature units are converted automatically. Other units are not converted.

In the following example, the volume in a tank should be measured in liters. The maximum volume of 1 000 l (264 gal) corresponds to a pressure of 450 mbar (6.75 psi).

The minimum volume of 0 liters corresponds to a pressure of 50 mbar (0.75 psi).

Prerequisites:

- Measured variable in direct proportion to the pressure
- Due to the orientation of the device, there may be pressure shifts in the measured value (when the vessel is empty or partly filled, the measured value is not zero)
Perform position adjustment if necessary

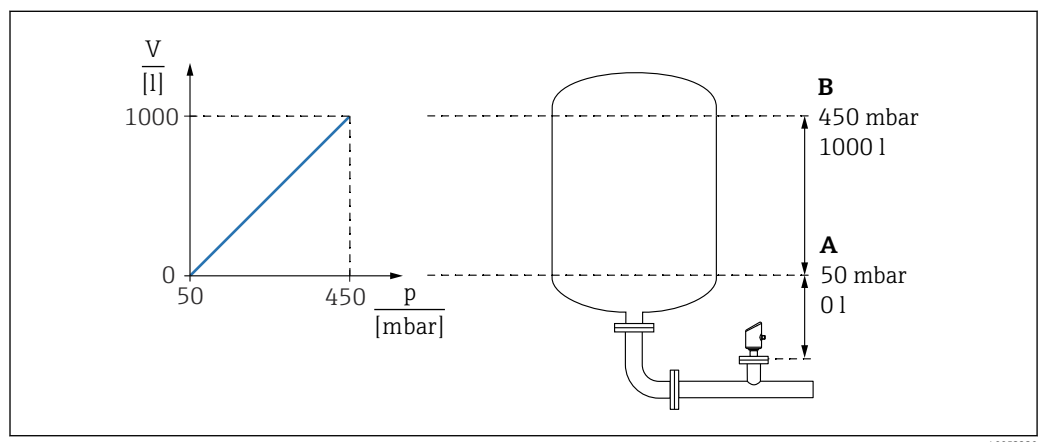

- A "Pressure value 1" parameter and "Scaled variable value 1" parameter
B "Pressure value 2" parameter and "Scaled variable value 2" parameter

i The pressure present is displayed in the operating tool on the same settings page in the "Pressure" field.

1. Using the **Pressure value 1** parameter, enter the pressure value for the lower calibration point: 50 mbar (0.75 psi)
 - ↳ Navigation: Application → Sensor → Scaled variable → Pressure value 1
2. Using the **Scaled variable value 1** parameter, enter the volume value for the lower calibration point: 0 l (0 gal)
 - ↳ Navigation: Application → Sensor → Scaled variable → Scaled variable value 1
3. Using the **Pressure value 2** parameter, enter the pressure value for the upper calibration point: 450 mbar (6.75 psi)
 - ↳ Navigation: Application → Sensor → Scaled variable → Pressure value 2
4. Using the **Scaled variable value 2** parameter, enter the volume value for the upper calibration point: 1 000 l (264 gal)
 - ↳ Navigation: Application → Sensor → Scaled variable → Scaled variable value 2

Result: The measuring range is set for 0 to 1 000 l (0 to 264 gal). Only the **Scaled variable value 1** parameter and **Scaled variable value 2** parameter are set with this setting. This setting has no effect on the current output.

Example: Linearization

In the following example, the volume in a tank with a conical outlet should be measured in m^3 .

Prerequisites:

- Points for linearization table are known
- Level calibration is performed
- Linearization characteristic must continually increase or decrease

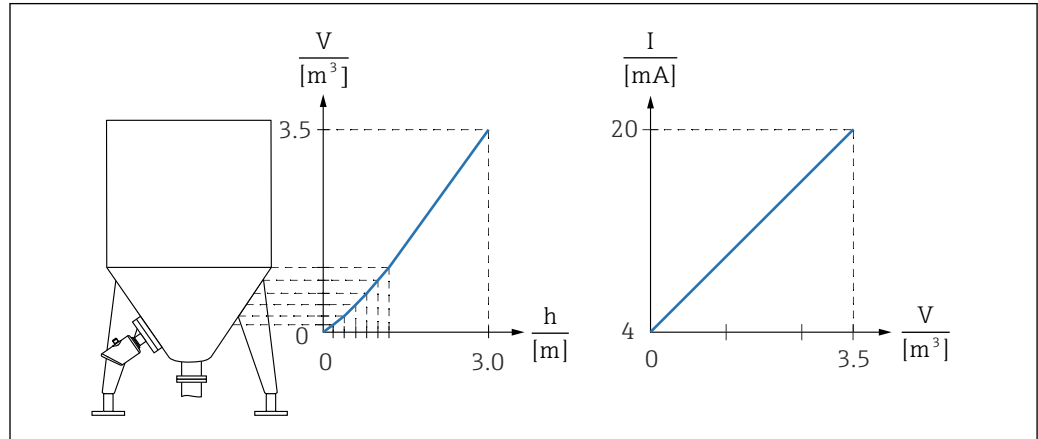

A0053233

1. In the **Assign PV** parameter, the **Scaled variable** option must be set.
 - ↳ Navigation: Application → HART output → HART output → Assign PV
2. Set the desired unit in the **Scaled variable unit** parameter.
 - ↳ Navigation: Application → Sensor → Scaled variable → Scaled variable unit
3. The linearization table can be opened via the **Go to linearization table** parameter **Table** option.
 - ↳ Navigation: Application → Sensor → Scaled variable → Scaled variable transfer function
4. Enter the desired table values.
5. The table is activated once all the points in the table have been entered.
6. Activate the table using the **Activate table** parameter.

Result:

The measured value after linearization is displayed.

- i** Error message F435 "Linearization" and the alarm current appear as long as the table is being entered and until the table is activated
- The 0 % value (= 4 mA) is defined by the smallest point in the table.
The 100 % value (= 20 mA) is defined by the largest point in the table.
- Assignment of the volume/mass values to the current values can be changed with the **Lower range value output** parameter and **Upper range value output** parameter.

9.10.2 "Simulation" submenu

Process variables and diagnostic events can be simulated with the **Simulation** submenu.

Navigation: Diagnostics → Simulation

During simulation of the switch output or current output, the device issues a warning message for the duration of the simulation.

9.11 Protecting settings from unauthorized access

9.11.1 Software locking or unlocking

Locking via password in FieldCare/DeviceCare/SmartBlue app

Access to parameter configuration of the device can be locked by assigning a password. When the device is delivered from the factory, the user role is set to **Maintenance** option. The device parameters can be fully configured with the **Maintenance** option user role. Afterwards, access to the configuration can be locked by assigning a password. The **Maintenance** option switches to the **Operator** option as a result of this locking. The configuration can be accessed by entering the password.

The password is defined under:

System menu **User management** submenu

The user role is changed from the **Maintenance** option to **Operator** option under:

System → User management

Canceling the locking procedure via onsite display/FieldCare/DeviceCare/SmartBlue

After entering the password, you can enable parameter configuration of the device as an **Operator** option with the password. The user role then changes to the **Maintenance** option.

If necessary, the password can be deleted in User management: System → User management

10 Operation

10.1 Reading off the device locking status

10.1.1 LED indicator

Keypad lock LED

-  LED lit: Device is locked
-  LED not lit: Device is unlocked

10.1.2 Onsite display

Onsite display locked:

The main page does **not** display the menu symbol   

10.1.3 Operating tool

 Operating tool (FieldCare/DeviceCare/FieldXpert/SmartBlue app)

Navigation: System → Device management → Locking status

10.2 Reading off measured values

The measured values can be read off via the operating tool or the display.

Navigation: **Application** menu → **Measured values** submenu

10.3 Adapting the device to process conditions

The following menus are available for this purpose:

- Basic settings in the **Guidance** menu
- Advanced settings in:
 - **Diagnostics** menu
 - **Application** menu
 - **System** menu



For details, see the "Description of device parameters" documentation.

10.4 Heartbeat Technology (optional)

10.4.1 Heartbeat Verification

"Heartbeat Verification" wizard

This wizard is used to start an automatic verification of the device functionality. The results can be documented as a verification report.

- The wizard can be used via the operating tools and the onsite display.
The wizard can be started on the onsite display, but only shows the result **Passed** option or **Failed** option.
- The wizard guides the user through the entire process for creating the verification report.

10.4.2 Heartbeat Verification/Monitoring



The **Heartbeat** submenu is only available during operation via FieldCare, DeviceCare or the SmartBlue app. The submenu contains the wizards that are available with the Heartbeat Verification and Heartbeat Monitoring application packages.



Documentation on the Heartbeat Technology: Endress+Hauser website: www.endress.com → Downloads.

10.5 Proof test for WHG devices (optional) ³⁾

The "Proof test" module contains the **Proof test** wizard required at appropriate intervals for the following applications: WHG (German Water Resources Act):

- The wizard can be used via the operating tools (SmartBlue app, DTM).
- The wizard guides the user through the entire process for creating the verification report.
- The verification report can be saved as a PDF file.

10.6 Displaying the measured value history



See Special Documentation for SD Heartbeat Technology.

³⁾ Only available for devices with WHG approval

10.7 Sensor calibration ⁴⁾

In the course of their life cycle, pressure measuring cells **can** deviate, or drift, ⁵⁾ from the original pressure characteristic curve. This deviation depends on the operating conditions and can be corrected in the **Sensor calibration** submenu.

Set the value of the zero point shift before the Sensor calibration to 0.00. Application
→ Sensor → Sensor calibration → Zero adjustment offset

1. Apply the lower pressure value (value measured with pressure reference) to the device. Enter this pressure value in the **Lower sensor trim** parameter. Application
→ Sensor → Sensor calibration → Lower sensor trim
↳ The value entered causes a parallel shift of the pressure characteristic in relation to the current Sensor calibration.
2. Apply the upper pressure value (value measured with pressure reference) to the device. Enter this pressure value in the **Upper sensor trim** parameter. Application
→ Sensor → Sensor calibration → Upper sensor trim
↳ The value entered causes a change in the slope of the current Sensor calibration.

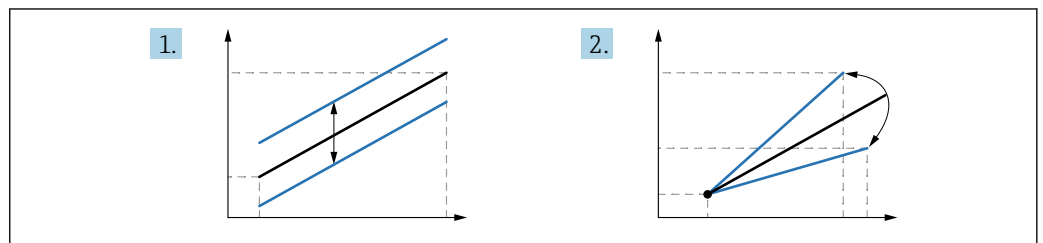

A0052045

i The accuracy of the pressure reference determines the accuracy of the device. The pressure reference must be more accurate than the device.

11 Diagnostics and troubleshooting

11.1 General troubleshooting

11.1.1 General errors

Device not starting

- Possible cause: Supply voltage does not match the specification on the nameplate
Remedial action: Apply the correct voltage
- Possible cause: The polarity of the supply voltage is wrong
Remedial action: Correct the polarity
- Possible cause: Load resistance too high
Remedial action: Increase the supply voltage to reach the minimum terminal voltage

"Communication error" appears on the onsite display or LEDs flash when the device is started

Possible cause: Electromagnetic interference influence
Remedial action: Check grounding of the device

4) Not possible with color display

5) Deviations caused by physical factors are also known as "Sensor drift".

HART communication not working

- Possible cause: Communication resistor missing or incorrectly installed
Remedial action: Install the communication resistor (250 Ω) correctly
- Possible cause: Commubox is connected incorrectly
Remedial action: Connect Commubox correctly

11.1.2 Error - SmartBlue operation with Bluetooth®

Operation via SmartBlue is only possible on devices that have a display with Bluetooth (optionally available).

Device is not visible in the live list

- Possible cause: No Bluetooth connection available
Remedial action: Enable Bluetooth in the field device via display or software tool and/or in the smartphone/tablet
- Possible cause: Bluetooth signal outside range
Remedial action: Reduce distance between field device and smartphone/tablet
The connection has a range of up to 25 m (82 ft)
Operating radius with intervisibility 10 m (33 ft)
- Possible cause: Geopositioning is not enabled on Android devices or is not permitted for the SmartBlue app
Remedial action: Enable/permit the geopositioning service on Android device for the SmartBlue app
- Display does not have Bluetooth

Device appears in the live list but a connection cannot be established

- Possible cause: The device is already connected with another smartphone/tablet via Bluetooth
Only one point-to-point connection is permitted
Remedial action: Disconnect the smartphone/tablet from the device
- Possible cause: Incorrect user name and password
Remedial action: The standard user name is "admin" and the password is the device serial number indicated on the device nameplate (only if the password was not changed by the user beforehand)
If the password has been forgotten, contact Endress+Hauser Service (www.addresses.endress.com)

Connection via SmartBlue not possible

- Possible cause: Incorrect password entered
Remedial action: Enter the correct password, paying attention to lower/upper case
- Possible cause: Forgotten password
If the password has been forgotten, contact Endress+Hauser Service (www.addresses.endress.com)

Login via SmartBlue not possible

- Possible cause: Device is being put into operation for the first time
Remedial action: Enter the user name "admin" and the password (device serial number), paying attention to lower/upper case
- Possible cause: The electric current and voltage are not correct.
Remedial action: Increase the supply voltage.

Device cannot be operated via SmartBlue

- Possible cause: Incorrect password entered
Remedial action: Enter the correct password, paying attention to lower/upper case
- Possible cause: Forgotten password
If the password has been forgotten, contact Endress+Hauser Service (www.addresses.endress.com)
- Possible cause: **Operator** option has no authorization
Remedial action: Change to the **Maintenance** option

11.1.3 Measures

For information on measures in the case of an error message: See  "Pending diagnostic messages" section.

If the measures do not rectify the problem, contact your Endress+Hauser office.

11.1.4 Additional tests

If no clear cause of the error can be identified or the source of the problem can be both the device and the application, the following additional tests can be performed:

1. Check the digital value (e.g. value from onsite display or value from digital communication).
2. Check that the device concerned is functioning correctly. Replace the device if the digital value does not correspond to the expected value.
3. Switch on simulation and check the current output. Replace the device if the current output does not correspond to the simulated value.
4. Reset the device to the factory setting.

11.1.5 Behavior of the device in the event of a power outage

In the event of an unexpected power outage, the dynamic data are stored permanently (according to NAMUR NE 032).

11.1.6 Behavior of the current output in the event of a failure

The behavior of the current output in the event of failures is defined by the **Failure behavior current output** parameter.

Parameter overview with brief description

Parameter	Description	Selection / User entry
Failure behavior current output	Defines which current the output assumes in the case of an error. Min: < 3.6 mA Max: >21.5 mA Note: The hardware DIP Switch for alarm current (if available) has priority over software setting.	<ul style="list-style-type: none"> ▪ Min. ▪ Max.
Failure current	Enter current output value in alarm condition	21.5 to 23 mA

11.2 Diagnostic information on operating status LED

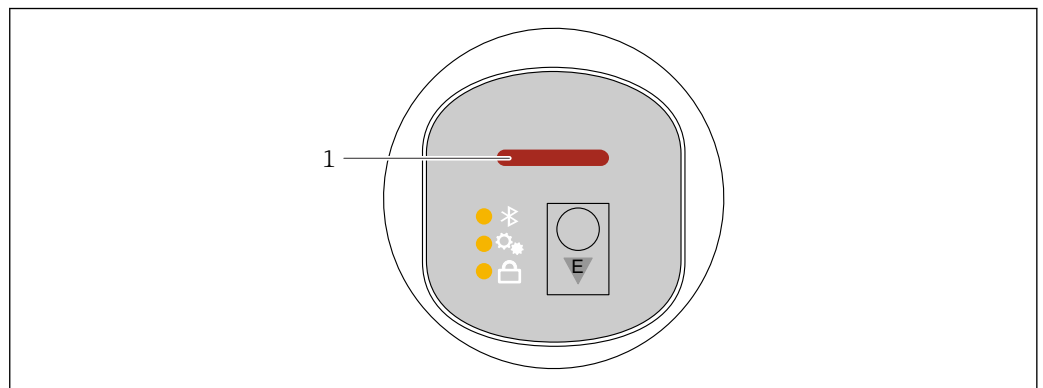

1 Operating status LED

A0052452

- Operating status LED is continuously lit in green: everything is OK
- Operating status LED is continuously lit in red: diagnosis type "Alarm" is active
- During device search (Squawk HART) or device identification or Bluetooth pairing, the operating status LED flashes while the function is carried out.
LED flashes independently of the LED color

11.3 Diagnostic information on onsite display

11.3.1 Diagnostic message

Measured value display and diagnostic message in the event of a fault

Faults detected by the device's self-monitoring system are displayed as a diagnostic message in alternation with the unit.

Status signals

F

"Failure (F)" option

A device error has occurred. The measured value is no longer valid.

C

"Function check (C)" option

The device is in the service mode (e.g. during a simulation).

S

"Out of specification (S)" option

The device is operated:

- Outside of its technical specifications (e.g. during startup or a cleaning)
- Outside of the configuration performed by the user (e.g. level outside configured span)

M

"Maintenance required (M)" option

Maintenance required. The measured value remains valid.

Diagnostic event and event text

The fault can be identified by means of the diagnostic event.

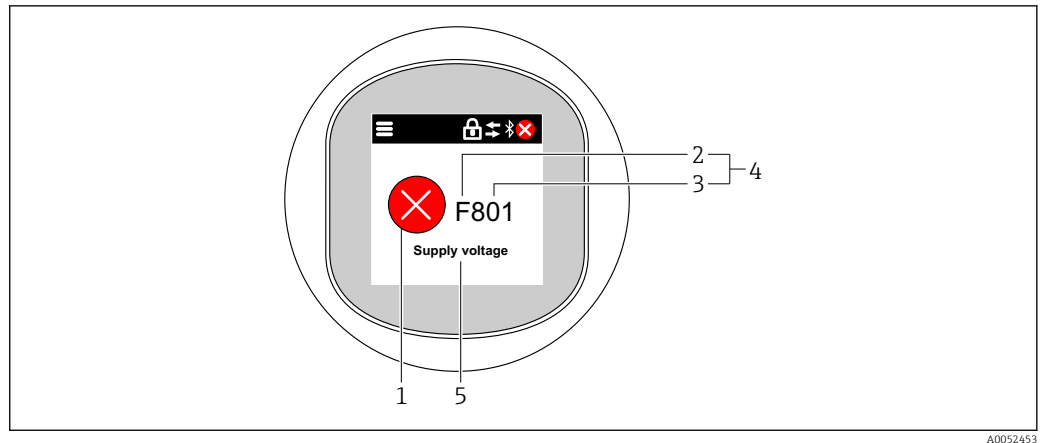

- 1 Status symbol
- 2 Status signal
- 3 Event number
- 4 Diagnostic event
- 5 Brief description of the diagnostic event

If several diagnostic events are pending at the same time, only the diagnostic message with the highest priority is displayed.

11.4 Diagnostic event in the operating tool

If a diagnostic event has occurred in the device, the status signal appears in the top left status area of the operating tool together with the corresponding symbol for the event level according to NAMUR NE 107:

- Failure (F)
- Function check (C)
- Out of specification (S)
- Maintenance required (M)

Click the status signal to see the detailed status signal.

The diagnostic events and remedial measures can be printed from the **Diagnostic list** submenu.

11.5 Adapting the diagnostic information

The event level can be configured:

Navigation: Diagnostics → Diagnostic settings → Configuration

11.6 Pending diagnostic messages

Pending diagnostic messages are displayed in alternating sequence with the measured value display in the onsite display.

Pending diagnostic messages can be displayed in the **Active diagnostics** parameter.

Navigation: Diagnostics → Active diagnostics

11.7 Diagnostic list

All of the diagnostic messages currently pending can be displayed in the **Diagnostic list** submenu.

Navigation: Diagnostics → Diagnostic list

11.7.1 List of diagnostic events

 Diagnosis 242 and 252 cannot occur with this device.

For diagnoses 270, 273, 803 and 805: The device must be replaced if the electronics are replaced.

Diagnostic number	Short text	Remedy instructions	Status signal [from the factory]	Diagnostic behavior [from the factory]
Diagnostic of sensor				
062	Sensor connection faulty	Check sensor connection	F	Alarm
081	Sensor initialization faulty	1. Restart device 2. Contact service	F	Alarm
100	Sensor error	1. Restart the device 2. Contact Endress+Hauser Service	F	Alarm
101	Sensor temperature	1. Check process temperature 2. Check ambient temperature	F	Alarm
102	Sensor incompatible error	1. Restart device 2. Contact service	F	Alarm
Diagnostic of electronic				
203	HART Device Malfunction	Check device specific diagnosis.	S	Warning
204	HART Electronic Defect	Check device specific diagnosis.	F	Alarm
242	Firmware incompatible	1. Check software 2. Flash or change main electronic module	F	Alarm
252	Module incompatible	1. Check if correct electronic module is plugged 2. Replace electronic module	F	Alarm
263	Incompatibility detected	Check electronic module type	M	Warning
270	Main electronics defective	Replace main electronics or device.	F	Alarm
272	Main electronics faulty	1. Restart device 2. Contact service	F	Alarm
273	Main electronics defective	Replace main electronics or device.	F	Alarm
282	Data storage inconsistent	Restart device	F	Alarm
283	Memory content inconsistent	1. Restart device 2. Contact service	F	Alarm
287	Memory content inconsistent	1. Restart device 2. Contact service	M	Warning
388	Electronics and HistoROM defective	1. Restart device 2. Replace electronics and HistoROM 3. Contact service	F	Alarm
Diagnostic of configuration				
410	Data transfer failed	1. Retry data transfer 2. Check connection	F	Alarm
412	Processing download	Download active, please wait	C	Warning
420	HART Device Configuration Locked	Check device locking configuration.	S	Warning
421	HART Loop Current fixed	Check Multi-drop mode or current simulation.	S	Warning

Diagnostic number	Short text	Remedy instructions	Status signal [from the factory]	Diagnostic behavior [from the factory]
431	Trim required	Carry out trim	C	Warning
435	Linearization faulty	Check data points and min span	F	Alarm
437	Configuration incompatible	1. Update firmware 2. Execute factory reset	F	Alarm
438	Dataset different	1. Check dataset file 2. Check device parameterization 3. Download new device parameterization	M	Warning
441	Current output 1 saturated	1. Check process 2. Check current output settings	S	Warning
484	Failure mode simulation active	Deactivate simulation	C	Alarm
485	Process variable simulation active	Deactivate simulation	C	Warning
491	Current output simulation active	Deactivate simulation	C	Warning
495	Diagnostic event simulation active	Deactivate simulation	S	Warning
500	Process alert pressure	1. Check process pressure 2. Check configuration of process alert	S	Warning ¹⁾
501	Process alert scaled variable	1. Check process conditions 2. Check scaled variable configuration	S	Warning ¹⁾
502	Process alert temperature	1. Check process temperature 2. Check configuration of process alert	S	Warning ¹⁾
503	Zero adjustment	1. Check measuring range 2. Check position adjustment	M	Warning
Diagnostic of process				
801	Supply voltage too low	Increase supply voltage	F	Alarm
802	Supply voltage too high	Decrease supply voltage	S	Warning
805	Loop current faulty	1. Check wiring 2. Replace electronics or device	F	Alarm
806	Loop diagnostics	1. Check supply voltage 2. Check wiring and terminals	M	Warning ¹⁾
807	No Baseline due to insuf. volt. at 20 mA	Increase supply voltage	M	Warning
822	Sensor temperature out of range	1. Check process temperature 2. Check ambient temperature	S	Warning ¹⁾
825	Electronics temperature	1. Check ambient temperature 2. Check process temperature	S	Warning
841	Operating range	1. Check the process pressure 2. Check the sensor range	S	Warning ¹⁾
846	HART Non-Primary Variable Out of Limit	Check device specific diagnosis.	S	Warning
847	HART Primary Variable Out of Limit	Check device specific diagnosis.	S	Warning
848	HART Device Variable Alert	Check device specific diagnosis.	S	Warning

Diagnostic number	Short text	Remedy instructions	Status signal [from the factory]	Diagnostic behavior [from the factory]
900	High signal noise detected	1. Check impulse line 2. Check valve position 3. Check process	M	Warning ¹⁾
901	Low signal noise detected	1. Check impulse line 2. Check valve position 3. Check process	M	Warning ¹⁾
902	Min signal noise detected	1. Check impulse line 2. Check valve position 3. Check process	M	Warning ¹⁾
906	Out of range signal detected	1. Process Information. No action 2. Rebuild baseline 3. Adapt signal range thresholds	S	Warning ¹⁾

1) Diagnostic behavior can be changed.

11.8 Event logbook

11.8.1 Event history

The "Event logbook" submenu ⁶⁾.

Navigation: Diagnostics → Event logbook

A maximum of 100 event messages can be displayed in chronological order.

The event history includes entries for:

- Diagnostic events
- Information events

In addition to the operating time when the event occurred, each event is also assigned a symbol that indicates whether the event has occurred or is finished:

- Diagnostic event
 - ☹: Occurrence of the event
 - ☺: End of the event
- Information event
 - ☹: Occurrence of the event

11.8.2 Filtering the event logbook

Filters can be used to determine which category of event messages is displayed in the **Event logbook** submenu.

Navigation: Diagnostics → Event logbook

Filter categories

- All
- Failure (F)
- Function check (C)
- Out of specification (S)
- Maintenance required (M)
- Information

6) provides a chronological overview of the event messages that have occurred. If the device is operated via FieldCare, the events list can be displayed via the FieldCare function "Event List".

11.8.3 Overview of information events

Info number	Info name
I1000	------(Device ok)
I1079	Sensor changed
I1089	Power on
I1090	Configuration reset
I1091	Configuration changed
I11074	Device verification active
I1110	Write protection switch changed
I11104	Loop diagnostics
I11284	DIP MIN setting to HW active
I11285	DIP SW setting active
I11341	SSD baseline created
I1151	History reset
I1154	Reset terminal voltage min/max
I1155	Reset electronics temperature
I1157	Memory error event list
I1256	Display: access status changed
I1264	Safety sequence aborted
I1335	Firmware changed
I1397	Fieldbus: access status changed
I1398	CDI: access status changed
I1440	Main electronic module changed
I1444	Device verification passed
I1445	Device verification failed
I1461	Sensor verification failed
I1512	Download started
I1513	Download finished
I1514	Upload started
I1515	Upload finished
I1551	Assignment error fixed
I1552	Failed: Main electronic verification
I1554	Safety sequence started
I1555	Safety sequence confirmed
I1556	Safety mode off
I1956	Reset

11.9 Resetting the device

11.9.1 Reset via digital communication

The device can be reset with the **Device reset** parameter.

Navigation: System → Device management

 Any customer-specific configuration carried out at the factory is not affected by a reset (customer-specific configuration remains).

11.9.2 Resetting the password via the operating tool

Enter a code to reset the current "Maintenance" password.
The code is delivered by your local support.

Navigation: System → User management → Reset password → Reset password

 For details see the "Description of device parameters" documentation.

11.10 Device information

All device information is contained in the **Information** submenu.

Navigation: System → Information

 For details see the "Description of device parameters" documentation.

11.11 Firmware history

11.11.1 Version

01.00.00

Initial software

12 Maintenance

12.1 Maintenance work

12.1.1 Filter element

Keep the filter element (1) free from contamination. The device version determines whether or not a filter element is installed.

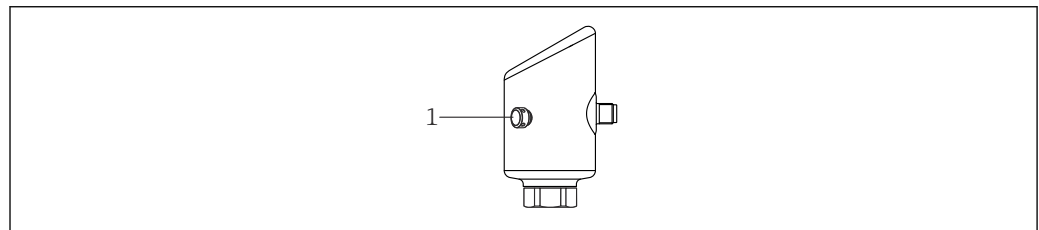

A0053239

12.1.2 Exterior cleaning

The cleaning agents used should not corrode the surface and the seals.

The following cleaning agents can be used:

- Ecolab P3 topaktive 200
- Ecolab P3 topaktive 500
- Ecolab P3 topaktive OKTO
- Ecolab P3 topax 66
- Ecolab TOPAZ AC5

Avoid mechanical damage to the membrane (e.g. caused by pointed objects).

Observe the degree of protection of the device.

13 Repair

13.1 General notes

13.1.1 Repair concept

The Endress+Hauser repair concept is devised in such a way that repairs can only be carried out through device replacement.

13.1.2 Replacing a device

After the device is replaced, previously saved parameters can be copied to the newly installed device.

After an entire device has been replaced, the parameters can be downloaded to the device again via the communication interface. The data must have been uploaded to the PC or the SmartBlue app beforehand using the "FieldCare/DeviceCare" software.

13.2 Return

The requirements for safe device return can vary depending on the device type and national legislation.

1. Refer to the web page for information:
<https://www.endress.com/support/return-material>
↳ Select the region.
2. If returning the device, pack the device in such a way that it is reliably protected against impact and external influences. The original packaging offers the best protection.

13.3 Disposal



If required by the Directive 2012/19/EU on waste electrical and electronic equipment (WEEE), the product is marked with the depicted symbol in order to minimize the disposal of WEEE as unsorted municipal waste. Do not dispose of products bearing this marking as unsorted municipal waste. Instead, return them to the manufacturer for disposal under the applicable conditions.

14 Accessories

Accessories currently available for the product can be selected via the Product Configurator at www.endress.com:

1. Select the product using the filters and search field.
2. Open the product page.
3. Select **Spare parts & Accessories**.

14.1 Device-specific accessories

14.1.1 M12 socket

M12 socket, straight

- Material:
Body: PA; union nut: stainless steel; seal: EPDM
- Degree of protection (fully locked): IP69
- Order number: 71638191

M12 socket, elbowed

- Material:
Body: PA; union nut: stainless steel; seal: EPDM
- Degree of protection (fully locked): IP69
- Order number: 71638253

14.1.2 Cables

Cable 4 x 0.34 mm² (20 AWG) with M12 socket, elbowed, screw plug, length 5 m (16 ft)

- Material: body: TPU; union nut: nickel-plated die-cast zinc; cable: PVC
- Degree of protection (fully locked): IP68/69
- Order number: 52010285
- Wire colors
 - 1 = BN = brown
 - 2 = WT = white
 - 3 = BU = blue
 - 4 = BK = black

14.1.3 Welding neck, process adapter and flange



For details, refer to TI00426F/00/EN "Weld-in adapters, process adapters and flanges".

14.1.4 Mechanical accessories



For technical data (e.g. materials, dimensions or order numbers), see the accessory document SD01553P.

14.2 DeviceCare SFE100

Configuration tool for IO-Link, HART, PROFIBUS and FOUNDATION Fieldbusfield devices
DeviceCare is available for download free of charge at www.software-products.endress.com. You need to register in the Endress+Hauser software portal to download the application.



Technical Information TI01134S

14.3 FieldCare SFE500

FDT-based plant asset management tool

It can configure all intelligent field units in your system and helps you manage them. By using the status information, it is also a simple but effective way of checking their status and condition.



Technical Information TI00028S

14.4 Device Viewer

All the spare parts for the device, along with the order code, are listed in the *Device Viewer* (www.endress.com/deviceviewer).

14.5 Field Xpert SMT70

Universal, high-performance tablet PC for device configuration in Ex Zone 2 and non-Ex areas



For details, see "Technical Information" TI01342S

14.6 Field Xpert SMT77

Universal, high-performance tablet PC for device configuration in Ex Zone 1 areas



For details, see "Technical Information" TI01418S

14.7 SmartBlue app

Mobile app for easy configuration of devices on site via Bluetooth wireless technology

15 Technical data

15.1 Input

15.1.1 Measured variable

Measured process variables

- Absolute pressure
- Gauge pressure

Calculated process variables

- Pressure
- Scaled variable

15.1.2 Measuring range

Depending on the device configuration, the maximum working pressure (MWP) and the overpressure limit (OPL) can deviate from the values in the tables.

Absolute pressure

Measuring cell	Maximum measuring range		Smallest factory-calibratable span	
	lower (LRL)	upper (URL)	Standard	Platinum
	[bar (psi)]	[bar (psi)]	[bar (psi)]	
400 mbar (6 psi)	0	+0.4 (+6)	0.05 (0.75) ¹⁾	80 mbar (1.2 psi)
1 bar (15 psi)	0	+1 (+15)	0.05 (0.75) ²⁾	200 mbar (3 psi)
2 bar (30 psi)	0	+2 (+30)	0.10 (1.50) ²⁾	400 mbar (6 psi)
4 bar (60 psi)	0	+4 (+60)	0.20 (3.00) ²⁾	800 mbar (12 psi)
10 bar (150 psi)	0	+10 (+150)	0.50 (7.50) ²⁾	2 bar (30 psi)
40 bar (600 psi)	0	+40 (+600)	2.00 (30.0) ²⁾	8 bar (120 psi)
100 bar (1 500 psi)	0	+100 (+1500)	5.00 (73) ²⁾	20 bar (300 psi)

- 1) Largest factory-configurable turn down: 8:1
 2) Largest factory-configurable turn down: 20:1

Absolute pressure

Measuring cell	MWP	OPL	Factory settings ¹⁾
	[bar (psi)]	[bar (psi)]	
400 mbar (6 psi)	1 (14.5)	1.6 (23)	0 to 400 mbar (0 to 6 psi)
1 bar (15 psi)	2.7 (39)	4 (58)	0 to 1 bar (0 to 15 psi)
2 bar (30 psi)	6.7 (97)	10 (145)	0 to 2 bar (0 to 30 psi)
4 bar (60 psi)	10.7 (155)	16 (232)	0 to 4 bar (0 to 60 psi)
10 bar (150 psi)	25 (362)	40 (580)	0 to 10 bar (0 to 150 psi)
40 bar (600 psi)	100 (1450)	160 (2320)	0 to 40 bar (0 to 600 psi)
100 bar (1 500 psi)	103.5 (1500)	160 (2320)	0 to 100 bar (0 to 1 500 psi)

- 1) Different measuring ranges (e.g. -1 to +5 bar (-15 to +75 psi)) can be ordered with customized settings. It is possible to invert the output signal (LRV = 20 mA; URV = 4 mA). Prerequisite: URV < LRV

Gauge pressure

Measuring cell	Maximum measuring range		Smallest factory-calibratable span ¹⁾	
	lower (LRL)	upper (URL)	Standard	Platinum
	[bar (psi)]	[bar (psi)]	[bar (psi)]	
400 mbar (6 psi)	-0.4 (-6)	+0.4 (+6)	0.05 (0.75) ²⁾	80 mbar (1.2 psi)
1 bar (15 psi)	-1 (-15)	+1 (+15)	0.05 (0.75) ³⁾	200 mbar (3 psi)
2 bar (30 psi)	-1 (-15)	+2 (+30)	0.10 (1.50) ³⁾	400 mbar (6 psi)
4 bar (60 psi)	-1 (-15)	+4 (+60)	0.20 (3.00) ³⁾	800 mbar (12 psi)
10 bar (150 psi)	-1 (-15)	+10 (+150)	0.50 (7.50) ³⁾	2 bar (30 psi)
25 bar (375 psi)	-1 (-15)	+25 (+375)	1.25 (18.50) ³⁾	5 bar (75 psi)
40 bar (600 psi)	-1 (-15)	+40 (+600)	2.00 (30.00) ³⁾	8 bar (120 psi)
100 bar (1 500 psi)	-1 (-15)	+100 (+1500)	5.00 (73) ³⁾	20 bar (300 psi)

- 1) Largest factory-configurable turn down: 5:1.
 2) Largest factory-configurable turn down: 8:1
 3) Largest factory-configurable turn down: 20:1

Gauge pressure

Measuring cell	MWP	OPL	Factory settings ¹⁾
	[bar (psi)]	[bar (psi)]	
400 mbar (6 psi)	1 (14.5)	1.6 (23)	0 to 400 mbar (0 to 6 psi)
1 bar (15 psi)	2.7 (39)	4 (58)	0 to 1 bar (0 to 15 psi)
2 bar (30 psi)	6.7 (97)	10 (145)	0 to 2 bar (0 to 30 psi)
4 bar (60 psi)	10.7 (155)	16 (232)	0 to 4 bar (0 to 60 psi)
10 bar (150 psi)	25 (363)	40 (580)	0 to 10 bar (0 to 150 psi)
25 bar (375 psi)	25.8 (375)	100 (1450)	0 to 25 bar (0 to 375 psi)
40 bar (600 psi)	100 (1450)	160 (2320)	0 to 40 bar (0 to 600 psi)
100 bar (1 500 psi)	103.5 (1500)	160 (2320)	0 to 100 bar (0 to 1 500 psi)

- 1) Different measuring ranges (e.g. -1 to +5 bar (-15 to +75 psi)) can be ordered with customized settings. It is possible to invert the output signal (LRV = 20 mA; URV = 4 mA). Prerequisite: URV < LRV

15.2 Output

15.2.1 Output signal

- 4 to 20 mA with superimposed digital communication protocol HART, 2-wire
- The current output offers a choice of three different operating modes:
 - 4 to 20.5 mA
 - NAMUR NE 43: 3.8 to 20.5 mA (factory setting)
 - US mode: 3.9 to 20.5 mA

15.2.2 Signal on alarm for devices with current output

Current output

Signal on alarm in accordance with NAMUR recommendation NE 43.

- Max. alarm: can be set from 21.5 to 23 mA
- Min. alarm: < 3.6 mA (factory setting)

Onsite display and operating tool via digital communication

Status signal (according to NAMUR Recommendation NE 107):
Plain text display

15.2.3 Load

In order to guarantee sufficient terminal voltage, a maximum load resistance R_L (including line resistance) must not be exceeded, depending on the supply voltage U of the supply unit.

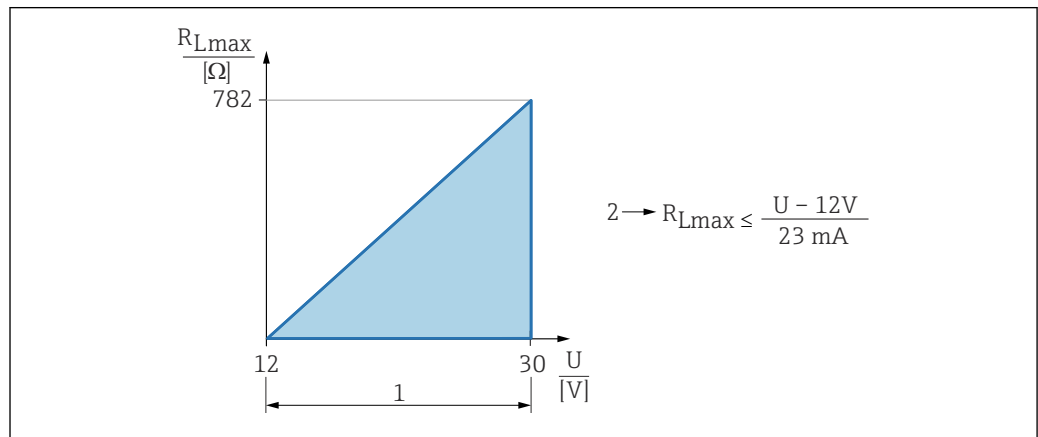

A0052602

- 1 Power supply 12 to 30 V
- 2 R_{Lmax} maximum load resistance
- U Supply voltage

If load is too great:

- Failure current is indicated and error message is displayed (indication: MIN alarm current)
- Periodic checking to establish if it is possible to quit fault state

i Operation via handheld terminal or PC with operating program: take minimum communication resistor of 250 Ω into consideration.

15.2.4 Damping

A damping affects all continuous outputs: Damping can be enabled as follows:

- Via onsite display, Bluetooth, handheld terminal or PC with operating program continuously from 0 to 999 s, in increments of 0.1 s
- Factory setting: 1 s (adjustable from 0 to 999 s)

15.2.5 Ex connection data

📖 See the separate technical documentation (Safety Instructions (XA)) on www.endress.com/download.

15.2.6 Protocol-specific data

Manufacturer ID:
17(0x0011)

Device type ID:
0x11C5

Device revision:
1

HART specification:

7.6

DD version:

1

Device description files (DTM, DD)

Information and files at:

- www.endress.com

On the product page for the device: Documents/Software → Device drivers

- www.fieldcommgroup.org

HART load:

Min. 250 Ω

The following measured values are assigned to the device variables at the factory:

Device variable	Measured value
Primary variable (PV) ¹⁾	Pressure ²⁾
Secondary variable (SV)	Sensor temperature
Tertiary variable (TV)	Electronics temperature
Quaternary variable (QV)	Sensor pressure ³⁾

- 1) The PV is always applied to the current output.
- 2) The pressure is the calculated signal after damping and position adjustment.
- 3) The Sensor pressure is the raw signal of the measuring cell before damping and position adjustment.

Choice of HART device variables

- Pressure
- Scaled variable
- Sensor temperature
- Sensor pressure
- Electronics temperature
- Terminal current ⁷⁾
- Terminal voltage ⁷⁾
- Median of pressure signal ⁷⁾
- Noise of pressure signal ⁷⁾
- Signal noise detected ⁷⁾
- Percent of range
- Loop current
- Not used

15.3 Environment

15.3.1 Ambient temperature range

-40 to +85 °C (-40 to +185 °F)

The permitted ambient temperature is reduced at higher process temperatures.



The following information only takes into account functional aspects. Additional restrictions may apply for certified device versions.

The permitted process temperature varies, depending on the process connection used. For an overview of the process connections, see Section "Process temperature range".

7) Visible depending on the order options or device settings

Maximum process temperature +130 °C (+266 °F)

(Product feature "Application"; order option "B")

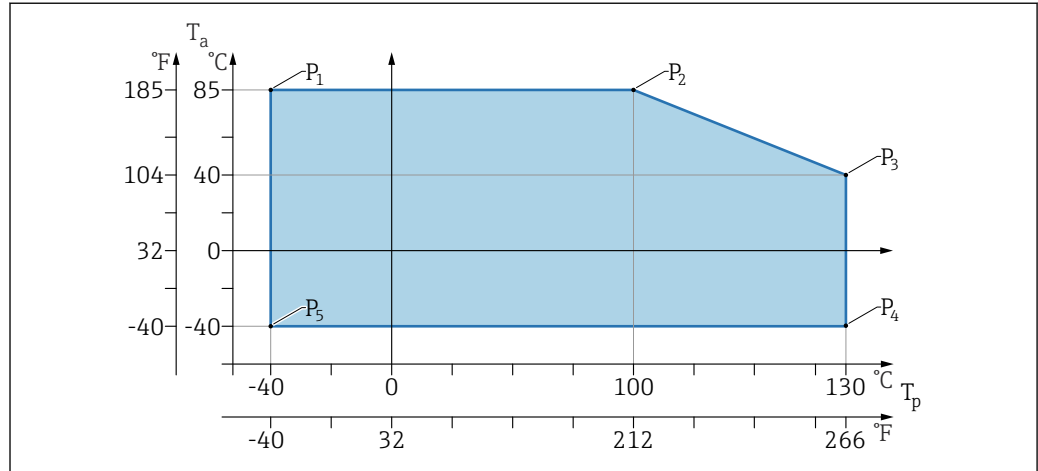

A0055963

4 Ambient temperature T_a depending on the process temperature T_p

P	T_p	T_a
P1	-40 °C (-40 °F)	+85 °C (+185 °F)
P2	+100 °C (+212 °F)	+85 °C (+185 °F)
P3	+130 °C (+266 °F)	+40 °C (+77 °F)
P4	+130 °C (+266 °F)	-40 °C (-40 °F)
P5	-40 °C (-40 °F)	-40 °C (-40 °F)

Maximum process temperature +150 °C (+302 °F)

(Product feature "Application"; order option "C")

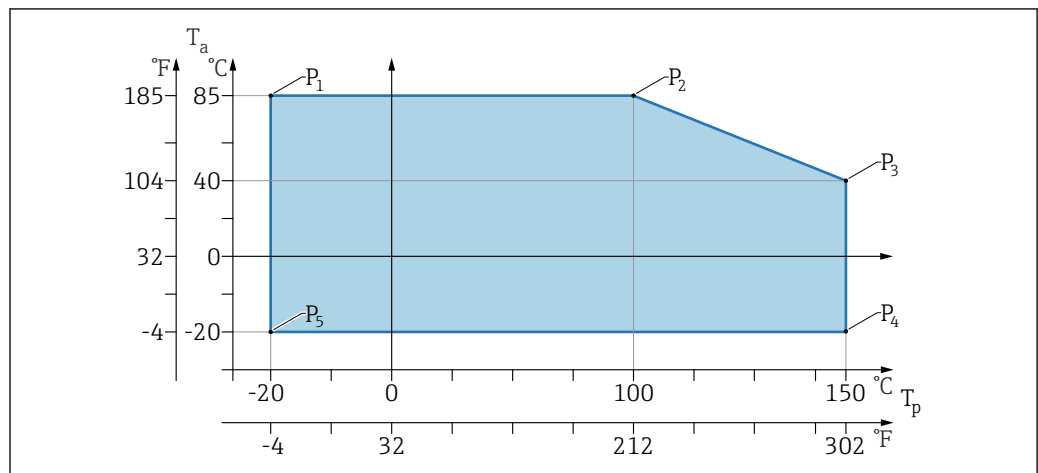

A0055962

5 Ambient temperature T_a depending on the process temperature T_p

P	T_p	T_a
P1	-20 °C (-4 °F)	+85 °C (+185 °F)
P2	+100 °C (+212 °F)	+85 °C (+185 °F)
P3	+150 °C (+302 °F)	+40 °C (+77 °F)

P	T _p	T _a
P4	+150 °C (+302 °F)	-20 °C (-4 °F)
P5	-20 °C (-4 °F)	-20 °C (-4 °F)

Maximum process temperature +200 °C (+392 °F)

(Product feature "Application"; order option "D")

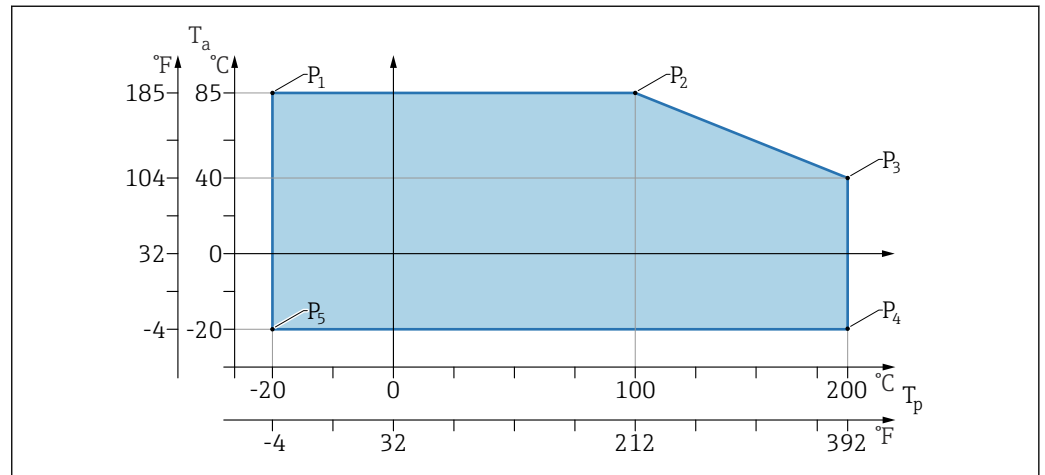

6 Ambient temperature T_a depending on the process temperature T_p

A0055469

P	T _p	T _a
P1	-20 °C (-4 °F)	+85 °C (+185 °F)
P2	+100 °C (+212 °F)	+85 °C (+185 °F)
P3	+200 °C (+392 °F)	+40 °C (+77 °F)
P4	+200 °C (+392 °F)	-20 °C (-4 °F)
P5	-20 °C (-4 °F)	-20 °C (-4 °F)

15.3.2 Storage temperature

-40 to +85 °C (-40 to +185 °F)

15.3.3 Operating height

Up to 5 000 m (16 404 ft) above sea level

15.3.4 Climate class

According to IEC 60068-2-38 test Z/AD (relative humidity 4 to 100 %).

15.3.5 Degree of protection

Test as per IEC 60529 Edition 2.2 2013-08/ DIN EN 60529:2014-09 and NEMA 250-2014

For mounted M12 connecting cable: IP66/68/69, NEMA type 4X/6P

/IP68,: (1.83 mH₂O for 24 h)

15.3.6 Pollution degree

Pollution degree 2 according to IEC/EN 61010-1.

15.3.7 Vibration resistance

- Stochastic noise (random sweep) according to IEC/DIN EN 60068-2-64 Case 2
- Guaranteed for 5 to 2 000 Hz: $1.25 (m/s^2)^2/Hz$, ~ 5 g
- Sinusoidal vibration according to IEC 62828-1:2017 with 10 to 60 Hz ± 0.35 mm; 60 to 1 000 Hz 5 g

15.3.8 Shock resistance

- Testing standard: IEC/DIN EN 60068-2-27 Case 2
- Shock resistance: 30 g (18 ms) in all 3 axes

15.3.9 Electromagnetic compatibility (EMC)

- Electromagnetic compatibility as per IEC/DIN EN 61326 series and NAMUR recommendation EMC (NE21)
- Maximum deviation under interference influence: < 0.5 %

For more details refer to the EU Declaration of Conformity.

15.4 Process

15.4.1 Process temperature

Maximum process temperature	Version ¹⁾
+100 °C (+212 °F)	A
+130 °C (+266 °F)(+150 °C (+302 °F) ²⁾)	B
+150 °C (+302 °F)	C
+200 °C (+392 °F)	D

1) Product Configurator, "Application" feature

2) Temperature for maximum one hour (device in operation but not within measurement specification)

Fill fluid

Fill fluid	Process temperature range	Version ¹⁾
Synthetic oil, FDA	-40 to +130 °C (-40 to +266 °F)(+150 °C (+302 °F) ²⁾)	3
Vegetable oil, FDA	-20 to +200 °C (-4 to +392 °F)	4

1) Product Configurator, "Fill fluid" feature

2) Temperature for one hour maximum (device in operation but not within measurement specification)

15.4.2 Process pressure range

Pressure specifications

⚠ WARNING

The maximum pressure for the device depends on the lowest-rated component with regard to pressure (components are: process connection, optional mounted parts or accessories).

- ▶ Only operate the device within the specified limits for the components!
- ▶ MWP (maximum working pressure): The maximum working pressure is specified on the nameplate. This value refers to a reference temperature of +20 °C (+68 °F) and may be applied to the device for an unlimited time. Note temperature dependence of maximum working pressure. For higher temperatures, refer to the following standards for the permitted pressure values for flanges: EN 1092-1 (materials 1.4435 and 1.4404 are identical with regard to their stability/temperature property and are grouped together in under 13E0 in EN 1092-1 Tab. 18; the chemical composition of the two materials can be identical), ASME B 16.5a (the latest version of the standard applies in each case).
- ▶ The overpressure limit is the maximum pressure that a device may be subjected to during a test. It exceeds the maximum working pressure by a certain factor. This value refers to a reference temperature of +20 °C (+68 °F).
- ▶ In the case of sensor range and process connection combinations where the overpressure limit (OPL) of the process connection is less than the nominal value of the measuring cell, the device is set at the factory, at the very maximum, to the OPL value of the process connection. If the entire measuring cell range must be used, select a process connection with a higher OPL value (1.5 x MWP; MWP = PN).
- ▶ The Pressure Equipment Directive (2014/68/EU) uses the abbreviation "PS". The abbreviation "PS" corresponds to the maximum working pressure of the device.
- ▶ For maximum working pressure data that deviate from this, see the "Mechanical construction" section.

15.4.3 Cleaned of oil and grease

Endress+Hauser also offers devices, cleaned of oil and grease, for special applications. No special restrictions regarding the process conditions apply to these devices.

Index

A

Access authorization to parameters	
Read access	17
Write access	17
Access code	17
Incorrect input	17

C

CE mark	9
Cleaning	42

D

Declaration of conformity	9
Device locking, status	31
Device replacement	43
DeviceCare	21
Diagnosis	
Symbols	36
Diagnostic event	36
In the operating tool	37
Diagnostic events	35, 36
Diagnostic list	37
Diagnostic message	36
Display values	
For locking status	31
Disposal	43
Document	
Function	5
Document function	5

E

Event history	40
Event text	36
Events list	40
Exterior cleaning	42

F

Field of application	
Residual risks	9
FieldCare	21
Function	21
Filtering the event logbook	40
FV (HART variable)	22

H

HART variables	22
----------------	----

I

Intended use	8
--------------	---

N

Nameplate	12
-----------	----

O

Occupational safety	9
Onsite display	
see Diagnostic message	

see In alarm condition

Operational safety	9
--------------------	---

P

Post-connection check	16
Product security	9
PV (HART variable)	22

R

Read access	17
Reading off measured values	31
Repair concept	43
Replacing a device	43
Requirements for personnel	8
Return	43

S

Settings	
Adapting the device to process conditions	32
Status signals	36
Submenu	
Events list	40
SV (HART variable)	22

T

Troubleshooting	33
TV (HART variable)	22

U

Use of the measuring instruments	
Borderline cases	8
Incorrect use	8
Using the device	
see Intended use	

W

Write access	17
--------------	----



71668323

www.addresses.endress.com
