

Operating Instructions

Dosimass

IO-Link

Coriolis flowmeter

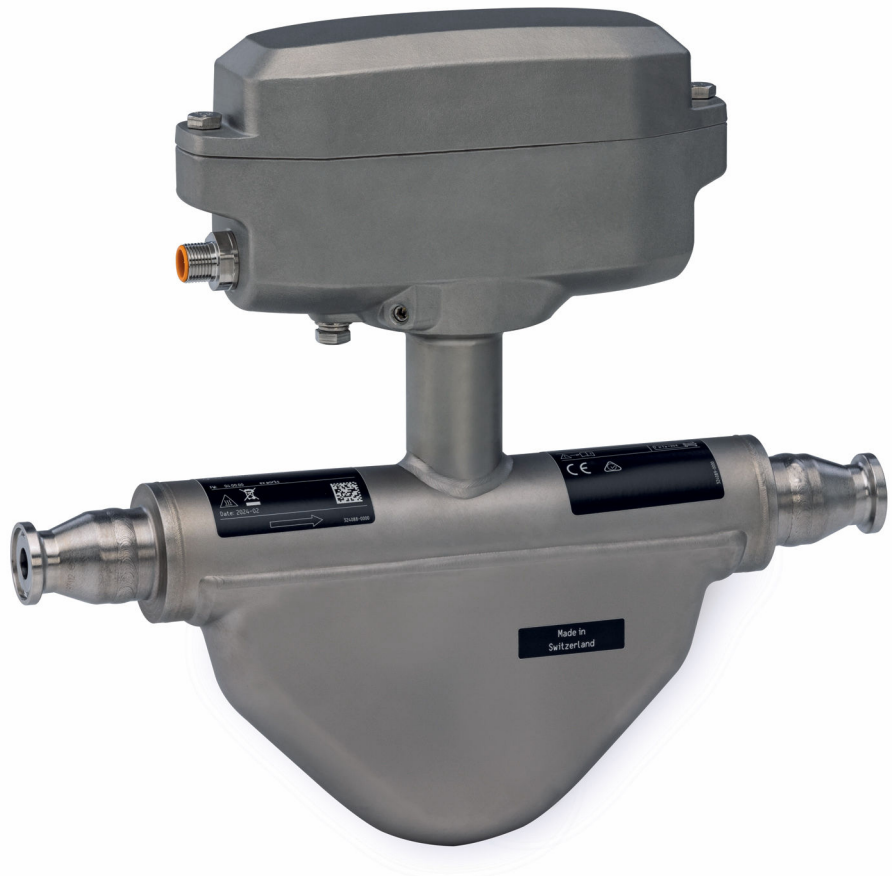

- Make sure the document is stored in a safe place such that it is always available when working on or with the device.
- To avoid danger to individuals or the facility, read the "Basic safety instructions" section carefully, as well as all other safety instructions in the document that are specific to working procedures.
- The manufacturer reserves the right to modify technical data without prior notice. Your Endress+Hauser sales organization will supply you with current information and updates to this manual.

Table of contents

1	About this document	5		
1.1	Document function	5		
1.2	Symbols	5		
1.2.1	Safety symbols	5		
1.2.2	Electrical symbols	5		
1.2.3	Symbols for certain types of information	5		
1.2.4	Symbols in graphics	6		
1.3	Documentation	6		
1.4	Registered trademarks	7		
2	Safety instructions	8		
2.1	Requirements for the personnel	8		
2.2	Intended use	8		
2.3	Workplace safety	9		
2.4	Operational safety	9		
2.5	Product safety	9		
2.6	IT security	9		
3	Product description	10		
3.1	Product design	10		
4	Incoming acceptance and product identification	11		
4.1	Incoming acceptance	11		
4.2	Product identification	11		
4.2.1	Measuring instrument nameplate	12		
4.2.2	Symbols on the device	14		
5	Storage and transport	15		
5.1	Storage conditions	15		
5.2	Transporting the product	15		
5.3	Packaging disposal	15		
6	Mounting	16		
6.1	Mounting requirements	16		
6.1.1	Mounting position	16		
6.1.2	Environmental and process requirements	19		
6.1.3	Special mounting instructions	21		
6.2	Mounting the measuring instrument	24		
6.2.1	Required tools	24		
6.2.2	Preparing the measuring instrument	24		
6.2.3	Mounting the measuring device	24		
6.3	Post-mounting check	25		
7	Electrical connection	26		
7.1	Electrical safety	26		
7.2	Connecting requirements	26		
7.2.1	Requirements for connecting cable	26		
7.2.2	Terminal assignment	26		
7.2.3	Available device plugs	26		
7.2.4	Requirements for the supply unit	27		
7.3	Connecting the measuring instrument	28		
7.3.1	Connection via device plug	28		
7.3.2	Grounding	28		
7.4	Ensuring potential equalization	28		
7.5	Ensuring the degree of protection	28		
7.6	Post-connection check	29		
8	Operation options	30		
8.1	Overview of operation options	30		
8.2	Access to the operating menu via the operating tool	30		
8.2.1	Connecting the operating tool	30		
8.2.2	FieldCare	31		
8.2.3	DeviceCare	32		
9	System integration	33		
9.1	Overview of device description files	33		
9.1.1	Current version data for the device	33		
9.1.2	Operating tools	33		
9.2	Information about IO-Link communication	33		
10	Commissioning	34		
10.1	Post-mounting and post-connection check	34		
10.2	Switching on the measuring device	34		
10.3	Connecting via FieldCare	34		
10.4	Configuring the measuring instrument	34		
11	Operation	35		
11.1	Reading the device locking status	35		
11.2	Reading access authorization status on operating software	35		
11.3	Reading measured values	35		
11.4	Adapting the measuring instrument to the process conditions	36		
11.5	Performing a totalizer reset	36		
12	Diagnostics and troubleshooting	37		
12.1	General troubleshooting	37		
12.2	Diagnostic information in FieldCare or DeviceCare	37		
12.2.1	Diagnostic options	37		
12.2.2	Calling up remedy information	38		
12.3	Adapting the diagnostic information	38		
12.3.1	Adapting the diagnostic behavior	38		
12.4	Overview of diagnostic information	39		
12.5	Pending diagnostic events	41		
12.6	Actual diagnostics	42		
12.7	Event logbook	42		
12.7.1	Event history	42		
12.7.2	Overview of information events	42		

12.8	Resetting the measuring device	43
12.9	Device	43
12.10	Firmware history	45
13	Maintenance	46
13.1	Maintenance work	46
13.1.1	Exterior cleaning	46
13.1.2	Internal cleaning	46
13.2	Measuring and test equipment	46
13.3	Endress+Hauser services	46
14	Repair	47
14.1	General information	47
14.1.1	Repair and conversion concept	47
14.2	Endress+Hauser services	47
14.3	Return	47
14.4	Disposal	47
14.4.1	Removing the measuring device	47
14.4.2	Disposing of the measuring device	48
15	Accessories	49
15.1	Device-specific accessories	49
15.2	Communication-specific accessories	49
15.3	Service-specific accessories	49
16	Technical data	50
16.1	Application	50
16.2	Function and system design	50
16.3	Input	50
16.4	Output	51
16.5	Power supply	54
16.6	Performance characteristics	55
16.7	Mounting	58
16.8	Environment	58
16.9	Process	59
16.10	Mechanical construction	61
16.11	Operability	62
16.12	Certificates and approvals	63
16.13	Accessories	65
16.14	Documentation	65
Index	67

1 About this document

1.1 Document function

These Operating Instructions contain all the information required in the various life cycle phases of the device: from product identification, incoming acceptance and storage, to installation, connection, operation and commissioning, through to troubleshooting, maintenance and disposal.

1.2 Symbols

1.2.1 Safety symbols

⚠ DANGER

This symbol alerts you to a dangerous situation. Failure to avoid this situation will result in serious or fatal injury.

⚠ WARNING

This symbol alerts you to a potentially dangerous situation. Failure to avoid this situation can result in serious or fatal injury.





⚠ CAUTION

This symbol alerts you to a potentially dangerous situation. Failure to avoid this situation can result in minor or medium injury.



NOTICE









This symbol alerts you to a potentially harmful situation. Failure to avoid this situation can result in damage to the product or something in its vicinity.

1.2.2 Electrical symbols





Symbol	Meaning
	Direct current
	Alternating current
	Direct current and alternating current
	Ground connection A grounded terminal which, as far as the operator is concerned, is grounded via a grounding system.
	Potential equalization connection (PE: protective earth) Ground terminals that must be connected to ground prior to establishing any other connections. The ground terminals are located on the interior and exterior of the device: <ul style="list-style-type: none"> ▪ Interior ground terminal: potential equalization is connected to the supply network. ▪ Exterior ground terminal: device is connected to the plant grounding system.

1.2.3 Symbols for certain types of information

Symbol	Meaning
	Permitted Procedures, processes or actions that are permitted.
	Preferred Procedures, processes or actions that are preferred.
	Forbidden Procedures, processes or actions that are forbidden.

Symbol	Meaning
	Tip Indicates additional information.
	Reference to documentation
	Reference to page
	Reference to graphic
	Notice or individual step to be observed
	Series of steps
	Result of a step
	Help in the event of a problem
	Visual inspection

1.2.4 Symbols in graphics

Symbol	Meaning
1, 2, 3, ...	Item numbers
	Series of steps
A, B, C, ...	Views
A-A, B-B, C-C, ...	Sections
	Hazardous area
	Safe area (non-hazardous area)
	Flow direction

1.3 Documentation

 For an overview of the scope of the associated Technical Documentation, refer to the following:

- *Device Viewer* (www.endress.com/deviceviewer): Enter the serial number from the nameplate
- *Endress+Hauser Operations app*: Enter serial number from nameplate or scan matrix code on nameplate.

The following documentation may be available depending on the device version ordered:

Document type	Purpose and content of the document
Technical Information (TI)	Planning aid for your device The document contains all the technical data on the device and provides an overview of the accessories and other products that can be ordered for the device.
Brief Operating Instructions (KA)	Guide that takes you quickly to the 1st measured value The Brief Operating Instructions contain all the essential information from incoming acceptance to initial commissioning.

Document type	Purpose and content of the document
Operating Instructions (BA)	<p>Your reference document</p> <p>These Operating Instructions contain all the information that is required in the various life cycle phases of the device: from product identification, incoming acceptance and storage, to mounting, connection, operation and commissioning, through to troubleshooting, maintenance and disposal.</p>
Description of Device Parameters (GP)	<p>Reference for your parameters</p> <p>The document provides a detailed explanation of each individual parameter. The description is aimed at those who work with the device over the entire life cycle and perform specific configurations.</p>
Safety Instructions (XA)	<p>Depending on the approval, safety instructions for electrical equipment in hazardous areas are also supplied with the device. The Safety Instructions are a constituent part of the Operating Instructions.</p> <p> Information on the Safety Instructions (XA) that are relevant for the device is provided on the nameplate.</p>
Supplementary device-dependent documentation (SD/FY)	<p>Always comply strictly with the instructions in the relevant supplementary documentation. The supplementary documentation is a constituent part of the device documentation.</p>

1.4 Registered trademarks

IO-Link®

Is a registered trademark. It may only be used in conjunction with products and services by members of the IO-Link Community or by non-members who hold an appropriate license. For more specific guidelines on use, refer to the IO-Link Community rules on: www.io-link.com.

TRI-CLAMP®

Registered trademark of Ladish & Co., Inc., Kenosha, USA

2 Safety instructions

2.1 Requirements for the personnel

The personnel for installation, commissioning, diagnostics and maintenance must fulfill the following requirements:

- ▶ Trained, qualified specialists must have a relevant qualification for this specific function and task.
- ▶ Are authorized by the plant owner/operator.
- ▶ Are familiar with federal/national regulations.
- ▶ Before starting work, read and understand the instructions in the manual and supplementary documentation as well as the certificates (depending on the application).
- ▶ Follow instructions and comply with basic conditions.

The operating personnel must fulfill the following requirements:

- ▶ Are instructed and authorized according to the requirements of the task by the facility's owner-operator.
- ▶ Follow the instructions in this manual.

2.2 Intended use

Application and media

The measuring device described in this manual is intended only for the flow measurement of liquids and gases.

Depending on the version ordered, the measuring instrument can also be used to measure potentially explosive ¹⁾, flammable, toxic and oxidizing media.

Measuring instruments for use in hazardous areas, in hygienic applications, or where there is an increased risk due to pressure, are specially labeled on the nameplate.

To ensure that the measuring instrument is in perfect condition during operation:

- ▶ Only use the measuring instrument in full compliance with the data on the nameplate and the general conditions listed in the Operating Instructions and supplementary documentation.
- ▶ Using the nameplate, check whether the ordered device is permitted for the intended use in the hazardous area (e.g. explosion protection, pressure vessel safety).
- ▶ Use the measuring instrument only for media to which the process-wetted materials are sufficiently resistant.
- ▶ Keep within the specified pressure and temperature range.
- ▶ Keep within the specified ambient temperature range.
- ▶ Protect the measuring instrument permanently against corrosion from environmental influences.

Incorrect use

Non-designated use can compromise safety. The manufacturer is not liable for damage caused by improper or non-designated use.

WARNING

Danger of breakage due to corrosive or abrasive fluids and ambient conditions!

- ▶ Verify the compatibility of the process fluid with the sensor material.
- ▶ Ensure the resistance of all fluid-wetted materials in the process.
- ▶ Keep within the specified pressure and temperature range.

1) Not applicable for IO-Link measuring instruments

NOTICE**Verification for borderline cases:**

- ▶ For special fluids and fluids for cleaning, Endress+Hauser is glad to provide assistance in verifying the corrosion resistance of fluid-wetted materials, but does not accept any warranty or liability as minute changes in the temperature, concentration or level of contamination in the process can alter the corrosion resistance properties.

Residual risks**⚠ CAUTION**

Risk of hot or cold burns! The use of media and electronics with high or low temperatures can produce hot or cold surfaces on the device.

- ▶ Mount suitable touch protection.

2.3 Workplace safety

When working on and with the device:

- ▶ Wear the required personal protective equipment as per national regulations.

2.4 Operational safety

Damage to the device!

- ▶ Operate the device in proper technical condition and fail-safe condition only.
- ▶ The operator is responsible for the interference-free operation of the device.

Modifications to the device

Unauthorized modifications to the device are not permitted and can lead to unforeseeable dangers!

- ▶ If modifications are nevertheless required, consult with the manufacturer.

Repair

To ensure continued operational safety and reliability:

- ▶ Carry out repairs on the device only if they are expressly permitted.
- ▶ Observe federal/national regulations pertaining to the repair of an electrical device.
- ▶ Use only original spare parts and accessories.

2.5 Product safety

This measuring device is designed in accordance with good engineering practice to meet state-of-the-art safety requirements, has been tested, and left the factory in a condition in which it is safe to operate.

It meets general safety standards and legal requirements. It also complies with the EU directives listed in the device-specific EU Declaration of Conformity. The manufacturer confirms this by affixing the CE mark to the device..

2.6 IT security

Our warranty is valid only if the product is installed and used as described in the Operating Instructions. The product is equipped with security mechanisms to protect it against any inadvertent changes to the settings.

IT security measures, which provide additional protection for the product and associated data transfer, must be implemented by the operators themselves in line with their security standards.

3 Product description

The device consists of a transmitter and a sensor.

3.1 Product design

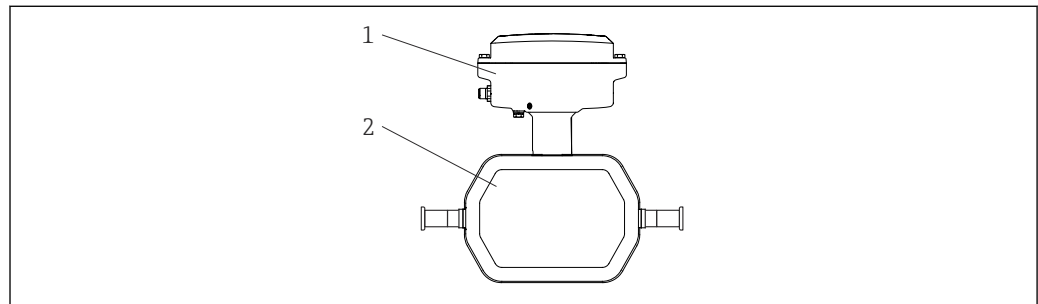

A0055042

1 Important measuring instrument components DN 1 to 4 ($\frac{1}{24}$ to $\frac{1}{8}$ ")

1 Transmitter

2 Sensor

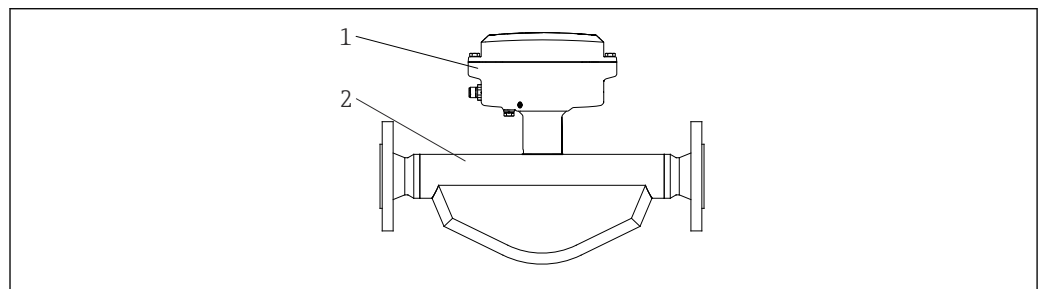

A0055044

2 Important measuring instrument components DN 8 to 40 ($\frac{3}{8}$ to $1 \frac{1}{2}$ ")

1 Transmitter

2 Sensor

4 Incoming acceptance and product identification

4.1 Incoming acceptance

On receipt of the delivery:

1. Check the packaging for damage.
 - ↳ Report all damage immediately to the manufacturer.
Do not install damaged components.
2. Check the scope of delivery using the delivery note.
3. Compare the data on the nameplate with the order specifications on the delivery note.
4. Check the technical documentation and all other necessary documents, e.g. certificates, to ensure they are complete.

 If one of the conditions is not satisfied, contact the manufacturer.

4.2 Product identification

The device can be identified in the following ways:

- Nameplate
- Order code with details of the device features on the delivery note
- Enter the serial numbers from the nameplates in the *Device Viewer* (www.endress.com/deviceviewer): all the information about the device is displayed.
- Enter the serial numbers from the nameplates into the *Endress+Hauser Operations app* or scan the DataMatrix code on the nameplate with the *Endress+Hauser Operations app*: all the information about the device is displayed.

For an overview of the scope of the associated Technical Documentation, refer to the following:

- The "Additional standard device documentation" and "Supplementary device-dependent documentation" sections
- The *Device Viewer*: Enter the serial number from the nameplate (www.endress.com/deviceviewer)
- The *Endress+Hauser Operations app*: Enter the serial number from the nameplate or scan the DataMatrix code on the nameplate.

4.2.1 Measuring instrument nameplate

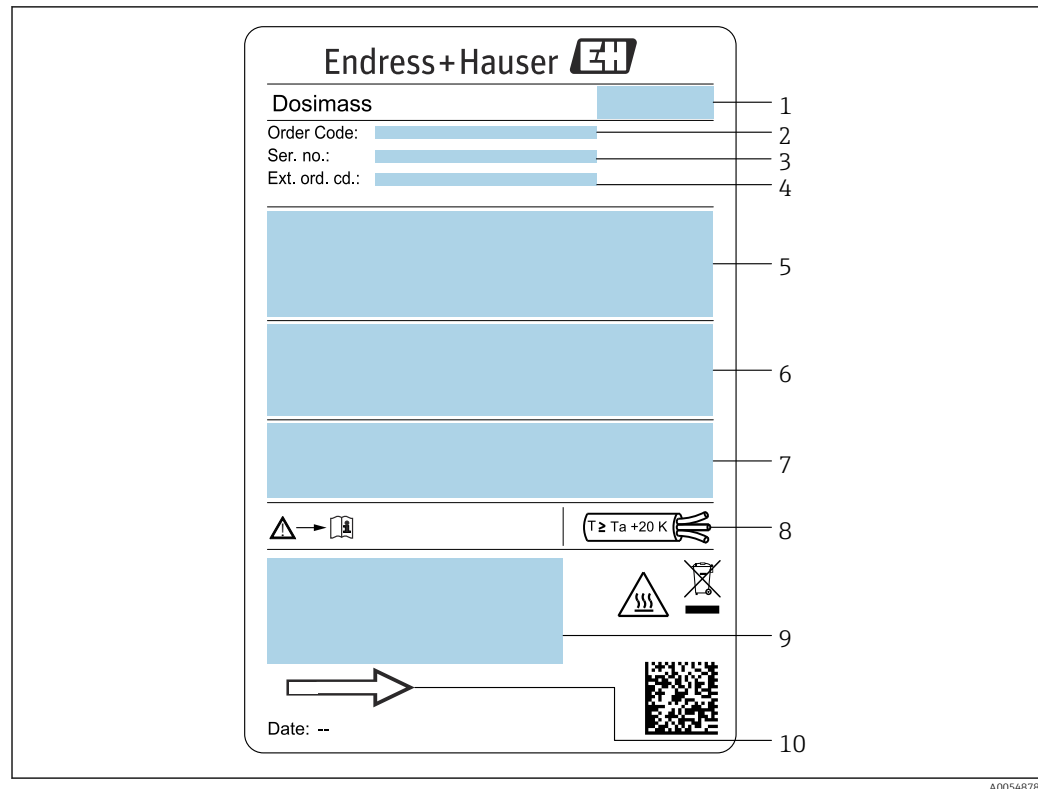

A0054878

3 Example of a measuring instrument nameplate DN 1 to 4 ($\frac{1}{24}$ to $\frac{1}{8}$ ")

- 1 Manufacturer address/certificate holder
- 2 Order code
- 3 Serial number (Ser. no.)
- 4 Extended order code (Ext. ord. cd.): See the specifications on the order confirmation for the meanings of the individual letters and digits
- 5 Supply voltage; power consumption; process connection
- 6 Nominal diameter of sensor; max. flow (Q_{max}); pressure rating ($PN = PS$); materials in contact with medium; permitted medium temperature (T_m); permitted ambient temperature (T_a)
- 7 Degree of protection
- 8 Cable temperature
- 9 Space reserved for additional information on the device version (approvals, certificates, etc.)
- 10 Flow direction

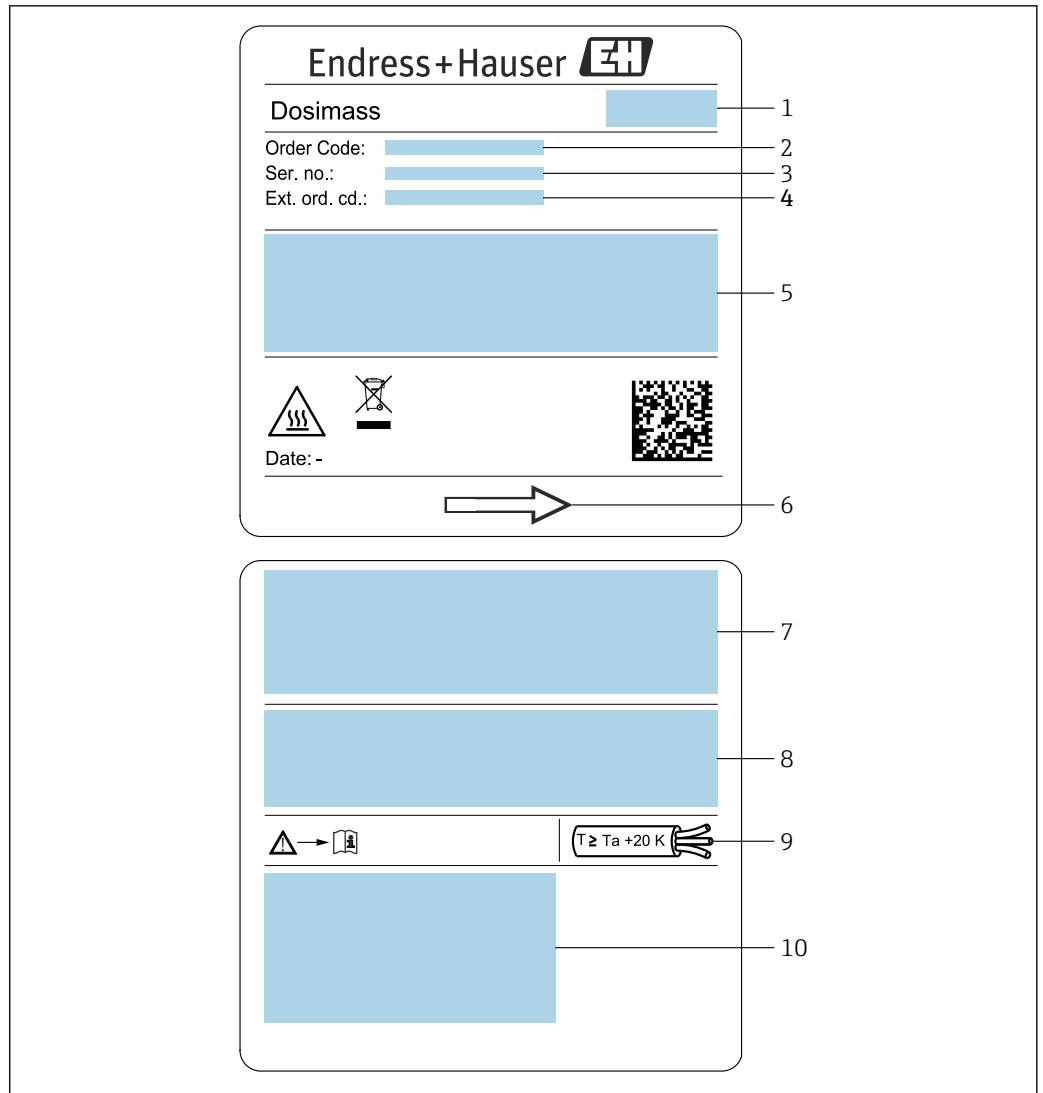

A0054877

4 Example of a measuring instrument nameplate DN 8 to 40 (3/8 to 1 1/2")

- 1 Manufacturer address/certificate holder
- 2 Order code
- 3 Serial number (Ser. no.)
- 4 Extended order code (Ext. ord. cd.): See the specifications on the order confirmation for the meanings of the individual letters and digits
- 5 Supply voltage; power consumption; process connection
- 6 Flow direction
- 7 Nominal diameter of sensor; max. flow (Qmax); pressure rating (PN = PS); materials in contact with medium; permitted medium temperature (Tm); permitted ambient temperature (Ta)
- 8 Degree of protection
- 9 Cable temperature
- 10 Space reserved for additional information on the device version (approvals, certificates, etc.)



i Order code

The measuring device is reordered using the order code.

Extended order code

- The device type (product root) and basic specifications (mandatory features) are always listed.
- Of the optional specifications (optional features), only the safety and approval-related specifications are listed (e.g. LA). If other optional specifications are also ordered, these are indicated collectively using the # placeholder symbol (e.g. #LA#).
- If the ordered optional specifications do not include any safety and approval-related specifications, they are indicated by the + placeholder symbol (e.g. XXXXXX-ABCDE+).

4.2.2 Symbols on the device

Symbol	Meaning
	WARNING! This symbol alerts you to a dangerous situation. Failure to avoid this situation can result in serious or fatal injury. Please consult the documentation for the measuring instrument to discover the type of potential danger and measures to avoid it.
	Reference to documentation Refers to the corresponding device documentation.
	Ground connection A grounded terminal which, as far as the operator is concerned, is grounded via a grounding system.

5 Storage and transport

5.1 Storage conditions

Observe the following notes for storage:

- ▶ Store in the original packaging to ensure protection from shock.
- ▶ Do not remove protective covers or protective caps installed on process connections. They prevent mechanical damage to the sealing surfaces and contamination in the measuring tube.
- ▶ Protect from direct sunlight. Avoid unacceptably high surface temperatures.
- ▶ Store in a dry and dust-free place.
- ▶ Do not store outdoors.

Storage temperature →  58

5.2 Transporting the product

Transport the measuring instrument to the measuring point in the original packaging.

-  Do not remove protective covers or caps installed on process connections. They prevent mechanical damage to the sealing surfaces and contamination in the measuring tube.

5.3 Packaging disposal

All packaging materials are environmentally friendly and 100% recyclable:

- Outer packaging of device
 - Stretch wrap made of polymer in accordance with EU Directive 2002/95/EC (RoHS)
- Packaging
 - Wood crate treated in accordance with ISPM 15 standard, confirmed by IPPC logo
 - Cardboard box in accordance with European packaging guideline 94/62/EC, recyclability confirmed by Resy symbol
- Transport material and fastening fixtures
 - Disposable plastic pallet
 - Plastic straps
 - Plastic adhesive strips
- Filler material
 - Paper pads

6 Mounting

6.1 Mounting requirements

6.1.1 Mounting position

Installation point

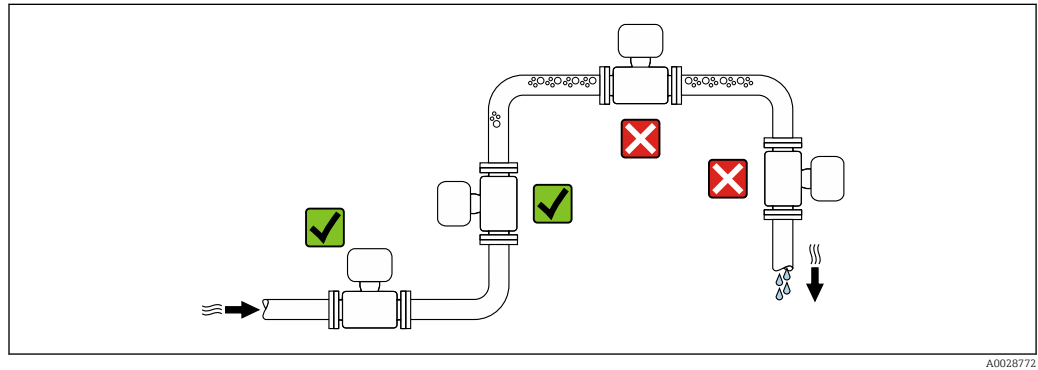



To prevent measuring errors arising from accumulation of gas bubbles in the measuring pipe, avoid the following mounting locations in the piping:

- Highest point of a pipeline.
- Directly upstream of a free pipe outlet in a down pipe.

Installation in down pipes

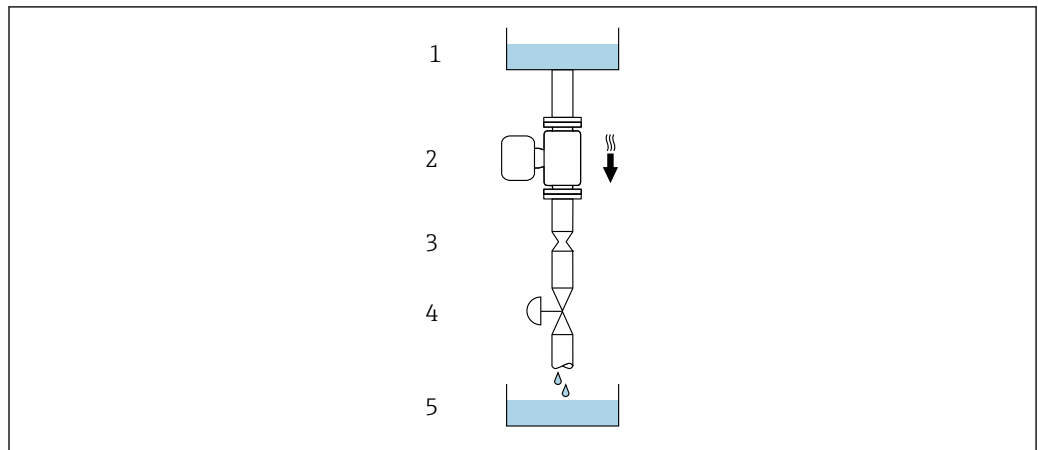
However, the following installation suggestion allows for installation in an open vertical pipeline. Pipe restrictions or the use of an orifice with a smaller cross-section than the nominal diameter prevent the sensor running empty while measurement is in progress.



 5 Installation in a down pipe (e.g. for batching applications)



- 1 Supply tank
- 2 Sensor
- 3 Orifice plate, pipe restriction
- 4 Valve
- 5 Filling vessel

DN		Ø orifice plate, pipe restriction	
[mm]	[in]	[mm]	[in]
1	1/24	0.8	0.03
2	1/12	1.5	0.06
4	1/8	3.0	0.12
8	3/8	6	0.24
15	1/2	10	0.40
25	1	14	0.55
40	1 1/2	22	0.87

Orientation

The direction of the arrow on the sensor nameplate helps you to install the sensor according to the flow direction (direction of medium flow through the piping).

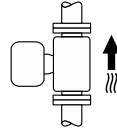
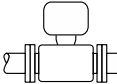
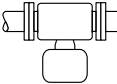

Recommended orientation for DN 1 to 4 (1/24 to 1/8 ")

Orientation		Recommendation	
A	Vertical orientation	 A0015591	☑☑ ¹⁾
B	Horizontal orientation, transmitter at top	 A0015589	☑ ²⁾
C	Horizontal orientation, transmitter at bottom	 A0015590	☑ ³⁾
D	Horizontal orientation, transmitter at side	 A0015592	☑

- 1) This orientation is recommended to ensure self-draining.
- 2) Applications with low process temperatures may reduce the ambient temperature. To maintain the minimum ambient temperature for the transmitter, this orientation is recommended.
- 3) Applications with high process temperatures may increase the ambient temperature. To maintain the maximum ambient temperature for the transmitter, this orientation is recommended.

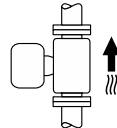
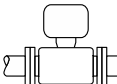
Recommended orientation for DN 8 to 40 (3/8 to 1 1/2")

Orientation		Recommendation	
A	Vertical orientation	 A0015591	☑☑ ¹⁾
B	Horizontal orientation, transmitter at top	 A0015589	☑☑ ²⁾

Orientation		Recommendation
C	Horizontal orientation, transmitter at bottom	 ³⁾
D	Horizontal orientation, transmitter at side	

- 1) This orientation is recommended to ensure self-draining.
- 2) Applications with low process temperatures may reduce the ambient temperature. To maintain the minimum ambient temperature for the transmitter, this orientation is recommended.
- 3) Applications with high process temperatures may increase the ambient temperature. To maintain the maximum ambient temperature for the transmitter, this orientation is recommended.

Horizontal orientation for DN 8 to 40 (3/8 to 1 1/2")

If a sensor is installed horizontally with a curved measuring tube, match the position of the sensor to the fluid properties.

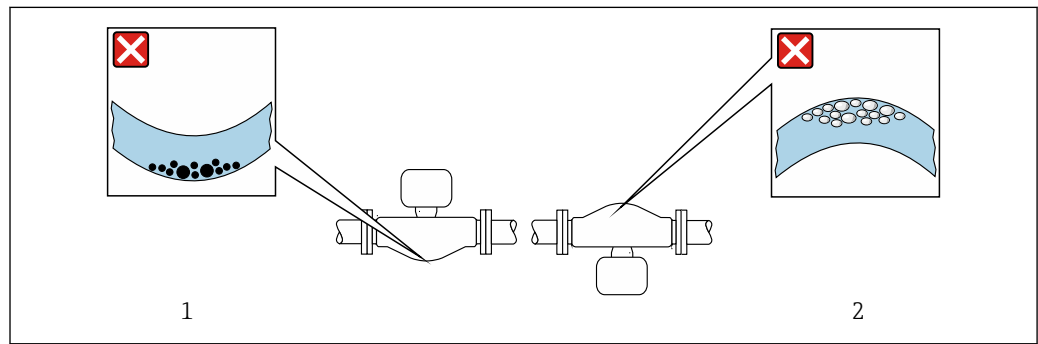

 6 Orientation of sensor with curved measuring tube

- 1 Avoid this orientation for fluids with entrained solids: Risk of solids accumulating
- 2 Avoid this orientation for outgassing fluids: Risk of gas accumulating

Valves

Never install the sensor downstream from a filling valve. If the sensor is completely empty this corrupts the measured value.

 Correct measurement is possible only if the piping is completely filled. Perform sample fillings before commencing filling in production.

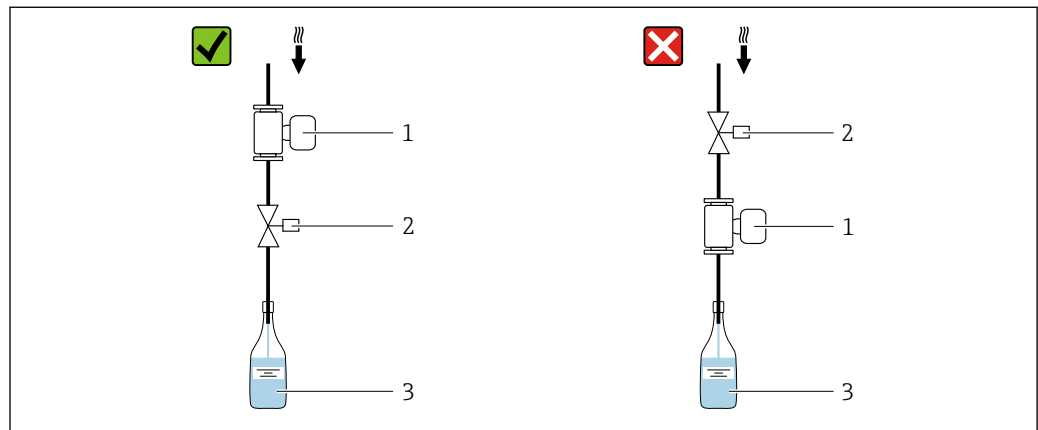

- 1 Measuring device
- 2 Filling valve
- 3 Vessel

Filling systems

The pipe system must be completely full to ensure optimum measurement.

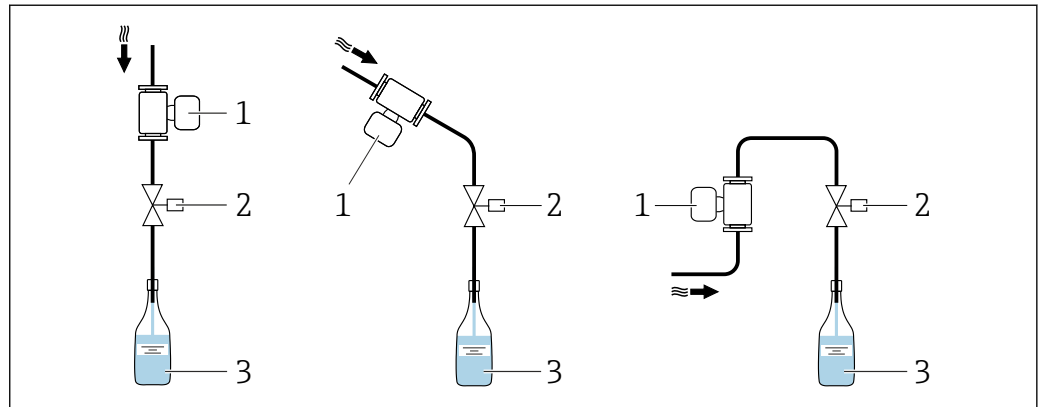

A0003795

7 Filling system

- 1 Measuring device
- 2 Filling valve
- 3 Vessel

Inlet and outlet runs

No special precautions need to be taken for fittings that create turbulence, such as valves, elbows or T-pieces, as long as no cavitation occurs → 19.

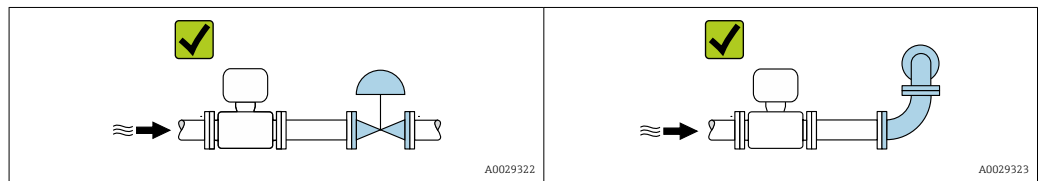

A0029322

A0029323

Installation dimensions

For the dimensions and installation lengths of the device, see the "Technical Information" document, "Mechanical construction" section

6.1.2 Environmental and process requirements

Ambient temperature range

Measuring instrument	-40 to +60 °C (-40 to +140 °F) (Sensor, transmitter) Install the measuring instrument in a shady location. Avoid direct sunlight, particularly in warm climatic regions.
-----------------------------	--

Static pressure

It is important that cavitation does not occur, or that gases entrained in the liquids do not outgas.

Cavitation is caused if the pressure drops below the vapor pressure:

- In liquids that have a low boiling point (e.g. hydrocarbons, solvents, liquefied gases)
- In suction lines
- ▶ Ensure the static pressure is sufficiently high to prevent cavitation and outgassing.

For this reason, the following mounting locations are recommended:

- At the lowest point in a vertical pipe
- Downstream from pumps (no danger of vacuum)

Thermal insulation

In the case of some fluids, it is important to keep the heat radiated from the sensor to the transmitter to a low level. A wide range of materials can be used for the required insulation.

NOTICE

Electronics overheating on account of thermal insulation!

- ▶ Recommended orientation: horizontal orientation, transmitter housing pointing downwards.
- ▶ Do not insulate the transmitter housing .
- ▶ Maximum permissible temperature at the lower end of the transmitter housing: 80 °C (176 °F)
- ▶ Regarding thermal insulation with an exposed extended neck: We advise against insulating the extended neck to ensure optimal heat dissipation.

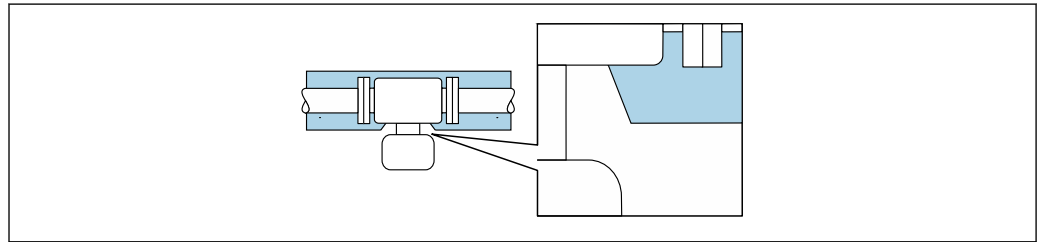

A0034391

8 Thermal insulation with exposed extended neck

Heating

NOTICE

Electronics can overheat due to elevated ambient temperature!

- ▶ Observe maximum permitted ambient temperature for the transmitter.
- ▶ Depending on the medium temperature, take the device orientation requirements into account.

NOTICE

Danger of overheating when heating

- ▶ Ensure that the temperature at the lower end of the transmitter housing does not exceed 80 °C (176 °F).
- ▶ Ensure that sufficient convection takes place at the transmitter neck.
- ▶ Ensure that a sufficiently large area of the transmitter neck remains exposed. The uncovered part serves as a radiator and protects the electronics from overheating and excessive cooling.

Heating options

If a fluid requires that no heat loss should occur at the sensor, users can avail of the following heating options:

- Electrical heating, e.g. with electric band heaters ²⁾
- Via pipes carrying hot water or steam
- Via heating jackets

2) The use of parallel electric band heaters is generally recommended (bidirectional electricity flow). Particular considerations must be made if a single-wire heating cable is to be used. For additional information, refer to EA01339D "Installation Instructions for Electrical Trace Heating Systems".

Vibrations

The high oscillation frequency of the measuring tubes ensures that the correct operation of the measuring system is not influenced by plant vibrations.

6.1.3 Special mounting instructions

Information for filling systems

Correct measurement is only possible if the pipe is completely full. We therefore recommend that some test batches be carried out prior to production batching.

Circular filling system

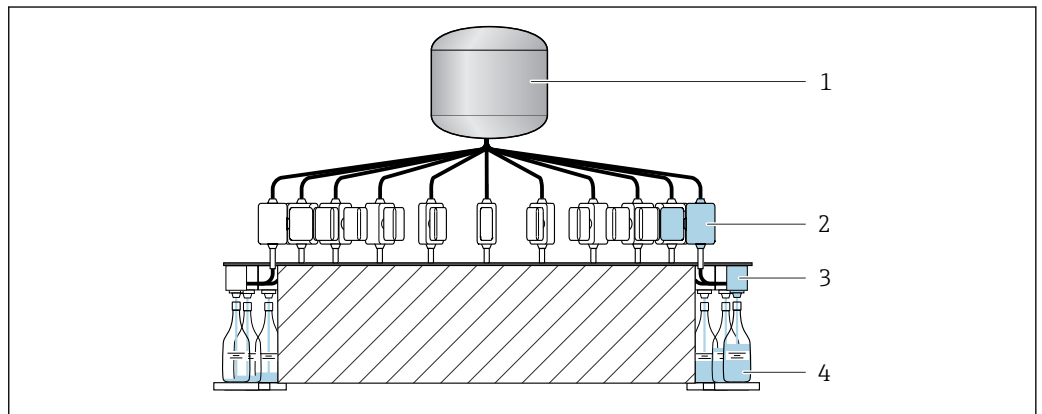

A0003761

- 1 Tank
- 2 Measuring instrument
- 3 Filling valve
- 4 Vessel

Linear filling system

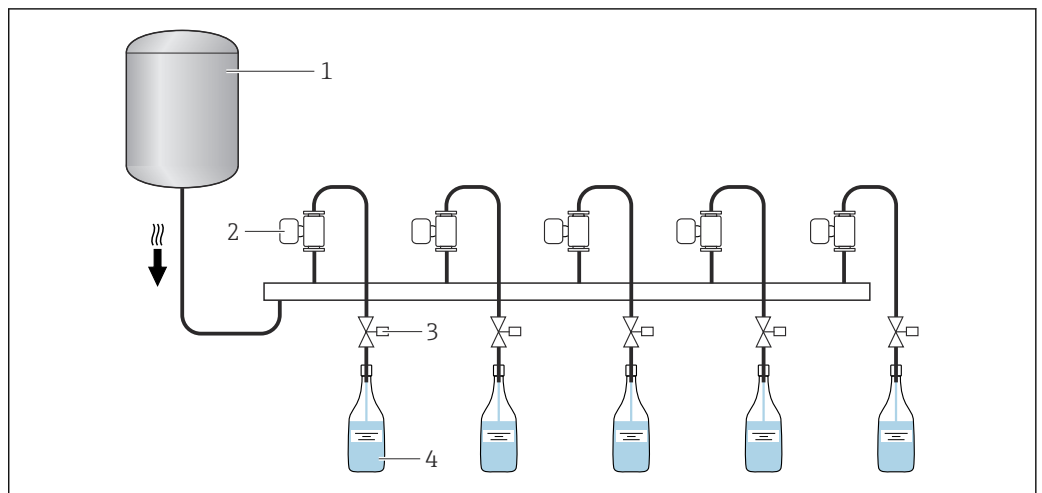

A0003762

- 1 Tank
- 2 Measuring instrument
- 3 Filling valve
- 4 Vessel

Hygienic compatibility

i When installing in hygienic applications, please refer to the information in the "Certificates and approvals/hygienic compatibility" section → 64

Sensor holder DN 1 to 4 (1/24 to 1/8")

- The appropriate sensor holder must be used for all applications with increased safety or load requirements and for sensors with clamp process connections.
- The Endress+Hauser sensor holder is generally recommended for mounting for all applications → 49.

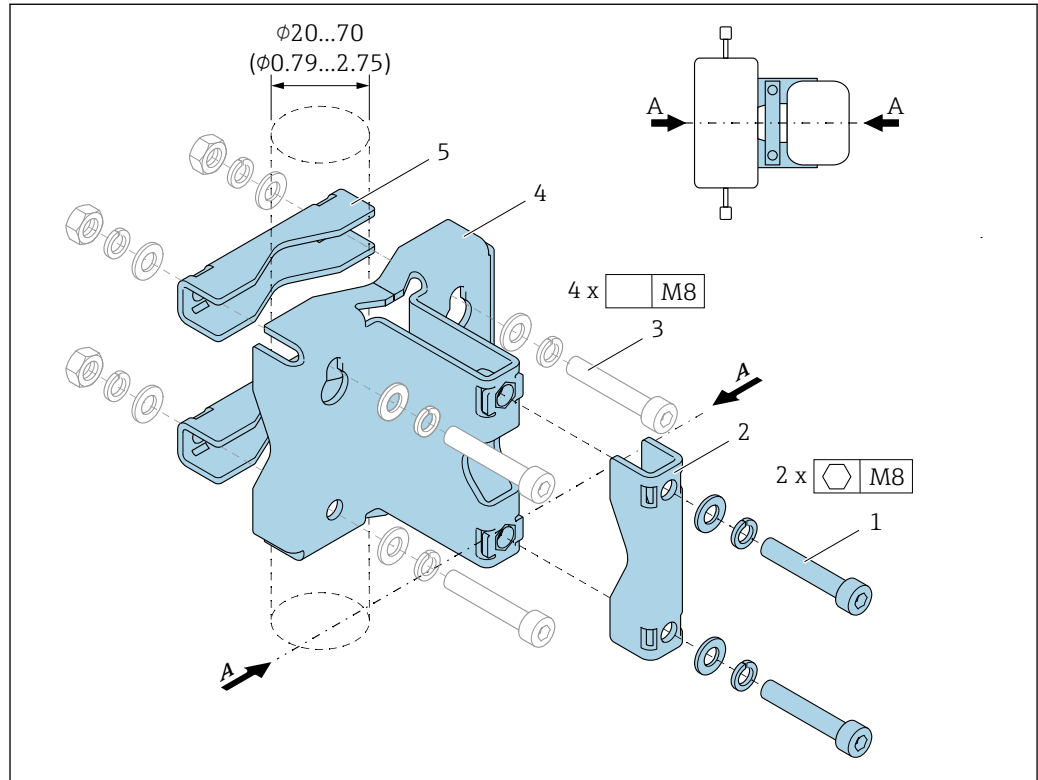

A0036471

- 1 2 x Allen screw M8 x 50, washer and spring washer A4
- 2 1 x clamp (measuring instrument neck)
- 3 4 x securing screw for wall, tabletop or pipe mounting (not supplied)
- 4 1 x base profile
- 5 2 x clamp (pipe mounting)
- A Measuring instrument central line

⚠ WARNING

Strain on pipes!

Excessive strain on an unsupported pipe can cause the pipe to break.

- Install the sensor in a sufficiently supported pipe. In addition to the use of the sensor holder, for maximum mechanical stability the sensor can also be supported on the inlet and outlet sides onsite at the installation location with the use of pipe clamps, for example.

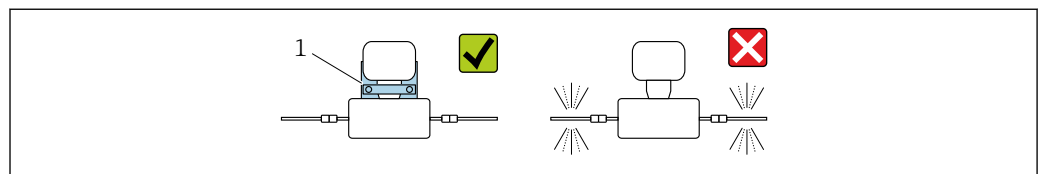

A0036492

- 1 Sensor holder Order number: 71392563

The following mounting versions are recommended for the installation:

-  Lubricate all threaded joints prior to mounting. The screws for wall, tabletop or pipe mounting are not supplied with the device and must be chosen to suit the individual installation position.

Wall mounting

Screw the sensor holder to the wall with four screws. Two of the four holes to secure the holder are designed to hook into the screws.

Mounting on a table

Screw the sensor holder onto the tabletop with four screws.

Pipe mounting

Secure the sensor holder to the pipe with two clamps.



⚠ WARNING

Failure to comply with the specifications for vibration and shock resistance can damage the measuring instrument!

- ▶ During operation, transportation and storage, ensure compliance with the specifications for maximum vibration and shock resistance →  58.

Zero adjustment

The **Sensor adjustment** submenu contains parameters required for zero adjustment.

-  Detailed information on the "**Sensor adjustment** submenu": Device parameters →  66

NOTICE

All Dosimass measuring instruments are calibrated in accordance with state-of-the-art technology. Calibration takes place under reference conditions .

Zero adjustment is therefore not required for the Dosimass as a general rule.

- ▶ Experience shows that a zero adjustment is advisable only in special cases.
- ▶ When maximum measurement accuracy is required and flow rates are very low.
- ▶ Under extreme process or operating conditions (e.g. very high process temperatures or very high-viscosity fluids).

-  Detailed information on reference operating conditions →  55

Prerequisites for zero adjustment

Note the following points before performing the adjustment:

- A zero adjustment can be performed only with fluids that contain no gas or solid contents.
- Zero adjustment is performed with the measuring tubes completely filled and at zero flow ($v = 0 \text{ m/s}$ (0 ft/s)). Shutoff valves, for example, may be provided for this purpose or existing valves and sliders can be used.
 - Normal operation → Valve 1 open
 - Zero adjustment → Valve 1 closed

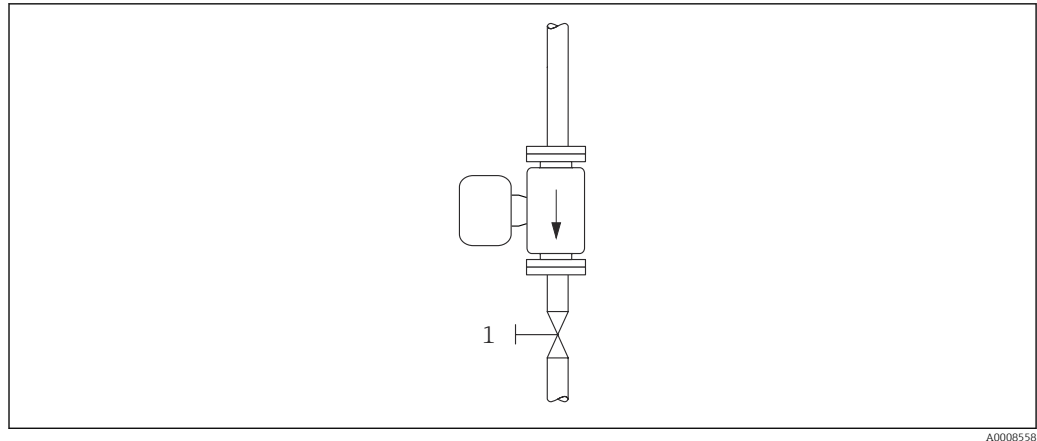

9

Performing the zero adjustment

1. Let the system run until normal operating conditions are present.
2. Stop the flow ($v = 0 \text{ m/s}$ (0 ft/s)).
3. Check the shutoff valves for leaks.
4. Perform adjustment using the **Zero point adjustment control** function.

6.2 Mounting the measuring instrument

6.2.1 Required tools

For process connections, use the appropriate installation tool

6.2.2 Preparing the measuring instrument

1. Remove all remaining transport packaging.
2. Remove any protective covers or protective caps present from the sensor.
3. Remove the transport label on the transmitter housing.

6.2.3 Mounting the measuring device

⚠ WARNING

Danger due to improper process sealing!

- ▶ Ensure that the inside diameters of the gaskets are greater than or equal to that of the process connections and piping.
- ▶ Ensure that the seals are clean and undamaged.
- ▶ Secure the seals correctly.
- ▶ Ensure that the direction of the arrow on the nameplate of the sensor matches the flow direction of the medium.

6.3 Post-mounting check

Is the measuring instrument undamaged (visual inspection)?	<input type="checkbox"/>
Does the measuring instrument conform to the measuring point specifications? For example: <ul style="list-style-type: none"> ▪ Process temperature → 59 ▪ Pressure (see the "Pressure-temperature ratings" section of the "Technical Information" document.) ▪ Ambient temperature → 58 ▪ Measuring range → 50 	<input type="checkbox"/>
Has the correct orientation for the sensor been selected → 17? <ul style="list-style-type: none"> ▪ According to sensor type ▪ According to medium temperature ▪ According to medium properties (outgassing, with entrained solids) 	<input type="checkbox"/>
Does the arrow on the sensor nameplate match the direction of medium flow through the piping ? → 12?	<input type="checkbox"/>
Are the measuring point identification and labeling correct (visual inspection)?	<input type="checkbox"/>
Is the device adequately protected against precipitation and direct sunlight?	<input type="checkbox"/>

7 Electrical connection

WARNING

Live parts! Incorrect work performed on the electrical connections can result in an electric shock.

- ▶ Set up a disconnecting device (switch or power-circuit breaker) to easily disconnect the device from the supply voltage.
- ▶ In addition to the device fuse, include an overcurrent protection unit with max. 16 A in the plant installation.

7.1 Electrical safety

In accordance with applicable national regulations.

7.2 Connecting requirements

7.2.1 Requirements for connecting cable

The connecting cables provided by the customer must fulfill the following requirements.

Permitted temperature range

- The installation guidelines that apply in the country of installation must be observed.
- The cables must be suitable for the minimum and maximum temperatures to be expected.

Signal cable

 Cables are not included in the scope of delivery.

 Please note the following with regard to cable loading:
Voltage drop due to the cable length and cable type.

Pulse/frequency/switch output

Standard installation cable is sufficient.

IO-Link

Standard installation cable is sufficient.

Cable length \leq 20 m.

7.2.2 Terminal assignment

Connection is solely by means of device plug →  26.

7.2.3 Available device plugs

Device version: IO-Link, 1 pulse/frequency/switch output

Order code for "Output, input", option FA:
IO-Link, 1 pulse/frequency/switch output

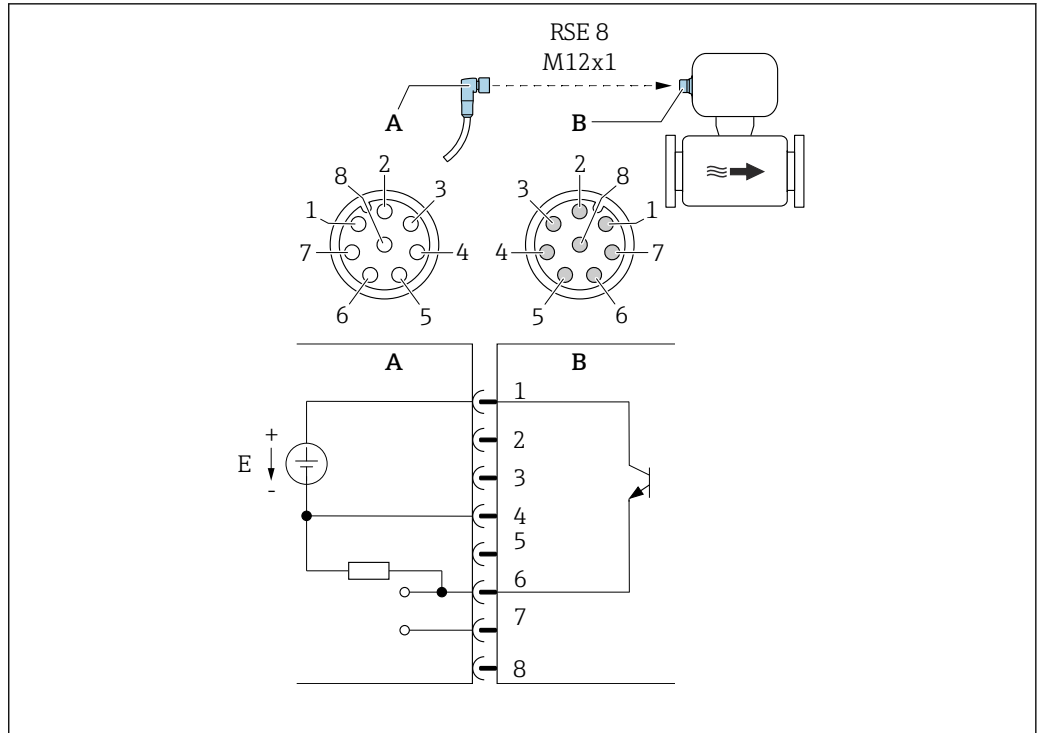

A0059318

10 Connection to device

- A Coupling: Supply voltage, pulse/freq./switch output
- B Connector: Supply voltage, pulse/freq./switch output
- E PELV or SELV power supply
- 1 to 8 Pin assignment

Pin assignment

Connection: Coupling (A) – Connector (B)		
Pin	Assignment	
1	L+	Supply voltage
2	+	Service interface RX
3	+	Service interface TX
4	L-	Supply voltage
5	Not used	
6	-	Pulse/frequency/switch output DQ
7	-	IO-Link communication signal C/Q
8	-	Service interface GND

i The pin assignment deviates from the IO-Link standard to enable compatibility with previous device versions and installations.

7.2.4 Requirements for the supply unit

Supply voltage

DC 24 V (nominal voltage: DC 18 to 30 V)

- i** The power unit must be safety-approved (e.g. PELV, SELV).
- The maximum short-circuit current must not exceed 50 A.

7.3 Connecting the measuring instrument

NOTICE

An incorrect connection compromises electrical safety!

- ▶ Only properly trained specialist staff may perform electrical connection work.
- ▶ Observe applicable federal/national installation codes and regulations.
- ▶ Comply with local workplace safety regulations.
- ▶ When using in potentially explosive atmospheres, observe the information in the device-specific Ex documentation.

7.3.1 Connection via device plug

Connection is solely by means of device plug.

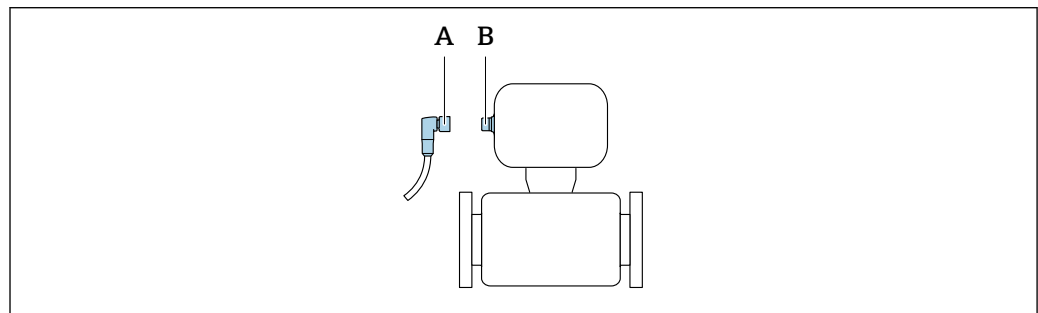

A0032652

- A Coupling
- B Plug

7.3.2 Grounding

Grounding is by means of a cable socket.

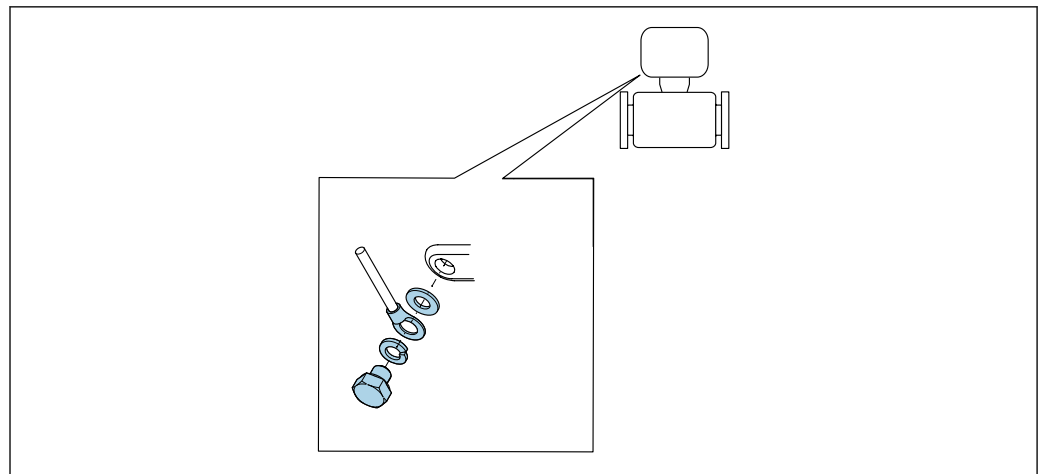

A0053306

7.4 Ensuring potential equalization

No special measures for potential equalization are required.





7.5 Ensuring the degree of protection

The measuring device fulfills all the requirements for IP67 degree of protection, Type 4X enclosure.

To guarantee IP67 degree of protection, Type 4X enclosure, carry out the following steps after the electrical connection:

- ▶ Tighten all device plugs.

7.6 Post-connection check

Is the measuring instrument undamaged (visual inspection)?	<input type="checkbox"/>
Does the supply voltage in the system match the data on the nameplate of the measuring instrument →  12?	<input type="checkbox"/>
Do the cables used meet the necessary specifications →  26?	<input type="checkbox"/>
Are the mounted cables relieved of tension?	<input type="checkbox"/>
Is the terminal assignment correct →  26?	<input type="checkbox"/>
Is the protective earthing established correctly →  28?	<input type="checkbox"/>
Are the maximum values for voltage and current observed at the IO-Link interface and pulse/frequency/switch outputs →  51?	<input type="checkbox"/>

8 Operation options

8.1 Overview of operation options

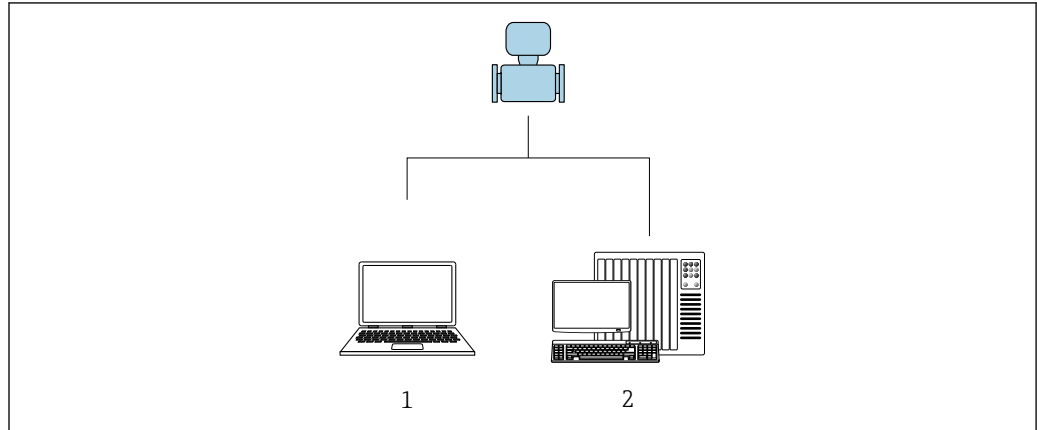

A0017760

- 1 Computer with "FieldCare" or "DeviceCare" operating tool
- 2 Control system (e.g. PLC)

8.2 Access to the operating menu via the operating tool

8.2.1 Connecting the operating tool

Using service adapter and Commubox FXA291

Operation and configuration can be performed using the Endress+Hauser FieldCare or DeviceCare service and configuration software.

The device is connected to the USB port of the computer via the service adapter and Commubox FXA291.

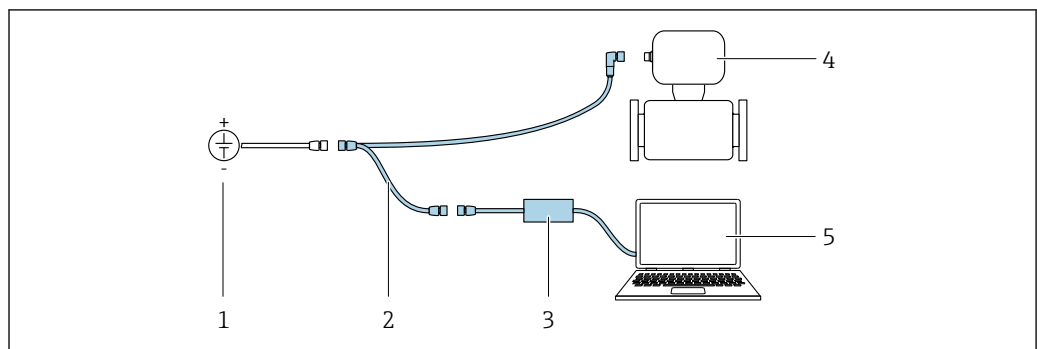

A0032567

- 1 Supply voltage 24 VDC
- 2 Service adapter
- 3 Commubox FXA291
- 4 Dosimass
- 5 Computer with "FieldCare" or "DeviceCare" operating tool

i The service adapter, cable and Commubox FXA291 are not included in the delivery. These components can be ordered as accessories → 49.

8.2.2 FieldCare

Function range

FDT-based (Field Device Technology) plant asset management tool from Endress+Hauser. It can configure all smart field units in a system and helps you manage them. By using the status information, it is also a simple but effective way of checking their status and condition.

Access is via:

Service adapter and Commubox FXA291

Typical functions:

- Transmitter parameter configuration
- Loading and saving of device data (upload/download)
- Documentation of the measuring point
- Visualization of the measured value memory (line recorder) and event logbook



- Operating Instructions BA00027S
- Operating Instructions BA00059S



Source for device description files →  33

Establishing a connection

Service adapter, Commubox FXA291 and "FieldCare" operating tool

1. Start FieldCare and launch the project.
2. In the network: Add a device.
 - ↳ The **Add device** window opens.
3. Select the **CDI Communication FXA291** option from the list and press **OK** to confirm.
4. Right-click **CDI Communication FXA291** and select the **Add device** option in the context menu that opens.
5. Select the desired device from the list and press **OK** to confirm.
6. Establish the online connection to the device.



- Operating Instructions BA00027S
- Operating Instructions BA00059S

User interface

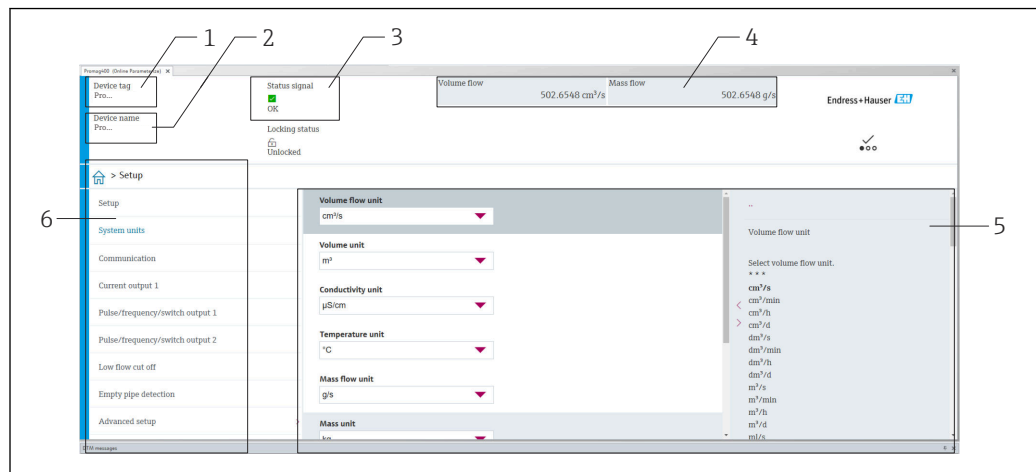

A0008200

- 1 Device name
- 2 Device tag
- 3 Status area with status signal → 37
- 4 Display area for current measured values
- 5 Editing toolbar with other functions
- 6 Navigation area with operating menu structure

8.2.3 DeviceCare

Function range

Tool for connecting and configuring Endress+Hauser field devices.

The fastest way to configure Endress+Hauser field devices is with the dedicated "DeviceCare" tool. Together with the device type managers (DTMs) it presents a convenient, comprehensive solution.



Innovation brochure IN01047S





Source for device description files → 33

9 System integration

9.1 Overview of device description files

9.1.1 Current version data for the device

Firmware version	01.00.zz	<ul style="list-style-type: none"> ▪ On the title page of the manual ▪ On the transmitter nameplate →  12 ▪ Firmware version System → Information → Device → Firmware version
Release date of firmware version	07.2024	---

 For an overview of the various firmware versions for the device →  45

9.1.2 Operating tools



The suitable device description file for the individual operating tools is listed in the table below, along with information on where the file can be acquired.

FieldCare	<ul style="list-style-type: none"> ▪ www.endress.com → Downloads area ▪ USB stick (contact Endress+Hauser) ▪ DVD (contact Endress+Hauser)
DeviceCare	<ul style="list-style-type: none"> ▪ www.endress.com → Downloads area ▪ CD-ROM (contact Endress+Hauser) ▪ DVD (contact Endress+Hauser)

9.2 Information about IO-Link communication

 The following contents are described in the accompanying Special Documentation: Reading out and writing device data (ISDU – Indexed Service Data Unit)



- Endress+Hauser-specific device data
- IO-Link-specific device data
- System commands

 Detailed IO-Link information: "IO-Link" Special Documentation for the device →  66

10 Commissioning

10.1 Post-mounting and post-connection check

Before commissioning the device:

- ▶ Make sure that the post-installation and post-connection checks have been performed successfully.
- Checklist for "Post-mounting" check →  25
- Checklist for "Post-connection check" →  29

10.2 Switching on the measuring device

- ▶ The function check has been completed successfully.
Switch on the supply voltage.
 - ↳ The measuring device runs through internal test functions.

The device is operational and operation commences.

 If the device does not start up successfully, depending on the cause, a diagnostic message is displayed in the system asset management tool "FieldCare".

10.3 Connecting via FieldCare

- For connecting FieldCare →  30
- For connecting via FieldCare →  31
- For user interface of FieldCare →  32

10.4 Configuring the measuring instrument

 The device-specific parameters are configured via the "**Commissioning** wizard".

 For detailed information on the "**Commissioning** wizard": Separate "Description of Device Parameters "(GP) document

11 Operation

11.1 Reading the device locking status

Navigation

"System" menu → Device management → Locking status

Parameter overview with brief description

Parameter	Description	User interface
Locking status	Indicates the write protection with the highest priority that is currently active.	Temporarily locked

11.2 Reading access authorization status on operating software

Navigation

"System" menu → User management → User role

Parameter overview with brief description

Parameter	Description	User interface
User role	Displays the role the user is currently logged on in. The role determines the user's access rights for the parameters. The access rights can be changed via the "Enter access code" parameter.	<ul style="list-style-type: none"> ▪ Operator ▪ Maintenance ▪ Service ▪ Production ▪ Development

11.3 Reading measured values

Navigation

"Application" menu → Measured values

Parameter overview with brief description

Parameter	Description	User interface
Mass flow	Shows the mass flow currently measured.	Signed floating-point number
Volume flow	Shows the volume flow currently measured.	Signed floating-point number
Density	Shows the density currently measured.	Positive floating-point number
Temperature	Shows the medium temperature currently measured.	Positive floating-point number

11.4 Adapting the measuring instrument to the process conditions

The following menus are available for this purpose:

- Guidance
- Application



Detailed information on "**Guidance** menu" and "**Application** menu": Device parameters
→ 66

11.5 Performing a totalizer reset

Navigation

"Application" menu → Totalizers → Totalizer handling → Reset all totalizers

Parameter overview with brief description

Parameter	Description	Selection
Reset all totalizers	Reset all totalizers to "0" and restart the totalizers. The counter readings are not logged prior to the reset.	<ul style="list-style-type: none"> ▪ Cancel ▪ Reset + totalize

12 Diagnostics and troubleshooting

12.1 General troubleshooting

For access

Error	Possible causes	Remedial action
Write access to parameter not possible.	Current user role has limited access authorization.	Check the access authorization status → 35.
Connection via the service adapter is not possible.	<ul style="list-style-type: none"> ▪ The USB port on the PC is incorrectly configured. ▪ The driver is not installed correctly. 	Observe the documentation for the Commubox FXA291: Technical Information TI00405C

12.2 Diagnostic information in FieldCare or DeviceCare

12.2.1 Diagnostic options

Any faults detected by the measuring device are displayed on the home page of the operating tool once the connection has been established.

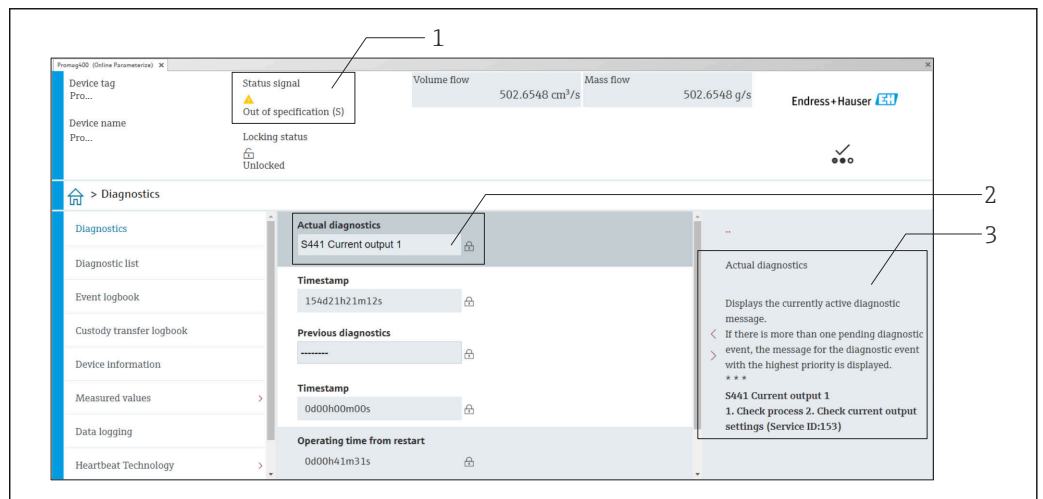

A0008199

- 1 Status area with status signal
- 2 Diagnostic information → 38
- 3 Remedial measures with service ID

In addition, diagnostic events which have occurred can be shown in the **Diagnostics** menu:

- Via parameter
- Via submenu

Status signals

The status signals provide information on the state and reliability of the device by categorizing the cause of the diagnostic information (diagnostic event).

Symbol	Meaning
	Failure A device error has occurred. The measured value is no longer valid.
	Function check The device is in service mode (e.g. during a simulation).
	Out of specification The device is being operated: Outside its technical specification limits (e.g. outside the process temperature range)
	Maintenance required Maintenance is required. The measured value remains valid.

The status signals are categorized in accordance with VDI/VDE 2650 and NAMUR Recommendation NE 107.

Diagnostic information

The fault can be identified using the diagnostic information. The short text helps you by providing information about the fault.

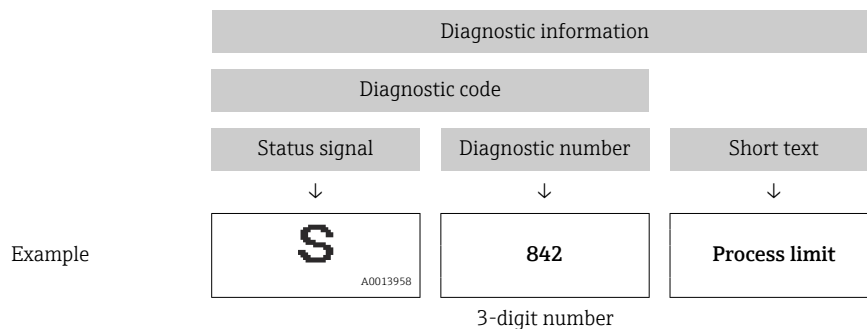

12.2.2 Calling up remedy information

Remedy information is provided for every diagnostic event to ensure that problems can be rectified quickly:

- On the home page
Remedy information is displayed in a separate field below the diagnostics information.
- In the **Diagnostics** menu
Remedy information can be called up in the working area of the user interface.

The user is in the **Diagnostics** menu.

1. Call up the desired parameter.
2. On the right in the working area, mouse over the parameter.
 - ↳ A tool tip with remedy information for the diagnostic event appears.

12.3 Adapting the diagnostic information

12.3.1 Adapting the diagnostic behavior



Each item of diagnostic information is assigned a specific diagnostic behavior at the factory. The user can change this assignment for specific diagnostic information in the **Diagnostic settings** submenu.

Diagnostics → Diagnostic settings

You can assign the following options to the diagnostic number as the diagnostic behavior:

Options	Description
Alarm	The device stops measurement. The signal outputs and totalizers assume the defined alarm condition. A diagnostic message is generated.
Warning	The device continues to measure. The signal outputs and totalizers are not affected. A diagnostic message is generated.
Logbook entry only	The device continues to measure. The diagnostic message is entered only in the Event logbook submenu.
Off	The diagnostic event is ignored, and no diagnostic message is generated or entered.

12.4 Overview of diagnostic information

 In the case of some items of diagnostic information, the diagnostic behavior can be changed. Adapting the diagnostic information →  38

Diagnostic number	Short text	Remedy instructions	Status signal [from the factory]	Diagnostic behavior [from the factory]
Diagnostic of sensor				
022	Temperature sensor defective	Replace device	F	Alarm
046	Sensor limit exceeded	1. Check process conditions 2. Check sensor	S	Warning ¹⁾
062	Sensor connection faulty	Replace device	F	Alarm
082	Data storage inconsistent	1. Restart device 2. Replace device	F	Alarm
083	Memory content inconsistent	1. Restart device 2. Restore S-DAT	F	Alarm
140	Sensor signal asymmetrical	Replace device	S	Warning
Diagnostic of electronic				
201	Electronics faulty	1. Restart device 2. Replace device	F	Alarm
230	Date/time incorrect	1. Replace RTC buffer battery 2. Set date and time	M	Warning ¹⁾
231	Date/time not available	1. Replace display module or its cable 2. Set date and time	M	Warning ¹⁾
242	Firmware incompatible	1. Check firmware version 2. Flash device	F	Alarm
252	Module incompatible	Replace device	F	Alarm
270	Main electronics defective	1. Restart device 2. Replace device	F	Alarm
271	Main electronics faulty	1. Restart device 2. Replace device	F	Alarm
272	Electronic module faulty	Restart device	F	Alarm
273	Main electronics defective	1. Restart device 2. Replace device	F	Alarm
283	Memory content inconsistent	Restart device	F	Alarm



Diagnostic number	Short text	Remedy instructions	Status signal [from the factory]	Diagnostic behavior [from the factory]
311	Electronic module faulty	Maintenance required! Do not reset device	M	Warning
331	Firmware update failed in module 1 to n	1. Update firmware of device 2. Restart device	F	Warning
372	Electronic module faulty	1. Restart device 2. Check if failure recurs 3. Replace device	F	Alarm
374	Electronic module faulty	Restart device	S	Warning ¹⁾
Diagnostic of configuration				
410	Data transfer failed	1. Retry data transfer 2. Check connection	F	Alarm
412	Processing download	Download active, please wait	C	Warning
419	Power cycle required	Power cycle device	F	Alarm
437	Configuration incompatible	1. Update firmware 2. Execute factory reset	F	Alarm
438	Dataset different	1. Check dataset file 2. Check device parameterization 3. Download new device parameterization	M	Warning
442	Frequency output 1 saturated	1. Check frequency output settings 2. Check process	S	Warning ¹⁾
443	Pulse output 1 saturated	1. Check pulse output settings 2. Check process	S	Warning ¹⁾
453	Flow override active	Deactivate flow override	C	Warning
484	Failure mode simulation active	Deactivate simulation	C	Alarm
485	Process variable simulation active	Deactivate simulation	C	Warning
492	Frequency output 1 simulation active	Deactivate simulation frequency output	C	Warning
493	Pulse output 1 simulation active	Deactivate simulation pulse output	C	Warning
494	Switch output 1 simulation active	Deactivate simulation switch output	C	Warning
495	Diagnostic event simulation active	Deactivate simulation	C	Warning
Diagnostic of process				
834	Process temperature too high	Reduce process temperature	S	Warning ¹⁾
835	Process temperature too low	Increase process temperature	S	Warning ¹⁾
842	Process value below limit	Low flow cut off active! Check low flow cut off configuration	S	Warning ¹⁾
862	Partly filled pipe	1. Check for gas in process 2. Adjust detection limits	S	Warning ¹⁾
880	Output overloaded	Reduce load at the outputs	S	Warning
910	Tubes not oscillating	1. Check electronic module 2. Check sensor	F	Alarm

Diagnostic number	Short text	Remedy instructions	Status signal [from the factory]	Diagnostic behavior [from the factory]
912	Medium inhomogeneous	1. Check process cond. 2. Increase system pressure	S	Warning ¹⁾
913	Medium unsuitable	1. Check process conditions 2. Check electronic modules or sensor	S	Warning ¹⁾
948	Oscillation damping too high	Check process conditions	S	Warning ¹⁾

1) Diagnostic behavior can be changed.

12.5 Pending diagnostic events







The **Diagnostics** menu allows the user to view the current diagnostic event and the previous diagnostic event separately.

-  To call up the measures to rectify a diagnostic event:
 - Via "FieldCare" operating tool →  38
 - Via "DeviceCare" operating tool →  38

Navigation

"Diagnostics" menu → Active diagnostics

▶ Active diagnostics

Actual diagnostics	→  41
Timestamp	→  41
Previous diagnostics	→  41
Timestamp	→  41
Operating time from restart	→  42
Operating time	→  42

Parameter overview with brief description

Parameter	Description	User interface
Actual diagnostics	Displays the currently active diagnostic message. If there is more than one pending diagnostic event, the message for the diagnostic event with the highest priority is displayed.	Positive integer
Timestamp	Displays the timestamp for the currently active diagnostic message.	Days (d), hours (h), minutes (m), seconds (s)
Previous diagnostics	Displays the diagnostic message for the last diagnostic event that has ended.	Positive integer
Timestamp	Displays the timestamp of the diagnostic message generated for the last diagnostic event that has ended.	Days (d), hours (h), minutes (m), seconds (s)

Parameter	Description	User interface
Operating time from restart	Indicates how long the device has been in operation since the last time the device was restarted.	Days (d), hours (h), minutes (m), seconds (s)
Operating time	Indicates how long the device has been in operation.	Days (d), hours (h), minutes (m), seconds (s)



12.6 Actual diagnostics

The current diagnostic message is displayed under Actual diagnostics. If several diagnostic events are pending at the same time, only the diagnostic message with the highest priority is displayed.

Navigation path

Diagnostics → Active diagnostics → Actual diagnostics



 To call up the measures to rectify a diagnostic event:

- Via "FieldCare" operating tool →  38
- Via "DeviceCare" operating tool →  38

12.7 Event logbook



12.7.1 Event history

 To call up the measures to rectify a diagnostic event:

- Via "FieldCare" operating tool →  38
- Via "DeviceCare" operating tool →  38

12.7.2 Overview of information events

Unlike a diagnostic event, an information event is displayed in the event logbook only and not in the diagnostic list.

 Compare also information in the IODD finder →  63.

Info number	Info name
I1000	----- (Device ok)
I1089	Power on
I1090	Configuration reset
I1091	Configuration changed
I11036	Date/time set successfully
I1111	Density adjust failure
I11167	Date/time resynchronized
I1151	History reset
I1157	Memory error event list
I1209	Density adjustment ok
I1221	Zero point adjust failure
I1222	Zero point adjustment ok
I1335	Firmware changed
I1397	Fieldbus: access status changed
I1398	CDI: access status changed
I1512	Download started
I1513	Download finished

Info number	Info name
I1514	Upload started
I1515	Upload finished
I1622	Calibration changed
I1624	All totalizers reset
I1629	CDI: login successful
I1635	Reset to delivery settings

12.8 Resetting the measuring device

The entire device configuration or some of the configuration can be reset to a defined state with the **Device reset** parameter (→  43).

Navigation

"System" menu → Device management → Device reset

Parameter overview with brief description

Parameter	Description	Selection
Device reset	Reset the device configuration - either entirely or in part - to a defined state.	<ul style="list-style-type: none"> ■ Cancel ■ To delivery settings ■ Restart device ■ Restore S-DAT backup * ■ Create T-DAT backup ■ Restore T-DAT backup *

* Visibility depends on order options or device settings







12.9 Device





The **Device** submenu contains all the parameters that display different information for identifying the device.

Navigation

"System" menu → Information → Device

▶ Device

Device name	→  44
Device tag	→  44
Serial number	→  44
Order code	→  44
Firmware version	→  44
Extended order code 1	→  44

Extended order code 2	→  44
Extended order code 3	→  44
ENP version	→  44
Manufacturer	→  44

Parameter overview with brief description

Parameter	Description	User interface / User entry
Device name	Displays the name of the transmitter. The transmitter name is also provided on the nameplate of the transmitter.	Character string comprising numbers, letters and special characters
Device tag	Displays the name for the measuring point.	Character string comprising numbers, letters and special characters (32)
Serial number	Displays the serial number of the measuring device. The serial number is also provided on the nameplate of the sensor and of the transmitter. The serial number can also be used to retrieve further device-related information and documentation via the Operations app or the Device Viewer on the Endress+Hauser website.	Character string comprising numbers, letters and special characters
Order code	Displays the device order code. The order code is used for instance to order a replacement or spare device or to verify that the device features specified on the order form match the shipping note.	Character string comprising numbers, letters and special characters
Firmware version	Displays the device firmware version installed.	Character string comprising numbers, letters and special characters
Extended order code 1	Displays the first, second and/or third part of the extended order code. Due to character length restrictions, the extended order code is split into a maximum of 3 parameters. The extended order code indicates for each feature in the product structure the selected option, thereby uniquely identifying the device model. The extended order code can also be found on the nameplate.	Character string comprising numbers, letters and special characters
Extended order code 2	Displays the first, second and/or third part of the extended order code. Due to character length restrictions, the extended order code is split into a maximum of 3 parameters. The extended order code indicates for each feature in the product structure the selected option, thereby uniquely identifying the device model. The extended order code can also be found on the nameplate.	Character string comprising numbers, letters and special characters
Extended order code 3	Displays the first, second and/or third part of the extended order code. Due to character length restrictions, the extended order code is split into a maximum of 3 parameters. The extended order code indicates for each feature in the product structure the selected option, thereby uniquely identifying the device model. The extended order code can also be found on the nameplate.	Character string comprising numbers, letters and special characters
ENP version	Displays the version of the electronic nameplate (ENP).	Character string comprising numbers, letters and special characters
Manufacturer	Displays the manufacturer.	Character string comprising numbers, letters and special characters

12.10 Firmware history

Release date	Firmware version	Order code for "Firmware version"	Firmware Changes	Documentation type	Documentation
07.2024	01.00.zz	Option 77	<ul style="list-style-type: none"> ▪ Original firmware ▪ Can be operated via FieldCare and DeviceCare 	Operating Instructions	BA02330D/06/EN/01.24-00



The manufacturer's information is available:

- In the Download Area of the Endress+Hauser web site: www.endress.com → Downloads
- Specify the following details:
 - Product root: e.g. D8AB
The product root is the first part of the order code: see the nameplate on the device.
 - Text search: Manufacturer's information
 - Media type: Documentation – Technical Documentation

13 Maintenance

13.1 Maintenance work

No special maintenance work is required.

13.1.1 Exterior cleaning

When cleaning the exterior of measuring devices, always use cleaning agents that do not attack the surface of the housing or the seals.

13.1.2 Internal cleaning

Observe the following points for CIP and SIP cleaning:

- Use only cleaning agents to which the process-wetted materials are adequately resistant.
- Observe the maximum permitted medium temperature for the measuring device
→  59.

13.2 Measuring and test equipment

Endress+Hauser offers a variety of measuring and testing equipment, such as Netilion or device tests.

 Your Endress+Hauser Sales Center can provide detailed information on the services.

List of some of the measuring and testing equipment: →  49

13.3 Endress+Hauser services

Endress+Hauser offers a wide variety of services for maintenance such as recalibration, maintenance service or device tests.

 Your Endress+Hauser Sales Center can provide detailed information on the services.

14 Repair

14.1 General information

14.1.1 Repair and conversion concept

The Endress+Hauser repair and conversion concept provides for the following:

- The measuring device cannot be converted.
- If the measuring device is defective, the entire device is replaced.
- It is possible to replace seals.

14.2 Endress+Hauser services

Endress+Hauser offers a wide range of services.

 Your Endress+Hauser Sales Center can provide detailed information on the services.

14.3 Return

The requirements for safe device return can vary depending on the device type and national legislation.

1. Refer to the web page for information:
<https://www.endress.com/support/return-material>
↳ Select the region.
2. If returning the device, pack the device in such a way that it is reliably protected against impact and external influences. The original packaging offers the best protection.

14.4 Disposal

 If required by the Directive 2012/19/EU on waste electrical and electronic equipment (WEEE), the product is marked with the depicted symbol in order to minimize the disposal of WEEE as unsorted municipal waste. Do not dispose of products bearing this marking as unsorted municipal waste. Instead, return them to the manufacturer for disposal under the applicable conditions.

14.4.1 Removing the measuring device

1. Switch off the device.

WARNING

Danger to persons from process conditions!

- ▶ Beware of hazardous process conditions such as pressure in the measuring device, high temperatures or aggressive media.
2. Carry out the mounting and connection steps from the "Mounting the measuring device" and "Connecting the measuring device" sections in reverse order. Observe the safety instructions.

14.4.2 Disposing of the measuring device

WARNING

Danger to personnel and environment from fluids that are hazardous to health.

- ▶ Ensure that the measuring device and all cavities are free of fluid residues that are hazardous to health or the environment, e.g. substances that have permeated into crevices or diffused through plastic.



Observe the following notes during disposal:

- ▶ Observe valid federal/national regulations.
- ▶ Ensure proper separation and reuse of the device components.



15 Accessories

Various accessories, which can be ordered with the device or subsequently from Endress+Hauser, are available for the device. Detailed information on the order code in question is available from your local Endress+Hauser sales center or on the product page of the Endress+Hauser website: www.endress.com.

15.1 Device-specific accessories

Accessories	Description
Sensor holder	<p>For wall, tabletop and pipe mounting.</p> <p> Order number: 71392563</p> <p> Installation Instructions EA01195D</p>

15.2 Communication-specific accessories

Accessory	Description
FieldCare	<p>FDT-based plant asset management tool from Endress+Hauser. It can configure all smart field units in your system and helps you manage them. By using the status information, it is also a simple but effective way of checking their status and condition.</p> <p> Operating Instructions BA00027S and BA00059S</p>
DeviceCare	<p>Tool to connect and configure Endress+Hauser field devices.</p> <p> Innovation brochure IN01047S</p>
Commubox FXA291	<p>Connects Endress+Hauser field devices with a CDI interface (= Endress+Hauser Common Data Interface) and the USB port of a computer or laptop.</p> <p> Technical Information TI00405C</p>
Adapter connection	<p>Adapter connections for installation on other electrical connections: Adapter FXA291 (order number: 71035809)</p>

15.3 Service-specific accessories

Accessories	Description
Applicator	<p>Software for selecting and sizing Endress+Hauser measuring devices:</p> <ul style="list-style-type: none"> ▪ Choice of measuring devices for industrial requirements ▪ Calculation of all the necessary data for identifying the optimum flowmeter: e.g. nominal diameter, pressure loss, flow velocity and accuracy. ▪ Graphic illustration of the calculation results ▪ Determination of the partial order code, administration, documentation and access to all project-related data and parameters over the entire life cycle of a project. <p>Applicator is available:</p> <ul style="list-style-type: none"> ▪ Via the Internet: https://portal.endress.com/webapp/applicator ▪ As a downloadable DVD for local PC installation.
Commubox FXA291	<p>Connects Endress+Hauser field devices with a CDI interface (= Endress+Hauser Common Data Interface) and the USB port of a computer or laptop.</p> <p> Technical Information TI00405C</p>

16 Technical data

16.1 Application

The measuring device is intended only for the flow measurement of liquids and gases.

Depending on the version ordered, the measuring device can also measure potentially explosive, flammable, poisonous and oxidizing media.

To ensure that the device remains in proper operating condition for its service life, use the measuring device only for media against which the process-wetted materials are sufficiently resistant.

16.2 Function and system design

Measuring principle Mass flow measurement based on the Coriolis measuring principle

Measuring system The device consists of a transmitter and a sensor.
 For information on the structure of the measuring instrument →  10

16.3 Input

Measured variable **Direct measured variables**

- Mass flow
- Density
- Temperature



Calculated measured variables
 Volume flow

Measuring range *Flow values in SI units*



DN [mm]	Measuring range full scale values $\dot{m}_{\min(F)}$ to $\dot{m}_{\max(F)}$ [kg/h]
1	0 to 20
2	0 to 100
4	0 to 450
8	0 to 2 000
15	0 to 6 500
25	0 to 18 000
40	0 to 45 000

Flow values in US units

DN [in]	Measuring range full scale values $\dot{m}_{\min(F)}$ to $\dot{m}_{\max(F)}$ [lb/min]
1/24	0 to 0.735
1/12	0 to 3.675
1/8	0 to 16.54
3/8	0 to 73.50
1/2	0 to 238.9
1	0 to 661.5
1 1/2	0 to 1 654

 To calculate the measuring range, use the *Applicator* →  49 sizing tool

Recommended measuring range

 Flow limit →  59

Operable flow range

Over 1000 : 1.

Flow rates above the preset full scale value do not override the electronics unit, with the result that the totalizer values are registered correctly.

16.4 Output

Output signal

Pulse/frequency/switch output

Function	Can be set to: <ul style="list-style-type: none"> ▪ Pulse Quantity-proportional pulse with pulse width to be configured. ▪ Automatic pulse Quantity-proportional pulse with on/off ratio of 1:1 ▪ Frequency Flow-proportional frequency output with 1:1 on/off ratio ▪ Switch Contact for displaying a status
Version	Option FA: IO-Link, 1 pulse/frequency/switch output Active, high-side
Maximum output values	Option FA: IO-Link, 1 pulse/frequency/switch output <ul style="list-style-type: none"> ▪ DC 30 V ▪ 100 mA
Voltage drop	Option FA: IO-Link, 1 pulse/frequency/switch output At 100 mA: ≤ DC 3 V
Pulse output	
Pulse width	Configurable: 0.05 to 2 000 ms
Maximum pulse rate	10 000 Impulse/s
Pulse value	Configurable
Assignable measured variables	<ul style="list-style-type: none"> ▪ Mass flow ▪ Volume flow
Frequency output	
Output frequency	Configurable: 0 to 10 000 Hz

Damping	Configurable: 0 to 999.9 s
Pulse/pause ratio	1:1
Assignable measured variables	<ul style="list-style-type: none"> ▪ Mass flow ▪ Volume flow ▪ Density ▪ Temperature ▪ Exciter current ▪ Oscillation frequency ▪ Oscillation amplitude ▪ Frequency fluctuation ▪ Oscillation damping ▪ Fluctuation ▪ Signal asymmetry
Switch output	
Switching behavior	Binary, conductive or non-conductive
Number of switching cycles	Unlimited
Assignable functions	<ul style="list-style-type: none"> ▪ Off ▪ On ▪ Diagnostic behavior <ul style="list-style-type: none"> ▪ Alarm ▪ Alarm and warning ▪ Warning ▪ Limit value <ul style="list-style-type: none"> ▪ Mass flow ▪ Volume flow ▪ Density ▪ Temperature ▪ Totalizer 1-3 ▪ Oscillation damper ▪ Flow direction monitoring ▪ Status <ul style="list-style-type: none"> ▪ Partially filled pipe detection ▪ Low flow cut off

IO-Link

Physical interface	According to Standard IEC 61131-9
Signal	IO-Link digital communication signal, 3-wire
IO-Link version	1.1
IO-Link SSP version	Identification and Diagnosis, Measuring and Switching Sensor (as per SSP 4.3.4)
IO-Link device port	IO-Link port class A

 The pin assignment deviates from the IO-Link standard to enable compatibility with previous device versions and installations.

Signal on alarm

Depending on the interface, failure information is displayed as follows.

Pulse/frequency/switch output

Pulse output	
Failure mode	Choose from: <ul style="list-style-type: none"> ▪ Actual value ▪ No pulses
Frequency output	

Failure mode	Choose from: <ul style="list-style-type: none"> ▪ Actual value ▪ 0 Hz ▪ Definable value between: 0 to 10 000 Hz
Switch output	
Failure mode	Choose from: <ul style="list-style-type: none"> ▪ Current status ▪ Open ▪ Closed

IO-Link

Operating mode	Digital transmission of all failure information
Device status	Readable via cyclical and acyclical data transmission

Low flow cut off The switch points for low flow cut off are user-selectable.

Galvanic isolation Device version: IO-Link, 1 pulse/frequency/switch output
 (Order code for "Output, input": option FA)
 Pulse/frequency/switch outputs on supply potential.

Protocol-specific data

IO-Link

IO-Link specification	Version 1.1.3
Device ID	0x947401 (9729281)
Manufacturer ID	0x0011 (17)
Smart Sensor Profile 2nd Edition	Supports <ul style="list-style-type: none"> ▪ Identification and Diagnosis ▪ Digital Measuring and Switching Sensor (as per SSP type 4.3.4)
Smart Sensor Profile Type	Measuring profile type 4.3.4 Measuring and Switching Sensor, floating point, 4 channel
SIO	Yes
IO-Link transmission rate	COM3; 230.4 kBd
Minimum period	1.5 ms
Process data width input/output	18 bytes/2 bytes (as per SSP 4.3.4)
OnRequestdata PreOp/Op	8 bytes/2 bytes
Data storage	Yes
Block configuration	Yes

Device operational	The device is operational 3 seconds after the supply voltage is applied
System integration	<p>Input cyclic process data</p> <ul style="list-style-type: none"> ▪ Mass flow [kg/s] ▪ Density [kg/m³] ▪ Totalizer 1 [kg] ▪ Temperature [°C] <p>Output cyclic process data</p> <ul style="list-style-type: none"> ▪ Control signal channel - Volume flow ▪ Control signal channel - Density ▪ Control signal channel - Temperature ▪ Control signal channel - Totalizer 1 ▪ Flow override ▪ Totalizer 1 - Hold ▪ Totalizer 1 - Reset + totalize ▪ Totalizer 1 - Reset + hold ▪ Totalizer 1 - Totalize

Device description

In order to integrate field devices into a digital communication system, the IO-Link system needs a description of the device parameters, such as output data, input data, data format, data volume and supported transmission rate.

The data are included in the device description (IODD) that are provided to the IO-Link master during commissioning of the communication system.

The IODD can be downloaded as follows:

- www.endress.com
- <https://ioddfinder.io-link.com>

16.5 Power supply

Terminal assignment → 26

Supply voltage DC 24 V (nominal voltage: DC 18 to 30 V)

-  ▪ The power unit must be safety-approved (e.g. PELV, SELV).
- The maximum short-circuit current must not exceed 50 A.

Power consumption 2.5 W (no outputs)

Current consumption

Order code for "Output, input"	Maximum current consumption
Option FA: IO-Link, 1 pulse/frequency/switch output	100 mA + 100 mA ¹⁾ at supply voltage ≥ 21 V

1) If pulse/frequency/switch output is used

Switch-on current

Option FA: IO-Link, 1 pulse/frequency/switch output
Max. 400 mA (< 20 ms)

Power supply failure

- Totalizers stop at the last value measured.
- Configuration is retained in the device memory.
- Error messages (incl. total operated hours) are stored.

Electrical connection →  28

Potential equalization →  28

Cable specification →  26



16.6 Performance characteristics

Reference operating conditions

- Error limits based on ISO 11631
- Water
 - +15 to +45 °C (+59 to +113 °F)
 - 2 to 6 bar (29 to 87 psi)
- Data as indicated in the calibration protocol
- Accuracy based on accredited calibration rigs according to ISO 17025

Installation

- Measuring device is grounded.
- The sensor is centered in the pipe.

 To obtain measured errors, use the *Applicator* sizing tool →  49

Maximum measurement error

o.r. = of reading; 1 g/cm³ = 1 kg/l; T = medium temperature

Base accuracy

Bases for calculation →  57

Mass flow and volume flow (liquids)

±0.15 %

Density (liquids)

Under reference conditions [g/cm ³]	Field density adjustment [g/cm ³]	Standard density calibration [g/cm ³]
±0.0005 g/cm ³	±0.0005 g/cm ³	±0.0025 g/cm ³

Temperature

±0.5 °C ± 0.005 · T °C (±0.9 °F ± 0.003 · (T - 32) °F)

Zero point stability

DN		Zero point stability	
[mm]	[in]	[kg/h]	[lb/min]
1	1/24	0.0005	0.000018
2	1/12	0.0025	0.00009
4	1/6	0.0100	0.00036
8	3/8	0.20	0.007
15	1/2	0.65	0.024

DN		Zero point stability	
[mm]	[in]	[kg/h]	[lb/min]
25	1	1.80	0.066
40	1 ½	4.50	0.165

Flow values

Flow values as turndown parameters depending on nominal diameter.

SI units

DN [mm]	1:1	1:10	1:20	1:50	1:100	1:500
	[kg/h]	[kg/h]	[kg/h]	[kg/h]	[kg/h]	[kg/h]
1	20	2	1	0.4	0.2	0.04
2	100	10	5	2	1	0.2
4	450	45	22.5	9	4.5	0.9
8	2000	200	100	40	20	4
15	6500	650	325	130	65	13
25	18000	1800	900	360	180	36
40	45000	4500	2250	900	450	90

US units

DN	1:1	1:10	1:20	1:50	1:100	1:500
	[in]	[lb/min]	[lb/min]	[lb/min]	[lb/min]	[lb/min]
¼	0.735	0.074	0.037	0.015	0.007	0.001
½	3.675	0.368	0.184	0.074	0.037	0.007
¾	16.54	1.654	0.827	0.331	0.165	0.033
1 ¼	73.50	7.350	3.675	1.470	0.735	0.147
1 ½	238.9	23.89	11.95	4.778	2.389	0.478
1	661.5	66.15	33.08	13.23	6.615	1.323
1 ½	1654	165.4	82.70	33.08	16.54	3.308

Repeatability

Base repeatability

Dosing time [s]	Standard deviation [%]
0.75 s < t _a < 1.5 s	0.2
1.5 s < t _a < 3 s	0.1
3 s < t _a	0.05

Density (liquids)

±0.00025 g/cm³

Temperature

±0.25 °C ± 0.0025 · T °C (±0.45 °F ± 0.0015 · (T-32) °F)

Response time

The response time depends on the configuration (damping).

Influence of ambient temperature

Pulse/frequency output

Temperature coefficient	No additional effect. Included in accuracy.
--------------------------------	---

Influence of medium temperature

Mass flow

If there is a differential between the temperature during zero adjustment and the process temperature, the typical measurement error of the sensor is $\pm 0.0002\%$ of the full scale value/ $^{\circ}\text{C}$ ($\pm 0.0001\%$ of the full scale value/ $^{\circ}\text{F}$).

Temperature

$$\pm 0.005 \cdot T \text{ } ^{\circ}\text{C} (\pm 0.005 \cdot (T - 32) \text{ } ^{\circ}\text{F})$$

Influence of medium pressure

A difference between the calibration pressure and process pressure does not affect accuracy.

Design fundamentals

o.r. = of reading, o.f.s. = of full scale value

BaseAccu = base accuracy in % o.r., BaseRepeat = base repeatability in % o.r.

MeasValue = measured value; ZeroPoint = zero point stability

Calculation of the maximum measured error as a function of the flow rate

Flow rate	Maximum measured error in % o.r.
$\geq \frac{\text{ZeroPoint}}{\text{BaseAccu}} \cdot 100$ <small>A0021332</small>	$\pm \text{BaseAccu}$ <small>A0021339</small>
$< \frac{\text{ZeroPoint}}{\text{BaseAccu}} \cdot 100$ <small>A0021333</small>	$\pm \frac{\text{ZeroPoint}}{\text{MeasValue}} \cdot 100$ <small>A0021334</small>

Calculation of the maximum repeatability as a function of the flow rate

Flow rate	Maximum repeatability in % o.r.
$\geq \frac{1/2 \cdot \text{ZeroPoint}}{\text{BaseRepeat}} \cdot 100$ <small>A0021335</small>	$\pm \text{BaseRepeat}$ <small>A0021340</small>
$< \frac{1/2 \cdot \text{ZeroPoint}}{\text{BaseRepeat}} \cdot 100$ <small>A0021336</small>	$\pm 1/2 \cdot \frac{\text{ZeroPoint}}{\text{MeasValue}} \cdot 100$ <small>A0021337</small>

Example of maximum measurement error

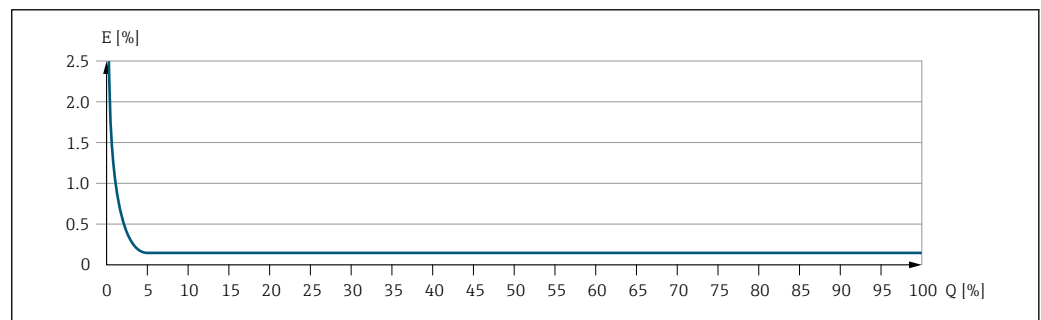

E Maximum measurement error in % o.r. (example)
Q Flow rate in % of maximum full scale value



16.7 Mounting

Mounting requirements →  16

16.8 Environment

Ambient temperature range →  19

Temperature tables

-  Observe the interdependencies between the permitted ambient and fluid temperatures when operating the device in hazardous areas.
-  For detailed information on the temperature tables, see the separate document entitled "Safety Instructions" (XA) for the device.

Storage temperature -40 to +80 °C (-40 to +176 °F), preferably at +20 °C (+68 °F)

Degree of protection Standard: IP67, Type 4X enclosure, suitable for pollution degree 4

Shock and vibration resistance

Vibration sinusoidal, in accordance with IEC 60068-2-6

- 2 to 8.4 Hz, 3.5 mm peak
- 8.4 to 2 000 Hz, 1 g peak

Vibration broad-band random, according to IEC 60068-2-64

- 10 to 200 Hz, 0.003 g²/Hz
- 200 to 2 000 Hz, 0.001 g²/Hz
- Total: 1.54 g rms

Shock half-sine, according to IEC 60068-2-27

6 ms 30 g



Rough handling shocks according to IEC 60068-2-31

Internal cleaning

- CIP cleaning
- SIP cleaning

Options

Oil- and grease-free version for wetted parts, without declaration
Order code for "Service", option HA ³⁾

-  Observe the maximum medium temperatures →  59

Electromagnetic compatibility (EMC)

As per IEC/EN 61326

-  Details are provided in the Declaration of Conformity.

-  This unit is not intended for use in residential environments and cannot guarantee adequate protection of the radio reception in such environments.

3) The cleaning refers to the measuring instrument only. Any accessories supplied are not cleaned.

16.9 Process

Medium temperature range **Sensor**
 -40 to +130 °C (-40 to +266 °F)

Cleaning
 +150 °C (+302 °F) for a maximum of 60 min for CIP and SIP processes

Seals
 No internal seals

Medium pressure range Max. 40 bar (580 psi), depending on the process connection

Medium density	DN		ρ_{max} [kg/m ³]
	[mm]	[in]	
	1	1/24	3 150
	2	1/12	3 100
	4	1/8	3 100
	8	3/8	4 548
	15	1/2	4 900
	25	1	4 270
	40	1 1/2	4 700



Pressure-temperature ratings  For an overview of the pressure-temperature ratings for the process connections, see the Technical Information

Sensor housing The sensor housing is filled with dry nitrogen gas and protects the electronics and mechanics inside.



- The housing does not have a pressure rating classification.
- Reference value for the pressure loading capacity of the sensor housing: 16 bar (232 psi)



 For the dimensions and installation lengths of the device, see the "Technical Information" document, "Mechanical construction" section

Flow limit Select the nominal diameter by optimizing between the required flow range and permissible pressure loss.

 For an overview of the full scale values for the measuring range, see the "Measuring range" section →  50

- The minimum recommended full scale value is approx. 1/20 of the maximum full scale value
- In most applications, 20 to 50 % of the maximum full scale value can be considered ideal
- A low full scale value must be selected for abrasive media (such as liquids with entrained solids): flow velocity < 1 m/s (< 3 ft/s).

 To calculate the flow limit, use the *Applicator* sizing tool →  49

Pressure loss  To calculate the pressure loss, use the *Applicator* sizing tool →  49

Heating →  20

Vibrations

→  21

16.10 Mechanical construction

Design, dimensions



For the dimensions and installation lengths of the device, see the "Technical Information" document, "Mechanical construction" section

Weight

Weight in SI units

DN [mm]	Weight [kg]
1	3.7
2	5.3
4	7.1
8	4.2
15	4.5
25	5.0
40	8.0

Weight in US units

DN [in]	Weight [lbs]
1/24	8.2
1/12	11.7
1/8	15.7
3/8	9.3
1/2	9.9
1	11.0
1 1/2	17.6

Materials

Transmitter housing

- Acid and alkali-resistant outer surface
- Stainless steel, 1.4409 (CF3M)

Device plug

Electrical connection	Material
M12x1 plug	<ul style="list-style-type: none"> ▪ Socket: Polyamide contact support ▪ Connector: Contact support made of thermoplastic polyurethane (TPU-GF) ▪ Contacts: Gold-plated brass

Sensor housing

Acid and alkali-resistant outer surface

DN 1 to 4 mm (1/24 to 1/8")

Stainless steel, 1.4404 (316/316L)

DN 8 to 40 mm (3/8 to 1 1/2")

Stainless steel 1.4301 (304)

Measuring tubes**DN 1 to 4 mm ($\frac{1}{24}$ to $\frac{1}{8}$ "**

Stainless steel, 1.4435 (316/316L)

DN 8 to 40 mm ($\frac{3}{8}$ to 1 $\frac{1}{2}$ "

Stainless steel, 1.4539 (904L)



Process connections**DN 1 to 4 mm ($\frac{1}{24}$ to $\frac{1}{8}$ "** $\frac{1}{2}$ " Tri-Clamp:

Stainless steel, 1.4435 (316L)

DN 8 to 40 mm ($\frac{3}{8}$ to 1 $\frac{1}{2}$ "

All process connections:

Stainless steel, 1.4404 (316/316L)

 Available process connections →  62**Seals**

Welded process connections without internal seals

Accessories*Sensor holder*

Stainless steel, 1.4404 (316L)

Process connections

Fixed flange

- EN 1092-1 (DIN 2501 / DIN 2512N)
- EN 1092-1 (DIN 2501)

Clamp connections

1" clamp according to DIN 32676

Tri-Clamp

- $\frac{1}{2}$ " Tri-Clamp
- $\frac{1}{2}$ " Tri-Clamp BS4825-3
- $\frac{3}{4}$ " Tri-Clamp
- 1" Tri-Clamp

Threaded adapter

- DIN 11864-1 Form A
- DIN 11851
- ISO 2853

 Process connection materials →  62

Surface roughness

All data refer to parts in contact with the medium. The following surface roughness categories can be ordered.



- $Ra_{max} = 0.76 \mu\text{m}$ (30 μin)
- $Ra_{max} = 0.38 \mu\text{m}$ (15 μin)

16.11 Operability

Languages

Can be operated in the following languages:

Via "FieldCare", "DeviceCare" operating tool: English, German, French, Spanish, Italian, Chinese, Japanese

Local operation	This device cannot be operated locally using a display or operating elements.
IO-Link	<p> The device-specific parameters are configured via IO-Link. There are specific configuration or operating programs from different manufacturers available to the user for this purpose. The device description file (IODD) is provided for the device.</p> <p>IO-Link operating concept Operator-oriented menu structure for user-specific tasks. Efficient diagnostic behavior increases measurement availability:</p> <ul style="list-style-type: none"> ■ Diagnostic messages ■ Remedial measures ■ Simulation options <p>IODD download Two options to download the IODD:</p> <ul style="list-style-type: none"> ■ www.endress.com/download ■ https://ioddfinder.io-link.com/ <p>www.endress.com/download</p> <ol style="list-style-type: none"> 1. Select "Device drivers". 2. Select the "IO Device Description (IODD)" entry under "Type". 3. Select "Product root". 4. Click "Search". <ul style="list-style-type: none"> ↳ A list of search results is displayed. <p>Select the appropriate version and download.</p> <p>https://ioddfinder.io-link.com/</p> <ol style="list-style-type: none"> 1. Enter "Endress" as the manufacturer and select. 2. Select product name. <ul style="list-style-type: none"> ↳ A list of search results is displayed. <p>Select the appropriate version and download.</p>
Remote operation	→  30

16.12 Certificates and approvals

Current certificates and approvals for the product are available at www.endress.com on the relevant product page:

1. Select the product using the filters and search field.
2. Open the product page.
3. Select **Downloads**.

CE mark	<p>The device meets the legal requirements of the applicable EU Directives. These are listed in the corresponding EU Declaration of Conformity along with the standards applied.</p> <p>Endress+Hauser confirms successful testing of the device by affixing to it the CE mark.</p>
UKCA marking	<p>The device meets the legal requirements of the applicable UK regulations (Statutory Instruments). These are listed in the UKCA Declaration of Conformity along with the designated standards. By selecting the order option for UKCA marking, Endress+Hauser confirms a successful evaluation and testing of the device by affixing the UKCA mark.</p>

Contact address Endress+Hauser UK:
 Endress+Hauser Ltd.
 Floats Road
 Manchester M23 9NF
 United Kingdom
www.uk.endress.com

RCM marking

The measuring system meets the EMC requirements of the "Australian Communications and Media Authority (ACMA)".

Ex-approval



- Only measuring instruments with the order code for "Approval", option "BT", "FC" and "US" have an Ex approval.
- The devices are certified for use in hazardous areas and the relevant safety instructions are provided in the separate "Safety Instructions" (XA) document. Reference is made to this document on the nameplate.

Hygienic compatibility

- 3-A approval
 - Only measuring devices with the order code for "Additional approval", option LP "3A" have 3-A approval.
 - The 3-A approval refers to the measuring device.
 - When installing the measuring device, ensure that no liquid can accumulate on the outside of the measuring device.
 - Accessories (e.g. sensor holder) must be installed in accordance with the 3-A Standard. Each accessory can be cleaned. Disassembly may be necessary under certain circumstances.
 - EHEDG-certified ⁴⁾

Only devices with the order code for "Additional approval", option LT "EHEDG" have been tested and meet the requirements of the EHEDG.

To meet the requirements for EHEDG certification, the device must be used with process connections in accordance with the EHEDG position paper entitled "Easy cleanable Pipe couplings and Process connections" (www.ehedg.org).

When installed, the orientation of the device must facilitate draining in order to meet the requirements of EHEDG certification.
 - Food Contact Materials Regulation (EC) 1935/2004
-  Observe special mounting instructions →  21

Pharmaceutical compatibility

- FDA 21 CFR 177
- USP <87>
- USP <88> Class VI 121 °C
- TSE/BSE Certificate of Suitability
- cGMP

Devices with the order code for "Test, certificate", option JG "Conformity with cGMP-derived requirements, declaration" comply with the requirements of cGMP with regard to the surfaces of parts in contact with the medium, design, FDA 21 CFR material conformity, USP Class VI tests and TSE/BSE conformity.

A serial number-specific declaration is generated.

4) DN 8 to 40 (3/8 to 1 1/2")

Pressure Equipment Directive

- With the marking
 - a) PED/G1/x (x = category) or
 - b) PESR/G1/x (x = category)
 on the sensor nameplate, Endress+Hauser confirms compliance with the "Essential Safety Requirements"
 - a) specified in Annex I of the Pressure Equipment Directive 2014/68/EU or
 - b) Schedule 2 of Statutory Instruments 2016 No. 1105.
- Devices not bearing this marking (without PED or PESR) are designed and manufactured according to sound engineering practice. They meet the requirements of
 - a) Art. 4 Para. 3 of the Pressure Equipment Directive 2014/68/EU or
 - b) Part 1, Para. 8 of Statutory Instruments 2016 No. 1105.
 The scope of application is indicated
 - a) in diagrams 6 to 9 in Annex II of the Pressure Equipment Directive 2014/68/EU or
 - b) Schedule 3, Para. 2 of Statutory Instruments 2016 No. 1105.

External standards and guidelines



- EN 60529
Degrees of protection provided by enclosures (IP code)
- EN 61010-1
Safety requirements for electrical equipment for measurement, control and laboratory use
- EN 61326-1/-2-3
EMC requirements for electrical equipment for measurement, control and laboratory use
- CAN/CSA C22.2 No. 61010-1-12
Safety Requirements for Electrical Equipment for Measurement, Control and Laboratory Use, Part 1: General Requirements
- ANSI/ISA-61010-1 (82.02.01)
Safety Requirements for Electrical Equipment for Measurement, Control and Laboratory Use – Part 1: General Requirements

Additional certification

CRN approval

Some device versions have CRN approval. A CRN-approved process connection with a CSA approval must be ordered for a CRN-approved device.

16.13 Accessories

 Overview of accessories available to order →  49

16.14 Documentation

-  For an overview of the scope of the associated Technical Documentation, refer to the following:
 - *Device Viewer* (www.endress.com/deviceviewer): Enter the serial number from the nameplate
 - *Endress+Hauser Operations app*: Enter serial number from nameplate or scan matrix code on nameplate.

Standard documentation

Brief Operating Instructions

Measuring instrument	Documentation code
Dosimass	KA01688D

Description of Device Parameters

Measuring instrument	Documentation code
Dosimass	GP01216D

Technical Information

Measuring instrument	Documentation code
Dosimass	TI01785D

Supplementary device-dependent documentation

Safety instructions

Contents	Documentation code
ATEX Ex ec	XA03257D
UL Class I, Division 2	XA03263D
UKEX Ex ec	XA03264D

Special Documentation

Contents	Documentation code
IO-Link	SD03250D

Installation instructions

Contents	Note
Installation instructions for spare part sets and accessories	<ul style="list-style-type: none"> ▪ Access the overview of all the available spare part sets via <i>Device Viewer</i> ▪ Accessories available for order with Installation Instructions →  49

Index

0 ... 9

3-A approval 64

A

Adapting the diagnostic behavior 38
 Ambient conditions
 Shock and vibration resistance 58
 Ambient temperature
 Influence 57
 Ambient temperature range 19
 Application 50
 Resetting the totalizer 36
 Totalizer reset 36
 Approvals 63

C

CE mark 9, 63
 Certificates 63
 cGMP 64
 Check
 Connection 29
 Checklist
 Post-connection check 29
 Post-mounting check 25
 CIP cleaning 58
 Cleaning
 CIP cleaning 46
 Exterior cleaning 46
 Internal cleaning 46
 SIP cleaning 46
 Commissioning 34
 Configuring the measuring instrument 34
 Connecting cable 26
 Connecting requirements 26
 Connecting the measuring instrument
 Device plug 28
 Grounding 28
 Connection
 see Electrical connection
 Current consumption 54

D

Date of manufacture 12
 Declaration of Conformity 9
 Degree of protection 28, 58
 Design
 Measuring instrument 10
 Design fundamentals
 Measurement error 57
 Repeatability 57
 Device components 10
 Device description files 33
 Device locking, status 35
 Device name
 Sensor 12
 Device Viewer 11

DeviceCare 32
 Device description file 33
 Diagnostic information
 Design, description 38
 DeviceCare 37
 FieldCare 37
 Overview 39
 Remedial measures 39
 Diagnostic list 42
 Display
 Current diagnostic event 41
 Previous diagnostic event 41
 Display values
 For locking status 35
 Disposal 47
 Document
 Function 5
 Symbols 5
 Document function 5
 Down pipe 16

E

EHEDG-tested 64
 Electrical connection
 Degree of protection 28
 Measuring instrument 26
 Electromagnetic compatibility 58
 Endress+Hauser services
 Maintenance 46
 Repair 47
 Environment
 Storage temperature 58
 Error messages
 see Diagnostic messages
 Event history 42
 Event list 42
 Ex-approval 64
 Extended order code
 Sensor 12
 Exterior cleaning 46

F

FDA 64
 Field of application
 Residual risks 9
 FieldCare 31
 Device description file 33
 Establishing a connection 31
 Function 31
 User interface 32
 Firmware
 Release date 33
 Version 33
 Firmware history 45
 Flow direction 17, 24
 Flow limit 59

- Food Contact Materials Regulation 64
- Functions
 - see Parameter
- G**
- Galvanic isolation 53
- H**
- Hygienic compatibility 64
- I**
- Identifying the measuring instrument 11
- Incoming acceptance 11
- Influence
 - Ambient temperature 57
 - Medium pressure 57
 - Medium temperature 57
- Information about this document 5
- Inlet runs 19
- Input 50
- Inspection
 - Mounting 25
 - Received goods 11
- Installation
 - Mounting 24
- Installation dimensions 19
- Installation point 16
- Intended use 8
- Internal cleaning 46, 58
- L**
- Languages, operation options 62
- Local operation 63
- Low flow cut off 53
- M**
- Maintenance work 46
- Materials 61
- Maximum measurement error 55
- Measured variables
 - see Process variables
- Measurement accuracy 55
- Measuring and test equipment 46
- Measuring device
 - Conversion 47
 - Disposal 48
 - Mounting the sensor 24
 - Removing 47
 - Repair 47
 - Switching on 34
- Measuring instrument 33
 - Configuring 34
 - Design 10
 - Preparing for mounting 24
- Measuring principle 50
- Measuring range, recommended 59
- Measuring system 50
- Medium density 59
- Medium pressure
 - Influence 57
- Medium temperature
 - Influence 57
- Menus
 - For measuring instrument configuration 34
- Mounting 16
- Mounting dimensions
 - see Installation dimensions
- Mounting preparations 24
- Mounting requirements
 - Down pipe 16
 - Inlet and outlet runs 19
 - Installation dimensions 19
 - Installation point 16
 - Orientation 17
 - Sensor heating 20
 - Static pressure 19
 - Thermal insulation 20
 - Vibrations 21
- Mounting tool 24
- N**
- Nameplate
 - Sensor 12
- Netilion 46
- O**
- Operable flow range 51
- Operation 35
- Operation options 30
- Operational safety 9
- Order code 12
- Orientation
 - Filling systems 19
- Orientation (vertical, horizontal) 17
- Outlet runs 19
- Output signal 51
- Output variables 51
- P**
- Packaging disposal 15
- Parameter settings
 - Active diagnostics (Submenu) 41
 - Device (Submenu) 43
 - Device management (Submenu) 35, 43
 - Measured values (Submenu) 35
 - Totalizer handling (Submenu) 36
 - User management (Submenu) 35
- Performance characteristics 55
- Pharmaceutical compatibility 64
- Pin assignment, device plug 26
- Post-connection check 34
- Post-connection check (checklist) 29
- Post-mounting check 34
- Post-mounting check (checklist) 25
- Potential equalization 28
- Power consumption 54
- Power supply failure 54
- Pressure Equipment Directive 65
- Pressure loss 59

Pressure range		Supply unit	
Medium pressure	59	Requirements	27
Pressure-temperature ratings	59	Supply voltage	27, 54
Process connections	62	Surface roughness	62
Process variables		System design	
Calculated	50	Measuring system	50
Measured	50	see Measuring instrument design	
Product safety	9	System integration	33
R		T	
RCM marking	64	Technical data, overview	50
Reading measured values	35	Temperature range	
Recalibration	46	Medium temperature	59
Reference operating conditions	55	Storage temperature	15
Registered trademarks	7	Terminal assignment	26
Remote operation	63	Thermal insulation	20
Repair	47	Tool	
Repeatability	56	Mounting	24
Replacement		Transporting	15
Device components	47	Transporting the measuring instrument	15
Requirements for personnel	8	Troubleshooting	
Response time	56	General	37
Return	47	TSE/BSE Certificate of Suitability	64
S		U	
Safety	8	UKCA marking	63
Seals		Use of measuring device	
Medium temperature range	59	Borderline cases	8
Sensor		Incorrect use	8
Installing	24	Use of measuring instrument	
Medium temperature range	59	see Intended use	
Sensor heating	20	USP Class VI	64
Sensor housing	59	V	
Serial number	12	Vibrations	21
Settings		W	
Adapting the measuring instrument to the process		Weight	
conditions	36	SI units	61
Resetting the device	43	Transport (notes)	15
Shock and vibration resistance	58	US units	61
Signal on alarm	52	Workplace safety	9
SIP cleaning	58		
Special mounting instructions			
Hygienic compatibility	21		
Standards and guidelines	65		
Static pressure	19		
Status signals	37		
Storage conditions	15		
Storage temperature	15		
Storage temperature range	58		
Submenu			
Active diagnostics	41		
Device	43		
Device management	35, 43		
Event list	42		
Measured values	35		
Totalizer handling	36		
User management	35		
Supplementary documentation	65		



71658073

www.addresses.endress.com
