

Technical Information

Liquiphant FTL43

IO-Link

Vibronic



Point level switch for liquids

Application

- Point level switch for all pumpable liquids, for minimum or maximum detection in vessels, e.g. process tanks, storage tanks, and piping.
- Process temperature range: -40 to +150 °C (-40 to +302 °F)
- Pressures up to 64 bar (928 psi)
- Viscosities up to 10 000 mPa·s
- Ideal substitute for float switches as reliable function is not affected by flow, turbulence, air bubbles, foam, vibration, solids content or buildup.

Advantages

- Easy commissioning with plug and play functionality
- Certified, hygienic design (3-A, EHEDG, ASME BPE)
- Proven conformity with materials standards, e.g. EC1935/2004, FDA, GB 4806, cGMP
- Heartbeat Technology for predictive and preventive maintenance
- Bluetooth® wireless technology for commissioning, operation and maintenance
- CIP and SIP capabilities - up to protection class IP69









Table of contents

About this document	4	Climate class	15
Symbols	4	Degree of protection	15
List of abbreviations	4	Pollution degree	15
Graphic conventions	5	Vibration resistance	15
		Shock resistance	15
		Electromagnetic compatibility (EMC)	15
Function and system design	5	Process	15
Measuring principle	5	Process temperature range	15
Measuring system	5	Thermal shock	16
Communication and data processing	5	Process pressure range	16
Reliability	5	Test pressure	16
Device-specific IT security	6	Density	16
		Viscosity	16
		Pressure tightness	16
		Solids contents	16
Input	6	Mechanical construction	16
Measured variable	6	Design, dimensions	16
Measuring range	6	Dimensions	17
		Weight	19
		Materials	19
		Process connections	19
		Surface roughness	25
Output	6	Display and user interface	25
Output signal	6	LED indicator	25
Switching capacity	6	Remote operation	26
Signal on alarm for devices with current output	6	System integration	27
Load	6	Supported operating tools	27
Damping	7	Certificates and approvals	27
Switch output	7	Hygienic design requirements	27
Protocol-specific data	7	Compliance with requirements derived from cGMP	27
		TSE (BSE) compliance (ADI free - Animal Derived Ingredients)	27
		Industry Canada	27
		ASME BPE	27
Power supply	7	Ordering information	27
Terminal assignment	7	Identification	28
Available device plugs	8	Application packages	28
Supply voltage	8	Heartbeat Technology	28
Power consumption	8	"Medium detection" operating mode	29
Potential equalization	8	Accessories	30
Overvoltage protection	8	Device-specific accessories	30
		DeviceCare SFE100	30
		FieldCare SFE500	30
		Device Viewer	30
		Field Xpert SMT70	30
		SmartBlue app	30
Performance characteristics	9	Documentation	31
Reference operating conditions	9	Standard documentation	31
Take switch point into consideration	9		
Resolution	9		
Maximum measured error	9		
Hysteresis	9		
Non-repeatability	9		
Influence of the process temperature	9		
Influence of the process pressure	9		
Influence of the process medium density (at room temperature and normal pressure)	10		
Response time	10		
Warm-up time (according to IEC 62828-4)	10		
Mounting	10		
Orientation	10		
Installation instructions	11		
Installing the device in piping	13		
Special mounting instructions	13		
Environment	14		
Ambient temperature range	14		
Storage temperature	15		
Operating height	15		

Supplementary device-dependent documentation 31

Registered trademarks 31

About this document

<p>Symbols</p>	<p>Safety symbols</p> <p>⚠ DANGER This symbol alerts you to a dangerous situation. Failure to avoid this situation will result in serious or fatal injury.</p> <p>⚠ WARNING This symbol alerts you to a dangerous situation. Failure to avoid this situation can result in serious or fatal injury.</p> <p>⚠ CAUTION This symbol alerts you to a dangerous situation. Failure to avoid this situation can result in minor or medium injury.</p> <p>NOTICE This symbol contains information on procedures and other facts which do not result in personal injury.</p> <p>Tool symbols</p> <p> Open-ended wrench</p> <p>Communication-specific symbols</p> <p>Bluetooth®:  Wireless data transmission between devices over a short distance.</p> <p>IO-Link:  IO-Link Communications system for connecting intelligent sensors and actuators to an automation system. In the IEC 61131-9 standard, IO-Link is standardized under the description "Single-drop digital communication interface for small sensors and actuators (SDCI)".</p> <p>Symbols for certain types of information</p> <p><i>Permitted:</i>  Procedures, processes or actions that are permitted.</p> <p><i>Forbidden:</i>  Procedures, processes or actions that are forbidden.</p> <p><i>Additional information:</i> </p> <p><i>Reference to documentation:</i> </p> <p><i>Reference to page:</i> </p> <p><i>Series of steps:</i> 1., 2., 3.</p> <p><i>Result of an individual step:</i> </p> <p>Symbols in graphics</p> <p><i>Item numbers:</i> 1, 2, 3 ...</p> <p><i>Series of steps:</i> 1., 2., 3.</p> <p><i>Views:</i> A, B, C, ...</p>
<p>List of abbreviations</p>	<p>PN Nominal pressure</p> <p>MWP Maximum working pressure The maximum working pressure is indicated on the nameplate.</p> <p>Operating tool</p>

The term "operating tool" is used in place of the following operating software:

- FieldCare / DeviceCare, for operation via IO-Link communication and PC
- SmartBlue app, for operation using an Android or iOS smartphone or tablet

PLC

Programmable logic controller (PLC)

Graphic conventions

- Installation, explosion and electrical connection drawings are presented in simplified format
- Devices, assemblies, components and dimensional drawings are presented in reduced-line format
- Dimensional drawings are not to-scale representations; the dimensions indicated are rounded off to 2 decimal places
- Unless otherwise described, flanges are presented with sealing surface form EN 1092-1; ASME B16.5, RF.

Function and system design

Measuring principle

The sensor's tuning fork vibrates at its intrinsic frequency. As soon as the liquid covers the tuning fork, the vibration frequency decreases. The change in frequency causes the point level switch to switch.

Point level detection

Maximum or minimum detection for liquids in tanks or pipes in all industries. Suitable for leakage monitoring, pump dry-running protection or overflow prevention, for example.

The point level switch differentiates between the "covered" and "not covered" conditions.

Depending on the MIN (minimum detection) or MAX (maximum detection) modes, there are two possibilities in each case: OK status and demand mode.

OK status

- In MIN mode, the fork is covered, e.g. pump dry-running protection
- In MAX mode, the fork is not covered, e.g. overflow prevention

Demand mode

- In MIN mode, the fork is not covered, e.g. pump dry-running protection
- In MAX mode, the fork is covered, e.g. overflow prevention

Measuring system

A complete measuring system comprises:

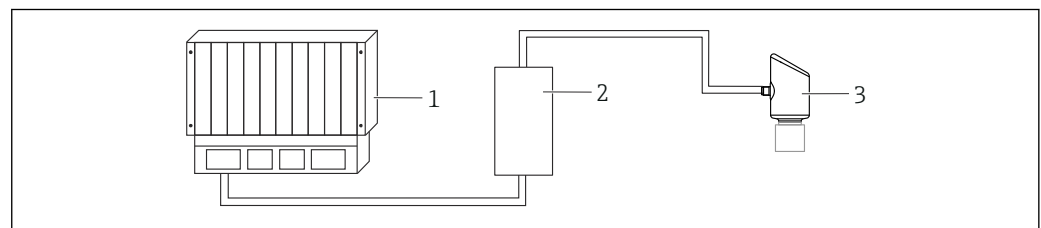

- 1 PLC (programmable logic controller)
- 2 IO-Link master
- 3 Device

Communication and data processing

- Digital communication protocol IO-Link, 3-wire
- Bluetooth (optional)

Reliability

IT security

Our warranty is valid only if the product is installed and used as described in the Operating Instructions. The product is equipped with security mechanisms to protect it against any inadvertent changes to the settings.

IT security measures, which provide additional protection for the product and associated data transfer, must be implemented by the operators themselves in line with their security standards.

Device-specific IT security	The device offers specific functions to support protective measures by the operator. These functions can be configured by the user and guarantee greater in-operation safety if used correctly. The user role can be changed with an access code (applies to operation via Bluetooth or FieldCare, DeviceCare or asset management tools (e.g. AMS, PDM)).
------------------------------------	---

Access via Bluetooth® wireless technology

Secure signal transmission via Bluetooth® wireless technology uses an encryption method tested by the Fraunhofer Institute.

- Without the SmartBlue app, the device is not visible via Bluetooth® wireless technology.
- Only one point-to-point connection is established between the device and a smartphone or tablet.
- The Bluetooth® wireless technology interface can be disabled via local operation or via SmartBlue.

Input

Measured variable	Level (point level), MAX or MIN safety
Measuring range	Depends on the installation location and the pipe extension ordered Maximum sensor length 1.5 m (5 ft)

Output

Output signal	<ul style="list-style-type: none"> ▪ 2 outputs, configurable as switch output, analog output or IO-Link output ▪ The current output offers a choice of three different operating modes: <ul style="list-style-type: none"> ▪ 4 to 20.5 mA ▪ NAMUR NE 43: 3.8 to 20.5 mA (factory setting) ▪ US mode: 3.9 to 20.5 mA
Switching capacity	<ul style="list-style-type: none"> ▪ Switch status ON: $I_a \leq 200 \text{ mA}^{1)}$; switch status OFF: $I_a < 0.1 \text{ mA}^{2)}$ ▪ Switch cycles: $> 1 \cdot 10^7$ ▪ Voltage drop PNP: $\leq 2 \text{ V}$ ▪ Overload protection: Automatic load testing of switching current; <ul style="list-style-type: none"> ▪ Max. capacitive load: $1 \mu\text{F}$ at max. supply voltage (without resistive load) ▪ Max. cycle duration: 0.5 s; min. t_{on}: $40 \mu\text{s}$ ▪ Periodic disconnection from protective circuit in the event of overcurrent ($f = 1 \text{ Hz}$)
Signal on alarm for devices with current output	<p>Current output</p> <p>Signal on alarm in accordance with NAMUR recommendation NE 43.</p> <ul style="list-style-type: none"> ▪ Max. alarm: can be set from 21.5 to 23 mA ▪ Min. alarm: $< 3.6 \text{ mA}$ (factory setting)
Load	For the current output, the following applies: In order to guarantee sufficient terminal voltage, a maximum load resistance R_L (including line resistance) must not be exceeded, depending on the supply voltage U of the supply unit.

- 1) If outputs "1 x PNP + 4 to 20 mA" are used at the same time, switch output OUT1 can be loaded with up to 100 mA load current over the entire temperature range. Up to 50 °C (122 °F) ambient temperature and up to 85 °C (185 °F) process temperature, the switching current may be up to 200 mA. If the "1 x PNP" or "2 x PNP" configuration is used, the switch outputs can be loaded in total with up to 200 mA over the entire temperature range.
- 2) Differing for switch output OUT2, for switch status OFF: $I_a < 3.6 \text{ mA}$ and $U_a < 2 \text{ V}$ and for switch status ON: voltage drop PNP: $\leq 2.5 \text{ V}$

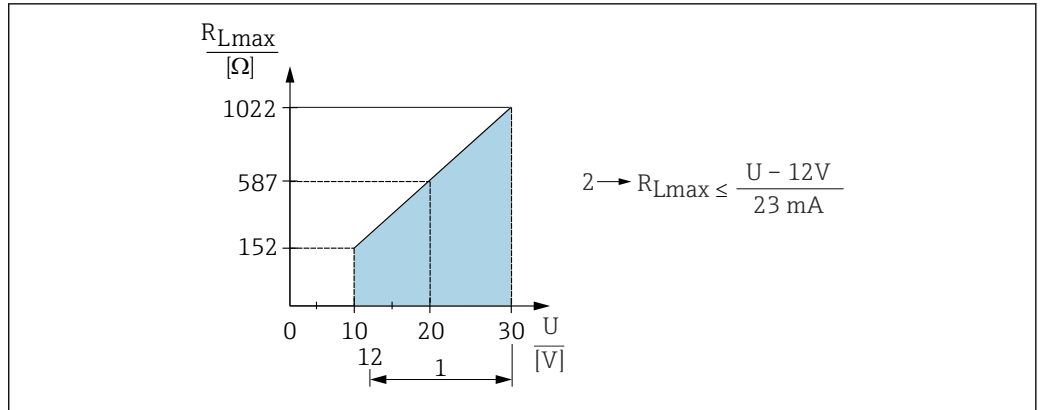

A0052603

- 1 Power supply 12 to 30 V
- 2 R_{Lmax} maximum load resistance
- U Supply voltage

If load is too great:

- Failure current is indicated and error message is displayed (indication: MIN alarm current)
- Periodic checking to establish if it is possible to quit fault state

Damping

A damping affects all continuous outputs.
 Factory setting: 1 s (can be configured from 0 to 999 s)

Switch output

- Preset switching delay times can be ordered:
- 0.5 s when the tuning fork is covered and 1.0 s when the tuning fork is uncovered (factory setting)
 - 0.25 s when the tuning fork is covered and 0.25 s when the tuning fork is uncovered
 - 1.5 s when the tuning fork is covered and 1.5 s when the tuning fork is uncovered
 - 5.0 s when the tuning fork is covered and 5.0 s when the tuning fork is uncovered

 The user can also set the switching delays for when the fork is covered and uncovered in the range from 1 to 60 seconds independently of one another.

(Operation via Bluetooth or FieldCare, DeviceCare)

Protocol-specific data

IO-Link specification 1.1.3

Device type ID:
 0x91 0xDF 0x01

Power supply

Terminal assignment

2-wire

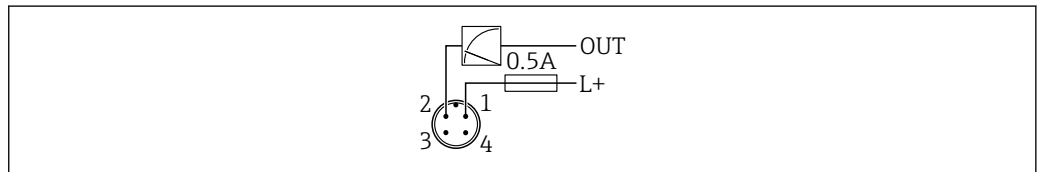

A0052660

- 1 Supply voltage L+, brown wire (BN)
- 2 OUT (L-), white wire (WH)

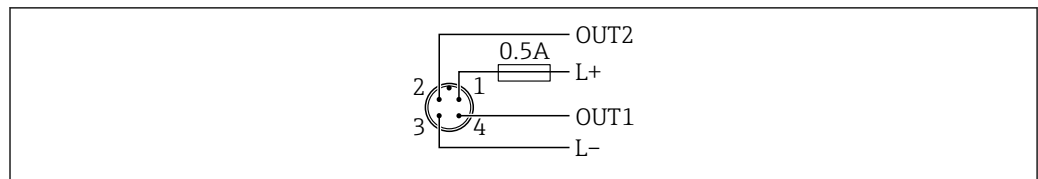
3-wire or 4-wire

A0052457

- 1 Supply voltage L+, brown wire (BN)
- 2 Switch or analog output (OUT2), white wire (WH)
- 3 Supply voltage L-, blue wire (BU)
- 4 Switching or IO-Link output (OUT1), black wire (BK)

The functionality of output 1 and 2 can be configured.

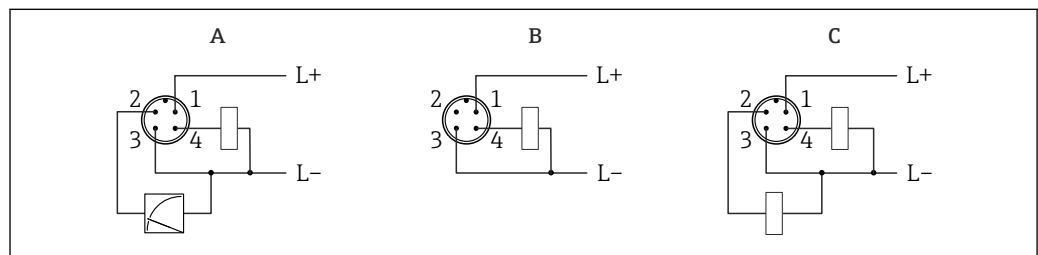
Connection examples

A0052458

- A 1 x PNP switch and analog output
- B 1 x PNP switch output
- C 2 x PNP switch output

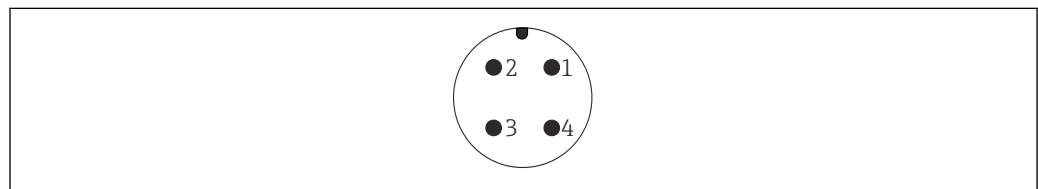
Available device plugs**M12 plug**

A0052661

 1 View of the connection on the device

 For further information, see the "Device-specific accessories" section

Supply voltage

12 to 30 V_{DC} on a direct current power unit

IO-Link communication is guaranteed only if the supply voltage is at least 18 V.

 The power unit must be tested to ensure it meets safety requirements (e.g. PELV, SELV, Class 2) and must comply with the relevant protocol specifications.

A suitable circuit breaker should be provided for the device in accordance with IEC/EN 61010-1.

Protective circuits against reverse polarity, HF influences and overvoltage peaks are installed.

Power consumption

Non-hazardous area: To meet device safety specifications according to the IEC/EN 61010 standard, the installation must ensure that the maximum current is limited to 500 mA.

Potential equalization

If necessary, establish potential equalization using the process connection or the grounding clamp supplied by the customer.

Overvoltage protection

The device satisfies the IEC/DIN EN 61326-1 product standard (Table 2 Industrial environment). Depending on the type of connection (DC supply, input/output line) different test levels according to

IEC/DIN EN 61326-1 against transient overvoltages are applied (IEC/DIN EN 61000-4-5 Surge): test level for DC power supply lines and input/output lines: 1 000 V line to earth.

Overvoltage protection category

In accordance with IEC/DIN EN 61010-1, the device is intended for use in networks with overvoltage protection category II.

Performance characteristics

Reference operating conditions

- As per IEC 62828-2
- Ambient temperature: +23 °C (+73 °F)
- Process temperature: +23 °C (+73 °F)
- Humidity ϕ = constant, in the range: 5 to 80 % RH \pm 5 %
- Medium density (water): 1 g/cm³ (62.4 lb/ft³)
- Medium viscosity: 1 mPa·s
- Ambient pressure p_A = constant, in the range: 860 to 1 060 mbar (12.47 to 15.37 psi)
- Process pressure: atmospheric pressure/unpressurized
- Sensor installation: vertically from above
- Switch direction of sensor: uncovered to covered
- Supply voltage: 24 V DC \pm 3 V DC

Take switch point into consideration

The following are typical switch points, depending on the orientation of the point level switch.
Water +23 °C (+73 °F)

 Minimum distance between the tuning fork and the tank wall or pipe wall: 10 mm (0.39 in)

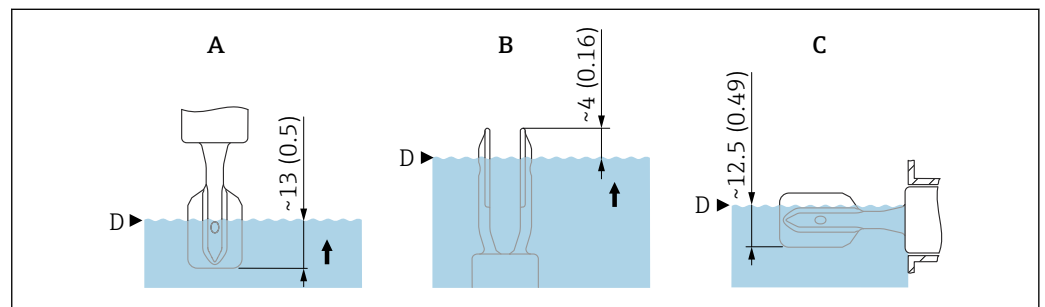

 2 Typical switch points. Unit of measurement mm (in)

- A Installation from above
- B Installation from below
- C Installation from the side
- D Switch point

Resolution	Current output: < 1 μ A
Maximum measured error	At reference operating conditions: max. \pm 1 mm (0.04 in) at switch point
Hysteresis	Typically 2.5 mm (0.1 in)
Non-repeatability	0.5 mm (0.02 in)
Influence of the process temperature	The switch point moves from +1.4 to -2.6 mm (+0.06 to -0.1 in) in the temperature range of -50 to +150 °C (-58 to +302 °F)
Influence of the process pressure	The switch point moves from 0 to 2.6 mm (0 to 0.1 in) in the pressure range of -1 to +64 bar (-14.5 to +928 psi)

Influence of the process medium density (at room temperature and normal pressure)

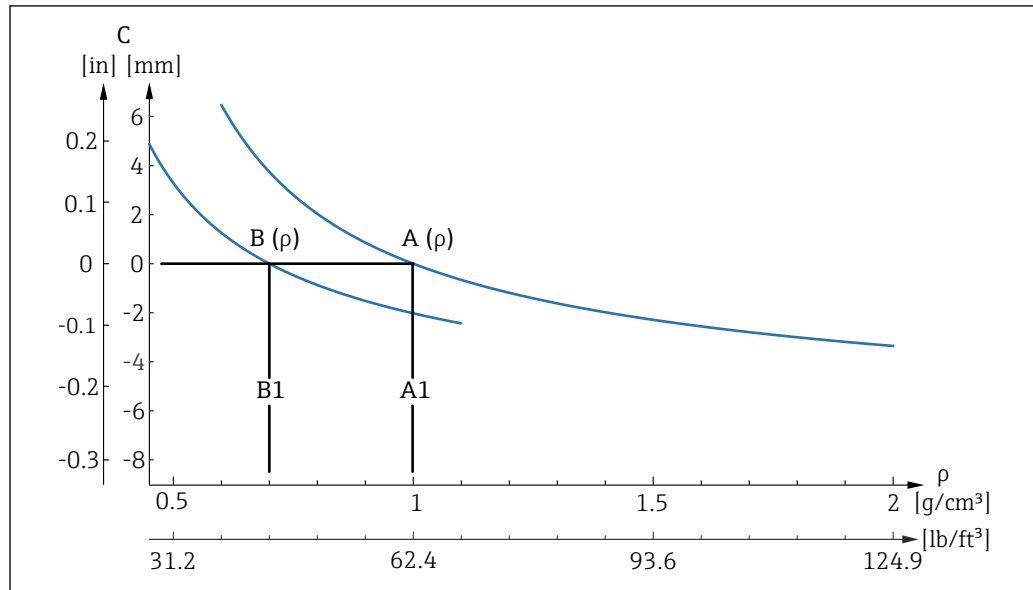

A0037669

3 Switch point deviation over density

- A Setting (ρ) > 0.7 g/cm³ (43.7 lb/ft³)
- A1 Reference operating condition $\rho = 1 \text{ g/cm}^3$ (62.4 lb/ft³)
- B Setting (ρ) > 0.5 g/cm³ (31.21 lb/ft³)
- B1 Reference operating condition $\rho = 0.7 \text{ g/cm}^3$ (43.7 lb/ft³)
- C Switch point deviation

Density setting

- $TC_{typ.}$ [mm/10 k]
 - $\rho > 0.7 \text{ g/cm}^3$ (43.7 lb/ft³): -0.2
 - $\rho > 0.5 \text{ g/cm}^3$ (31.21 lb/ft³): -0.2
- $Pressure_{typ.}$ [mm/10 bar]
 - $\rho > 0.7 \text{ g/cm}^3$ (43.7 lb/ft³): -0.3
 - $\rho > 0.5 \text{ g/cm}^3$ (31.21 lb/ft³): -0.4

Response time

Dynamic behavior of switch output

≤ 20 ms

Dynamic behavior, current output

- Dead time (t_1): 3.5 ms maximum
- Time constant T63 (t_2): 10 ms maximum
- Time constant T90 (t_3): 24 ms maximum

Warm-up time (according to IEC 62828-4)

The warm-up time indicates the time the sensor requires to reach its maximum accuracy or performance after the supply voltage is applied

Warm-up time: ≤ 10 s

Mounting

Orientation

- Any orientation for compact version or version with a tube length up to approx. 500 mm (19.7 in)
- Vertical orientation from above for device with long pipe
- Minimum distance between the tuning fork and the tank wall or pipe wall: 10 mm (0.39 in)

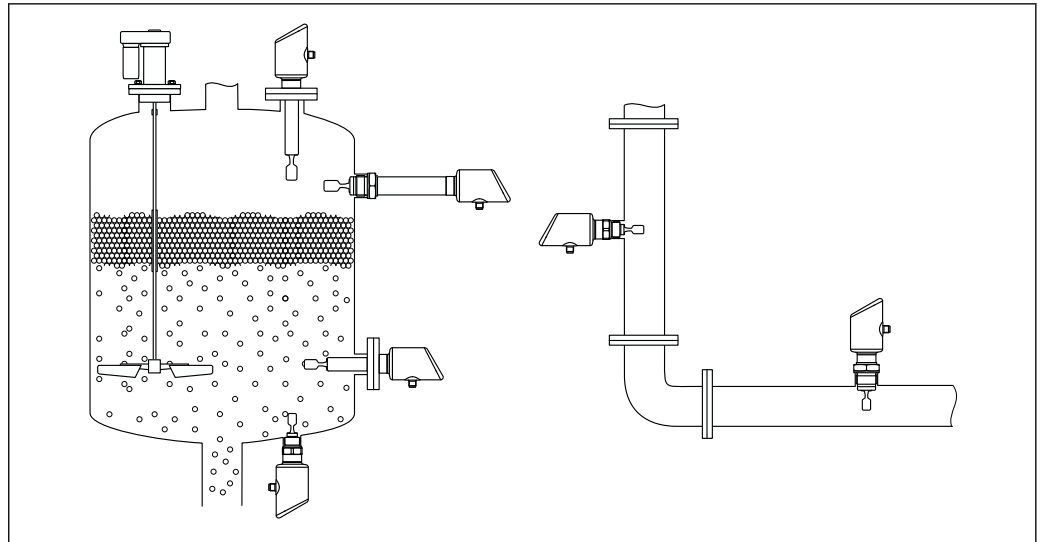

A0053113

4 Installation examples for a vessel, tank or pipe

Installation instructions

Mounting instructions

i During installation, it is important to ensure that the sealing element used has an operating temperature that corresponds to the maximum temperature of the process.

- Devices with CSA approval are intended for indoor use
- Devices are suitable for use in wet environments in accordance with IEC/EN 61010-1

Take viscosity into consideration

- i** Viscosity values
- Low viscosity: < 2 000 mPa·s
 - High viscosity: > 2 000 to 10 000 mPa·s

Low viscosity

- i** Low viscosity, e.g. water: < 2 000 mPa·s
It is permitted to position the tuning fork within the installation socket.

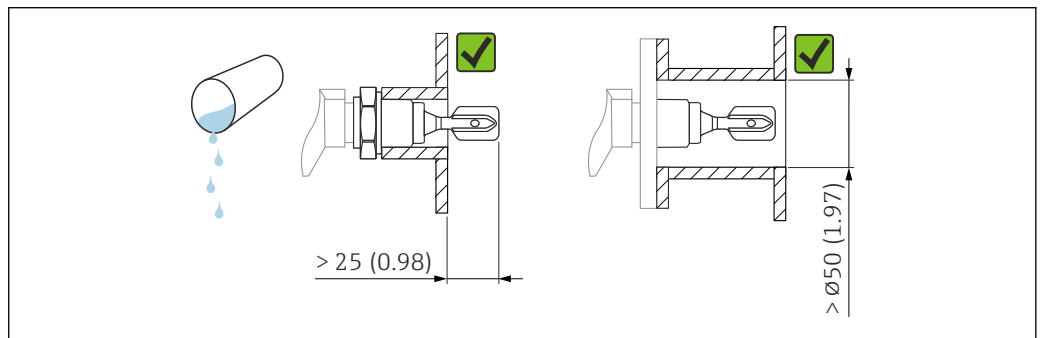

A0033297

5 Installation example for low-viscosity liquids. Unit of measurement mm (in)

High viscosity

NOTICE

Highly viscous liquids may cause switching delays.

- ▶ Make sure that the liquid can run off the tuning fork easily.
- ▶ Deburr the socket surface.

- i** High viscosity, e.g. viscous oils: $\leq 10\,000$ mPa·s
The tuning fork must be located outside the installation socket!

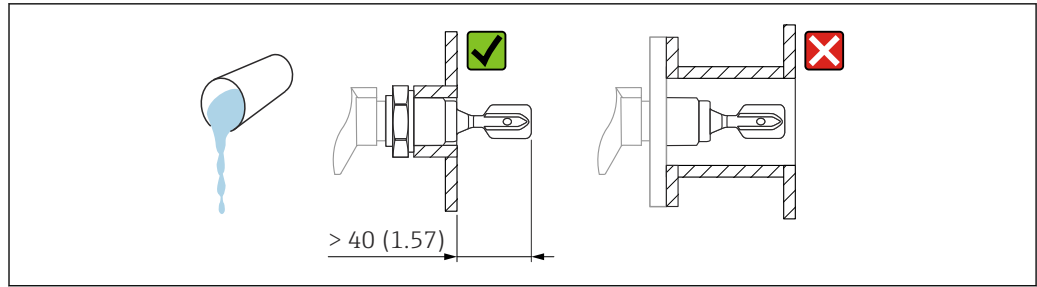

A0037348

6 Installation example for a highly viscous liquid. Unit of measurement mm (in)

Avoid buildup

- Use short installation sockets to ensure that the tuning fork projects freely into the vessel
- Leave sufficient distance between the buildup expected on the tank wall and the tuning fork

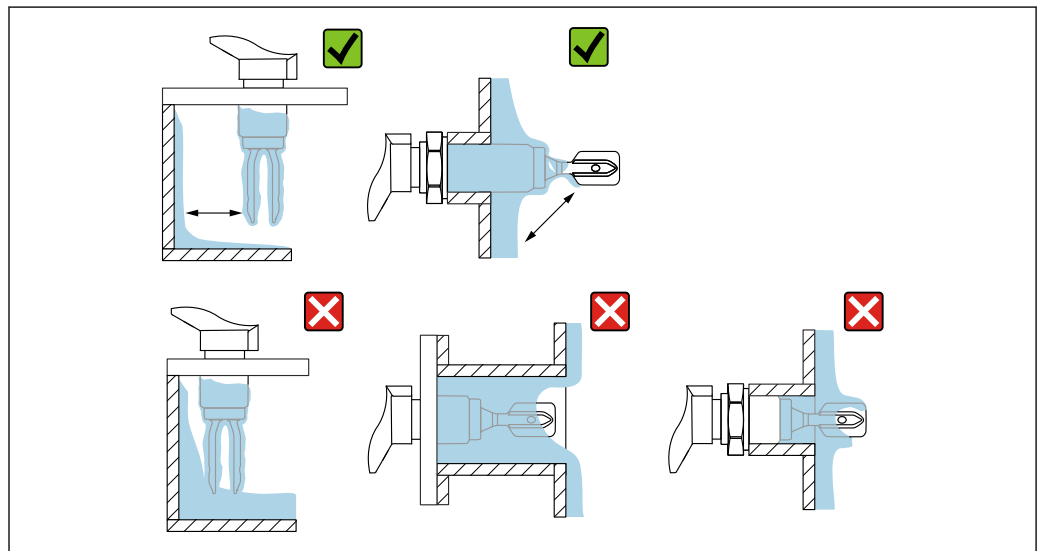

A0033239

7 Installation examples for a highly viscous process medium

Take clearance into consideration.

Allow sufficient clearance outside the tank for mounting and electrical connection.

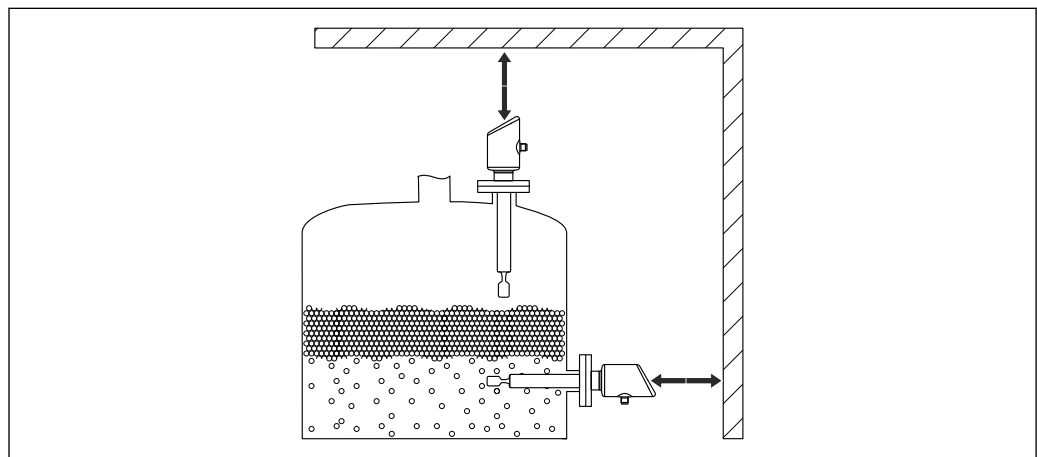

A0053359

8 Take clearance into consideration.

Aligning the tuning fork using the marking

The tuning fork can be aligned using the marking in such a way that the medium drains off easily and buildup is avoided.

Markings on process connection:

Material specification, thread designation, circle, line or double line

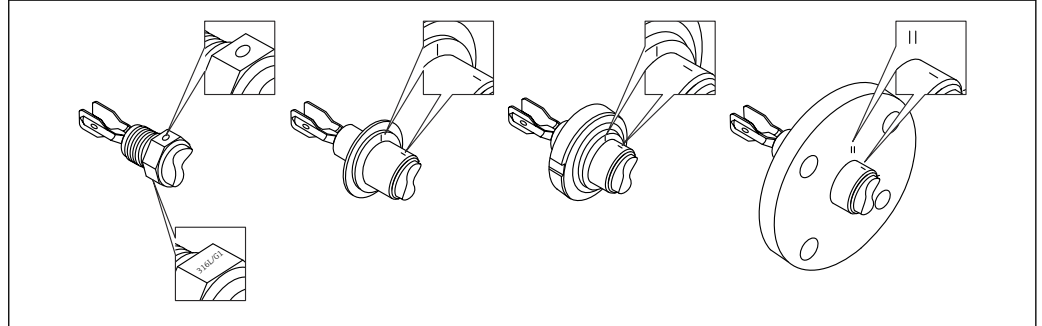

A0039125

9 Position of the tuning fork when installed horizontally in the vessel using the marking

Installing the device in piping

- Flow velocity up to 5 m/s with a viscosity of 1 mPa·s and density of 1 g/cm³ (62.4 lb/ft³) (SGU). Check for correct functioning in the event of other process medium conditions.
- The flow will not be significantly impeded if the tuning fork is correctly aligned and the marking is pointing in the direction of flow.
- The marking is visible when installed.

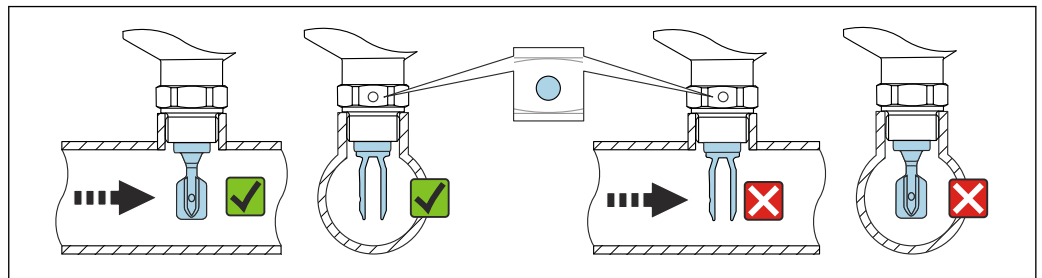

A0034851

10 Installation in pipes (take fork position and marking into consideration)

Special mounting instructions

Vessel with heat insulation

If process temperatures are high, the device should be incorporated in the usual vessel insulation system to prevent the electronics from heating as a result of thermal radiation or convection. The insulation in this case should not be higher than the neck of the device.

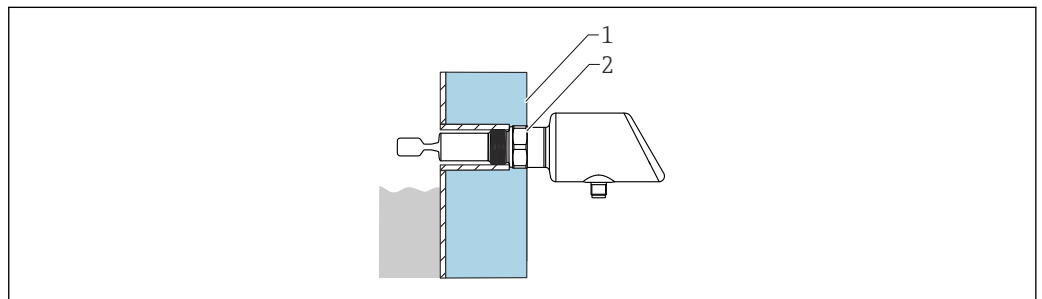

A0053115

11 Vessel with heat insulation (example)

- 1 Vessel insulation
- 2 Insulation max. up to the housing neck

Support the device

Support the device in the event of severe dynamic load. Maximum lateral loading capacity of the pipe extensions and sensors: 75 Nm (55 lbf ft).

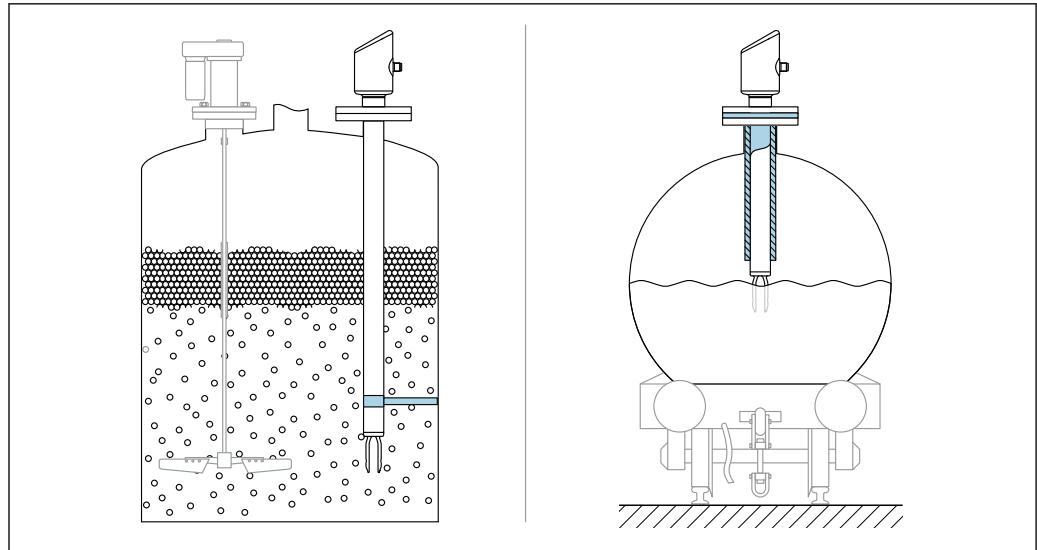

A0053109

12 Examples of support in the event of dynamic load

Weld-in adapter with leakage hole

Weld in the weld-in adapter in such a way that the leakage hole is pointing downwards. This enables any leaks to be detected quickly.

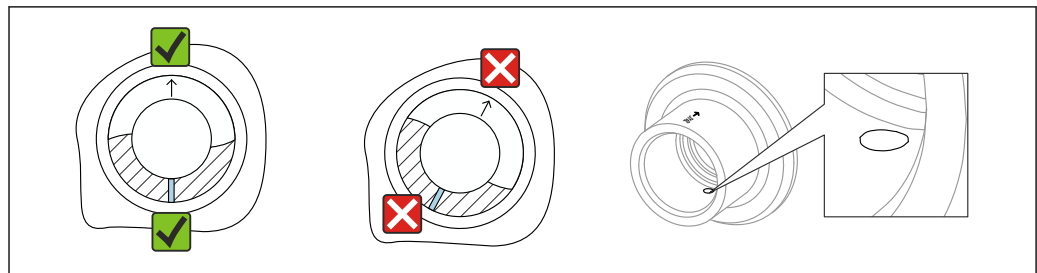

A0039230

13 Weld-in adapter with leakage hole

Environment

Ambient temperature range -40 to +85 °C (-40 to +185 °F)

The permitted ambient temperature is reduced at higher process temperatures.

i The following information only takes functional aspects into consideration. Additional restrictions may apply for certified device versions.

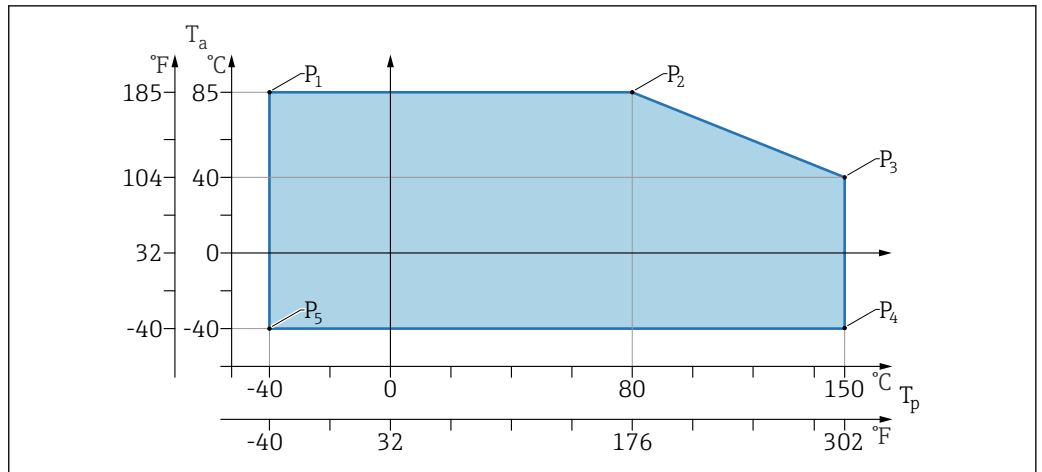

14 Ambient temperature T_a depending on the process temperature T_p

P	T_p	T_a
P1	-40 °C (-40 °F)	+85 °C (+185 °F)
P2	+80 °C (+176 °F)	+85 °C (+185 °F)
P3	+150 °C (+302 °F)	+40 °C (+77 °F)
P4	+150 °C (+302 °F)	-40 °C (-40 °F)
P5	-40 °C (-40 °F)	-40 °C (-40 °F)

Storage temperature	-40 to +85 °C (-40 to +185 °F)
Operating height	Up to 5 000 m (16 404 ft) above sea level
Climate class	According to IEC 60068-2-38 test Z/AD (relative humidity 4 to 100 %).
Degree of protection	Test as per IEC 60529 Edition 2.2 2013-08/ DIN EN 60529:2014-09 DIN EN 60529:2014-09 and NEMA 250-2014 For mounted M12 connecting cable: IP66/68/69, NEMA type 4X/6P /IP68,: (1.83 mH ₂ O for 24 h))
Pollution degree	Pollution degree 2 according to IEC/EN 61010-1
Vibration resistance	<ul style="list-style-type: none"> Stochastic noise (random sweep) as per DIN EN 60068-2-64 Case 2/ IEC 60068-2-64 Case 2 Guaranteed for 5 to 2 000 Hz: 1.25 (m/s²)²/Hz, ~ 5 g
Shock resistance	<ul style="list-style-type: none"> Test standard: DIN EN 60068-2-27 Case 2 Shock resistance: 30 g (18 ms) in all 3 axes
Electromagnetic compatibility (EMC)	<ul style="list-style-type: none"> Electromagnetic compatibility as per EN 61326 series and NAMUR recommendation EMC (NE21) Maximum deviation under the effect of disturbance: < 0.5% For more details refer to the EU Declaration of Conformity.

Process

Process temperature range	-40 to +150 °C (-40 to +302 °F) Pay attention to the pressure and temperature dependency.
----------------------------------	--

Thermal shock ≤ 120 K/s

Process pressure range Pressure specifications

⚠ WARNING

The maximum pressure for the device depends on the lowest-rated component with regard to pressure (components are: process connection, optional mounted parts or accessories).

- ▶ Only operate the device within the specified limits for the components!
- ▶ MWP (maximum working pressure): The MWP is specified on the nameplate. This value refers to a reference temperature of +20 °C (+68 °F) and may be applied to the device for an unlimited time. Note temperature dependence of MWP. For flanges, refer to the following standards for the permitted pressure values at higher temperatures: EN 1092-1 (with regard to their stability/temperature property, the materials 1.4435 and 1.4404 are grouped together under 13E0 in EN 1092-1, Tab. 18; the chemical composition of the two materials can be identical) ASME B 16.5a, (the latest version of the standard applies in each case).
- ▶ The Pressure Equipment Directive (2014/68/EU) uses the abbreviation "PS". The abbreviation "PS" corresponds to the MWP (maximum working pressure) of the device.
- ▶ MWP data that deviate from this are provided in the relevant sections of the Technical Information.

Test pressure

- PN = 64 bar (928 psi): test pressure = $1.5 \cdot$ PN maximum 100 bar (1 450 psi) depending on the selected process connection
- Membrane burst pressure at 200 bar (2 900 psi)

The device function is limited during the pressure test.

Mechanical integrity is guaranteed up to 1.5 times the process nominal pressure PN.

Density

Liquids with density > 0.7 g/cm³ (43.7 lb/ft³)

Setting > 0.7 g/cm³ (43.7 lb/ft³), as supplied to the customer

Liquids with density 0.5 g/cm³ (31.2 lb/ft³)

Setting > 0.5 g/cm³ (31.2 lb/ft³), can be ordered as preset value or configurable

Liquids with density > 0.4 g/cm³ (25.0 lb/ft³)

Setting > 0.4 g/cm³ (25.0 lb/ft³), can be ordered as preset value or configurable

i For information on medium differentiation/density detection: Documentation Liquiphant density (FEL60D) with density computer FML621 (Endress+Hauser website www.endress.com → Downloads)

Viscosity $\leq 10\,000$ mPa·s

Pressure tightness Up to vacuum

i In vacuum evaporation plants, select the 0.4 g/cm³ (25.0 lb/ft³) / density setting.

Solids contents $\varnothing \leq 5$ mm (0.2 in)

Mechanical construction

Design, dimensions

Device height

The device height consists of the following components:

- Housing with electronics module
- Temperature spacer with/without pressure-tight feedthrough (second line of defense), optional
- Compact version, pipe extension or short pipe version
- Process connection

The individual heights of the components can be found in the following sections:

- Determine the height of the device and add the individual heights
- Take the installation clearance into consideration (space that is needed to install the device)

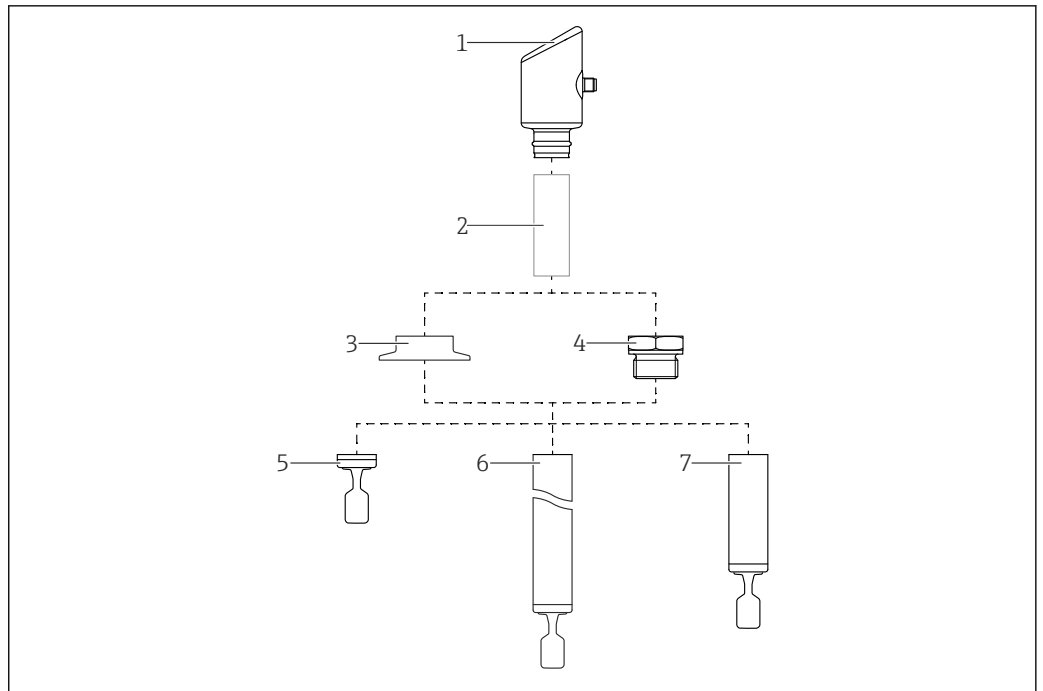

A0053358

15 Product design

- 1 Housing with electronics module
- 2 Temperature spacer, pressure-tight feedthrough (second line of defense), optional
- 3 Process connection, e.g. clamp/Tri-Clamp
- 4 Process connection, e.g. thread
- 5 Compact probe version with tuning fork
- 6 Pipe extension probe with tuning fork
- 7 Short pipe version of probe with tuning fork

Dimensions

Housing

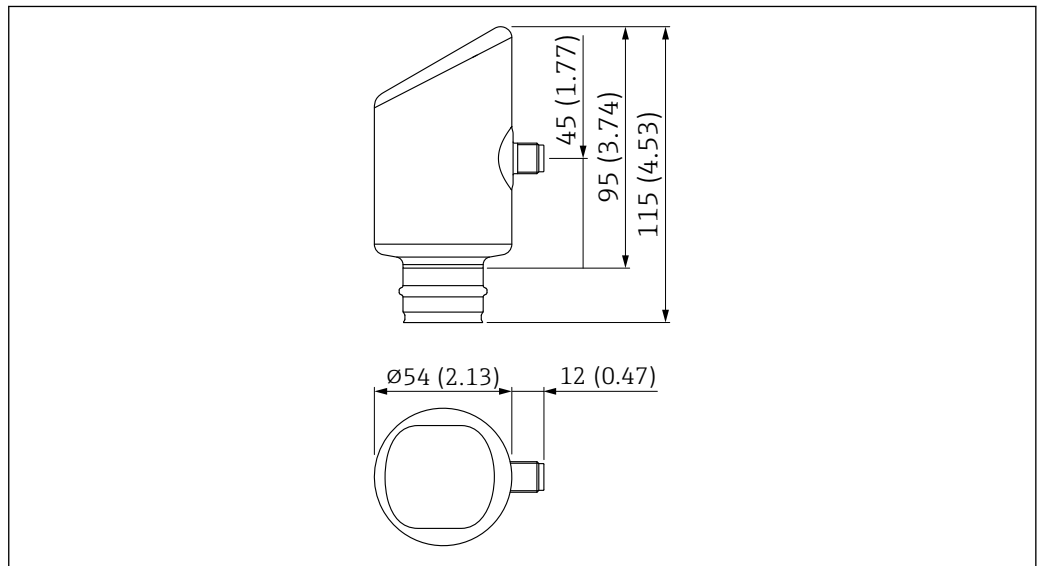

A0053970

Temperature spacer, pressure-tight feedthrough (optional)

Provides sealed insulation for the vessel and a normal ambient temperature for the housing.

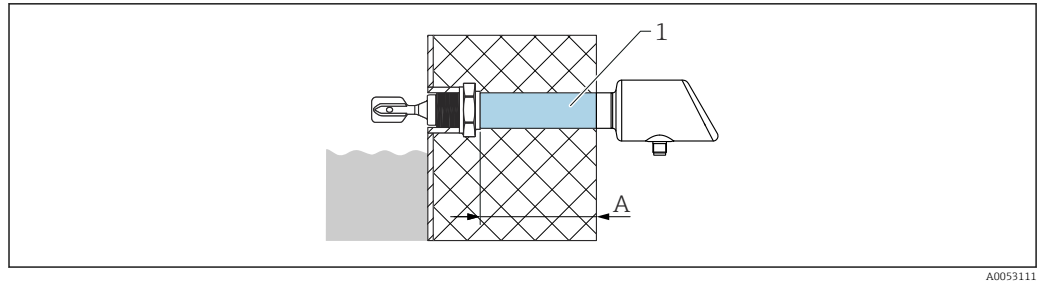

A0053111

- 1 Temperature spacer with/without pressure-tight feedthrough with maximum insulation length
 A 140 mm (5.51 in)

Product Configurator, feature "Sensor design":

- Temperature spacer
- Pressure-tight feedthrough (second line of defense)
 If the sensor is damaged, this protects the housing from vessel pressures up to 100 bar (1450 psi).

i The "Pressure-tight feedthrough" version can only be selected in conjunction with the "Temperature spacer" option.

Probe design

Compact version

Sensor length L: depends on process connection

 For more details, see the "Process connections" section.

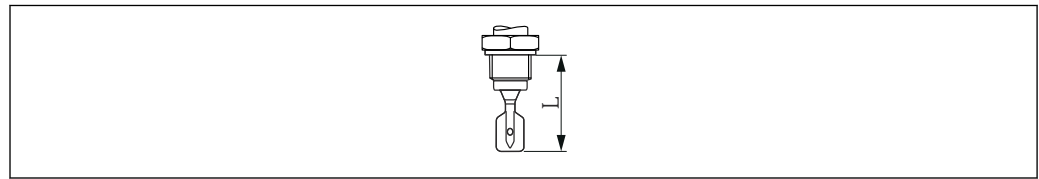

A0042435

-  16 Probe design: Compact version, sensor length L

Short tube version

Sensor length L: depends on process connection

- Thread G 1 approx. 118 mm (4.65 in)
- Ingold, flush-mounted tank connection, DIN11851 pipe union, Varivent, Clamp/Tri-Clamp approx. 115 mm (4.53 in)
- Flush-mounted 1" (G 1 welding boss from Endress+Hauser) approx. 104 mm (4.09 in)

Pipe extension

- Sensor lengths L: 148 to 1500 mm (5.83 to 59.06 in)
- Length tolerances L: < 1 m (3.3 ft) = -5 mm (-0.2 in), 1 to 3 m (3.3 to 9.8 ft) = -10 mm (-0.39 in)

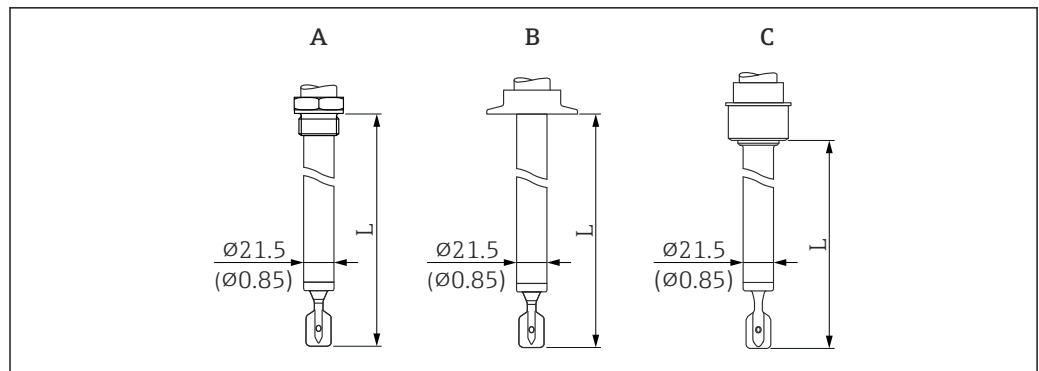

A0051989

-  17 Probe designs: pipe extension, short pipe (sensor length L). Unit of measurement mm (in)

- A Thread G 1
 B e.g. Clamp/Tri-Clamp, Varivent
 C Flush-mounted tank connection for installation in welding neck

Tuning fork

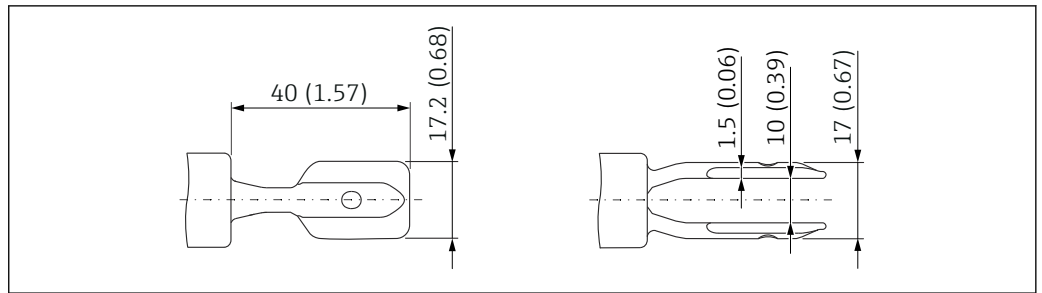

18 Tuning fork. Unit of measurement mm (in)

A0038269

Weight

i The weights of the individual components must be added together for the total weight.

Housing including electronics module

0.2 kg (0.44 lb)

Temperature spacer

0.6 kg (1.32 lb)

Pressure-tight feedthrough

0.7 kg (1.54 lb)

Pipe extension

- 1 000 mm: 0.9 kg (1.98 lb)
- 50 in: 1.15 kg (2.54 lb)

Process connection

See "Process connections" section

Materials

Materials in contact with process

Delta-ferrite content

For the delta-ferrite content of the wetted parts, ≤ 1% can be guaranteed and certified (for welds ≤ 3%).

Process connection and pipe extension

316L (1.4404 or 1.4435)

Tuning fork

316L (1.4435)

Seals



Scope of delivery including seal

- Ingold fitting, seal material: EPDM (in compliance with FDA, USP Class VI)
- Flush-mounted tank connection for installation in welding neck, seal material: silicone

Materials not in contact with process

- Housing: 316L (1.4404)
- Display: Polycarbonate
- Device plug: For more information, see section on "Power supply".

Process connections

Process connection, sealing surface

- Flange ASME B16.5, RF
- Flange EN1092-1, A
- Flange EN1092-1, B1
- Thread ISO228, G
- Ingold
- Flush-mounted tank connection
- DIN11851 pipe union
- DIN11864-1 pipe union

- DRD
- SMS1145 pipe union
- Varivent (Varinline)
- Clamp/Tri-Clamp

Height of process connection

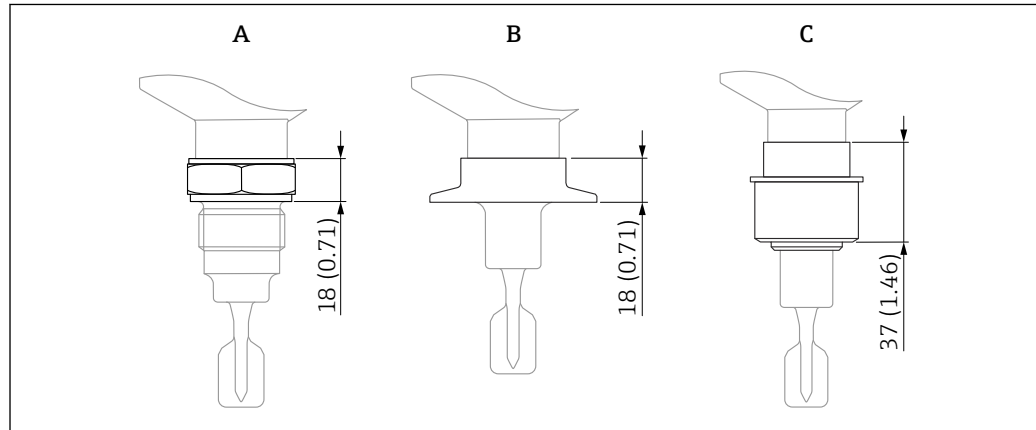

19 Maximum height specification for the process connections. Unit of measurement mm (in)

- A Process connection with threaded connection
 B For example: Clamp/Tri-Clamp, Varivent
 C Flush-mounted tank connection for installation in welding neck

Thread ISO228 G 3/4 for installation in weld-in adapter

G 3/4 with defined thread start for flush mounting in weld-in adapter

- Only for sensor design: compact version
- Material: 316L
- Pressure rating, temperature: ≤ 40 bar (580 psi), ≤ +100 °C (+212 °F)
- Pressure rating, temperature: ≤ 25 bar (363 psi), ≤ +150 °C (+302 °F)
- Weight: 0.2 kg (0.44 lb)
- Accessories: weld-in adapter, optionally available as "Accessory enclosed"

i A seal is not included in the delivery. The maximum temperature and maximum pressure depend on the clamping ring and sealing element used (according to the process connection design). The lowest value applies in each case.

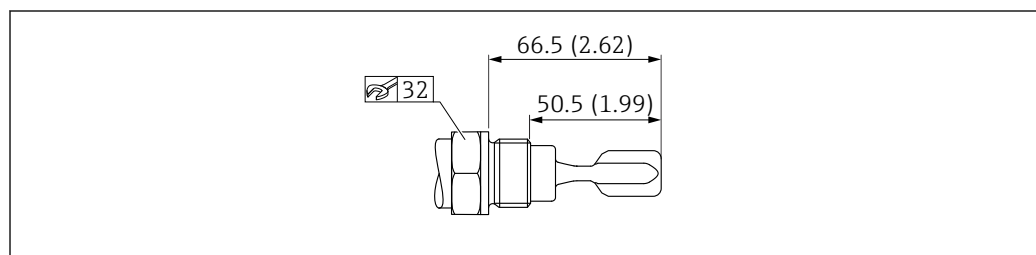

20 Thread ISO228 G 3/4. Unit of measurement mm (in)

Thread ISO228 G 1 for installation in weld-in adapter

G 1 with defined thread start, comprising sealing surface for flush mounting in weld-in adapter

- Material: 316L
- Pressure rating, temperature: ≤ 40 bar (580 psi), ≤ +100 °C (+212 °F)
- Pressure rating, temperature: ≤ 25 bar (363 psi), ≤ +150 °C (+302 °F)
- Weight: 0.33 kg (0.73 lb)
- Accessories: weld-in adapter, optionally available as "Accessory enclosed"

i A seal is not included in the delivery. The maximum temperature and maximum pressure depend on the clamping ring and sealing element used (according to the process connection design). The lowest value applies in each case.

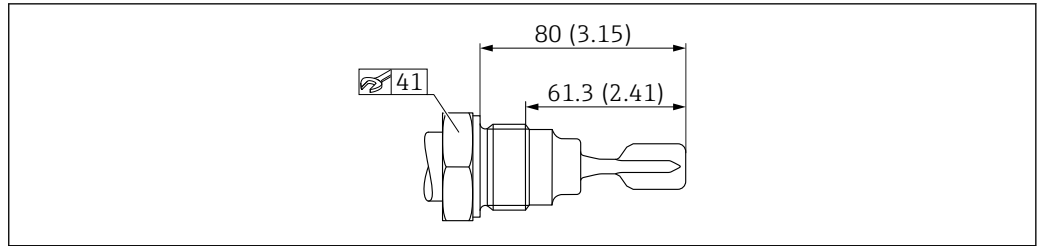

A0035551

21 Thread ISO228 G 1. Unit of measurement mm (in)

Ingold fitting

Ingold fitting 25 x 46 mm (2.52 in)

- Material: 316L
- Pressure rating: ≤ 16 bar (232 psi)
- Temperature: ≤ 150 °C (302 °F)
- Weight: 0.2 kg (0.44 lb)
- Scope of delivery: cap-nut G 1¼, seal

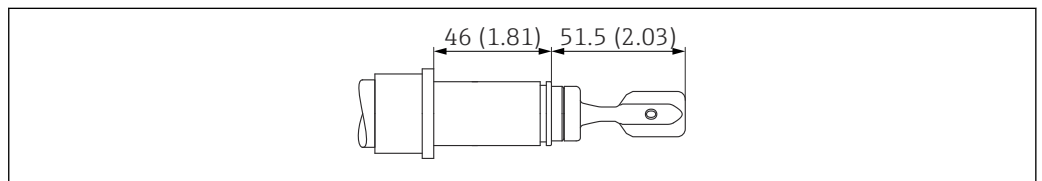

A0051991

22 Ingold fitting 25 x 46 mm (2.52 in). Unit of measurement mm (in)

Flush-mounted tank connection for installation in weld-in adapter

- Material: 316L
- Pressure rating, temperature: ≤ 40 bar (580 psi), ≤ +100 °C (+212 °F)
- Pressure rating, temperature: ≤ 25 bar (363 psi), ≤ 140 °C (284 °F)
- Weight: 0.44 kg (0.97 lb)
- Accessories: weld-in adapter, optionally available as "Accessory enclosed"
- Scope of delivery: cap-nut, seal

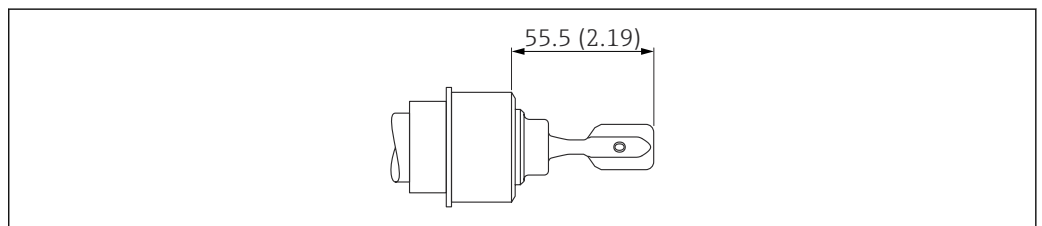

A0051993

23 Flush-mounted tank connection. Unit of measurement mm (in)

DIN11851 pipe union

DN32 PN25

- Material: 316L
- Slotted nut
- Pressure rating, temperature: ≤ 40 bar (580 psi), ≤ +100 °C (+212 °F)
- Pressure rating, temperature: ≤ 25 bar (363 psi), ≤ 140 °C (284 °F)
- Weight: 0.3 kg (0.66 lb)

DN40 PN25

- Material: 316L
- Slotted nut
- Pressure rating, temperature: ≤ 40 bar (580 psi), ≤ +100 °C (+212 °F)
- Pressure rating, temperature: ≤ 25 bar (363 psi), ≤ 140 °C (284 °F)
- Weight: 0.35 kg (0.77 lb)

DN50 PN25

- Material: 316L
- Slotted nut
- Pressure rating: ≤ 25 bar (363 psi)
- Temperature: ≤ 140 °C (284 °F)
- Weight: 0.47 kg (1.04 lb)

i A seal is not included in the delivery. The maximum temperature and maximum pressure depend on the clamping ring and sealing element used (according to the process connection design). The lowest value applies in each case.

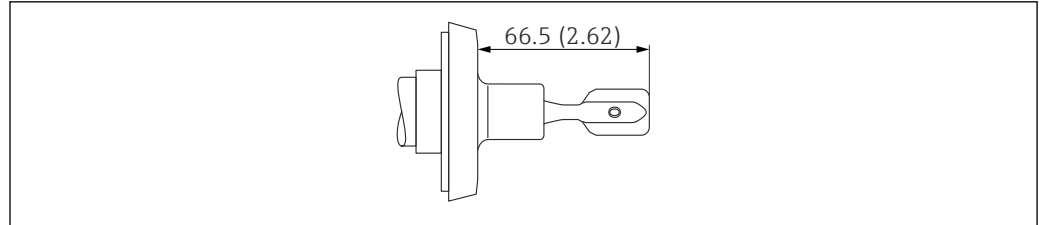

A0051995

24 DIN11851 pipe union. Unit of measurement mm (in)

DIN11864-1 pipe union

DIN11864-1 A DN50 pipe DIN11850

- Material: 316L
- Slotted nut
- Pressure rating: ≤ 25 bar (363 psi)
- Temperature: ≤ 140 °C (284 °F)
- Weight: 0.47 kg (1.04 lb)

i A seal is not included in the delivery. The maximum temperature and maximum pressure depend on the clamping ring and sealing element used (according to the process connection design). The lowest value applies in each case.

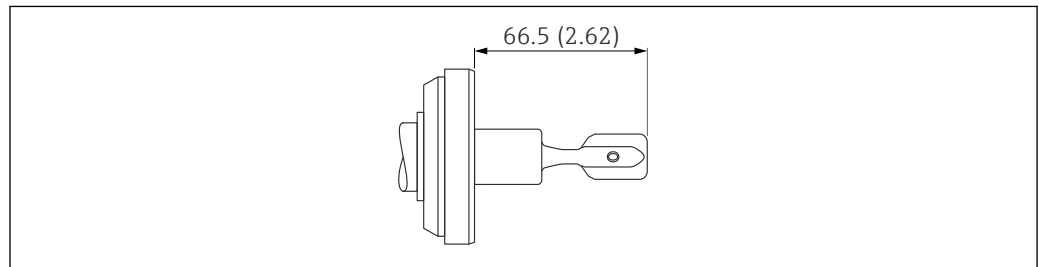

A0052381

25 DIN11864-1 pipe union. Unit of measurement mm (in)

DRD

DRD 65 mm (2.56 in)

- Material: 316L
- Pressure rating, temperature: ≤ 40 bar (580 psi), $\leq +100$ °C (+212 °F)
- Pressure rating, temperature: ≤ 25 bar (363 psi), ≤ 140 °C (284 °F)
- Weight: 0.43 kg (0.95 lb)
- Accessories: welding flange with PTFE flat seal, optionally available as "Accessory enclosed"

i A seal is not included in the delivery. The maximum temperature and maximum pressure depend on the clamping ring and sealing element used (according to the process connection design). The lowest value applies in each case.

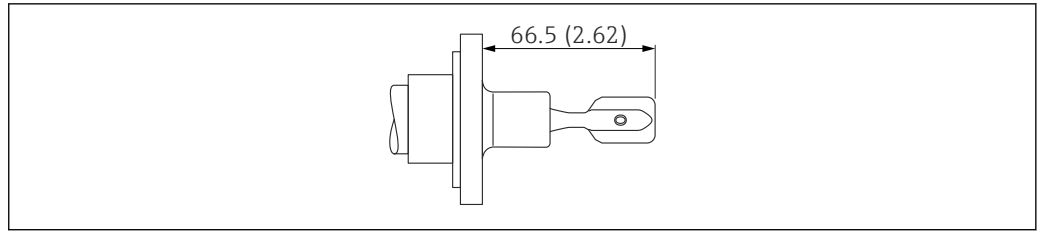

A0051992

26 DRD. Unit of measurement mm (in)

SMS1145 pipe union

SMS 2" PN25

- Material: 316L
- Pressure rating: ≤ 25 bar (363 psi)
- Temperature: ≤ 140 °C (284 °F)
- With cap-nut
- Weight: 0.33 kg (0.72 lb)

i A seal is not included in the delivery. The maximum temperature and maximum pressure depend on the clamping ring and sealing element used (according to the process connection design). The lowest value applies in each case.

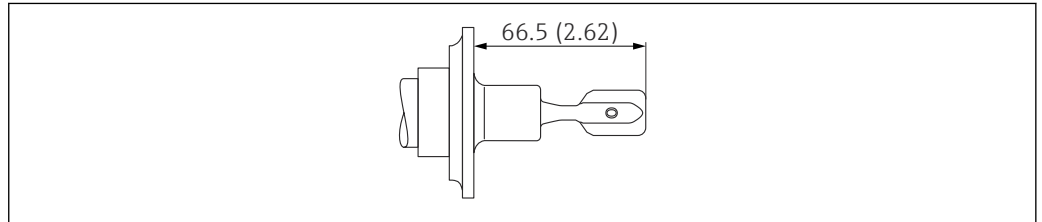

A0051994

27 SMS1145 pipe union. Unit of measurement mm (in)

Varivent (Varinline)

Varivent F pipe DN25-32 PN40

- Material: 316L
- Pressure rating: ≤ 25 bar (363 psi)
- Temperature: ≤ 150 °C (302 °F)
- Weight: 0.36 kg (0.79 lb)

i A seal is not included in the delivery. The maximum temperature and maximum pressure depend on the clamping ring and sealing element used (according to the process connection design). The lowest value applies in each case.

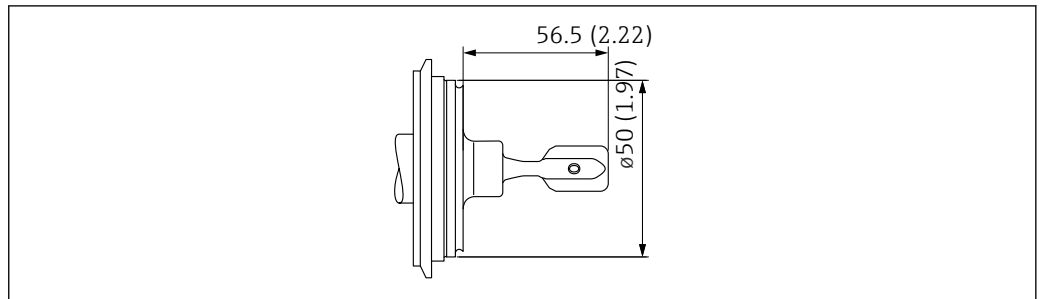

A0052749

28 Varivent F pipe DN25-32 PN40. Unit of measurement mm (in)

Varivent N pipe DN65-162 PN25

- Material: 316L
- Pressure rating: ≤ 25 bar (363 psi)
- Temperature: ≤ 150 °C (302 °F)
Suitable for GEA Tuchenhagen
- Weight: 0.72 kg (1.59 lb)

i A seal is not included in the delivery. The maximum temperature and maximum pressure depend on the clamping ring and sealing element used (according to the process connection design). The lowest value applies in each case.

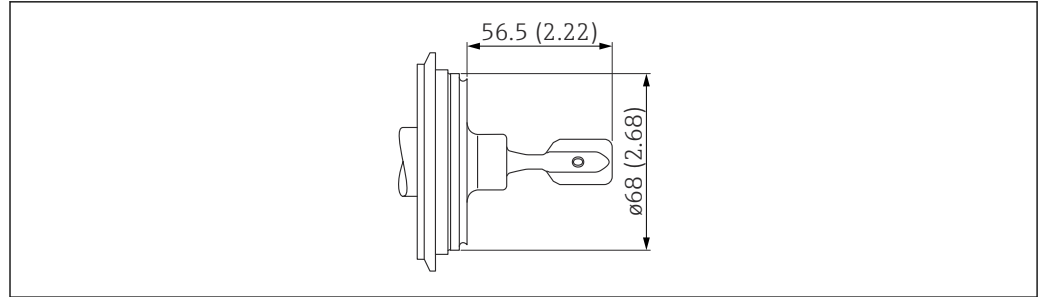

A0051996

29 Varivent N pipe DN65-162 PN25. Unit of measurement mm (in)

Tri-Clamp

ISO 2852 DN25-38 (1 to 1 ½"), DIN 32676 DN25-40

- Material: 316L
- Pressure rating: ≤ 25 bar (363 psi)
- Temperature: ≤ 150 °C (302 °F)
- Weight: 0.3 kg (0.66 lb)

ISO 2852 DN40-51 (2"), DIN 32676 DN50

- Material: 316L
- Pressure rating: ≤ 25 bar (363 psi)
- Temperature: ≤ 150 °C (302 °F)
- Weight: 0.3 kg (0.66 lb)

i The Tri-Clamp connection is compatible with NA Connect.

i A seal is not included in the delivery. The maximum temperature and maximum pressure depend on the clamping ring and sealing element used (according to the process connection design). The lowest value applies in each case.

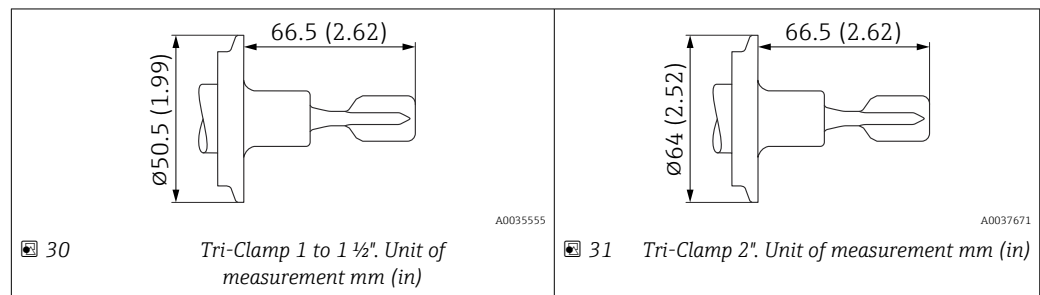

A0035555

A0037671

30 Tri-Clamp 1 to 1 ½". Unit of measurement mm (in)

31 Tri-Clamp 2". Unit of measurement mm (in)

Flanges

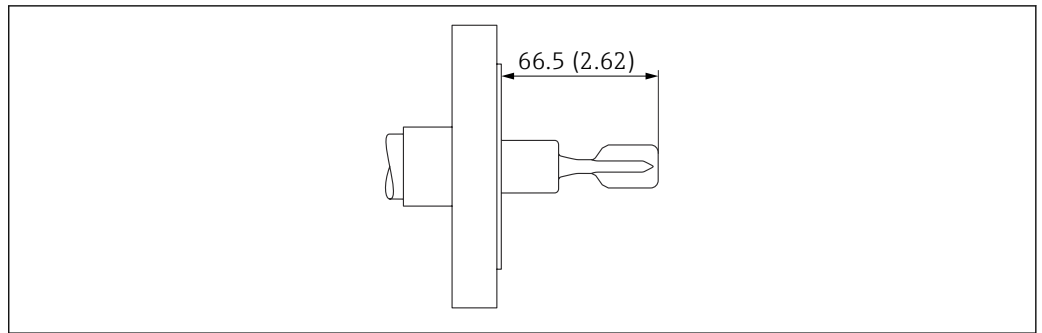

A0035554

32 Example with flange. Unit of measurement mm (in)

ASME B16.5 flanges, RF

Pressure rating	Type	Material	Weight
Cl.150	NPS 2"	316/316L	2.4 kg (5.29 lb)

EN flanges EN 1092-1, A

Pressure rating	Type	Material	Weight
PN25/40	DN25	316L (1.4404)	1.3 kg (2.87 lb)
PN25/40	DN50	316L (1.4404)	3.2 kg (7.06 lb)

EN flanges EN 1092-1, B1

Pressure rating	Type	Material	Weight
PN25/40	DN25	316L (1.4404)	1.4 kg (3.09 lb)
PN25/40	DN50	316L (1.4404)	3.2 kg (7.06 lb)

Surface roughness

- Housing: Ra <1.6 µm (63 µin), electropolished
- Parts in contact with process: Ra <1.5 µm (59.1 µin) CoC ASME BPE

Optional:

- Ra <0.3 µm (12 µin) mechanically polished (3-A, EHEDG)
- Ra <0.38 µm (15 µin) electropolished, (3-A, EHEDG, CoC ASME BPE)

In this version, the wetted parts are made of 316L (1.4435) in accordance with BN2 (delta-ferrite content < 1 %)

Display and user interface

LED indicator

 The device is optionally available with Bluetooth® wireless technology.

Functions:

- Display of the operating status (operation or fault)
- Display of Bluetooth connection, locking status and function
- Easy setup of the following functions with one button:
 - Bluetooth On/Off
 - Locking On/Off
 - Trigger proof test or functional test

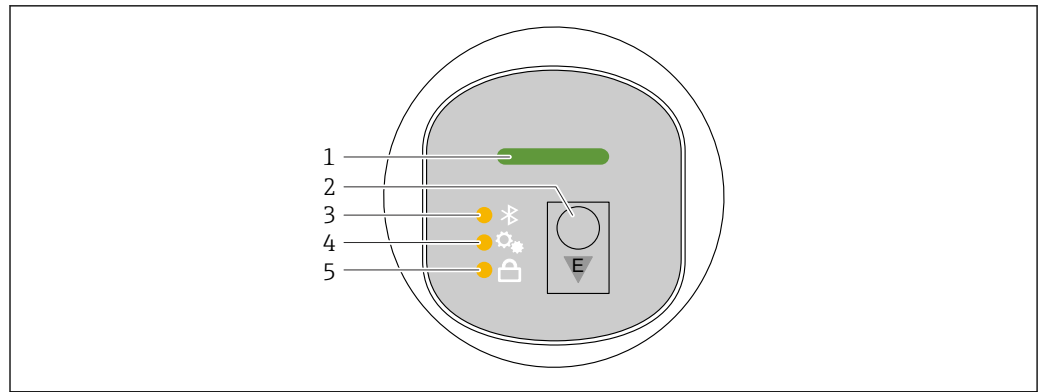

A0052426

- 1 Operating status LED
- 2 Operating key "E"
- 3 Bluetooth LED
- 4 Trigger proof test or functional test LED
- 5 Keypad lock LED

Proof-test function

For proof testing in safety instrumented systems according to WHG

 The operating status LED shows the simulation status generated by the proof test.

Remote operation

Via IO-Link or Bluetooth

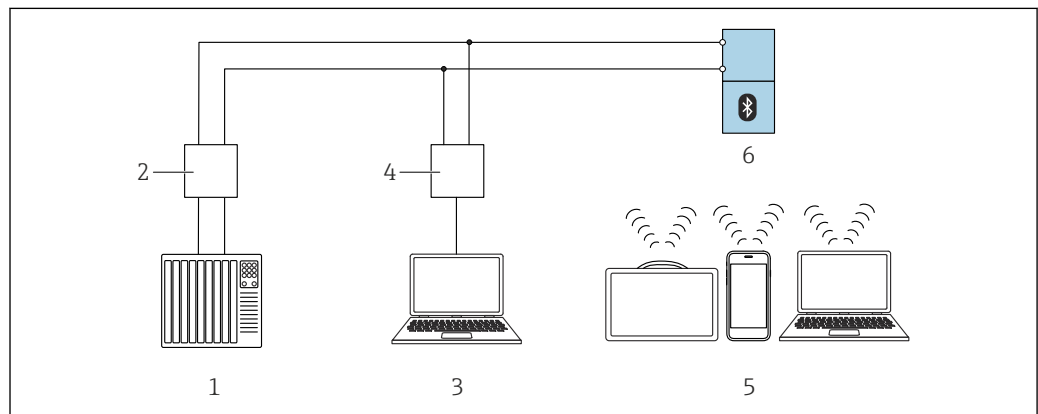

A0053130

 33 Options for remote operation via IO-Link

- 1 PLC (programmable logic controller)
- 2 IO-Link master
- 3 Computer with operating tool e.g. DeviceCare/FieldCare)
- 4 FieldPort SFP20
- 5 Field Xpert SMT70/SMT77 or computer with operating tool (e.g. DeviceCare/FieldCare)
- 6 Transmitter

Operation via Bluetooth® wireless technology (optional)

Prerequisite

- Device with Bluetooth order option
- Smartphone or tablet with Endress+Hauser SmartBlue app or PC with DeviceCare from version 1.07.07 or FieldXpert SMT70/SMT77

The connection has a range of up to 25 m (82 ft). The range can vary depending on environmental conditions such as attachments, walls or ceilings.

 The operating keys on the display are locked as soon as the device is connected via Bluetooth.



System integration	<ul style="list-style-type: none"> ■ IO-Link V1.1. ■ Smart Sensor Profile type 4.3 ■ SIO: Yes ■ Speed: COM2; 38.4 kBaud ■ Process data width:  See Operating Instructions ■ Data storage: Yes ■ Block configuration: Yes
Supported operating tools	Smartphone or tablet with Endress+Hauser SmartBlue app, DeviceCare from version 1.07.07, FieldCare.

Certificates and approvals

Current certificates and approvals for the product are available at www.endress.com on the relevant product page:

1. Select the product using the filters and search field.
2. Open the product page.
3. Select **Downloads**.

Other certificates and approvals for the product are available under <https://www.endress.com>-> Downloads.

Hygienic design requirements	<ul style="list-style-type: none"> ■ Notes on installation and certification in accordance with 3-A and EHEDG: <ul style="list-style-type: none">  SD02503F document "Hygienic approvals" ■ Information on 3-A and EHEDG-certified adapters: <ul style="list-style-type: none">  TI00426F document "Weld-in adapters, process adapters and flanges" ■ 3-A and EHEDG-certified versions of the sensor are suitable for Cleaning-in-Place (CIP) and Sterilization-in-Place (SIP) without removing them from the plant. This means that the sensor does not need to be removed during cleaning. The maximum permitted pressure and temperature values for sensor and adapter must not be exceeded (see notes in this TI). ■ ASME BPE
Compliance with requirements derived from cGMP	<p>cGMP is suitable for wetted parts:</p> <ul style="list-style-type: none"> ■ The certificate is only available in English ■ Materials of construction ■ ADI-free based upon EMA/410/01 Rev.3 (TSE/BSE compliant) ■ Polishing and surface finish ■ Material/compound compliance table: USP, FDA
TSE (BSE) compliance (ADI free - Animal Derived Ingredients)	<p>As the manufacturer, Endress+Hauser states:</p> <ul style="list-style-type: none"> ■ That the parts of this product in contact with the process are not made from materials derived from animals or ■ at least comply with the requirements of guidelines outlined in EMA/410/01 rev. 3 (TSE (BSE) compliance).
Industry Canada	CNR-Gen Section 7.1.3
ASME BPE	The measuring system meets the requirements of the ASME BPE standard (Bioprocessing Equipment).

Ordering information

Detailed ordering information is available from your nearest sales organization www.addresses.endress.com or in the Product Configurator at www.endress.com:

1. Select the product using the filters and search field.
2. Open the product page.

3. Select Configuration.



Product Configurator - the tool for individual product configuration

- Up-to-the-minute configuration data
- Depending on the device: Direct input of measuring point-specific information such as measuring range or operating language
- Automatic verification of exclusion criteria
- Automatic creation of the order code and its breakdown in PDF or Excel output format
- Ability to order directly in the Endress+Hauser Online Shop

Identification

Measuring point (TAG)

The device can be ordered with a tag name.

Location of tag name

Select in the additional specification:

- Stainless steel wired-on tag plate
- Paper adhesive label
- Tag provided by the customer
- Nameplate
- IEC 61406 stainless steel tag
- IEC 61406 stainless steel + NFC tag
- IEC 61406 stainless steel, stainless steel tag
- IEC 61406 stainless steel + NFC, stainless steel
- IEC 61406 stainless steel tag, plate provided
- IEC 61406 stainless steel + NFC, plate provided

Definition of tag name

Specify in the additional specification:

3 lines of maximum 18 characters each

The specified tag name appears on the selected plate.

Visualization in SmartBlue app

The first 32 characters of the tag name

The tag name can always be changed specifically for the measuring point via Bluetooth.

Display on the nameplate

The first 16 characters of the tag name

Display in electronic nameplate (ENP)

The first 32 characters of the tag name



For details, see document SD03128P

Application packages

The application package can be ordered together with the device or can be activated subsequently with an activation code. Detailed information on the relevant order code is available from the website www.endress.com or from the Endress +Hauser Sales Center.

Heartbeat Technology

Heartbeat Technology offers diagnostic functionality through continuous self-monitoring, the transmission of additional measured variables to an external Condition Monitoring system and the in situ verification of devices in the application.

Heartbeat Diagnostics

Continuous self-monitoring of the device.

Diagnostic messages output to:

- the onsite display
- an asset management system (e.g. FieldCare or DeviceCare)
- an automation system (e.g. PLC)

Heartbeat Verification

- Monitoring of the installed device without interrupting the process, including a verification report
- Clear measuring point assessment (pass/fail) with high total test coverage as part of the manufacturer's specification
- Can be used to document normative requirements
- Meets the requirements for measurement traceability in accordance with ISO 9001 (ISO 9001:2015 Section 7.1.5.2)

 The verification report can be generated via Bluetooth.

Heartbeat Monitoring

- Continuously provides device and/or process data for an external system. Analysis of these data provides a basis for process optimization and predictive maintenance.
- **Loop diagnostics** wizard: Detection of elevated measuring circuit resistance values or declining power supply
- **Process window** wizard: Two frequency limits for monitoring the upper and lower range of the oscillation frequency (can be defined independently of one another). Changes in the process can be identified, e.g. corrosion or buildup.
- **Safety mode** wizard: The device can be write-protected via the software using this wizard. The safety-related parameters must be confirmed in the wizard.

Detailed description

 See Special Documentation for SD Heartbeat Technology.

"Medium detection" operating mode

 Default setting of operating mode (as-delivered state): point level detection of liquids. This setting covers most applications.

In addition, the following operating modes can be selected in combination with the Heartbeat package:

- Foam detection
- Foam suppression

Foam detection

Area of application: point level detection in liquids with foam generation.

The device detects the foam and switches as soon as the tuning fork is immersed in the foam or when the fork is uncovered.

 Application in accordance with the WHG (German Water Resources Act) is not possible in this operating mode.

Detection of light foams such as:

- Beer foam
- Milk foam

Influence on switching behavior:

- Particularly large air bubbles in the foam
- Significantly reduced liquid content in the foam
- Change in the properties of the foam during operation

Foam suppression

Area of application: point level detection in liquids with foam generation.

The device only switches when immersed in a homogeneous liquid.

The device does not react to the foam in this setting (is suppressed).

 Application in accordance with the WHG (German Water Resources Act) is not possible in this operating mode.

Accessories

Accessories currently available for the product can be selected via the Product Configurator at www.endress.com:

1. Select the product using the filters and search field.
2. Open the product page.
3. Select **Spare parts & Accessories**.

Device-specific accessories

M12 socket

M12 socket, straight

- Material:
Body: PA; union nut: stainless steel; seal: EPDM
- Degree of protection (fully locked): IP69
- Order number: 71638191

M12 socket, elbowed

- Material:
Body: PA; union nut: stainless steel; seal: EPDM
- Degree of protection (fully locked): IP69
- Order number: 71638253

Cables

Cable 4 x 0.34 mm² (20 AWG) with M12 socket, elbowed, screw plug, length 5 m (16 ft)

- Material: body: TPU; union nut: nickel-plated die-cast zinc; cable: PVC
- Degree of protection (fully locked): IP68/69
- Order number: 52010285
- Wire colors
 - 1 = BN = brown
 - 2 = WT = white
 - 3 = BU = blue
 - 4 = BK = black

Welding neck, process adapter and flange



For details, refer to TI00426F/00/EN "Weld-in adapters, process adapters and flanges".

DeviceCare SFE100

Configuration tool for IO-Link, HART, PROFIBUS and FOUNDATION Fieldbusfield devices
DeviceCare is available for download free of charge at www.software-products.endress.com. You need to register in the Endress+Hauser software portal to download the application.



Technical Information TI01134S

FieldCare SFE500

FDT-based plant asset management tool
It can configure all intelligent field units in your system and helps you manage them. By using the status information, it is also a simple but effective way of checking their status and condition.



Technical Information TI00028S

Device Viewer

All the spare parts for the device, along with the order code, are listed in the *Device Viewer* (www.endress.com/deviceviewer).

Field Xpert SMT70

Universal, high-performance tablet PC for device configuration in Ex Zone 2 and non-Ex areas



For details, see "Technical Information" TI01342S

SmartBlue app

Mobile app for easy configuration of devices on site via Bluetooth wireless technology

Documentation



For an overview of the scope of the associated Technical Documentation, refer to the following:

- *Device Viewer* (www.endress.com/deviceviewer): Enter the serial number from the nameplate
- *Endress+Hauser Operations app*: Enter serial number from nameplate or scan matrix code on nameplate.

Standard documentation

Document type: Operating Instructions (BA)

Installation and initial commissioning – contains all the functions in the operating menu that are needed for a routine measuring task. Functions beyond this scope are not included.

Document type: Description of Device Parameters (GP)

The document is part of the Operating Instructions and serves as a reference for parameters, providing a detailed explanation of each individual parameter of the operating menu.

Document type: Brief Operating Instructions (KA)

Quick guide to the first measured value – includes all essential information from incoming acceptance to electrical connection.

Document type: Safety Instructions, certificates

Depending on the approval, safety instructions are supplied with the device, e.g. XA. This documentation is an integral part of the Operating Instructions.

Information on the Safety Instructions (XA) that are relevant for the device is provided on the nameplate.

Supplementary device-dependent documentation

Additional documents are supplied depending on the device version ordered: Always comply strictly with the instructions in the supplementary documentation. The supplementary documentation is an integral part of the device documentation.

Registered trademarks

Apple®

Apple, the Apple logo, iPhone, and iPod touch are trademarks of Apple Inc., registered in the U.S. and other countries. App Store is a service mark of Apple Inc.

Android®

Android, Google Play and the Google Play logo are trademarks of Google Inc.

Bluetooth®

The *Bluetooth*® word mark and logos are registered trademarks owned by the Bluetooth SIG, Inc. and any use of such marks by Endress+Hauser is under license. Other trademarks and trade names are those of their respective owners.

IO-Link®

Is a registered trademark. It may only be used in conjunction with products and services by members of the IO-Link Community or by non-members who hold an appropriate license. For more detailed information on its use, refer to the rules of the IO-Link Community at: www.io.link.com.



71645385

www.addresses.endress.com
