

Brief Operating Instructions

Solimotion FTR20

Flow indicator for bulk solids



These Instructions are Brief Operating Instructions; they are not a substitute for the Operating Instructions pertaining to the device.

Detailed information about the device can be found in the Operating Instructions and the other documentation:

Available for all device versions via:

- Internet: www.endress.com/deviceviewer
- Smart phone/tablet: *Endress+Hauser Operations App*

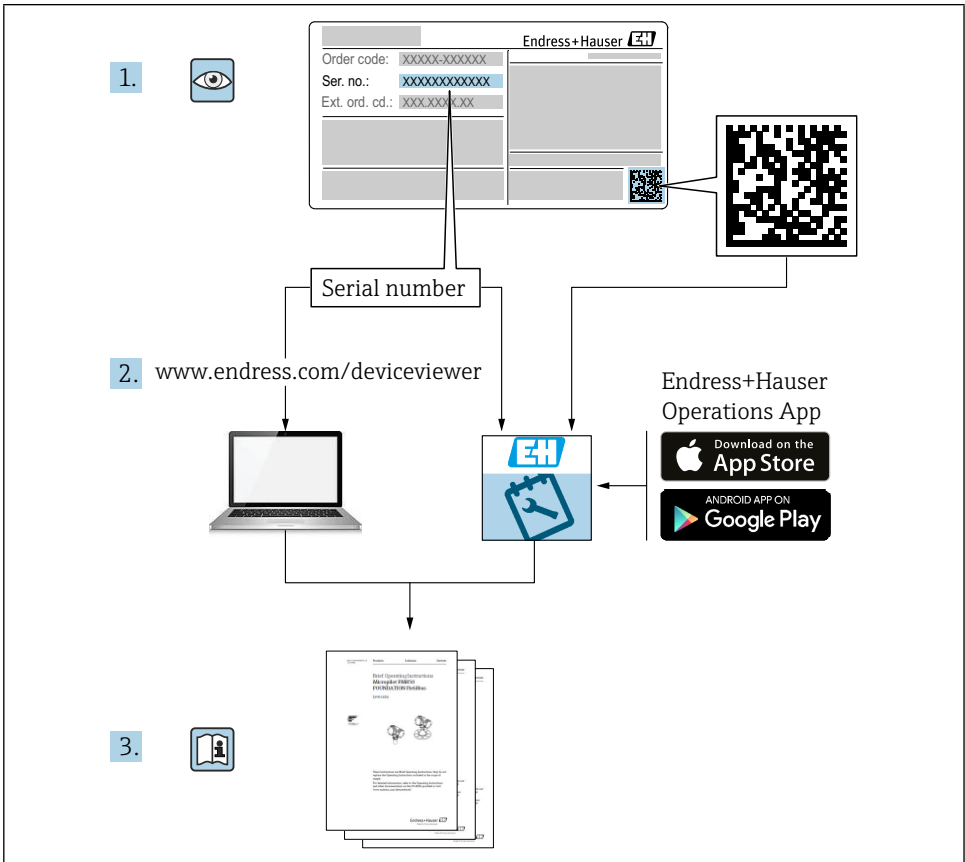

Table of contents

1	About this document	4
1.1	Symbols	4
2	Basic safety instructions	5
2.1	Requirements for the personnel	5
2.2	Designated use	5
2.3	Workplace safety	6
2.4	Operational safety	6
2.5	Product safety	6
3	Incoming acceptance and product identification	6
3.1	Incoming acceptance	6
3.2	Product identification	7
3.3	Storage and transport	8
4	Mounting	8
4.1	Mounting conditions	8
4.2	Mounting the device	10
4.3	Post-installation check	11
5	Electrical connection	11
5.1	Connection requirements	12
5.2	Connecting the device	13
5.3	Post-connection check	16
6	Operation options	17
6.1	Overview	17
6.2	Operating	17
7	Commissioning	18
7.1	Function check	18
7.2	Basic setup	18
7.3	Advanced settings	20
7.4	Reset to factory settings	25
7.5	Simulation	25
7.6	Overview device functions	26

1 About this document

1.1 Symbols

1.1.1 Safety symbols

DANGER

This symbol alerts you to a dangerous situation. Failure to avoid this situation will result in serious or fatal injury.

WARNING

This symbol alerts you to a dangerous situation. Failure to avoid this situation can result in serious or fatal injury.

CAUTION

This symbol alerts you to a dangerous situation. Failure to avoid this situation can result in minor or medium injury.

NOTICE

This symbol contains information on procedures and other facts which do not result in personal injury.

1.1.2 Electrical symbols

 Ground connection

Grounded clamp, which is grounded via a grounding system.

1.1.3 Symbols for certain types of information

 Permitted

Procedures, processes or actions that are permitted.

 Forbidden

Procedures, processes or actions that are forbidden.

 Tip

Indicates additional information

 Reference to documentation

 Reference to another section

 1., 2., 3. Series of steps

1.1.4 Symbols in graphics

A, B, C ... View

1, 2, 3 ... Item numbers

 Hazardous area

 Safe area (non-hazardous area)

1.1.5 Device-specific symbols

 LED on

Indicates an illuminated LED

 LED off

Indicates a non-illuminated LED

 Configuration mode

Indicates the function number or value

 Normal operation

Indicates only the signal strength of the limit detection

 Key (+)

Indicates the key for increasing a function value

 Key (-)

Indicates the key for reducing a function value

 Minimum bulk flow

Indicates a minimum or absent bulk flow

 Maximum bulk flow

Indicates a maximum bulk flow

2 Basic safety instructions

2.1 Requirements for the personnel

The personnel must fulfill the following requirements to carry out the necessary tasks, e. g., commissioning and maintenance:

- ▶ Trained, qualified specialists must have a relevant qualification for the specific function and task
- ▶ Are authorized by the plant owner/operator
- ▶ Are familiar with federal/national regulations
- ▶ Must have read and understood the instructions in the manual and supplementary documentation
- ▶ Follow instructions and comply with conditions

2.2 Designated use

Only use the flow indicator to monitor a bulk material movement. Improper use can pose hazards. Ensure that the measuring device is free of defects while it is in operation.

- Use the measuring device only for media to which the process-wetted materials have an adequate level of resistance
- Do not exceed or drop below the limit values for the measuring device

 TI00447F

2.2.1 Incorrect use

The manufacturer is not liable for damage caused by improper or non-designated use.

Clarification of borderline cases:

- In the case of special fluids and media used for cleaning, Endress+Hauser is glad to provide assistance in verifying the corrosion resistance of wetted materials, but does not accept any warranty or liability.

Residual risks

The electronics housing and the modules installed in it can heat up to 80 °C (176 °F) during operation due to heat input from the process as well as the power dissipation of the electronics.

Danger of burns from contact with surfaces!

- ▶ If necessary, ensure protection against contact to prevent burns.

2.3 Workplace safety

For work on and with the device:

- ▶ Wear the required protective equipment according to federal/national regulations.

2.4 Operational safety

Risk of injury!

- ▶ Operate the device in proper technical condition and fail-safe condition only.
- ▶ The operator is responsible for interference-free operation of the device.

2.5 Product safety

This flow indicator is designed in accordance with good engineering practice to meet state-of-the-art safety requirements, has been tested, and left the factory in a condition in which it is safe to operate.

It meets general safety standards and legal requirements. It also complies with the EU directives listed in the device-specific EU Declaration of Conformity. Endress+Hauser confirms this by affixing the CE mark to the device.

3 Incoming acceptance and product identification

3.1 Incoming acceptance

Check the following during goods acceptance:

- Are the order codes on the delivery note and the product sticker identical?
- Are the goods undamaged?
- Do the nameplate data match the ordering information on the delivery note?
- If required (see nameplate): Are the Safety Instructions, e. g. XA, provided?
- Is the device properly secured?



If one of these conditions is not met, please contact the manufacturer's sales office.

3.2 Product identification

The measuring device can be identified in the following ways:

- Nameplate data
- Extended order code with breakdown of the device features on the delivery note
- Enter serial number from nameplates in *W@M Device Viewer* (www.endress.com/deviceviewer): All of the information on the measuring device is displayed along with an overview of the scope of technical documentation provided
- Enter the serial number on the nameplate into the *Endress+Hauser Operations App* or use the *Endress+Hauser Operations App* to scan the 2-D matrix code (QR Code) on the nameplate

3.2.1 Nameplate

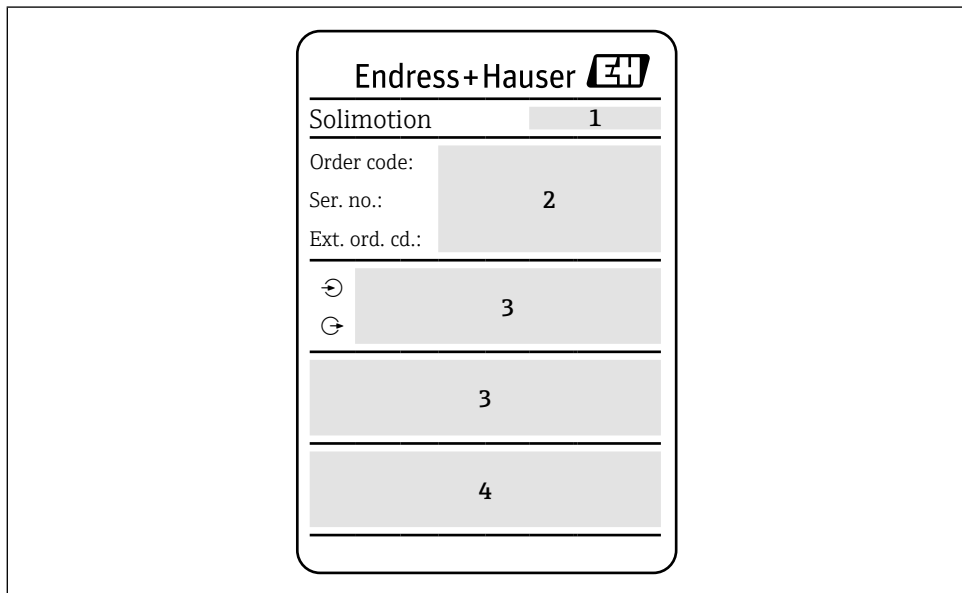

1 Nameplate data

1 Manufacturer address

2 Order number, extended order code, serial number

3 Technical data

4 Approval-specific information

3.2.2 Manufacturer address

Endress+Hauser SE+Co. KG
Hauptstraße 1
79689 Maulburg, Germany

3.3 Storage and transport

3.3.1 Storage conditions

Use original packaging.

3.3.2 Storage temperature

→ Operating temperature range

3.3.3 Transporting the device

Transport the device to the measuring point in the original packaging.

4 Mounting

4.1 Mounting conditions

Minimization of application-specific influences

→  TI00447F "Performance characteristics"

4.1.1 Mounting position

The installation position is arbitrary for the FTR20. However, a small angle α may increase the signal quality.

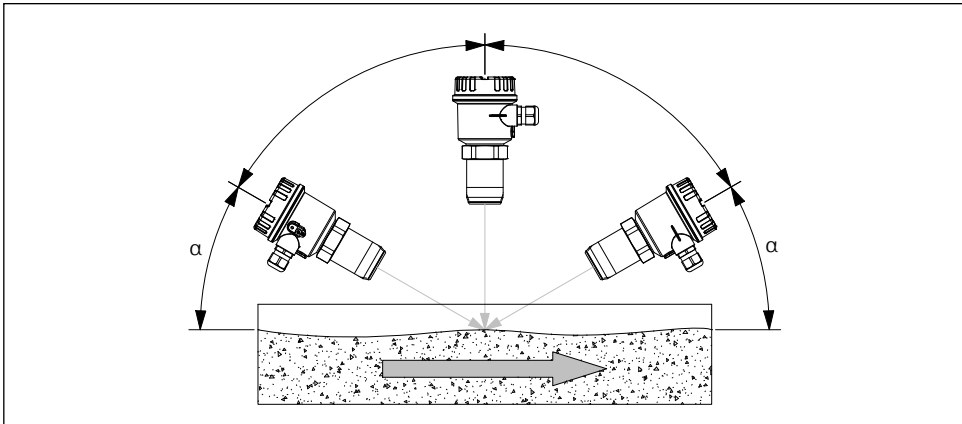

000000380

 2 Mounting position

 Two FTR20s installed opposite each other can influence each other. We recommend frequency-selected devices for this installation situation (TSP 71274253/71274248).

4.1.2 Operating temperature range

-40 to +70 °C (-40 to +158 °F)

4.1.3 Mounting with accessories

Details of available accessories

→  TI00447F "Accessories"

4.1.4 Mounting dimensions

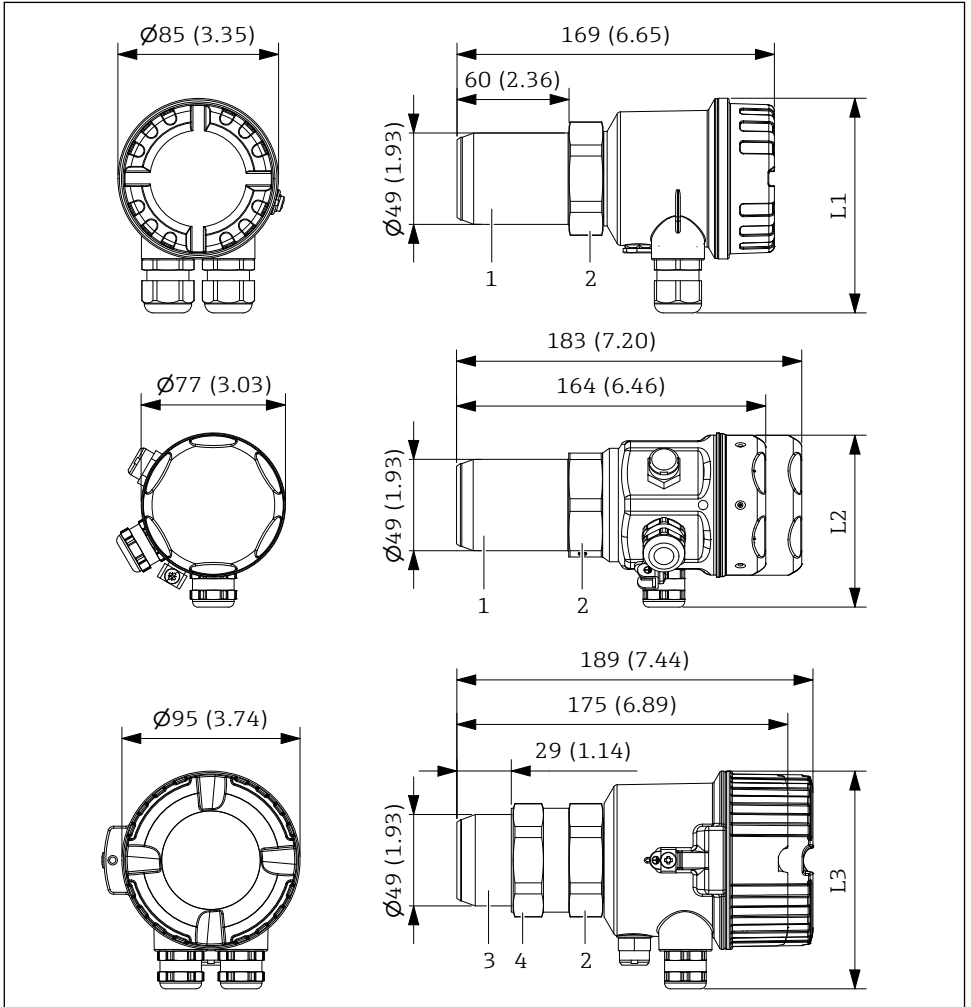

0000000296

 3 Mounting dimensions. Unit of measurement mm (in)

- 1 Connection thread R 1½ / 1½ NPT
- 2 Hexagon SW55
- 3 Connection thread G 1½
- 4 Counternut (SW55)

4.2 Mounting the device

4.2.1 Mounting with connection thread

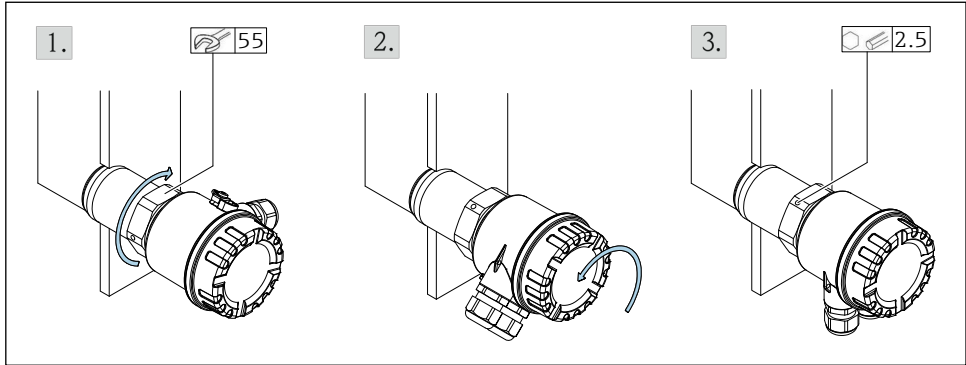

000000166



4 Mounting with connection thread

- A 1½ NPT
B G 1 / G 1½

1. Screw in connection thread. For G 1½ thread: Tighten counter nut.
2. Align the housing of the electronics.
3. Fix the housing in place.

 Seal: to be provided by the customer

4.2.2 Mounting without contact with the process

-  Risk of condensate formation on the inner process wall → plug 2
- A minimize → minimize signal attenuation
 - Observe maximum temperature T →  8

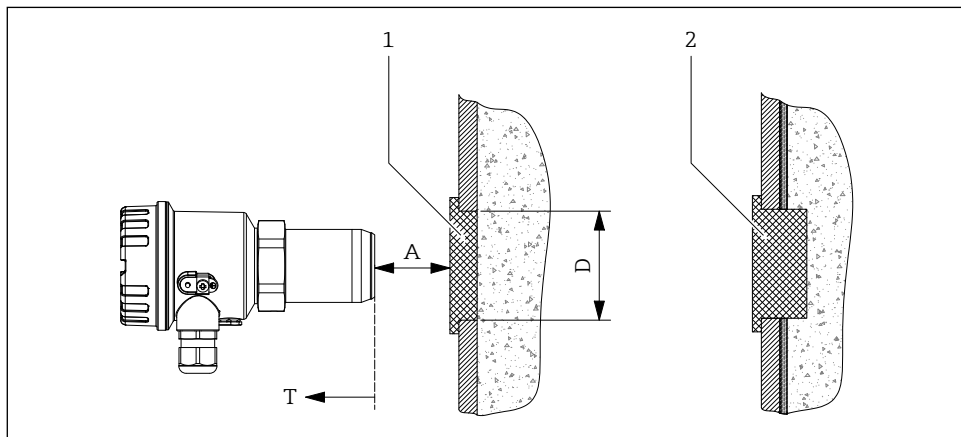

000000191

5 Mounting in front of microwave-impermeable process wall

- 1 Microwave-permeable plug
- 2 Microwave-permeable plug in case of condensate formation on the inner process wall

4.2.3 Mounting with accessories

→ BA01136F

 Observe the enclosed instructions enclosed with the accessories!

4.3 Post-installation check

- Is the device undamaged (visual inspection)?
- Does the device conform to the measuring point specifications?

For example:

- Process temperature
- Process pressure
- Ambient temperature
- Are the measuring point number and labeling correct (visual inspection)?
- Is the device adequately protected against precipitation and direct sunlight?
- Is the device properly secured?

5 Electrical connection

 For a device for the hazardous area:
Observe the instructions in the Ex documentation (XA).

5.1 Connection requirements

The following points must be observed before connecting the device:

- The voltage supply must match the voltage specified on the nameplate.
- Switch off the supply voltage before connecting the device.
- When using the public powers supply, install an easy accessible power switch in the proximity of the instrument. Mark the power switch as a disconnecter for the instrument (EN/IEC 61010).
- The cable glands and connectors are permitted for connecting fixed cables and lines only. The operator must ensure adequate strain relief.
- The device is to be attached so that the cable gland is protected from mechanical damage (degree of mechanical hazard "low" – impact energy: 4 joules).
- Seal unused entry glands with approved sealing plugs that correspond to the type of protection. The plastic transport sealing plug does not meet this requirement and must therefore be replaced during installation.

5.1.1 Connect potential equalization

- The potential equalization must be connected to the external ground terminal on the device.
- For optimum electromagnetic compatibility, keep the potential equalization line as short as possible.
- The recommended minimum cable cross-section is 2.5 mm².
- The potential equalization of the FTR20 must be included in the local potential equalization.

5.1.2 Connecting cable requirements

- Permissible temperature range →  8
- Normal installation cable sufficient
- Cable cross-sections: 0.2 to 2.5 mm²

Cable gland

- Clamping range:
 - 5 to 10 mm (0.2 to 0.39 in) acc. to EN 50262 or 7 to 10 mm (0.28 to 0.39 in) acc. to UL-514 B (Cable gland made of plastic)
 - 7 to 10.5 mm (0.28 to 0.41 in) (Cable gland made of metal)
- Tightening torque
 - Max. 6 Nm (Cable gland made of plastic)
 - Max. 10 Nm (Cable gland made of metal)

For the optionally supplied mating M12 connectors, the following requirements apply:

- Clamping range of the cable: 6 to 8 mm (0.24 to 0.31 in)
- Cable cross-sections: Max. 0.75 mm²

5.2 Connecting the device

5.2.1 Wiring

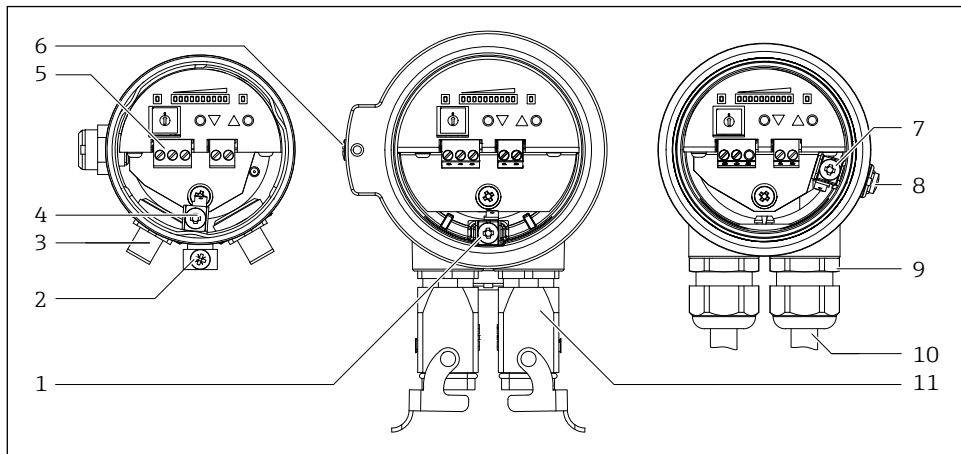

000000381

6 Electrical connection

- 1 Connecting potential matching (inside) F34 housing
- 2 Connecting potential matching (outside) F15 housing
- 3 M12 connector
- 4 Connecting potential matching (inside) F15 housing
- 5 Terminals
- 6 Connecting potential matching (outside) F34 housing
- 7 Connecting potential matching (inside) F16 housing
- 8 Connecting potential matching (outside) F16 housing
- 9 Cable gland
- 10 Connecting cable
- 11 Harting connector

5.2.2 Supply circuit connection

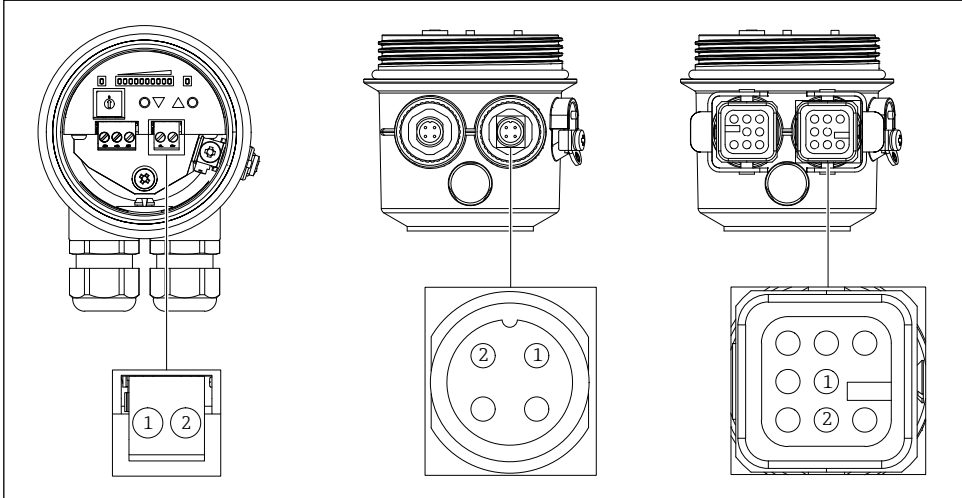

000000163

 7 Supply circuit connection (Connector 1)

Supply voltage

- 85 to 253 V AC, 50/60 Hz
- 20 to 60 V DC or 20 to 30 V AC, 50/60 Hz

Power consumption

- 9 VA (85 to 253 V AC, 50/60 Hz)
- 2.4 W (20 to 60 V DC) / 4 VA (20 to 30 V AC, 50/60 Hz)

Electrical connection	Supply voltage
Connection terminals	Terminals 1 - 2
M12 connector Binder series 713/763	Connector 1, contact 1 - 2
Harting connector type HAN8D	Connector 1, contact 1 - 2

NOTICE

- Connect the power supply according to the device version
- The polarity of the supply voltage can be set as required.
- Provide overcurrent protection device (max. 10 A) for the supply voltage.
- In accordance with IEC/EN 61010 a suitable circuit breaker must be provided for the measuring device.
- The electrical connection with connector is only available for the power supply with 20 to 60 V DC or 20 to 30 V AC, 50/60 Hz (ordering option "E").

5.2.3 Connection signal circuit

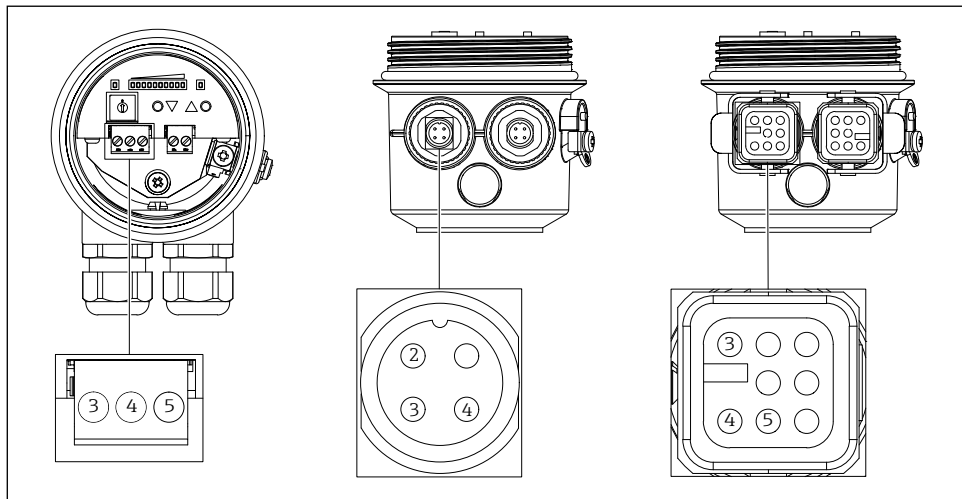

000000162

8 Connection signal circuit (Connector 2)

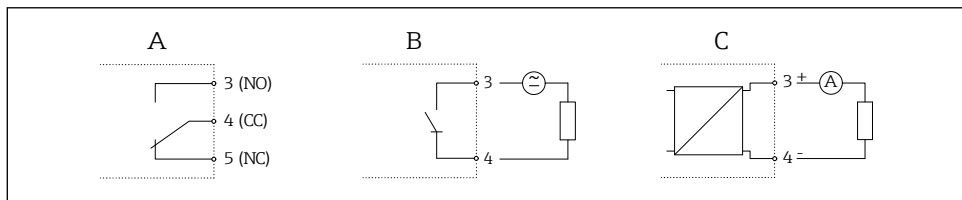

000000149

9 Signal circuits

Relay output

- Switching capacity 250 V AC / 4 A, 125 V DC / 0.4 A or 30 V DC / 4 A
- Switching delay parameterizable (off, 500 ms to 10 s)
- Switching hysteresis adjustable
- Switching frequency max. 4 Hz

Electrical connection	Relay output
Connection terminals	Terminals 3 (NO) - 4 (CC) - 5 (NC)
M12 connector Binder series 713/763	Connector 2, contact 2 (NO) - 3 (CC) - 4 (NC)
Harting connector type HAN8D	Connector 2, contact 3 (NO) - 4 (CC) - 5 (NC)

NOTICE

- The contact material of the relay is also suitable for switching small signal circuits, if no inductive loads or higher currents have been switched previously.
- If the switching frequency is high, the solid-state relay should be selected.
- When using the Harting connector type HAN8D the maximum switching voltage is 120 V DC or 50 V AC.

Current output

- Current 4-20 mA, active
- Load max. 600 Ω

Electrical connection	Current output
Connection terminals	Terminals 3 (+) - 4 (-)
M12 connector Binder series 713/763	Connector 2, contact 3 (+) - 4 (-)
Harting connector type HAN8D	Connector 2, contact 3 (+) - 4 (-)

Solid-state relay

- Switching capacity 30 V AC / 0.4 A or 40 V DC / 0.4 A
- Switching delay parameterizable (off, 500 ms to 10 s)
- Switching hysteresis adjustable
- Switching frequency max. 4 Hz

Electrical connection	Solid-state relay
Connection terminals	Terminals 3 - 4
M12 connector Binder series 713/763	Connector 2, contact 3 - 4
Harting connector type HAN8D	Connector 2, contact 3 - 4



The polarity of the solid-state relay can be set as required.

5.3 Post-connection check

- Is the device or cable undamaged (visual inspection)?
- Do the cables used comply with the requirements?
- Do the mounted cables have adequate strain relief?
- Are the connectors firmly tightened?
- Does the supply voltage match the specifications on the nameplate?
- No reverse polarity, is terminal assignment correct?
- If supply voltage is present, is the green LED lit?

6 Operation options

6.1 Overview

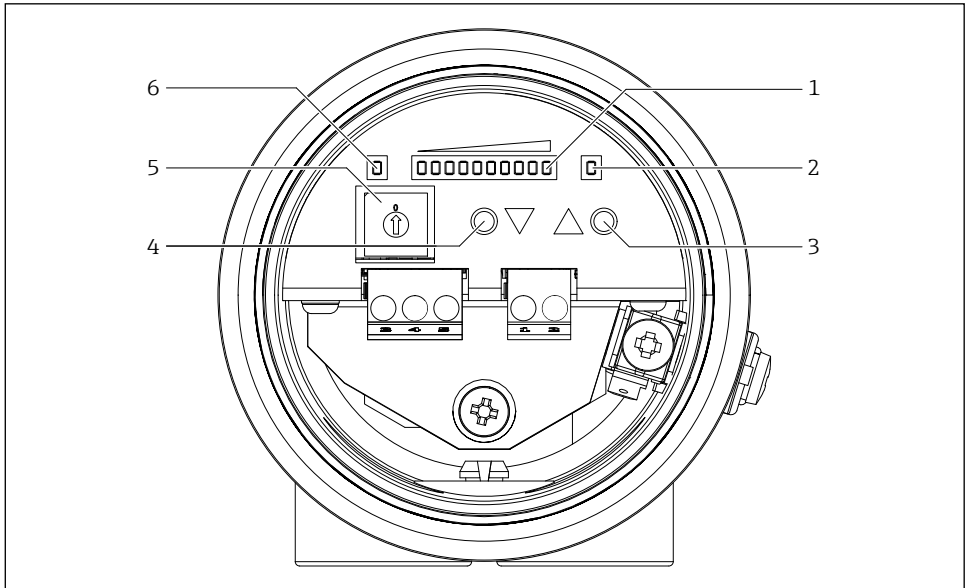

10 Display and operating elements

000000354

- 1 Display
 - Normal operation: Signal strength
 - Configuration mode: Function number and function value
- 2 Switch output LED (yellow), only relay
- 3 Operating button ▲ (increase or toggle)
- 4 Operating button ▼ (decrease or toggle)
- 5 Function selection switch
- 6 Ready for operation LED (green)

6.2 Operating

1. Select any function (Overview → 26)

→ Encoding switch 1 to F



→ The display shows the selected function 1 to F for two seconds.



2. Setting the selected function

→ The two operating buttons can be used to increase/decrease the value or to switch the selection.

Example: Function 3 (manual adjustment with movement of bulk solids)

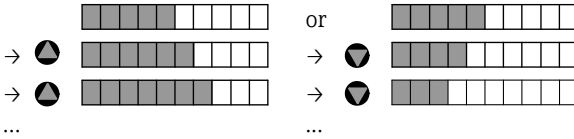

3. The configured value is stored as soon as the function is switched.

→ The value can be displayed again at any time by selecting the corresponding parameter configuration function and changed if necessary.

4. After completion of the parameterization (after adaptation of the flow indicator to the respective bulk material), return the coding switch to the "0" position, the FTR20 is now ready for operation.



- The device is in operating mode in encoding switch position "0" only. All other positions are for parameter configuration.
- In parameterization mode, the flow indicator continues to operate in the background, and changed settings are taken into account directly.
- After completing the settings, set the encoding switch back to the initial position "0" (= operation).

7 Commissioning

The Solimotion flow indicator will be switched on by an applied power supply on FTR20.

The device is ready for operation a maximum of 3 s after the supply voltage is applied.

7.1 Function check

Function check



- "Post-installation check" checklist
- "Post-connection check" checklist

7.2 Basic setup



- The FTR20 is calibrated if, a) for moving bulk solids, the switch point (LED 5) of the switch output is exceeded reliably and b) for the current output, only one or two (minimum solid flow) or at least six LEDs (maximum solid flow) are illuminated.
- A repeated automatic adjustment (function 1 or function 2) resets any adjustment carried out earlier.



7.2.1 Adjustment with maximum bulk flow (function 1)

1. Set encoding switch to Position 1
 → Display of the function number

 → After 2 seconds: Display of the current signal strength, example:

2. Simultaneously press the operating keys on the device with maximum bulk flow
 → Automatic adjustment is carried out
 → Display of the signal strength after adjustment, example:

3. Move the encoding switch to the initial position 0
 → Display of the current signal strength

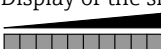

Optional:

Additional manual calibration with movement of bulk solids (function 3)

For most applications the automatic setup is sufficient. The manual setup can be used to adapt the flow indicator individually to the application.

1. Move the encoding switch to position 3
 → Display of the function number

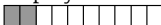
 → After 2 seconds: Display of the current signal strength, example:

2. Press the corresponding operating key on the device to achieve an increase or reduction of the signal strength with maximum bulk flow
 → Display of the signal strength with maximum bulk flow (all 10 LEDs illuminate)

3. Move the encoding switch to the initial position 0
 → Display of the current signal strength

7.2.2 Calibration with no movement of bulk solids or minimum solid flow (function 2)

1. Move the encoding switch to position 2
 → Display of the function number

 → After 2 seconds: Display of the current signal strength, example:

2. Simultaneously press the operating keys on the device with no movement of bulk solids or minimum solid flow
 → Automatic adjustment is carried out
 → Display of the signal strength after adjustment

3. Move the encoding switch to the initial position 0
→ Display of the current signal strength

Optional:

Additional manual calibration with no movement of bulk solids or minimum solid flow (function 4)

For most applications the automatic setup is sufficient. The manual setup can be used to adapt the flow indicator individually to the application.

1. Move the encoding switch to position 3
→ Display of the function number

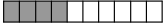

→ After 2 seconds: Display of the current signal strength, example:



2. Press the corresponding operating key on the device to achieve an increase or reduction of the signal strength with no movement of bulk solids or minimum solid flow

→ Display of the signal strength with no movement of bulk solids or minimum solid flow (all 10 LEDs are not lit)



3. Move the encoding switch to the initial position 0
→ Display of the current signal strength

7.2.3 Gain and detection range (function B and C)

The "gain" and "detection range" functions are for fine adjustment after an automatic and/or manual calibration; for most applications they are not needed. Alternatively, a calibration even without the process is possible only with these functions.

→  BA01136F

7.3 Advanced settings

7.3.1 Hysteresis (Function 5)

A hysteresis from 1 to 4 LEDs can be programmed for the switch output (change-over contact with relay, normally open contact with solid-state relay, of no significance for current output). The fixed switch point with increasing signal strength is at the transition from LED 5 to LED 6. For decreasing signal strength, the switch point can be configured between the transition from LED 5 to LED 4 (minimum hysteresis of an LED) and maximum between LED 2 to LED 1 (maximum hysteresis of four LEDs).

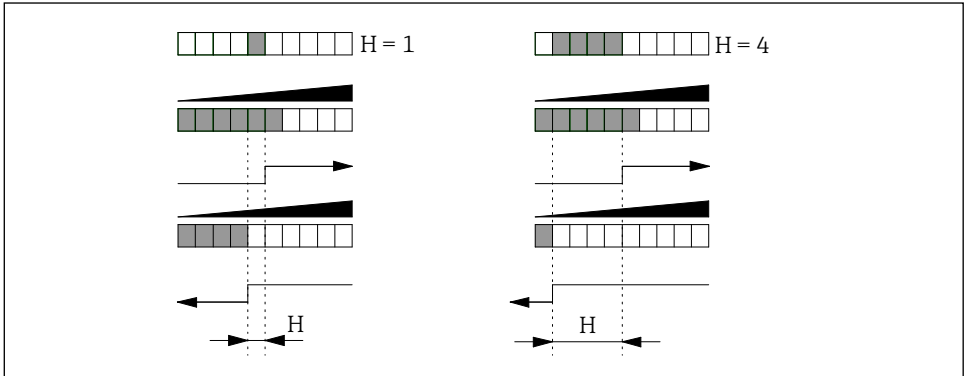

000000275

11 Adjustment of the switching hysteresis

H Hysteresis

1. Move the encoding switch to position 5

→ Display of the function number



→ After 2 seconds: Display of the configured hysteresis, example:



2. Press the operation buttons on the device in order to configure the hysteresis in the range from 1 to 4 LEDs

→ Display of the changed hysteresis, example hysteresis increased from 3 LEDs to 4 LEDs:



3. Move the encoding switch to the initial position 0

→ Display of the current signal strength



- A larger hysteresis can also be used to prevent the output from continuously switching with a fluctuating signal strength. If, for example, the signal strength continuously fluctuates between the third and eighth LED, the factory default hysteresis of an LED would lead to the switch output continuously switching when the fourth LED is undershot.
- This setting has no significance for the current output.

7.3.2 Limit signal function (function 6)

For devices with a relay and solid-state relay, the limit signal function determines the switching behavior upon exceeding and undershooting the limit value (upper limit value LED 5, lower limit determined by hysteresis).

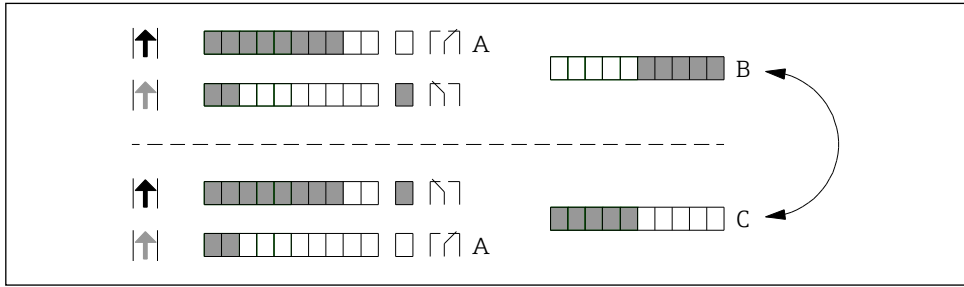

0000000362

12 Adjustment of limit signal function

- A Rest position (supply voltage missing)
- B Relay switches with no movement of bulk solids
- C Relay switches with movement of bulk solids (default setting)

1. Move the encoding switch to position 6

→ Display of the function number



→ After 2 seconds: Display of the configured limit signal function, example:



2. Press the button on the device in order to change between the two possible limit signal functions

→ Display of the changed limit signal function, example:



3. Move the encoding switch to the initial position 0

→ Display of the current signal strength

Output	Rest position	Setting	Exceeding of switch point (LED 5)	Undershooting hysteresis (function 5)
Relay (Contact 3-4-5) or solid-state relay (Contact 3-4)				

- These settings are for adapting the switching function to the downstream analysis (process control system).
 - This setting has no significance for the current output.

7.3.3 Switching delay (function 7 and function 8)

An additional switch-on and/or switch-off delay can be configured for the switch output. This can be used, for example, to stabilize the switch output when the signal strength fluctuates greatly, so that the relay does not switch until the switch point has been exceeded or undershot for a corresponding time.



For the following illustration, function 6 = standard setting.

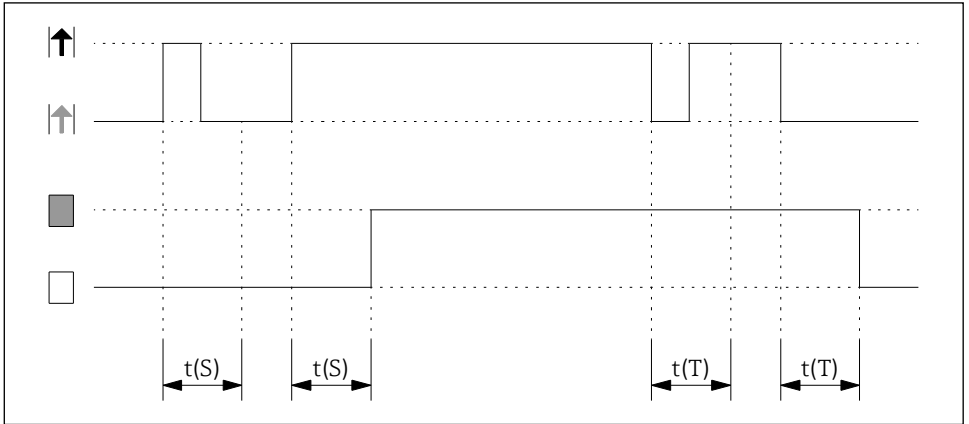

000000363

13 Adjustment of switching delays

$t(S)$ Switch-on delay (function 7)

$t(T)$ Switch-off delay (function 8)

Setting	Delay $t(S)$, $t(T)$	Setting	Delay $t(S)$, $t(T)$
	Without		2 s
	100 ms		3 s
	200 ms		5 s
	300 ms		10 s
	500 ms		20 s
	1 s		

1. Move the encoding switch to position 7 (switch-on delay $t(S)$) or position 8 (switch-off delay $t(T)$)

→ Display of the function number, switch-off delay example



→ After 2 seconds: Display of the configured delay time, example switch-off delay = off:

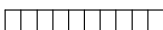

- Press the button on the device to configure the delay time
→ Display of the changed delay time, example switch-off delay = 300 ms:

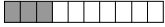









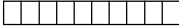

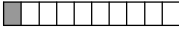

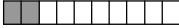
- Move the encoding switch to the initial position 0
→ Display of the current signal strength

-  The delays impact only the switch outputs (relay and solid-state relay); they have no significance for the current output.
- If the process conditions are unstable, the signal strength can be calmed with a parameterizable damping (function A).

7.3.4 Damping (function A)

For unstable process conditions, the display of the signal strength can be stabilized by a configurable damping; averaging of the output signal takes place here over the set time.

Setting	Damping	Setting	Damping
	Without		2 s
	100 ms		3 s
	200 ms		5 s
	300 ms		10 s
	500 ms		20 s
	1 s		



- Move the encoding switch to position A
→ Display of the function number

→ After 2 seconds: Display of the configured damping, example damping = 200 ms:



- Press the button on the device to configure the damping
→ Display of the changed damping, example damping increased to 500 ms



- Move the encoding switch to the initial position 0
→ Display of the current signal strength



-  The set time not only damps the signal strength display, but also impacts the switch output (for example, a delayed switching) and the current output (rises/falls with a delay).
- If only the switch output is to be stabilized, it is advisable to configure a switch-on and/or off delay. →  23
- The switch-on and/or off delay and damping can be combined, which causes the detection to be significantly slower.

7.4 Reset to factory settings

1. Move the encoding switch to position F
→ Display of the function number

→ All LEDs go out after 2 seconds.
2. Press both buttons on the device to set it to the factory defaults
→ All LEDs illuminate as confirmation.
3. Move the encoding switch to the initial position 0
→ Display of the current signal strength

7.5 Simulation

The simulation is carried out as follows (function 6 = standard setting):

1. Move the encoding switch to position 9
→ Display of the function number

→ After 2 seconds: Display of the simulated signal strength, example: signal strength = 0 LEDs, switch output: not switched, current output: 4 mA

2. Press the button on the device to configure the desired signal strength
→ Display of the changed simulated signal strength, example: signal strength = 8 LEDs, switch output: switched, current output: 16.8 mA

3. Move the encoding switch to the initial position 0
→ Display of the current signal strength



The simulation ends as soon as the encoding switch is no longer at position 9.

7.6 Overview device functions

	Function	Description	Factory settings
0		Display of the signal strength	—
1		Automatic adjustment with movement of bulk solids	—
2		Automatic adjustment with no movement of bulk solids	—
3		Manual adjustment with movement of bulk solids	—
4		Manual adjustment with no movement of bulk solids	—
5		Hysteresis	
6		Limit signal function	
7		Switch-on delay	
8		Switch-off delay	
9		Simulation	—
A		Damping	
B		Gain	
C		Detection range	
D		Without function	—
E		Without function	—
F		Reset to factory settings	—

www.addresses.endress.com
