

# Operating Instructions

## Dosimag

Electromagnetic flowmeter



- Make sure the document is stored in a safe place such that it is always available when working on or with the device.
- To avoid danger to individuals or the facility, read the "Basic safety instructions" section carefully, as well as all other safety instructions in the document that are specific to working procedures.
- The manufacturer reserves the right to modify technical data without prior notice. Your Endress+Hauser sales organization will supply you with current information and updates to this manual.

# Table of contents

|           |  |           |  |  |  |
|-----------|--|-----------|--|--|--|
| <b>1</b>  | <b>About this document</b> .....                                     | <b>5</b>  |  |  |  |
| 1.1       | Document function .....  | 5         |  |  |  |
| 1.2       | Symbols .....  | 5         |  |  |  |
| 1.2.1     | Safety symbols .....   | 5         |  |  |  |
| 1.2.2     | Electrical symbols .....   | 5         |  |  |  |
| 1.2.3     | Symbols for<br>certain types of information .....                    | 5         |  |  |  |
| 1.2.4     | Symbols in graphics .....  | 6         |  |  |  |
| 1.3       | Documentation .....  | 6         |  |  |  |
| 1.4       | Registered trademarks .....  | 7         |  |  |  |
| <b>2</b>  | <b>Safety instructions</b> .....                                     | <b>8</b>  |  |  |  |
| 2.1       | Requirements for the personnel .....                                 | 8         |  |  |  |
| 2.2       | Intended use .....   | 8         |  |  |  |
| 2.3       | Workplace safety .....   | 9         |  |  |  |
| 2.4       | Operational safety .....   | 9         |  |  |  |
| 2.5       | Product safety .....   | 9         |  |  |  |
| 2.6       | IT security .....  | 9         |  |  |  |
| <b>3</b>  | <b>Product description</b> .....                                     | <b>10</b> |  |  |  |
| 3.1       | Product design .....   | 10        |  |  |  |
| <b>4</b>  | <b>Incoming acceptance and product<br/>identification</b> .....      | <b>11</b> |  |  |  |
| 4.1       | Incoming acceptance .....  | 11        |  |  |  |
| 4.2       | Product identification .....   | 11        |  |  |  |
| 4.2.1     | Measuring instrument nameplate ...                                   | 12        |  |  |  |
| 4.2.2     | Symbols on the device .....  | 12        |  |  |  |
| <b>5</b>  | <b>Storage and transport</b> .....                                   | <b>13</b> |  |  |  |
| 5.1       | Storage conditions .....   | 13        |  |  |  |
| 5.2       | Transporting the product .....                                       | 13        |  |  |  |
| 5.3       | Packaging disposal .....   | 13        |  |  |  |
| <b>6</b>  | <b>Mounting</b> .....  | <b>14</b> |  |  |  |
| 6.1       | Mounting requirements .....  | 14        |  |  |  |
| 6.1.1     | Mounting position .....  | 14        |  |  |  |
| 6.1.2     | Environmental and process<br>requirements .....                      | 19        |  |  |  |
| 6.1.3     | Special mounting instructions .....                                  | 19        |  |  |  |
| 6.2       | Mounting the measuring instrument .....                              | 21        |  |  |  |
| 6.2.1     | Required tools .....   | 21        |  |  |  |
| 6.2.2     | Preparing the measuring instrument .                                 | 22        |  |  |  |
| 6.2.3     | Mounting the measuring<br>instrument .....                           | 22        |  |  |  |
| 6.3       | Post-mounting check .....  | 24        |  |  |  |
| <b>7</b>  | <b>Electrical connection</b> .....                                   | <b>25</b> |  |  |  |
| 7.1       | Electrical safety .....  | 25        |  |  |  |
| 7.2       | Connecting requirements .....  | 25        |  |  |  |
| 7.2.1     | Requirements for connecting cable ...                                | 25        |  |  |  |
| 7.2.2     | Terminal assignment .....  | 25        |  |  |  |
| 7.2.3     | Available device plugs .....   | 25        |  |  |  |
| 7.2.4     | Requirements for the supply unit ...                                 | 26        |  |  |  |
| 7.3       | Connecting the measuring instrument .....                            | 27        |  |  |  |
| 7.3.1     | Connection via device plug .....                                     | 27        |  |  |  |
| 7.3.2     | Grounding .....  | 27        |  |  |  |
| 7.4       | Ensuring potential equalization .....                                | 28        |  |  |  |
| 7.4.1     | Requirements .....   | 28        |  |  |  |
| 7.4.2     | Metal process connections .....                                      | 28        |  |  |  |
| 7.4.3     | Plastic process connections .....                                    | 28        |  |  |  |
| 7.5       | Ensuring the degree of protection .....                              | 29        |  |  |  |
| 7.6       | Post-connection check .....  | 30        |  |  |  |
| <b>8</b>  | <b>Operation options</b> .....                                       | <b>31</b> |  |  |  |
| 8.1       | Overview of operation options .....                                  | 31        |  |  |  |
| 8.2       | Access to the operating menu via the<br>operating tool .....         | 31        |  |  |  |
| 8.2.1     | Connecting the operating tool .....                                  | 31        |  |  |  |
| 8.2.2     | FieldCare .....  | 32        |  |  |  |
| 8.2.3     | DeviceCare .....   | 33        |  |  |  |
| <b>9</b>  | <b>System integration</b> .....                                      | <b>34</b> |  |  |  |
| 9.1       | Overview of device description files .....                           | 34        |  |  |  |
| 9.1.1     | Current version data for the device ...                              | 34        |  |  |  |
| 9.1.2     | Operating tools .....  | 34        |  |  |  |
| <b>10</b> | <b>Commissioning</b> .....   | <b>35</b> |  |  |  |
| 10.1      | Post-mounting and post-connection check ...                          | 35        |  |  |  |
| 10.2      | Switching on the measuring device .....                              | 35        |  |  |  |
| 10.3      | Connecting via FieldCare .....                                       | 35        |  |  |  |
| 10.4      | Configuring the measuring instrument .....                           | 35        |  |  |  |
| <b>11</b> | <b>Operation</b> .....   | <b>36</b> |  |  |  |
| 11.1      | Reading the device locking status .....                              | 36        |  |  |  |
| 11.2      | Reading access authorization status on<br>operating software .....   | 36        |  |  |  |
| 11.3      | Reading measured values .....  | 36        |  |  |  |
| 11.4      | Adapting the measuring instrument to the<br>process conditions ..... | 36        |  |  |  |
| 11.5      | Performing a totalizer reset .....                                   | 37        |  |  |  |
| <b>12</b> | <b>Diagnostics and troubleshooting ...</b>                           | <b>38</b> |  |  |  |
| 12.1      | General troubleshooting .....  | 38        |  |  |  |
| 12.2      | Diagnostic information in FieldCare or<br>DeviceCare .....           | 38        |  |  |  |
| 12.2.1    | Diagnostic options .....   | 38        |  |  |  |
| 12.2.2    | Calling up remedy information .....                                  | 39        |  |  |  |
| 12.3      | Adapting the diagnostic information .....                            | 39        |  |  |  |
| 12.3.1    | Adapting the diagnostic behavior ...                                 | 39        |  |  |  |
| 12.4      | Overview of diagnostic information .....                             | 40        |  |  |  |
| 12.5      | Pending diagnostic events .....                                      | 42        |  |  |  |
| 12.6      | Actual diagnostics .....   | 42        |  |  |  |

---

|              |  |           |
|--------------|--|-----------|
| 12.7         | Event logbook . . . . .  | 43        |
| 12.7.1       | Event history . . . . .  | 43        |
| 12.7.2       | Overview of information events . . . . .                         | 43        |
| 12.8         | Resetting the measuring device . . . . .                         | 43        |
| 12.9         | Device . . . . .   | 44        |
| 12.10        | Firmware history . . . . .                                       | 45        |
| <b>13</b>    | <b>Maintenance . . . . .</b>                                     | <b>47</b> |
| 13.1         | Maintenance work . . . . .                                       | 47        |
| 13.1.1       | Cleaning of surfaces not in contact<br>with the medium . . . . . | 47        |
| 13.1.2       | Cleaning of surfaces in contact with<br>the medium . . . . .     | 47        |
| 13.1.3       | Cleaning with pigs . . . . .                                     | 47        |
| 13.1.4       | Replacing seals . . . . .  | 47        |
| 13.2         | Measuring and test equipment . . . . .                           | 47        |
| 13.3         | Endress+Hauser services . . . . .                                | 48        |
| <b>14</b>    | <b>Repair . . . . .</b>  | <b>49</b> |
| 14.1         | General information . . . . .                                    | 49        |
| 14.1.1       | Repair and conversion concept . . . . .                          | 49        |
| 14.2         | Endress+Hauser services . . . . .                                | 49        |
| 14.3         | Return . . . . .   | 49        |
| 14.4         | Disposal . . . . .   | 49        |
| 14.4.1       | Removing the measuring device . . . . .                          | 49        |
| 14.4.2       | Disposing of the measuring device . . . . .                      | 50        |
| <b>15</b>    | <b>Accessories . . . . .</b>                                     | <b>51</b> |
| 15.1         | Device-specific accessories . . . . .                            | 51        |
| 15.2         | Communication-specific accessories . . . . .                     | 51        |
| 15.3         | Service-specific accessories . . . . .                           | 52        |
| <b>16</b>    | <b>Technical data . . . . .</b>                                  | <b>53</b> |
| 16.1         | Application . . . . .  | 53        |
| 16.2         | Function and system design . . . . .                             | 53        |
| 16.3         | Input . . . . .  | 53        |
| 16.4         | Output . . . . .   | 54        |
| 16.5         | Power supply . . . . .   | 55        |
| 16.6         | Performance characteristics . . . . .                            | 56        |
| 16.7         | Mounting . . . . .   | 57        |
| 16.8         | Environment . . . . .  | 57        |
| 16.9         | Process . . . . .  | 58        |
| 16.10        | Mechanical construction . . . . .                                | 60        |
| 16.11        | Operability . . . . .  | 62        |
| 16.12        | Certificates and approvals . . . . .                             | 62        |
| 16.13        | Accessories . . . . .  | 63        |
| 16.14        | Documentation . . . . .  | 63        |
| <b>Index</b> | <b>. . . . .</b>   | <b>65</b> |

# 1 About this document

## 1.1 Document function

These Operating Instructions contain all the information required in the various life cycle phases of the device: from product identification, incoming acceptance and storage, to installation, connection, operation and commissioning, through to troubleshooting, maintenance and disposal.

## 1.2 Symbols

### 1.2.1 Safety symbols

** DANGER**

This symbol alerts you to a dangerous situation. Failure to avoid this situation will result in serious or fatal injury.

** WARNING**

This symbol alerts you to a potentially dangerous situation. Failure to avoid this situation can result in serious or fatal injury.





** CAUTION**

This symbol alerts you to a potentially dangerous situation. Failure to avoid this situation can result in minor or medium injury.



**NOTICE**









This symbol alerts you to a potentially harmful situation. Failure to avoid this situation can result in damage to the product or something in its vicinity.

### 1.2.2 Electrical symbols





| Symbol  | Meaning  |
|---|--|
|  | Direct current   |
|  | Alternating current  |
|  | Direct current and alternating current   |
|  | <b>Ground connection</b><br>A grounded terminal which, as far as the operator is concerned, is grounded via a grounding system.  |
|  | <b>Potential equalization connection (PE: protective earth)</b><br>Ground terminals that must be connected to ground prior to establishing any other connections.<br><br>The ground terminals are located on the interior and exterior of the device: <ul style="list-style-type: none"> <li>▪ Interior ground terminal: potential equalization is connected to the supply network.</li> <li>▪ Exterior ground terminal: device is connected to the plant grounding system.</li> </ul> |

### 1.2.3 Symbols for certain types of information

| Symbol  | Meaning  |
|---|--|
|  | <b>Permitted</b><br>Procedures, processes or actions that are permitted. |
|  | <b>Preferred</b><br>Procedures, processes or actions that are preferred. |
|  | <b>Forbidden</b><br>Procedures, processes or actions that are forbidden. |

| Symbol  | Meaning   |
|---|---|
|  | <b>Tip</b><br>Indicates additional information. |
|  | Reference to documentation                      |
|  | Reference to page                               |
|  | Reference to graphic                            |
|  | Notice or individual step to be observed        |
|  | Series of steps                                 |
|  | Result of a step                                |
|  | Help in the event of a problem                  |
|  | Visual inspection                               |

### 1.2.4 Symbols in graphics

| Symbol  | Meaning                        |
|---|--------------------------------|
| 1, 2, 3, ...  | Item numbers                   |
|  | Series of steps                |
| A, B, C, ...  | Views                          |
| A-A, B-B, C-C, ...  | Sections                       |
|  | Hazardous area                 |
|  | Safe area (non-hazardous area) |
|  | Flow direction                 |

## 1.3 Documentation

 For an overview of the scope of the associated Technical Documentation, refer to the following:

- *Device Viewer* ([www.endress.com/deviceviewer](http://www.endress.com/deviceviewer)): Enter the serial number from the nameplate
- *Endress+Hauser Operations app*: Enter serial number from nameplate or scan matrix code on nameplate.

The following documentation may be available depending on the device version ordered:

| Document type                     | Purpose and content of the document  |
|-----------------------------------|--|
| Technical Information (TI)        | <b>Planning aid for your device</b><br>The document contains all the technical data on the device and provides an overview of the accessories and other products that can be ordered for the device. |
| Brief Operating Instructions (KA) | <b>Guide that takes you quickly to the 1st measured value</b><br>The Brief Operating Instructions contain all the essential information from incoming acceptance to initial commissioning.           |

| Document type  | Purpose and content of the document   |
|--|---|
| Operating Instructions (BA)                          | <b>Your reference document</b><br>These Operating Instructions contain all the information that is required in the various life cycle phases of the device: from product identification, incoming acceptance and storage, to mounting, connection, operation and commissioning, through to troubleshooting, maintenance and disposal.   |
| Description of Device Parameters (GP)                | <b>Reference for your parameters</b><br>The document provides a detailed explanation of each individual parameter. The description is aimed at those who work with the device over the entire life cycle and perform specific configurations.   |
| Safety Instructions (XA)                             | Depending on the approval, safety instructions for electrical equipment in hazardous areas are also supplied with the device. The Safety Instructions are a constituent part of the Operating Instructions.<br> Information on the Safety Instructions (XA) that are relevant for the device is provided on the nameplate. |
| Supplementary device-dependent documentation (SD/FY) | Always comply strictly with the instructions in the relevant supplementary documentation. The supplementary documentation is a constituent part of the device documentation.  |

## 1.4 Registered trademarks

### **KALREZ®**

Registered trademarks of DuPont Performance Elastomers L.L.C., Wilmington, DE USA

### **TRI-CLAMP®**

Registered trademark of Ladish & Co., Inc., Kenosha, USA

## 2 Safety instructions

### 2.1 Requirements for the personnel

The personnel for installation, commissioning, diagnostics and maintenance must fulfill the following requirements:

- ▶ Trained, qualified specialists must have a relevant qualification for this specific function and task.
- ▶ Are authorized by the plant owner/operator.
- ▶ Are familiar with federal/national regulations.
- ▶ Before starting work, read and understand the instructions in the manual and supplementary documentation as well as the certificates (depending on the application).
- ▶ Follow instructions and comply with basic conditions.

The operating personnel must fulfill the following requirements:

- ▶ Are instructed and authorized according to the requirements of the task by the facility's owner-operator.
- ▶ Follow the instructions in this manual.

### 2.2 Intended use

#### Application and media

Depending on the version ordered, the measuring instrument can also be used to measure potentially explosive <sup>1)</sup>, flammable, toxic and oxidizing media.

Measuring instruments for use in hazardous areas, in hygienic applications, or where there is an increased risk due to pressure, are specially labeled on the nameplate.

To ensure that the measuring instrument is in perfect condition during operation:

- ▶ Only use the measuring instrument in full compliance with the data on the nameplate and the general conditions listed in the Operating Instructions and supplementary documentation.
- ▶ Using the nameplate, check whether the ordered device is permitted for the intended use in the hazardous area (e.g. explosion protection, pressure vessel safety).
- ▶ Use the measuring instrument only for media to which the process-wetted materials are sufficiently resistant.
- ▶ Keep within the specified pressure and temperature range.
- ▶ Keep within the specified ambient temperature range.
- ▶ Protect the measuring instrument permanently against corrosion from environmental influences.

#### Incorrect use

Non-designated use can compromise safety. The manufacturer is not liable for damage caused by improper or non-designated use.

#### **WARNING**

#### **Danger of breakage due to corrosive or abrasive fluids and ambient conditions!**

- ▶ Verify the compatibility of the process fluid with the sensor material.
- ▶ Ensure the resistance of all fluid-wetted materials in the process.
- ▶ Keep within the specified pressure and temperature range.

---

1) Not applicable for IO-Link measuring instruments



**NOTICE****Verification for borderline cases:**

- ▶ For special fluids and fluids for cleaning, Endress+Hauser is glad to provide assistance in verifying the corrosion resistance of fluid-wetted materials, but does not accept any warranty or liability as minute changes in the temperature, concentration or level of contamination in the process can alter the corrosion resistance properties.

**Residual risks****⚠ CAUTION**

**Risk of hot or cold burns! The use of media and electronics with high or low temperatures can produce hot or cold surfaces on the device.**

- ▶ Mount suitable touch protection.

## 2.3 Workplace safety

When working on and with the device:

- ▶ Wear the required personal protective equipment as per national regulations.

## 2.4 Operational safety

Damage to the device!

- ▶ Operate the device in proper technical condition and fail-safe condition only.
- ▶ The operator is responsible for the interference-free operation of the device.

**Modifications to the device**

Unauthorized modifications to the device are not permitted and can lead to unforeseeable dangers!

- ▶ If modifications are nevertheless required, consult with the manufacturer.

**Repair**

To ensure continued operational safety and reliability:

- ▶ Carry out repairs on the device only if they are expressly permitted.
- ▶ Observe federal/national regulations pertaining to the repair of an electrical device.
- ▶ Use only original spare parts and accessories.

## 2.5 Product safety

This measuring device is designed in accordance with good engineering practice to meet state-of-the-art safety requirements, has been tested, and left the factory in a condition in which it is safe to operate.

It meets general safety standards and legal requirements. It also complies with the EU directives listed in the device-specific EU Declaration of Conformity. The manufacturer confirms this by affixing the CE mark to the device..

## 2.6 IT security

Our warranty is valid only if the product is installed and used as described in the Operating Instructions. The product is equipped with security mechanisms to protect it against any inadvertent changes to the settings.

IT security measures, which provide additional protection for the product and associated data transfer, must be implemented by the operators themselves in line with their security standards.

### 3 Product description

Compact version – transmitter and sensor form a mechanical unit in a fully welded housing.

#### 3.1 Product design

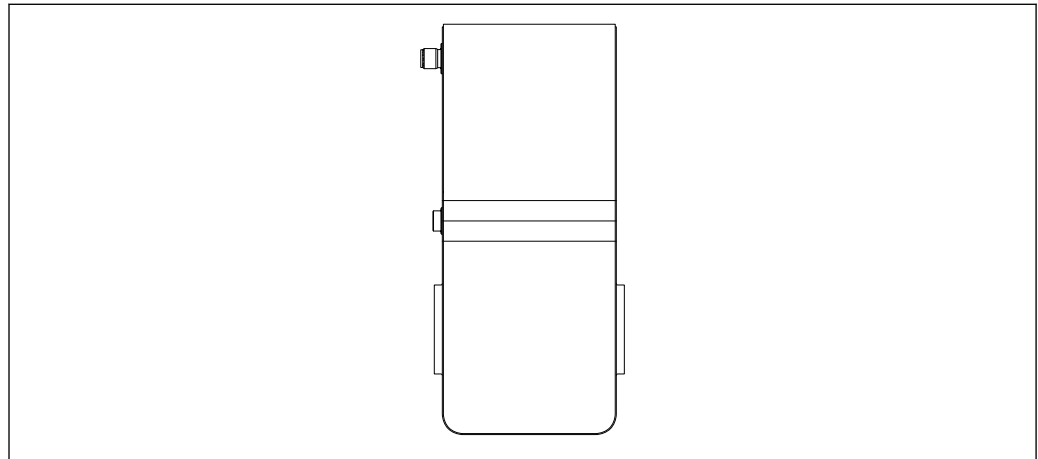

A0055041

 1 *Measuring instrument*

## 4 Incoming acceptance and product identification

### 4.1 Incoming acceptance

On receipt of the delivery:

1. Check the packaging for damage.
  - ↳ Report all damage immediately to the manufacturer.  
Do not install damaged components.
2. Check the scope of delivery using the delivery note.
3. Compare the data on the nameplate with the order specifications on the delivery note.
4. Check the technical documentation and all other necessary documents, e.g. certificates, to ensure they are complete.

 If one of the conditions is not satisfied, contact the manufacturer.

### 4.2 Product identification

The device can be identified in the following ways:

- Nameplate
- Order code with details of the device features on the delivery note
- Enter the serial numbers from the nameplates in the *Device Viewer* ([www.endress.com/deviceviewer](http://www.endress.com/deviceviewer)): all the information about the device is displayed.
- Enter the serial numbers from the nameplates into the *Endress+Hauser Operations app* or scan the DataMatrix code on the nameplate with the *Endress+Hauser Operations app*: all the information about the device is displayed.

For an overview of the scope of the associated Technical Documentation, refer to the following:

- The "Additional standard device documentation" and "Supplementary device-dependent documentation" sections
- The *Device Viewer*: Enter the serial number from the nameplate ([www.endress.com/deviceviewer](http://www.endress.com/deviceviewer))
- The *Endress+Hauser Operations app*: Enter the serial number from the nameplate or scan the DataMatrix code on the nameplate.

### 4.2.1 Measuring instrument nameplate

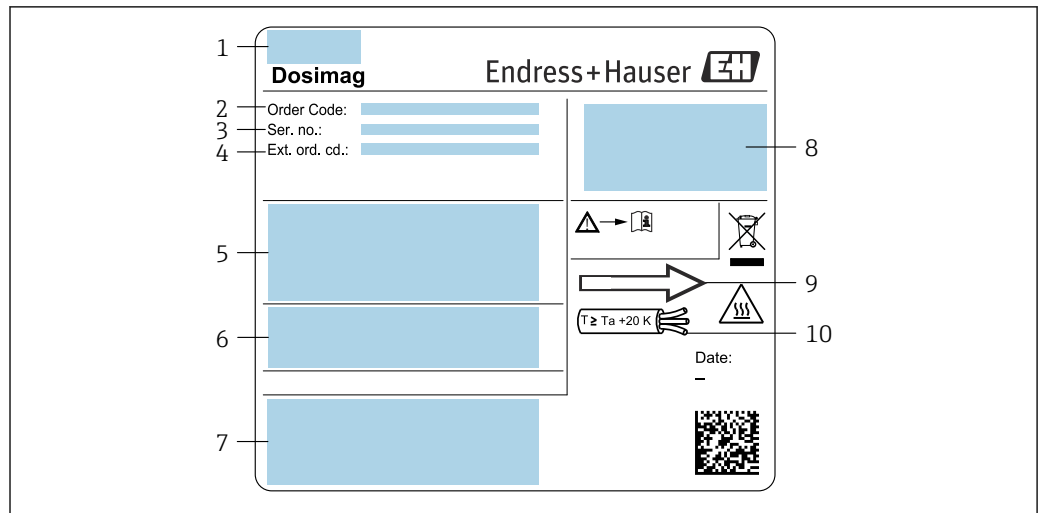

A0054879

2 Example of measuring instrument nameplate

- 1 Manufacturer address/certificate holder
- 2 Order code
- 3 Serial number (Ser. no.)
- 4 Extended order code (Ext. ord. cd.): See the specifications on the order confirmation for the meanings of the individual letters and digits
- 5 Supply voltage; power consumption; process connection
- 6 Nominal diameter of sensor; pressure rating (PN = PS); materials in contact with medium; permitted medium temperature (Tm); permitted ambient temperature (Ta)
- 7 Space reserved for additional information on the device version (approvals, certificates, etc.)
- 8 Degree of protection
- 9 Flow direction
- 10 Cable temperature

#### Order code

The measuring device is reordered using the order code.

##### Extended order code

- The device type (product root) and basic specifications (mandatory features) are always listed.
- Of the optional specifications (optional features), only the safety and approval-related specifications are listed (e.g. LA). If other optional specifications are also ordered, these are indicated collectively using the # placeholder symbol (e.g. #LA#).
- If the ordered optional specifications do not include any safety and approval-related specifications, they are indicated by the + placeholder symbol (e.g. XXXXXX-ABCDE+).

### 4.2.2 Symbols on the device

| Symbol | Meaning   |
|--------|---|
|        | <b>WARNING!</b><br>This symbol alerts you to a dangerous situation. Failure to avoid this situation can result in serious or fatal injury. Please consult the documentation for the measuring instrument to discover the type of potential danger and measures to avoid it. |
|        | <b>Reference to documentation</b><br>Refers to the corresponding device documentation.  |
|        | <b>Ground connection</b><br>A grounded terminal which, as far as the operator is concerned, is grounded via a grounding system.   |

## 5 Storage and transport

### 5.1 Storage conditions

Observe the following notes for storage:

- ▶ Store in the original packaging to ensure protection from shock.
- ▶ Do not remove protective covers or protective caps installed on process connections. They prevent mechanical damage to the sealing surfaces and contamination in the measuring tube.
- ▶ Protect from direct sunlight. Avoid unacceptably high surface temperatures.
- ▶ Select a storage location that excludes the possibility of condensation forming on the measuring device. Fungi and bacteria can damage the liner.
- ▶ Store in a dry and dust-free place.
- ▶ Do not store outdoors.

Storage temperature →  57

### 5.2 Transporting the product

Transport the measuring instrument to the measuring point in the original packaging.

-  Do not remove protective covers or caps installed on process connections. They prevent mechanical damage to the sealing surfaces and contamination in the measuring tube.

### 5.3 Packaging disposal

All packaging materials are environmentally friendly and 100% recyclable:

- Outer packaging of device
  - Stretch wrap made of polymer in accordance with EU Directive 2002/95/EC (RoHS)
- Packaging
  - Wood crate treated in accordance with ISPM 15 standard, confirmed by IPPC logo
  - Cardboard box in accordance with European packaging guideline 94/62/EC, recyclability confirmed by Resy symbol
- Transport material and fastening fixtures
  - Disposable plastic pallet
  - Plastic straps
  - Plastic adhesive strips
- Filler material
  - Paper pads

## 6 Mounting

### 6.1 Mounting requirements

#### 6.1.1 Mounting position

##### Mounting location

- Do not install the device at the highest point of the pipe.
- Do not install the device upstream from a free pipe outlet in a down pipe.

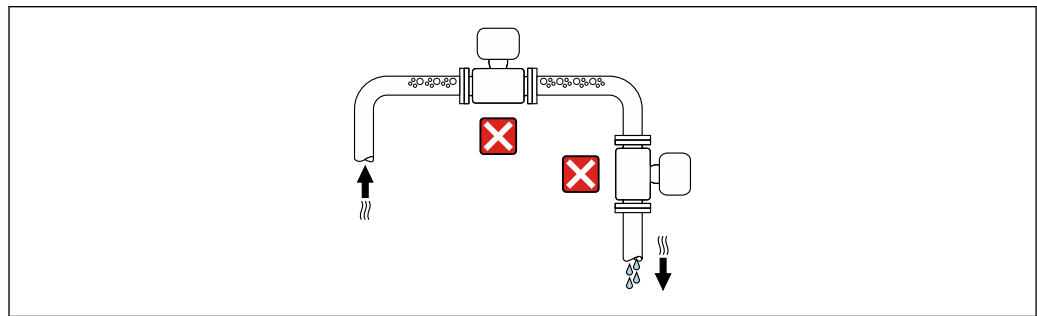

A0042131

The device should ideally be installed in an ascending pipe.

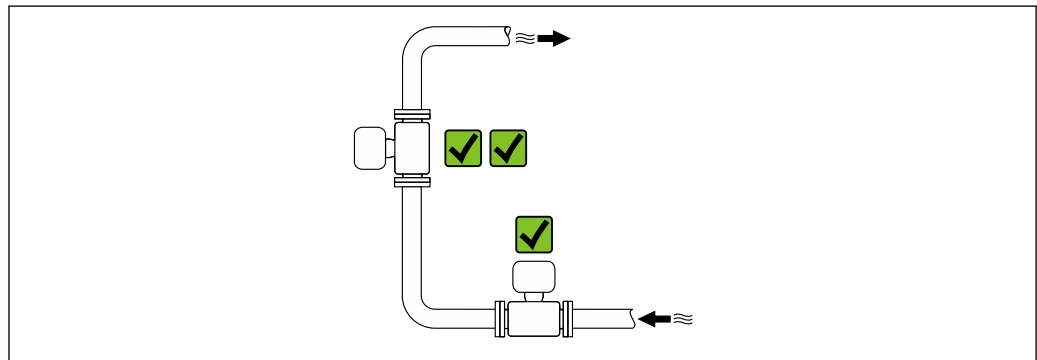

A0042317

*Installation upstream from a down pipe*

#### NOTICE

**Negative pressure in the measuring pipe can damage the liner!**

- ▶ If installing upstream of down pipes whose length  $h \geq 5$  m (16.4 ft): install a siphon with a vent valve downstream of the device.

**i** This arrangement prevents the flow of liquid stopping in the pipe and air entrainment.

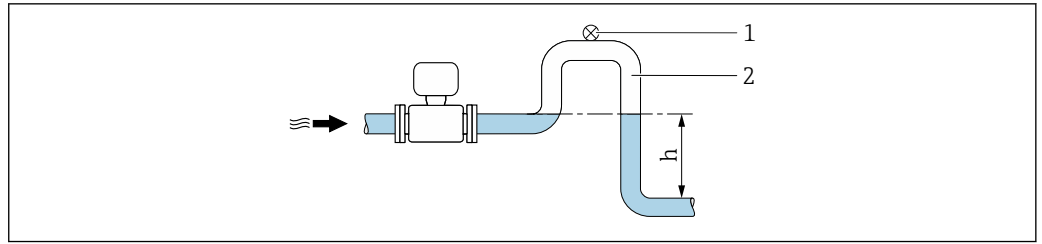

A0028981

- 1 Vent valve
- 2 Pipe siphon
- h Length of down pipe

*Installation with partially filled pipes*

- Partially filled pipes with a gradient require a drain-type configuration.
- The installation of a cleaning valve is recommended.

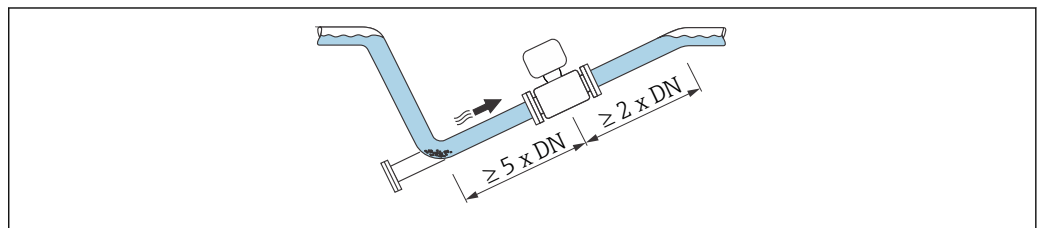

A0041088

*Installation near pumps*

**NOTICE**

**Negative pressure in the measuring tube can damage the liner!**

- ▶ In order to maintain the system pressure, install the device in the flow direction downstream from the pump.
- ▶ Install pulsation dampers if reciprocating, diaphragm or peristaltic pumps are used.

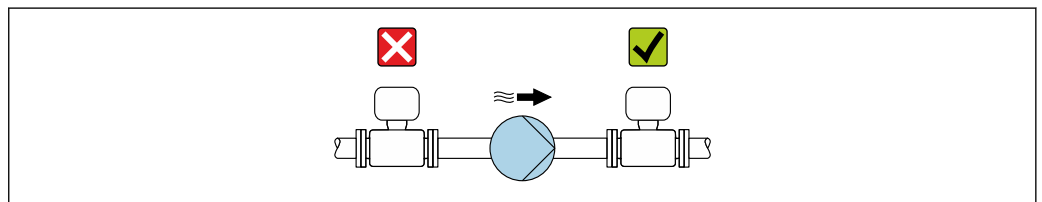

A0041083

- i
  - Information on the liner's resistance to partial vacuum → 59
  - Information on the measuring system's resistance to vibration and shock → 58

*Installation in event of pipe vibrations*



**NOTICE**

**Pipe vibrations can damage the device!**

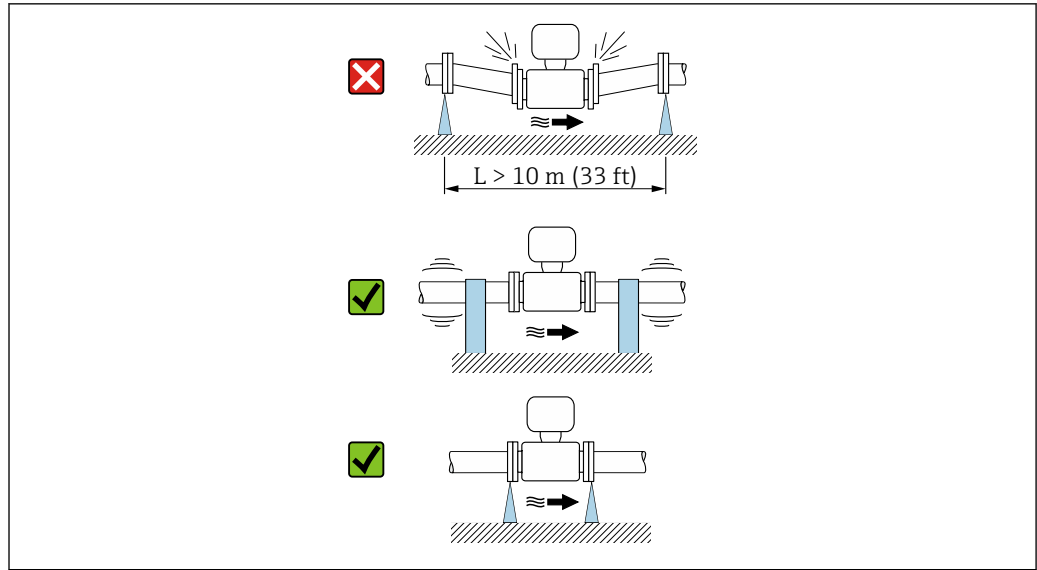
- ▶ Do not expose the device to strong vibrations.
- ▶ Support the pipe and fix it in place.
- ▶ Support the device and fix it in place.











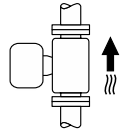

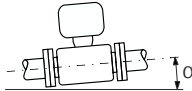
A0041092

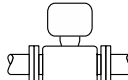
 Information on the measuring system's resistance to vibration and shock →  58

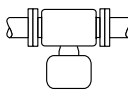
**Orientation**

The direction of the arrow on the nameplate helps you to install the measuring device according to the flow direction (direction of medium flow through the piping).

| Orientation                                   |   | Recommendation   |
|---|---|--|
| Vertical orientation                          |  <p style="text-align: right; font-size: small;">A0015591</p> |                   |
| Horizontal orientation                        |  <p style="text-align: right; font-size: small;">A0041328</p> |  <sup>1)</sup>    |
| Horizontal orientation, transmitter at top    |  <p style="text-align: right; font-size: small;">A0015589</p> |  <sup>2)</sup>    |
| Horizontal orientation, transmitter at bottom |  <p style="text-align: right; font-size: small;">A0015590</p> |  <sup>3) 4)</sup> |
| Horizontal orientation, transmitter at side   |  <p style="text-align: right; font-size: small;">A0015592</p> |                   |

- 1) The measuring device should be self-draining for hygiene applications. A vertical orientation is recommended for this. If only a horizontal orientation is possible, an angle of inclination  $\alpha \geq 10^\circ$  is recommended.
- 2) Applications with low process temperatures may reduce the ambient temperature. To maintain the minimum ambient temperature for the transmitter, this orientation is recommended.
- 3) Applications with high process temperatures may increase the ambient temperature. To maintain the maximum ambient temperature for the transmitter, this orientation is recommended.
- 4) To prevent the electronics from overheating in the event of strong heat formation (e.g. CIP or SIP cleaning process), install the device with the transmitter part pointing downwards.



*Horizontal*

Ideally, the measuring electrode plane should be horizontal. This prevents brief insulation of the measuring electrodes by entrained air bubbles.

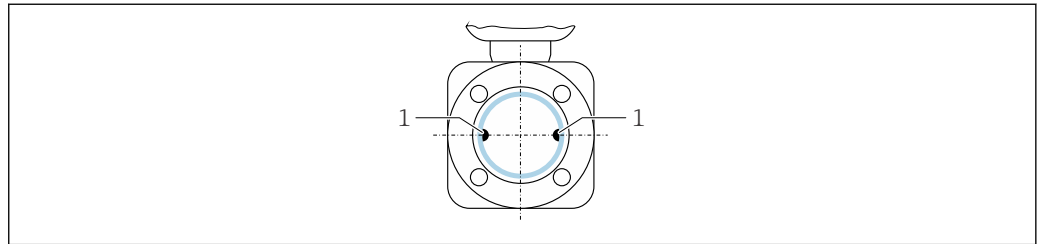

A0025817

1 Measuring electrodes for signal detection

*Valves*

Never install the measuring device downstream from a filling valve. Completely emptying the measuring device results in a high distortion of the measured value.

**i** Correct measurement is possible only if the piping is completely filled. Perform sample fillings before commencing filling in production.

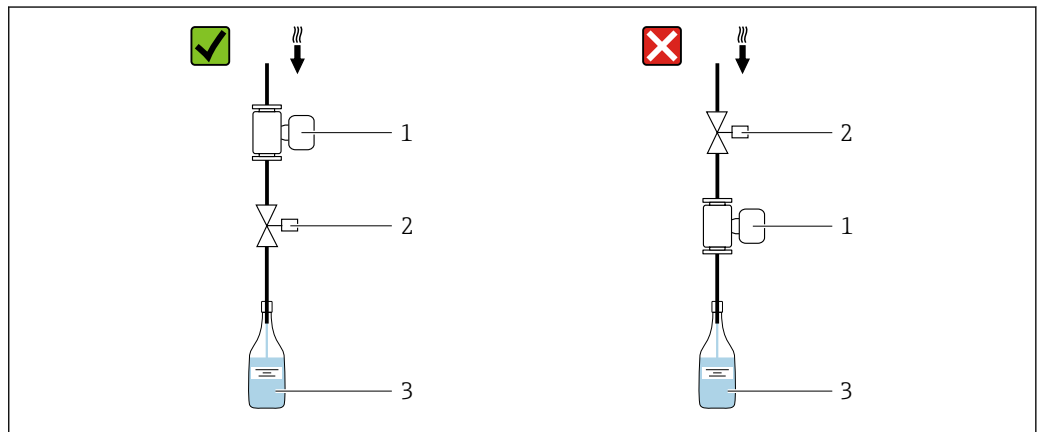

A0003768

1 Measuring device  
 2 Filling valve  
 3 Vessel

*Filling systems*

The pipe system must be completely full to ensure optimum measurement.

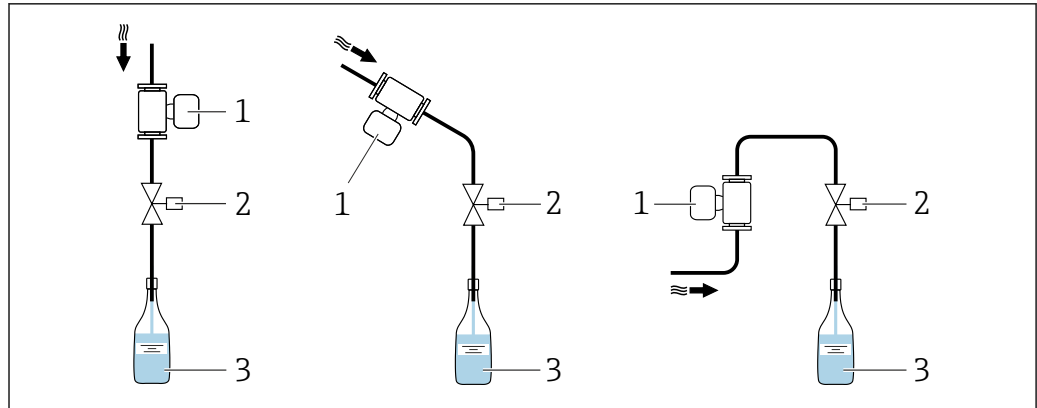

A0003795

3 Filling system

- 1 Measuring device
- 2 Filling valve
- 3 Vessel

**Inlet and outlet runs**

*Installation with inlet and outlet runs*

To avoid a vacuum and to maintain the specified level of measurement accuracy, install the device upstream from assemblies that produce turbulence (e.g. valves, T-sections) and downstream from pumps.

Maintain straight, unimpeded inlet and outlet runs.

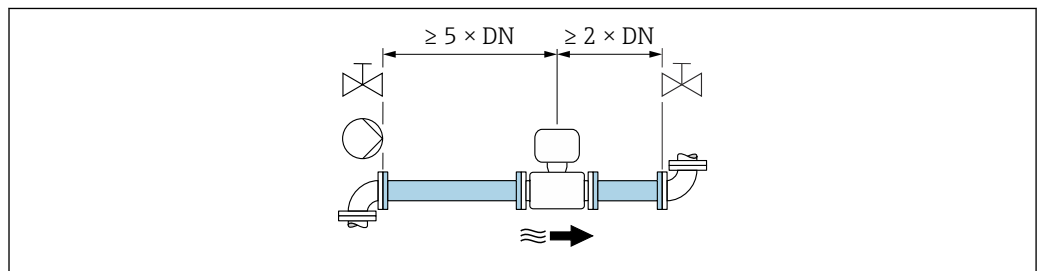

A0028997

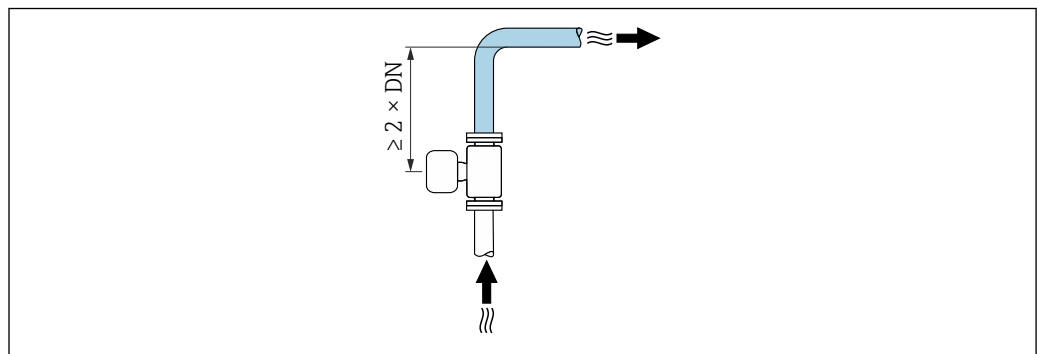

A0042132

**Installation dimensions**

For the dimensions and installation lengths of the device, see the "Technical Information" document, "Mechanical construction" section

### 6.1.2 Environmental and process requirements

#### Ambient temperature range

|                      |   |
|----------------------|---|
| Measuring instrument | -40 to +60 °C (-40 to +140 °F)<br>Install the measuring instrument in a shady location. Avoid direct sunlight, particularly in warm climatic regions. |
| Liner                | Do not exceed or fall below the permitted temperature range of the liner → 58.  |

#### System pressure

Installation near pumps → 15

#### Vibrations

Installation in event of pipe vibrations → 15

#### Adapters

The measuring device can also be installed in larger-diameter pipes with the aid of suitable adapters according to DIN EN 545 (double-flange reducers). The resultant increase in the rate of flow improves measuring accuracy with very slow-moving fluids. The nomogram shown here can be used to calculate the pressure loss caused by reducers and expanders.

- i** The nomogram only applies to liquids with a viscosity similar to that of water.
- If the medium has a high viscosity, a larger measuring tube diameter can be considered in order to reduce pressure loss.

1. Calculate the ratio of the diameters  $d/D$ .
2. From the nomogram read off the pressure loss as a function of flow velocity (downstream from the reduction) and the  $d/D$  ratio.

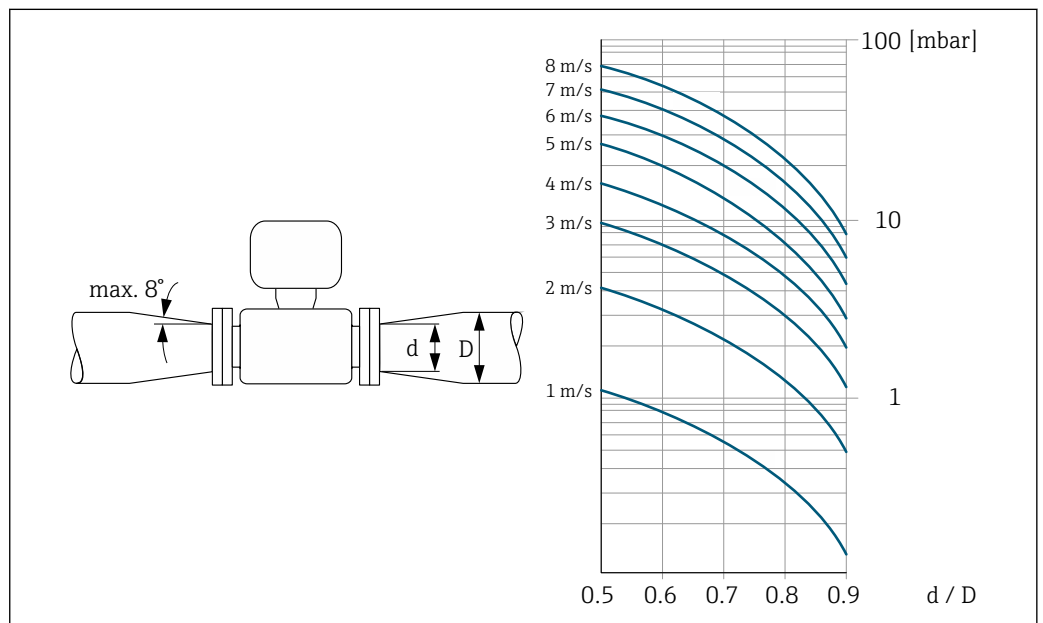

### 6.1.3 Special mounting instructions

#### Information for filling systems

Correct measurement is only possible if the pipe is completely full. We therefore recommend that some test batches be carried out prior to production batching.

*Circular filling system*

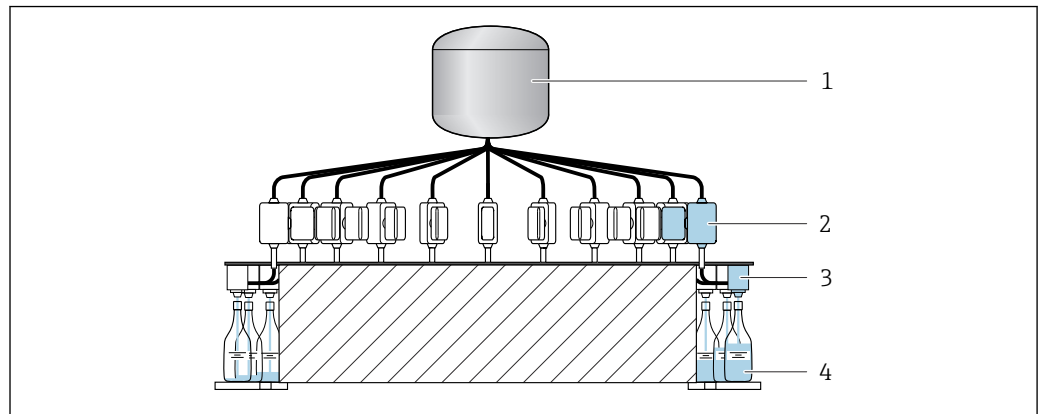

A0003761

- 1 Tank
- 2 Measuring instrument
- 3 Filling valve
- 4 Vessel

*Linear filling system*

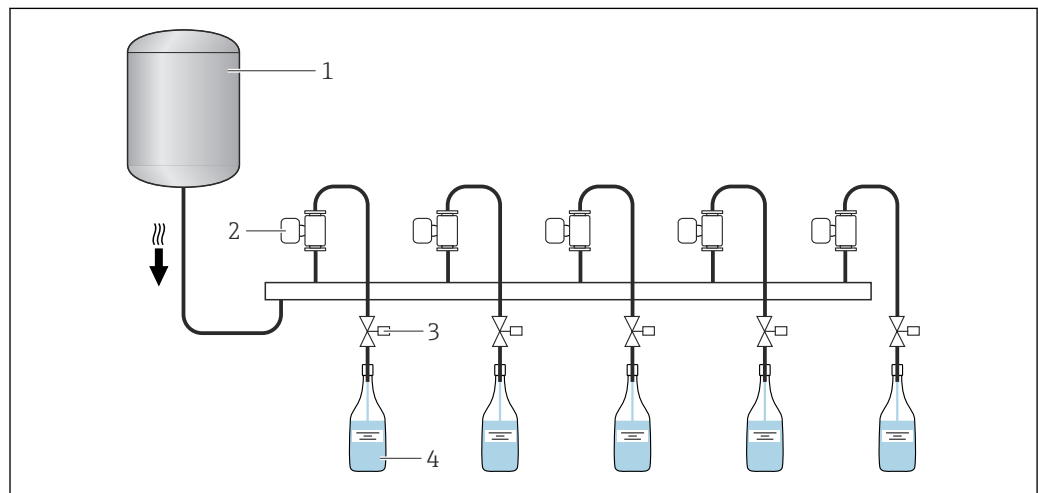

A0003762

- 1 Tank
- 2 Measuring instrument
- 3 Filling valve
- 4 Vessel

**Hygienic compatibility**

**i** When installing in hygienic applications, please refer to the information in the "Certificates and approvals/hygienic compatibility" section → 63

**Wall mounting kit**

**i** Depending on the application and pipe length, the measuring instrument may need to be supported or additionally secured. In particular, it is absolutely essential to secure the measuring instrument additionally if plastic process connections are used. An appropriate wall mounting kit can be ordered separately as an accessory from Endress +Hauser. → 51

### Zero adjustment

The **Sensor adjustment** submenu contains parameters required for zero adjustment.



Detailed information on the "**Sensor adjustment** submenu": Device parameters → 64

#### NOTICE

**All Dosimag measuring instruments are calibrated in accordance with state-of-the-art technology. Calibration takes place under reference conditions .**

Zero adjustment is therefore not required for the Dosimag as a general rule.

- ▶ Experience shows that a zero adjustment is advisable only in special cases.
- ▶ When maximum measurement accuracy is required and flow rates are very low.



Detailed information on reference operating conditions → 56

#### Prerequisites for zero adjustment

Note the following points before performing the adjustment:

- A zero adjustment can be performed only with fluids that contain no gas or solid contents.
- Zero adjustment is performed with the measuring tubes completely filled and at zero flow ( $v = 0 \text{ m/s}$  (0 ft/s)). Shutoff valves, for example, may be provided for this purpose or existing valves and sliders can be used.
  - Normal operation → Valve 1 open
  - Zero adjustment → Valve 1 closed

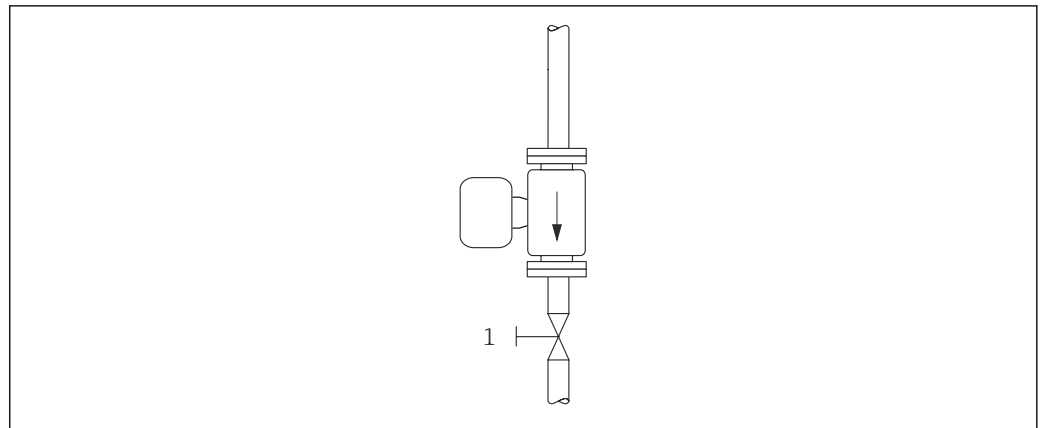

4

A0008558

#### Performing the zero adjustment

1. Let the system run until normal operating conditions are present.
2. Stop the flow ( $v = 0 \text{ m/s}$  (0 ft/s)).
3. Check the shutoff valves for leaks.
4. Perform adjustment using the **Zero point adjustment control** function.

## 6.2 Mounting the measuring instrument

### 6.2.1 Required tools

For process connections, use the appropriate installation tool

## 6.2.2 Preparing the measuring instrument

1. Remove all remaining transport packaging.
2. Remove any protective covers or protective caps present from the measuring instrument.

## 6.2.3 Mounting the measuring instrument



### **⚠ WARNING**

#### **Danger due to improper process sealing!**

- ▶ Ensure that the inside diameters of the gaskets are greater than or equal to that of the process connections and piping.
- ▶ Ensure that the seals are clean and undamaged.
- ▶ Secure the seals correctly.

The measuring instrument is supplied to order, with or without pre-installed process connections. Pre-installed process connections are secured to the measuring instrument using 4 hexagonal-headed bolts.



- ▶ Ensure that the direction of the arrow on the nameplate of the measuring instrument matches the flow direction of the medium. →  12

-  Depending on the application and pipe length, the measuring instrument may need to be supported or additionally secured. →  51

### **Welding the measuring instrument into the pipe (welding nipples)**

#### **⚠ WARNING**

#### **Risk of destroying the electronics!**

- ▶ Make sure that the welding system is not earthed via the measuring instrument.
1. Tack-weld the measuring instrument to secure it in the pipe. A suitable welding jig can be ordered separately as an accessory. →  63
  2. Loosen the screws on the process connection flange and remove the measuring instrument, along with the seal, from the pipe.
  3. Weld the process connection into the pipe.
  4. Reinstall the measuring instrument in the pipe, and in doing so make sure that the seal is clean and in the right position.
- 
    - If thin-walled pipes carrying food are welded correctly, the seal is not damaged by the heat even when mounted. However, it is recommended to disassemble the measuring instrument and seal.
    - It must be possible to open the pipe by at least 8 mm (0.31 in) for disassembly.

### **Mounting the seals**

Comply with the following instructions when installing seals:

1. The seals should be dry, clean, undamaged and correctly centered.
2. In the case of metal process connections, the screws must be tightened securely. The process connection forms a metal connection with the measuring instrument, which ensures a defined compression of the seal.
3. With regard to process connections made of plastic material, comply with the max. torques for lubricated threads: 7 Nm (5.2 lbf ft).
4. Depending on the application, the seals should be replaced periodically, particularly if molded seals are used (aseptic version). The interval between changes depends on the frequency of the cleaning cycles, the cleaning temperature and the medium temperature. Replacement seals can be ordered as an accessory.

**Mounting grounding rings**

In the case of plastic process connections (e.g. external thread), the potential equalization between the measuring instrument/medium and the additional ground rings must be ensured. If grounding rings are not installed, this can affect the measurement accuracy or cause the destruction of the measuring instrument as a result of the electrochemical decomposition of the electrodes.

**i** Pay attention to the information on potential equalization → 28.

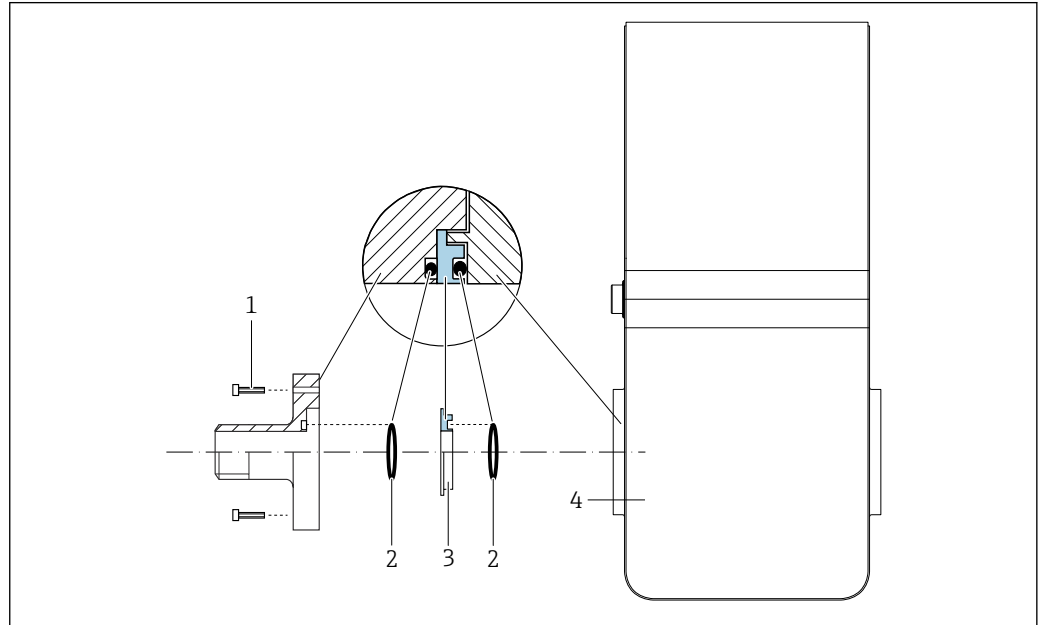

A0053324

**5** *Installing grounding rings*

- 1 Hexagonal-headed bolts of process connection
- 2 O-ring seals
- 3 Grounding ring or plastic disk (spacer)
- 4 Measuring instrument

1. Release 4 hexagonal-headed bolts (1) and remove the process connection from the measuring instrument (4).
2. Remove the plastic disk (3), along with the two O-ring seals (2), from the process connection.
3. Place the first O-ring seal (2) back into the groove of the process connection.
4. Fit the metal grounding ring (3) in the process connection as illustrated.
5. Place the second O-ring seal (2) into the groove of the grounding ring.
6. Mount the process connection back on the measuring instrument. When doing so, make sure to observe the maximum screw tightening torques for lubricated threads: 7 Nm (5.2 lbf ft)

## 6.3 Post-mounting check

|   |                          |
|---|--------------------------|
| Is the measuring instrument undamaged (visual inspection)?  | <input type="checkbox"/> |
| Does the measuring instrument conform to the measuring point specifications?<br>For example:<br><ul style="list-style-type: none"> <li>▪ Process temperature → 58</li> <li>▪ Process pressure → 59</li> <li>▪ Ambient temperature → 57</li> <li>▪ Measuring range → 53</li> </ul>             | <input type="checkbox"/> |
| Horizontal position of the measuring electrode plane → 17?  | <input type="checkbox"/> |
| Has the correct orientation been selected for the measuring instrument → 16?<br><ul style="list-style-type: none"> <li>▪ As per measuring instrument type</li> <li>▪ According to medium temperature</li> <li>▪ According to medium properties (outgassing, with entrained solids)</li> </ul> | <input type="checkbox"/> |
| Does the arrow on the measuring instrument nameplate match the direction of flow of the medium through the piping → 12?   | <input type="checkbox"/> |
| Are the measuring point identification and labeling correct (visual inspection)?  | <input type="checkbox"/> |
| Is the measuring instrument adequately protected against vibration (attachment, support) → 15?  | <input type="checkbox"/> |
| Are the inlet and outlet runs to respected → 18?  | <input type="checkbox"/> |



## 7 Electrical connection

### WARNING

**Live parts! Incorrect work performed on the electrical connections can result in an electric shock.**

- ▶ Set up a disconnecting device (switch or power-circuit breaker) to easily disconnect the device from the supply voltage.
- ▶ In addition to the device fuse, include an overcurrent protection unit with max. 16 A in the plant installation.

### 7.1 Electrical safety

In accordance with applicable national regulations.

### 7.2 Connecting requirements

#### 7.2.1 Requirements for connecting cable

The connecting cables provided by the customer must fulfill the following requirements.

##### Permitted temperature range

- The installation guidelines that apply in the country of installation must be observed.
- The cables must be suitable for the minimum and maximum temperatures to be expected.

##### Signal cable

 Cables are not included in the scope of delivery.

 Please note the following with regard to cable loading:  
Voltage drop due to the cable length and cable type.

*Pulse/frequency/switch output*

Standard installation cable is sufficient.

#### 7.2.2 Terminal assignment

Connection is solely by means of device plug →  25.

#### 7.2.3 Available device plugs

##### Device version: 2 pulse/frequency/switch outputs

Order code for "Output, input": option AA:  
2 pulse/frequency/switch outputs

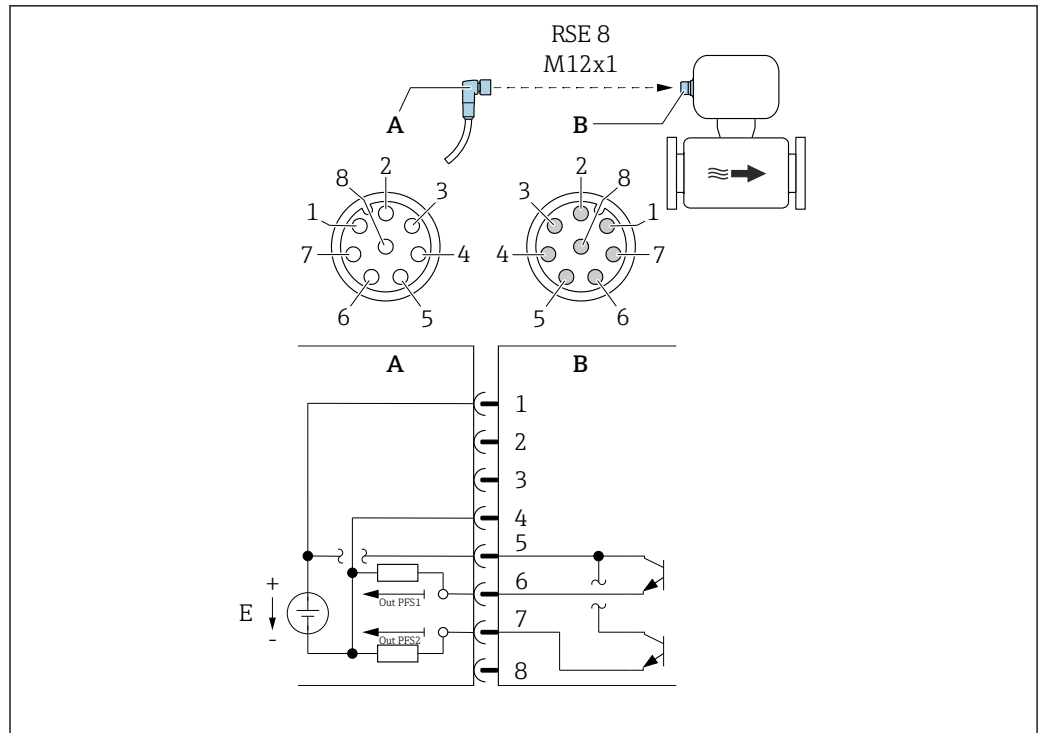

A0054873

6 Connection to device

- A Coupling: Supply voltage, pulse/freq./switch output
- B Connector: Supply voltage, pulse/freq./switch output
- E PELV or SELV power supply
- 1 to Pin assignment
- 8

Pin assignment

| Connection: Coupling (A) – Connector (B) |            |                                       |
|--|------------|---------------------------------------|
| Pin                                      | Assignment |                                       |
| 1  | L+         | Supply voltage                        |
| 2  | +          | Service interface RX                  |
| 3  | +          | Service interface TX                  |
| 4  | L-         | Supply voltage                        |
| 5  | +          | Pulse/frequency/switch output 1 and 2 |
| 6  | -          | Pulse/frequency/switch output 1       |
| 7  | -          | Pulse/frequency/switch output 2       |
| 8  | -          | Service interface GND                 |

### 7.2.4 Requirements for the supply unit

#### Supply voltage

DC 24 V (nominal voltage: DC 18 to 30 V)

- i** The power unit must be safety-approved (e.g. PELV, SELV).
- The maximum short-circuit current must not exceed 50 A.

## 7.3 Connecting the measuring instrument

### NOTICE

**An incorrect connection compromises electrical safety!**

- ▶ Only properly trained specialist staff may perform electrical connection work.
- ▶ Observe applicable federal/national installation codes and regulations.
- ▶ Comply with local workplace safety regulations.
- ▶ When using in potentially explosive atmospheres, observe the information in the device-specific Ex documentation.

### 7.3.1 Connection via device plug

Connection is solely by means of device plug.

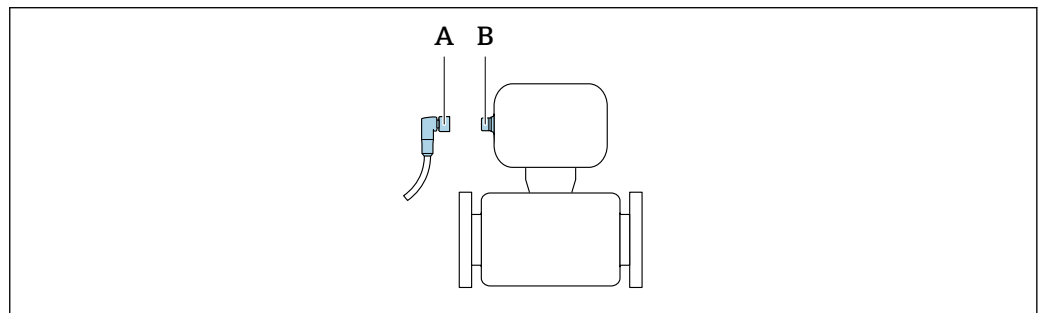

A0032652

- A Coupling
- B Plug

### 7.3.2 Grounding

Grounding is by means of a cable socket.

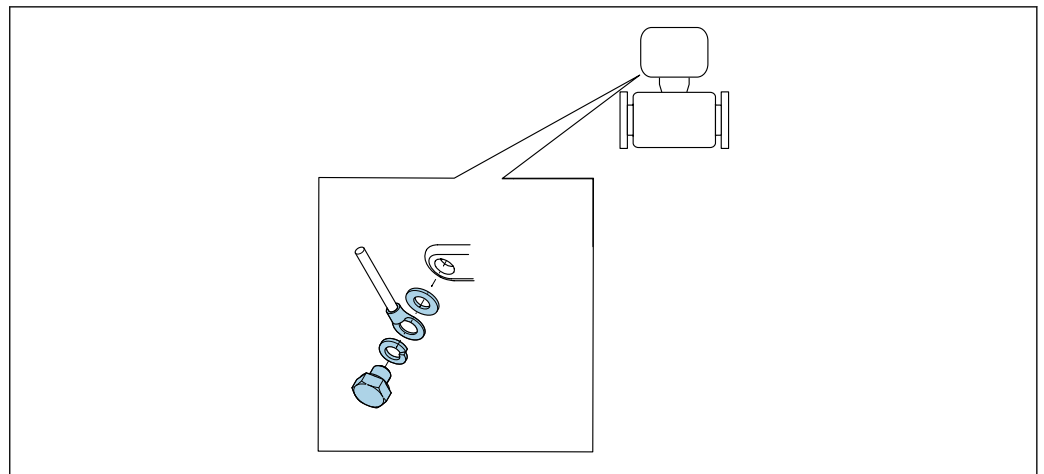

A0053306

## 7.4 Ensuring potential equalization

### 7.4.1 Requirements

For potential equalization:

- Pay attention to in-house grounding concepts
- Take account of operating conditions like the pipe material and grounding
- Connect the medium and measuring instrument to the same electric potential
- Use a ground cable with a minimum cross-section of 6 mm<sup>2</sup> (0.0093 in<sup>2</sup>) and a cable lug for potential equalization connections



For devices intended for use in hazardous locations, please observe the guidelines in the Ex documentation (XA).



### 7.4.2 Metal process connections

Potential equalization is via the metal process connections that are in contact with the medium and mounted directly on the measuring instrument.

### 7.4.3 Plastic process connections



Note the following when using grounding rings:

- Depending on the option ordered, plastic disks are used instead of grounding rings on some process connections. The plastic disks act as "spacers" and do not have any potential equalization function. They perform a significant sealing function at the measuring instrument and process connection interfaces. In the case of process connections without metal grounding rings, the plastic disks and seals must never be removed. Plastic disks and seals must always be installed.
- Grounding rings can be ordered separately as an accessory from Endress+Hauser →  63. The grounding rings must be compatible with the electrode material, as otherwise there is the danger that the electrodes could be destroyed by electrochemical corrosion. Material specifications →  60.
- Grounding rings, including seals, are installed inside the process connections. This does not affect the installed length.

**Potential equalization via additional grounding ring**

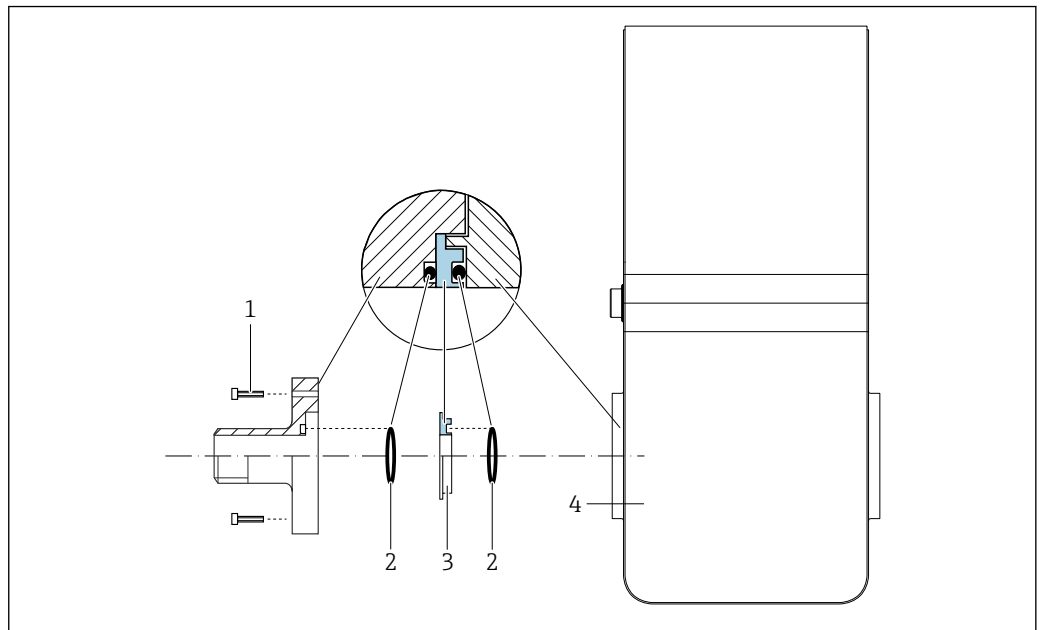

A0053324

- 1 Hexagonal-headed bolts of process connection
- 2 O-ring seals
- 3 Plastic disk (spacer) or grounding ring
- 4 Measuring instrument

**Potential equalization via grounding electrodes on process connection**

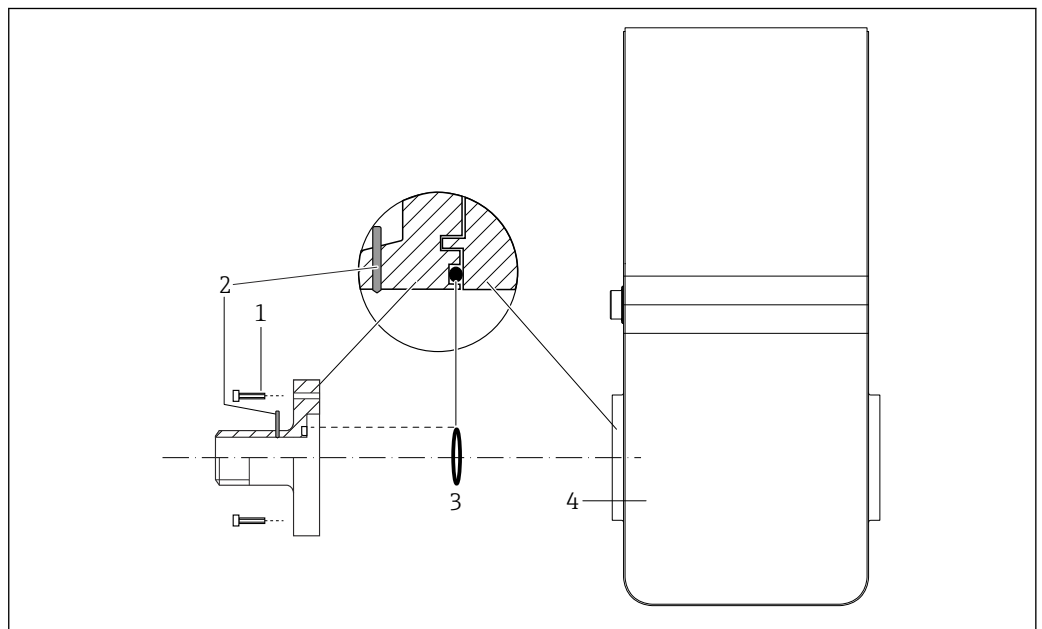

A0053325

- 1 Hexagonal-headed bolts of process connection
- 2 Integrated grounding electrodes
- 3 O-ring seal
- 4 Measuring instrument







**7.5 Ensuring the degree of protection**

The measuring device fulfills all the requirements for IP67 degree of protection, Type 4X enclosure.

To guarantee IP67 degree of protection, Type 4X enclosure, carry out the following steps after the electrical connection:

- ▶ Tighten all device plugs.

## 7.6 Post-connection check

|   |                          |
|---|--------------------------|
| Is the measuring instrument undamaged (visual inspection)?  | <input type="checkbox"/> |
| Does the supply voltage in the system match the data on the nameplate of the measuring instrument →  12? | <input type="checkbox"/> |
| Do the cables used meet the necessary specifications →  25?  | <input type="checkbox"/> |
| Are the mounted cables relieved of tension?   | <input type="checkbox"/> |
| Is the terminal assignment correct →  25?  | <input type="checkbox"/> |
| Is the protective earthing established correctly →  27?  | <input type="checkbox"/> |
| Is the potential equalization established correctly →  28?   | <input type="checkbox"/> |
| Are the maximum values for voltage and current observed at the pulse/frequency/switch outputs →  54?     | <input type="checkbox"/> |

## 8 Operation options

### 8.1 Overview of operation options

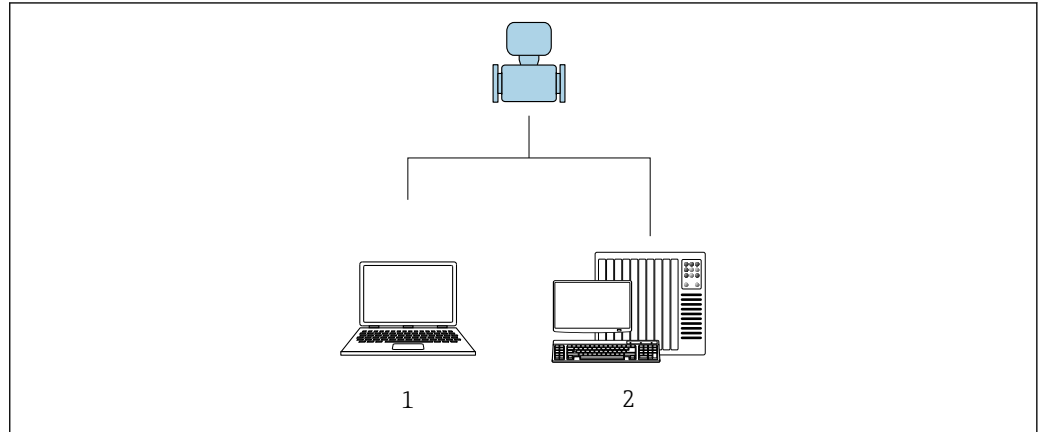

- 1 Computer with "FieldCare" or "DeviceCare" operating tool
- 2 Control system (e.g. PLC)

A0017760

### 8.2 Access to the operating menu via the operating tool

#### 8.2.1 Connecting the operating tool

##### Using service adapter and Commubox FXA291

Operation and configuration can be performed using the Endress+Hauser FieldCare or DeviceCare service and configuration software.

The device is connected to the USB port of the computer via the service adapter and Commubox FXA291.

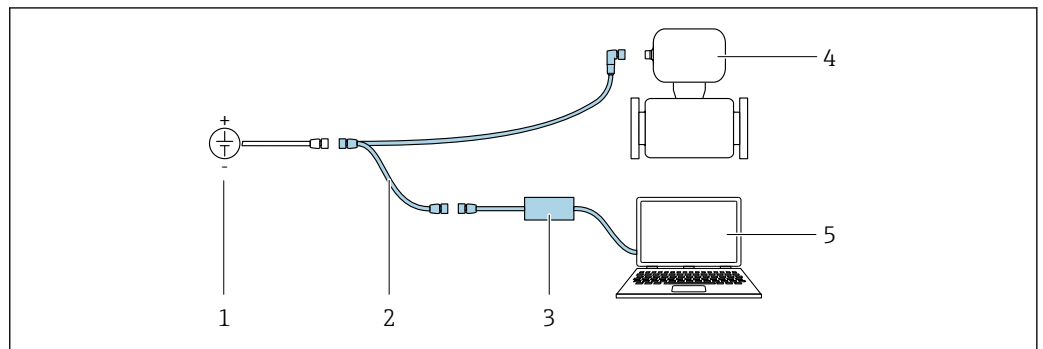

- 1 Supply voltage 24 V DC
- 2 Service adapter
- 3 Commubox FXA291
- 4 Dosimag
- 5 Computer with "FieldCare" or "DeviceCare" operating tool

A0032567

**i** The service adapter, cable and Commubox FXA291 are not included in the delivery. These components can be ordered as accessories → 51.

## 8.2.2 FieldCare

### Function range

FDT-based (Field Device Technology) plant asset management tool from Endress+Hauser. It can configure all smart field units in a system and helps you manage them. By using the status information, it is also a simple but effective way of checking their status and condition.

Access is via:

Service adapter and Commubox FXA291

Typical functions:

- Transmitter parameter configuration
- Loading and saving of device data (upload/download)
- Documentation of the measuring point
- Visualization of the measured value memory (line recorder) and event logbook



- Operating Instructions BA00027S
- Operating Instructions BA00059S



Source for device description files →  34

### Establishing a connection

Service adapter, Commubox FXA291 and "FieldCare" operating tool

1. Start FieldCare and launch the project.
2. In the network: Add a device.
  - ↳ The **Add device** window opens.
3. Select the **CDI Communication FXA291** option from the list and press **OK** to confirm.
4. Right-click **CDI Communication FXA291** and select the **Add device** option in the context menu that opens.
5. Select the desired device from the list and press **OK** to confirm.
6. Establish the online connection to the device.



- Operating Instructions BA00027S
- Operating Instructions BA00059S



### User interface

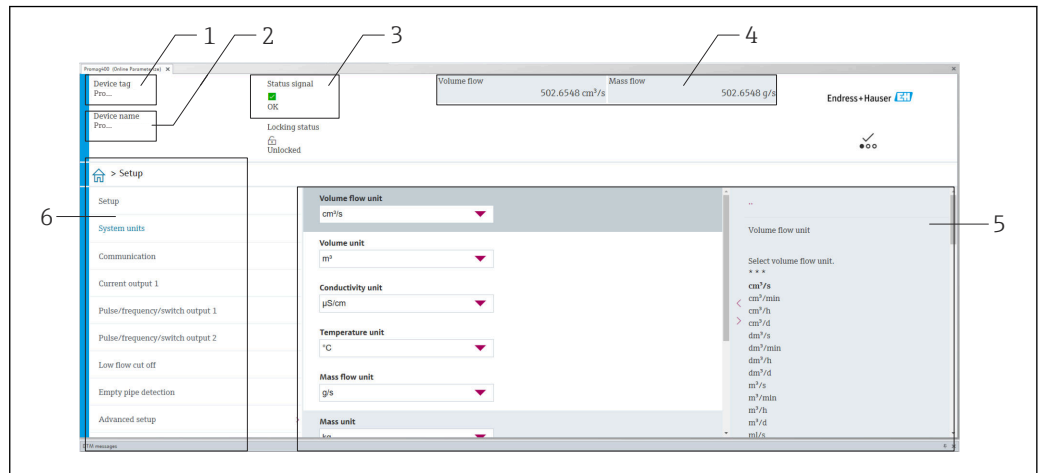

A0008200

- 1 Device name
- 2 Device tag
- 3 Status area with status signal → 38
- 4 Display area for current measured values
- 5 Editing toolbar with other functions
- 6 Navigation area with operating menu structure

### 8.2.3 DeviceCare

#### Function range

Tool for connecting and configuring Endress+Hauser field devices.

The fastest way to configure Endress+Hauser field devices is with the dedicated "DeviceCare" tool. Together with the device type managers (DTMs) it presents a convenient, comprehensive solution.



Innovation brochure IN01047S





Source for device description files → 34

## 9 System integration

### 9.1 Overview of device description files

#### 9.1.1 Current version data for the device

|                                  |          |  |
|----------------------------------|----------|--|
| Firmware version                 | 04.00.zz | <ul style="list-style-type: none"> <li>▪ On the title page of the manual</li> <li>▪ On the measuring instrument nameplate →  12</li> <li>▪ Firmware version<br/>System → Information → Device → Firmware version</li> </ul> |
| Release date of firmware version | 06.2024  | ---  |

 For an overview of the various firmware versions for the device →  45

#### 9.1.2 Operating tools



The suitable device description file for the individual operating tools is listed in the table below, along with information on where the file can be acquired.

| Operating tool | Sources for obtaining device descriptions   |
|----------------|---|
| FieldCare      | <ul style="list-style-type: none"> <li>▪ <a href="http://www.endress.com">www.endress.com</a> → Downloads area</li> <li>▪ USB stick (contact Endress+Hauser)</li> <li>▪ DVD (contact Endress+Hauser)</li> </ul> |
| DeviceCare     | <ul style="list-style-type: none"> <li>▪ <a href="http://www.endress.com">www.endress.com</a> → Downloads area</li> <li>▪ CD-ROM (contact Endress+Hauser)</li> <li>▪ DVD (contact Endress+Hauser)</li> </ul>    |

## 10 Commissioning

### 10.1 Post-mounting and post-connection check

Before commissioning the device:

- ▶ Make sure that the post-installation and post-connection checks have been performed successfully.
- Checklist for "Post-mounting" check →  24
- Checklist for "Post-connection check" →  30

### 10.2 Switching on the measuring device

- ▶ The function check has been completed successfully.  
Switch on the supply voltage.
  - ↳ The measuring device runs through internal test functions.

The device is operational and operation commences.

 If the device does not start up successfully, depending on the cause, a diagnostic message is displayed in the system asset management tool "FieldCare".

### 10.3 Connecting via FieldCare

- For connecting FieldCare →  31
- For connecting via FieldCare →  32
- For user interface of FieldCare →  33

### 10.4 Configuring the measuring instrument

 The device-specific parameters are configured via the "**Commissioning** wizard".

 For detailed information on the "**Commissioning** wizard": Separate "Description of Device Parameters"(GP) document →  64

## 11 Operation

### 11.1 Reading the device locking status

#### Navigation

"System" menu → Device management → Locking status

#### Parameter overview with brief description

| Parameter      | Description  | User interface     |
|----------------|--|--------------------|
| Locking status | Indicates the write protection with the highest priority that is currently active. | Temporarily locked |

### 11.2 Reading access authorization status on operating software

#### Navigation

"System" menu → User management → User role

#### Parameter overview with brief description

| Parameter | Description  | User interface  |
|-----------|--|---|
| User role | Displays the role the user is currently logged on in. The role determines the user's access rights for the parameters. The access rights can be changed via the "Enter access code" parameter. | <ul style="list-style-type: none"> <li>▪ Operator</li> <li>▪ Maintenance</li> <li>▪ Service</li> <li>▪ Production</li> <li>▪ Development</li> </ul> |

### 11.3 Reading measured values

#### Navigation

"Application" menu → Measured values

#### Parameter overview with brief description

| Parameter   | Description                               | User interface               |
|-------------|---|------------------------------|
| Volume flow | Shows the volume flow currently measured. | Signed floating-point number |

### 11.4 Adapting the measuring instrument to the process conditions

The following menus are available for this purpose:

- Guidance
- Application



Detailed information on "**Guidance** menu" and "**Application** menu": Device parameters  
→ 64

## 11.5 Performing a totalizer reset

### Navigation

"Application" menu → Totalizers → Totalizer handling → Reset all totalizers

### Parameter overview with brief description

| Parameter            | Description   | Selection   |
|----------------------|---|---|
| Reset all totalizers | Reset all totalizers to "0" and restart the totalizers. The counter readings are not logged prior to the reset. | <ul style="list-style-type: none"><li>▪ Cancel</li><li>▪ Reset + totalize</li></ul> |

## 12 Diagnostics and troubleshooting

### 12.1 General troubleshooting

For access

| Error   | Possible causes   | Remedial action   |
|---|---|---|
| Write access to parameter not possible.             | Current user role has limited access authorization.   | Check the access authorization status → 36.   |
| Connection via the service adapter is not possible. | <ul style="list-style-type: none"> <li>The USB port on the PC is incorrectly configured.</li> <li>The driver is not installed correctly.</li> </ul> | Observe the documentation for the Commubox FXA291:<br> Technical Information TI00405C |

### 12.2 Diagnostic information in FieldCare or DeviceCare

#### 12.2.1 Diagnostic options

Any faults detected by the measuring device are displayed on the home page of the operating tool once the connection has been established.

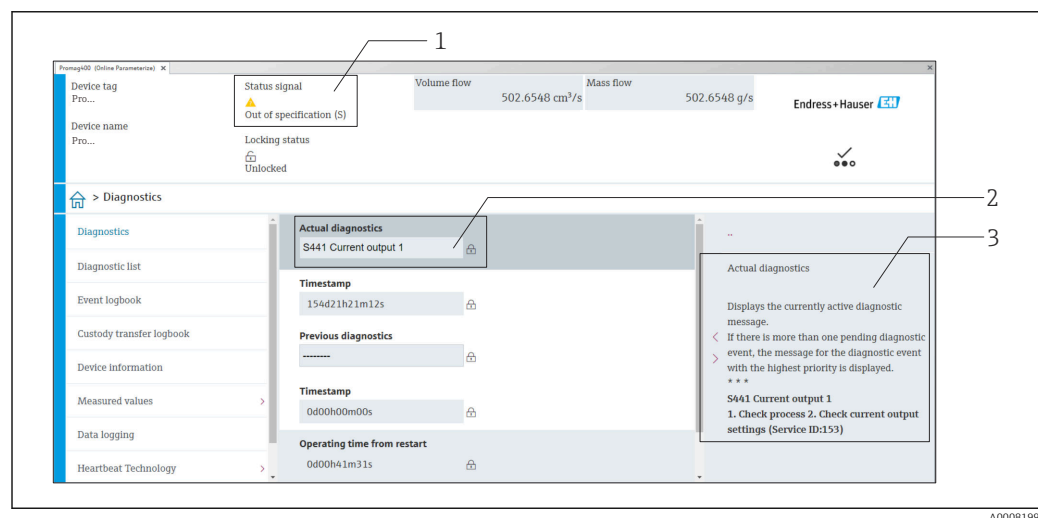

A0008199





- 1 Status area with status signal
- 2 Diagnostic information → 39
- 3 Remedial measures with service ID

 In addition, diagnostic events which have occurred can be shown in the **Diagnostics** menu:

- Via parameter
- Via submenu

#### Status signals

The status signals provide information on the state and reliability of the device by categorizing the cause of the diagnostic information (diagnostic event).

| Symbol  | Meaning   |
|---|---|
|  | <b>Failure</b><br>A device error has occurred. The measured value is no longer valid.   |
|  | <b>Function check</b><br>The device is in service mode (e.g. during a simulation).  |
|  | <b>Out of specification</b><br>The device is being operated:<br>Outside its technical specification limits (e.g. outside the process temperature range) |
|  | <b>Maintenance required</b><br>Maintenance is required. The measured value remains valid.   |

 The status signals are categorized in accordance with VDI/VDE 2650 and NAMUR Recommendation NE 107.

### Diagnostic information

The fault can be identified using the diagnostic information. The short text helps you by providing information about the fault.

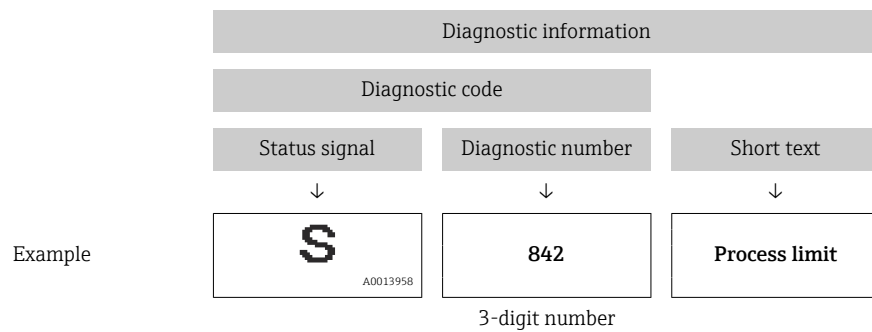

### 12.2.2 Calling up remedy information

Remedy information is provided for every diagnostic event to ensure that problems can be rectified quickly:

- On the home page  
Remedy information is displayed in a separate field below the diagnostics information.
- In the **Diagnostics** menu  
Remedy information can be called up in the working area of the user interface.

The user is in the **Diagnostics** menu.

1. Call up the desired parameter.
2. On the right in the working area, mouse over the parameter.
  - ↳ A tool tip with remedy information for the diagnostic event appears.

## 12.3 Adapting the diagnostic information

### 12.3.1 Adapting the diagnostic behavior



Each item of diagnostic information is assigned a specific diagnostic behavior at the factory. The user can change this assignment for specific diagnostic information in the **Diagnostic settings** submenu.

Diagnostics → Diagnostic settings

You can assign the following options to the diagnostic number as the diagnostic behavior:

| Options            | Description  |
|--------------------|--|
| Alarm              | The device stops measurement. The signal outputs and totalizers assume the defined alarm condition. A diagnostic message is generated. |
| Warning            | The device continues to measure. The signal outputs and totalizers are not affected. A diagnostic message is generated.                |
| Logbook entry only | The device continues to measure. The diagnostic message is entered only in the <b>Event logbook</b> submenu.                           |
| Off                | The diagnostic event is ignored, and no diagnostic message is generated or entered.  |

## 12.4 Overview of diagnostic information

 In the case of some items of diagnostic information, the diagnostic behavior can be changed. Adapting the diagnostic information →  39

| Diagnostic number                  | Short text                              | Remedy instructions   | Status signal [from the factory] | Diagnostic behavior [from the factory] |
|------------------------------------|---|---|----------------------------------|--|
| <b>Diagnostic of sensor</b>        |   |   |                                  |  |
| 004                                | Sensor defective                        | Change sensor   | S                                | Warning                                |
| 082                                | Data storage inconsistent               | 1. Restart device<br>2. Replace device  | F                                | Alarm                                  |
| 083                                | Memory content inconsistent             | 1. Restart device<br>2. Restore S-DAT   | F                                | Alarm                                  |
| 180                                | Temperature sensor defective            | 1. Check sensor connections<br>2. Replace sensor cable or sensor<br>3. Turn off temperature measurement | F                                | Warning                                |
| 181                                | Sensor connection faulty                | Replace device  | F                                | Alarm                                  |
| <b>Diagnostic of electronic</b>    |   |   |                                  |  |
| 201                                | Electronics faulty                      | 1. Restart device<br>2. Replace device  | F                                | Alarm                                  |
| 242                                | Firmware incompatible                   | 1. Check firmware version<br>2. Flash device  | F                                | Alarm                                  |
| 252                                | Module incompatible                     | Replace device  | F                                | Alarm                                  |
| 270                                | Main electronics defective              | 1. Restart device<br>2. Replace device  | F                                | Alarm                                  |
| 271                                | Main electronics faulty                 | 1. Restart device<br>2. Replace device  | F                                | Alarm                                  |
| 272                                | Electronic module faulty                | Restart device  | F                                | Alarm                                  |
| 273                                | Main electronics defective              | 1. Restart device<br>2. Replace device  | F                                | Alarm                                  |
| 283                                | Memory content inconsistent             | Restart device  | F                                | Alarm                                  |
| 311                                | Electronic module faulty                | Maintenance required!<br>Do not reset device  | M                                | Warning                                |
| 331                                | Firmware update failed in module 1 to n | 1. Update firmware of device<br>2. Restart device   | F                                | Warning                                |
| <b>Diagnostic of configuration</b> |   |   |                                  |  |
| 410                                | Data transfer failed                    | 1. Retry data transfer<br>2. Check connection   | F                                | Alarm                                  |





| Diagnostic number            | Short text                                | Remedy instructions  | Status signal [from the factory] | Diagnostic behavior [from the factory] |
|------------------------------|---|--|----------------------------------|--|
| 412                          | Processing download                       | Download active, please wait   | C                                | Warning                                |
| 437                          | Configuration incompatible                | 1. Update firmware<br>2. Execute factory reset   | F                                | Alarm                                  |
| 438                          | Dataset different                         | 1. Check dataset file<br>2. Check device parameterization<br>3. Download new device parameterization               | M                                | Warning                                |
| 442                          | Frequency output 1 to n saturated         | 1. Check frequency output settings<br>2. Check process   | S                                | Warning <sup>1)</sup>                  |
| 443                          | Pulse output 1 to n saturated             | 1. Check pulse output settings<br>2. Check process   | S                                | Warning <sup>1)</sup>                  |
| 453                          | Flow override active                      | Deactivate flow override   | C                                | Warning                                |
| 484                          | Failure mode simulation active            | Deactivate simulation  | C                                | Alarm                                  |
| 485                          | Process variable simulation active        | Deactivate simulation  | C                                | Warning                                |
| 492                          | Frequency output 1 to n simulation active | Deactivate simulation frequency output   | C                                | Warning                                |
| 493                          | Pulse output simulation active            | Deactivate simulation pulse output   | C                                | Warning                                |
| 494                          | Switch output 1 to n simulation active    | Deactivate simulation switch output  | C                                | Warning                                |
| 495                          | Diagnostic event simulation active        | Deactivate simulation  | C                                | Warning                                |
| 496                          | Status input 1 simulation active          | Deactivate status input simulation   | C                                | Warning                                |
| <b>Diagnostic of process</b> |   |  |                                  |  |
| 834                          | Process temperature too high              | Reduce process temperature   | S                                | Warning <sup>1)</sup>                  |
| 835                          | Process temperature too low               | Increase process temperature   | S                                | Warning <sup>1)</sup>                  |
| 842                          | Process value below limit                 | Low flow cut off active!<br>Check low flow cut off configuration   | S                                | Warning <sup>1)</sup>                  |
| 880                          | Output overloaded                         | Reduce load at the outputs   | S                                | Warning                                |
| 937                          | Sensor symmetry                           | 1. Eliminate external magnetic field near sensor<br>2. Turn off diagnostic message                                 | S                                | Warning <sup>1)</sup>                  |
| 938                          | Coil current not stable                   | 1. Check if external magnetic interference is present<br>2. Check flow value                                       | F                                | Alarm <sup>1)</sup>                    |
| 961                          | Electrode potential out of specification  | 1. Check process conditions<br>2. Check ambient conditions   | S                                | Warning <sup>1)</sup>                  |
| 991                          | Batch process aborted                     | Check process conditions   | F                                | Alarm <sup>1)</sup>                    |
| 992                          | Batch start failed                        | 1. Check fill quantity<br>2. Check device status<br>3. Complete last batch<br>4. Check switch output configuration | F                                | Warning <sup>1)</sup>                  |

1) Diagnostic behavior can be changed.







## 12.5 Pending diagnostic events

The **Diagnostics** menu allows the user to view the current diagnostic event and the previous diagnostic event separately.

-  To call up the measures to rectify a diagnostic event:
- Via "FieldCare" operating tool →  39
  - Via "DeviceCare" operating tool →  39

### Navigation

"Diagnostics" menu → Active diagnostics

| ▶ Active diagnostics        |   |  |
|-----------------------------|---|--|
| Actual diagnostics          | → |  42   |
| Timestamp                   | → |  42   |
| Previous diagnostics        | → |  42   |
| Timestamp                   | → |  42   |
| Operating time from restart | → |  42  |
| Operating time              | → |  42 |

### Parameter overview with brief description



| Parameter                   | Description   | User interface                                |
|-----------------------------|---|---|
| Actual diagnostics          | Displays the currently active diagnostic message.<br>If there is more than one pending diagnostic event, the message for the diagnostic event with the highest priority is displayed. | Positive integer                              |
| Timestamp                   | Displays the timestamp for the currently active diagnostic message.   | Days (d), hours (h), minutes (m), seconds (s) |
| Previous diagnostics        | Displays the diagnostic message for the last diagnostic event that has ended.   | Positive integer                              |
| Timestamp                   | Displays the timestamp of the diagnostic message generated for the last diagnostic event that has ended.  | Days (d), hours (h), minutes (m), seconds (s) |
| Operating time from restart | Indicates how long the device has been in operation since the last time the device was restarted.   | Days (d), hours (h), minutes (m), seconds (s) |
| Operating time              | Indicates how long the device has been in operation.  | Days (d), hours (h), minutes (m), seconds (s) |

## 12.6 Actual diagnostics

The current diagnostic message is displayed under Actual diagnostics. If several diagnostic events are pending at the same time, only the diagnostic message with the highest priority is displayed.



### Navigation path

Diagnostics → Active diagnostics → Actual diagnostics

-  To call up the measures to rectify a diagnostic event:
- Via "FieldCare" operating tool →  39
  - Via "DeviceCare" operating tool →  39

## 12.7 Event logbook

### 12.7.1 Event history

-  To call up the measures to rectify a diagnostic event:
- Via "FieldCare" operating tool →  39
  - Via "DeviceCare" operating tool →  39

### 12.7.2 Overview of information events

Unlike a diagnostic event, an information event is displayed in the event logbook only and not in the diagnostic list.

| Info number | Info name                       |
|-------------|---------------------------------|
| I1000       | ----- (Device ok)               |
| I1089       | Power on                        |
| I1090       | Configuration reset             |
| I1091       | Configuration changed           |
| I1151       | History reset                   |
| I1157       | Memory error event list         |
| I1335       | Firmware changed                |
| I1397       | Fieldbus: access status changed |
| I1398       | CDI: access status changed      |
| I1512       | Download started                |
| I1513       | Download finished               |
| I1514       | Upload started                  |
| I1515       | Upload finished                 |
| I1622       | Calibration changed             |
| I1624       | All totalizers reset            |
| I1629       | CDI: login successful           |
| I1635       | Reset to delivery settings      |

## 12.8 Resetting the measuring device

The entire device configuration or some of the configuration can be reset to a defined state with the **Device reset** parameter (→  43).

### Navigation

"System" menu → Device management → Device reset

### Parameter overview with brief description

| Parameter    | Description   | Selection   |
|--------------|---|---|
| Device reset | Reset the device configuration - either entirely or in part - to a defined state. | <ul style="list-style-type: none"> <li>■ Cancel</li> <li>■ To delivery settings</li> <li>■ Restart device</li> <li>■ Restore S-DAT backup *</li> <li>■ Create T-DAT backup</li> <li>■ Restore T-DAT backup *</li> </ul> |

\* Visibility depends on order options or device settings

## 12.9 Device

The **Device** submenu contains all the parameters that display different information for identifying the device.

### Navigation

"System" menu → Information → Device

| ► Device              |        |
|-----------------------|--------|
| Device name           | → ⓘ 44 |
| Device tag            | → ⓘ 44 |
| Serial number         | → ⓘ 44 |
| Order code            | → ⓘ 44 |
| Firmware version      | → ⓘ 44 |
| Extended order code 1 | → ⓘ 45 |
| Extended order code 2 | → ⓘ 45 |
| Extended order code 3 | → ⓘ 45 |
| ENP version           | → ⓘ 45 |
| Manufacturer          | → ⓘ 45 |

### Parameter overview with brief description

| Parameter        | Description   | User interface / User entry  |
|------------------|---|--|
| Device name      | Displays the name of the transmitter. The transmitter name is also provided on the nameplate of the transmitter.  | Character string comprising numbers, letters and special characters      |
| Device tag       | Enter a unique designation for the measuring point to be able to easily identify it within the plant.   | Character string comprising numbers, letters and special characters (32) |
| Serial number    | Displays the serial number of the measuring device. The serial number is also provided on the nameplate of the sensor and of the transmitter.<br>The serial number can also be used to retrieve further device-related information and documentation via the Operations app or the Device Viewer on the Endress+Hauser website. | Character string comprising numbers, letters and special characters      |
| Order code       | Displays the device order code.<br>The order code is used for instance to order a replacement or spare device or to verify that the device features specified on the order form match the shipping note.  | Character string comprising numbers, letters and special characters      |
| Firmware version | Displays the device firmware version installed.   | Character string comprising numbers, letters and special characters      |

| Parameter             | Description  | User interface / User entry   |
|-----------------------|--|---|
| Extended order code 1 | <p>Displays the first, second and/or third part of the extended order code.</p> <p>Due to character length restrictions, the extended order code is split into a maximum of 3 parameters. The extended order code indicates for each feature in the product structure the selected option, thereby uniquely identifying the device model.</p> <p>The extended order code can also be found on the nameplate.</p> | Character string comprising numbers, letters and special characters |
| Extended order code 2 | <p>Displays the first, second and/or third part of the extended order code.</p> <p>Due to character length restrictions, the extended order code is split into a maximum of 3 parameters. The extended order code indicates for each feature in the product structure the selected option, thereby uniquely identifying the device model.</p> <p>The extended order code can also be found on the nameplate.</p> | Character string comprising numbers, letters and special characters |
| Extended order code 3 | <p>Displays the first, second and/or third part of the extended order code.</p> <p>Due to character length restrictions, the extended order code is split into a maximum of 3 parameters. The extended order code indicates for each feature in the product structure the selected option, thereby uniquely identifying the device model.</p> <p>The extended order code can also be found on the nameplate.</p> | Character string comprising numbers, letters and special characters |
| ENP version           | Displays the version of the electronic nameplate (ENP).  | Character string comprising numbers, letters and special characters |
| Manufacturer          | Displays the manufacturer.   | Character string comprising numbers, letters and special characters |

## 12.10 Firmware history

| Release date | Firmware version | Order code for "Firmware version" | Firmware Changes  | Documentation type     | Documentation           |
|--------------|------------------|-----------------------------------|---|------------------------|-------------------------|
| 06.2024      | 04.00.zz         | Option 76                         | <ul style="list-style-type: none"> <li>▪ New original firmware</li> <li>▪ Can be operated via FieldCare and DeviceCare</li> </ul>             | Operating Instructions | BA02344D/06/EN/01.24-00 |
| 09.2015      | 03.00.zz         | Option A                          | No change in firmware   | Operating Instructions | BA00098D/06/EN/14.15    |
| 08.2014      | 03.00.zz         | Option A                          | <ul style="list-style-type: none"> <li>▪ New original firmware</li> <li>▪ Can be operated via FieldCare and DeviceCare</li> </ul>             | Operating Instructions | BA00098D/06/EN/13.14    |
| 08.2012      | 01.01.zz         | –                                 | No change in firmware   | Operating Instructions | BA00097D/06/EN/14.12    |
| 05.2006      | 02.02.zz         | –                                 | New functionality: <ul style="list-style-type: none"> <li>▪ Automatic pulse width</li> <li>▪ On-value and off-value, status output</li> </ul> | Operating Instructions | BA098D/06/EN/05.06      |

| Release date | Firmware version | Order code for "Firmware version" | Firmware Changes   | Documentation type     | Documentation      |
|--------------|------------------|-----------------------------------|--|------------------------|--------------------|
| 07.2005      | 02.01.zz         | –                                 | Additional "Symmetry" option for pulse output.   | Operating Instructions | BA098D/06/EN/10.05 |
| 12.2003      | 01.00.zz         | –                                 | <ul style="list-style-type: none"> <li>▪ Original firmware</li> <li>▪ Can be operated via FieldCare</li> </ul> | Operating Instructions | BA098D/06/EN/04.04 |

 For the compatibility of the firmware version with the previous version, the installed device description files and operating tools, observe the information about the device in the "Manufacturer's information" document.

-  The manufacturer's information is available:
- In the Download Area of the Endress+Hauser web site: [www.endress.com](http://www.endress.com) → Downloads
  - Specify the following details:
    - Product root: e.g. D5AB  
The product root is the first part of the order code: see the nameplate on the device.
    - Text search: Manufacturer's information
    - Media type: Documentation – Technical Documentation

## 13 Maintenance

### 13.1 Maintenance work

No special maintenance work is required.

#### 13.1.1 Cleaning of surfaces not in contact with the medium

1. Recommendation: Use a lint-free cloth that is either dry or slightly dampened using water.
2. Do not use any sharp objects or aggressive cleaning agents that corrode the surfaces (displays, housing, for example) and seals.
3. Do not use high-pressure steam.
4. Observe the degree of protection of the device.

#### NOTICE

##### **Cleaning agents can damage the surfaces!**

Incorrect cleaning agents can damage the surfaces!

- ▶ Do not use cleaning agents with concentrated mineral acids, bases or organic solvents e.g. benzyl alcohol, methylene chloride, xylene, concentrated glycerol cleaners or acetone.

#### 13.1.2 Cleaning of surfaces in contact with the medium

Note the following for cleaning and sterilization in place (CIP/SIP):

- Use only cleaning agents to which the materials in contact with the medium are sufficiently resistant.
- Observe the permitted maximum medium temperature.

#### 13.1.3 Cleaning with pigs

It is essential to take the internal diameters of the measuring tube and process connection into account when cleaning with pigs. All the dimensions and lengths of the measuring instrument are provided in the separate "Technical Information" document.

#### 13.1.4 Replacing seals

The measuring instrument seals (particularly aseptic molded seals) must be replaced periodically.

The interval between changes depends on the frequency of the cleaning cycles, the cleaning temperature and the medium temperature.

Replacement seals (accessory) →  63

### 13.2 Measuring and test equipment

Endress+Hauser offers a variety of measuring and testing equipment, such as Netilion or device tests.

 Your Endress+Hauser Sales Center can provide detailed information on the services.

List of some of the measuring and testing equipment: →  52

### 13.3 Endress+Hauser services

Endress+Hauser offers a wide variety of services for maintenance such as recalibration, maintenance service or device tests.



Your Endress+Hauser Sales Center can provide detailed information on the services.



## 14 Repair

### 14.1 General information

#### 14.1.1 Repair and conversion concept

The Endress+Hauser repair and conversion concept provides for the following:

- The measuring device cannot be converted.
- If the measuring device is defective, the entire device is replaced.
- It is possible to replace seals.

### 14.2 Endress+Hauser services

Endress+Hauser offers a wide range of services.

 Your Endress+Hauser Sales Center can provide detailed information on the services.

### 14.3 Return

The requirements for safe device return can vary depending on the device type and national legislation.

1. Refer to the web page for information:  
<https://www.endress.com/support/return-material>  
↳ Select the region.
2. If returning the device, pack the device in such a way that it is reliably protected against impact and external influences. The original packaging offers the best protection.

### 14.4 Disposal

 If required by the Directive 2012/19/EU on waste electrical and electronic equipment (WEEE), the product is marked with the depicted symbol in order to minimize the disposal of WEEE as unsorted municipal waste. Do not dispose of products bearing this marking as unsorted municipal waste. Instead, return them to the manufacturer for disposal under the applicable conditions.

#### 14.4.1 Removing the measuring device

1. Switch off the device.

#### WARNING

**Danger to persons from process conditions!**

- ▶ Beware of hazardous process conditions such as pressure in the measuring device, high temperatures or aggressive media.
2. Carry out the mounting and connection steps from the "Mounting the measuring device" and "Connecting the measuring device" sections in reverse order. Observe the safety instructions.

### 14.4.2 Disposing of the measuring device

**⚠ WARNING**

**Danger to personnel and environment from fluids that are hazardous to health.**

- ▶ Ensure that the measuring device and all cavities are free of fluid residues that are hazardous to health or the environment, e.g. substances that have permeated into crevices or diffused through plastic.

Observe the following notes during disposal:

- ▶ Observe valid federal/national regulations.
- ▶ Ensure proper separation and reuse of the device components.



## 15 Accessories

Various accessories, which can be ordered with the device or subsequently from Endress+Hauser, are available for the device. Detailed information on the order code in question is available from your local Endress+Hauser sales center or on the product page of the Endress+Hauser website: [www.endress.com](http://www.endress.com).

### 15.1 Device-specific accessories

| Accessory         | Description   | Order code |
|-------------------|---|------------|
| Seal set          | For regular replacement of the seals on the process connections   | DK5G**_*** |
| Wall mounting kit | For all applications with increased safety or load requirements   | DK5HM**    |
| Mounting kit      | Consists of: <ul style="list-style-type: none"> <li>▪ 2 process connections</li> <li>▪ Screws</li> <li>▪ Seals</li> </ul> | DKH**_**** |

### 15.2 Communication-specific accessories

| Accessory          | Description  |
|--------------------|--|
| FieldCare          | FDT-based plant asset management tool from Endress+Hauser. It can configure all smart field units in your system and helps you manage them. By using the status information, it is also a simple but effective way of checking their status and condition.<br> Operating Instructions BA00027S and BA00059S |
| DeviceCare         | Tool to connect and configure Endress+Hauser field devices.<br> Innovation brochure IN01047S  |
| Commubox FXA291    | Connects Endress+Hauser field devices with a CDI interface (= Endress+Hauser Common Data Interface) and the USB port of a computer or laptop.<br> Technical Information TI00405C  |
| Adapter connection | Adapter connections for installation on other electrical connections: Adapter FXA291 (order number: 71035809)  |

### 15.3 Service-specific accessories

| Accessories     | Description  |
|-----------------|--|
| Applicator      | <p>Software for selecting and sizing Endress+Hauser measuring devices:</p> <ul style="list-style-type: none"> <li>▪ Choice of measuring devices for industrial requirements</li> <li>▪ Calculation of all the necessary data for identifying the optimum flowmeter: e.g. nominal diameter, pressure loss, flow velocity and accuracy.</li> <li>▪ Graphic illustration of the calculation results</li> <li>▪ Determination of the partial order code, administration, documentation and access to all project-related data and parameters over the entire life cycle of a project.</li> </ul> <p>Applicator is available:</p> <ul style="list-style-type: none"> <li>▪ Via the Internet: <a href="https://portal.endress.com/webapp/applicator">https://portal.endress.com/webapp/applicator</a></li> <li>▪ As a downloadable DVD for local PC installation.</li> </ul> |
| Commubox FXA291 | <p>Connects Endress+Hauser field devices with a CDI interface (= Endress +Hauser Common Data Interface) and the USB port of a computer or laptop.</p> <p> Technical Information TI00405C</p>  |

## 16 Technical data

### 16.1 Application

To ensure that the device remains in proper operating condition for its service life, use the measuring device only for media against which the process-wetted materials are sufficiently resistant.

### 16.2 Function and system design

Measuring principle Electromagnetic flow measurement on the basis of *Faraday's law of magnetic induction*.

Measuring system Compact version – transmitter and sensor form a mechanical unit in a fully welded housing.

For information on the structure of the measuring instrument →  10

### 16.3 Input

Measured variable **Direct measured variables**  
Volume flow (proportional to induced voltage)

Measuring range Typically  $v = 0.01$  to  $10$  m/s ( $0.03$  to  $33$  ft/s) with the specified measurement accuracy

*Flow characteristic values in SI units*

| Nominal diameter<br>[mm] | Recommended Flow rate<br>Maximum full scale value<br>[l/s] | Factory settings    |  |
|--------------------------|--|---------------------|--|
|                          |  | Pulse value<br>[ml] | Low flow cut off<br>( $v \sim 0.04$ m/s)<br>[ml/s] |
| 4                        | 0.14   | 0.005               | 0.5  |
| 8                        | 0.5  | 0.02                | 2  |
| 15K <sup>1)</sup>        | 1.2  | 0.1                 | 7  |
| 15                       | 1.66   | 0.1                 | 7  |
| 25                       | 5  | 0.2                 | 16   |

1) Conical version (corresponds to DN 12)



*Flow characteristic values in US units*

| Nominal diameter<br>[in] | Recommended Flow rate<br>Maximum full scale value<br>[gal/s] | Factory settings       |  |
|--------------------------|--|------------------------|--|
|                          |  | Pulse value<br>[oz fl] | Low flow cut off<br>( $v \sim 0.13$ ft/s)<br>[oz fl/s] |
| $\frac{5}{32}$           | 0.035  | 0.0002                 | 0.02   |
| $\frac{5}{16}$           | 0.13   | 0.001                  | 0.08   |

| Nominal diameter | Recommended Flow rate | Factory settings |                                  |
|------------------|-----------------------|------------------|----------------------------------|
|                  |                       | Pulse value      | Low flow cut off (v ~ 0.13 ft/s) |
| [in]             | [gal/s]               | [oz fl]          | [oz fl/s]                        |
| ½K <sup>1)</sup> | 0.32                  | 0.004            | 0.25                             |
| ½                | 0.44                  | 0.004            | 0.25                             |
| 1                | 1.33                  | 0.007            | 0.53                             |

1) Conical version (corresponds to DN 12)

### Recommended measuring range

 Flow limit →  59

Operable flow range

Over 1000 : 1

## 16.4 Output

Output signal

### Pulse/frequency/switch output

|                                      |   |
|--------------------------------------|---|
| <b>Function</b>                      | Can be set to: <ul style="list-style-type: none"> <li>▪ Pulse<br/>Quantity-proportional pulse with pulse width to be configured.</li> <li>▪ Automatic pulse<br/>Quantity-proportional pulse with on/off ratio of 1:1</li> <li>▪ Frequency<br/>Flow-proportional frequency output with 1:1 on/off ratio</li> <li>▪ Switch<br/>Contact for displaying a status</li> </ul> |
| <b>Version</b>                       | Option AA: 2 pulse/frequency/switch outputs<br>Passive, high-side   |
| <b>Maximum output values</b>         | Option AA: 2 pulse/frequency/switch outputs <ul style="list-style-type: none"> <li>▪ DC 30 V</li> <li>▪ 30 mA</li> </ul>  |
| <b>Voltage drop</b>                  | Option AA: 2 pulse/frequency/switch outputs<br>At 25 mA: ≤ DC 3 V   |
| <b>Pulse output</b>                  |   |
| <b>Pulse width</b>                   | Configurable: 0.05 to 2 000 ms  |
| <b>Maximum pulse rate</b>            | 10 000 Impulse/s  |
| <b>Pulse value</b>                   | Configurable  |
| <b>Assignable measured variables</b> | Volume flow   |
| <b>Frequency output</b>              |   |
| <b>Output frequency</b>              | Configurable: 0 to 10 000 Hz  |
| <b>Damping</b>                       | Configurable: 0 to 999.9 s  |
| <b>Pulse/pause ratio</b>             | 1:1   |
| <b>Assignable measured variables</b> | Volume flow   |
| <b>Switch output</b>                 |   |
| <b>Switching behavior</b>            | Binary, conductive or non-conductive  |

|                                   |  |
|-----------------------------------|--|
| <b>Number of switching cycles</b> | Unlimited  |
| <b>Assignable functions</b>       | <ul style="list-style-type: none"> <li>▪ Off</li> <li>▪ On</li> <li>▪ Diagnostic behavior                             <ul style="list-style-type: none"> <li>▪ Alarm</li> <li>▪ Alarm and warning</li> <li>▪ Warning</li> </ul> </li> <li>▪ Limit value:                             <ul style="list-style-type: none"> <li>▪ Off</li> <li>▪ Volume flow</li> <li>▪ Flow velocity</li> </ul> </li> <li>▪ Status                             <ul style="list-style-type: none"> <li>Low flow cut off</li> </ul> </li> </ul> |

Signal on alarm                      Depending on the interface, failure information is displayed as follows.

**Pulse/frequency/switch output**

|                         |  |
|-------------------------|--|
| <b>Pulse output</b>     |  |
| <b>Failure mode</b>     | Choose from: <ul style="list-style-type: none"> <li>▪ Actual value</li> <li>▪ No pulses</li> </ul>   |
| <b>Frequency output</b> |  |
| <b>Failure mode</b>     | Choose from: <ul style="list-style-type: none"> <li>▪ Actual value</li> <li>▪ 0 Hz</li> <li>▪ Definable value between: 0 to 10 000 Hz</li> </ul> |
| <b>Switch output</b>    |  |
| <b>Failure mode</b>     | Choose from: <ul style="list-style-type: none"> <li>▪ Current status</li> <li>▪ Open</li> <li>▪ Closed</li> </ul>                                |

Low flow cut off                      The switch points for low flow cut off are user-selectable.

Galvanic isolation                      Device version: 2 pulse/frequency/switch outputs  
 (Order code for "Output, input": option AA)  
 ▪ Pulse/frequency/switch outputs galvanically isolated from supply potential.  
 ▪ Pulse/frequency/switch outputs not galvanically isolated from each other.

**16.5 Power supply**

Terminal assignment                      →  25

Supply voltage                              DC 24 V (nominal voltage: DC 18 to 30 V)  
 ▪ The power unit must be safety-approved (e.g. PELV, SELV).  
 ▪ The maximum short-circuit current must not exceed 50 A.

Power consumption                      4.0 W (no outputs)

|                     |   |                                    |
|---------------------|---|------------------------------------|
| Current consumption | <b>Order code for "Output, input"</b>       | <b>Maximum current consumption</b> |
|                     | Option AA: 2 pulse/frequency/switch outputs | 250 mA                             |

**Switch-on current**

Option AA: 2 pulse/frequency/switch outputs  
 Max. 1.2 A (< 15 ms)

- Power supply failure
- Totalizers stop at the last value measured.
  - Configuration is retained in the device memory.
  - Error messages (incl. total operated hours) are stored.

Electrical connection →  27

Potential equalization →  28

Cable specification →  25

## 16.6 Performance characteristics

- Reference operating conditions
- Maximum permissible error according to DIN EN 29104
  - Water at +15 to +45 °C (+59 to +113 °F)
  - Medium conductivity: 400 µS/cm ±100 µS/cm
  - Ambient temperature: +22 ±2 °C (+72 ±4 °F)
  - Warm-up period: 30 min
  - Data as indicated in the calibration certificate
  - Measurement error based on accredited calibration rigs according to ISO 17025

**Installation**

- Inlet run > 10 × DN
- Outlet run > 5 × DN
- Measuring instrument is grounded.
- The measuring instrument is centered in the pipe.

Maximum measurement error **Maximum permissible error under reference operating conditions**  
 o.r. = of reading

**Volume flow**

±0.25 % o.r. in the 1 to 4 m/s (3.3 to 13 ft/s) range

 Fluctuations in the supply voltage do not have any effect within the specified range.

**Accuracy of outputs**

The outputs have the following base accuracy specifications.

*Pulse/frequency output*

o.r. = of reading

|                             |  |
|-----------------------------|--|
| <b>Temperature accuracy</b> | Max. ±100 ppm/K o.r. (over the entire ambient temperature range) |
|-----------------------------|--|



|                           |                        |
|---------------------------|------------------------|
| <b>Long-term accuracy</b> | Max. ±0.05 %/Jahr o.r. |
|---------------------------|------------------------|

Repeatability

*DN 25 (500 ml/s), DN 15 (200 ml/s), DN 8 (50 ml/s), DN 4 (10 ml/s); 400 µS/cm*

| Dosing time <sub>a</sub> [s] | Relative standard deviation in relation to the batched volume [%] |
|------------------------------|---|
| 1.5 s < t <sub>a</sub> < 3 s | 0.4   |
| 3 s < t <sub>a</sub> < 5 s   | 0.2   |
| 5 s < t <sub>a</sub>         | 0.1   |

*DN 15K<sup>1)</sup> (200 ml/s); 400 µS/cm*

| Dosing time <sub>a</sub> [s] | Relative standard deviation in relation to the batched volume [%] |
|------------------------------|---|
| 1.5 s < t <sub>a</sub> < 3 s | 0.25  |
| 3 s < t <sub>a</sub> < 5 s   | 0.12  |
| 5 s < t <sub>a</sub>         | 0.08  |

1) Conical version (corresponds to DN 12)

Influence of ambient temperature

**Pulse/frequency output**

|                                |   |
|--------------------------------|---|
| <b>Temperature coefficient</b> | No additional effect. Included in accuracy. |
|--------------------------------|---|

## 16.7 Mounting

Mounting requirements

→  14

## 16.8 Environment

Ambient temperature range

→  19

**Temperature tables**

 Observe the interdependencies between the permitted ambient and fluid temperatures when operating the device in hazardous areas.

 For detailed information on the temperature tables, see the separate document entitled "Safety Instructions" (XA) for the device.

Storage temperature

The storage temperature corresponds to the ambient temperature range →  19.

- Protect the measuring instrument against direct sunlight during storage in order to avoid unacceptably high surface temperatures.
- Select a storage location where moisture cannot collect in the measuring instrument as fungus or bacteria infestation can damage the liner.
- If protective caps or protective covers are mounted, only remove them immediately before mounting the measuring instrument.

Degree of protection

Standard: IP67, Type 4X enclosure, suitable for pollution degree 4

Vibration-resistance and shock-resistance

**Vibration sinusoidal, in accordance with IEC 60068-2-6**

- 2 to 8.4 Hz, 7.5 mm peak
- 8.4 to 2 000 Hz, 2 g peak

**Vibration broad-band random, according to IEC 60068-2-64**

- 10 to 200 Hz, 0.01 g<sup>2</sup>/Hz
- 200 to 2 000 Hz, 0.003 g<sup>2</sup>/Hz
- Total: 2.70 g rms



**Shock half-sine, according to IEC 60068-2-27**

6 ms 50 g

**Rough handling shocks according to IEC 60068-2-31**

Internal cleaning

- CIP cleaning
- SIP cleaning

 Observe the maximum medium temperatures →  58

Electromagnetic compatibility (EMC)

As per IEC/EN 61326

 Details are provided in the Declaration of Conformity.

 This unit is not intended for use in residential environments and cannot guarantee adequate protection of the radio reception in such environments.

## 16.9 Process

Medium temperature range

**Measuring instrument**

-20 to +130 °C (-4 to +266 °F)

**Cleaning**

Process connections with aseptic molded seal and Tri-Clamp: +150 °C (+302 °F) max.  
60 min for CIP and SIP processes

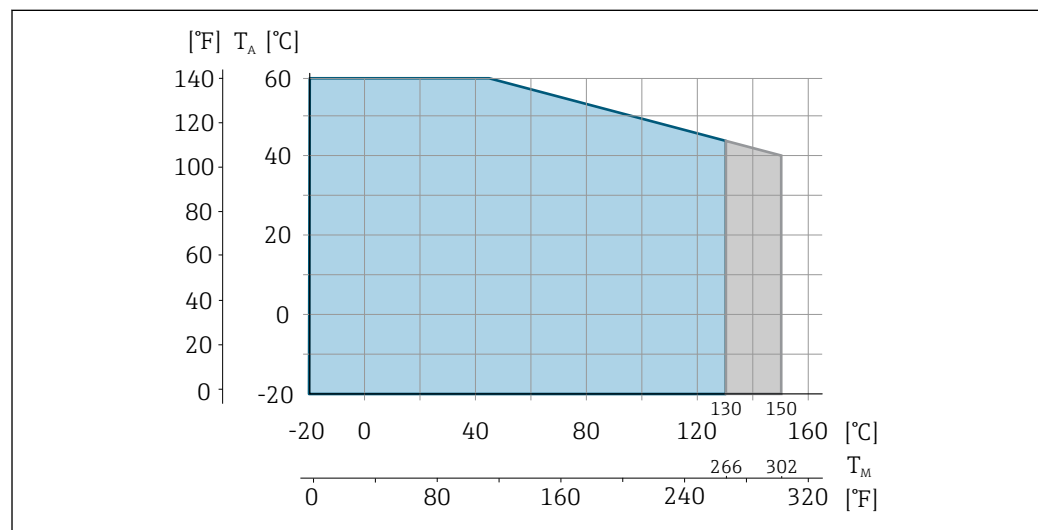

A0004805

- T<sub>A</sub> Ambient temperature
- T<sub>M</sub> Medium temperature
- Blue area: Standard medium temperature range
- Gray area: Medium temperature range for cleaning (max. 60 min)

- Conductivity
- ≥ 5 μS/cm for liquids in general
  - ≥ 10 μS/cm for demineralized water

- Pressure-temperature ratings
-  For an overview of the pressure-temperature ratings for the process connections, see the Technical Information

Pressure tightness *Liner: PFA*

| Nominal diameter |           | Limit values for absolute pressure in [mbar] ([psi]) for fluid temperatures: |   |
|------------------|-----------|--|---|
| [mm]             | [in]      | +25 °C (+77 °F)  | +150 °C (+302 °F)                       |
| 4 to 25          | 5/32 to 1 | > 1 mbar (0.402 inH <sub>2</sub> O) (0)                                      | > 1 mbar (0.402 inH <sub>2</sub> O) (0) |

- Flow limit
- The diameter of the pipe and the flow rate determine the nominal diameter of the measuring instrument. The optimum flow velocity is between 2 to 3 m/s (6.56 to 9.84 ft/s). Also match the flow velocity (v) to the physical properties of the medium:
- v < 2 m/s (6.56 ft/s): for abrasive media (e.g. cleaning agents)
  - v > 2 m/s (6.56 ft/s): for media producing buildup (e.g. liquids containing oil and sugar)
-  A necessary increase in the flow velocity can be achieved by reducing the measuring instrument nominal diameter.
- In the case of media with a high solids content, a measuring instrument with a nominal diameter > DN (8 3/8") can improve the signal stability and cleanability due to the larger electrodes.

- Pressure loss
- For DN 8 (5/16"), DN 15 (1/2") and DN 25 (1"), there is no pressure loss if the measuring device is installed in a pipe with the same nominal diameter.
  - Pressure losses for configurations incorporating adapters according to DIN EN 545 →  19

System pressure →  19

Vibrations →  19

Magnetism and static electricity

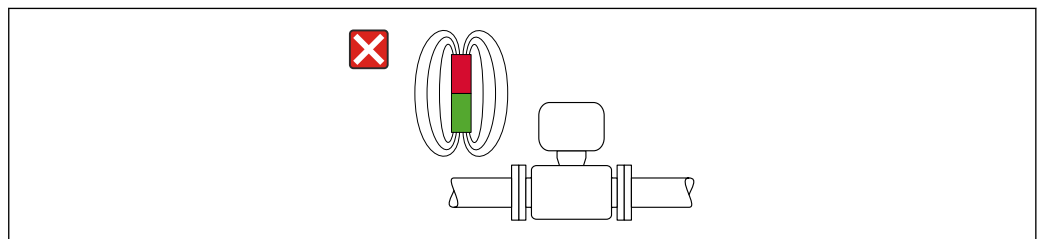

 7 Avoid magnetic fields

A0042152

## 16.10 Mechanical construction

### Design, dimensions



For the dimensions and installation lengths of the device, see the "Technical Information" document, "Mechanical construction" section

### Weight

#### Weight in SI units

| DN [mm]                 | Weight [kg] |
|-------------------------|-------------|
| 4                       | 1.8         |
| 8                       | 1.8         |
| 15K <sup>1)</sup><br>15 | 1.8         |
| 25                      | 2.3         |

1) Conical version (corresponds to DN 12)

#### Weight in US units

| DN [in]  | Weight [lbs] |
|--|--------------|
| $\frac{5}{32}$                                 | 4.0          |
| $\frac{5}{16}$                                 | 4.0          |
| $\frac{1}{2}$ K <sup>1)</sup><br>$\frac{1}{2}$ | 4.0          |
| 1  | 5.1          |

1) Conical version (corresponds to DN 12)

### Materials

#### Measuring instrument housing

- Acid and alkali-resistant outer surface
- Stainless steel, 1.4404 (316/316L)

#### Device plug

| Electrical connection | Material   |
|-----------------------|--|
| M12x1 plug            | <ul style="list-style-type: none"> <li>■ Socket: Polyamide contact support</li> <li>■ Connector: Contact support made of thermoplastic polyurethane (TPU-GF)</li> <li>■ Contacts: Gold-plated brass</li> </ul> |

#### Measuring tube

Stainless steel 1.4301 (304)

#### Liner



PFA (USP Class VI, FDA 21 CFR 177.2600)

#### Electrodes

- 1.4435 (316L)
- Alloy C22, 2.4602 (UNS N06022)
- Platinum
- Tantalum

**Process connections**

- Welding nipple:  
Stainless steel, 1.4404 (316L)
- Clamp connections:  
Stainless steel, 1.4404 (316L)
- Tri-Clamp:  
Stainless steel, 1.4404 (316L)
- Glands:  
PVDF

 Available process connections →  61

**Seals**

Molded seal: FFKM (Kalrez), EPDM, FKM, VMQ (silicone)

**Accessories**

*Wall mounting kit*

Stainless steel, 1.4404 (316L)

Does not meet the hygienic design installation guidelines.

Fitted electrodes

- Standard: stainless steel 1.4435 (316L)
- Optional: Alloy C22, 2.4602 (UNS N06022), platinum, tantalum

Process connections

**With aseptic molded seal**

**Welding nipple**

- EN 10357 (series A)
- ASME BPE (DIN 11866 series C)

**Clamp connections**

Clamp according to DIN 32676 (series A)

**Tri-Clamp**

- Tri-Clamp (ASME BPE)
- ¾" Tri-Clamp L14 AM7
- 1" Tri-Clamp L14 AM7

**With O-ring seal**

**Gland**

G1" external thread (EN ISO 228/EN 10226)

 Process connection materials →  61

Surface roughness

Data relate to surfaces in contact with the medium.

Stainless steel electrodes, 1.4435 (316L); Alloy C22, 2.4602 (UNS N06022), platinum, tantalum:

≤ 0.3 to 0.5 µm (11.8 to 19.7 µin)

Liner with PFA:

≤ 0.4 µm (15.7 µin)

Stainless steel process connections:

- With O-ring seal: Ra ≤ 1.6 µm (63 µin)
- With aseptic molded seal: R<sub>amax</sub> = 0.76 µm (30 µin)

## 16.11 Operability

|                  |   |
|------------------|---|
| Languages        | Can be operated in the following languages:<br>Via "FieldCare", "DeviceCare" operating tool: English, German, French, Spanish, Italian, Chinese, Japanese |
| Local operation  | This device cannot be operated locally using a display or operating elements.   |
| Remote operation | →  31  |

## 16.12 Certificates and approvals

Current certificates and approvals for the product are available at [www.endress.com](http://www.endress.com) on the relevant product page:

1. Select the product using the filters and search field.
2. Open the product page.
3. Select **Downloads**.

|              |  |
|--------------|--|
| CE mark      | The device meets the legal requirements of the applicable EU Directives. These are listed in the corresponding EU Declaration of Conformity along with the standards applied.<br>Endress+Hauser confirms successful testing of the device by affixing to it the CE mark.   |
| UKCA marking | The device meets the legal requirements of the applicable UK regulations (Statutory Instruments). These are listed in the UKCA Declaration of Conformity along with the designated standards. By selecting the order option for UKCA marking, Endress+Hauser confirms a successful evaluation and testing of the device by affixing the UKCA mark.<br><br>Contact address Endress+Hauser UK:<br>Endress+Hauser Ltd.<br>Floats Road<br>Manchester M23 9NF<br>United Kingdom<br><a href="http://www.uk.endress.com">www.uk.endress.com</a> |
| RCM marking  | The measuring system meets the EMC requirements of the "Australian Communications and Media Authority (ACMA)".   |
| Ex-approval  | <ul style="list-style-type: none"> <li>■ Only measuring instruments with the order code for "Approval", option "BT", "FC" and "US" have an Ex approval.</li> <li>■ The devices are certified for use in hazardous areas and the relevant safety instructions are provided in the separate "Safety Instructions" (XA) document. Reference is made to this document on the nameplate.</li> </ul>   |

## Hygienic compatibility

- 3-A SSI 28-06 or more recent
  - Confirmation by affixing the 3-A logo.
  - The 3-A approval refers to the measuring instrument.
  - When installing the measuring instrument, ensure that no liquid can accumulate on the outside of the measuring instrument.
- EHEDG Type EL Class I
  - Confirmation by affixing the EHEDG symbol.
  - EPDM is not a suitable seal material for media with a fat content > 8 %.
  - To meet the requirements for EHEDG certification, the device must be used with process connections in accordance with the EHEDG position paper entitled "Easy cleanable Pipe couplings and Process connections" ([www.ehedg.org](http://www.ehedg.org)).
- Seals: FDA-compliant (except Kalrez seals)
- Pasteurized Milk Ordinance (PMO)



## Pressure Equipment Directive

- With the marking
  - a) PED/G1/x (x = category) or
  - b) PESR/G1/x (x = category)
 on the sensor nameplate, Endress+Hauser confirms compliance with the "Essential Safety Requirements"
  - a) specified in Annex I of the Pressure Equipment Directive 2014/68/EU or
  - b) Schedule 2 of Statutory Instruments 2016 No. 1105.
- Devices not bearing this marking (without PED or PESR) are designed and manufactured according to sound engineering practice. They meet the requirements of
  - a) Art. 4 Para. 3 of the Pressure Equipment Directive 2014/68/EU or
  - b) Part 1, Para. 8 of Statutory Instruments 2016 No. 1105.
 The scope of application is indicated
  - a) in diagrams 6 to 9 in Annex II of the Pressure Equipment Directive 2014/68/EU or
  - b) Schedule 3, Para. 2 of Statutory Instruments 2016 No. 1105.

## External standards and guidelines

- EN 60529  
Degrees of protection provided by enclosures (IP code)
- EN 61010-1  
Safety requirements for electrical equipment for measurement, control and laboratory use
- EN 61326-1/-2-3  
EMC requirements for electrical equipment for measurement, control and laboratory use
- CAN/CSA C22.2 No. 61010-1-12  
Safety Requirements for Electrical Equipment for Measurement, Control and Laboratory Use, Part 1: General Requirements
- ANSI/ISA-61010-1 (82.02.01)  
Safety Requirements for Electrical Equipment for Measurement, Control and Laboratory Use – Part 1: General Requirements

## 16.13 Accessories

 Overview of accessories available to order →  51

## 16.14 Documentation

-  For an overview of the scope of the associated Technical Documentation, refer to the following:
  - *Device Viewer* ([www.endress.com/deviceviewer](http://www.endress.com/deviceviewer)): Enter the serial number from the nameplate
  - *Endress+Hauser Operations app*: Enter serial number from nameplate or scan matrix code on nameplate.

Standard documentation **Brief Operating Instructions**

| Measuring instrument | Documentation code |
|----------------------|--------------------|
| Dosimag              | KA01687D           |

**Description of device parameters**

| Measuring instrument | Documentation code |
|----------------------|--------------------|
| Dosimag              | GP01217D           |

**Technical Information**

| Measuring instrument | Documentation code |
|----------------------|--------------------|
| Dosimag              | TI01784D           |

Supplementary device-dependent documentation **Safety instructions**

| Contents               | Documentation code |
|------------------------|--------------------|
| ATEX Ex ec             | XA03265D           |
| UL Class I, Division 2 | XA03266D           |
| UKEX Ex ec             | XA03267D           |

**Installation instructions**

| Contents  | Note   |
|---|--|
| Installation instructions for spare part sets and accessories | <ul style="list-style-type: none"> <li>▪ Access the overview of all the available spare part sets via <i>Device Viewer</i></li> <li>▪ Accessories available for order with Installation Instructions → 📖 51</li> </ul> |



# Index

## A

- Adapters . . . . . 19
- Adapting the diagnostic behavior . . . . . 39
- Ambient conditions
  - Ambient temperature . . . . . 19
  - Storage temperature . . . . . 57
  - Vibration-resistance and shock-resistance . . . . . 58
- Ambient temperature
  - Influence . . . . . 57
- Ambient temperature range . . . . . 19
- Application . . . . . 53
  - Resetting the totalizer . . . . . 37
  - Totalizer reset . . . . . 37
- Approvals . . . . . 62

## C

- CE mark . . . . . 9, 62
- Certificates . . . . . 62
- Check
  - Connection . . . . . 30
  - Mounting . . . . . 24
  - Received goods . . . . . 11
- Checklist
  - Post-connection check . . . . . 30
  - Post-mounting check . . . . . 24
- CIP cleaning . . . . . 58
- Commissioning . . . . . 35
  - Configuring the measuring instrument . . . . . 35
- Conductivity . . . . . 59
- Connecting cable . . . . . 25
- Connecting requirements . . . . . 25
- Connecting the measuring instrument
  - Device plug . . . . . 27
  - Grounding . . . . . 27
- Connection
  - see Electrical connection
- Current consumption . . . . . 56

## D

- Date of manufacture . . . . . 12
- Declaration of Conformity . . . . . 9
- Degree of protection . . . . . 29, 57
- Design
  - Measuring instrument . . . . . 10
- Device components . . . . . 10
- Device description files . . . . . 34
- Device locking, status . . . . . 36
- Device name
  - Measuring instrument . . . . . 12
- Device Viewer . . . . . 11
- DeviceCare . . . . . 33
  - Device description file . . . . . 34
- Diagnostic information
  - Design, description . . . . . 39
  - DeviceCare . . . . . 38
  - FieldCare . . . . . 38

- Overview . . . . . 40
- Remedial measures . . . . . 40
- Diagnostic list . . . . . 42
- Display
  - Current diagnostic event . . . . . 42
  - Previous diagnostic event . . . . . 42
- Display values
  - For locking status . . . . . 36
- Disposal . . . . . 49
- Document
  - Function . . . . . 5
  - Symbols . . . . . 5
- Document function . . . . . 5
- Documentation . . . . . 63
- Down pipe . . . . . 14

## E

- Electrical connection
  - Degree of protection . . . . . 29
  - Measuring instrument . . . . . 25
- Electromagnetic compatibility . . . . . 58
- Endress+Hauser services
  - Maintenance . . . . . 48
  - Repair . . . . . 49
- Error messages
  - see Diagnostic messages
- Event history . . . . . 43
- Event list . . . . . 43
- Ex-approval . . . . . 62
- Extended order code
  - Measuring instrument . . . . . 12

## F

- Field of application
  - Residual risks . . . . . 9
- FieldCare . . . . . 32
  - Device description file . . . . . 34
  - Establishing a connection . . . . . 32
  - Function . . . . . 32
  - User interface . . . . . 33
- Firmware
  - Release date . . . . . 34
  - Version . . . . . 34
- Firmware history . . . . . 45
- Fitted electrodes . . . . . 61
- Flow direction . . . . . 16
- Flow limit . . . . . 59
- Functions
  - see Parameter

## G

- Galvanic isolation . . . . . 55

## H

- Hygienic compatibility . . . . . 63

|  |    |
|--|----|
| <b>I</b>   |    |
| Identifying the measuring instrument . . . . .   | 11 |
| Incoming acceptance . . . . .                    | 11 |
| Influence  |    |
| Ambient temperature . . . . .                    | 57 |
| Information about this document . . . . .        | 5  |
| Inlet runs . . . . .                             | 18 |
| Input . . . . .                                  | 53 |
| Installation                                     |    |
| Mounting . . . . .                               | 21 |
| Installation conditions                          |    |
| Partially filled pipe . . . . .                  | 15 |
| System pressure . . . . .                        | 19 |
| Installation dimensions . . . . .                | 18 |
| Intended use . . . . .                           | 8  |
| Internal cleaning . . . . .                      | 58 |
| <b>L</b>   |    |
| Languages, operation options . . . . .           | 62 |
| Local operation . . . . .                        | 62 |
| Low flow cut off . . . . .                       | 55 |
| <b>M</b>   |    |
| Magnetism . . . . .                              | 59 |
| Maintenance work . . . . .                       | 47 |
| Replacing seals . . . . .                        | 47 |
| Materials . . . . .                              | 60 |
| Maximum measurement error . . . . .              | 56 |
| Measured variables                               |    |
| Measured . . . . .                               | 53 |
| see Process variables                            |    |
| Measuring and test equipment . . . . .           | 47 |
| Measuring device                                 |    |
| Conversion . . . . .                             | 49 |
| Disposal . . . . .                               | 50 |
| Removing . . . . .                               | 49 |
| Repair . . . . .                                 | 49 |
| Switching on . . . . .                           | 35 |
| Measuring instrument . . . . .                   | 34 |
| Configuring . . . . .                            | 35 |
| Design . . . . .                                 | 10 |
| Mounting the measuring instrument                |    |
| Cleaning with pigs . . . . .                     | 47 |
| Mounting grounding rings . . . . .               | 23 |
| Mounting the seals . . . . .                     | 22 |
| Welding nipple . . . . .                         | 22 |
| Preparing for mounting . . . . .                 | 22 |
| Measuring principle . . . . .                    | 53 |
| Measuring range . . . . .                        | 53 |
| Measuring system . . . . .                       | 53 |
| Medium temperature range . . . . .               | 58 |
| Menus  |    |
| For measuring instrument configuration . . . . . | 35 |
| Mounting . . . . .                               | 14 |
| Mounting dimensions                              |    |
| see Installation dimensions                      |    |
| Mounting location . . . . .                      | 14 |
| Mounting preparations . . . . .                  | 22 |

|  |        |
|--|--------|
| Mounting requirements                        |        |
| Adapters . . . . .                           | 19     |
| Down pipe . . . . .                          | 14     |
| Inlet and outlet runs . . . . .              | 18     |
| Installation dimensions . . . . .            | 18     |
| Mounting location . . . . .                  | 14     |
| Orientation . . . . .                        | 16     |
| Vibrations . . . . .                         | 19     |
| Mounting tool . . . . .                      | 21     |
| <b>N</b>                                     |        |
| Nameplate                                    |        |
| Measuring instrument . . . . .               | 12     |
| Netilion . . . . .                           | 47     |
| <b>O</b>                                     |        |
| Operable flow range . . . . .                | 54     |
| Operation . . . . .                          | 36     |
| Operation options . . . . .                  | 31     |
| Operational safety . . . . .                 | 9      |
| Order code . . . . .                         | 12     |
| Orientation                                  |        |
| Filling systems . . . . .                    | 17     |
| Orientation (vertical, horizontal) . . . . . | 16     |
| Outlet runs . . . . .                        | 18     |
| Output signal . . . . .                      | 54     |
| Output variables . . . . .                   | 54     |
| <b>P</b>                                     |        |
| Packaging disposal . . . . .                 | 13     |
| Parameter settings                           |        |
| Active diagnostics (Submenu) . . . . .       | 42     |
| Device (Submenu) . . . . .                   | 44     |
| Device management (Submenu) . . . . .        | 36, 43 |
| Measured values (Submenu) . . . . .          | 36     |
| Totalizer handling (Submenu) . . . . .       | 37     |
| User management (Submenu) . . . . .          | 36     |
| Partially filled pipe . . . . .              | 15     |
| Performance characteristics . . . . .        | 56     |
| Pin assignment, device plug . . . . .        | 25     |
| Post-connection check . . . . .              | 35     |
| Post-connection check (checklist) . . . . .  | 30     |
| Post-mounting check . . . . .                | 35     |
| Post-mounting check (checklist) . . . . .    | 24     |
| Potential equalization . . . . .             | 28     |
| Power consumption . . . . .                  | 55     |
| Power supply failure . . . . .               | 56     |
| Pressure Equipment Directive . . . . .       | 63     |
| Pressure loss . . . . .                      | 59     |
| Pressure tightness . . . . .                 | 59     |
| Pressure-temperature ratings . . . . .       | 59     |
| Process conditions                           |        |
| Conductivity . . . . .                       | 59     |
| Flow limit . . . . .                         | 59     |
| Medium temperature . . . . .                 | 58     |
| Pressure loss . . . . .                      | 59     |
| Pressure tightness . . . . .                 | 59     |
| Process connections . . . . .                | 61     |
| Product safety . . . . .                     | 9      |

|   |        |
|---|--------|
| <b>R</b>  |        |
| RCM marking . . . . .   | 62     |
| Reading measured values . . . . .                                     | 36     |
| Recalibration . . . . .   | 48     |
| Reference operating conditions . . . . .                              | 56     |
| Registered trademarks . . . . .                                       | 7      |
| Remote operation . . . . .  | 62     |
| Repair . . . . .  | 49     |
| Repeatability . . . . .   | 57     |
| Replacement   |        |
| Device components . . . . .   | 49     |
| Replacing seals . . . . .   | 47     |
| Requirements for personnel . . . . .                                  | 8      |
| Return . . . . .  | 49     |
| <b>S</b>  |        |
| Safety . . . . .  | 8      |
| Serial number . . . . .   | 12     |
| Settings  |        |
| Adapting the measuring instrument to the process conditions . . . . . | 36     |
| Resetting the device . . . . .  | 43     |
| Signal on alarm . . . . .   | 55     |
| SIP cleaning . . . . .  | 58     |
| Special mounting instructions   |        |
| Hygienic compatibility . . . . .                                      | 20     |
| Standards and guidelines . . . . .                                    | 63     |
| Static electricity . . . . .  | 59     |
| Status signals . . . . .  | 38     |
| Storage conditions . . . . .  | 13     |
| Storage temperature . . . . .   | 13     |
| Storage temperature range . . . . .                                   | 57     |
| Submenu   |        |
| Active diagnostics . . . . .  | 42     |
| Device . . . . .  | 44     |
| Device management . . . . .   | 36, 43 |
| Event list . . . . .  | 43     |
| Measured values . . . . .   | 36     |
| Totalizer handling . . . . .  | 37     |
| User management . . . . .   | 36     |
| Supply unit   |        |
| Requirements . . . . .  | 26     |
| Supply voltage . . . . .  | 26, 55 |
| Surface roughness . . . . .   | 61     |
| System design   |        |
| Measuring system . . . . .  | 53     |
| see Measuring instrument design                                       |        |
| System integration . . . . .  | 34     |
| System pressure . . . . .   | 19     |
| <b>T</b>  |        |
| Technical data, overview . . . . .                                    | 53     |
| Temperature range   |        |
| Storage temperature . . . . .   | 13     |
| Terminal assignment . . . . .   | 25     |
| Tool  |        |
| Mounting . . . . .  | 21     |
| Transporting . . . . .  | 13     |
| Transporting the measuring instrument . . . . .                       | 13     |
| Troubleshooting   |        |
| General . . . . .   | 38     |
| <b>U</b>  |        |
| UKCA marking . . . . .  | 62     |
| Use of measuring device   |        |
| Borderline cases . . . . .  | 8      |
| Incorrect use . . . . .   | 8      |
| Use of measuring instrument   |        |
| see Intended use  |        |
| <b>V</b>  |        |
| Vibration-resistance and shock-resistance . . . . .                   | 58     |
| Vibrations . . . . .  | 19     |
| <b>W</b>  |        |
| Weight  |        |
| SI units . . . . .  | 60     |
| Transport (notes) . . . . .   | 13     |
| US units . . . . .  | 60     |
| Workplace safety . . . . .  | 9      |



71656461

[www.addresses.endress.com](http://www.addresses.endress.com)

---