

Operating Instructions

Levelflex FMP55

HART

Guided-wave radar



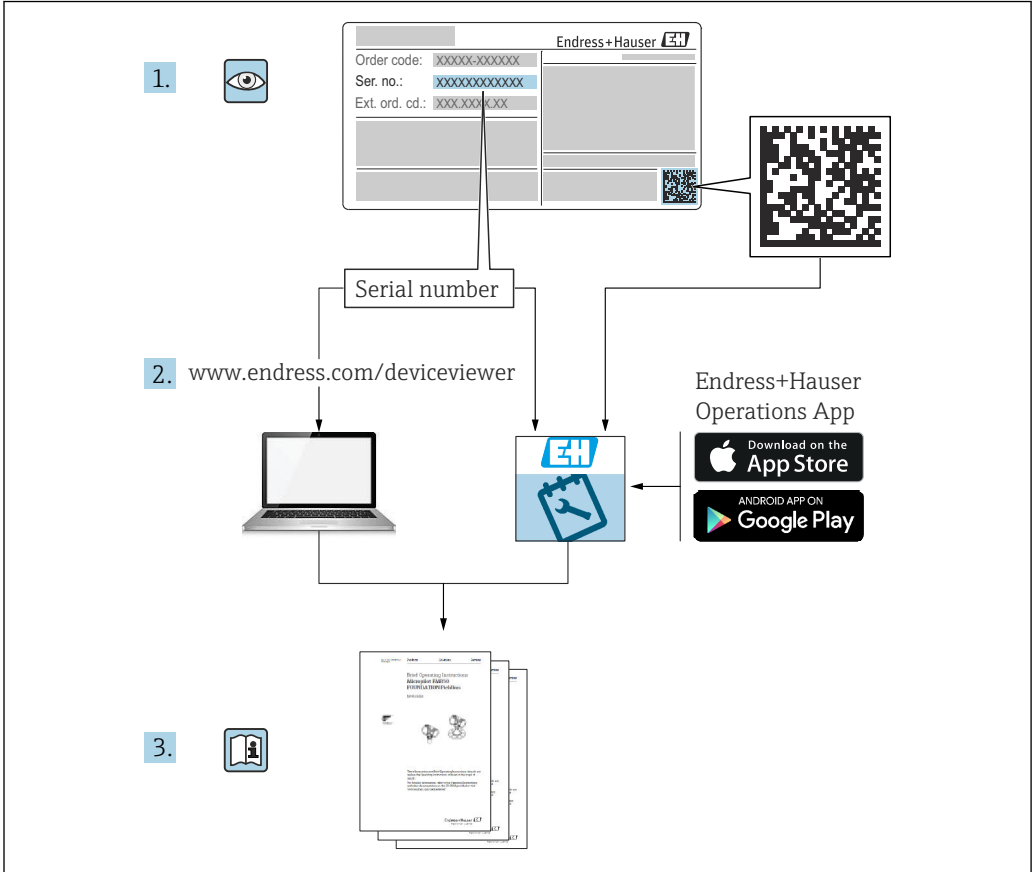

A0023555

Table of contents

1	Important document information	5		
1.1	Purpose of this document	5		
1.2	Symbols	5		
1.2.1	Safety symbols	5		
1.2.2	Electrical symbols	5		
1.2.3	Tool symbols	5		
1.2.4	Symbols for certain types of information and graphics	6		
1.3	Documentation	7		
1.3.1	Technical Information (TI)	7		
1.3.2	Brief Operating Instructions (KA)	7		
1.3.3	Safety Instructions (XA)	7		
1.3.4	Functional Safety Manual (FY)	7		
1.4	Terms and abbreviations	7		
1.5	Registered trademarks	8		
2	Basic safety instructions	9		
2.1	Requirements for the personnel	9		
2.2	Intended use	9		
2.3	Workplace safety	10		
2.4	Operational safety	10		
2.5	Product safety	10		
2.5.1	CE mark	10		
2.5.2	EAC conformity	10		
3	Product description	11		
3.1	Product design	11		
3.1.1	Levelflex FMP51/FMP52/FMP54/FMP55	11		
3.1.2	Electronics housing	12		
4	Incoming acceptance and product identification	13		
4.1	Incoming acceptance	13		
4.2	Product identification	13		
4.2.1	Nameplate	14		
5	Storage, transport	15		
5.1	Storage temperature	15		
5.2	Transporting the product to the measuring point	15		
6	Mounting	17		
6.1	Mounting requirements	17		
6.1.1	Suitable mounting position	17		
6.1.2	Mounting under confined conditions	18		
6.1.3	Notes on the mechanical load of the probe	19		
6.1.4	Lateral loading capacity (flexural strength) of coax probes	19		
6.1.5	Mounting cladded flanges	20		
6.1.6	Securing the probe	21		
6.1.7	Special installation situations	22		
6.2	Mounting the measuring device	26		
6.2.1	Tool list	26		
6.2.2	Mounting the device	26		
6.2.3	Mounting the "Sensor, remote" version	26		
6.2.4	Turning the transmitter housing	28		
6.2.5	Turning the display	29		
6.3	Post-installation check	29		
7	Electrical connection	31		
7.1	Connecting requirements	31		
7.1.1	Terminal assignment	31		
7.1.2	Cable specification	36		
7.1.3	Device plug	36		
7.1.4	Supply voltage	38		
7.1.5	Overvoltage protection	40		
7.2	Connecting the device	40		
7.2.1	Opening cover	41		
7.2.2	Connecting	41		
7.2.3	Plug-in spring-force terminals	41		
7.2.4	Closing the cover of the connection compartment	42		
7.3	Post-connection check	42		
8	Operation methods	43		
8.1	Overview	43		
8.1.1	Local operation	43		
8.1.2	Operation with remote display and operating module FHX50	44		
8.1.3	Operation via Bluetooth® wireless technology	45		
8.1.4	Remote operation	46		
8.2	Structure and function of the operating menu	47		
8.2.1	Structure of the operating menu	47		
8.2.2	User roles and related access authorization	49		
8.2.3	Data access - Security	49		
8.3	Display and operating module	54		
8.3.1	Display	54		
8.3.2	Operating elements	57		
8.3.3	Entering numbers and text	58		
8.3.4	Opening the context menu	59		
8.3.5	Envelope curve display on the display and operating module	61		
9	Device integration via the HART protocol	62		
9.1	Overview of the Device Description files (DD)	62		
9.2	HART device variables and measuring values	62		

10	Commissioning via SmartBlue (App)	63		
10.1	Prerequisites	63		
10.2	SmartBlue App	63		
10.3	Envelope curve display in SmartBlue	63		
11	Commissioning using the Commissioning Wizard	65		
12	Commissioning via operating menu	66		
12.1	Function check	66		
12.2	Setting the operating language	66		
12.3	Configuring interface measurement	67		
12.4	Recording the reference envelope curve	69		
12.5	Configuring the local display	70		
12.5.1	Factory setting of local display for interface measurements	70		
12.5.2	Adjusting the local display	70		
12.6	Configuring the current outputs	71		
12.6.1	Factory setting of current outputs for interface measurements	71		
12.6.2	Adjusting the current outputs	71		
12.7	Configuration management	72		
12.8	Protecting settings from unauthorized access	73		
13	Diagnostics and troubleshooting	74		
13.1	General troubleshooting	74		
13.1.1	General errors	74		
13.1.2	Error - SmartBlue operation	76		
13.1.3	Parametrization errors	77		
13.2	Diagnostic information on local display	78		
13.2.1	Diagnostic message	78		
13.2.2	Calling up remedial measures	80		
13.3	Diagnostic event in the operating tool	81		
13.4	Diagnostic list	82		
13.5	List of diagnostic events	83		
13.6	Event logbook	85		
13.6.1	Event history	85		
13.6.2	Filtering the event logbook	85		
13.6.3	Overview of information events	85		
13.7	Firmware history	87		
14	Maintenance	88		
14.1	Exterior cleaning	88		
14.2	General cleaning instructions	88		
14.3	Cleaning coax probes	88		
15	Repair	89		
15.1	General information	89		
15.1.1	Repair concept	89		
15.1.2	Repair of Ex-certified devices	89		
15.1.3	Replacing electronics modules	89		
15.1.4	Replacing a device	89		
15.2	Spare parts	90		
15.3	Return	90		
15.4	Disposal	90		
16	Accessories	91		
16.1	Device-specific accessories	91		
16.1.1	Weather protection cover	91		
16.1.2	Mounting bracket for electronics housing	92		
16.1.3	Centering star	93		
16.1.4	Remote display FHX50	94		
16.1.5	Overvoltage protection	95		
16.1.6	Bluetooth module BT10 for HART devices	96		
16.2	Communication-specific accessories	97		
16.3	Service-specific accessories	98		
16.4	System components	98		
17	Operating menu	99		
17.1	Overview of the operating menu (SmartBlue)	99		
17.2	Overview of the operating menu (display module)	104		
17.3	Overview of the operating menu (operating tool)	111		
17.4	"Setup" menu	118		
17.4.1	"Mapping" wizard	128		
17.4.2	"Advanced setup" submenu	129		
17.5	"Diagnostics" menu	180		
17.5.1	"Diagnostic list" submenu	182		
17.5.2	"Event logbook" submenu	183		
17.5.3	"Device information" submenu	184		
17.5.4	"Measured values" submenu	187		
17.5.5	"Data logging" submenu	190		
17.5.6	"Simulation" submenu	193		
17.5.7	"Device check" submenu	198		
17.5.8	"Heartbeat" submenu	200		
	Index	201		

1 Important document information

1.1 Purpose of this document

These Operating Instructions contain all the information that is required in the various phases of the life cycle of the device: from product identification, incoming acceptance and storage, to mounting, connection, operation and commissioning through to troubleshooting, maintenance and disposal.

1.2 Symbols

1.2.1 Safety symbols

DANGER

This symbol alerts you to a dangerous situation. Failure to avoid this situation will result in serious or fatal injury.

WARNING

This symbol alerts you to a dangerous situation. Failure to avoid this situation can result in serious or fatal injury.

CAUTION

This symbol alerts you to a dangerous situation. Failure to avoid this situation can result in minor or medium injury.

NOTICE

This symbol contains information on procedures and other facts which do not result in personal injury.

1.2.2 Electrical symbols



Alternating current



Direct current and alternating current



Direct current



Ground connection

A grounded terminal which, as far as the operator is concerned, is grounded via a grounding system.

Protective earth (PE)

Ground terminals that must be connected to ground prior to establishing any other connections.

The ground terminals are located on the interior and exterior of the device:

- Interior ground terminal: protective earth is connected to the mains supply.
- Exterior ground terminal: device is connected to the plant grounding system.

1.2.3 Tool symbols



Phillips head screwdriver



Flat blade screwdriver



Torx screwdriver



Allen key



Open-ended wrench

1.2.4 Symbols for certain types of information and graphics



Permitted

Procedures, processes or actions that are permitted



Preferred

Procedures, processes or actions that are preferred



Forbidden

Procedures, processes or actions that are forbidden



Tip

Indicates additional information



Reference to documentation



Reference to graphic



Notice or individual step to be observed

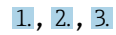

Series of steps



Result of a step



Visual inspection



Operation via operating tool



Write-protected parameter

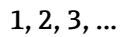

Item numbers

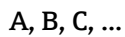

Views



Safety instructions

Observe the safety instructions contained in the associated Operating Instructions



Temperature resistance of the connection cables

Specifies the minimum value of the temperature resistance of the connection cables

1.3 Documentation

The following types of documentation are available in the Download Area of the Endress+Hauser website (www.endress.com/downloads):

-  For an overview of the scope of the associated Technical Documentation, refer to the following:
 - *Device Viewer* (www.endress.com/deviceviewer): Enter the serial number from the nameplate
 - *Endress+Hauser Operations app*: Enter serial number from nameplate or scan matrix code on nameplate.

1.3.1 Technical Information (TI)

Planning aid

The document contains all the technical data on the device and provides an overview of the accessories and other products that can be ordered for the device.

1.3.2 Brief Operating Instructions (KA)

Guide that takes you quickly to the 1st measured value

The Brief Operating Instructions contain all the essential information from incoming acceptance to initial commissioning.

1.3.3 Safety Instructions (XA)

Depending on the approval, the following Safety Instructions (XA) are supplied with the device. They are an integral part of the Operating Instructions.

-  The nameplate indicates the Safety Instructions (XA) that are relevant to the device.

1.3.4 Functional Safety Manual (FY)

Depending on the SIL approval, the Functional Safety Manual (FY) is an integral part of the Operating Instructions and applies in addition to the Operating Instructions, Technical Information and ATEX Safety Instructions.

-  The different requirements that apply for the protective function are described in the Functional Safety Manual (FY).

1.4 Terms and abbreviations

BA

Document type "Operating Instructions"

KA

Document type "Brief Operating Instructions"

TI

Document type "Technical Information"

SD

Document type "Special Documentation"

XA

Document type "Safety Instructions"

PN

Nominal pressure

MWP

Maximum working pressure

The MWP is indicated on the nameplate.

ToF

Time of Flight

FieldCare

Scalable software tool for device configuration and integrated plant asset management solutions

DeviceCare

Universal configuration software for Endress+Hauser HART, PROFIBUS, FOUNDATION Fieldbus and Ethernet field devices

DTM

Device Type Manager

DD

Device Description for HART communication protocol

 ϵ_r (Dk value)

Relative dielectric constant

PLC

Programmable logic controller (PLC)

CDI

Common Data Interface

Operating tool

The term "operating tool" is used in place of the following operating software:

- FieldCare / DeviceCare, for operation via HART communication and PC
- SmartBlue app, for operation using an Android or iOS smartphone or tablet

BD

Blocking Distance; no signals are analyzed within the BD.

PLC

Programmable logic controller (PLC)

CDI

Common Data Interface

PFS

Pulse Frequency Status (Switch output)

1.5 Registered trademarks

HART®

Registered trademark of the FieldComm Group, Austin, Texas, USA

Bluetooth®

The *Bluetooth*® word mark and logos are registered trademarks owned by the Bluetooth SIG, Inc. and any use of such marks by Endress+Hauser is under license. Other trademarks and trade names are those of their respective owners.

Apple®

Apple, the Apple logo, iPhone, and iPod touch are trademarks of Apple Inc., registered in the U.S. and other countries. App Store is a service mark of Apple Inc.

Android®

Android, Google Play and the Google Play logo are trademarks of Google Inc.

KALREZ®, VITON®

Registered trademarks of DuPont Performance Elastomers L.L.C., Wilmington, DE USA

TEFLON®

Registered trademark of E.I. DuPont de Nemours & Co., Wilmington, USA

TRI-CLAMP®

Registered trademark of Ladish & Co., Inc., Kenosha, USA

2 Basic safety instructions

2.1 Requirements for the personnel

The personnel for installation, commissioning, diagnostics and maintenance must fulfill the following requirements:

- ▶ Trained, qualified specialists must have a relevant qualification for this specific function and task.
- ▶ Are authorized by the plant owner/operator.
- ▶ Are familiar with federal/national regulations.
- ▶ Before starting work, read and understand the instructions in the manual and supplementary documentation as well as the certificates (depending on the application).
- ▶ Follow instructions and comply with basic conditions.

The operating personnel must fulfill the following requirements:

- ▶ Are instructed and authorized according to the requirements of the task by the facility's owner-operator.
- ▶ Follow the instructions in this manual.

2.2 Intended use

Application and media

The measuring device described in this manual is intended only for the level and interface measurement of liquids. Depending on the version ordered, the measuring device can also measure potentially explosive, flammable, poisonous and oxidizing media.

If the limit values specified in the "Technical data" and the conditions listed in the instructions and additional documentation are observed, the measuring device may be used for the following measurements only:

- ▶ Measured process variables: level and/or interface height
- ▶ Calculable process variables: volume or mass in any shape of vessel (calculated from the level by the linearization functionality)

To ensure that the measuring device remains in proper condition for the operation time:

- ▶ Use the measuring device only for media to which the process-wetted materials have an adequate level of resistance.
- ▶ Observe the limit values in the "Technical data".

Incorrect use

The manufacturer is not liable for damage caused by improper or non-intended use.

Clarification of borderline cases:

- ▶ For special fluids and fluids for cleaning, Endress+Hauser is glad to provide assistance in verifying the corrosion resistance of fluid-wetted materials, but does not accept any warranty or liability.

Residual risks

Due to heat transfer from the process as well as power loss in the electronics, the temperature of the electronics housing and the assemblies contained therein (e.g. display module, main electronics module and I/O electronics module) may rise up to 80 °C (176 °F). When in operation, the sensor may reach a temperature close to the medium temperature.

Danger of burns from contact with surfaces!

- ▶ In the event of high medium temperatures, ensure protection against contact to prevent burns.

2.3 Workplace safety

When working on and with the device:

- ▶ Wear the required protective equipment according to federal or national regulations.

2.4 Operational safety

Risk of injury!

- ▶ Operate the device only if it is in proper technical condition, free from errors and faults.
- ▶ The operator is responsible for the interference-free operation of the device.

Modifications to the device

Unauthorized modifications to the device are not permitted and can lead to unforeseeable dangers:

- ▶ If modifications are nevertheless required, consult with the manufacturer.

Repair

To ensure continued operational safety and reliability:

- ▶ Carry out repairs on the device only if they are expressly permitted.
- ▶ Observe federal/national regulations pertaining to the repair of an electrical device.
- ▶ Use only original spare parts and accessories from the manufacturer.

Hazardous area

To eliminate danger to persons or the installation when the device is used in the hazardous area (e.g. explosion protection, pressure vessel safety):

- ▶ Check the nameplate to verify whether the ordered device can be put to its intended use in the hazardous area.
- ▶ Observe the specifications in the separate supplementary documentation, which is an integral part of this manual.

2.5 Product safety

This measuring device is designed in accordance with good engineering practice to meet state-of-the-art safety requirements, has been tested, and left the factory in a condition in which it is safe to operate. It meets the general safety standards and legal requirements.

NOTICE

Loss of degree of protection by opening of the device in humid environments

- ▶ If the device is opened in a humid environment, the degree of protection indicated on the nameplate is no longer valid. This may also impair the safe operation of the device.

2.5.1 CE mark

The measuring system meets the legal requirements of the applicable EU directives. These are listed in the corresponding EU Declaration of Conformity together with the standards applied.

The manufacturer confirms successful testing of the device by affixing to it the CE mark.

2.5.2 EAC conformity

The measuring system meets the legal requirements of the applicable EAC guidelines. These are listed in the corresponding EAC Declaration of Conformity along with the standards applied.

The manufacturer confirms successful testing of the device by affixing to it the EAC mark.

3 Product description

3.1 Product design

3.1.1 Levelflex FMP51/FMP52/FMP54/FMP55

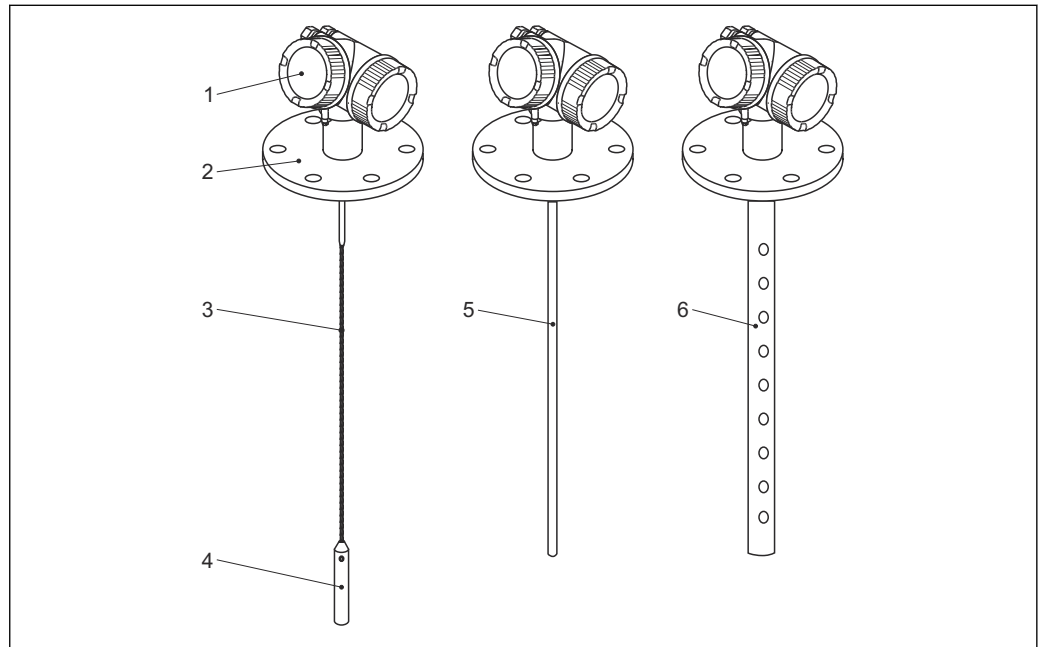

A0012399

1 Design of the Levelflex

- 1 Electronics housing
- 2 Process connection (here as an example: flange)
- 3 Rope probe
- 4 End-of-probe weight
- 5 Rod probe
- 6 Coax probe

3.1.2 Electronics housing

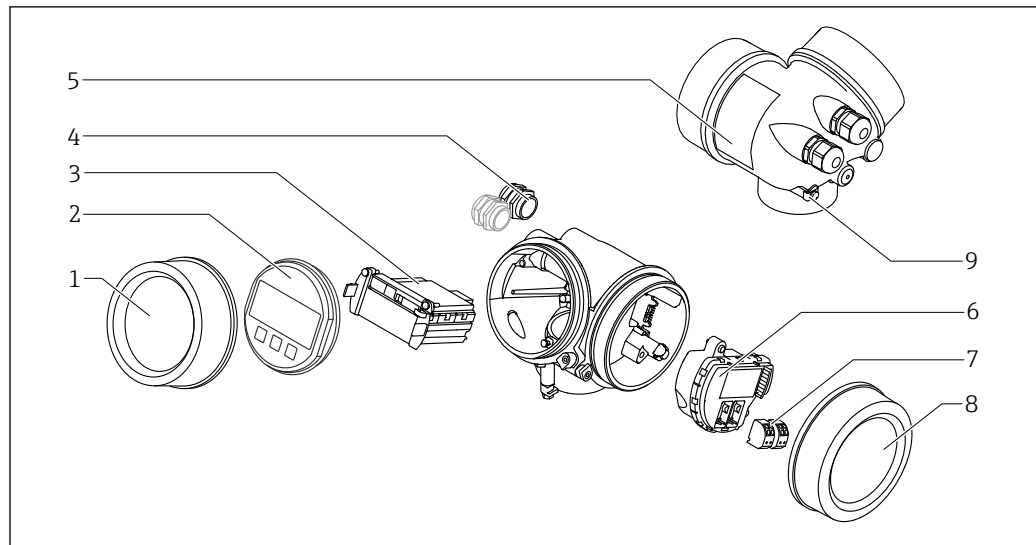

A0012422

2 Design of the electronics housing

- 1 Electronics compartment cover
- 2 Display module
- 3 Main electronics module
- 4 Cable glands (1 or 2, depending on instrument version)
- 5 Nameplate
- 6 I/O electronics module
- 7 Terminals (pluggable spring terminals)
- 8 Connection compartment cover
- 9 Grounding terminal

4 Incoming acceptance and product identification

4.1 Incoming acceptance

Check the following during incoming acceptance:

- Are the order codes on the delivery note and the product sticker identical?
- Are the goods undamaged?
- Do the nameplate data match the ordering information on the delivery note?
- If required (see nameplate): are the Safety Instructions (XA) provided?



If one of these conditions is not met, please contact your Endress+Hauser sales office.

4.2 Product identification

The following options are available for the identification of the measuring device:

- Nameplate specifications
- Order code with breakdown of the device features on the delivery note
- Enter the serial number from the nameplate in *W@M Device Viewer* (www.endress.com/deviceviewer): all the information about the device is displayed.
- Enter the serial number on the nameplate into the *Endress+Hauser Operations App* or scan the 2-D matrix code (QR code) on the nameplate with the *Endress+Hauser Operations App*: all the information about the measuring device is displayed.

4.2.1 Nameplate

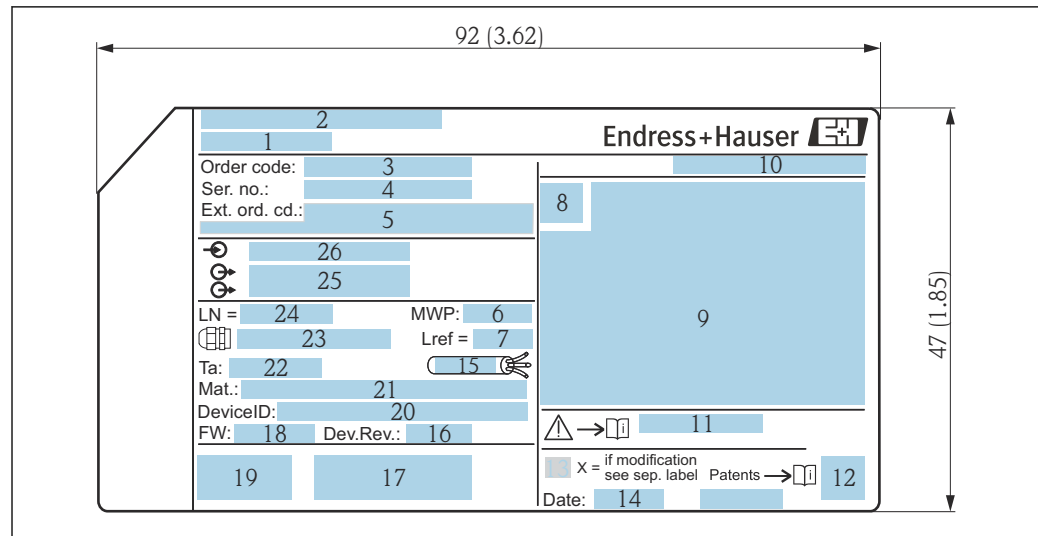

A0010725

 3 Nameplate of the Levelflex; engineering unit: mm (in)

- 1 Device name
- 2 Manufacturer address
- 3 Order code
- 4 Serial number (Ser. no.)
- 5 Extended order code (Ext. ord. cd.)
- 6 Process pressure
- 7 Gas phase compensation: reference length
- 8 Certificate symbol
- 9 Certificate- and approval-related data
- 10 Degree of protection: e.g. IP, NEMA
- 11 Document number of the Safety Instructions: e.g. XA, ZD, ZE
- 12 2-D matrix code (QR code)
- 13 Modification mark
- 14 Manufacturing date: year-month
- 15 Permitted temperature range for cable
- 16 Device revision (Dev.Rev.)
- 17 Additional information about the device version (certificates, approvals, communication protocol): e.g. SIL, PROFIBUS
- 18 Firmware version (FW)
- 19 CE mark, C-Tick
- 20 DeviceID
- 21 Materials in contact with process
- 22 Permitted ambient temperature (T_a)
- 23 Size of the cable gland thread
- 24 Probe length
- 25 Signal outputs
- 26 Supply voltage

 Up to 33 characters of the extended order code are indicated on the nameplate. If the extended order code contains additional characters, these cannot be displayed. However, the complete extended order code can also be displayed via the device operating menu: **Extended order code 1 to 3** parameter

5 Storage, transport

5.1 Storage temperature

- Permitted storage temperature: -40 to +80 °C (-40 to +176 °F)
- Use original packaging.

5.2 Transporting the product to the measuring point

⚠ WARNING

Housing or rod may become damaged or pull off.

Danger of injury!

- ▶ Transport the measuring device to the measuring point in its original packaging or by the process connection.
- ▶ Always secure lifting equipment (slings, eyes, etc.) at the process connection and never lift the device by the electronic housing or probe. Pay attention to the center of gravity of the device so that it does not tilt or slip unintentionally.
- ▶ Follow the safety instructions and transport conditions for devices weighing more than 18 kg (39.6 lbs) (IEC 61010).

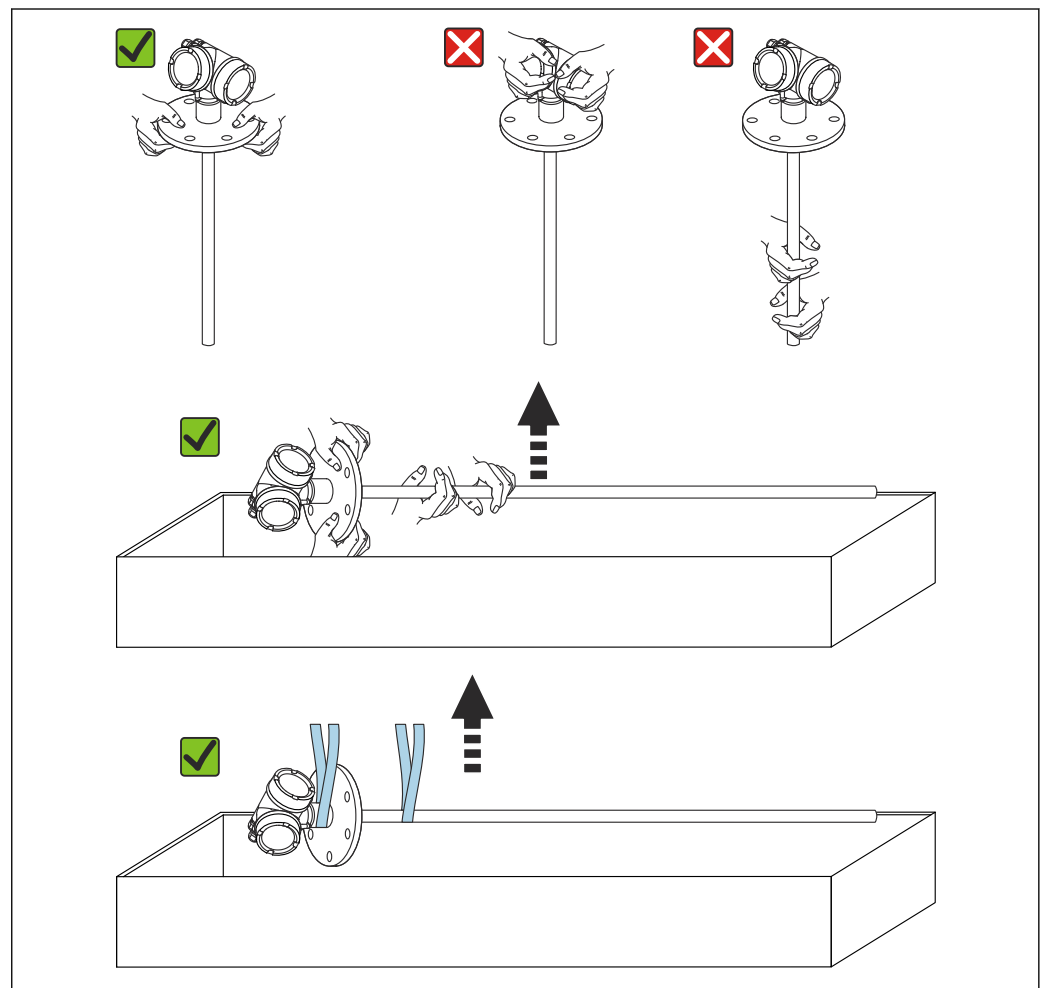

A0013920

NOTICE**Transport lock in the FMP55 with coax probe**

- ▶ The coax tube is not firmly connected to the electronics housing in the FMP55 with coax probe. It is fixed onto the mounting flange with two cable ties during transportation. These cable ties must not be released during transportation or installation of the device to prevent the spacer from sliding at the probe rod. They may only be removed immediately before screwing the process connection flange into place.

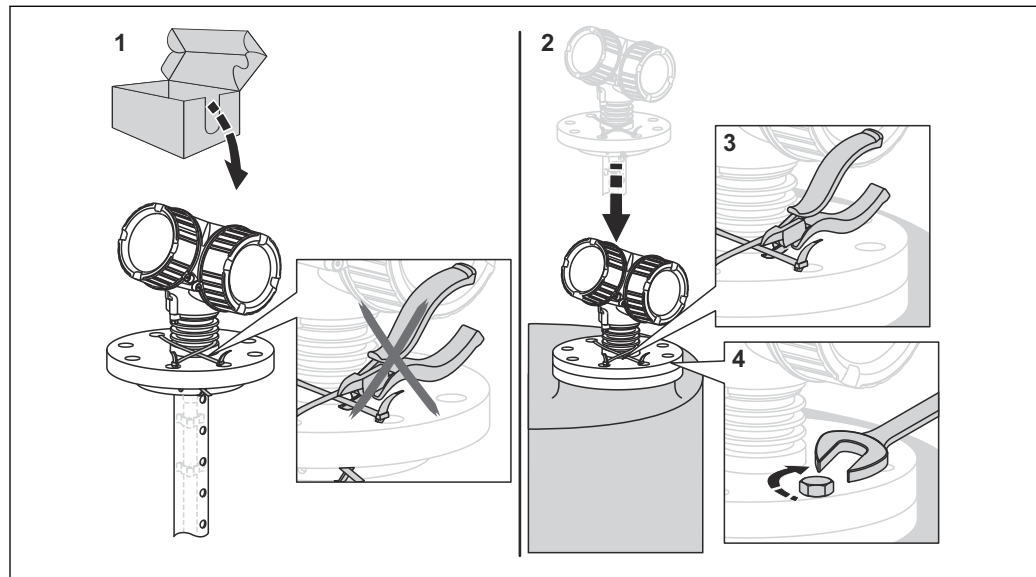

A0015471

6 Mounting

6.1 Mounting requirements

6.1.1 Suitable mounting position

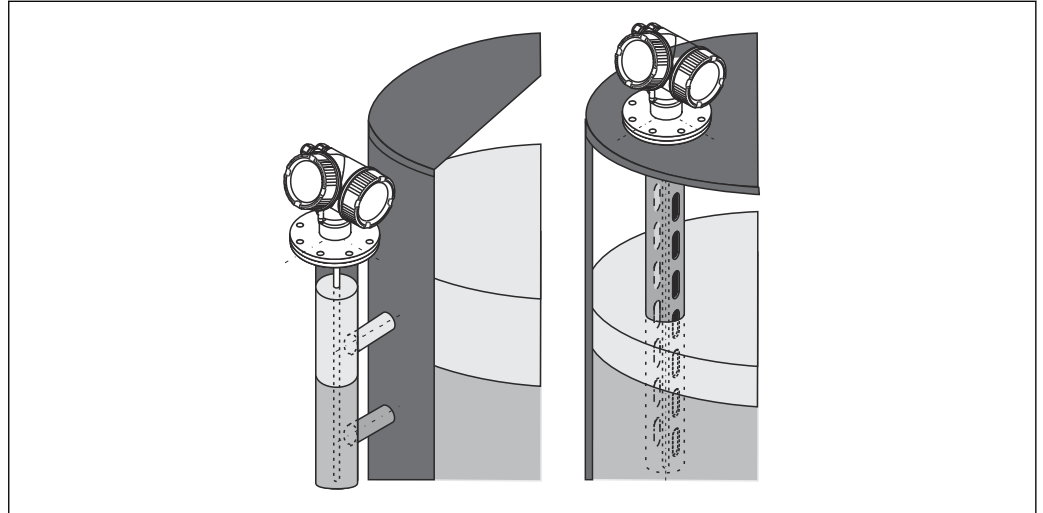

4 Mounting position of Levelflex FMP55

A0011281

- Rod probes/rope probes: mount in the bypass/stilling well.
- Coax probes can be mounted at any distance from the wall.
- When mounting outdoors, a weather protection cover can be used to protect the device against extreme weather conditions.
- Minimum distance from the end of the probe to the bottom of the vessel: 10 mm (0.4 in)

6.1.2 Mounting under confined conditions

Mounting with remote probe

The device version with a remote probe is suitable for applications with restricted mounting space. In this case, the electronics housing is mounted at a separate position from the probe.

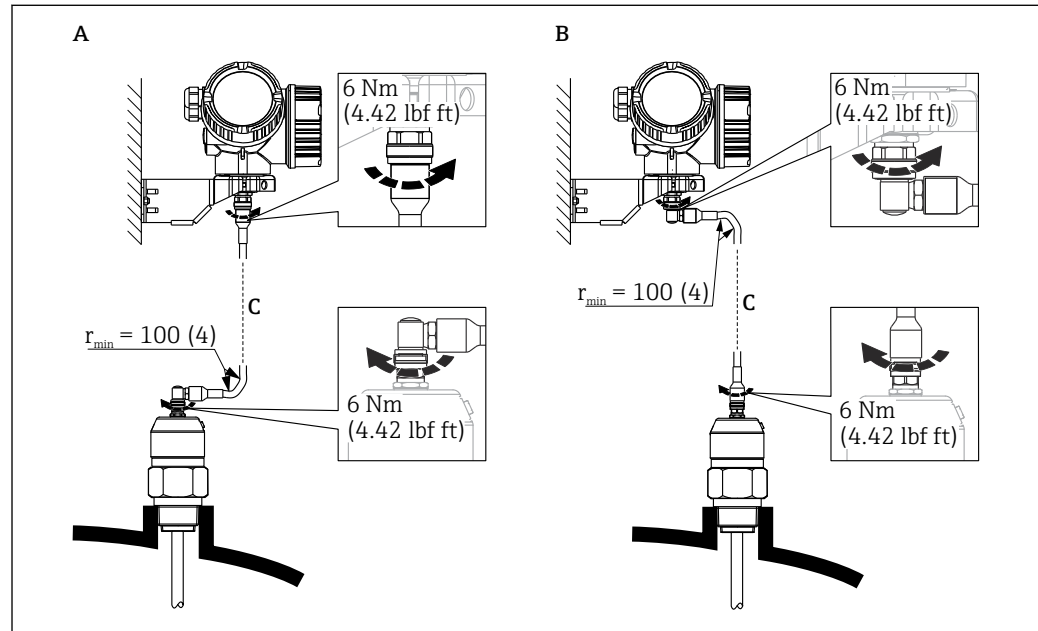

A0014794

- A Angled plug at the probe
- B Angled plug at the electronics housing
- C Length of the remote cable as ordered

- Product structure, feature 600 "Probe design":
Version MB "Sensor remote, 3m cable"
 - The connecting cable is included in the delivery with these versions.
Minimum bending radius: 100 mm (4 inch)
 - The mounting bracket for the electronics housing is included in the delivery with these versions. Mounting options:
 - Wall mounting
 - Mounting on DN32 to DN50 (1-1/4 to 2 inch) post or pipe
 - The connection cable has one straight plug and one plug angled at 90°. Depending on the local conditions the angled plug can be connected at the probe or at the electronics housing.
- i** The probe, electronics and connection cable are mutually compatible and bear a common serial number. Only components with the same serial number may be connected to one another.

6.1.3 Notes on the mechanical load of the probe

Tensile loading capacity of rope probes

FMP55

Rope 4mm (1/6") PFA>316

2 kN

Lateral loading capacity (flexural strength) of rod probes

FMP55

Rod 16mm (0.63") PFA>316L

30 Nm

6.1.4 Lateral loading capacity (flexural strength) of coax probes

FMP55

Probe Ø 42.4 mm 316L

300 Nm

6.1.5 Mounting cladded flanges



Note the following for cladded flanges:

- Use the same number of flange screws as the number of flange bores provided.
- Tighten the screws with the necessary torque (see Table).
- Retighten after 24 hours or after the first temperature cycle.
- Depending on the process pressure and temperature, check and retighten the screws, where necessary, at regular intervals.

The PTFE flange cladding normally acts simultaneously as a seal between the nozzle and the device flange.

Flange size	Number of screws	Tightening torque
EN		
DN40/PN40	4	35 to 55 Nm
DN50/PN16	4	45 to 65 Nm
DN50/PN40	4	45 to 65 Nm
DN80/PN16	8	40 to 55 Nm
DN80/PN40	8	40 to 55 Nm
DN100/PN16	8	40 to 60 Nm
DN100/PN40	8	55 to 80 Nm
DN150/PN16	8	75 to 115 Nm
DN150/PN40	8	95 to 145 Nm
ASME		
1½"/150lbs	4	20 to 30 Nm
1½"/300lbs	4	30 to 40 Nm
2"/150lbs	4	40 to 55 Nm
2"/300lbs	8	20 to 30 Nm
3"/150lbs	4	65 to 95 Nm
3"/300lbs	8	40 to 55 Nm
4"/150lbs	8	45 to 70 Nm
4"/300lbs	8	55 to 80 Nm
6"/150lbs	8	85 to 125 Nm
6"/300lbs	12	60 to 90 Nm
JIS		
10K 40A	4	30 to 45 Nm
10K 50A	4	40 to 60 Nm
10K 80A	8	25 to 35 Nm
10K 100A	8	35 to 55 Nm
10K 100A	8	75 to 115 Nm

6.1.6 Securing the probe

Securing coax probes

For WHG approval: A support is required for probe lengths ≥ 3 m (10 ft).

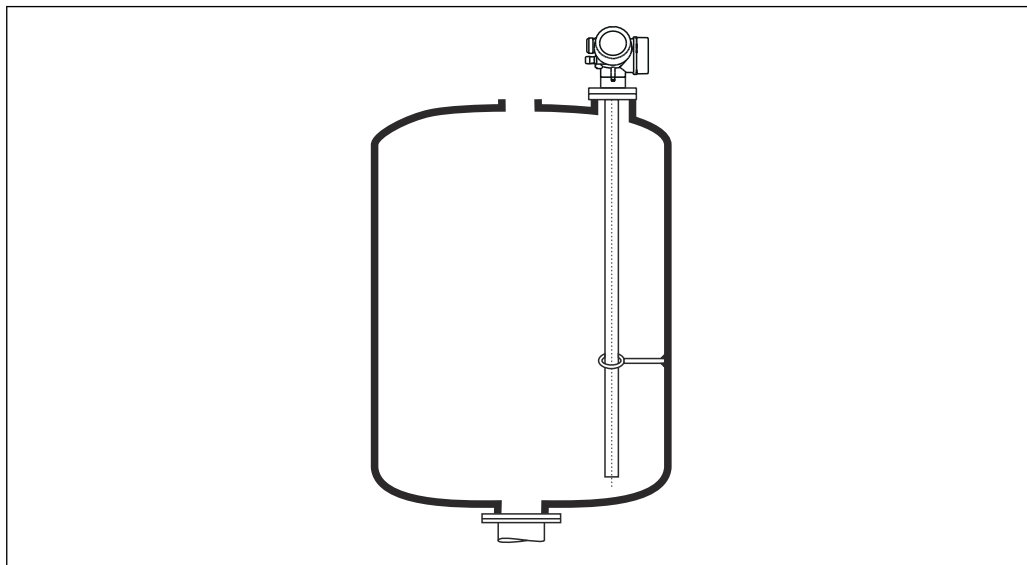

A0012608

Coax probes can be secured (fixed) at any point in the ground tube.

6.1.7 Special installation situations

Bypasses and stilling wells

- i** The use of centering disks/stars/weights (available as accessories) is recommended in bypass and stilling well applications.
- i** As the measuring signal penetrates many plastics, installation in plastic bypasses or stilling wells can produce incorrect results. For this reason use a metal bypass or stilling well.

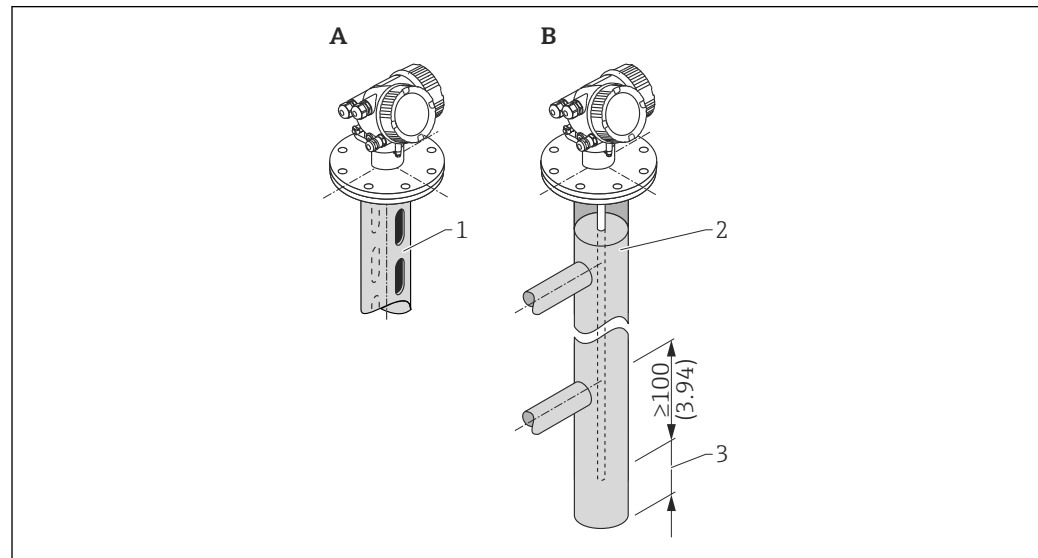

A0014129

- 1 Mounting in stilling well
- 2 Mounting in bypass
- 3 Minimum distance between probe end and lower edge of bypass 10 mm (0.4 in)

- Pipe diameter: > 40 mm (1.6 in) (for rod probes).
- A rod probe can be installed in pipes with a diameter of up to 150 mm (6 in). The use of a coax probe is recommended for larger pipe diameters.
- Side outlets, holes, slots and welds - with a maximum inward projection of 5 mm (0.2 in) - do not affect the measurement.
- There should not be any changes in the diameter of the pipe.
- The probe must be 100 mm (4 in) longer than the lower outlet.
- The probes must not touch the pipe wall within the measuring range. Support or brace the probe if necessary. All rope probes are prepared for bracing in vessels (tensioning weight with anchor hole).
- The probes must not touch the pipe wall within the measuring range. If necessary, use a PFA centering star.
- Coax probes can be used within any restrictions provided that the pipe diameter permits their installation.

- i** For bypasses with condensate formation (water) and a medium with a low dielectric constant (e.g. hydrocarbons):

Over time, the bypass fills with condensate up to the lower outlet. When levels are low, the level echo is masked by the echo of the condensate as a result. In this range, the level of the condensate is output and the correct value is only output when levels are higher. For this reason, ensure that the lower outlet is 100 mm (4 in) below the lowest level to be measured and fit a metal centering disk at the level of the lower outlet.

- i** In thermally insulated vessels, the bypass should also be insulated in order to prevent condensate formation.

Assignment of centering disk/centering star/centering weight to the pipe diameter

Underground tanks

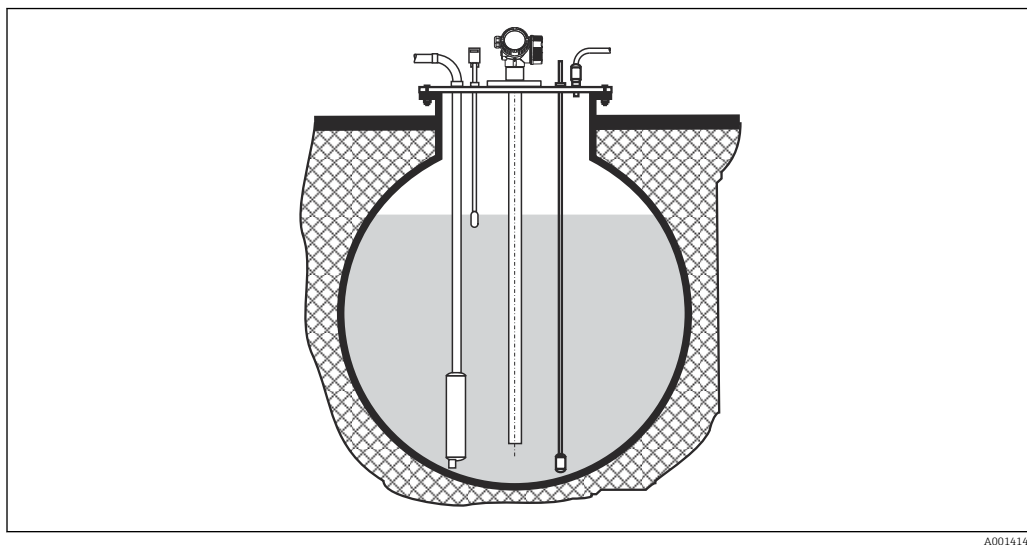

A0014142

In the case of nozzles with large diameters, use a coax probe to avoid reflections at the nozzle wall.

Non-metal vessels

Use a coax probe if mounting in non-metal vessels.

Vessel with thermal insulation

i If process temperatures are high, the device must be included in normal vessel insulation (1) in order to prevent the electronics heating up as a result of thermal radiation or convection. The insulation may not go beyond the points labeled "MAX" in the drawings.

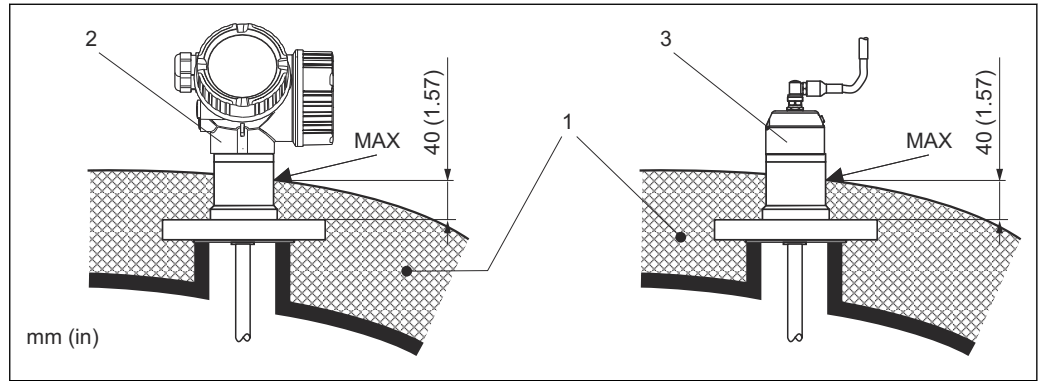

5 Process connection with flange

- 1 Vessel insulation
- 2 Compact device
- 3 Sensor, remote

6.2 Mounting the measuring device

6.2.1 Tool list

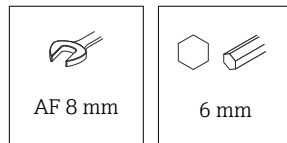

For flanges and other process connections: use an appropriate mounting tool

6.2.2 Mounting the device

Mounting devices with a flange

If a seal is used to mount the device, use uncoated metal screws to ensure good electrical contact between the process flange and the probe flange.

Mounting rope probes

NOTICE

Electrostatic discharge can damage the electronics.

- ▶ Ground the housing before lowering the rope probe into the vessel.

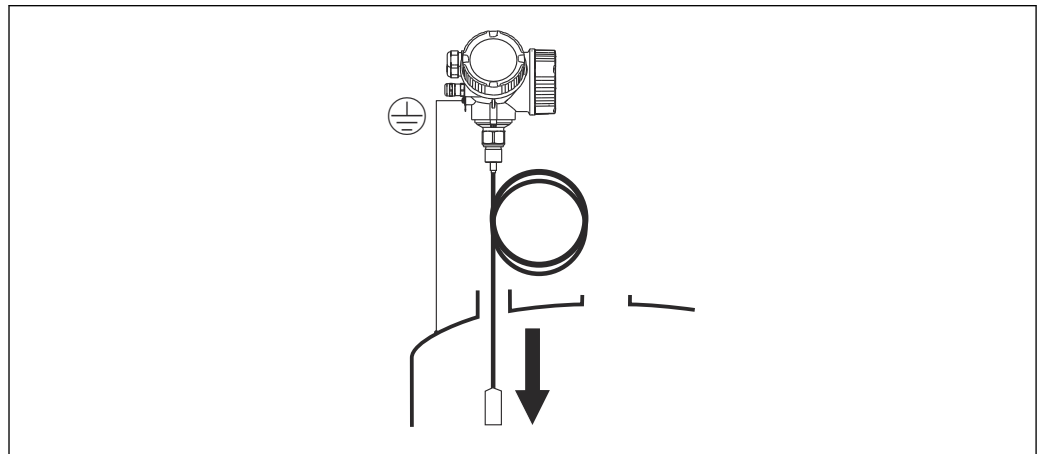

A0012852

Pay attention to the following when introducing the rope probe into the vessel:

- Uncoil the rope slowly and lower it carefully into the vessel.
- Make sure the rope does not bend or buckle.
- Avoid uncontrolled swinging of the weight, as this could damage internal fittings in the vessel.

6.2.3 Mounting the "Sensor, remote" version

i This section only applies for devices with the version "Probe design" = "Sensor, remote" (feature 600, version MB/MC/MD).

The following is included in the delivery with the version "Probe design" = "Remote":

- The probe with process connection
- The electronics housing
- The mounting bracket for mounting the electronics housing on a wall or post
- The connection cable (length as ordered). The cable has one straight plug and one plug angled at 90°. Depending on the local conditions the angled plug can be connected at the probe or at the electronics housing.

CAUTION

Mechanical stress can damage the plugs of the connection cable or cause them to become loose.

- ▶ Mount the probe and the electronics housing securely before connecting the connecting cable.
- ▶ Lay the connecting cable in such a way that it is not exposed to mechanical stress. Minimum bending radius: 100 mm (4 in).
- ▶ When connecting the cable, connect the straight plug before you connect the angled plug. Torque for the union nuts of both plugs: 6 Nm.

i The probe, electronics and connection cable are mutually compatible and bear a common serial number. Only components with the same serial number may be connected to one another.

In the event of strong vibrations, a locking compound, e.g. Loctite 243, can also be used on the plug-in connectors.

Mounting the electronics housing

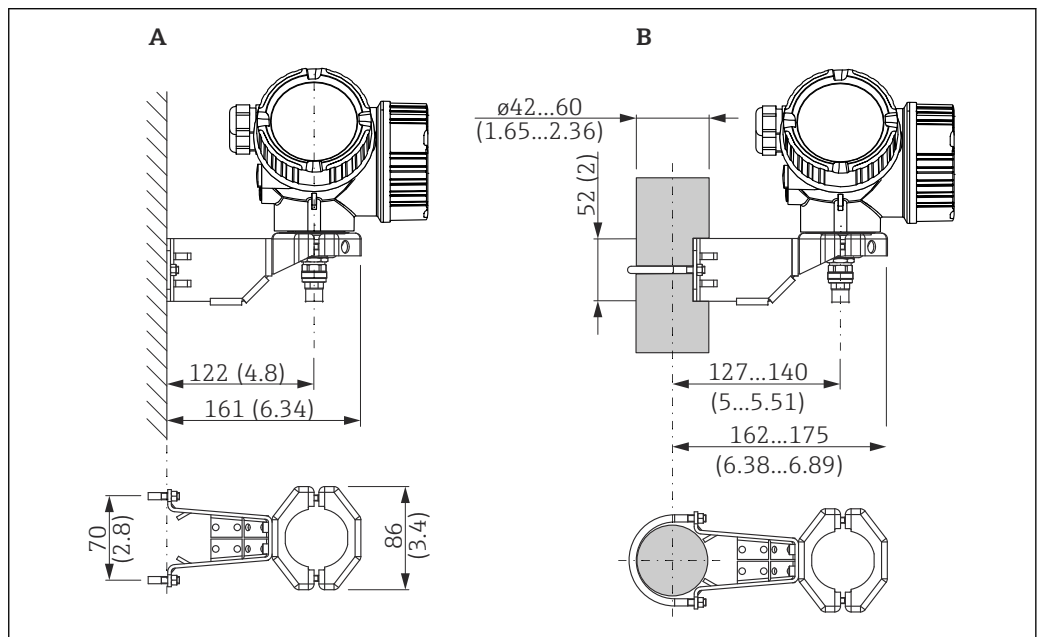

6 Mounting the electronics housing with the mounting bracket. Unit of measurement mm (in)

- A Wall mounting
- B Post mounting

Connecting the connecting cable



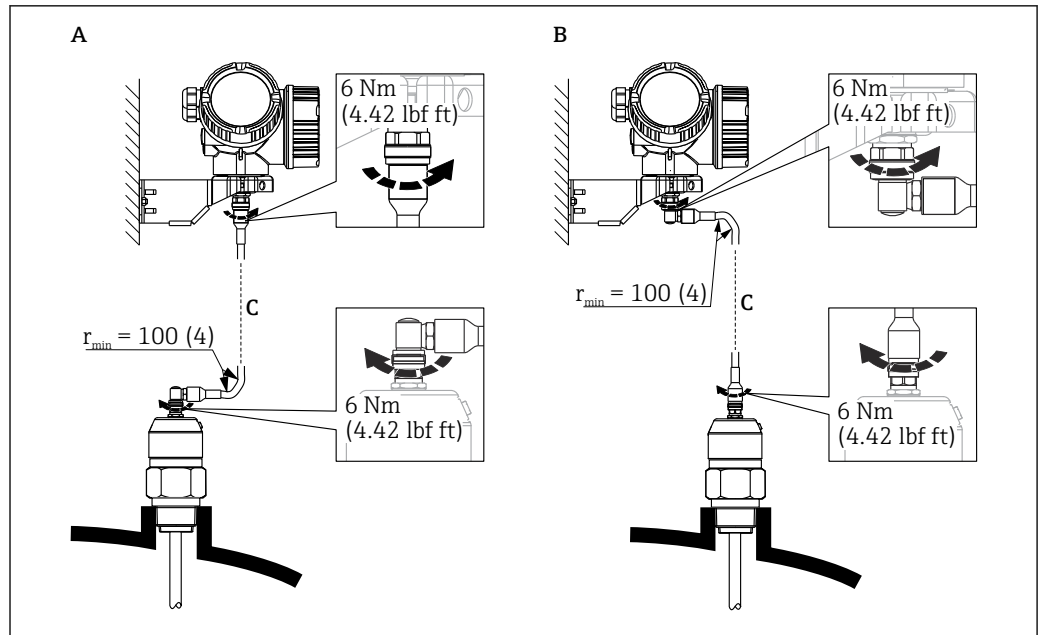

7 Connecting the connecting cable. The cable can be connected in the following ways: Unit of measurement mm (in)

- A Angled plug at the probe
- B Angled plug at the electronics housing
- C Length of the remote cable as ordered

6.2.4 Turning the transmitter housing

To provide easier access to the connection compartment or display module, the transmitter housing can be turned:

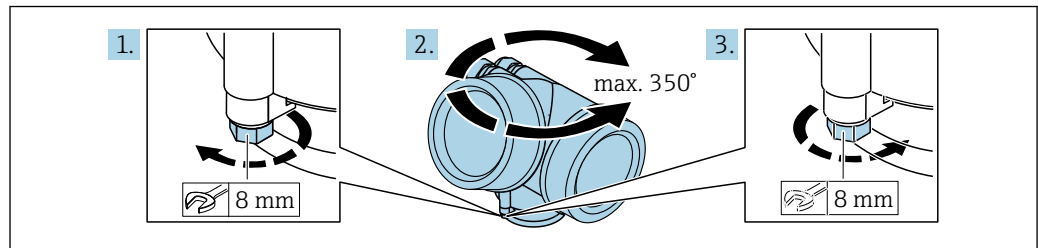

1. Unscrew the securing screw using an open-ended wrench.
2. Rotate the housing in the desired direction.
3. Tighten the securing screw (1.5 Nm for plastic housing; 2.5 Nm for aluminum or stainless steel housing).

6.2.5 Turning the display

Opening the cover

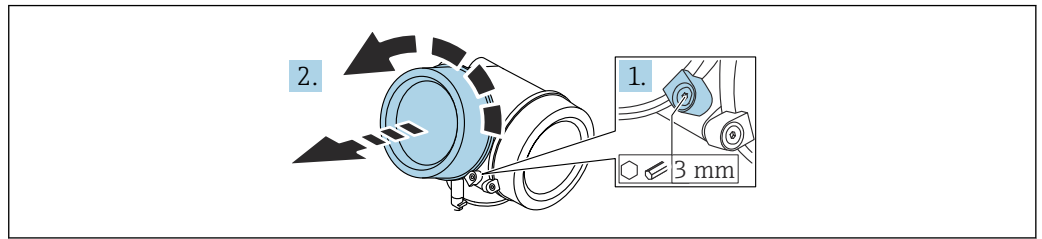

A0021430

1. Loosen the screw of the securing clamp of the electronics compartment cover using an Allen key (3 mm) and turn the clamp 90° counterclockwise.
2. Unscrew the electronics compartment cover and check the cover seal; replace it if necessary.

Turning the display module

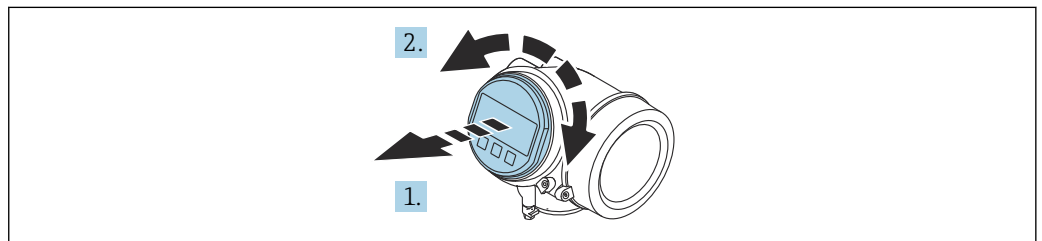

A0036401

1. Pull out the display module with a gentle rotational movement.
2. Turn the display module to the desired position: Max. $8 \times 45^\circ$ in each direction.
3. Feed the coiled cable into the gap between the housing and main electronics module and plug the display module into the electronics compartment until it engages.

Closing the cover of the electronics compartment

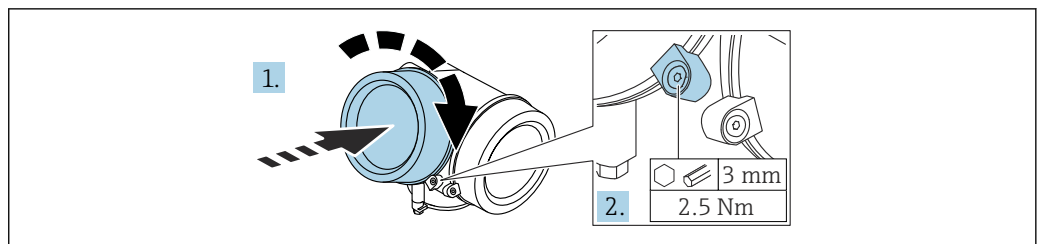

A0021451

1. Screw down the cover of the electronics compartment.
2. Turn the securing clamp 90° in the clockwise direction and, using an Allen key (3 mm), tighten the screw of the securing clamp on the electronics compartment cover with 2.5 Nm.

6.3 Post-installation check

- Is the device undamaged (visual inspection)?

- Does the device comply with the measuring point specifications?
 - Process temperature
 - Process pressure
 - Ambient temperature range
 - Measuring range
- Are the measuring point identification and labeling correct (visual inspection)?
- Is the device adequately protected against precipitation and direct sunlight?
- Is the device adequately protected against impact?
- Are all mounting and safety screws securely tightened?
- Is the device properly secured?

7 Electrical connection

7.1 Connecting requirements

7.1.1 Terminal assignment

Terminal assignment, 2-wire: 4 to 20 mA HART

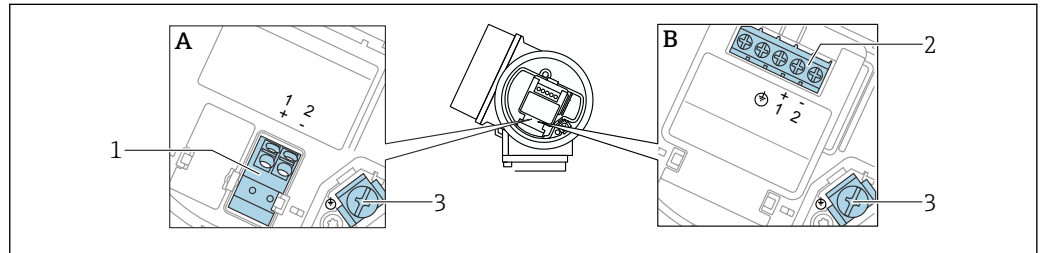

A0036498

8 Terminal assignment, 2-wire: 4 to 20 mA HART

A Without integrated overvoltage protection

B With integrated overvoltage protection

1 Connection 4 to 20 mA, HART passive: terminals 1 and 2, without integrated overvoltage protection

2 Connection 4 to 20 mA, HART passive: terminals 1 and 2, with integrated overvoltage protection

3 Terminal for cable shield

Block diagram, 2-wire: 4 to 20 mA HART

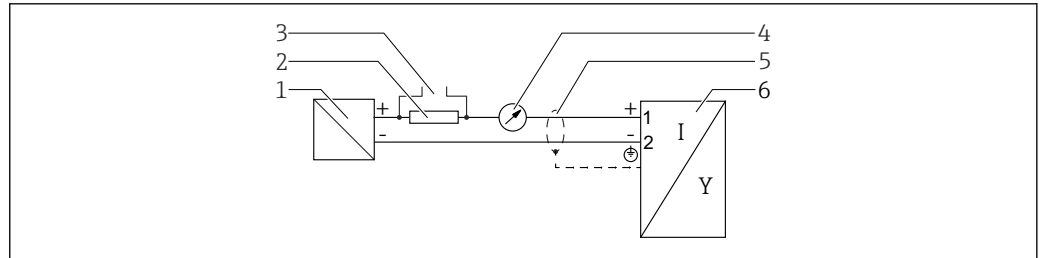

A0036499

9 Block diagram, 2-wire: 4 to 20 mA HART

1 Active barrier for power supply (e.g. RN221N); observe terminal voltage

2 Resistor for HART communication ($\geq 250 \Omega$); observe maximum load

3 Connection for Commubox FXA195 or FieldXpert SFX350/SFX370 (via VIATOR Bluetooth modem)

4 Analog display unit; observe maximum load

5 Cable screen; observe cable specification

6 Measuring device

Terminal assignment, 2-wire: 4 to 20 mA HART, switch output

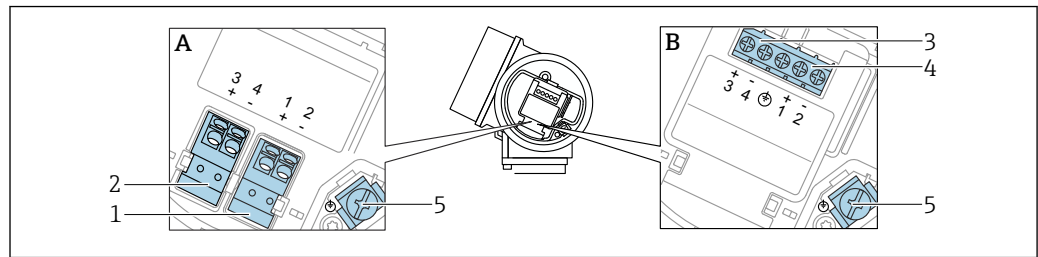

A0036500

10 Terminal assignment, 2-wire: 4 to 20 mA HART, switch output

A Without integrated overvoltage protection

B With integrated overvoltage protection

1 Connection 4 to 20 mA, HART passive: terminals 1 and 2, without integrated overvoltage protection

2 Connection, switch output (open collector): terminals 3 and 4, without integrated overvoltage protection

3 Connection, switch output (open collector): terminals 3 and 4, with integrated overvoltage protection

4 Connection 4 to 20 mA, HART passive: terminals 1 and 2, with integrated overvoltage protection

5 Terminal for cable shield

Block diagram, 2-wire: 4 to 20 mA HART, switch output

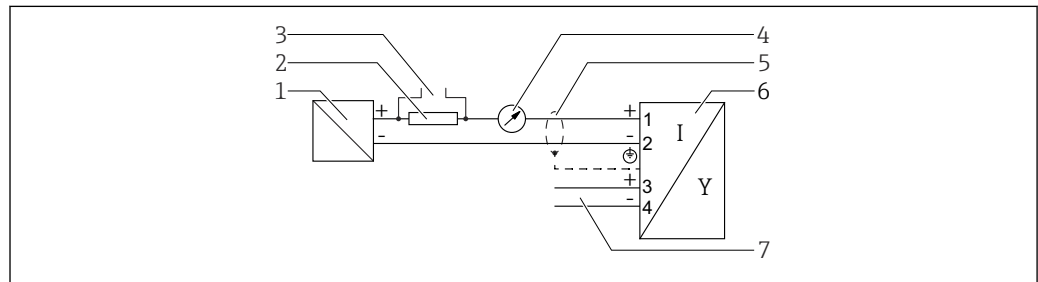

A0036501

11 Block diagram, 2-wire: 4 to 20 mA HART, switch output

1 Active barrier for power supply (e.g. RN221N); observe terminal voltage

2 Resistor for HART communication ($\geq 250 \Omega$); observe maximum load

3 Connection for Commubox FXA195 or FieldXpert SFX350/SFX370 (via VIATOR Bluetooth modem)

4 Analog display unit; observe maximum load

5 Cable screen; observe cable specification

6 Measuring device

7 Switch output (open collector)

Terminal assignment, 2-wire: 4 to 20 mA HART, 4 to 20 mA

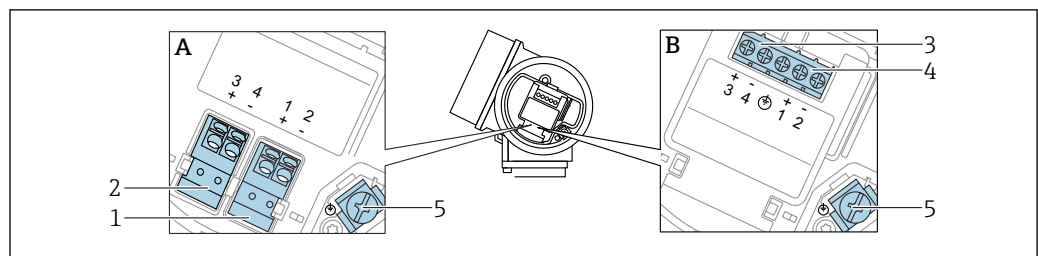

A0036500

12 Terminal assignment, 2-wire: 4 to 20 mA HART, 4 to 20 mA

A Without integrated overvoltage protection

B With integrated overvoltage protection

1 Connection current output 1, 4 to 20 mA HART passive: terminals 1 and 2, without integrated overvoltage protection

2 Connection current output 2, 4 to 20 mA: terminals 3 and 4, without integrated overvoltage protection

3 Connection current output 2, 4 to 20 mA: terminals 3 and 4, with integrated overvoltage protection

4 Connection current output 1, 4 to 20 mA HART passive: terminals 1 and 2, with integrated overvoltage protection

5 Terminal for cable shield

Block diagram, 2-wire: 4 to 20 mA HART, 4 to 20 mA

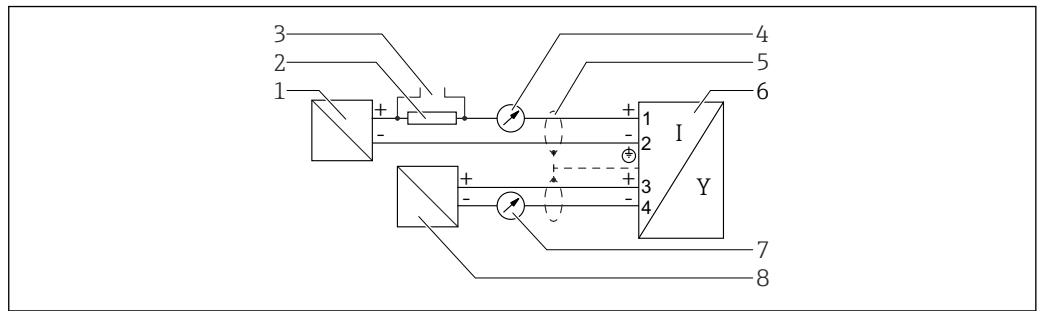

A0036502

13 Block diagram, 2-wire: 4 to 20 mA HART, 4 to 20 mA

- 1 Active barrier for power supply (e.g. RN221N), current output 1; observe terminal voltage
- 2 Resistor for HART communication ($\geq 250 \Omega$); observe maximum load
- 3 Connection for Commubox FXA195 or FieldXpert SFX350/SFX370 (via VIATOR Bluetooth modem)
- 4 Analog display unit; observe maximum load
- 5 Cable screen; observe cable specification
- 6 Measuring device
- 7 Analog display unit; observe maximum load
- 8 Active barrier for power supply (e.g. RN221N), current output 2; observe terminal voltage

Terminal assignment, 4-wire: 4 to 20 mA HART (10.4 to 48 V_{DC})

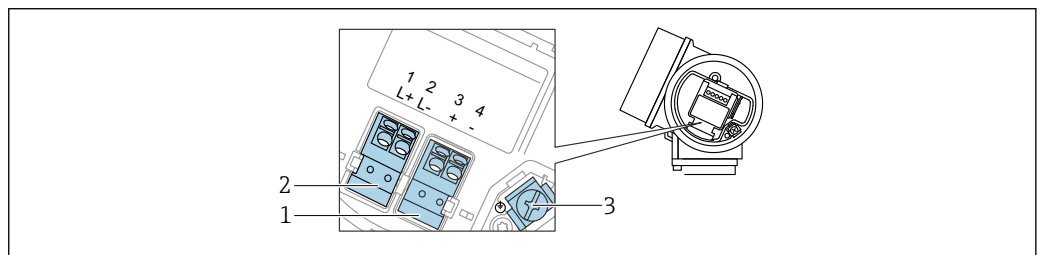

A0036516

14 Terminal assignment, 4-wire: 4 to 20 mA HART (10.4 to 48 V_{DC})

- 1 Connection 4 to 20 mA HART (active): terminals 3 and 4
- 2 Connection, supply voltage: terminals 1 and 2
- 3 Terminal for cable shield

Block diagram, 4-wire: 4 to 20 mA HART (10.4 to 48 V_{DC})

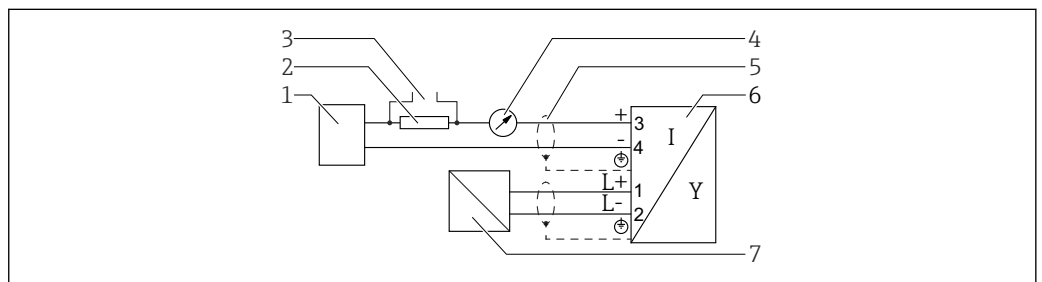

A0036526

15 Block diagram, 4-wire: 4 to 20 mA HART (10.4 to 48 V_{DC})

- 1 Evaluation unit, e.g. PLC
- 2 Resistor for HART communication ($\geq 250 \Omega$); observe maximum load
- 3 Connection for Commubox FXA195 or FieldXpert SFX350/SFX370 (via VIATOR Bluetooth modem)
- 4 Analog display unit; observe maximum load
- 5 Cable screen; observe cable specification
- 6 Measuring device
- 7 Supply voltage; observe terminal voltage, observe cable specification

Terminal assignment, 4-wire: 4 to 20 mA HART (90 to 253 V_{AC})

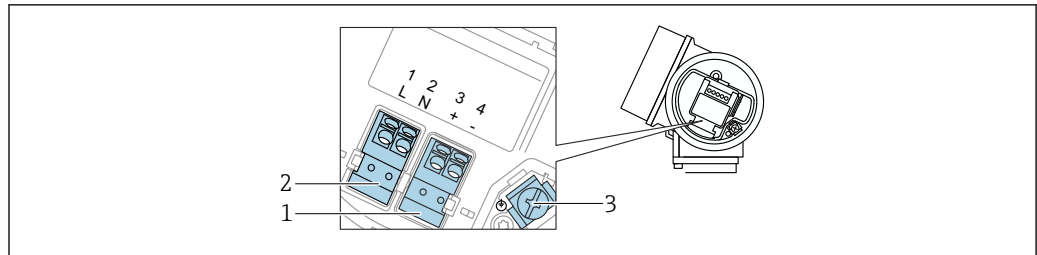

A0036519

16 Terminal assignment, 4-wire: 4 to 20 mA HART (90 to 253 V_{AC})

- 1 Connection 4 to 20 mA HART (active): terminals 3 and 4
- 2 Connection, supply voltage: terminals 1 and 2
- 3 Terminal for cable shield

CAUTION

To ensure electrical safety:

- ▶ Do not disconnect the protective ground connection.
- ▶ Disconnect the device from the supply voltage before disconnecting the protective ground.

i Connect protective ground to the inner ground terminal (3) before connecting the supply voltage. If necessary, connect the potential matching line to the outer ground terminal.

i In order to ensure electromagnetic compatibility (EMC): do **not** ground the device exclusively via the protective ground conductor of the supply cable. Instead, the functional grounding must also be connected to the process connection (flange or threaded connection) or to the external ground terminal.

i An easily accessible power switch must be installed in the proximity of the device. The power switch must be marked as a disconnecter for the device (IEC/EN61010).

Block diagram, 4-wire: 4 to 20 mA HART (90 to 253 V_{AC})

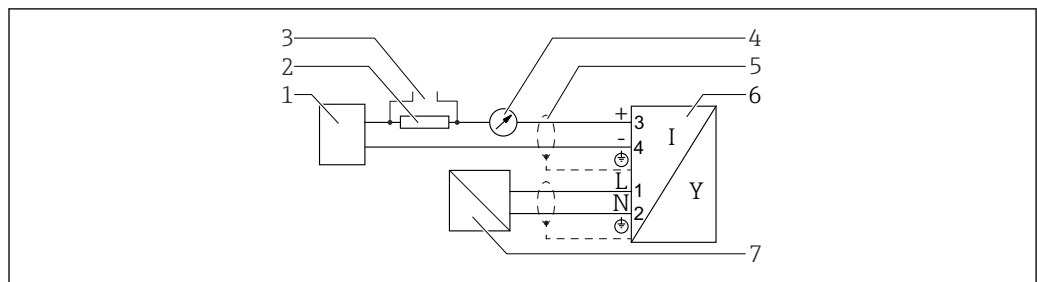

A0036527

17 Block diagram, 4-wire: 4 to 20 mA HART (90 to 253 V_{AC})

- 1 Evaluation unit, e.g. PLC
- 2 Resistor for HART communication ($\geq 250 \Omega$); observe maximum load
- 3 Connection for Commubox FXA195 or FieldXpert SFX350/SFX370 (via VIATOR Bluetooth modem)
- 4 Analog display unit; observe maximum load
- 5 Cable screen; observe cable specification
- 6 Measuring device
- 7 Supply voltage; observe terminal voltage, observe cable specification

Connection examples for the switch output

i For HART devices, the switch output is available as an option.

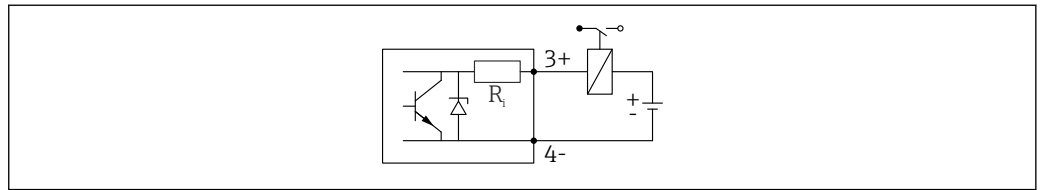

A0015909

18 Connection of a relay

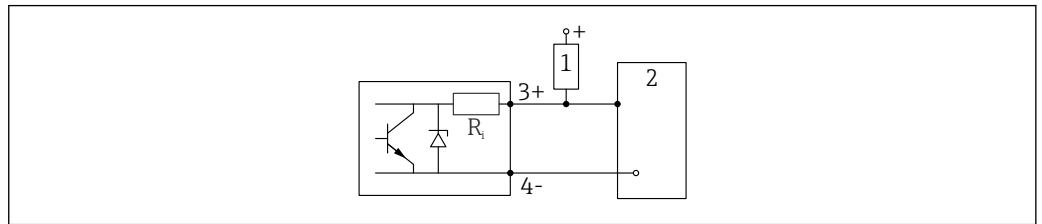

A0015910

19 Connection to a digital input

- 1 Pull-up resistor
- 2 Digital input

i For optimum interference immunity we recommend to connect an external resistor (internal resistance of the relay or pull-up resistor) of $< 1\,000\ \Omega$.

HART loop converter HMX50

The dynamic variables of the HART protocol can be converted into individual 4 to 20 mA sections using the HART loop converter HMX50. The variables are assigned to the current output and the measuring ranges of the individual parameters are defined in the HMX50.

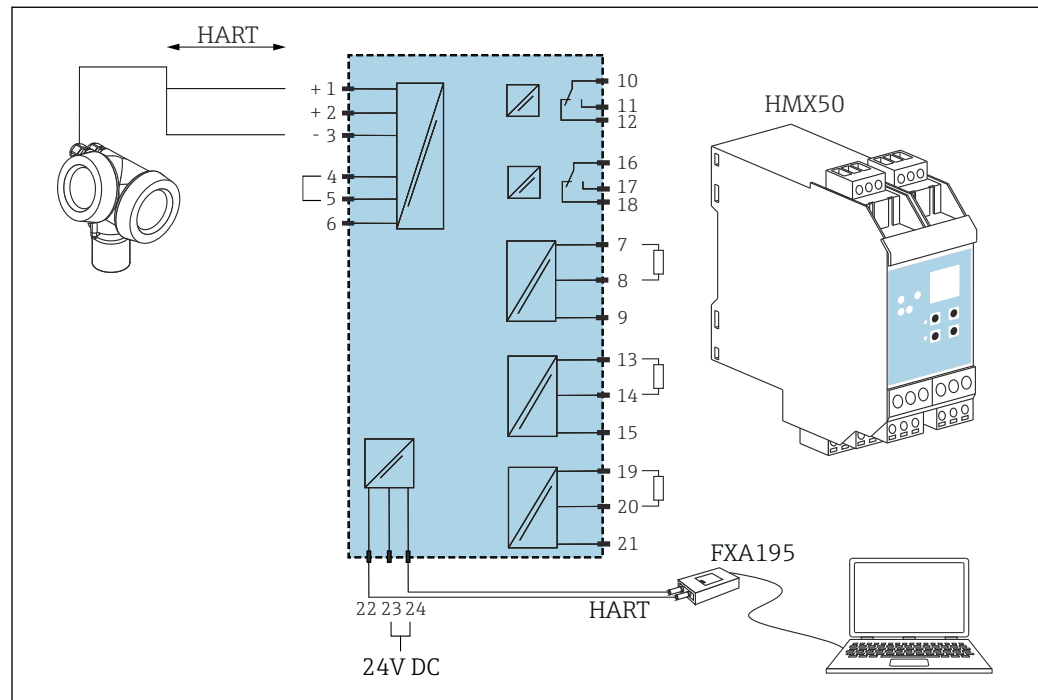

20 Connection diagram for HART loop converter HMX50 (example: passive 2-wire device and current outputs connected as power source)

The HART loop converter HMX50 can be acquired using the order number 71063562.

Additional documentation: TI00429F and BA00371F.

7.1.2 Cable specification

■ Devices without integrated overvoltage protection

Pluggable spring-force terminals for wire cross-sections 0.5 to 2.5 mm² (20 to 14 AWG)

■ Devices with integrated overvoltage protection

Screw terminals for wire cross-sections 0.2 to 2.5 mm² (24 to 14 AWG)

- For ambient temperature $T_U \geq 60^\circ\text{C}$ (140 °F): use cable for temperature $T_U + 20\text{ K}$.

HART

- A normal device cable suffices if only the analog signal is used.
- A shielded cable is recommended if using the HART protocol. Observe grounding concept of the plant.
- For 4-wire devices: Standard device cable is sufficient for the power line.

7.1.3 Device plug

i In the case of the device versions with a plug, the housing does not need to be opened to connect the signal cable.

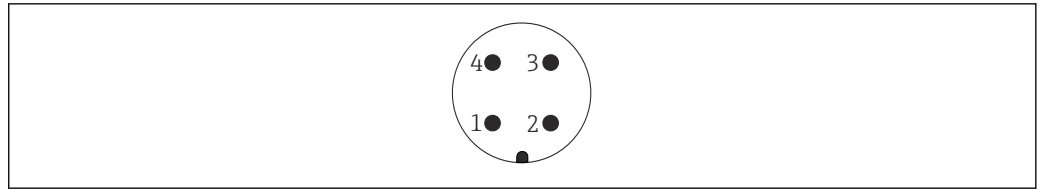

A0011175

21 Pin assignment of M12 plug

- 1 Signal +
- 2 Not assigned
- 3 Signal -
- 4 Ground

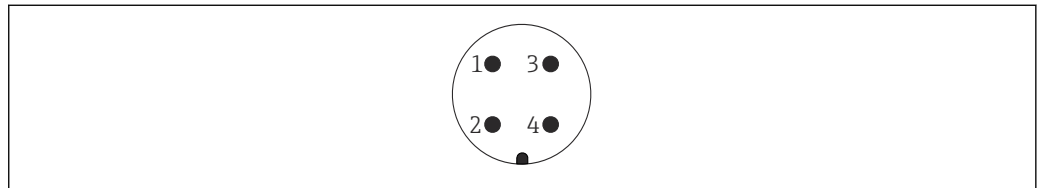

A0011176

22 Pin assignment of 7/8" plug

- 1 Signal -
- 2 Signal +
- 3 Not assigned
- 4 Shielding

7.1.4 Supply voltage

2-wire, 4-20mA HART, passive

2-wire; 4-20mA HART¹⁾

"Approval" ²⁾	Terminal voltage U at device	Maximum load R, depending on the supply voltage U ₀ of the power supply unit
<ul style="list-style-type: none"> ■ Non-hazardous ■ Ex nA ■ Ex ic ■ CSA GP 	17.5 to 35 V ³⁾	<p style="text-align: right; font-size: small;">A0014079</p>
Ex ia / IS	17.5 to 30 V ³⁾	
<ul style="list-style-type: none"> ■ Ex d / XP ■ Ex ic[ia] ■ Ex tD / DIP 	16 to 30 V ³⁾	<p style="text-align: right; font-size: small;">A0034970</p>

- 1) Feature 020 in the product structure: option A
- 2) Feature 010 in the product structure
- 3) If the Bluetooth module is used, the minimum supply voltage increases by 2 V.

2-wire; 4-20 mA HART, switch output¹⁾

"Approval" ²⁾	Terminal voltage U at device	Maximum load R, depending on the supply voltage U ₀ of the power supply unit
<ul style="list-style-type: none"> ■ Non-hazardous ■ Ex nA ■ Ex nA(ia) ■ Ex ic ■ Ex ic[ia] ■ Ex d[ia] / XP ■ Ex ta / DIP ■ CSA GP 	16 to 35 V ³⁾	<p style="text-align: right; font-size: small;">A0034972</p>
<ul style="list-style-type: none"> ■ Ex ia / IS ■ Ex ia + Ex d[ia] / IS + XP 	16 to 30 V ³⁾	

- 1) Feature 020 in the product structure: option B
- 2) Feature 010 in the product structure
- 3) If the Bluetooth module is used, the minimum supply voltage increases by 2 V.

2-wire; 4-20mA HART, 4-20mA ¹⁾

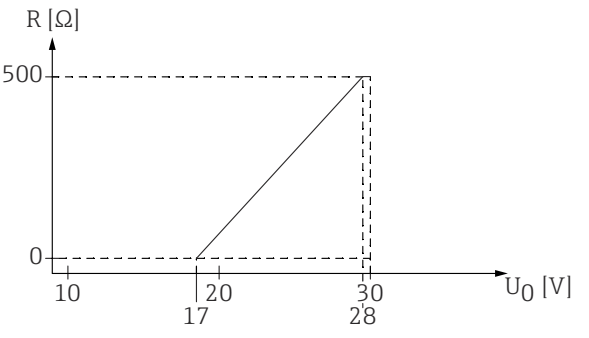
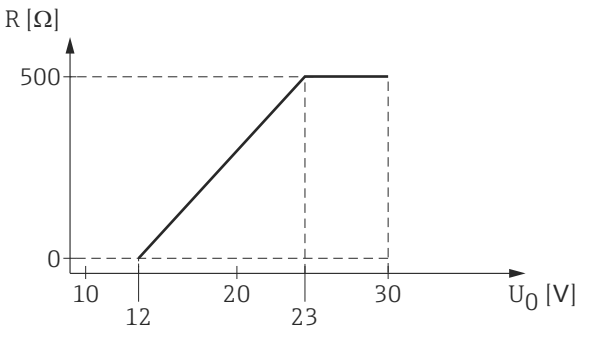
"Approval" ²⁾	Terminal voltage U at device	Maximum load R, depending on the supply voltage U ₀ of the power supply unit
All	Channel 1: 17 to 30 V ³⁾	 <p style="text-align: right; font-size: small;">A0034973</p>
	Channel 2: 12 to 30 V	 <p style="text-align: right; font-size: small;">A0022583</p>

- 1) Feature 020 in the product structure: option C
- 2) Feature 010 in the product structure
- 3) If the Bluetooth module is used, the minimum supply voltage increases by 2 V.

Integrated polarity reversal protection	Yes
Permitted residual ripple with f = 0 to 100 Hz	U _{SS} < 1 V
Permitted residual ripple with f = 100 to 10000 Hz	U _{SS} < 10 mV

4-wire, 4-20mA HART, active

"Power supply; output" ¹⁾	Terminal voltage U	Maximum load R _{max}
K: 4-wire 90-253VAC; 4-20mA HART	90 to 253 V _{AC} (50 to 60 Hz), overvoltage category II	500 Ω
L: 4-wire 10.4-48VDC; 4-20mA HART	10.4 to 48 V _{DC}	

1) Feature 020 in the product structure

7.1.5 Overvoltage protection

If the measuring device is used for level measurement in flammable liquids which requires the use of overvoltage protection according to DIN EN 60079-14, standard for test procedures 60060-1 (10 kA, pulse 8/20 μs), an overvoltage protection module has to be installed.

Integrated overvoltage protection module

An integrated overvoltage protection module is available for 2-wire HART as well as PROFIBUS PA and FOUNDATION Fieldbus devices.

Product structure: Feature 610 "Accessory mounted", option NA "Overvoltage protection".

Technical data	
Resistance per channel	2 × 0.5 Ω max.
Threshold DC voltage	400 to 700 V
Threshold impulse voltage	< 800 V
Capacitance at 1 MHz	< 1.5 pF
Nominal arrest impulse voltage (8/20 μs)	10 kA

External overvoltage protection module

HAW562 or HAW569 from Endress+Hauser are suited as external overvoltage protection.



For detailed information please refer to the following documents:

- HAW562: TI01012K
- HAW569: TI01013K

7.2 Connecting the device**⚠ WARNING****Explosion Hazard!**

- ▶ Observe applicable national standards.
- ▶ Comply with the specifications in the Safety Instructions (XA).
- ▶ Use specified cable glands only.
- ▶ Check to ensure that the power supply matches the information on the nameplate.
- ▶ Switch off the power supply before connecting the device.
- ▶ Connect the potential matching line to the outer ground terminal before applying the power supply.

Required tools/accessories:

- For devices with a cover lock: Allen key AF3
- Wire stripper
- When using stranded cables: One ferrule for every wire to be connected.

7.2.1 Opening cover

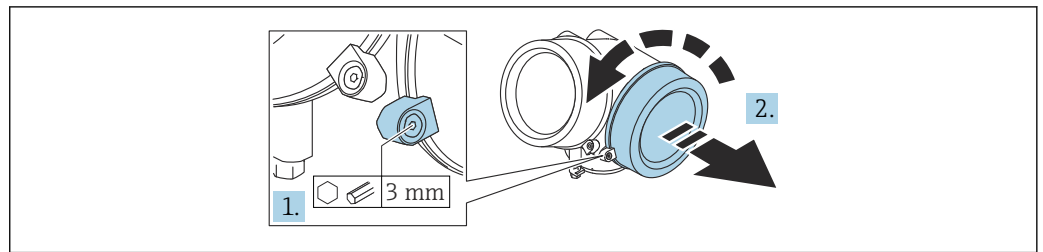

1. Loosen the screw of the securing clamp of the connection compartment cover using an Allen key (3 mm) and turn the clamp 90 ° counterclockwise.
2. Unscrew the connection compartment cover and check the cover seal; replace it if necessary.

7.2.2 Connecting

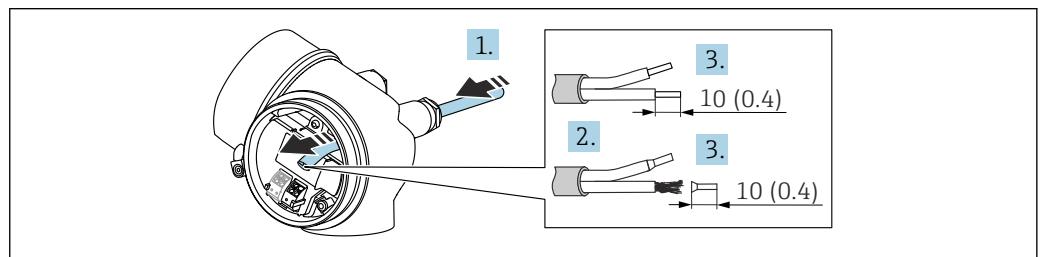

23 Engineering unit: mm (in)

1. Push the cable through the cable entry . To ensure tight sealing, do not remove the sealing ring from the cable entry.
2. Remove the cable sheath.
3. Strip the cable ends 10 mm (0.4 in). In the case of stranded cables, also fit wire end ferrules.
4. Firmly tighten the cable glands.
5. Connect the cable according to the terminal assignment.

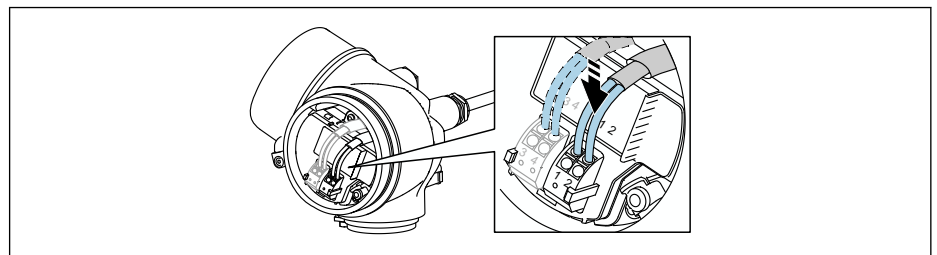

6. If using shielded cables: Connect the cable shield to the ground terminal.

7.2.3 Plug-in spring-force terminals

The electrical connection of device versions without an integrated overvoltage protection is via plug-in spring-force terminals. Rigid conductors or flexible conductors with ferrules can be inserted directly into the terminal without using the lever, and create a contact automatically.

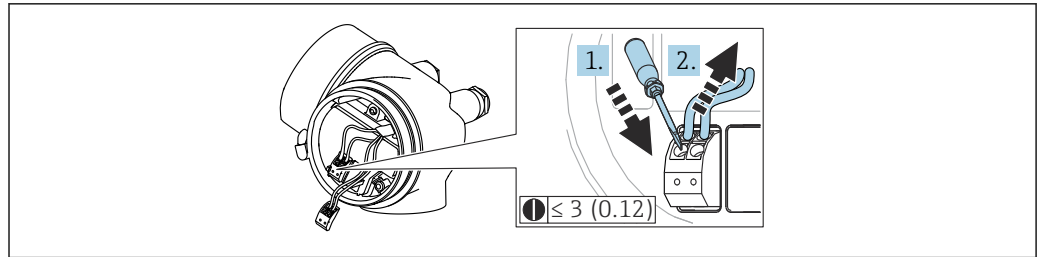

A0013661

24 Engineering unit: mm (in)

To remove the cable from the terminal again:

1. Using a flat-blade screwdriver ≤ 3 mm, press down on the slot between the two terminal holes
2. Simultaneously pull the cable end out of the terminal.

7.2.4 Closing the cover of the connection compartment

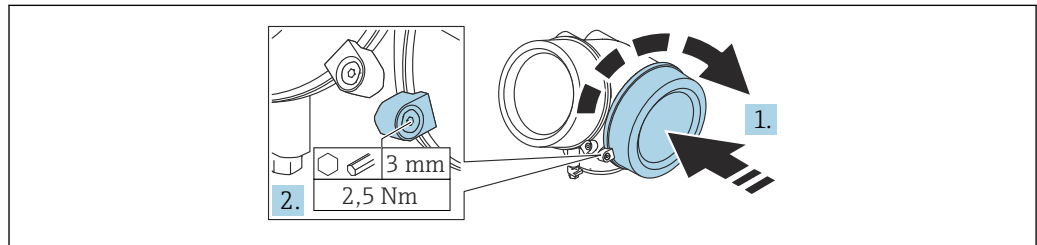

A0021491

1. Screw down the cover of the connection compartment.
2. Turn the securing clamp 90° in the clockwise direction and, using an Allen key (3 mm), tighten the screw of the securing clamp on the connection compartment cover with 2.5 Nm.

7.3 Post-connection check

- Is the device or cable undamaged (visual inspection)?
- Do the cables used comply with the requirements?
- Do the mounted cables have adequate strain relief?
- Are all the cable glands installed, firmly tightened and leak-tight?
- Does the supply voltage match the specifications on the nameplate?
- Is the terminal assignment correct?
- If necessary, has a protective ground connection been established?
- If supply voltage is present, is the device ready for operation and do values appear on the display module?
- Are all the housing covers installed and tightened?
- Is the securing clamp firmly tightened?

8 Operation methods

8.1 Overview

8.1.1 Local operation

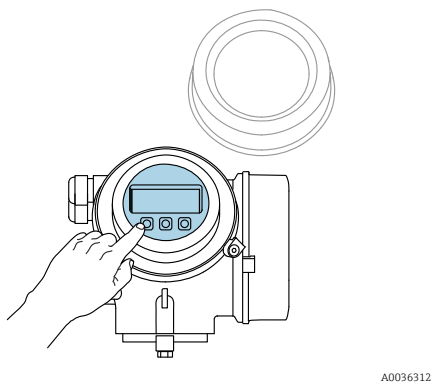
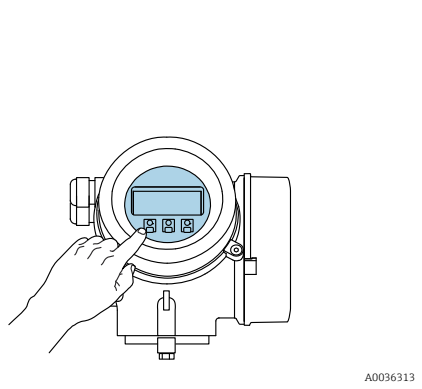
Operation with	Pushbuttons	Touch Control
Order code for "Display; Operation"	Option C "SD02"	Option E "SD03"
		
Display elements	4-line display	4-line display white background lighting; switches to red in event of device error
	Format for displaying measured variables and status variables can be individually configured	
	Permitted ambient temperature for the display: -20 to +70 °C (-4 to +158 °F) The readability of the display may be impaired at temperatures outside the temperature range.	
Operating elements	local operation with 3 push buttons (⊕, ⊖, ⊞)	external operation via touch control; 3 optical keys: ⊕, ⊖, ⊞
	Operating elements also accessible in various hazardous areas	
Additional functionality	Data backup function The device configuration can be saved in the display module.	
	Data comparison function The device configuration saved in the display module can be compared to the current device configuration.	
	Data transfer function The transmitter configuration can be transmitted to another device using the display module.	

8.1.2 Operation with remote display and operating module FHX50

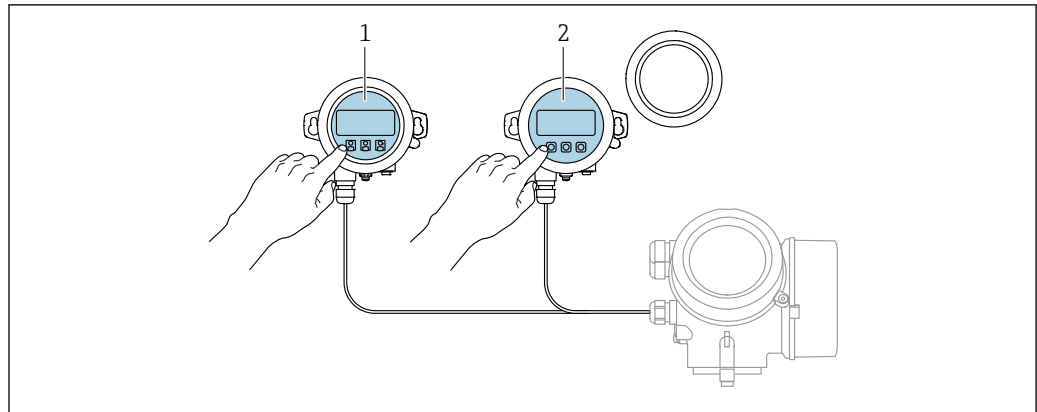

A0036314

25 FHX50 operating options

- 1 Display and operating module SD03, optical keys; can be operated through the glass of the cover
- 2 Display and operating module SD02, push buttons; cover must be removed

8.1.3 Operation via Bluetooth® wireless technology

Requirements

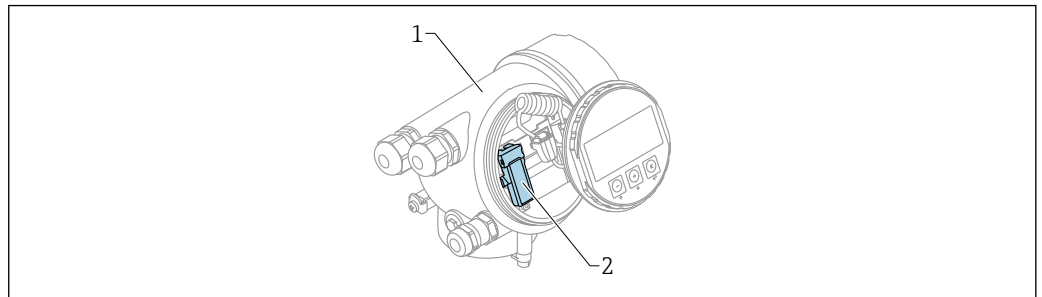

A0036790

26 Device with Bluetooth module

- 1 Electronics housing of the device
- 2 Bluetooth module

This operation option is only available for devices with Bluetooth module. There are the following options:

- The device has been ordered with a Bluetooth module:
Feature 610 "Accessory Mounted", option NF "Bluetooth"
- The Bluetooth module has been ordered as an accessory (ordering number: 71377355) and has been mounted. See Special Documentation SD02252F.

Operation via SmartBlue (app)

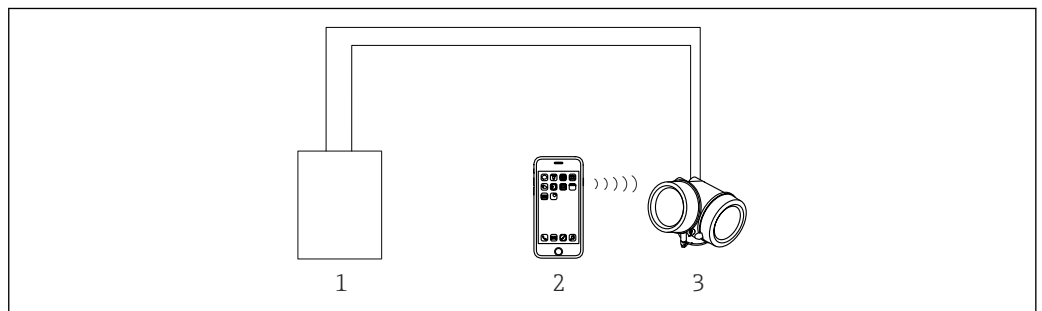

A0034939

27 Operation via SmartBlue (app)

- 1 Transmitter power supply unit
- 2 Smartphone / tablet with SmartBlue (app)
- 3 Transmitter with Bluetooth module

8.1.4 Remote operation

Via HART protocol

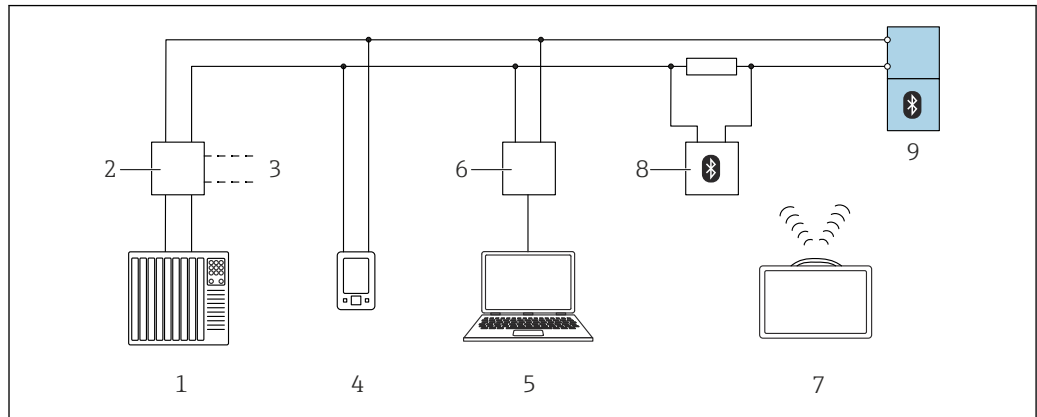

A0044334

▣ 28 Options for remote operation via HART protocol

- 1 PLC (programmable logic controller)
- 2 Transmitter power supply unit, e.g., RN42
- 3 Connection for Commubox FXA195 and AMS Trex™ device communicator
- 4 AMS Trex™ device communicator
- 5 Computer with operating tool (e.g., DeviceCare/FieldCare, AMS Device View, SIMATIC PDM)
- 6 Commubox FXA195 (USB)
- 7 Field Xpert SMT70
- 8 Bluetooth modem with connecting cable (e.g., VIATOR)
- 9 Transmitter

Via service interface (CDI)

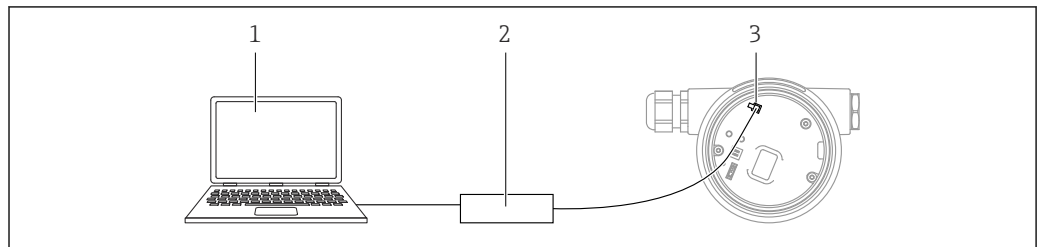

A0039148

- 1 Computer with FieldCare/DeviceCare operating tool
- 2 Commubox FXA291
- 3 Service interface (CDI) of the measuring device (= Endress+Hauser Common Data Interface)

8.2 Structure and function of the operating menu

8.2.1 Structure of the operating menu

Menu	Submenu / parameter	Meaning
	Language ¹⁾	Defines the operating language of the local display
Commissioning ²⁾		Launches the interactive wizard for guided commissioning. Additional settings generally do not need to be made in the other menus when the wizard is finished.
Setup	Parameter 1 ... Parameter N	Once values have been set for these parameters, the measurement should generally be completely configured.
	Advanced setup	Contains additional submenus and parameters: <ul style="list-style-type: none"> ■ For more customized configuration of the measurement (adaptation to special measuring conditions). ■ For converting the measured value (scaling, linearization). ■ For scaling the output signal.
Diagnostics	Diagnostic list	Contains up to 5 currently active error messages.
	Event logbook ³⁾	Contains the last 20 messages (which are no longer active).
	Device information	Contains information for identifying the device.
	Measured values	Contains all current measured values.
	Data logging	Contains the history of the individual measuring values.
	Simulation	Is used to simulate measured values or output values.
	Device check	Contains all parameters needed to check the measurement capability of the device.
	Heartbeat ⁴⁾	Contains all the wizards for the Heartbeat Verification and Heartbeat Monitoring application packages.
Expert ⁵⁾ Contains all the parameters of the device (including those that are already contained in one of the other menus). This menu is organized according to the function blocks of the device. The parameters of the Expert menu are described in: GP01000F (HART)	System	Contains all higher-level device parameters that do not pertain either to the measurement or to measured value communication.
	Sensor	Contains all parameters needed to configure the measurement.
	Output	<ul style="list-style-type: none"> ■ Contains all parameters needed to configure the analog current output. ■ Contains all parameters needed to configure the switch output (PFS).

Menu	Submenu / parameter	Meaning
	Communication	Contains all parameters needed to configure the digital communication interface.
	Diagnostics	Contains all parameters needed to detect and analyze operational errors.

- 1) If you are operating via operating tools (e.g. FieldCare), the "Language" parameter is located under "Setup → Advanced setup → Display"
- 2) Only if operating via an FDT/DTM system
- 3) Only available if operating via the local display
- 4) Only available if operating via DeviceCare or FieldCare
- 5) When you call up the "Expert" menu, you are always asked for an access code. If a customer-specific access code has not been defined, "0000" must be entered.

8.2.2 User roles and related access authorization

The two user roles **Operator** and **Maintenance** have different write access to the parameters if a device-specific access code has been defined. This protects the device configuration via the local display from unauthorized access →  49.

Access authorization to parameters

User role	Read access		Write access	
	Without access code (from the factory)	With access code	Without access code (from the factory)	With access code
Operator	✓	✓	✓	--
Maintenance	✓	✓	✓	✓

If an incorrect access code is entered, the user obtains the access rights of the **Operator** role.

 The user role with which the user is currently logged on is indicated by the **Access status display** parameter (for display operation) or **Access status tooling** parameter (for tool operation).

8.2.3 Data access - Security

Write protection via access code

Using the device-specific access code, the parameters for the measuring device configuration are write-protected and their values can no longer be changed via local operation.

Define access code via local display

1. Navigate to: Setup → Advanced setup → Administration → Define access code → Define access code
2. Define a max. 4-digit numeric code as an access code.
3. Repeat the numeric code in the **Confirm access code** parameter to confirm it.
 - ↳ The -symbol appears in front of all write-protected parameters.



Define access code via operating tool (e.g. FieldCare)

1. Navigate to: Setup → Advanced setup → Administration → Define access code
2. Define a max. 4-digit numeric code as an access code.
 - ↳ Write protection is active.



Parameters that can always be changed

The write protection does not include certain parameters that do not affect the measurement. Despite the defined access code, these parameters can always be modified even if the other parameters are locked.



The device automatically locks the write-protected parameters again if a key is not pressed for 10 minutes in the navigation and editing view. If the user goes from the navigation and editing mode back to the measured value display mode, the device automatically locks the write-protected parameters after 60 s.

-  If write access is activated via an access code, it can only be deactivated again via this access code →  50.
- In the "Description of Device Parameters" documents, each write-protected parameter is identified with the -symbol.

Disabling write protection via access code

If the  symbol appears in front of a parameter on the local display, the parameter is write-protected by a device-specific access code and its value cannot currently be changed via the local display →  49.

The locking of the write access via local operation can be disabled by entering the device-specific access code.

1. After you press , the input prompt for the access code appears.
2. Enter the access code.
 - ↳ The -symbol in front of the parameters disappears; all previously write-protected parameters are now re-enabled.

Deactivation of the write protection via access code

Via local display

1. Navigate to: Setup → Advanced setup → Administration → Define access code → Define access code
2. Enter **0000**.
3. Repeat **0000** in the **Confirm access code** parameter to confirm.
 - ↳ The write protection is deactivated. Parameters can be changed without entering an access code.

Via an operating tool (e.g. FieldCare)

1. Navigate to: Setup → Advanced setup → Administration → Define access code
2. Enter **0000**.
 - ↳ The write protection is deactivated. Parameters can be changed without entering an access code.

Write protection via write protection switch

Unlike parameter write protection via a user-specific access code, this allows the user to lock write access to the entire operating menu - apart from the **"Contrast display" parameter**.

The parameter values are now read only and cannot be edited any more (exception **"Contrast display" parameter**):

- Via local display
- Via service interface (CDI)
- Via HART protocol

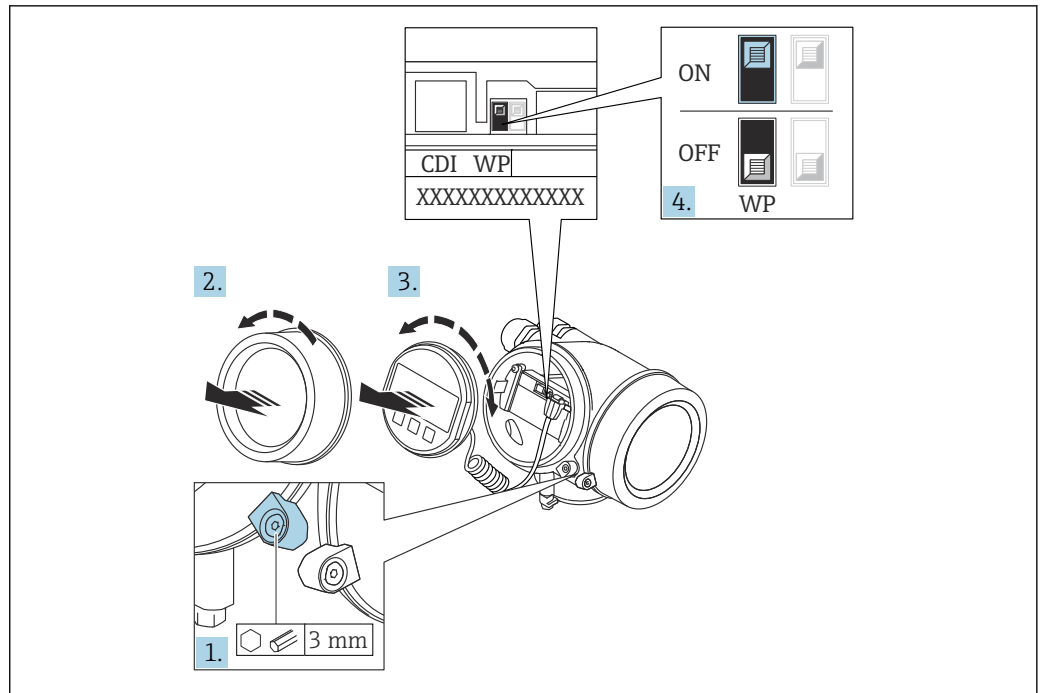

A0026157

1. Loosen the securing clamp.
2. Unscrew the electronics compartment cover.
3. Pull out the display module with a gentle rotational movement. To make it easier to access the write protection switch, attach the display module to the edge of the electronics compartment.

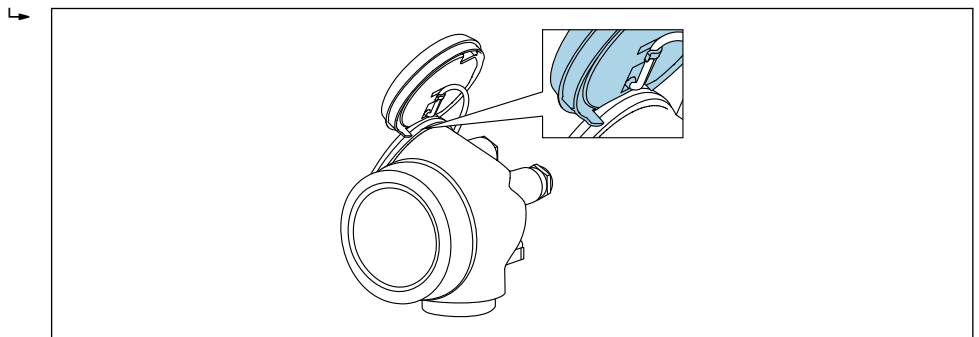

A0036086

4. Setting the write protection switch (WP) on the main electronics module to the **ON** position enables hardware write protection. Setting the write protection switch (WP) on the main electronics module to the **OFF** position (factory setting) disables hardware write protection.
 - ↳ If hardware write protection is enabled, the **Hardware locked** option is displayed in the **Locking status** parameter. In addition, on the local display the  symbol appears in front of the parameters in the header of the operational display and in the navigation view.

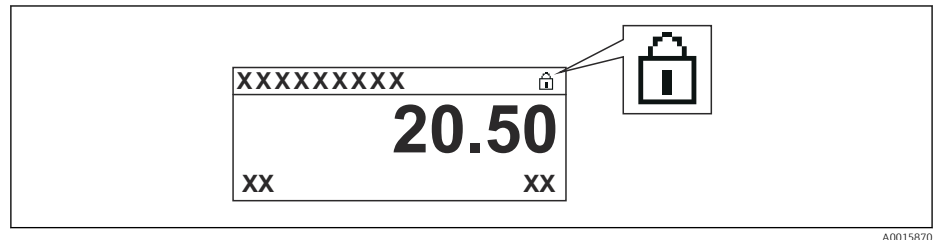

If hardware write protection is disabled, no option is displayed in the **Locking status** parameter. On the local display, the  symbol disappears from in front of the parameters in the header of the operational display and in the navigation view.

5. Feed the cable into the gap between the housing and main electronics module and plug the display module into the electronics compartment in the desired direction until it engages.
6. Reverse the removal procedure to reassemble the transmitter.

Enabling and disabling the keypad lock

Access to the entire operating menu via local operation can be locked via the keypad lock. When access is locked, it is no longer possible to navigate through the operating menu or change the values of individual parameters. Users can only read the measured values on the operational display.

The keypad lock is switched on and off via a context menu.

Switching on the keypad lock

SD03 display module only

The keypad lock is switched on automatically:

- If the device has not been operated via the display for > 1 minute.
- Each time the device is restarted.

To activate the keylock manually:

1. The device is in the measured value display.
Press  for at least 2 seconds.
↳ A context menu appears.
2. In the context menu select the **Keylock on** option.
↳ The keypad lock is switched on.

 If the user attempts to access the operating menu while the keypad lock is active, the message **Keylock on** appears.

Switching off the keypad lock

1. The keypad lock is switched on.
Press  for at least 2 seconds.
↳ A context menu appears.
2. In the context menu select the **Keylock off** option.
↳ The keypad lock is switched off.

Bluetooth® wireless technology

Signal transmission via Bluetooth® wireless technology uses a cryptographic technique tested by the Fraunhofer Institute

- The device is not visible via *Bluetooth®* wireless technology without the SmartBlue app
- Only one point-to-point connection between **one** sensor and **one** smartphone or tablet is established

8.3 Display and operating module

8.3.1 Display

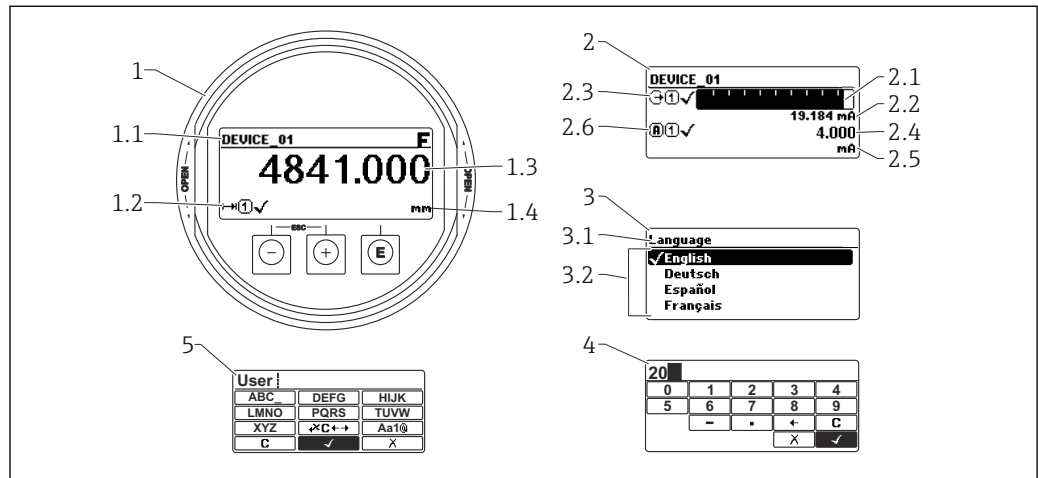





A0012635

29 Display format on the display and operating module

- 1 Measured value display (1 value max. size)
- 1.1 Header containing tag and error symbol (if an error is active)
- 1.2 Measured value symbols
- 1.3 Measured value
- 1.4 Unit
- 2 Measured value display (bar graph + 1 value)
 - 2.1 Bargraph for measured value 1
 - 2.2 Measured value 1 (including unit)
 - 2.3 Measured value symbols for measured value 1
 - 2.4 Measured value 2
 - 2.5 Unit for measured value 2
 - 2.6 Measured value symbols for measured value 2
- 3 Parameter display (here: parameter with picklist)
 - 3.1 Header containing parameter name and error symbol (if an error is active)
 - 3.2 Picklist; marks the current parameter value.
- 4 Input matrix for numbers
- 5 Input matrix for alphanumeric and special characters



Display symbols for the submenus

Symbol	Meaning
 <small>A0018367</small>	Display/operat. Is displayed: <ul style="list-style-type: none"> ▪ In the main menu next to the "Display/operat." selection ▪ In the header on the left in the "Display/operat." menu
 <small>A0018364</small>	Setup Is displayed: <ul style="list-style-type: none"> ▪ In the main menu next to the "Setup" selection ▪ In the header on the left in the "Setup" menu
 <small>A0018365</small>	Expert Is displayed: <ul style="list-style-type: none"> ▪ In the main menu next to the "Expert" selection ▪ In the header on the left in the "Expert" menu
 <small>A0018366</small>	Diagnostics Is displayed: <ul style="list-style-type: none"> ▪ In the main menu next to the "Diagnostics" selection ▪ In the header on the left in the "Diagnostics" menu











Status signals

Symbol	Meaning
F <small>A0032902</small>	"Failure" A device error has occurred. The measured value is no longer valid.
C <small>A0032903</small>	"Function check" The device is in the service mode (e.g. during a simulation).
S <small>A0032904</small>	"Out of specification" The device is operated: <ul style="list-style-type: none"> ▪ Outside of its technical specifications (e.g. during startup or a cleaning) ▪ Outside of the configuration performed by the user (e.g. level outside the configured range)
M <small>A0032905</small>	"Maintenance required" Maintenance is required. The measured value is still valid.





Display symbols for locking status

Symbol	Meaning
 <small>A0013148</small>	Read-only parameter The parameter shown is only for display purposes and cannot be edited.
 <small>A0013150</small>	Device locked <ul style="list-style-type: none"> ▪ In front of a parameter name: The device is locked via software and/or hardware. ▪ In the header of the measured value screen: The device is locked via hardware.

Measured value symbols

Symbol	Meaning
Measured values	
 A0032892	Level
 A0032893	Distance
 A0032908	Current output
 A0032894	Measured current
 A0032895	Terminal voltage
 A0032896	Electronics or sensor temperature
Measuring channels	
 A0032897	Measuring channel 1
 A0032898	Measuring channel 2
Status of the measured value	
 A0018361	"Alarm" status The measurement is interrupted. The output assumes the defined alarm condition. A diagnostic message is generated.
 A0018360	"Warning" status The device continues to measure. A diagnostic message is generated.

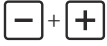
8.3.2 Operating elements

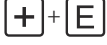
Key	Meaning
 <small>A0018330</small>	<p>Minus key</p> <p><i>In a menu, submenu</i> Moves the selection bar upwards in a picklist.</p> <p><i>In the text and numeric editor</i> In the input mask, moves the selection bar to the left (backwards).</p>
 <small>A0018329</small>	<p>Plus key</p> <p><i>In a menu, submenu</i> Moves the selection bar downwards in a picklist.</p> <p><i>In the text and numeric editor</i> In the input mask, moves the selection bar to the right (forwards).</p>
 <small>A0018328</small>	<p>Enter key</p> <p><i>For measured value display</i></p> <ul style="list-style-type: none"> ▪ Pressing the key briefly opens the operating menu. ▪ Pressing the key for 2 s opens the context menu. <p><i>In a menu, submenu</i></p> <ul style="list-style-type: none"> ▪ Pressing the key briefly: Opens the selected menu, submenu or parameter. ▪ Pressing the key for 2 s in a parameter: If present, opens the help text for the function of the parameter. <p><i>In the text and numeric editor</i></p> <ul style="list-style-type: none"> ▪ Pressing the key briefly: <ul style="list-style-type: none"> ▪ Opens the selected group. ▪ Carries out the selected action. ▪ Pressing the key for 2 s confirms the edited parameter value.
 <small>A0032909</small>	<p>Escape key combination (press keys simultaneously)</p> <p><i>In a menu, submenu</i></p> <ul style="list-style-type: none"> ▪ Pressing the key briefly: <ul style="list-style-type: none"> ▪ Exits the current menu level and takes you to the next higher level. ▪ If help text is open, closes the help text of the parameter. ▪ Pressing the key for 2 s returns you to the measured value display ("home position"). <p><i>In the text and numeric editor</i> Closes the text or numeric editor without applying changes.</p>
 <small>A0032910</small>	<p>Minus/Enter key combination (press and hold down the keys simultaneously)</p> <p>Reduces the contrast (brighter setting).</p>
 <small>A0032911</small>	<p>Plus/Enter key combination (press and hold down the keys simultaneously)</p> <p>Increases the contrast (darker setting).</p>



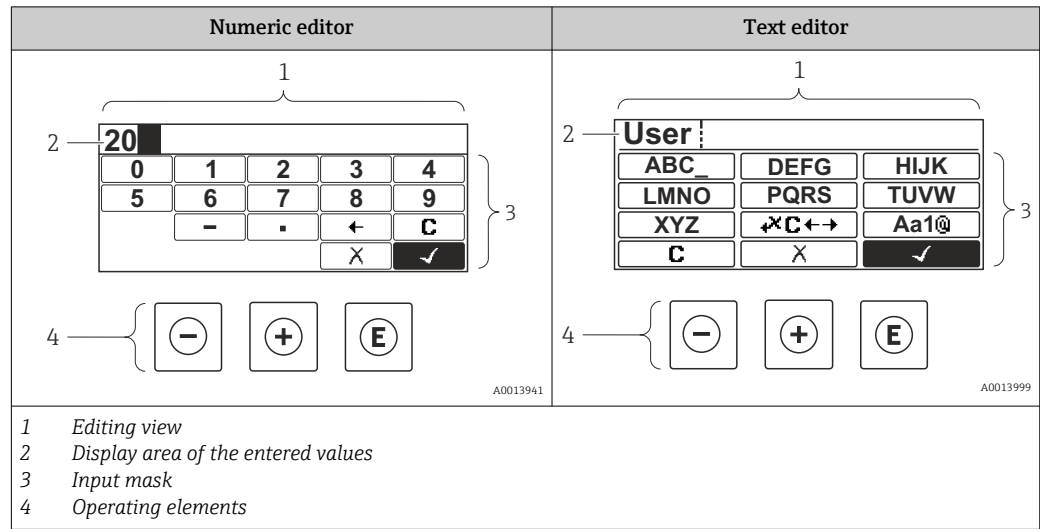



8.3.3 Entering numbers and text



Input mask

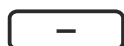



The following input and operating symbols are available in the input mask of the numeric and text editor:

Numeric editor

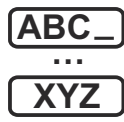



Symbol	Meaning
 A0013998	Selection of numbers from 0 to 9.
 A0016619	Inserts decimal separator at the cursor position.
 A0016620	Inserts minus sign at the cursor position.
 A0013985	Confirms selection.
 A0016621	Moves the input position one position to the left.
 A0013986	Exits the input without applying the changes.
 A0014040	Clears all entered characters.

Text editor

Symbol	Meaning
 A0013997	Selection of letters from A to Z

 <small>A0013981</small>	Toggle <ul style="list-style-type: none"> Between upper-case and lower-case letters For entering numbers For entering special characters
 <small>A0013985</small>	Confirms selection.
 <small>A0013987</small>	Switches to the selection of the correction tools.
 <small>A0013986</small>	Exits the input without applying the changes.
 <small>A0014040</small>	Clears all entered characters.

Text correction under 

Symbol	Meaning
 <small>A0032907</small>	Clears all entered characters.
 <small>A0018324</small>	Moves the input position one position to the right.
 <small>A0018326</small>	Moves the input position one position to the left.
 <small>A0032906</small>	Deletes one character immediately to the left of the input position.

8.3.4 Opening the context menu

Using the context menu, the user can call up the following menus quickly and directly from the operational display:



- Setup
- Conf. backup disp.
- Envelope curve
- Keylock on

Calling up and closing the context menu

The user is in the operational display.

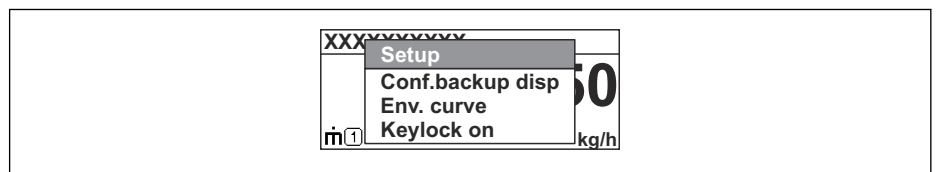
1. Press  for 2 s.
 ↳ The context menu opens.



2. Press  +  simultaneously.
 ↳ The context menu is closed and the operational display appears.

Calling up the menu via the context menu

1. Open the context menu.
2. Press  to navigate to the desired menu.

3. Press  to confirm the selection.
 - ↳ The selected menu opens.

8.3.5 Envelope curve display on the display and operating module

In order to assess the measuring signal, the envelope curve and - if a mapping has been recorded - the mapping curve can be shown on the display and operating module:

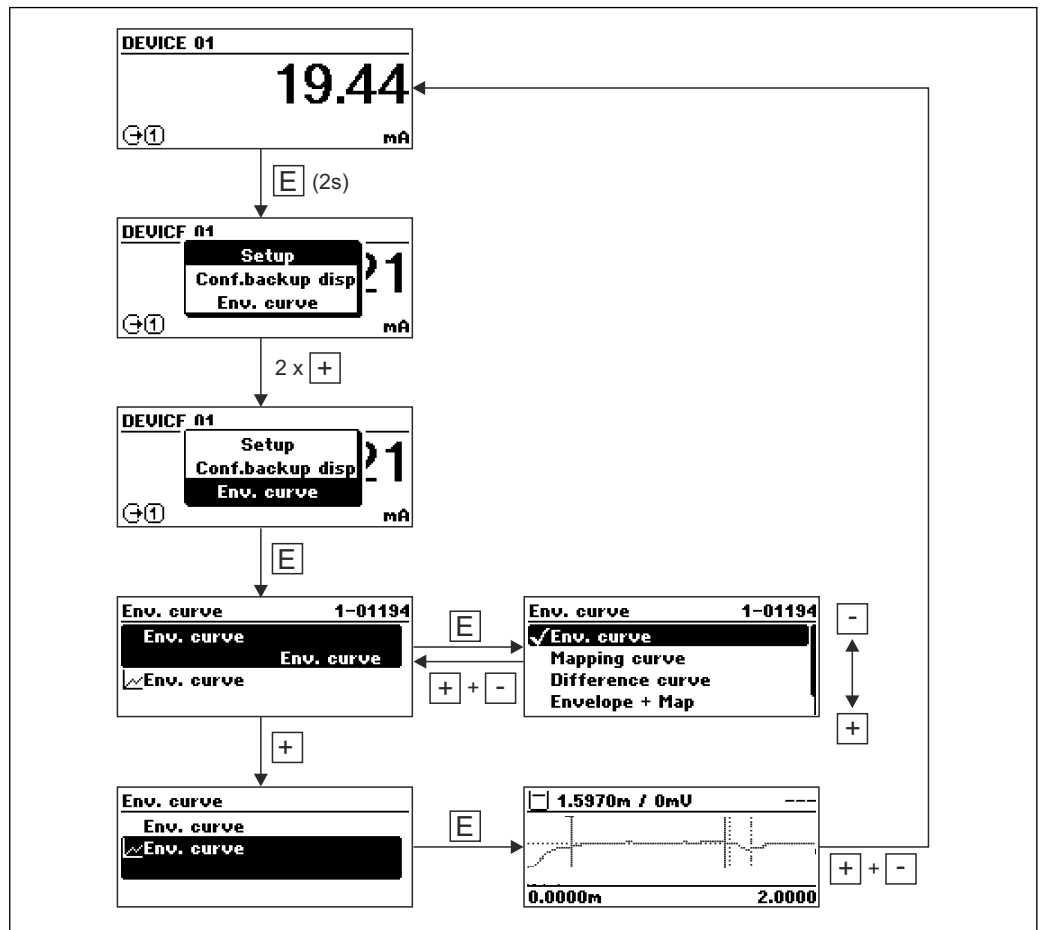

A0014277

9 Device integration via the HART protocol

9.1 Overview of the Device Description files (DD)

HART

Manufacturer ID	0x11
Device type	0x1122
HART specification	7.0
DD files	For information and files see: <ul style="list-style-type: none"> ▪ www.endress.com ▪ www.fieldcommgroup.org

9.2 HART device variables and measuring values

On delivery the following measuring values are assigned to the HART device variables:

Device variables for interface measurements

Device variable	Measuring value
Primary variable (PV)	Interface linearized
Secondary variable (SV)	Level linearized
Tertiary variable (TV)	Thickness upper layer
Quaternary variable (QV)	Absolute interface amplitude

 The allocation of the measuring values to the device variables can be changed in the following submenu:

Expert → Communication → Output

10 Commissioning via SmartBlue (App)

10.1 Prerequisites

System requirements

The SmartBlue app is available for download for use with a smartphone or tablet.

- iOS devices: iPhone 5S or higher from iOS11; iPad 5th generation or higher from iOS11; iPod Touch 6th generation or higher from iOS11
- Devices with Android: from Android 6.0 and *Bluetooth*® 4.0

Initial password

The serial number of the device serves as the initial password when the connection is established for the first time.

- i** Note the following if the Bluetooth module is removed from one device and installed in another device: the password that is changed by the user is only saved in the Bluetooth module and not in the device itself.

10.2 SmartBlue App

1. Scan the QR code or enter "SmartBlue" in the search field of the App Store.

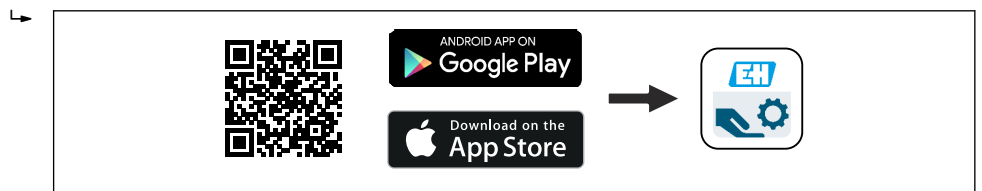

A0039186

30 [Download link](#)

2. Start SmartBlue.
3. Select device from livelist displayed.
4. Enter the login data:
 - ↳ User name: admin
 - Password: serial number of the device
5. Tap the icons for more information.

- i** After logging in for the first time, change the password!

10.3 Envelope curve display in SmartBlue

Envelope curves can be displayed and recorded in SmartBlue.

In addition to the envelope curve, the following values are displayed:

- D = Distance
- L = Level
- A = Absolute amplitude
- With screenshots, the displayed section (zoom function) is saved
- With video sequences, the whole area without zoom function is saved all the time



A0029486

31 Envelope curve display (sample) in SmartBlue for Android

- 1 Record video
- 2 Create screenshot
- 3 Display mapping menu
- 4 Start/stop video recording
- 5 Move time on time axis

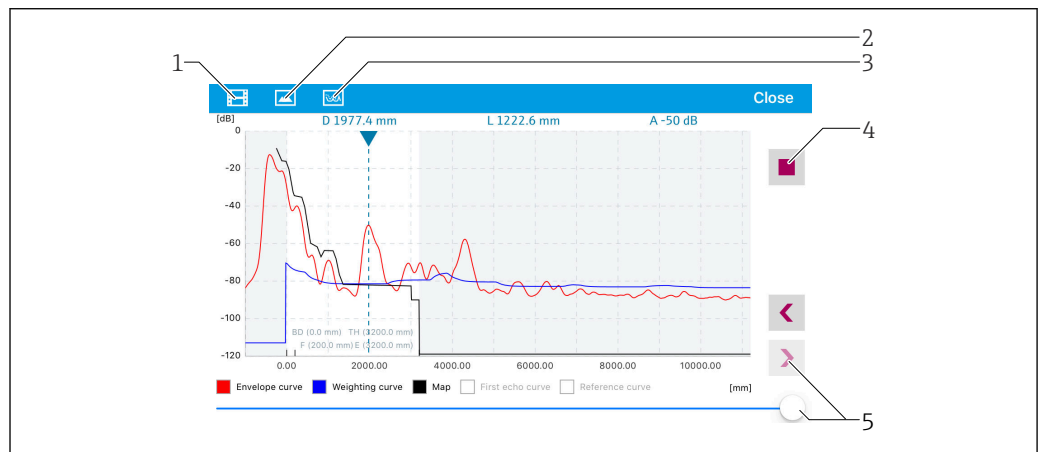

A0029487

32 Envelope curve display (sample) in SmartBlue for iOS

- 1 Record video
- 2 Create screenshot
- 3 Display mapping menu
- 4 Start/stop video recording
- 5 Move time on time axis

11 Commissioning using the Commissioning Wizard

A Wizard is provided in FieldCare and DeviceCare ¹⁾ that guides the user through the initial commissioning process.

1. Connect the device with FieldCare or DeviceCare.
2. Open the device in FieldCare or DeviceCare.
 - ↳ The dashboard (homepage) of the device is displayed:

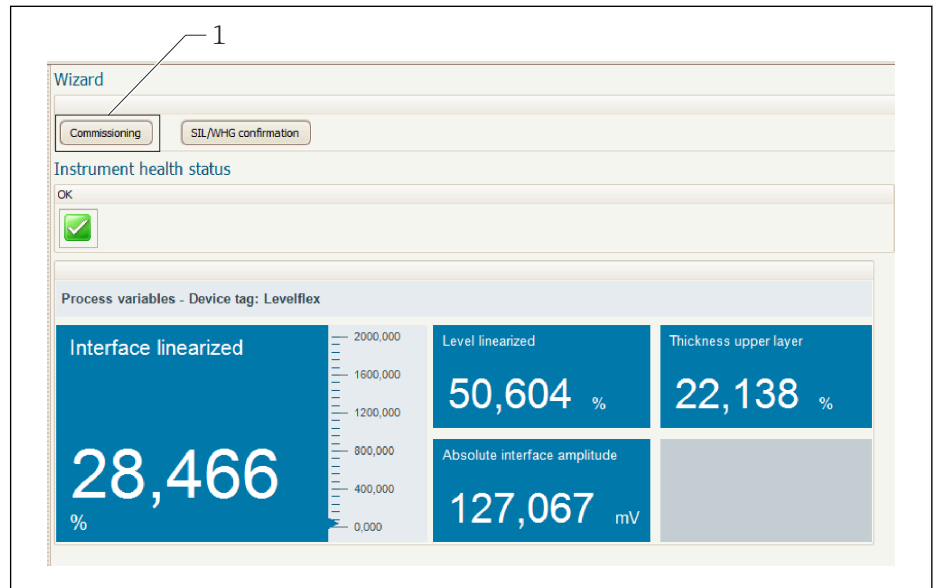

A0025866

1 "Commissioning" button calls up the wizard

3. Click "Commissioning" to launch the Wizard.
 4. Enter the appropriate value in each parameter or select the appropriate option. These values are written directly to the device.
 5. Click "Next" to go to the next page.
 6. Once all the pages have been completed, click "Finish" to close the Wizard.
- i** If you cancel the Wizard before all the necessary parameters have been entered, the device may be in an undefined state. In such situations, it is advisable to reset the device to the factory default settings.

1) DeviceCare is available for download at www.software-products.endress.com. To download the software, it is necessary to register in the Endress+Hauser software portal.

12 Commissioning via operating menu

12.1 Function check

Before commissioning your measuring point, ensure that the post-installation and post-connection checks have been performed:

12.2 Setting the operating language

Factory setting: English or ordered local language

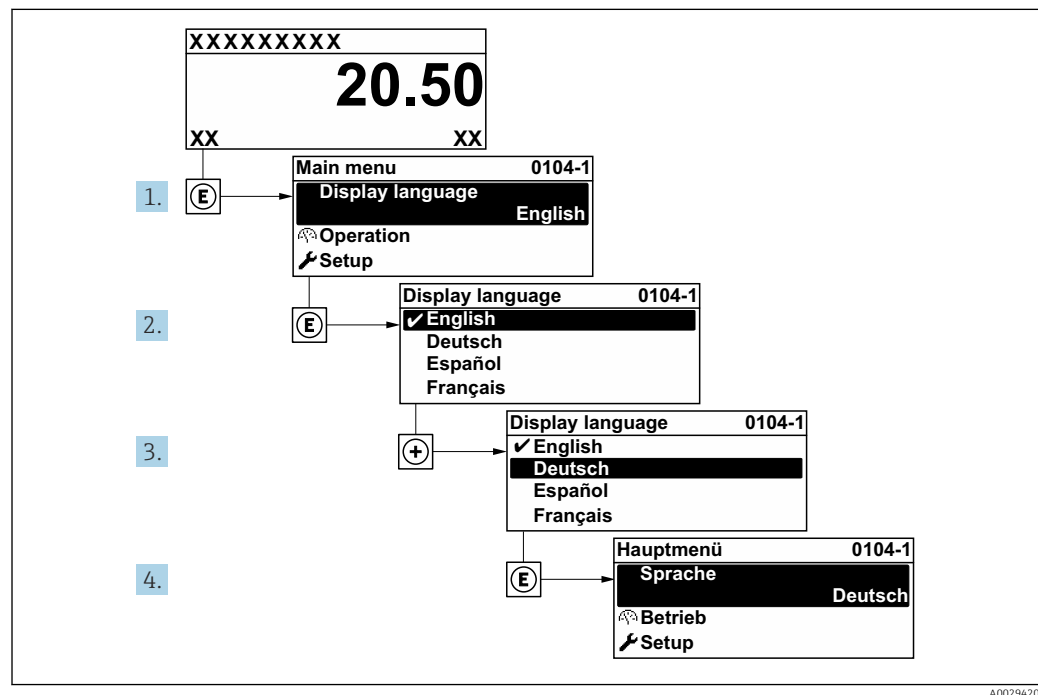

33 Taking the example of the local display

A0029420

12.3 Configuring interface measurement

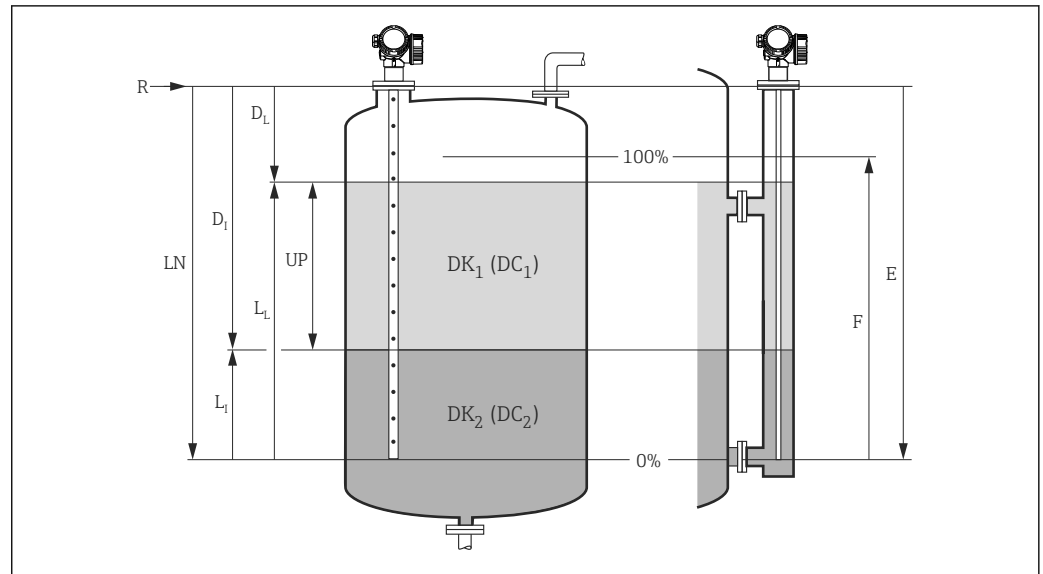

A0011177

34 Configuration parameters for interface measurement

- LN Probe length
- R Reference point of measurement
- DI Interface distance (distance from flange to lower medium)
- LI Interface
- DL Distance
- LL Level
- UP Thickness upper layer
- E Empty calibration (= zero point)
- F Full calibration (= span)

1. Navigate to: Setup → Device tag
 - ↳ Enter device tag.
2. Navigate to: Setup → Operating mode
 - ↳ Select the **Interface with capacitance** option.
3. Navigate to: Setup → Distance unit
 - ↳ Select the distance unit.
4. Navigate to: Setup → Tank type
 - ↳ Select tank type.
5. For **Tank type** parameter = Bypass / pipe:
 - Navigate to: Setup → Tube diameter
 - ↳ Specify the diameter of the bypass or stilling well.
6. Navigate to: Setup → DC value
 - ↳ Specify the relative dielectric constant (ϵ_r) of the upper medium.
7. Navigate to: Setup → Empty calibration
 - ↳ Specify the empty distance E (distance from reference point R to 0% mark).
8. Navigate to: Setup → Full calibration
 - ↳ Specify the full distance F (distance from the 0% mark to the 100% mark).
9. Navigate to: Setup → Level
 - ↳ Displays the measured level L_L .
10. Navigate to: Setup → Interface
 - ↳ Displays the interface height L_I .

11. Navigate to: Setup → Distance
 - ↳ Displays the distance D_L between the reference point R and the level L_L .
12. Navigate to: Setup → Interface distance
 - ↳ Displays the distance D_I between the reference point R and the interface L_I .
13. Navigate to: Setup → Signal quality
 - ↳ Displays the signal quality of the analyzed level echo.
14. Operation via local display:
Navigate to: Setup → Mapping → Confirm distance
 - ↳ Ensure that the tank is fully drained. Then select the Tank empty option.
15. Via an operating tool (e.g. FieldCare):
Navigate to: Setup → Confirm distance
 - ↳ Ensure that the tank is fully drained. Then select the Tank empty option.

NOTICE**Wrong measurement due to incorrect dielectric constant of the lower medium**

- ▶ The dielectric constant (DC value) of the lower medium must be specified if the lower medium is not water when **Operating mode = Interface with capacitance**. Navigation: Setup → Advanced setup → Interface → DC value lower medium

NOTICE**Wrong measurement due to incorrect empty capacitance**

- ▶ In the case of rod and rope probes in the bypass, a correct measurement is only possible for **Operating mode = Interface with capacitance** after the empty capacitance has been determined. For this purpose, select **Confirm distance = Tank empty** after installing the probe when the tank is completely empty. A calculated empty capacitance can be entered for rod probes in the following parameters in exceptional cases only (if the tank cannot be emptied during commissioning): Expert → Sensor → Interface → Empty capacitance.

-  The empty capacitance is always calibrated ex works in the case of coax probes.

12.4 Recording the reference envelope curve

After the measurement has been configured, it is recommended to record the current envelope curve as a reference envelope curve. This can then be used later for diagnostic purposes. The **Save reference curve** parameter is used to record the envelope curve.

Path in the menu

Expert → Diagnostics → Envelope diagnostics → Save reference curve

Meaning of the options

- No
No action
- Yes
The current envelope curve is saved as a reference curve.

 This submenu is only visible for the "Service" user role in devices supplied with software version 01.00.zz or 01.01.zz.

 The reference envelope curve can only be displayed in the envelope curve diagram of FieldCare after it has been loaded from the device into FieldCare. The "Load Reference Curve" function in FieldCare is used for this.

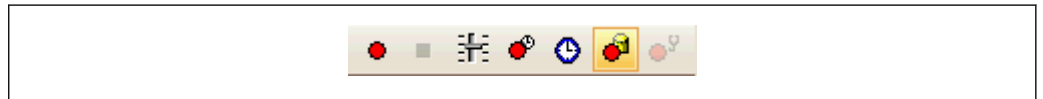

 35 "Load Reference Curve" function

12.5 Configuring the local display

12.5.1 Factory setting of local display for interface measurements

Parameter	Factory setting for devices with 1 current output	Factory setting for devices with 2 current outputs
Format display	1 value, max. size	1 value, max. size
Value 1 display	Interface linearized	Interface linearized
Value 2 display	Level linearized	Level linearized
Value 3 display	Thickness upper layer	Current output 1
Value 4 display	Current output 1	Current output 2

12.5.2 Adjusting the local display

The local display can be adjusted in the following submenu:

Setup → Advanced setup → Display

12.6 Configuring the current outputs

12.6.1 Factory setting of current outputs for interface measurements

Current output	Assigned measured value	4mA value	20mA value
1	Interface linearized	0% or the corresponding linearized value	100% or the corresponding linearized value
2 ¹⁾	Level linearized	0% or the corresponding linearized value	100% or the corresponding linearized value

1) For devices with two current outputs

12.6.2 Adjusting the current outputs

The current outputs can be adjusted in the following submenus:

Basic settings

Setup → Advanced setup → Current output 1 to 2

Advanced settings

Expert → Output 1 to 2 → Current output 1 to 2

See "Description of Device Parameters" GP01000F

12.7 Configuration management

After commissioning, you can save the current device configuration, copy it to another measuring point or restore the previous device configuration. You can do so using the **Configuration management** parameter and the options available.

Path in the menu

Setup → Advanced setup → Configuration backup display → Configuration management

Meaning of the options

- **Cancel**

No action is executed and the user exits the parameter.

- **Execute backup**

A backup copy of the current device configuration is saved from the HistoROM (integrated in the device) to the display module of the device.

- **Restore**

The last backup copy of the device configuration is copied from the display module to the HistoROM of the device.

- **Duplicate**

The transmitter configuration of the device is duplicated to another device using the display module. The following parameters, which characterize the individual measuring point are **not** transferred:

- HART date code
- HART short tag
- HART message
- HART descriptor
- HART address
- Device tag
- Medium type

- **Compare**

The device configuration saved in the display module is compared to the current device configuration of the HistoROM. The result of the comparison is displayed in the **Comparison result** parameter.

- **Clear backup data**

The backup copy of the device configuration is deleted from the display module of the device.

 While this action is in progress, the configuration cannot be edited via the local display and a message on the processing status appears on the display.

 If an existing backup copy is restored on a device other than the original device using the **Restore** option, in some cases individual device functions may not be available. In some cases it is also not possible to restore the original state by resetting to the "as-delivered" state.

The **Duplicate** option should always be used to copy the configuration to another device.

12.8 Protecting settings from unauthorized access

The settings can be protected from unauthorized access in two ways:

- Locking via parameters (software locking)
- Locking via write protection switch (hardware locking)

13 Diagnostics and troubleshooting

13.1 General troubleshooting

13.1.1 General errors

Error	Possible cause	Solution
Device does not respond.	Supply voltage does not match the value indicated on the nameplate.	Connect the correct voltage.
	The polarity of the supply voltage is wrong.	Correct the polarity.
	The cables do not contact the terminals properly.	Ensure electrical contact between the cable and the terminal.
Values on the display invisible	Contrast setting is too weak or too strong.	<ul style="list-style-type: none"> ▪ Increase contrast by pressing \oplus and \boxplus simultaneously. ▪ Decrease contrast by pressing \ominus and \boxplus simultaneously.
	The plug of the display cable is not connected correctly.	Connect the plug correctly.
	Display is defective.	Replace display.
"Communication error" is indicated on the display when starting the device or connecting the display.	Electromagnetic interference	Check grounding of the device.
	Broken display cable or display plug.	Replace display.
Duplication of parameters via display from one device to another not working. Only the "Save" and "Cancel" options are available.	Display with backup is not properly detected if a data backup was not carried out on the new device previously.	Connect display (with backup) and restart device.
Output current <3.6 mA	Signal cable connection incorrect.	Check connection.
	Electronics module is defective.	Replace electronics.
HART communication does not function.	Communication resistor missing or incorrectly installed.	Install the communication resistor (250 Ω) correctly.
	Commubox is connected incorrectly.	Connect Commubox correctly.
	Commubox is not set to "HART".	Set Commubox selector switch to "HART".
CDI communication does not work.	Wrong setting of the COM port on the computer.	Check the setting of the COM port on the computer and change it if necessary.
Device measures incorrectly.	Parameter configuration error	Check and correct the parameter configuration.
No communication with device via SmartBlue	No Bluetooth connection	Enable Bluetooth function on smartphone or tablet
	The device is already connected with another smartphone/tablet	Disconnect the device from the other smartphone/tablet
	Bluetooth module not connected	Connect Bluetooth module (see SD02252F).
Login via SmartBlue not possible	Device is being put into operation for the first time	Enter initial password (ID of Bluetooth module) and change it

Error	Possible cause	Solution
Device cannot be operated via SmartBlue	Incorrect password entered	Enter the correct password, paying attention to lower/upper case
Device cannot be operated via SmartBlue	Password forgotten	Contact Endress+Hauser Service (www.addresses.endress.com)

13.1.2 Error - SmartBlue operation

Error	Possible cause	Solution
Device is not visible in the live list	No Bluetooth connection	Enable Bluetooth® function on smartphone or tablet
		Bluetooth® function of sensor disabled, perform recovery sequence
Device is not visible in the live list	The device is already connected with another smartphone/tablet	Only one point-to-point connection is established between a sensor and a smartphone or tablet
Device is visible in the live list but cannot be accessed via SmartBlue	Android end device	Is the location function enabled for the app, was it approved the first time?
		GPS or positioning function must be activated for certain Android versions in conjunction with Bluetooth®
		Activate GPS - close the app fully and restart - enable the positioning function for the app
Device is visible in the live list but cannot be accessed via SmartBlue	Apple end device	Log in as standard Enter user name "admin" Enter initial password (ID of the Bluetooth module) paying attention to lower/upper case
Login via SmartBlue not possible	Device is being put into operation for the first time	Enter initial password (ID of the Bluetooth module) and change; paying attention to lower/upper case
Device cannot be operated via SmartBlue	Incorrect password entered	Enter correct password
Device cannot be operated via SmartBlue	Password forgotten	Contact the Endress+Hauser Service department (www.addresses.endress.com)

13.1.3 Parametrization errors

Parametrization errors for level measurements

Problem	Possible cause	Remedy
Measured value is incorrect	If measured distance (Setup → Distance) matches the real distance: Calibration error	<ul style="list-style-type: none"> ▪ Check the Empty calibration parameter (→ ☰ 120) and correct if necessary. ▪ Check the Full calibration parameter (→ ☰ 121) and correct if necessary. ▪ Check the linearization and correct if necessary (Linearization submenu (→ ☰ 139)).
	If measured distance (Setup → Distance) does not match the real distance: An interference echo is present.	Carry out mapping (Confirm distance parameter (→ ☰ 125)).
No change of measured value on filling/emptying	An interference echo is present.	Carry out mapping (Confirm distance parameter (→ ☰ 125)).
	Buildup at the probe.	Clean the probe.
	Error in the echo tracking.	Deactivate echo tracking (Expert → Sensor → Echo tracking → Evaluation mode = History off).
Echo lost diagnostic message appears after the supply voltage is switched on.	Echo threshold too high.	Check the Medium group parameter (→ ☰ 119). If necessary, select a more detailed setting with the Medium property parameter.
	Level echo suppressed.	Delete the map and record it again if necessary (Record map parameter (→ ☰ 127)).
Device displays a level when the tank is empty.	Incorrect probe length	Perform probe length correction (Confirm probe length parameter (→ ☰ 155)).
	Interference echo	Carry out mapping over the entire probe length when the tank is empty (Confirm distance parameter (→ ☰ 125)).
Wrong slope of the level over the entire measuring range	Wrong tank type selected.	Select the correct Tank type parameter (→ ☰ 119).

Parametrization errors for interface measurements

Problem	Possible cause	Remedy
Incorrect slope of the interface measured value	The dielectric constant (DC value) of the upper medium is incorrectly set.	Enter the correct dielectric constant (DC value) of the upper medium (DC value parameter (→ ☰ 123)).
The measured value for the interface and the total level are identical.	The echo threshold for the total level is too high due to an incorrect dielectric constant.	Enter the correct dielectric constant (DC value) of the upper medium (DC value parameter (→ ☰ 123)).
The total level jumps to the interface level in the case of thin interfaces.	The thickness of the upper medium is lower than 60 mm.	Measurement of the interface is only possible for interface heights greater than 60 mm.

13.2 Diagnostic information on local display

13.2.1 Diagnostic message

Faults detected by the self-monitoring system of the measuring device are displayed as a diagnostic message in alternation with the measured value display.

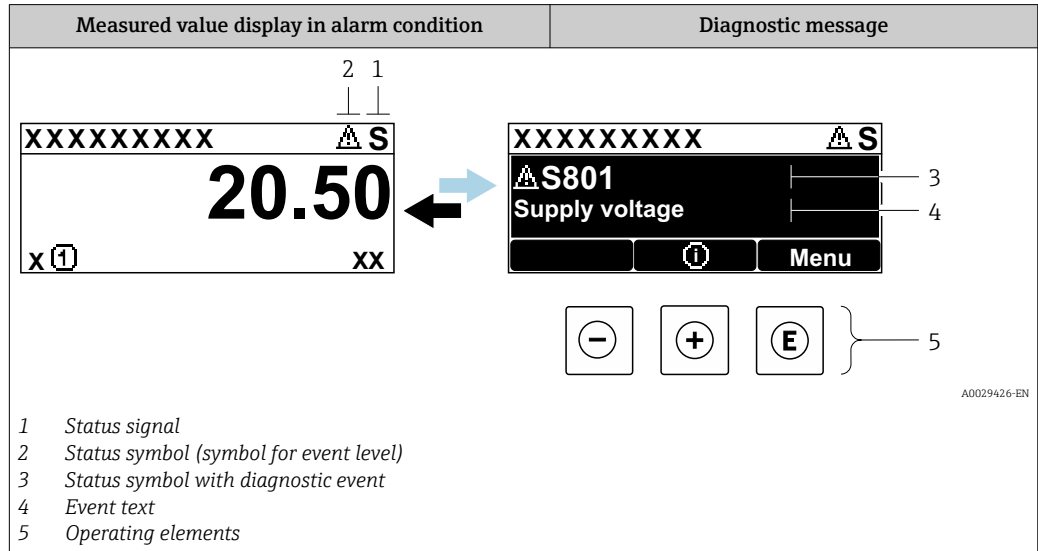

Status signals

F <small>A0032902</small>	"Failure (F)" option A device error has occurred. The measured value is no longer valid.
C <small>A0032903</small>	"Function check (C)" option The device is in the service mode (e.g. during a simulation).
S <small>A0032904</small>	"Out of specification (S)" option The device is operated: <ul style="list-style-type: none"> ▪ Outside of its technical specifications (e.g. during startup or a cleaning) ▪ Outside of the configuration performed by the user (e.g. level outside the configured range)
M <small>A0032905</small>	"Maintenance required (M)" option Maintenance is required. The measured value is still valid.

Status symbol (symbol for event level)

⊗	"Alarm" status The measurement is interrupted. The signal outputs adopt the defined alarm condition. A diagnostic message is generated.
⚠	"Warning" status The device continues to measure. A diagnostic message is generated.

Diagnostic event and event text

The fault can be identified by means of the diagnostic event. The event text helps you by providing information about the fault. In addition, the associated status symbol is displayed in front of the diagnostic event.

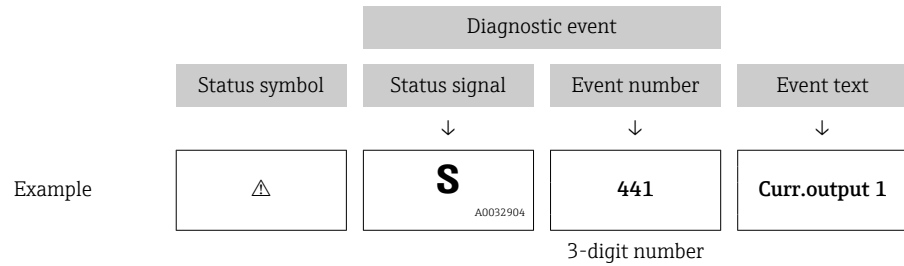

If two or more diagnostic events occur simultaneously, only the diagnostic message with the highest priority is shown. Additional queued diagnostic messages can be shown in the **Diagnostic list** submenu.

-  Past diagnostic messages that are no longer pending are shown as follows:
 - On the local display:
 - In the **Event logbook** submenu
 - In FieldCare:
 - Via the "Event List /HistoROM" function.

Operating elements

Operating functions in menu, submenu	
+	Plus key Opens the message about the remedial measures.
E	Enter key Opens the operating menu.

13.2.2 Calling up remedial measures

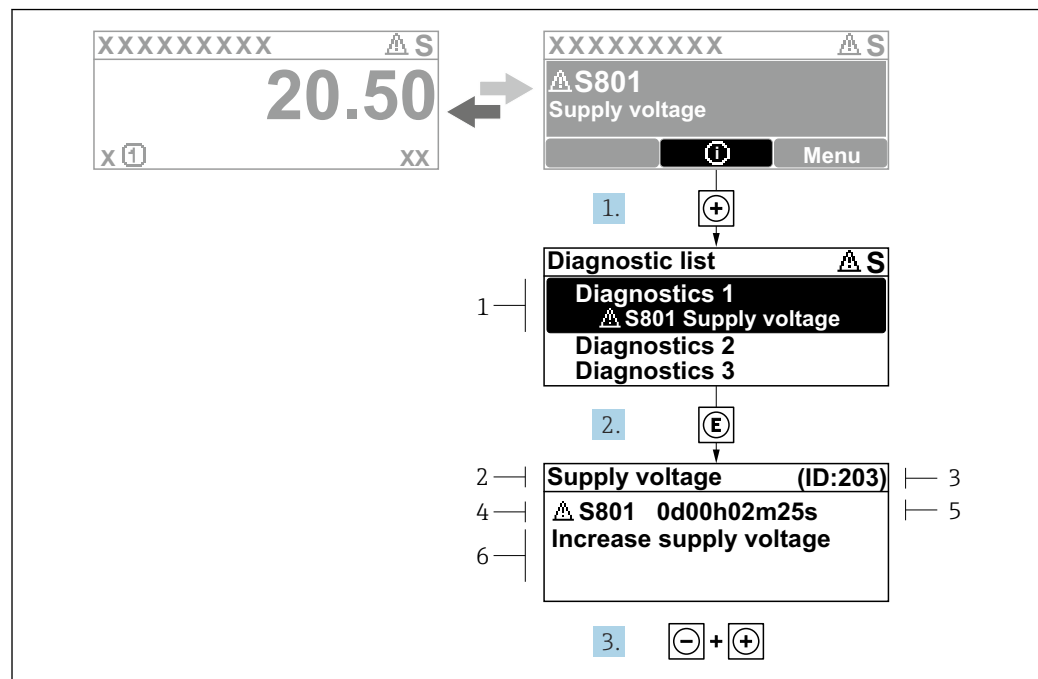

36 Message for remedial measures

- 1 Diagnostic information
- 2 Short text
- 3 Service ID
- 4 Diagnostic behavior with diagnostic code
- 5 Operation time when error occurred
- 6 Remedial measures

The user is in the diagnostic message.

1. Press \oplus ($\textcircled{1}$ symbol).
 ↳ The **Diagnostic list** submenu opens.
2. Select the desired diagnostic event with \oplus or \ominus and press \textcircled{E} .
 ↳ The message for the remedial measures for the selected diagnostic event opens.
3. Press $\ominus + \oplus$ simultaneously.
 ↳ The message about the remedial measures closes.

The user is in the **Diagnostics** menu at an entry for a diagnostics event, e.g. in the **Diagnostic list** or in **Previous diagnostics**.

1. Press \textcircled{E} .
 ↳ The message for the remedial measures for the selected diagnostic event opens.
2. Press $\ominus + \oplus$ simultaneously.
 ↳ The message about the remedial measures closes.

13.3 Diagnostic event in the operating tool

If a diagnostic event is present in the device, the status signal appears in the top left status in the operating tool along with the corresponding symbol for event level in accordance with NAMUR NE 107:

- Failure (F)
- Function check (C)
- Out of specification (S)
- Maintenance required (M)

A: Via the operating menu

1. Navigate to the **Diagnostics** menu.
 - ↳ In the **Actual diagnostics** parameter, the diagnostic event is shown with event text.
2. On the right in the display range, hover the cursor over the **Actual diagnostics** parameter.

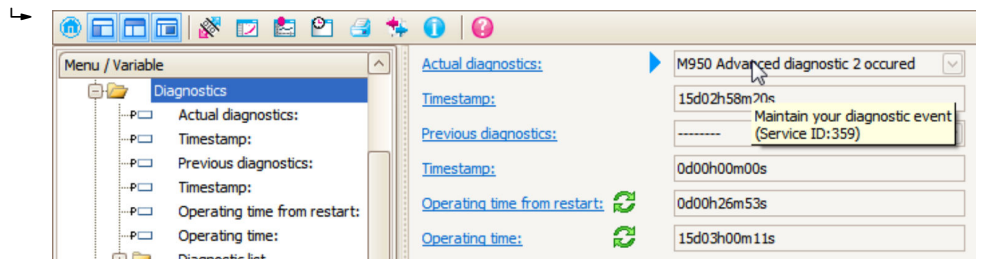

A tool tip with remedial measures for the diagnostic event appears.

B: Via the "Create documentation" function

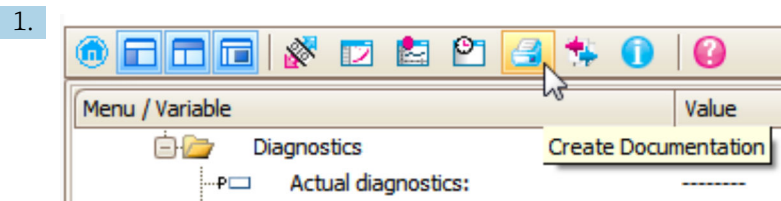

Select the "Create documentation" function.

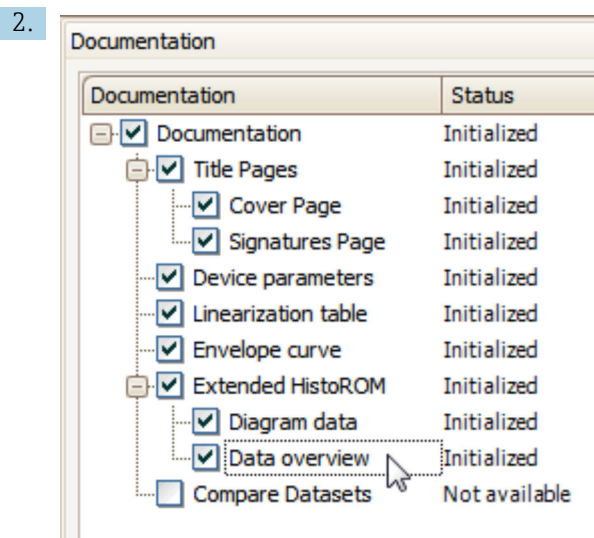

Make sure "Data overview" is marked.

3. Click "Save as ..." and save a PDF of the protocol.
 - ↳ The protocol contains the diagnostic messages and remedy information.

C: Via the "Eventlist / Extended HistoROM" function

1.

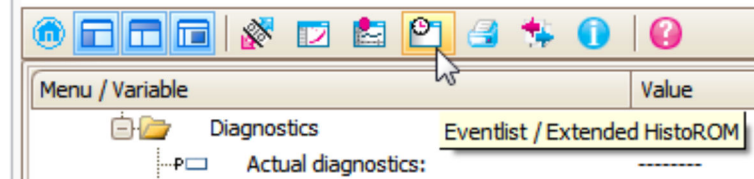

Select the "Eventlist / Extended HistoROM" function.

2.

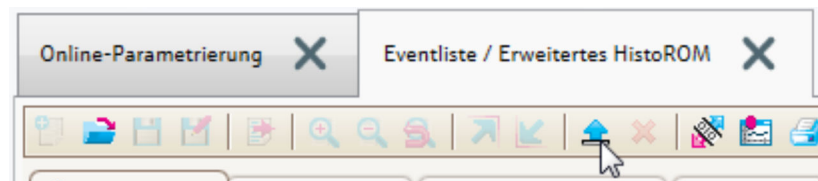

Select the "Load Eventlist" function.

- ↳ The list of events, including remedy information, is shown in the "Data overview" window.

13.4 Diagnostic list

In the **Diagnostic list** submenu submenu, up to 5 currently pending diagnostic messages can be displayed. If more than 5 messages are pending, the messages with the highest priority are shown on the display.

Navigation path

Diagnostics → Diagnostic list

Calling up and closing the remedial measures

1. Press \square .
 - ↳ The message for the remedial measures for the selected diagnostic event opens.
2. Press \square + \oplus simultaneously.
 - ↳ The message about the remedial measures closes.

13.5 List of diagnostic events

Diagnostic number	Short text	Remedy instructions	Status signal [from the factory]	Diagnostic behavior [from the factory]
Diagnostic of sensor				
003	Broken probe detected	1. Check map 2. Check sensor	F	Alarm
046	Build-up detected	Clean sensor	F	Alarm
104	HF cable	and check sealing 1. Dry HF cable connection 2. Change HF cable	F	Alarm
105	HF cable	1. Tighten HF cable connection 2. Check sensor 3. Change HF cable	F	Alarm
106	Sensor	1. Check sensor 2. Check HF cable 3. Contact service	F	Alarm
Diagnostic of electronic				
242	Software incompatible	1. Check software 2. Flash or change main electronics module	F	Alarm
252	Modules incompatible	1. Check if correct electronic modul is plugged 2. Replace electronic module	F	Alarm
261	Electronic modules	1. Restart device 2. Check electronic modules 3. Change I/O Modul or main electronics	F	Alarm
262	Module connection	1. Check module connections 2. Change electronic modules	F	Alarm
270	Main electronic failure	Change main electronic module	F	Alarm
271	Main electronic failure	1. Restart device 2. Change main electronic module	F	Alarm
272	Main electronic failure	1. Restart device 2. Contact service	F	Alarm
273	Main electronic failure	1. Emergency operation via display 2. Change main electronics	F	Alarm
275	I/O module defective	Change I/O module	F	Alarm
276	I/O module faulty	1. Restart device	F	Alarm
276	I/O module faulty	2. Change I/O module	F	Alarm
282	Data storage	1. Restart device 2. Contact service	F	Alarm
283	Memory content	1. Transfer data or reset device 2. Contact service	F	Alarm
311	Electronic failure	Maintenance required! 1. Do not perform reset 2. Contact service	M	Warning
Diagnostic of configuration				
410	Data transfer	1. Check connection 2. Retry data transfer	F	Alarm
411	Up-/download active	Up-/download active, please wait	C	Warning
412	Processing download	Download active, please wait	C	Warning

Diagnostic number	Short text	Remedy instructions	Status signal [from the factory]	Diagnostic behavior [from the factory]
431	Trim 1 to 2	Carry out trim	C	Warning
435	Linearization	Check linearization table	F	Alarm
437	Configuration incompatible	1. Restart device 2. Contact service	F	Alarm
438	Dataset	1. Check data set file 2. Check device configuration 3. Up- and download new configuration	M	Warning
441	Current output 1 to 2	1. Check process 2. Check current output settings	S	Warning
484	Failure mode simulation	Deactivate simulation	C	Alarm
485	Simulation measured value	Deactivate simulation	C	Warning
491	Current output 1 to 2 simulation	Deactivate simulation	C	Warning
494	Switch output simulation	Deactivate simulation switch output	C	Warning
495	Diagnostic event simulation	Deactivate simulation	C	Warning
585	Simulation distance	Deactivate simulation	C	Warning
Diagnostic of process				
801	Energy too low	Increase supply voltage	S	Warning
803	Current loop	1. Check wiring 2. Change I/O module	F	Alarm
825	Operating temperature	1. Check ambient temperature 2. Check process temperature	S	Warning
825	Operating temperature		F	Alarm
921	Change of reference	1. Check reference configuration 2. Check pressure 3. Check sensor	S	Warning
936	EMC interference	Check installation on EMC	F	Alarm
941	Echo lost	Check parameter 'DC value'	F	Alarm ¹⁾
942	In safety distance	1. Check level 2. Check safety distance 3. Reset self holding	S	Alarm ¹⁾
943	In blocking distance	Reduced accuracy Check level	S	Warning
944	Level range	Reduced accuracy Level at process connection	S	Warning
950	Advanced diagnostic 1 to 2 occurred	Maintain your diagnostic event	M	Warning ¹⁾

1) Diagnostic behavior can be changed.

13.6 Event logbook

13.6.1 Event history

A chronological overview of the event messages that have occurred is provided in the **Event list** submenu ²⁾.

Navigation path

Diagnostics → Event logbook → Event list

A maximum of 100 event messages can be displayed in chronological order.



Die Ereignishistorie umfasst Einträge zu:

- Diagnostic events
- Information events

In addition to the operation time of its occurrence, each event is also assigned a symbol that indicates whether the event has occurred or is ended:

- Diagnostic event
 - ☉: Event has occurred
 - ☏: Event has ended
- Information event
 - ☉: Event has occurred

Calling up and closing the remedial measures

1. Press 
 - ↳ The message for the remedial measures for the selected diagnostic event opens.
2. Press  +  simultaneously.
 - ↳ The message about the remedial measures closes.

13.6.2 Filtering the event logbook

Using the **Filter options** parameter, you can define which category of event messages is displayed in the **Event list** submenu.

Navigation path

Diagnostics → Event logbook → Filter options

Filter categories

- All
- Failure (F)
- Function check (C)
- Out of specification (S)
- Maintenance required (M)
- Information

13.6.3 Overview of information events

Info number	Info name
I1000	----- (Device ok)
I1089	Power on
I1090	Configuration reset
I1091	Configuration changed

2) This submenu is only available for operation via local display. In the case of operation via FieldCare, the event list can be displayed with the "Event List / HistoROM" functionality of FieldCare.

Info number	Info name
I1092	Embedded HistoROM deleted
I1110	Write protection switch changed
I1137	Electronic changed
I1151	History reset
I1154	Reset terminal voltage min/max
I1155	Reset electronic temperature
I1156	Memory error trend
I1157	Memory error event list
I1184	Display connected
I1185	Display backup done
I1186	Restore via display done
I1187	Settings downloaded with display
I1188	Display data cleared
I1189	Backup compared
I1256	Display: access status changed
I1264	Safety sequence aborted
I1335	Firmware changed
I1397	Fieldbus: access status changed
I1398	CDI: access status changed
I1512	Download started
I1513	Download finished
I1514	Upload started
I1515	Upload finished
I1554	Safety sequence started
I1555	Safety sequence confirmed
I1556	Safety mode off

13.7 Firmware history

Date	Firmware version	Modifications	Documentation (FMP55, HART)		
			Operating Instructions	Description of Device Parameters	Technical Information
07.2010	01.00.zz	Original software	BA01003F/00/EN/05.10	GP01000F/00/EN/05.10	TI01003F/00/EN/05.10
01.2011	01.01.zz	<ul style="list-style-type: none"> ▪ SIL integrated ▪ Improvements and bugfixes ▪ Additional languages 	<ul style="list-style-type: none"> ▪ BA01003F/00/EN/10.10 ▪ BA01003F/00/EN/13.11 ▪ BA01003F/00/EN/14.12 	<ul style="list-style-type: none"> ▪ GP01000F/00/EN/10.10 ▪ GP01000F/00/EN/13.11 	<ul style="list-style-type: none"> ▪ TI01003F/00/EN/10.10 ▪ TI01003F/00/EN/13.11 ▪ TI01003F/00/EN/14.12 ▪ TI01003F/00/EN/15.12
02.2014	01.02.zz	<ul style="list-style-type: none"> ▪ Support of SD03 ▪ Additional languages ▪ HistoROM functionality enhanced ▪ "Advanced Diagnostics" function block integrated ▪ Improvements and bugfixes 	<ul style="list-style-type: none"> ▪ BA01003F/00/EN/15.13 ▪ BA01003F/00/EN/16.14 	<ul style="list-style-type: none"> ▪ GP01000F/00/EN/14.13 ▪ GP01000F/00/EN/15.14 	<ul style="list-style-type: none"> ▪ TI01003F/00/EN/16.13 ▪ TI01003F/00/EN/17.14
04.2016	01.03.zz	<ul style="list-style-type: none"> ▪ Update to HART 7 ▪ All 17 languages available in the device ▪ Improvements and bugfixes 	<ul style="list-style-type: none"> ▪ BA01003F/00/EN/17.16 ▪ BA01003F/00/EN/18.16 ¹⁾ ▪ BA01003F/00/EN/20.18 ²⁾ 	GP01000F/00/EN/16.16	<ul style="list-style-type: none"> ▪ TI01003F/00/EN/18.16 ▪ TI01003F/00/EN/20.16 ¹⁾ ▪ TI01003F/00/EN/22.18 ²⁾

- 1) Contains information on the Heartbeat wizards available in the current DTM version for DeviceCare and FieldCare.
- 2) Contains information on the Bluetooth interface.



The firmware version can explicitly be ordered via the product structure. In this way it is possible to ensure compatibility of the firmware version with an existing or planned system integration.

14 Maintenance

No special maintenance work is required.

14.1 Exterior cleaning

When cleaning the exterior, always use cleaning agents that do not corrode the surface of the housing and the seals.

14.2 General cleaning instructions

Dirt or buildup may form on the probe depending on the application. A thin, even layer has little impact on the measurement. Thick layers can dampen the signal and reduce the measuring range. Very uneven deposit formation or caking (e.g. due to crystallization) can result in incorrect measurements. In such cases, use a non-contact measuring principle, or regularly inspect the probe for contamination.

Cleaning with sodium hydroxide solution (e.g. in CIP procedures): if the coupling is wetted, larger measurement errors can occur than under reference operating conditions. Wetting can cause temporary incorrect measurements.

14.3 Cleaning coax probes

The ground tube can be removed towards the bottom for cleaning purposes. When disassembling and reassembling, make sure that the spacers between the probe rod and ground tube are not displaced. A spacer is located approx. 10 cm (4 in) from the end of the probe. Depending of the length of the probe there may be additional spacers evenly distributed along the probe.

15 Repair

15.1 General information

15.1.1 Repair concept

Under the Endress+Hauser repair concept, devices have a modular design and repairs can be carried out by Endress+Hauser Service or by properly trained customers.

Spare parts are grouped into logical kits with the associated replacement instructions.

For more information on service and spare parts, please contact Endress+Hauser Service.

15.1.2 Repair of Ex-certified devices

WARNING

Incorrect repair can compromise electrical safety!

Explosion Hazard!

- ▶ Repairs to Ex-certified devices must be carried out by Endress+Hauser Service or by specialist personnel according to national regulations.
- ▶ Relevant standards and national regulations on hazardous areas, safety instructions and certificates must be observed.
- ▶ Use only original Endress+Hauser spare parts.
- ▶ Please note the device designation on the nameplate. Only identical parts may be used as replacements.
- ▶ Carry out repairs according to the instructions.
- ▶ Only the Endress+Hauser service team is permitted to modify a certified device and convert it to another certified version.

15.1.3 Replacing electronics modules

When electronics modules have been replaced the device does not need to be recalibrated as the parameters are saved in the HistoROM inside the housing. It may be necessary when replacing the main electronics to record a new interference echo suppression.

15.1.4 Replacing a device

Once a complete device has been replaced, the parameters can be transferred back into the device using one of the following methods:

- Using the display module
Prerequisite: The configuration of the old device was saved previously to the display module.
- Via FieldCare
Prerequisite: The configuration of the old device was saved previously to the computer using FieldCare.

You can continue measuring without performing a new calibration. Only interference echo suppression may need to be carried out once again.

15.2 Spare parts

- Some replaceable measuring device components are identified by means of a spare part nameplate. This contains information about the spare part.
- In the connection compartment cover of the device there is a spare part nameplate which contains the following information:
 - A list of the most important spare parts for the measuring device, including their ordering information.
 - The URL to the *W@M Device Viewer* (www.endress.com/deviceviewer):
All the spare parts for the measuring device, along with the order code, are listed here and can be ordered. If available, users can also download the associated Installation Instructions.

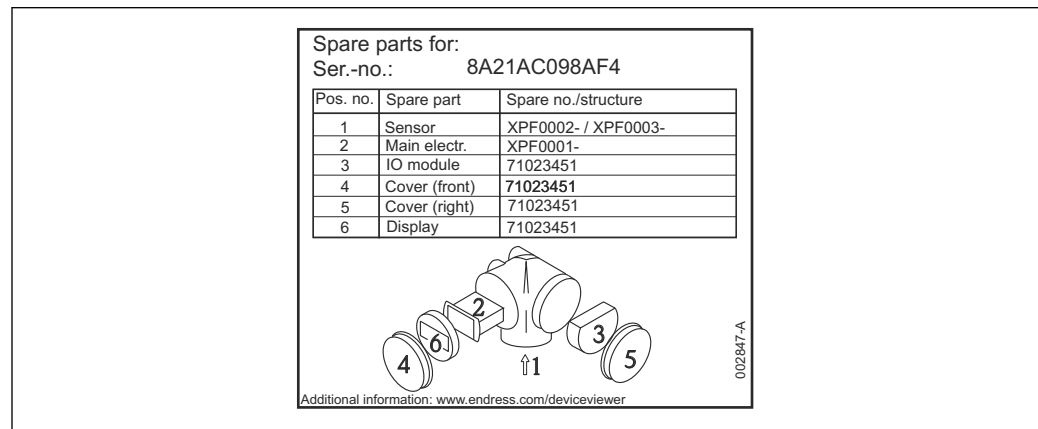

37 Example for spare part nameplate in the connection compartment cover

- i** Measuring device serial number:
 - Located on the device and spare part nameplate.
 - Can be read out via the "Serial number" parameter in the "Device information" submenu.

15.3 Return

The requirements for safe device return can vary depending on the device type and national legislation.

1. Refer to the web page for information:
<http://www.endress.com/support/return-material>
↳ Select the region.
2. Return the device if repairs or a factory calibration are required, or if the wrong device was ordered or delivered.

15.4 Disposal



If required by the Directive 2012/19/EU on waste electrical and electronic equipment (WEEE), the product is marked with the depicted symbol in order to minimize the disposal of WEEE as unsorted municipal waste. Do not dispose of products bearing this marking as unsorted municipal waste. Instead, return them to the manufacturer for disposal under the applicable conditions.

16 Accessories

16.1 Device-specific accessories

16.1.1 Weather protection cover

The weather protection cover can be ordered together with the device via the "Accessory enclosed" product structure.

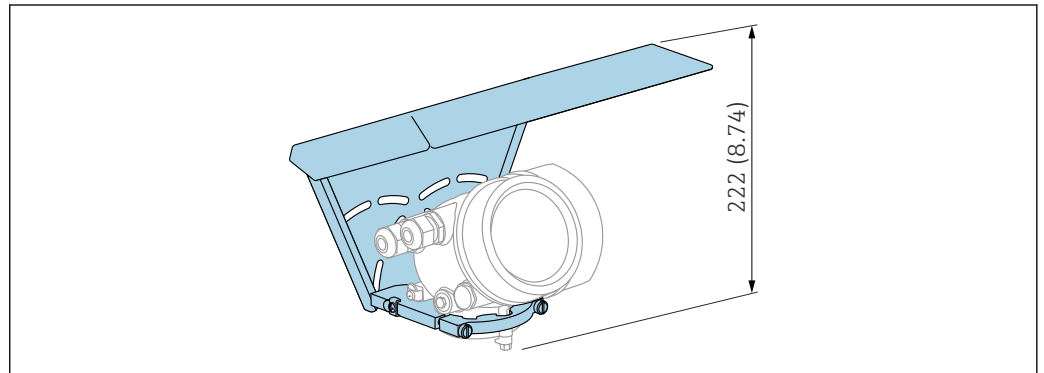

A0015466

38 Height. Unit of measurement mm (in)

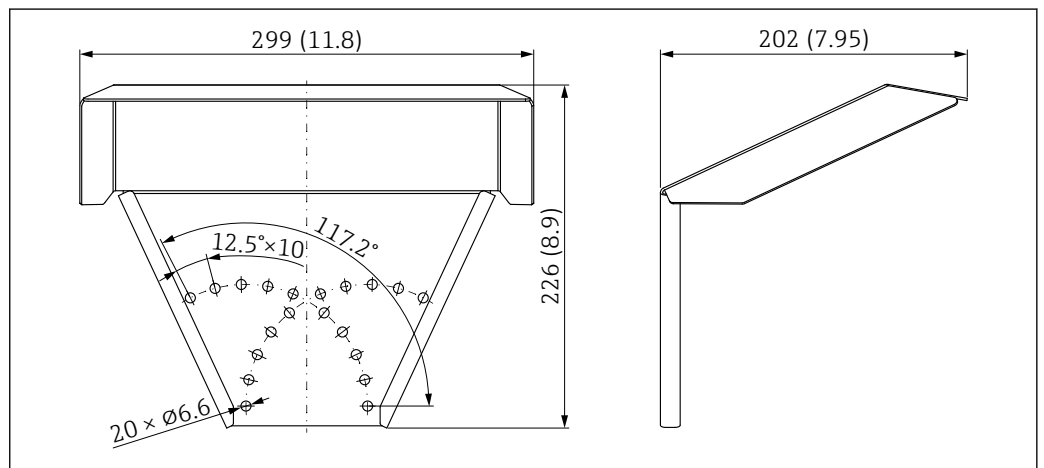

A0015472

39 Dimensions. Unit of measurement mm (in)



Material

316L

Order number for accessories:

71162242

16.1.2 Mounting bracket for electronics housing

Accessories	Description
<p>Mounting bracket for electronics housing</p>	<div style="display: flex; justify-content: space-around;"> <div style="text-align: center;"> <p>A</p> </div> <div style="text-align: center;"> <p>B</p> </div> </div> <p> 40 Mounting bracket for electronics housing; engineering unit: mm (in)</p> <p>A Wall mounting B Post mounting</p> <p> With "remote sensor" device versions (see feature 060 in the product structure), the mounting bracket is included in the scope of delivery. However, it can also be ordered separately as an accessory (order number: 71102216).</p> <p style="text-align: right; font-size: small;">A0014793</p>

16.1.3 Centering star

Accessories	Description
<p>Centering star PFA</p> <ul style="list-style-type: none"> ▪ ϕ 16.4 mm (0.65 in) ▪ ϕ 37 mm (1.46 in) <p>suitable for FMP55</p>	<div style="text-align: right; margin-bottom: 10px;"> </div> <p>A For probe 8 mm (0.3 in) B For probes 12 mm (0.47 in) and 16 mm (0.63 in)</p> <p>The centering star is suitable for probes with a rod diameter of 8 mm (0.3 in), 12 mm (0.47 in) and 16 mm (0.63 in) (including coated rod probes) and can be used in pipes from DN40 to DN50. See also Operating Instructions BA00378F/00/A2.</p> <ul style="list-style-type: none"> ▪ Material: PFA ▪ Permitted process temperature range: -200 to +250 °C (-328 to +482 °F) ▪ Order number <ul style="list-style-type: none"> ▪ Probe 8 mm (0.3 in) : 71162453 ▪ Probe 12 mm (0.47 in): 71157270 ▪ Probe 16 mm (0.63 in): 71069065 <p> The PFA centering star can also be ordered directly with the device (Levelflex product structure, feature 610 "Accessory mounted", option OE).</p> <p style="text-align: right; font-size: small;">A0014577</p>

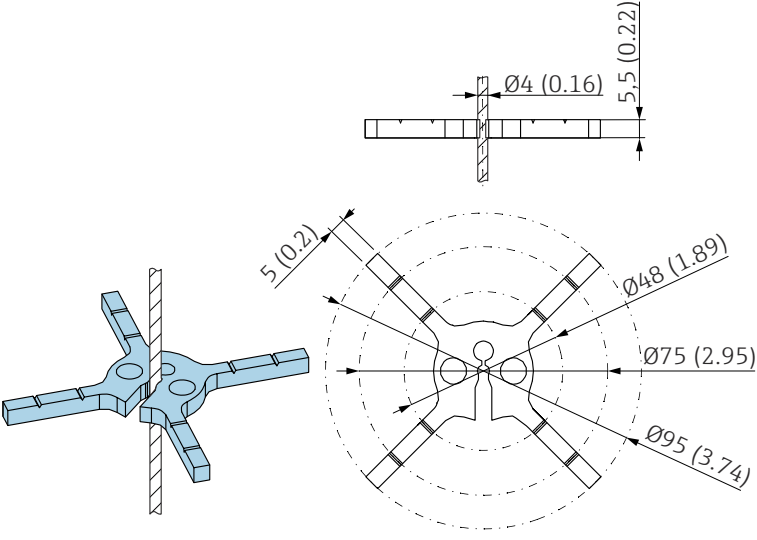
Accessories	Description
<p>Centering star PEEK, Ø 48 to 95 mm (1.9 to 3.7 in) suitable for FMP55</p>	 <p>The centering star is suitable for probes with a rope diameter of 4 mm (1/8 in) (including coated rope probes). See also Operating Instructions SD01961F.</p> <ul style="list-style-type: none"> ■ Material: PEEK ■ Permitted process temperature range: -60 to +250 °C (-76 to +482 °F) ■ Order number <ul style="list-style-type: none"> ■ 71373490 (1x) ■ 71373492 (5x)

16.1.4 Remote display FHX50

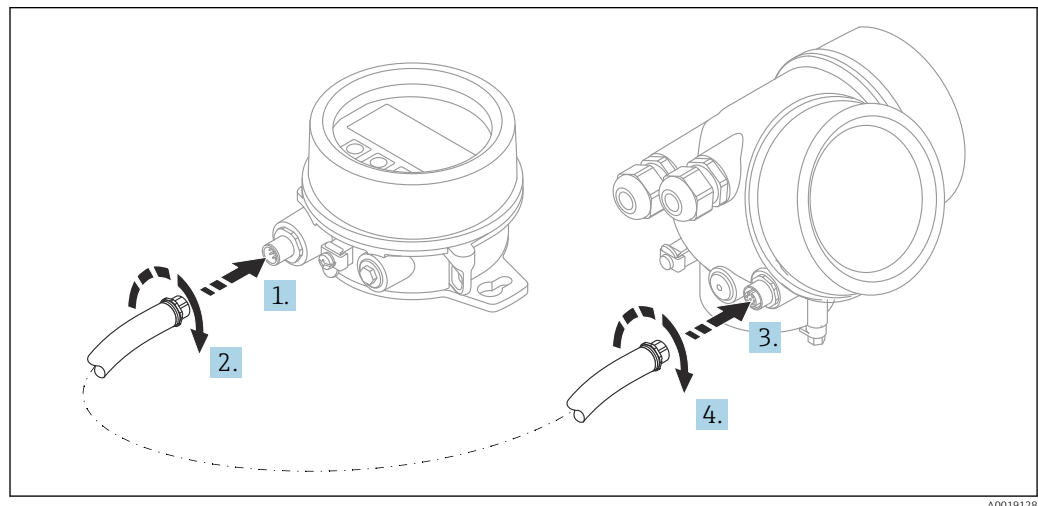

Technical data

- Material:
 - Plastic PBT
 - 316L/1.4404
 - Aluminum
- Degree of protection: IP68 / NEMA 6P and IP66 / NEMA 4x
- Suitable for display modules:
 - SD02 (push buttons)
 - SD03 (touch control)

- Connecting cable:
 - Cable supplied with device up to 30 m (98 ft)
 - Standard cable supplied by customer up to 60 m (196 ft)
- Ambient temperature: -40 to 80 °C (-40 to 176 °F)
- Ambient temperature (option): -50 to 80 °C (-58 to 176 °F) ³⁾

Ordering information

- If the remote display is to be used, the device version "Prepared for display FHX50" must be ordered.
For the FHX50, the option "Prepared for display FHX50" must be selected under "Measuring device version".
- If a measuring device has not been ordered with the version "Prepared for display FHX50" and is to be retrofitted with an FHX50, the version "Not prepared for display FHX50" must be ordered for the FHX50 under "Measuring device version". In this case, a retrofit kit for the device is supplied with the FHX50. The kit can be used to prepare the device so that the FHX50 can be used.

 Use of the FHX50 may be restricted for transmitters with an approval. A device may only be retrofitted with the FHX50 if the option "Prepared for FHX50" is listed in the associated Safety Instructions (XA) under *Basic specifications*, "Display, operation".

Also pay attention to the Safety Instructions (XA) of the FHX50.

Retrofitting is not possible on transmitters with:

- An approval for use in areas with flammable dust (dust ignition-proof approval)
- Type of protection Ex nA

 For details, see the "Special Documentation" SD01007F

16.1.5 Overvoltage protection

The surge arrester for loop-powered devices can be ordered together with the device via the "Accessory mounted" section of the product order structure.

The surge arrester can be used for loop-powered devices.

- 1-channel devices - OVP10
- 2-channel devices - OVP20

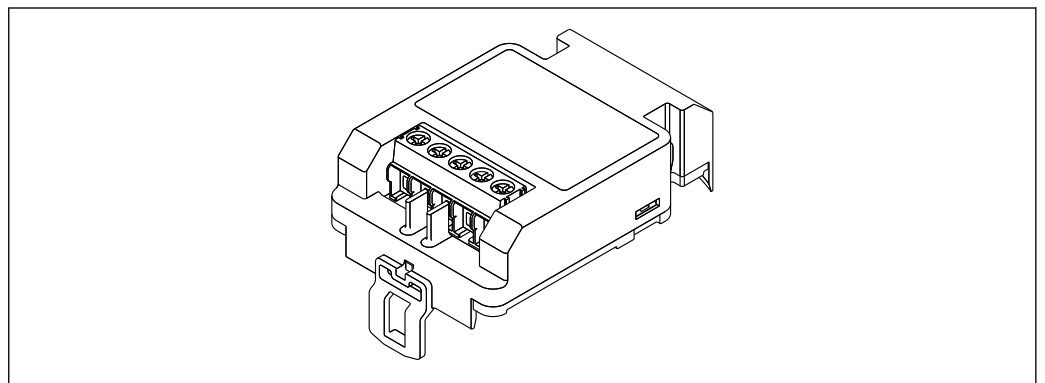

A0021734

Technical data

- Resistance per channel: $2 \times 0.5 \Omega_{\max}$
- Threshold DC voltage: 400 to 700 V
- Threshold surge voltage: < 800 V

3) This range applies if the option JN "Transmitter ambient temperature" -50 °C (-58 °F) was selected in feature 580 "Test, Certificate". If the temperature is permanently below -40 °C (-40 °F), higher failure rates can be expected.

- Capacitance at 1 MHz: < 1.5 pF
- Nominal leakage current (8/20 μ s): 10 kA
- Suitable for conductor cross-sections: 0.2 to 2.5 mm² (24 to 14 AWG)

If retrofitting:

- Order number for 1-channel devices (OVP10): 71128617
- Order number for 2-channel devices (OVP20): 71128619
- The use of the OVP module may be restricted depending on the transmitter approval. A device may only be retrofitted with the OVP module if the option *NA* (overvoltage protection) is listed under *Optional specifications* in the Safety Instructions (XA) associated with the device.
- In order to keep the necessary safety distances when using the surge arrester module, the housing cover also needs to be replaced when the device is retrofitted. Depending on the housing type, the suitable cover can be ordered using the following order number:
 - Housing GT18: 71185516
 - Housing GT19: 71185518
 - Housing GT20: 71185517



For details, see the "Special Documentation" SD01090F

16.1.6 Bluetooth module BT10 for HART devices

The Bluetooth module BT10 can be ordered together with the device via the "Accessory mounted" section of the product order structure.

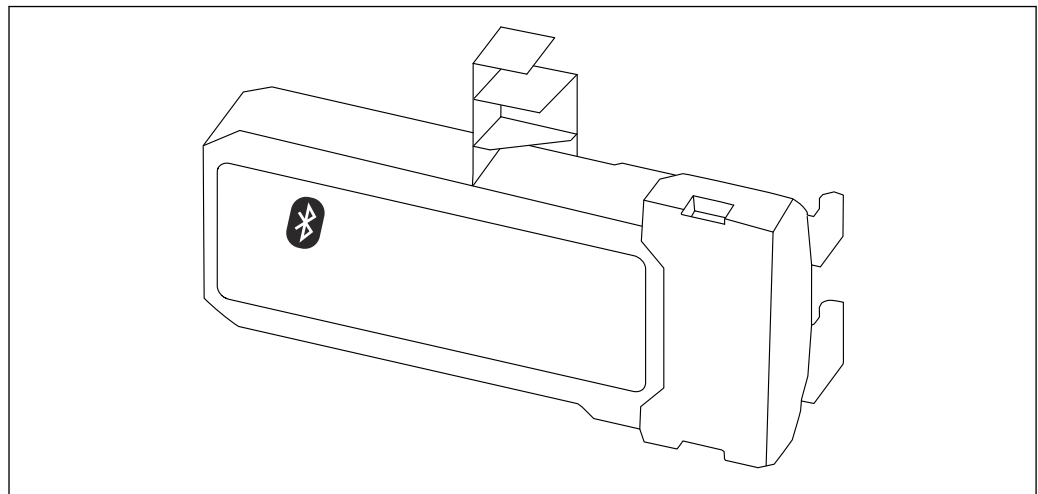

A0036493

Technical data

- Quick and easy setup with the SmartBlue app
- No additional tools or adapters needed
- Signal curve via SmartBlue (app)
- Encrypted single point-to-point data transmission (tested by Fraunhofer Institute) and password-protected communication via Bluetooth® wireless technology
- Range under reference conditions:
 - > 10 m (33 ft)
- When the Bluetooth module is used, the minimum supply voltage of the device increases by up to 3 V.

If retrofitting:

- Order number: 71377355
- The use of the Bluetooth module may be restricted depending on the transmitter approval. A device may only be retrofitted with the Bluetooth module if the option *NF* (Bluetooth module) is listed under *Optional specifications* in the Safety Instructions (XA) associated with the device.

 For details, see the "Special Documentation" SD02252F

16.2 Communication-specific accessories

Commubox FXA195 HART

For intrinsically safe HART communication with FieldCare via the USB interface

 For details, see "Technical Information" TI00404F

Commubox FXA291

Connects Endress+Hauser field devices with a CDI interface (= Endress+Hauser Common Data Interface) and the USB port of a computer or laptop

Order number: 51516983

 For details, see "Technical Information" TI00405C

HART Loop Converter HMX50

Is used to evaluate and convert dynamic HART process variables to analog current signals or limit values

Order number: 71063562

 For details, see "Technical Information" TI00429F and Operating Instructions BA00371F

WirelessHART adapter SWA70

- Is used for the wireless connection of field devices
- The WirelessHART adapter can be easily integrated into field devices and existing infrastructures, offers data protection and transmission safety and can be operated in parallel with other wireless networks

 For details, see Operating Instructions BA00061S

Fieldgate FXA42

Fieldgates enable communication between connected 4 to 20 mA, Modbus RS485 and Modbus TCP devices and SupplyCare Hosting or SupplyCare Enterprise. The signals are transmitted either via Ethernet TCP/IP, WLAN or mobile communications (UMTS). Advanced automation capabilities are available, such as an integrated Web-PLC, OpenVPN and other functions.

 For details, see "Technical Information" TI01297S and Operating Instructions BA01778S.

SupplyCare Enterprise SCE30B

Inventory management software that displays the level, volume, mass, temperature, pressure, density or other parameters of tanks. The parameters are recorded and transmitted by means of gateways like Fieldgate FXA42, Connect Sensor FXA30B or other gateway types.

This Web-based software is installed on a local server and can also be visualized and operated with mobile terminals such as a smartphone or tablet.

 For details, see Technical Information TI01228S and Operating Instructions BA00055S

SupplyCare Hosting SCH30

Inventory management software that displays the level, volume, mass, temperature, pressure, density or other parameters of tanks. The parameters are recorded and

transmitted by means of gateways like Fieldgate FXA42, Connect Sensor FXA30B or other gateway types.

SupplyCare Hosting is offered as a hosting service (Software as a Service, SaaS). In the Endress+Hauser portal, the user is provided with the data over the Internet.



For details, see Technical Information TI01229S and Operating Instructions BA00050S

Field Xpert SFX350

Field Xpert SFX350 is a mobile computer for commissioning and maintenance. It enables efficient device configuration and diagnostics for HART and FOUNDATION Fieldbus devices in the **non-Ex area**.



For details, see Operating Instructions BA01202S

Field Xpert SFX370

Field Xpert SFX370 is a mobile computer for commissioning and maintenance. It enables efficient device configuration and diagnostics for HART and FOUNDATION Fieldbus devices in the **non-Ex area** and the **Ex area**.



For details, see Operating Instructions BA01202S

16.3 Service-specific accessories

DeviceCare SFE100

Configuration tool for HART, PROFIBUS and FOUNDATION Fieldbus field devices



Technical Information TI01134S

FieldCare SFE500

FDT-based plant asset management tool

It can configure all smart field units in your system and helps you manage them. By using the status information, it is also a simple but effective way of checking their status and condition.



Technical Information TI00028S

16.4 System components

Memograph M graphic data manager

The Memograph M graphic data manager provides information on all the relevant process variables. Measured values are recorded correctly, limit values are monitored and measuring points analyzed. The data are stored in the 256 MB internal memory and also on a SD card or USB stick.



Technical Information TI00133R and Operating Instructions BA00247R

RN221N

Active barrier with power supply for safe separation of 4 to 20 mA standard signal circuits. Offers bidirectional HART transmission.



Technical Information TI00073R and Operating Instructions BA00202R

RN221

Supply unit for powering two 2-wire measuring devices solely in the non-Ex area. Bidirectional communication is possible via the HART communication jacks.

















































Technical Information TI00081R and Brief Operating Instructions KA00110R

17 Operating menu

17.1 Overview of the operating menu (SmartBlue)

Navigation  SmartBlue

Setup	→  118
Device tag	→  118
Operating mode	→  118
Distance unit	→  118
Tank type	→  119
Tube diameter	→  119
DC value	→  123
Medium group	→  119
Empty calibration	→  120
Full calibration	→  121
Level	→  121
Interface	→  124
Distance	→  122
Interface distance	→  125
Signal quality	→  123
Confirm distance	→  125
Present mapping	→  126
Mapping end point	→  127
Record map	→  127
► Advanced setup	→  129
Locking status	→  129

Access status tooling	→  129
Enter access code	→  130
► Interface	→  131
Process property	→  131
Interface property	→  131
DC value lower medium	→  132
Level unit	→  133
Blocking distance	→  133
Level correction	→  134
Manual thickness upper layer	→  134
Measured thickness upper layer	→  135
DC value	→  135
Calculated DC value	→  135
Use calculated DC value	→  136
► Linearization	→  139
Linearization type	→  141
Unit after linearization	→  142
Free text	→  143
Level linearized	→  144
Interface linearized	→  144
Maximum value	→  144
Diameter	→  145
Intermediate height	→  145
Table mode	→  145
Table number	→  146

Level	→ 147
Level	→ 147
Customer value	→ 147
Activate table	→ 147
► Probe settings	→ 154
Probe grounded	→ 154
Present probe length	→ 154
Confirm probe length	→ 155
► Safety settings	→ 149
Output echo lost	→ 149
Value echo lost	→ 149
Ramp at echo lost	→ 150
Blocking distance	→ 150
► Current output 1 to 2	→ 157
Assign current output	→ 157
Current span	→ 158
Fixed current	→ 159
Damping output	→ 159
Failure mode	→ 159
Failure current	→ 160
Output current 1 to 2	→ 161
► Switch output	→ 162
Switch output function	→ 162
Assign status	→ 163
Assign limit	→ 163

	Assign diagnostic behavior	→ 163
	Switch-on value	→ 164
	Switch-on delay	→ 165
	Switch-off value	→ 165
	Switch-off delay	→ 166
	Failure mode	→ 166
	Switch status	→ 166
	Invert output signal	→ 166
Diagnostics		→ 180
	Actual diagnostics	→ 180
	Timestamp	→ 180
	Previous diagnostics	→ 180
	Timestamp	→ 181
	Operating time from restart	→ 181
	Operating time	→ 174
	► Diagnostic list	→ 182
	Diagnostics 1 to 5	→ 182
	Timestamp 1 to 5	→ 182
	► Measured values	→ 187
	Distance	→ 122
	Level linearized	→ 144
	Interface distance	→ 125
	Interface linearized	→ 144
	Thickness upper layer	→ 188
	Output current 1 to 2	→ 161

Measured current 1	→ 189
Terminal voltage 1	→ 189
► Device information	→ 184
Device tag	→ 184
Serial number	→ 184
Firmware version	→ 184
Device name	→ 184
Order code	→ 185
Extended order code 1 to 3	→ 185
Device revision	→ 185
Device ID	→ 185
Device type	→ 186
Manufacturer ID	→ 186
► Simulation	→ 194
Assign measurement variable	→ 195
Process variable value	→ 195
Current output 1 to 2 simulation	→ 195
Value current output 1 to 2	→ 196
Switch output simulation	→ 196
Switch status	→ 196
Device alarm simulation	→ 197























17.2 Overview of the operating menu (display module)

Navigation



























Operating menu

Language	
Setup	→ 118
Device tag	→ 118
Operating mode	→ 118
Distance unit	→ 118
Tank type	→ 119
Tube diameter	→ 119
DC value	→ 123
Medium group	→ 119
Empty calibration	→ 120
Full calibration	→ 121
Level	→ 121
Interface	→ 124
Distance	→ 122
Interface distance	→ 125
Signal quality	→ 123
Mapping	→ 128
Confirm distance	→ 128
Mapping end point	→ 128
Record map	→ 128
Distance	→ 128
Advanced setup	→ 129
Locking status	→ 129

Access status display	→  130
Enter access code	→  130
► Interface	→  131
Process property	→  131
Interface property	→  131
DC value lower medium	→  132
Level unit	→  133
Blocking distance	→  133
Level correction	→  134
► Automatic DC calculation	→  137
Manual thickness upper layer	→  137
DC value	→  137
Use calculated DC value	→  137
► Linearization	→  139
Linearization type	→  141
Unit after linearization	→  142
Free text	→  143
Maximum value	→  144
Diameter	→  145
Intermediate height	→  145
Table mode	→  145
► Edit table	
Level	
Customer value	
Activate table	→  147

▶ Safety settings	→ 149
Output echo lost	→ 149
Value echo lost	→ 149
Ramp at echo lost	→ 150
Blocking distance	→ 150
▶ SIL/WHG confirmation	→ 152
▶ Deactivate SIL/WHG	→ 153
Reset write protection	→ 153
Code incorrect	→ 153
▶ Probe settings	→ 154
Probe grounded	→ 154
▶ Probe length correction	→ 156
Confirm probe length	→ 156
Present probe length	→ 156
▶ Current output 1 to 2	→ 157
Assign current output	→ 157
Current span	→ 158
Fixed current	→ 159
Damping output	→ 159
Failure mode	→ 159
Failure current	→ 160
Output current 1 to 2	→ 161
▶ Switch output	→ 162
Switch output function	→ 162
Assign status	→ 163

Assign limit	→  163
Assign diagnostic behavior	→  163
Switch-on value	→  164
Switch-on delay	→  165
Switch-off value	→  165
Switch-off delay	→  166
Failure mode	→  166
Switch status	→  166
Invert output signal	→  166
► Display	→  168
Language	→  168
Format display	→  168
Value 1 to 4 display	→  170
Decimal places 1 to 4	→  170
Display interval	→  171
Display damping	→  171
Header	→  171
Header text	→  172
Separator	→  172
Number format	→  172
Decimal places menu	→  172
Backlight	→  173
Contrast display	→  173
► Configuration backup display	→  174
Operating time	→  174

Last backup	→ 📄 174
Configuration management	→ 📄 174
Comparison result	→ 📄 175
▶ Administration	→ 📄 177
▶ Define access code	→ 📄 179
Define access code	→ 📄 179
Confirm access code	→ 📄 179
Device reset	→ 📄 177
🔍 Diagnostics	→ 📄 180
Actual diagnostics	→ 📄 180
Previous diagnostics	→ 📄 180
Operating time from restart	→ 📄 181
Operating time	→ 📄 174
▶ Diagnostic list	→ 📄 182
Diagnostics 1 to 5	→ 📄 182
▶ Event logbook	→ 📄 183
Filter options	
▶ Event list	→ 📄 183
▶ Device information	→ 📄 184
Device tag	→ 📄 184
Serial number	→ 📄 184
Firmware version	→ 📄 184
Device name	→ 📄 184
Order code	→ 📄 185
Extended order code 1 to 3	→ 📄 185

Device revision	→ 185
Device ID	→ 185
Device type	→ 186
Manufacturer ID	→ 186
► Measured values	→ 187
Distance	→ 122
Level linearized	→ 144
Interface distance	→ 125
Interface linearized	→ 144
Thickness upper layer	→ 188
Output current 1 to 2	→ 161
Measured current 1	→ 189
Terminal voltage 1	→ 189
► Data logging	→ 190
Assign channel 1 to 4	→ 190
Logging interval	→ 191
Clear logging data	→ 191
► Display channel 1 to 4	→ 192
► Simulation	→ 194
Assign measurement variable	→ 195
Process variable value	→ 195
Current output 1 to 2 simulation	→ 195
Value current output 1 to 2	→ 196
Switch output simulation	→ 196

Switch status	→ 196
Device alarm simulation	→ 197
► Device check	→ 198
Start device check	→ 198
Result device check	→ 198
Last check time	→ 198
Level signal	→ 199
Launch signal	→ 199
Interface signal	→ 199

























17.3 Overview of the operating menu (operating tool)

Navigation



























Operating menu

























Setup	→ 118
Device tag	→ 118
Operating mode	→ 118
Distance unit	→ 118
Tank type	→ 119
Tube diameter	→ 119
Medium group	→ 119
Empty calibration	→ 120
Full calibration	→ 121
Level	→ 121
Distance	→ 122
Signal quality	→ 123
DC value	→ 123
Interface	→ 124
Interface distance	→ 125
Confirm distance	→ 125
Present mapping	→ 126
Mapping end point	→ 127
Record map	→ 127
► Advanced setup	→ 129
Locking status	→ 129
Access status tooling	→ 129
Enter access code	→ 130

▶ Interface	→  131
Process property	→  131
Interface property	→  131
DC value lower medium	→  132
Level unit	→  133
Blocking distance	→  133
Level correction	→  134
Manual thickness upper layer	→  134
Measured thickness upper layer	→  135
DC value	→  135
Calculated DC value	→  135
Use calculated DC value	→  136
▶ Linearization	→  139
Linearization type	→  141
Unit after linearization	→  142
Free text	→  143
Level linearized	→  144
Interface linearized	→  144
Maximum value	→  144
Diameter	→  145
Intermediate height	→  145
Table mode	→  145
Table number	→  146
Level	→  147
Level	→  147

Customer value	→ 147
Activate table	→ 147
► Safety settings	→ 149
Output echo lost	→ 149
Value echo lost	→ 149
Ramp at echo lost	→ 150
Blocking distance	→ 150
► SIL/WHG confirmation	→ 152
► Deactivate SIL/WHG	→ 153
Reset write protection	→ 153
Code incorrect	→ 153
► Probe settings	→ 154
Probe grounded	→ 154
Present probe length	→ 154
Confirm probe length	→ 155
► Current output 1 to 2	→ 157
Assign current output	→ 157
Current span	→ 158
Fixed current	→ 159
Damping output	→ 159
Failure mode	→ 159
Failure current	→ 160
Output current 1 to 2	→ 161
► Switch output	→ 162
Switch output function	→ 162





Assign status	→  163
Assign limit	→  163
Assign diagnostic behavior	→  163
Switch-on value	→  164
Switch-on delay	→  165
Switch-off value	→  165
Switch-off delay	→  166
Failure mode	→  166
Switch status	→  166
Invert output signal	→  166
► Display	→  168
Language	→  168
Format display	→  168
Value 1 to 4 display	→  170
Decimal places 1 to 4	→  170
Display interval	→  171
Display damping	→  171
Header	→  171
Header text	→  172
Separator	→  172
Number format	→  172
Decimal places menu	→  172
Backlight	→  173
Contrast display	→  173

<ul style="list-style-type: none"> ▶ Configuration backup display Operating time Last backup Configuration management Backup state Comparison result ▶ Administration Define access code Device reset 	<ul style="list-style-type: none"> → 174 → 174 → 174 → 174 → 175 → 175 → 177 → 177
<ul style="list-style-type: none"> 🔍 Diagnostics Actual diagnostics Timestamp Previous diagnostics Timestamp Operating time from restart Operating time ▶ Diagnostic list Diagnostics 1 to 5 Timestamp 1 to 5 ▶ Device information Device tag Serial number Firmware version Device name Order code 	<ul style="list-style-type: none"> → 180 → 180 → 180 → 181 → 181 → 174 → 182 → 182 → 182 → 184 → 184 → 184 → 184 → 185

Extended order code 1 to 3	→  185
Device revision	→  185
Device ID	→  185
Device type	→  186
Manufacturer ID	→  186
► Measured values	→  187
Distance	→  122
Level linearized	→  144
Interface distance	→  125
Interface linearized	→  144
Thickness upper layer	→  188
Output current 1 to 2	→  161
Measured current 1	→  189
Terminal voltage 1	→  189
► Data logging	→  190
Assign channel 1 to 4	→  190
Logging interval	→  191
Clear logging data	→  191
► Simulation	→  194
Assign measurement variable	→  195
Process variable value	→  195
Current output 1 to 2 simulation	→  195
Value current output 1 to 2	→  196
Switch output simulation	→  196



Switch status	→ 196
Device alarm simulation	→ 197
▶ Device check	→ 198
Start device check	→ 198
Result device check	→ 198
Last check time	→ 198
Level signal	→ 199
Launch signal	→ 199
Interface signal	→ 199
▶ Heartbeat	→ 200

17.4 "Setup" menu



- 
 -  : Indicates how to navigate to the parameter using the display and operating module
 -  : Indicates how to navigate to the parameter using operating tools (e.g. FieldCare)
 -  : Indicates parameters that can be locked via the access code.

Navigation   Setup



Device tag

Navigation	  Setup → Device tag
Description	Enter a unique name for the measuring point to identify the device quickly within the plant.
User entry	Character string comprising numbers, letters and special characters (32)

Operating mode

Navigation	  Setup → Operating mode
Prerequisite	The device has the "interface measurement" application package ⁴⁾ . FMP55 always contains this package.
Description	Select operating mode.
Selection	<ul style="list-style-type: none"> ▪ Level ▪ Interface with capacitance * ▪ Interface *
Factory setting	FMP55: Interface with capacitance
Additional information	The Interface with capacitance option is only available for FMP55.

Distance unit

Navigation	  Setup → Distance unit
Description	Used for the basic calibration (Empty / Full).

4) Product structure: Feature 540 "Application Package", Option EB "Interface measurement"

* Visibility depends on order options or device settings

Selection	<i>SI units</i>	<i>US units</i>
	<ul style="list-style-type: none"> ■ mm ■ m 	<ul style="list-style-type: none"> ■ ft ■ in

Tank type

Navigation Setup → Tank type

Prerequisite **Medium type = Liquid**

Description Select tank type.

Selection

- Metallic
- Bypass / pipe
- Non metallic
- Mounted outside
- Coaxial

Factory setting Depending on the probe

Additional information

- Depending on the probe some of the options mentioned above may not be available or there may be additional options.
- For coax probes and probes with metallic center washer **Tank type** parameter corresponds to the type of probe and cannot be changed.

Tube diameter

Navigation Setup → Tube diameter

Prerequisite

- **Tank type** (→ 119) = **Bypass / pipe**
- The probe is coated.

Description Specify diameter of bypass or stilling well.

User entry 0 to 9.999 m

Medium group

Navigation Setup → Medium group

Prerequisite

- For FMP51/FMP52/FMP54/FMP55: **Operating mode** (→ 118) = **Level**
- **Medium type** = **Liquid**

Description Select medium group.

Selection

- Others
- Water based (DC >= 4)

Additional information

This parameter roughly specifies the dielectric constant (DC) of the medium. For a more detailed definition of the DC use the **Medium property** parameter.

The **Medium group** parameter presets the **Medium property** parameter as follows:

Medium group	Medium property
Others	Unknown
Water based (DC >= 4)	DC 4 ... 7

i The **Medium property** parameter can be changed at a later point of time. However, when doing so, the **Medium group** parameter retains its value. Only the **Medium property** parameter is relevant for the signal evaluation.

i The measuring range may be reduced for small dielectric constants. For details refer to the Technical Information (TI) of the respective device.

Empty calibration



Navigation

Setup → Empty calibr.

Description

Distance between process connection and minimum level (0%).

User entry

Depending on the probe

Factory setting

Depending on the probe

Additional information

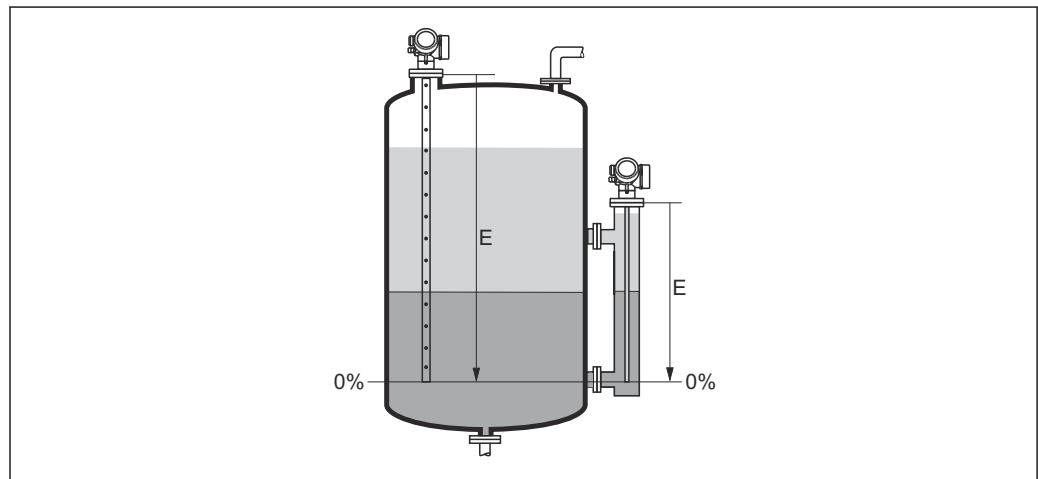

A0013177

41 Empty calibration (E) for interface measurements

i In the case of interface measurements the **Empty calibration** parameter is valid for both, the total and the interface level.

Full calibration
**Navigation**

Setup → Full calibr.

Description

Distance between minimum level (0%) and maximum level (100%).

User entry

Depending on the probe

Factory setting

Depending on the probe

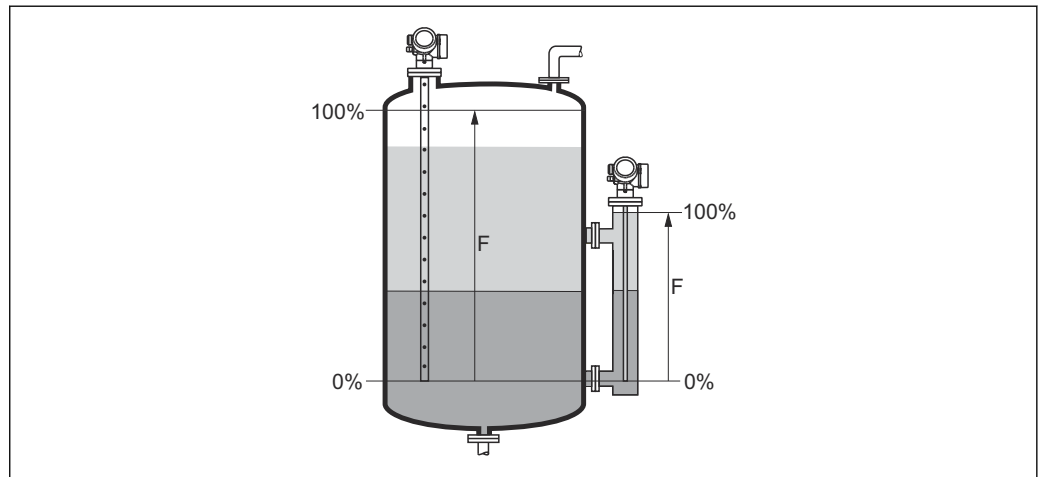
Additional information

A0013188

42 Full calibration (F) for interface measurements



In the case of interface measurements the **Full calibration** parameter is valid for both, the total and the interface level.

Level
Navigation

Setup → Level

DescriptionDisplays measured level L_L (before linearization).

Additional information

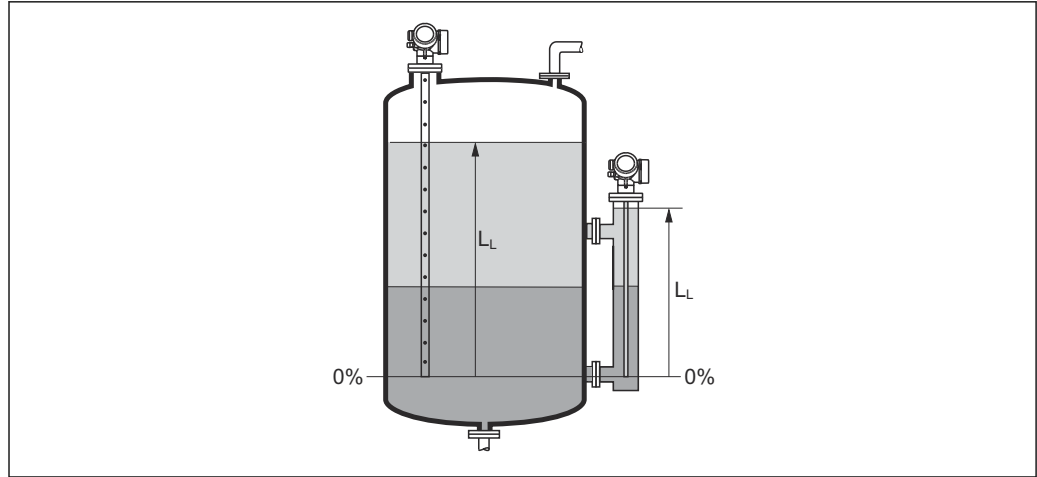

A0013195

43 Level in case of interface measurements

- i** The unit is defined in the **Level unit** parameter (→ 133).
- In case of interface measurements, this parameter always refers to the total level.

Distance

Navigation

Setup → Distance

Description

Displays the measured distance D_L between the reference point (lower edge of the flange or threaded connection) and the level.

Additional information

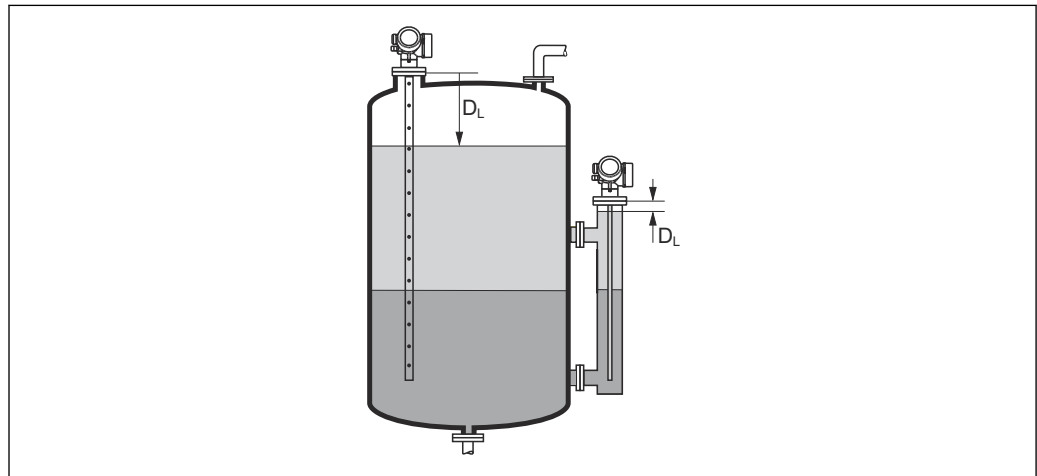

A0013199

44 Distance for interface measurements

- i** The unit is defined in the **Distance unit** parameter (→ 118).

Signal quality

Navigation   Setup → Signal quality



Description Displays the signal quality of the evaluated echo.

Additional information**Meaning of the display options**

- **Strong**
The evaluated echo exceeds the threshold by at least 10 mV.
- **Medium**
The evaluated echo exceeds the threshold by at least 5 mV.
- **Weak**
The evaluated echo exceeds the threshold by less than 5 mV.
- **No signal**
The device does not find a usable echo.

The signal quality indicated in this parameter always refers to the currently evaluated echo: either the level/interface echo ⁵⁾ or the end-of-probe echo. To differentiate between these two, the quality of the end-of-probe echo is always displayed in brackets.

 In case of a lost echo (**Signal quality = No signal**) the device generates the following error message:

- F941, for **Output echo lost** (→  149) = **Alarm**.
- S941, if another option has been selected in **Output echo lost** (→  149).

DC value



Navigation   Setup → DC value

Prerequisite The device has the "Interface measurement" application package ⁶⁾.

Description Specify the relative dielectric constant ϵ_r of the upper medium (DC_1).

User entry 1.0 to 100

5) Of these two echos the one with the lower quality is indicated.

6) Product structure: feature 540 "Application packages", option EB "Interface measurement"

Additional information

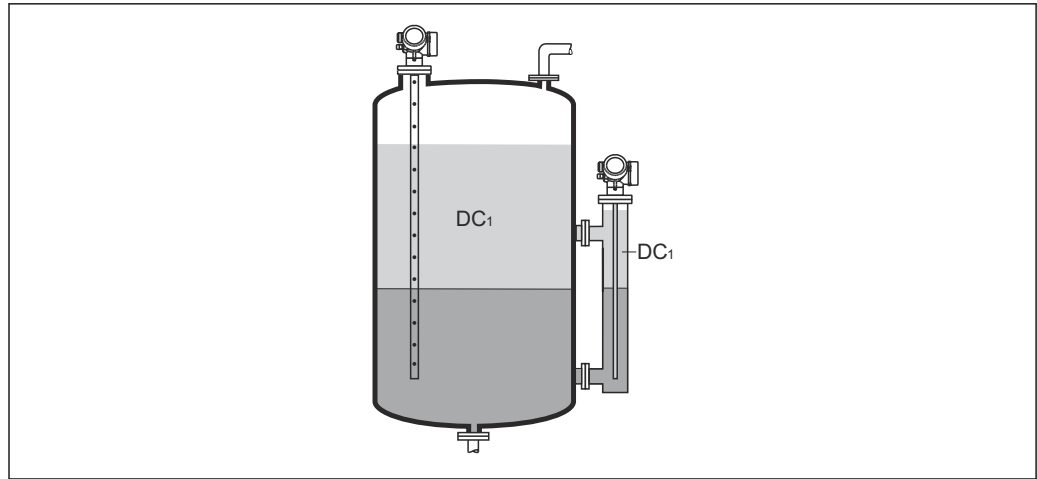



A0013181

DC1 Relative dielectric constant of the upper medium.

-  For the dielectric constants (DC values) of many media commonly used in industry, please refer to:
 - Dielectric constant (DC value) Compendium CP01076F
 - The Endress+Hauser "DC Values app" (available for Android and iOS)

Interface

Navigation

  Setup → Interface

Prerequisite

Operating mode (→  118) = **Interface** or **Interface with capacitance**

Description

Displays the measured interface level L_I (before linearization).

Additional information

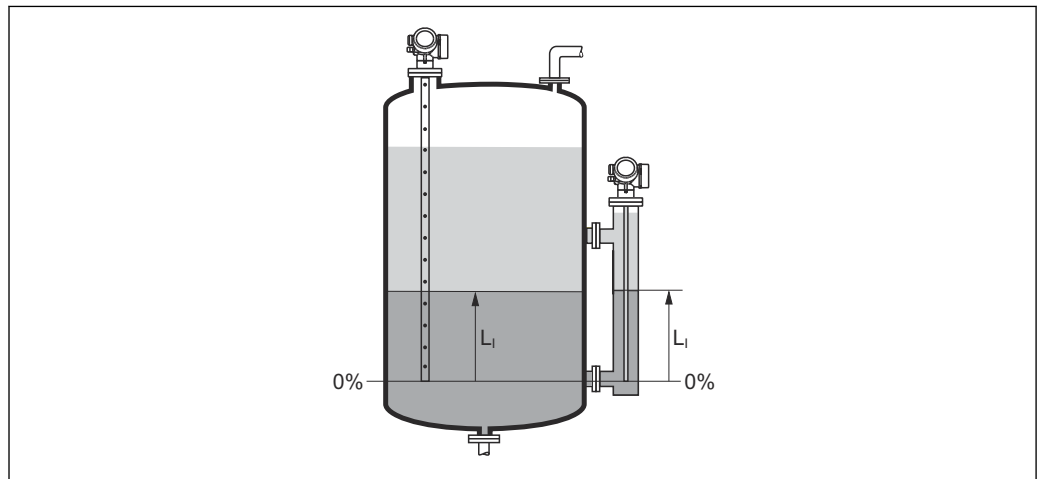

A0013197

-  The unit is defined in the **Level unit** parameter (→  133).

Interface distance

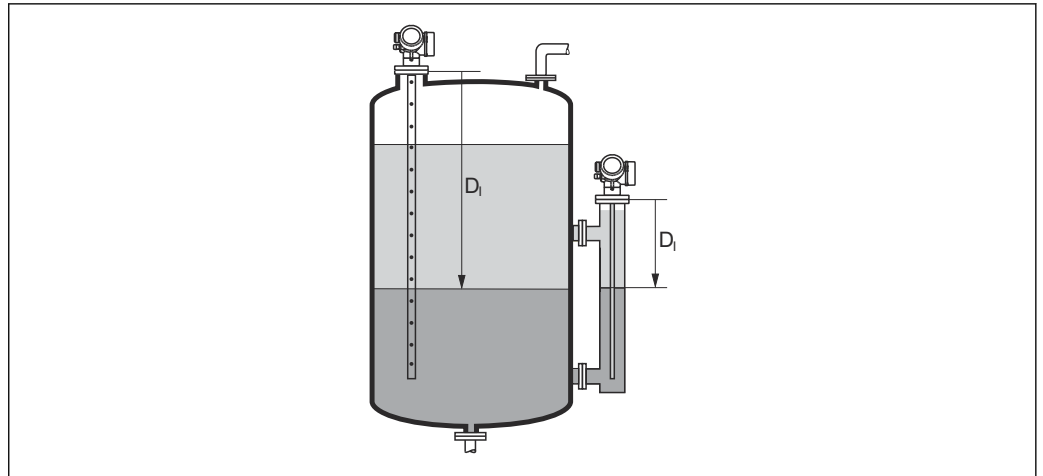
Navigation
 Setup → Interface dist.
Prerequisite
Operating mode (→  118) = Interface or Interface with capacitance
Description
 Displays the measured distance D_1 between the reference point (lower edge of flange or threaded connection) and the interface.
Additional information

A0013202

 The unit is defined in the **Distance unit** parameter (→  118).

Confirm distance

**Navigation**
 Setup → Confirm distance
Description

Specify, whether the measured distance matches the real distance.

Depending on the selection the device automatically sets the range of mapping.

Selection

- Manual map
- Distance ok
- Distance unknown
- Distance too small*
- Distance too big*
- Tank empty
- Delete map

 * Visibility depends on order options or device settings

Additional information**Meaning of the options**

- **Manual map**

To be selected if the range of mapping is to be defined manually in the **Mapping end point** parameter (→  127). In this case it is not necessary to confirm the distance.

- **Distance ok**

To be selected if the measured distance matches the actual distance. The device performs a mapping.

- **Distance unknown**

To be selected if the actual distance is unknown. A mapping can not be performed in this case.

- **Distance too small**

To be selected if the measured distance is smaller than the actual distance. The device searches for the next echo and returns to the **Confirm distance** parameter. The distance is recalculated and displayed. The comparison must be repeated until the displayed distance matches the actual distance. After this, the recording of the map can be started by selecting **Distance ok**.

- **Distance too big⁷⁾**

To be selected if the measured distance exceeds the actual distance. The device adjusts the signal evaluation and returns to the **Confirm distance** parameter. The distance is recalculated and displayed. The comparison must be repeated until the displayed distance matches the actual distance. After this, the recording of the map can be started by selecting **Distance ok**.

- **Tank empty**

To be selected if the tank is completely empty. The device records a mapping covering the complete measuring range.



To be selected if the tank is completely empty. The device records a mapping covering the complete measuring range minus **Map gap to LN**.

- **Factory map**

To be selected if the present mapping curve (if one exists) is to be deleted. The device returns to the **Confirm distance** parameter and a new mapping can be recorded.

 When operating via the display module, the measured distance is displayed together with this parameter for reference purposes.

 For interface measurements the distance always refers to the total level (not the interface level).

 For FMP55 with rope probes and **Operating mode** (→  118) = **Interface with capacitance** the mapping must be recorded with the tank being empty, and the **Tank empty** option must be selected. Otherwise the device can not register the correct empty capacitance.

For FMP55 with coax probes a mapping must be recorded at least in the upper part of the probe, as tightening the flange has an influence on the envelope curve. However, even with coax probes it is recommended to record the mapping with the tank being completely empty (and selecting the **Tank empty** option).

 If the teaching procedure with the **Distance too small** option or the **Distance too big** option is quit before the distance has been confirmed, a map is **not** recorded and the teaching procedure is reset after 60 s.

Present mapping

Navigation

 Setup → Present mapping

Description

Indicates up to which distance a mapping has already been recorded.

7) Only available for "Expert → Sensor → Echo tracking → **Evaluation mode** parameter" = "Short time history" or "Long time history"



Mapping end point



Navigation	Setup → Map. end point
Prerequisite	Confirm distance (→ 125) = Manual map or Distance too small
Description	Specify new end of the mapping.
User entry	0 to 200 000.0 m
Additional information	<p>This parameter defines up to which distance the new mapping is to be recorded. The distance is measured from the reference point, i.e. from the lower edge of the mounting flange or the threaded connection.</p> <p> For reference purposes the Present mapping parameter (→ 126) is displayed together with this parameter. It indicates up to which distance a mapping has already been recorded.</p>

Record map

Navigation	Setup → Record map
Prerequisite	Confirm distance (→ 125) = Manual map or Distance too small
Description	Start recording of the map.
Selection	<ul style="list-style-type: none"> ▪ No ▪ Record map ▪ Delete map
Additional information	<p>Meaning of the options</p> <ul style="list-style-type: none"> ▪ No The map is not recorded. ▪ Record map The map is recorded. After the recording is completed, the new measured distance and the new mapping range appear on the display. When operating via the local display, these values must be confirmed by pressing . ▪ Delete map The mapping (if one exists) is deleted and the device displays the recalculated measured distance and the mapping range. When operating via the local display, these values must be confirmed by pressing .

17.4.1 "Mapping" wizard

 The **Mapping** wizard is only available when operating via the local display. When operating via an operating tool, all parameters concerning the mapping are located directly in the **Setup** menu (→  118).

 In the **Mapping** wizard two parameters are displayed simultaneously on the display module at any one time. The upper parameter can be edited, whereas the lower parameter is displayed for reference purposes only.

Navigation  Setup → Mapping

Confirm distance

Navigation  Setup → Mapping → Confirm distance

Description →  125

Mapping end point

Navigation  Setup → Mapping → Map. end point

Description →  127

Record map

Navigation  Setup → Mapping → Record map

Description →  127

Distance





Navigation  Setup → Mapping → Distance

Description →  122





17.4.2 "Advanced setup" submenu

Navigation  Setup → Advanced setup





Locking status

Navigation	  Setup → Advanced setup → Locking status
Description	Indicates the write protection with the highest priority that is currently active.
User interface	<ul style="list-style-type: none"> ▪ Hardware locked ▪ SIL locked ▪ CT active - defined parameters ▪ WHG locked ▪ Temporarily locked
Additional information	<p>Meaning and priorities of the types of write protection</p> <ul style="list-style-type: none"> ▪ Hardware locked (priority 1) The DIP switch for hardware locking is activated on the main electronics module. This locks write access to the parameters. ▪ SIL locked (priority 2) The SIL mode is activated. Writing access to the relevant parameters is denied. ▪ WHG locked (priority 3) The WHG mode is activated. Writing access to the relevant parameters is denied. ▪ Temporarily locked (priority 4) Write access to the parameters is temporarily locked on account of internal processes in progress in the device (e.g. data upload/download, reset etc.). The parameters can be modified as soon as the processes are complete. <p> On the display module, the -symbol appears in front of parameters that cannot be modified since they are write-protected.</p>





Access status tooling

Navigation	 Setup → Advanced setup → Access stat.tool
Description	Shows the access authorization to the parameters via the operating tool.
Additional information	<p> The access authorization can be changed via the Enter access code parameter (→  130).</p> <p> If additional write protection is active, this restricts the current access authorization even further. The write protection status can be viewed via the Locking status parameter (→  129).</p>

Access status display

Navigation	 Setup → Advanced setup → Access stat.disp
Prerequisite	The device has a local display.
Description	Indicates access authorization to parameters via local display.
Additional information	<p> The access authorization can be changed via the Enter access code parameter (→  130).</p> <p> If additional write protection is active, this restricts the current access authorization even further. The write protection status can be viewed via the Locking status parameter (→  129).</p>

Enter access code

Navigation	 Setup → Advanced setup → Ent. access code
Description	Enter access code to disable write protection of parameters.
User entry	0 to 9999
Additional information	<ul style="list-style-type: none"> ▪ The customer-specific access code that was defined in the Define access code parameter (→  177) must be entered for local operation. ▪ If an incorrect access code is entered, users retain their current access authorization. ▪ The write protection affects all parameters marked with the  symbol in the document. On the local display, the  symbol in front of a parameter indicates that the parameter is write-protected. ▪ If no key is pressed for 10 minutes or the user goes from the navigation and editing mode back to the measured value display mode, the device automatically locks the write-protected parameters after another 60 s. <p> Please contact your Endress+Hauser Sales Center if you lose your access code.</p>

"Interface" submenu

Navigation  Setup → Advanced setup → Interface

Process property 

Navigation  Setup → Advanced setup → Interface → Process property

Description Specify typical rate of change for the interface position.

- Selection**
- Fast > 1 m (40 in)/min
 - Standard < 1 m (40in) /min
 - Medium < 10 cm (4in) /min
 - Slow < 1 cm (0.4in) /min
 - No filter / test

Additional information The device adjusts the signal evaluation filters and the damping of the output signal to the typical rate of level change defined in this parameter:

Process property	Step response time / s
Fast > 1 m (40 in)/min	5
Standard < 1 m (40in) /min	15
Medium < 10 cm (4in) /min	40
Slow < 1 cm (0.4in) /min	74
No filter / test	2.2

Interface property 

Navigation  Setup → Advanced setup → Interface → Interface prop.



Prerequisite **Operating mode (→  118) = Interface with capacitance**

Description Select interface property.
The interface property determines how the Guided Radar and the Capacitance Measurement interact.



- Selection**
- Special: automatic DC
 - Build up
 - Standard
 - Emulsion layer

Additional information	<p>Meaning of the options</p> <ul style="list-style-type: none"> ■ Special: automatic DC <ul style="list-style-type: none"> ■ Condition: The specific capacitance (pF/m) is known.⁸⁾ ■ Signal evaluation: As long as a clear interface is detected, both the total and the interface level are determined via the Guided Radar. The dielectric constant of the upper medium is continuously adjusted. If an emulsion layer is present, the total level is determined via the Guided Radar whereas the interface level is determined via the Capacitance Measurement. ■ Build up <ul style="list-style-type: none"> ■ Condition: The dielectric constant of the upper medium and the specific capacitance (pF/m) are known.⁸⁾ ■ Signal evaluation: As long as a clear interface is detected, the interface level is determined via the Guided Radar as well as via the Capacitance Measurement. If these two values start to diverge from each other due to build-up formation, an error message is generated. If an emulsion layer is present, the total level is determined via the Guided Radar whereas the interface level is determined via the Capacitance Measurement. ■ Standard <ul style="list-style-type: none"> ■ Condition: The dielectric constant of the upper medium is known. ■ Signal evaluation: As long as a clear interface is detected, the specific capacitance (pF/m) is continuously adjusted. Therefore build-up has only little influence on the measurement. If an emulsion layer is present, the total level is determined via the Guided Radar whereas the interface level is determined via the Capacitance Measurement. ■ Oil/Water condensate <ul style="list-style-type: none"> ■ Condition: The dielectric constant of the upper medium and the specific capacitance (pF/m) are known.⁸⁾ ■ Signal evaluation: The total level is always determined via the Guided Radar. The interface level is always determined via the Capacitance Measurement.
-------------------------------	--

DC value lower medium	
------------------------------	---





Navigation	  Setup → Advanced setup → Interface → DC lower medium
Prerequisite	Operating mode (→  118) = Interface or Interface with capacitance
Description	Specify the dielectric constant ϵ_r of the lower medium.
User entry	1 to 100

8) The specific capacitance of the media depends on the DC value and the geometry of the probe, which may differ noticeably. For rod probes < 2 m, the probe geometry is measured after production and the resulting specific capacitance for conductive media is preset on delivery.

- Additional information**
-  For the dielectric constants (DC values) of many media commonly used in industry, please refer to:
 - Dielectric constant (DC value) Compendium CPO1076F
 - The Endress+Hauser "DC Values app" (available for Android and iOS)
 -  The factory setting, $\epsilon_r = 80$, applies for water at 20 °C (68 °F).



Level unit



- Navigation**   Setup → Advanced setup → Interface → Level unit
- Description** Select level unit.
- Selection**
- | <i>SI units</i> | <i>US units</i> |
|-----------------|-----------------|
| ▪ % | ▪ ft |
| ▪ m | ▪ in |
| ▪ mm | |
- Additional information** The level unit may differ from the distance unit defined in the **Distance unit** parameter (→  118):
- The unit defined in the **Distance unit** parameter is used for the basic calibration (**Empty calibration** (→  120) and **Full calibration** (→  121)).
 - The unit defined in the **Level unit** parameter is used to display the (nonlinearized) level and interface position.

Blocking distance



- Navigation**   Setup → Advanced setup → Interface → Blocking dist.
- Description** Specify upper blocking distance UB.
- User entry** 0 to 200 m
- Factory setting**
- For coax probes: 100 mm (3.9 in)
 - For rod and rope probes up to 8 m (26 ft): 200 mm (8 in)
 - For rod and rope probes above 8 m (26 ft): 0.025 * length of probe
- Additional information** Echoes from within the blocking distance are not taken into account in the signal evaluation. The upper blocking distance is used
- to suppress interference echoes at the top end of the probe.
 - to suppress the echo of the total level in the case of flooded bypasses.

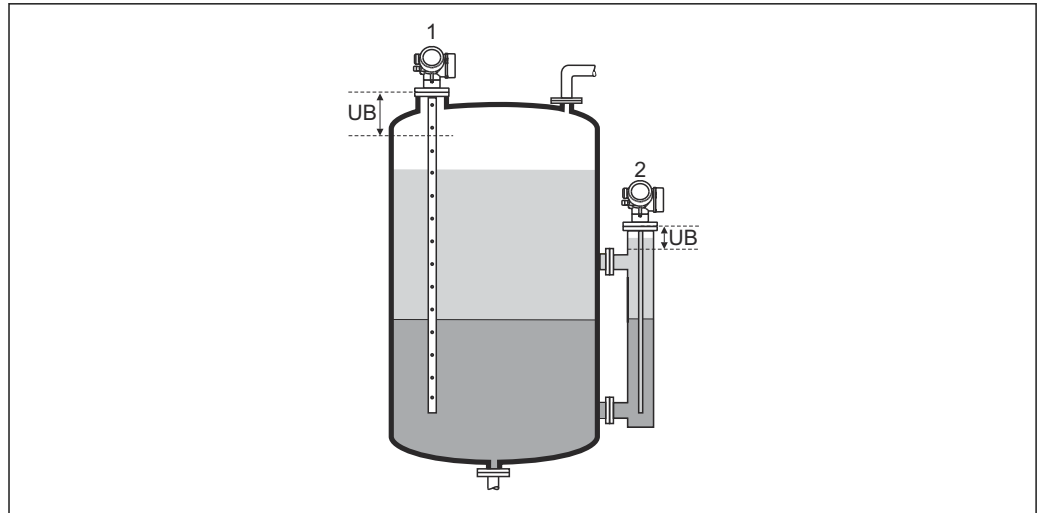

A0013220

- 1 Suppression of interference echoes at the top end of the probe.
- 2 Suppression of the level signal in case of a flooded bypass.
- UB Upper blocking distance

Level correction



Navigation	☰☰ Setup → Advanced setup → Interface → Level correction
Description	Specify level correction (if required).
User entry	-200 000.0 to 200 000.0 %
Additional information	The value specified in this parameter is added to the measured total and interface levels (before linearization).

Manual thickness upper layer



Navigation	☰ Setup → Advanced setup → Interface → Man.thick.up.lay
Description	Specify the manually determined interface thickness UP (i.e. the thickness of the upper medium).
User entry	0 to 200 m

Additional information

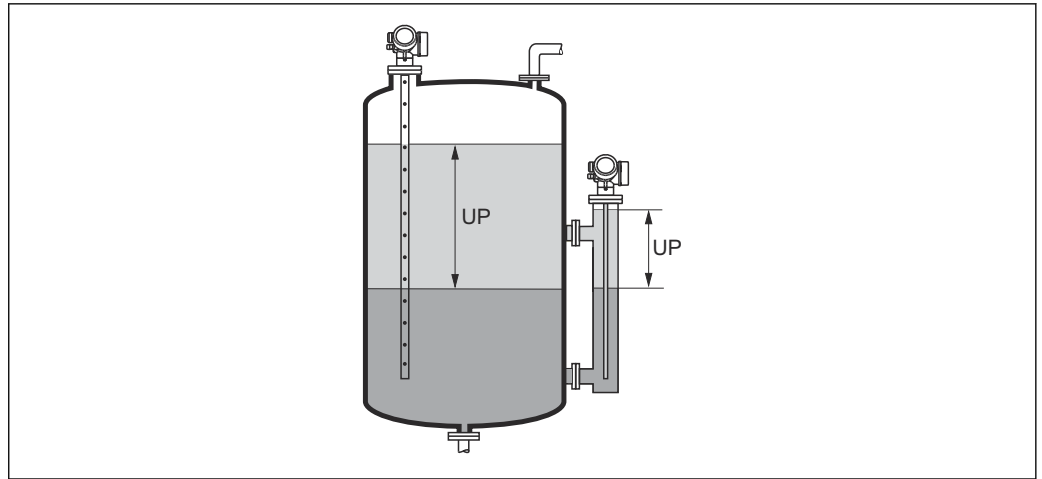

A0013313

UP Interface thickness (= thickness of upper medium)

 On the local display, the measured interface thickness is indicated together with the manual interface thickness. By comparing these two values the device can automatically adjust the dielectric constant of the upper medium.

Measured thickness upper layer

Navigation  Setup → Advanced setup → Interface → Meas.thick.u.lay

Description Displays the measured interface thickness. (Thickness UP of the upper medium).

DC value



Navigation  Setup → Advanced setup → Interface → DC value

Description Displays relative dielectric constant ϵ_r of the upper medium (DC₁) before correction.

Calculated DC value

Navigation  Setup → Advanced setup → Interface → Calc. DC value

Description Displays calculated (i.e. corrected) relative dielectric constant ϵ_r (DC1) of the upper medium.

Use calculated DC value

**Navigation**

Setup → Advanced setup → Interface → Use calc. DC

Description

Specify whether the calculated dielectric constant is to be used.

Selection



- Save and exit
- Cancel and exit

Additional information**Meaning of the options**

- Save and exit
The calculated constant is assumed to be the correct one.
- Cancel and exit
The calculated dielectric constant is rejected; the previous dielectric constant remains active.

On the local display, the **Calculated DC value** parameter (→ 135) is displayed together with this parameter.

"Automatic DC calculation" wizard

-  The **Automatic DC calculation** wizard is only available when operating via the local display. When operating via an operating tool, all parameters concerning the automatic DC calculation are located directly in the **Interface** submenu (→  131)
-  In the **Automatic DC calculation** wizard two parameters are displayed simultaneously on the display module at any one time. The upper parameter can be edited, whereas the lower parameter is displayed for reference purposes only.

Navigation  Setup → Advanced setup → Interface → Autom. DC calc.

Manual thickness upper layer

Navigation  Setup → Advanced setup → Interface → Autom. DC calc. → Man.thick.up.lay

Description →  134

DC value

Navigation  Setup → Advanced setup → Interface → Autom. DC calc. → DC value

Description →  135

Use calculated DC value

Navigation  Setup → Advanced setup → Interface → Autom. DC calc. → Use calc. DC

Description →  136

"Linearization" submenu

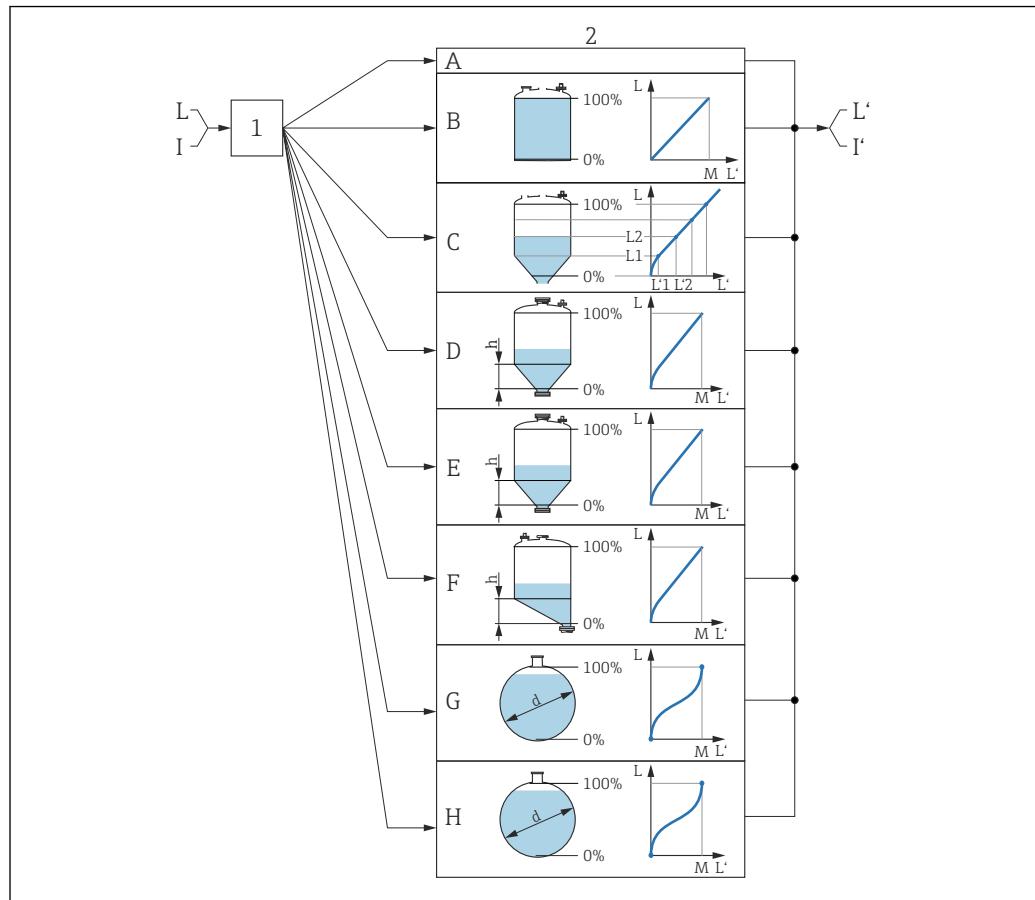

A0016084

45 Linearization: Conversion of the level and, if applicable, interface into a volume or a weight; the conversion depends on the vessel shape

- 1 Selection of linearization type and unit
- 2 Configuration of the linearization
- A Linearization type (→ 141) = None
- B Linearization type (→ 141) = Linear
- C Linearization type (→ 141) = Table
- D Linearization type (→ 141) = Pyramid bottom
- E Linearization type (→ 141) = Conical bottom
- F Linearization type (→ 141) = Angled bottom
- G Linearization type (→ 141) = Horizontal cylinder
- H Linearization type (→ 141) = Sphere
- I For "Operating mode (→ 118)" = "Interface" or "Interface with capacitance": interface before linearization (measured in the level unit)
- I' For "Operating mode (→ 118)" = "Interface" or "Interface with capacitance": interface after linearization (corresponds to volume or weight)
- L Level before linearization (measured in level unit)
- L' Level linearized (→ 144) (corresponds to volume or weight)
- M Maximum value (→ 144)
- d Diameter (→ 145)
- h Intermediate height (→ 145)

Structure of the submenu on the local display

Navigation  Setup → Advanced setup → Linearization

► **Linearization**

Linearization type

Unit after linearization

Free text

Maximum value

Diameter

Intermediate height

Table mode

► **Edit table**

Level

Customer value

Activate table

Structure of the submenu in the operating tool (e.g. FieldCare)

Navigation  Setup → Advanced setup → Linearization

► Linearization

Linearization type

Unit after linearization

Free text

Level linearized

Interface linearized

Maximum value

Diameter

Intermediate height

Table mode

Table number

Level

Level

Customer value

Activate table

Description of the parameters

Navigation  Setup → Advanced setup → Linearization

Linearization type 

Navigation  Setup → Advanced setup → Linearization → Lineariz. type

Description Select linearization type.

- Selection**
- None
 - Linear
 - Table
 - Pyramid bottom
 - Conical bottom
 - Angled bottom
 - Horizontal cylinder
 - Sphere

Additional information

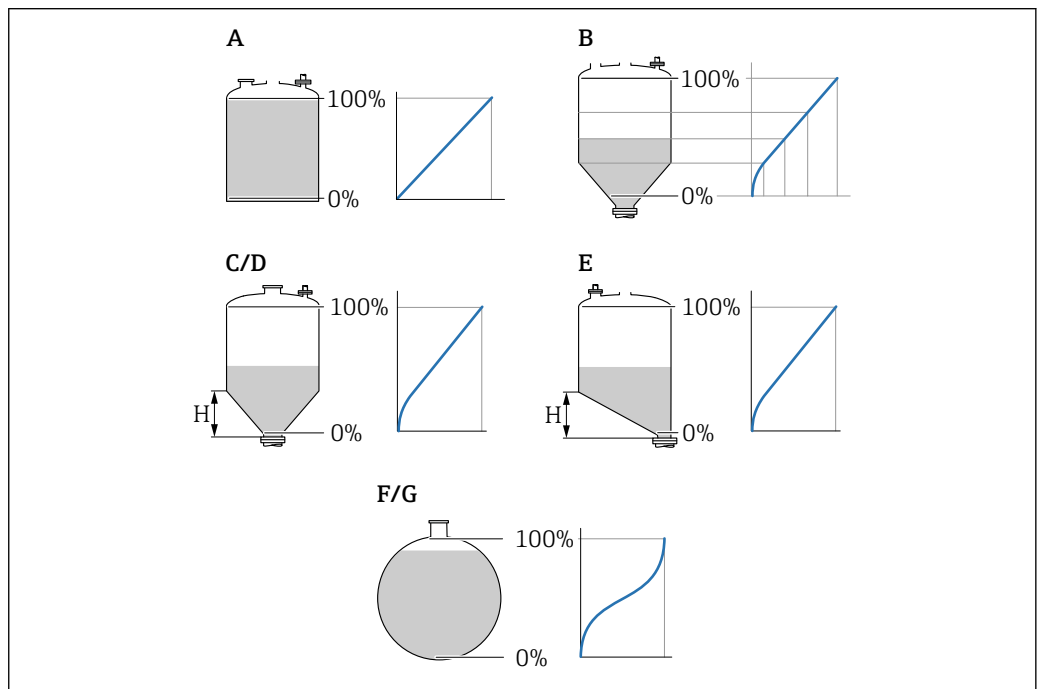

A0021476

 46 Linearization types

- A None
- B Table
- C Pyramid bottom
- D Conical bottom
- E Angled bottom
- F Sphere
- G Horizontal cylinder

Meaning of the options

- **None**

The level is output in the level unit without being converted (linearized) beforehand.

- **Linear**

The output value (volume/weight) is proportional to the level L. This applies, for example, to vertical cylindrical tanks and silos. The following parameters must also be specified:

- **Unit after linearization** (→  142)

- **Maximum value** (→  144): maximum volume or weight

- **Table**

The relationship between the measured level L and the output value (volume/weight) is defined by a linearization table consisting of up to 32 pairs of values "level - volume" or "level - weight" respectively. The following parameters must also be specified:

- **Unit after linearization** (→  142)

- **Table mode** (→  145)

- For every point in the table: **Level** (→  147)

- For every point in the table: **Customer value** (→  147)

- **Activate table** (→  147)

- **Pyramid bottom**

The output value corresponds to the volume or weight in a silo with a pyramid bottom.

The following parameters must also be specified:

- **Unit after linearization** (→  142)

- **Maximum value** (→  144): maximum volume or weight

- **Intermediate height** (→  145): the height of the pyramid

- **Conical bottom**

The output value corresponds to the volume or weight in a tank with a conical bottom.

The following parameters must also be specified:

- **Unit after linearization** (→  142)

- **Maximum value** (→  144): maximum volume or weight

- **Intermediate height** (→  145): the height of the cone

- **Angled bottom**

The output value corresponds to the volume or weight in a silo with an angled bottom.

The following parameters must also be specified:

- **Unit after linearization** (→  142)

- **Maximum value** (→  144): maximum volume or weight

- **Intermediate height** (→  145): height of the angled bottom

- **Horizontal cylinder**

The output value corresponds to the volume or weight in a horizontal cylinder. The following parameters must also be specified:

- **Unit after linearization** (→  142)

- **Maximum value** (→  144): maximum volume or weight

- **Diameter** (→  145)

- **Sphere**



The output value corresponds to the volume or weight in a spherical tank. The following parameters must also be specified:

- **Unit after linearization** (→  142)

- **Maximum value** (→  144): maximum volume or weight

- **Diameter** (→  145)

Unit after linearization
**Navigation**

  Setup → Advanced setup → Linearization → Unit lineariz.

Prerequisite



Linearization type (→  141) ≠ None

Description Select the unit for the linearized value.

Selection Selection/input (uint16)



- 1095 = [short Ton]
- 1094 = [lb]
- 1088 = [kg]
- 1092 = [Ton]
- 1048 = [US Gal.]
- 1049 = [Imp. Gal.]
- 1043 = [ft³]
- 1571 = [cm³]
- 1035 = [dm³]
- 1034 = [m³]
- 1038 = [l]
- 1041 = [hl]
- 1342 = [%]
- 1010 = [m]
- 1012 = [mm]
- 1018 = [ft]
- 1019 = [inch]
- 1351 = [l/s]
- 1352 = [l/min]
- 1353 = [l/h]
- 1347 = [m³/s]
- 1348 = [m³/min]
- 1349 = [m³/h]
- 1356 = [ft³/s]
- 1357 = [ft³/min]
- 1358 = [ft³/h]
- 1362 = [US Gal./s]
- 1363 = [US Gal./min]
- 1364 = [US Gal./h]
- 1367 = [Imp. Gal./s]
- 1358 = [Imp. Gal./min]
- 1359 = [Imp. Gal./h]
- 32815 = [ML/s]
- 32816 = [ML/min]
- 32817 = [ML/h]
- 1355 = [ML/d]

Additional information The selected unit is only used for display purposes. The measured value is **not** converted on the basis of the selected unit.

 Distance-to-distance linearization is also possible, i.e. a linearization from the level unit to another length unit. Select the **Linear** linearization mode for this purpose. To specify the new level unit, select the **Free text** option in the **Unit after linearization** parameter and enter the unit in the **Free text** parameter (→  143).

Free text



Navigation   Setup → Advanced setup → Linearization → Free text

Prerequisite **Unit after linearization** (→  142) = **Free text**

Description Enter unit symbol.

User entry Up to 32 alphanumeric characters (letters, numbers, special characters)

Level linearized

Navigation  Setup → Advanced setup → Linearization → Level linearized

Description Displays linearized level.

Additional information 



- The unit is defined by the **Unit after linearization** parameter →  142.
- For interface measurements, this parameter always refers to the total level.

Interface linearized

Navigation  Setup → Advanced setup → Linearization → Interf. lineariz

Prerequisite **Operating mode** (→  118) = **Interface** or **Interface with capacitance**

Description Displays the linearized interface height.

Additional information  The unit is defined in the **Unit after linearization** parameter →  142.

Maximum value

Navigation   Setup → Advanced setup → Linearization → Maximum value

Prerequisite **Linearization type** (→  141) has one of the following values:

- Linear
- Pyramid bottom
- Conical bottom
- Angled bottom
- Horizontal cylinder
- Sphere

Description Linearized value corresponding to a level of 100%.

User entry -50 000.0 to 50 000.0 %

Diameter

**Navigation**

Setup → Advanced setup → Linearization → Diameter

Prerequisite
Linearization type (→ 141) has one of the following values:

- Horizontal cylinder
- Sphere

Description

Diameter of the cylindrical or spherical tank.

User entry

0 to 9999.999 m

Additional informationThe unit is defined in the **Distance unit** parameter (→ 118).

Intermediate height

**Navigation**

Setup → Advanced setup → Linearization → Intermed. height

Prerequisite
Linearization type (→ 141) has one of the following values:

- Pyramid bottom
- Conical bottom
- Angled bottom

Description

Height of the pyramid, conical or angled bottom.

User entry

0 to 200 m

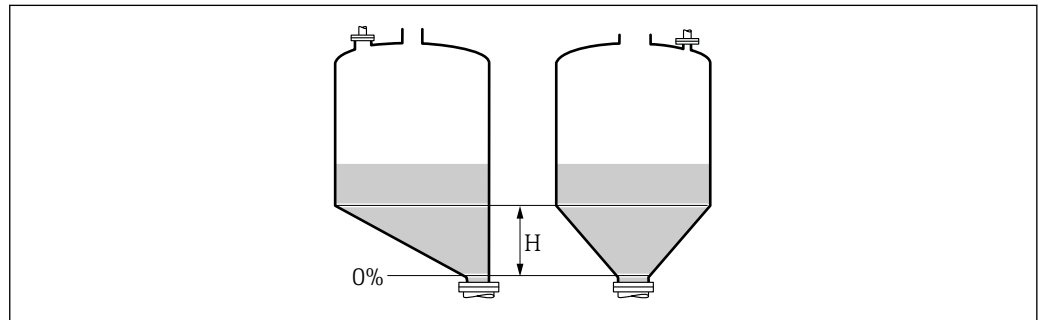
Additional information

A0013264

H Intermediate height

The unit is defined in the **Distance unit** parameter (→ 118).

Table mode

**Navigation**

Setup → Advanced setup → Linearization → Table mode

Prerequisite
Linearization type (→ 141) = Table
Description

Select editing mode of the linearization table.

Selection

- Manual
- Semiautomatic
- Clear table
- Sort table

Additional information**Meaning of the options**

- **Manual**

The level and the associated linearized value are entered manually for each linearization point.

- **Semiautomatic**

The level is measured by the device for each linearization point. The associated linearized value is entered manually.

- **Clear table**



Deletes the existing linearization table.

- **Sort table**

Rearranges the linearization points into an ascending order.

Conditions the linearization table must meet:



- The table may consist of up to 32 pairs of values "Level - Linearized Value".
- The table must be monotonic (monotonically increasing or decreasing).
- The first linearization point must refer to the minimum level.
- The last linearization point must refer to the maximum level.

 Before entering a linearization table, the values for **Empty calibration** (→  120) and **Full calibration** (→  121) must be set correctly.

If values of the table need to be changed after the full or empty calibration have been changed, a correct evaluation is only ensured if the existing table is deleted and the complete table is entered again. To do so delete the existing table (**Table mode** (→  145) = **Clear table**). Then enter a new table.



How to enter the table

- Via FieldCare

The table points can be entered via the **Table number** (→  146), **Level** (→  147) and **Customer value** (→  147) parameters. As an alternative, the graphic table editor may be used: Device Operation → Device Functions → Additional Functions → Linearization (Online/Offline)

- Via local display

Select the **Edit table** submenu to call up the graphic table editor. The table is displayed and can be edited line by line.

 The factory setting for the level unit is "%". If you want to enter the linearization table in physical units, you must select the appropriate unit in the **Level unit** parameter (→  133) beforehand.



 If a decreasing table is entered, the values for 20 mA and 4 mA of the current output are interchanged. That means: 20 mA refers to the lowest level, whereas 4 mA refers to the highest level.

Table number**Navigation**

 Setup → Advanced setup → Linearization → Table number

Prerequisite

Linearization type (→  141) = **Table**

Description



Select table point you are going to enter or change.

User entry 1 to 32

Level (Manual)

Navigation  Setup → Advanced setup → Linearization → Level

Prerequisite

- **Linearization type** (→  141) = Table
- **Table mode** (→  145) = Manual



Description Enter level value of the table point (value before linearization).

User entry Signed floating-point number

Level (Semiautomatic)

Navigation  Setup → Advanced setup → Linearization → Level

Prerequisite

- **Linearization type** (→  141) = Table
- **Table mode** (→  145) = Semiautomatic

Description Displays measured level (value before linearization). This value is transmitted to the table.

Customer value

Navigation  Setup → Advanced setup → Linearization → Customer value

Prerequisite **Linearization type** (→  141) = Table

Description Enter linearized value for the table point.

User entry Signed floating-point number

Activate table

Navigation   Setup → Advanced setup → Linearization → Activate table

Prerequisite **Linearization type** (→  141) = Table

Description Activate (enable) or deactivate (disable) the linearization table.

Selection

- Disable
- Enable

Additional information**Meaning of the options****■ Disable**

The measured level is not linearized.

If **Linearization type** (→  **141**) = **Table** at the same time, the device issues error message F435.

■ Enable

The measured level is linearized according to the table.



When editing the table, the **Activate table** parameter is automatically reset to **Disable** and must be reset to **Enable** after the table has been entered.

"Safety settings" submenu

Navigation  Setup → Advanced setup → Safety sett.

Output echo lost 



Navigation  Setup → Advanced setup → Safety sett. → Output echo lost

Description Output signal in case of a lost echo.

Selection

- Last valid value
- Ramp at echo lost
- Value echo lost
- Alarm

Additional information **Meaning of the options**

- **Last valid value**
The last valid value is kept in the case of a lost echo.
- **Ramp at echo lost**⁹⁾
In the case of a lost echo the output value is continuously shifted towards 0% or 100%.
The slope of the ramp is defined in the **Ramp at echo lost** parameter (→  150).
- **Value echo lost**⁹⁾
In the case of a lost echo the output assumes the value defined in the **Value echo lost** parameter (→  149).
- **Alarm**
In the case of a lost echo the device generates an alarm; see the **Failure mode** parameter (→  159)

Value echo lost 



Navigation  Setup → Advanced setup → Safety sett. → Value echo lost

Prerequisite **Output echo lost (→  149) = Value echo lost**

Description Output value in case of a lost echo

User entry 0 to 200 000.0 %

Additional information Use the unit which has been defined for the measured value output:

- without linearization: **Level unit** (→  133)
- with linearization: **Unit after linearization** (→  142)

9) Only visible if "Linearization type (→  141)" = "None"

Ramp at echo lost



Navigation

Setup → Advanced setup → Safety sett. → Ramp echo lost

Prerequisite

Output echo lost (→ 149) = Ramp at echo lost

Description

Slope of the ramp in the case of a lost echo

User entry

Signed floating-point number

Additional information

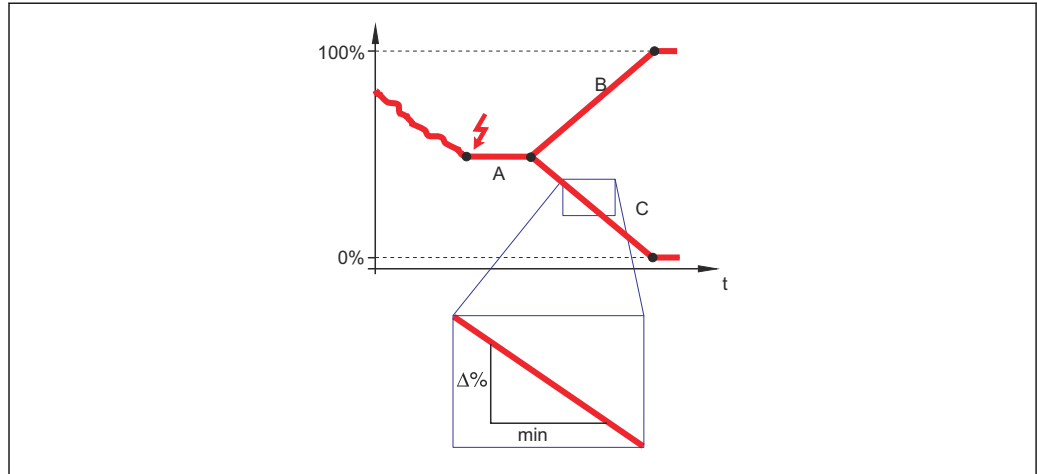

A0013269

- A Delay time echo lost
- B Ramp at echo lost (→ 150) (positive value)
- C Ramp at echo lost (→ 150) (negative value)

- The unit for the slope of the ramp is "percentage of the measuring range per minute" (%/min).
- For a negative slope of the ramp: The measured value is continuously decreased until it reaches 0%.
- For a positive slope of the ramp: The measured value is continuously increased until it reaches 100%.

Blocking distance



Navigation

Setup → Advanced setup → Safety sett. → Blocking dist.

Description

Specify upper blocking distance UB.

User entry

0 to 200 m

Factory setting

- For coax probes: 0 mm (0 in)
- For rod and rope probes up to 8 m (26 ft): 200 mm (8 in)
- For rod and rope probes above 8 m (26 ft): 0.025 * Sondenlänge

For FMP51/FMP52/FMP54 with the **Interface measurement** application package ¹⁰⁾ and for FMP55:
100 mm (3.9 in) for all antenna types

Additional information

Signals in the upper blocking distance are only evaluated if they have been outside the blocking distance when the device was switched on and move into the blocking distance due to a level change during operation. Signals which are already in the blocking distance when the device is switched on, are ignored.



This behavior is only valid if the following two conditions are met:

- Expert → Sensor → Echo tracking → Evaluation mode = **Short time history** or **Long time history**)
- Expert → Sensor → Gas phase compensation → GPC mode= **On, Without correction** or **External correction**

If one of these conditions is not met, signals in the blocking distance will always be ignored.



A different behavior for signals in the blocking distance can be defined in the **Blocking distance evaluation mode** parameter.



If required, a different behavior for signals in the blocking distance can be defined by the Endress+Hauser service.

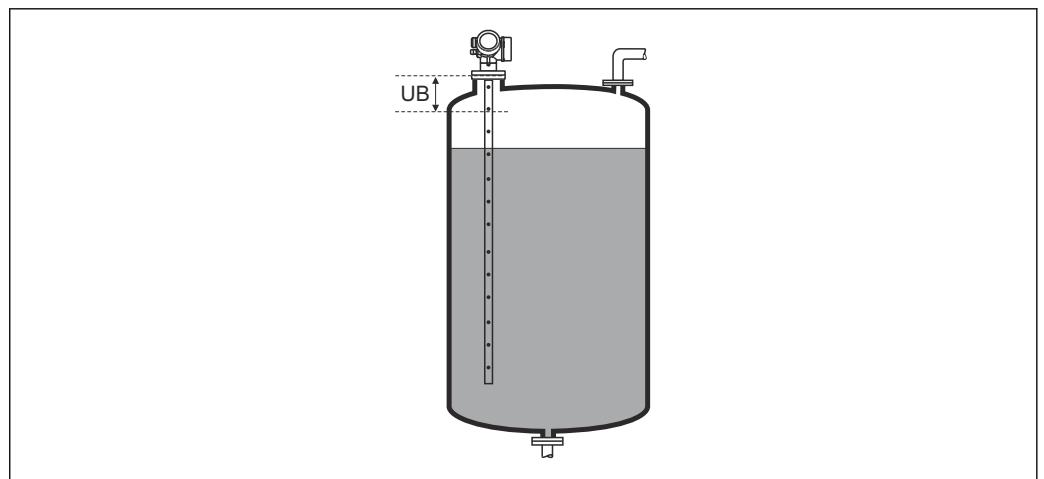

A0013219

47 Blocking distance (UB) for liquid measurements

10) Ordering feature 540 "Application Package", option EB "Interface measurement"



"SIL/WHG confirmation" wizard

 The **SIL/WHG confirmation** wizard is only available for devices with SIL or WHG approval (Feature 590: "Additional Approval", option LA: "SIL" or LC: "WHG overflow prevention") which are currently **not** in the SIL- or WHG-locked state.

The **SIL/WHG confirmation** wizard is required to lock the device according to SIL or WHG. For details refer to the "Functional Safety Manual" of the respective device, which describes the locking procedure and the parameters of the sequence.

Navigation  Setup → Advanced setup → SIL/WHG confirm.

"Deactivate SIL/WHG" wizard

 The **Deactivate SIL/WHG** wizard (→  153) is only visible if the device is SIL-locked or WHG-locked. For details refer to the "Functional Safety Manual" of the respective device.

Navigation   Setup → Advanced setup → Deactiv. SIL/WHG

Reset write protection**Navigation**

  Setup → Advanced setup → Deactiv. SIL/WHG → Res. write prot.



Description

Enter unlocking code.

User entry

0 to 65 535

Code incorrect**Navigation**

  Setup → Advanced setup → Deactiv. SIL/WHG → Code incorrect

Description







Indicates that a wrong unlocking code has been entered. Select procedure.



Selection

- Reenter code
- Abort sequence



"Probe settings" submenu

The **Probe settings** submenu helps to ensure that the end of probe signal within the envelope curve is correctly assigned by the evaluation algorithm. The assignment is correct if the length of probe indicated by the device matches the actual length of the probe. The automatic probe length correction can only be performed if the probe is installed in the vessel and is completely uncovered (no medium). For partially filled vessels and if the probe length is known, select **Confirm probe length** (→  155) = **Manual input** in order to enter the value manually.



-  If a mapping (interference echo suppression) has been recorded after shortening the probe, it is no longer possible to perform an automatic probe length correction. In this case there are two options:
 - Delete the map using the **Record map** parameter (→  127) before performing the automatic probe length correction. After the probe length correction, a new map can be recorded using the **Record map** parameter (→  127).
 - Alternative: Select **Confirm probe length** (→  155) = **Manual input** and enter the probe length manually into the **Present probe length** parameter →  154.
-  An automatic probe length correction is only possible after the correct option has been selected in the **Probe grounded** parameter (→  154).

Navigation   Setup → Advanced setup → Probe settings

Probe grounded 

- Navigation   Setup → Advanced setup → Probe settings → Probe grounded
- Prerequisite **Operating mode** (→  118) = **Level**
- Description Specify whether the probe is grounded.
- Selection
 - No
 - Yes

Present probe length 

- Navigation  Setup → Advanced setup → Probe settings → Pres. length
- Description
 - In most cases:
Displays the length of the probe according to the currently measured end-of-probe signal.
 - For **Confirm probe length** (→  155) = **Manual input**:
Enter actual length of probe.
- User entry 0 to 200 m

Confirm probe length
**Navigation**

Setup → Advanced setup → Probe settings → Confirm length

Description

Select, whether the value displayed in the **Present probe length** parameter → 154 matches the actual length of the probe. Based on this input, the device performs a probe length correction.

Selection

- Probe length OK
- Probe length too small
- Probe length too big
- Probe covered
- Manual input
- Probe length unknown

Additional information**Meaning of the options**

- **Probe length OK**

To be selected if the indicated length is correct. An adjustment is not required. The device quits the sequence.

- **Probe length too small**

To be selected if the displayed length is smaller than the actual length of the probe. A different end of probe signal is allocated and the newly calculated length is displayed in the **Present probe length** parameter → 154. This procedure has to be repeated until the displayed value matches the actual length of the probe.

- **Probe length too big**

To be selected if the displayed length is bigger than the actual length of the probe. A different end of probe signal is allocated and the newly calculated length is indicated in the **Present probe length** parameter → 154. This procedure has to be repeated until the displayed value matches the actual length of the probe.

- **Probe covered**

To be selected if the probe is (partially or completely) covered. A probe length correction is impossible in this case. The device quits the sequence.

- **Manual input**



To be selected if no automatic probe length correction is to be performed. Instead, the actual length of the probe must be entered manually into the **Present probe length** parameter → 154 ¹¹⁾.

- **Probe length unknown**

To be selected if the actual length of the probe is unknown. A probe length correction is impossible in this case and the device quits the sequence.

11) When operated via FieldCare, the **Manual input** option needs not to be selected explicitly. In FieldCare the length of the probe can always be edited.

"Probe length correction" wizard

 The **Probe length correction** wizard is only available when operating via the local display. When operating via an operating tool, all parameters concerning the probe length correction are located directly in the **Probe settings** submenu (→  154).

Navigation  Setup → Advanced setup → Probe settings → Prob.length corr

Confirm probe length



Navigation  Setup → Advanced setup → Probe settings → Prob.length corr → Confirm length

Description →  155



Present probe length





Navigation  Setup → Advanced setup → Probe settings → Prob.length corr → Pres. length

Description →  154

"Current output 1 to 2" submenu

 The **Current output 2** submenu (→  157) is only available for devices with two current outputs.

Navigation   Setup → Advanced setup → Curr.output 1 to 2

Assign current output 1 to 2 

Navigation   Setup → Advanced setup → Curr.output 1 to 2 → Assign curr.

Description Select process variable for current output.



- Selection**
- Level linearized
 - Distance
 - Electronic temperature
 - Für FMP55: Measured capacitance
 - Relative echo amplitude
 - Analog output adv. diagnostics 1
 - Analog output adv. diagnostics 2

Additionally for Operating mode = "Interface" or "Interface with capacitance":

- Interface linearized
- Interface distance
- Thickness upper layer
- Relative interface amplitude



- Factory setting**
- For interface measurements**
- Current output 1: Interface linearized
 - Current output 2 ¹²⁾: Level linearized

Additional information *Definition of the current range for the process variables*

Process variable	4 mA value	20 mA value
Level linearized	0 % ¹⁾ or the associated linearized value	100 % ²⁾ or the associated linearized value
Distance	0 (i.e. level is at the reference point)	Empty calibration (→  120) (i.e. level is at 0 %)
Electronic temperature	-50 °C (-58 °F)	100 °C (212 °F)
Measured capacitance	0 pF	4 000 pF
Relative echo amplitude	0 mV	2 000 mV
Analog output adv. diagnostics 1/2	depending on the parametrization of the Advanced Diagnostics	
Interface linearized	0 % ¹⁾ or the associated linearized value	100 % ²⁾ or the associated linearized value
Interface distance	0 (i.e. interface at the reference point)	Empty calibration (→  120) (i.e. interface is at 0 %)

12) only for devices with two current outputs

Process variable	4 mA value	20 mA value
Thickness upper layer	0 % ¹⁾ or the associated linearized value	100 % ²⁾ or the associated linearized value
Relative interface amplitude	0 mV	2 000 mV

- 1) the 0% level is defined by **Empty calibration** parameter (→  120)
- 2) The 100% level is defined by **Full calibration** parameter (→  121)



 It may be necessary to adjust the 4mA and 20mA values to the application (especially in the case of the **Analog output adv. diagnostics 1/2** option).

This can be done by the following parameters:

- Expert → Output → Current output 1 to 2 → Turn down
- Expert → Output → Current output 1 to 2 → 4 mA value
- Expert → Output → Current output 1 to 2 → 20 mA value

Current span

Navigation

  Setup → Advanced setup → Curr.output 1 to 2 → Current span

Description

Determines the current range used to transmit the measured value.

‘4...20mA’:

Measured variable: 4 ...20 mA

‘4...20mA NAMUR’:

Measured variable: 3.8 ... 20.5 mA

‘4...20mA US’:

Measured variable: 3.9 ... 20.8 mA

‘Fixed current’:

Measured variable transmitted via HART only

Note:

Currents below 3.6 mA or above 21.95 mA can be used to signal an alarm.

Selection



- 4...20 mA
- 4...20 mA NAMUR
- 4...20 mA US
- Fixed current

Additional information



Meaning of the options

Option	Current range for process variable	Lower alarm signal level	Upper alarm signal level
4...20 mA	4 to 20.5 mA	< 3.6 mA	> 21.95 mA
4...20 mA NAMUR	3.8 to 20.5 mA	< 3.6 mA	> 21.95 mA



Option	Current range for process variable	Lower alarm signal level	Upper alarm signal level
4...20 mA US	3.9 to 20.8 mA	< 3.6 mA	> 21.95 mA
Fixed current	Constant current, defined in the Fixed current parameter (→ ⓘ 159).		

-  In the case of an error, the output current assumes the value defined in the **Failure mode** parameter (→ ⓘ 159).
 - If the measured value is out of the measuring range, **Current output** diagnostic message is issued.
-  In a HART multidrop loop only one device can use the analog current to transmit a signal. For all other devices one must set:
 - **Current span** = **Fixed current**
 - **Fixed current** (→ ⓘ 159) = **4 mA**



Fixed current 





- Navigation**   Setup → Advanced setup → Curr.output 1 to 2 → Fixed current
- Prerequisite** **Current span** (→ ⓘ 158) = **Fixed current**
- Description** Define constant value of the output current.
- User entry** 4 to 22.5 mA

Damping output 



- Navigation**   Setup → Advanced setup → Curr.output 1 to 2 → Damping out.
- Description** Reaction time of the output signal on fluctuation in the measured value.
- User entry** 0.0 to 999.9 s
- Additional information** Fluctuations of the measured value affect the output current with an exponential delay, the time constant τ of which is defined in this parameter. With a small time constant the output reacts immediately to changes of the measured value. With a big time constant the reaction of the output is more delayed. For $\tau = 0$ (factory setting) there is no damping.

Failure mode 

- Navigation**   Setup → Advanced setup → Curr.output 1 to 2 → Failure mode
- Prerequisite** **Current span** (→ ⓘ 158) ≠ **Fixed current**

Description	<p>Defines which current the output assumes in the case of an error.</p> <p>'Min.': < 3.6mA</p> <p>'Max.': > 21.95mA</p> <p>'Last valid value': Last valid value before occurrence of the error.</p> <p>'Actual value': Output current is equal to the measured value; error is ignored.</p> <p>'Defined value': User defined value.</p>
Selection	<ul style="list-style-type: none"> ▪ Min. ▪ Max. ▪ Last valid value ▪ Actual value ▪ Defined value
Additional information	<p>Meaning of the options</p> <ul style="list-style-type: none"> ▪ Min. The current output adopts the value of the lower alarm level according to the Current span parameter (→  158). ▪ Max. The current output adopts the value of the upper alarm level according to the Current span parameter (→  158). ▪ Last valid value The current remains constant at the last value it had before the error occurred. ▪ Actual value The output current follows the actual measured value; the error is ignored. ▪ Defined value The output current assumes the value defined in the Failure current parameter (→  160). <p> The error behavior of other output channels is not influenced by these settings but is defined in separate parameters.</p>

Failure current

Navigation	  Setup → Advanced setup → Curr.output 1 to 2 → Failure current
Prerequisite	Failure mode (→  159) = Defined value
Description	Defines which current the output assumes in case of an error.
User entry	3.59 to 22.5 mA

Output current 1 to 2



Navigation

 Setup → Advanced setup → Curr.output 1 to 2 → Output curr. 1 to 2

Description

Shows the actual calculated value of the output current.

"Switch output" submenu

 The **Switch output** submenu (→  162) is only visible for devices with switch output.¹³⁾

Navigation  Setup → Advanced setup → Switch output

Switch output function**Navigation**

 Setup → Advanced setup → Switch output → Switch out funct

Description

Defines the function of the switch output.

'Off'

The switch output is always open (non-conductive)

'On'

The switch output is always closed (conductive).

'Diagnostic behavior'

The switch output is normally closed and is only opened if a diagnostic event is present.

'Limit'

The switch output is normally closed and is only opened if a measured variable exceeds a defined limit.

'Digital output'

The switch output is controlled by one of the digital output blocks of the device.

Selection

- Off
- On
- Diagnostic behavior
- Limit
- Digital Output

Additional information**Meaning of the options**

- **Off**

The output is always open (non-conductive).

- **On**

The output is always closed (conductive).

- **Diagnostic behavior**

The output is normally closed and is only opened if a diagnostic event is present. The **Assign diagnostic behavior** parameter (→  163) determines for which type of event the output is opened.

- **Limit**

The output is normally closed and is only opened if a measured variable exceeds or falls below a defined limit. The limit values are defined by the following parameters:

- **Assign limit** (→  163)

- **Switch-on value** (→  164)

- **Switch-off value** (→  165)



- **Digital Output**

The switching state of the output tracks the output value of a DI function block. The function block is selected in the **Assign status** parameter (→  163).



 The **Off** and **On** options can be used to simulate the switch output.

13) Ordering feature 020 "Power supply; Output", option B, E or G



Assign status

Navigation	  Setup → Advanced setup → Switch output → Assign status
Prerequisite	Switch output function (→  162) = Digital Output
Description	Assigns a Discrete Output Block or an Advanced Diagnostic Block to the switch output.
Selection	<ul style="list-style-type: none"> ■ Off ■ Digital output AD 1 ■ Digital output AD 2
Additional information	The Digital output AD 1 and Digital output AD 2 options refer to the Advanced Diagnostic Blocks. A switch signal generated in these blocks can be transmitted via the switch output.

Assign limit

Navigation	  Setup → Advanced setup → Switch output → Assign limit
Prerequisite	Switch output function (→  162) = Limit
Description	Defines which process variable will be checked for limit violation.
Selection	<ul style="list-style-type: none"> ■ Off ■ Level linearized ■ Distance ■ Interface linearized * ■ Interface distance * ■ Thickness upper layer * ■ Terminal voltage ■ Electronic temperature ■ Measured capacitance * ■ Relative echo amplitude ■ Relative interface amplitude * ■ Absolute echo amplitude ■ Absolute interface amplitude *

Assign diagnostic behavior

Navigation	  Setup → Advanced setup → Switch output → Assign diag. beh
Prerequisite	Switch output function (→  162) = Diagnostic behavior
Description	Defines to which behavior of diagnostic events the switch output reacts.

* Visibility depends on order options or device settings

- Selection**
- Alarm
 - Alarm or warning
 - Warning

Switch-on value

Navigation Setup → Advanced setup → Switch output → Switch-on value

Prerequisite **Switch output function (→ 162) = Limit**

Description Defines the switch-on point.
The output is closed if the assigned process variable rises above this point.

User entry Signed floating-point number

Additional information The switching behavior depends on the relative position of the **Switch-on value** and **Switch-off value** parameters:

Switch-on value > Switch-off value

- The output is closed if the measured value is larger than **Switch-on value**.
- The output is opened if the measured value is smaller than **Switch-off value**.

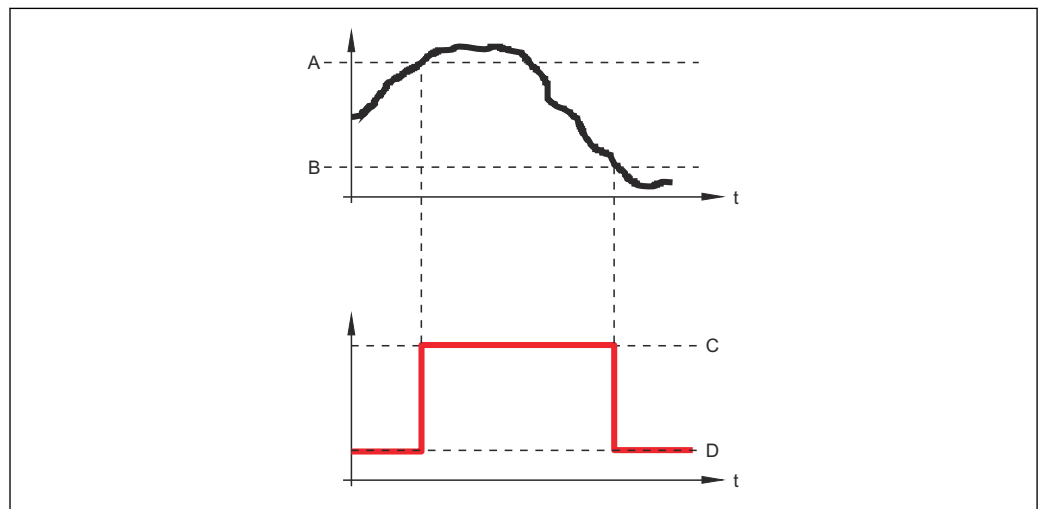

A0015585

- A *Switch-on value*
 B *Switch-off value*
 C *Output closed (conductive)*
 D *Output opened (non-conductive)*

Switch-on value < Switch-off value

- The output is closed if the measured value is smaller than **Switch-on value**.
- The output is opened if the measured value is larger than **Switch-off value**.

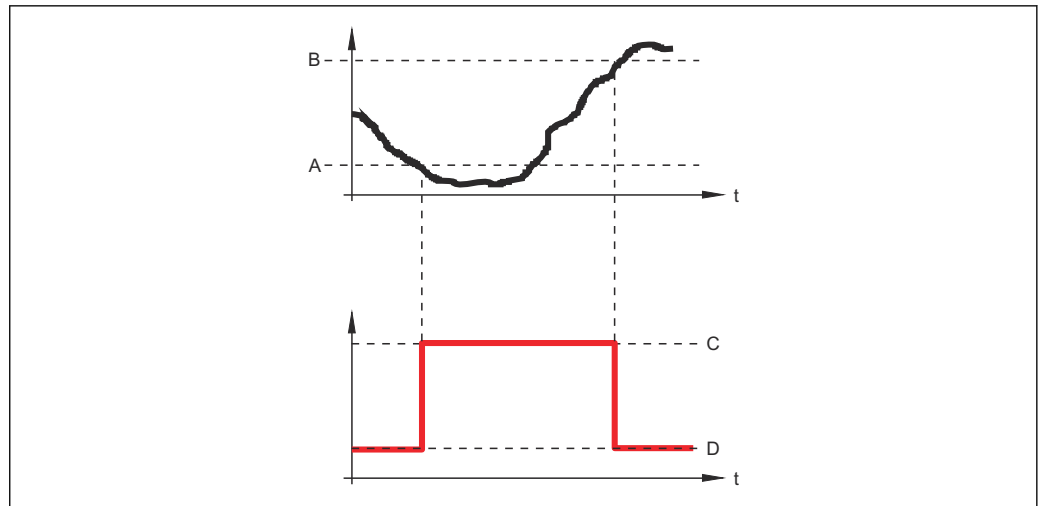

A0015586

- A Switch-on value
- B Switch-off value
- C Output closed (conductive)
- D Output opened (non-conductive)

Switch-on delay



Navigation

Setup → Advanced setup → Switch output → Switch-on delay

Prerequisite

- Switch output function (→ 162) = Limit
- Assign limit (→ 163) ≠ Off

Description

Defines the delay applied before the output is switched on.

User entry

0.0 to 100.0 s

Switch-off value



Navigation

Setup → Advanced setup → Switch output → Switch-off value

Prerequisite

Switch output function (→ 162) = Limit

Description

Defines the switch-off point.
The output is opened if the assigned process variable falls below this point.





User entry

Signed floating-point number



Additional information

The switching behavior depends on the relative position of the **Switch-on value** and **Switch-off value** parameters; description: see the **Switch-on value** parameter (→ 164).

Switch-off delay



Navigation	  Setup → Advanced setup → Switch output → Switch-off delay
Prerequisite	<ul style="list-style-type: none"> ▪ Switch output function (→  162) = Limit ▪ Assign limit (→  163) ≠ Off
Description	Defines the delay applied before the output is switched off.
User entry	0.0 to 100.0 s

Failure mode



Navigation	  Setup → Advanced setup → Switch output → Failure mode
Prerequisite	Switch output function (→  162) = Limit or Digital Output
Description	Defines the state of the switch output in case of an error.
Selection	<ul style="list-style-type: none"> ▪ Actual status ▪ Open ▪ Closed

Additional information

Switch status

Navigation	  Setup → Advanced setup → Switch output → Switch status
Description	Current status of the switch output.

Invert output signal

Navigation	  Setup → Advanced setup → Switch output → Invert outp.sig.
Description	<p>'No' The switch output behaves as per its parameter setting.</p> <p>'Yes' The switching behavior is inverted as compared to its parameter setting.</p>
Selection	<ul style="list-style-type: none"> ▪ No ▪ Yes

Additional information**Meaning of the options**

- **No**
The behavior of the switch output is as described above.
- **Yes**
The states **Open** and **Closed** are inverted as compared to the description above.

"Display" submenu

 **Display** submenu is only visible if a display module is connected to the device.

Navigation  Setup → Advanced setup → Display

Language**Navigation**

 Setup → Advanced setup → Display → Language

Description

Set display language.

Selection

- English
- Deutsch *
- Français *
- Español *
- Italiano *
- Nederlands *
- Portuguesa *
- Polski *
- русский язык (Russian) *
- Svenska *
- Türkçe *
- 中文 (Chinese) *
- 日本語 (Japanese) *
- 한국어 (Korean) *
- Bahasa Indonesia *
- tiếng Việt (Vietnamese) *
- čeština (Czech) *

Factory setting

The language selected in feature 500 of the product structure.
If no language has been selected: **English**

Additional information**Format display****Navigation**

 Setup → Advanced setup → Display → Format display

Description

Select how measured values are shown on the display.

Selection

- 1 value, max. size
- 1 bargraph + 1 value
- 2 values
- 1 value large + 2 values
- 4 values

* Visibility depends on order options or device settings

Additional information



A0019963

48 "Format display" = "1 value, max. size"

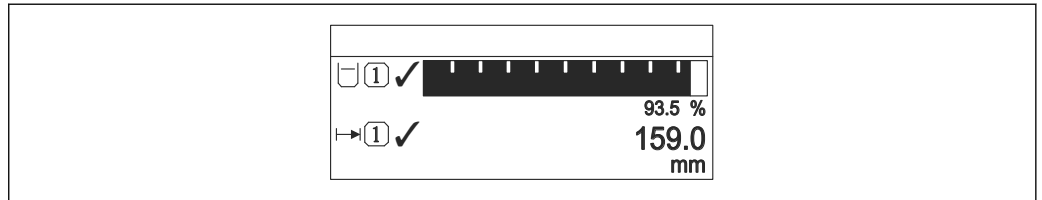

A0019964

49 "Format display" = "1 bargraph + 1 value"

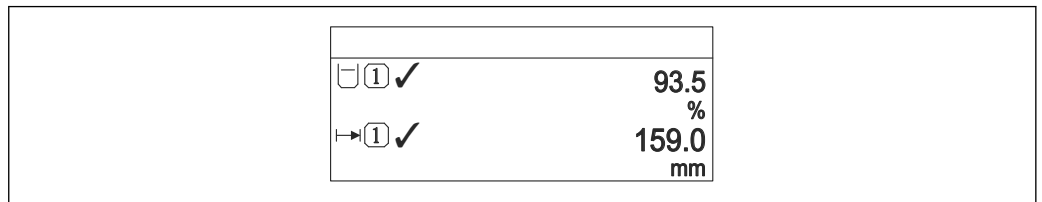

A0019965

50 "Format display" = "2 values"

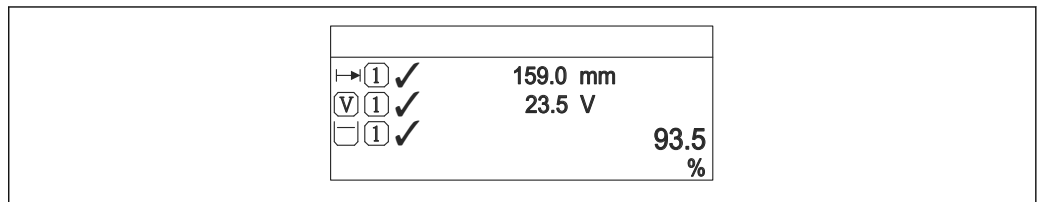

A0019966

51 "Format display" = "1 value large + 2 values"

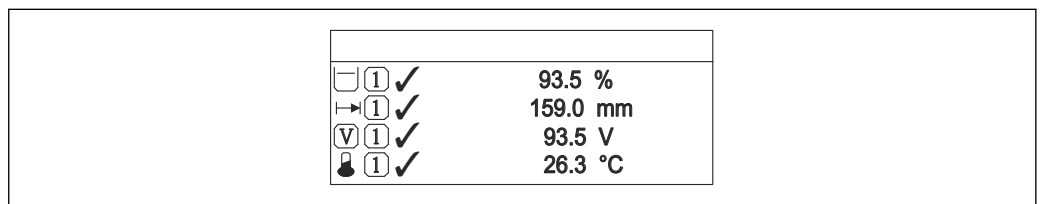

A0019968

52 "Format display" = "4 values"

- i
■
 The **Value 1 to 4 display** → 170 parameters specify which measured values are shown on the display and in which order.
- If more measured values are specified than the current display mode permits, the values alternate on the device display. The display time until the next change is configured in the **Display interval** parameter (→ 171).

Value 1 to 4 display

Navigation	Setup → Advanced setup → Display → Value 1 display
Description	Select the measured value that is shown on the local display.
Selection	<ul style="list-style-type: none"> ■ Level linearized ■ Distance ■ Interface linearized * ■ Interface distance * ■ Thickness upper layer * ■ Current output 1 ■ Measured current ■ Current output 2 * ■ Terminal voltage ■ Electronic temperature ■ Measured capacitance * ■ Analog output adv. diagnostics 1 ■ Analog output adv. diagnostics 2

Factory setting	<p>For interface measurements and one current output</p> <ul style="list-style-type: none"> ■ Value 1 display: Interface linearized ■ Value 2 display: Level linearized ■ Value 3 display: Thickness upper layer ■ Value 4 display: Current output 1 <p>For interface measurements and two current outputs</p> <ul style="list-style-type: none"> ■ Value 1 display: Interface linearized ■ Value 2 display: Level linearized ■ Value 3 display: Current output 1 ■ Value 4 display: Current output 2
------------------------	---

Decimal places 1 to 4

Navigation	Setup → Advanced setup → Display → Decimal places 1
Description	This selection does not affect the measurement and calculation accuracy of the device.
Selection	<ul style="list-style-type: none"> ■ x ■ x.x ■ x.xx ■ x.xxx ■ x.xxxx
Additional information	The setting does not affect the measuring or computational accuracy of the device.

* Visibility depends on order options or device settings

Display interval

Navigation	☰☰ Setup → Advanced setup → Display → Display interval
Description	Set time measured values are shown on display if display alternates between values.
User entry	1 to 10 s
Additional information	This parameter is only relevant if the number of selected measuring values exceeds the number of values the selected display format can display simultaneously.

Display damping



Navigation	☰☰ Setup → Advanced setup → Display → Display damping
Description	Set display reaction time to fluctuations in the measured value.
User entry	0.0 to 999.9 s

Header



Navigation	☰☰ Setup → Advanced setup → Display → Header
Description	Select header contents on local display.
Selection	<ul style="list-style-type: none"> ■ Device tag ■ Free text

Additional information

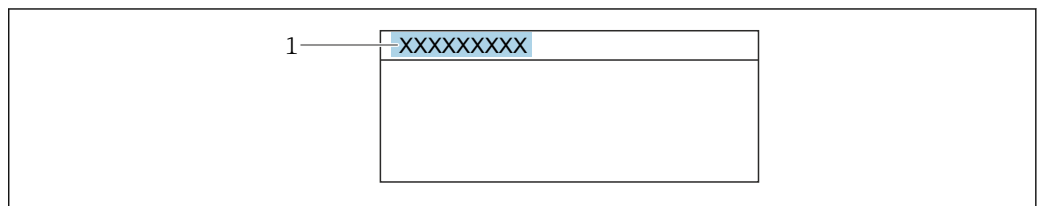



A0029422

1 Position of the header text on the display



Meaning of the options

- **Device tag**
Is defined in the **Device tag** parameter (→ ☰ 118).
- **Free text**
Is defined in the **Header text** parameter (→ ☰ 172).



Header text 

Navigation	  Setup → Advanced setup → Display → Header text
Prerequisite	Header (→  171) = Free text
Description	Enter display header text.
User entry	Character string comprising numbers, letters and special characters (12)
Additional information	The number of characters which can be displayed depends on the characters used.



Separator 

Navigation	  Setup → Advanced setup → Display → Separator
Description	Select decimal separator for displaying numerical values.
Selection	<ul style="list-style-type: none"> ▪ . ▪ ,

Number format 



Navigation	  Setup → Advanced setup → Display → Number format
Description	Choose number format for the display.
Selection	<ul style="list-style-type: none"> ▪ Decimal ▪ ft-in-1/16"
Additional information	The ft-in-1/16" option is only valid for distance units.

Decimal places menu 







Navigation	  Setup → Advanced setup → Display → Dec. places menu
Description	Select number of decimal places for the representation of numbers within the operating menu.
Selection	<ul style="list-style-type: none"> ▪ x ▪ x.x ▪ x.xx ▪ x.xxx ▪ x.xxxx

- Additional information**
- Is only valid for numbers in the operating menu (e.g. **Empty calibration**, **Full calibration**), but not for the measured value display. The number of decimal places for the measured value display is defined in the **Decimal places 1 to 4** →  170 parameters.
 - The setting does not affect the accuracy of the measurement or the calculations.

Backlight

- Navigation**   Setup → Advanced setup → Display → Backlight
- Prerequisite** The device has the SD03 local display (with optical keys).
- Description** Switch the local display backlight on and off.
- Selection**
- Disable
 - Enable
- Additional information**
- Meaning of the options**
- **Disable**
Switches the backlight off.
 - **Enable**
Switches the backlight on.
-  Regardless of the setting in this parameter the backlight may be automatically switched off by the device if the supply voltage is too low.



Contrast display

- Navigation**   Setup → Advanced setup → Display → Contrast display
- Description** Adjust local display contrast setting to ambient conditions (e.g. lighting or reading angle).
- User entry** 20 to 80 %
- Factory setting** Dependent on the display.
- Additional information**
-  Setting the contrast via push-buttons:
- Darker: press the   buttons simultaneously.
 - Brighter: press the   buttons simultaneously.

"Configuration backup display" submenu

 This submenu is only visible if a display module is connected to the device.

The configuration of the device can be saved to the display module at a certain point of time (backup). The saved configuration can be restored to the device if required, e.g. in order to bring the device back into a defined state. The configuration can also be transferred to a different device of the same type using the display module.

 Configurations can only be exchanged between devices which are in the same operating mode (see the **Operating mode** parameter (→  118)).

Navigation  Setup → Advanced setup → Conf.backup disp

Operating time

Navigation  Setup → Advanced setup → Conf.backup disp → Operating time

Description Indicates how long the device has been in operation.

Additional information *Maximum time*
9999 d (≈ 27 years)

Last backup

Navigation  Setup → Advanced setup → Conf.backup disp → Last backup

Description Indicates when the last data backup was saved to the display module.

Configuration management





Navigation  Setup → Advanced setup → Conf.backup disp → Config. managem.

Description Select action for managing the device data in the display module.

- Selection**
- Cancel
 - Execute backup
 - Restore
 - Duplicate
 - Compare
 - Clear backup data



Additional information

Meaning of the options

- **Cancel**
No action is executed and the user exits the parameter.
 - **Execute backup**
A backup copy of the current device configuration in the HistoROM (built-in in the device) is saved to the display module of the device.
 - **Restore**
The last backup copy of the device configuration is copied from the display module to the HistoROM of the device.
 - **Duplicate**
The transmitter configuration is duplicated to another device using the transmitter display module. The following parameters, which characterize the individual measuring point are **not** included in the transmitted configuration:
 - HART date code
 - HART short tag
 - HART message
 - HART descriptor
 - HART address
 - Device tag
 - Medium type
 - **Compare**
The device configuration saved in the display module is compared to the current device configuration of the HistoROM. The result of this comparison is displayed in the **Comparison result** parameter (→  175).
 - **Clear backup data**
The backup copy of the device configuration is deleted from the display module of the device.
-  While this action is in progress, the configuration cannot be edited via the local display and a message on the processing status appears on the display.
-  If an existing backup is restored to a different device using the **Restore** option, it may occur that some device functionalities are no longer available. In some cases even a device reset will not restore the original status.
- In order to transmit a configuration to a different device, the **Duplicate** option should always be used.

Backup state

Navigation



  Setup → Advanced setup → Conf.backup disp → Backup state

Description

Displays which backup action is currently in progress.

Comparison result

Navigation

  Setup → Advanced setup → Conf.backup disp → Compar. result

Description

Comparison between present device data and display backup.

Additional information**Meaning of the display options****■ Settings identical**

The current device configuration of the HistoROM is identical to the backup copy in the display module.

■ Settings not identical

The current device configuration of the HistoROM is not identical to the backup copy in the display module.

■ No backup available

There is no backup copy of the device configuration of the HistoROM in the display module.

■ Backup settings corrupt

The current configuration of the HistoROM is corrupt or not compatible with the backup copy in the display module.

■ Check not done

The device configuration of the HistoROM has not yet been compared to the backup copy in the display module.

■ Dataset incompatible

The data sets are incompatible and can not be compared.





To start the comparison, set **Configuration management** (→  174) = **Compare**.













If the transmitter configuration has been duplicated from a different device by **Configuration management** (→  174) = **Duplicate**, the new device configuration in the HistoROM is only partially identical to the configuration stored in the display module: Sensor specific properties (e.g. the mapping curve) are not duplicated. Thus, the result of the comparison will be **Settings not identical**.



"Administration" submenu

Navigation  Setup → Advanced setup → Administration

Define access code 

Navigation	 Setup → Advanced setup → Administration → Def. access code
Description	Define release code for write access to parameters.
User entry	0 to 9999
Additional information	<p> If the factory setting is not changed or if "0" is entered, the parameters are not write-protected and the device configuration data can therefore always be modified. The user is logged on in the "Maintenance" role.</p> <p> The write protection affects all parameters marked with the  symbol in the document. On the local display, the  symbol in front of a parameter indicates that the parameter is write-protected.</p> <p> Once the access code has been defined, write-protected parameters can only be modified if the access code is entered in the Enter access code parameter (→  130).</p> <p> Please contact your Endress+Hauser Sales Center if you lose the access code.</p> <p> If operating via the local display: the new access code is only valid once it has been confirmed in the Confirm access code parameter (→  179).</p>

Device reset 

Navigation	  Setup → Advanced setup → Administration → Device reset
Description	Reset the device configuration - either entirely or in part - to a defined state.
Selection	<ul style="list-style-type: none"> ■ Cancel ■ To factory defaults ■ To delivery settings ■ Of customer settings ■ To transducer defaults ■ Restart device
Additional information	<p>Meaning of the options</p> <ul style="list-style-type: none"> ■ Cancel No action ■ To factory defaults All parameters are reset to the order-code specific factory setting. ■ To delivery settings All parameters are reset to the delivery setting. The delivery setting may differ from the factory default if customer specific settings have been ordered. This option is only visible if customer specific settings have been ordered.

- **Of customer settings**

All customer parameters are reset to their factory setting. Service parameters, however, remain unchanged.

- **To transducer defaults**

Every measurement-related parameter is reset to its factory setting. Service parameters and communication-related parameters, however, remain unchanged.

- **Restart device**

The restart resets every parameter which is stored in the volatile memory (RAM) to the factory setting (e.g. measured value data). The device configuration remains unchanged.

"Define access code" wizard

 The **Define access code** wizard is only available when operating via the local display. When operating via an operating tool, the **Define access code** parameter is located directly in the **Administration** submenu. The **Confirm access code** parameter is not available for operation via operating tool.

Navigation  Setup → Advanced setup → Administration → Def. access code

Define access code



Navigation

 Setup → Advanced setup → Administration → Def. access code → Def. access code

Description

→  177

Confirm access code



Navigation

 Setup → Advanced setup → Administration → Def. access code → Confirm code

Description

Confirm the entered access code.

User entry

0 to 9999

17.5 "Diagnostics" menu

Navigation  Diagnostics

Actual diagnostics



Navigation  Diagnostics → Actual diagnos.

Description Displays current diagnostic message.

Additional information The display consists of:

- Symbol for event behavior
- Code for diagnostic behavior
- Operating time of occurrence
- Event text

 If several messages are active at the same time, the messages with the highest priority is displayed.

 Information on what is causing the message, and remedy measures, can be viewed via the  symbol on the display.

Timestamp

Navigation  Diagnostics → Timestamp

Description Displays the timestamp for the currently active diagnostic message.



Previous diagnostics

Navigation  Diagnostics → Prev.diagnostics

Description Displays the last diagnostic message which has been active before the current message.

Additional information The display consists of:

- Symbol for event behavior
- Code for diagnostic behavior
- Operating time of occurrence
- Event text

 The condition displayed may still apply. Information on what is causing the message, and remedy measures, can be viewed via the  symbol on the display.

Timestamp

Navigation  Diagnostics → Timestamp

Description Shows the timestamp of the previous diagnostic message.

Operating time from restart

Navigation   Diagnostics → Time fr. restart

Description Displays the time the device has been in operation since the last device restart.

Operating time

Navigation   Diagnostics → Operating time

Description Indicates how long the device has been in operation.

Additional information *Maximum time*
9999 d (≈ 27 years)

17.5.1 "Diagnostic list" submenu

Navigation  Diagnostics → Diagnostic list

Diagnostics 1 to 5

Navigation

 Diagnostics → Diagnostic list → Diagnostics 1

Description

Display the current diagnostics messages with the highest to fifth-highest priority.

Additional information

The display consists of:

- Symbol for event behavior
- Code for diagnostic behavior
- Operating time of occurrence
- Event text

Timestamp 1 to 5

Navigation

 Diagnostics → Diagnostic list → Timestamp 1 to 5

Description

Timestamp of the diagnostic message.

17.5.2 "Event logbook" submenu

 The **Event logbook** submenu is only available when operating via the local display. When operating via FieldCare, the event list can be displayed in the FieldCare function "Event List / HistoROM".

Navigation  Diagnostics → Event logbook

Filter options

Navigation

 Diagnostics → Event logbook → Filter options

Description

Define which category of event messages is shown in the Events list submenu.

Selection

- All
- Failure (F)
- Function check (C)
- Out of specification (S)
- Maintenance required (M)
- Information (I)



Additional information



-  ▪ This parameter is only used for operation via the local display.
 ▪ The status signals are categorized according to NAMUR NE 107.

"Event list" submenu

The **Event list** submenu displays the history of past events of the category selected in the **Filter options** parameter (→  183). A maximum of 100 events are displayed in chronological order.

The following symbols indicate whether an event has occurred or has ended:

- : Event has occurred
- : Event has ended

 Information on what is causing the message, and remedy instructions, can be viewed via the -button.

Display format

- For event messages in category I: information event, event text, "recording event" symbol and time the event occurred
- For event messages in category F, M, C, S (status signal): diagnostics event, event text, "recording event" symbol and time the event occurred

Navigation  Diagnostics → Event logbook → Event list



17.5.3 "Device information" submenu

Navigation  Diagnostics → Device info



Device tag

Navigation	 Diagnostics → Device info → Device tag
Description	Enter the name for the measuring point.
User interface	Character string comprising numbers, letters and special characters

Serial number







Navigation	 Diagnostics → Device info → Serial number
Description	Shows the serial number of the measuring device.
Additional information	<p> Uses of the serial number</p> <ul style="list-style-type: none"> ▪ To identify the device quickly, e.g. when contacting Endress+Hauser. ▪ To obtain specific information on the device using the Device Viewer: www.endress.com/deviceviewer <p> The serial number is also indicated on the nameplate.</p>

Firmware version

Navigation	 Diagnostics → Device info → Firmware version
Description	Shows the device firmware version installed.
User interface	xx.yy.zz
Additional information	<p> For firmware versions differing only in the last two digits ("zz") there is no difference concerning functionality or operation.</p>

Device name

Navigation	 Diagnostics → Device info → Device name
Description	Shows the name of the transmitter.

Order code	
Navigation	  Diagnostics → Device info → Order code
Description	Shows the device order code.
User interface	Character string comprising numbers, letters and special characters
Additional information	The order code is generated from the extended order code, which defines all device features of the product structure. In contrast, the device features can not be read directly from the order code.
Extended order code 1 to 3	
Navigation	  Diagnostics → Device info → Ext. order cd. 1
Description	Display the three parts of the extended order code.
User interface	Character string comprising numbers, letters and special characters
Additional information	The extended order code indicates the version of all the features of the product structure and thus uniquely identifies the device.
Device revision	
Navigation	  Diagnostics → Device info → Device revision
Description	Shows the device revision with which the device is registered with the HART Communication Foundation.
Additional information	The device revision is used to allocate the correct Device Description file (DD) to the device.
Device ID	
Navigation	  Diagnostics → Device info → Device ID
Description	Shows the device ID for identifying the device in a HART network.
Additional information	In addition to the Device type and Manufacturer ID, the Device ID is part of the unique device identification (Unique ID) which characterizes each HART device unambiguously.

Device type

Navigation Diagnostics → Device info → Device type**Description**

Shows the device type with which the measuring device is registered with the HART Communication Foundation.

Additional information

Manufacturer ID

Navigation Diagnostics → Device info → Manufacturer ID**Description**

Use this function to view the manufacturer ID with which the measuring device is registered with the HART Communication Foundation.

User interface

2-digit hexadecimal number

Factory setting

0x11 (for Endress+Hauser)

17.5.4 "Measured values" submenu

Navigation   Diagnostics → Measured val.

Distance

Navigation   Diagnostics → Measured val. → Distance

Description Displays the measured distance D_L between the reference point (lower edge of the flange or threaded connection) and the level.

Additional information

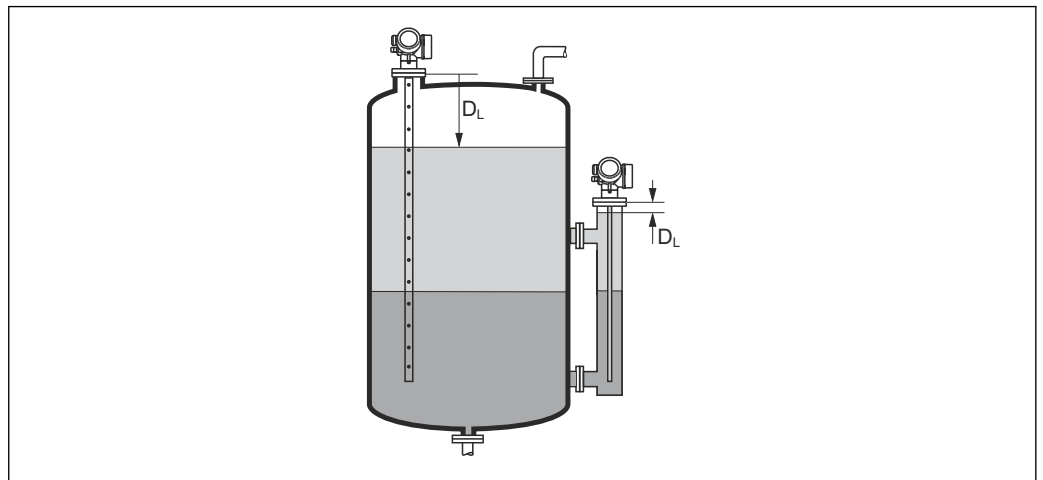

A0013199

 53 Distance for interface measurements

 The unit is defined in the **Distance unit** parameter (→  118).

Level linearized

Navigation   Diagnostics → Measured val. → Level linearized

Description Displays linearized level.

Additional information 

- The unit is defined by the **Unit after linearization** parameter →  142.
- For interface measurements, this parameter always refers to the total level.

Interface distance

Navigation   Diagnostics → Measured val. → Interface dist.

Prerequisite **Operating mode** (→  118) = **Interface** or **Interface with capacitance**

Description

Displays the measured distance D_1 between the reference point (lower edge of flange or threaded connection) and the interface.

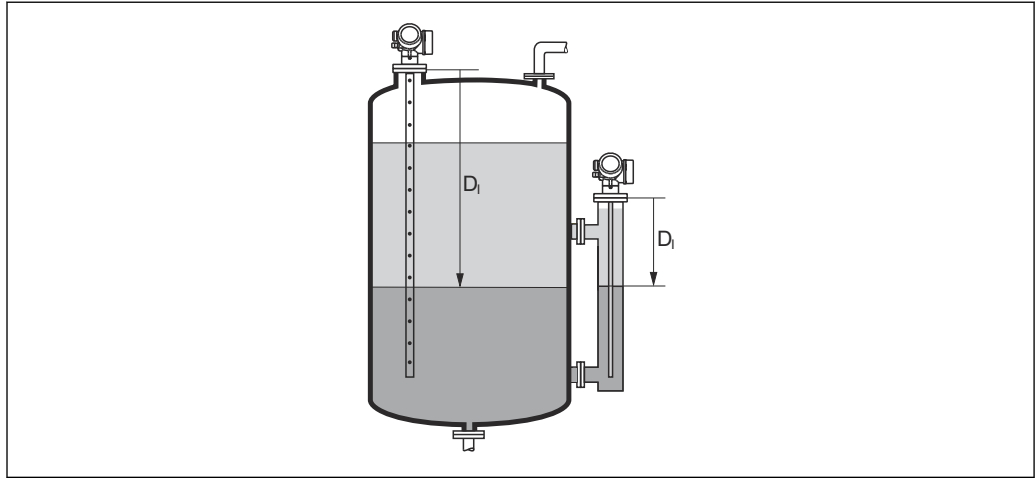
Additional information

A0013202



The unit is defined in the **Distance unit** parameter (→ 📄 118).

Interface linearized**Navigation**

📄📄 Diagnostics → Measured val. → Interf. lineariz

Prerequisite

Operating mode (→ 📄 118) = **Interface** or **Interface with capacitance**

Description

Displays the linearized interface height.

Additional information

The unit is defined in the **Unit after linearization** parameter → 📄 142.

Thickness upper layer**Navigation**

📄📄 Diagnostics → Measured val. → Thickn.upp.layer

Prerequisite

Operating mode (→ 📄 118) = **Interface** or **Interface with capacitance**

Description

Displays the upper interface thickness (UP).

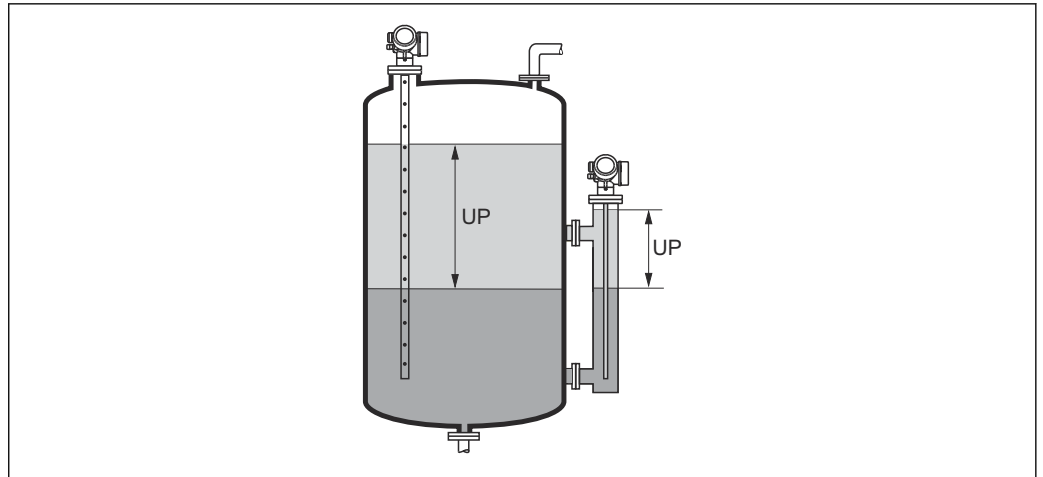
Additional information

A0013313

UP Thickness upper layer



The unit is defined by the **Unit after linearization** parameter → 142.

Output current 1 to 2**Navigation**

Diagnostics → Measured val. → Output curr. 1 to 2

Description

Shows the actual calculated value of the output current.

Measured current 1**Navigation**

Diagnostics → Measured val. → Measur. curr. 1

Prerequisite

Only available for current output 1

Description

Shows the current value of the current output which is currently measured.

Terminal voltage 1**Navigation**

Diagnostics → Measured val. → Terminal volt. 1

Description

Shows the current terminal voltage that is applied at the output.

17.5.5 "Data logging" submenu

Navigation  Diagnostics → Data logging

Assign channel 1 to 4

Navigation	 Diagnostics → Data logging → Assign chan. 1 to 4
Description	Assign a process variable to logging channel.
Selection	<ul style="list-style-type: none"> ■ Off ■ Level linearized ■ Distance ■ Unfiltered distance ■ Interface linearized * ■ Interface distance * ■ Unfiltered interface distance ■ Thickness upper layer * ■ Current output 1 ■ Measured current ■ Current output 2 * ■ Terminal voltage ■ Electronic temperature ■ Measured capacitance * ■ Absolute echo amplitude ■ Relative echo amplitude ■ Absolute interface amplitude * ■ Relative interface amplitude * ■ Absolute EOP amplitude ■ EOP shift ■ Noise of signal ■ Calculated DC value * ■ Analog output adv. diagnostics 1 ■ Analog output adv. diagnostics 2

Additional information A total of 1000 measured values can be logged. This means:

- 1000 data points if 1 logging channel is used
- 500 data points if 2 logging channels are used
- 333 data points if 3 logging channels are used
- 250 data points if 4 logging channels are used

If the maximum number of data points is reached, the oldest data points in the data log are cyclically overwritten in such a way that the last 1000, 500, 333 or 250 measured values are always in the log (ring memory principle).

 The logged data are deleted if a new option is selected in this parameter.

* Visibility depends on order options or device settings

Logging interval
**Navigation**

- Diagnostics → Data logging → Logging interval
- Diagnostics → Data logging → Logging interval

Description

Define the logging interval t_{log} for data logging. This value defines the time interval between the individual data points in the memory.

User entry

1.0 to 3 600.0 s

Additional information

This parameter defines the interval between the individual data points in the data log, and thus the maximum loggable process time T_{log} :

- If 1 logging channel is used: $T_{log} = 1000 \cdot t_{log}$
- If 2 logging channels are used: $T_{log} = 500 \cdot t_{log}$
- If 3 logging channels are used: $T_{log} = 333 \cdot t_{log}$
- If 4 logging channels are used: $T_{log} = 250 \cdot t_{log}$

Once this time elapses, the oldest data points in the data log are cyclically overwritten such that a time of T_{log} always remains in the memory (ring memory principle).



The logged data are deleted if this parameter is changed.

*Example***When using 1 logging channel**

- $T_{log} = 1000 \cdot 1 \text{ s} = 1000 \text{ s} \approx 16.5 \text{ min}$
- $T_{log} = 1000 \cdot 10 \text{ s} = 1000 \text{ s} \approx 2.75 \text{ h}$
- $T_{log} = 1000 \cdot 80 \text{ s} = 80000 \text{ s} \approx 22 \text{ h}$
- $T_{log} = 1000 \cdot 3600 \text{ s} = 3600000 \text{ s} \approx 41 \text{ d}$

Clear logging data
**Navigation**

- Diagnostics → Data logging → Clear logging
- Diagnostics → Data logging → Clear logging

Description

Clear the entire logging data.

Selection

- Cancel
- Clear data

"Display channel 1 to 4" submenu

i The **Display channel 1 to 4** submenus are only available for operation via the local display. When operating via FieldCare, the logging diagram can be displayed in the FieldCare function "Event List / HistoROM" .

The **Display channel 1 to 4** submenus invoke a diagram of the logging history of the respective channel.

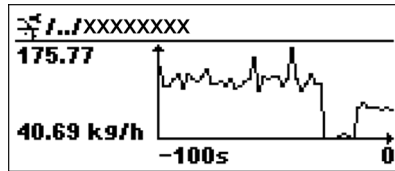

- x-axis: depending on the number of selected channels, 250 to 1000 measured values of a process variable are displayed.
- y-axis: covers the approximate measured value span and constantly adapts this to the measurement.









i To return to the operating menu, press **⏏** and **⏏** simultaneously.

Navigation **⏏** **⏏** Diagnostics → Data logging → Displ.channel 1 to 4

17.5.6 "Simulation" submenu









The **Simulation** submenu is used to simulate specific measuring values or other conditions. This helps to check the correct configuration of the device and connected control units.

Conditions which can be simulated

Condition to be simulated	Associated parameters
Specific value of a process variable	<ul style="list-style-type: none"> ▪ Assign measurement variable (→  195) ▪ Process variable value (→  195)
Specific value of the output current	<ul style="list-style-type: none"> ▪ Current output simulation (→  195) ▪ Value current output (→  196)
Specific state of the switch output	<ul style="list-style-type: none"> ▪ Switch output simulation (→  196) ▪ Switch status (→  196)
Existence of an alarm	Device alarm simulation (→  197)
Existence of a specific diagnostic message	Diagnostic event simulation (→  197)

Structure of the submenu

Navigation  Expert → Diagnostics → Simulation

▶ Simulation	
Assign measurement variable	→  195
Process variable value	→  195
Current output 1 to 2 simulation	→  195
Value current output 1 to 2	→  196
Switch output simulation	→  196
Switch status	→  196
Device alarm simulation	→  197
Diagnostic event simulation	→  197

Description of parameters

Navigation  Expert → Diagnostics → Simulation

Assign measurement variable

Navigation  Expert → Diagnostics → Simulation → Assign meas.var.

Description Defines the process variable to be simulated.

Selection

- Off
- Level
- Interface *
- Thickness upper layer *
- Level linearized
- Interface linearized
- Thickness linearized

Additional information

- The value of the variable to be simulated is defined in the **Process variable value** parameter (→  195).
- If **Assign measurement variable** ≠ **Off**, a simulation is active. This is indicated by a diagnostic message of the *Function check (C)* category.

Process variable value

Navigation  Expert → Diagnostics → Simulation → Proc. var. value

Prerequisite **Assign measurement variable** (→  195) ≠ **Off**

Description Defines the value of the selected variable.
The outputs assume values or states according to this value.

User entry Signed floating-point number

Additional information Downstream measured value processing and the signal output use this simulation value. In this way, users can verify whether the measuring device has been configured correctly.

Current output 1 to 2 simulation

Navigation  Expert → Diagnostics → Simulation → Curr.out. 1 to 2 sim.

Description Switch the simulation of the current output on and off.

* Visibility depends on order options or device settings

Selection	<ul style="list-style-type: none"> ■ Off ■ On
Additional information	An active simulation is indicated by a diagnostic message of the <i>Function check (C)</i> category.

Value current output 1 to 2

Navigation	Expert → Diagnostics → Simulation → Value curr.out 1 to 2
Prerequisite	Current output simulation (→ 195) = On
Description	Defines the value of the simulated output current.
User entry	3.59 to 22.5 mA
Additional information	The current output assumes the value specified in this parameter. In this way, users can verify the correct adjustment of the current output and the correct function of connected control units.

Switch output simulation

Navigation	Expert → Diagnostics → Simulation → Switch sim.
Description	Switch the simulation of the switch output on and off.
Selection	<ul style="list-style-type: none"> ■ Off ■ On

Switch status

Navigation	Expert → Diagnostics → Simulation → Switch status
Prerequisite	Switch output simulation (→ 196) = On
Description	Current status of the switch output.
Selection	<ul style="list-style-type: none"> ■ Open ■ Closed
Additional information	The switch status assumes the value defined in this parameter. This helps to check correct operation of connected control units.

Device alarm simulation

**Navigation**

Expert → Diagnostics → Simulation → Dev. alarm sim.

Description

Switch the device alarm on and off.

Selection

- Off
- On

Additional information

When selecting the **On** option, the device generates an alarm. This helps to check the correct output behavior of the device in the case of an alarm.

An active simulation is indicated by the **✘C484 Failure mode simulation** diagnostic message.

Diagnostic event simulation

**Navigation**

Expert → Diagnostics → Simulation → Diag. event sim.

Description

Select the diagnostic event to be simulated.

Note:





To terminate the simulation, select 'Off'.

Additional information



When operated via the local display, the selection list can be filtered according to the event categories (**Diagnostic event category** parameter).

17.5.7 "Device check" submenu



Navigation  Diagnostics → Device check

Start device check 	
Navigation	 Diagnostics → Device check → Start dev. check
Description	Start a device check.
Selection	<ul style="list-style-type: none"> ■ No ■ Yes
Additional information	In the case of a lost echo a device check can not be performed.
Result device check	
Navigation	 Diagnostics → Device check → Result dev.check
Description	Displays the result of the device check.
Additional information	<p>Meaning of the display options</p> <ul style="list-style-type: none"> ■ Installation ok Measurement possible without restrictions. ■ Accuracy reduced A measurement is possible. However, the measuring accuracy may be reduced due to the signal amplitudes. ■ Measurement capability reduced A measurement is currently possible. However, there is the risk of an echo loss. Check the mounting position of the device and the dielectric constant of the medium. ■ Check not done No device check has been performed.
Last check time	
Navigation	 Diagnostics → Device check → Last check time
Description	Displays the operating time at which the last device check has been performed.
User interface	Character string comprising numbers, letters and special characters



Level signal

Navigation	  Diagnostics → Device check → Level signal
Prerequisite	Device check has been performed.
Description	Displays result of the device check for the level signal.
User interface	<ul style="list-style-type: none"> ■ Check not done ■ Check not OK ■ Check OK
Additional information	For Level signal = Check not OK : Check the mounting position of the device and the dielectric constant of the medium.

Launch signal

Navigation	  Diagnostics → Device check → Launch signal
Prerequisite	Device check has been performed.
Description	Displays result of the display check for the launch signal.
User interface	<ul style="list-style-type: none"> ■ Check not done ■ Check not OK ■ Check OK
Additional information	For Launch signal = Check not OK : Check the mounting position of the device. In non-metallic vessels use a metal plate or a metal flange.

Interface signal

Navigation	  Diagnostics → Device check → Interface signal
Prerequisite	<ul style="list-style-type: none"> ■ Operating mode (→  118) = Interface or Interface with capacitance ■ Device check has been performed.
Description	Displays result of the device check for the interface signal.
User interface	<ul style="list-style-type: none"> ■ Check not done ■ Check not OK ■ Check OK

17.5.8 "Heartbeat" submenu

 The **Heartbeat** submenu is only available via **FieldCare** or **DeviceCare**. It contains the wizards which are part of the **Heartbeat Verification** and **Heartbeat Monitoring** application packages.

Detailed description

SD01872F

Navigation

 Diagnostics → Heartbeat

Index

A

- Access authorization to parameters
 - Read access 49
 - Write access 49
- Access code 49
 - Incorrect input 49
- Access status display (Parameter) 130
- Access status tooling (Parameter) 129
- Accessories
 - Communication-specific 97
 - Device-specific 91
 - Service-specific 98
 - System components 98
- Activate table (Parameter) 147
- Actual diagnostics (Parameter) 180
- Administration (Submenu) 177
- Advanced setup (Submenu) 129
- Application 9
- Assign channel 1 to 4 (Parameter) 190
- Assign current output (Parameter) 157
- Assign diagnostic behavior (Parameter) 163
- Assign limit (Parameter) 163
- Assign measurement variable (Parameter) 195
- Assign status (Parameter) 163
- Automatic DC calculation (Wizard) 137

B

- Backlight (Parameter) 173
- Backup state (Parameter) 175
- Blocking distance (Parameter) 133, 150
- Bluetooth® wireless technology 45
- Bypass 22

C

- Calculated DC value (Parameter) 135
- Cleaning 88
- Clear logging data (Parameter) 191
- Coax probe
 - Design 11
- Coax probes
 - Lateral loading capacity 19
- Code incorrect (Parameter) 153
- Comparison result (Parameter) 175
- Configuration backup display (Submenu) 174
- Configuration management (Parameter) 174
- Configuration of an interface measurement 67
- Configuring interface measurement 67
- Confirm access code (Parameter) 179
- Confirm distance (Parameter) 125, 128
- Confirm probe length (Parameter) 155, 156
- Context menu 59
- Contrast display (Parameter) 173
- Current output 1 to 2 (Submenu) 157
- Current output 1 to 2 simulation (Parameter) 195
- Current span (Parameter) 158
- Customer value (Parameter) 147

D

- Damping output (Parameter) 159
- Data logging (Submenu) 190
- DC value (Parameter) 123, 135, 137
- DC value lower medium (Parameter) 132
- DD 62
- Deactivate SIL/WHG (Wizard) 153
- Decimal places 1 (Parameter) 170
- Decimal places menu (Parameter) 172
- Define access code (Parameter) 177, 179
- Define access code (Wizard) 179
- Define the access code 49
- Device alarm simulation (Parameter) 197
- Device check (Submenu) 198
- Device Descriptions 62
- Device ID (Parameter) 185
- Device information (Submenu) 184
- Device name (Parameter) 184
- Device replacement 89
- Device reset (Parameter) 177
- Device revision (Parameter) 185
- Device tag (Parameter) 118, 184
- Device type (Parameter) 186
- Diagnostic event 79
 - In the operating tool 81
- Diagnostic event simulation (Parameter) 197
- Diagnostic events 78
- Diagnostic list 82
- Diagnostic list (Submenu) 182
- Diagnostic message 78
- Diagnostics
 - Symbols 78
- Diagnostics (Menu) 180
- Diagnostics 1 (Parameter) 182
- Diameter (Parameter) 145
- DIP switch
 - see Write protection switch
- Display (Submenu) 168
- Display and operating module FHX50 44
- Display channel 1 to 4 (Submenu) 192
- Display damping (Parameter) 171
- Display interval (Parameter) 171
- Display module 54
- Display symbols 55
- Disposal 90
- Distance (Parameter) 122, 128, 187
- Distance unit (Parameter) 118
- Document
 - Purpose 5

E

- Electronics housing
 - Design 12
- Empty calibration (Parameter) 120
- Enter access code (Parameter) 130
- Envelope curve display 61

Event history	85
Event level	
Explanation	78
Symbols	78
Event list (Submenu)	183
Event logbook (Submenu)	183
Event text	79
Events list	85
Extended order code 1 (Parameter)	185
Exterior cleaning	88

F

Failure current (Parameter)	160
Failure mode (Parameter)	159, 166
FHX50	44
Field of application	
Residual risks	9
Filter options (Parameter)	183
Filtering the event logbook	85
Firmware version (Parameter)	184
Fixed current (Parameter)	159
Flange	26
Format display (Parameter)	168
Free text (Parameter)	143
Full calibration (Parameter)	121
Functional Safety Manual (FY)	7
FV (HART device variable)	62

H

Hardware write protection	50
HART device variables	62
HART loop converter HMX50	36
HART protocol	46
HART-Integration	62
Header (Parameter)	171
Header text (Parameter)	172
Heartbeat (Submenu)	200
HMX50	36
Housing	
Design	12
Turning	28

I

Input mask	58
Intended use	9
Interface (Parameter)	124
Interface (Submenu)	131
Interface distance (Parameter)	125, 187
Interface linearized (Parameter)	144, 188
Interface property (Parameter)	131
Interface signal (Parameter)	199
Intermediate height (Parameter)	145
Invert output signal (Parameter)	166

K

Keypad lock	
Disabling	53
Enabling	53

L

Language (Parameter)	168
Last backup (Parameter)	174
Last check time (Parameter)	198
Launch signal (Parameter)	199
Level (Parameter)	121, 147
Level correction (Parameter)	134
Level linearized (Parameter)	144, 187
Level signal (Parameter)	199
Level unit (Parameter)	133
Linearization (Submenu)	139, 140, 141
Linearization type (Parameter)	141
Local display	43
see Diagnostic message	
see In alarm condition	
Locking status	55
Locking status (Parameter)	129
Logging interval (Parameter)	191

M

Maintenance	88
Managing the device configuration	72
Manual thickness upper layer (Parameter)	134, 137
Manufacturer ID (Parameter)	186
Mapping (Wizard)	128
Mapping end point (Parameter)	127, 128
Maximum value (Parameter)	144
Measured current 1 (Parameter)	189
Measured thickness upper layer (Parameter)	135
Measured value symbols	56
Measured values (Submenu)	187
Media	9
Medium group (Parameter)	119
Menu	
Diagnostics	180
Setup	118
Mounting position for interface measurements	17

N

Number format (Parameter)	172
-------------------------------------	-----

O

Operating elements	
Diagnostic message	79
Operating mode (Parameter)	118
Operating module	54
Operating time (Parameter)	174, 181
Operating time from restart (Parameter)	181
Operational safety	10
Order code (Parameter)	185
Output current 1 to 2 (Parameter)	161, 189
Output echo lost (Parameter)	149
Overvoltage protection	
General information	40

P

Present mapping (Parameter)	126
Present probe length (Parameter)	154, 156
Previous diagnostics (Parameter)	180

Probe grounded (Parameter) 154
 Probe length correction (Wizard) 156
 Probe settings (Submenu) 154
 Process property (Parameter) 131
 Process variable value (Parameter) 195
 Product safety 10
 Purpose of this document 5
 PV (HART device variable) 62

R

Ramp at echo lost (Parameter) 150
 Read access 49
 Record map (Parameter) 127, 128
 Registered trademarks 8
 Remedial measures
 Calling up 80
 Closing 80
 Remote operation 46
 Repair concept 89
 Replacing a device 89
 Requirements for personnel 9
 Reset write protection (Parameter) 153
 Result device check (Parameter) 198
 Return 90
 Rod probe
 Design 11
 Rod probes
 Lateral loading capacity 19
 Rope probe
 Design 11
 Rope probes
 Mounting 26
 Tensile loading capacity 19

S

Safety instructions
 Basic 9
 Safety Instructions (XA) 7
 Safety settings (Submenu) 149
 Securing coax probes 21
 Separator (Parameter) 172
 Serial number (Parameter) 184
 Service interface (CDI) 46
 Setting the operating language 66
 Settings
 Managing the device configuration 72
 Operating language 66
 Setup (Menu) 118
 Signal quality (Parameter) 123
 SIL/WHG confirmation (Wizard) 152
 Simulation (Submenu) 194, 195
 Spare parts 90
 Nameplate 90
 Start device check (Parameter) 198
 Status signals 55, 78
 Stilling well 22
 Submenu
 Administration 177
 Advanced setup 129

Configuration backup display 174
 Current output 1 to 2 157
 Data logging 190
 Device check 198
 Device information 184
 Diagnostic list 182
 Display 168
 Display channel 1 to 4 192
 Event list 183
 Event logbook 183
 Events list 85
 Heartbeat 200
 Interface 131
 Linearization 139, 140, 141
 Measured values 187
 Probe settings 154
 Safety settings 149
 Simulation 194, 195
 Switch output 162
 SV (HART device variable) 62
 Switch output (Submenu) 162
 Switch output function (Parameter) 162
 Switch output simulation (Parameter) 196
 Switch status (Parameter) 166, 196
 Switch-off delay (Parameter) 166
 Switch-off value (Parameter) 165
 Switch-on delay (Parameter) 165
 Switch-on value (Parameter) 164
 Symbols
 For correction 58
 In the text and numeric editor 58
 System components 98

T

Table mode (Parameter) 145
 Table number (Parameter) 146
 Tank type (Parameter) 119
 Terminal voltage 1 (Parameter) 189
 Thermal insulation 25
 Thickness upper layer (Parameter) 188
 Timestamp (Parameter) 180, 181
 Timestamp 1 to 5 (Parameter) 182
 Tool 26
 Transmitter
 Turning the display 29
 Turning the display module 29
 Transmitter housing
 Turning 28
 Troubleshooting 74
 Tube diameter (Parameter) 119
 Turning the display 29
 Turning the display module 29
 TV (HART device variable) 62

U

Underground tanks 24
 Unit after linearization (Parameter) 142
 Use calculated DC value (Parameter) 136, 137

Use of the measuring device	
see Intended use	
Use of the measuring devices	
Borderline cases	9
Incorrect use	9
V	
Value 1 display (Parameter)	170
Value current output 1 to 2 (Parameter)	196
Value echo lost (Parameter)	149
W	
Wizard	
Automatic DC calculation	137
Deactivate SIL/WHG	153
Define access code	179
Mapping	128
Probe length correction	156
SIL/WHG confirmation	152
Workplace safety	10
Write access	49
Write protection	
Via access code	49
Via write protection switch	50
Write protection switch	50



71664103

www.addresses.endress.com
