

# Operating Instructions

## Levelflex FMP56, FMP57

### HART

Guided-wave radar



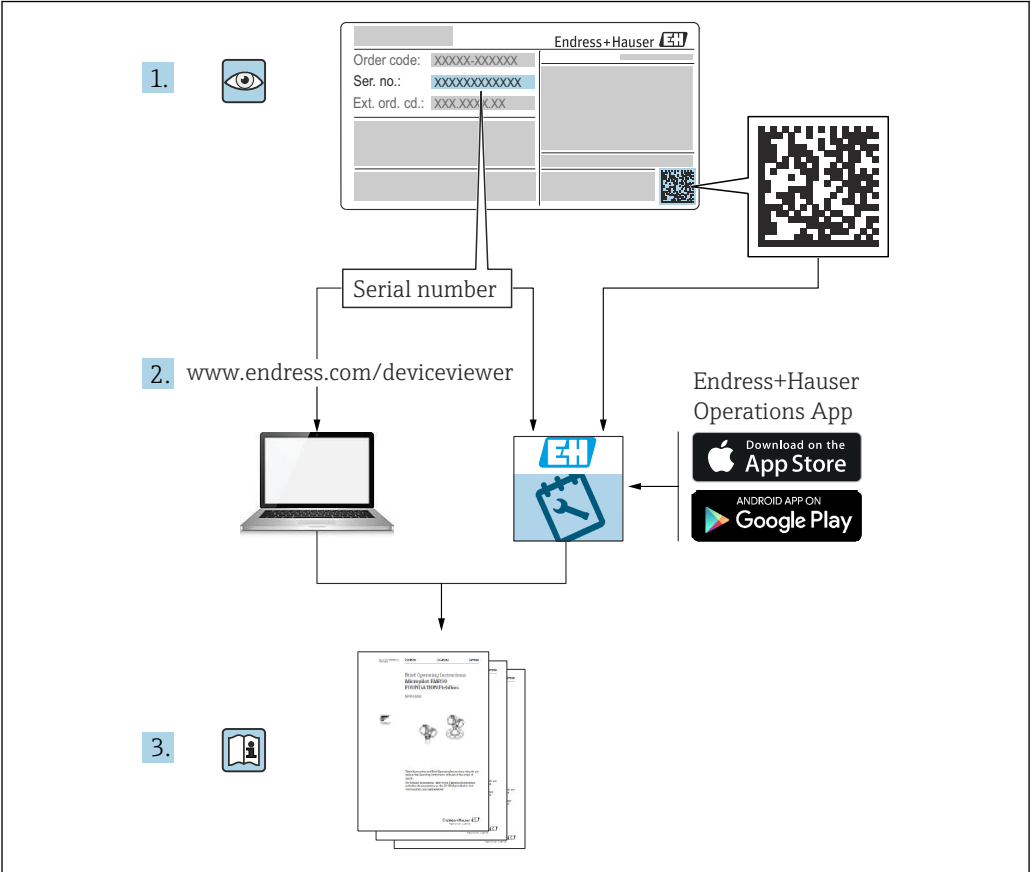

A0023555

# Table of contents

<b>1</b>	<b>About this document</b> .....	<b>5</b>		
1.1	Document function .....	5		
1.2	Symbols .....	5		
1.2.1	Safety symbols .....	5		
1.2.2	Electrical symbols .....	5		
1.2.3	Tool symbols .....	5		
1.2.4	Symbols for certain types of information and graphics .....	6		
1.3	List of abbreviations .....	6		
1.4	Documentation .....	7		
1.5	Registered trademarks .....	8		
<b>2</b>	<b>Basic safety instructions</b> .....	<b>9</b>		
2.1	Requirements for the personnel .....	9		
2.2	Intended use .....	9		
2.3	Workplace safety .....	10		
2.4	Operational safety .....	10		
2.5	Product security .....	10		
2.5.1	CE mark .....	10		
2.5.2	EAC conformity .....	10		
<b>3</b>	<b>Product description</b> .....	<b>11</b>		
3.1	Product design .....	11		
3.1.1	Levelflex FMP56/FMP57 .....	11		
3.1.2	Electronics housing .....	12		
<b>4</b>	<b>Incoming acceptance and product identification</b> .....	<b>13</b>		
4.1	Incoming acceptance .....	13		
4.2	Product identification .....	13		
4.2.1	Nameplate .....	13		
4.2.2	Manufacturer address .....	14		
<b>5</b>	<b>Storage, transport</b> .....	<b>15</b>		
5.1	Storage temperature .....	15		
5.2	Transporting to the measuring point .....	15		
<b>6</b>	<b>Installation</b> .....	<b>16</b>		
6.1	Mounting requirements .....	16		
6.1.1	Suitable mounting position .....	16		
6.1.2	Mounting under confined conditions .....	17		
6.1.3	Notes on the mechanical load of the probe .....	18		
6.1.4	Information concerning the process connection .....	21		
6.1.5	Securing the probe .....	24		
6.1.6	Special installation situations .....	25		
6.2	Mounting the device .....	28		
6.2.1	Tool list .....	28		
6.2.2	Shortening the probe .....	28		
6.2.3	Mounting the device .....	30		
6.2.4	Mounting the "Sensor, remote" version .....	32		
6.2.5	Turning the transmitter housing .....	33		
6.2.6	Turning the display .....	34		
6.3	Post-mounting check .....	34		
<b>7</b>	<b>Electrical connection</b> .....	<b>36</b>		
7.1	Connecting requirements .....	36		
7.1.1	Terminal assignment .....	36		
7.1.2	Cable specification .....	40		
7.1.3	Device plug .....	40		
7.1.4	Supply voltage .....	42		
7.1.5	Overvoltage protection .....	43		
7.2	Connecting the device .....	44		
7.2.1	Opening cover .....	44		
7.2.2	Connecting .....	45		
7.2.3	Plug-in spring-force terminals .....	45		
7.2.4	Closing the cover of the connection compartment .....	46		
7.3	Post-connection check .....	46		
<b>8</b>	<b>Operation options</b> .....	<b>47</b>		
8.1	Overview of operation options .....	47		
8.1.1	Access to operating menu via local display .....	47		
8.1.2	Access to the operating menu via the operating tool .....	48		
8.2	Structure and function of the operating menu .....	49		
8.2.1	Structure of the operating menu .....	49		
8.2.2	User roles and related access authorization .....	50		
8.2.3	Data access - Security .....	51		
8.3	Display and operating module .....	55		
8.3.1	Display format .....	55		
8.3.2	Operating elements .....	57		
8.3.3	Entering numbers and text .....	58		
8.3.4	Opening the context menu .....	60		
8.3.5	Envelope curve display on the display and operating module .....	61		
<b>9</b>	<b>System integration</b> .....	<b>62</b>		
9.1	Overview of the device description files .....	62		
9.2	Measured variables via HART protocol .....	62		
<b>10</b>	<b>Commissioning via SmartBlue (App)</b> .....	<b>63</b>		
10.1	Operation via Bluetooth® wireless technology (optional) .....	63		
10.1.1	Operation via SmartBlue App .....	63		
10.2	Envelope curve display in SmartBlue .....	64		

<b>11</b>	<b>Commissioning using the wizard ...</b>	<b>65</b>		
<b>12</b>	<b>Commissioning via operating menu .....</b>	<b>66</b>		
12.1	Installation and function check .....	66		
12.2	Configuring the operating language .....	66		
12.3	Configuring level measurement .....	67		
12.4	Recording the reference echo curve .....	68		
12.5	Configuring the local display .....	68		
12.5.1	Factory setting of local display for level measurements .....	68		
12.5.2	Adjusting the local display .....	68		
12.6	Configuring the current outputs .....	69		
12.6.1	Factor setting of current outputs for level measurements .....	69		
12.6.2	Adjusting the current outputs .....	69		
12.7	Configuration management .....	69		
12.8	Protecting settings from unauthorized access ..	70		
<b>13</b>	<b>Diagnostics and troubleshooting ...</b>	<b>71</b>		
13.1	General troubleshooting .....	71		
13.1.1	General errors .....	71		
13.1.2	Error - SmartBlue operation .....	72		
13.1.3	Parameter configuration errors .....	72		
13.2	Diagnostic information on local display .....	73		
13.2.1	Diagnostic message .....	73		
13.2.2	Calling up remedial measures .....	75		
13.3	Diagnostic event in the operating tool .....	75		
13.4	Diagnostic list .....	77		
13.5	List of diagnostic events .....	78		
13.6	Event logbook .....	80		
13.6.1	Event history .....	80		
13.6.2	Filtering the event logbook .....	80		
13.6.3	Overview of information events .....	80		
13.7	Firmware history .....	81		
<b>14</b>	<b>Maintenance .....</b>	<b>83</b>		
14.1	Exterior cleaning .....	83		
14.2	General cleaning instructions .....	83		
<b>15</b>	<b>Repair .....</b>	<b>84</b>		
15.1	General information .....	84		
15.1.1	Repair concept .....	84		
15.1.2	Repairs to Ex-approved devices .....	84		
15.1.3	Replacing electronics modules .....	84		
15.1.4	Replacing a device .....	84		
15.2	Spare parts .....	85		
15.3	Return .....	85		
15.4	Disposal .....	85		
<b>16</b>	<b>Accessories .....</b>	<b>86</b>		
16.1	Device-specific accessories .....	86		
16.1.1	Weather protection cover .....	86		
16.1.2	Mounting bracket for electronics housing .....	87		
16.1.3	Rod extension (centering device) HMP40 .....	89		
16.1.4	Mounting kit, insulated .....	89		
16.1.5	Remote display FHX50 .....	90		
16.1.6	Overvoltage protection .....	91		
16.1.7	Bluetooth module BT10 for HART devices .....	92		
16.2	Communication-specific accessories .....	93		
16.3	Service-specific accessories .....	94		
16.4	System components .....	94		
16.4.1	Memograph M RSG45 .....	94		
16.4.2	RN42 .....	94		
<b>17</b>	<b>Operating menu .....</b>	<b>95</b>		
17.1	Overview of the operating menu (SmartBlue) ..	95		
17.2	Overview of the operating menu (display module) .....	100		
17.3	Overview of the operating menu (operating tool) .....	107		
17.4	"Setup" menu .....	113		
17.4.1	"Mapping" wizard .....	119		
17.4.2	"Advanced setup" submenu .....	120		
17.5	"Diagnostics" menu .....	168		
17.5.1	"Diagnostic list" submenu .....	170		
17.5.2	"Event logbook" submenu .....	171		
17.5.3	"Device information" submenu .....	172		
17.5.4	"Measured values" submenu .....	175		
17.5.5	"Data logging" submenu .....	177		
17.5.6	"Simulation" submenu .....	180		
17.5.7	"Device check" submenu .....	185		
17.5.8	"Heartbeat" submenu .....	187		
	<b>Index .....</b>	<b>188</b>		

# 1 About this document

## 1.1 Document function

These Operating Instructions contain all the information required in the various life cycle phases of the device: from product identification, incoming acceptance and storage, to installation, connection, operation and commissioning, through to troubleshooting, maintenance and disposal.

## 1.2 Symbols

### 1.2.1 Safety symbols

#### **DANGER**

This symbol alerts you to a dangerous situation. Failure to avoid this situation will result in serious or fatal injury.

#### **WARNING**

This symbol alerts you to a potentially dangerous situation. Failure to avoid this situation can result in serious or fatal injury.





#### **CAUTION**

This symbol alerts you to a potentially dangerous situation. Failure to avoid this situation can result in minor or medium injury.

#### **NOTICE**

This symbol alerts you to a potentially harmful situation. Failure to avoid this situation can result in damage to the product or something in its vicinity.

### 1.2.2 Electrical symbols

Symbol	Meaning
	Direct current
	Alternating current
	Direct and alternating current
	<b>Ground connection</b> A grounded terminal which, as far as the operator is concerned, is grounded via a grounding system.
	<b>Protective earth (PE)</b> Ground terminals that must be connected to ground prior to establishing any other connections.  The ground terminals are located on the interior and exterior of the device: <ul style="list-style-type: none"> <li>▪ Interior ground terminal: protective earth is connected to the mains supply.</li> <li>▪ Exterior ground terminal: device is connected to the plant grounding system.</li> </ul>

### 1.2.3 Tool symbols



Phillips head screwdriver



Flat blade screwdriver



Torx screwdriver



Allen key



Open-ended wrench

### 1.2.4 Symbols for certain types of information and graphics

#### Permitted

Procedures, processes or actions that are permitted

#### Preferred

Procedures, processes or actions that are preferred

#### Forbidden

Procedures, processes or actions that are forbidden

#### Tip

Indicates additional information



Reference to documentation



Reference to graphic



Notice or individual step to be observed

**1, 2, 3**

Series of steps



Result of a step



Visual inspection



Operation via operating tool



Write-protected parameter

**1, 2, 3, ...**

Item numbers

**A, B, C, ...**

Views

#### **Safety instructions**

Observe the safety instructions contained in the associated Operating Instructions



#### **Temperature resistance of the connection cables**

Specifies the minimum value of the temperature resistance of the connection cables

## 1.3 List of abbreviations

### **BA**

Document type "Operating Instructions"

### **KA**

Document type "Brief Operating Instructions"

### **TI**

Document type "Technical Information"

### **SD**

Document type "Special Documentation"

**XA**

Document type "Safety Instructions"

**PN**

Nominal pressure

**MWP**

Maximum working pressure

The MWP is indicated on the nameplate.

**ToF**

Time of Flight

**FieldCare**

Scalable software tool for device configuration and integrated plant asset management solutions

**DeviceCare**

Universal configuration software for Endress+Hauser HART, PROFIBUS, FOUNDATION Fieldbus and Ethernet field devices

**DTM**

Device Type Manager

**DD**

Device Description for HART communication protocol

 **$\epsilon_r$  (Dk value)**

Relative dielectric constant

**PLC**

Programmable logic controller (PLC)

**CDI**

Common Data Interface

**Operating tool**

The term "operating tool" is used in place of the following operating software:

- FieldCare / DeviceCare, for operation via HART communication and PC
- SmartBlue app, for operation using an Android or iOS smartphone or tablet

**BD**

Blocking Distance; no signals are analyzed within the BD.

**PLC**

Programmable logic controller (PLC)

**CDI**

Common Data Interface

**PFS**

Pulse Frequency Status (Switch output)

## 1.4 Documentation



For an overview of the scope of the associated Technical Documentation, refer to the following:

- *Device Viewer* ([www.endress.com/deviceviewer](http://www.endress.com/deviceviewer)): Enter the serial number from the nameplate
- *Endress+Hauser Operations app*: Enter serial number from nameplate or scan matrix code on nameplate.

The following documentation may be available depending on the device version ordered:

Document type	Purpose and content of the document
Technical Information (TI)	<b>Planning aid for your device</b> The document contains all the technical data on the device and provides an overview of the accessories and other products that can be ordered for the device.
Brief Operating Instructions (KA)	<b>Guide that takes you quickly to the 1st measured value</b> The Brief Operating Instructions contain all the essential information from incoming acceptance to initial commissioning.
Operating Instructions (BA)	<b>Your reference document</b> These Operating Instructions contain all the information that is required in the various life cycle phases of the device: from product identification, incoming acceptance and storage, to mounting, connection, operation and commissioning, through to troubleshooting, maintenance and disposal.
Description of Device Parameters (GP)	<b>Reference for your parameters</b> The document provides a detailed explanation of each individual parameter. The description is aimed at those who work with the device over the entire life cycle and perform specific configurations.
Safety Instructions (XA)	Depending on the approval, safety instructions for electrical equipment in hazardous areas are also supplied with the device. The Safety Instructions are a constituent part of the Operating Instructions.  Information on the Safety Instructions (XA) that are relevant for the device is provided on the nameplate.
Supplementary device-dependent documentation (SD/FY)	Always comply strictly with the instructions in the relevant supplementary documentation. The supplementary documentation is a constituent part of the device documentation.

## 1.5 Registered trademarks

### **HART®**

Registered trademark of the FieldComm Group, Austin, Texas, USA

### **Bluetooth®**

The *Bluetooth*® word mark and logos are registered trademarks owned by the Bluetooth SIG, Inc. and any use of such marks by Endress+Hauser is under license. Other trademarks and trade names are those of their respective owners.

### **Apple®**

Apple, the Apple logo, iPhone, and iPod touch are trademarks of Apple Inc., registered in the U.S. and other countries. App Store is a service mark of Apple Inc.

### **Android®**

Android, Google Play and the Google Play logo are trademarks of Google Inc.

### **KALREZ®, VITON®**

Registered trademarks of DuPont Performance Elastomers L.L.C., Wilmington, DE USA

### **TEFLON®**

Registered trademark of E.I. DuPont de Nemours & Co., Wilmington, USA

### **TRI-CLAMP®**

Registered trademark of Ladish & Co., Inc., Kenosha, USA



## 2 Basic safety instructions

### 2.1 Requirements for the personnel

The personnel for installation, commissioning, diagnostics and maintenance must fulfill the following requirements:

- ▶ Trained, qualified specialists must have a relevant qualification for this specific function and task.
- ▶ Are authorized by the plant owner/operator.
- ▶ Are familiar with federal/national regulations.
- ▶ Before starting work, read and understand the instructions in the manual and supplementary documentation as well as the certificates (depending on the application).
- ▶ Follow instructions and comply with basic conditions.

The operating personnel must fulfill the following requirements:

- ▶ Are instructed and authorized according to the requirements of the task by the facility's owner-operator.
- ▶ Follow the instructions in this manual.

### 2.2 Intended use

#### Application and media

The measuring instrument described in this manual is intended only for the level measurement of bulk solids. Depending on the version ordered, the measuring instrument can also measure potentially explosive, flammable, poisonous and oxidizing media.

If the limit values specified in the "Technical data" and the conditions listed in the instructions and additional documentation are observed, the measuring instrument may be used only for the following measurements:

- ▶ Measured process variables: level
- ▶ Calculable process variables: volume or mass in any shape of vessel (calculated from the level by the linearization functionality)

To ensure that the measuring instrument remains in proper condition for the operation time:

- ▶ Use the measuring instrument only for media to which the process-wetted materials are sufficiently resistant.
- ▶ Observe the limit values in the "Technical data".

#### Incorrect use

The manufacturer is not liable for harm caused by improper or unintended use.

Clarification for borderline cases:

- ▶ For special fluids and fluids for cleaning, Endress+Hauser is glad to provide assistance in verifying the corrosion resistance of fluid-wetted materials, but does not accept any warranty or liability.

#### Residual risks

Due to heat transfer from the process as well as power loss in the electronics, the temperature of the electronics housing and the assemblies contained therein (e.g. display module, main electronics module and I/O electronics module) may rise up to 80 °C (176 °F). When in operation, the sensor may reach a temperature close to the medium temperature.

Danger of burns from contact with surfaces!

- ▶ In the event of elevated fluid temperatures, ensure protection against contact to prevent burns.

## 2.3 Workplace safety

When working on and with the device:

- ▶ Wear the required personal protective equipment as per national regulations.

## 2.4 Operational safety

Risk of injury!

- ▶ Operate the device only if it is in proper technical condition, free from errors and faults.
- ▶ The operator is responsible for ensuring that the device is in good working order.

### Modifications to the device

Unauthorized modifications to the device are not permitted and can lead to unforeseeable dangers:

- ▶ If modifications are nevertheless required, consult with the manufacturer.

### Repair

To ensure continued operational safety and reliability:

- ▶ Carry out repairs on the device only if they are expressly permitted.
- ▶ Observe national regulations pertaining to the repair of an electrical device.
- ▶ Use only original spare parts and accessories from the manufacturer.

### Hazardous area

To eliminate danger to persons or the installation when the device is used in the hazardous area (e.g. explosion protection, pressure vessel safety):

- ▶ Check the nameplate to verify if the device ordered can be put to its intended use in the hazardous area.
- ▶ Observe the specifications in the separate supplementary documentation included as an integral part of these instructions.

## 2.5 Product security

This measuring instrument is designed in accordance with good engineering practice to meet state-of-the-art safety requirements, has been tested, and left the factory in a condition in which it is safe to operate. It meets general safety standards and legal requirements.

### NOTICE

#### Loss of degree of protection by opening of the device in humid environments

- ▶ If the device is opened in a humid environment, the degree of protection indicated on the nameplate is no longer valid. This may also impair the safe operation of the device.

### 2.5.1 CE mark

The measuring system meets the legal requirements of the applicable EU directives. These are listed in the corresponding EU Declaration of Conformity together with the standards applied.

The manufacturer confirms successful testing of the device by affixing to it the CE mark.

### 2.5.2 EAC conformity

The measuring system meets the legal requirements of the applicable EAC guidelines. These are listed in the corresponding EAC Declaration of Conformity along with the standards applied.

The manufacturer confirms successful testing of the device by affixing to it the EAC mark.

## 3 Product description

### 3.1 Product design

#### 3.1.1 Levelflex FMP56/FMP57

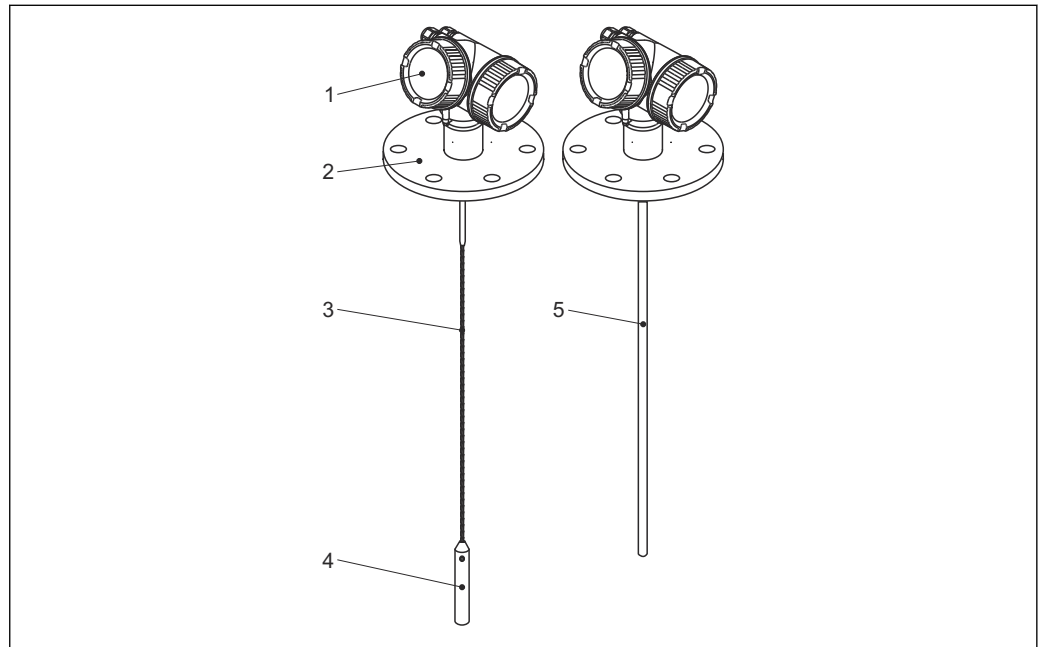

A0012470

#### 1 Design of the Levelflex

- 1 Electronics housing
- 2 Process connection (here as an example: flange)
- 3 Rope probe
- 4 End-of-probe weight
- 5 Rod probe

### 3.1.2 Electronics housing

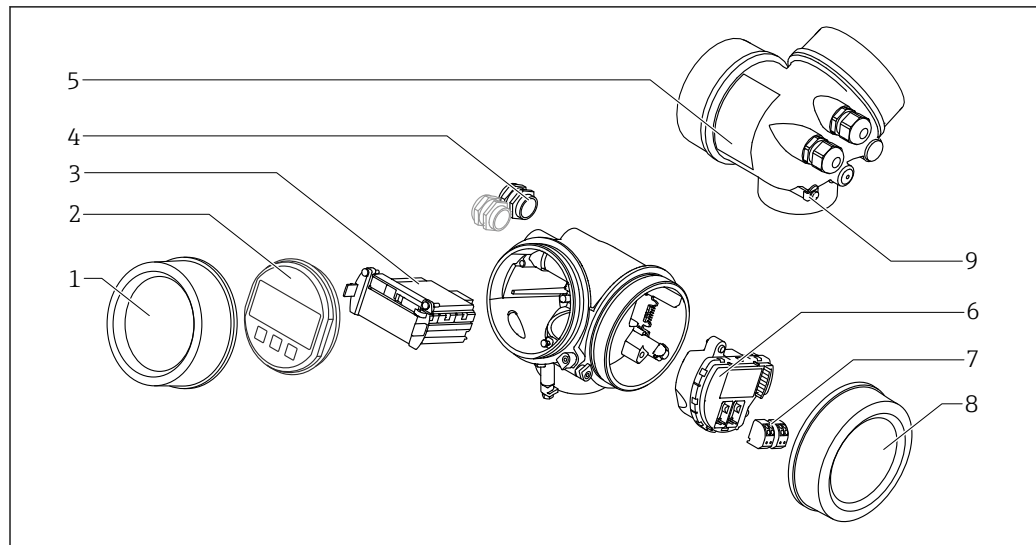

A0012422

#### 2 Design of the electronics housing

- 1 Electronics compartment cover
- 2 Display module
- 3 Main electronics module
- 4 Cable glands (1 or 2, depending on instrument version)
- 5 Nameplate
- 6 I/O electronics module
- 7 Terminals (pluggable spring terminals)
- 8 Connection compartment cover
- 9 Grounding terminal

## 4 Incoming acceptance and product identification

### 4.1 Incoming acceptance

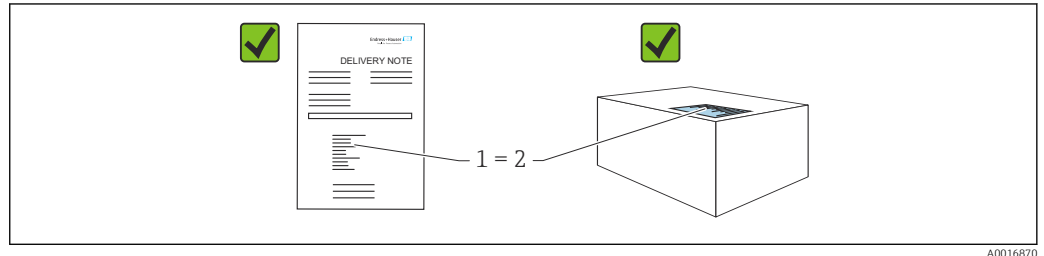

A0016870

Check the following during incoming acceptance:

- Is the order code on the delivery note (1) identical to the order code on the product sticker (2)?
- Are the goods undamaged?
- Do the data on the nameplate correspond to the order specifications and the delivery note?
- Is the documentation provided?
- If required (see nameplate): are the Safety Instructions (XA) provided?



If one of these conditions is not met, please contact the manufacturer's sales office.

### 4.2 Product identification

The following options are available for identification of the device:

- Nameplate specifications
- Extended order code with breakdown of the device features on the delivery note
- ▶ *Device Viewer* ([www.endress.com/deviceviewer](http://www.endress.com/deviceviewer)); manually enter the serial number from the nameplate.
  - ↳ All the information about the measuring device is displayed.
- ▶ *Endress+Hauser Operations app*; manually enter the serial number indicated on the nameplate or scan the 2D matrix code on the nameplate.
  - ↳ All the information about the measuring device is displayed.

#### 4.2.1 Nameplate

The information that is required by law and is relevant to the device is shown on the nameplate, e.g.:

- Manufacturer identification
- Order number, extended order code, serial number
- Technical data, degree of protection
- Firmware version, hardware version
- Approval-related information, reference to Safety Instructions (XA)
- DataMatrix code (information about the device)

#### **4.2.2 Manufacturer address**

Endress+Hauser SE+Co. KG  
Hauptstraße 1  
79689 Maulburg, Germany  
Place of manufacture: See nameplate.

## 5 Storage, transport

### 5.1 Storage temperature

- Permitted storage temperature: -40 to +80 °C (-40 to +176 °F)
- Use original packaging.

### 5.2 Transporting to the measuring point

#### ⚠ WARNING

Housing or probe may become damaged or break off.

Risk of injury!

- ▶ Transport the measuring instrument to the measuring point in its original packaging or by the process connection.
- ▶ Always secure lifting equipment (slings, eyes, etc.) at the process connection and never lift the device by the electronic housing or probe. Pay attention to the center of gravity of the device so that it does not tilt or slip unintentionally.
- ▶ Follow the safety instructions and transport conditions for devices weighing more than 18 kg (39.6 lbs) (IEC 61010).

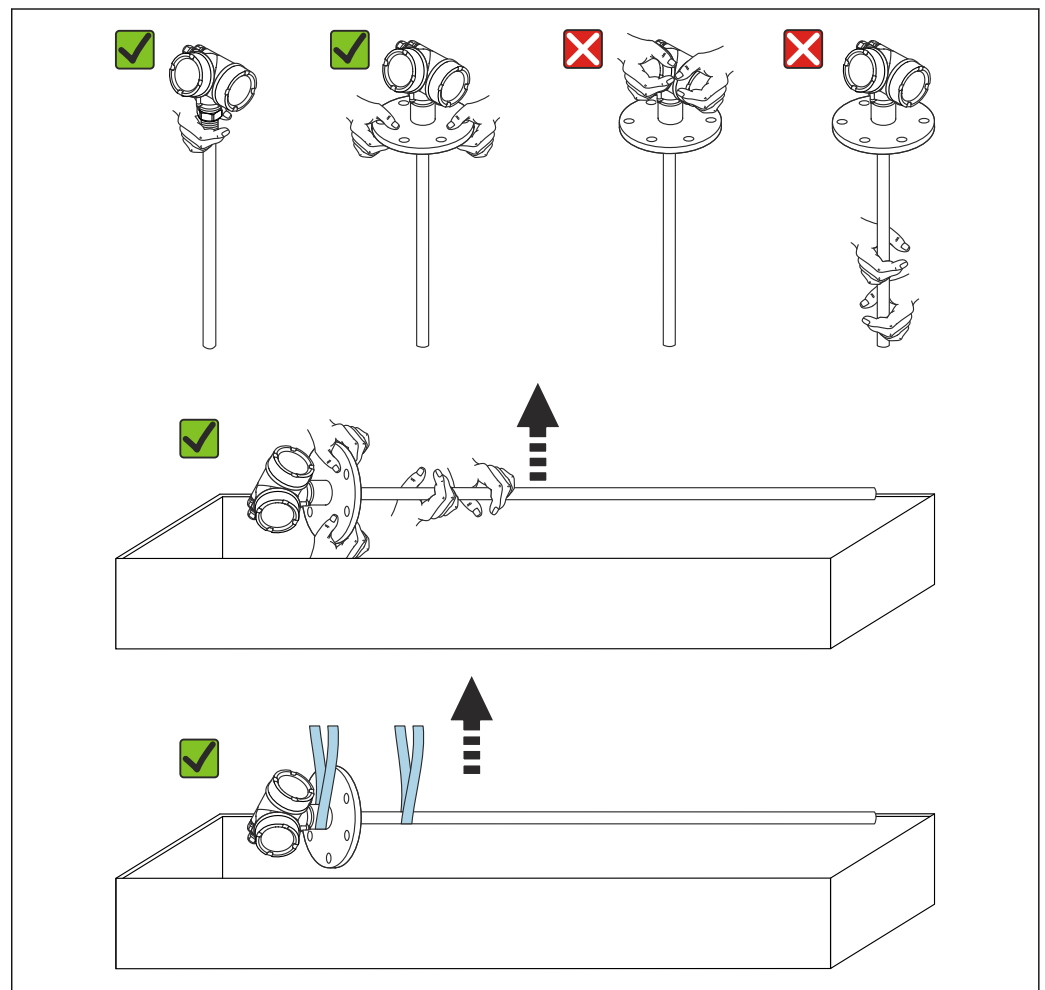

A0043233

## 6 Installation

### 6.1 Mounting requirements

#### 6.1.1 Suitable mounting position

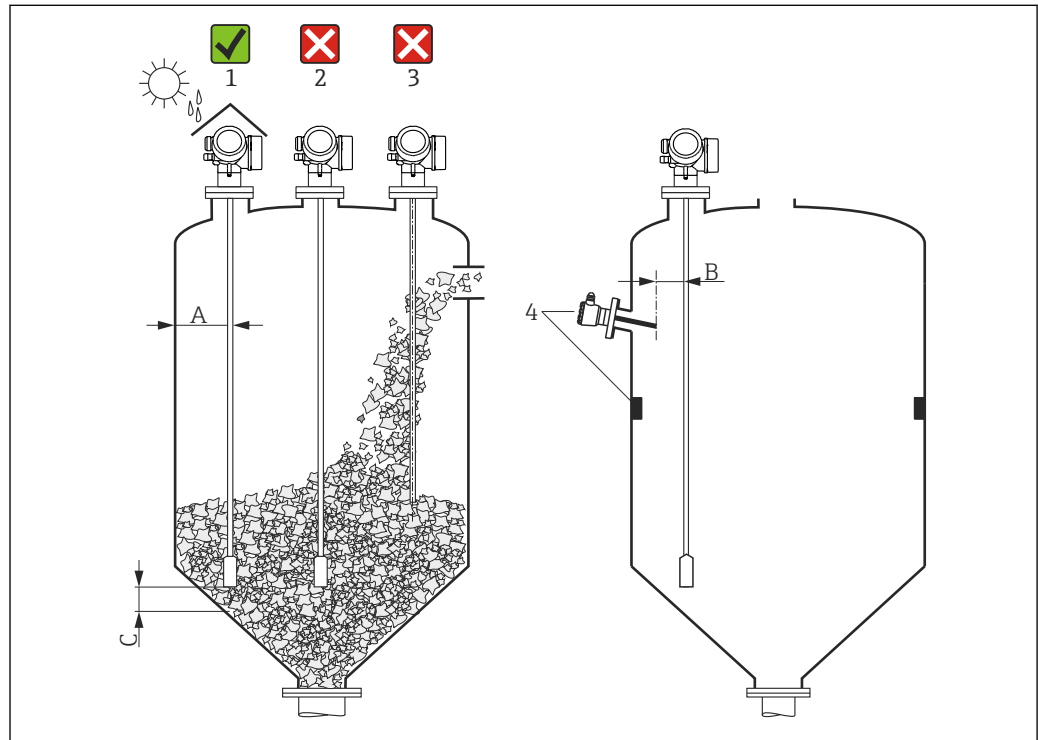

3 Installation positions

#### Spacing requirements when mounting

- Distance (A) between the vessel wall and rod and rope probes:
  - For smooth metallic walls: > 50 mm (2 in)
  - For plastic walls: > 300 mm (12 in) to metallic parts outside the vessel
  - For concrete walls: > 500 mm (20 in), otherwise the permitted measuring range may be reduced.
- Distance (B) between rod probes and internal fittings (3): > 300 mm (12 in)
- When using more than one Levelflex:
  - Minimum distance between the sensor axes: 100 mm (3.94 in)
- Distance (C) from the end of the probe to the bottom of the vessel:
  - Rope probe: > 150 mm (6 in)
  - Rod probe: > 10 mm (0.4 in)



### Additional mounting requirements

- When mounting outdoors, a weather protection cover (1) can be used to protect the device against extreme weather conditions.
- In metallic vessels, preferably do not mount the probe in the center of the vessel (2), as this would lead to increased interference echoes.  
If a central mounting position cannot be avoided, it is essential to perform interference echo suppression (mapping) after commissioning the device.
- Do not mount the probe in the filling curtain (3).
- Avoid buckling the rope probe during installation or operation (e.g. as a result of product movement against silo wall) by selecting a suitable mounting location.
- The probe must be checked regularly for damage during operation.

**i** In the case of freely suspended rope probes (probe end not fixed at the bottom), the distance between the probe rope and internal fittings, which can change due to the movement of the product, must never be less than 300 mm (12 in). Occasional contact between the probe weight and the cone of the vessel, however, does not influence the measurement provided that the relative permittivity is at least  $\epsilon_r = 1.8$ .

**i** When mounting the housing in a recess (e.g. in a concrete ceiling), observe a minimum distance of 100 mm (4 in) between the cover of the connection compartment/electronics compartment and the wall. Otherwise the connection compartment/electronics compartment will not be accessible after installation.

## 6.1.2 Mounting under confined conditions

### Mounting with remote probe

The device version with a remote probe is suitable for applications with restricted mounting space. In this case, the electronics housing is mounted at a separate position from the probe.

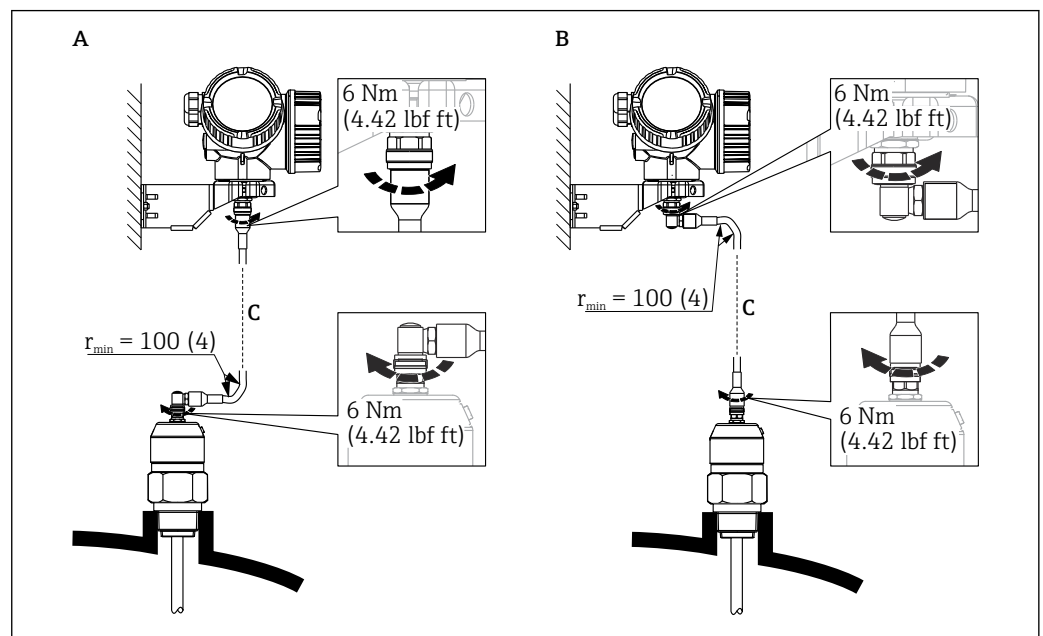

- A Angled plug at the probe  
 B Angled plug at the electronics housing  
 C Length of the remote cable as ordered

- Product structure, feature 600 "Probe design":
  - Version MB "Remote sensor, 3 m cable"
  - Version MC "Remote sensor, 6 m cable"
  - Version MD "Remote sensor, 9 m cable"
- The connecting cable is included in the delivery with these versions.  
Minimum bending radius: 100 mm (4 inch)
- The mounting bracket for the electronics housing is included in the delivery with these versions. Mounting options:
  - Wall mounting
  - Mounting on DN32 to DN50 (1¼ to 2 inch) post or pipe
- The connecting cable has one straight plug and one plug angled at 90°. Depending on the local conditions the angled plug can be connected at the probe or at the electronics housing.

 The probe, electronics and connection cable are mutually compatible and bear a common serial number. Only components with the same serial number may be connected to one another.

### 6.1.3 Notes on the mechanical load of the probe

#### Tensile load

Bulk solids exert tensile forces on rope probes which increase with:

- The probe length, i.e. the maximum cover
- The bulk density of the product
- The silo diameter and
- The diameter of the probe rope

As the tensile forces also depend greatly on the flowability of the product, a higher safety factor is necessary for highly viscous products and if there is a risk of cornice buildup. In critical cases it is better to use a 6 mm (0.24 in) rope instead of a 4 mm (0.16 in) one.

The same forces also act on the silo ceiling. The tensile forces on a fixed rope are always greater, but cannot be calculated. Observe the tensile loading capacity of the probes.

Ways to reduce the tensile forces:

- Shorten the probe.
- If the maximum tensile load is exceeded, check whether it would be possible to use a non-contact ultrasonic or level radar device.

The following diagrams show typical loads for common bulk solids as reference values. The calculation was performed for the following conditions:

- Calculation according to DIN 1055, Part 6 for the cylindrical part of the silo
- Suspended probe (probe end not fixed at the bottom)
- Free-flowing bulk solid, i.e. mass flow. A calculation for core flow is not possible. In the event of collapsing cornices, considerably higher loads can occur.
- The specification for tensile forces contains safety factor 2 (in addition to the safety factors already contained in DIN 1055), which compensates for the normal fluctuation range in pourable bulk solids.

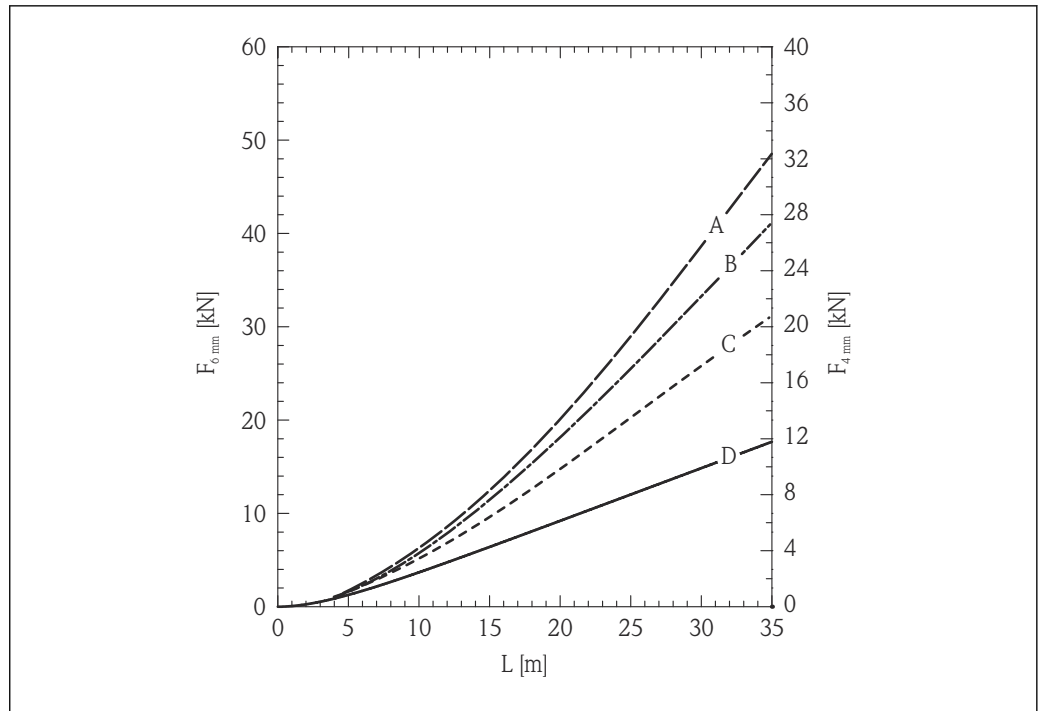

A0017170

4 Silica sand in metal silo with smooth walls; tensile load as a function of level L for rope diameters 6 mm (0.24 in) and 4 mm (0.16 in)

- A Silo diameter 12 m (40 ft)
- B Silo diameter 9 m (30 ft)
- C Silo diameter 6 m (20 ft)
- D Silo diameter 3 m (10 ft)

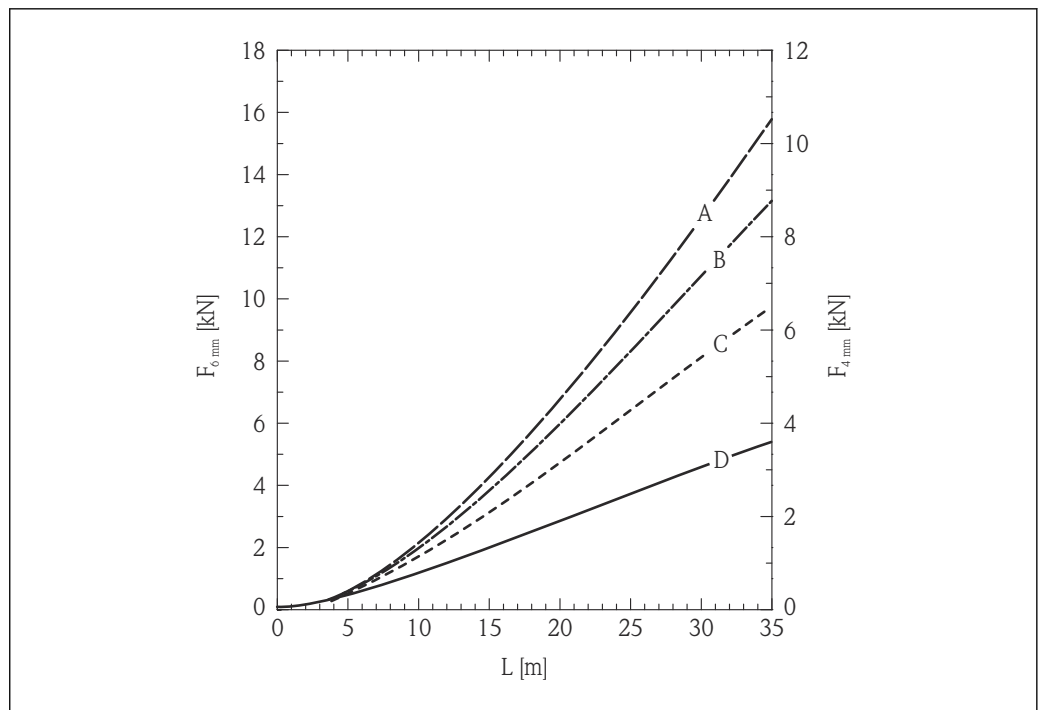

A0017171

5 Polyethylene pellets in metal silo with smooth walls; tensile load as a function of level L for rope diameters 6 mm (0.24 in) and 4 mm (0.16 in)

- A Silo diameter 12 m (40 ft)
- B Silo diameter 9 m (30 ft)
- C Silo diameter 6 m (20 ft)
- D Silo diameter 3 m (10 ft)

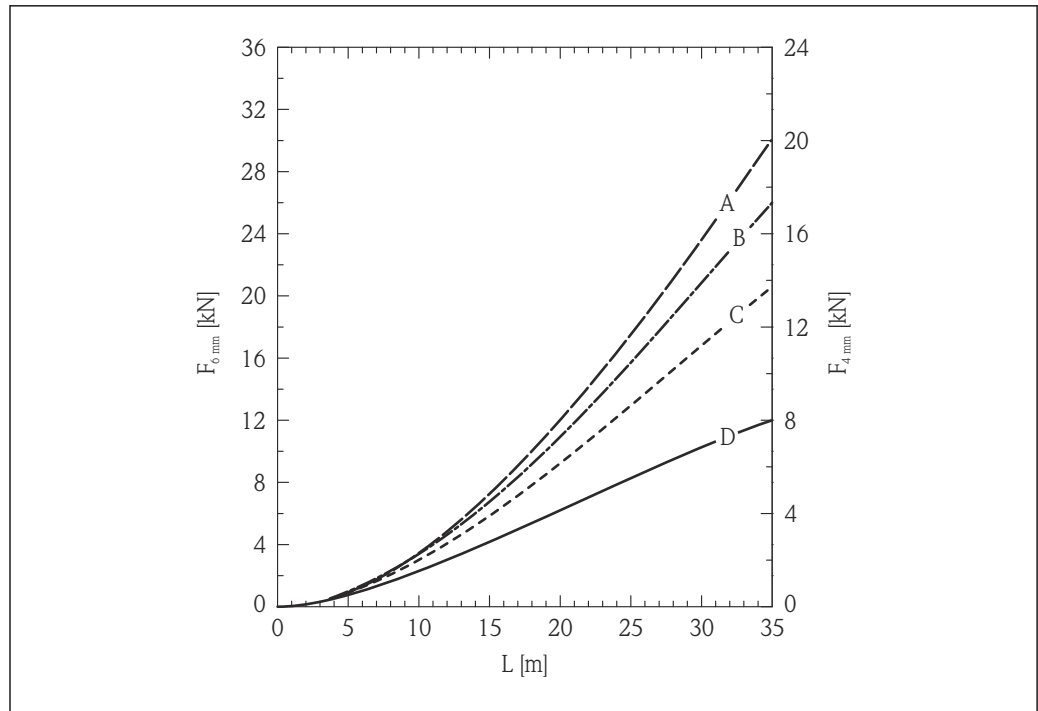

A0017172

6 Wheat in metal silo with smooth walls; tensile load as a function of level  $L$  for rope diameters 6 mm (0.24 in) and 4 mm (0.16 in)

- A Silo diameter 12 m (40 ft)
- B Silo diameter 9 m (30 ft)
- C Silo diameter 6 m (20 ft)
- D Silo diameter 3 m (10 ft)

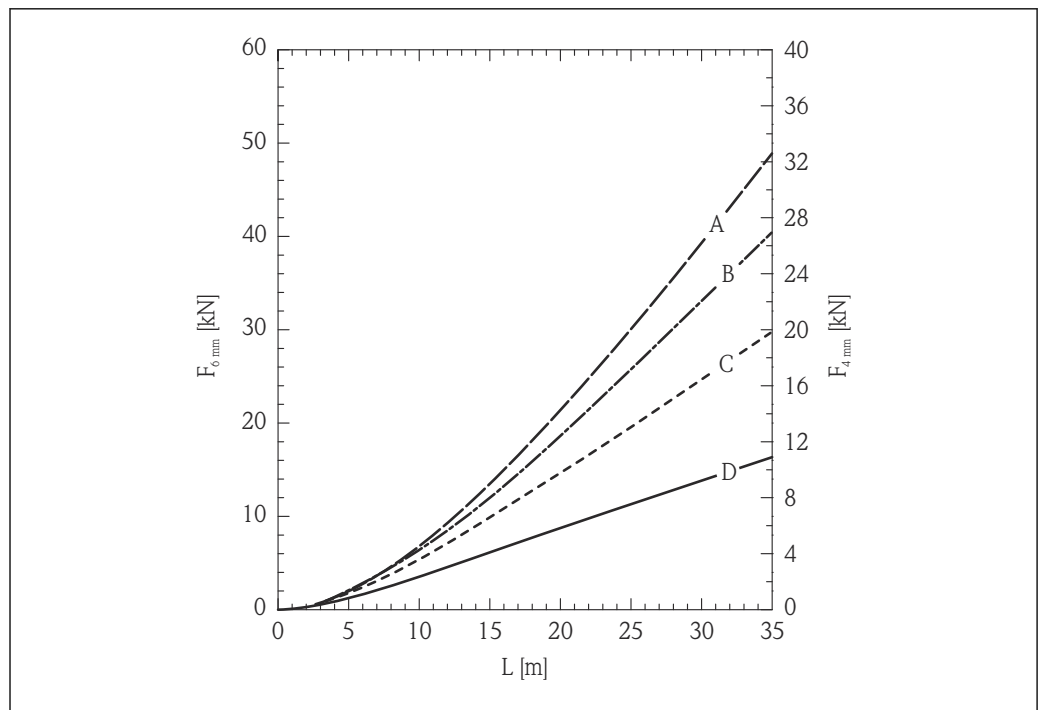

A0017173

7 Cement in metal silo with smooth walls; tensile load as a function of level  $L$  for rope diameters 6 mm (0.24 in) and 4 mm (0.16 in)

- A Silo diameter 12 m (40 ft)
- B Silo diameter 9 m (30 ft)
- C Silo diameter 6 m (20 ft)
- D Silo diameter 3 m (10 ft)

### Tensile loading capacity of rope probe and breaking load (silo ceiling)

 The ceiling of the silo must be designed to withstand the maximum breaking load.

#### FMP56

##### Rope 4 mm (1/8 in) 316

- Tensile loading capacity 12 kN
- Max. breaking load 20 kN

##### Rope 6 mm (1/4 in) PA>steel

- Tensile loading capacity 12 kN
- Max. breaking load 20 kN

#### FMP57

##### Rope 4 mm (1/8 in) 316

- Tensile loading capacity 12 kN
- Max. breaking load 20 kN

##### Rope 6 mm (1/4 in) 316

- Tensile loading capacity 30 kN
- Max. breaking load 42 kN

##### Rope 6 mm (1/4 in) PA>steel

- Tensile loading capacity 12 kN
- Max. breaking load 20 kN

##### Rope 8 mm (1/3 in) PA>steel

- Tensile loading capacity 30 kN
- Max. breaking load 42 kN

### Lateral loading capacity (flexural strength) of rod probes

#### FMP57

##### Rod 16 mm (0.63 in) 316L

Flexural strength 30 Nm

## 6.1.4 Information concerning the process connection

 Probes are mounted on the process connection with threaded connections or flanges. If there is the danger with this installation that the probe end moves so much that it occasionally touches the vessel floor or cone, the probe may need to be shortened at the lower end and fixed in place.

### Threaded connection

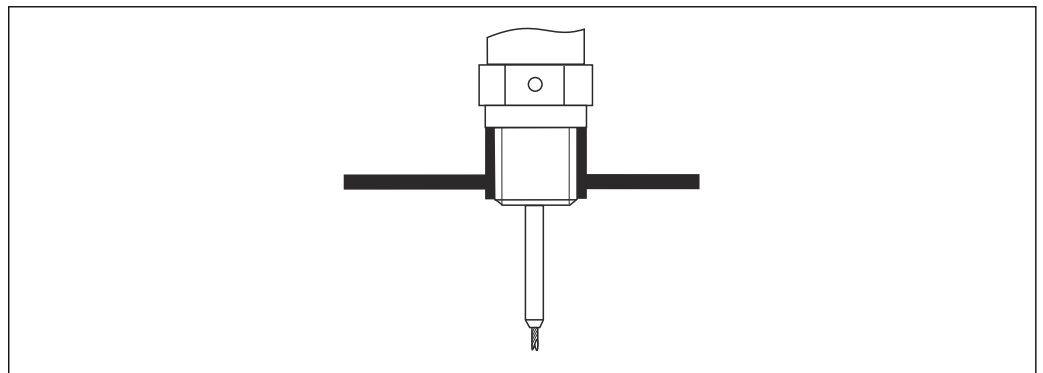

 8 Mounting with threaded connection; flush with the vessel ceiling

A0015121

### Sealing

The thread and the type of seal comply with DIN3852 Part 2, screwed plug, form A.

The following types of sealing ring can be used:

- For thread G $\frac{3}{4}$ " according to DIN7603 with dimensions 27 mm × 32 mm
- For thread G1 $\frac{1}{2}$ " according to DIN 7603 with dimensions 48 mm × 55 mm

Use a sealing ring according to this standard in form A, C or D and of a material that offers appropriate resistance for the application.

### Nozzle installation

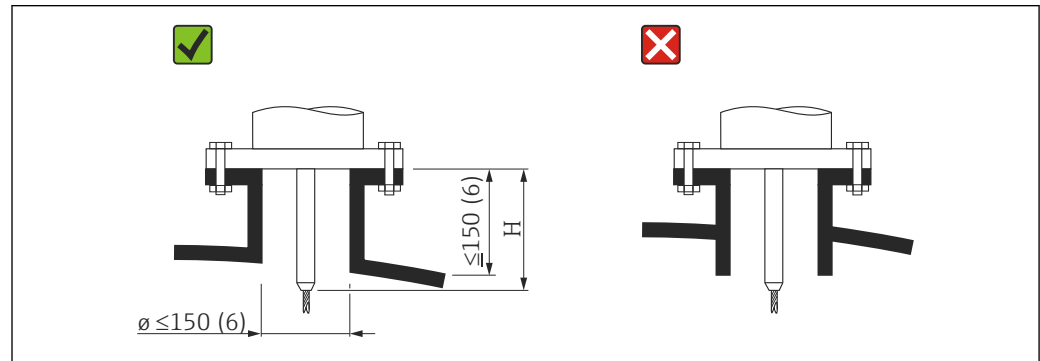

H Length of the centering rod or the rigid part of the rope probe

#### FMP56

**Rope, Ø 4 mm (0.16 in)**

Length H 120 mm (4.7 in)

#### FMP57

**Rope, Ø 4 mm (0.16 in)**

Length H 94 mm (3.7 in)

**Rope, Ø 6 mm (0.24 in)**

Length H 135 mm (5.3 in)

- Permissible nozzle diameter: ≤ 150 mm (6 in)  
For larger diameters, the near-range measuring capability may be reduced.  
For large nozzles, see the section "Mounting in nozzles ≥ DN300"
- Permissible nozzle height: ≤ 150 mm (6 in)  
For larger heights, the near-range measuring capability may be reduced.  
Larger nozzle heights are possible in special cases (on request), see section "Rod extension/centering device HMP40 for FMP57".
- The end of the nozzle should be flush with the tank ceiling in order to avoid ringing effects.

**i** In thermally insulated vessels, the nozzle should also be insulated in order to prevent condensate formation.

*Rod extension/centering device HMP40 for FMP57*

For FMP57 with rope probes, the rod extension/centering device HMP40 is available as an accessory. It must be used if the probe rope would otherwise come into contact with the lower edge of the nozzle.

**i** This accessory consists of the extension rod, corresponding to the nozzle height, on which a centering disk is also mounted if the nozzles are narrow or when used in bulk solids. We deliver this component separately from the device. Please order a correspondingly shorter probe length.

Only use centering disks with small diameters (DN40 and DN50) if there is no significant build-up in the nozzle above the disk. The nozzle must not become clogged with product.

*Mounting in nozzles  $\geq$  DN300*

If installation in nozzles  $\geq$  300 mm (12 in) is unavoidable, installation must be carried out in accordance with the following diagram in order to avoid interference signals in the near range.

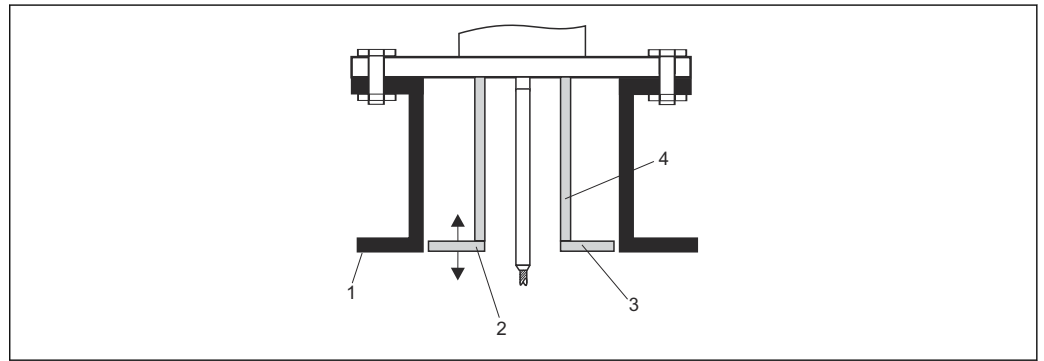

A0014199

- 1 Lower edge of the nozzle
- 2 Approximately flush with the lower edge of the nozzle ( $\pm 50$  mm)
- 3 Plate, nozzle  $\varnothing$  300 mm (12 in) = plate  $\varnothing$  280 mm (11 in); nozzle  $\varnothing$   $\geq$  400 mm (16 in) = plate  $\varnothing$   $\geq$  350 mm (14 in)
- 4 Pipe  $\varnothing$  150 to 180 mm

## 6.1.5 Securing the probe

### Securing rope probes

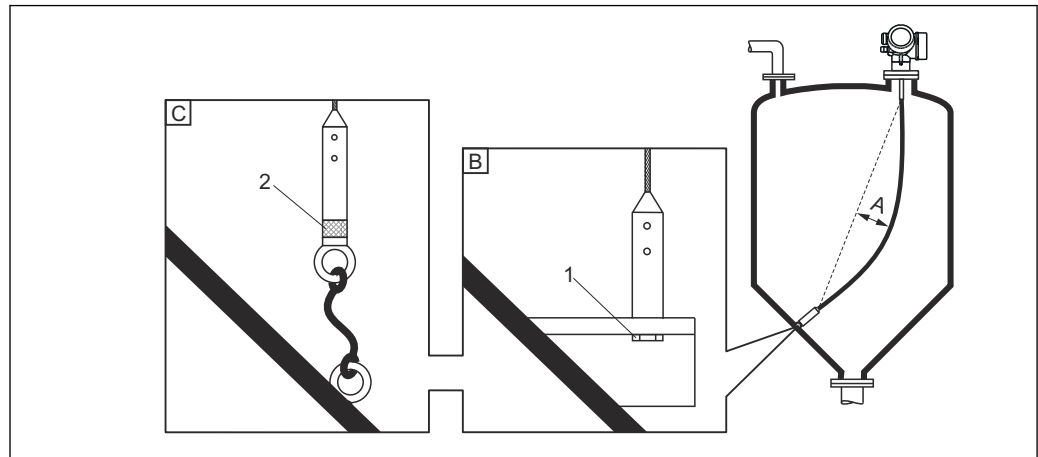

- A Sag:  $\geq 10 \text{ mm/m}$  (0.12 in/ft) probe length  
 B Reliably grounded end of probe  
 C Reliably insulated end of probe  
 1 Fastener in female thread of probe weight  
 2 Insulated fastening kit

- The end of the rope probe must be secured or fixed down under the following conditions:
  - If the probe temporarily comes into contact with the vessel wall, the cone, internal fittings/beams or another part of the installation
  - If the probe comes closer than 0.5 m (1.6 ft) to a concrete wall.
- A female thread is provided in the probe weight to secure the end of the probe:
  - Rope 4 mm ( $\frac{1}{8}$  in), 316: M 14
  - Rope 6 mm ( $\frac{1}{4}$  in), 316: M 20
  - Rope 6 mm ( $\frac{1}{4}$  in), PA>steel: M14
  - Rope 8 mm ( $\frac{1}{3}$  in), PA>steel: M20
- Far higher tensile loads occur on the probe when it is fixed down. It is therefore preferable to use the 6 mm ( $\frac{1}{4}$  in) rope probe.
- When fixed down, the end of the probe must be reliably grounded or reliably insulated. If it is not otherwise possible to secure the probe with a reliably insulated connection, use the insulated fastening kit.
- If the end of the probe is fixed down and grounded, the search for a positive end-of-probe signal must be activated. Otherwise automatic probe length correction is not possible.  
 Navigation: Expert → Sensor → EOP evaluation → EOP search mode  
 Setting: **Positive EOP** option
- To prevent an extremely high tensile load (e.g. due to thermal expansion) and the risk of the rope breaking, the rope must be slack. Required sag:  $\geq 10 \text{ mm/m}$  (0.12 in/ft) rope length.  
 Pay attention to the tensile loading capacity of rope probes.

### Securing rod probes

- In the case of WHG approval: a support is required for probe lengths  $\geq 3 \text{ m}$  (10 ft).
- In general, rod probes must be secured in the event of horizontal flow (e.g. from an agitator) or strong vibrations.
- Only secure rod probes directly at the end of the probe.



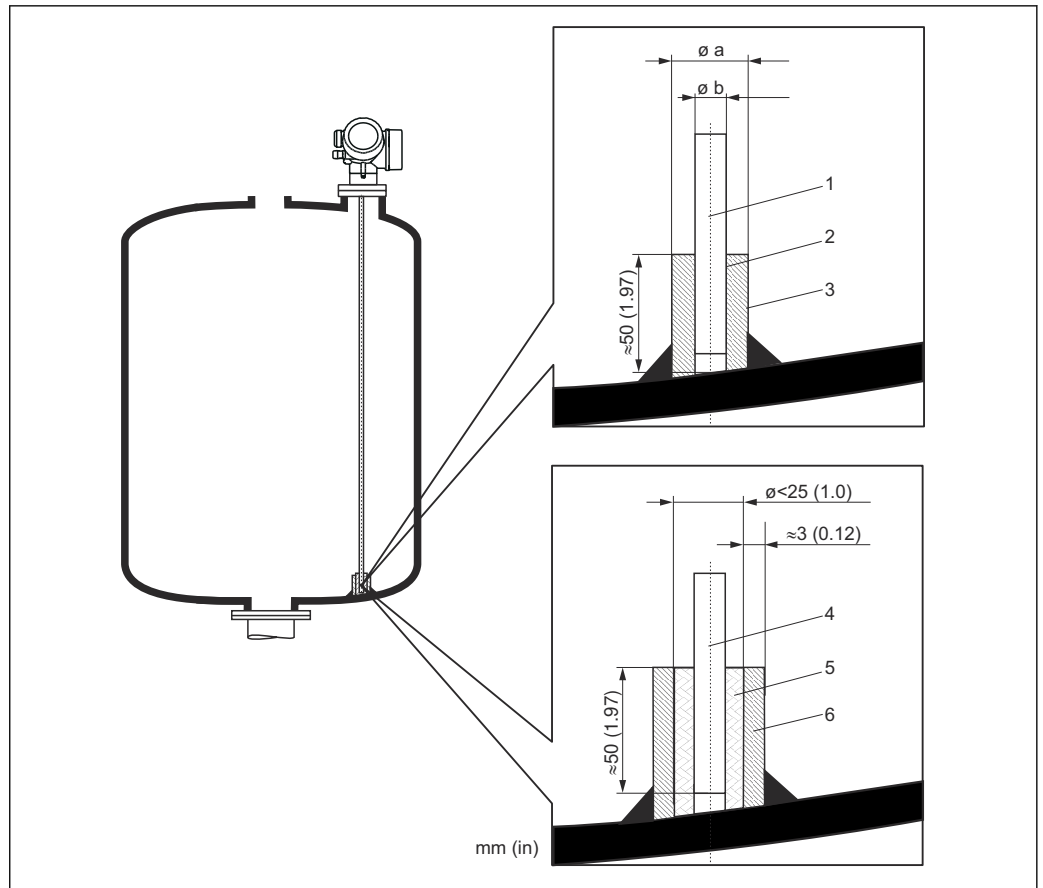

A0012607

Unit of measurement mm (in)

- 1 Probe rod, uncoated
- 2 Sleeve with narrow bore to ensure electrical contact between the sleeve and the rod.
- 3 Short metal pipe, e.g. welded in place
- 4 Probe rod, coated
- 5 Plastic sleeve, e.g. PTFE, PEEK, PPS
- 6 Short metal pipe, e.g. welded in place

**NOTICE**

**Poor grounding of the probe end may cause incorrect measurements.**

- ▶ Use a sleeve with a narrow bore to ensure good electrical contact between the sleeve and the probe rod.

**NOTICE**

**Welding can damage the main electronics module.**

- ▶ Before welding: Ground the probe rod and remove the electronics.

### 6.1.6 Special installation situations

#### Concrete silos

Installation in a thick concrete ceiling, for example, should be flush with the lower edge. Alternatively, the probe can also be installed in a pipe that must not protrude over the lower edge of the silo ceiling. The pipe should be as short as possible. For installation suggestions, see the diagram below.

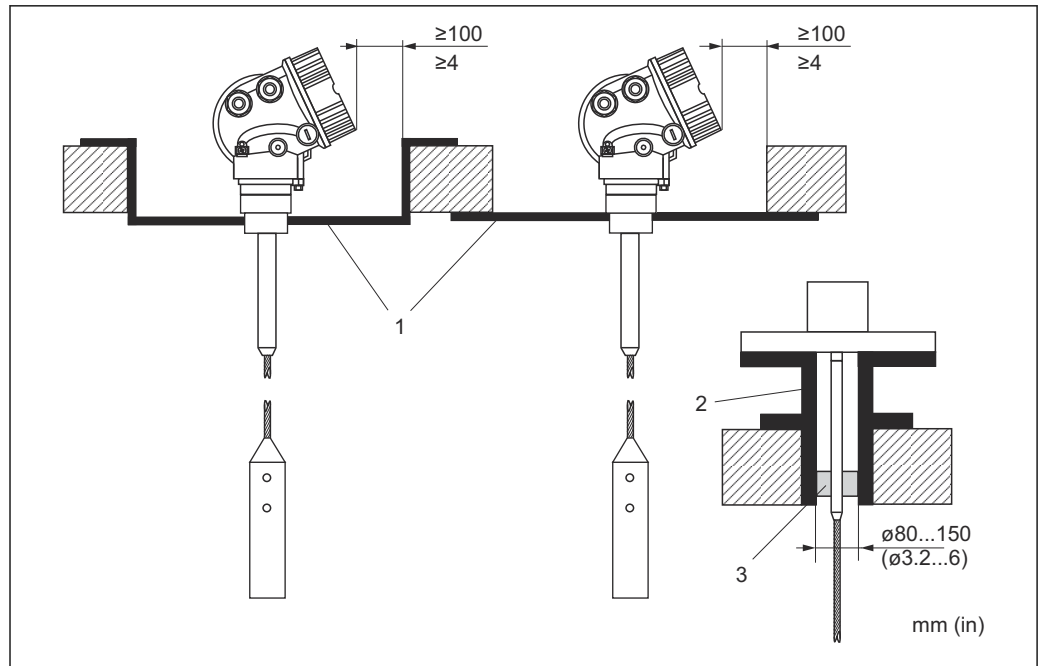

A0014138

- 1 Metal plate
- 2 Metal pipe
- 3 Rod extension/centering device HMP40 (see "Accessories")



**Installation with rod extension/centering device (accessory):**

Strong dust generation can lead to build-up behind the centering disk. This can result in interference echoes. For other installation options, please contact Endress+Hauser.

**Mounting from the side**

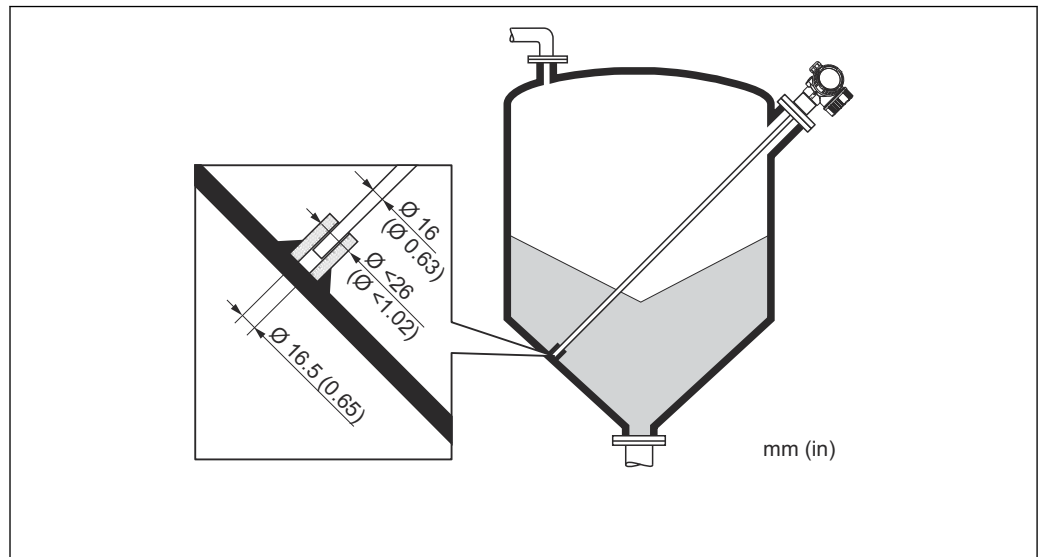

A0014140

- If installation from above is not possible, the device can also be mounted from the side
- Always secure the rope probe in this case
- Support the rod and coaxial probe if the lateral load-bearing capacity is exceeded
- Only secure rod probes at the end of the probe

**Non-metal vessels**

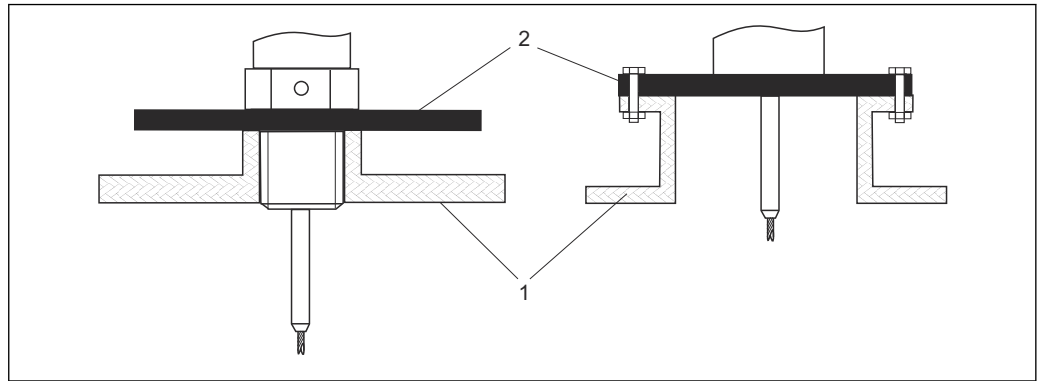

A0012527

- 1 Non-metal vessel
- 2 Metal sheet or metal flange

To ensure good measurement results when mounting on non-metal vessels

- Use a device with a metal flange (minimum size DN50/2").
- Alternatively, mount a metal plate with a diameter of at least 200 mm (8 in) at a right angle to the probe at the process connection.

**Vessel with thermal insulation**

**i** If process temperatures are high, the device must be included in normal vessel insulation (1) in order to prevent the electronics heating up as a result of thermal radiation or convection. The insulation may not go beyond the points labeled "MAX" in the drawings.

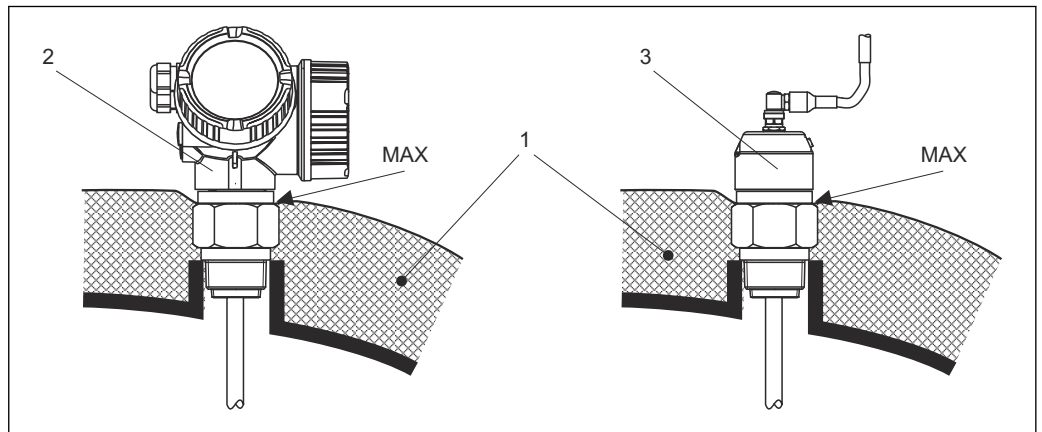

A0014653

- 9 Process connection with thread
- 1 Vessel insulation
- 2 Compact device
- 3 Sensor, remote

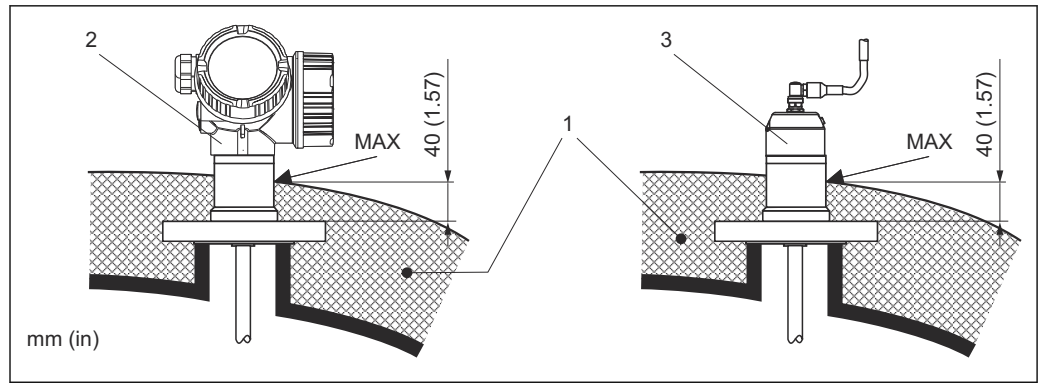

10 Process connection with flange - FMP57

- 1 Vessel insulation
- 2 Compact device
- 3 Sensor, remote

## 6.2 Mounting the device

### 6.2.1 Tool list

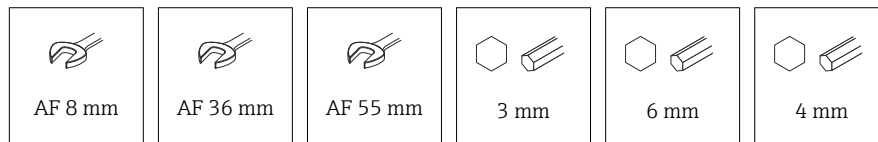

- To shorten rope probes: use a saw or bolt cutters.
- To shorten rod or coaxial probes: use a saw.
- For flanges and other process connections: use an appropriate mounting tool.

### 6.2.2 Shortening the probe

#### Shortening rod probes

Rod probes must be shortened if the distance to the vessel floor or outlet cone is less than 10 mm (0.4 in). To shorten, saw off the bottom end of the rod probe.

#### Shortening rope probes

Rope probes must be shortened if the distance to the vessel floor or outlet cone is less than 150 mm (6 in).

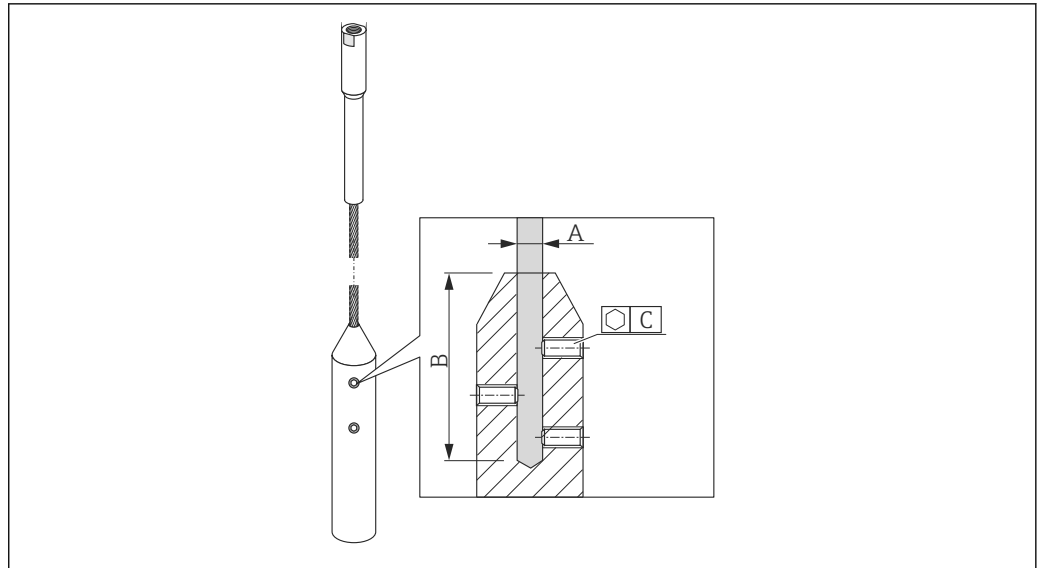

A0021693

**Rope material 316**

- A:  
4 mm (0.16 in)
- B:  
40 mm (1.6 in)
- C:  
3 mm; 5 Nm (3.69 lbf ft)

**Rope material 316**

- A:  
6 mm (0.24 in)
- B:  
70.5 mm (2.78 in)
- C:  
4 mm; 15 Nm (11.06 lbf ft)

**Rope material PA > steel**

- A:  
6 mm (0.24 in)
- B:  
40 mm (1.6 in)
- C:  
3 mm; 5 Nm (3.69 lbf ft)

**Rope material PA > steel**

- A:  
8 mm (0.31 in)
- B:  
70.5 mm (2.78 in)
- C:  
4 mm; 15 Nm (11.06 lbf ft)

1. Using an Allen key, loosen the set screws on the rope weight. Note: The setscrews have a clamping coating in order to prevent them from becoming loose accidentally. A higher torque is therefore required to loosen the screws.
2. Remove the released rope from the weight.
3. Measure off the new rope length.
4. At the point to be shortened, wrap adhesive tape around the rope to prevent it from fraying.

5. Saw off the rope at a right angle or cut it off with a bolt cutter.
6. Insert the rope completely into the weight.
7. Screw the setscrews back into place. Due to the clamping coating of the setscrews, it is not necessary to apply a locking compound.

### Entering the new probe length

After shortening the probe:

1. Switch to the **Probe settings** submenu and perform a probe length correction.
- 2.

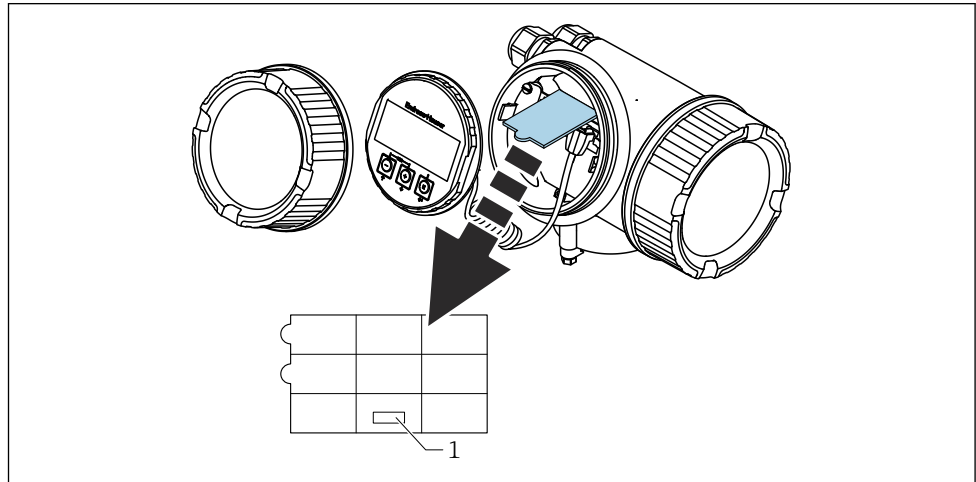

A0014241

1 Field for the new probe length

For documentation purposes, enter the new probe length into the quick reference guide which can be found in the electronics housing behind the display module.

## 6.2.3 Mounting the device

### Mounting devices with a threaded connection

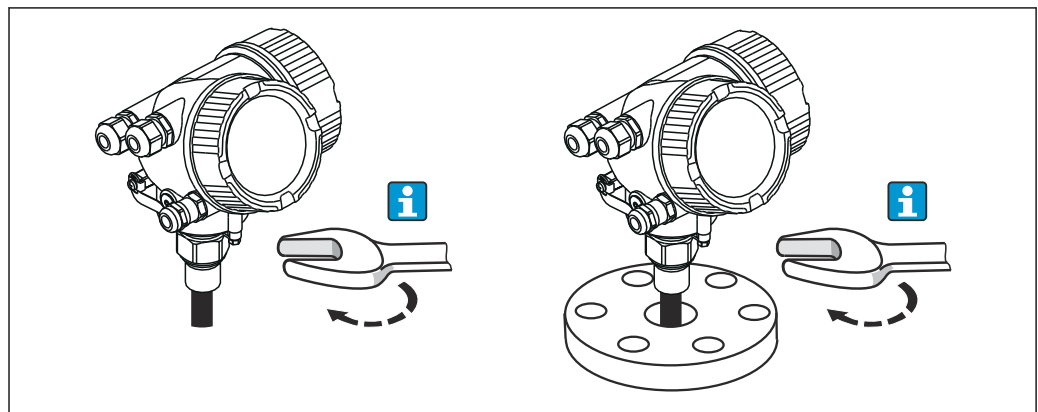

A0012528

Screw the device with the threaded connection into a sleeve or flange and then secure it to the process vessel via the sleeve/flange.

- i**
  - When screwing into place, turn by the hex bolt only:
    - Thread  $\frac{3}{4}$ " :  $\approx$  36 mm
    - Thread  $1\frac{1}{2}$ " :  $\approx$  55 mm
  - Maximum permissible tightening torque:
    - Thread  $\frac{3}{4}$ " : 45 Nm
    - Thread  $1\frac{1}{2}$ " : 450 Nm
  - Recommended torque when using the supplied aramid fiber seal and 40 bar (580 psi) pressure (FMP51 only; no seal is supplied for FMP54):
    - Thread  $\frac{3}{4}$ " : 25 Nm
    - Thread  $1\frac{1}{2}$ " : 140 Nm
  - When installing in metal vessels, ensure there is good metal contact between the process connection and the vessel.

### Mounting devices with a flange

If a seal is used to mount the device, use uncoated metal screws to ensure good electrical contact between the process flange and the probe flange.

### Mounting rope probes

#### NOTICE

**Electrostatic discharge can damage the electronics.**

- ▶ Ground the housing before lowering the rope probe into the vessel.

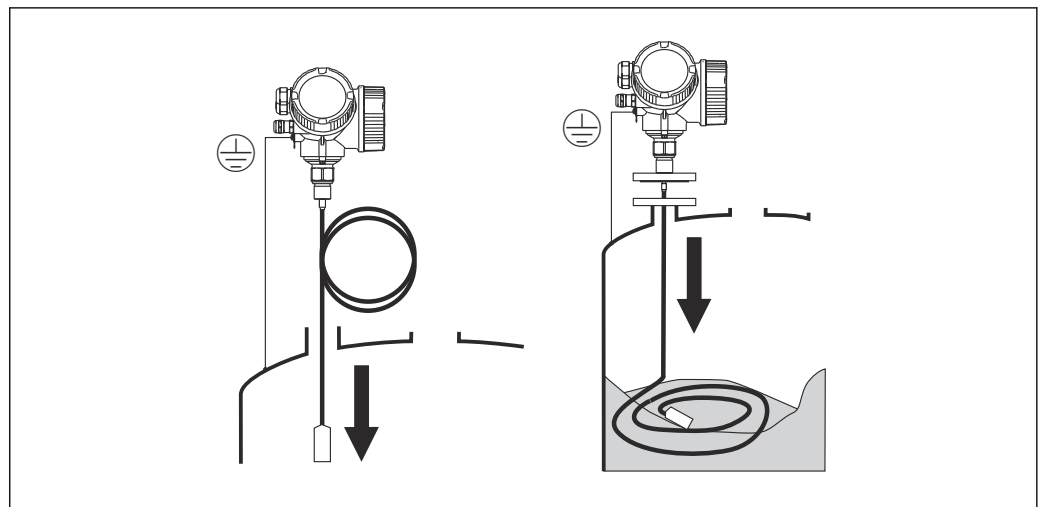

A0012529

Pay attention to the following when introducing the rope probe into the vessel:

- Uncoil the rope slowly and lower it carefully into the vessel.
- Make sure the rope does not bend or buckle.
- Avoid uncontrolled swinging of the weight, as this could damage internal fittings in the vessel.

#### **i** Mounting rope probes in a partially filled silo

If a silo is retrofitted with a Levelflex, it is not always possible to empty the silo. If the vessel is at least  $\frac{2}{3}$  empty, it is possible to mount the rope probe even in a partially filled silo. In this case, if possible perform a visual inspection after mounting: the rope should not become tangled or knotted when the silo is emptied. The probe rope must hang fully extended before an accurate measurement can be performed.

### 6.2.4 Mounting the "Sensor, remote" version

**i** This section only applies for devices with the version "Probe design" = "Sensor, remote" (feature 600, version MB/MC/MD).

The following is included in the delivery with the version "Probe design" = "Remote":

- The probe with process connection
- The electronics housing
- The mounting bracket for mounting the electronics housing on a wall or post
- The connection cable (length as ordered). The cable has one straight plug and one angled at 90°. Depending on the local conditions the angled plug can be connected at the probe or at the electronics housing.

#### **CAUTION**

**Mechanical stress can damage the plugs of the connection cable or cause them to become loose.**

- ▶ Mount the probe and the electronics housing securely before connecting the connecting cable.
- ▶ Lay the connecting cable in such a way that it is not exposed to mechanical stress. Minimum bending radius: 100 mm (4 in).
- ▶ When connecting the cable, connect the straight plug before you connect the angled plug. Torque for the union nuts of both plugs: 6 Nm.

**i** The probe, electronics and connection cable are mutually compatible and bear a common serial number. Only components with the same serial number may be connected to one another.

In the event of strong vibrations, a locking compound, e.g. Loctite 243, can also be used on the plug-in connectors.

#### Mounting the electronics housing

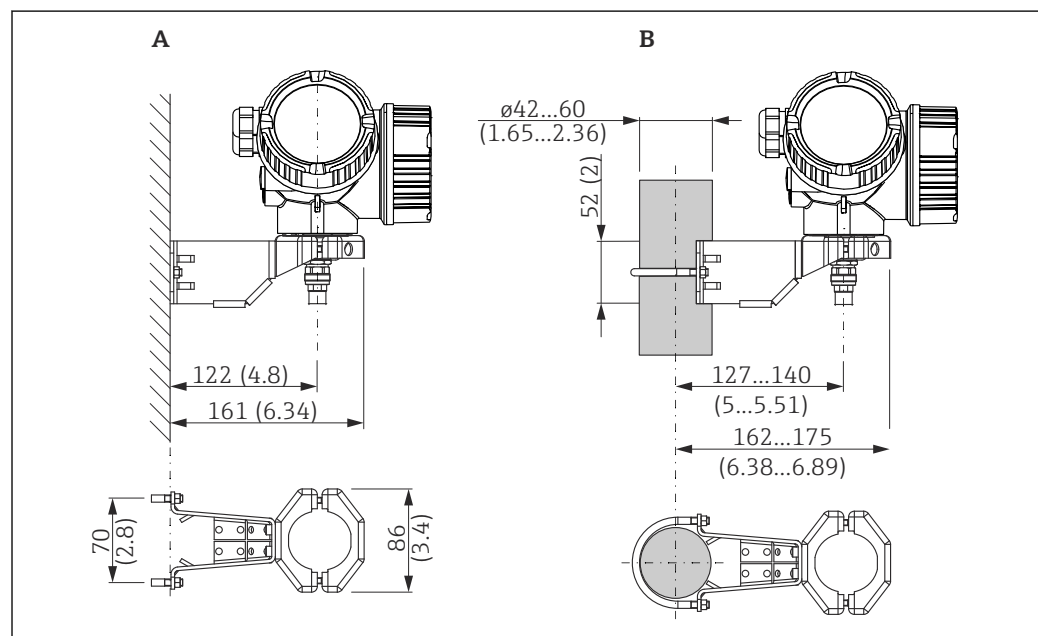

**11** Mounting the electronics housing with the mounting bracket. Unit of measurement mm (in)

- A Wall mounting  
B Post mounting



### Connecting the connecting cable

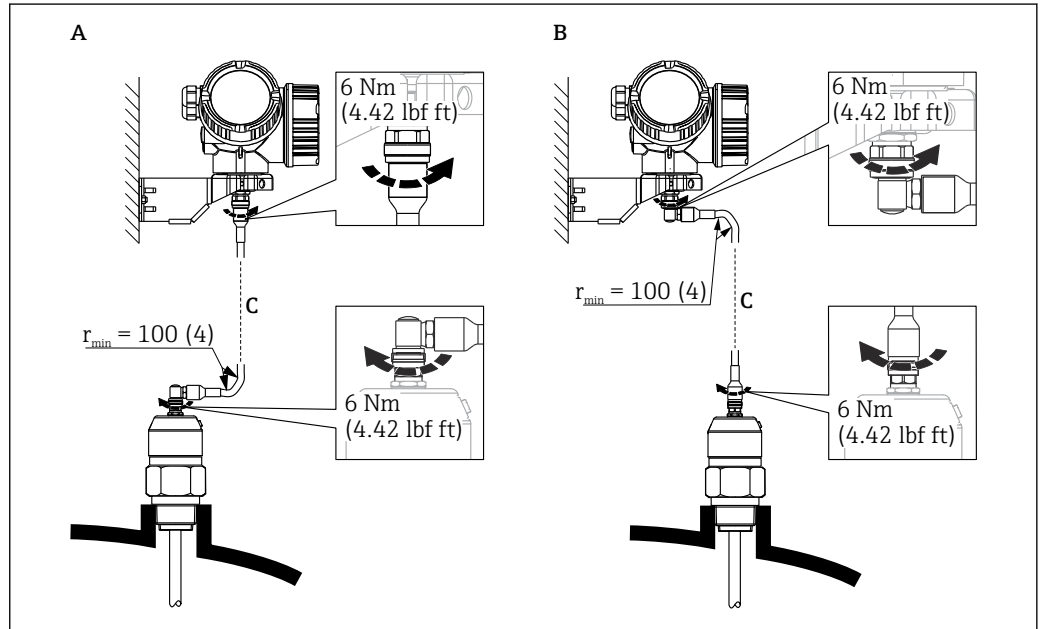

12 Connecting the connecting cable. The cable can be connected in the following ways: Unit of measurement mm (in)

- A Angled plug at the probe
- B Angled plug at the electronics housing
- C Length of the remote cable as ordered

### 6.2.5 Turning the transmitter housing

To provide easier access to the connection compartment or display module, the transmitter housing can be turned:

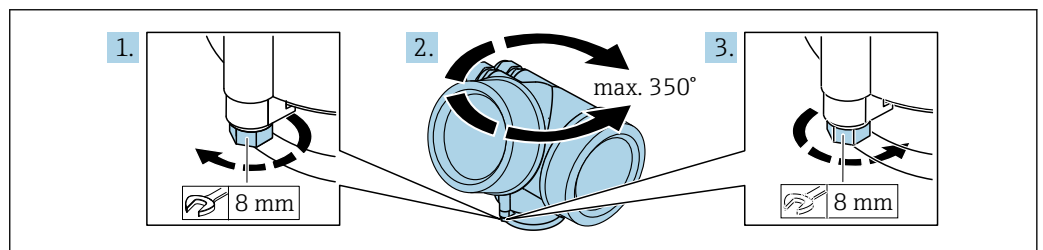

1. Unscrew the securing screw using an open-ended wrench.
2. Rotate the housing in the desired direction.
3. Tighten the securing screw (1.5 Nm for plastic housings; 2.5 Nm for aluminum or stainless steel housing).

## 6.2.6 Turning the display

### Opening the cover

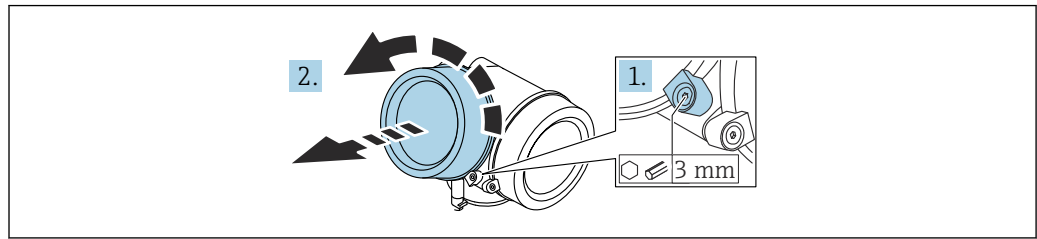

A0021430

1. Loosen the screw of the securing clamp of the electronics compartment cover using an Allen key (3 mm) and turn the clamp 90 ° counterclockwise.
2. Unscrew the electronics compartment cover and check the cover seal; replace it if necessary.

### Turning the display module

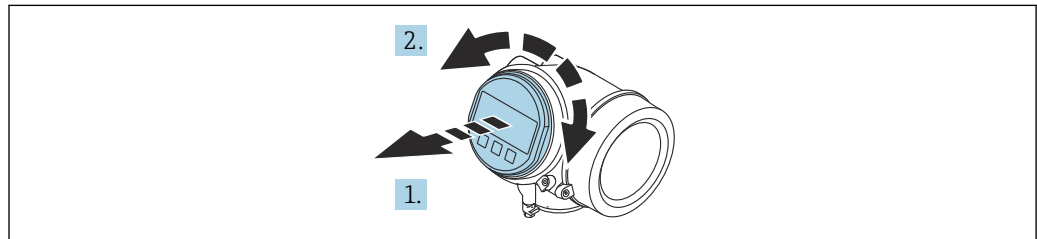

A0036401

1. Pull out the display module with a gentle rotational movement.
2. Turn the display module to the desired position: Max.  $8 \times 45^\circ$  in each direction.
3. Feed the coiled cable into the gap between the housing and main electronics module and plug the display module into the electronics compartment until it engages.

### Closing the cover of the electronics compartment

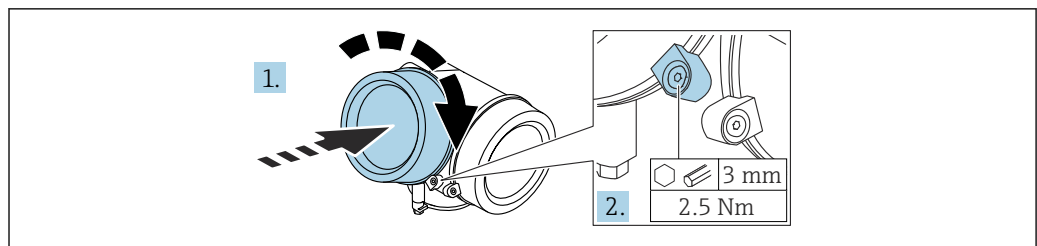

A0021451

1. Screw down the cover of the electronics compartment.
2. Turn the securing clamp 90 ° in the clockwise direction and, using an Allen key (3 mm), tighten the screw of the securing clamp on the electronics compartment cover with 2.5 Nm.

## 6.3 Post-mounting check

- Is the device free from damage (visual inspection)?
- Are the measuring point identification and labeling correct (visual inspection)?

- Is the measuring device protected against precipitation and sunlight?
- Are the securing screws and cover lock tightened securely?
- Does the measuring device comply with the measuring point specifications?

For example:

- Process temperature
- Process pressure
- Ambient temperature
- Measuring range

## 7 Electrical connection

### 7.1 Connecting requirements

#### 7.1.1 Terminal assignment

##### Terminal assignment, 2-wire: 4 to 20 mA HART

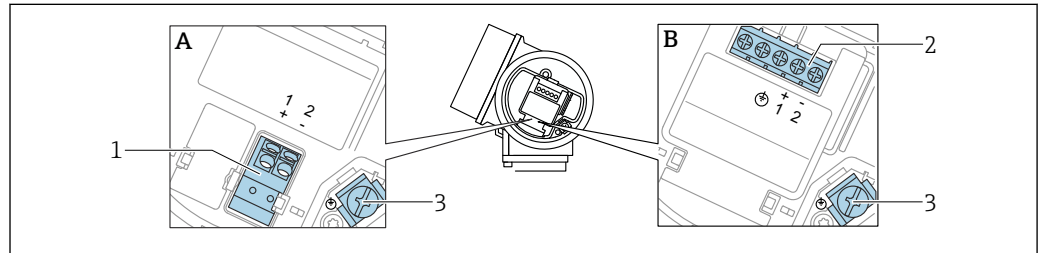

13 Terminal assignment, 2-wire: 4 to 20 mA HART

A Without integrated overvoltage protection

B With integrated overvoltage protection

1 Connection 4 to 20 mA, HART passive: terminals 1 and 2, without integrated overvoltage protection

2 Connection 4 to 20 mA, HART passive: terminals 1 and 2, with integrated overvoltage protection

3 Terminal for cable shield

##### Function diagram of 4 to 20 mA HART

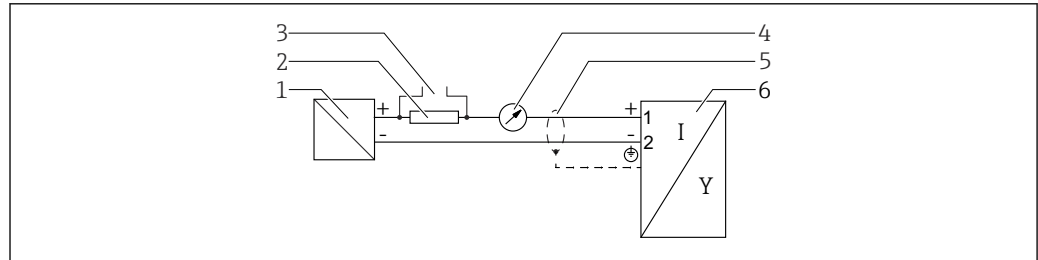

14 Function diagram of 4 to 20 mA HART

1 Active barrier for power supply; observe terminal voltage.

2 Resistor for HART communication ( $\geq 250 \Omega$ ); observe maximum load

3 Connection for Commubox FXA195 or FieldXpert (via VIATOR Bluetooth modem)

4 Analog display unit; observe maximum load

5 Cable screen; observe cable specification

6 Measuring instrument

**Terminal assignment, 2-wire: 4 to 20 mA HART, switch output**

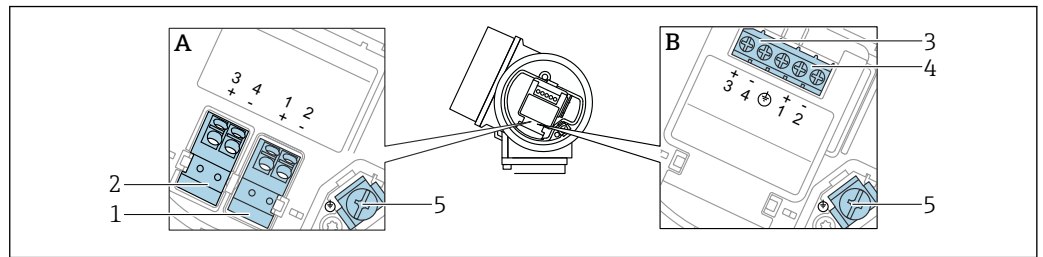

A0036500

15 Terminal assignment, 2-wire: 4 to 20 mA HART, switch output

A Without integrated overvoltage protection

B With integrated overvoltage protection

1 Connection 4 to 20 mA, HART passive: terminals 1 and 2, without integrated overvoltage protection

2 Connection, switch output (open collector): terminals 3 and 4, without integrated overvoltage protection

3 Connection, switch output (open collector): terminals 3 and 4, with integrated overvoltage protection

4 Connection 4 to 20 mA, HART passive: terminals 1 and 2, with integrated overvoltage protection

5 Terminal for cable shield

**Function diagram 4 to 20 mA HART, switch output**

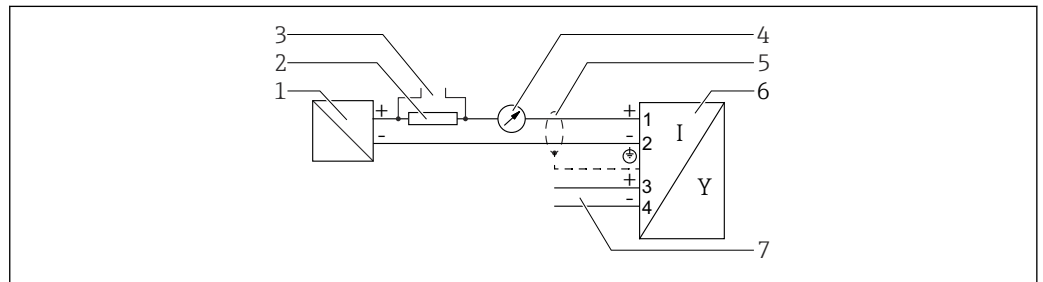

A0036501

16 Function diagram 4 to 20 mA HART, switch output

1 Active barrier for power supply; observe terminal voltage.

2 Resistor for HART communication ( $\geq 250 \Omega$ ); observe maximum load.

3 Connection for Commubox FXA195 or FieldXpert (via VIATOR Bluetooth modem)

4 Analog display unit; observe maximum load

5 Cable screen; observe cable specification

6 Measuring instrument

7 Switch output (open collector)

**Connection example of relay**

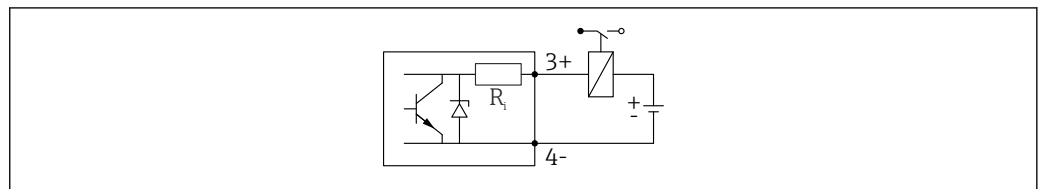

A0015909

17 Connection example of relay

Connection example for the digital input

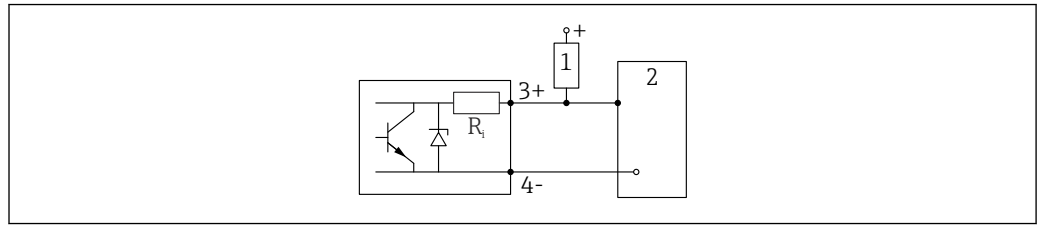

A0015910

18 Connection example for the digital input

- 1 Pull-up resistor
- 2 Digital input

Terminal assignment, 2-wire: 4 to 20 mA HART, 4 to 20 mA

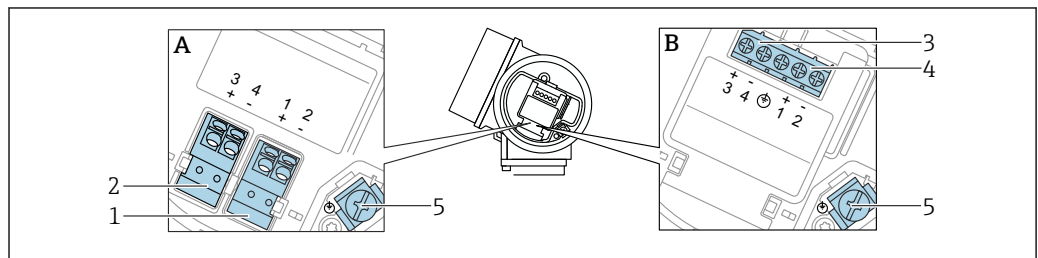

A0036500

19 Terminal assignment, 2-wire: 4 to 20 mA HART, 4 to 20 mA

- A Without integrated overvoltage protection
- B With integrated overvoltage protection
- 1 Connection current output 1, 4 to 20 mA HART passive: terminals 1 and 2, without integrated overvoltage protection
- 2 Connection current output 2, 4 to 20 mA: terminals 3 and 4, without integrated overvoltage protection
- 3 Connection current output 2, 4 to 20 mA: terminals 3 and 4, with integrated overvoltage protection
- 4 Connection current output 1, 4 to 20 mA HART passive: terminals 1 and 2, with integrated overvoltage protection
- 5 Terminal for cable shield

Function diagram 4 to 20 mA HART + 4 to 20 mA analog

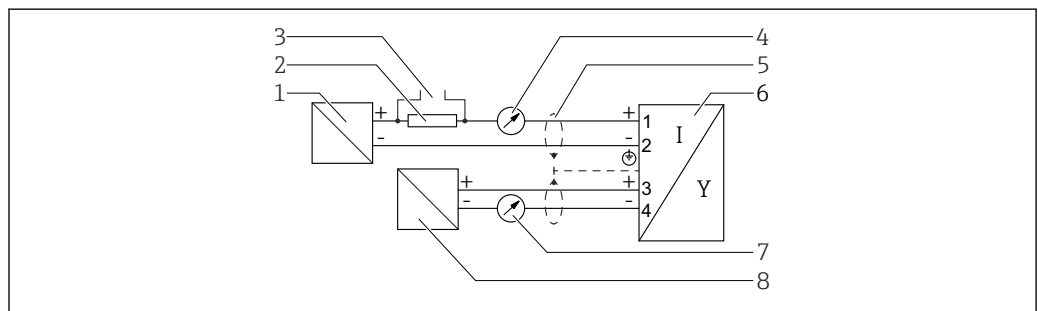

A0036502

20 Function diagram 4 to 20 mA HART + 4 to 20 mA analog

- 1 Active barrier for power supply, current output 1; observe terminal voltage.
- 2 Resistor for HART communication ( $\geq 250 \Omega$ ); observe maximum load.
- 3 Connection for Commubox FXA195 or FieldXpert (via VIATOR Bluetooth modem)
- 4 Analog display unit; observe maximum load
- 5 Cable screen; observe cable specification
- 6 Measuring instrument
- 7 Analog display unit; observe maximum load
- 8 Active barrier for power supply, current output 2; observe terminal voltage.

**Terminal assignment, 4-wire: 4 to 20 mA HART (10.4 to 48 V<sub>DC</sub>)**

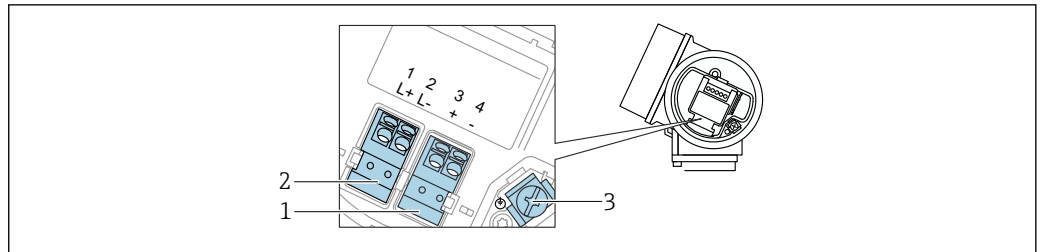

A0036516

21 Terminal assignment, 4-wire: 4 to 20 mA HART (10.4 to 48 V<sub>DC</sub>)

- 1 Connection 4 to 20 mA HART (active): terminals 3 and 4
- 2 Power supply connection: terminals 1 and 2
- 3 Terminal for cable shield

**Function diagram 4-wire: 4 to 20 mA HART (10.4 to 48 V<sub>DC</sub>)**

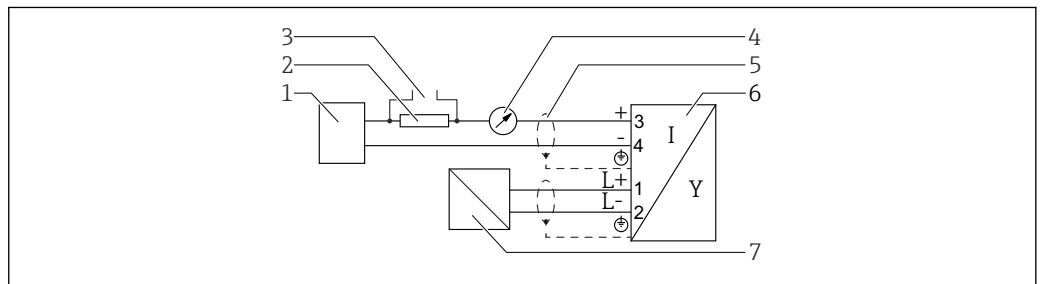

A0036526

22 Function diagram 4-wire: 4 to 20 mA HART (10.4 to 48 V<sub>DC</sub>)

- 1 Evaluation unit, e.g. PLC
- 2 Resistor for HART communication ( $\geq 250 \Omega$ ); observe maximum load
- 3 Connection for Commubox FXA195 or FieldXpert (via VIATOR Bluetooth modem)
- 4 Analog display unit; observe maximum load
- 5 Cable screen; observe cable specification
- 6 Device
- 7 Supply voltage; observe terminal voltage, observe cable specification

**Terminal assignment, 4-wire: 4 to 20 mA HART (90 to 253 V<sub>AC</sub>)**

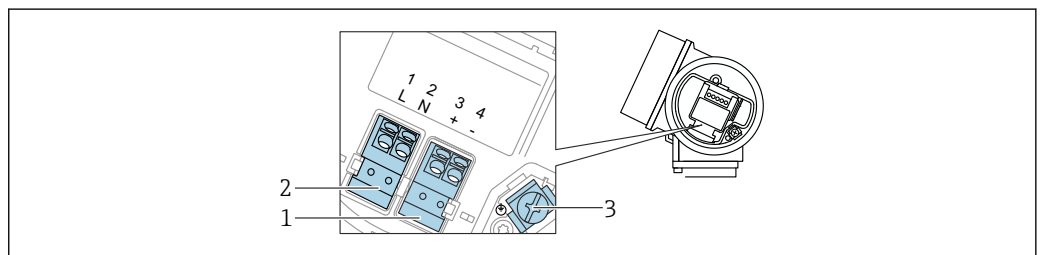

A0036519

23 Terminal assignment, 4-wire: 4 to 20 mA HART (90 to 253 V<sub>AC</sub>)

- 1 Connection 4 to 20 mA HART (active): terminals 3 and 4
- 2 Power supply connection: terminals 1 and 2
- 3 Terminal for cable shield

**⚠ CAUTION****To ensure electrical safety:**

- ▶ Do not disconnect the protective ground connection.
  - ▶ Disconnect the device from the supply voltage before disconnecting the protective ground.
- i** Connect protective ground to the inner ground terminal (3) before connecting the power supply. If necessary, connect the potential matching line to the outer ground terminal.
  - i** In order to ensure electromagnetic compatibility (EMC): do **not** ground the device exclusively via the protective ground conductor of the supply cable. Instead, the functional grounding must also be connected to the process connection (flange or threaded connection) or to the external ground terminal.
  - i** An easily accessible power switch must be installed in the proximity of the device. The switch must be marked as a disconnecter for the device (61010IEC/).

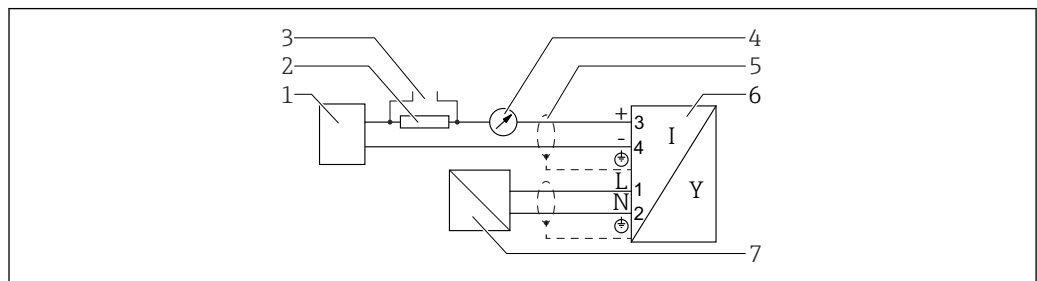
**Function diagram 4-wire: 4 to 20 mA HART (90 to 253 V<sub>AC</sub>)**

A0036527

24 Function diagram 4-wire: 4 to 20 mA HART (90 to 253 V<sub>AC</sub>)

- 1 Evaluation unit, e.g. PLC
- 2 Resistor for HART communication ( $\geq 250 \Omega$ ); observe maximum load
- 3 Connection for Commubox FXA195 or FieldXpert (via VIATOR Bluetooth modem)
- 4 Analog display unit; observe maximum load
- 5 Cable screen; observe cable specification
- 6 Device
- 7 Supply voltage; observe terminal voltage, observe cable specification

**7.1.2 Cable specification****■ Devices without integrated overvoltage protection**

Pluggable spring-force terminals for wire cross-sections 0.5 to 2.5 mm<sup>2</sup> (20 to 14 AWG)

**■ Devices with integrated overvoltage protection**

Screw terminals for wire cross-sections 0.2 to 2.5 mm<sup>2</sup> (24 to 14 AWG)

- For ambient temperature  $T_U \geq 60^\circ\text{C}$  (140 °F): use cable for temperature  $T_U + 20\text{ K}$ .

**HART**

- A normal device cable suffices if only the analog signal is used.
- A shielded cable is recommended if using the HART protocol. Observe grounding concept of the plant.
- For 4-wire devices: Standard device cable is sufficient for the power line.

**7.1.3 Device plug**

- i** In the case of the device versions with a plug, the housing does not need to be opened to connect the signal cable.



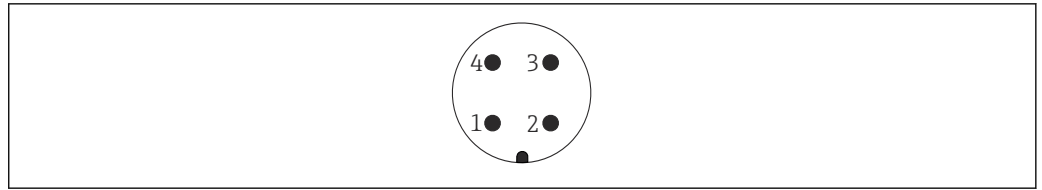

A0011175

25 Pin assignment of M12 plug

- 1 Signal +
- 2 Not assigned
- 3 Signal -
- 4 Ground

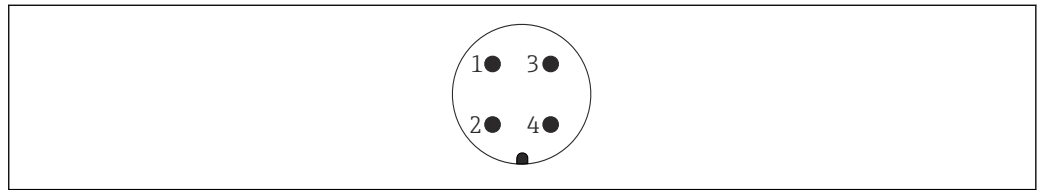

A0011176

26 Pin assignment of 7/8" plug

- 1 Signal -
- 2 Signal +
- 3 Not assigned
- 4 Shielding

## 7.1.4 Supply voltage

### 2-wire, 4-20mA HART, passive

#### 2-wire; 4-20mA HART<sup>1)</sup>

"Approval" <sup>2)</sup>	Terminal voltage U at device	Maximum load R, depending on the supply voltage U <sub>0</sub> of the power supply unit
<ul style="list-style-type: none"> <li>■ Non-hazardous</li> <li>■ Ex nA</li> <li>■ Ex ic</li> <li>■ CSA GP</li> </ul>	11.5 to 35 V <sup>3) 4)</sup>	<p style="text-align: right; font-size: small;">A0035511</p>
Ex ia / IS	11.5 to 30 V <sup>4)</sup>	
<ul style="list-style-type: none"> <li>■ Ex d / XP</li> <li>■ Ex ic[ia]</li> <li>■ Ex tD / DIP</li> </ul>	13.5 to 30 V <sup>4) 5)</sup>	<p style="text-align: right; font-size: small;">A0034969</p>

1) Feature 020 in the product structure: option A

2) Feature 010 in the product structure

3) At ambient temperatures  $T_a \leq -30^\circ\text{C}$ , a terminal voltage  $U \geq 14\text{ V}$  is required to start the device with the minimum failure current (3.6 mA). At ambient temperatures  $T_a > 60^\circ\text{C}$ , a terminal voltage  $U \geq 12\text{ V}$  is required to start the device with the minimum failure current (3.6 mA). The start-up current can be configured. If the device is operated with a fixed current  $I \geq 4.5\text{ mA}$  (HART Multidrop mode), a voltage  $U \geq 11.5\text{ V}$  in the entire ambient temperature range suffices.

4) If the Bluetooth module is used, the minimum supply voltage increases by 2 V.

5) At ambient temperatures  $T_a \leq -30^\circ\text{C}$ , a terminal voltage  $U \geq 16\text{ V}$  is required to start the device with the minimum failure current (3.6 mA).

#### 2-wire; 4-20 mA HART, switch output<sup>1)</sup>

"Approval" <sup>2)</sup>	Terminal voltage U at device	Maximum load R, depending on the supply voltage U <sub>0</sub> of the power supply unit
<ul style="list-style-type: none"> <li>■ Non-hazardous</li> <li>■ Ex nA</li> <li>■ Ex nA(ia)</li> <li>■ Ex ic</li> <li>■ Ex ic[ia]</li> <li>■ Ex d[ia] / XP</li> <li>■ Ex ta / DIP</li> <li>■ CSA GP</li> </ul>	13.5 to 35 V <sup>3) 4)</sup>	<p style="text-align: right; font-size: small;">A0034971</p>
<ul style="list-style-type: none"> <li>■ Ex ia / IS</li> <li>■ Ex ia + Ex d[ia] / IS + XP</li> </ul>	13.5 to 30 V <sup>3) 4)</sup>	

1) Feature 020 in the product structure: option B

2) Feature 010 in the product structure

3) At ambient temperatures  $T_a \leq -30^\circ\text{C}$ , a terminal voltage  $U \geq 16\text{ V}$  is required to start the device with the minimum failure current (3.6 mA).

4) If the Bluetooth module is used, the minimum supply voltage increases by 2 V.

2-wire; 4-20mA HART, 4-20mA <sup>1)</sup>

"Approval" <sup>2)</sup>	Terminal voltage U at device	Maximum load R, depending on the supply voltage U <sub>0</sub> of the power supply unit
all	<b>Channel 1:</b> 13.5 to 30 V <sup>3) 4) 5)</sup>	
	<b>Channel 2:</b> 12 to 30 V	

- 1) Feature 020 in the product structure: option C
- 2) Feature 010 in the product structure
- 3) At ambient temperatures  $T_a \leq -30\text{ °C}$ , a terminal voltage  $U \geq 16\text{ V}$  is required to start the device with the minimum failure current (3.6 mA).
- 4) At ambient temperatures  $T_a \leq -40\text{ °C}$ , the maximum terminal voltage must be limited to  $U \leq 28\text{ V}$ .
- 5) If the Bluetooth module is used, the minimum supply voltage increases by 2 V.

Integrated polarity reversal protection	Yes
Permitted residual ripple with $f = 0$ to 100 Hz	$U_{SS} < 1\text{ V}$
Permitted residual ripple with $f = 100$ to 10000 Hz	$U_{SS} < 10\text{ mV}$

**4-wire, 4-20mA HART, active**

"Power supply; output" <sup>1)</sup>	Terminal voltage U	Maximum load R <sub>max</sub>
<b>K:</b> 4-wire 90-253VAC; 4-20mA HART	90 to 253 V <sub>AC</sub> (50 to 60 Hz), overvoltage category II	500 Ω
<b>L:</b> 4-wire 10.4-48VDC; 4-20mA HART	10.4 to 48 V <sub>DC</sub>	

- 1) Feature 020 in the product structure

**7.1.5 Overvoltage protection**

If the device is intended to be used for level measurement of flammable liquids which requires overvoltage protection in accordance with DIN EN 60079-14, test standard 60060-1 (10 kA, pulse  $\frac{8}{20}\text{ }\mu\text{s}$ ): use the overvoltage protection module.

### Integrated overvoltage protection module

An integrated overvoltage protection module is available for the HART 2-wire devices as well as for PROFIBUS PA and FOUNDATION Fieldbus.

Product structure: Feature 610 "Accessory mounted", option NA "Overvoltage protection".

Resistance per channel	Maximum $2 \times 0.5 \Omega$
DC sparkover voltage	400 to 700 V
Trip surge voltage	< 800 V
Capacity at 1 MHz	< 1.5 pF
Nominal discharge current (8/20 $\mu$ s)	10 kA

### External overvoltage protection module

The HAW562 or HAW569 for example from Endress+Hauser are suitable options for external overvoltage protection.



More information is provided in the following documents:

- HAW562: TI01012K
- HAW569: TI01013K

## 7.2 Connecting the device

### **⚠ WARNING**

#### Explosion hazard!

- ▶ Comply with applicable national standards.
- ▶ Comply with the specifications in the Safety Instructions (XA).
- ▶ Use specified cable glands only.
- ▶ Check to ensure that the power supply matches the information on the nameplate.
- ▶ Switch off the power supply before connecting the device.
- ▶ Connect the potential matching line to the outer ground terminal before applying the power supply.

#### Required tools/accessories:

- For devices with a cover lock: Allen key AF3
- Wire stripper
- When using stranded cables: One ferrule for every wire to be connected.

### 7.2.1 Opening cover

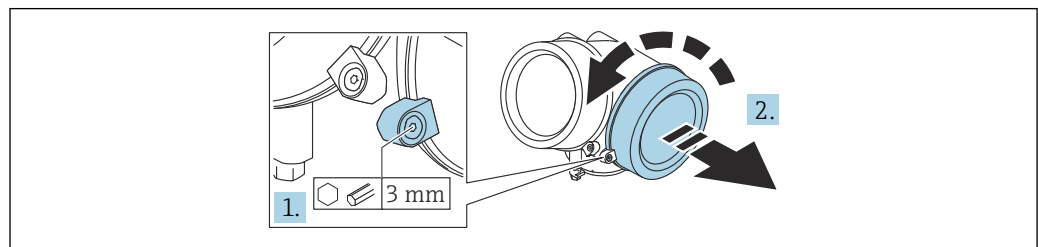

A0021490

1. Loosen the screw of the securing clamp of the connection compartment cover using an Allen key (3 mm) and turn the clamp 90 ° counterclockwise.
2. Unscrew the connection compartment cover and check the cover seal; replace it if necessary.

### 7.2.2 Connecting

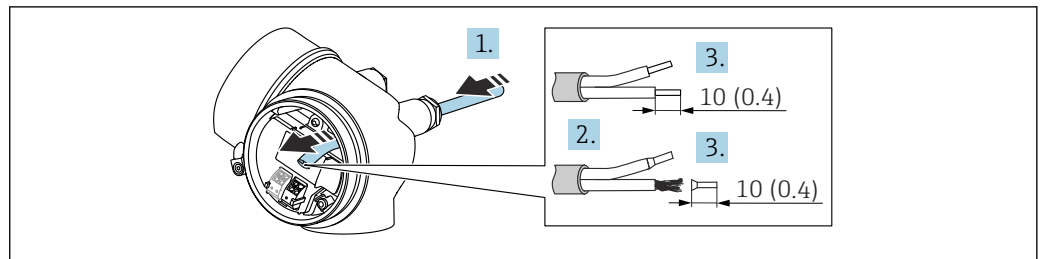

A0036418

27 Unit: mm (in)

1. Push the cable through the cable entry . To ensure tight sealing, do not remove the sealing ring from the cable entry.
2. Remove the cable sheath.
3. Strip the cable ends 10 mm (0.4 in). In the case of stranded cables, also fit ferrules.
4. Firmly tighten the cable glands.
5. Connect the cable according to the terminal assignment.

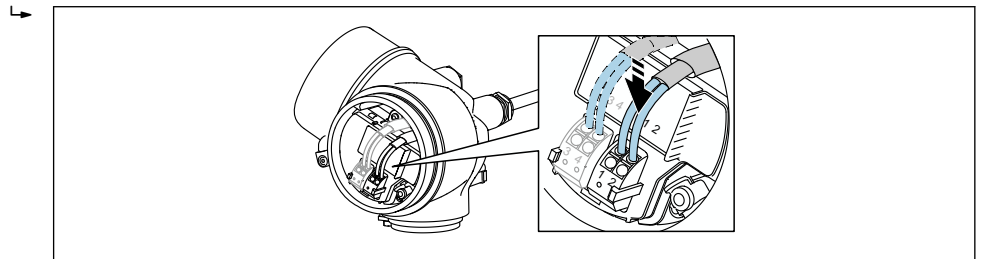

A0036682

6. If using shielded cables: Connect the cable shield to the ground terminal.

### 7.2.3 Plug-in spring-force terminals

The electrical connection of device versions without an integrated overvoltage protection is via plug-in spring-force terminals. Rigid conductors or flexible conductors with ferrules can be inserted directly into the terminal without using the lever, and create a contact automatically.

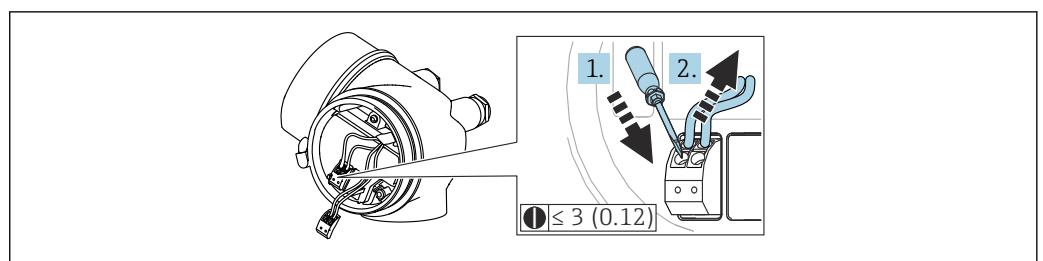

A0013661

28 Unit: mm (in)

To remove the cable from the terminal again:

1. Use a flat-blade screwdriver  $\le 3$  mm (0.12 in) to press down on the slot between the two terminal holes.
2. Simultaneously pull the cable end out of the terminal.

### 7.2.4 Closing the cover of the connection compartment

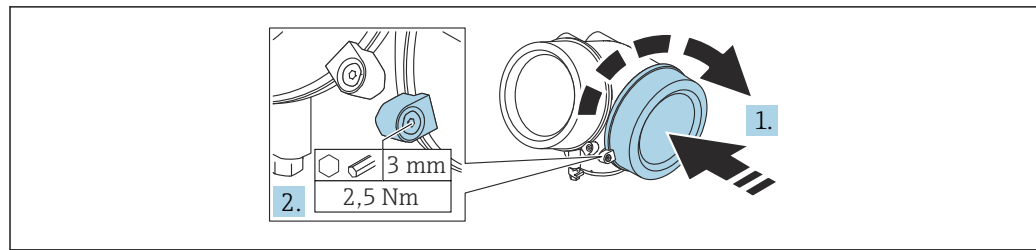

A0021491

1. Screw down the cover of the connection compartment.
2. Turn the securing clamp 90 ° in the clockwise direction and, using an Allen key (3 mm), tighten the screw of the securing clamp on the connection compartment cover with 2.5 Nm.

### 7.3 Post-connection check

- Is the device or cable undamaged (visual inspection)?
- Do the cables used comply with the requirements?
- Do the mounted cables have adequate strain relief?
- Are all the cable glands installed, firmly tightened and leak-tight?
- Does the supply voltage match the specifications on the nameplate?
- Is the terminal assignment correct?
- If necessary, has a protective ground connection been established?
- If supply voltage is present, is the device ready for operation and do values appear on the display module?
- Are all the housing covers installed and tightened?
- Is the securing clamp firmly tightened?

## 8 Operation options

### 8.1 Overview of operation options

#### 8.1.1 Access to operating menu via local display

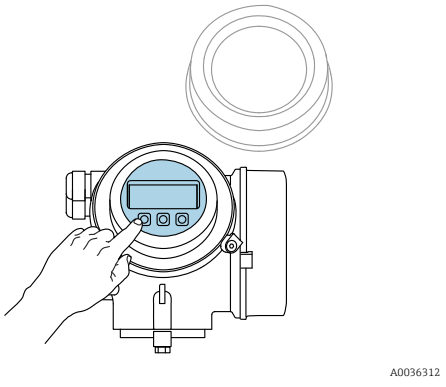
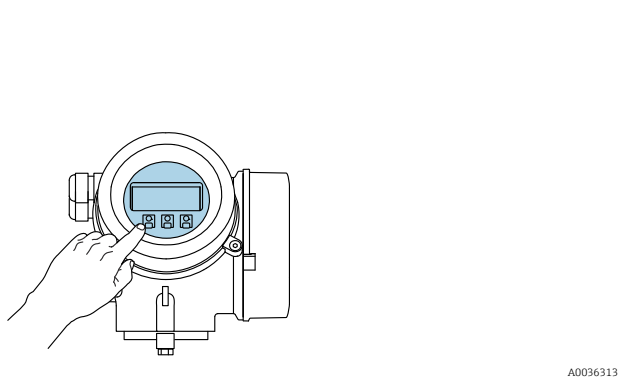
Operation with	Pushbuttons	Touch control
Order code for "Display; operation"	Option C "SD02"	Option E "SD03"
		
Display elements	4-line display	4-line display White background lighting; switches to red in event of device errors
	Format for displaying measured variables and status variables can be individually configured	
	Permitted ambient temperature for the display: -20 to +70 °C (-4 to +158 °F) The readability of the display may be impaired at temperatures outside the temperature range.	
Operating elements	Onsite operation with 3 pushbuttons (⊕, ⊖, ⊞)	External operation via touch control; 3 optical keys: ⊕, ⊖, ⊞
	Operating elements also accessible in various hazardous areas	
Additional functionality	Data backup function The device configuration can be saved in the display module.	
	Data comparison function The device configuration saved in the display module can be compared to the current device configuration.	
	Data transfer function The transmitter configuration can be transmitted to another device using the display module.	

#### Operation with remote display and operating module FHX50

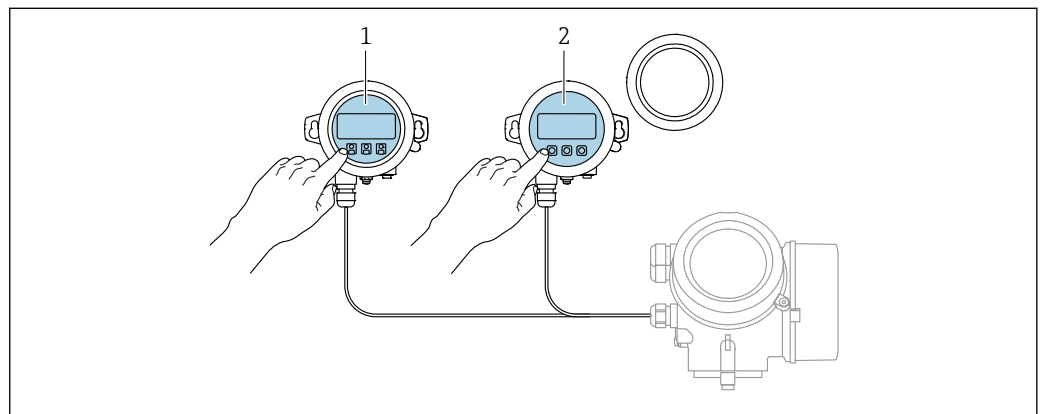

29 FHX50 operating options

- 1 Display and operating module SD03, optical keys; can be operated through the glass of the cover
- 2 Display and operating module SD02, push buttons; cover must be removed

## 8.1.2 Access to the operating menu via the operating tool

### Via HART protocol

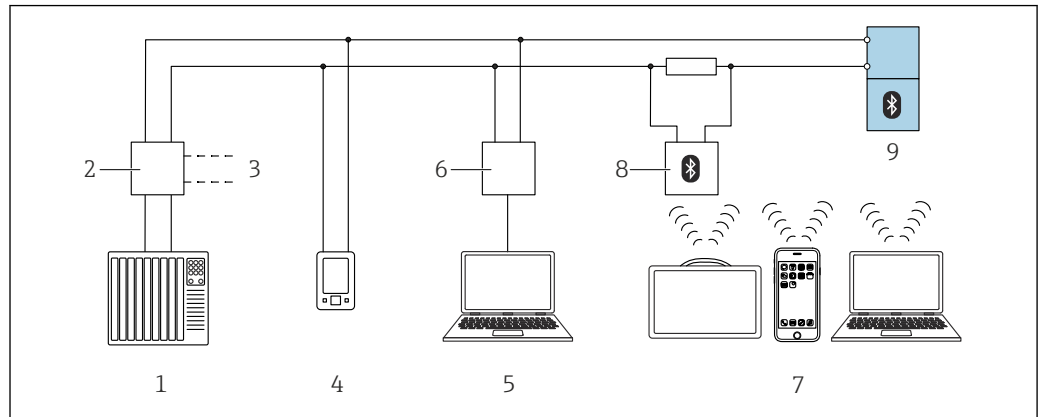

A0044334

30 Options for remote operation via HART protocol

- 1 PLC (programmable logic controller)
- 2 Transmitter power supply unit, e.g. RN221N (with communication resistor)
- 3 Connection for Commubox FXA195 and AMS Trex™ device communicator
- 4 AMS Trex™ device communicator
- 5 Computer with operating tool (e.g. DeviceCare/FieldCare , AMS Device View, SIMATIC PDM)
- 6 Commubox FXA195 (USB)
- 7 Field Xpert SMT70/SMT77, smartphone or computer with operating tool (e.g. DeviceCare/FieldCare , AMS Device View, SIMATIC PDM)
- 8 Bluetooth modem with connecting cable (e.g. VIATOR)
- 9 Transmitter

### Via service interface (CDI)

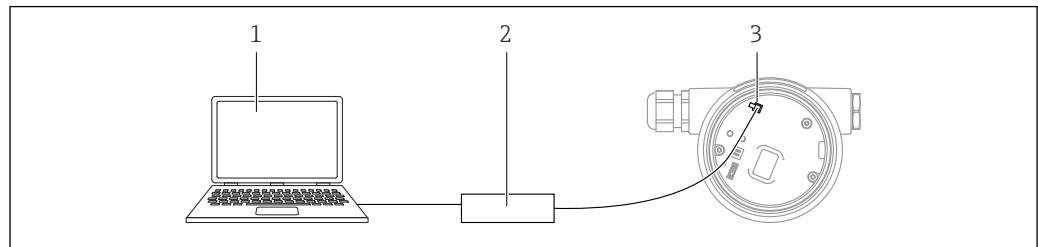

A0039148

- 1 Computer with FieldCare/DeviceCare operating tool
- 2 Commubox
- 3 Service interface (CDI) of the measuring instrument (= Endress+Hauser Common Data Interface)



## Operation via Bluetooth® wireless technology

### Requirements

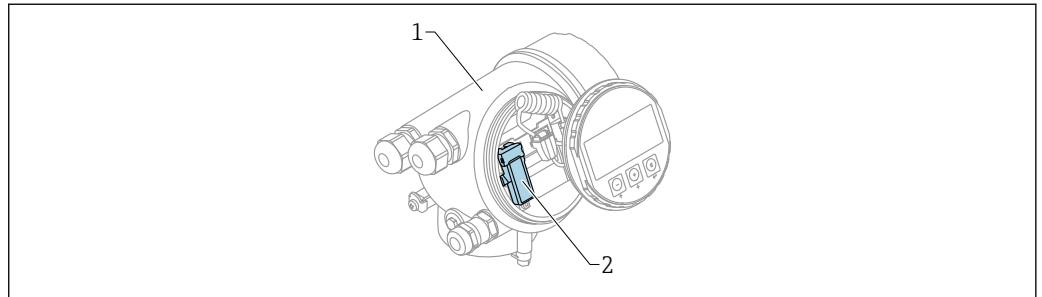

A0036790

31 Device with Bluetooth module

- 1 Electronics housing of the device
- 2 Bluetooth module

This operation option is only available for devices with Bluetooth module. There are the following options:

- The device has been ordered with a Bluetooth module:  
Feature 610 "Accessory Mounted", option NF "Bluetooth"
- The Bluetooth module has been ordered as an accessory (ordering number: 71377355) and has been mounted. See Special Documentation SD02252F.

### Operation via SmartBlue (app)

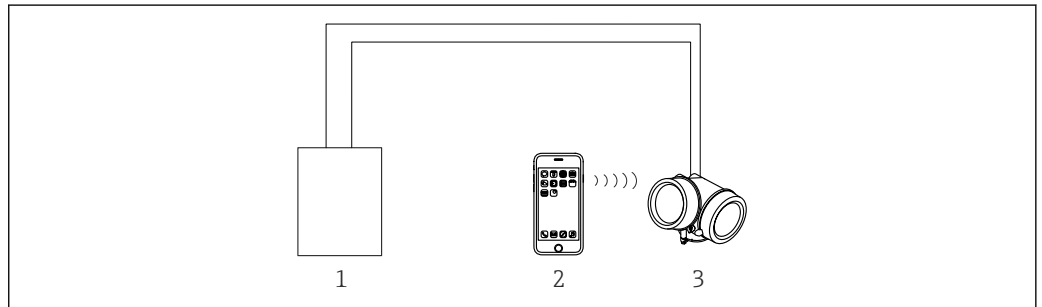

A0034939

32 Operation via SmartBlue (app)

- 1 Transmitter power supply unit
- 2 Smartphone / tablet with SmartBlue (app)
- 3 Transmitter with Bluetooth module

## 8.2 Structure and function of the operating menu

### 8.2.1 Structure of the operating menu

Menu	Submenu / parameter	Meaning
	Language <sup>1)</sup>	Defines the operating language of the local display
Commissioning <sup>2)</sup>		Launches the interactive wizard for guided commissioning. Additional settings generally do not need to be made in the other menus when the wizard is finished.

Menu	Submenu / parameter	Meaning
<b>Setup</b>	Parameter 1 ... Parameter N	Once values have been set for these parameters, the measurement should usually be fully configured.
	<b>Advanced setup</b>	Contains additional submenus and parameters: <ul style="list-style-type: none"> <li>▪ For more accurate configuration of the measurement (adaptation to special measuring conditions).</li> <li>▪ For converting the measured value (scaling, linearization).</li> <li>▪ For scaling the output signal.</li> </ul>
<b>Diagnostics</b>	<b>Diagnostic list</b>	Contains up to 5 currently active error messages.
	<b>Event logbook</b> <sup>3)</sup>	Contains the last 20 messages (which are no longer active).
	<b>Device information</b>	Contains information for identifying the device.
	<b>Measured values</b>	Contains all current measured values.
	<b>Data logging</b>	Contains the history of the individual measured values
	<b>Simulation</b>	Is used to simulate measured values or output values.
	<b>Device check</b>	Contains all parameters needed to check the measurement capability of the device.
<b>Expert</b> <sup>5)</sup> Contains all the parameters of the device (including those already contained in one of the other menus). This menu is organized according to the function blocks of the device.  The parameters of the Expert menu are described in: GPO1000F (HART)	<b>System</b>	Contains all higher-level device parameters that do not affect measurement or measured value communication.
	<b>Sensor</b>	Contains all parameters for configuring the measurement.
	<b>Output</b>	<ul style="list-style-type: none"> <li>▪ Contains all parameters for configuring the analog current output.</li> <li>▪ Contains all parameters to configure the switch output (PFS)</li> </ul>
	<b>Communication</b>	Contains all parameters needed to configure the digital communication interface.
	<b>Diagnostics</b>	Contains all parameters needed to detect and analyze operational errors.
	<b>Heartbeat</b> <sup>4)</sup>	Contains all the wizards for the <b>Heartbeat Verification</b> and <b>Heartbeat Monitoring</b> application packages.

- 1) If you are operating via operating tools (e.g. FieldCare), the "Language" parameter is located under "Setup → Advanced setup → Display"
- 2) Only if operating via an FDT/DTM system
- 3) Only available if operating via the local display
- 4) Only available if operating via DeviceCare or FieldCare
- 5) When you call up the "Expert" menu, you are always asked for an access code. If a customer-specific access code has not been defined, "0000" must be entered.

## 8.2.2 User roles and related access authorization

The two user roles **Operator** and **Maintenance** have different write access to the parameters if a device-specific access code has been defined. This protects the device configuration via the local display from unauthorized access →  51.

Access authorization to parameters

User role	Read access		Write access	
	Without access code (from the factory)	With access code	Without access code (from the factory)	With access code
Operator	✓	✓	✓	--
Maintenance	✓	✓	✓	✓

If an incorrect access code is entered, the user obtains the access rights of the **Operator** role.

 The user role with which the user is currently logged on is indicated by the **Access status display** parameter (if operating via the local display) or the **Access status tooling** parameter (if operating via an operating tool).

### 8.2.3 Data access - Security

#### Write protection via access code

Using the device-specific access code, the parameters for the measuring instrument configuration are write-protected and their values can no longer be changed via local operation.

#### Defining the access code via the local display

1. Navigate to: Setup → Advanced setup → Administration → Define access code → Define access code
2. Define a max. 4-digit numeric code as an access code.
3. Repeat the numeric code in the **Confirm access code** parameter to confirm it.
  - ↳ The -symbol appears in front of all write-protected parameters.



#### Defining the access code via operating tool (e.g. FieldCare)

1. Navigate to: Setup → Advanced setup → Administration → Define access code
2. Define a max. 4-digit numeric code as an access code.
  - ↳ Write protection is active.

#### Parameters that can always be changed

The write protection does not include certain parameters that do not affect the measurement. Despite the defined access code, these parameters can always be modified even if the other parameters are locked.

The device automatically locks the write-protected parameters again if a key is not pressed for 10 minutes in the navigation and editing view. If the user goes from the navigation and editing mode back to the measured value display mode, the device automatically locks the write-protected parameters after 60 s.

-  If write access is activated via an access code, it can be only be deactivated again via this access code.
- In the "Description of Device Parameters" documents, each write-protected parameter is identified with the -symbol.

#### Disabling write protection via access code

If the  symbol appears in front of a parameter on the local display, the parameter is write-protected by a device-specific access code and its value cannot currently be changed via the local display.

The locking of the write access via local operation can be disabled by entering the device-specific access code.

1. After you press  $\square$ , the input prompt for the access code appears.
2. Enter the access code.
  - ↳ The  $\square$  symbol in front of the parameters disappears; all previously write-protected parameters are now re-enabled.

### Deactivation of the write protection via access code

#### Via local display

1. Navigate to: Setup → Advanced setup → Administration → Define access code → Define access code
2. Enter **0000**.
3. Repeat **0000** in the **Confirm access code** parameter to confirm.
  - ↳ The write protection is deactivated. Parameters can be changed without entering an access code.

#### Via an operating tool (e.g. FieldCare)

1. Navigate to: Setup → Advanced setup → Administration → Define access code
2. Enter **0000**.
  - ↳ The write protection is deactivated. Parameters can be changed without entering an access code.

### Write protection via write protection switch

Unlike parameter write protection via a user-specific access code, this allows the user to lock write access to the entire operating menu - apart from the **"Contrast display" parameter**.

The parameter values are now read only and cannot be edited any more (exception **"Contrast display" parameter**):

- Via local display
- Via service interface (CDI)
- Via HART protocol

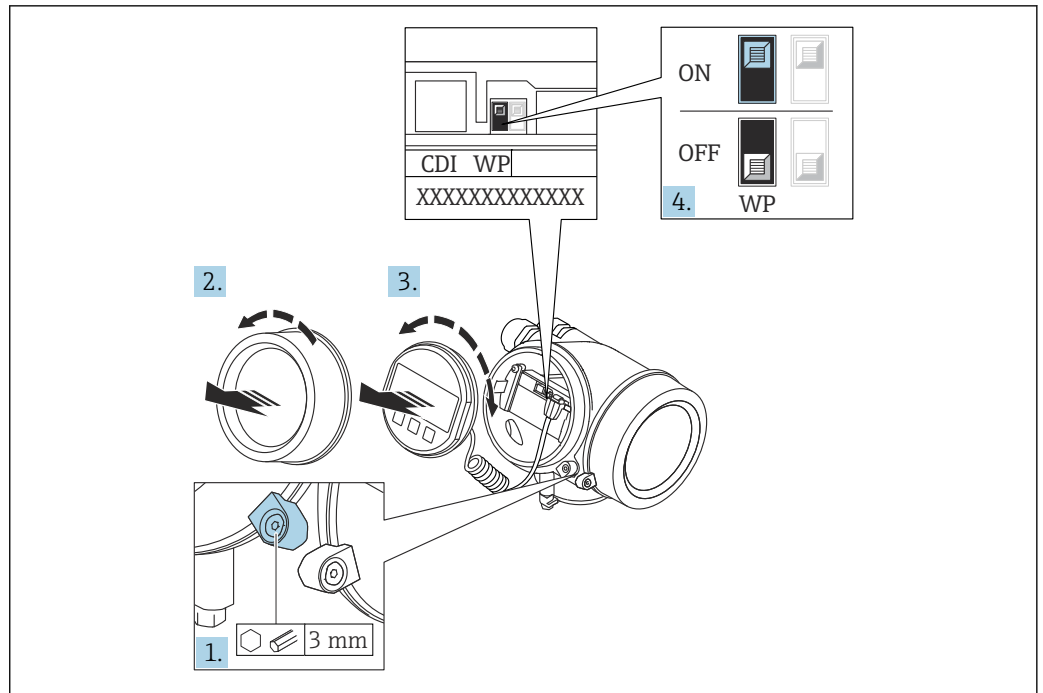

A0026157

1. Loosen the securing clamp.
2. Unscrew the electronics compartment cover.
3. Pull out the display module with a gentle rotational movement. To make it easier to access the write protection switch, attach the display module to the edge of the electronics compartment.

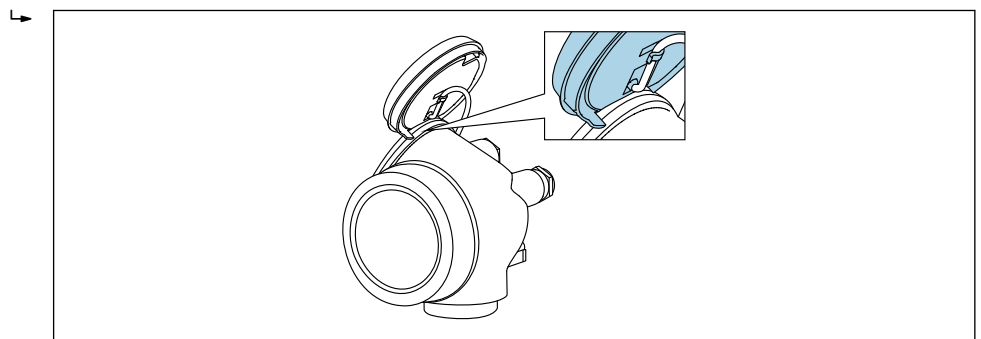

A0036086

4. Setting the write protection switch (WP) on the main electronics module to the **ON** position enables hardware write protection. Setting the write protection switch (WP) on the main electronics module to the **OFF** position (factory setting) disables hardware write protection.
  - ↳ If the hardware write protection is enabled: The **Hardware locked** option is displayed in the **Locking status** parameter. In addition, on the local display the  symbol appears in front of the parameters in the header of the operational display and in the navigation view.

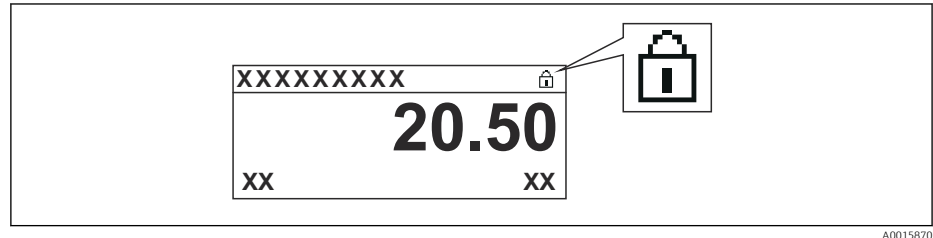

If hardware write protection is disabled: No option is displayed in the **Locking status** parameter. On the local display, the  symbol disappears from in front of the parameters in the header of the operational display and in the navigation view.

5. Feed the cable into the gap between the housing and main electronics module and plug the display module into the electronics compartment in the desired direction until it engages.
6. Reassemble the transmitter in the reverse order.

### Enabling and disabling the keypad lock

Access to the entire operating menu via local operation can be locked via the keypad lock. When access is locked, it is no longer possible to navigate through the operating menu or change the values of individual parameters. Users can only read the measured values on the operational display.

The keypad lock is switched on and off via a context menu.

#### Switching on the keypad lock

##### SD03 display module only

The keypad lock is switched on automatically:

- If the device has not been operated via the display for > 1 minute.
- Each time the device is restarted.

#### Switching on the keypad lock manually

1. The device is in the measured value display.  
Press  for at least 2 seconds.  
↳ A context menu appears.
2. Select the **Keylock on** option in the context menu.  
↳ The keypad lock is switched on.

 If the user attempts to access the operating menu while the keypad lock is active, the message **Keylock on** appears.

#### Switching off the keypad lock

1. The keypad lock is switched on.  
Press  for at least 2 seconds.  
↳ A context menu appears.

2. Select the **Keylock off** option in the context menu.
  - ↳ The keypad lock is switched off.

### Bluetooth® wireless technology

Signal transmission via Bluetooth® wireless technology uses a cryptographic technique tested by the Fraunhofer Institute

- The device is not visible via Bluetooth® wireless technology without the SmartBlue app
- Only one point-to-point connection is established between **one** sensor and **one** smartphone or tablet

## 8.3 Display and operating module



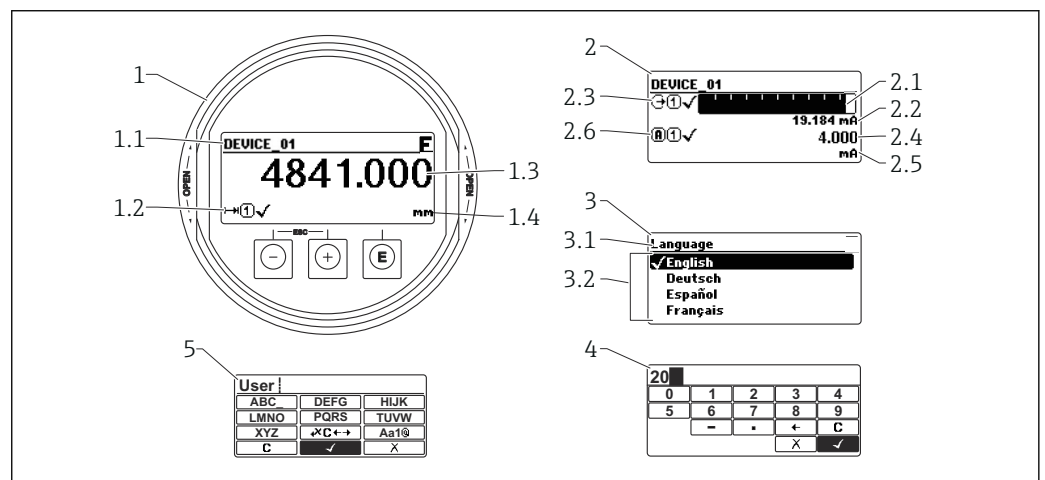

### 8.3.1 Display format



33 Display format on the display and operating module

- 1 Measured value display (1 value max. size)
  - 1.1 Header containing tag and error symbol (if an error is active)
  - 1.2 Measured value symbols
  - 1.3 Measured value
  - 1.4 Unit
- 2 Measured value display (bar graph + 1 value)
  - 2.1 Bargraph for measured value 1
  - 2.2 Measured value 1 (including unit)
  - 2.3 Measured value symbols for measured value 1
  - 2.4 Measured value 2
  - 2.5 Unit for measured value 2
  - 2.6 Measured value symbols for measured value 2
- 3 Parameter display (here: parameter with drop-down list)
  - 3.1 Header containing parameter name and error symbol (if an error is active)
  - 3.2 Drop-down list; ✓ marks the current parameter value.
- 4 Input matrix for numbers
- 5 Input matrix for alphanumeric and special characters



### Display symbols for the submenus

Symbol	Meaning
 A0018367	<b>Display/operat.</b> Is displayed: <ul style="list-style-type: none"> <li>■ In the main menu next to the "Display/operat." selection</li> <li>■ In the header on the left in the "Display/operat." menu</li> </ul>
 A0018364	<b>Setup</b> Is displayed: <ul style="list-style-type: none"> <li>■ In the main menu next to the "Setup" selection</li> <li>■ In the header on the left in the "Setup" menu</li> </ul>
 A0018365	<b>Expert</b> Is displayed: <ul style="list-style-type: none"> <li>■ In the main menu next to the "Expert" selection</li> <li>■ In the header on the left in the "Expert" menu</li> </ul>
 A0018366	<b>Diagnostics</b> Is displayed: <ul style="list-style-type: none"> <li>■ In the main menu next to the "Diagnostics" selection</li> <li>■ In the header on the left in the "Diagnostics" menu</li> </ul>

### Status signals











Symbol	Meaning
<b>F</b> A0032902	<b>"Failure"</b> A device error has occurred. The measured value is no longer valid.
<b>C</b> A0032903	<b>"Function check"</b> The device is in the service mode (e.g. during a simulation).
<b>S</b> A0032904	<b>"Out of specification"</b> The device is operated: <ul style="list-style-type: none"> <li>■ Outside its technical specifications (e.g. during startup or cleaning)</li> <li>■ Outside the configuration performed by the user (e.g. level outside the configured range)</li> </ul>
<b>M</b> A0032905	<b>"Maintenance required"</b> Maintenance is required. The measured value is still valid.

### Display symbols for locking status



Symbol	Meaning
 A0013148	<b>Read-only parameter</b> The parameter shown is only for display purposes and cannot be edited.
 A0013150	<b>Device locked</b> <ul style="list-style-type: none"> <li>■ In front of a parameter name: The device is locked via software and/or hardware.</li> <li>■ In the header of the measured value screen: The device is locked via hardware.</li> </ul>







### Measured value symbols

Symbol	Meaning
<b>Measured values</b>	
 <small>A0032892</small>	Level
 <small>A0032893</small>	Distance
 <small>A0032908</small>	Current output
 <small>A0032894</small>	Measured current
 <small>A0032895</small>	Terminal voltage
 <small>A0032896</small>	Electronics or sensor temperature
<b>Measuring channels</b>	
 <small>A0032897</small>	Measuring channel 1
 <small>A0032898</small>	Measuring channel 2
<b>Status of the measured value</b>	
 <small>A0018361</small>	<b>"Alarm" status</b> Measurement is interrupted. The output assumes the defined alarm condition. A diagnostic message is generated.
 <small>A0018360</small>	<b>"Warning" status</b> The device continues to measure. A diagnostic message is generated.

### 8.3.2 Operating elements

Operating key	Meaning
 <small>A0018330</small>	<b>Minus key</b> <i>In a menu, submenu</i> Moves the selection bar upwards in a picklist. <i>In the text and numeric editor</i> In the input screen, moves the selection bar to the left (backwards).
 <small>A0018329</small>	<b>Plus key</b> <i>In a menu, submenu</i> Moves the selection bar downwards in a picklist. <i>In the text and numeric editor</i> In the input screen, moves the selection bar to the right (forwards).

Operating key	Meaning
 <small>A0018328</small>	<p><b>Enter key</b></p> <p><i>For measured value display</i></p> <ul style="list-style-type: none"> <li>Pressing the key briefly opens the operating menu.</li> <li>Pressing the key for 2 s opens the context menu.</li> </ul> <p><i>In a menu, submenu</i></p> <ul style="list-style-type: none"> <li>Pressing the key briefly: Opens the selected menu, submenu or parameter.</li> <li>Pressing the key for 2 s for parameter: If present, opens the help text for the function of the parameter.</li> </ul> <p><i>In the text and numeric editor</i></p> <ul style="list-style-type: none"> <li>Pressing the key briefly:                             <ul style="list-style-type: none"> <li>Opens the selected group.</li> <li>Carries out the selected action.</li> </ul> </li> <li>Pressing the key for 2 s confirms the edited parameter value.</li> </ul>
 <small>A0032909</small>	<p><b>Escape key combination (press keys simultaneously)</b></p> <p><i>In a menu, submenu</i></p> <ul style="list-style-type: none"> <li>Pressing the key briefly:                             <ul style="list-style-type: none"> <li>Exits the current menu level and takes you to the next higher level.</li> <li>If help text is open, closes the help text of the parameter.</li> </ul> </li> <li>Pressing the key for 2 s returns you to the measured value display ("home position").</li> </ul> <p><i>In the text and numeric editor</i></p> <p>Closes the text or numeric editor without applying changes.</p>
 <small>A0032910</small>	<p><b>Minus/Enter key combination (press and hold down the keys simultaneously)</b></p> <p>Reduces the contrast (brighter setting).</p>
 <small>A0032911</small>	<p><b>Plus/Enter key combination (press and hold down the keys simultaneously)</b></p> <p>Increases the contrast (darker setting).</p>



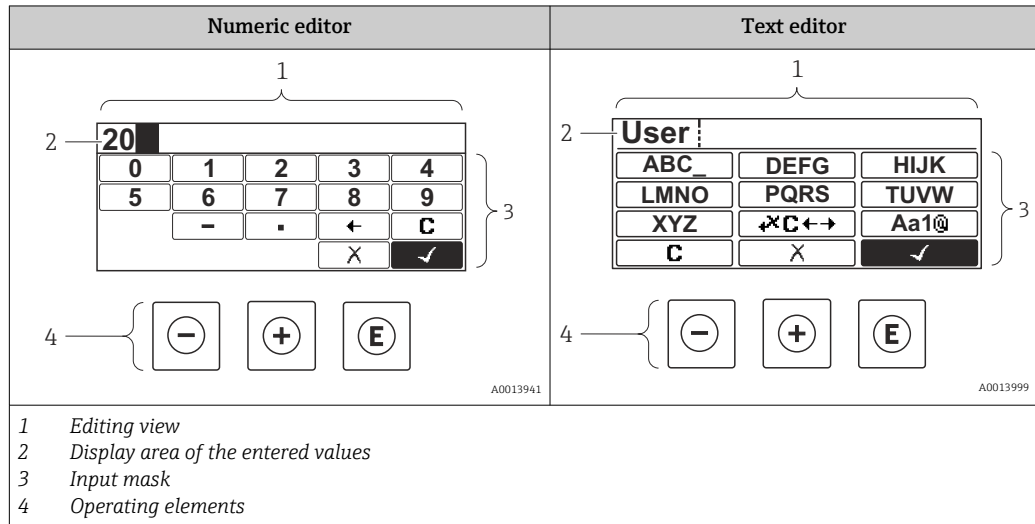



### 8.3.3 Entering numbers and text









#### Input mask

The following input and operating symbols are available in the input mask of the numeric and text editor:



*Numeric editor*



Symbol	Meaning
 <p>A0013998</p>	Selection of numbers from 0 to 9
 <p>A0016619</p>	Inserts decimal separator at the cursor position.
 <p>A0016620</p>	Inserts minus sign at the cursor position.
 <p>A0013985</p>	Confirms selection.
 <p>A0016621</p>	Moves the input position one position to the left.
 <p>A0013986</p>	Exits the input without applying the changes.
 <p>A0014040</p>	Clears all entered characters.

*Text editor*

Symbol	Meaning
 <p>A0013997</p>	Selection of letters from A to Z
 <p>A0013981</p>	Toggle <ul style="list-style-type: none"> <li>▪ Between upper-case and lower-case letters</li> <li>▪ For entering numbers</li> <li>▪ For entering special characters</li> </ul>
 <p>A0013985</p>	Confirms selection.
 <p>A0013987</p>	Switches to the selection of the correction tools.
 <p>A0013986</p>	Exits the input without applying the changes.
 <p>A0014040</p>	Clears all entered characters.

*Text correction under *

Symbol	Meaning
 <p>A0032907</p>	Clears all entered characters.
 <p>A0018324</p>	Moves the input position one position to the right.

 <small>A0018326</small>	Moves the input position one position to the left.
 <small>A0032906</small>	Deletes one character immediately to the left of the input position.

### 8.3.4 Opening the context menu

Using the context menu, the user can call up the following menus quickly and directly from the operational display:

- Setup
- Conf. backup disp.
- Envelope curve
- Keylock on



#### Calling up and closing the context menu

The user is in the operational display.

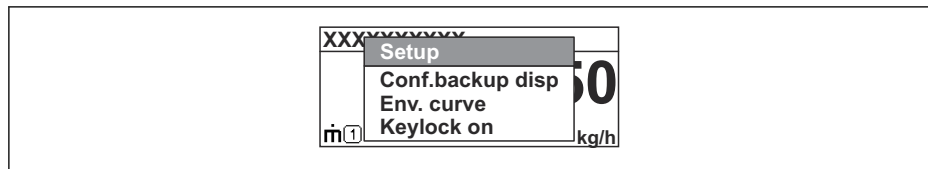

1. Press  for 2 s.  
 ↳ The context menu opens.



A0037872

2. Press  +  simultaneously.  
 ↳ The context menu is closed and the operational display appears.

#### Calling up the menu via the context menu

1. Open the context menu.
2. Press  to navigate to the desired menu.
3. Press  to confirm the selection.  
 ↳ The selected menu opens.

### 8.3.5 Envelope curve display on the display and operating module

In order to assess the measuring signal, the envelope curve and - if a mapping has been recorded - the mapping curve can be shown on the display and operating module:

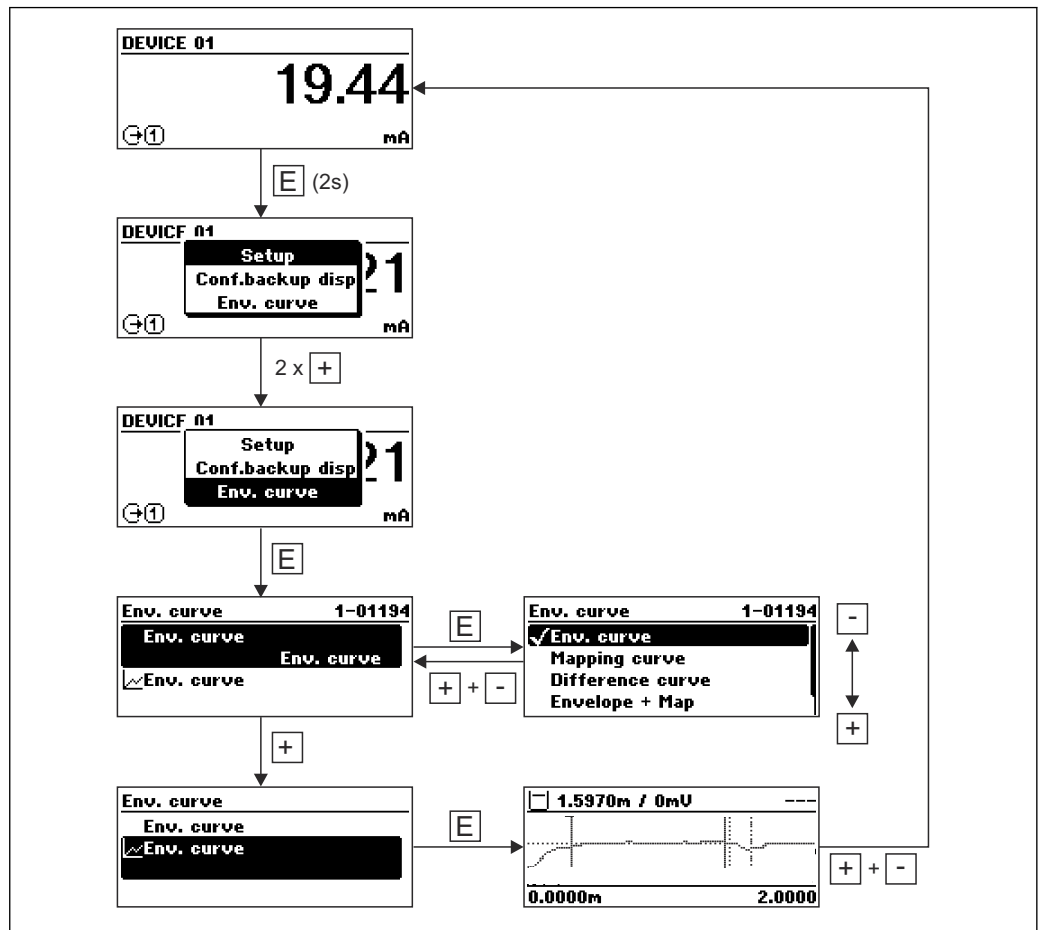

A0014277

## 9 System integration

### 9.1 Overview of the device description files

*HART*

Manufacturer ID	0x11
Device type code	0x1122
HART specification	7.0
DD files	Information and files available at: <ul style="list-style-type: none"> <li>▪ <a href="http://www.endress.com">www.endress.com</a></li> <li>▪ <a href="http://www.fieldcommgroup.org">www.fieldcommgroup.org</a></li> </ul>

### 9.2 Measured variables via HART protocol

The following measured values are assigned to the device variables at the factory:

*Device variables for level measurement*

Device variable	Measured value
Primary variable (PV)	Level linearized
Secondary variable (SV)	Unfiltered distance
Tertiary variable (TV)	Absolute echo amplitude
Quaternary variable (QV)	Relative echo amplitude

 The assignment of the measured values to the device variables can be changed in the following submenu:

Expert → Communication → Output

## 10 Commissioning via SmartBlue (App)

### 10.1 Operation via Bluetooth® wireless technology (optional)

Prerequisite

- Device with device display including Bluetooth
- Smartphone or tablet with Endress+Hauser SmartBlue app or PC with DeviceCare from version 1.07.05 or FieldXpert SMT70

The connection has a range of up to 25 m (82 ft). The range can vary depending on environmental conditions such as attachments, walls or ceilings.

 The operating keys on the display are locked as soon as the device is connected via Bluetooth.

A flashing Bluetooth symbol indicates that a Bluetooth connection is available.

 **Please note the following**

If the Bluetooth display is removed from one device and installed in another device:

- All the log-in data are only saved in the Bluetooth display and not in the device
- The password changed by the user is also saved in the Bluetooth display

#### 10.1.1 Operation via SmartBlue App

The device can be operated and configured with the SmartBlue App.

- The SmartBlue App must be downloaded onto a mobile device for this purpose.
- For information on the compatibility of the SmartBlue App with mobile devices, see **Apple App Store (iOS devices)** or **Google Play Store (Android devices)**.
- Incorrect operation by unauthorized persons is prevented by means of encrypted communication and password encryption.
- The Bluetooth® function can be deactivated after initial device setup.

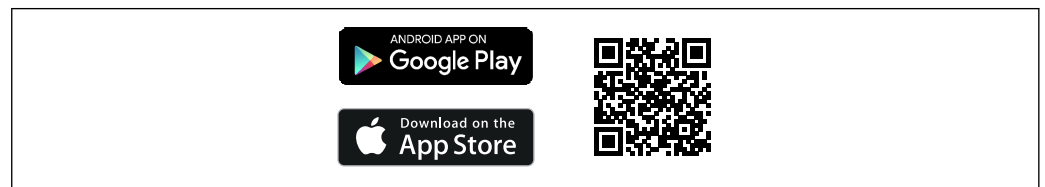

 34 QR code for free Endress+Hauser SmartBlue App

A0033202

Download and installation:

1. Scan the QR code or enter **SmartBlue** in the search field of the Apple App Store (iOS) or Google Play Store (Android).
2. Install and start the SmartBlue App.
3. For Android devices: enable location tracking (GPS) (not required for iOS devices).
4. Select a device that is ready to receive from the device list displayed.

Login:

1. Enter the user name: admin
2. Enter the initial password: serial number of the device

 Change the password after logging in for the first time.

 Forgotten your password? Contact Endress+Hauser Service.

## 10.2 Envelope curve display in SmartBlue

Envelope curves can be displayed and recorded in SmartBlue.

In addition to the envelope curve, the following values are displayed:

- D = Distance
- L = Level
- A = Absolute amplitude
- With screenshots, the displayed section (zoom function) is saved
- With video sequences, the whole area without zoom function is saved all the time



35 Envelope curve display (sample) in SmartBlue for Android

- 1 Record video
- 2 Create screenshot
- 3 Display mapping menu
- 4 Start/stop video recording
- 5 Move time on time axis

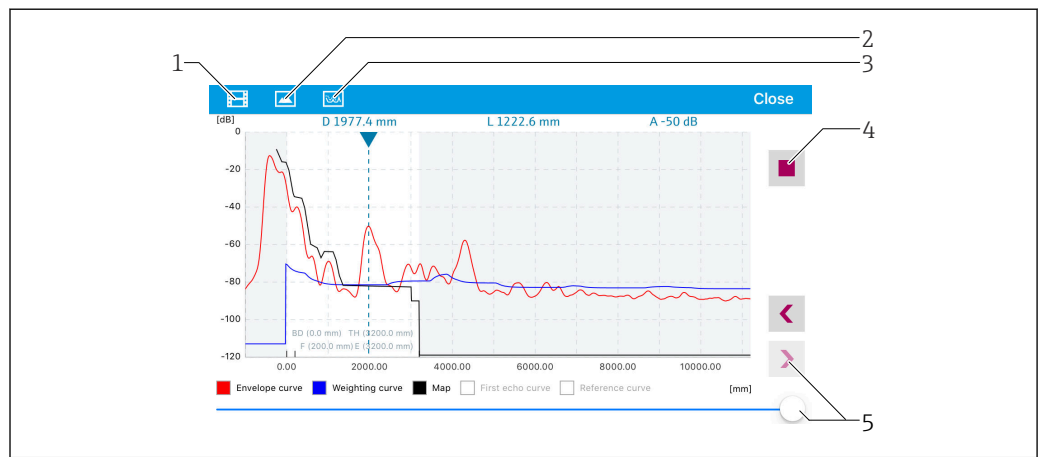

36 Envelope curve display (sample) in SmartBlue for iOS

- 1 Record video
- 2 Create screenshot
- 3 Display mapping menu
- 4 Start/stop video recording
- 5 Move time on time axis



# 11 Commissioning using the wizard

FieldCare and DeviceCare have a wizard that guides the user through initial commissioning.

1. Connect the device with FieldCare or DeviceCare.
2. Open the device in FieldCare or DeviceCare.
  - ↳ The dashboard (homepage) of the device is displayed:

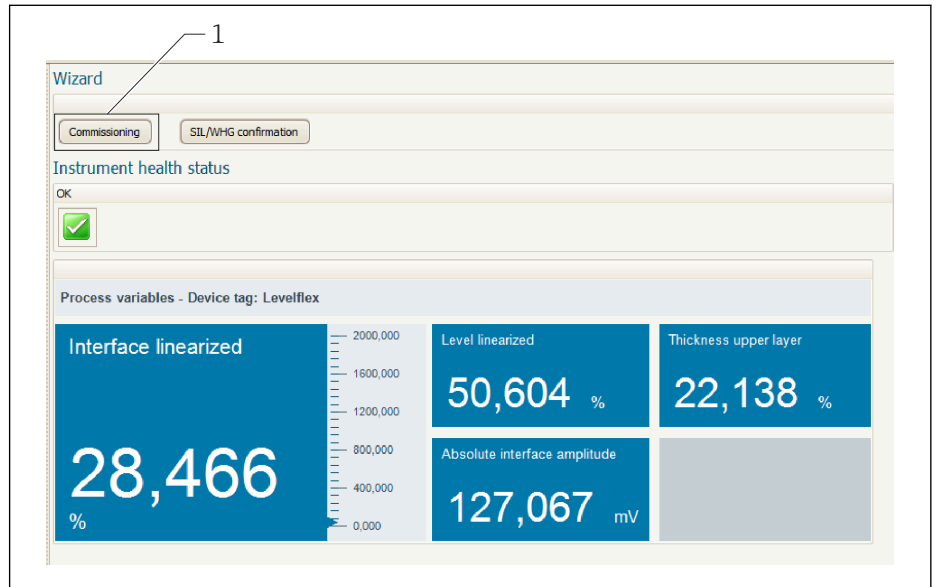

1 "Commissioning" button calls up the wizard

3. Click "Commissioning" to launch the Wizard.
  4. Enter the appropriate value in each parameter or select the appropriate option. These values are written directly to the device.
  5. Click "Next" to go to the next page.
  6. Once all the pages have been completed, click "Finish" to close the Wizard.
- i** If you cancel the Wizard before all the necessary parameters have been entered, the device may be in an undefined state. In such situations, it is advisable to reset the device to the factory default settings.

## 12 Commissioning via operating menu

### 12.1 Installation and function check

Before commissioning the measuring point, check whether the post-installation and post-connection checks have been performed.

 Post-mounting check

 Post-connection check

### 12.2 Configuring the operating language

Factory setting: English or ordered local language

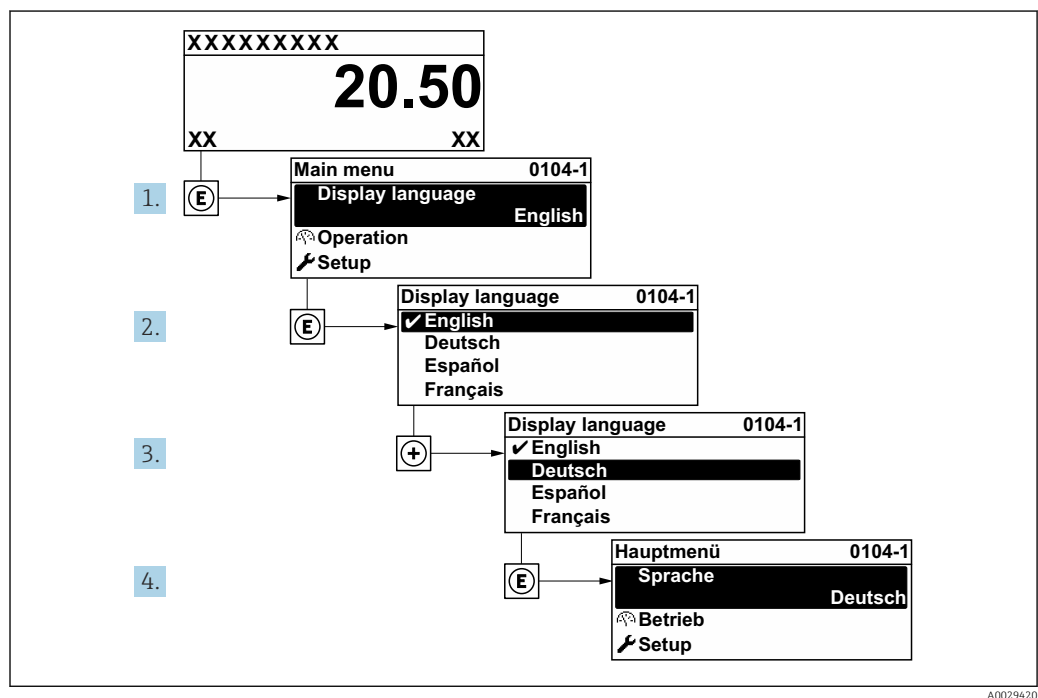

 37 Using the example of the local display

A0029420

## 12.3 Configuring level measurement

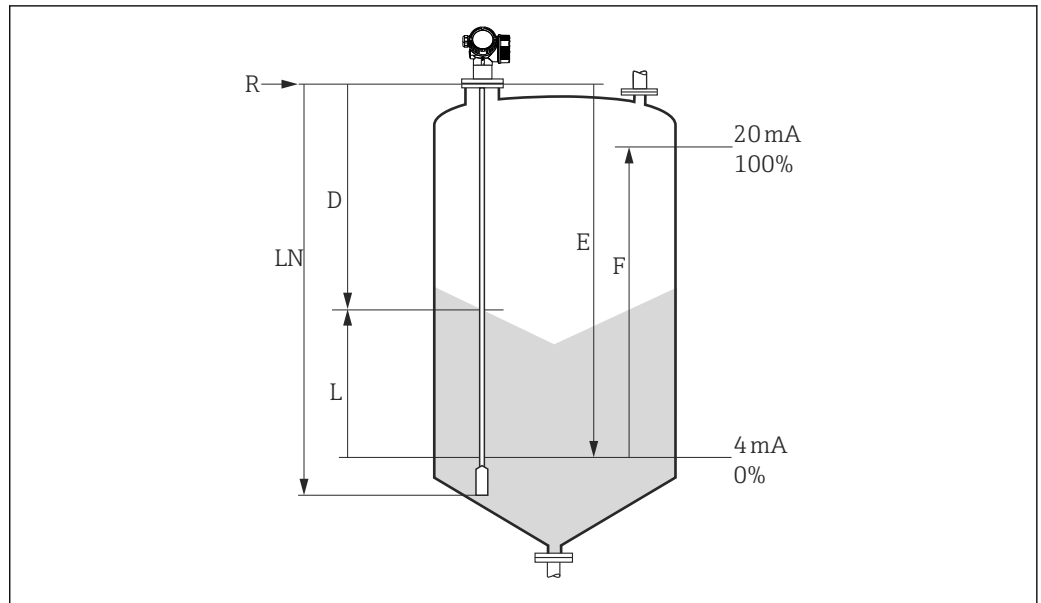

A0012838

38 Configuration parameters for level measurement in bulk solids

- LN Length of probe
- R Reference point of the measurement
- D Distance
- L Level
- E Empty calibration (= zero point)
- F Full calibration (= span)

**i** If the  $\epsilon_r$  value is lower than 7 in the case of rope probes, measurement is not possible in the area of the probe weight. The empty calibration  $E$  should not exceed  $LN - 250$  mm ( $LN - 10$  in) in these cases.

1. Setup → Device tag
  - ↳ Enter the tag name.
2. Navigate to: Setup → Distance unit
  - ↳ Select the length unit.
3. Navigate to: Setup → Bin type
  - ↳ Select bin type.
4. Navigate to: Setup → Empty calibration
  - ↳ Specify empty distance  $E$  (distance from reference point  $R$  to 0% mark).
5. Navigate to: Setup → Full calibration
  - ↳ Specify the full distance  $F$  (distance from the 0% mark to the 100% mark).
6. Navigate to: Setup → Level
  - ↳ Displays the measured level  $L$ .
7. Navigate to: Setup → Distance
  - ↳ Displays the distance  $D$  between the reference point  $R$  and the level  $L$ .
8. Navigate to: Setup → Signal quality
  - ↳ Displays the signal quality of the analyzed level echo.
9. Operation via local display:
  - Navigate to: Setup → Mapping → Confirm distance
    - ↳ Compare the distance displayed with the actual value to start recording an interference echo map if necessary.

10. Operation via operating tool:  
 Navigate to: Setup → Confirm distance  
 ↳ Compare the distance displayed with the actual value to start recording an interference echo map if necessary.

## 12.4 Recording the reference echo curve

After the measurement has been configured, it is recommended to record the current envelope curve as a reference echo curve. This can then be used later for diagnostic purposes. The **Save reference curve** parameter is used to record the envelope curve.

### Path in the menu

Expert → Diagnostics → Envelope diagnostics → Save reference curve

### Meaning of the options

- No  
No action
- Yes  
The current envelope curve is saved as a reference curve.

 This submenu is only visible for the "Service" user role in devices supplied with software version 01.00.zz or 01.01.zz.

 The reference echo curve can only be displayed in the envelope curve diagram of FieldCare after it has been loaded from the device into FieldCare. The "Load Reference Curve" function in FieldCare is used for this.

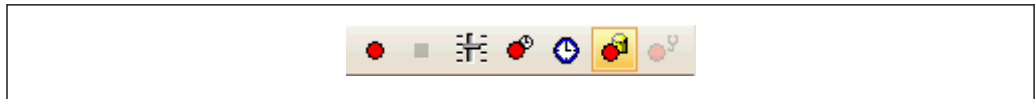

 39 "Load Reference Curve" function

## 12.5 Configuring the local display

### 12.5.1 Factory setting of local display for level measurements

Parameter	Factory setting for devices with 1 current output	Factory setting for devices with 2 current outputs
Format display	1 value, max. size	1 value, max. size
Value 1 display	Level linearized	Level linearized
Value 2 display	Distance	Distance
Value 3 display	Current output 1	Current output 1
Value 4 display	None	Current output 2

### 12.5.2 Adjusting the local display

The local display can be adjusted in the following submenu:

Setup → Advanced setup → Display

## 12.6 Configuring the current outputs

### 12.6.1 Factor setting of current outputs for level measurements

Current output	Assigned measured value	4mA value	20mA value
1	Level linearized	0% or the corresponding linearized value	100% or the corresponding linearized value
2 (For devices with two current outputs)	Relative echo amplitude	0 mV	2 000 mV

### 12.6.2 Adjusting the current outputs

The current outputs can be adjusted in the following submenus:

#### Basic setup

Setup → Advanced setup → Current output 1 to 2

#### Advanced settings

Expert → Output 1 to 2 → Current output 1 to 2

See "Description of Device Parameters" GP01000F

## 12.7 Configuration management

After commissioning, you can save the current device configuration, copy it to another measuring point or restore the previous device configuration. You can do so using the **Configuration management** parameter and the options available.

#### Path in the menu

Setup → Advanced setup → Configuration backup display → Configuration management

#### Meaning of the options

##### ■ Cancel

No action is executed and the user exits the parameter.

##### ■ Execute backup

A backup copy of the current device configuration is saved from the HistoROM (integrated in the device) to the display module of the device.

##### ■ Restore

The last backup copy of the device configuration is copied from the display module to the HistoROM of the device.

- **Duplicate**

The transmitter configuration of the device is duplicated to another device using the display module. The following parameters, which characterize the individual measuring point are **not** transferred:

- HART date code
- HART short tag
- HART message
- HART descriptor
- HART address
- Device tag
- Medium type

- **Compare**

The device configuration saved in the display module is compared to the current device configuration of the HistoROM. The result of the comparison is displayed in the **Comparison result** parameter.

- **Clear backup data**

The backup copy of the device configuration is deleted from the display module of the device.



While this action is in progress, the configuration cannot be edited via the local display and a message on the processing status appears on the display.



If an existing backup copy is restored on a device other than the original device using the **Restore** option, in some cases individual device functions may not be available. In some cases it is also not possible to restore the original state by resetting to the "as-delivered" state.

The **Duplicate** option should always be used to copy the configuration to another device.

## 12.8 Protecting settings from unauthorized access





The settings can be protected from unauthorized access in two ways:

- Locking via parameters (software locking)
- Locking via write protection switch (hardware locking)

## 13 Diagnostics and troubleshooting

### 13.1 General troubleshooting

#### 13.1.1 General errors

Error	Possible cause	Solution
Device does not respond.	Supply voltage does not match the value indicated on the nameplate.	Connect the correct voltage.
	The polarity of the supply voltage is wrong.	Correct the polarity.
	The cables do not contact the terminals properly.	Ensure electrical contact between the cable and the terminal.
Values on the display invisible	Contrast setting is too weak or too strong.	<ul style="list-style-type: none"> <li>■ Increase contrast by pressing  and  simultaneously.</li> <li>■ Decrease contrast by pressing  and  simultaneously.</li> </ul>
	The plug of the display cable is not connected correctly.	Connect the plug correctly.
	Display is defective.	Replace display.
"Communication error" is indicated on the display when starting the device or connecting the display.	Electromagnetic interference	Check grounding of the device.
	Broken display cable or display plug.	Replace display.
Duplication of parameters via display from one device to another not working. Only the "Save" and "Cancel" options are available.	Display with backup is not properly detected if a data backup was not carried out on the new device previously.	Connect display (with backup) and restart device.
Output current <3.6 mA	Signal cable connection incorrect.	Check connection.
	Electronics module is defective.	Replace electronics.
HART communication does not function.	Communication resistor missing or incorrectly installed.	Install the communication resistor (250 Ω) correctly.
	Commubox is connected incorrectly.	Connect Commubox correctly.
	Commubox is not set to "HART".	Set Commubox selector switch to "HART".
CDI communication does not work.	Wrong setting of the COM port on the computer.	Check the setting of the COM port on the computer and change it if necessary.
Device measures incorrectly.	Parameter configuration error	Check and correct the parameter configuration.
No communication with device via SmartBlue	No Bluetooth connection	Enable Bluetooth function on smartphone or tablet
	The device is already connected with another smartphone/tablet	Disconnect the device from the other smartphone/tablet
	Bluetooth module not connected	Connect Bluetooth module (see SD02252F).
Login via SmartBlue not possible	Device is being put into operation for the first time	Enter initial password (ID of Bluetooth module) and change it

Error	Possible cause	Solution
Device cannot be operated via SmartBlue	Incorrect password entered	Enter the correct password, paying attention to lower/upper case
Device cannot be operated via SmartBlue	Password forgotten	Contact Endress+Hauser Service ( <a href="http://www.addresses.endress.com">www.addresses.endress.com</a> )

### 13.1.2 Error - SmartBlue operation

Error	Possible cause	Solution
Device is not visible in the live list	No Bluetooth connection	Enable Bluetooth® function on smartphone or tablet
		Bluetooth® function of sensor disabled, perform recovery sequence
Device is not visible in the live list	The device is already connected with another smartphone/tablet	Only <b>one</b> point-to-point connection is established between a sensor and a smartphone or tablet
Device is visible in the live list but cannot be accessed via SmartBlue	Android end device	Is the location function permitted for the app, was it approved the first time?
		GPS or positioning function must be activated for certain Android versions in conjunction with Bluetooth®
		Activate GPS - close the app fully and restart - enable the positioning function for the app
Device is visible in the live list but cannot be accessed via SmartBlue	Apple end device	Log in as standard Enter user name "admin" Enter initial password (ID of Bluetooth module), paying attention to lower/upper case
Login via SmartBlue not possible	Device is being put into operation for the first time	Enter initial password (ID of Bluetooth module) and change, paying attention to lower/upper case
Device cannot be operated via SmartBlue	Incorrect password entered	Enter the correct password, paying attention to lower/upper case
Device cannot be operated via SmartBlue	Password forgotten	contact Endress+Hauser Service ( <a href="http://www.addresses.endress.com">www.addresses.endress.com</a> )

### 13.1.3 Parameter configuration errors

#### *Parameter configuration errors for level measurements*

Error	Possible cause	Solution
Measured value is incorrect	If measured distance (Setup → Distance) matches the real distance: Calibration error	<ul style="list-style-type: none"> <li>▪ Check the <b>Empty calibration</b> parameter (→ ☰ 114) and correct if necessary.</li> <li>▪ Check the <b>Full calibration</b> parameter (→ ☰ 114) and correct if necessary.</li> <li>▪ Check the linearization and correct if necessary (<b>Linearization</b> submenu (→ ☰ 128)).</li> </ul>
	If measured distance (Setup → Distance) does not match the real distance: An interference echo is present.	Carry out mapping ( <b>Confirm distance</b> parameter (→ ☰ 117)).
No change of measured value on filling/emptying	An interference echo is present.	Carry out mapping ( <b>Confirm distance</b> parameter (→ ☰ 117)).
	Buildup at the probe.	Clean the probe.



Error	Possible cause	Solution
	Error in the echo tracking	Deactivate echo tracking (Expert → Sensor → Echo tracking → Evaluation mode = <b>History off</b> ).
<b>Echo lost</b> diagnostic message appears after the supply voltage is switched on.	Noise level too high during initialization phase.	Enter a new value for the <b>Empty calibration</b> parameter (→ ☰ 114).
Device displays a level when the tank is empty.	Incorrect probe length	<ul style="list-style-type: none"> <li>Perform a probe length correction (<b>Confirm probe length</b> parameter (→ ☰ 143)).</li> <li>Carry out mapping over the entire probe length when the tank is empty (<b>Confirm distance</b> parameter (→ ☰ 117)).</li> </ul>
Wrong slope of the level over the entire measuring range	Wrong bin property selected.	Select the correct <b>Bin type</b> parameter (→ ☰ 113).

## 13.2 Diagnostic information on local display

### 13.2.1 Diagnostic message

Faults detected by the self-monitoring system of the measuring instrument are displayed as a diagnostic message in alternation with the measured value display.

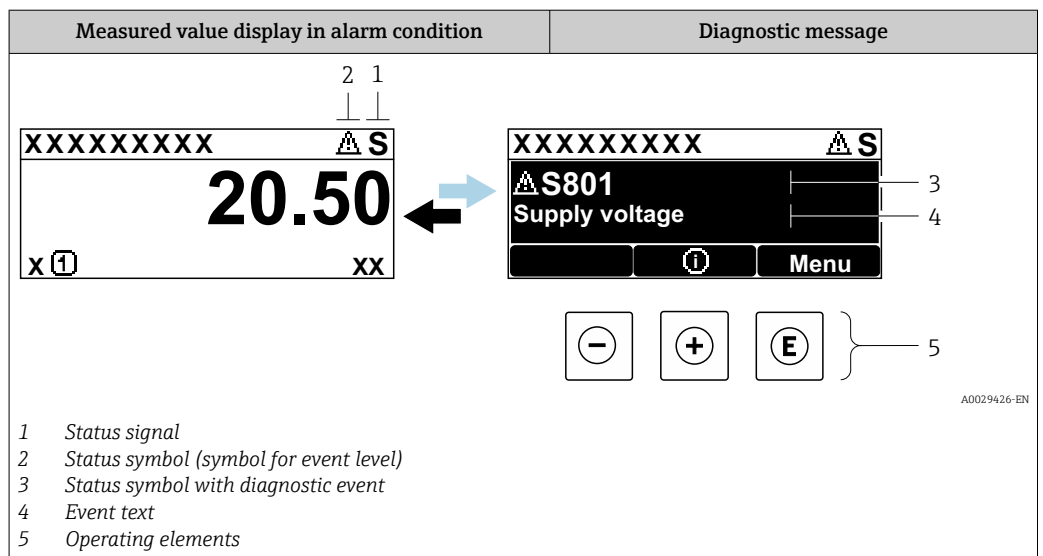

### Status signals

<b>F</b> <small>A0032902</small>	<b>"Failure (F)" option</b> A device error has occurred. The measured value is no longer valid.
<b>C</b> <small>A0032903</small>	<b>"Function check (C)" option</b> The device is in the service mode (e.g. during a simulation).
<b>S</b> <small>A0032904</small>	<b>"Out of specification (S)" option</b> The device is operated: <ul style="list-style-type: none"> <li>Outside its technical specifications (e.g. during startup or cleaning)</li> <li>Outside the configuration performed by the user (e.g. level outside the configured range)</li> </ul>
<b>M</b> <small>A0032905</small>	<b>"Maintenance required (M)" option</b> Maintenance is required. The measured value is still valid.

### Status symbols (symbol for event level)

⊗	<b>"Alarm" status</b> Measurement is interrupted. The signal outputs adopt the defined alarm state. A diagnostic message is generated.
⚠	<b>"Warning" status</b> The device continues to measure. A diagnostic message is generated.

### Diagnostic event and event text

The fault can be identified by means of the diagnostic event. The event text helps you by providing information about the fault. In addition, the associated status symbol is displayed in front of the diagnostic event.

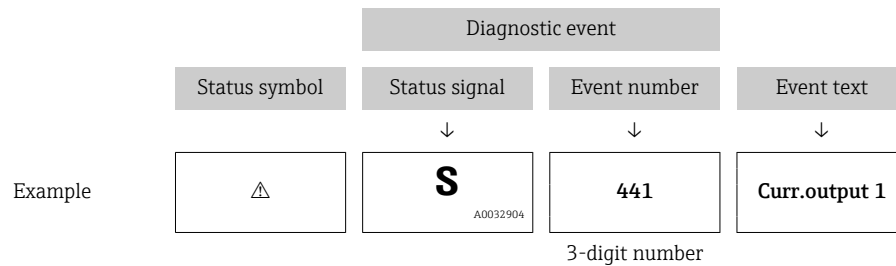

If several diagnostic events are pending at the same time, only the diagnostic message with the highest priority is displayed. Additional queued diagnostic messages can be shown in the **Diagnostic list** submenu.



Past diagnostic messages that are no longer pending are shown as follows:

- On the local display:  
in the **Event logbook** submenu
- In FieldCare:  
via the "Event List/HistoROM" function

### Operating elements

Operating functions in menu, submenu	
+	<b>Plus key</b> Opens the message about the remedial measures.
E	<b>Enter key</b> Opens the operating menu.

### 13.2.2 Calling up remedial measures

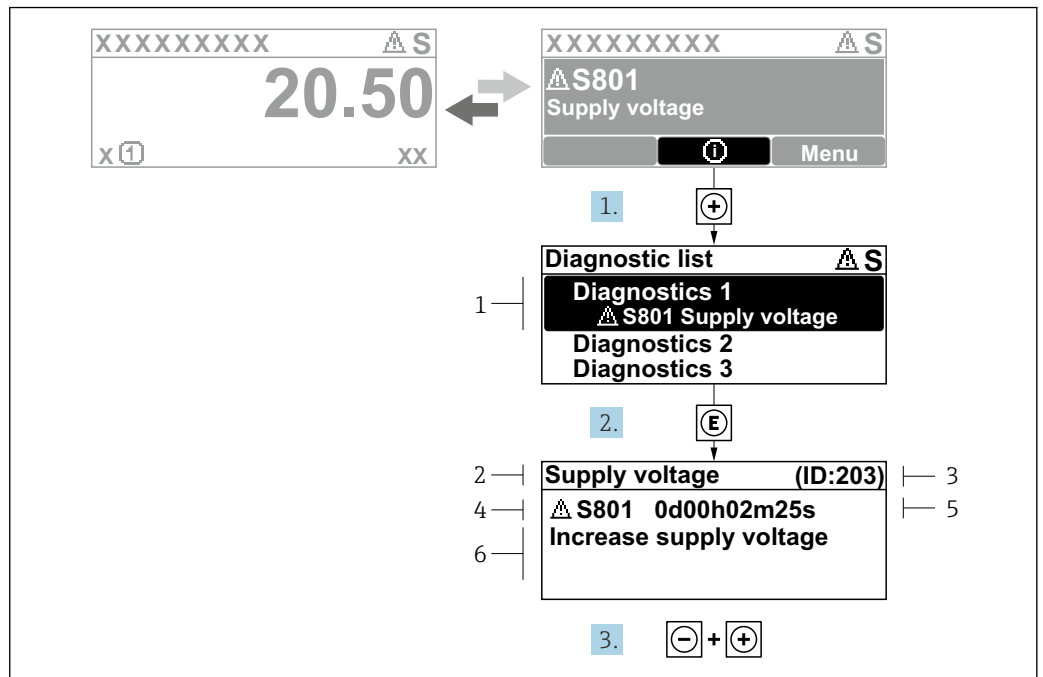

40 Message for remedial measures

- 1 Diagnostic information
- 2 Short text
- 3 Service ID
- 4 Diagnostic behavior with diagnostic code
- 5 Operation time when error occurred
- 6 Remedial measures

The user is in the diagnostic message.

1. Press  $\oplus$  ( $\text{\textcircled{+}}$  symbol).
  - ↳ The **Diagnostic list** submenu opens.
2. Select the desired diagnostic event with  $\oplus$  or  $\ominus$  and press  $\text{\textcircled{E}}$ .
  - ↳ The message for the remedial measures for the selected diagnostic event opens.
3. Press  $\ominus + \oplus$  simultaneously.
  - ↳ The message about the remedial measures closes.

The user is in the **Diagnostics** menu at an entry for a diagnostics event, e.g. in **Diagnostic list** or in **Previous diagnostics**.

1. Press  $\text{\textcircled{E}}$ .
  - ↳ The message for the remedial measures for the selected diagnostic event opens.
2. Press  $\ominus + \oplus$  simultaneously.
  - ↳ The message about the remedial measures closes.

### 13.3 Diagnostic event in the operating tool

If a diagnostic event has occurred in the device, the status signal appears in the top left status area of the operating tool together with the corresponding symbol for the event level according to NAMUR NE 107:

- Failure (F)
- Function check (C)
- Out of specification (S)
- Maintenance required (M)

**A: Via the operating menu**

1. Navigate to the **Diagnostics** menu.
  - ↳ In the **Actual diagnostics** parameter, the diagnostic event is shown with event text.
2. On the right in the display area, hover the cursor over the **Actual diagnostics** parameter.

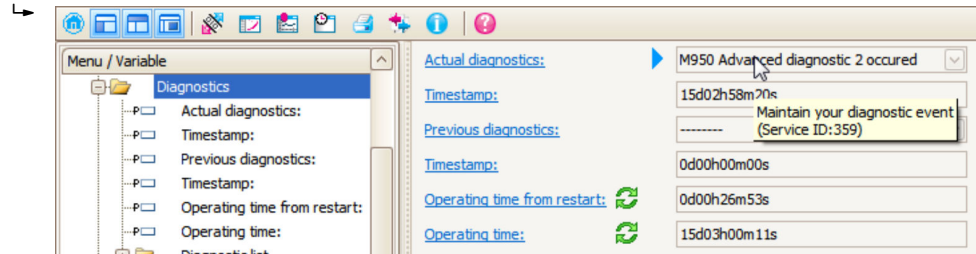

A tool tip with remedy information for the diagnostic event appears.

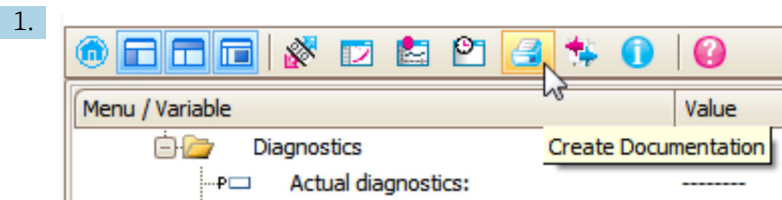
**B: Via the "Create Documentation" function**

Select the "Create documentation" function.

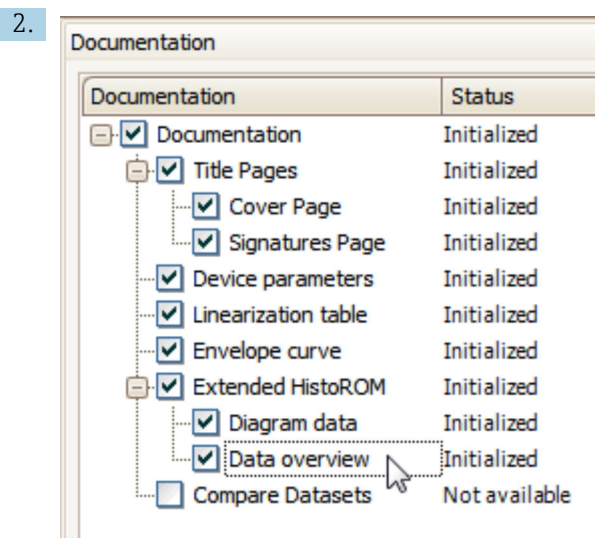

Make sure that "Data overview" is marked.

3. Click "Save as..." and save a PDF of the report.
  - ↳ The report contains the diagnostic messages including remedial measures.

**C: Via the "Event list/Extended HistoROM" function**

1.

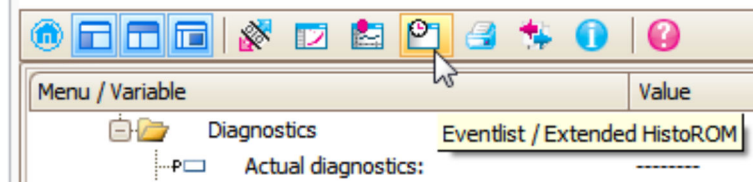

Select the ("Event list/Extended HistoROM") function.

2.

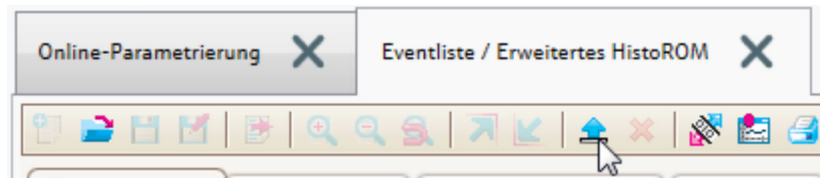

Select the "Load event list" function.

- ↳ The event list including remedial measures is displayed in the "Data overview" window.

## 13.4 Diagnostic list

In the **Diagnostic list** submenu submenu, up to 5 currently pending diagnostic messages can be displayed. If more than 5 messages are pending, the messages with the highest priority are shown on the display.

### Navigation path

Diagnostics → Diagnostic list

### Calling up and closing the remedial measures

1. Press  $\square$ .

- ↳ The message for the remedial measures for the selected diagnostic event opens.

2. Press  $\square$  +  $\boxplus$  simultaneously.

- ↳ The message about the remedial measures closes.

## 13.5 List of diagnostic events

Diagnostic number	Short text	Remedy instructions	Status signal [from the factory]	Diagnostic behavior [from the factory]
<b>Diagnostic of sensor</b>				
003	Broken probe detected	1. Check map 2. Check sensor	F	Alarm
046	Build-up detected	Clean sensor	F	Alarm
104	HF cable	and check sealing 1. Dry HF cable connection 2. Change HF cable	F	Alarm
105	HF cable	1. Tighten HF cable connection 2. Check sensor 3. Change HF cable	F	Alarm
106	Sensor	1. Check sensor 2. Check HF cable 3. Contact service	F	Alarm
<b>Diagnostic of electronic</b>				
242	Software incompatible	1. Check software 2. Flash or change main electronics module	F	Alarm
252	Modules incompatible	1. Check if correct electronic modul is plugged 2. Replace electronic module	F	Alarm
261	Electronic modules	1. Restart device 2. Check electronic modules 3. Change I/O Modul or main electronics	F	Alarm
262	Module connection	1. Check module connections 2. Change electronic modules	F	Alarm
270	Main electronic failure	Change main electronic module	F	Alarm
271	Main electronic failure	1. Restart device 2. Change main electronic module	F	Alarm
272	Main electronic failure	1. Restart device 2. Contact service	F	Alarm
273	Main electronic failure	1. Emergency operation via display 2. Change main electronics	F	Alarm
275	I/O module defective	Change I/O module	F	Alarm
276	I/O module faulty	1. Restart device 2. Change I/O module	F	Alarm
276	I/O module faulty		F	Alarm
282	Data storage	1. Restart device 2. Contact service	F	Alarm
283	Memory content	1. Transfer data or reset device 2. Contact service	F	Alarm
311	Electronic failure	Maintenance required! 1. Do not perform reset 2. Contact service	M	Warning
<b>Diagnostic of configuration</b>				
410	Data transfer	1. Check connection 2. Retry data transfer	F	Alarm
411	Up-/download active	Up-/download active, please wait	C	Warning
412	Processing download	Download active, please wait	C	Warning

Diagnostic number	Short text	Remedy instructions	Status signal [from the factory]	Diagnostic behavior [from the factory]
431	Trim 1 to 2	Carry out trim	C	Warning
435	Linearization	Check linearization table	F	Alarm
437	Configuration incompatible	1. Restart device 2. Contact service	F	Alarm
438	Dataset	1. Check data set file 2. Check device configuration 3. Up- and download new configuration	M	Warning
441	Current output 1 to 2	1. Check process 2. Check current output settings	S	Warning
484	Failure mode simulation	Deactivate simulation	C	Alarm
485	Simulation measured value	Deactivate simulation	C	Warning
491	Current output 1 to 2 simulation	Deactivate simulation	C	Warning
494	Switch output simulation	Deactivate simulation switch output	C	Warning
495	Diagnostic event simulation	Deactivate simulation	C	Warning
585	Simulation distance	Deactivate simulation	C	Warning
<b>Diagnostic of process</b>				
801	Energy too low	Increase supply voltage	S	Warning
803	Current loop	1. Check wiring 2. Change I/O module	F	Alarm
825	Operating temperature	1. Check ambient temperature 2. Check process temperature	S	Warning
825	Operating temperature		F	Alarm
921	Change of reference	1. Check reference configuration 2. Check pressure 3. Check sensor	S	Warning
936	EMC interference	Check installation on EMC	F	Alarm
941	Echo lost	Check parameter 'DC value'	F	Alarm <sup>1)</sup>
942	In safety distance	1. Check level 2. Check safety distance 3. Reset self holding	S	Alarm <sup>1)</sup>
943	In blocking distance	Reduced accuracy Check level	S	Warning
944	Level range	Reduced accuracy Level at process connection	S	Warning
950	Advanced diagnostic 1 to 2 occurred	Maintain your diagnostic event	M	Warning <sup>1)</sup>

1) Diagnostic behavior can be changed.

## 13.6 Event logbook

### 13.6.1 Event history

A chronological overview of the event messages that have occurred is provided in the **Event list**

(This submenu only exists if operating via the local display. In the case of operation via FieldCare, the event list can be displayed with the "Event list/HistoROM" functionality of FieldCare.

#### Navigation path

Diagnostics → Event logbook → Event list

A maximum of 100 event messages can be displayed in chronological order.



The event history includes entries for:

- Diagnostic events
- Information events

In addition to the operating time when the event occurred, each event is also assigned a symbol that indicates whether the event has occurred or is finished:

- Diagnostic event
  - ☹: Occurrence of the event
  - ☺: End of the event
- Information event
  - ☹: Occurrence of the event

#### Calling up and closing the remedial measures

1. Press .
  - ↳ The message for the remedial measures for the selected diagnostic event opens.
2. Press  +  simultaneously.
  - ↳ The message about the remedial measures closes.

### 13.6.2 Filtering the event logbook

Using the **Filter options** parameter, you can define which category of event messages is displayed in the **Event list** submenu.

#### Navigation path

Diagnostics → Event logbook → Filter options

#### Filter categories

- All
- Failure (F)
- Function check (C)
- Out of specification (S)
- Maintenance required (M)
- Information

### 13.6.3 Overview of information events

Info number	Info name
I1000	----- (Device ok)
I1089	Power on
I1090	Configuration reset
I1091	Configuration changed



Info number	Info name
I1092	Embedded HistoROM deleted
I1110	Write protection switch changed
I1137	Electronic changed
I1151	History reset
I1154	Reset terminal voltage min/max
I1155	Reset electronic temperature
I1156	Memory error trend
I1157	Memory error event list
I1184	Display connected
I1185	Display backup done
I1186	Restore via display done
I1187	Settings downloaded with display
I1188	Display data cleared
I1189	Backup compared
I1256	Display: access status changed
I1264	Safety sequence aborted
I1335	Firmware changed
I1397	Fieldbus: access status changed
I1398	CDI: access status changed
I1512	Download started
I1513	Download finished
I1514	Upload started
I1515	Upload finished
I1554	Safety sequence started
I1555	Safety sequence confirmed
I1556	Safety mode off

### 13.7 Firmware history

Date	Firmware version	Modifications	Documentation (FMP56, FMP57, HART)		
			Operating Instructions	Description of Device Parameters	Technical Information
07.2010	01.00.zz	Original software	BA01004F/00/EN/05.10	GP01000F/00/EN/05.10	TI01004F/00/EN/05.10
01.2011	01.01.zz	<ul style="list-style-type: none"> <li>▪ SIL integrated</li> <li>▪ Improvements and bugfixes</li> <li>▪ Additional languages</li> </ul>	<ul style="list-style-type: none"> <li>▪ BA01004F/00/EN/10.10</li> <li>▪ BA01004F/00/EN/13.11</li> <li>▪ BA01004F/00/EN/14.12</li> </ul>	<ul style="list-style-type: none"> <li>▪ GP01000F/00/EN/10.10</li> <li>▪ GP01000F/00/EN/13.11</li> </ul>	<ul style="list-style-type: none"> <li>▪ TI01004F/00/EN/10.10</li> <li>▪ TI01004F/00/EN/13.11</li> <li>▪ TI01004F/00/EN/14.12</li> <li>▪ TI01004F/00/EN/15.12</li> </ul>

Date	Firmware version	Modifications	Documentation (FMP56, FMP57, HART)		
			Operating Instructions	Description of Device Parameters	Technical Information
02.2014	01.02.zz	<ul style="list-style-type: none"> <li>▪ Support of SD03</li> <li>▪ Additional languages</li> <li>▪ HistoROM functionality enhanced</li> <li>▪ "Advanced Diagnostics" function block integrated</li> <li>▪ Improvements and bugfixes</li> </ul>	<ul style="list-style-type: none"> <li>▪ BA01004F/00/EN/15.13</li> <li>▪ BA01004F/00/EN/16.14</li> </ul>	<ul style="list-style-type: none"> <li>▪ GP01000F/00/EN/14.13</li> <li>▪ GP01000F/00/EN/15.14</li> </ul>	<ul style="list-style-type: none"> <li>▪ TI01004F/00/EN/16.13</li> <li>▪ TI01004F/00/EN/17.14</li> </ul>
04.2016	01.03.zz	<ul style="list-style-type: none"> <li>▪ Update to HART 7</li> <li>▪ All 17 languages are available in the device</li> <li>▪ Improvements and bugfixes</li> </ul>	<ul style="list-style-type: none"> <li>▪ BA01004F/00/EN/17.16</li> <li>▪ BA01004F/00/EN/18.16<sup>1)</sup></li> <li>▪ BA01004F/00/EN/20.18<sup>2)</sup></li> </ul>	GP01000F/00/EN/16.16	<ul style="list-style-type: none"> <li>▪ TI01004F/00/EN/18.16</li> <li>▪ TI01004F/00/EN/20.16<sup>1)</sup></li> <li>▪ TI01004F/00/EN/22.18<sup>2)</sup></li> </ul>

1) Contains information on the Heartbeat wizards available in the current DTM version for DeviceCare and. FieldCare

2) Contains information on the Bluetooth interface.



The firmware version can explicitly be ordered via the product structure. In this way it is possible to ensure compatibility of the firmware version with an existing or planned system integration.

## 14 Maintenance

No special maintenance work is required.

### 14.1 Exterior cleaning

When cleaning the exterior, always use cleaning agents that do not corrode the surface of the housing and the seals.

### 14.2 General cleaning instructions

Dirt or buildup may form on the probe depending on the application. A thin, even layer has little impact on the measurement. Thick layers can dampen the signal and reduce the measuring range. Very uneven deposit formation or caking (e.g. due to crystallization) can result in incorrect measurements. In such cases, use a non-contact measuring principle, or regularly inspect the probe for contamination.

Cleaning with sodium hydroxide solution (e.g. in CIP procedures): if the coupling is wetted, larger measurement errors can occur than under reference operating conditions. Wetting can cause temporary incorrect measurements.

## 15 Repair

### 15.1 General information

#### 15.1.1 Repair concept

Under the Endress+Hauser repair concept, devices have a modular design and repairs can be carried out by Endress+Hauser Service or by properly trained customers.

Spare parts are grouped into logical kits with the associated replacement instructions.

For more information on service and spare parts, please contact Endress+Hauser Service.

#### 15.1.2 Repairs to Ex-approved devices

**⚠ WARNING**

**Incorrect repair can compromise electrical safety!**

Explosion hazard!

- ▶ Repairs to Ex-approved devices must be carried out by Endress+Hauser Service or by specialist personnel according to national regulations.
- ▶ Relevant standards and national regulations on hazardous areas, safety instructions and certificates must be observed.
- ▶ Use only original Endress+Hauser spare parts.
- ▶ Please note the device designation on the nameplate. Only identical parts may be used as replacements.
- ▶ Carry out repairs according to the instructions.
- ▶ Only the Endress+Hauser service team is permitted to modify a certified device and convert it to another certified version.

#### 15.1.3 Replacing electronics modules

When electronics modules have been replaced the device does not need to be recalibrated as the parameters are saved in the HistoROM inside the housing. It may be necessary when replacing the main electronics to record a new interference echo suppression.

#### 15.1.4 Replacing a device

Once a complete device has been replaced, the parameters can be transferred back into the device using one of the following methods:

- Using the display module  
Prerequisite: The configuration of the old device was saved previously to the display module.
- Via FieldCare  
Prerequisite: The configuration of the old device was saved previously to the computer using FieldCare.

You can continue measuring without performing a new calibration. Only interference echo suppression may need to be carried out once again.

## 15.2 Spare parts

- Some replaceable measuring instrument components are identified by means of a spare part nameplate. This contains information about the spare part.
- In the connection compartment cover of the device there is a spare part nameplate which contains the following information:
  - A list of the most important spare parts for the measuring instrument, including their ordering information.
  - The URL to the *W@M Device Viewer* ([www.endress.com/deviceviewer](http://www.endress.com/deviceviewer)):  
All the spare parts for the measuring instrument, along with the order code, are listed here and can be ordered. If available, users can also download the associated Installation Instructions.

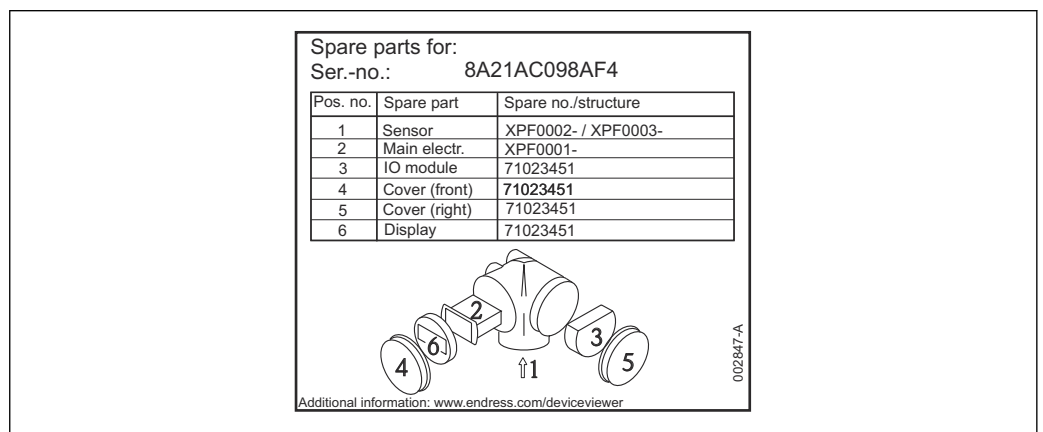

41 Example for spare part nameplate in the connection compartment cover

- i** Measuring instrument serial number:
  - Located on the device and spare part nameplate.
  - Can be read out via the "Serial number" parameter in the "Device information" submenu.

## 15.3 Return

The requirements for safe device return can vary depending on the device type and national legislation.

1. Refer to the web page for information:  
<https://www.endress.com/support/return-material>  
↳ Select the region.
2. If returning the device, pack the device in such a way that it is reliably protected against impact and external influences. The original packaging offers the best protection.

## 15.4 Disposal

-  If required by the Directive 2012/19/EU on waste electrical and electronic equipment (WEEE), the product is marked with the depicted symbol in order to minimize the disposal of WEEE as unsorted municipal waste. Do not dispose of products bearing this marking as unsorted municipal waste. Instead, return them to the manufacturer for disposal under the applicable conditions.

## 16 Accessories

The accessories currently available for the product can be selected at [www.endress.com](http://www.endress.com):

1. Select the product using the filters and search field.
2. Open the product page.
3. Select **Spare parts & Accessories**.

### 16.1 Device-specific accessories

#### 16.1.1 Weather protection cover

The weather protection cover can be ordered together with the device via the "Accessory enclosed" product structure.

It is used to protect against direct sunlight, precipitation and ice.

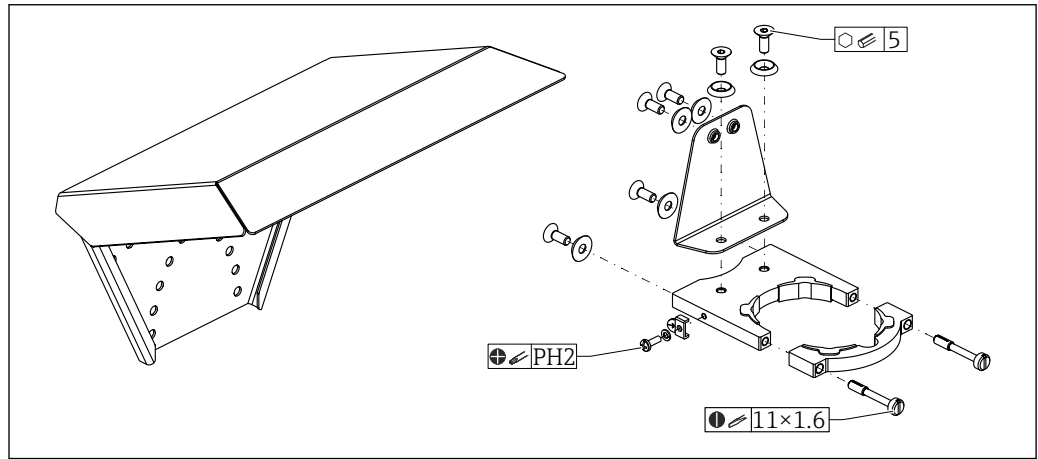

A0051672

42 Overview

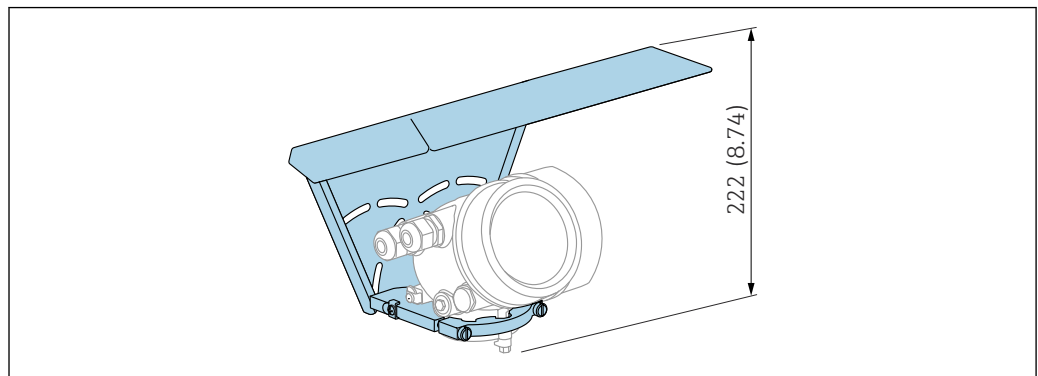

A0015466

43 Height. Unit of measurement mm (in)

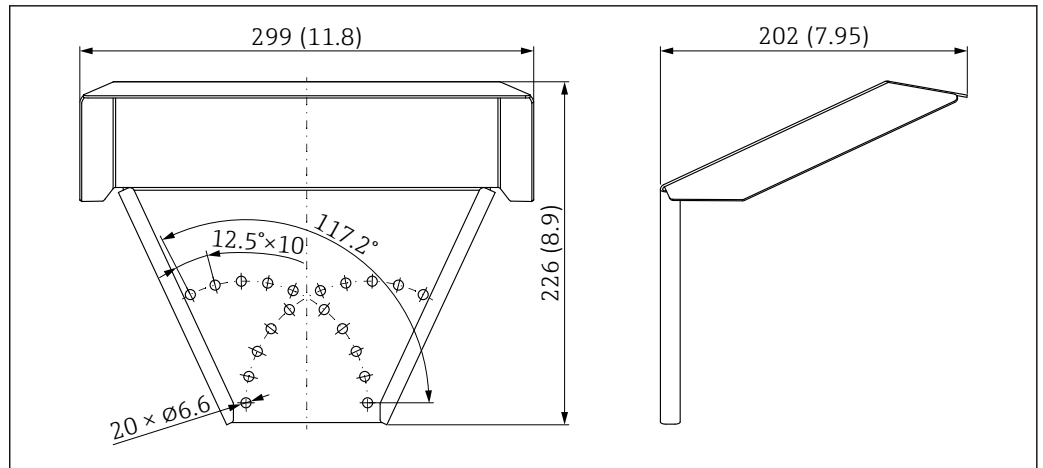

A0015472

44 Dimensions. Unit of measurement mm (in)

**Material**

- Protection cap; 316L (1.4404)
- Bracket; 316L (1.4404)
- Angle bracket; 316L (1.4404)
- Clamping screw; 316L (1.4404) + carbon fiber
- Molded rubber part (4x); EPDM
- Screws; A4
- Disks; A4
- Ground terminal; A4, 316L (1.4404)

**Order number for accessories:**

71162242

**16.1.2 Mounting bracket for electronics housing**

With "remote sensor" device versions (feature O60 in the product structure), the mounting bracket is included in the scope of delivery. It can be ordered as a separate accessory .

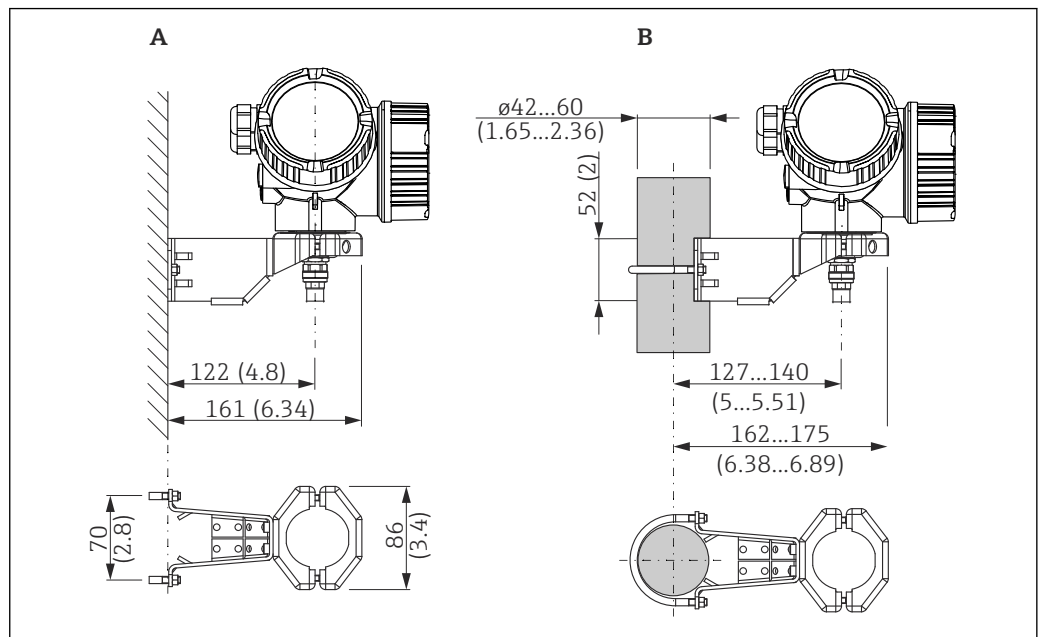

A0014793

45 Mounting bracket for electronics housing; unit: mm (in)

- A Wall mounting
- B Post mounting

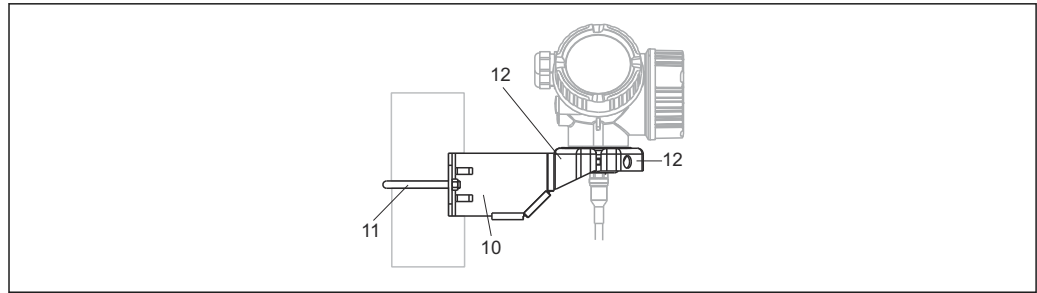

A0015143

46 *Material; mounting bracket*

10 *Bracket, 316L (1.4404)*

11 *Round bracket, 316L (1.4404); screws/nuts, A4-70; distance sleeves, 316L (1.4404)*

12 *Half-shells, 316 L (1.4404)*

**Order number for accessories:**

71102216



### 16.1.3 Rod extension (centering device) HMP40

The rod extension (centering device) HMP40 is ordered via the Product Configurator.

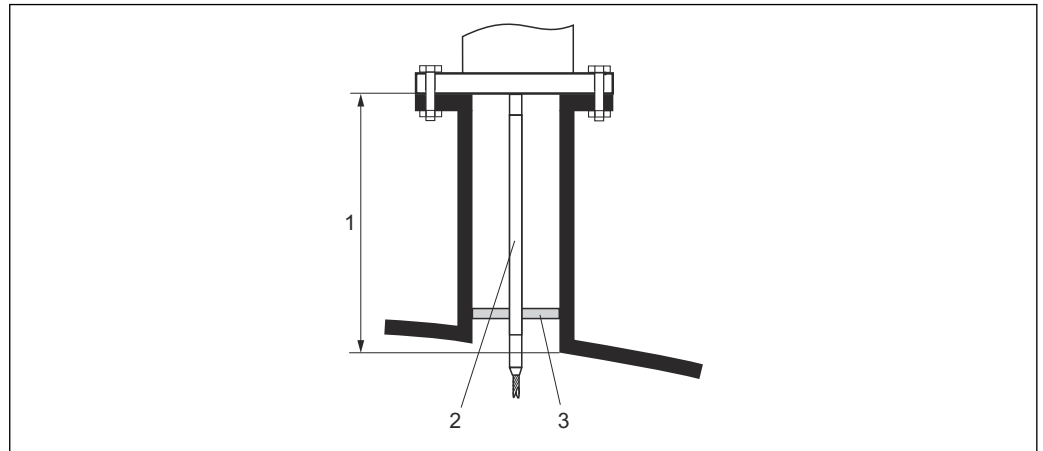

- 1 Nozzle height
- 2 Extension rod
- 3 Centering disk

Permitted temperature at lower edge of nozzle:

- Without centering disk, no restriction
- With centering disk,  $-40$  to  $+150$  °C ( $-40$  to  $+302$  °F)



For details, see SD01002F.

### 16.1.4 Mounting kit, insulated

To secure rope probes so that they are reliably insulated.

Maximum process temperature:  $150$  °C ( $300$  °F)

Mounting set, insulated, can be used for:

- FMP56
- FMP57

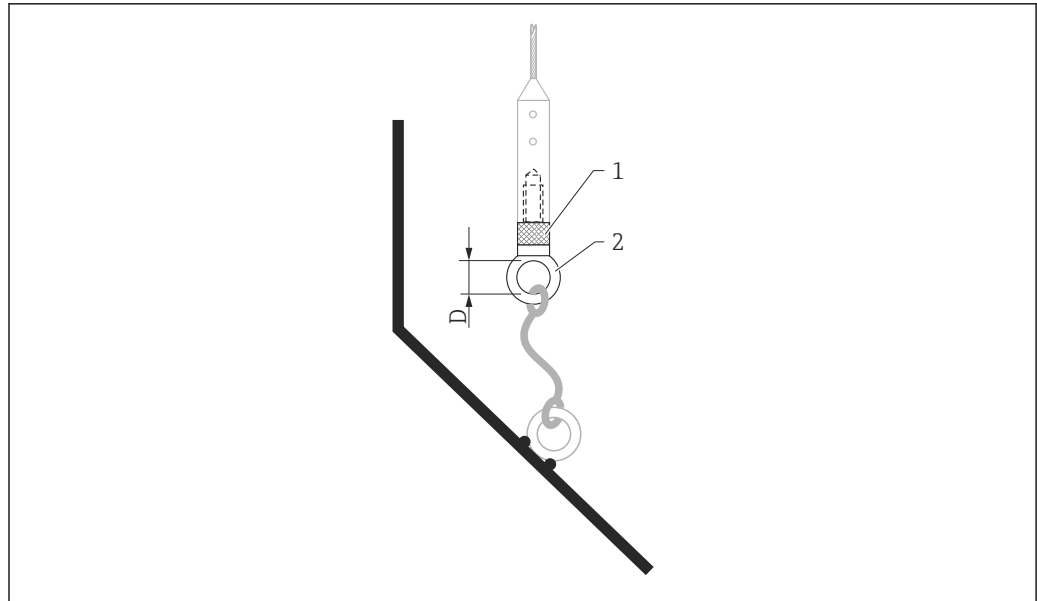

A0013586

47 Scope of delivery of mounting kit:

- 1 Insulation sleeve
- 2 Ring bolt

For rope probes 4 mm ( $\frac{1}{8}$  in) or 6 mm ( $\frac{1}{4}$  in) with PA > steel:  
Diameter D = 20 mm (0.8 in)

**Order number for accessories:**

52014249

For rope probes 6 mm ( $\frac{1}{4}$  in) or 8 mm ( $\frac{1}{2}$  in) with PA > steel:  
Diameter D = 25 mm (1 in)

**Order number for accessories:**

52014250

Due to the risk of electrostatic charge, the insulation sleeve is not suitable for use in hazardous areas! In this case, the probe must be secured so that it is reliably grounded.

**i** The mounting kit can also be ordered directly with the device (Levelflex product structure, feature 620 "Accessory enclosed", version PG "mounting kit, insulated, rope").

### 16.1.5 Remote display FHX50

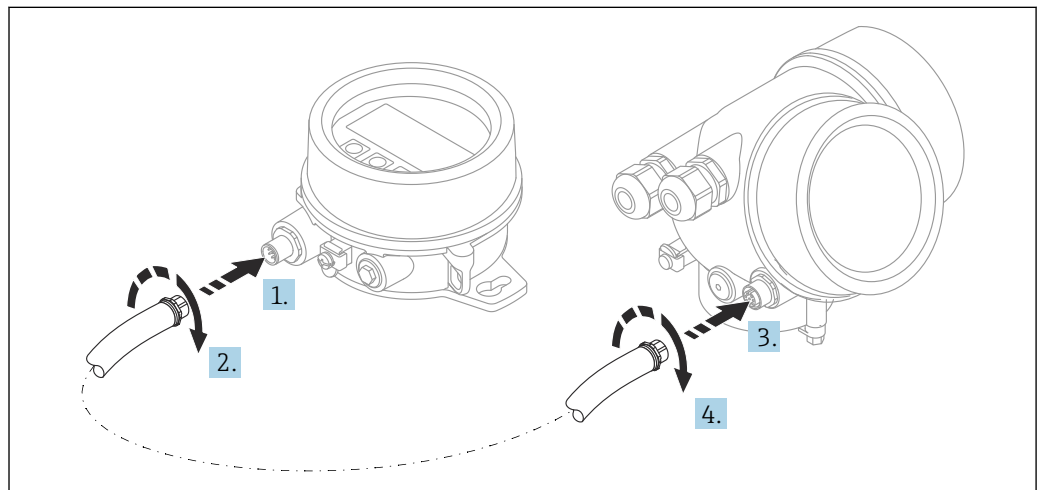

A0019128

**Technical data**

- Material:
    - Plastic PBT
    - 316L/1.4404
    - Aluminum
  - Degree of protection: IP68 / NEMA 6P and IP66 / NEMA 4x
  - Suitable for display modules:
    - SD02 (push buttons)
    - SD03 (touch control)
  - Connecting cable:
    - Cable supplied with device up to 30 m (98 ft)
    - Standard cable provided by customer onsite up to 60 m (196 ft)
  - Ambient temperature: -40 to 80 °C (-40 to 176 °F)
  - Ambient temperature, optionally available for order. -50 to 80 °C (-58 to 176 °F)
- NOTICE** If the temperature is permanently below -40 °C (-40 °F), higher failure rates can be expected.

**Ordering information**

- If the remote display is to be used, the device version "Prepared for display FHX50" must be ordered.  
For FHX50, the option "Prepared for display FHX50" must be selected under "Measuring device version".
- If a measuring instrument has not been ordered with the version "Prepared for display FHX50" and is to be retrofitted with an FHX50, the version "Not prepared for display FHX50" must be ordered for the FHX50 under "Measuring device version". In this case, a retrofit kit for the device is supplied with the FHX50. The kit can be used to prepare the device so that the FHX50 can be used.

**i** Use of the FHX50 may be restricted for transmitters with an approval. A device can only be retrofitted with the FHX50 if the option "Prepared for FHX50" is listed under *Basic specifications*, "Display, operation" in the Safety instructions (XA) for the device.

Also refer to the Safety Instructions (XA) of the FHX50.

Retrofitting is not possible on transmitters with:

- An approval for use in areas with flammable dust (dust ignition-proof approval)
- Type of protection Ex nA

**📖** For details, see "Special Documentation" document SD01007F.

**16.1.6 Overvoltage protection**

The surge arrester for loop-powered devices can be ordered together with the device via the "Accessory mounted" section of the product order structure.

The surge arrester can be used for loop-powered devices.

- 1-channel devices - OVP10
- 2-channel devices - OVP20

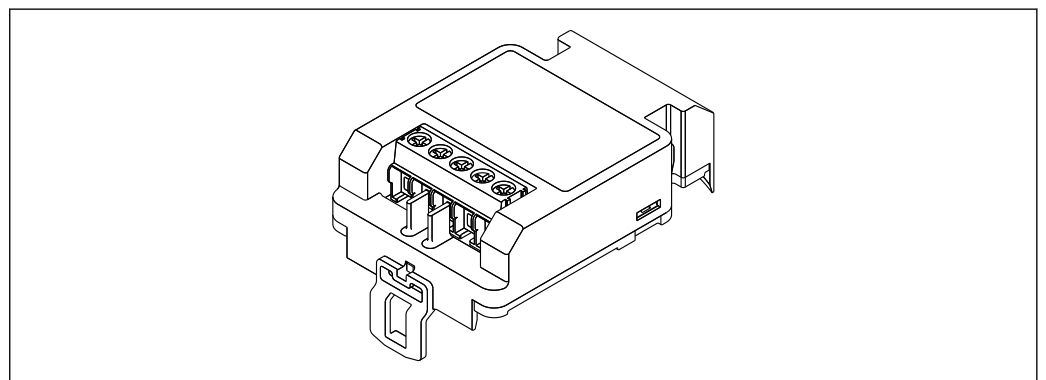

A0021734

**Technical data**

- Resistance per channel:  $2 \times 0.5 \Omega_{\max}$
- Threshold DC voltage: 400 to 700 V
- Threshold surge voltage: < 800 V
- Capacitance at 1 MHz: < 1.5 pF
- Nominal leakage current (8/20  $\mu$ s): 10 kA
- Suitable for conductor cross-sections: 0.2 to 2.5 mm<sup>2</sup> (24 to 14 AWG)

**If retrofitting:**

- Order number for 1-channel devices (OVP10): 71128617
- Order number for 2-channel devices (OVP20): 71128619
- The use of the OVP module may be restricted depending on the transmitter approval. A device may only be retrofitted with the OVP module if the option *NA* (overvoltage protection) is listed under *Optional specifications* in the Safety Instructions (XA) associated with the device.
- In order to keep the necessary safety distances when using the surge arrester module, the housing cover also needs to be replaced when the device is retrofitted. Depending on the housing type, the suitable cover can be ordered using the following order number:
  - Housing GT18: 71185516
  - Housing GT19: 71185518
  - Housing GT20: 71185517



For details, see the "Special Documentation" SD01090F

**16.1.7 Bluetooth module BT10 for HART devices**

The Bluetooth module BT10 can be ordered together with the device via the "Accessory mounted" section of the product order structure.

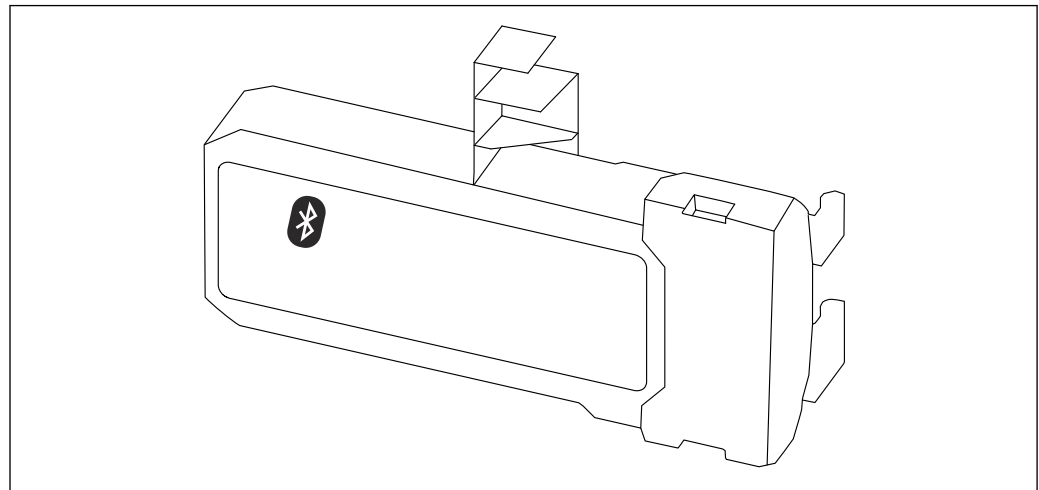

A0036493

**Technical data**

- Quick and easy setup with the SmartBlue app
- No additional tools or adapters needed
- Signal curve via SmartBlue (app)
- Encrypted single point-to-point data transmission (tested by Fraunhofer Institute) and password-protected communication via Bluetooth® wireless technology
- Range under reference conditions:
  - > 10 m (33 ft)
- When the Bluetooth module is used, the minimum supply voltage of the device increases by up to 3 V.

**If retrofitting:**

- Order number: 71377355
- The use of the Bluetooth module may be restricted depending on the transmitter approval. A device may only be retrofitted with the Bluetooth module if the option *NF* (Bluetooth module) is listed under *Optional specifications* in the Safety Instructions (XA) associated with the device.

 For details, see the "Special Documentation" SD02252F

## 16.2 Communication-specific accessories

### Commubox FXA195 HART

For intrinsically safe HART communication with FieldCare via the USB interface

 For details, see "Technical Information" TI00404F

### Commubox FXA291

Connects Endress+Hauser field devices with a CDI interface (= Endress+Hauser Common Data Interface) and the USB port of a computer or laptop

Order number: 51516983

 For details, see "Technical Information" TI00405C

### HART Loop Converter HMX50

Is used to evaluate and convert dynamic HART process variables to analog current signals or limit values

Order number: 71063562

 For details, see "Technical Information" TI00429F and Operating Instructions BA00371F

### WirelessHART adapter SWA70

- Is used for the wireless connection of field devices
- The WirelessHART adapter can be easily integrated into field devices and existing infrastructures, offers data protection and transmission safety and can be operated in parallel with other wireless networks

 For details, see Operating Instructions BA00061S

### Fieldgate FXA42

Fieldgates enable communication between connected 4 to 20 mA, Modbus RS485 and Modbus TCP devices and SupplyCare Hosting or SupplyCare Enterprise. The signals are transmitted either via Ethernet TCP/IP, WLAN or mobile communications (UMTS).

Advanced automation capabilities are available, such as an integrated Web-PLC, OpenVPN and other functions.

 For details, see "Technical Information" TI01297S and Operating Instructions BA01778S.

### SupplyCare Enterprise SCE30B

Inventory management software that displays the level, volume, mass, temperature, pressure, density or other parameters of tanks. The parameters are recorded and transmitted by means of gateways like Fieldgate FXA42, Connect Sensor FXA30B or other gateway types.

This Web-based software is installed on a local server and can also be visualized and operated with mobile terminals such as a smartphone or tablet.

 For details, see Technical Information TI01228S and Operating Instructions BA00055S

### SupplyCare Hosting SCH30

Inventory management software that displays the level, volume, mass, temperature, pressure, density or other parameters of tanks. The parameters are recorded and

transmitted by means of gateways like Fieldgate FXA42, Connect Sensor FXA30B or other gateway types.

SupplyCare Hosting is offered as a hosting service (Software as a Service, SaaS). In the Endress+Hauser portal, the user is provided with the data over the Internet.



For details, see Technical Information TI01229S and Operating Instructions BA00050S

#### **Field Xpert SFX350**

Field Xpert SFX350 is a mobile computer for commissioning and maintenance. It enables efficient device configuration and diagnostics for HART and FOUNDATION Fieldbus devices in the **non-Ex area**.



For details, see Operating Instructions BA01202S

#### **Field Xpert SFX370**

Field Xpert SFX370 is a mobile computer for commissioning and maintenance. It enables efficient device configuration and diagnostics for HART and FOUNDATION Fieldbus devices in the **non-Ex area** and the **Ex area**.



For details, see Operating Instructions BA01202S

## **16.3 Service-specific accessories**

### **DeviceCare SFE100**

Configuration tool for HART, PROFIBUS and FOUNDATION Fieldbus field devices



Technical Information TI01134S

### **FieldCare SFE500**

FDT-based plant asset management tool

It can configure all smart field units in your system and helps you manage them. By using the status information, it is also a simple but effective way of checking their status and condition.



Technical Information TI00028S

## **16.4 System components**

### **16.4.1 Memograph M RSG45**

The Advanced Data Manager is a flexible and powerful system for organizing process values.

The Memograph M is used for electronic acquisition, display, recording, analysis, remote transmission and archiving of analog and digital input signals as well as calculated values.



Technical Information TI01180R and Operating Instructions BA01338R

### **16.4.2 RN42**

Single-channel active barrier with wide-range power supply for safe electrical isolation of 4 to 20 mA standard signal circuits, HART transparent.

















































Technical Information TI01584K and Operating Instructions BA02090K

# 17 Operating menu



























## 17.1 Overview of the operating menu (SmartBlue)























Navigation  SmartBlue

<b>Setup</b>	→  113
Device tag	→  113
Distance unit	→  113
Bin type	→  113
Empty calibration	→  114
Full calibration	→  114
Level	→  115
Distance	→  115
Signal quality	→  116
Confirm distance	→  117
Present mapping	→  118
Mapping end point	→  118
Record map	→  118
<b>▶ Advanced setup</b>	→  120
Locking status	→  120
Access status tooling	→  120
Enter access code	→  121
<b>▶ Level</b>	→  122
Medium type	→  122
Medium property	→  122
Process property	→  123

Advanced process conditions	→  124
Level unit	→  125
Blocking distance	→  125
Level correction	→  126
<b>► Linearization</b>	→  128
Linearization type	→  130
Unit after linearization	→  131
Free text	→  132
Level linearized	→  133
Maximum value	→  133
Diameter	→  133
Intermediate height	→  134
Table mode	→  134
Table number	→  135
Level	→  135
Level	→  136
Customer value	→  136
Activate table	→  136
<b>► Probe settings</b>	→  142
Probe grounded	→  142
Present probe length	→  142
Confirm probe length	→  143
<b>► Safety settings</b>	→  137
Output echo lost	→  137
Value echo lost	→  137



Ramp at echo lost	→  138
Blocking distance	→  125
<b>► Current output 1 to 2</b>	→  146
Assign current output	→  146
Current span	→  147
Fixed current	→  147
Damping output	→  148
Failure mode	→  148
Failure current	→  149
Output current 1 to 2	→  149
<b>► Switch output</b>	→  150
Switch output function	→  150
Assign status	→  151
Assign limit	→  151
Assign diagnostic behavior	→  151
Switch-on value	→  152
Switch-on delay	→  153
Switch-off value	→  153
Switch-off delay	→  154
Failure mode	→  154
Switch status	→  154
Invert output signal	→  154
<b> Diagnostics</b>	→  168
Actual diagnostics	→  168
Timestamp	→  168

Previous diagnostics	→  168
Timestamp	→  169
Operating time from restart	→  169
Operating time	→  162
<b>▶ Diagnostic list</b>	→  170
Diagnostics 1 to 5	→  170
Timestamp 1 to 5	→  170
<b>▶ Measured values</b>	→  175
Distance	→  115
Level linearized	→  133
Output current 1 to 2	→  149
Measured current 1	→  176
Terminal voltage 1	→  176
<b>▶ Device information</b>	→  172
Device tag	→  172
Serial number	→  172
Firmware version	→  172
Device name	→  172
Order code	→  173
Extended order code 1 to 3	→  173
Device revision	→  173
Device ID	→  173

Device type	→ 174
Manufacturer ID	→ 174
► Simulation	→ 181
Assign measurement variable	→ 182
Process variable value	→ 182
Current output 1 to 2 simulation	→ 182
Value current output 1 to 2	→ 183
Switch output simulation	→ 183
Switch status	→ 183
Device alarm simulation	→ 184

## 17.2 Overview of the operating menu (display module)

Navigation  Operating menu

Language	
<b>Setup</b>	→ 113
Device tag	→ 113
Distance unit	→ 113
Bin type	→ 113
Empty calibration	→ 114
Full calibration	→ 114
Level	→ 115
Distance	→ 115
Signal quality	→ 116
<b>► Mapping</b>	→ 119
Confirm distance	→ 119
Mapping end point	→ 119
Record map	→ 119
Distance	→ 119
<b>► Advanced setup</b>	→ 120
Locking status	→ 120
Access status display	→ 121
Enter access code	→ 121
<b>► Level</b>	→ 122
Medium type	→ 122
Medium property	→ 122
Process property	→ 123

























Advanced process conditions	→ 124
Level unit	→ 125
Blocking distance	→ 125
Level correction	→ 126
<b>► Linearization</b>	→ 128
Linearization type	→ 130
Unit after linearization	→ 131
Free text	→ 132
Maximum value	→ 133
Diameter	→ 133
Intermediate height	→ 134
Table mode	→ 134
<b>► Edit table</b>	
Level	
Customer value	
Activate table	→ 136
<b>► Safety settings</b>	→ 137
Output echo lost	→ 137
Value echo lost	→ 137
Ramp at echo lost	→ 138
Blocking distance	→ 125
<b>► SIL/WHG confirmation</b>	→ 140
<b>► Deactivate SIL/WHG</b>	→ 141
Reset write protection	→ 141
Code incorrect	→ 141



▶ Probe settings	→ 142
Probe grounded	→ 142
▶ Probe length correction	→ 144
Confirm probe length	→ 144
Present probe length	→ 142
▶ Current output 1 to 2	→ 146
Assign current output	→ 146
Current span	→ 147
Fixed current	→ 147
Damping output	→ 148
Failure mode	→ 148
Failure current	→ 149
Output current 1 to 2	→ 149
▶ Switch output	→ 150
Switch output function	→ 150
Assign status	→ 151
Assign limit	→ 151
Assign diagnostic behavior	→ 151
Switch-on value	→ 152
Switch-on delay	→ 153
Switch-off value	→ 153
Switch-off delay	→ 154
Failure mode	→ 154
Switch status	→ 154
Invert output signal	→ 154

► Display	→ 156
Language	→ 156
Format display	→ 156
Value 1 to 4 display	→ 158
Decimal places 1 to 4	→ 158
Display interval	→ 158
Display damping	→ 159
Header	→ 159
Header text	→ 159
Separator	→ 160
Number format	→ 160
Decimal places menu	→ 160
Backlight	→ 160
Contrast display	→ 161
► Configuration backup display	→ 162
Operating time	→ 162
Last backup	→ 162

Configuration management	→ 162
Comparison result	→ 163
▶ Administration	→ 165
▶ Define access code	→ 167
Define access code	→ 167
Confirm access code	→ 167
Device reset	→ 165
🔍 Diagnostics	→ 168
Actual diagnostics	→ 168
Previous diagnostics	→ 168
Operating time from restart	→ 169
Operating time	→ 162
▶ Diagnostic list	→ 170
Diagnostics 1 to 5	→ 170
▶ Event logbook	→ 171
Filter options	
▶ Event list	→ 171
▶ Device information	→ 172
Device tag	→ 172
Serial number	→ 172
Firmware version	→ 172
Device name	→ 172
Order code	→ 173
Extended order code 1 to 3	→ 173
Device revision	→ 173



Device ID	→  173
Device type	→  174
Manufacturer ID	→  174
<b>► Measured values</b>	→  175
Distance	→  115
Level linearized	→  133
Output current 1 to 2	→  149
Measured current 1	→  176
Terminal voltage 1	→  176
<b>► Data logging</b>	→  177
Assign channel 1 to 4	→  177
Logging interval	→  178
Clear logging data	→  178
<b>► Display channel 1 to 4</b>	→  179
<b>► Simulation</b>	→  181
Assign measurement variable	→  182
Process variable value	→  182
Current output 1 to 2 simulation	→  182
Value current output 1 to 2	→  183
Switch output simulation	→  183
Switch status	→  183
Device alarm simulation	→  184
<b>► Device check</b>	→  185
Start device check	→  185
Result device check	→  185

Last check time	→  185
Level signal	→  186
Launch signal	→  186

























### 17.3 Overview of the operating menu (operating tool)

Navigation



Operating menu

<b>Setup</b>	→ 113
Device tag	→ 113
Distance unit	→ 113
Bin type	→ 113
Empty calibration	→ 114
Full calibration	→ 114
Level	→ 115
Distance	→ 115
Signal quality	→ 116
Confirm distance	→ 117
Present mapping	→ 118
Mapping end point	→ 118
Record map	→ 118
<b>▶ Advanced setup</b>	→ 120
Locking status	→ 120
Access status tooling	→ 120
Enter access code	→ 121
<b>▶ Level</b>	→ 122
Medium type	→ 122
Medium property	→ 122
Process property	→ 123
Advanced process conditions	→ 124
Level unit	→ 125

Blocking distance	→  125
Level correction	→  126
<b>► Linearization</b>	→  128
Linearization type	→  130
Unit after linearization	→  131
Free text	→  132
Level linearized	→  133
Maximum value	→  133
Diameter	→  133
Intermediate height	→  134
Table mode	→  134
Table number	→  135
Level	→  135
Level	→  136
Customer value	→  136
Activate table	→  136
<b>► Safety settings</b>	→  137
Output echo lost	→  137
Value echo lost	→  137
Ramp at echo lost	→  138
Blocking distance	→  125
<b>► SIL/WHG confirmation</b>	→  140
<b>► Deactivate SIL/WHG</b>	→  141
Reset write protection	→  141
Code incorrect	→  141

▶ Probe settings	→ 142
Probe grounded	→ 142
Present probe length	→ 142
Confirm probe length	→ 143
▶ Current output 1 to 2	→ 146
Assign current output	→ 146
Current span	→ 147
Fixed current	→ 147
Damping output	→ 148
Failure mode	→ 148
Failure current	→ 149
Output current 1 to 2	→ 149
▶ Switch output	→ 150
Switch output function	→ 150
Assign status	→ 151
Assign limit	→ 151
Assign diagnostic behavior	→ 151
Switch-on value	→ 152
Switch-on delay	→ 153
Switch-off value	→ 153
Switch-off delay	→ 154
Failure mode	→ 154
Switch status	→ 154
Invert output signal	→ 154





▶ Display	→ 156
Language	→ 156
Format display	→ 156
Value 1 to 4 display	→ 158
Decimal places 1 to 4	→ 158
Display interval	→ 158
Display damping	→ 159
Header	→ 159
Header text	→ 159
Separator	→ 160
Number format	→ 160
Decimal places menu	→ 160
Backlight	→ 160
Contrast display	→ 161
▶ Configuration backup display	→ 162
Operating time	→ 162
Last backup	→ 162
Configuration management	→ 162
Backup state	→ 163
Comparison result	→ 163
▶ Administration	→ 165
Define access code	
Device reset	→ 165
🔍 Diagnostics	→ 168
Actual diagnostics	→ 168

Timestamp	→ 168
Previous diagnostics	→ 168
Timestamp	→ 169
Operating time from restart	→ 169
Operating time	→ 162
<b>► Diagnostic list</b>	→ 170
Diagnostics 1 to 5	→ 170
Timestamp 1 to 5	→ 170
<b>► Device information</b>	→ 172
Device tag	→ 172
Serial number	→ 172
Firmware version	→ 172
Device name	→ 172
Order code	→ 173
Extended order code 1 to 3	→ 173
Device revision	→ 173
Device ID	→ 173
Device type	→ 174
Manufacturer ID	→ 174
<b>► Measured values</b>	→ 175
Distance	→ 115
Level linearized	→ 133
Output current 1 to 2	→ 149
Measured current 1	→ 176
Terminal voltage 1	→ 176











▶ Data logging	→ 177
Assign channel 1 to 4	→ 177
Logging interval	→ 178
Clear logging data	→ 178
▶ Simulation	→ 181
Assign measurement variable	→ 182
Process variable value	→ 182
Current output 1 to 2 simulation	→ 182
Value current output 1 to 2	→ 183
Switch output simulation	→ 183
Switch status	→ 183
Device alarm simulation	→ 184
▶ Device check	→ 185
Start device check	→ 185
Result device check	→ 185
Last check time	→ 185
Level signal	→ 186
Launch signal	→ 186
▶ Heartbeat	→ 187



## 17.4 "Setup" menu

- 
  -  : Indicates how to navigate to the parameter using the display and operating module
  -  : Indicates how to navigate to the parameter using operating tools (e.g. FieldCare)
  -  : Indicates parameters that can be locked via the access code.

Navigation   Setup

<b>Device tag</b>		
<b>Navigation</b>	  Setup → Device tag	
<b>Description</b>	Enter a unique name for the measuring point to identify the device quickly within the plant.	
<b>User entry</b>	Character string comprising numbers, letters and special characters (32)	
<b>Distance unit</b>		
<b>Navigation</b>	  Setup → Distance unit	
<b>Description</b>	Used for the basic calibration (Empty / Full).	
<b>Selection</b>	<i>SI units</i> <ul style="list-style-type: none"> <li>■ mm</li> <li>■ m</li> </ul>	<i>US units</i> <ul style="list-style-type: none"> <li>■ ft</li> <li>■ in</li> </ul>
<b>Bin type</b>		
<b>Navigation</b>	  Setup → Bin type	
<b>Prerequisite</b>	<b>Medium type</b> (→  122) = <b>Solid</b>	
<b>Description</b>	Specify bin type.	
<b>Selection</b>	<ul style="list-style-type: none"> <li>■ Concrete</li> <li>■ Plastic wood</li> <li>■ Metallic</li> <li>■ Aluminium</li> </ul>	

---

**Empty calibration**

---

**Navigation** Setup → Empty calibr.**Description**

Distance between process connection and minimum level (0%).

**User entry**

Depending on the probe

**Factory setting**

Depending on the probe

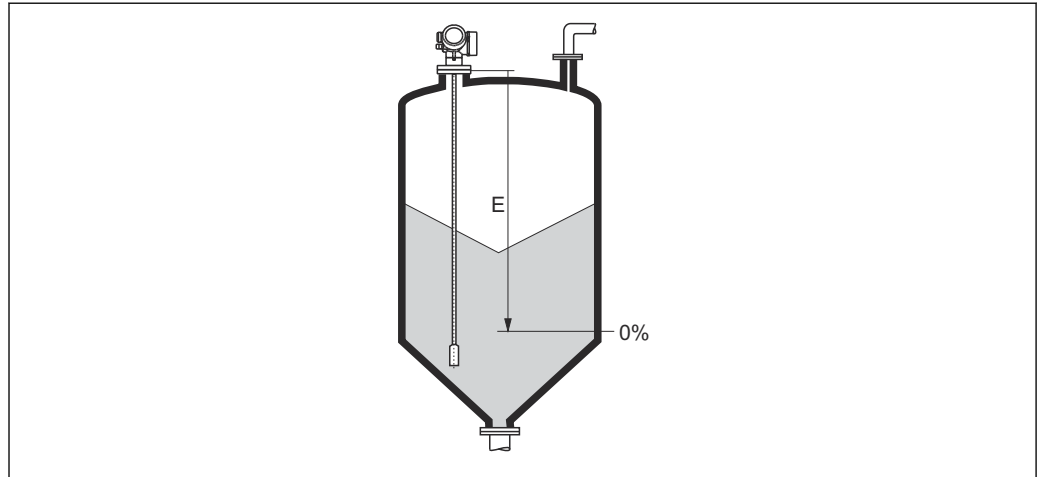
**Additional information**

A0013180

 48 *Empty calibration (E) for level measurements in bulk solids.*

---

**Full calibration**

---

**Navigation** Setup → Full calibr.**Description**

Distance between minimum level (0%) and maximum level (100%).

**User entry**

Depending on the probe

**Factory setting**

Depending on the probe

**Additional information**

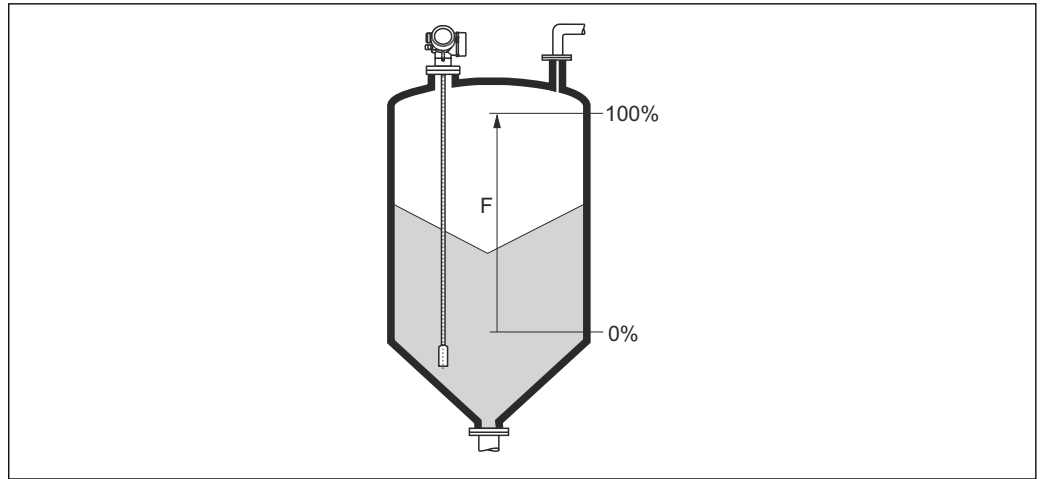

A0013191

49 Full calibration (F) for level measurements in bulk solids

---

**Level**

---

**Navigation**

Setup → Level

**Description**

Displays measured level  $L_L$  (before linearization).

**Additional information**

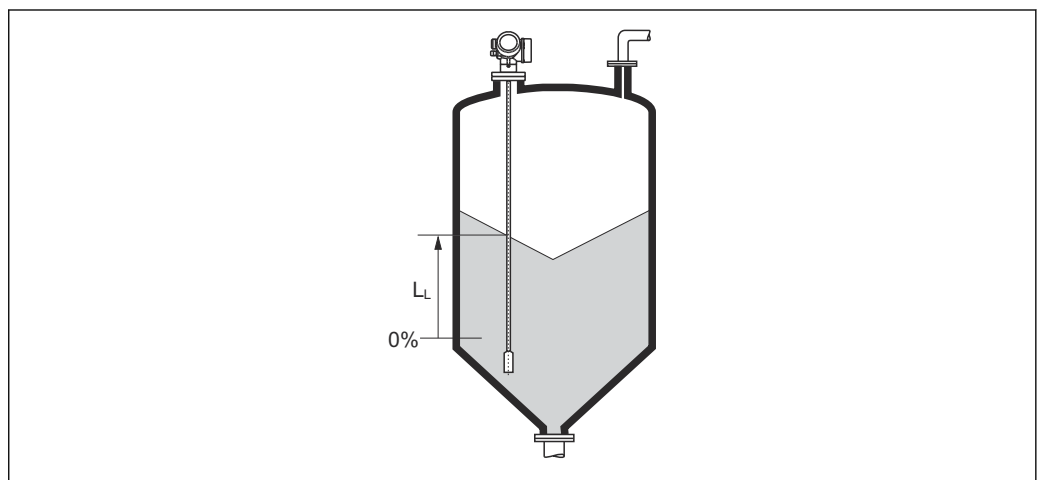

A0013196

50 Level in case of bulk solid measurements

**i** The unit is defined in the **Level unit** parameter (→ 125).

---

**Distance**

---

**Navigation**

Setup → Distance

**Description**

Displays the measured distance  $D_L$  between the reference point (lower edge of the flange or threaded connection) and the level.

## Additional information

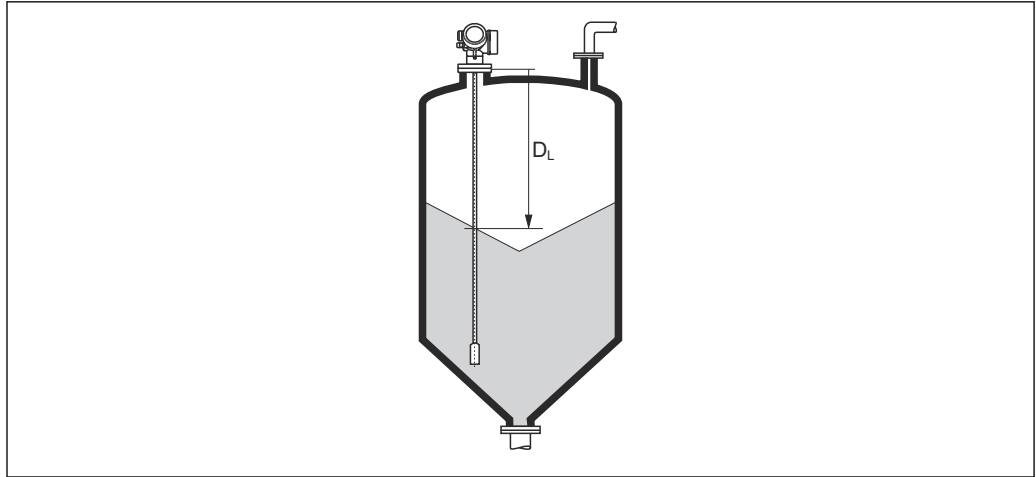

A0013201

51 Distance for bulk solid measurements

**i** The unit is defined in the **Distance unit** parameter (→ 113).

## Signal quality

## Navigation

Setup → Signal quality

## Description

Displays the signal quality of the evaluated echo.

## Additional information

**Meaning of the display options**





- **Strong**  
The evaluated echo exceeds the threshold by at least 10 mV.
- **Medium**  
The evaluated echo exceeds the threshold by at least 5 mV.
- **Weak**  
The evaluated echo exceeds the threshold by less than 5 mV.
- **No signal**  
The device does not find a usable echo.

The signal quality indicated in this parameter always refers to the currently evaluated echo: either the level/interface echo <sup>1)</sup> or the end-of-probe echo. To differentiate between these two, the quality of the end-of-probe echo is always displayed in brackets.

**i** In case of a lost echo (**Signal quality = No signal**) the device generates the following error message:

- F941, for **Output echo lost** (→ 137) = **Alarm**.
- S941, if another option has been selected in **Output echo lost** (→ 137).

1) Of these two echos the one with the lower quality is indicated.

Confirm distance 	
<b>Navigation</b>	 Setup → Confirm distance
<b>Description</b>	Specify, whether the measured distance matches the real distance. Depending on the selection the device automatically sets the range of mapping.
<b>Selection</b>	<ul style="list-style-type: none"> <li>■ Manual map</li> <li>■ Distance ok</li> <li>■ Distance unknown</li> <li>■ Distance too small<sup>*</sup></li> <li>■ Distance too big<sup>*</sup></li> <li>■ Tank empty</li> <li>■ Delete map</li> </ul>
<b>Additional information</b>	<p><b>Meaning of the options</b></p> <ul style="list-style-type: none"> <li>■ <b>Manual map</b> To be selected if the range of mapping is to be defined manually in the <b>Mapping end point</b> parameter (→  118). In this case it is not necessary to confirm the distance.</li> <li>■ <b>Distance ok</b> To be selected if the measured distance matches the actual distance. The device performs a mapping.</li> <li>■ <b>Distance unknown</b> To be selected if the actual distance is unknown. A mapping can not be performed in this case.</li> <li>■ <b>Distance too small</b> To be selected if the measured distance is smaller than the actual distance. The device searches for the next echo and returns to the <b>Confirm distance</b> parameter. The distance is recalculated and displayed. The comparison must be repeated until the displayed distance matches the actual distance. After this, the recording of the map can be started by selecting <b>Distance ok</b>.</li> <li>■ <b>Distance too big<sup>2)</sup></b> To be selected if the measured distance exceeds the actual distance. The device adjusts the signal evaluation and returns to the <b>Confirm distance</b> parameter. The distance is recalculated and displayed. The comparison must be repeated until the displayed distance matches the actual distance. After this, the recording of the map can be started by selecting <b>Distance ok</b>.</li> <li>■ <b>Tank empty</b> To be selected if the tank is completely empty. The device records a mapping covering the complete measuring range. To be selected if the tank is completely empty. The device records a mapping covering the complete measuring range minus <b>Map gap to LN</b>.</li> <li>■ <b>Factory map</b> To be selected if the present mapping curve (if one exists) is to be deleted. The device returns to the <b>Confirm distance</b> parameter and a new mapping can be recorded.</li> </ul> <p> When operating via the display module, the measured distance is displayed together with this parameter for reference purposes.</p> <p> If the teaching procedure with the <b>Distance too small</b> option or the <b>Distance too big</b> option is quit before the distance has been confirmed, a map is <b>not</b> recorded and the teaching procedure is reset after 60 s.</p>

\* Visibility depends on order options or device settings

2) Only available for "Expert → Sensor → Echo tracking → **Evaluation mode** parameter" = "Short time history" or "Long time history"

---

**Present mapping**





---

<b>Navigation</b>	 Setup → Present mapping
<b>Description</b>	Indicates up to which distance a mapping has already been recorded.

---

**Mapping end point**





---

<b>Navigation</b>	 Setup → Map. end point
<b>Prerequisite</b>	<b>Confirm distance</b> (→  117) = <b>Manual map</b> or <b>Distance too small</b>
<b>Description</b>	Specify new end of the mapping.
<b>User entry</b>	0 to 200 000.0 m
<b>Additional information</b>	<p>This parameter defines up to which distance the new mapping is to be recorded. The distance is measured from the reference point, i.e. from the lower edge of the mounting flange or the threaded connection.</p> <p> For reference purposes the <b>Present mapping</b> parameter (→  118) is displayed together with this parameter. It indicates up to which distance a mapping has already been recorded.</p>



---

**Record map**

---

<b>Navigation</b>	 Setup → Record map
<b>Prerequisite</b>	<b>Confirm distance</b> (→  117) = <b>Manual map</b> or <b>Distance too small</b>
<b>Description</b>	Start recording of the map.
<b>Selection</b>	<ul style="list-style-type: none"> <li>■ No</li> <li>■ Record map</li> <li>■ Delete map</li> </ul>
<b>Additional information</b>	<p><b>Meaning of the options</b></p> <ul style="list-style-type: none"> <li>■ <b>No</b> The map is not recorded.</li> <li>■ <b>Record map</b> The map is recorded. After the recording is completed, the new measured distance and the new mapping range appear on the display. When operating via the local display, these values must be confirmed by pressing .</li> <li>■ <b>Delete map</b> The mapping (if one exists) is deleted and the device displays the recalculated measured distance and the mapping range. When operating via the local display, these values must be confirmed by pressing .</li> </ul>

### 17.4.1 "Mapping" wizard

-  The **Mapping** wizard is only available when operating via the local display. When operating via an operating tool, all parameters concerning the mapping are located directly in the **Setup** menu (→  113).
-  In the **Mapping** wizard two parameters are displayed simultaneously on the display module at any one time. The upper parameter can be edited, whereas the lower parameter is displayed for reference purposes only.

Navigation  Setup → Mapping

---

#### Confirm distance

Navigation  Setup → Mapping → Confirm distance

Description →  117

---

#### Mapping end point

Navigation  Setup → Mapping → Map. end point

Description →  118

---

#### Record map

Navigation  Setup → Mapping → Record map

Description →  118

---

#### Distance

Navigation  Setup → Mapping → Distance

Description →  115

## 17.4.2 "Advanced setup" submenu



Navigation  Setup → Advanced setup

---

### Locking status

---

#### Navigation

  Setup → Advanced setup → Locking status

#### Description

Indicates the write protection with the highest priority that is currently active.

#### User interface

- Hardware locked
- SIL locked
- CT active - defined parameters
- WHG locked
- Temporarily locked

#### Additional information

##### Meaning and priorities of the types of write protection

##### ■ Hardware locked (priority 1)

The DIP switch for hardware locking is activated on the main electronics module. This locks write access to the parameters.

##### ■ SIL locked (priority 2)

The SIL mode is activated. Writing access to the relevant parameters is denied.

##### ■ WHG locked (priority 3)

The WHG mode is activated. Writing access to the relevant parameters is denied.

##### ■ Temporarily locked (priority 4)

Write access to the parameters is temporarily locked on account of internal processes in progress in the device (e.g. data upload/download, reset etc.). The parameters can be modified as soon as the processes are complete.

 On the display module, the -symbol appears in front of parameters that cannot be modified since they are write-protected.

---

### Access status tooling

---

#### Navigation



 Setup → Advanced setup → Access stat.tool

#### Description

Shows the access authorization to the parameters via the operating tool.

#### Additional information

 The access authorization can be changed via the **Enter access code** parameter (→  121).





 If additional write protection is active, this restricts the current access authorization even further. The write protection status can be viewed via the **Locking status** parameter (→  120).



---

## Access status display





---

<b>Navigation</b>	 Setup → Advanced setup → Access stat.disp
<b>Prerequisite</b>	The device has a local display.
<b>Description</b>	Indicates access authorization to parameters via local display.
<b>Additional information</b>	<p> The access authorization can be changed via the <b>Enter access code</b> parameter (→  121).</p> <p> If additional write protection is active, this restricts the current access authorization even further. The write protection status can be viewed via the <b>Locking status</b> parameter (→  120).</p>

---

## Enter access code



---

<b>Navigation</b>	 Setup → Advanced setup → Ent. access code
<b>Description</b>	Enter access code to disable write protection of parameters.
<b>User entry</b>	0 to 9999
<b>Additional information</b>	<ul style="list-style-type: none"> <li>▪ The customer-specific access code that was defined in the <b>Define access code</b> parameter (→  165) must be entered for local operation.</li> <li>▪ If an incorrect access code is entered, users retain their current access authorization.</li> <li>▪ The write protection affects all parameters marked with the  symbol in the document. On the local display, the  symbol in front of a parameter indicates that the parameter is write-protected.</li> <li>▪ If no key is pressed for 10 minutes or the user goes from the navigation and editing mode back to the measured value display mode, the device automatically locks the write-protected parameters after another 60 s.</li> </ul> <p> Please contact your Endress+Hauser Sales Center if you lose your access code.</p>



**"Level" submenu**

Navigation  Setup → Advanced setup → Level

**Medium type** 

<b>Navigation</b>	 Setup → Advanced setup → Level → Medium type
<b>Description</b>	Specify type of medium.
<b>User interface</b>	<ul style="list-style-type: none"> <li>▪ Liquid</li> <li>▪ Solid</li> </ul>
<b>Factory setting</b>	FMP56, FMP57: <b>Solid</b>
<b>Additional information</b>	 This parameter determines the value of several other parameters and strongly influences the complete signal evaluation. Therefore, it is strongly recommended <b>not to change</b> the factory setting.

**Medium property** 

<b>Navigation</b>	 Setup → Advanced setup → Level → Medium property
<b>Prerequisite</b>	<b>EOP level evaluation ≠ Fix DC</b>
<b>Description</b>	Specify the dielectric constant $\epsilon_r$ of the medium.
<b>Selection</b>	<ul style="list-style-type: none"> <li>▪ Unknown</li> <li>▪ DC 1.4 ... 1.6</li> <li>▪ DC 1.6 ... 1.9</li> <li>▪ DC 1.9 ... 2.5</li> <li>▪ DC 2.5 ... 4</li> <li>▪ DC 4 ... 7</li> <li>▪ DC 7 ... 15</li> <li>▪ DC &gt; 15</li> </ul>
<b>Factory setting</b>	Depends on the <b>Medium type</b> (→  122) and <b>Medium group</b> parameters.

**Additional information**

*Dependency of "Medium type" and "Medium group"*

Medium type (→ ⓘ 122)	Medium group	Medium property
Solid		Unknown
Liquid	Water based (DC >= 4)	DC 4 ... 7
	Others	Unknown

**i** For the relative permittivity values ( $\epsilon_r$  values) of many media commonly used in industry, please refer to:

- Relative permittivity ( $\epsilon_r$  value), Compendium CP01076F
- The Endress+Hauser "DC Values app" (available for Android and iOS)

**i** If **EOP level evaluation = Fix DC**, the exact dielectric constant must be specified in the **DC value** parameter. The **Medium property** parameter therefore does not apply in this case.

---

**Process property**



**Navigation**

☰☰ Setup → Advanced setup → Level → Process property

**Description**

Specify typical rate of level change.

**Selection**

**For "Medium type" = "Liquid"**

- Very fast > 10 m (400 in)/min
- Fast > 1 m (40 in)/min
- Standard < 1 m (40in) /min
- Medium < 10 cm (4in) /min
- Slow < 1 cm (0.4in) /min
- No filter / test

**For "Medium type" = "Solid"**

- Very fast > 100 m (333 ft) /h
- Fast > 10 m (33 ft) /h
- Standard < 10 m (33 ft) /h
- Medium < 1 m (3ft) /h
- Slow < 0.1 m (0.3ft) /h
- No filter / test

**Additional information**

The device adjusts the signal evaluation filters and the damping of the output signal to the typical rate of level change defined in this parameter:

*For "Operating mode" = "Level" and "Medium type" = "Liquid"*

Process property	Step response time / s
Very fast > 10 m (400 in)/min	5
Fast > 1 m (40 in)/min	5
Standard < 1 m (40in) /min	14
Medium < 10 cm (4in) /min	39
Slow < 1 cm (0.4in) /min	76
No filter / test	< 1

For "Operating mode" = "Level" and "Medium type" = "Solid"

Process property	Step response time / s
Very fast > 100 m (333 ft) /h	37
Fast > 10 m (33 ft) /h	37
Standard < 10 m (33 ft) /h	74
Medium < 1 m (3ft) /h	146
Slow < 0.1 m (0.3ft) /h	290
No filter / test	< 1

For "Operating mode" = "Interface" or "Interface with capacitance"

Process property	Step response time / s
Very fast > 10 m (400 in)/min	5
Fast > 1 m (40 in)/min	5
Standard < 1 m (40in) /min	23
Medium < 10 cm (4in) /min	47
Slow < 1 cm (0.4in) /min	81
No filter / test	2.2

Advanced process conditions



Navigation

Setup → Advanced setup → Level → Adv. conditions

Description

Specify additional process conditions (if required).

Selection

- None
- Oil/Water condensate
- Probe near tank bottom
- Build up
- Foam (>5cm/0,16ft)

Additional information

**Meaning of the options**





- **Oil/Water condensate** (only **Medium type = Liquid**)  
Makes sure that in the case of two-phase media only the total level is detected (example: oil/condensate application).
- **Probe near tank bottom** (only for **Medium type = Liquid**)  
Improves the empty detection, especially if the probe is mounted close to the tank bottom.
- **Build up**  
Increases **EOP range upper area** in order to ensure a safe empty-detection even if the end-of-probe signal has shifted due to build-up.  
Enables a safe empty-detection even if the end-of-probe signal has shifted due to build-up.
- **Foam (>5cm/0,16ft)** (only for **Medium type = Liquid**)  
Optimizes the signal evaluation in applications with foam formation.

---

**Level unit**







---

<b>Navigation</b>	  Setup → Advanced setup → Level → Level unit								
<b>Description</b>	Select level unit.								
<b>Selection</b>	<table> <thead> <tr> <th><i>SI units</i></th> <th><i>US units</i></th> </tr> </thead> <tbody> <tr> <td>■ %</td> <td>■ ft</td> </tr> <tr> <td>■ m</td> <td>■ in</td> </tr> <tr> <td>■ mm</td> <td></td> </tr> </tbody> </table>	<i>SI units</i>	<i>US units</i>	■ %	■ ft	■ m	■ in	■ mm	
<i>SI units</i>	<i>US units</i>								
■ %	■ ft								
■ m	■ in								
■ mm									
<b>Additional information</b>	<p>The level unit may differ from the distance unit defined in the <b>Distance unit</b> parameter (→  113):</p> <ul style="list-style-type: none"> <li>■ The unit defined in the <b>Distance unit</b> parameter is used for the basic calibration (<b>Empty calibration</b> (→  114) and <b>Full calibration</b> (→  114)).</li> <li>■ The unit defined in the <b>Level unit</b> parameter is used to display the (unlinearized) level.</li> </ul>								

---

**Blocking distance**

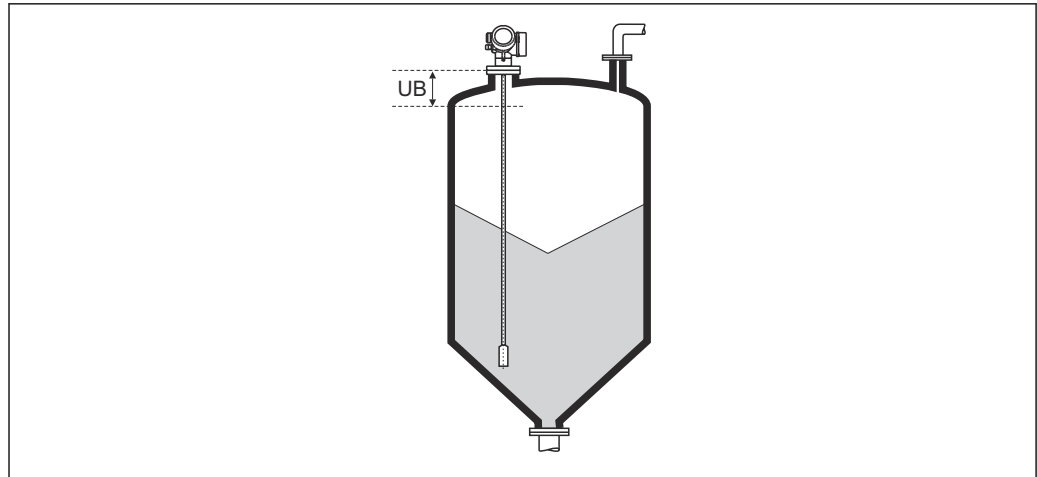

---

<b>Navigation</b>	  Setup → Advanced setup → Level → Blocking dist.
<b>Description</b>	Specify upper blocking distance UB.
<b>User entry</b>	0 to 200 m
<b>Factory setting</b>	<ul style="list-style-type: none"> <li>■ For rod and rope probes up to 8 m (26 ft): 200 mm (8 in)</li> <li>■ For rod and rope probes above 8 m (26 ft): 0.025 * Sondenlänge</li> </ul>
<b>Additional information</b>	<p>Signals in the upper blocking distance are only evaluated if they have been outside the blocking distance when the device was switched on and move into the blocking distance due to a level change during operation. Signals which are already in the blocking distance when the device is switched on, are ignored.</p> <p> This behavior is only valid if the following two conditions are met:</p> <ul style="list-style-type: none"> <li>■ Expert → Sensor → Echo tracking → Evaluation mode = <b>Short time history</b> or <b>Long time history</b>)</li> <li>■ Expert → Sensor → Gas phase compensation → GPC mode= <b>On, Without correction</b> or <b>External correction</b></li> </ul> <p>If one of these conditions is not met, signals in the blocking distance will always be ignored.</p> <p> A different behavior for signals in the blocking distance can be defined in the <b>Blocking distance evaluation mode</b> parameter.</p> <p> If required, a different behavior for signals in the blocking distance can be defined by the Endress+Hauser service.</p>



A0013221

52 Blocking distance (UB) for bulk solid measurements

## Level correction



### Navigation

  Setup → Advanced setup → Level → Level correction

### Description

Specify level correction (if required).

### User entry

-200 000.0 to 200 000.0 %

### Additional information

The value specified in this parameter is added to the measured level (before linearization).

"Linearization" submenu

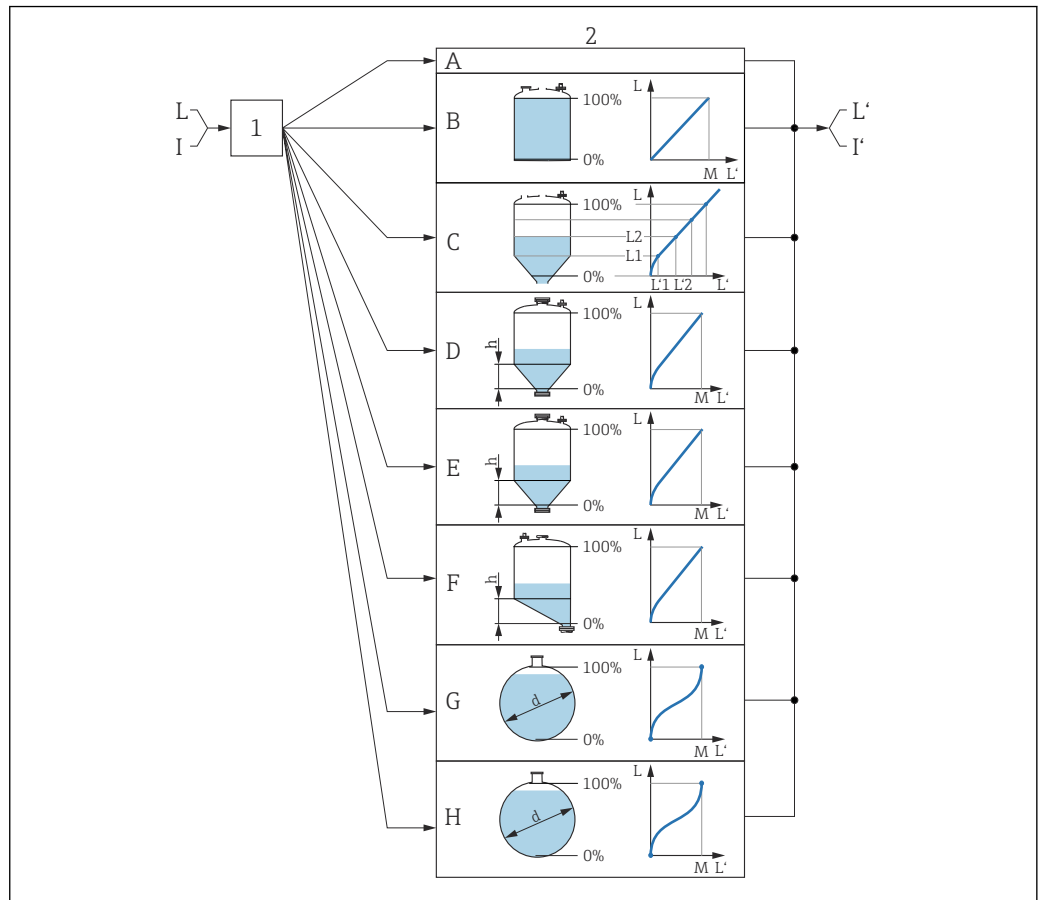

A0016084

53 Linearization: Conversion of the level and, if applicable, interface into a volume or a weight; the conversion depends on the vessel shape

- 1 Selection of linearization type and unit
- 2 Configuration of the linearization
- A Linearization type (→ 130) = None
- B Linearization type (→ 130) = Linear
- C Linearization type (→ 130) = Table
- D Linearization type (→ 130) = Pyramid bottom
- E Linearization type (→ 130) = Conical bottom
- F Linearization type (→ 130) = Angled bottom
- G Linearization type (→ 130) = Horizontal cylinder
- H Linearization type (→ 130) = Sphere
- I For "Operating mode" = "Interface" or "Interface with capacitance": interface before linearization (measured in the level unit)
- I' For "Operating mode" = "Interface" or "Interface with capacitance": interface after linearization (corresponds to volume or weight)
- L Level before linearization (measured in level unit)
- L' Level linearized (→ 133) (corresponds to volume or weight)
- M Maximum value (→ 133)
- d Diameter (→ 133)
- h Intermediate height (→ 134)

*Structure of the submenu on the local display*

Navigation  Setup → Advanced setup → Linearization

► **Linearization**

Linearization type

Unit after linearization

Free text

Maximum value

Diameter

Intermediate height

Table mode

► **Edit table**

Level

Customer value

Activate table



Structure of the submenu in the operating tool (e.g. FieldCare)

Navigation  Setup → Advanced setup → Linearization

▶ **Linearization**

Linearization type

Unit after linearization

Free text

Level linearized

Maximum value

Diameter

Intermediate height

Table mode

Table number

Level

Level

Customer value

Activate table

*Description of the parameters*

Navigation  Setup → Advanced setup → Linearization

**Linearization type** 

**Navigation**  Setup → Advanced setup → Linearization → Lineariz. type

**Description** Select linearization type.

- Selection**
- None
  - Linear
  - Table
  - Pyramid bottom
  - Conical bottom
  - Angled bottom
  - Horizontal cylinder
  - Sphere

**Additional information**

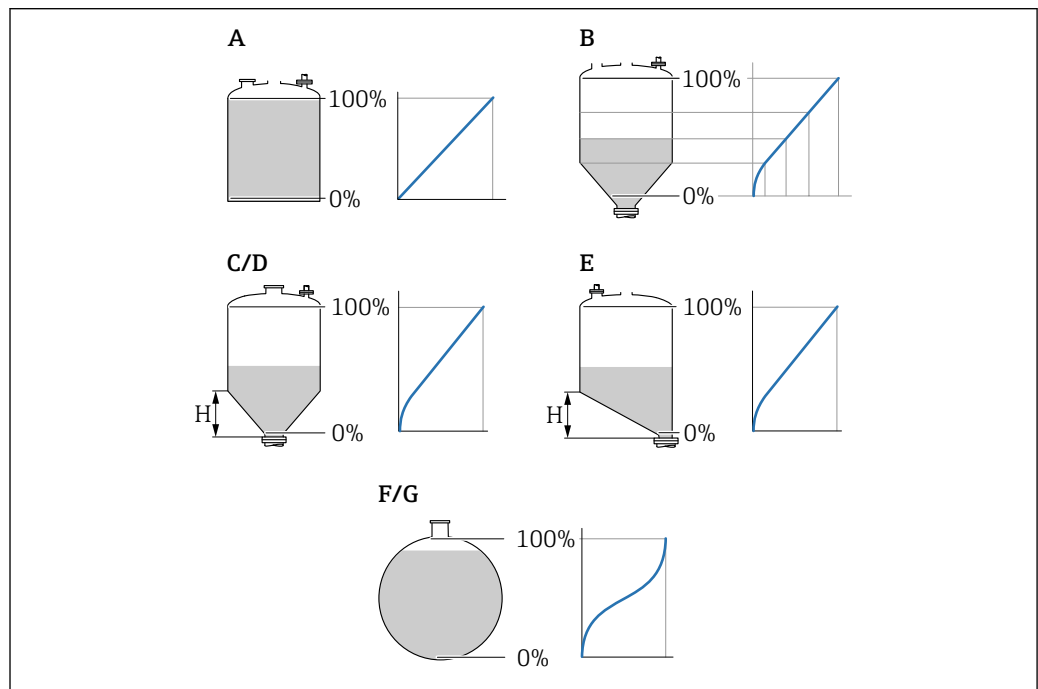

A0021476

 54 *Linearization types*

- A *None*
- B *Table*
- C *Pyramid bottom*
- D *Conical bottom*
- E *Angled bottom*
- F *Sphere*
- G *Horizontal cylinder*

### Meaning of the options

#### ■ None

The level is output in the level unit without being converted (linearized) beforehand.

#### ■ Linear

The output value (volume/weight) is proportional to the level L. This applies, for example, to vertical cylindrical tanks and silos. The following parameters must also be specified:

■ **Unit after linearization** (→  131)

■ **Maximum value** (→  133): maximum volume or weight

#### ■ Table

The relationship between the measured level L and the output value (volume/weight) is defined by a linearization table consisting of up to 32 pairs of values "level - volume" or "level - weight" respectively. The following parameters must also be specified:

■ **Unit after linearization** (→  131)

■ **Table mode** (→  134)

■ For every point in the table: **Level** (→  135)

■ For every point in the table: **Customer value** (→  136)

■ **Activate table** (→  136)

#### ■ Pyramid bottom

The output value corresponds to the volume or weight in a silo with a pyramid bottom. The following parameters must also be specified:

■ **Unit after linearization** (→  131)

■ **Maximum value** (→  133): maximum volume or weight

■ **Intermediate height** (→  134): the height of the pyramid

#### ■ Conical bottom

The output value corresponds to the volume or weight in a tank with a conical bottom. The following parameters must also be specified:

■ **Unit after linearization** (→  131)

■ **Maximum value** (→  133): maximum volume or weight

■ **Intermediate height** (→  134): the height of the cone

#### ■ Angled bottom

The output value corresponds to the volume or weight in a silo with an angled bottom. The following parameters must also be specified:

■ **Unit after linearization** (→  131)

■ **Maximum value** (→  133): maximum volume or weight

■ **Intermediate height** (→  134): height of the angled bottom

#### ■ Horizontal cylinder

The output value corresponds to the volume or weight in a horizontal cylinder. The following parameters must also be specified:

■ **Unit after linearization** (→  131)

■ **Maximum value** (→  133): maximum volume or weight

■ **Diameter** (→  133)

#### ■ Sphere

The output value corresponds to the volume or weight in a spherical tank. The following parameters must also be specified:

■ **Unit after linearization** (→  131)

■ **Maximum value** (→  133): maximum volume or weight



■ **Diameter** (→  133)

---

### Unit after linearization





#### Navigation

  Setup → Advanced setup → Linearization → Unit lineariz.



#### Prerequisite

**Linearization type** (→  130) ≠ None

<b>Description</b>	Select the unit for the linearized value.
<b>Selection</b>	<p>Selection/input (uint16)</p> <ul style="list-style-type: none"> <li>▪ 1095 = [short Ton]</li> <li>▪ 1094 = [lb]</li> <li>▪ 1088 = [kg]</li> <li>▪ 1092 = [Ton]</li> <li>▪ 1048 = [US Gal.]</li> <li>▪ 1049 = [Imp. Gal.]</li> <li>▪ 1043 = [ft<sup>3</sup>]</li> <li>▪ 1571 = [cm<sup>3</sup>]</li> <li>▪ 1035 = [dm<sup>3</sup>]</li> <li>▪ 1034 = [m<sup>3</sup>]</li> <li>▪ 1038 = [l]</li> <li>▪ 1041 = [hl]</li> <li>▪ 1342 = [%]</li> <li>▪ 1010 = [m]</li> <li>▪ 1012 = [mm]</li> <li>▪ 1018 = [ft]</li> <li>▪ 1019 = [inch]</li> <li>▪ 1351 = [l/s]</li> <li>▪ 1352 = [l/min]</li> <li>▪ 1353 = [l/h]</li> <li>▪ 1347 = [m<sup>3</sup>/s]</li> <li>▪ 1348 = [m<sup>3</sup>/min]</li> <li>▪ 1349 = [m<sup>3</sup>/h]</li> <li>▪ 1356 = [ft<sup>3</sup>/s]</li> <li>▪ 1357 = [ft<sup>3</sup>/min]</li> <li>▪ 1358 = [ft<sup>3</sup>/h]</li> <li>▪ 1362 = [US Gal./s]</li> <li>▪ 1363 = [US Gal./min]</li> <li>▪ 1364 = [US Gal./h]</li> <li>▪ 1367 = [Imp. Gal./s]</li> <li>▪ 1358 = [Imp. Gal./min]</li> <li>▪ 1359 = [Imp. Gal./h]</li> <li>▪ 32815 = [Ml/s]</li> <li>▪ 32816 = [Ml/min]</li> <li>▪ 32817 = [Ml/h]</li> <li>▪ 1355 = [Ml/d]</li> </ul>
<b>Additional information</b>	<p>The selected unit is only used for display purposes. The measured value is <b>not</b> converted on the basis of the selected unit.</p> <p> Distance-to-distance linearization is also possible, i.e. a linearization from the level unit to another length unit. Select the <b>Linear</b> linearization mode for this purpose. To specify the new level unit, select the <b>Free text</b> option in the <b>Unit after linearization</b> parameter and enter the unit in the <b>Free text</b> parameter (→  132).</p>

---

**Free text**

**Navigation**   Setup → Advanced setup → Linearization → Free text

**Prerequisite** **Unit after linearization** (→  131) = **Free text**

**Description** Enter unit symbol.

**User entry** Up to 32 alphanumerical characters (letters, numbers, special characters)

---

### Level linearized

---

**Navigation**  Setup → Advanced setup → Linearization → Level linearized

**Description** Displays linearized level.

**Additional information**  This unit is defined by the **Unit after linearization** parameter.

---

### Maximum value

---

**Navigation**   Setup → Advanced setup → Linearization → Maximum value

**Prerequisite** **Linearization type** (→  130) has one of the following values:

- Linear
- Pyramid bottom
- Conical bottom
- Angled bottom
- Horizontal cylinder
- Sphere



**Description** Linearized value corresponding to a level of 100%.

**User entry** -50 000.0 to 50 000.0 %

---

### Diameter

---

**Navigation**   Setup → Advanced setup → Linearization → Diameter

**Prerequisite** **Linearization type** (→  130) has one of the following values:

- Horizontal cylinder
- Sphere

**Description** Diameter of the cylindrical or spherical tank.

**User entry** 0 to 9 999.999 m

**Additional information** The unit is defined in the **Distance unit** parameter (→  113).

## Intermediate height



## Navigation

Setup → Advanced setup → Linearization → Intermed. height

## Prerequisite

**Linearization type** (→ 130) has one of the following values:

- Pyramid bottom
- Conical bottom
- Angled bottom

## Description

Height of the pyramid, conical or angled bottom.

## User entry

0 to 200 m

## Additional information

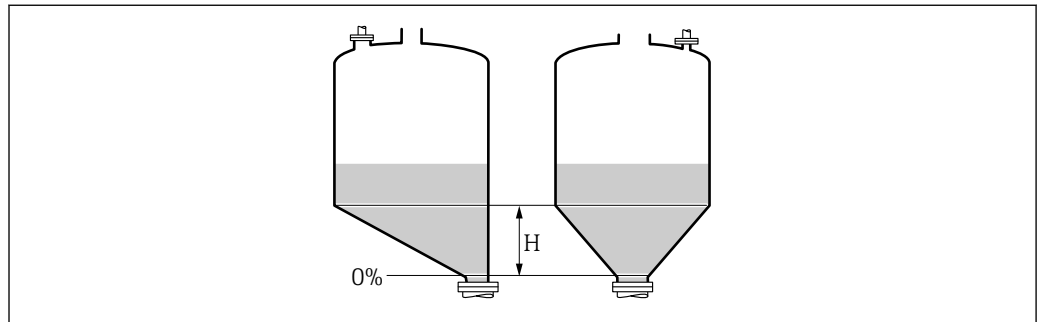

A0013264

*H* Intermediate height

The unit is defined in the **Distance unit** parameter (→ 113).

## Table mode



## Navigation

Setup → Advanced setup → Linearization → Table mode

## Prerequisite

**Linearization type** (→ 130) = Table

## Description

Select editing mode of the linearization table.

## Selection

- Manual
- Semiautomatic
- Clear table
- Sort table

## Additional information

**Meaning of the options**

- **Manual**

The level and the associated linearized value are entered manually for each linearization point.

- **Semiautomatic**

The level is measured by the device for each linearization point. The associated linearized value is entered manually.

- **Clear table**



Deletes the existing linearization table.

- **Sort table**

Rearranges the linearization points into an ascending order.



**Conditions the linearization table must meet:**



- The table may consist of up to 32 pairs of values "Level - Linearized Value".
- The table must be monotonic (monotonically increasing or decreasing).
- The first linearization point must refer to the minimum level.
- The last linearization point must refer to the maximum level.

 Before entering a linearization table, the values for **Empty calibration** (→  114) and **Full calibration** (→  114) must be set correctly.

If values of the table need to be changed after the full or empty calibration have been changed, a correct evaluation is only ensured if the existing table is deleted and the complete table is entered again. To do so delete the existing table (**Table mode** (→  134) = **Clear table**). Then enter a new table.



**How to enter the table**

- Via FieldCare  
The table points can be entered via the **Table number** (→  135), **Level** (→  135) and **Customer value** (→  136) parameters. As an alternative, the graphic table editor may be used: Device Operation → Device Functions → Additional Functions → Linearization (Online/Offline)
- Via local display  
Select the **Edit table** submenu to call up the graphic table editor. The table is displayed and can be edited line by line.





 The factory setting for the level unit is "%". If you want to enter the linearization table in physical units, you must select the appropriate unit in the **Level unit** parameter (→  125) beforehand.

 If a decreasing table is entered, the values for 20 mA and 4 mA of the current output are interchanged. That means: 20 mA refers to the lowest level, whereas 4 mA refers to the highest level.

---

<b>Table number</b>	
<b>Navigation</b>	 Setup → Advanced setup → Linearization → Table number
<b>Prerequisite</b>	<b>Linearization type</b> (→  130) = <b>Table</b>
<b>Description</b>	Select table point you are going to enter or change.
<b>User entry</b>	1 to 32



---

<b>Level (Manual)</b>	
<b>Navigation</b>	 Setup → Advanced setup → Linearization → Level
<b>Prerequisite</b>	<ul style="list-style-type: none"> <li>▪ <b>Linearization type</b> (→  130) = <b>Table</b></li> <li>▪ <b>Table mode</b> (→  134) = <b>Manual</b></li> </ul>
<b>Description</b>	Enter level value of the table point (value before linearization).
<b>User entry</b>	Signed floating-point number

---

**Level (Semiautomatic)**

---



<b>Navigation</b>	 Setup → Advanced setup → Linearization → Level
<b>Prerequisite</b>	<ul style="list-style-type: none"> <li>▪ <b>Linearization type</b> (→  130) = <b>Table</b></li> <li>▪ <b>Table mode</b> (→  134) = <b>Semiautomatic</b></li> </ul>
<b>Description</b>	Displays measured level (value before linearization). This value is transmitted to the table.

---

**Customer value**

---







<b>Navigation</b>	 Setup → Advanced setup → Linearization → Customer value
<b>Prerequisite</b>	<b>Linearization type</b> (→  130) = <b>Table</b>
<b>Description</b>	Enter linearized value for the table point.
<b>User entry</b>	Signed floating-point number

---

**Activate table**



---



<b>Navigation</b>	  Setup → Advanced setup → Linearization → Activate table
<b>Prerequisite</b>	<b>Linearization type</b> (→  130) = <b>Table</b>
<b>Description</b>	Activate (enable) or deactivate (disable) the linearization table.
<b>Selection</b>	<ul style="list-style-type: none"> <li>▪ <b>Disable</b></li> <li>▪ <b>Enable</b></li> </ul>
<b>Additional information</b>	<p><b>Meaning of the options</b></p> <ul style="list-style-type: none"> <li>▪ <b>Disable</b> The measured level is not linearized. If <b>Linearization type</b> (→  130) = <b>Table</b> at the same time, the device issues error message F435.</li> <li>▪ <b>Enable</b> The measured level is linearized according to the table.</li> </ul> <p> When editing the table, the <b>Activate table</b> parameter is automatically reset to <b>Disable</b> and must be reset to <b>Enable</b> after the table has been entered.</p>



**"Safety settings" submenu**

*Navigation*       Setup → Advanced setup → Safety sett.

**Output echo lost** 



**Navigation**       Setup → Advanced setup → Safety sett. → Output echo lost

**Description**      Output signal in case of a lost echo.

**Selection**

- Last valid value
- Ramp at echo lost
- Value echo lost
- Alarm

**Additional information**      **Meaning of the options**

- **Last valid value**  
The last valid value is kept in the case of a lost echo.
- **Ramp at echo lost**<sup>3)</sup>  
In the case of a lost echo the output value is continuously shifted towards 0% or 100%. The slope of the ramp is defined in the **Ramp at echo lost** parameter (→  138).
- **Value echo lost**<sup>3)</sup>  
In the case of a lost echo the output assumes the value defined in the **Value echo lost** parameter (→  137).
- **Alarm**  
In the case of a lost echo the device generates an alarm; see the **Failure mode** parameter (→  148)

**Value echo lost** 



**Navigation**       Setup → Advanced setup → Safety sett. → Value echo lost

**Prerequisite**      **Output echo lost (→  137) = Value echo lost**

**Description**      Output value in case of a lost echo

**User entry**      0 to 200 000.0 %

**Additional information**      Use the unit which has been defined for the measured value output:

- without linearization: **Level unit** (→  125)
- with linearization: **Unit after linearization** (→  131)

3) Only visible if "Linearization type (→  130)" = "None"

**Ramp at echo lost**



**Navigation**                      Setup → Advanced setup → Safety sett. → Ramp echo lost

**Prerequisite**                      **Output echo lost (→ 137) = Ramp at echo lost**

**Description**                      Slope of the ramp in the case of a lost echo

**User entry**                      Signed floating-point number

**Additional information**

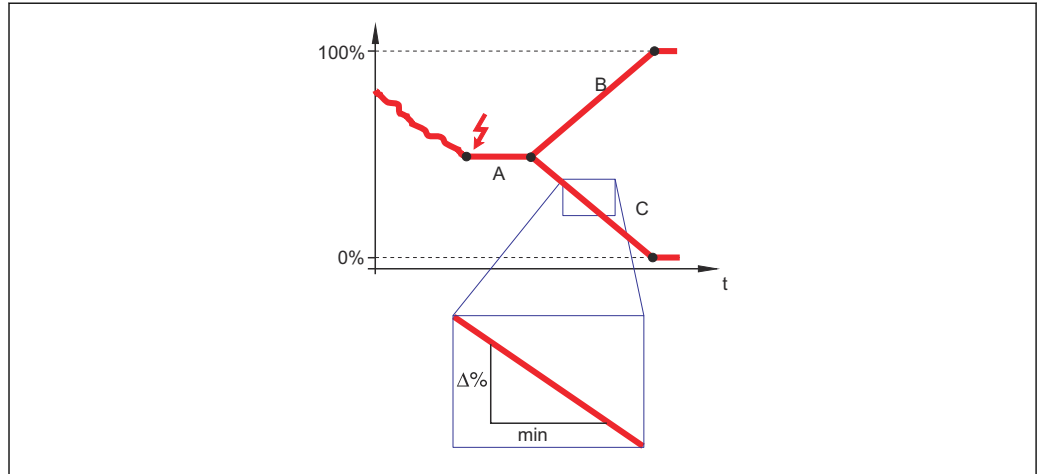

A0013269

- A    Delay time echo lost
- B    Ramp at echo lost (→ 138) (positive value)
- C    Ramp at echo lost (→ 138) (negative value)

- The unit for the slope of the ramp is "percentage of the measuring range per minute" (%/min).
- For a negative slope of the ramp: The measured value is continuously decreased until it reaches 0%.
- For a positive slope of the ramp: The measured value is continuously increased until it reaches 100%.

**Blocking distance**



**Navigation**                      Setup → Advanced setup → Safety sett. → Blocking dist.

**Description**                      Specify upper blocking distance UB.

**User entry**                      0 to 200 m

- Factory setting**
- For rod and rope probes up to 8 m (26 ft): 200 mm (8 in)
  - For rod and rope probes above 8 m (26 ft): 0.025 \* Sondenlänge

**Additional information**                      Signals in the upper blocking distance are only evaluated if they have been outside the blocking distance when the device was switched on and move into the blocking distance

due to a level change during operation. Signals which are already in the blocking distance when the device is switched on, are ignored.

- i** This behavior is only valid if the following two conditions are met:
- Expert → Sensor → Echo tracking → Evaluation mode = **Short time history** or **Long time history**)
  - Expert → Sensor → Gas phase compensation → GPC mode= **On, Without correction** or **External correction**

If one of these conditions is not met, signals in the blocking distance will always be ignored.

- i** A different behavior for signals in the blocking distance can be defined in the **Blocking distance evaluation mode** parameter.

- i** If required, a different behavior for signals in the blocking distance can be defined by the Endress+Hauser service.

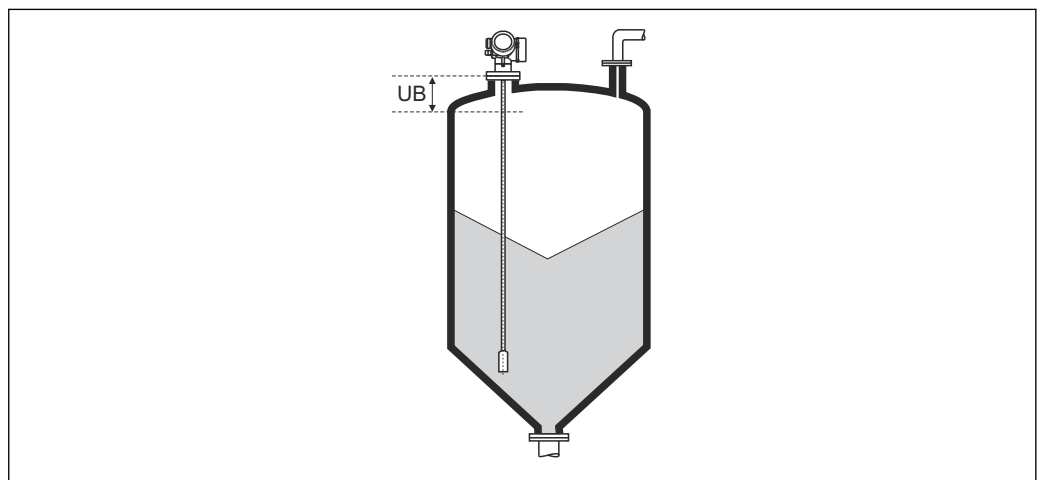

**55** Blocking distance (UB) for bulk solid measurements

A0013221



**"SIL/WHG confirmation" wizard**

 The **SIL/WHG confirmation** wizard is only available for devices with SIL or WHG approval (Feature 590: "Additional Approval", option LA: "SIL" or LC: "WHG overflow prevention" ) which are currently **not** in the SIL- or WHG-locked state.

The **SIL/WHG confirmation** wizard is required to lock the device according to SIL or WHG. For details refer to the "Functional Safety Manual" of the respective device, which describes the locking procedure and the parameters of the sequence.

*Navigation*       Setup → Advanced setup → SIL/WHG confirm.

**"Deactivate SIL/WHG" wizard**

 The **Deactivate SIL/WHG** wizard (→  141) is only visible if the device is SIL-locked or WHG-locked. For details refer to the "Functional Safety Manual" of the respective device.

*Navigation*       Setup → Advanced setup → Deactiv. SIL/WHG

---

**Reset write protection** 

**Navigation**       Setup → Advanced setup → Deactiv. SIL/WHG → Res. write prot.

**Description**      Enter unlocking code.

**User entry**      0 to 65 535

---

**Code incorrect** 

**Navigation**       Setup → Advanced setup → Deactiv. SIL/WHG → Code incorrect







**Description**      Indicates that a wrong unlocking code has been entered. Select procedure.



**Selection**

- Reenter code
- Abort sequence

**"Probe settings" submenu**

The **Probe settings** submenu helps to ensure that the device correctly assigns the end of probe signal within the envelope curve. The assignment is correct if the length of probe indicated by the device matches the actual length of the probe. The automatic probe length correction can only be performed if the probe is installed in the vessel and is completely uncovered (no medium) over the entire length. For partially filled vessels and if the probe length is known, select **Confirm probe length** (→  **143**) = **Manual input** to enter the value manually.



-  If a mapping has been recorded after shortening the probe, it is no longer possible to perform an automatic probe length correction. There are two options if this occurs:
  - First delete the mapping curve using the **Record map** parameter (→  118) and the probe length correction can then be performed. After the probe length correction, a new mapping curve can be recorded using the **Record map** parameter (→  118).
  - Alternatively, select **Confirm probe length** (→  **143**) = **Manual input** and manually enter the probe length in the **Present probe length** parameter.
-  An automatic probe length correction is only possible after the correct option has been selected in the **Probe grounded** parameter (→  142).

*Navigation*        Setup → Advanced setup → Probe settings

---

**Probe grounded** 



---

- Navigation**        Setup → Advanced setup → Probe settings → Probe grounded
- Prerequisite**      **Operating mode = Level**
- Description**      Specify whether the probe is grounded.
- Selection**
  - No
  - Yes

---

**Present probe length** 

---

- Navigation**       Setup → Advanced setup → Probe settings → Pres. length
- Description**
  - In most cases:  
Displays the length of the probe according to the currently measured end-of-probe signal.
  - For **Confirm probe length** (→  **143**) = **Manual input**:  
Enter actual length of probe.
- User entry**      0 to 200 m

---

**Confirm probe length**
**Navigation**

Setup → Advanced setup → Probe settings → Confirm length

**Description**

Specify whether the value displayed in the **Present probe length** parameter matches the actual length of the probe. Based on this input, the device performs a probe length correction.

**Selection**

- Probe length OK
- Probe length too small
- Probe length too big
- Probe covered
- Manual input
- Probe length unknown

**Additional information****Meaning of the options**

- **Probe length OK**

To be selected if the correct probe length is displayed. A correction is not required. The device exits the sequence.

- **Probe length too small**

To be selected if the displayed length is less than the actual probe length. A different end of probe signal is allocated and the newly calculated length is displayed in the **Present probe length** parameter. This procedure has to be repeated until the displayed value matches the actual length of the probe.

- **Probe length too big**

To be selected if the displayed length is greater than the actual probe length. A different end of probe signal is allocated and the newly calculated length is displayed in the **Present probe length** parameter. This procedure has to be repeated until the displayed value matches the actual length of the probe.

- **Probe covered**

To be selected if the probe is (partially or completely) covered. A probe length correction is impossible in this case.

- **Manual input**

To be selected if no automatic probe length correction is to be performed. Instead, the actual length of the probe must be entered manually in the **Present probe length** parameter. <sup>4)</sup>



- **Probe length unknown**

To be selected if the actual probe length is unknown. A probe length correction is impossible in this case.

---

4) When operating via FieldCare, the **Manual input** option does not need to be selected explicitly; manual editing of the probe length is always possible here.

*"Probe length correction" wizard*

 The **Probe length correction** wizard is only available when operating via the local display. When operating via an operating tool, the parameters for probe length correction are located directly in the **Probe settings** submenu (→  142).

*Navigation*       Setup → Advanced setup → Probe settings → Prob.length corr

**Confirm probe length** **Navigation**

 Setup → Advanced setup → Probe settings → Prob.length corr → Confirm length

**Description**

Specify whether the value displayed in the **Present probe length** parameter matches the actual length of the probe. Based on this input, the device performs a probe length correction.

**Selection**

- Probe length OK
- Probe length too small
- Probe length too big
- Probe covered
- Manual input
- Probe length unknown

**Additional information****Meaning of the options**

- **Probe length OK**  
To be selected if the correct probe length is displayed. A correction is not required. The device exits the sequence.
- **Probe length too small**  
To be selected if the displayed length is less than the actual probe length. A different end of probe signal is allocated and the newly calculated length is displayed in the **Present probe length** parameter. This procedure has to be repeated until the displayed value matches the actual length of the probe.
- **Probe length too big**  
To be selected if the displayed length is greater than the actual probe length. A different end of probe signal is allocated and the newly calculated length is displayed in the **Present probe length** parameter. This procedure has to be repeated until the displayed value matches the actual length of the probe.
- **Probe covered**  
To be selected if the probe is (partially or completely) covered. A probe length correction is impossible in this case.
- **Manual input**  
To be selected if no automatic probe length correction is to be performed. Instead, the actual length of the probe must be entered manually in the **Present probe length** parameter.<sup>5)</sup>
- **Probe length unknown**  
To be selected if the actual probe length is unknown. A probe length correction is impossible in this case.

5) When operating via FieldCare, the **Manual input** option does not need to be selected explicitly; manual editing of the probe length is always possible here.



---

**Present probe length**

---

**Navigation**

Setup → Advanced setup → Probe settings → Prob.length corr → Pres. length



**Description**

- In most cases:  
Displays the length of the probe according to the currently measured end-of-probe signal.
- For **Confirm probe length** (→ 143) = **Manual input**:  
Enter actual length of probe.

**User entry**

0 to 200 m

**"Current output 1 to 2" submenu**

 The **Current output 2** submenu (→  146) is only available for devices with two current outputs.

*Navigation*  Setup → Advanced setup → Curr.output 1 to 2

**Assign current output 1 to 2** 

**Navigation**

 Setup → Advanced setup → Curr.output 1 to 2 → Assign curr.

**Description**

Select process variable for current output.

**Selection**

- Level linearized
- Distance
- Electronic temperature
- Relative echo amplitude
- Analog output adv. diagnostics 1
- Analog output adv. diagnostics 2

**Factory setting**



**For level measurements**

- Current output 1: Level linearized
- Current output 2 <sup>6)</sup>: Level linearized

**Additional information**

*Definition of the current range for the process variables*

Process variable	4 mA value	20 mA value
Level linearized	0 % <sup>1)</sup> or the associated linearized value	100 % <sup>2)</sup> or the associated linearized value
Distance	0 (i.e. level is at the reference point)	<b>Empty calibration</b> (→  114) (i.e. level is at 0 %)
Electronic temperature	-50 °C (-58 °F)	100 °C (212 °F)
Relative echo amplitude	0 mV	2 000 mV
Analog output adv. diagnostics 1/2	depending on the parametrization of the Advanced Diagnostics	

- 1) the 0% level is defined by **Empty calibration** parameter (→  114)
- 2) The 100% level is defined by **Full calibration** parameter (→  114)

 It may be necessary to adjust the 4mA and 20mA values to the application (especially in the case of the **Analog output adv. diagnostics 1/2** option ).

This can be done by the following parameters:

- Expert → Output → Current output 1 to 2 → Turn down
- Expert → Output → Current output 1 to 2 → 4 mA value
- Expert → Output → Current output 1 to 2 → 20 mA value

6) only for devices with two current outputs

**Current span**



**Navigation** Setup → Advanced setup → Curr.output 1 to 2 → Current span

**Description** Determines the current range used to transmit the measured value.  
 '4...20mA':  
 Measured variable: 4 ...20 mA  
 '4...20mA NAMUR':  
 Measured variable: 3.8 ... 20.5 mA  
 '4...20mA US':  
 Measured variable: 3.9 ... 20.8 mA  
 'Fixed current':  
 Measured variable transmitted via HART only  
 Note:  
 Currents below 3.6 mA or above 21.95 mA can be used to signal an alarm.

- Selection**
- 4...20 mA
  - 4...20 mA NAMUR
  - 4...20 mA US
  - Fixed current

**Additional information** *Meaning of the options*

Option	Current range for process variable	Lower alarm signal level	Upper alarm signal level
4...20 mA	4 to 20.5 mA	< 3.6 mA	> 21.95 mA
4...20 mA NAMUR	3.8 to 20.5 mA	< 3.6 mA	> 21.95 mA
4...20 mA US	3.9 to 20.8 mA	< 3.6 mA	> 21.95 mA
Fixed current	Constant current, defined in the <b>Fixed current</b> parameter (→  147).		

- In the case of an error, the output current assumes the value defined in the **Failure mode** parameter (→ 148).
  - If the measured value is out of the measuring range, **Current output** diagnostic message is issued.
- In a HART multidrop loop only one device can use the analog current to transmit a signal. For all other devices one must set:
  - **Current span** = **Fixed current**
  - **Fixed current** (→ 147) = **4 mA**

**Fixed current**



**Navigation** Setup → Advanced setup → Curr.output 1 to 2 → Fixed current

**Prerequisite** **Current span** (→ 147) = **Fixed current**

**Description** Define constant value of the output current.

**User entry** 4 to 22.5 mA

---

**Damping output**

---



<b>Navigation</b>	Setup → Advanced setup → Curr.output 1 to 2 → Damping out.
<b>Description</b>	Reaction time of the output signal on fluctuation in the measured value.
<b>User entry</b>	0.0 to 999.9 s
<b>Additional information</b>	Fluctuations of the measured value affect the output current with an exponential delay, the time constant $\tau$ of which is defined in this parameter. With a small time constant the output reacts immediately to changes of the measured value. With a big time constant the reaction of the output is more delayed. For $\tau = 0$ (factory setting) there is no damping.





---

**Failure mode**

---





<b>Navigation</b>	Setup → Advanced setup → Curr.output 1 to 2 → Failure mode
<b>Prerequisite</b>	<b>Current span (→  147) ≠ Fixed current</b>
<b>Description</b>	<p>Defines which current the output assumes in the case of an error.</p> <p>'Min.': &lt; 3.6mA</p> <p>'Max.': &gt; 21.95mA</p> <p>'Last valid value': Last valid value before occurrence of the error.</p> <p>'Actual value': Output current is equal to the measured value; error is ignored.</p> <p>'Defined value': User defined value.</p>
<b>Selection</b>	<ul style="list-style-type: none"> <li>▪ Min.</li> <li>▪ Max.</li> <li>▪ Last valid value</li> <li>▪ Actual value</li> <li>▪ Defined value</li> </ul>

<b>Additional information</b>	<p><b>Meaning of the options</b></p> <ul style="list-style-type: none"> <li>▪ <b>Min.</b> The current output adopts the value of the lower alarm level according to the <b>Current span</b> parameter (→  147).</li> <li>▪ <b>Max.</b> The current output adopts the value of the upper alarm level according to the <b>Current span</b> parameter (→  147).</li> <li>▪ <b>Last valid value</b> The current remains constant at the last value it had before the error occurred.</li> <li>▪ <b>Actual value</b> The output current follows the actual measured value; the error is ignored.</li> <li>▪ <b>Defined value</b> The output current assumes the value defined in the <b>Failure current</b> parameter (→  149).</li> </ul> <p> The error behavior of other output channels is not influenced by these settings but is defined in separate parameters.</p>
-------------------------------	--

---

### Failure current



---

<b>Navigation</b>	  Setup → Advanced setup → Curr.output 1 to 2 → Failure current
<b>Prerequisite</b>	<b>Failure mode</b> (→  148) = <b>Defined value</b>
<b>Description</b>	Defines which current the output assumes in case of an error.
<b>User entry</b>	3.59 to 22.5 mA



---

### Output current 1 to 2

---

<b>Navigation</b>	  Setup → Advanced setup → Curr.output 1 to 2 → Output curr. 1 to 2
<b>Description</b>	Shows the actual calculated value of the output current.

**"Switch output" submenu**

 The **Switch output** submenu (→  150) is only available for devices with a switch output.<sup>7)</sup>

*Navigation*  Setup → Advanced setup → Switch output

**Switch output function****Navigation**

 Setup → Advanced setup → Switch output → Switch out funct

**Description**

Defines the function of the switch output.

'Off'

The switch output is always open (non-conductive)

'On'

The switch output is always closed (conductive).

'Diagnostic behavior'

The switch output is normally closed and is only opened if a diagnostic event is present.

'Limit'

The switch output is normally closed and is only opened if a measured variable exceeds a defined limit.

'Digital output'

The switch output is controlled by one of the digital output blocks of the device.

**Selection**

- Off
- On
- Diagnostic behavior
- Limit
- Digital Output

**Additional information****Meaning of the options**

- **Off**

The output is always open (non-conductive).

- **On**

The output is always closed (conductive).

- **Diagnostic behavior**

The output is normally closed and is only opened if a diagnostic event is present. The **Assign diagnostic behavior** parameter (→  151) determines for which type of event the output is opened.

- **Limit**

The output is normally closed and is only opened if a measured variable exceeds or falls below a defined limit. The limit values are defined by the following parameters:

- **Assign limit** (→  151)

- **Switch-on value** (→  152)

- **Switch-off value** (→  153)

- **Digital Output**

The switching state of the output tracks the output value of a DI function block. The function block is selected in the **Assign status** parameter (→  151).

 The **Off** and **On** options can be used to simulate the switch output.

7) Order code 020 "Power supply; output", option B, E or G

**Assign status**



<b>Navigation</b>	Setup → Advanced setup → Switch output → Assign status
<b>Prerequisite</b>	<b>Switch output function (→  150) = Digital Output</b>
<b>Description</b>	Assigns a Discrete Output Block or an Advanced Diagnostic Block to the switch output.
<b>Selection</b>	<ul style="list-style-type: none"> <li>■ Off</li> <li>■ Digital output AD 1</li> <li>■ Digital output AD 2</li> </ul>
<b>Additional information</b>	The <b>Digital output AD 1</b> and <b>Digital output AD 2</b> options refer to the Advanced Diagnostics Blocks. A switch signal generated in these blocks can be output via the switch output.

**Assign limit**



<b>Navigation</b>	Setup → Advanced setup → Switch output → Assign limit
<b>Prerequisite</b>	<b>Switch output function (→  150) = Limit</b>
<b>Description</b>	Defines which process variable will be checked for limit violation.
<b>Selection</b>	<ul style="list-style-type: none"> <li>■ Off</li> <li>■ Level linearized</li> <li>■ Distance</li> <li>■ Interface linearized *</li> <li>■ Interface distance *</li> <li>■ Thickness upper layer *</li> <li>■ Terminal voltage</li> <li>■ Electronic temperature</li> <li>■ Measured capacitance *</li> <li>■ Relative echo amplitude</li> <li>■ Relative interface amplitude *</li> <li>■ Absolute echo amplitude</li> <li>■ Absolute interface amplitude *</li> </ul>

**Assign diagnostic behavior**



<b>Navigation</b>	Setup → Advanced setup → Switch output → Assign diag. beh
<b>Prerequisite</b>	<b>Switch output function (→  150) = Diagnostic behavior</b>
<b>Description</b>	Defines to which behavior of diagnostic events the switch output reacts.

\* Visibility depends on order options or device settings

- Selection**
- Alarm
  - Alarm or warning
  - Warning

**Switch-on value**



**Navigation**      Setup → Advanced setup → Switch output → Switch-on value

**Prerequisite**      **Switch output function (→ 150) = Limit**

**Description**      Defines the switch-on point.  
The output is closed if the assigned process variable rises above this point.

**User entry**      Signed floating-point number

**Additional information**      The switching behavior depends on the relative position of the **Switch-on value** and **Switch-off value** parameters:

**Switch-on value > Switch-off value**

- The output is closed if the measured value is larger than **Switch-on value**.
- The output is opened if the measured value is smaller than **Switch-off value**.

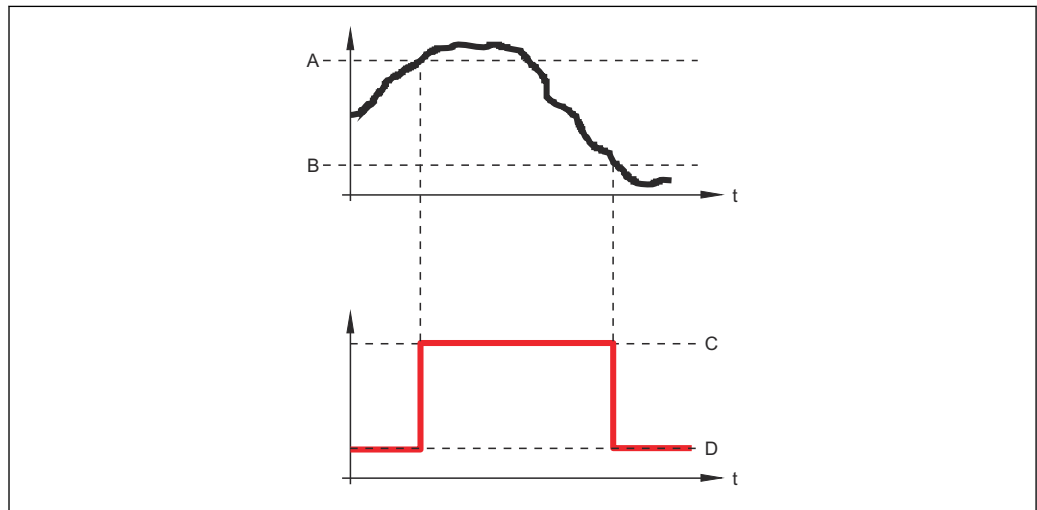

A0015585

- A    *Switch-on value*
- B    *Switch-off value*
- C    *Output closed (conductive)*
- D    *Output opened (non-conductive)*

**Switch-on value < Switch-off value**

- The output is closed if the measured value is smaller than **Switch-on value**.
- The output is opened if the measured value is larger than **Switch-off value**.



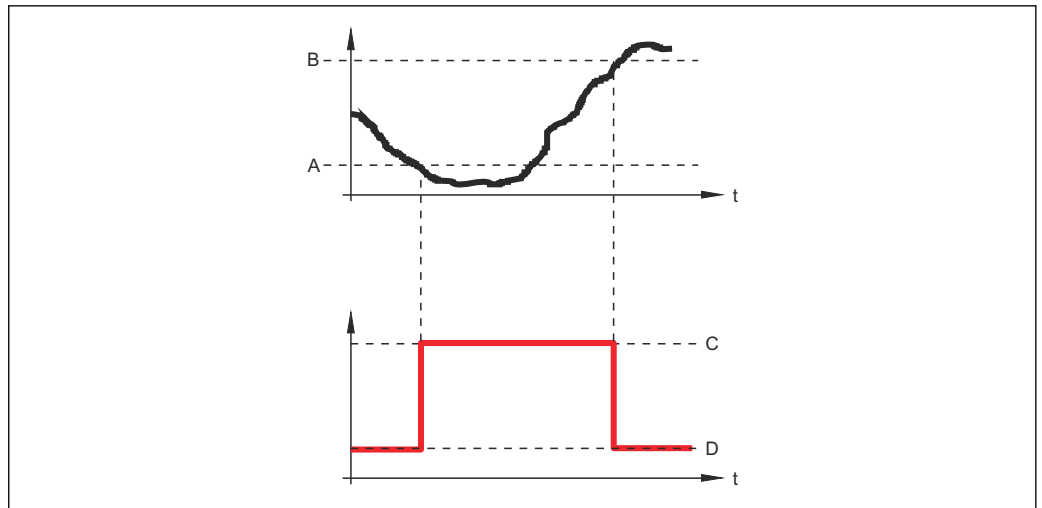

A0015586

- A Switch-on value
- B Switch-off value
- C Output closed (conductive)
- D Output opened (non-conductive)

**Switch-on delay**



**Navigation**                      Setup → Advanced setup → Switch output → Switch-on delay

**Prerequisite**                      ■ **Switch output function** (→ 150) = **Limit**  
 ■ **Assign limit** (→ 151) ≠ **Off**

**Description**                      Defines the delay applied before the output is switched on.

**User entry**                        0.0 to 100.0 s

**Switch-off value**



**Navigation**                      Setup → Advanced setup → Switch output → Switch-off value

**Prerequisite**                      **Switch output function** (→ 150) = **Limit**

**Description**                      Defines the switch-off point.  
 The output is opened if the assigned process variable falls below this point.

**User entry**                        Signed floating-point number





**Additional information**                      The switching behavior depends on the relative position of the **Switch-on value** and **Switch-off value** parameters; description: see the **Switch-on value** parameter (→ 152).

---

**Switch-off delay**

---







<b>Navigation</b>	  Setup → Advanced setup → Switch output → Switch-off delay
<b>Prerequisite</b>	<ul style="list-style-type: none"> <li>▪ <b>Switch output function</b> (→  150) = <b>Limit</b></li> <li>▪ <b>Assign limit</b> (→  151) ≠ <b>Off</b></li> </ul>
<b>Description</b>	Defines the delay applied before the output is switched off.
<b>User entry</b>	0.0 to 100.0 s

---

**Failure mode**

---





<b>Navigation</b>	  Setup → Advanced setup → Switch output → Failure mode
<b>Prerequisite</b>	<b>Switch output function</b> (→  150) = <b>Limit</b> or <b>Digital Output</b>
<b>Description</b>	Defines the state of the switch output in case of an error.
<b>Selection</b>	<ul style="list-style-type: none"> <li>▪ Actual status</li> <li>▪ Open</li> <li>▪ Closed</li> </ul>

**Additional information**

---

**Switch status**

---



<b>Navigation</b>	  Setup → Advanced setup → Switch output → Switch status
<b>Description</b>	Current status of the switch output.

---

**Invert output signal**

---





<b>Navigation</b>	  Setup → Advanced setup → Switch output → Invert outp.sig.
<b>Description</b>	<p>'No' The switch output behaves as per its parameter setting.</p> <p>'Yes' The switching behavior is inverted as compared to its parameter setting.</p>
<b>Selection</b>	<ul style="list-style-type: none"> <li>▪ No</li> <li>▪ Yes</li> </ul>

**Additional information****Meaning of the options**

- **No**  
The behavior of the switch output is as described above.
- **Yes**  
The states **Open** and **Closed** are inverted as compared to the description above.

**"Display" submenu**

 **Display** submenu is only visible if a display module is connected to the device.

*Navigation*       Setup → Advanced setup → Display

**Language****Navigation**

 Setup → Advanced setup → Display → Language

**Description**

Set display language.

**Selection**

- English
- Deutsch \*
- Français \*
- Español \*
- Italiano \*
- Nederlands \*
- Portuguesa \*
- Polski \*
- русский язык (Russian) \*
- Svenska \*
- Türkçe \*
- 中文 (Chinese) \*
- 日本語 (Japanese) \*
- 한국어 (Korean) \*
- Bahasa Indonesia \*
- tiếng Việt (Vietnamese) \*
- čeština (Czech) \*

**Factory setting**

The language selected in feature 500 of the product structure.  
If no language has been selected: **English**

**Additional information****Format display****Navigation**

 Setup → Advanced setup → Display → Format display

**Description**

Select how measured values are shown on the display.

**Selection**

- 1 value, max. size
- 1 bargraph + 1 value
- 2 values
- 1 value large + 2 values
- 4 values

\* Visibility depends on order options or device settings

**Additional information**



A0019963

56 "Format display" = "1 value, max. size"

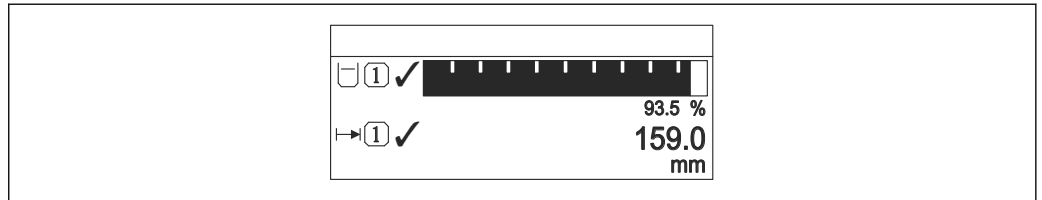

A0019964

57 "Format display" = "1 bargraph + 1 value"

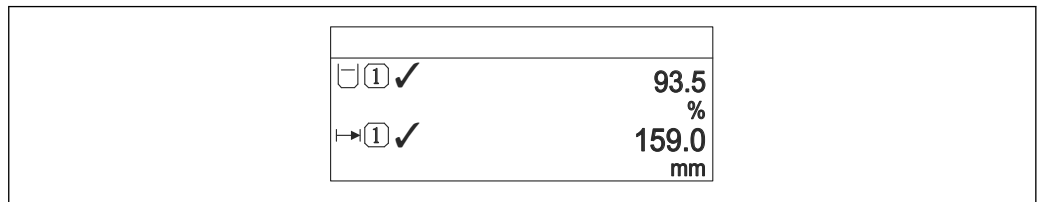

A0019965

58 "Format display" = "2 values"

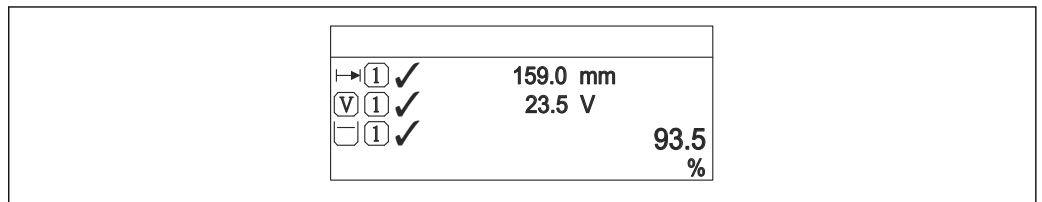

A0019966

59 "Format display" = "1 value large + 2 values"

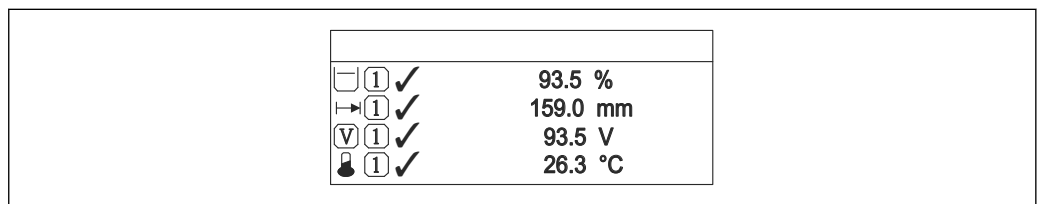

A0019968

60 "Format display" = "4 values"

- i

 ■ The **Value 1 to 4 display** parameters are used to specify which measured values are shown on the local display and in what order.
- If more measured values are specified than the display mode selected permits, then the values alternate on the device display. The display time until the next change is configured in the **Display interval** parameter (→ 158).

---

**Value 1 to 4 display**

**Navigation** Setup → Advanced setup → Display → Value 1 display

**Description** Select the measured value that is shown on the local display.

**Selection**

- Level linearized
- Distance
- Interface linearized \*
- Interface distance \*
- Thickness upper layer \*
- Current output 1
- Measured current
- Current output 2 \*
- Terminal voltage
- Electronic temperature
- Measured capacitance \*
- Analog output adv. diagnostics 1
- Analog output adv. diagnostics 2

**Factory setting**

**For level measurements**

- Value 1 display: Level linearized
- Value 2 display: Distance
- Value 3 display: Current output 1
- Value 4 display: None

---

**Decimal places 1 to 4**

**Navigation** Setup → Advanced setup → Display → Decimal places 1

**Description** This selection does not affect the measurement and calculation accuracy of the device.

**Selection**

- x
- x.x
- x.xx
- x.xxx
- x.xxxx

**Additional information** The setting does not affect the measuring or computational accuracy of the device.

---

**Display interval**

**Navigation** Setup → Advanced setup → Display → Display interval

**Description** Set time measured values are shown on display if display alternates between values.



**User entry** 1 to 10 s

---

\* Visibility depends on order options or device settings

**Additional information** This parameter is only relevant if the number of selected measuring values exceeds the number of values the selected display format can display simultaneously.

**Display damping** 

**Navigation**   Setup → Advanced setup → Display → Display damping

**Description** Set display reaction time to fluctuations in the measured value.

**User entry** 0.0 to 999.9 s

**Header** 

**Navigation**   Setup → Advanced setup → Display → Header

**Description** Select header contents on local display.

- Selection**
- Device tag
  - Free text

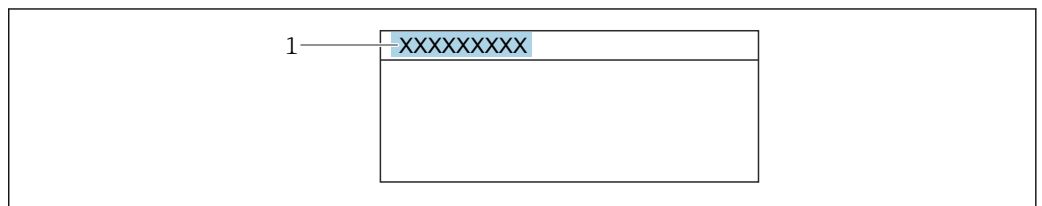

**Additional information**





A0029422

1 Position of the header text on the display

*Meaning of the options*

- **Device tag**  
Is defined in the **Device tag** parameter (→  113).
- **Free text**  
Is defined in the **Header text** parameter (→  159).

**Header text** 

**Navigation**   Setup → Advanced setup → Display → Header text

**Prerequisite** **Header** (→  159) = **Free text**

**Description** Enter display header text.

**User entry** Character string comprising numbers, letters and special characters (12)

**Additional information** The number of characters which can be displayed depends on the characters used.

---

**Separator**

**Navigation** Setup → Advanced setup → Display → Separator

**Description** Select decimal separator for displaying numerical values.

**Selection**

- .
- ,

---

**Number format**

**Navigation** Setup → Advanced setup → Display → Number format

**Description** Choose number format for the display.

**Selection**

- Decimal
- ft-in-1/16"

**Additional information** The **ft-in-1/16"** option is only valid for distance units.

---

**Decimal places menu**

**Navigation** Setup → Advanced setup → Display → Dec. places menu

**Description** Select number of decimal places for the representation of numbers within the operating menu.

**Selection**

- x
- x.x
- x.xx
- x.xxx
- x.xxxx

**Additional information**

- Is only valid for numbers in the operating menu (e.g. **Empty calibration, Full calibration**), but not for the measured value display. The number of decimal places for the measured value display is defined in the **Decimal places 1 to 4** parameters
- This setting does not affect the accuracy of the device for measuring or calculating the value

---

**Backlight**

**Navigation** Setup → Advanced setup → Display → Backlight

**Prerequisite** The device has the SD03 local display (with optical keys).

**Description** Switch the local display backlight on and off.



- Selection**
- Disable
  - Enable

**Additional information**

**Meaning of the options**

- **Disable**  
Switches the backlight off.
- **Enable**  
Switches the backlight on.

 Regardless of the setting in this parameter the backlight may be automatically switched off by the device if the supply voltage is too low.

---

**Contrast display**

---

**Navigation**

 Setup → Advanced setup → Display → Contrast display

**Description**

Adjust local display contrast setting to ambient conditions (e.g. lighting or reading angle).





**User entry**

20 to 80 %

**Factory setting**

Dependent on the display.

**Additional information**

-  Setting the contrast via push-buttons:
- Darker: press the   buttons simultaneously.
  - Brighter: press the   buttons simultaneously.

**"Configuration backup display" submenu**

 This submenu is only visible if a display module is connected to the device.

The configuration of the device can be saved to the display module at a certain point of time (backup). The saved configuration can be restored to the device if required, e.g. in order to bring the device back into a defined state. The configuration can also be transferred to a different device of the same type using the display module.

*Navigation*  Setup → Advanced setup → Conf.backup disp

**Operating time**

**Navigation**  Setup → Advanced setup → Conf.backup disp → Operating time

**Description** Indicates how long the device has been in operation.

**Additional information** *Maximum time*  
9999 d ( ≈ 27 years)

**Last backup**

**Navigation**  Setup → Advanced setup → Conf.backup disp → Last backup

**Description** Indicates when the last data backup was saved to the display module.

**Configuration management**

**Navigation**  Setup → Advanced setup → Conf.backup disp → Config. managem.



**Description** Select action for managing the device data in the display module.

**Selection**

- Cancel
- Execute backup
- Restore
- Duplicate
- Compare
- Clear backup data

**Additional information**

**Meaning of the options**



- **Cancel**  
No action is executed and the user exits the parameter.
  - **Execute backup**  
A backup copy of the current device configuration in the HistoROM (built-in in the device) is saved to the display module of the device.
  - **Restore**  
The last backup copy of the device configuration is copied from the display module to the HistoROM of the device.
  - **Duplicate**  
The transmitter configuration is duplicated to another device using the transmitter display module. The following parameters, which characterize the individual measuring point are **not** included in the transmitted configuration:
    - HART date code
    - HART short tag
    - HART message
    - HART descriptor
    - HART address
    - Device tag
    - Medium type
  - **Compare**  
The device configuration saved in the display module is compared to the current device configuration of the HistoROM. The result of this comparison is displayed in the **Comparison result** parameter (→  163).
  - **Clear backup data**  
The backup copy of the device configuration is deleted from the display module of the device.
-  While this action is in progress, the configuration cannot be edited via the local display and a message on the processing status appears on the display.
-  If an existing backup is restored to a different device using the **Restore** option, it may occur that some device functionalities are no longer available. In some cases even a device reset will not restore the original status.
- In order to transmit a configuration to a different device, the **Duplicate** option should always be used.

---

**Backup state**

---

**Navigation**

  Setup → Advanced setup → Conf.backup disp → Backup state

**Description**



Displays which backup action is currently in progress.

---

**Comparison result**

---

**Navigation**

  Setup → Advanced setup → Conf.backup disp → Compar. result

**Description**

Comparison between present device data and display backup.

**Additional information****Meaning of the display options****■ Settings identical**

The current device configuration of the HistoROM is identical to the backup copy in the display module.

**■ Settings not identical**

The current device configuration of the HistoROM is not identical to the backup copy in the display module.

**■ No backup available**

There is no backup copy of the device configuration of the HistoROM in the display module.

**■ Backup settings corrupt**

The current device configuration of the HistoROM is corrupt or not compatible with the backup copy in the display module.

**■ Check not done**

The device configuration of the HistoROM has not yet been compared to the backup copy in the display module.

**■ Dataset incompatible**

The data sets are incompatible and can not be compared.





To start the comparison, set **Configuration management** (→  162) = **Compare**.













If the transmitter configuration has been duplicated from a different device by **Configuration management** (→  162) = **Duplicate**, the new device configuration in the HistoROM is only partially identical to the configuration stored in the display module: Sensor specific properties (e.g. the mapping curve) are not duplicated. Thus, the result of the comparison will be **Settings not identical**.



**"Administration" submenu**

Navigation  Setup → Advanced setup → Administration

**Define access code** 

<b>Navigation</b>	 Setup → Advanced setup → Administration → Def. access code
<b>Description</b>	Define release code for write access to parameters.
<b>User entry</b>	0 to 9999
<b>Additional information</b>	<p> If the factory setting is not changed or if "0" is entered, the parameters are not write-protected and the device configuration data can therefore always be modified. The user is logged on in the "Maintenance" role.</p> <p> The write protection affects all parameters marked with the  symbol in the document. On the local display, the  symbol in front of a parameter indicates that the parameter is write-protected.</p> <p> Once the access code has been defined, write-protected parameters can only be modified if the access code is entered in the <b>Enter access code</b> parameter (→  121).</p> <p> Please contact your Endress+Hauser Sales Center if you lose the access code.</p> <p> If operating via the local display: the new access code is only valid once it has been confirmed in the <b>Confirm access code</b> parameter (→  167).</p>

**Device reset** 

<b>Navigation</b>	  Setup → Advanced setup → Administration → Device reset
<b>Description</b>	Reset the device configuration - either entirely or in part - to a defined state.
<b>Selection</b>	<ul style="list-style-type: none"> <li>■ Cancel</li> <li>■ To factory defaults</li> <li>■ To delivery settings</li> <li>■ Of customer settings</li> <li>■ To transducer defaults</li> <li>■ Restart device</li> </ul>
<b>Additional information</b>	<p><b>Meaning of the options</b></p> <ul style="list-style-type: none"> <li>■ <b>Cancel</b> No action</li> <li>■ <b>To factory defaults</b> All parameters are reset to the order-code specific factory setting.</li> <li>■ <b>To delivery settings</b> All parameters are reset to the delivery setting. The delivery setting may differ from the factory default if customer specific settings have been ordered. This option is only visible if customer specific settings have been ordered.</li> </ul>

- **Of customer settings**

All customer parameters are reset to their factory setting. Service parameters, however, remain unchanged.

- **To transducer defaults**

Every measurement-related parameter is reset to its factory setting. Service parameters and communication-related parameters, however, remain unchanged.

- **Restart device**

The restart resets every parameter which is stored in the volatile memory (RAM) to the factory setting (e.g. measured value data). The device configuration remains unchanged.

*"Define access code" wizard*

 The **Define access code** wizard is only available when operating via the local display. When operating via an operating tool, the **Define access code** parameter is located directly in the **Administration** submenu. The **Confirm access code** parameter is not available for operation via operating tool.

*Navigation*  Setup → Advanced setup → Administration → Def. access code

---

**Define access code**



**Navigation**  Setup → Advanced setup → Administration → Def. access code → Def. access code

**Description** →  165

---

**Confirm access code**



**Navigation**  Setup → Advanced setup → Administration → Def. access code → Confirm code

**Description** Confirm the entered access code.

**User entry** 0 to 9999

## 17.5 "Diagnostics" menu

Navigation  Diagnostics

---

### Actual diagnostics

---



**Navigation**  Diagnostics → Actual diagnos.

**Description** Displays current diagnostic message.

**Additional information** The display consists of:

- Symbol for event behavior
- Code for diagnostic behavior
- Operating time of occurrence
- Event text

 If several messages are active at the same time, the messages with the highest priority is displayed.

 Information on what is causing the message, and remedy measures, can be viewed via the  symbol on the display.

---

### Timestamp

---

**Navigation**  Diagnostics → Timestamp

**Description** Displays the timestamp for the currently active diagnostic message.

---

### Previous diagnostics



---

**Navigation**  Diagnostics → Prev.diagnostics

**Description** Displays the last diagnostic message which has been active before the current message.

**Additional information** The display consists of:

- Symbol for event behavior
- Code for diagnostic behavior
- Operating time of occurrence
- Event text

 The condition displayed may still apply. Information on what is causing the message, and remedy measures, can be viewed via the  symbol on the display.



---

**Timestamp**

---

**Navigation**  Diagnostics → Timestamp

**Description** Shows the timestamp of the previous diagnostic message.

---

**Operating time from restart**

---

**Navigation**   Diagnostics → Time fr. restart

**Description** Displays the time the device has been in operation since the last device restart.

---

**Operating time**

---

**Navigation**   Diagnostics → Operating time

**Description** Indicates how long the device has been in operation.

**Additional information** *Maximum time*  
9999 d ( ≈ 27 years)

## 17.5.1 "Diagnostic list" submenu

*Navigation*  Diagnostics → Diagnostic list

---

### Diagnostics 1 to 5

---

**Navigation**

 Diagnostics → Diagnostic list → Diagnostics 1

**Description**

Display the current diagnostics messages with the highest to fifth-highest priority.

**Additional information**

The display consists of:

- Symbol for event behavior
- Code for diagnostic behavior
- Operating time of occurrence
- Event text

---

### Timestamp 1 to 5

---

**Navigation**

 Diagnostics → Diagnostic list → Timestamp 1 to 5

**Description**

Timestamp of the diagnostic message.

### 17.5.2 "Event logbook" submenu

 The **Event logbook** submenu is only available when operating via the local display. When operating via FieldCare, the event list can be displayed in the FieldCare function "Event List / HistoROM".

*Navigation*  Diagnostics → Event logbook

---

#### Filter options

**Navigation**  Diagnostics → Event logbook → Filter options

**Description** Define which category of event messages is shown in the Events list submenu.

- Selection**
- All
  - Failure (F)
  - Function check (C)
  - Out of specification (S)
  - Maintenance required (M)
  - Information (I)



**Additional information** 



- This parameter is only used for operation via the local display.
- The status signals are categorized according to NAMUR NE 107.

#### "Event list" submenu

The **Event list** submenu displays the history of past events of the category selected in the **Filter options** parameter (→  171). A maximum of 100 events are displayed in chronological order.

The following symbols indicate whether an event has occurred or has ended:

- : Event has occurred
- : Event has ended

 Information on what is causing the message, and remedy instructions, can be viewed via the -button.

#### Display format

- For event messages in category I: information event, event text, "recording event" symbol and time the event occurred
- For event messages in category F, M, C, S (status signal): diagnostics event, event text, "recording event" symbol and time the event occurred

*Navigation*  Diagnostics → Event logbook → Event list

### 17.5.3 "Device information" submenu

Navigation  Diagnostics → Device info

---

#### Device tag



---

<b>Navigation</b>	 Diagnostics → Device info → Device tag
<b>Description</b>	Enter the name for the measuring point.
<b>User interface</b>	Character string comprising numbers, letters and special characters

---

#### Serial number



---

<b>Navigation</b>	 Diagnostics → Device info → Serial number
<b>Description</b>	Shows the serial number of the measuring device.
<b>Additional information</b>	<p> <b>Uses of the serial number</b></p> <ul style="list-style-type: none"> <li>▪ To identify the device quickly, e.g. when contacting Endress+Hauser.</li> <li>▪ To obtain specific information on the device using the Device Viewer: <a href="http://www.endress.com/deviceviewer">www.endress.com/deviceviewer</a></li> </ul> <p> The serial number is also indicated on the nameplate.</p>

---

#### Firmware version

---

<b>Navigation</b>	 Diagnostics → Device info → Firmware version
<b>Description</b>	Shows the device firmware version installed.
<b>User interface</b>	xx.yy.zz
<b>Additional information</b>	<p> For firmware versions differing only in the last two digits ("zz") there is no difference concerning functionality or operation.</p>

---

#### Device name

---

<b>Navigation</b>	 Diagnostics → Device info → Device name
<b>Description</b>	Shows the name of the transmitter.

---

**Order code**

---



<b>Navigation</b>	Diagnostics → Device info → Order code
<b>Description</b>	Shows the device order code.
<b>User interface</b>	Character string comprising numbers, letters and special characters
<b>Additional information</b>	The order code is generated from the extended order code, which defines all device features of the product structure. In contrast, the device features can not be read directly from the order code.

---

**Extended order code 1 to 3**

---



<b>Navigation</b>	Diagnostics → Device info → Ext. order cd. 1
<b>Description</b>	Display the three parts of the extended order code.
<b>User interface</b>	Character string comprising numbers, letters and special characters
<b>Additional information</b>	The extended order code indicates the version of all the features of the product structure and thus uniquely identifies the device.

---

**Device revision**

---

<b>Navigation</b>	Diagnostics → Device info → Device revision
<b>Description</b>	Shows the device revision with which the device is registered with the HART Communication Foundation.
<b>Additional information</b>	The device revision is used to allocate the correct Device Description file (DD) to the device.

---

**Device ID**

---

<b>Navigation</b>	Diagnostics → Device info → Device ID
<b>Description</b>	Shows the device ID for identifying the device in a HART network.
<b>Additional information</b>	In addition to the Device type and Manufacturer ID, the Device ID is part of the unique device identification (Unique ID) which characterizes each HART device unambiguously.

**Device type**

---

**Navigation** Diagnostics → Device info → Device type**Description**

Shows the device type with which the measuring device is registered with the HART Communication Foundation.

**Additional information**

---

**Manufacturer ID**

---

**Navigation** Diagnostics → Device info → Manufacturer ID**Description**

Use this function to view the manufacturer ID with which the measuring device is registered with the HART Communication Foundation.

**User interface**

2-digit hexadecimal number

**Factory setting**

0x11 (for Endress+Hauser)

## 17.5.4 "Measured values" submenu

Navigation  Diagnostics → Measured val.

---

### Distance

---

Navigation  Diagnostics → Measured val. → Distance

Description Displays the measured distance  $D_L$  between the reference point (lower edge of the flange or threaded connection) and the level.

### Additional information

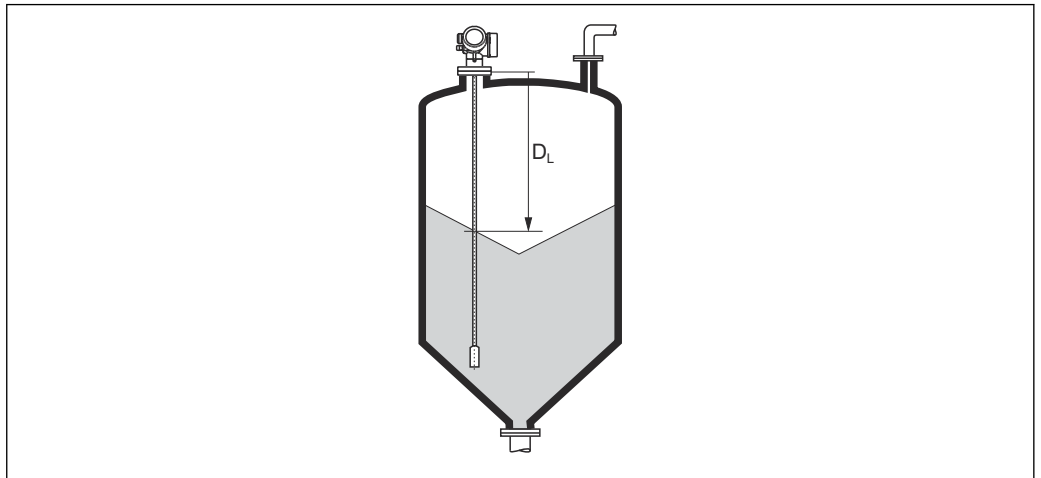

A0013201

 61 Distance for bulk solid measurements

 The unit is defined in the **Distance unit** parameter (→  113).

---

### Level linearized

---

Navigation  Diagnostics → Measured val. → Level linearized

Description Displays linearized level.

Additional information  This unit is defined by the **Unit after linearization** parameter.

---

### Output current 1 to 2

---

Navigation  Diagnostics → Measured val. → Output curr. 1 to 2

Description Shows the actual calculated value of the output current.

**Measured current 1**

---

**Navigation** Diagnostics → Measured val. → Measur. curr. 1**Prerequisite**

Only available for current output 1

**Description**Shows the current value of the current output which is currently measured.

---

**Terminal voltage 1**

---

**Navigation** Diagnostics → Measured val. → Terminal volt. 1**Description**

Shows the current terminal voltage that is applied at the output.



## 17.5.5 "Data logging" submenu

Navigation  Diagnostics → Data logging

---

### Assign channel 1 to 4

---

**Navigation**  Diagnostics → Data logging → Assign chan. 1 to 4

**Description** Assign a process variable to logging channel.

**Selection**

- Off
- Level linearized
- Distance
- Unfiltered distance
- Interface linearized \*
- Interface distance \*
- Unfiltered interface distance
- Thickness upper layer \*
- Current output 1
- Measured current
- Current output 2 \*
- Terminal voltage
- Electronic temperature
- Measured capacitance \*
- Absolute echo amplitude
- Relative echo amplitude
- Absolute interface amplitude \*
- Relative interface amplitude \*
- Absolute EOP amplitude
- EOP shift
- Noise of signal
- Calculated DC value \*
- Analog output adv. diagnostics 1
- Analog output adv. diagnostics 2

**Additional information** A total of 1000 measured values can be logged. This means:

- 1000 data points if 1 logging channel is used
- 500 data points if 2 logging channels are used
- 333 data points if 3 logging channels are used
- 250 data points if 4 logging channels are used

If the maximum number of data points is reached, the oldest data points in the data log are cyclically overwritten in such a way that the last 1000, 500, 333 or 250 measured values are always in the log (ring memory principle).

 The logged data are deleted if a new option is selected in this parameter.

---

\* Visibility depends on order options or device settings

---

**Logging interval**
**Navigation**

- Diagnostics → Data logging → Logging interval
- Diagnostics → Data logging → Logging interval

**Description**

Define the logging interval  $t_{log}$  for data logging. This value defines the time interval between the individual data points in the memory.

**User entry**

1.0 to 3 600.0 s

**Additional information**

This parameter defines the interval between the individual data points in the data log, and thus the maximum loggable process time  $T_{log}$  :

- If 1 logging channel is used:  $T_{log} = 1000 \cdot t_{log}$
- If 2 logging channels are used:  $T_{log} = 500 \cdot t_{log}$
- If 3 logging channels are used:  $T_{log} = 333 \cdot t_{log}$
- If 4 logging channels are used:  $T_{log} = 250 \cdot t_{log}$

Once this time elapses, the oldest data points in the data log are cyclically overwritten such that a time of  $T_{log}$  always remains in the memory (ring memory principle).



The logged data are deleted if this parameter is changed.

*Example***When using 1 logging channel**

- $T_{log} = 1000 \cdot 1 \text{ s} = 1000 \text{ s} \approx 16.5 \text{ min}$
- $T_{log} = 1000 \cdot 10 \text{ s} = 10000 \text{ s} \approx 2.75 \text{ h}$
- $T_{log} = 1000 \cdot 80 \text{ s} = 80000 \text{ s} \approx 22 \text{ h}$
- $T_{log} = 1000 \cdot 3600 \text{ s} = 3600000 \text{ s} \approx 41 \text{ d}$

---

**Clear logging data**
**Navigation**

- Diagnostics → Data logging → Clear logging
- Diagnostics → Data logging → Clear logging

**Description**

Clear the entire logging data.

**Selection**

- Cancel
- Clear data

**"Display channel 1 to 4" submenu**

**i** The **Display channel 1 to 4** submenus are only available for operation via the local display. When operating via FieldCare, the logging diagram can be displayed in the FieldCare function "Event List / HistoROM" .

The **Display channel 1 to 4** submenus invoke a diagram of the logging history of the respective channel.

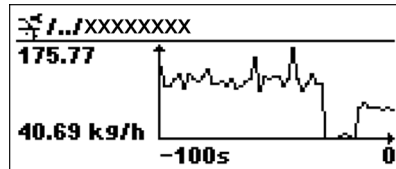

- x-axis: depending on the number of selected channels, 250 to 1000 measured values of a process variable are displayed.
- y-axis: covers the approximate measured value span and constantly adapts this to the measurement.









**i** To return to the operating menu, press  $\oplus$  and  $\ominus$  simultaneously.

Navigation  $\left[ \text{Menu} \right] \left[ \text{Menu} \right]$  Diagnostics  $\rightarrow$  Data logging  $\rightarrow$  Displ.channel 1 to 4

### 17.5.6 "Simulation" submenu









The **Simulation** submenu is used to simulate specific measuring values or other conditions. This helps to check the correct configuration of the device and connected control units.

*Conditions which can be simulated*

Condition to be simulated	Associated parameters
Specific value of a process variable	<ul style="list-style-type: none"> <li>▪ Assign measurement variable (→  182)</li> <li>▪ Process variable value (→  182)</li> </ul>
Specific value of the output current	<ul style="list-style-type: none"> <li>▪ Current output simulation (→  182)</li> <li>▪ Value current output (→  183)</li> </ul>
Specific state of the switch output	<ul style="list-style-type: none"> <li>▪ Switch output simulation (→  183)</li> <li>▪ Switch status (→  183)</li> </ul>
Existence of an alarm	Device alarm simulation (→  184)
Existence of a specific diagnostic message	Diagnostic event simulation (→  184)

**Structure of the submenu**

*Navigation*  Expert → Diagnostics → Simulation

<b>► Simulation</b>	
Assign measurement variable	→  182
Process variable value	→  182
Current output 1 to 2 simulation	→  182
Value current output 1 to 2	→  183
Switch output simulation	→  183
Switch status	→  183
Device alarm simulation	→  184
Diagnostic event simulation	→  184



## Description of parameters

*Navigation*  Expert → Diagnostics → Simulation

---

### Assign measurement variable



---

<b>Navigation</b>	 Expert → Diagnostics → Simulation → Assign meas.var.
<b>Description</b>	Defines the process variable to be simulated.
<b>Selection</b>	<ul style="list-style-type: none"> <li>■ Off</li> <li>■ Level</li> <li>■ Interface *</li> <li>■ Thickness upper layer *</li> <li>■ Level linearized</li> <li>■ Interface linearized</li> <li>■ Thickness linearized</li> </ul>
<b>Additional information</b>	<ul style="list-style-type: none"> <li>■ The value of the variable to be simulated is defined in the <b>Process variable value</b> parameter (→  182).</li> <li>■ If <b>Assign measurement variable</b> ≠ <b>Off</b>, a simulation is active. This is indicated by a diagnostic message of the <i>Function check (C)</i> category.</li> </ul>

---

### Process variable value

---

<b>Navigation</b>	 Expert → Diagnostics → Simulation → Proc. var. value
<b>Prerequisite</b>	<b>Assign measurement variable</b> (→  182) ≠ <b>Off</b>
<b>Description</b>	Defines the value of the selected variable. The outputs assume values or states according to this value.
<b>User entry</b>	Signed floating-point number
<b>Additional information</b>	Downstream measured value processing and the signal output use this simulation value. In this way, users can verify whether the measuring device has been configured correctly.

---











### Current output 1 to 2 simulation

---



<b>Navigation</b>	 Expert → Diagnostics → Simulation → Curr.out. 1 to 2 sim.
<b>Description</b>	Switch the simulation of the current output on and off.

---



\* Visibility depends on order options or device settings

<b>Selection</b>	<ul style="list-style-type: none"> <li>■ Off</li> <li>■ On</li> </ul>
<b>Additional information</b>	An active simulation is indicated by a diagnostic message of the <i>Function check (C)</i> category.
<hr/>	
<b>Value current output 1 to 2</b> 	
<b>Navigation</b>	  Expert → Diagnostics → Simulation → Value curr.out 1 to 2
<b>Prerequisite</b>	<b>Current output simulation (→  182) = On</b>
<b>Description</b>	Defines the value of the simulated output current.
<b>User entry</b>	3.59 to 22.5 mA
<b>Additional information</b>	The current output assumes the value specified in this parameter. In this way, users can verify the correct adjustment of the current output and the correct function of connected control units.
<hr/>	
<b>Switch output simulation</b> 	
<b>Navigation</b>	  Expert → Diagnostics → Simulation → Switch sim.
<b>Description</b>	Switch the simulation of the switch output on and off.
<b>Selection</b>	<ul style="list-style-type: none"> <li>■ Off</li> <li>■ On</li> </ul>
<hr/>	
<b>Switch status</b> 	
<b>Navigation</b>	  Expert → Diagnostics → Simulation → Switch status
<b>Prerequisite</b>	<b>Switch output simulation (→  183) = On</b>
<b>Description</b>	Current status of the switch output.
<b>Selection</b>	<ul style="list-style-type: none"> <li>■ Open</li> <li>■ Closed</li> </ul>
<b>Additional information</b>	The switch status assumes the value defined in this parameter. This helps to check correct operation of connected control units.

---

<b>Device alarm simulation</b>		
<b>Navigation</b>	 Expert → Diagnostics → Simulation → Dev. alarm sim.	
<b>Description</b>	Switch the device alarm on and off.	
<b>Selection</b>	<ul style="list-style-type: none"><li>■ Off</li><li>■ On</li></ul>	
<b>Additional information</b>	<p>When selecting the <b>On</b> option, the device generates an alarm. This helps to check the correct output behavior of the device in the case of an alarm.</p> <p>An active simulation is indicated by the  <b>C484 Failure mode simulation</b> diagnostic message.</p>	

---

<b>Diagnostic event simulation</b>		
<b>Navigation</b>	 Expert → Diagnostics → Simulation → Diag. event sim.	
<b>Description</b>	<p>Select the diagnostic event to be simulated.</p> <p>Note: To terminate the simulation, select 'Off'.</p>	
<b>Additional information</b>	When operated via the local display, the selection list can be filtered according to the event categories ( <b>Diagnostic event category</b> parameter).	



## 17.5.7 "Device check" submenu

*Navigation*  Diagnostics → Device check

---

### Start device check

---

<b>Navigation</b>	 Diagnostics → Device check → Start dev. check
<b>Description</b>	Start a device check.
<b>Selection</b>	<ul style="list-style-type: none"> <li>■ No</li> <li>■ Yes</li> </ul>
<b>Additional information</b>	In the case of a lost echo a device check can not be performed.

---

### Result device check

---

<b>Navigation</b>	 Diagnostics → Device check → Result dev.check
<b>Description</b>	Displays the result of the device check.
<b>Additional information</b>	<p><b>Meaning of the display options</b></p> <ul style="list-style-type: none"> <li>■ <b>Installation ok</b> Measurement possible without restrictions.</li> <li>■ <b>Accuracy reduced</b> A measurement is possible. However, the measuring accuracy may be reduced due to the signal amplitudes.</li> <li>■ <b>Measurement capability reduced</b> A measurement is currently possible. However, there is the risk of an echo loss. Check the mounting position of the device and the dielectric constant of the medium.</li> <li>■ <b>Check not done</b> No device check has been performed.</li> </ul>

---

### Last check time



---

<b>Navigation</b>	 Diagnostics → Device check → Last check time
<b>Description</b>	Displays the operating time at which the last device check has been performed.
<b>User interface</b>	Character string comprising numbers, letters and special characters

---

**Level signal**



---

<b>Navigation</b>	  Diagnostics → Device check → Level signal
<b>Prerequisite</b>	Device check has been performed.
<b>Description</b>	Displays result of the device check for the level signal.
<b>User interface</b>	<ul style="list-style-type: none"><li>■ Check not done</li><li>■ Check not OK</li><li>■ Check OK</li></ul>
<b>Additional information</b>	For <b>Level signal = Check not OK</b> : Check the mounting position of the device and the dielectric constant of the medium.

---

**Launch signal**

---

<b>Navigation</b>	  Diagnostics → Device check → Launch signal
<b>Prerequisite</b>	Device check has been performed.
<b>Description</b>	Displays result of the display check for the launch signal.
<b>User interface</b>	<ul style="list-style-type: none"><li>■ Check not done</li><li>■ Check not OK</li><li>■ Check OK</li></ul>
<b>Additional information</b>	For <b>Launch signal = Check not OK</b> : Check the mounting position of the device. In non-metallic vessels use a metal plate or a metal flange.

### 17.5.8 "Heartbeat" submenu

 The **Heartbeat** submenu is only available via **FieldCare** or **DeviceCare**. It contains the wizards which are part of the **Heartbeat Verification** and **Heartbeat Monitoring** application packages.

#### Detailed description

SD01872F

*Navigation*  Diagnostics → Heartbeat

# Index

## A

Access authorization to parameters	
Read access	50
Write access	50
Access code	50
Incorrect input	50
Access status display (Parameter)	121
Access status tooling (Parameter)	120
Accessories	
Communication-specific	93
Device-specific	86
Service-specific	94
System components	94
Activate table (Parameter)	136
Actual diagnostics (Parameter)	168
Administration (Submenu)	165
Advanced process conditions (Parameter)	124
Advanced setup (Submenu)	120
Application	9
Assign channel 1 to 4 (Parameter)	177
Assign current output (Parameter)	146
Assign diagnostic behavior (Parameter)	151
Assign limit (Parameter)	151
Assign measurement variable (Parameter)	182
Assign status (Parameter)	151

## B

Backlight (Parameter)	160
Backup state (Parameter)	163
Bin type (Parameter)	113
Blocking distance (Parameter)	125, 138
Bluetooth® wireless technology	49, 63

## C

Cleaning	83
Clear logging data (Parameter)	178
Code incorrect (Parameter)	141
Comparison result (Parameter)	163
Configuration backup display (Submenu)	162
Configuration management (Parameter)	162
Configuration of a level measurement	67
Configuring level measurement	67
Configuring the operating language	66
Confirm access code (Parameter)	167
Confirm distance (Parameter)	117, 119
Confirm probe length (Parameter)	143, 144
Context menu	60
Contrast display (Parameter)	161
Current output 1 to 2 (Submenu)	146
Current output 1 to 2 simulation (Parameter)	182
Current span (Parameter)	147
Customer value (Parameter)	136

## D

Damping output (Parameter)	148
Data logging (Submenu)	177

Deactivate SIL/WHG (Wizard)	141
Decimal places 1 (Parameter)	158
Decimal places menu (Parameter)	160
Define access code (Parameter)	165, 167
Define access code (Wizard)	167
Defining the access code	51
Device alarm simulation (Parameter)	184
Device check (Submenu)	185
Device description files	62
Device ID (Parameter)	173
Device information (Submenu)	172
Device name (Parameter)	172
Device replacement	84
Device reset (Parameter)	165
Device revision (Parameter)	173
Device tag (Parameter)	113, 172
Device type (Parameter)	174
Diagnostic event	74
In the operating tool	75
Diagnostic event simulation (Parameter)	184
Diagnostic events	73
Diagnostic list	77
Diagnostic list (Submenu)	170
Diagnostic message	73
Diagnostics	
Symbols	73
Diagnostics (Menu)	168
Diagnostics 1 (Parameter)	170
Diameter (Parameter)	133
DIP switch	
see Write protection switch	
Display (Submenu)	156
Display and operating module FHX50	47
Display channel 1 to 4 (Submenu)	179
Display damping (Parameter)	159
Display interval (Parameter)	158
Display module	55
Display symbols	56
Disposal	85
Distance (Parameter)	115, 119, 175
Distance unit (Parameter)	113
Document	
Function	5
Document function	5

## E

Electronics housing	
Design	12
Empty calibration (Parameter)	114
Enter access code (Parameter)	121
Envelope curve display	61
Event history	80
Event level	
Explanation	74
Symbols	74
Event list	80

Event list (Submenu) . . . . . 171  
 Event logbook (Submenu) . . . . . 171  
 Event text . . . . . 74  
 Extended order code 1 (Parameter) . . . . . 173  
 Exterior cleaning . . . . . 83

**F**

Failure current (Parameter) . . . . . 149  
 Failure mode (Parameter) . . . . . 148, 154  
 FHX50 . . . . . 47  
 Field of application  
     Residual risks . . . . . 9  
 Filter options (Parameter) . . . . . 171  
 Filtering the event logbook . . . . . 80  
 Firmware version (Parameter) . . . . . 172  
 Fixed current (Parameter) . . . . . 147  
 Flange . . . . . 31  
 Format display (Parameter) . . . . . 156  
 Free text (Parameter) . . . . . 132  
 Full calibration (Parameter) . . . . . 114  
 FV (HART variable) . . . . . 62

**H**

Hardware write protection . . . . . 52  
 HART protocol . . . . . 48  
 HART variables . . . . . 62  
 Header (Parameter) . . . . . 159  
 Header text (Parameter) . . . . . 159  
 Heartbeat (Submenu) . . . . . 187  
 Housing  
     Design . . . . . 12  
     Turning . . . . . 33

**I**

Input mask . . . . . 58  
 Intended use . . . . . 9  
 Intermediate height (Parameter) . . . . . 134  
 Invert output signal (Parameter) . . . . . 154

**K**

Keypad lock  
     Disabling . . . . . 54  
     Enabling . . . . . 54

**L**

Language (Parameter) . . . . . 156  
 Last backup (Parameter) . . . . . 162  
 Last check time (Parameter) . . . . . 185  
 Launch signal (Parameter) . . . . . 186  
 Level (Parameter) . . . . . 115, 135, 136  
 Level (Submenu) . . . . . 122  
 Level correction (Parameter) . . . . . 126  
 Level linearized (Parameter) . . . . . 133, 175  
 Level signal (Parameter) . . . . . 186  
 Level unit (Parameter) . . . . . 125  
 Linearization (Submenu) . . . . . 128, 129, 130  
 Linearization type (Parameter) . . . . . 130  
 Local display  
     see Diagnostic message  
     see In alarm condition

Locking status . . . . . 56  
 Locking status (Parameter) . . . . . 120  
 Logging interval (Parameter) . . . . . 178

**M**

Maintenance . . . . . 83  
 Managing the device configuration . . . . . 69  
 Manufacturer ID (Parameter) . . . . . 174  
 Mapping (Wizard) . . . . . 119  
 Mapping end point (Parameter) . . . . . 118, 119  
 Maximum value (Parameter) . . . . . 133  
 Measured current 1 (Parameter) . . . . . 176  
 Measured value symbols . . . . . 57  
 Measured values (Submenu) . . . . . 175  
 Media . . . . . 9  
 Medium property (Parameter) . . . . . 122  
 Medium type (Parameter) . . . . . 122  
 Menu  
     Diagnostics . . . . . 168  
     Setup . . . . . 113  
 Mounting position for level measurements . . . . . 16

**N**

Non-metal vessels . . . . . 27  
 Number format (Parameter) . . . . . 160

**O**

Onsite operation . . . . . 47  
 Operating elements  
     Diagnostic message . . . . . 74  
 Operating module . . . . . 55  
 Operating time (Parameter) . . . . . 162, 169  
 Operating time from restart (Parameter) . . . . . 169  
 Operational safety . . . . . 10  
 Order code (Parameter) . . . . . 173  
 Output current 1 to 2 (Parameter) . . . . . 149, 175  
 Output echo lost (Parameter) . . . . . 137  
 Overvoltage protection  
     General information . . . . . 43

**P**

Present mapping (Parameter) . . . . . 118  
 Present probe length (Parameter) . . . . . 142, 145  
 Previous diagnostics (Parameter) . . . . . 168  
 Probe grounded (Parameter) . . . . . 142  
 Probe length correction (Wizard) . . . . . 144  
 Probe settings (Submenu) . . . . . 142  
 Process property (Parameter) . . . . . 123  
 Process variable value (Parameter) . . . . . 182  
 Product security . . . . . 10  
 PV (HART variable) . . . . . 62

**R**

Ramp at echo lost (Parameter) . . . . . 138  
 Read access . . . . . 50  
 Record map (Parameter) . . . . . 118, 119  
 Registered trademarks . . . . . 8  
 Remedial measures  
     Calling up . . . . . 75  
     Closing . . . . . 75

- Repair concept . . . . . 84
- Replacing a device . . . . . 84
- Requirements for personnel . . . . . 9
- Reset write protection (Parameter) . . . . . 141
- Result device check (Parameter) . . . . . 185
- Return . . . . . 85
- Rod probe
  - Design . . . . . 11
- Rod probes
  - Lateral loading capacity . . . . . 21
  - Shortening . . . . . 28
- Rope probe
  - Design . . . . . 11
- Rope probes
  - Installation . . . . . 31
  - Shortening . . . . . 28
- S**
- Safety instructions
  - Basic . . . . . 9
- Safety settings (Submenu) . . . . . 137
- Securing rod probes . . . . . 24
- Securing rope probes . . . . . 24
- Separator (Parameter) . . . . . 160
- Serial number (Parameter) . . . . . 172
- Service interface (CDI) . . . . . 48
- Settings
  - Managing the device configuration . . . . . 69
  - Operating language . . . . . 66
- Setup (Menu) . . . . . 113
- Signal quality (Parameter) . . . . . 116
- SIL/WHG confirmation (Wizard) . . . . . 140
- Simulation (Submenu) . . . . . 181, 182
- Spare parts . . . . . 85
  - Nameplate . . . . . 85
- Start device check (Parameter) . . . . . 185
- Status signals . . . . . 56, 73
- Submenu
  - Administration . . . . . 165
  - Advanced setup . . . . . 120
  - Configuration backup display . . . . . 162
  - Current output 1 to 2 . . . . . 146
  - Data logging . . . . . 177
  - Device check . . . . . 185
  - Device information . . . . . 172
  - Diagnostic list . . . . . 170
  - Display . . . . . 156
  - Display channel 1 to 4 . . . . . 179
  - Event list . . . . . 80, 171
  - Event logbook . . . . . 171
  - Heartbeat . . . . . 187
  - Level . . . . . 122
  - Linearization . . . . . 128, 129, 130
  - Measured values . . . . . 175
  - Probe settings . . . . . 142
  - Safety settings . . . . . 137
  - Simulation . . . . . 181, 182
  - Switch output . . . . . 150
- SV (HART variable) . . . . . 62
- Switch output (Submenu) . . . . . 150
- Switch output function (Parameter) . . . . . 150
- Switch output simulation (Parameter) . . . . . 183
- Switch status (Parameter) . . . . . 154, 183
- Switch-off delay (Parameter) . . . . . 154
- Switch-off value (Parameter) . . . . . 153
- Switch-on delay (Parameter) . . . . . 153
- Switch-on value (Parameter) . . . . . 152
- Symbols
  - For correction . . . . . 58
  - In the text and numeric editor . . . . . 58
- System components . . . . . 94
- System integration . . . . . 62
- T**
- Table mode (Parameter) . . . . . 134
- Table number (Parameter) . . . . . 135
- Terminal voltage 1 (Parameter) . . . . . 176
- Thermal insulation . . . . . 27
- Threaded connection . . . . . 30
- Timestamp (Parameter) . . . . . 168, 169
- Timestamp 1 to 5 (Parameter) . . . . . 170
- Tool . . . . . 28
- Transmitter
  - Turning the display . . . . . 34
  - Turning the display module . . . . . 34
- Transmitter housing
  - Turning . . . . . 33
- Troubleshooting . . . . . 71
- Turning the display . . . . . 34
- Turning the display module . . . . . 34
- TV (HART variable) . . . . . 62
- U**
- Unit after linearization (Parameter) . . . . . 131
- Use of measuring instrument
  - see Intended use
- Use of the measuring instruments
  - Borderline cases . . . . . 9
  - Incorrect use . . . . . 9
- V**
- Value 1 display (Parameter) . . . . . 158
- Value current output 1 to 2 (Parameter) . . . . . 183
- Value echo lost (Parameter) . . . . . 137
- W**
- Wizard
  - Deactivate SIL/WHG . . . . . 141
  - Define access code . . . . . 167
  - Mapping . . . . . 119
  - Probe length correction . . . . . 144
  - SIL/WHG confirmation . . . . . 140
- Workplace safety . . . . . 10
- Write access . . . . . 50
- Write protection
  - Via access code . . . . . 51
  - Via write protection switch . . . . . 52
- Write protection switch . . . . . 52





71664104

[www.addresses.endress.com](http://www.addresses.endress.com)

---