

Safety Instructions

Remote display FHX50B

Ex tb IIIC T85 °C T_L 85 °C Db

Segurança



Remote display FHX50B

Table of contents

Associated documentation	4
Supplementary documentation	4
Certificates and declarations	4
Manufacturer address	4
Extended order code	4
Safety instructions: General	6
Safety instructions: Specific conditions of use	7
Safety instructions: Installation	8
Temperature tables	9
Connection data	10

Associated documentation

All documentation is available on the Internet:
www.endress.com/Deviceviewer
 (enter the serial number from the nameplate).



If not yet available, a translation into EU languages can be ordered.

To commission the device, please observe the Operating Instructions pertaining to the device:

SD02991F

Supplementary documentation

Explosion protection brochure: CP00021Z

The explosion protection brochure is available on the Internet:
www.endress.com/Downloads

Certificates and declarations**Certificate of Conformity**

Certificate number:

Production Maulburg, Germany
 TÜV 23.0904 X

Production Itatiba, Brazil
 TÜV 23.0903 X

Production Greenwood, Indiana, USA
 TÜV 23.0905 X

Affixing the certificate number certifies conformity with the following standards (depending on the device version):

- ABNT NBR IEC 60079-0:2020
- ABNT NBR IEC 60079-31:2014

Manufacturer address

Endress+Hauser SE+Co. KG
 Hauptstraße 1
 79689 Maulburg, Germany

Address of the manufacturing plant: See nameplate.

Extended order code

The extended order code is indicated on the nameplate, which is affixed to the device in such a way that it is clearly visible. Additional information about the nameplate is provided in the associated Operating Instructions.

Structure of the extended order code

FHX50B <i>(Device type)</i>	–	***** <i>(Basic specifications)</i>	+	A*B*C*D*E*F*G*.. <i>(Optional specifications)</i>
------------------------------------	---	--	---	--

* = Placeholder

At this position, an option (number or letter) selected from the specification is displayed instead of the placeholders.

Basic specifications

The features that are absolutely essential for the device (mandatory features) are specified in the basic specifications. The number of positions depends on the number of features available.

The selected option of a feature can consist of several positions.

Optional specifications

The optional specifications describe additional features for the device (optional features). The number of positions depends on the number of features available. The features have a 2-digit structure to aid identification (e.g. JA). The first digit (ID) stands for the feature group and consists of a number or a letter (e.g. J = Test, Certificate). The second digit constitutes the value that stands for the feature within the group (e.g. A = 3.1 material (wetted parts), inspection certificate).

More detailed information about the device is provided in the following tables. These tables describe the individual positions and IDs in the extended order code which are relevant to hazardous locations.

Extended order code: Remote display



The following specifications reproduce an extract from the product structure and are used to assign:

- This documentation to the device (using the extended order code on the nameplate).
- The device options cited in the document.

Device type

FHX50B

Basic specifications

Position 1, 2 (Approval)		
Selected option	Description	
FHX50B	MG	INMETRO Ex tb IIIC T85 °C T ₁ 85 °C Db

Position 4 (Housing, Material)		
Selected option	Description	
FHX50B	B	Single compartment; Alu, coated

Position 5 (Electrical Connection, Cable)		
Selected option	Description	
FHX50B	2	Gland M20, brass nickel plated; w/o
	3	Gland M20, 316L; w/o
	5	Thread M20; w/o
	6	Thread G1/2; w/o
	7	Thread NPT1/2; w/o

Optional specifications

ID Jx, Kx (Test, Certificate, Declaration)		
Selected option	Description	
FHX50B	JL	Ambient temperature -50°C/-58°F

Safety instructions: General



The FHX50B remote display can only be operated with compatible Endress+Hauser measuring devices.

- The device is intended to be used in explosive atmospheres as defined in the scope of IEC 60079-0 or equivalent national standards. If no potentially explosive atmospheres are present or if additional protective measures have been taken: The device may be operated according to the manufacturer's specifications.
- Comply with the installation and safety instructions in the Operating Instructions.
- Staff must meet the following conditions for mounting, electrical installation, commissioning and maintenance of the device:
 - Be suitably qualified for their role and the tasks they perform
 - Be trained in explosion protection
 - Be familiar with national regulations

- Install the device according to the manufacturer's instructions and national regulations.
- Do not operate the device outside the specified electrical, thermal and mechanical parameters.
- Only use the device in media to which the wetted materials have sufficient durability.
- Avoid electrostatic charging:
 - Of plastic surfaces (e.g. enclosure, sensor element, special varnishing, attached additional plates, ...)
 - Of isolated capacities (e.g. isolated metallic plates)
- Alterations to the device can affect the explosion protection and must be carried out by staff authorized to perform such work by Endress+Hauser.

**Safety
instructions:
Specific
conditions of use**

- To avoid electrostatic charging: Do not rub surfaces with a dry cloth.
- In the event of additional or alternative special varnishing on the enclosure or other metal parts or for adhesive plates:
 - Observe the danger of electrostatic charging and discharge.
 - Do not install in the vicinity of processes (≤ 0.5 m) generating strong electrostatic charges.
- Avoid sparks caused by impact and friction.
- In the case of process connections made of polymeric material or with polymeric coatings, avoid electrostatic charging of the plastic surfaces.

Safety instructions: Installation

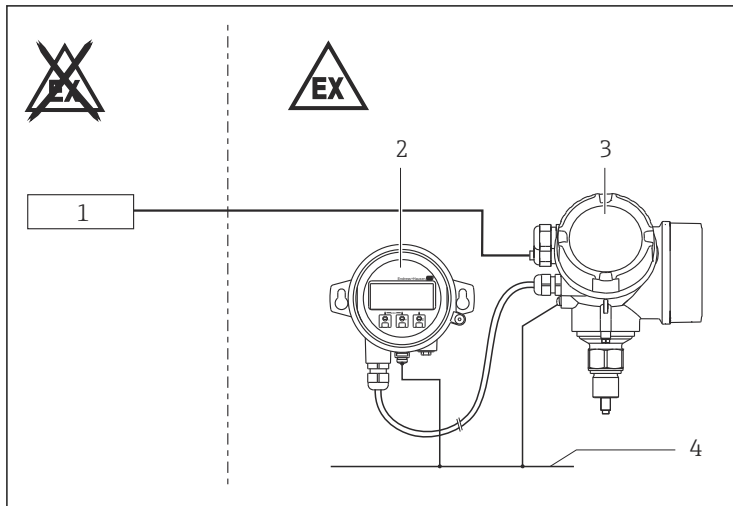

A0032629

- 1 Power supply or certified associated apparatus (dependent on Endress+Hauser measuring device)
- 2 FHX50B in Zone 21
- 3 Endress+Hauser measuring device
- 4 Local potential equalization

- After aligning (rotating) the enclosure, retighten the fixing screw.
- Continuous service temperature of the connecting cable: $-40\text{ }^{\circ}\text{C}$ to $\geq +85\text{ }^{\circ}\text{C}$.
- Do not open in a potentially explosive dust atmosphere.
- Seal the cable entry or piping tight (see protection type of enclosure in the "Temperature tables" chapter).
- Before operation:
 - Screw in the cover all the way.
 - Tighten the securing screw on the cover.

Basic specification, Position 5 = 6

Devices under the protection type "Equipment dust ignition protection by enclosure (Ex t)" with G threaded holes are not intended for new installations, but only for replacing equipment in existing installations. Use of this equipment shall comply with the local installation requirements.

Basic specification, Position 5 = 7

Observe the requirements according to IEC/EN 60079-14 for conduit systems and the wiring and installation instructions of the suitable Safety Instructions (XA). In addition, observe national regulations and standards for conduit systems.

Optional specification, ID Jx, Kx = JL

Continuous service temperature of the connecting cable:

-50 °C to ≥ +85 °C; in accordance with the range of service temperature taking into account additional influences of the process conditions ($T_{a,min}$), ($T_{a,max} + 20$ K).

Permitted ambient conditions

Ex tb IIIC T85 °C T_L 85 °C Db

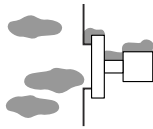

Process Zone 21	Enclosure Zone 21
Continuous dust deposits or temporary explosive dust atmosphere	Dust accumulation or temporary explosive dust atmosphere



Potential equalization

Integrate the device into the local potential equalization.

Temperature tables

-  The specified surface temperature takes into account all direct heat influences from the ambient temperature and from self-heating at the enclosure.
-  The specified ambient temperature ranges exclusively refer to the explosion protection and must not be exceeded. Operationally permitted ambient temperature ranges can be restricted depending on the version: See Operating Instructions.
-  Do not exceed the max. ambient temperature at the enclosure.

 *Optional specification, ID Jx, Kx = JL*
Lower limit of the ambient temperature for explosion protection changes to -50 °C.

Specific conditions of use:

The surface temperature for equipment protection level (EPL) Db is: $T_L xxx$ °C (with dust accumulation T_L)

 T_L marking:
The assigned surface temperature without dust layer is the same.

Max. surface temperature	Ambient temperature range
$T_L 85$ °C	-40 °C ≤ T_a ≤ $+80$ °C

Connection data

Power supply
$U \leq 3.2 V_{DC}$ $P \leq 0.04 W$

Cable entry: Connection compartment

Cable gland: *Basic specification, Position 5 = 2*

Thread	Clamping range	Material	Sealing insert	O-ring
M20x1,5	ø 8 to 10.5 mm	Ms, nickel-plated	Silicone	EPDM (ø 17x2)

Cable gland: *Basic specification, Position 5 = 3*

Thread	Clamping range	Material	Sealing insert	O-ring
M20x1,5	ø 7 to 12 mm	1.4404	NBR	EPDM (ø 17x2)



- The tightening torque refers to cable glands installed by the manufacturer:
 - Recommended: 3.5 Nm
 - Maximum: 10 Nm
- This value may be different depending on the type of cable. However, the maximum value must not be exceeded.
- Only suitable for fixed installation. The operator must pay attention to a suitable strain relief of the cable.
- The cable glands are suitable for a low risk of mechanical danger (4 Joule) and must be mounted in a protected position if larger impact energy levels are expected.
- To maintain the ingress protection of the enclosure: Install the enclosure cover, cable glands and blind plugs correctly.



71624421

www.addresses.endress.com
