

Operating Instructions

Levelflex FMP56, FMP57

PROFIBUS PA

Guided-wave radar





A0023555

Table of contents

1	About this document	5		
1.1	Document function	5		
1.2	Symbols	5		
1.2.1	Safety symbols	5		
1.2.2	Electrical symbols	5		
1.2.3	Tool symbols	5		
1.2.4	Symbols for certain types of information and graphics	6		
1.3	List of abbreviations	6		
1.4	Documentation	7		
1.5	Registered trademarks	8		
2	Basic safety instructions	9		
2.1	Requirements for the personnel	9		
2.2	Intended use	9		
2.3	Workplace safety	10		
2.4	Operational safety	10		
2.5	Product security	10		
2.5.1	CE mark	10		
2.5.2	EAC conformity	10		
3	Product description	11		
3.1	Product design	11		
3.1.1	Levelflex FMP56/FMP57	11		
3.1.2	Electronics housing	12		
4	Incoming acceptance and product identification	13		
4.1	Incoming acceptance	13		
4.2	Product identification	13		
4.2.1	Nameplate	13		
4.2.2	Manufacturer address	14		
5	Storage, transport	15		
5.1	Storage temperature	15		
5.2	Transporting to the measuring point	15		
6	Installation	16		
6.1	Mounting requirements	16		
6.1.1	Suitable mounting position	16		
6.1.2	Mounting under confined conditions	17		
6.1.3	Notes on the mechanical load of the probe	18		
6.1.4	Information concerning the process connection	21		
6.1.5	Securing the probe	24		
6.1.6	Special installation situations	25		
6.2	Mounting the device	28		
6.2.1	Tool list	28		
6.2.2	Shortening the probe	28		
6.2.3	Mounting the device	30		
6.2.4	Mounting the "Sensor, remote" version	32		
6.2.5	Turning the transmitter housing	33		
6.2.6	Turning the display	34		
6.3	Post-mounting check	34		
7	Electrical connection	36		
7.1	Connecting requirements	36		
7.1.1	Terminal assignment	36		
7.1.2	Cable specification	37		
7.1.3	Device plug	37		
7.1.4	Supply voltage	38		
7.1.5	Overvoltage protection	38		
7.2	Connecting the device	39		
7.2.1	Opening cover	39		
7.2.2	Connecting	39		
7.2.3	Plug-in spring-force terminals	40		
7.2.4	Closing the cover of the connection compartment	40		
7.3	Post-connection check	41		
8	Operation options	42		
8.1	Overview of operation options	42		
8.1.1	Access to operating menu via local display	42		
8.1.2	Access to the operating menu via the operating tool	43		
8.2	Structure and function of the operating menu	44		
8.2.1	Structure of the operating menu	44		
8.2.2	User roles and related access authorization	45		
8.2.3	Data access - Security	46		
8.3	Display and operating module	50		
8.3.1	Display format	50		
8.3.2	Operating elements	52		
8.3.3	Entering numbers and text	53		
8.3.4	Opening the context menu	55		
8.3.5	Envelope curve display on the display and operating module	56		
9	System integration	57		
9.1	Overview of device master file (GSD)	57		
9.2	Setting the device address	57		
9.2.1	Hardware addressing	57		
9.2.2	Software addressing	57		
10	Commissioning using the wizard ...	59		
11	Commissioning via operating menu	60		
11.1	Installation and function check	60		

11.2	Configuring the operating language	60	16	Operating menu	85
11.3	Configuring level measurement	61	16.1	Overview of the operating menu (display module)	85
11.4	Recording the reference echo curve	62	16.2	Overview of the operating menu (operating tool)	92
11.5	Configuring the local display	62	16.3	"Setup" menu	98
	11.5.1 Factory setting of local display for level measurements	62	16.3.1	"Mapping" wizard	104
	11.5.2 Adjusting the local display	62	16.3.2	"Analog input 1 to 6" submenu	105
11.6	Configuration management	63	16.3.3	"Advanced setup" submenu	107
11.7	Protecting settings from unauthorized access .	63	16.4	"Diagnostics" menu	151
12	Diagnostics and troubleshooting	64	16.4.1	"Diagnostic list" submenu	153
12.1	General troubleshooting	64	16.4.2	"Event logbook" submenu	154
	12.1.1 General errors	64	16.4.3	"Device information" submenu	155
	12.1.2 Parameter configuration errors	64	16.4.4	"Measured values" submenu	157
12.2	Diagnostic information on local display	65	16.4.5	"Analog input 1 to 6" submenu	159
	12.2.1 Diagnostic message	65	16.4.6	"Data logging" submenu	161
	12.2.2 Calling up remedial measures	67	16.4.7	"Simulation" submenu	164
12.3	Diagnostic event in the operating tool	67	16.4.8	"Device check" submenu	168
12.4	Diagnostic list	69	16.4.9	"Heartbeat" submenu	170
12.5	List of diagnostic events	70	Index	171	
12.6	Event logbook	71			
	12.6.1 Event history	71			
	12.6.2 Filtering the event logbook	72			
	12.6.3 Overview of information events	72			
12.7	Firmware history	73			
13	Maintenance	74			
13.1	Exterior cleaning	74			
13.2	General cleaning instructions	74			
14	Repair	75			
14.1	General information	75			
	14.1.1 Repair concept	75			
	14.1.2 Repairs to Ex-approved devices	75			
	14.1.3 Replacing electronics modules	75			
	14.1.4 Replacing a device	75			
14.2	Spare parts	76			
14.3	Return	76			
14.4	Disposal	76			
15	Accessories	77			
15.1	Device-specific accessories	77			
	15.1.1 Weather protection cover	77			
	15.1.2 Mounting bracket for electronics housing	78			
	15.1.3 Rod extension (centering device) HMP40	80			
	15.1.4 Mounting kit, insulated	80			
	15.1.5 Remote display FHX50	81			
	15.1.6 Overvoltage protection	82			
	15.1.7 Bluetooth module BT10 for HART devices	83			
15.2	Communication-specific accessories	84			
15.3	Service-specific accessories	84			
15.4	System components	84			
	15.4.1 Memograph M RSG45	84			

1 About this document

1.1 Document function

These Operating Instructions contain all the information required in the various life cycle phases of the device: from product identification, incoming acceptance and storage, to installation, connection, operation and commissioning, through to troubleshooting, maintenance and disposal.

1.2 Symbols

1.2.1 Safety symbols

DANGER

This symbol alerts you to a dangerous situation. Failure to avoid this situation will result in serious or fatal injury.

WARNING

This symbol alerts you to a potentially dangerous situation. Failure to avoid this situation can result in serious or fatal injury.





CAUTION

This symbol alerts you to a potentially dangerous situation. Failure to avoid this situation can result in minor or medium injury.

NOTICE

This symbol alerts you to a potentially harmful situation. Failure to avoid this situation can result in damage to the product or something in its vicinity.

1.2.2 Electrical symbols

Symbol	Meaning
	Direct current
	Alternating current
	Direct and alternating current
	Ground connection A grounded terminal which, as far as the operator is concerned, is grounded via a grounding system.
	Protective earth (PE) Ground terminals that must be connected to ground prior to establishing any other connections. The ground terminals are located on the interior and exterior of the device: <ul style="list-style-type: none"> ▪ Interior ground terminal: protective earth is connected to the mains supply. ▪ Exterior ground terminal: device is connected to the plant grounding system.

1.2.3 Tool symbols

 Phillips head screwdriver

 Flat blade screwdriver

 Torx screwdriver



Allen key



Open-ended wrench

1.2.4 Symbols for certain types of information and graphics



Permitted

Procedures, processes or actions that are permitted



Preferred

Procedures, processes or actions that are preferred



Forbidden

Procedures, processes or actions that are forbidden



Tip

Indicates additional information



Reference to documentation



Reference to graphic



Notice or individual step to be observed

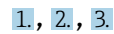

Series of steps



Result of a step



Visual inspection



Operation via operating tool



Write-protected parameter

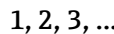

Item numbers

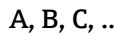

Views



Safety instructions

Observe the safety instructions contained in the associated Operating Instructions



Temperature resistance of the connection cables

Specifies the minimum value of the temperature resistance of the connection cables

1.3 List of abbreviations

BA

Document type "Operating Instructions"

KA

Document type "Brief Operating Instructions"

TI

Document type "Technical Information"

SD

Document type "Special Documentation"

XA

Document type "Safety Instructions"

PN

Nominal pressure

MWP

Maximum working pressure

The MWP is indicated on the nameplate.

ToF

Time of Flight

ϵ_r (Dk value)

Relative dielectric constant

PLC

Programmable logic controller (PLC)

CDI

Common Data Interface

BD

Blocking Distance; no signals are analyzed within the BD.

PLC

Programmable logic controller (PLC)

CDI

Common Data Interface

PFS

Pulse Frequency Status (Switch output)

1.4 Documentation

 For an overview of the scope of the associated Technical Documentation, refer to the following:

- *Device Viewer* (www.endress.com/deviceviewer): Enter the serial number from the nameplate
- *Endress+Hauser Operations app*: Enter serial number from nameplate or scan matrix code on nameplate.

The following documentation may be available depending on the device version ordered:

Document type	Purpose and content of the document
Technical Information (TI)	Planning aid for your device The document contains all the technical data on the device and provides an overview of the accessories and other products that can be ordered for the device.
Brief Operating Instructions (KA)	Guide that takes you quickly to the 1st measured value The Brief Operating Instructions contain all the essential information from incoming acceptance to initial commissioning.
Operating Instructions (BA)	Your reference document These Operating Instructions contain all the information that is required in the various life cycle phases of the device: from product identification, incoming acceptance and storage, to mounting, connection, operation and commissioning, through to troubleshooting, maintenance and disposal.
Description of Device Parameters (GP)	Reference for your parameters The document provides a detailed explanation of each individual parameter. The description is aimed at those who work with the device over the entire life cycle and perform specific configurations.

Document type	Purpose and content of the document
Safety Instructions (XA)	Depending on the approval, safety instructions for electrical equipment in hazardous areas are also supplied with the device. The Safety Instructions are a constituent part of the Operating Instructions.  Information on the Safety Instructions (XA) that are relevant for the device is provided on the nameplate.
Supplementary device-dependent documentation (SD/FY)	Always comply strictly with the instructions in the relevant supplementary documentation. The supplementary documentation is a constituent part of the device documentation.

1.5 Registered trademarks

PROFIBUS®

PROFIBUS and the associated trademarks (The Association Trademark, the Technology Trademarks, the Certification Trademark and the Certified by PI Trademark) are registered trademarks of the PROFIBUS User Organization e.V. (Profibus User Organization), Karlsruhe - Germany

Bluetooth®

The *Bluetooth*® word mark and logos are registered trademarks owned by the Bluetooth SIG, Inc. and any use of such marks by Endress+Hauser is under license. Other trademarks and trade names are those of their respective owners.

Apple®

Apple, the Apple logo, iPhone, and iPod touch are trademarks of Apple Inc., registered in the U.S. and other countries. App Store is a service mark of Apple Inc.

Android®

Android, Google Play and the Google Play logo are trademarks of Google Inc.

KALREZ®, VITON®

Registered trademarks of DuPont Performance Elastomers L.L.C., Wilmington, DE USA

TEFLON®

Registered trademark of E.I. DuPont de Nemours & Co., Wilmington, USA

TRI-CLAMP®

Registered trademark of Ladish & Co., Inc., Kenosha, USA

2 Basic safety instructions

2.1 Requirements for the personnel

The personnel for installation, commissioning, diagnostics and maintenance must fulfill the following requirements:

- ▶ Trained, qualified specialists must have a relevant qualification for this specific function and task.
- ▶ Are authorized by the plant owner/operator.
- ▶ Are familiar with federal/national regulations.
- ▶ Before starting work, read and understand the instructions in the manual and supplementary documentation as well as the certificates (depending on the application).
- ▶ Follow instructions and comply with basic conditions.

The operating personnel must fulfill the following requirements:

- ▶ Are instructed and authorized according to the requirements of the task by the facility's owner-operator.
- ▶ Follow the instructions in this manual.

2.2 Intended use

Application and media

The measuring instrument described in this manual is intended only for the level measurement of bulk solids. Depending on the version ordered, the measuring instrument can also measure potentially explosive, flammable, poisonous and oxidizing media.

If the limit values specified in the "Technical data" and the conditions listed in the instructions and additional documentation are observed, the measuring instrument may be used only for the following measurements:

- ▶ Measured process variables: level
- ▶ Calculable process variables: volume or mass in any shape of vessel (calculated from the level by the linearization functionality)

To ensure that the measuring instrument remains in proper condition for the operation time:

- ▶ Use the measuring instrument only for media to which the process-wetted materials are sufficiently resistant.
- ▶ Observe the limit values in the "Technical data".

Incorrect use

The manufacturer is not liable for harm caused by improper or unintended use.

Clarification for borderline cases:

- ▶ For special fluids and fluids for cleaning, Endress+Hauser is glad to provide assistance in verifying the corrosion resistance of fluid-wetted materials, but does not accept any warranty or liability.

Residual risks

Due to heat transfer from the process as well as power loss in the electronics, the temperature of the electronics housing and the assemblies contained therein (e.g. display module, main electronics module and I/O electronics module) may rise up to 80 °C (176 °F). When in operation, the sensor may reach a temperature close to the medium temperature.

Danger of burns from contact with surfaces!

- ▶ In the event of elevated fluid temperatures, ensure protection against contact to prevent burns.

2.3 Workplace safety

When working on and with the device:

- ▶ Wear the required personal protective equipment as per national regulations.

2.4 Operational safety

Risk of injury!

- ▶ Operate the device only if it is in proper technical condition, free from errors and faults.
- ▶ The operator is responsible for ensuring that the device is in good working order.

Modifications to the device

Unauthorized modifications to the device are not permitted and can lead to unforeseeable dangers:

- ▶ If modifications are nevertheless required, consult with the manufacturer.

Repair

To ensure continued operational safety and reliability:

- ▶ Carry out repairs on the device only if they are expressly permitted.
- ▶ Observe national regulations pertaining to the repair of an electrical device.
- ▶ Use only original spare parts and accessories from the manufacturer.

Hazardous area

To eliminate danger to persons or the installation when the device is used in the hazardous area (e.g. explosion protection, pressure vessel safety):

- ▶ Check the nameplate to verify if the device ordered can be put to its intended use in the hazardous area.
- ▶ Observe the specifications in the separate supplementary documentation included as an integral part of these instructions.

2.5 Product security

This measuring instrument is designed in accordance with good engineering practice to meet state-of-the-art safety requirements, has been tested, and left the factory in a condition in which it is safe to operate. It meets general safety standards and legal requirements.

NOTICE

Loss of degree of protection by opening of the device in humid environments

- ▶ If the device is opened in a humid environment, the degree of protection indicated on the nameplate is no longer valid. This may also impair the safe operation of the device.

2.5.1 CE mark

The measuring system meets the legal requirements of the applicable EU directives. These are listed in the corresponding EU Declaration of Conformity together with the standards applied.

The manufacturer confirms successful testing of the device by affixing to it the CE mark.

2.5.2 EAC conformity

The measuring system meets the legal requirements of the applicable EAC guidelines. These are listed in the corresponding EAC Declaration of Conformity along with the standards applied.

The manufacturer confirms successful testing of the device by affixing to it the EAC mark.

3 Product description

3.1 Product design

3.1.1 Levelflex FMP56/FMP57

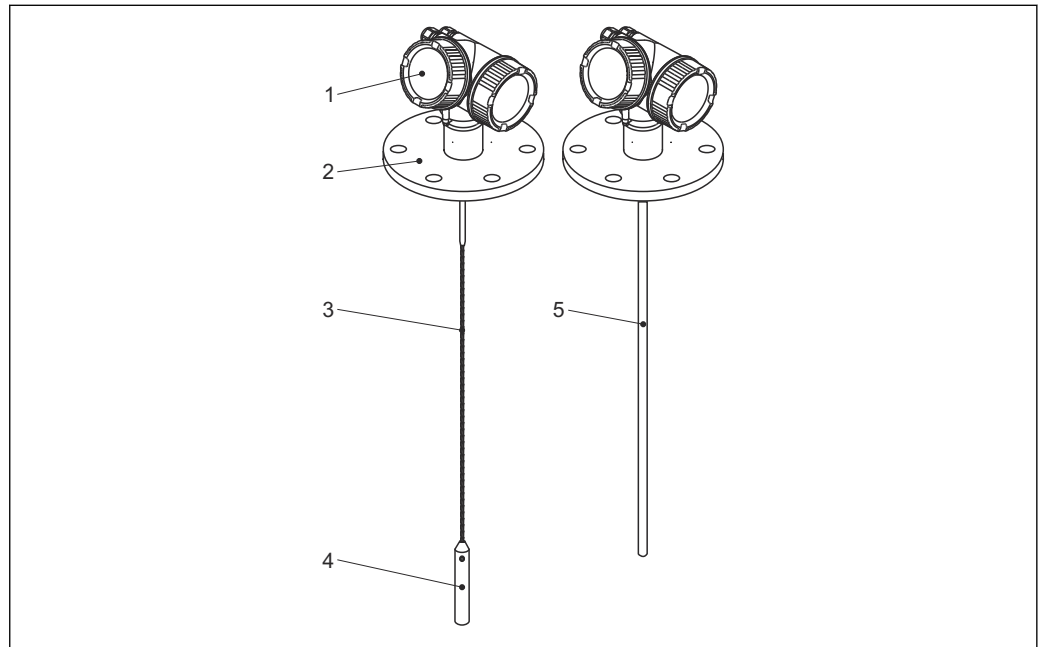

A0012470

1 Design of the Levelflex

- 1 Electronics housing
- 2 Process connection (here as an example: flange)
- 3 Rope probe
- 4 End-of-probe weight
- 5 Rod probe

3.1.2 Electronics housing

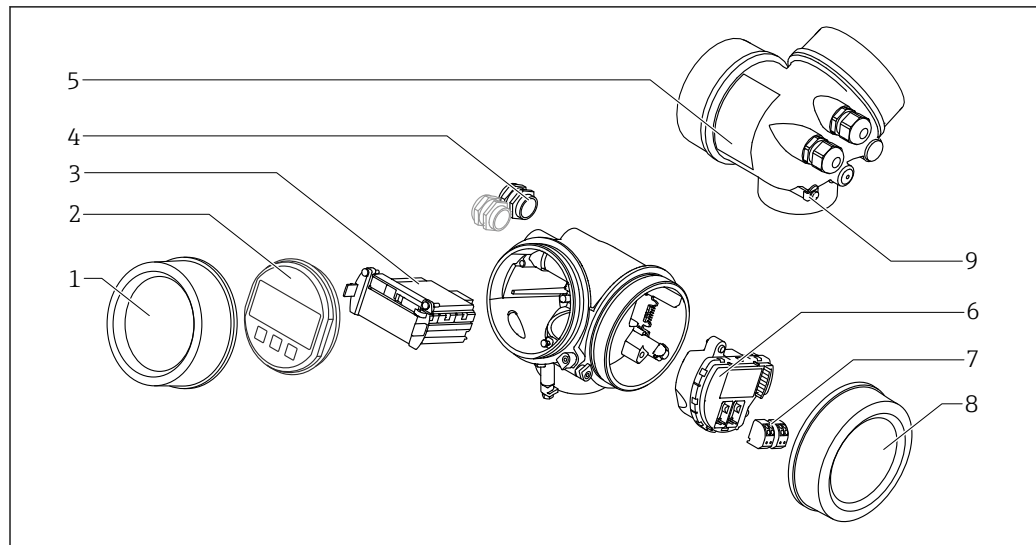

A0012422

2 Design of the electronics housing

- 1 Electronics compartment cover
- 2 Display module
- 3 Main electronics module
- 4 Cable glands (1 or 2, depending on instrument version)
- 5 Nameplate
- 6 I/O electronics module
- 7 Terminals (pluggable spring terminals)
- 8 Connection compartment cover
- 9 Grounding terminal

4 Incoming acceptance and product identification

4.1 Incoming acceptance

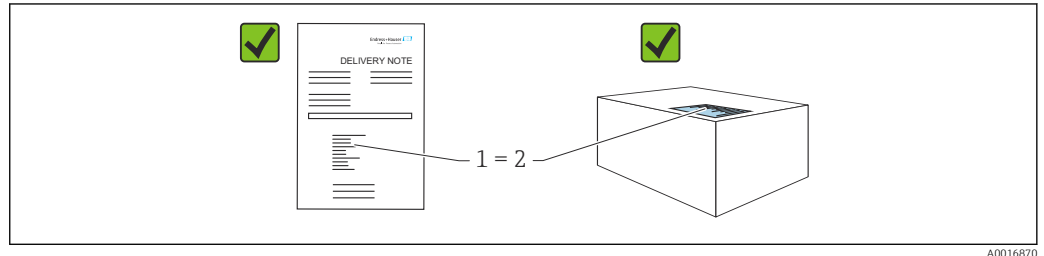

Check the following during incoming acceptance:

- Is the order code on the delivery note (1) identical to the order code on the product sticker (2)?
- Are the goods undamaged?
- Do the data on the nameplate correspond to the order specifications and the delivery note?
- Is the documentation provided?
- If required (see nameplate): are the Safety Instructions (XA) provided?



If one of these conditions is not met, please contact the manufacturer's sales office.

4.2 Product identification

The following options are available for identification of the device:

- Nameplate specifications
- Extended order code with breakdown of the device features on the delivery note
- ▶ *Device Viewer* (www.endress.com/deviceviewer); manually enter the serial number from the nameplate.
 - ↳ All the information about the measuring device is displayed.
- ▶ *Endress+Hauser Operations app*; manually enter the serial number indicated on the nameplate or scan the 2D matrix code on the nameplate.
 - ↳ All the information about the measuring device is displayed.

4.2.1 Nameplate

The information that is required by law and is relevant to the device is shown on the nameplate, e.g.:

- Manufacturer identification
- Order number, extended order code, serial number
- Technical data, degree of protection
- Firmware version, hardware version
- Approval-related information, reference to Safety Instructions (XA)
- DataMatrix code (information about the device)

4.2.2 Manufacturer address

Endress+Hauser SE+Co. KG
Hauptstraße 1
79689 Maulburg, Germany
Place of manufacture: See nameplate.

5 Storage, transport

5.1 Storage temperature

- Permitted storage temperature: -40 to +80 °C (-40 to +176 °F)
- Use original packaging.

5.2 Transporting to the measuring point

⚠ WARNING

Housing or probe may become damaged or break off.

Risk of injury!

- ▶ Transport the measuring instrument to the measuring point in its original packaging or by the process connection.
- ▶ Always secure lifting equipment (slings, eyes, etc.) at the process connection and never lift the device by the electronic housing or probe. Pay attention to the center of gravity of the device so that it does not tilt or slip unintentionally.
- ▶ Follow the safety instructions and transport conditions for devices weighing more than 18 kg (39.6 lbs) (IEC 61010).

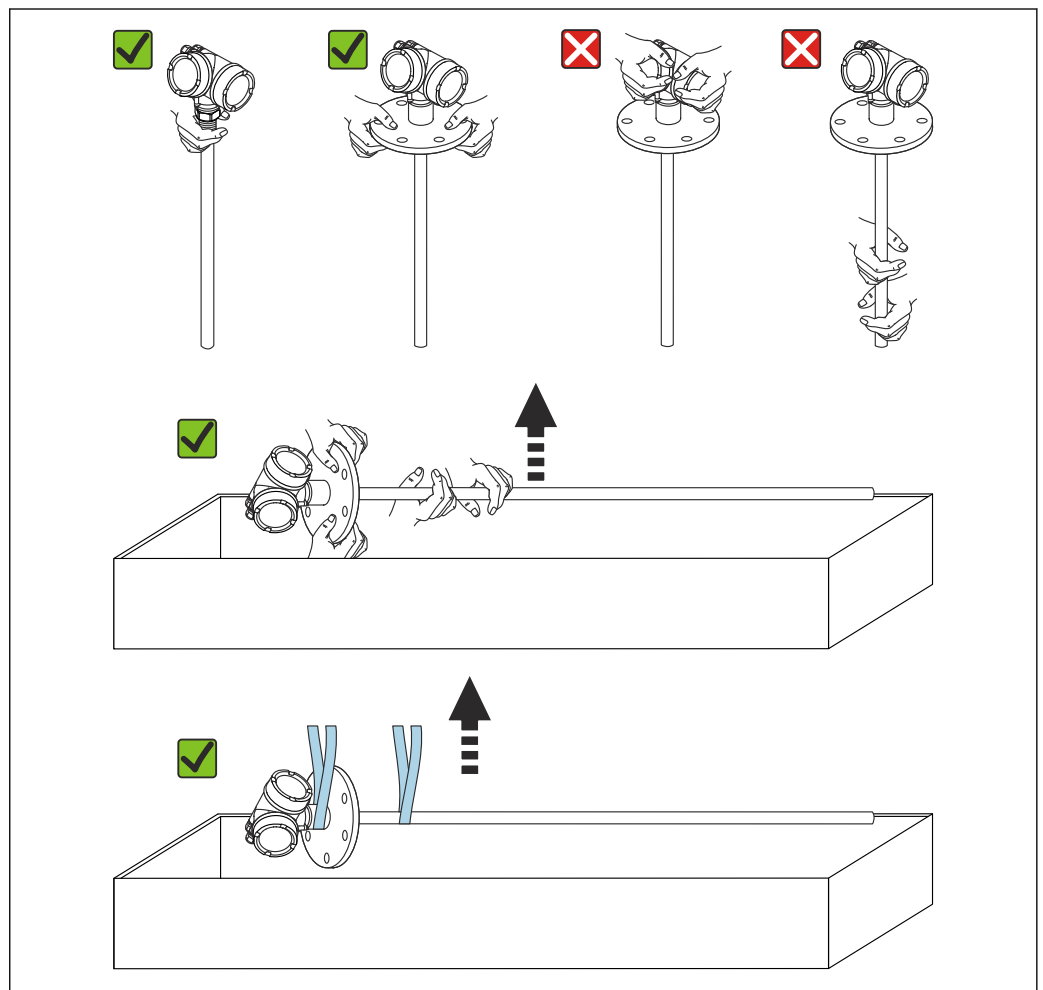

A0043233

6 Installation

6.1 Mounting requirements

6.1.1 Suitable mounting position

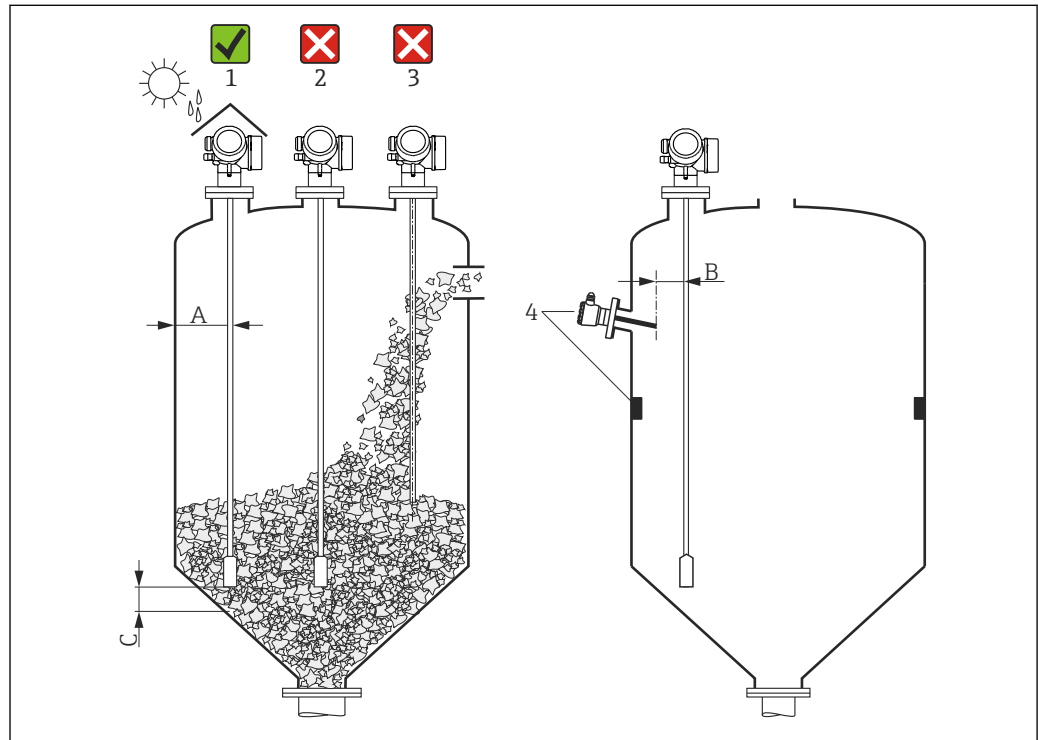

3 Installation positions

Spacing requirements when mounting

- Distance (A) between the vessel wall and rod and rope probes:
 - For smooth metallic walls: > 50 mm (2 in)
 - For plastic walls: > 300 mm (12 in) to metallic parts outside the vessel
 - For concrete walls: > 500 mm (20 in), otherwise the permitted measuring range may be reduced.
- Distance (B) between rod probes and internal fittings (3): > 300 mm (12 in)
- When using more than one Levelflex:
 - Minimum distance between the sensor axes: 100 mm (3.94 in)
- Distance (C) from the end of the probe to the bottom of the vessel:
 - Rope probe: > 150 mm (6 in)
 - Rod probe: > 10 mm (0.4 in)

Additional mounting requirements

- When mounting outdoors, a weather protection cover (1) can be used to protect the device against extreme weather conditions.
- In metallic vessels, preferably do not mount the probe in the center of the vessel (2), as this would lead to increased interference echoes.
If a central mounting position cannot be avoided, it is essential to perform interference echo suppression (mapping) after commissioning the device.
- Do not mount the probe in the filling curtain (3).
- Avoid buckling the rope probe during installation or operation (e.g. as a result of product movement against silo wall) by selecting a suitable mounting location.
- The probe must be checked regularly for damage during operation.

i In the case of freely suspended rope probes (probe end not fixed at the bottom), the distance between the probe rope and internal fittings, which can change due to the movement of the product, must never be less than 300 mm (12 in). Occasional contact between the probe weight and the cone of the vessel, however, does not influence the measurement provided that the relative permittivity is at least $\epsilon_r = 1.8$.

i When mounting the housing in a recess (e.g. in a concrete ceiling), observe a minimum distance of 100 mm (4 in) between the cover of the connection compartment/electronics compartment and the wall. Otherwise the connection compartment/electronics compartment will not be accessible after installation.

6.1.2 Mounting under confined conditions

Mounting with remote probe

The device version with a remote probe is suitable for applications with restricted mounting space. In this case, the electronics housing is mounted at a separate position from the probe.

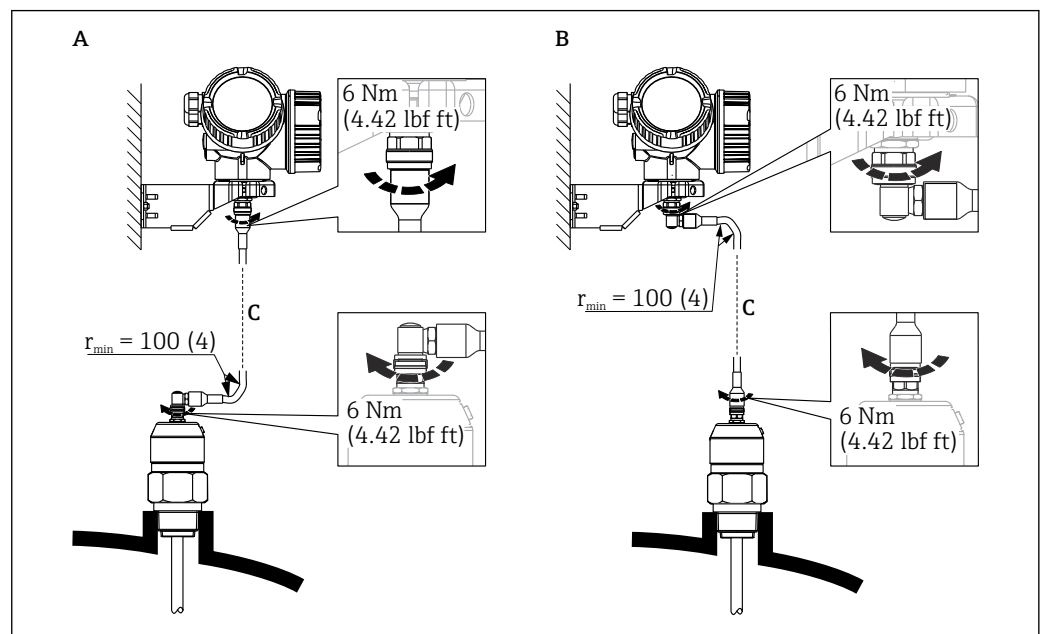

- A Angled plug at the probe
 B Angled plug at the electronics housing
 C Length of the remote cable as ordered

- Product structure, feature 600 "Probe design":
 - Version MB "Remote sensor, 3 m cable"
 - Version MC "Remote sensor, 6 m cable"
 - Version MD "Remote sensor, 9 m cable"
- The connecting cable is included in the delivery with these versions.
Minimum bending radius: 100 mm (4 inch)
- The mounting bracket for the electronics housing is included in the delivery with these versions. Mounting options:
 - Wall mounting
 - Mounting on DN32 to DN50 (1¼ to 2 inch) post or pipe
- The connecting cable has one straight plug and one plug angled at 90°. Depending on the local conditions the angled plug can be connected at the probe or at the electronics housing.

 The probe, electronics and connection cable are mutually compatible and bear a common serial number. Only components with the same serial number may be connected to one another.

6.1.3 Notes on the mechanical load of the probe

Tensile load

Bulk solids exert tensile forces on rope probes which increase with:

- The probe length, i.e. the maximum cover
- The bulk density of the product
- The silo diameter and
- The diameter of the probe rope

As the tensile forces also depend greatly on the flowability of the product, a higher safety factor is necessary for highly viscous products and if there is a risk of cornice buildup. In critical cases it is better to use a 6 mm (0.24 in) rope instead of a 4 mm (0.16 in) one.

The same forces also act on the silo ceiling. The tensile forces on a fixed rope are always greater, but cannot be calculated. Observe the tensile loading capacity of the probes.

Ways to reduce the tensile forces:

- Shorten the probe.
- If the maximum tensile load is exceeded, check whether it would be possible to use a non-contact ultrasonic or level radar device.

The following diagrams show typical loads for common bulk solids as reference values. The calculation was performed for the following conditions:

- Calculation according to DIN 1055, Part 6 for the cylindrical part of the silo
- Suspended probe (probe end not fixed at the bottom)
- Free-flowing bulk solid, i.e. mass flow. A calculation for core flow is not possible. In the event of collapsing cornices, considerably higher loads can occur.
- The specification for tensile forces contains safety factor 2 (in addition to the safety factors already contained in DIN 1055), which compensates for the normal fluctuation range in pourable bulk solids.

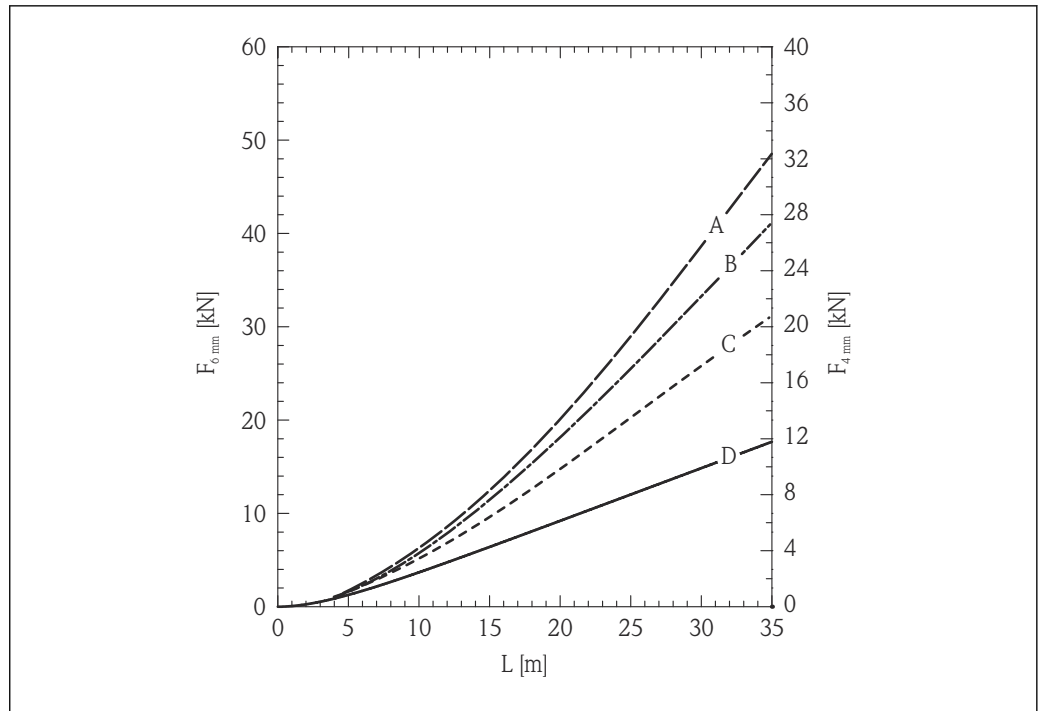

A0017170

4 Silica sand in metal silo with smooth walls; tensile load as a function of level L for rope diameters 6 mm (0.24 in) and 4 mm (0.16 in)

- A Silo diameter 12 m (40 ft)
- B Silo diameter 9 m (30 ft)
- C Silo diameter 6 m (20 ft)
- D Silo diameter 3 m (10 ft)

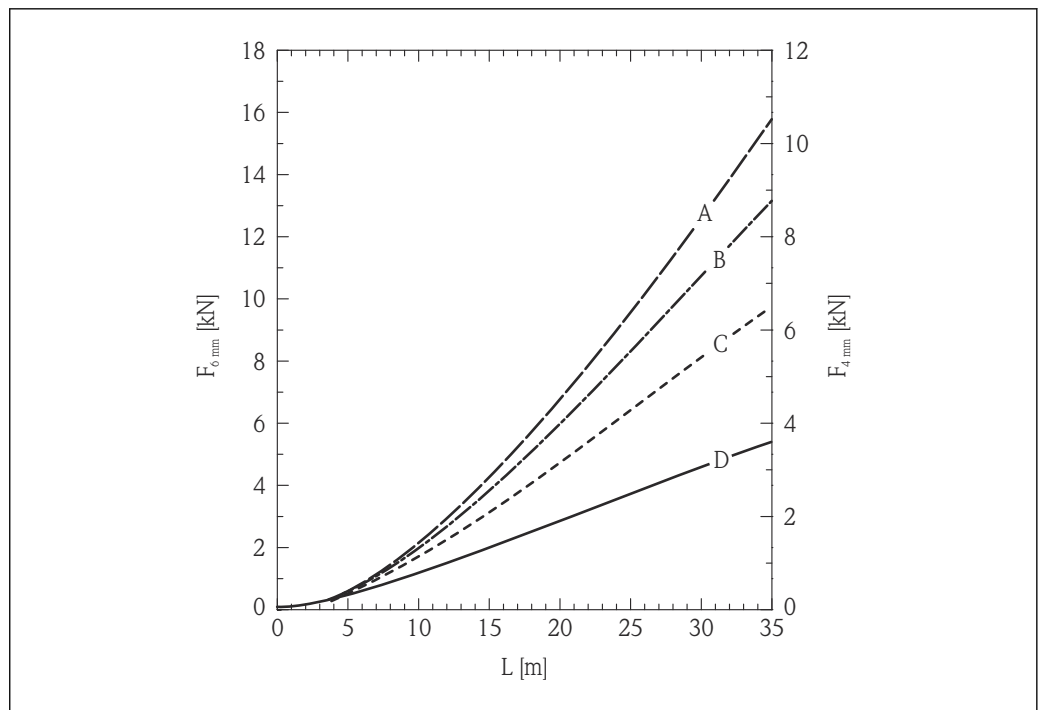

A0017171

5 Polyethylene pellets in metal silo with smooth walls; tensile load as a function of level L for rope diameters 6 mm (0.24 in) and 4 mm (0.16 in)

- A Silo diameter 12 m (40 ft)
- B Silo diameter 9 m (30 ft)
- C Silo diameter 6 m (20 ft)
- D Silo diameter 3 m (10 ft)

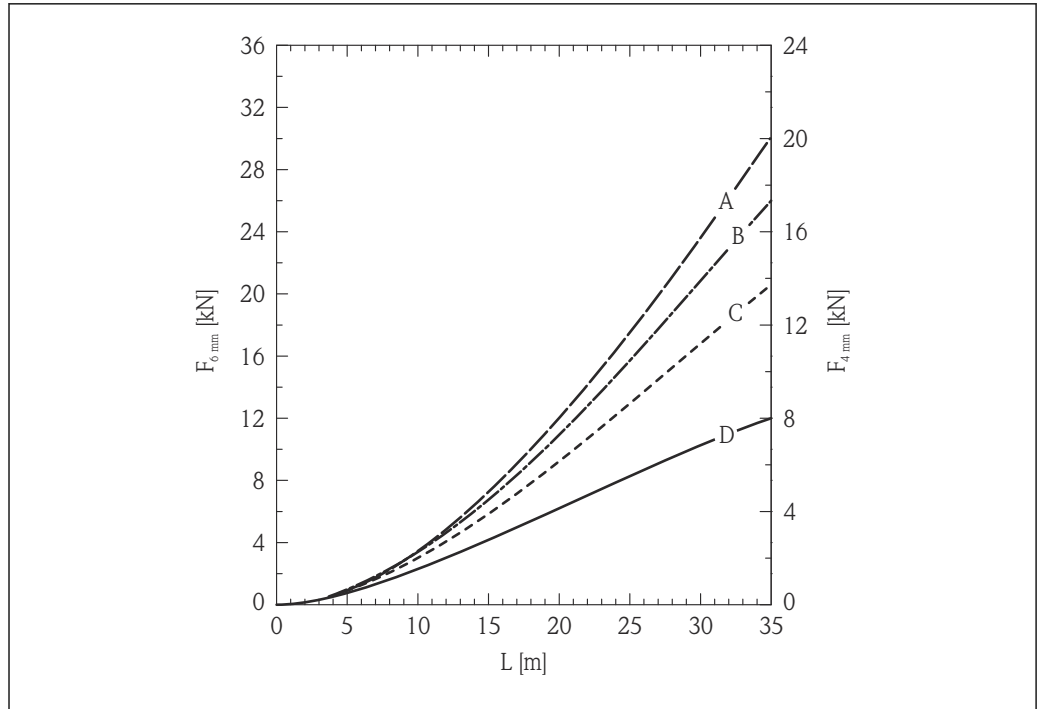

A0017172

6 Wheat in metal silo with smooth walls; tensile load as a function of level L for rope diameters 6 mm (0.24 in) and 4 mm (0.16 in)

- A Silo diameter 12 m (40 ft)
- B Silo diameter 9 m (30 ft)
- C Silo diameter 6 m (20 ft)
- D Silo diameter 3 m (10 ft)

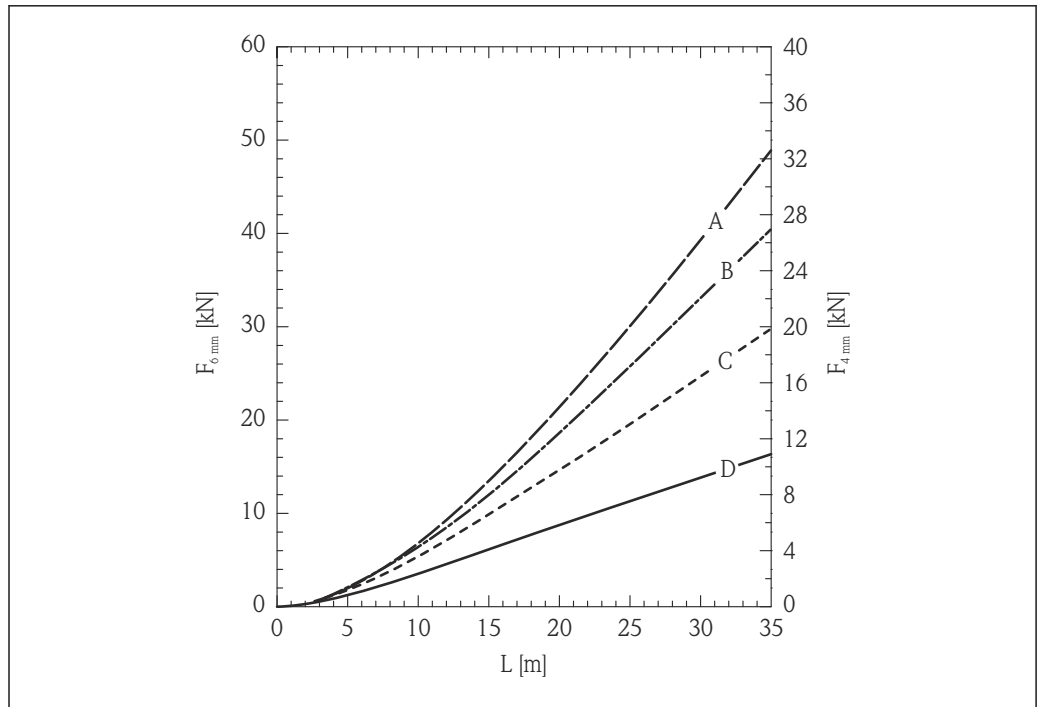

A0017173

7 Cement in metal silo with smooth walls; tensile load as a function of level L for rope diameters 6 mm (0.24 in) and 4 mm (0.16 in)

- A Silo diameter 12 m (40 ft)
- B Silo diameter 9 m (30 ft)
- C Silo diameter 6 m (20 ft)
- D Silo diameter 3 m (10 ft)

Tensile loading capacity of rope probe and breaking load (silo ceiling)

 The ceiling of the silo must be designed to withstand the maximum breaking load.

FMP56

Rope 4 mm (1/8 in) 316

- Tensile loading capacity 12 kN
- Max. breaking load 20 kN

Rope 6 mm (1/4 in) PA>steel

- Tensile loading capacity 12 kN
- Max. breaking load 20 kN

FMP57

Rope 4 mm (1/8 in) 316

- Tensile loading capacity 12 kN
- Max. breaking load 20 kN

Rope 6 mm (1/4 in) 316

- Tensile loading capacity 30 kN
- Max. breaking load 42 kN

Rope 6 mm (1/4 in) PA>steel

- Tensile loading capacity 12 kN
- Max. breaking load 20 kN

Rope 8 mm (1/3 in) PA>steel

- Tensile loading capacity 30 kN
- Max. breaking load 42 kN

Lateral loading capacity (flexural strength) of rod probes

FMP57

Rod 16 mm (0.63 in) 316L

Flexural strength 30 Nm

6.1.4 Information concerning the process connection

 Probes are mounted on the process connection with threaded connections or flanges. If there is the danger with this installation that the probe end moves so much that it occasionally touches the vessel floor or cone, the probe may need to be shortened at the lower end and fixed in place.

Threaded connection

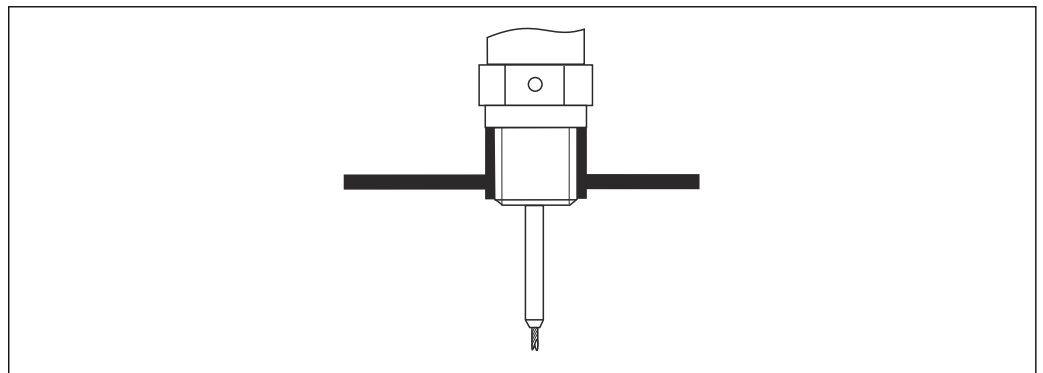

 8 Mounting with threaded connection; flush with the vessel ceiling

A0015121

Sealing

The thread and the type of seal comply with DIN3852 Part 2, screwed plug, form A.

The following types of sealing ring can be used:

- For thread G $\frac{3}{4}$ " according to DIN7603 with dimensions 27 mm × 32 mm
- For thread G1 $\frac{1}{2}$ " according to DIN 7603 with dimensions 48 mm × 55 mm

Use a sealing ring according to this standard in form A, C or D and of a material that offers appropriate resistance for the application.

Nozzle installation

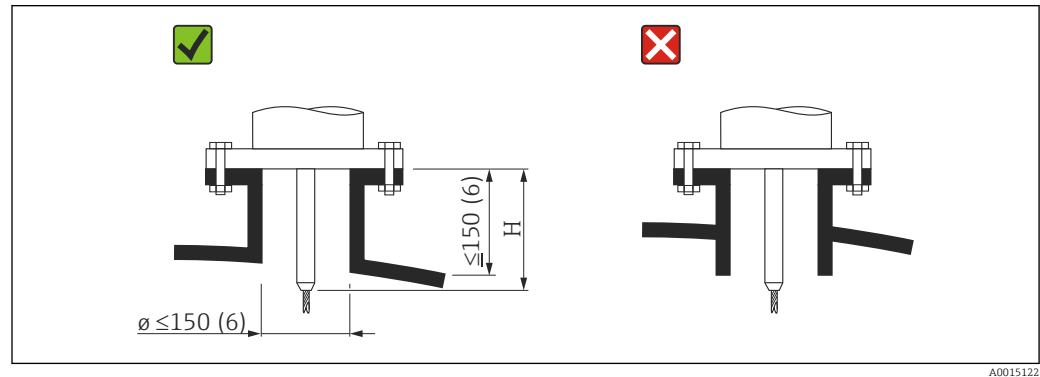

H Length of the centering rod or the rigid part of the rope probe

FMP56

Rope, Ø 4 mm (0.16 in)

Length H 120 mm (4.7 in)

FMP57

Rope, Ø 4 mm (0.16 in)

Length H 94 mm (3.7 in)

Rope, Ø 6 mm (0.24 in)

Length H 135 mm (5.3 in)

- Permissible nozzle diameter: ≤ 150 mm (6 in)
For larger diameters, the near-range measuring capability may be reduced.
For large nozzles, see the section "Mounting in nozzles ≥ DN300"
- Permissible nozzle height: ≤ 150 mm (6 in)
For larger heights, the near-range measuring capability may be reduced.
Larger nozzle heights are possible in special cases (on request), see section "Rod extension/centering device HMP40 for FMP57".
- The end of the nozzle should be flush with the tank ceiling in order to avoid ringing effects.

i In thermally insulated vessels, the nozzle should also be insulated in order to prevent condensate formation.

Rod extension/centering device HMP40 for FMP57

For FMP57 with rope probes, the rod extension/centering device HMP40 is available as an accessory. It must be used if the probe rope would otherwise come into contact with the lower edge of the nozzle.

i This accessory consists of the extension rod, corresponding to the nozzle height, on which a centering disk is also mounted if the nozzles are narrow or when used in bulk solids. We deliver this component separately from the device. Please order a correspondingly shorter probe length.

Only use centering disks with small diameters (DN40 and DN50) if there is no significant build-up in the nozzle above the disk. The nozzle must not become clogged with product.

Mounting in nozzles \geq DN300

If installation in nozzles \geq 300 mm (12 in) is unavoidable, installation must be carried out in accordance with the following diagram in order to avoid interference signals in the near range.

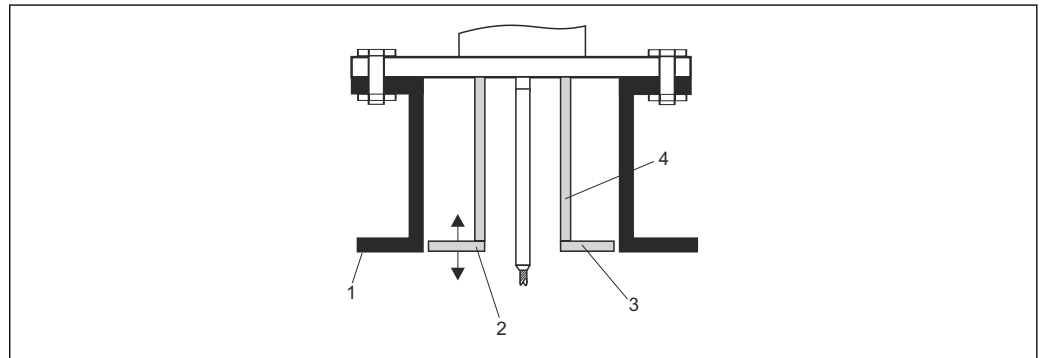

A0014199

- 1 Lower edge of the nozzle
- 2 Approximately flush with the lower edge of the nozzle (± 50 mm)
- 3 Plate, nozzle \varnothing 300 mm (12 in) = plate \varnothing 280 mm (11 in); nozzle \varnothing \geq 400 mm (16 in) = plate \varnothing \geq 350 mm (14 in)
- 4 Pipe \varnothing 150 to 180 mm

6.1.5 Securing the probe

Securing rope probes

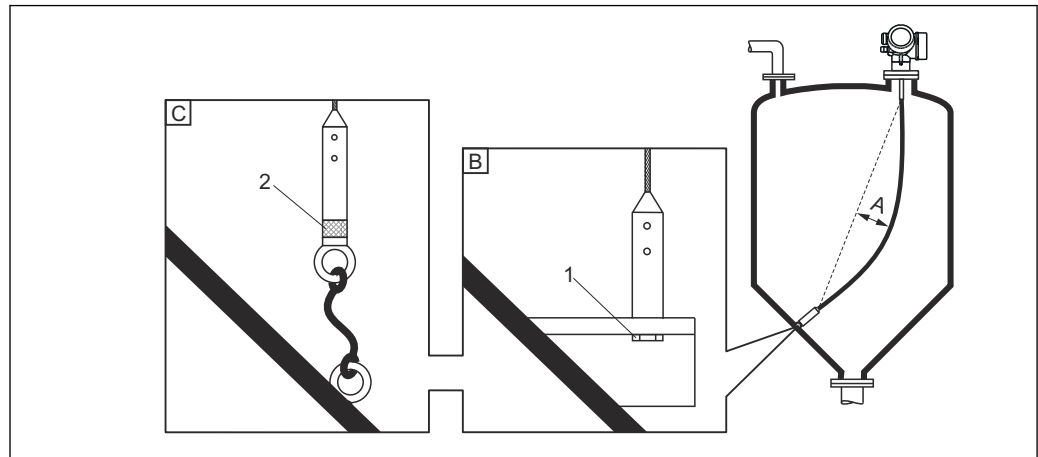

- A Sag: $\geq 10 \text{ mm/m}$ (0.12 in/ft) probe length
 B Reliably grounded end of probe
 C Reliably insulated end of probe
 1 Fastener in female thread of probe weight
 2 Insulated fastening kit

- The end of the rope probe must be secured or fixed down under the following conditions:
 - If the probe temporarily comes into contact with the vessel wall, the cone, internal fittings/beams or another part of the installation
 - If the probe comes closer than 0.5 m (1.6 ft) to a concrete wall.
- A female thread is provided in the probe weight to secure the end of the probe:
 - Rope 4 mm ($\frac{1}{8}$ in), 316: M 14
 - Rope 6 mm ($\frac{1}{4}$ in), 316: M 20
 - Rope 6 mm ($\frac{1}{4}$ in), PA>steel: M14
 - Rope 8 mm ($\frac{1}{3}$ in), PA>steel: M20
- Far higher tensile loads occur on the probe when it is fixed down. It is therefore preferable to use the 6 mm ($\frac{1}{4}$ in) rope probe.
- When fixed down, the end of the probe must be reliably grounded or reliably insulated. If it is not otherwise possible to secure the probe with a reliably insulated connection, use the insulated fastening kit.
- If the end of the probe is fixed down and grounded, the search for a positive end-of-probe signal must be activated. Otherwise automatic probe length correction is not possible.
 Navigation: Expert → Sensor → EOP evaluation → EOP search mode
 Setting: **Positive EOP** option
- To prevent an extremely high tensile load (e.g. due to thermal expansion) and the risk of the rope breaking, the rope must be slack. Required sag: $\geq 10 \text{ mm/m}$ (0.12 in/ft) rope length.
 Pay attention to the tensile loading capacity of rope probes.

Securing rod probes

- In the case of WHG approval: a support is required for probe lengths $\geq 3 \text{ m}$ (10 ft).
- In general, rod probes must be secured in the event of horizontal flow (e.g. from an agitator) or strong vibrations.
- Only secure rod probes directly at the end of the probe.

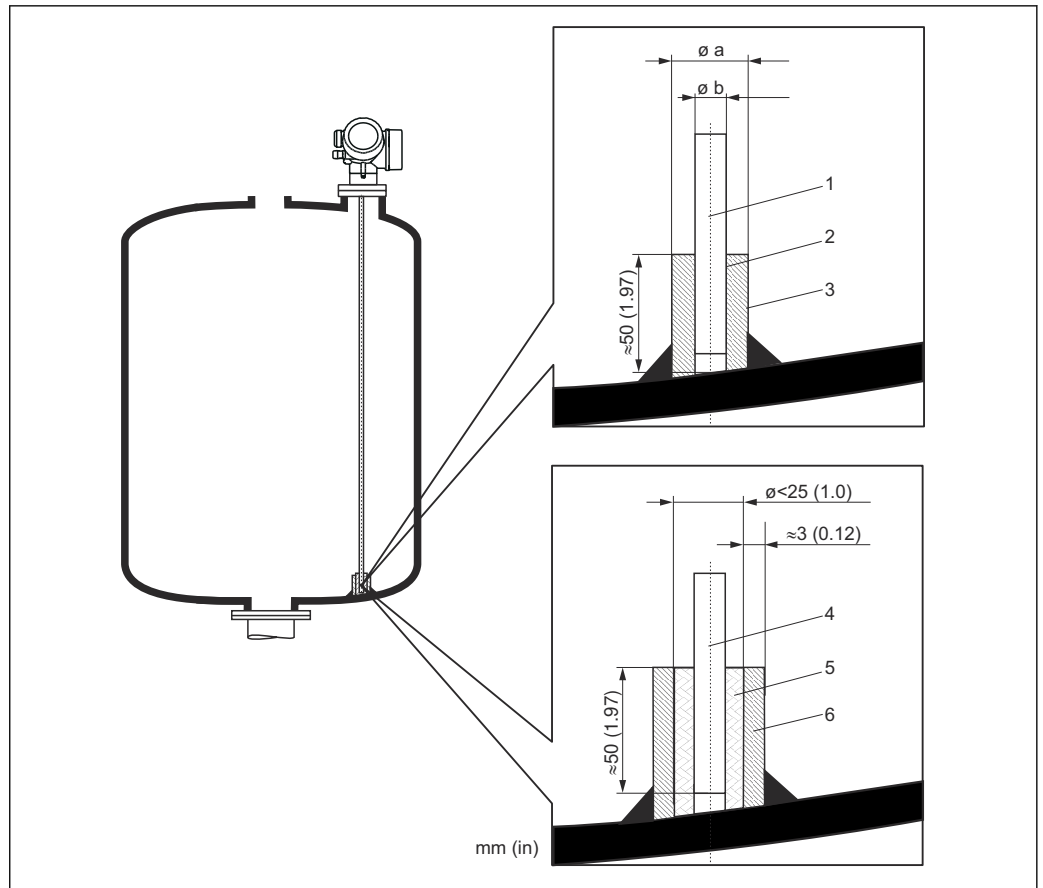

A0012607

Unit of measurement mm (in)

- 1 Probe rod, uncoated
- 2 Sleeve with narrow bore to ensure electrical contact between the sleeve and the rod.
- 3 Short metal pipe, e.g. welded in place
- 4 Probe rod, coated
- 5 Plastic sleeve, e.g. PTFE, PEEK, PPS
- 6 Short metal pipe, e.g. welded in place

NOTICE

Poor grounding of the probe end may cause incorrect measurements.

- ▶ Use a sleeve with a narrow bore to ensure good electrical contact between the sleeve and the probe rod.

NOTICE

Welding can damage the main electronics module.

- ▶ Before welding: Ground the probe rod and remove the electronics.

6.1.6 Special installation situations

Concrete silos

Installation in a thick concrete ceiling, for example, should be flush with the lower edge. Alternatively, the probe can also be installed in a pipe that must not protrude over the lower edge of the silo ceiling. The pipe should be as short as possible. For installation suggestions, see the diagram below.

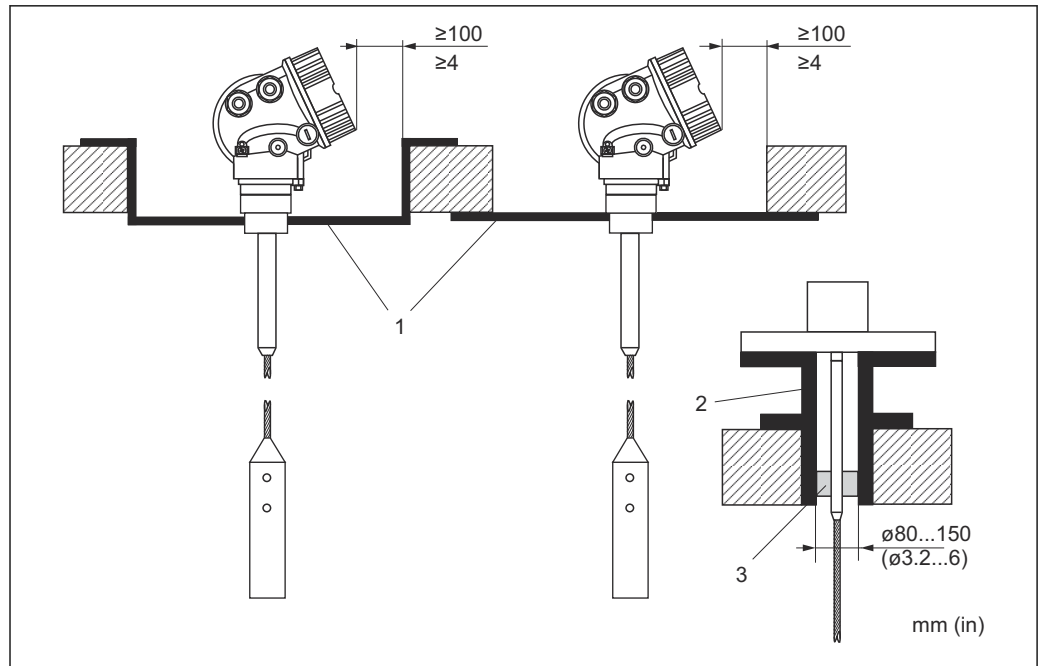

A0014138

- 1 Metal plate
- 2 Metal pipe
- 3 Rod extension/centering device HMP40 (see "Accessories")

i Installation with rod extension/centering device (accessory):

Strong dust generation can lead to build-up behind the centering disk. This can result in interference echoes. For other installation options, please contact Endress+Hauser.

Mounting from the side

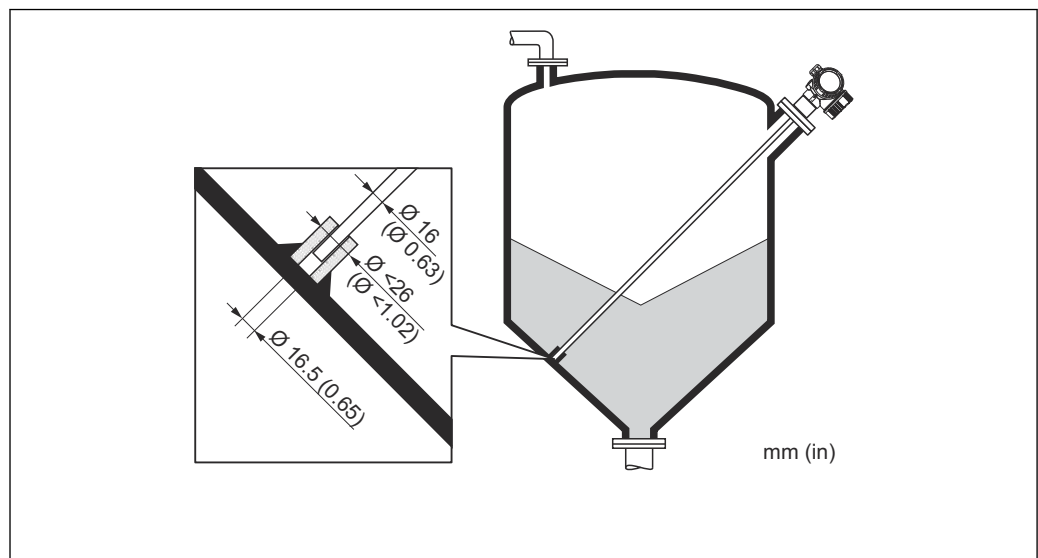

A0014140

- If installation from above is not possible, the device can also be mounted from the side
- Always secure the rope probe in this case
- Support the rod and coaxial probe if the lateral load-bearing capacity is exceeded
- Only secure rod probes at the end of the probe

Non-metal vessels

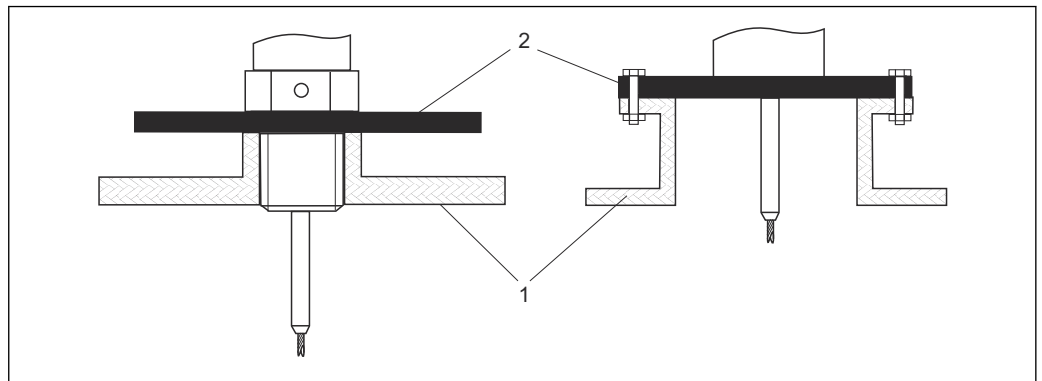

A0012527

- 1 Non-metal vessel
- 2 Metal sheet or metal flange

To ensure good measurement results when mounting on non-metal vessels

- Use a device with a metal flange (minimum size DN50/2").
- Alternatively, mount a metal plate with a diameter of at least 200 mm (8 in) at a right angle to the probe at the process connection.

Vessel with thermal insulation

i If process temperatures are high, the device must be included in normal vessel insulation (1) in order to prevent the electronics heating up as a result of thermal radiation or convection. The insulation may not go beyond the points labeled "MAX" in the drawings.

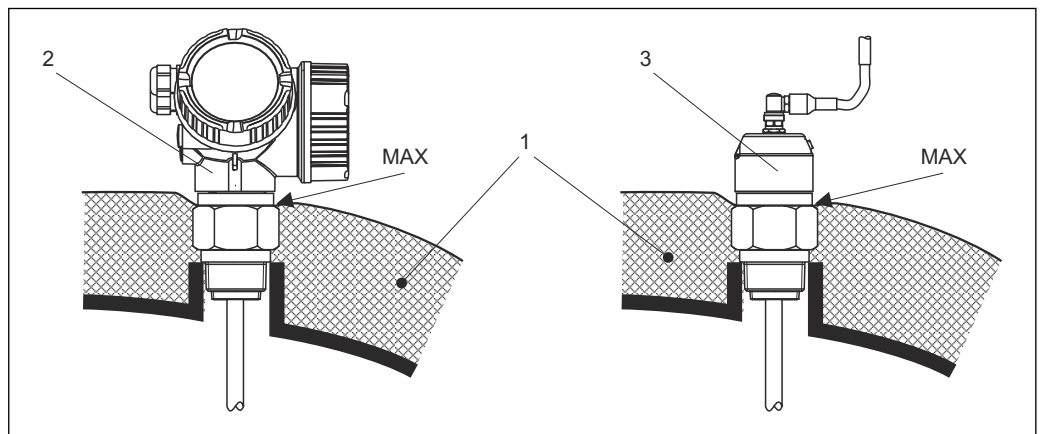

A0014653

- 9 Process connection with thread
- 1 Vessel insulation
- 2 Compact device
- 3 Sensor, remote

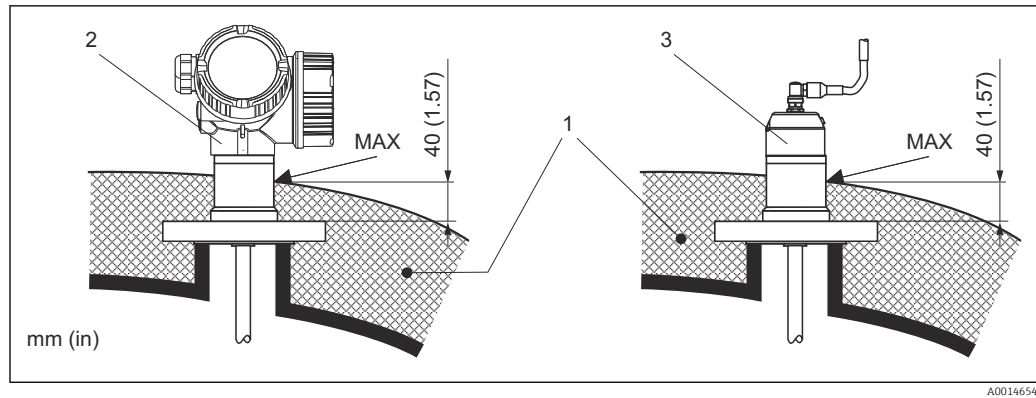

10 Process connection with flange - FMP57

- 1 Vessel insulation
- 2 Compact device
- 3 Sensor, remote

6.2 Mounting the device

6.2.1 Tool list

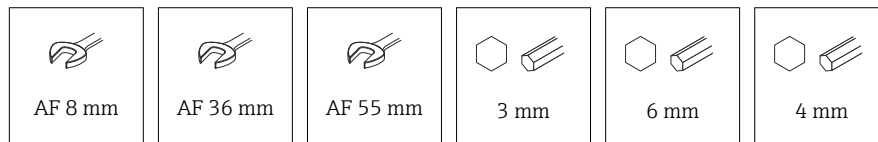

- To shorten rope probes: use a saw or bolt cutters.
- To shorten rod or coaxial probes: use a saw.
- For flanges and other process connections: use an appropriate mounting tool.

6.2.2 Shortening the probe

Shortening rod probes

Rod probes must be shortened if the distance to the vessel floor or outlet cone is less than 10 mm (0.4 in). To shorten, saw off the bottom end of the rod probe.

Shortening rope probes

Rope probes must be shortened if the distance to the vessel floor or outlet cone is less than 150 mm (6 in).

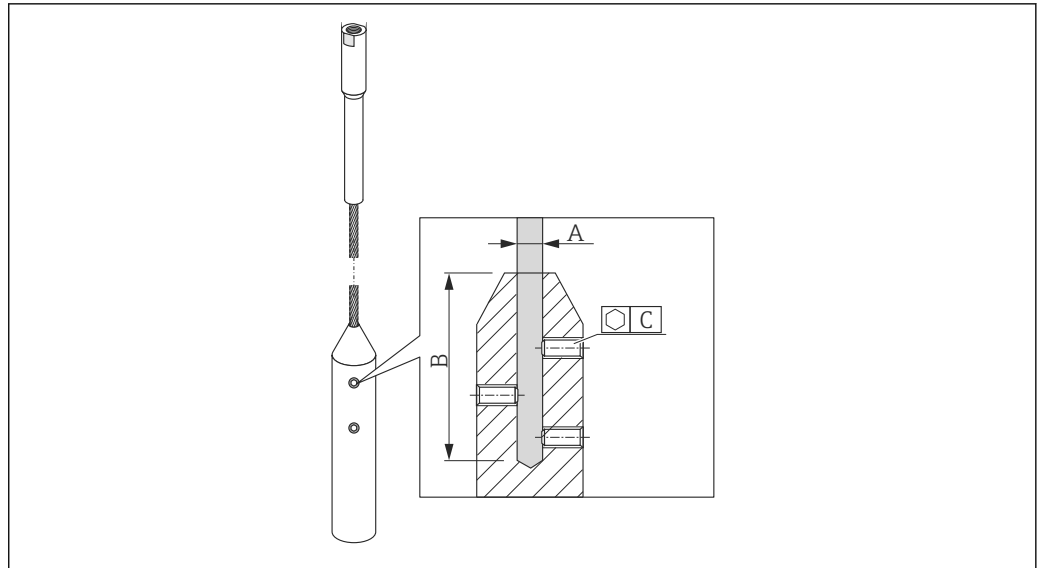

A0021693

Rope material 316

- A:
4 mm (0.16 in)
- B:
40 mm (1.6 in)
- C:
3 mm; 5 Nm (3.69 lbf ft)

Rope material 316

- A:
6 mm (0.24 in)
- B:
70.5 mm (2.78 in)
- C:
4 mm; 15 Nm (11.06 lbf ft)

Rope material PA > steel

- A:
6 mm (0.24 in)
- B:
40 mm (1.6 in)
- C:
3 mm; 5 Nm (3.69 lbf ft)

Rope material PA > steel

- A:
8 mm (0.31 in)
- B:
70.5 mm (2.78 in)
- C:
4 mm; 15 Nm (11.06 lbf ft)

1. Using an Allen key, loosen the set screws on the rope weight. Note: The setscrews have a clamping coating in order to prevent them from becoming loose accidentally. A higher torque is therefore required to loosen the screws.
2. Remove the released rope from the weight.
3. Measure off the new rope length.
4. At the point to be shortened, wrap adhesive tape around the rope to prevent it from fraying.

5. Saw off the rope at a right angle or cut it off with a bolt cutter.
6. Insert the rope completely into the weight.
7. Screw the setscrews back into place. Due to the clamping coating of the setscrews, it is not necessary to apply a locking compound.

Entering the new probe length

After shortening the probe:

1. Switch to the **Probe settings** submenu and perform a probe length correction.
- 2.

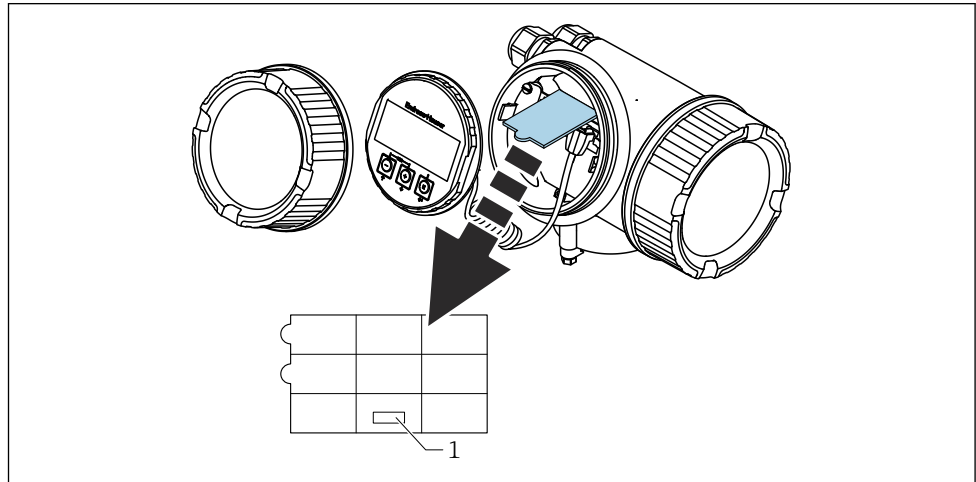

A0014241

1 Field for the new probe length

For documentation purposes, enter the new probe length into the quick reference guide which can be found in the electronics housing behind the display module.

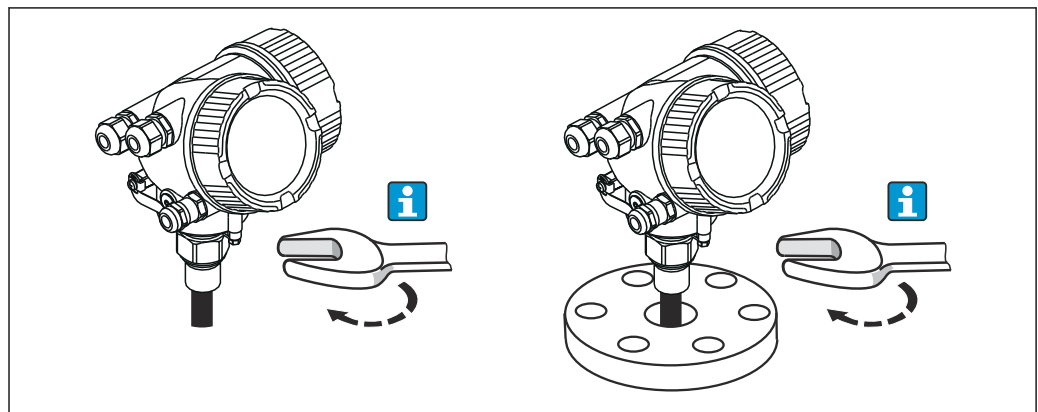

6.2.3 Mounting the device

Mounting devices with a threaded connection



A0012528

Screw the device with the threaded connection into a sleeve or flange and then secure it to the process vessel via the sleeve/flange.

- i
 - When screwing into place, turn by the hex bolt only:
 - Thread $\frac{3}{4}$ " :  36 mm
 - Thread $1\frac{1}{2}$ " :  55 mm
 - Maximum permissible tightening torque:
 - Thread $\frac{3}{4}$ " : 45 Nm
 - Thread $1\frac{1}{2}$ " : 450 Nm
 - Recommended torque when using the supplied aramid fiber seal and 40 bar (580 psi) pressure (FMP51 only; no seal is supplied for FMP54):
 - Thread $\frac{3}{4}$ " : 25 Nm
 - Thread $1\frac{1}{2}$ " : 140 Nm
 - When installing in metal vessels, ensure there is good metal contact between the process connection and the vessel.

Mounting devices with a flange

If a seal is used to mount the device, use uncoated metal screws to ensure good electrical contact between the process flange and the probe flange.

Mounting rope probes

NOTICE

Electrostatic discharge can damage the electronics.

- ▶ Ground the housing before lowering the rope probe into the vessel.

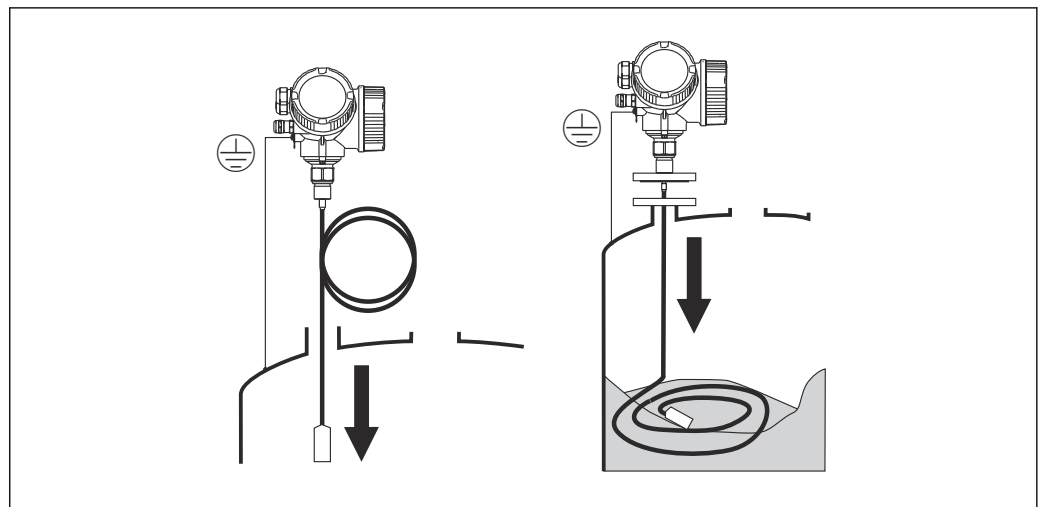

A0012529

Pay attention to the following when introducing the rope probe into the vessel:

- Uncoil the rope slowly and lower it carefully into the vessel.
- Make sure the rope does not bend or buckle.
- Avoid uncontrolled swinging of the weight, as this could damage internal fittings in the vessel.

i Mounting rope probes in a partially filled silo

If a silo is retrofitted with a Levelflex, it is not always possible to empty the silo. If the vessel is at least $\frac{2}{3}$ empty, it is possible to mount the rope probe even in a partially filled silo. In this case, if possible perform a visual inspection after mounting: the rope should not become tangled or knotted when the silo is emptied. The probe rope must hang fully extended before an accurate measurement can be performed.

6.2.4 Mounting the "Sensor, remote" version

i This section only applies for devices with the version "Probe design" = "Sensor, remote" (feature 600, version MB/MC/MD).

The following is included in the delivery with the version "Probe design" = "Remote":

- The probe with process connection
- The electronics housing
- The mounting bracket for mounting the electronics housing on a wall or post
- The connection cable (length as ordered). The cable has one straight plug and one angled at 90°. Depending on the local conditions the angled plug can be connected at the probe or at the electronics housing.

CAUTION

Mechanical stress can damage the plugs of the connection cable or cause them to become loose.

- ▶ Mount the probe and the electronics housing securely before connecting the connecting cable.
- ▶ Lay the connecting cable in such a way that it is not exposed to mechanical stress. Minimum bending radius: 100 mm (4 in).
- ▶ When connecting the cable, connect the straight plug before you connect the angled plug. Torque for the union nuts of both plugs: 6 Nm.

i The probe, electronics and connection cable are mutually compatible and bear a common serial number. Only components with the same serial number may be connected to one another.

In the event of strong vibrations, a locking compound, e.g. Loctite 243, can also be used on the plug-in connectors.

Mounting the electronics housing

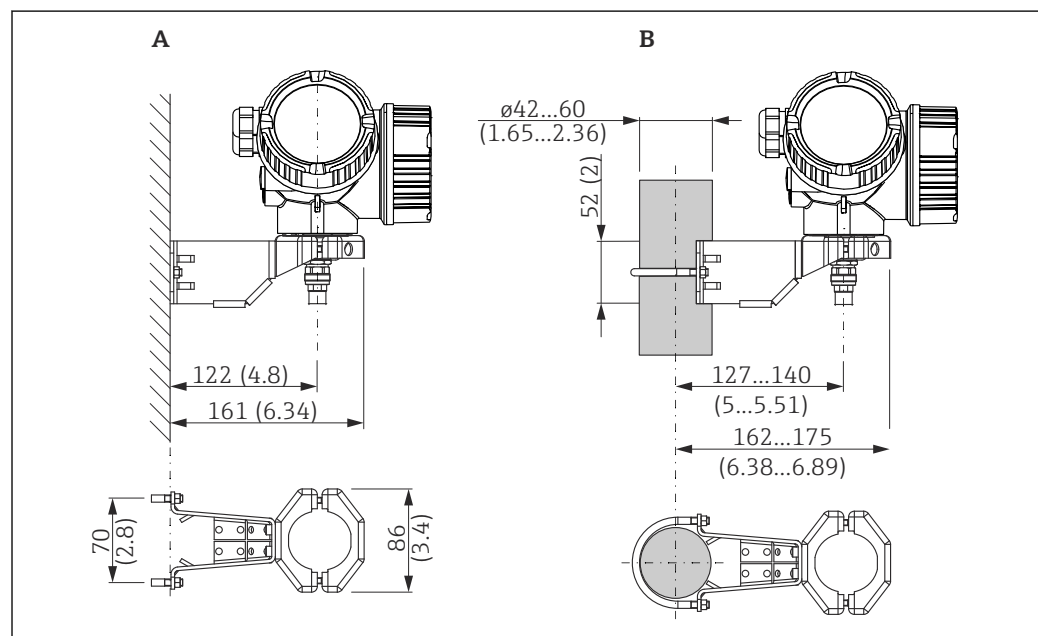

11 Mounting the electronics housing with the mounting bracket. Unit of measurement mm (in)

A Wall mounting

B Post mounting

Connecting the connecting cable

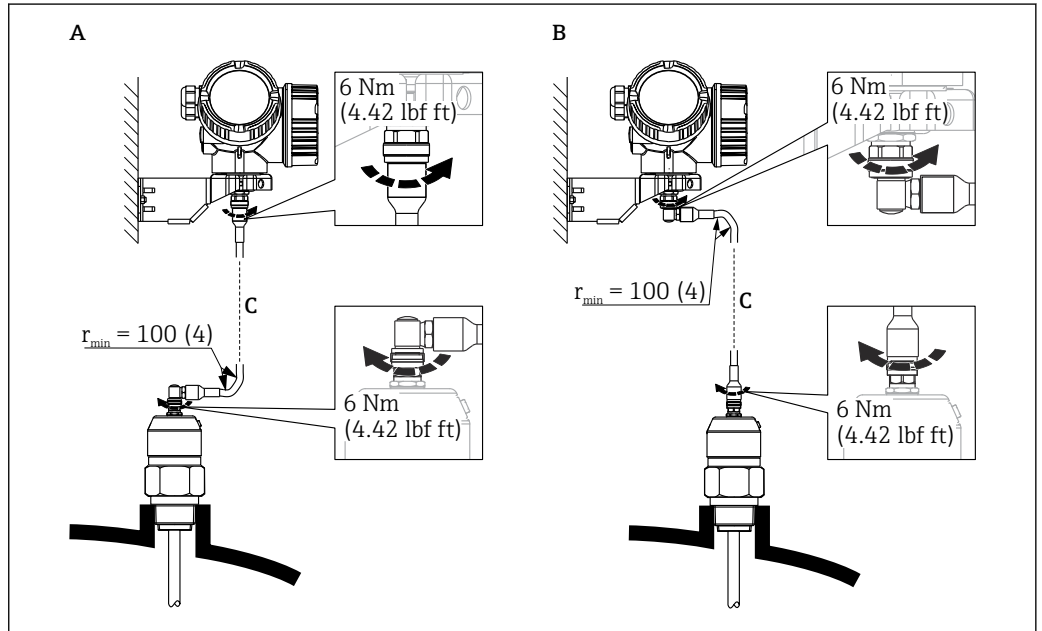

12 Connecting the connecting cable. The cable can be connected in the following ways: Unit of measurement mm (in)

- A Angled plug at the probe
- B Angled plug at the electronics housing
- C Length of the remote cable as ordered

6.2.5 Turning the transmitter housing

To provide easier access to the connection compartment or display module, the transmitter housing can be turned:

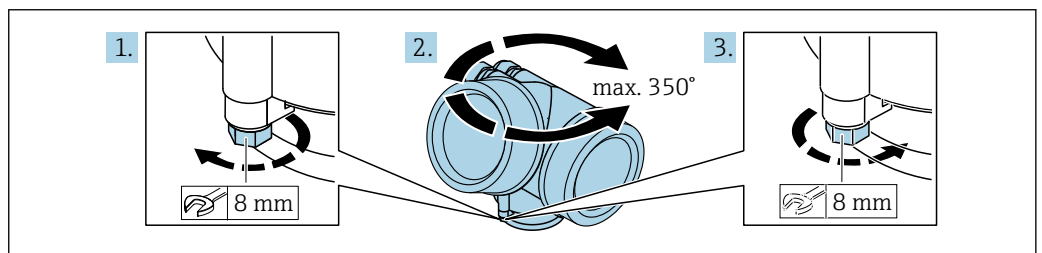

1. Unscrew the securing screw using an open-ended wrench.
2. Rotate the housing in the desired direction.
3. Tighten the securing screw (1.5 Nm for plastic housings; 2.5 Nm for aluminum or stainless steel housing).

6.2.6 Turning the display

Opening the cover

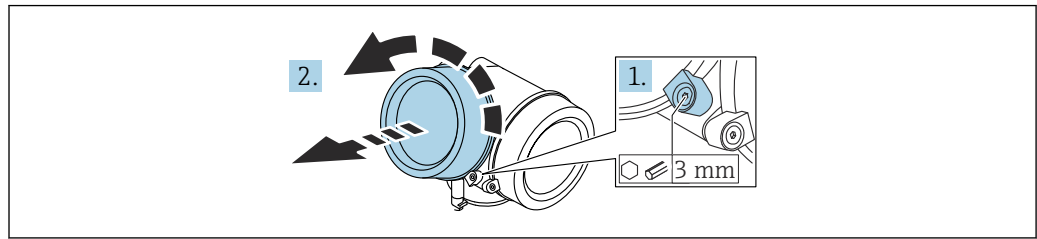

A0021430

1. Loosen the screw of the securing clamp of the electronics compartment cover using an Allen key (3 mm) and turn the clamp 90 ° counterclockwise.
2. Unscrew the electronics compartment cover and check the cover seal; replace it if necessary.

Turning the display module

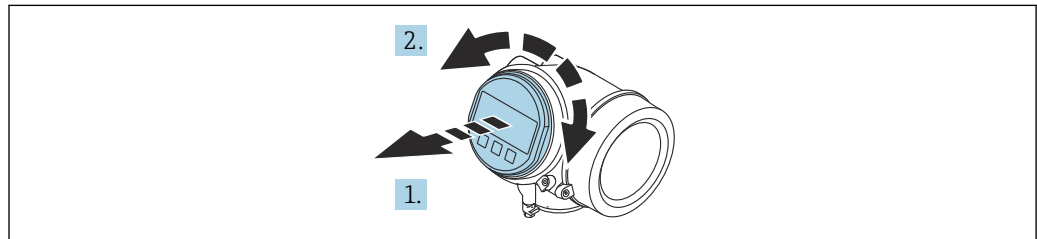

A0036401

1. Pull out the display module with a gentle rotational movement.
2. Turn the display module to the desired position: Max. $8 \times 45^\circ$ in each direction.
3. Feed the coiled cable into the gap between the housing and main electronics module and plug the display module into the electronics compartment until it engages.

Closing the cover of the electronics compartment

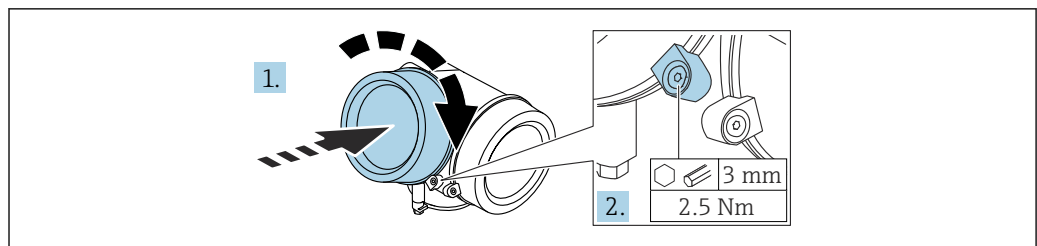

A0021451

1. Screw down the cover of the electronics compartment.
2. Turn the securing clamp 90 ° in the clockwise direction and, using an Allen key (3 mm), tighten the screw of the securing clamp on the electronics compartment cover with 2.5 Nm.

6.3 Post-mounting check

- Is the device free from damage (visual inspection)?
- Are the measuring point identification and labeling correct (visual inspection)?

- Is the measuring device protected against precipitation and sunlight?
- Are the securing screws and cover lock tightened securely?
- Does the measuring device comply with the measuring point specifications?

For example:

- Process temperature
- Process pressure
- Ambient temperature
- Measuring range

7 Electrical connection

7.1 Connecting requirements

7.1.1 Terminal assignment

Terminal assignment, 4-wire: 4 to 20 mA HART (90 to 253 V_{AC})

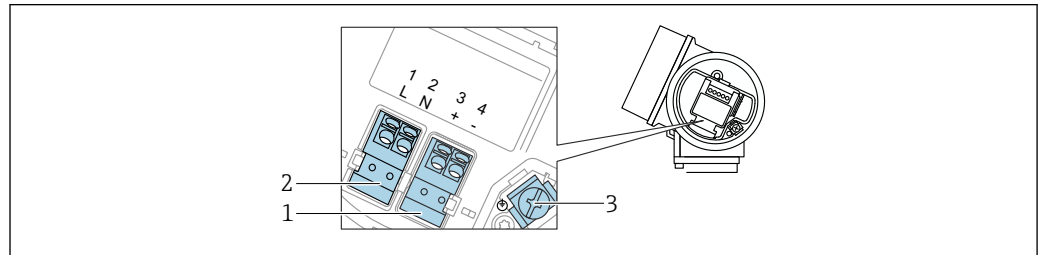



A0036519

 13 Terminal assignment, 4-wire: 4 to 20 mA HART (90 to 253 V_{AC})

- 1 Connection 4 to 20 mA HART (active): terminals 3 and 4
- 2 Power supply connection: terminals 1 and 2
- 3 Terminal for cable shield

CAUTION

To ensure electrical safety:

- ▶ Do not disconnect the protective ground connection.
 - ▶ Disconnect the device from the supply voltage before disconnecting the protective ground.
-  Connect protective ground to the inner ground terminal (3) before connecting the power supply. If necessary, connect the potential matching line to the outer ground terminal.
 -  In order to ensure electromagnetic compatibility (EMC): do **not** ground the device exclusively via the protective ground conductor of the supply cable. Instead, the functional grounding must also be connected to the process connection (flange or threaded connection) or to the external ground terminal.
 -  An easily accessible power switch must be installed in the proximity of the device. The switch must be marked as a disconnecter for the device (61010IEC/).

Terminal assignment PROFIBUS PA / FOUNDATION Fieldbus

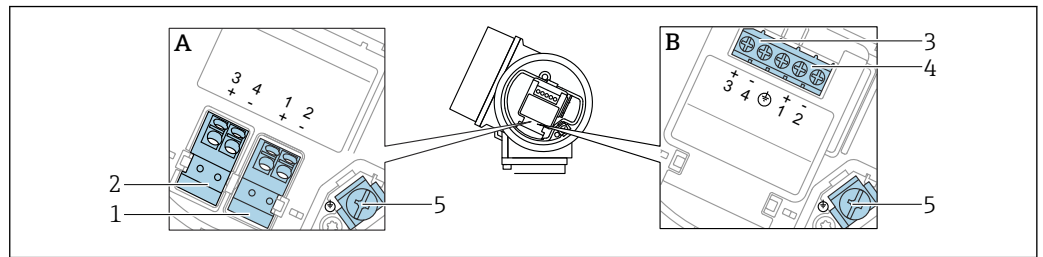

14 Terminal assignment PROFIBUS PA / FOUNDATION Fieldbus

A Without integrated overvoltage protection

B With integrated overvoltage protection

1 Connection, PROFIBUS PA / FOUNDATION Fieldbus: terminals 1 and 2, without integrated overvoltage protection

2 Connection, switch output (open collector): terminals 3 and 4, without integrated overvoltage protection

3 Connection, switch output (open collector): terminals 3 and 4, with integrated overvoltage protection

4 Connection, PROFIBUS PA / FOUNDATION Fieldbus: terminals 1 and 2, with integrated overvoltage protection

5 Terminal for cable shield

Block view PROFIBUS PA / FOUNDATION Fieldbus

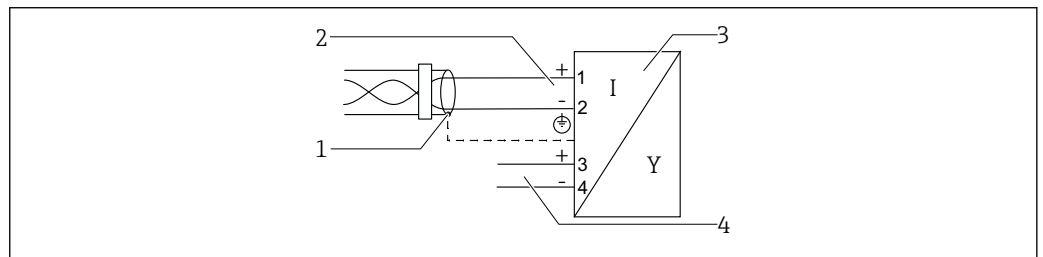

15 Block view PROFIBUS PA / FOUNDATION Fieldbus

1 Cable screen; observe cable specification

2 Connection PROFIBUS PA / FOUNDATION Fieldbus

3 Measuring instrument

4 Switch output (open collector)

7.1.2 Cable specification

■ Devices without integrated overvoltage protection

Pluggable spring-force terminals for wire cross-sections 0.5 to 2.5 mm² (20 to 14 AWG)

■ Devices with integrated overvoltage protection

Screw terminals for wire cross-sections 0.2 to 2.5 mm² (24 to 14 AWG)

■ For ambient temperature $T_U \geq 60^\circ\text{C}$ (140 °F): use cable for temperature $T_U + 20\text{ K}$.

PROFIBUS

Use a twisted, screened two-wire cable, preferably cable type A.

i For further information on the cable specifications, see Operating Instructions BA00034S "PROFIBUS DP/PA: Guidelines for planning and commissioning", PNO Guideline 2.092 "PROFIBUS PA User and Installation Guideline" and IEC 61158-2 (MBP).

7.1.3 Device plug

i In the case of the device versions with a plug, the housing does not need to be opened to connect the signal cable.

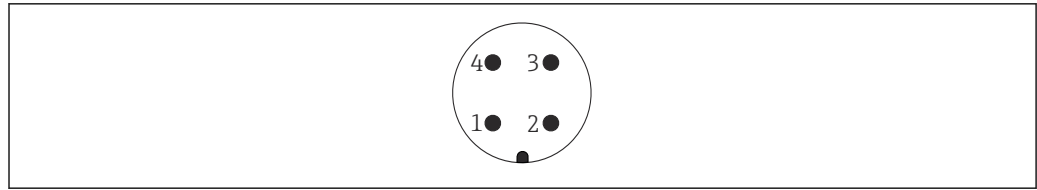

A0011175

16 Pin assignment of M12 plug

- 1 Signal +
- 2 Not assigned
- 3 Signal -
- 4 Ground

7.1.4 Supply voltage

PROFIBUS PA, FOUNDATION Fieldbus

"Power supply; output" ¹⁾	"Approval" ²⁾	Terminal voltage
E: 2-wire; FOUNDATION Fieldbus, switch output G: 2-wire; PROFIBUS PA, switch output	<ul style="list-style-type: none"> ■ Non-hazardous ■ Ex nA ■ Ex nA[ia] ■ Ex ic ■ Ex ic[ia] ■ Ex d[ia] / XP ■ Ex ta / DIP ■ CSA GP 	9 to 32 V ³⁾
	<ul style="list-style-type: none"> ■ Ex ia / IS ■ Ex ia + Ex d[ia] / IS + XP 	9 to 30 V ³⁾

- 1) Feature 020 in the product structure
- 2) Feature 010 in the product structure
- 3) Input voltages up to 35 V do not damage the device.

Polarity-dependent	Yes
FISCO/FNICO compliant according to IEC 60079-27	Yes

7.1.5 Overvoltage protection

If the device is intended to be used for level measurement of flammable liquids which requires overvoltage protection in accordance with DIN EN 60079-14, test standard 60060-1 (10 kA, pulse $\frac{8}{20}$ μ s): use the overvoltage protection module.

Integrated overvoltage protection module

An integrated overvoltage protection module is available for the HART 2-wire devices as well as for PROFIBUS PA and FOUNDATION Fieldbus.

Product structure: Feature 610 "Accessory mounted", option NA "Overvoltage protection".

Resistance per channel	Maximum $2 \times 0.5 \Omega$
DC sparkover voltage	400 to 700 V
Trip surge voltage	< 800 V
Capacity at 1 MHz	< 1.5 pF
Nominal discharge current (8/20 μ s)	10 kA

External overvoltage protection module

The HAW562 or HAW569 for example from Endress+Hauser are suitable options for external overvoltage protection.

-  More information is provided in the following documents:
 - HAW562: TI01012K
 - HAW569: TI01013K

7.2 Connecting the device

⚠ WARNING

Explosion hazard!

- ▶ Comply with applicable national standards.
- ▶ Comply with the specifications in the Safety Instructions (XA).
- ▶ Use specified cable glands only.
- ▶ Check to ensure that the power supply matches the information on the nameplate.
- ▶ Switch off the power supply before connecting the device.
- ▶ Connect the potential matching line to the outer ground terminal before applying the power supply.

Required tools/accessories:

- For devices with a cover lock: Allen key AF3
- Wire stripper
- When using stranded cables: One ferrule for every wire to be connected.

7.2.1 Opening cover

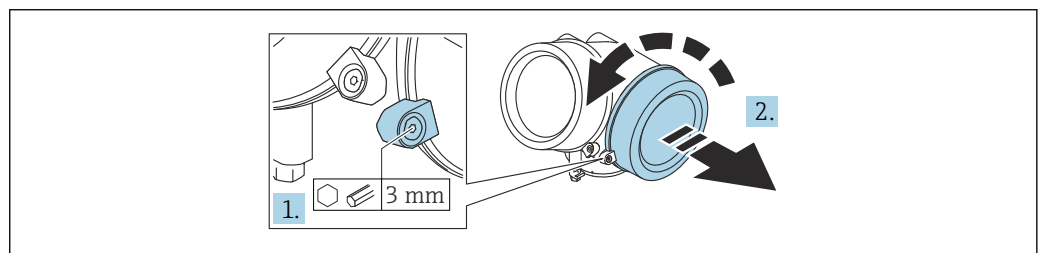

A0021490

1. Loosen the screw of the securing clamp of the connection compartment cover using an Allen key (3 mm) and turn the clamp 90° counterclockwise.
2. Unscrew the connection compartment cover and check the cover seal; replace it if necessary.

7.2.2 Connecting

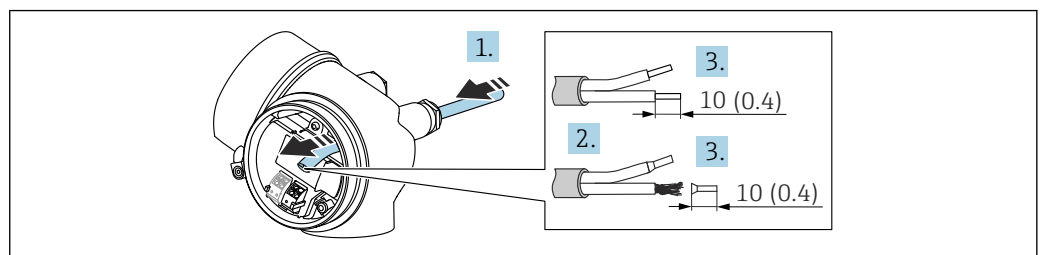

A0036418

 17 Unit: mm (in)

1. Push the cable through the cable entry . To ensure tight sealing, do not remove the sealing ring from the cable entry.

2. Remove the cable sheath.
3. Strip the cable ends 10 mm (0.4 in). In the case of stranded cables, also fit ferrules.
4. Firmly tighten the cable glands.
5. Connect the cable according to the terminal assignment.

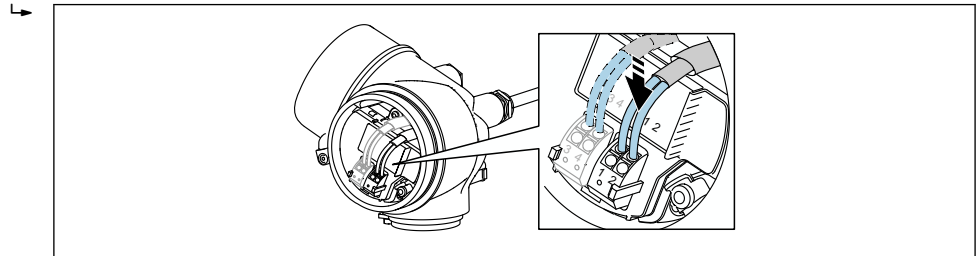

A0034682

6. If using shielded cables: Connect the cable shield to the ground terminal.

7.2.3 Plug-in spring-force terminals

The electrical connection of device versions without an integrated overvoltage protection is via plug-in spring-force terminals. Rigid conductors or flexible conductors with ferrules can be inserted directly into the terminal without using the lever, and create a contact automatically.

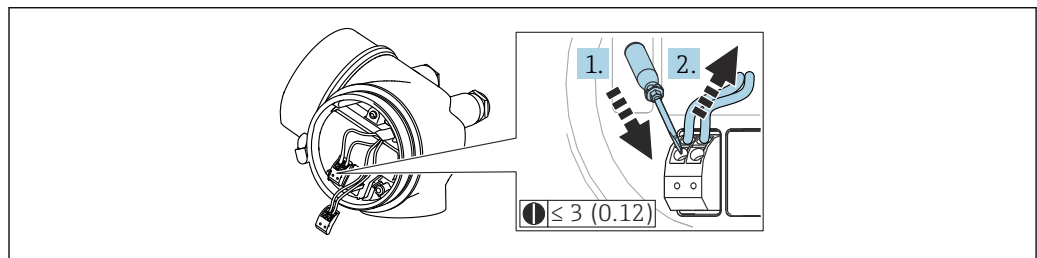

A0013661

18 Unit: mm (in)

To remove the cable from the terminal again:

1. Use a flat-blade screwdriver ≤ 3 mm (0.12 in) to press down on the slot between the two terminal holes.
2. Simultaneously pull the cable end out of the terminal.

7.2.4 Closing the cover of the connection compartment

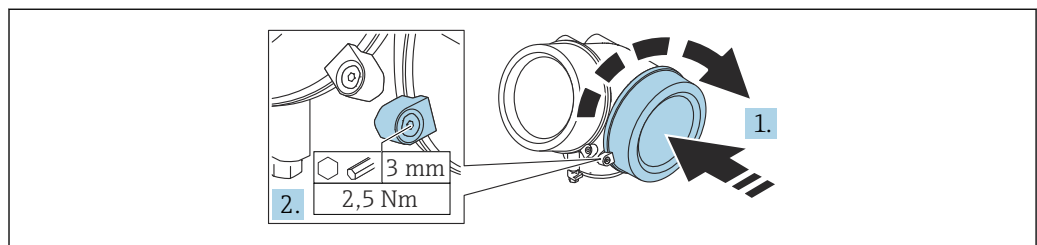

A0021491

1. Screw down the cover of the connection compartment.
2. Turn the securing clamp 90° in the clockwise direction and, using an Allen key (3 mm), tighten the screw of the securing clamp on the connection compartment cover with 2.5 Nm.

7.3 Post-connection check

- Is the device or cable undamaged (visual inspection)?
- Do the cables used comply with the requirements?
- Do the mounted cables have adequate strain relief?
- Are all the cable glands installed, firmly tightened and leak-tight?
- Does the supply voltage match the specifications on the nameplate?
- Is the terminal assignment correct?
- If necessary, has a protective ground connection been established?
- If supply voltage is present, is the device ready for operation and do values appear on the display module?
- Are all the housing covers installed and tightened?
- Is the securing clamp firmly tightened?

8 Operation options

8.1 Overview of operation options

8.1.1 Access to operating menu via local display

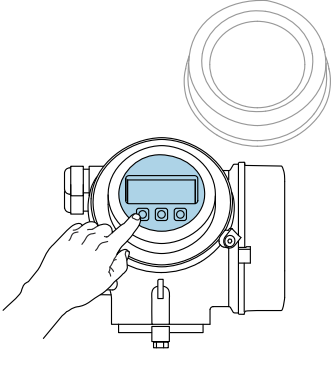
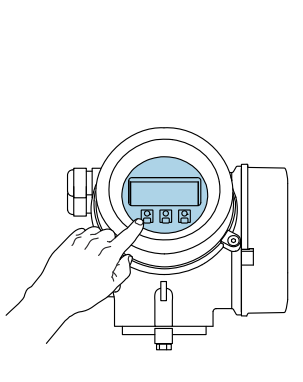
Operation with	Pushbuttons	Touch control
Order code for "Display; operation"	Option C "SD02"	Option E "SD03"
		
Display elements	4-line display	4-line display White background lighting; switches to red in event of device errors
	Format for displaying measured variables and status variables can be individually configured	
	Permitted ambient temperature for the display: -20 to +70 °C (-4 to +158 °F) The readability of the display may be impaired at temperatures outside the temperature range.	
Operating elements	Onsite operation with 3 pushbuttons (⊕, ⊖, ⊞)	External operation via touch control; 3 optical keys: ⊕, ⊖, ⊞
	Operating elements also accessible in various hazardous areas	
Additional functionality	Data backup function The device configuration can be saved in the display module.	
	Data comparison function The device configuration saved in the display module can be compared to the current device configuration.	
	Data transfer function The transmitter configuration can be transmitted to another device using the display module.	

Operation with remote display and operating module FHX50

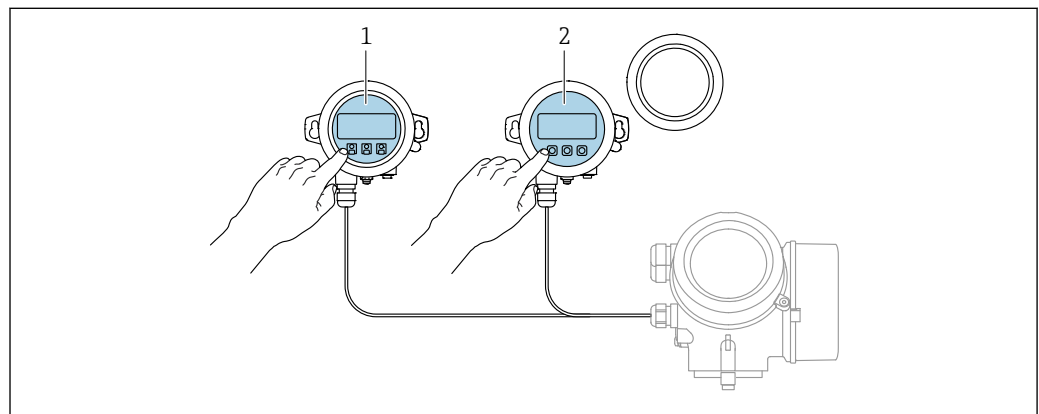

19 FHX50 operating options

- 1 Display and operating module SD03, optical keys; can be operated through the glass of the cover
- 2 Display and operating module SD02, push buttons; cover must be removed

8.1.2 Access to the operating menu via the operating tool

Via PROFIBUS PA protocol

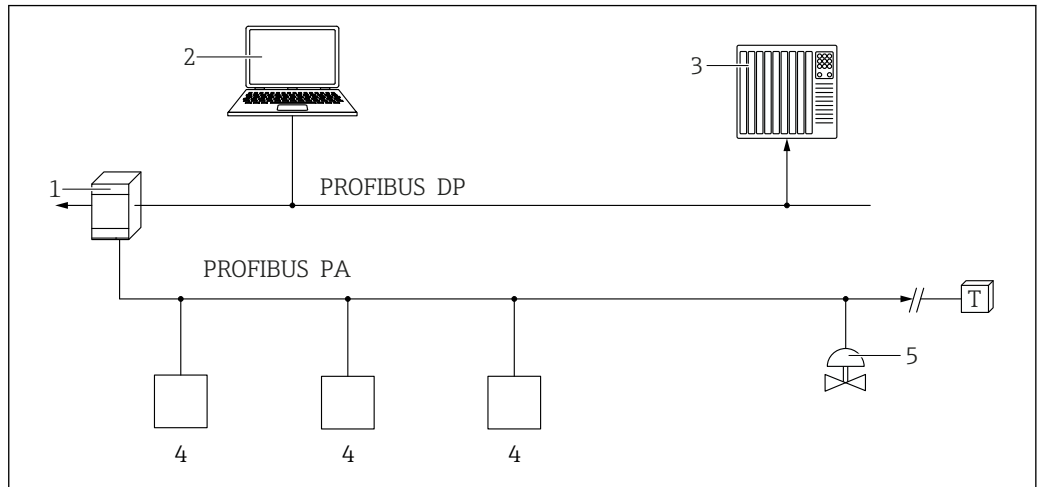

A0050944

- 1 Segment coupler
- 2 Computer with PROFibus and operating tool (e.g. DeviceCare/FieldCare)
- 3 PLC (programmable logic controller)
- 4 Transmitter
- 5 Additional functions (valves etc.)

Via service interface (CDI)

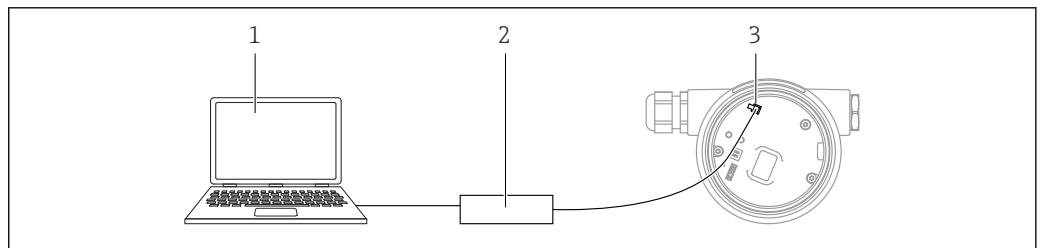

A0039148

- 1 Computer with FieldCare/DeviceCare operating tool
- 2 Commubox
- 3 Service interface (CDI) of the measuring instrument (= Endress+Hauser Common Data Interface)

Operation via Bluetooth® wireless technology

Requirements

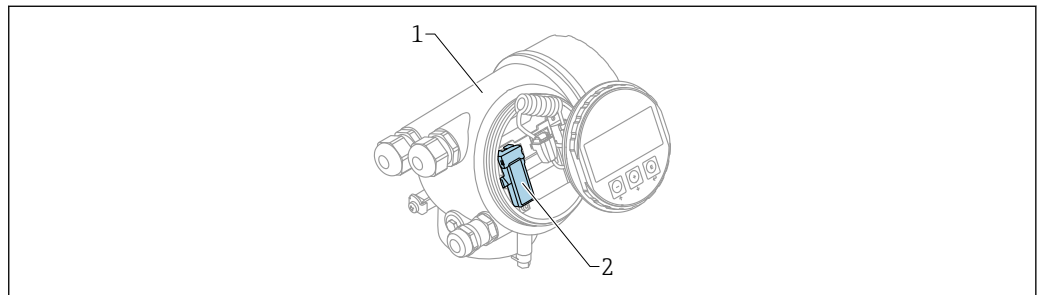

A0036790

- 20 Device with Bluetooth module
- 1 Electronics housing of the device
- 2 Bluetooth module

This operation option is only available for devices with Bluetooth module. There are the following options:

- The device has been ordered with a Bluetooth module:
Feature 610 "Accessory Mounted", option NF "Bluetooth"
- The Bluetooth module has been ordered as an accessory (ordering number: 71377355) and has been mounted. See Special Documentation SD02252F.

Operation via SmartBlue (app)

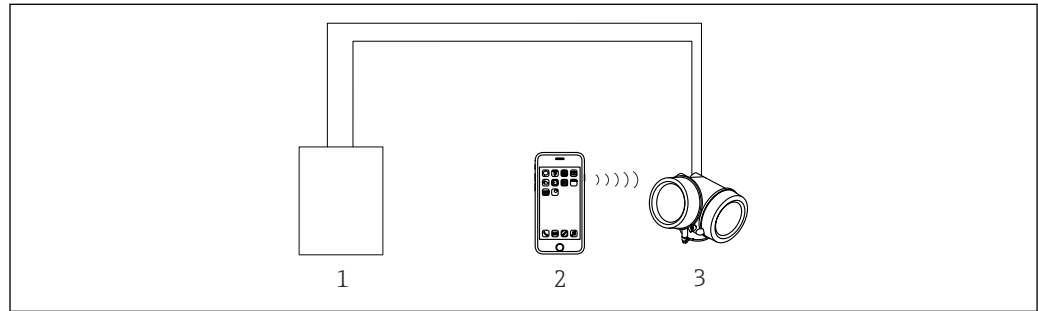

A0034939

21 Operation via SmartBlue (app)

- 1 Transmitter power supply unit
- 2 Smartphone / tablet with SmartBlue (app)
- 3 Transmitter with Bluetooth module

8.2 Structure and function of the operating menu

8.2.1 Structure of the operating menu

Menu	Submenu / parameter	Meaning
	Language ¹⁾	Defines the operating language of the local display
Commissioning ²⁾		Launches the interactive wizard for guided commissioning. Additional settings generally do not need to be made in the other menus when the wizard is finished.
Setup	Parameter 1 ... Parameter N	Once values have been set for these parameters, the measurement should usually be fully configured.
	Advanced setup	Contains additional submenus and parameters: <ul style="list-style-type: none"> ■ For more accurate configuration of the measurement (adaptation to special measuring conditions). ■ For converting the measured value (scaling, linearization). ■ For scaling the output signal.
Diagnostics	Diagnostic list	Contains up to 5 currently active error messages.
	Event logbook ³⁾	Contains the last 20 messages (which are no longer active).
	Device information	Contains information for identifying the device.
	Measured values	Contains all current measured values.
	Data logging	Contains the history of the individual measured values

Menu	Submenu / parameter	Meaning
	Simulation	Is used to simulate measured values or output values.
	Device check	Contains all parameters needed to check the measurement capability of the device.
	Heartbeat⁴⁾	Contains all the wizards for the Heartbeat Verification and Heartbeat Monitoring application packages.
Expert⁵⁾ Contains all the parameters of the device (including those already contained in one of the other menus). This menu is organized according to the function blocks of the device. The parameters of the Expert menu are described in: GPO1001F (PROFIBUS PA)	System	Contains all higher-level device parameters that do not affect measurement or measured value communication.
	Sensor	Contains all parameters for configuring the measurement.
	Output	Contains all parameters to configure the switch output (PFS)
	Communication	Contains all parameters needed to configure the digital communication interface.
	Diagnostics	Contains all parameters needed to detect and analyze operational errors.

- 1) If you are operating via operating tools (e.g. FieldCare), the "Language" parameter is located under "Setup → Advanced setup → Display"
- 2) Only if operating via an FDT/DTM system
- 3) Only available if operating via the local display
- 4) Only available if operating via DeviceCare or FieldCare
- 5) When you call up the "Expert" menu, you are always asked for an access code. If a customer-specific access code has not been defined, "0000" must be entered.

8.2.2 User roles and related access authorization

The two user roles **Operator** and **Maintenance** have different write access to the parameters if a device-specific access code has been defined. This protects the device configuration via the local display from unauthorized access →  46.

Access authorization to parameters

User role	Read access		Write access	
	Without access code (from the factory)	With access code	Without access code (from the factory)	With access code
Operator	✓	✓	✓	--
Maintenance	✓	✓	✓	✓

If an incorrect access code is entered, the user obtains the access rights of the **Operator** role.

 The user role with which the user is currently logged on is indicated by the **Access status display** parameter (if operating via the local display) or the **Access status tooling** parameter (if operating via an operating tool).

8.2.3 Data access - Security

Write protection via access code

Using the device-specific access code, the parameters for the measuring instrument configuration are write-protected and their values can no longer be changed via local operation.

Defining the access code via the local display

1. Navigate to: Setup → Advanced setup → Administration → Define access code → Define access code
2. Define a max. 4-digit numeric code as an access code.
3. Repeat the numeric code in the **Confirm access code** parameter to confirm it.
 - ↳ The -symbol appears in front of all write-protected parameters.



Defining the access code via operating tool (e.g. FieldCare)

1. Navigate to: Setup → Advanced setup → Administration → Define access code
2. Define a max. 4-digit numeric code as an access code.
 - ↳ Write protection is active.

Parameters that can always be changed

The write protection does not include certain parameters that do not affect the measurement. Despite the defined access code, these parameters can always be modified even if the other parameters are locked.



The device automatically locks the write-protected parameters again if a key is not pressed for 10 minutes in the navigation and editing view. If the user goes from the navigation and editing mode back to the measured value display mode, the device automatically locks the write-protected parameters after 60 s.

-  If write access is activated via an access code, it can be only be deactivated again via this access code.
 - In the "Description of Device Parameters" documents, each write-protected parameter is identified with the -symbol.

Disabling write protection via access code

If the  symbol appears in front of a parameter on the local display, the parameter is write-protected by a device-specific access code and its value cannot currently be changed via the local display.

The locking of the write access via local operation can be disabled by entering the device-specific access code.

1. After you press , the input prompt for the access code appears.
2. Enter the access code.
 - ↳ The  symbol in front of the parameters disappears; all previously write-protected parameters are now re-enabled.

Deactivation of the write protection via access code

Via local display

1. Navigate to: Setup → Advanced setup → Administration → Define access code → Define access code
2. Enter **0000**.

3. Repeat **0000** in the **Confirm access code** parameter to confirm.
 - ↳ The write protection is deactivated. Parameters can be changed without entering an access code.

Via an operating tool (e.g. FieldCare)

1. Navigate to: Setup → Advanced setup → Administration → Define access code
2. Enter **0000**.
 - ↳ The write protection is deactivated. Parameters can be changed without entering an access code.

Write protection via write protection switch

Unlike parameter write protection via a user-specific access code, this allows the user to lock write access to the entire operating menu - apart from the **"Contrast display" parameter**.

The parameter values are now read only and cannot be edited any more (exception **"Contrast display" parameter**):

- Via local display
- Via PROFIBUS PA protocol
- Via PROFIBUS DP protocol

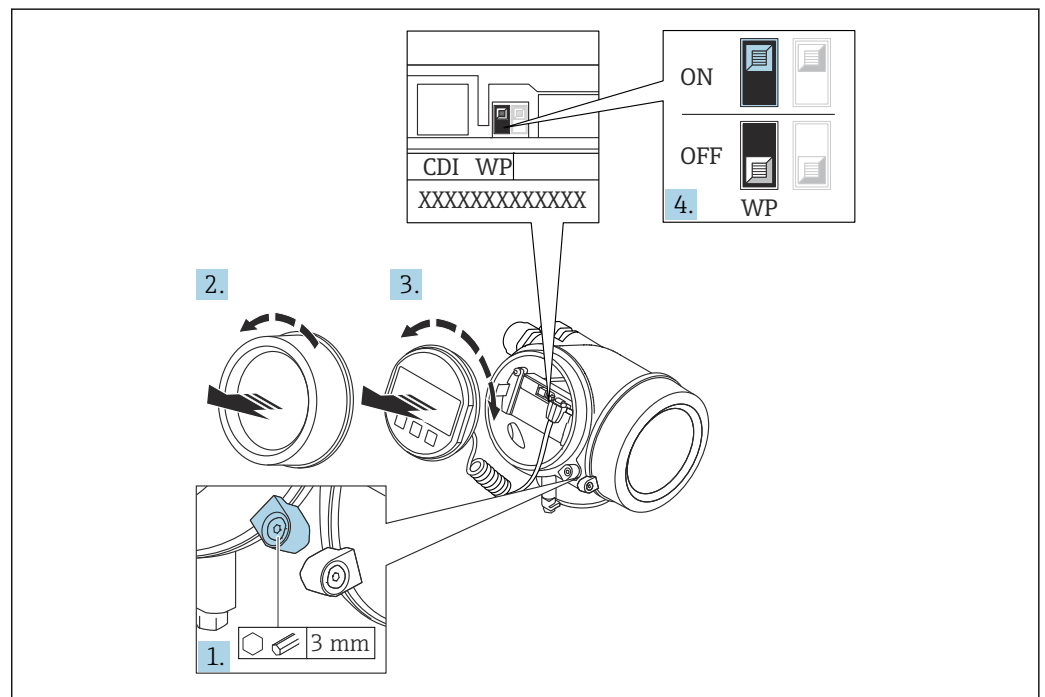

A0026157

1. Loosen the securing clamp.
2. Unscrew the electronics compartment cover.

3. Pull out the display module with a gentle rotational movement. To make it easier to access the write protection switch, attach the display module to the edge of the electronics compartment.

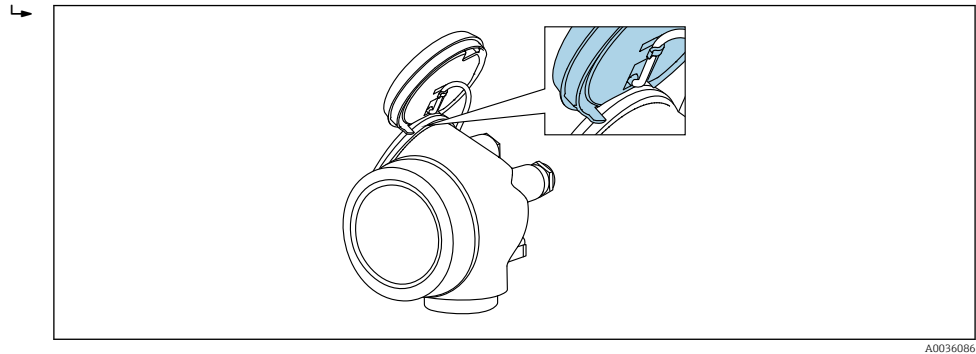

4. Setting the write protection switch (WP) on the main electronics module to the **ON** position enables hardware write protection. Setting the write protection switch (WP) on the main electronics module to the **OFF** position (factory setting) disables hardware write protection.

↳ If the hardware write protection is enabled: The **Hardware locked** option is displayed in the **Locking status** parameter. In addition, on the local display the  symbol appears in front of the parameters in the header of the operational display and in the navigation view.

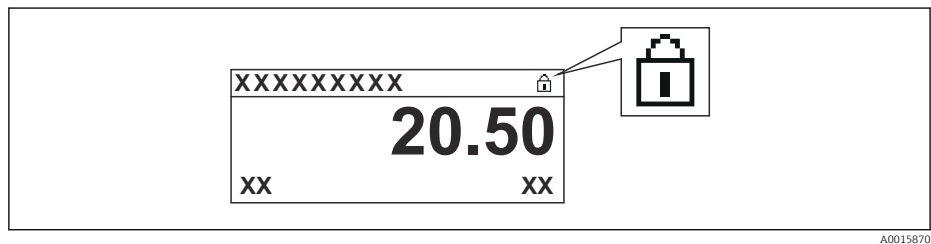

If hardware write protection is disabled: No option is displayed in the **Locking status** parameter. On the local display, the  symbol disappears from in front of the parameters in the header of the operational display and in the navigation view.

5. Feed the cable into the gap between the housing and main electronics module and plug the display module into the electronics compartment in the desired direction until it engages.
6. Reassemble the transmitter in the reverse order.

Enabling and disabling the keypad lock

Access to the entire operating menu via local operation can be locked via the keypad lock. When access is locked, it is no longer possible to navigate through the operating menu or change the values of individual parameters. Users can only read the measured values on the operational display.

The keypad lock is switched on and off via a context menu.

Switching on the keypad lock

SD03 display module only

The keypad lock is switched on automatically:

- If the device has not been operated via the display for > 1 minute.
- Each time the device is restarted.

Switching on the keypad lock manually

1. The device is in the measured value display.
Press  for at least 2 seconds.
 - ↳ A context menu appears.
2. Select the **Keylock on** option in the context menu.
 - ↳ The keypad lock is switched on.

 If the user attempts to access the operating menu while the keypad lock is active, the message **Keylock on** appears.

Switching off the keypad lock

1. The keypad lock is switched on.
Press  for at least 2 seconds.
 - ↳ A context menu appears.
2. Select the **Keylock off** option in the context menu.
 - ↳ The keypad lock is switched off.

Bluetooth® wireless technology

Signal transmission via Bluetooth® wireless technology uses a cryptographic technique tested by the Fraunhofer Institute

- The device is not visible via *Bluetooth®* wireless technology without the SmartBlue app
- Only one point-to-point connection is established between **one** sensor and **one** smartphone or tablet

8.3 Display and operating module

8.3.1 Display format

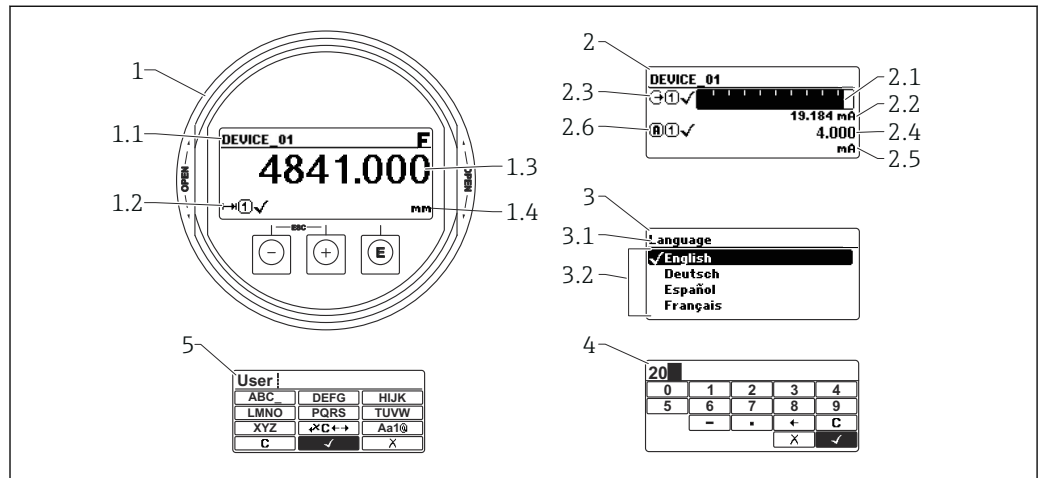





A0012635

22 Display format on the display and operating module

- 1 Measured value display (1 value max. size)
- 1.1 Header containing tag and error symbol (if an error is active)
- 1.2 Measured value symbols
- 1.3 Measured value
- 1.4 Unit
- 2 Measured value display (bar graph + 1 value)
 - 2.1 Bargraph for measured value 1
 - 2.2 Measured value 1 (including unit)
 - 2.3 Measured value symbols for measured value 1
 - 2.4 Measured value 2
 - 2.5 Unit for measured value 2
 - 2.6 Measured value symbols for measured value 2
- 3 Parameter display (here: parameter with drop-down list)
 - 3.1 Header containing parameter name and error symbol (if an error is active)
 - 3.2 Drop-down list; marks the current parameter value.
- 4 Input matrix for numbers
- 5 Input matrix for alphanumeric and special characters



Display symbols for the submenus

Symbol	Meaning
 <small>A0018367</small>	Display/operat. Is displayed: <ul style="list-style-type: none"> ▪ In the main menu next to the "Display/operat." selection ▪ In the header on the left in the "Display/operat." menu
 <small>A0018364</small>	Setup Is displayed: <ul style="list-style-type: none"> ▪ In the main menu next to the "Setup" selection ▪ In the header on the left in the "Setup" menu
 <small>A0018365</small>	Expert Is displayed: <ul style="list-style-type: none"> ▪ In the main menu next to the "Expert" selection ▪ In the header on the left in the "Expert" menu
 <small>A0018366</small>	Diagnostics Is displayed: <ul style="list-style-type: none"> ▪ In the main menu next to the "Diagnostics" selection ▪ In the header on the left in the "Diagnostics" menu











Status signals

Symbol	Meaning
F <small>A0032902</small>	"Failure" A device error has occurred. The measured value is no longer valid.
C <small>A0032903</small>	"Function check" The device is in the service mode (e.g. during a simulation).
S <small>A0032904</small>	"Out of specification" The device is operated: <ul style="list-style-type: none"> ▪ Outside its technical specifications (e.g. during startup or cleaning) ▪ Outside the configuration performed by the user (e.g. level outside the configured range)
M <small>A0032905</small>	"Maintenance required" Maintenance is required. The measured value is still valid.



Display symbols for locking status





Symbol	Meaning
 <small>A0013148</small>	Read-only parameter The parameter shown is only for display purposes and cannot be edited.
 <small>A0013150</small>	Device locked <ul style="list-style-type: none"> ▪ In front of a parameter name: The device is locked via software and/or hardware. ▪ In the header of the measured value screen: The device is locked via hardware.

Measured value symbols

Symbol	Meaning
Measured values	
 A0032892	Level
 A0032893	Distance
 A0032908	Current output
 A0032894	Measured current
 A0032895	Terminal voltage
 A0032896	Electronics or sensor temperature
Measuring channels	
 A0032897	Measuring channel 1
 A0032898	Measuring channel 2
Status of the measured value	
 A0018361	"Alarm" status Measurement is interrupted. The output assumes the defined alarm condition. A diagnostic message is generated.
 A0018360	"Warning" status The device continues to measure. A diagnostic message is generated.

8.3.2 Operating elements

Operating key	Meaning
 A0018330	Minus key <i>In a menu, submenu</i> Moves the selection bar upwards in a picklist. <i>In the text and numeric editor</i> In the input screen, moves the selection bar to the left (backwards).
 A0018329	Plus key <i>In a menu, submenu</i> Moves the selection bar downwards in a picklist. <i>In the text and numeric editor</i> In the input screen, moves the selection bar to the right (forwards).

Operating key	Meaning
 <small>A0018328</small>	<p>Enter key</p> <p><i>For measured value display</i></p> <ul style="list-style-type: none"> Pressing the key briefly opens the operating menu. Pressing the key for 2 s opens the context menu. <p><i>In a menu, submenu</i></p> <ul style="list-style-type: none"> Pressing the key briefly: Opens the selected menu, submenu or parameter. Pressing the key for 2 s for parameter: If present, opens the help text for the function of the parameter. <p><i>In the text and numeric editor</i></p> <ul style="list-style-type: none"> Pressing the key briefly: <ul style="list-style-type: none"> Opens the selected group. Carries out the selected action. Pressing the key for 2 s confirms the edited parameter value.
 <small>A0032909</small>	<p>Escape key combination (press keys simultaneously)</p> <p><i>In a menu, submenu</i></p> <ul style="list-style-type: none"> Pressing the key briefly: <ul style="list-style-type: none"> Exits the current menu level and takes you to the next higher level. If help text is open, closes the help text of the parameter. Pressing the key for 2 s returns you to the measured value display ("home position"). <p><i>In the text and numeric editor</i></p> <p>Closes the text or numeric editor without applying changes.</p>
 <small>A0032910</small>	<p>Minus/Enter key combination (press and hold down the keys simultaneously)</p> <p>Reduces the contrast (brighter setting).</p>
 <small>A0032911</small>	<p>Plus/Enter key combination (press and hold down the keys simultaneously)</p> <p>Increases the contrast (darker setting).</p>



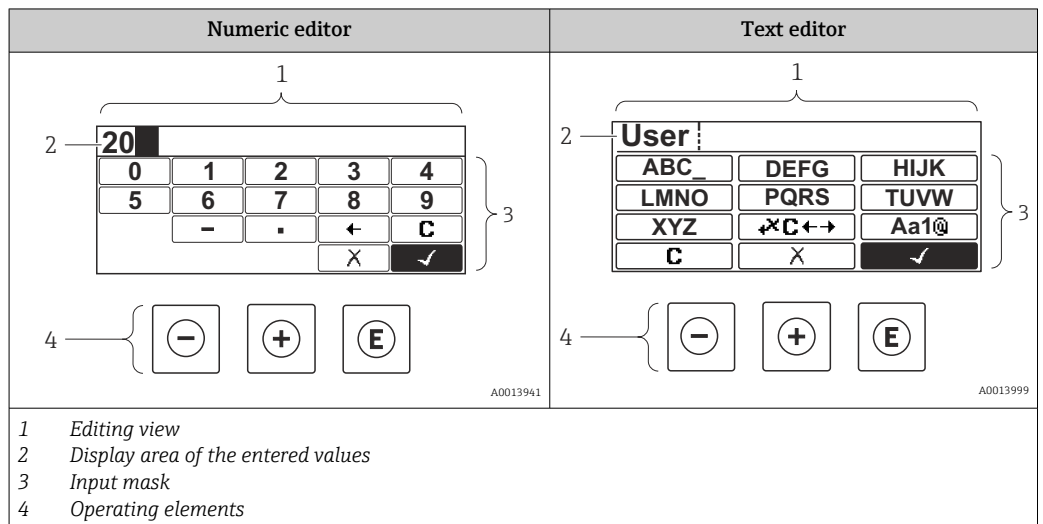



8.3.3 Entering numbers and text









Input mask

The following input and operating symbols are available in the input mask of the numeric and text editor:

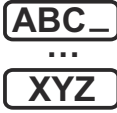

Numeric editor



Symbol	Meaning
 <small>A0013998</small>	Selection of numbers from 0 to 9
 <small>A0016619</small>	Inserts decimal separator at the cursor position.
 <small>A0016620</small>	Inserts minus sign at the cursor position.
 <small>A0013985</small>	Confirms selection.
 <small>A0016621</small>	Moves the input position one position to the left.
 <small>A0013986</small>	Exits the input without applying the changes.
 <small>A0014040</small>	Clears all entered characters.

Text editor

Symbol	Meaning
 <small>A0013997</small>	Selection of letters from A to Z
 <small>A0013981</small>	Toggle <ul style="list-style-type: none"> ▪ Between upper-case and lower-case letters ▪ For entering numbers ▪ For entering special characters
 <small>A0013985</small>	Confirms selection.
 <small>A0013987</small>	Switches to the selection of the correction tools.
 <small>A0013986</small>	Exits the input without applying the changes.
 <small>A0014040</small>	Clears all entered characters.

Text correction under 

Symbol	Meaning
 <small>A0032907</small>	Clears all entered characters.
 <small>A0018324</small>	Moves the input position one position to the right.

 <small>A0018326</small>	Moves the input position one position to the left.
 <small>A0032906</small>	Deletes one character immediately to the left of the input position.

8.3.4 Opening the context menu

Using the context menu, the user can call up the following menus quickly and directly from the operational display:

- Setup
- Conf. backup disp.
- Envelope curve
- Keylock on



Calling up and closing the context menu

The user is in the operational display.

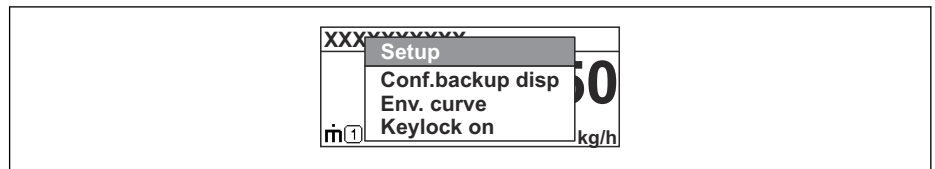

1. Press  for 2 s.
 - ↳ The context menu opens.



A0037872

2. Press  +  simultaneously.
 - ↳ The context menu is closed and the operational display appears.

Calling up the menu via the context menu

1. Open the context menu.
2. Press  to navigate to the desired menu.
3. Press  to confirm the selection.
 - ↳ The selected menu opens.

8.3.5 Envelope curve display on the display and operating module

In order to assess the measuring signal, the envelope curve and - if a mapping has been recorded - the mapping curve can be shown on the display and operating module:

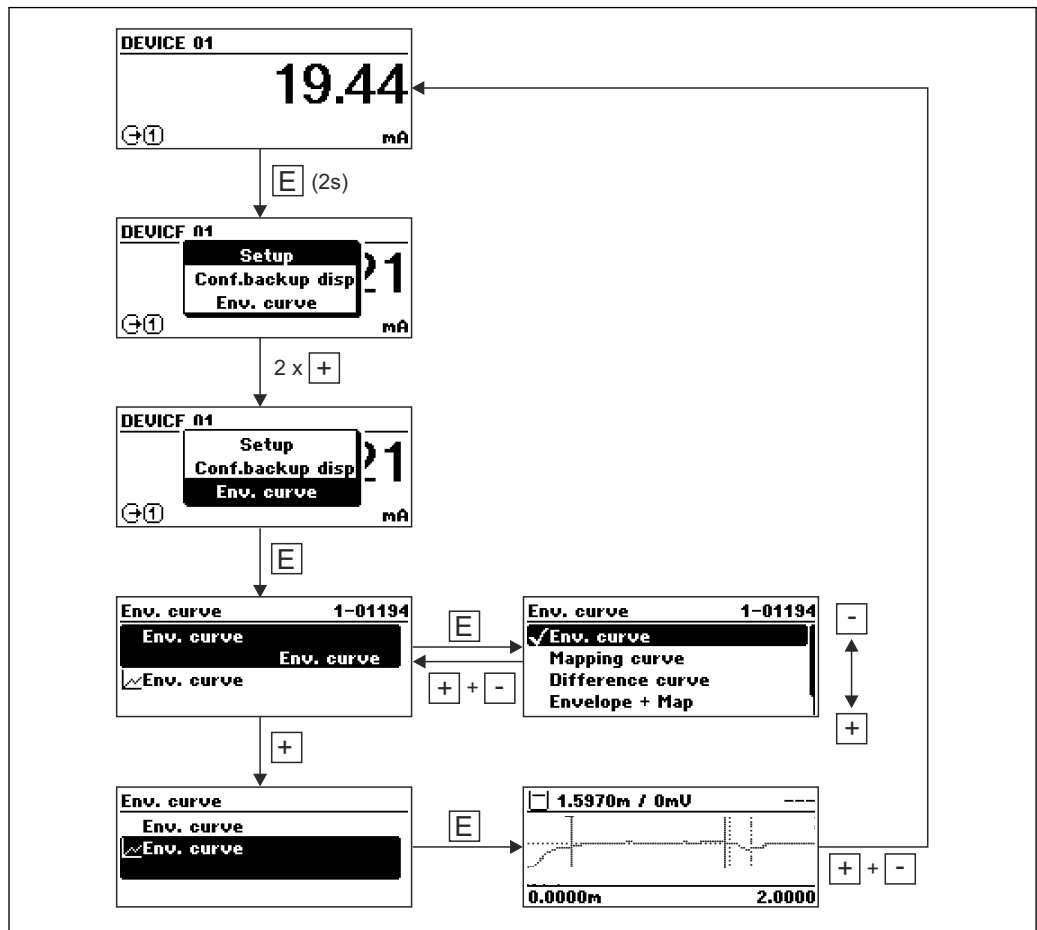

A0014277

9 System integration

9.1 Overview of device master file (GSD)

Manufacturer ID	17 (0x11)
Ident number	0x1558
Profile version	3.02
GSD file	Information and files available at:
GSD file version	<ul style="list-style-type: none"> ▪ www.endress.com ▪ www.profibus.org

9.2 Setting the device address

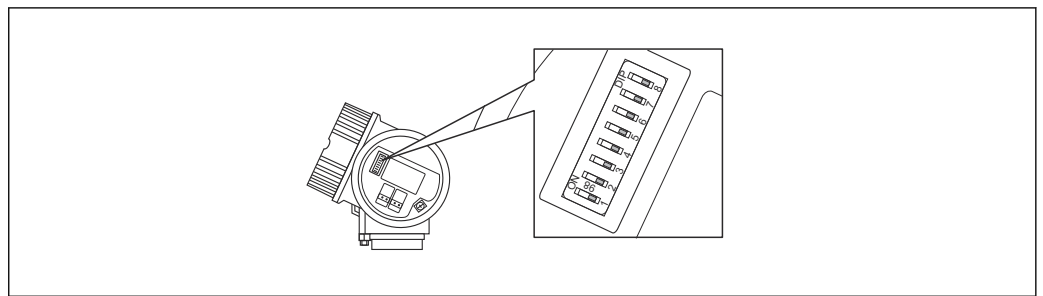

A0015686

23 Address switch in the connection compartment

9.2.1 Hardware addressing

1. Set switch 8 to the "OFF" position.
2. Using switches 1 to 7, set the address as indicated in the table below.

The change of address takes effect after 10 seconds. The device is restarted.

Switch	1	2	3	4	5	6	7
Value in "ON" position	1	2	4	8	16	32	64
Value in "OFF" position	0	0	0	0	0	0	0

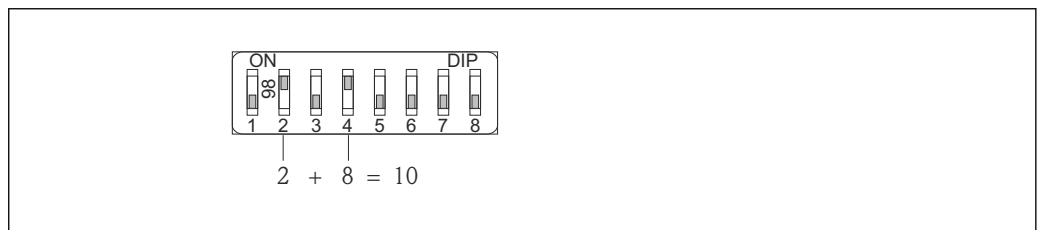

A0015902

24 Example of hardware addressing; switch 8 is set to the "OFF" position; switches 1 to 7 define the address.

9.2.2 Software addressing

1. Set switch 8 to "ON".

2. The device restarts automatically and reports the current address (factory setting: 126).
3. Configure the address via the operating menu: Setup → Device address

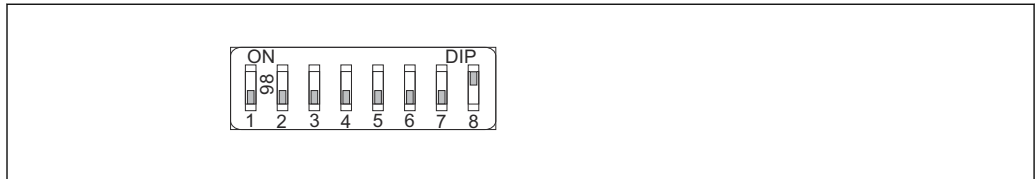

A0015903

- 25 Example of software addressing; switch 8 is set to the "ON" position; the address is defined in the operating menu (Setup → Device address).

10 Commissioning using the wizard

FieldCare and DeviceCare have a wizard that guides the user through initial commissioning.

1. Connect the device with FieldCare or DeviceCare.
2. Open the device in FieldCare or DeviceCare.
 - ↳ The dashboard (homepage) of the device is displayed:

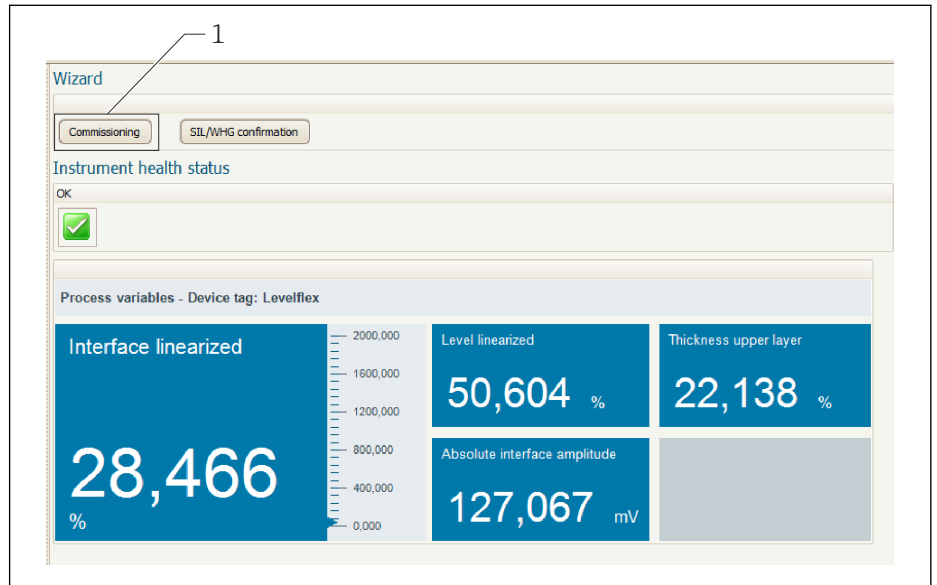

1 "Commissioning" button calls up the wizard

3. Click "Commissioning" to launch the Wizard.
 4. Enter the appropriate value in each parameter or select the appropriate option. These values are written directly to the device.
 5. Click "Next" to go to the next page.
 6. Once all the pages have been completed, click "Finish" to close the Wizard.
- i** If you cancel the Wizard before all the necessary parameters have been entered, the device may be in an undefined state. In such situations, it is advisable to reset the device to the factory default settings.

11 Commissioning via operating menu

11.1 Installation and function check

Before commissioning the measuring point, check whether the post-installation and post-connection checks have been performed.

 Post-mounting check

 Post-connection check

11.2 Configuring the operating language

Factory setting: English or ordered local language

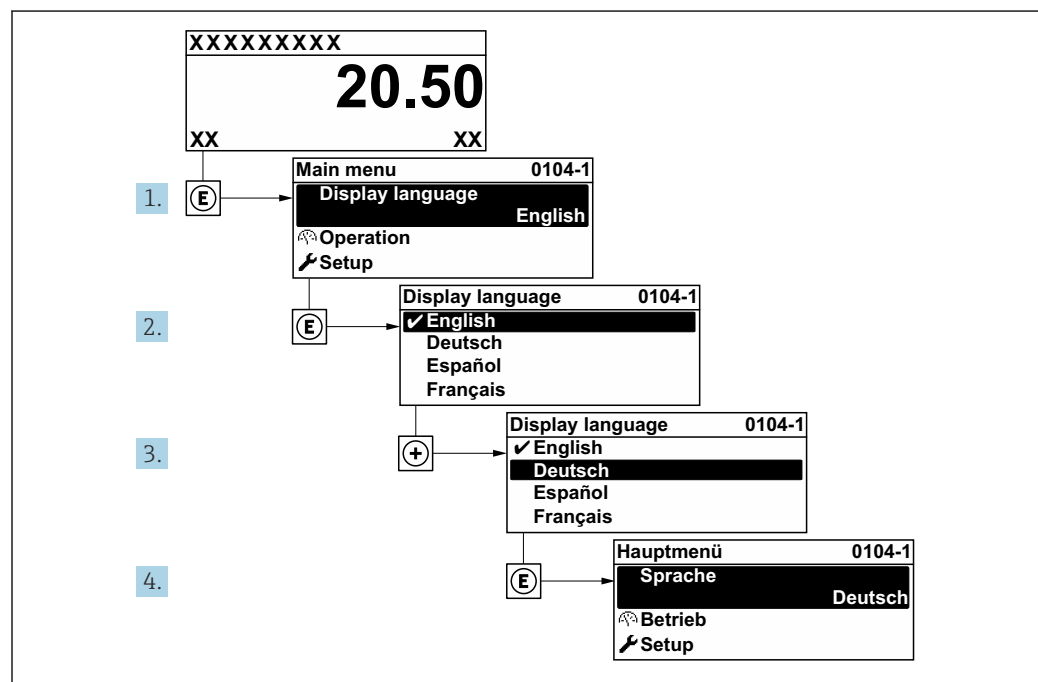

A0029420

 26 Using the example of the local display

11.3 Configuring level measurement

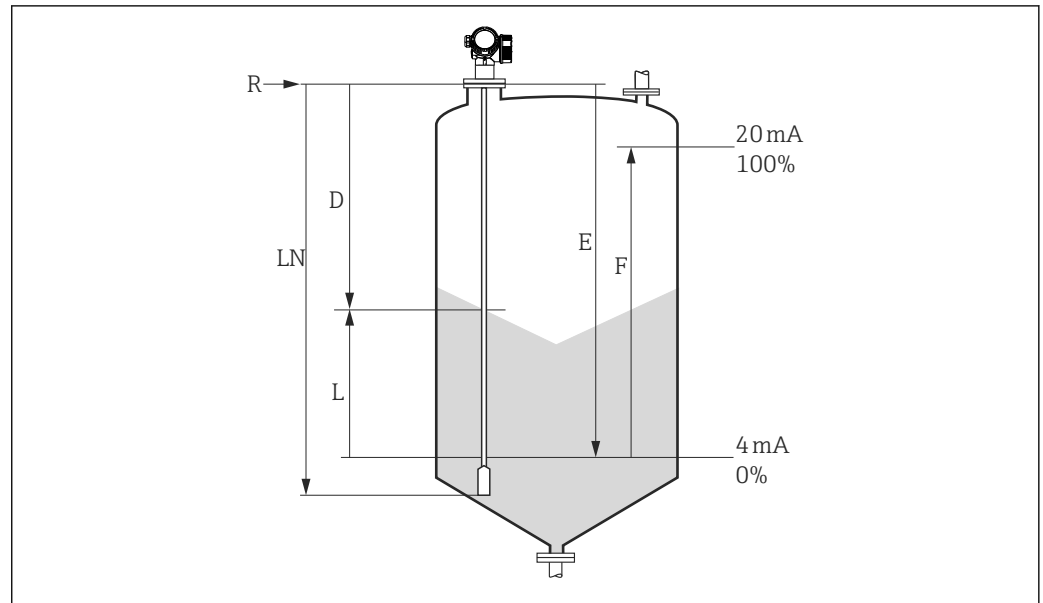

A0012838

27 Configuration parameters for level measurement in bulk solids

- LN Length of probe
- R Reference point of the measurement
- D Distance
- L Level
- E Empty calibration (= zero point)
- F Full calibration (= span)

i If the ϵ_r value is lower than 7 in the case of rope probes, measurement is not possible in the area of the probe weight. The empty calibration E should not exceed $LN - 250$ mm ($LN - 10$ in) in these cases.

1. Navigate to: Setup → Device tag
 - ↳ Enter the tag name.
2. Navigate to: Setup → Device address
 - ↳ Enter the device bus address (only if the address is set via the software).
3. Navigate to: Setup → Distance unit
 - ↳ Select the length unit.
4. Navigate to: Setup → Bin type
 - ↳ Select bin type.
5. Navigate to: Setup → Empty calibration
 - ↳ Specify empty distance E (distance from reference point R to 0% mark).
6. Navigate to: Setup → Full calibration
 - ↳ Specify the full distance F (distance from the 0% mark to the 100% mark).
7. Navigate to: Setup → Level
 - ↳ Displays the measured level L .
8. Navigate to: Setup → Distance
 - ↳ Displays the distance D between the reference point R and the level L .
9. Navigate to: Setup → Signal quality
 - ↳ Displays the signal quality of the analyzed level echo.

10. Operation via local display:
 Navigate to: Setup → Mapping → Confirm distance
 ↳ Compare the distance displayed with the actual value to start recording an interference echo map if necessary.
11. Operation via operating tool:
 Navigate to: Setup → Confirm distance
 ↳ Compare the distance displayed with the actual value to start recording an interference echo map if necessary.

11.4 Recording the reference echo curve

After the measurement has been configured, it is recommended to record the current envelope curve as a reference echo curve. This can then be used later for diagnostic purposes. The **Save reference curve** parameter is used to record the envelope curve.

Path in the menu

Expert → Diagnostics → Envelope diagnostics → Save reference curve

Meaning of the options

- No
No action
- Yes
The current envelope curve is saved as a reference curve.

 This submenu is only visible for the "Service" user role in devices supplied with software version 01.00.zz.

 The reference echo curve can only be displayed in the envelope curve diagram of FieldCare after it has been loaded from the device into FieldCare. The "Load Reference Curve" function in FieldCare is used for this.

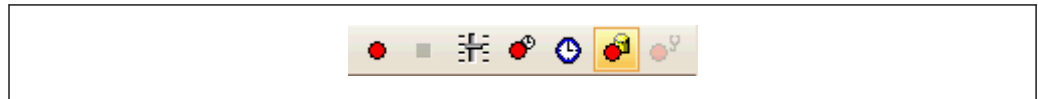

 28 "Load Reference Curve" function

11.5 Configuring the local display

11.5.1 Factory setting of local display for level measurements

Parameter	Factory setting for devices with 1 current output	Factory setting for devices with 2 current outputs
Format display	1 value, max. size	1 value, max. size
Value 1 display	Level linearized	Level linearized
Value 2 display	Distance	Distance
Value 3 display	Current output 1	Current output 1
Value 4 display	None	Current output 2

11.5.2 Adjusting the local display

The local display can be adjusted in the following submenu:
 Setup → Advanced setup → Display

11.6 Configuration management

After commissioning, you can save the current device configuration, copy it to another measuring point or restore the previous device configuration. You can do so using the **Configuration management** parameter and the options available.

Path in the menu

Setup → Advanced setup → Configuration backup display → Configuration management

Meaning of the options

- **Cancel**

No action is executed and the user exits the parameter.

- **Execute backup**

A backup copy of the current device configuration is saved from the HistoROM (integrated in the device) to the display module of the device.

- **Restore**

The last backup copy of the device configuration is copied from the display module to the HistoROM of the device.

- **Duplicate**

The transmitter configuration of the device is duplicated to another device using the display module. The following parameters, which characterize the individual measuring point are **not** transferred:

Medium type

- **Compare**

The device configuration saved in the display module is compared to the current device configuration of the HistoROM. The result of the comparison is displayed in the **Comparison result** parameter.

- **Clear backup data**

The backup copy of the device configuration is deleted from the display module of the device.



While this action is in progress, the configuration cannot be edited via the local display and a message on the processing status appears on the display.



If an existing backup copy is restored on a device other than the original device using the **Restore** option, in some cases individual device functions may not be available. In some cases it is also not possible to restore the original state by resetting to the "as-delivered" state.

The **Duplicate** option should always be used to copy the configuration to another device.

11.7 Protecting settings from unauthorized access





The settings can be protected from unauthorized access in two ways:

- Locking via parameters (software locking)
- Locking via write protection switch (hardware locking)

12 Diagnostics and troubleshooting





12.1 General troubleshooting

12.1.1 General errors

Error	Possible cause	Solution
Device does not respond.	Supply voltage not connected.	Connect the correct voltage.
	The cables do not contact the terminals properly.	Ensure electrical contact between the cable and the terminal.
Values on the display invisible	Contrast setting is too weak or too strong.	<ul style="list-style-type: none"> ▪ Increase contrast by pressing  and  simultaneously. ▪ Decrease contrast by pressing  and  simultaneously.
	The plug of the display cable is not connected correctly.	Connect the plug correctly.
	Display is defective.	Replace display.
"Communication error" is indicated on the display when starting the device or connecting the display.	Electromagnetic interference	Check grounding of the device.
	Broken display cable or display plug.	Replace display.
Duplication of parameters via display from one device to another not working. Only the "Save" and "Cancel" options are available.	Display with backup is not properly detected if a data backup was not carried out on the new device previously.	Connect display (with backup) and restart device.
CDI communication does not work.	Wrong setting of the COM port on the computer.	Check the setting of the COM port on the computer and change it if necessary.
Device measures incorrectly.	Parameter configuration error	Check and correct the parameter configuration.

12.1.2 Parameter configuration errors

Parameter configuration errors for level measurements

Error	Possible cause	Solution
Measured value is incorrect	If measured distance (Setup → Distance) matches the real distance: Calibration error	<ul style="list-style-type: none"> ▪ Check the Empty calibration parameter (→  99) and correct if necessary. ▪ Check the Full calibration parameter (→  99) and correct if necessary. ▪ Check the linearization and correct if necessary (Linearization submenu (→  115)).
	If measured distance (Setup → Distance) does not match the real distance: An interference echo is present.	Carry out mapping (Confirm distance parameter (→  102)).
No change of measured value on filling/emptying	An interference echo is present.	Carry out mapping (Confirm distance parameter (→  102)).
	Buildup at the probe.	Clean the probe.
	Error in the echo tracking	Deactivate echo tracking (Expert → Sensor → Echo tracking → Evaluation mode = History off).

Error	Possible cause	Solution
Echo lost diagnostic message appears after the supply voltage is switched on.	Noise level too high during initialization phase.	Enter a new value for the Empty calibration parameter (→ 99).
Device displays a level when the tank is empty.	Incorrect probe length	<ul style="list-style-type: none"> Perform a probe length correction (Confirm probe length parameter (→ 130)). Carry out mapping over the entire probe length when the tank is empty (Confirm distance parameter (→ 102)).
Wrong slope of the level over the entire measuring range	Wrong bin property selected.	Select the correct Bin type parameter (→ 98).

12.2 Diagnostic information on local display

12.2.1 Diagnostic message

Faults detected by the self-monitoring system of the measuring instrument are displayed as a diagnostic message in alternation with the measured value display.

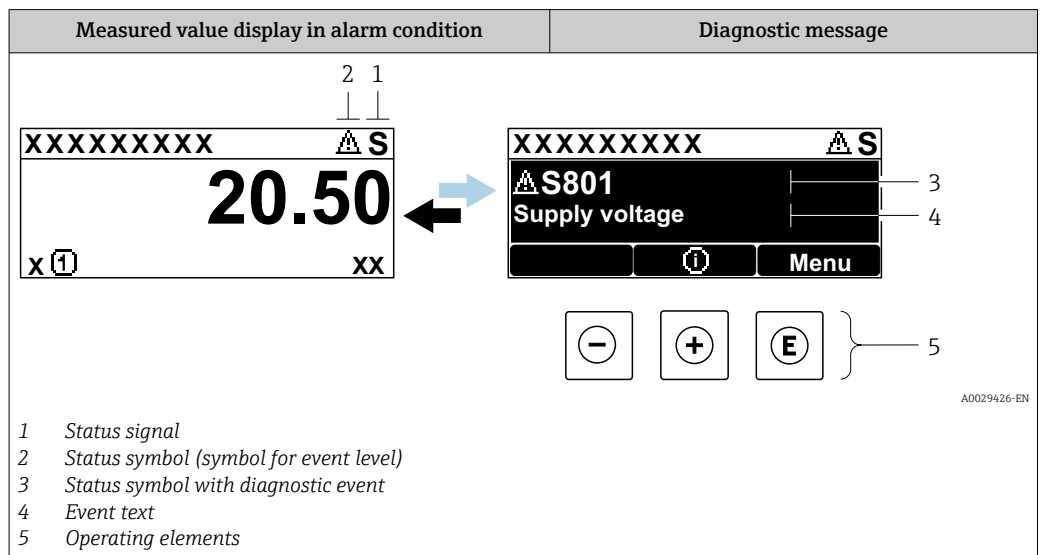

Status signals

F A0032902	"Failure (F)" option A device error has occurred. The measured value is no longer valid.
C A0032903	"Function check (C)" option The device is in the service mode (e.g. during a simulation).
S A0032904	"Out of specification (S)" option The device is operated: <ul style="list-style-type: none"> Outside its technical specifications (e.g. during startup or cleaning) Outside the configuration performed by the user (e.g. level outside the configured range)
M A0032905	"Maintenance required (M)" option Maintenance is required. The measured value is still valid.

Status symbols (symbol for event level)

⊗	"Alarm" status Measurement is interrupted. The signal outputs adopt the defined alarm state. A diagnostic message is generated.
⚠	"Warning" status The device continues to measure. A diagnostic message is generated.

Diagnostic event and event text

The fault can be identified by means of the diagnostic event. The event text helps you by providing information about the fault. In addition, the associated status symbol is displayed in front of the diagnostic event.

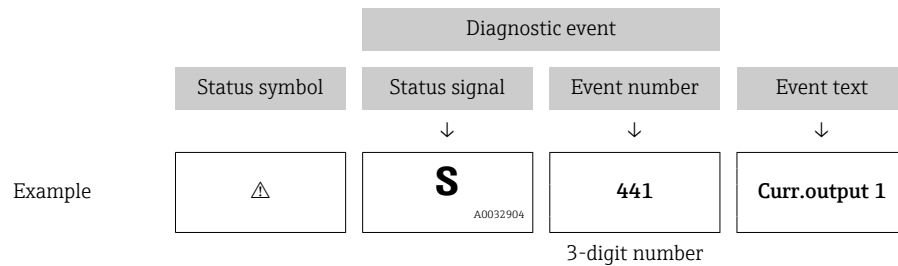

If several diagnostic events are pending at the same time, only the diagnostic message with the highest priority is displayed. Additional queued diagnostic messages can be shown in the **Diagnostic list** submenu.



Past diagnostic messages that are no longer pending are shown as follows:

- On the local display:
in the **Event logbook** submenu
- In FieldCare:
via the "Event List/HistoROM" function

Operating elements

Operating functions in menu, submenu	
+	Plus key Opens the message about the remedial measures.
E	Enter key Opens the operating menu.

12.2.2 Calling up remedial measures

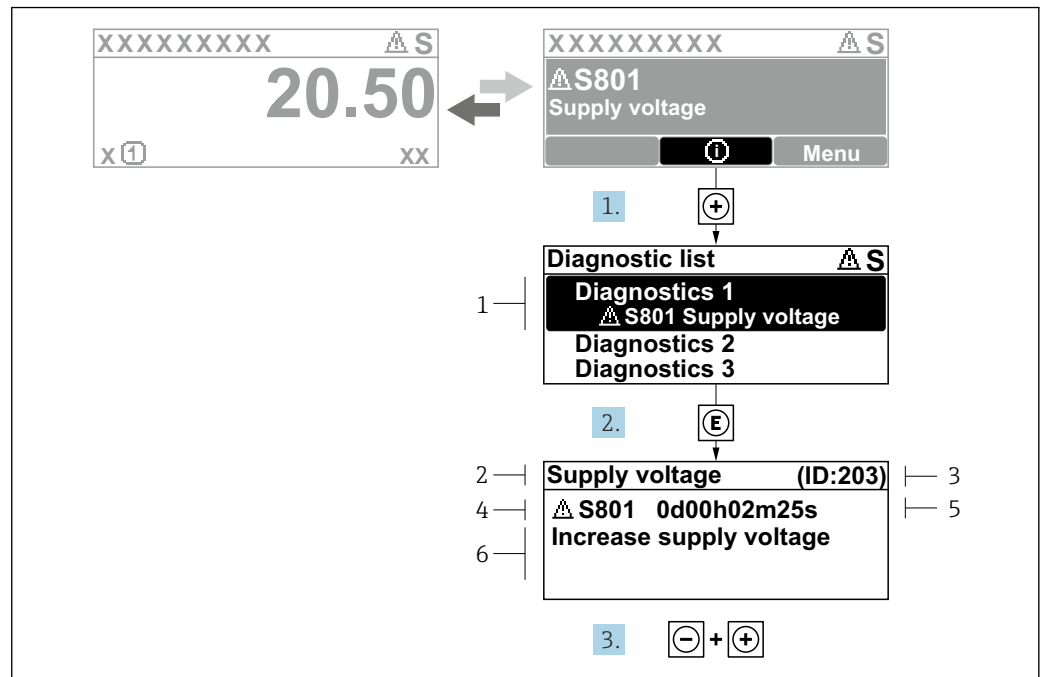

29 Message for remedial measures

- 1 Diagnostic information
- 2 Short text
- 3 Service ID
- 4 Diagnostic behavior with diagnostic code
- 5 Operation time when error occurred
- 6 Remedial measures

The user is in the diagnostic message.

1. Press **+** (**Ⓢ** symbol).
↳ The **Diagnostic list** submenu opens.
2. Select the desired diagnostic event with **+** or **-** and press **E**.
↳ The message for the remedial measures for the selected diagnostic event opens.
3. Press **-** + **+** simultaneously.
↳ The message about the remedial measures closes.

The user is in the **Diagnostics** menu at an entry for a diagnostics event, e.g. in **Diagnostic list** or in **Previous diagnostics**.

1. Press **E**.
↳ The message for the remedial measures for the selected diagnostic event opens.
2. Press **-** + **+** simultaneously.
↳ The message about the remedial measures closes.

12.3 Diagnostic event in the operating tool

If a diagnostic event has occurred in the device, the status signal appears in the top left status area of the operating tool together with the corresponding symbol for the event level according to NAMUR NE 107:

- Failure (F)
- Function check (C)
- Out of specification (S)
- Maintenance required (M)

A: Via the operating menu

1. Navigate to the **Diagnostics** menu.
 - ↳ In the **Actual diagnostics** parameter, the diagnostic event is shown with event text.
2. On the right in the display area, hover the cursor over the **Actual diagnostics** parameter.

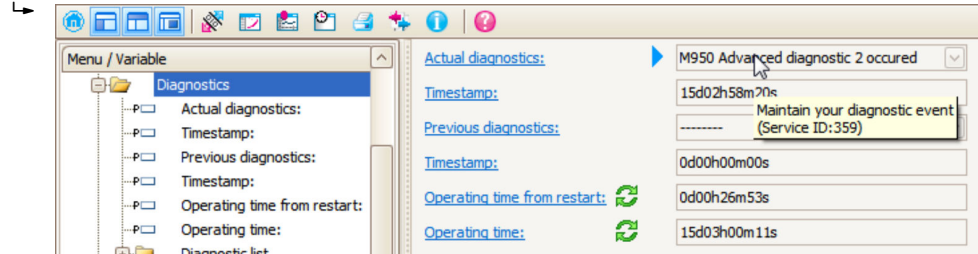

A tool tip with remedy information for the diagnostic event appears.

B: Via the "Create Documentation" function

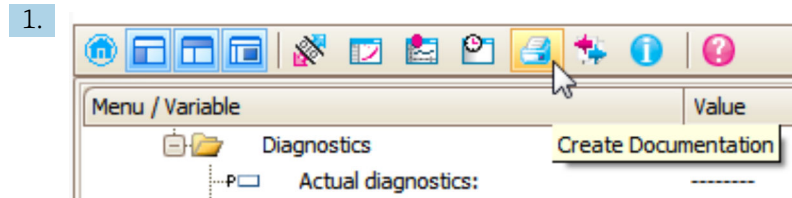

Select the "Create documentation" function.

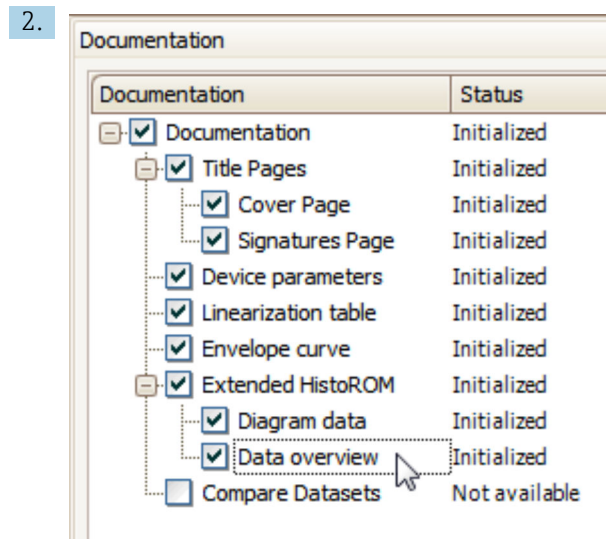

Make sure that "Data overview" is marked.

3. Click "Save as..." and save a PDF of the report.
 - ↳ The report contains the diagnostic messages including remedial measures.

C: Via the "Event list/Extended HistoROM" function

1.

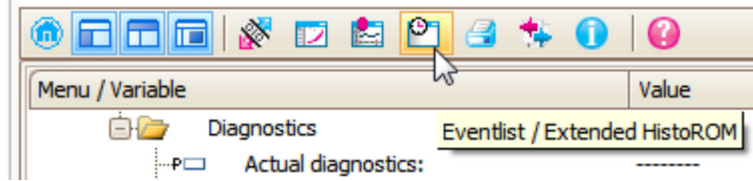

Select the ("Event list/Extended HistoROM") function.

2.

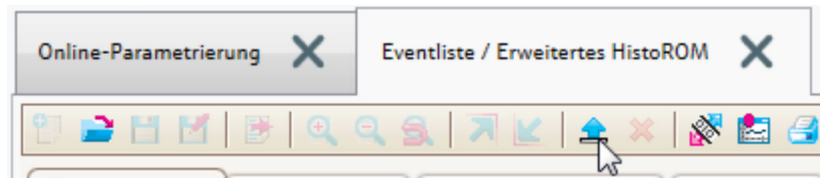

Select the "Load event list" function.

- ↳ The event list including remedial measures is displayed in the "Data overview" window.

12.4 Diagnostic list

In the **Diagnostic list** submenu submenu, up to 5 currently pending diagnostic messages can be displayed. If more than 5 messages are pending, the messages with the highest priority are shown on the display.

Navigation path

Diagnostics → Diagnostic list

Calling up and closing the remedial measures

1. Press .

- ↳ The message for the remedial measures for the selected diagnostic event opens.

2. Press  +  simultaneously.

- ↳ The message about the remedial measures closes.

12.5 List of diagnostic events

Diagnostic number	Short text	Remedy instructions	Status signal [from the factory]	Diagnostic behavior [from the factory]
Diagnostic of sensor				
003	Broken probe detected	1. Check map 2. Check sensor	F	Alarm
046	Build-up detected	Clean sensor	F	Alarm
104	HF cable	and check sealing 1. Dry HF cable connection 2. Change HF cable	F	Alarm
105	HF cable	1. Tighten HF cable connection 2. Check sensor 3. Change HF cable	F	Alarm
106	Sensor	1. Check sensor 2. Check HF cable 3. Contact service	F	Alarm
Diagnostic of electronic				
242	Software incompatible	1. Check software 2. Flash or change main electronics module	F	Alarm
252	Modules incompatible	1. Check electronic modules 2. Change I/O or main electronic module	F	Alarm
261	Electronic modules	1. Restart device 2. Check electronic modules 3. Change I/O Modul or main electronics	F	Alarm
262	Module connection	1. Check module connections 2. Change electronic modules	F	Alarm
270	Main electronic failure	Change main electronic module	F	Alarm
271	Main electronic failure	1. Restart device 2. Change main electronic module	F	Alarm
272	Main electronic failure	1. Restart device 2. Contact service	F	Alarm
273	Main electronic failure	1. Emergency operation via display 2. Change main electronics	F	Alarm
275	I/O module failure	Change I/O module	F	Alarm
276	I/O module failure	1. Restart device 2. Change I/O module	F	Alarm
282	Data storage	1. Restart device 2. Contact service	F	Alarm
283	Memory content	1. Transfer data or reset device 2. Contact service	F	Alarm
311	Electronic failure	1. Transfer data or reset device 2. Contact service	F	Alarm
311	Electronic failure	Maintenance required! 1. Do not perform reset 2. Contact service	M	Warning
Diagnostic of configuration				
410	Data transfer	1. Check connection 2. Retry data transfer	F	Alarm
412	Processing Download	Download active, please wait	C	Warning

Diagnostic number	Short text	Remedy instructions	Status signal [from the factory]	Diagnostic behavior [from the factory]
435	Linearization	Check linearization table	F	Alarm
437	Configuration incompatible	1. Restart device 2. Contact service	F	Alarm
438	Dataset	1. Check data set file 2. Check device configuration 3. Up- and download new configuration	M	Warning
482	Block in OOS	Set Block in AUTO mode	F	Alarm
484	Simulation failure mode	Deactivate simulation	C	Alarm
485	Simulation measured value	Deactivate simulation	C	Warning
494	Switch output simulation	Deactivate simulation switch output	C	Warning
495	Simulation diagnostic event	Deactivate simulation	C	Warning
497	Simulation block output	Deactivate simulation	C	Warning
585	Simulation distance	Deactivate simulation	C	Warning
Diagnostic of process				
801	Energy too low	Increase supply voltage	S	Warning
825	Operating temperature	1. Check ambient temperature 2. Check process temperature	S	Warning
825	Operating temperature		F	Alarm
921	Change of reference	1. Check reference configuration 2. Check pressure 3. Check sensor	S	Warning
936	EMC interference	Check installation on EMC	F	Alarm
941	Echo lost	Check parameter 'DC value'	F	Alarm ¹⁾
942	In safety distance	1. Check level 2. Check safety distance 3. Reset self holding	S	Alarm ¹⁾
943	In blocking distance	Reduced accuracy Check level	S	Warning
944	Level range	Reduced accuracy Level at process connection	S	Warning
950	Advanced diagnostic 1 to 2 occurred	Maintain your diagnostic event	M	Warning ¹⁾

1) Diagnostic behavior can be changed.

12.6 Event logbook

12.6.1 Event history

A chronological overview of the event messages that have occurred is provided in the **Event list**

(This submenu only exists if operating via the local display. In the case of operation via FieldCare, the event list can be displayed with the "Event list/HistoROM" functionality of FieldCare.

Navigation path

Diagnostics → Event logbook → Event list

A maximum of 100 event messages can be displayed in chronological order.



The event history includes entries for:

- Diagnostic events
- Information events

In addition to the operating time when the event occurred, each event is also assigned a symbol that indicates whether the event has occurred or is finished:

- Diagnostic event
 - ☹: Occurrence of the event
 - ☺: End of the event
- Information event
 - ☹: Occurrence of the event

Calling up and closing the remedial measures

1. Press .
 - ↳ The message for the remedial measures for the selected diagnostic event opens.
2. Press  +  simultaneously.
 - ↳ The message about the remedial measures closes.

12.6.2 Filtering the event logbook

Using the **Filter options** parameter, you can define which category of event messages is displayed in the **Event list** submenu.

Navigation path

Diagnostics → Event logbook → Filter options

Filter categories

- All
- Failure (F)
- Function check (C)
- Out of specification (S)
- Maintenance required (M)
- Information

12.6.3 Overview of information events

Info number	Info name
I1000	----- (Device ok)
I1089	Power on
I1090	Configuration reset
I1091	Configuration changed
I1092	Trend data deleted
I1110	Write protection switch changed
I1137	Electronic changed
I1151	History reset
I1154	Reset terminal voltage min/max
I1155	Reset electronic temperature
I1156	Memory error trend
I1157	Memory error event list

Info number	Info name
I1185	Display backup done
I1186	Restore via display done
I1187	Settings downloaded with display
I1188	Display data cleared
I1189	Backup compared
I1256	Display: access status changed
I1264	Safety sequence aborted
I1335	Firmware changed
I1397	Fieldbus: access status changed
I1398	CDI: access status changed
I1512	Download started
I1513	Download finished
I1514	Upload started
I1515	Upload finished

12.7 Firmware history

Date	Firmware version	Modifications	Documentation (FMP56, FMP57, PROFIBUS)		
			Operating Instructions	Description of Device Parameters	Technical Information
07.2011	01.00.zz	Original software	BA01009F/00/EN/10.10	GP01001F/00/EN/10.10	TI01004F/00/EN/13.11
02.2015	01.01.zz	<ul style="list-style-type: none"> ▪ Support of SD03 ▪ Additional languages ▪ HistoROM functionality enhanced ▪ "Advanced Diagnostics" function block integrated ▪ Improvements and bugfixes 	BA01009F/00/EN/14.14 BA01009F/00/EN/15.16 ¹⁾	GP01001F/00/EN/13.14	TI01004F/00/EN/17.14 TI01004F/00/EN/20.16 ¹⁾

1) Contains information on the Heartbeat wizards available in the current DTM version for DeviceCare and. FieldCare

 The firmware version can explicitly be ordered via the product structure. In this way it is possible to ensure compatibility of the firmware version with an existing or planned system integration.

13 Maintenance

No special maintenance work is required.

13.1 Exterior cleaning

When cleaning the exterior, always use cleaning agents that do not corrode the surface of the housing and the seals.

13.2 General cleaning instructions

Dirt or buildup may form on the probe depending on the application. A thin, even layer has little impact on the measurement. Thick layers can dampen the signal and reduce the measuring range. Very uneven deposit formation or caking (e.g. due to crystallization) can result in incorrect measurements. In such cases, use a non-contact measuring principle, or regularly inspect the probe for contamination.

Cleaning with sodium hydroxide solution (e.g. in CIP procedures): if the coupling is wetted, larger measurement errors can occur than under reference operating conditions. Wetting can cause temporary incorrect measurements.

14 Repair

14.1 General information

14.1.1 Repair concept

Under the Endress+Hauser repair concept, devices have a modular design and repairs can be carried out by Endress+Hauser Service or by properly trained customers.

Spare parts are grouped into logical kits with the associated replacement instructions.

For more information on service and spare parts, please contact Endress+Hauser Service.

14.1.2 Repairs to Ex-approved devices

⚠ WARNING

Incorrect repair can compromise electrical safety!

Explosion hazard!

- ▶ Repairs to Ex-approved devices must be carried out by Endress+Hauser Service or by specialist personnel according to national regulations.
- ▶ Relevant standards and national regulations on hazardous areas, safety instructions and certificates must be observed.
- ▶ Use only original Endress+Hauser spare parts.
- ▶ Please note the device designation on the nameplate. Only identical parts may be used as replacements.
- ▶ Carry out repairs according to the instructions.
- ▶ Only the Endress+Hauser service team is permitted to modify a certified device and convert it to another certified version.

14.1.3 Replacing electronics modules

When electronics modules have been replaced the device does not need to be recalibrated as the parameters are saved in the HistoROM inside the housing. It may be necessary when replacing the main electronics to record a new interference echo suppression.

14.1.4 Replacing a device

Once a complete device has been replaced, the parameters can be transferred back into the device using one of the following methods:

- Using the display module
Prerequisite: The configuration of the old device was saved previously to the display module.
- Via FieldCare
Prerequisite: The configuration of the old device was saved previously to the computer using FieldCare.

You can continue measuring without performing a new calibration. Only interference echo suppression may need to be carried out once again.

14.2 Spare parts

- Some replaceable measuring instrument components are identified by means of a spare part nameplate. This contains information about the spare part.
- In the connection compartment cover of the device there is a spare part nameplate which contains the following information:
 - A list of the most important spare parts for the measuring instrument, including their ordering information.
 - The URL to the *W@M Device Viewer* (www.endress.com/deviceviewer):
All the spare parts for the measuring instrument, along with the order code, are listed here and can be ordered. If available, users can also download the associated Installation Instructions.

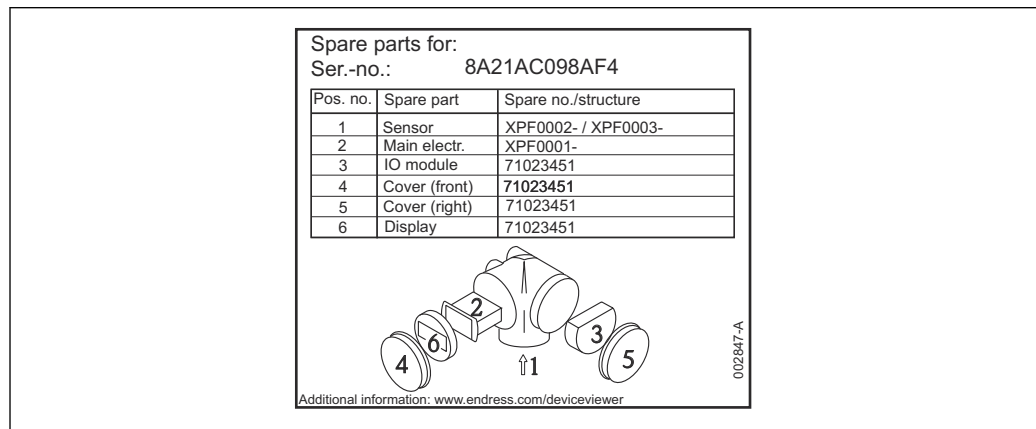

30 Example for spare part nameplate in the connection compartment cover

- i** Measuring instrument serial number:
 - Located on the device and spare part nameplate.
 - Can be read out via the "Serial number" parameter in the "Device information" submenu.

14.3 Return

The requirements for safe device return can vary depending on the device type and national legislation.

1. Refer to the web page for information:
<https://www.endress.com/support/return-material>
↳ Select the region.
2. If returning the device, pack the device in such a way that it is reliably protected against impact and external influences. The original packaging offers the best protection.

14.4 Disposal

-  If required by the Directive 2012/19/EU on waste electrical and electronic equipment (WEEE), the product is marked with the depicted symbol in order to minimize the disposal of WEEE as unsorted municipal waste. Do not dispose of products bearing this marking as unsorted municipal waste. Instead, return them to the manufacturer for disposal under the applicable conditions.

15 Accessories

The accessories currently available for the product can be selected at www.endress.com:

1. Select the product using the filters and search field.
2. Open the product page.
3. Select **Spare parts & Accessories**.

15.1 Device-specific accessories

15.1.1 Weather protection cover

The weather protection cover can be ordered together with the device via the "Accessory enclosed" product structure.

It is used to protect against direct sunlight, precipitation and ice.

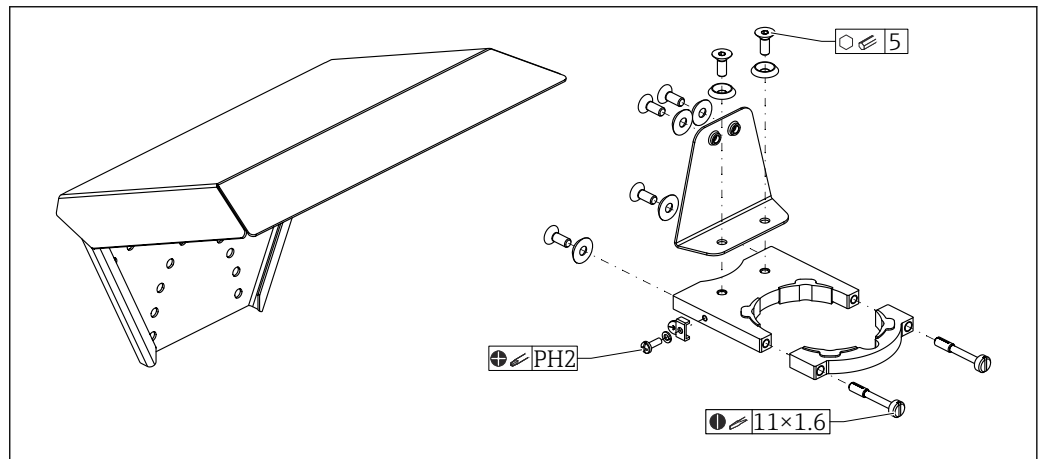

A0051672

31 Overview

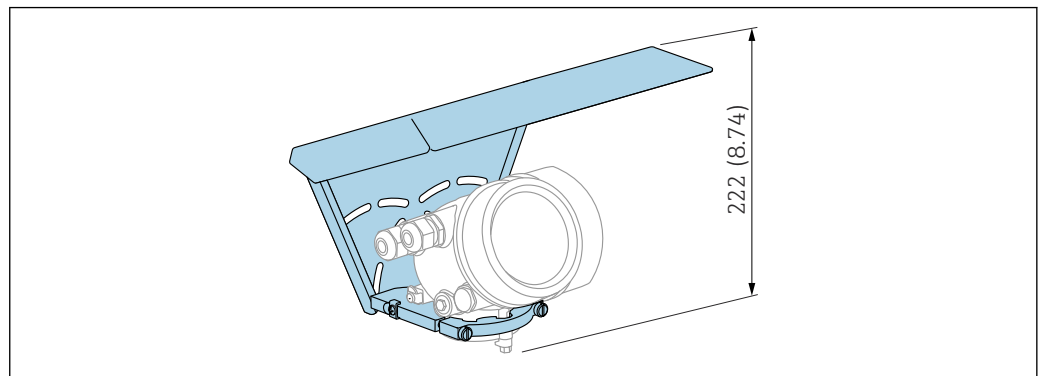

A0015466

32 Height. Unit of measurement mm (in)

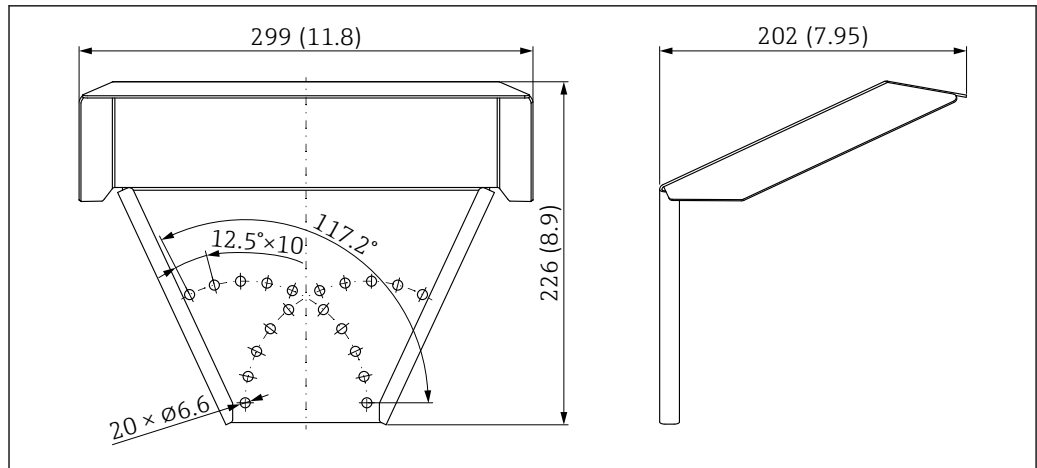

A0015472

33 Dimensions. Unit of measurement mm (in)

Material

- Protection cap; 316L (1.4404)
- Bracket; 316L (1.4404)
- Angle bracket; 316L (1.4404)
- Clamping screw; 316L (1.4404) + carbon fiber
- Molded rubber part (4x); EPDM
- Screws; A4
- Disks; A4
- Ground terminal; A4, 316L (1.4404)

Order number for accessories:

71162242

15.1.2 Mounting bracket for electronics housing

With "remote sensor" device versions (feature 060 in the product structure), the mounting bracket is included in the scope of delivery. It can be ordered as a separate accessory .

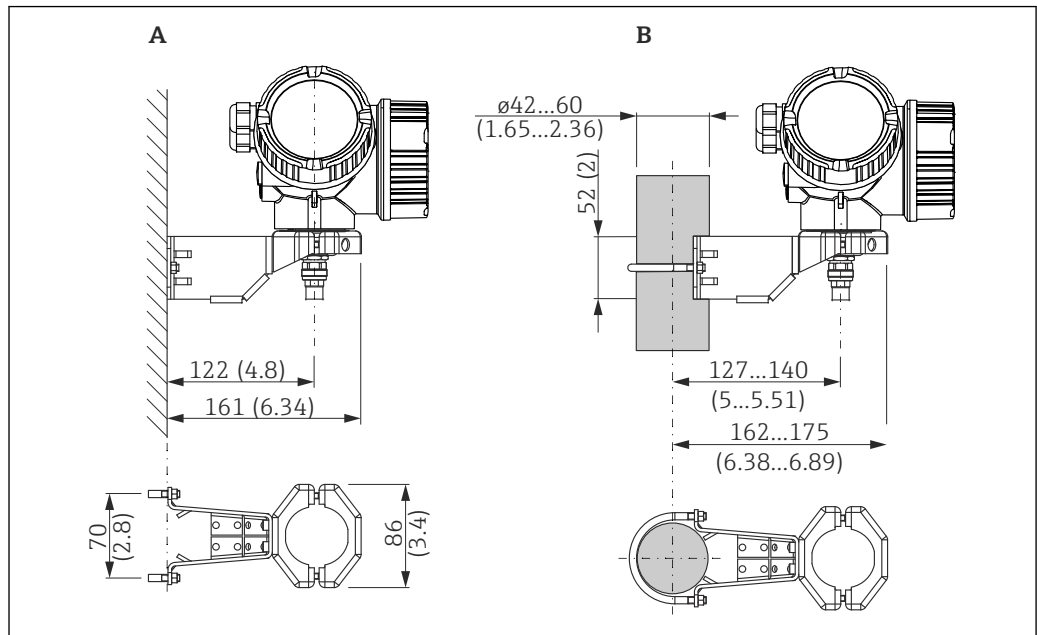

A0014793

34 Mounting bracket for electronics housing; unit: mm (in)

A Wall mounting

B Post mounting

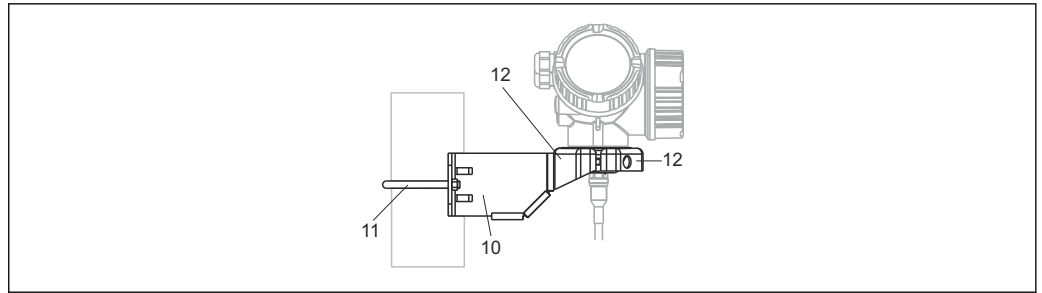

A0015143

35 Material; mounting bracket

10 Bracket, 316L (1.4404)

11 Round bracket, 316L (1.4404); screws/nuts, A4-70; distance sleeves, 316L (1.4404)

12 Half-shells, 316 L (1.4404)

Order number for accessories:

71102216

15.1.3 Rod extension (centering device) HMP40

The rod extension (centering device) HMP40 is ordered via the Product Configurator.

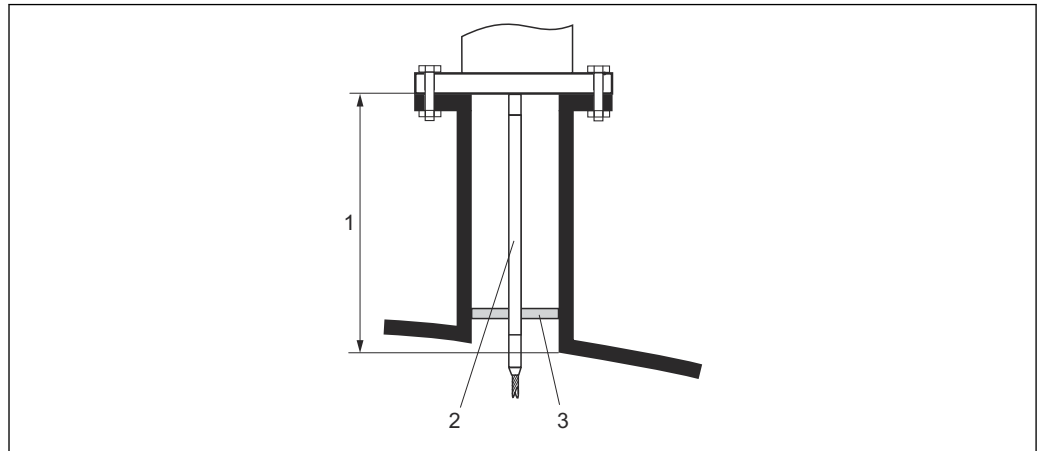

- 1 Nozzle height
- 2 Extension rod
- 3 Centering disk

Permitted temperature at lower edge of nozzle:

- Without centering disk, no restriction
- With centering disk, -40 to $+150$ °C (-40 to $+302$ °F)



For details, see SD01002F.

15.1.4 Mounting kit, insulated

To secure rope probes so that they are reliably insulated.

Maximum process temperature: 150 °C (300 °F)

Mounting set, insulated, can be used for:

- FMP56
- FMP57

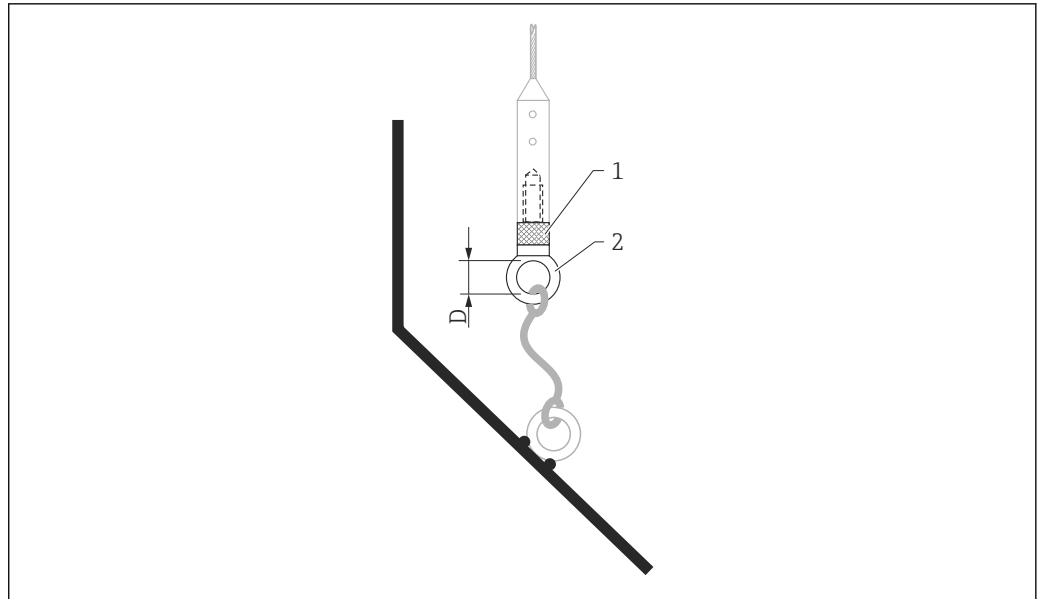

A0013586

36 Scope of delivery of mounting kit:

- 1 Insulation sleeve
- 2 Ring bolt

For rope probes 4 mm (1/6 in) or 6 mm (1/4 in) with PA > steel:
Diameter D = 20 mm (0.8 in)

Order number for accessories:
52014249

For rope probes 6 mm (1/4 in) or 8 mm (1/3 in) with PA > steel:
Diameter D = 25 mm (1 in)

Order number for accessories:
52014250

Due to the risk of electrostatic charge, the insulation sleeve is not suitable for use in hazardous areas! In this case, the probe must be secured so that it is reliably grounded.

i The mounting kit can also be ordered directly with the device (Levelflex product structure, feature 620 "Accessory enclosed", version PG "mounting kit, insulated, rope").

15.1.5 Remote display FHX50

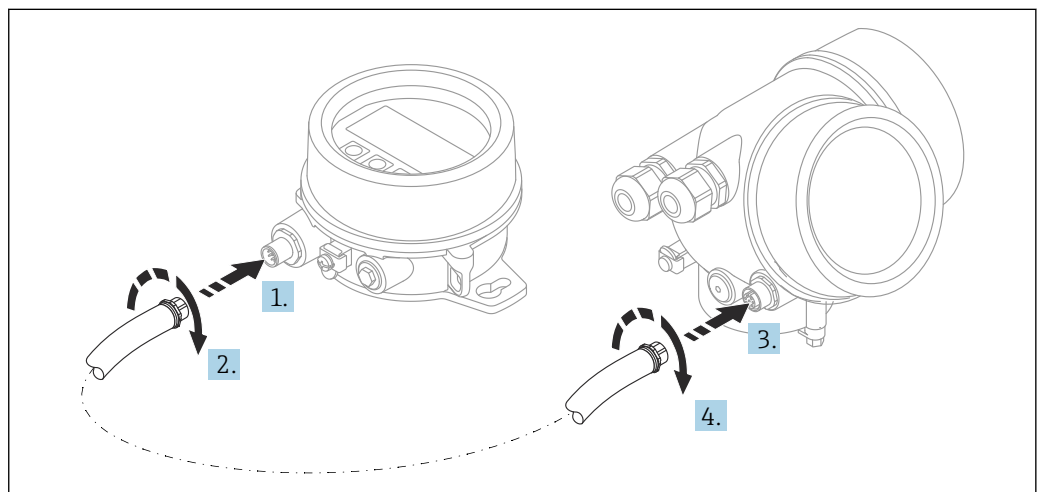

A0019128

Technical data

- Material:
 - Plastic PBT
 - 316L/1.4404
 - Aluminum
 - Degree of protection: IP68 / NEMA 6P and IP66 / NEMA 4x
 - Suitable for display modules:
 - SDO2 (push buttons)
 - SDO3 (touch control)
 - Connecting cable:
 - Cable supplied with device up to 30 m (98 ft)
 - Standard cable provided by customer onsite up to 60 m (196 ft)
 - Ambient temperature: -40 to 80 °C (-40 to 176 °F)
 - Ambient temperature, optionally available for order. -50 to 80 °C (-58 to 176 °F)
- NOTICE** If the temperature is permanently below -40 °C (-40 °F), higher failure rates can be expected.

Ordering information

- If the remote display is to be used, the device version "Prepared for display FHX50" must be ordered.
For FHX50, the option "Prepared for display FHX50" must be selected under "Measuring device version".
- If a measuring instrument has not been ordered with the version "Prepared for display FHX50" and is to be retrofitted with an FHX50, the version "Not prepared for display FHX50" must be ordered for the FHX50 under "Measuring device version". In this case, a retrofit kit for the device is supplied with the FHX50. The kit can be used to prepare the device so that the FHX50 can be used.

 Use of the FHX50 may be restricted for transmitters with an approval. A device can only be retrofitted with the FHX50 if the option "Prepared for FHX50" is listed under *Basic specifications*, "Display, operation" in the Safety instructions (XA) for the device.

Also refer to the Safety Instructions (XA) of the FHX50.

Retrofitting is not possible on transmitters with:

- An approval for use in areas with flammable dust (dust ignition-proof approval)
- Type of protection Ex nA

 For details, see "Special Documentation" document SD01007F.

15.1.6 Overvoltage protection

The surge arrester for loop-powered devices can be ordered together with the device via the "Accessory mounted" section of the product order structure.

The surge arrester can be used for loop-powered devices.

- 1-channel devices - OVP10
- 2-channel devices - OVP20

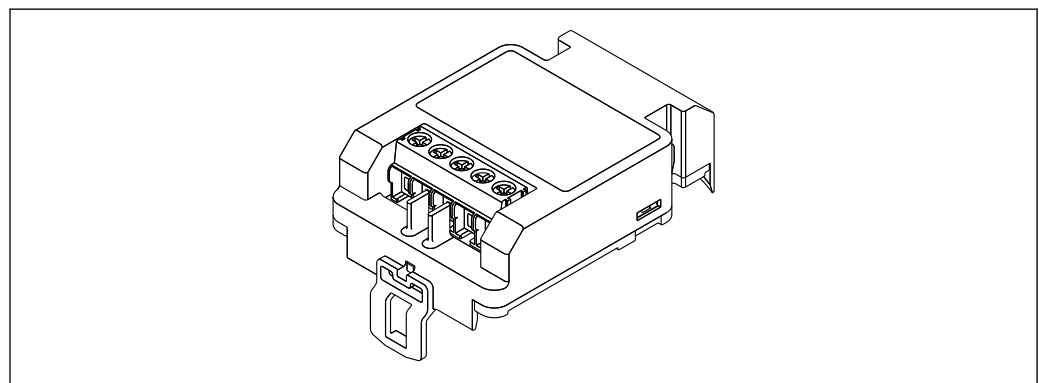

A0021734

Technical data

- Resistance per channel: $2 \times 0.5 \Omega_{\max}$
- Threshold DC voltage: 400 to 700 V
- Threshold surge voltage: < 800 V
- Capacitance at 1 MHz: < 1.5 pF
- Nominal leakage current (8/20 μ s): 10 kA
- Suitable for conductor cross-sections: 0.2 to 2.5 mm² (24 to 14 AWG)

If retrofitting:

- Order number for 1-channel devices (OVP10): 71128617
- Order number for 2-channel devices (OVP20): 71128619
- The use of the OVP module may be restricted depending on the transmitter approval. A device may only be retrofitted with the OVP module if the option *NA* (overvoltage protection) is listed under *Optional specifications* in the Safety Instructions (XA) associated with the device.
- In order to keep the necessary safety distances when using the surge arrester module, the housing cover also needs to be replaced when the device is retrofitted. Depending on the housing type, the suitable cover can be ordered using the following order number:
 - Housing GT18: 71185516
 - Housing GT19: 71185518
 - Housing GT20: 71185517



For details, see the "Special Documentation" SD01090F

15.1.7 Bluetooth module BT10 for HART devices

The Bluetooth module BT10 can be ordered together with the device via the "Accessory mounted" section of the product order structure.

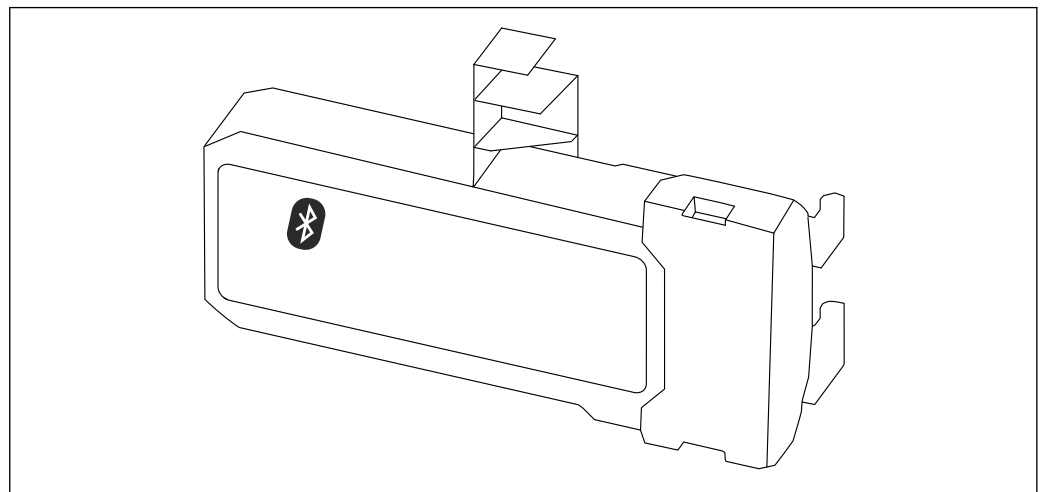

A0036493

Technical data

- Quick and easy setup with the SmartBlue app
- No additional tools or adapters needed
- Signal curve via SmartBlue (app)
- Encrypted single point-to-point data transmission (tested by Fraunhofer Institute) and password-protected communication via Bluetooth® wireless technology
- Range under reference conditions:
 - > 10 m (33 ft)
- When the Bluetooth module is used, the minimum supply voltage of the device increases by up to 3 V.

If retrofitting:

- Order number: 71377355
- The use of the Bluetooth module may be restricted depending on the transmitter approval. A device may only be retrofitted with the Bluetooth module if the option *NF* (Bluetooth module) is listed under *Optional specifications* in the Safety Instructions (XA) associated with the device.



For details, see the "Special Documentation" SD02252F

15.2 Communication-specific accessories

Commubox FXA291

Connects Endress+Hauser field devices with a CDI interface (= Endress+Hauser Common Data Interface) and the USB port of a computer or laptop

Order number: 51516983



For details, see "Technical Information" TI00405C

15.3 Service-specific accessories

DeviceCare SFE100

Configuration tool for HART, PROFIBUS and FOUNDATION Fieldbus field devices



Technical Information TI01134S

FieldCare SFE500

FDT-based plant asset management tool

It can configure all smart field units in your system and helps you manage them. By using the status information, it is also a simple but effective way of checking their status and condition.



Technical Information TI00028S

15.4 System components

15.4.1 Memograph M RSG45

The Advanced Data Manager is a flexible and powerful system for organizing process values.

The Memograph M is used for electronic acquisition, display, recording, analysis, remote transmission and archiving of analog and digital input signals as well as calculated values.

























Technical Information TI01180R and Operating Instructions BA01338R

16 Operating menu























16.1 Overview of the operating menu (display module)

Navigation  Operating menu























Language	
Setup	→ 98
Device tag	→ 98
Device address	→ 98
Distance unit	→ 98
Bin type	→ 98
Empty calibration	→ 99
Full calibration	→ 99
Level	→ 100
Distance	→ 100
Signal quality	→ 101
Mapping	→ 104
Confirm distance	→ 104
Mapping end point	→ 104
Record map	→ 104
Distance	→ 104
Analog inputs	
Analog input 1 to 6	→ 105
Channel	→ 105
PV filter time	→ 105

Fail safe type	→  106
Fail safe value	→  106
► Advanced setup	→  107
Locking status	→  107
Access status display	→  108
Enter access code	→  108
► Level	→  109
Medium type	→  109
Medium property	→  109
Process property	→  110
Advanced process conditions	→  111
Level unit	→  112
Blocking distance	→  112
Level correction	→  113
► Linearization	→  115
Linearization type	→  117
Unit after linearization	→  118
Free text	→  119
Maximum value	→  120
Diameter	→  120
Intermediate height	→  121
Table mode	→  121

▶ Edit table	
Level	
Customer value	
Activate table	→ 123
▶ Safety settings	→ 124
Output echo lost	→ 124
Value echo lost	→ 124
Ramp at echo lost	→ 125
Blocking distance	→ 112
▶ WHG confirmation	→ 127
▶ Deactivate WHG	→ 128
Reset write protection	→ 128
Code incorrect	→ 128
▶ Probe settings	→ 129
Probe grounded	→ 129
▶ Probe length correction	→ 131
Confirm probe length	→ 131
Present probe length	→ 129
▶ Switch output	→ 133
Switch output function	→ 133
Assign status	→ 133
Assign limit	→ 134
Assign diagnostic behavior	→ 134
Switch-on value	→ 135
Switch-on delay	→ 136

Switch-off value	→  136
Switch-off delay	→  137
Failure mode	→  137
Switch status	→  137
Invert output signal	→  137
► Display	→  139
Language	→  139
Format display	→  139
Value 1 to 4 display	→  141
Decimal places 1 to 4	→  141
Display interval	→  141
Display damping	→  142
Header	→  142
Header text	→  142
Separator	→  143
Number format	→  143
Decimal places menu	→  143
Backlight	→  144
Contrast display	→  144
► Configuration backup display	→  145
Operating time	→  145
Last backup	→  145

Configuration management	→ 145
Comparison result	→ 146
▶ Administration	→ 148
▶ Define access code	→ 150
Define access code	→ 150
Confirm access code	→ 150
Device reset	→ 148
🔍 Diagnostics	→ 151
Actual diagnostics	→ 151
Previous diagnostics	→ 151
Operating time from restart	→ 152
Operating time	→ 145
▶ Diagnostic list	→ 153
Diagnostics 1 to 5	→ 153
▶ Event logbook	→ 154
Filter options	
▶ Event list	→ 154
▶ Device information	→ 155
Device tag	→ 155
Serial number	→ 155
Firmware version	→ 155
Device name	→ 155
Order code	→ 156
Extended order code 1 to 3	→ 156

Status PROFIBUS Master Config	→  156
PROFIBUS ident number	→  156
▶ Measured values	→  157
Distance	→  100
Level linearized	→  120
Terminal voltage 1	→  158
Switch status	→  137
▶ Analog inputs	
▶ Analog input 1 to 6	→  159
Channel	→  105
Out value	→  159
Out status	→  160
Out status HEX	→  160
▶ Data logging	→  161
Assign channel 1 to 4	→  161
Logging interval	→  161
Clear logging data	→  162
▶ Display channel 1 to 4	→  163
▶ Simulation	→  165
Assign measurement variable	→  166
Value process variable	→  166
Switch output simulation	→  166
Switch status	→  167
Simulation device alarm	→  167

Diagnostic event category	
Simulation diagnostic event	→ 167
▶ Device check	→ 168
Start device check	→ 168
Result device check	→ 168
Last check time	→ 168
Level signal	→ 169
Launch signal	→ 169

16.2 Overview of the operating menu (operating tool)

























Navigation



















































Operating menu

Setup	→ 98
Device tag	→ 98
Device address	→ 98
Distance unit	→ 98
Bin type	→ 98
Empty calibration	→ 99
Full calibration	→ 99
Level	→ 100
Distance	→ 100
Signal quality	→ 101
Confirm distance	→ 102
Present mapping	→ 103
Mapping end point	→ 103
Record map	→ 103
▶ Analog inputs	
▶ Analog input 1 to 6	→ 105
Channel	→ 105
PV filter time	→ 105
Fail safe type	→ 106
Fail safe value	→ 106
▶ Advanced setup	→ 107
Locking status	→ 107
Access status tooling	→ 107

Enter access code	→ 108
► Level	→ 109
Medium type	→ 109
Medium property	→ 109
Process property	→ 110
Advanced process conditions	→ 111
Level unit	→ 112
Blocking distance	→ 112
Level correction	→ 113
► Linearization	→ 115
Linearization type	→ 117
Unit after linearization	→ 118
Free text	→ 119
Level linearized	→ 120
Maximum value	→ 120
Diameter	→ 120
Intermediate height	→ 121
Table mode	→ 121
Table number	→ 122
Level	→ 122
Level	→ 123
Customer value	→ 123
Activate table	→ 123
► Safety settings	→ 124
Output echo lost	→ 124





Value echo lost	→  124
Ramp at echo lost	→  125
Blocking distance	→  112
▶ WHG confirmation	→  127
▶ Deactivate WHG	→  128
Reset write protection	→  128
Code incorrect	→  128
▶ Probe settings	→  129
Probe grounded	→  129
Present probe length	→  129
Confirm probe length	→  130
▶ Switch output	→  133
Switch output function	→  133
Assign status	→  133
Assign limit	→  134
Assign diagnostic behavior	→  134
Switch-on value	→  135
Switch-on delay	→  136
Switch-off value	→  136
Switch-off delay	→  137
Failure mode	→  137
Switch status	→  137
Invert output signal	→  137
▶ Display	→  139
Language	→  139

Format display	→  139
Value 1 to 4 display	→  141
Decimal places 1 to 4	→  141
Display interval	→  141
Display damping	→  142
Header	→  142
Header text	→  142
Separator	→  143
Number format	→  143
Decimal places menu	→  143
Backlight	→  144
Contrast display	→  144
► Configuration backup display	→  145
Operating time	→  145
Last backup	→  145
Configuration management	→  145
Backup state	→  146
Comparison result	→  146
► Administration	→  148
Define access code	
Device reset	→  148
 Diagnostics	→  151
Actual diagnostics	→  151
Timestamp	→  151
Previous diagnostics	→  151

Timestamp	→  152
Operating time from restart	→  152
Operating time	→  145
▶ Diagnostic list	→  153
Diagnostics 1 to 5	→  153
Timestamp 1 to 5	→  153
▶ Device information	→  155
Device tag	→  155
Serial number	→  155
Firmware version	→  155
Device name	→  155
Order code	→  156
Extended order code 1 to 3	→  156
Status PROFIBUS Master Config	→  156
PROFIBUS ident number	→  156
▶ Measured values	→  157
Distance	→  100
Level linearized	→  120
Terminal voltage 1	→  158
Switch status	→  137
▶ Analog inputs	
▶ Analog input 1 to 6	→  159
Channel	→  105
Out value	→  159



Out status	→ 160
Out status HEX	→ 160
► Data logging	→ 161
Assign channel 1 to 4	→ 161
Logging interval	→ 161
Clear logging data	→ 162
► Simulation	→ 165
Assign measurement variable	→ 166
Value process variable	→ 166
Switch output simulation	→ 166
Switch status	→ 167
Simulation device alarm	→ 167
Simulation diagnostic event	→ 167
► Device check	→ 168
Start device check	→ 168
Result device check	→ 168
Last check time	→ 168
Level signal	→ 169
Launch signal	→ 169
► Heartbeat	→ 170

16.3 "Setup" menu

-   : Indicates how to navigate to the parameter using the display and operating module
-  : Indicates how to navigate to the parameter using operating tools (e.g. FieldCare)
-  : Indicates parameters that can be locked via the access code.

Navigation   Setup



Device tag

Navigation   Setup → Device tag

Description Enter tag for measuring point.

User entry Up to 32 alphanumerical characters

Device address



Navigation   Setup → Device address

Description

- for **Address mode = Software**: Enter bus address.
- for **Address mode = Hardware**: Displays bus address.

User entry 0 to 126

Distance unit



Navigation   Setup → Distance unit

Description Length unit for distance calculation.

Selection

<i>SI units</i>	<i>US units</i>
▪ mm	▪ ft
▪ m	▪ in

Bin type

Navigation   Setup → Bin type

Prerequisite **Medium type** (→  109) = **Solid**

Description Specify bin type.

- Selection**
- Concrete
 - Plastic wood
 - Metallic
 - Aluminium
 - Buffer silo (fast)
 - Bin / Pile
 - Crusher / belt
 - Silo
 - Workbench test

Empty calibration



Navigation Setup → Empty calibr.

Description Distance process connection to min. level.

User entry Depending on the probe

Factory setting Depending on the probe

Additional information

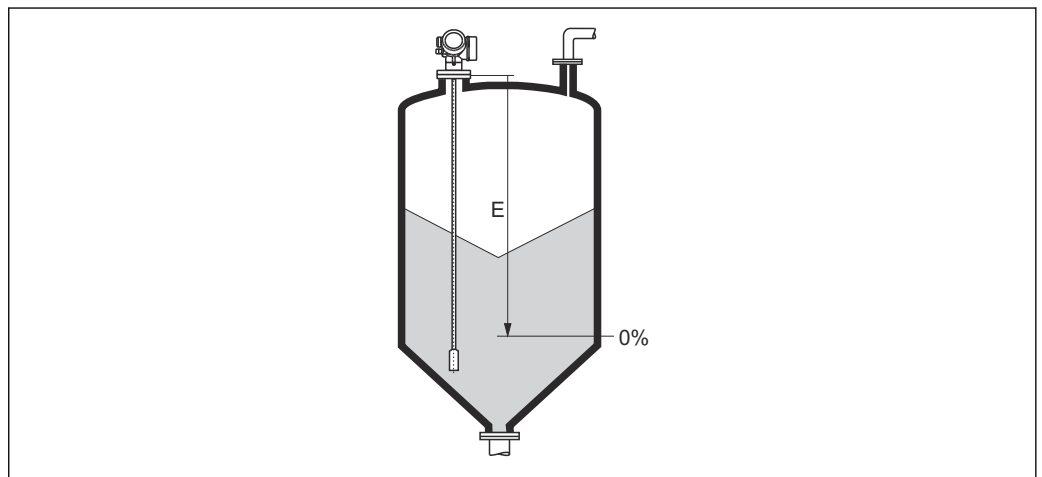

A0013180

37 Empty calibration (E) for level measurements in bulk solids.

Full calibration



Navigation Setup → Full calibr.

Description Span: max. level - min level.

User entry Depending on the probe

Factory setting Depending on the probe

Additional information

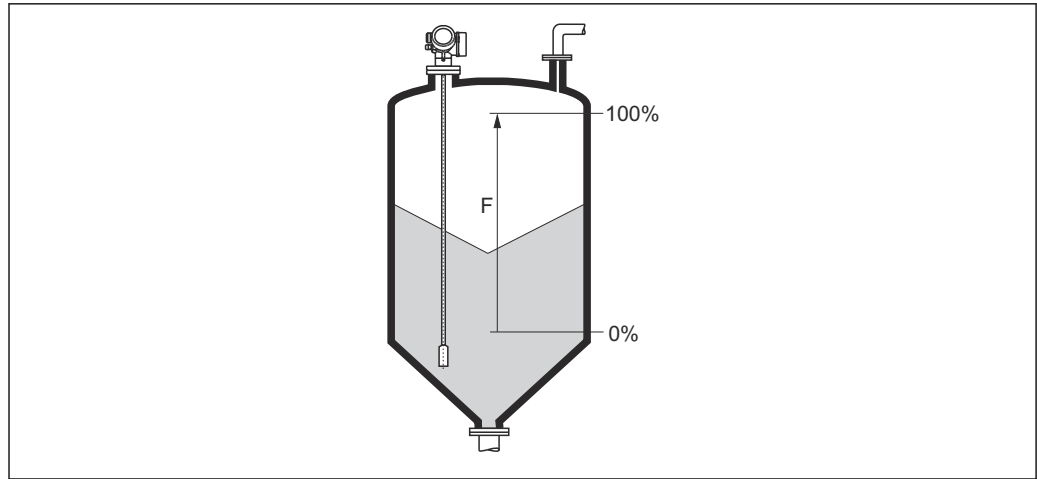

A0013191

38 Full calibration (F) for level measurements in bulk solids

Level

Navigation

☰☰ Setup → Level

Description

Displays measured level L_L (before linearization).

Additional information

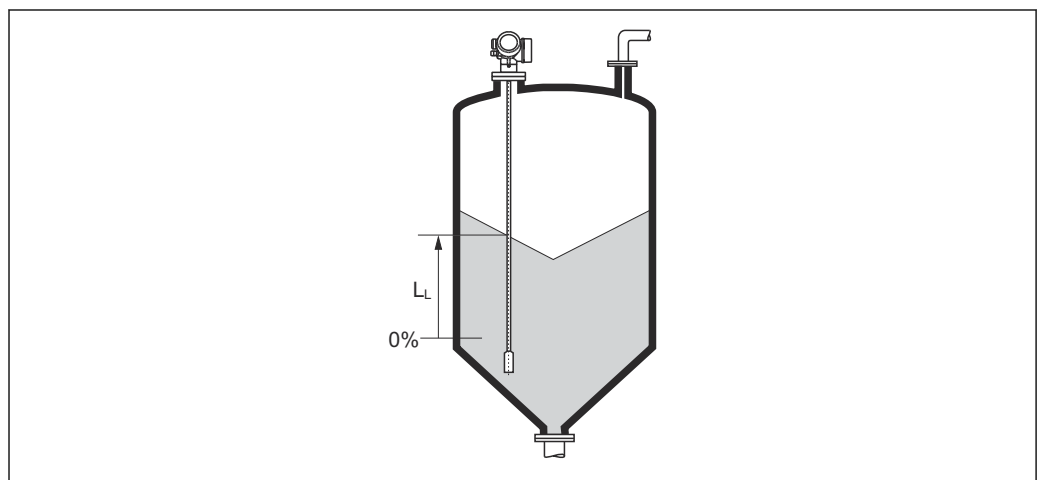

A0013196

39 Level in case of bulk solid measurements

i The unit is defined in the **Level unit** parameter (→ ☰ 112).

Distance

Navigation

☰☰ Setup → Distance

Description

Displays the measured distance D_L between the reference point (lower edge of the flange or threaded connection) and the level.

Additional information

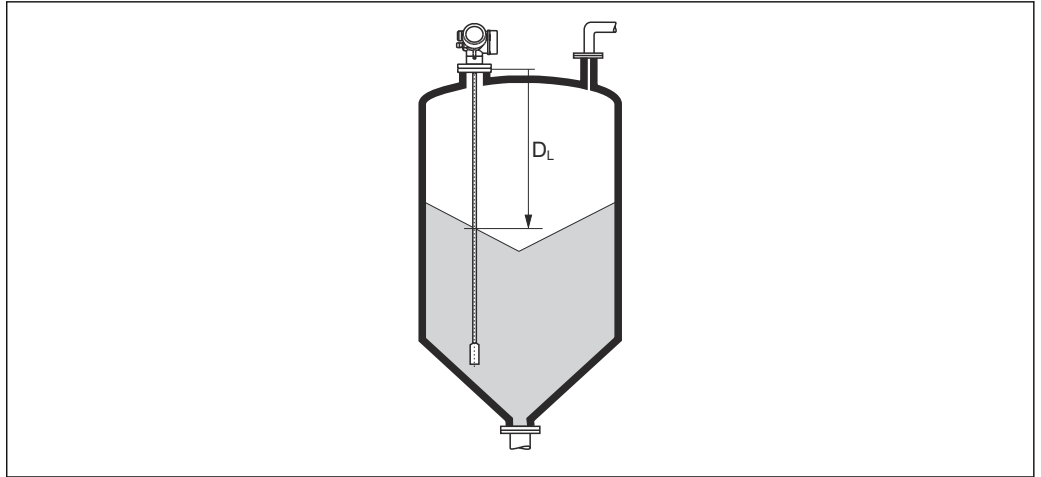

A0013201

40 Distance for bulk solid measurements

The unit is defined in the **Distance unit** parameter (→ 98).

Signal quality

Navigation

Setup → Signal quality

Description

Displays the signal quality of the evaluated echo.

Additional information

Meaning of the display options

- **Strong**
The evaluated echo exceeds the threshold by at least 10 mV.
- **Medium**
The evaluated echo exceeds the threshold by at least 5 mV.
- **Weak**
The evaluated echo exceeds the threshold by less than 5 mV.
- **No signal**
The device does not find a usable echo.

The signal quality indicated in this parameter always refers to the currently evaluated echo: either the level/interface echo ¹⁾ or the end-of-probe echo. To differentiate between these two, the quality of the end-of-probe echo is always displayed in brackets.

In case of a lost echo (**Signal quality = No signal**) the device generates the following error message:

- F941, for **Output echo lost** (→ 124) = **Alarm**.
- S941, if another option has been selected in **Output echo lost** (→ 124).

1) Of these two echos the one with the lower quality is indicated.

Confirm distance
**Navigation**

Setup → Confirm distance

Description

Specify, whether the measured distance matches the real distance.
Depending on the selection the device automatically sets the range of mapping.

Selection

- Manual map
- Distance ok
- Distance unknown
- Distance too small^{*}
- Distance too big^{*}
- Tank empty
- Delete map

Additional information**Meaning of the options**

- **Manual map**
To be selected if the range of mapping is to be defined manually in the **Mapping end point** parameter (→ 103). In this case it is not necessary to confirm the distance.
 - **Distance ok**
To be selected if the measured distance matches the actual distance. The device performs a mapping.
 - **Distance unknown**
To be selected if the actual distance is unknown. A mapping can not be performed in this case.
 - **Distance too small**
To be selected if the measured distance is smaller than the actual distance. The device searches for the next echo and returns to the **Confirm distance** parameter. The distance is recalculated and displayed. The comparison must be repeated until the displayed distance matches the actual distance. After this, the recording of the map can be started by selecting **Distance ok**.
 - **Distance too big²⁾**
To be selected if the measured distance exceeds the actual distance. The device adjusts the signal evaluation and returns to the **Confirm distance** parameter. The distance is recalculated and displayed. The comparison must be repeated until the displayed distance matches the actual distance. After this, the recording of the map can be started by selecting **Distance ok**.
 - **Tank empty**
To be selected if the tank is completely empty. The device records a mapping covering the complete measuring range.
To be selected if the tank is completely empty. The device records a mapping covering the complete measuring range minus **Map gap to LN**.
 - **Factory map**
To be selected if the present mapping curve (if one exists) is to be deleted. The device returns to the **Confirm distance** parameter and a new mapping can be recorded.
- When operating via the display module, the measured distance is displayed together with this parameter for reference purposes.
- If the teaching procedure with the **Distance too small** option or the **Distance too big** option is quit before the distance has been confirmed, a map is **not** recorded and the teaching procedure is reset after 60 s.





* Visibility depends on order options or device settings

2) Only available for "Expert → Sensor → Echo tracking → **Evaluation mode** parameter" = "Short time history" or "Long time history"





Present mapping

Navigation	 Setup → Present mapping
Description	Indicates up to which distance a mapping has already been recorded.



Mapping end point

Navigation	 Setup → Map. end point
Prerequisite	Confirm distance (→  102) = Manual map or Distance too small
Description	Specify new end of the mapping.
User entry	0 to 200 000.0 m
Additional information	<p>This parameter defines up to which distance the new mapping is to be recorded. The distance is measured from the reference point, i.e. from the lower edge of the mounting flange or the threaded connection.</p> <p> For reference purposes the Present mapping parameter (→  103) is displayed together with this parameter. It indicates up to which distance a mapping has already been recorded.</p>

Record map

Navigation	 Setup → Record map
Prerequisite	Confirm distance (→  102) = Manual map or Distance too small
Description	Start recording of the map.
Selection	<ul style="list-style-type: none"> ■ No ■ Record map ■ Delete map
Additional information	<p>Meaning of the options</p> <ul style="list-style-type: none"> ■ No The map is not recorded. ■ Record map The map is recorded. After the recording is completed, the new measured distance and the new mapping range appear on the display. When operating via the local display, these values must be confirmed by pressing . ■ Delete map The mapping (if one exists) is deleted and the device displays the recalculated measured distance and the mapping range. When operating via the local display, these values must be confirmed by pressing .

16.3.1 "Mapping" wizard

 The **Mapping** wizard is only available when operating via the local display. When operating via an operating tool, all parameters concerning the mapping are located directly in the **Setup** menu (→  98).

 In the **Mapping** wizard two parameters are displayed simultaneously on the display module at any one time. The upper parameter can be edited, whereas the lower parameter is displayed for reference purposes only.

Navigation  Setup → Mapping

Confirm distance

Navigation  Setup → Mapping → Confirm distance

Description →  102

Mapping end point

Navigation  Setup → Mapping → Map. end point

Description →  103

Record map

Navigation  Setup → Mapping → Record map

Description →  103

Distance

Navigation  Setup → Mapping → Distance





Description →  100



16.3.2 "Analog input 1 to 6" submenu

 There is an **Analog input** submenu for each AI block of the device. The AI block is used to configure the measured value transmission to the bus.

Only the most basic properties of the AI blocks can be configured in this submenu. For a detailed configuration of the AI blocks refer to Expert → Analog inputs → Analog input 1 to 6.

Navigation  Expert → Analog inputs → Analog input 1 to 6

Channel	
Navigation	  Expert → Analog inputs → Analog input 1 to 6 → Channel
Description	Standard parameter CHANNEL of the Analog Input Block according to the PROFIBUS Profile.
Selection	<ul style="list-style-type: none"> ■ Level linearized ■ Distance ■ Interface linearized * ■ Interface distance * ■ Thickness upper layer * ■ Terminal voltage ■ Electronic temperature ■ Measured capacitance * ■ Absolute echo amplitude ■ Relative echo amplitude ■ Absolute interface amplitude * ■ Relative interface amplitude * ■ Absolute EOP amplitude ■ Noise of signal ■ EOP shift ■ Calculated DC value * ■ Sensor debug ■ Analog output adv. diagnostics 1 ■ Analog output adv. diagnostics 2
Additional information	Allocates a measured value to the AI block.
PV filter time	

Navigation	  Expert → Analog inputs → Analog input 1 to 6 → PV filter time
Description	Standard parameter PV_FTIME of the Analog Input Block according to the PROFIBUS profile.
User entry	Positive floating-point number

* Visibility depends on order options or device settings

Additional information This parameter defines the damping constant τ (in seconds) for the output of the Analog Input Block.

Fail safe type

Navigation   Expert → Analog inputs → Analog input 1 to 6 → Fail safe type

Description Standard parameter **FSAFE_TYPE** of the Analog Input Block according to the PROFIBUS profile.

Selection

- Fail safe value
- Fallback value
- Off

Additional information **Meaning of the options**
This parameter specifies the output value of the Analog Input block in the event of an error.

- **Fail safe value**
The output value in the event of an error is defined in the **Fail safe value** parameter (→  106).
- **Fallback value**
The last output value that was valid before the error occurred is retained.
- **Off**
The output value follows the current measured value. The status is set to BAD.

Fail safe value

Navigation   Expert → Analog inputs → Analog input 1 to 6 → Fail safe value

Prerequisite **Fail safe type (→  106) = Fail safe value**

Description Standard parameter **FSAFE_VALUE** of the Analog Input Block according to the PROFIBUS profile.





User entry Signed floating-point number

Additional information This parameter defines the output value of the Analog Input Block in case of an error.





16.3.3 "Advanced setup" submenu

Navigation  Setup → Advanced setup





Locking status

Navigation	  Setup → Advanced setup → Locking status
Description	Indicates the write protection with the highest priority that is currently active.
User interface	<ul style="list-style-type: none"> ▪ Hardware locked ▪ SIL locked ▪ WHG locked ▪ Temporarily locked
Additional information	<p>Meaning and priorities of the types of write protection</p> <ul style="list-style-type: none"> ▪ Hardware locked (priority 1) The DIP switch for hardware locking is activated on the main electronics module. This locks write access to the parameters. ▪ SIL locked (priority 2) The SIL mode is activated. Writing access to the relevant parameters is denied. ▪ WHG locked (priority 3) The WHG mode is activated. Writing access to the relevant parameters is denied. ▪ Temporarily locked (priority 4) Write access to the parameters is temporarily locked on account of internal processes in progress in the device (e.g. data upload/download, reset etc.). The parameters can be modified as soon as the processes are complete. <p> On the display module, the -symbol appears in front of parameters that cannot be modified since they are write-protected.</p>





Access status tooling

Navigation	 Setup → Advanced setup → Access stat.tool
Description	Shows the access authorization to the parameters via the operating tool.
Additional information	<p> The access authorization can be changed via the Enter access code parameter (→  108).</p> <p> If additional write protection is active, this restricts the current access authorization even further. The write protection status can be viewed via the Locking status parameter (→  107).</p>

Access status display

Navigation	 Setup → Advanced setup → Access stat.disp
Prerequisite	The device has a local display.
Description	Indicates access authorization to parameters via local display.
Additional information	<p> The access authorization can be changed via the Enter access code parameter (→  108).</p> <p> If additional write protection is active, this restricts the current access authorization even further. The write protection status can be viewed via the Locking status parameter (→  107).</p>



Enter access code

Navigation	 Setup → Advanced setup → Ent. access code
Description	Enter access code to disable write protection of parameters.
User entry	0 to 9999
Additional information	<ul style="list-style-type: none"> ▪ The customer-specific access code that was defined in the Define access code parameter (→  148) must be entered for local operation. ▪ If an incorrect access code is entered, users retain their current access authorization. ▪ The write protection affects all parameters marked with the  symbol in the document. On the local display, the  symbol in front of a parameter indicates that the parameter is write-protected. ▪ If no key is pressed for 10 minutes or the user goes from the navigation and editing mode back to the measured value display mode, the device automatically locks the write-protected parameters after another 60 s. <p> Please contact your Endress+Hauser Sales Center if you lose your access code.</p>



"Level" submenu

Navigation  Setup → Advanced setup → Level

Medium type 

Navigation	 Setup → Advanced setup → Level → Medium type
Description	Specify type of medium.
User interface	<ul style="list-style-type: none"> ■ Liquid ■ Solid
Factory setting	FMP56, FMP57: Solid
Additional information	 This parameter determines the value of several other parameters and strongly influences the complete signal evaluation. Therefore, it is strongly recommended not to change the factory setting.

Medium property 

Navigation	 Setup → Advanced setup → Level → Medium property
Prerequisite	EOP level evaluation ≠ Fix DC
Description	Specify the dielectric constant ϵ_r of the medium.
Selection	<ul style="list-style-type: none"> ■ Unknown ■ DC 1.4 ... 1.6 ■ DC 1.6 ... 1.9 ■ DC 1.9 ... 2.5 ■ DC 2.5 ... 4 ■ DC 4 ... 7 ■ DC 7 ... 15 ■ DC > 15
Factory setting	Depends on the Medium type (→  109) and Medium group parameters.

Additional information *Dependency of "Medium type" and "Medium group"*

Medium type (→ ⓘ 109)	Medium group	Medium property
Solid		Unknown
Liquid	Water based (DC >= 4)	DC 4 ... 7
	Others	Unknown

i For the relative permittivity values (ϵ_r values) of many media commonly used in industry, please refer to:

- Relative permittivity (ϵ_r value), Compendium CP01076F
- The Endress+Hauser "DC Values app" (available for Android and iOS)

i If **EOP level evaluation = Fix DC**, the exact dielectric constant must be specified in the **DC value** parameter. The **Medium property** parameter therefore does not apply in this case.

Process property



Navigation Setup → Advanced setup → Level → Process property

Description Specify typical rate of level change.

- Selection**
- For "Medium type" = "Liquid"**
- Very fast > 10 m (400 in)/min
 - Fast > 1 m (40 in)/min
 - Standard < 1 m (40in) /min
 - Medium < 10 cm (4in) /min
 - Slow < 1 cm (0.4in) /min
 - No filter / test
- For "Medium type" = "Solid"**
- Very fast > 100 m (333 ft) /h
 - Fast > 10 m (33 ft) /h
 - Standard < 10 m (33 ft) /h
 - Medium < 1 m (3ft) /h
 - Slow < 0.1 m (0.3ft) /h
 - No filter / test

Additional information The device adjusts the signal evaluation filters and the damping of the output signal to the typical rate of level change defined in this parameter:

For "Operating mode" = "Level" and "Medium type" = "Liquid"

Process property	Step response time / s
Very fast > 10 m (400 in)/min	5
Fast > 1 m (40 in)/min	5
Standard < 1 m (40in) /min	14
Medium < 10 cm (4in) /min	39
Slow < 1 cm (0.4in) /min	76
No filter / test	< 1

For "Operating mode" = "Level" and "Medium type" = "Solid"

Process property	Step response time / s
Very fast > 100 m (333 ft) /h	37
Fast > 10 m (33 ft) /h	37
Standard < 10 m (33 ft) /h	74
Medium < 1 m (3ft) /h	146
Slow < 0.1 m (0.3ft) /h	290
No filter / test	< 1

For "Operating mode" = "Interface" or "Interface with capacitance"

Process property	Step response time / s
Very fast > 10 m (400 in)/min	5
Fast > 1 m (40 in)/min	5
Standard < 1 m (40in) /min	23
Medium < 10 cm (4in) /min	47
Slow < 1 cm (0.4in) /min	81
No filter / test	2.2

Advanced process conditions



Navigation

Setup → Advanced setup → Level → Adv. conditions

Description

Specify additional process conditions (if required).

Selection

- None
- Oil/Water condensate
- Probe near tank bottom
- Build up
- Foam (>5cm/0,16ft)

Additional information

Meaning of the options

- **Oil/Water condensate** (only **Medium type** = **Liquid**)
Makes sure that in the case of two-phase media only the total level is detected (example: oil/condensate application).
- **Probe near tank bottom** (only for **Medium type** = **Liquid**)
Improves the empty detection, especially if the probe is mounted close to the tank bottom.
- **Build up**
Increases **EOP range upper area** in order to ensure a safe empty-detection even if the end-of-probe signal has shifted due to build-up.
Enables a safe empty-detection even if the end-of-probe signal has shifted due to build-up.
- **Foam (>5cm/0,16ft)** (only for **Medium type** = **Liquid**)
Optimizes the signal evaluation in applications with foam formation.

Level unit



Navigation  Setup → Advanced setup → Level → Level unit

Description Select level unit.

Selection

<i>SI units</i>	<i>US units</i>
■ %	■ ft
■ m	■ in
■ mm	

Additional information The level unit may differ from the distance unit defined in the **Distance unit** parameter (→  98):

- The unit defined in the **Distance unit** parameter is used for the basic calibration (**Empty calibration** (→  99) and **Full calibration** (→  99)).
- The unit defined in the **Level unit** parameter is used to display the (unlinearized) level.

Blocking distance

Navigation  Setup → Advanced setup → Level → Blocking dist.

Description Specify upper blocking distance UB.

User entry 0 to 200 m

Factory setting

- For rod and rope probes up to 8 m (26 ft): 200 mm (8 in)
- For rod and rope probes above 8 m (26 ft): 0.025 * Sondenlänge

Additional information Signals in the upper blocking distance are only evaluated if they have been outside the blocking distance when the device was switched on and move into the blocking distance due to a level change during operation. Signals which are already in the blocking distance when the device is switched on, are ignored.

-  This behavior is only valid if the following two conditions are met:
- Expert → Sensor → Echo tracking → Evaluation mode = **Short time history** or **Long time history**)
 - Expert → Sensor → Gas phase compensation → GPC mode= **On, Without correction** or **External correction**

If one of these conditions is not met, signals in the blocking distance will always be ignored.

-  A different behavior for signals in the blocking distance can be defined in the **Blocking distance evaluation mode** parameter.

-  If required, a different behavior for signals in the blocking distance can be defined by the Endress+Hauser service.

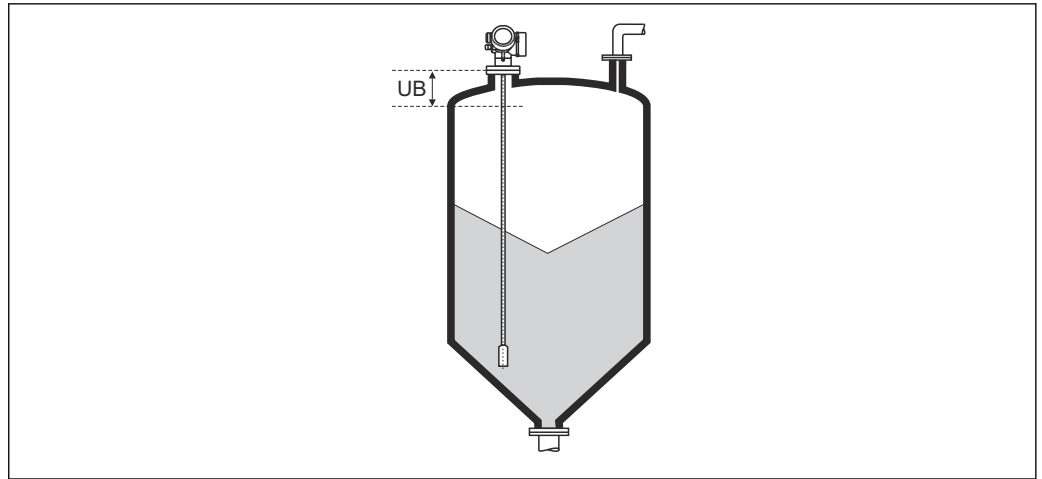

A0013221

41 Blocking distance (UB) for bulk solid measurements

Level correction



Navigation

Setup → Advanced setup → Level → Level correction

Description

Specify level correction (if required).

User entry

-200 000.0 to 200 000.0 %

Additional information

The value specified in this parameter is added to the measured level (before linearization).

"Linearization" submenu

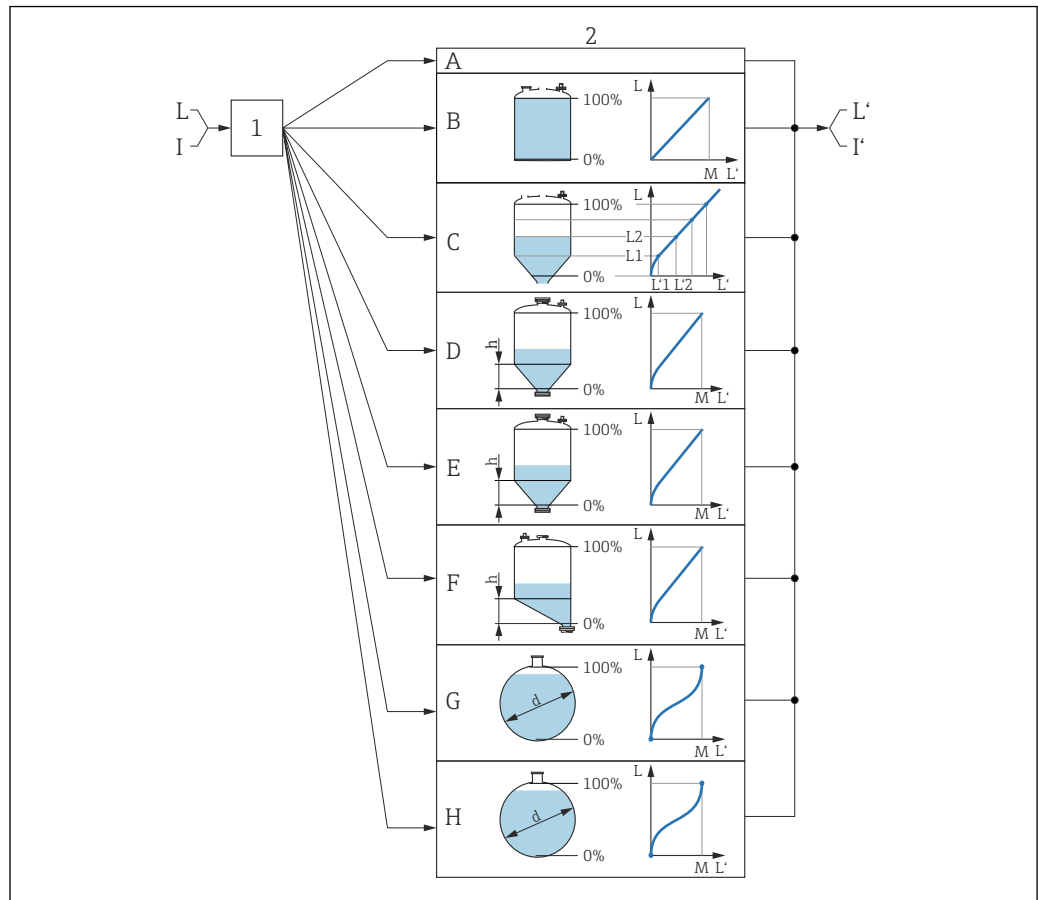

A0016084

42 Linearization: Conversion of the level and, if applicable, interface into a volume or a weight; the conversion depends on the vessel shape

- 1 Selection of linearization type and unit
- 2 Configuration of the linearization
- A Linearization type (→ 117) = None
- B Linearization type (→ 117) = Linear
- C Linearization type (→ 117) = Table
- D Linearization type (→ 117) = Pyramid bottom
- E Linearization type (→ 117) = Conical bottom
- F Linearization type (→ 117) = Angled bottom
- G Linearization type (→ 117) = Horizontal cylinder
- H Linearization type (→ 117) = Sphere
- I For "Operating mode" = "Interface" or "Interface with capacitance": interface before linearization (measured in the level unit)
- I' For "Operating mode" = "Interface" or "Interface with capacitance": interface after linearization (corresponds to volume or weight)
- L Level before linearization (measured in level unit)
- L' Level linearized (→ 120) (corresponds to volume or weight)
- M Maximum value (→ 120)
- d Diameter (→ 120)
- h Intermediate height (→ 121)

Structure of the submenu on the local display

Navigation  Setup → Advanced setup → Linearization

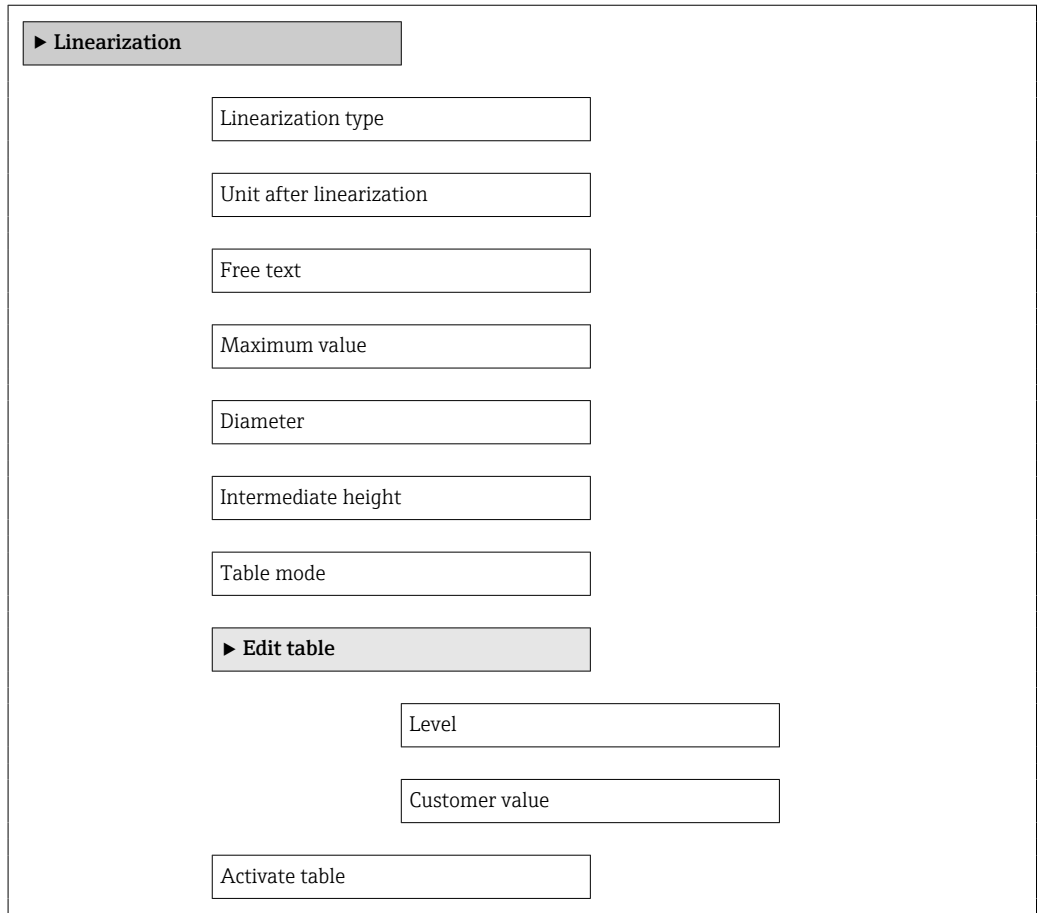

► **Linearization**

Linearization type

Unit after linearization

Free text

Maximum value

Diameter

Intermediate height

Table mode

► **Edit table**

Level

Customer value

Activate table

Structure of the submenu in the operating tool (e.g. FieldCare)

Navigation  Setup → Advanced setup → Linearization

► Linearization

Linearization type

Unit after linearization

Free text

Level linearized

Maximum value

Diameter

Intermediate height

Table mode

Table number

Level

Level

Customer value

Activate table

Description of the parameters

Navigation  Setup → Advanced setup → Linearization

Linearization type 

Navigation  Setup → Advanced setup → Linearization → Lineariz. type

Description Select linearization type.

- Selection**
- None
 - Linear
 - Table
 - Pyramid bottom
 - Conical bottom
 - Angled bottom
 - Horizontal cylinder
 - Sphere

Additional information

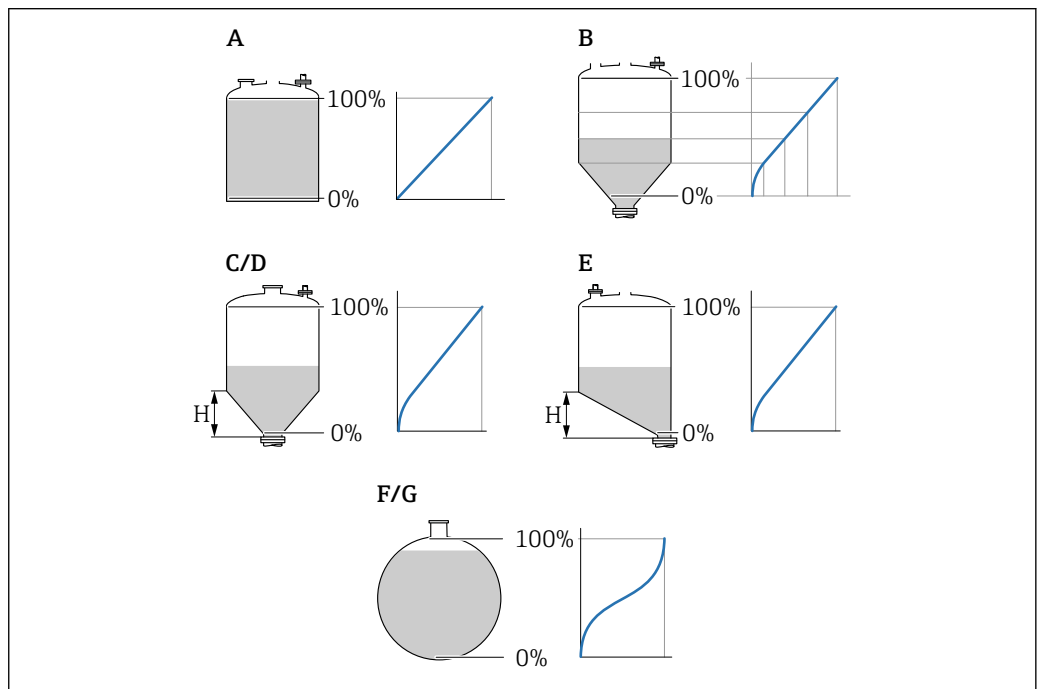

A0021476

 43 *Linearization types*

- A None
- B Table
- C Pyramid bottom
- D Conical bottom
- E Angled bottom
- F Sphere
- G Horizontal cylinder

Meaning of the options

- **None**

The level is output in the level unit without being converted (linearized) beforehand.

- **Linear**

The output value (volume/weight) is proportional to the level L. This applies, for example, to vertical cylindrical tanks and silos. The following parameters must also be specified:

- **Unit after linearization** (→  118)

- **Maximum value** (→  120): maximum volume or weight

- **Table**

The relationship between the measured level L and the output value (volume/weight) is defined by a linearization table consisting of up to 32 pairs of values "level - volume" or "level - weight" respectively. The following parameters must also be specified:

- **Unit after linearization** (→  118)

- **Table mode** (→  121)

- For every point in the table: **Level** (→  122)

- For every point in the table: **Customer value** (→  123)

- **Activate table** (→  123)

- **Pyramid bottom**

The output value corresponds to the volume or weight in a silo with a pyramid bottom.

The following parameters must also be specified:

- **Unit after linearization** (→  118)

- **Maximum value** (→  120): maximum volume or weight

- **Intermediate height** (→  121): the height of the pyramid

- **Conical bottom**

The output value corresponds to the volume or weight in a tank with a conical bottom.

The following parameters must also be specified:

- **Unit after linearization** (→  118)

- **Maximum value** (→  120): maximum volume or weight

- **Intermediate height** (→  121): the height of the cone

- **Angled bottom**

The output value corresponds to the volume or weight in a silo with an angled bottom.

The following parameters must also be specified:

- **Unit after linearization** (→  118)

- **Maximum value** (→  120): maximum volume or weight

- **Intermediate height** (→  121): height of the angled bottom

- **Horizontal cylinder**

The output value corresponds to the volume or weight in a horizontal cylinder. The following parameters must also be specified:

- **Unit after linearization** (→  118)

- **Maximum value** (→  120): maximum volume or weight

- **Diameter** (→  120)

- **Sphere**



The output value corresponds to the volume or weight in a spherical tank. The following parameters must also be specified:

- **Unit after linearization** (→  118)

- **Maximum value** (→  120): maximum volume or weight







- **Diameter** (→  120)

Unit after linearization
**Navigation**

  Setup → Advanced setup → Linearization → Unit lineariz.

Prerequisite

Linearization type (→  117) ≠ None

Description	Select the unit for the linearized value.
Selection	<p>Selection/input (uint16)</p> <ul style="list-style-type: none"> ■ 1095 = [short Ton] ■ 1094 = [lb] ■ 1088 = [kg] ■ 1092 = [Ton] ■ 1048 = [US Gal.] ■ 1049 = [Imp. Gal.] ■ 1043 = [ft³] ■ 1571 = [cm³] ■ 1035 = [dm³] ■ 1034 = [m³] ■ 1038 = [l] ■ 1041 = [hl] ■ 1342 = [%] ■ 1010 = [m] ■ 1012 = [mm] ■ 1018 = [ft] ■ 1019 = [inch] ■ 1351 = [l/s] ■ 1352 = [l/min] ■ 1353 = [l/h] ■ 1347 = [m³/s] ■ 1348 = [m³/min] ■ 1349 = [m³/h] ■ 1356 = [ft³/s] ■ 1357 = [ft³/min] ■ 1358 = [ft³/h] ■ 1362 = [US Gal./s] ■ 1363 = [US Gal./min] ■ 1364 = [US Gal./h] ■ 1367 = [Imp. Gal./s] ■ 1358 = [Imp. Gal./min] ■ 1359 = [Imp. Gal./h] ■ 32815 = [ML/s] ■ 32816 = [ML/min] ■ 32817 = [ML/h] ■ 1355 = [ML/d]
Additional information	<p>The selected unit is only used for display purposes. The measured value is not converted on the basis of the selected unit.</p> <p> Distance-to-distance linearization is also possible, i.e. a linearization from the level unit to another length unit. Select the Linear linearization mode for this purpose. To specify the new level unit, select the Free text option in the Unit after linearization parameter and enter the unit in the Free text parameter (→  119).</p>
Free text	
Navigation	  Setup → Advanced setup → Linearization → Free text
Prerequisite	Unit after linearization (→  118) = Free text
Description	Enter unit symbol.

User entry Up to 32 alphanumerical characters (letters, numbers, special characters)

Level linearized

Navigation  Setup → Advanced setup → Linearization → Level linearized

Description Displays linearized level.

Additional information  This unit is defined by the **Unit after linearization** parameter.

Maximum value



Navigation   Setup → Advanced setup → Linearization → Maximum value



Prerequisite **Linearization type** (→  117) has one of the following values:

- Linear
- Pyramid bottom
- Conical bottom
- Angled bottom
- Horizontal cylinder
- Sphere

User entry -50 000.0 to 50 000.0 %

Diameter



Navigation   Setup → Advanced setup → Linearization → Diameter

Prerequisite **Linearization type** (→  117) has one of the following values:

- Horizontal cylinder
- Sphere

User entry 0 to 9 999.999 m

Additional information The unit is defined in the **Distance unit** parameter (→  98).

Intermediate height
**Navigation**

Setup → Advanced setup → Linearization → Intermed. height

Prerequisite
Linearization type (→ 117) has one of the following values:

- Pyramid bottom
- Conical bottom
- Angled bottom

User entry

0 to 200 m

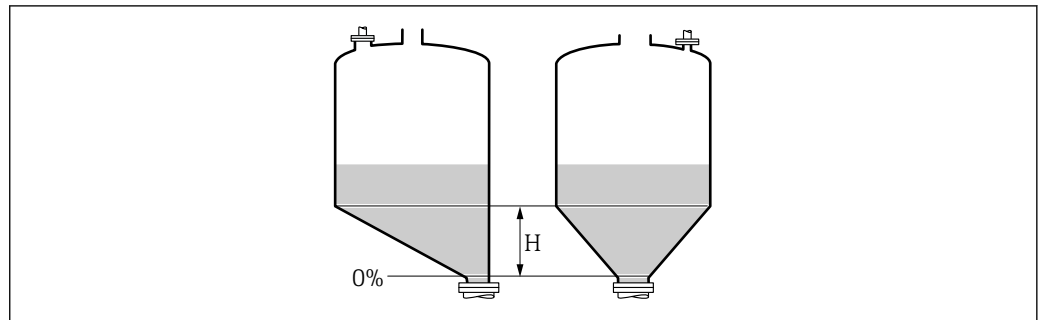
Additional information

A0013264

H Intermediate height

 The unit is defined in the **Distance unit** parameter (→ 98).

Table mode
**Navigation**

Setup → Advanced setup → Linearization → Table mode

Prerequisite
Linearization type (→ 117) = Table
Description

Select editing mode of the linearization table.

Selection

- Manual
- Semiautomatic *
- Clear table
- Sort table



Additional information**Meaning of the options**

- **Manual**
The level and the associated linearized value are entered manually for each linearization point.
- **Semiautomatic**
The level is measured by the device for each linearization point. The associated linearized value is entered manually.
- **Clear table**
Deletes the existing linearization table.
- **Sort table**
Rearranges the linearization points into an ascending order.

 * Visibility depends on order options or device settings



Conditions the linearization table must meet:

- The table may consist of up to 32 pairs of values "Level - Linearized Value".
- The table must be monotonic (monotonically increasing or decreasing).
- The first linearization point must refer to the minimum level.
- The last linearization point must refer to the maximum level.

 Before entering a linearization table, the values for **Empty calibration** (→  99) and **Full calibration** (→  99) must be set correctly.

If values of the table need to be changed after the full or empty calibration have been changed, a correct evaluation is only ensured if the existing table is deleted and the complete table is entered again. To do so delete the existing table (**Table mode** (→  121) = **Clear table**). Then enter a new table.

How to enter the table

- Via FieldCare
The table points can be entered via the **Table number** (→  122), **Level** (→  122) and **Customer value** (→  123) parameters. As an alternative, the graphic table editor may be used: Device Operation → Device Functions → Additional Functions → Linearization (Online/Offline)
- Via local display
Select the **Edit table** submenu to call up the graphic table editor. The table is displayed and can be edited line by line.









 The factory setting for the level unit is "%". If you want to enter the linearization table in physical units, you must select the appropriate unit in the **Level unit** parameter (→  112) beforehand.



Table number 

Navigation	 Setup → Advanced setup → Linearization → Table number
Prerequisite	Linearization type (→  117) = Table
Description	Select table point you are going to enter or change.
User entry	1 to 32



Level (Manual) 

Navigation	 Setup → Advanced setup → Linearization → Level
Prerequisite	<ul style="list-style-type: none"> ■ Linearization type (→  117) = Table ■ Table mode (→  121) = Manual
Description	Enter level value of the table point (value before linearization).
User entry	Signed floating-point number





Level (Semiautomatic)

Navigation	 Setup → Advanced setup → Linearization → Level
Prerequisite	<ul style="list-style-type: none"> ▪ Linearization type (→  117) = Table ▪ Table mode (→  121) = Semiautomatic
Description	Displays measured level (value before linearization). This value is transmitted to the table.

Customer value

Navigation	 Setup → Advanced setup → Linearization → Customer value
Prerequisite	Linearization type (→  117) = Table
Description	Enter linearized value for the table point.
User entry	Signed floating-point number



Activate table

Navigation	  Setup → Advanced setup → Linearization → Activate table
Prerequisite	Linearization type (→  117) = Table
Description	Activate (enable) or deactivate (disable) the linearization table.
Selection	<ul style="list-style-type: none"> ▪ Disable ▪ Enable
Additional information	<p>Meaning of the options</p> <ul style="list-style-type: none"> ▪ Disable The measured level is not linearized. If Linearization type (→  117) = Table at the same time, the device issues error message F435. ▪ Enable The measured level is linearized according to the table. <p> When editing the table, the Activate table parameter is automatically reset to Disable and must be reset to Enable after the table has been entered.</p>





"Safety settings" submenu

Navigation  Setup → Advanced setup → Safety sett.

Output echo lost 

Navigation	 Setup → Advanced setup → Safety sett. → Output echo lost
Description	Output signal in case of a lost echo.
Selection	<ul style="list-style-type: none"> ■ Last valid value ■ Ramp at echo lost ■ Value echo lost ■ Alarm
Additional information	<p>Meaning of the options</p> <ul style="list-style-type: none"> ■ Last valid value The last valid value is kept in the case of a lost echo. ■ Ramp at echo lost³⁾ In the case of a lost echo the output value is continuously shifted towards 0% or 100%. The slope of the ramp is defined in the Ramp at echo lost parameter (→  125). ■ Value echo lost³⁾ In the case of a lost echo the output assumes the value defined in the Value echo lost parameter (→  124). ■ Alarm In the case of a lost echo the device generates an alarm; see the Failure mode parameter

Value echo lost 

Navigation	 Setup → Advanced setup → Safety sett. → Value echo lost
Prerequisite	Output echo lost (→  124) = Value echo lost
Description	Output value in case of a lost echo
User entry	0 to 200 000.0 %
Additional information	<p>Use the unit which has been defined for the measured value output:</p> <ul style="list-style-type: none"> ■ without linearization: Level unit (→  112) ■ with linearization: Unit after linearization (→  118)

³⁾ Only visible if "Linearization type" (→  117) = "None"

Ramp at echo lost



Navigation	Setup → Advanced setup → Safety sett. → Ramp echo lost
Prerequisite	Output echo lost (→ 124) = Ramp at echo lost
Description	Slope of the ramp in the case of a lost echo
User entry	Signed floating-point number
Additional information	

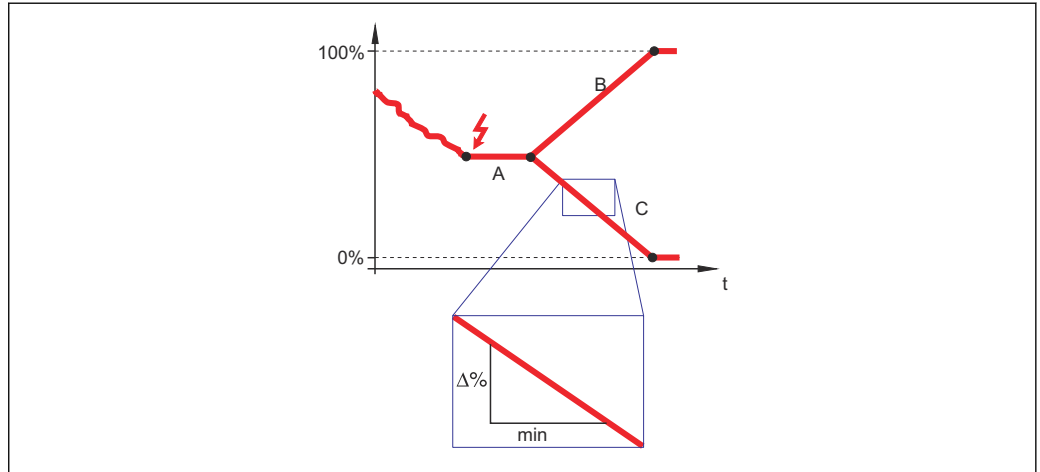

A0013269

- A Delay time echo lost
 B Ramp at echo lost (→ 125) (positive value)
 C Ramp at echo lost (→ 125) (negative value)

- The unit for the slope of the ramp is "percentage of the measuring range per minute" (%/min).
- For a negative slope of the ramp: The measured value is continuously decreased until it reaches 0%.
- For a positive slope of the ramp: The measured value is continuously increased until it reaches 100%.

Blocking distance



Navigation	Setup → Advanced setup → Safety sett. → Blocking dist.
Description	Specify upper blocking distance UB.
User entry	0 to 200 m
Factory setting	<ul style="list-style-type: none"> ■ For rod and rope probes up to 8 m (26 ft): 200 mm (8 in) ■ For rod and rope probes above 8 m (26 ft): 0.025 * Sondenlänge
Additional information	Signals in the upper blocking distance are only evaluated if they have been outside the blocking distance when the device was switched on and move into the blocking distance

due to a level change during operation. Signals which are already in the blocking distance when the device is switched on, are ignored.

- i** This behavior is only valid if the following two conditions are met:
- Expert → Sensor → Echo tracking → Evaluation mode = **Short time history** or **Long time history**)
 - Expert → Sensor → Gas phase compensation → GPC mode= **On, Without correction** or **External correction**

If one of these conditions is not met, signals in the blocking distance will always be ignored.

- i** A different behavior for signals in the blocking distance can be defined in the **Blocking distance evaluation mode** parameter.

- i** If required, a different behavior for signals in the blocking distance can be defined by the Endress+Hauser service.

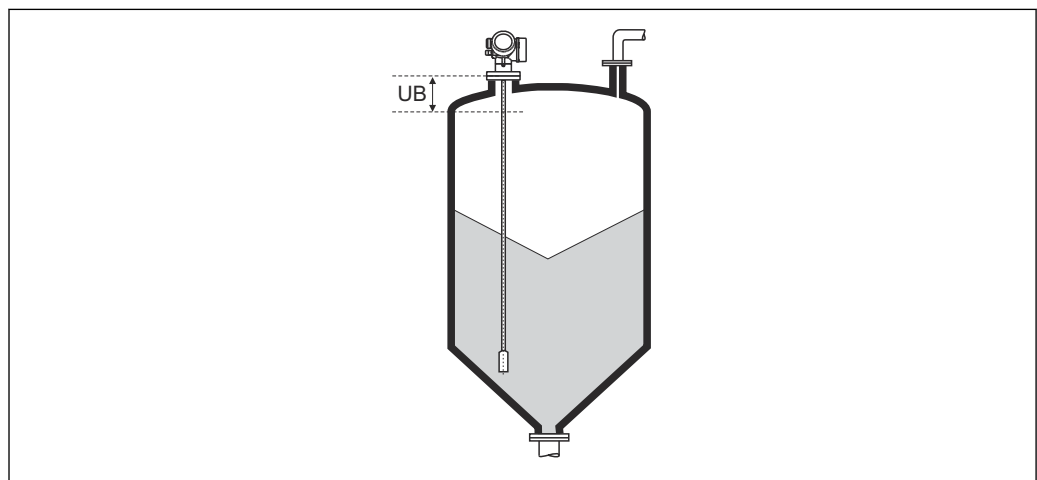

A0013221

i 44 Blocking distance (UB) for bulk solid measurements



"WHG confirmation" wizard

 The **WHG confirmation** wizard is only available for devices with WHG approval (Feature 590: "Additional Approval", option LC: "WHG overfill prevention") which are currently not in the WHG-locked state.

The **WHG confirmation** wizard is used to lock the device according to WHG. For details refer to the "Functional Safety Manual" of the respective device, which describes the locking procedure and the parameters of the sequence.

Navigation  Setup → Advanced setup → WHG confirmation

"Deactivate WHG" wizard

 The **Deactivate WHG** wizard (→  128) is only visible if the device is WHG-locked. For details refer to the "Functional Safety Manual" of the respective device.

Navigation  Setup → Advanced setup → Deactivate WHG

Reset write protection 

Navigation  Setup → Advanced setup → Deactivate WHG → Res. write prot.

Description Enter unlocking code.

User entry 0 to 65 535

Code incorrect 

Navigation  Setup → Advanced setup → Deactivate WHG → Code incorrect







Description Indicates that a wrong unlocking code has been entered. Select procedure.



Selection



- Reenter code
- Abort sequence



"Probe settings" submenu

The **Probe settings** submenu helps to ensure that the device correctly assigns the end of probe signal within the envelope curve. The assignment is correct if the length of probe indicated by the device matches the actual length of the probe. The automatic probe length correction can only be performed if the probe is installed in the vessel and is completely uncovered (no medium) over the entire length. For partially filled vessels and if the probe length is known, select **Confirm probe length** (→  130) = **Manual input** to enter the value manually.

-  If a mapping has been recorded after shortening the probe, it is no longer possible to perform an automatic probe length correction. There are two options if this occurs:
 - First delete the mapping curve using the **Record map** parameter (→  103) and the probe length correction can then be performed. After the probe length correction, a new mapping curve can be recorded using the **Record map** parameter (→  103).
 - Alternatively, select **Confirm probe length** (→  130) = **Manual input** and manually enter the probe length in the **Present probe length** parameter.
-  An automatic probe length correction is only possible after the correct option has been selected in the **Probe grounded** parameter (→  129).

Navigation   Setup → Advanced setup → Probe settings

Probe grounded	
<hr/>	
Navigation	  Setup → Advanced setup → Probe settings → Probe grounded
Prerequisite	Operating mode = Level
Description	Specify whether the probe is grounded.
Selection	<ul style="list-style-type: none"> ▪ No ▪ Yes

Present probe length	
<hr/>	
Navigation	 Setup → Advanced setup → Probe settings → Pres. length
Description	<ul style="list-style-type: none"> ▪ In most cases: Displays the length of the probe according to the currently measured end-of-probe signal. ▪ For Confirm probe length (→  130) = Manual input: Enter actual length of probe.
User entry	0 to 200 m

Confirm probe length
**Navigation**

Setup → Advanced setup → Probe settings → Confirm length

Description

Specify whether the value displayed in the **Present probe length** parameter matches the actual length of the probe. Based on this input, the device performs a probe length correction.

Selection

- Probe length OK
- Probe length too small
- Probe length too big
- Probe covered
- Manual input
- Probe length unknown

Additional information**Meaning of the options**

- **Probe length OK**
To be selected if the correct probe length is displayed. A correction is not required. The device exits the sequence.
- **Probe length too small**
To be selected if the displayed length is less than the actual probe length. A different end of probe signal is allocated and the newly calculated length is displayed in the **Present probe length** parameter. This procedure has to be repeated until the displayed value matches the actual length of the probe.
- **Probe length too big**
To be selected if the displayed length is greater than the actual probe length. A different end of probe signal is allocated and the newly calculated length is displayed in the **Present probe length** parameter. This procedure has to be repeated until the displayed value matches the actual length of the probe.
- **Probe covered**
To be selected if the probe is (partially or completely) covered. A probe length correction is impossible in this case.
- **Manual input**
To be selected if no automatic probe length correction is to be performed. Instead, the actual length of the probe must be entered manually in the **Present probe length** parameter. ⁴⁾
- **Probe length unknown**
To be selected if the actual probe length is unknown. A probe length correction is impossible in this case.

4) When operating via FieldCare, the **Manual input** option does not need to be selected explicitly; manual editing of the probe length is always possible here.

"Probe length correction" wizard

The **Probe length correction** wizard is only available when operating via the local display. When operating via an operating tool, the parameters for probe length correction are located directly in the **Probe settings** submenu (→ 129).

Navigation Setup → Advanced setup → Probe settings → Prob.length corr

Confirm probe length**Navigation**

Setup → Advanced setup → Probe settings → Prob.length corr → Confirm length

Description

Specify whether the value displayed in the **Present probe length** parameter matches the actual length of the probe. Based on this input, the device performs a probe length correction.

Selection

- Probe length OK
- Probe length too small
- Probe length too big
- Probe covered
- Manual input
- Probe length unknown

Additional information**Meaning of the options**

- **Probe length OK**
To be selected if the correct probe length is displayed. A correction is not required. The device exits the sequence.
- **Probe length too small**
To be selected if the displayed length is less than the actual probe length. A different end of probe signal is allocated and the newly calculated length is displayed in the **Present probe length** parameter. This procedure has to be repeated until the displayed value matches the actual length of the probe.
- **Probe length too big**
To be selected if the displayed length is greater than the actual probe length. A different end of probe signal is allocated and the newly calculated length is displayed in the **Present probe length** parameter. This procedure has to be repeated until the displayed value matches the actual length of the probe.
- **Probe covered**
To be selected if the probe is (partially or completely) covered. A probe length correction is impossible in this case.
- **Manual input**
To be selected if no automatic probe length correction is to be performed. Instead, the actual length of the probe must be entered manually in the **Present probe length** parameter.⁵⁾
- **Probe length unknown**
To be selected if the actual probe length is unknown. A probe length correction is impossible in this case.

5) When operating via FieldCare, the **Manual input** option does not need to be selected explicitly; manual editing of the probe length is always possible here.

Present probe length

**Navigation**

Setup → Advanced setup → Probe settings → Prob.length corr → Pres. length



Description



- In most cases:
Displays the length of the probe according to the currently measured end-of-probe signal.
- For **Confirm probe length** (→ 130) = **Manual input**:
Enter actual length of probe.

User entry



0 to 200 m

"Switch output" submenu

 The **Switch output** submenu (→  133) is only available for devices with a switch output.⁶⁾

Navigation   Setup → Advanced setup → Switch output

Switch output function**Navigation**

  Setup → Advanced setup → Switch output → Switch out funct





Description

Select function for switch output.

Selection



- Off
- On
- Diagnostic behavior
- Limit
- Digital Output

Additional information**Meaning of the options**

- **Off**
The output is always open (non-conductive).
- **On**
The output is always closed (conductive).
- **Diagnostic behavior**
The output is normally closed and is only opened if a diagnostic event is present. The **Assign diagnostic behavior** parameter (→  134) determines for which type of event the output is opened.
- **Limit**
The output is normally closed and is only opened if a measured variable exceeds or falls below a defined limit. The limit values are defined by the following parameters:
 - **Assign limit** (→  134)
 - **Switch-on value** (→  135)
 - **Switch-off value** (→  136)
- **Digital Output**
The switching state of the output tracks the output value of a DI function block. The function block is selected in the **Assign status** parameter (→  133).

 The **Off** and **On** options can be used to simulate the switch output.

Assign status**Navigation**

  Setup → Advanced setup → Switch output → Assign status

Prerequisite

Switch output function (→  133) = **Digital Output**

Description



Select device status for switch output.

6) Order code 020 "Power supply; output", option B, E or G

- Selection**
- Off
 - Digital output AD 1
 - Digital output AD 2
 - Digital output 1
 - Digital output 2
 - Digital output 3
 - Digital output 4

Additional information The **Digital output AD 1** and **Digital output AD 2** options refer to the Advanced Diagnostics Blocks. A switch signal generated in these blocks can be output via the switch output.

Assign limit

Navigation   Setup → Advanced setup → Switch output → Assign limit

Prerequisite **Switch output function (→  133) = Limit**

- Selection**
- Off
 - Level linearized
 - Distance
 - Interface linearized *
 - Interface distance *
 - Thickness upper layer *
 - Terminal voltage
 - Electronic temperature
 - Measured capacitance *
 - Relative echo amplitude
 - Relative interface amplitude *
 - Absolute echo amplitude
 - Absolute interface amplitude *

Assign diagnostic behavior

Navigation   Setup → Advanced setup → Switch output → Assign diag. beh

Prerequisite **Switch output function (→  133) = Diagnostic behavior**

Description Select diagnostic behavior for switch output.

- Selection**
- Alarm
 - Alarm or warning
 - Warning

* Visibility depends on order options or device settings

Switch-on value
**Navigation**

Setup → Advanced setup → Switch output → Switch-on value

Prerequisite**Switch output function** (→ 133) = **Limit****Description**

Enter measured value for the switch-on point.

User entry

Signed floating-point number

Additional information

The switching behavior depends on the relative position of the **Switch-on value** and **Switch-off value** parameters:

Switch-on value > Switch-off value

- The output is closed if the measured value is larger than **Switch-on value**.
- The output is opened if the measured value is smaller than **Switch-off value**.

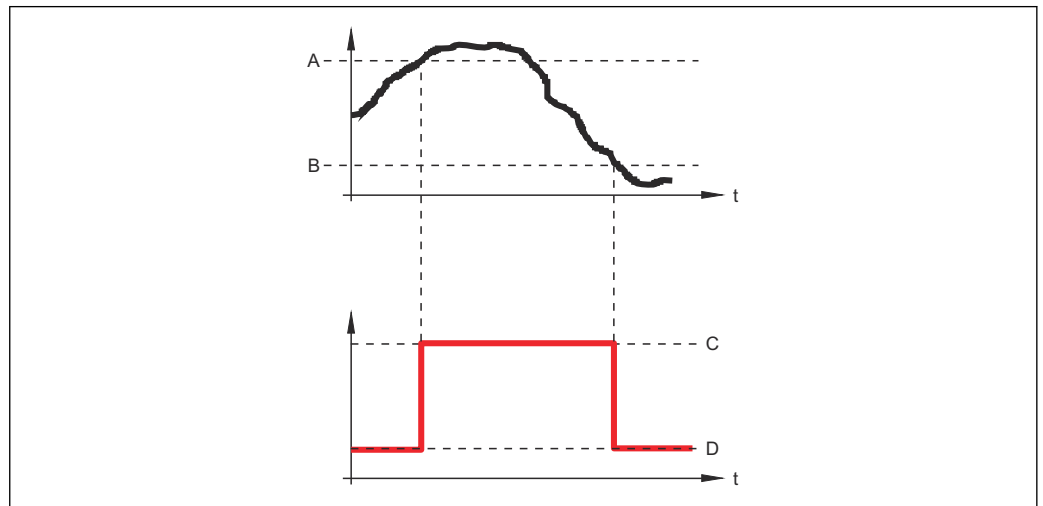

A0015585

- A *Switch-on value*
 B *Switch-off value*
 C *Output closed (conductive)*
 D *Output opened (non-conductive)*

Switch-on value < Switch-off value

- The output is closed if the measured value is smaller than **Switch-on value**.
- The output is opened if the measured value is larger than **Switch-off value**.

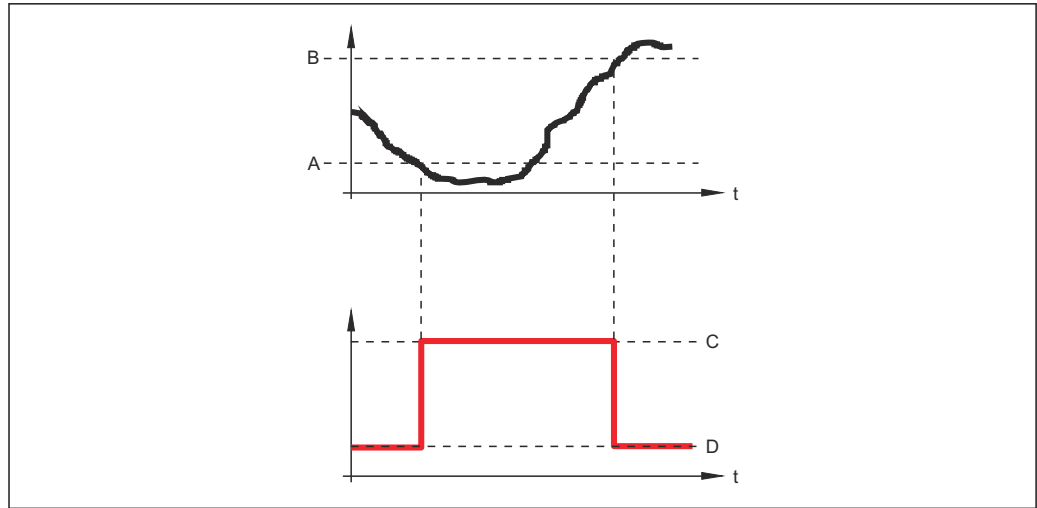

A0015586

- A Switch-on value
- B Switch-off value
- C Output closed (conductive)
- D Output opened (non-conductive)

Switch-on delay



- Navigation** Setup → Advanced setup → Switch output → Switch-on delay
- Prerequisite**
 - **Switch output function** (→ 133) = **Limit**
 - **Assign limit** (→ 134) ≠ **Off**
- Description** Define delay for the switch-on of status output.
- User entry** 0.0 to 100.0 s

Switch-off value



- Navigation** Setup → Advanced setup → Switch output → Switch-off value
- Prerequisite** **Switch output function** (→ 133) = **Limit**
- Description** Enter measured value for the switch-off point.
- User entry** Signed floating-point number
- Additional information** The switching behavior depends on the relative position of the **Switch-on value** and **Switch-off value** parameters; description: see the **Switch-on value** parameter (→ 135).

Switch-off delay

Navigation	Setup → Advanced setup → Switch output → Switch-off delay
Prerequisite	<ul style="list-style-type: none"> ▪ Switch output function (→ 133) = Limit ▪ Assign limit (→ 134) ≠ Off
Description	Define delay for the switch-off of status output.
User entry	0.0 to 100.0 s

Failure mode

Navigation	Setup → Advanced setup → Switch output → Failure mode
Prerequisite	Switch output function (→ 133) = Limit or Digital Output
Description	Define output behavior in alarm condition.
Selection	<ul style="list-style-type: none"> ▪ Actual status ▪ Open ▪ Closed

Additional information

Switch status

Navigation	Setup → Advanced setup → Switch output → Switch status
Description	Shows the current switch output status.

Invert output signal

Navigation	Setup → Advanced setup → Switch output → Invert outp.sig.
Description	Invert the output signal.
Selection	<ul style="list-style-type: none"> ▪ No ▪ Yes

Additional information**Meaning of the options**■ **No**

The behavior of the switch output is as described above.

■ **Yes**

The states **Open** and **Closed** are inverted as compared to the description above.

"Display" submenu

Display submenu is only visible if a display module is connected to the device.

Navigation



Setup → Advanced setup → Display

Language

Navigation

Setup → Advanced setup → Display → Language

Description

Set display language.

Selection

- English
- Deutsch *
- Français *
- Español *
- Italiano *
- Nederlands *
- Portuguesa *
- Polski *
- русский язык (Russian) *
- Svenska *
- Türkçe *
- 中文 (Chinese) *
- 日本語 (Japanese) *
- 한국어 (Korean) *
- Bahasa Indonesia *
- tiếng Việt (Vietnamese) *
- čeština (Czech) *

Factory setting

The language selected in feature 500 of the product structure.
If no language has been selected: **English**

Additional information

Format display

Navigation

Setup → Advanced setup → Display → Format display

Description

Select how measured values are shown on the display.

Selection

- 1 value, max. size
- 1 bargraph + 1 value
- 2 values
- 1 value large + 2 values
- 4 values

* Visibility depends on order options or device settings

Additional information

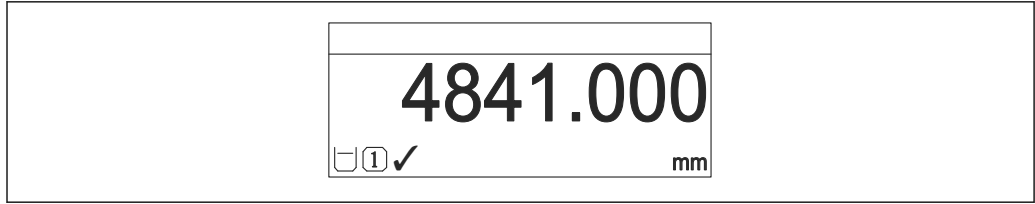

A0019963

45 "Format display" = "1 value, max. size"

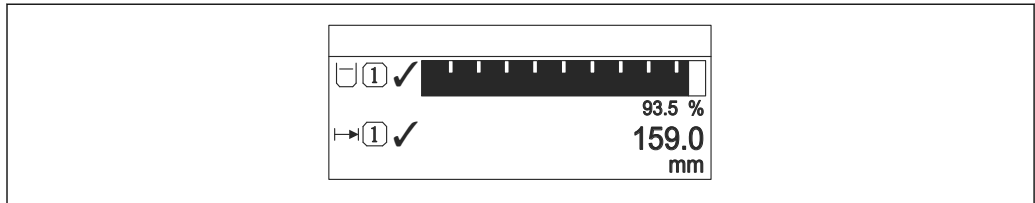

A0019964

46 "Format display" = "1 bargraph + 1 value"

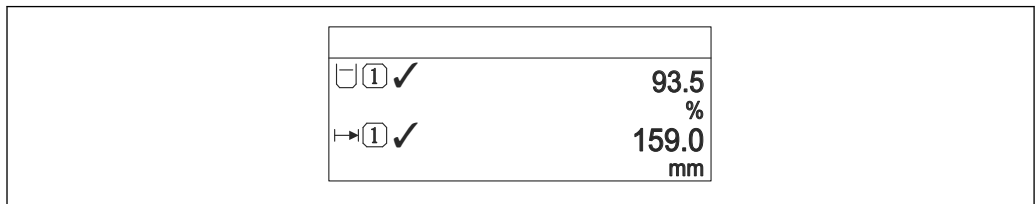

A0019965

47 "Format display" = "2 values"

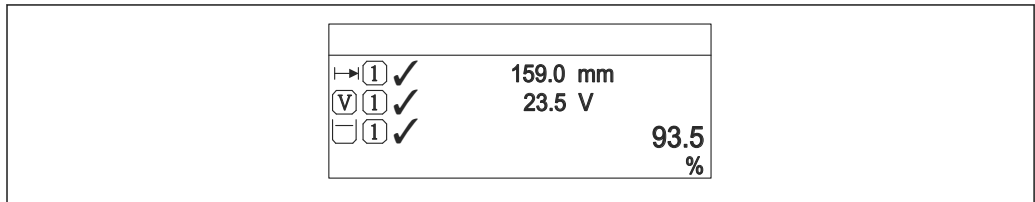

A0019966

48 "Format display" = "1 value large + 2 values"

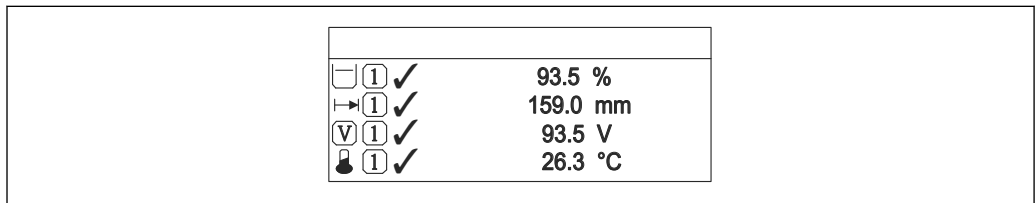

A0019968

49 "Format display" = "4 values"

- i** The **Value 1 to 4 display** parameters are used to specify which measured values are shown on the local display and in what order.
- If more measured values are specified than the display mode selected permits, then the values alternate on the device display. The display time until the next change is configured in the **Display interval** parameter (→ 141).

Value 1 to 4 display

Navigation	Setup → Advanced setup → Display → Value 1 display
Description	Select the measured value that is shown on the local display.
Selection	<ul style="list-style-type: none"> ■ Level linearized ■ Distance ■ Interface linearized * ■ Interface distance * ■ Thickness upper layer * ■ Terminal voltage ■ Electronic temperature ■ Measured capacitance * ■ Analog output 1 ■ Analog output 2 ■ Analog output 3 ■ Analog output 4 ■ Analog output adv. diagnostics 1 ■ Analog output adv. diagnostics 2
Factory setting	<p>For level measurements</p> <ul style="list-style-type: none"> ■ Value 1 display: Level linearized ■ Value 2 display: Distance ■ Value 3 display: Current output 1 ■ Value 4 display: None

Decimal places 1 to 4

Navigation	Setup → Advanced setup → Display → Decimal places 1
Description	Select the number of decimal places for the display value.
Selection	<ul style="list-style-type: none"> ■ x ■ x.x ■ x.xx ■ x.xxx ■ x.xxxx
Additional information	The setting does not affect the measuring or computational accuracy of the device.

Display interval



Navigation	Setup → Advanced setup → Display → Display interval
Description	Set time measured values are shown on display if display alternates between values.

* Visibility depends on order options or device settings

User entry 1 to 10 s

Additional information This parameter is only relevant if the number of selected measuring values exceeds the number of values the selected display format can display simultaneously.

Display damping 

Navigation   Setup → Advanced setup → Display → Display damping

Description Set display reaction time to fluctuations in the measured value.

User entry 0.0 to 999.9 s

Header 

Navigation   Setup → Advanced setup → Display → Header

Description Select header contents on local display.

- Selection**
- Device tag
 - Free text

Additional information

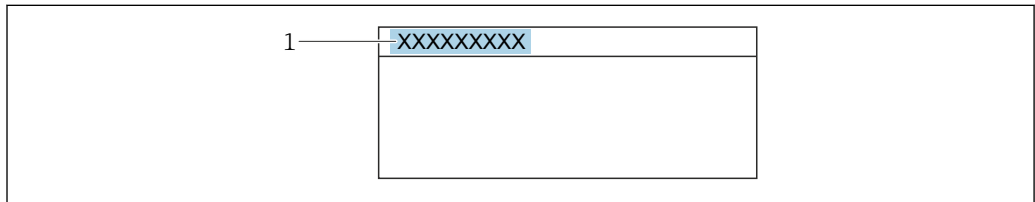



A0029422

1 Position of the header text on the display

Meaning of the options

- **Device tag**
Is defined in the **Device tag** parameter.
- **Free text**
Is defined in the **Header text** parameter (→  142).

Header text 

Navigation   Setup → Advanced setup → Display → Header text



Prerequisite **Header** (→  142) = **Free text**

Description Enter display header text.

User entry Character string comprising numbers, letters and special characters (12)

Additional information The number of characters which can be displayed depends on the characters used.

Separator



Navigation   Setup → Advanced setup → Display → Separator

Description Select decimal separator for displaying numerical values.

Selection

- .
- ,

Number format

Navigation   Setup → Advanced setup → Display → Number format



Description Choose number format for the display.

Selection

- Decimal
- ft-in-1/16"

Additional information The **ft-in-1/16"** option is only valid for distance units.

Decimal places menu

Navigation   Setup → Advanced setup → Display → Dec. places menu

Description Select number of decimal places for the representation of numbers within the operating menu.



Selection

- x
- x.x
- x.xx
- x.xxx
- x.xxxx







Additional information

- Is only valid for numbers in the operating menu (e.g. **Empty calibration, Full calibration**), but not for the measured value display. The number of decimal places for the measured value display is defined in the **Decimal places 1 to 4** parameters
- This setting does not affect the accuracy of the device for measuring or calculating the value

Backlight

Navigation	 Setup → Advanced setup → Display → Backlight
Prerequisite	The device has the SD03 local display (with optical keys).
Description	Switch the local display backlight on and off.
Selection	<ul style="list-style-type: none">▪ Disable▪ Enable
Additional information	<p>Meaning of the options</p> <ul style="list-style-type: none">▪ Disable Switches the backlight off.▪ Enable Switches the backlight on. <p> Regardless of the setting in this parameter the backlight may be automatically switched off by the device if the supply voltage is too low.</p>

Contrast display

Navigation	 Setup → Advanced setup → Display → Contrast display
Description	Adjust local display contrast setting to ambient conditions (e.g. lighting or reading angle).
User entry	20 to 80 %
Factory setting	Dependent on the display.
Additional information	<p> Setting the contrast via push-buttons:</p> <ul style="list-style-type: none">▪ Darker: press the   buttons simultaneously.▪ Brighter: press the   buttons simultaneously.

"Configuration backup display" submenu

This submenu is only visible if a display module is connected to the device.

The configuration of the device can be saved to the display module at a certain point of time (backup). The saved configuration can be restored to the device if required, e.g. in order to bring the device back into a defined state. The configuration can also be transferred to a different device of the same type using the display module.

Navigation Setup → Advanced setup → Conf.backup disp

Operating time

Navigation Setup → Advanced setup → Conf.backup disp → Operating time

Description Indicates how long the device has been in operation.

Additional information *Maximum time*
9 999 d (≈ 27 years)

Last backup

Navigation Setup → Advanced setup → Conf.backup disp → Last backup

Description Indicates when the last data backup was saved to the display module.

Configuration management

Navigation Setup → Advanced setup → Conf.backup disp → Config. managem.



Description Select action for managing the device data in the display module.

Selection

- Cancel
- Execute backup
- Restore
- Duplicate
- Compare
- Clear backup data

Additional information

Meaning of the options

- **Cancel**
No user is executed and the user exits the parameter.
 - **Execute backup**
A backup copy of the current device configuration in the HistoROM (built-in in the device) is saved to the display module of the device.
 - **Restore**
The last backup copy of the device configuration is copied from the display module to the HistoROM of the device.
 - **Duplicate**
The transmitter configuration is duplicated to another device using the transmitter display module. The following parameters, which characterize the individual measuring point are **not** included in the transmitted configuration:
Medium type
 - **Compare**
The device configuration saved in the display module is compared to the current device configuration of the HistoROM. The result of this comparison is displayed in the **Comparison result** parameter (→  146).
 - **Clear backup data**
The backup copy of the device configuration is deleted from the display module of the device.
-  While this action is in progress, the configuration cannot be edited via the local display and a message on the processing status appears on the display.
-  If an existing backup is restored to a different device using the **Restore** option, it may occur that some device functionalities are no longer available. In some cases even a device reset will not restore the original status.
- In order to transmit a configuration to a different device, the **Duplicate** option should always be used.

Backup state

Navigation



 Setup → Advanced setup → Conf.backup disp → Backup state

Description

Displays which backup action is currently in progress.

Comparison result

Navigation

  Setup → Advanced setup → Conf.backup disp → Compar. result

Description

Comparison between present device data and display backup.

Additional information**Meaning of the display options****■ Settings identical**

The current device configuration of the HistoROM is identical to the backup copy in the display module.

■ Settings not identical

The current device configuration of the HistoROM is not identical to the backup copy in the display module.

■ No backup available

There is no backup copy of the device configuration of the HistoROM in the display module.

■ Backup settings corrupt

The current device configuration of the HistoROM is corrupt or not compatible with the backup copy in the display module.

■ Check not done

The device configuration of the HistoROM has not yet been compared to the backup copy in the display module.

■ Dataset incompatible

The data sets are incompatible and can not be compared.





To start the comparison, set **Configuration management** (→  145) = **Compare**.



If the transmitter configuration has been duplicated from a different device by **Configuration management** (→  145) = **Duplicate**, the new device configuration in the HistoROM is only partially identical to the configuration stored in the display module: Sensor specific properties (e.g. the mapping curve) are not duplicated. Thus, the result of the comparison will be **Settings not identical**.

"Administration" submenu

Navigation  Setup → Advanced setup → Administration









Define access code 

Navigation  Setup → Advanced setup → Administration → Def. access code

Description Define release code for write access to parameters.

User entry 0 to 9999

Additional information

-  If the factory setting is not changed or if "0" is entered, the parameters are not write-protected and the device configuration data can therefore always be modified. The user is logged on in the "Maintenance" role.
-  The write protection affects all parameters marked with the  symbol in the document. On the local display, the  symbol in front of a parameter indicates that the parameter is write-protected.
-  Once the access code has been defined, write-protected parameters can only be modified if the access code is entered in the **Enter access code** parameter (→  108).
-  Please contact your Endress+Hauser Sales Center if you lose the access code.
-  If operating via the local display: the new access code is only valid once it has been confirmed in the **Confirm access code** parameter (→  150).

Device reset 

Navigation   Setup → Advanced setup → Administration → Device reset

Description Reset the device configuration - either entirely or in part - to a defined state.

Selection

- Cancel
- To factory defaults
- To delivery settings
- Of customer settings
- To transducer defaults
- Restart device

Additional information

Meaning of the options

- **Cancel**
No action
- **To factory defaults**
All parameters are reset to the order-code specific factory setting.
- **To delivery settings**
All parameters are reset to the delivery setting. The delivery setting may differ from the factory default if customer specific settings have been ordered.
This option is only visible if customer specific settings have been ordered.

- **Of customer settings**

All customer parameters are reset to their factory setting. Service parameters, however, remain unchanged.

- **To transducer defaults**

Every measurement-related parameter is reset to its factory setting. Service parameters and communication-related parameters, however, remain unchanged.

- **Restart device**

The restart resets every parameter which is stored in the volatile memory (RAM) to the factory setting (e.g. measured value data). The device configuration remains unchanged.

"Define access code" wizard

 The **Define access code** wizard is only available when operating via the local display. When operating via an operating tool, the **Define access code** parameter is located directly in the **Administration** submenu. The **Confirm access code** parameter is not available for operation via operating tool.

Navigation  Setup → Advanced setup → Administration → Def. access code

Define access code 

Navigation  Setup → Advanced setup → Administration → Def. access code → Def. access code

Description →  148

Confirm access code 

Navigation  Setup → Advanced setup → Administration → Def. access code → Confirm code

Description Confirm the entered access code.

User entry 0 to 9 999

16.4 "Diagnostics" menu

Navigation   Diagnostics

Actual diagnostics



Navigation   Diagnostics → Actual diagnos.

Description Displays current diagnostic message.

Additional information The display consists of:

- Symbol for event behavior
- Code for diagnostic behavior
- Operating time of occurrence
- Event text

 If several messages are active at the same time, the messages with the highest priority is displayed.

 Information on what is causing the message, and remedy measures, can be viewed via the  symbol on the display.

Timestamp

Navigation  Diagnostics → Timestamp



Previous diagnostics

Navigation   Diagnostics → Prev.diagnostics

Description Displays the last diagnostic message which has been active before the current message.

Additional information The display consists of:

- Symbol for event behavior
- Code for diagnostic behavior
- Operating time of occurrence
- Event text

 The condition displayed may still apply. Information on what is causing the message, and remedy measures, can be viewed via the  symbol on the display.

Timestamp

Navigation  Diagnostics → Timestamp

Operating time from restart

Navigation   Diagnostics → Time fr. restart

Description Displays the time the device has been in operation since the last device restart.

Operating time

Navigation   Diagnostics → Operating time

Description Indicates how long the device has been in operation.

Additional information *Maximum time*
9 999 d (≈ 27 years)

16.4.1 "Diagnostic list" submenu

Navigation  Diagnostics → Diagnostic list

Diagnostics 1 to 5

Navigation	 Diagnostics → Diagnostic list → Diagnostics 1
Description	Display the current diagnostics messages with the highest to fifth-highest priority.
Additional information	The display consists of: <ul style="list-style-type: none">■ Symbol for event behavior■ Code for diagnostic behavior■ Operating time of occurrence■ Event text

Timestamp 1 to 5

Navigation  Diagnostics → Diagnostic list → Timestamp 1 to 5

16.4.2 "Event logbook" submenu

 The **Event logbook** submenu is only available when operating via the local display. When operating via FieldCare, the event list can be displayed in the FieldCare function "Event List / HistoROM".

Navigation  Diagnostics → Event logbook

Filter options

Navigation

 Diagnostics → Event logbook → Filter options

Selection

- All
- Failure (F)
- Function check (C)
- Out of specification (S)
- Maintenance required (M)
- Information (I)



Additional information



-  This parameter is only used for operation via the local display.
- The status signals are categorized according to NAMUR NE 107.

"Event list" submenu

The **Event list** submenu displays the history of past events of the category selected in the **Filter options** parameter (→  154). A maximum of 100 events are displayed in chronological order.

The following symbols indicate whether an event has occurred or has ended:

- : Event has occurred
- : Event has ended

 Information on what is causing the message, and remedy instructions, can be viewed via the -button.

Display format

- For event messages in category I: information event, event text, "recording event" symbol and time the event occurred
- For event messages in category F, M, C, S (status signal): diagnostics event, event text, "recording event" symbol and time the event occurred

Navigation  Diagnostics → Event logbook → Event list



16.4.3 "Device information" submenu

Navigation  Diagnostics → Device info



Device tag

Navigation	 Diagnostics → Device info → Device tag
Description	Enter the name for the measuring point.
User interface	Character string comprising numbers, letters and special characters

Serial number

Navigation	 Diagnostics → Device info → Serial number
Description	Shows the serial number of the measuring device.
Additional information	<p> Uses of the serial number</p> <ul style="list-style-type: none"> ▪ To identify the device quickly, e.g. when contacting Endress+Hauser. ▪ To obtain specific information on the device using the Device Viewer: www.endress.com/deviceviewer <p> The serial number is also indicated on the nameplate.</p>



Firmware version

Navigation	 Diagnostics → Device info → Firmware version
Description	Shows the device firmware version installed.
User interface	xx.yy.zz
Additional information	<p> For firmware versions differing only in the last two digits ("zz") there is no difference concerning functionality or operation.</p>



Device name

Navigation	 Diagnostics → Device info → Device name
Description	Shows the name of the transmitter.



Order code 

Navigation	  Diagnostics → Device info → Order code
Description	Shows the device order code.
User interface	Character string comprising numbers, letters and special characters
Additional information	The order code is generated from the extended order code, which defines all device features of the product structure. In contrast, the device features can not be read directly from the order code.



Extended order code 1 to 3 

Navigation	  Diagnostics → Device info → Ext. order cd. 1
Description	Display the three parts of the extended order code.
User interface	Character string comprising numbers, letters and special characters
Additional information	The extended order code indicates the version of all the features of the product structure and thus uniquely identifies the device.

Status PROFIBUS Master Config

Navigation	  Diagnostics → Device info → Stat Master Conf
Description	Indicates whether the cyclic data exchange with the master is currently active.
User interface	<ul style="list-style-type: none"> ■ Active ■ Not active

PROFIBUS ident number

Navigation	  Diagnostics → Device info → Ident number
Description	Indicates the ident number of the device.
Additional information	The Ident number selector parameter can be used to define which ident number is used.

16.4.4 "Measured values" submenu

Navigation  Diagnostics → Measured val.

Distance

Navigation  Diagnostics → Measured val. → Distance

Description Displays the measured distance D_L between the reference point (lower edge of the flange or threaded connection) and the level.

Additional information

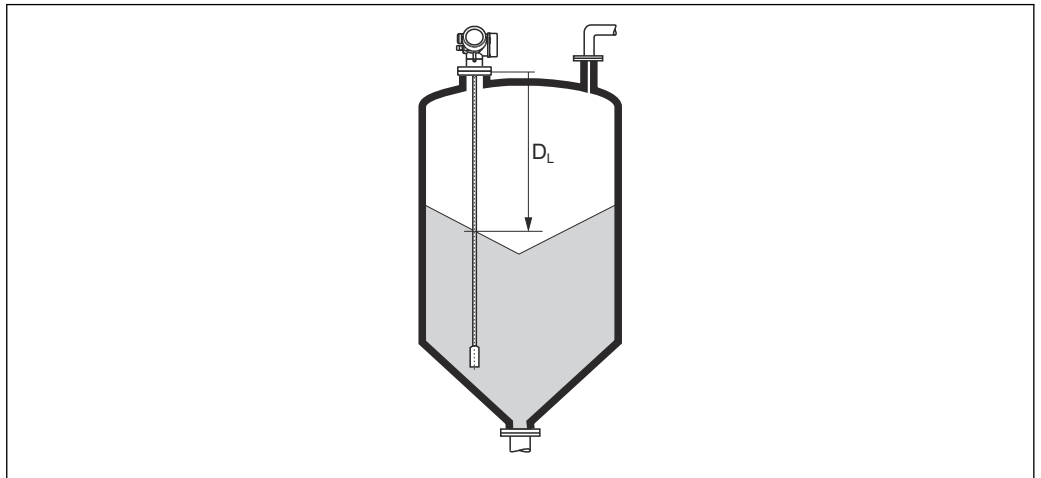

A0013201

 50 Distance for bulk solid measurements

 The unit is defined in the **Distance unit** parameter (→  98).

Level linearized

Navigation  Diagnostics → Measured val. → Level linearized

Description Displays linearized level.

Additional information  This unit is defined by the **Unit after linearization** parameter.

Terminal voltage 1

Navigation Diagnostics → Measured val. → Terminal volt. 1**Switch status**



Navigation Diagnostics → Measured val. → Switch status**Description**



Shows the current switch output status.

16.4.5 "Analog input 1 to 6" submenu

 There is an **Analog input** submenu for each Analog Input Block of the device. Only the most important parameters of the respective block are available at this position of the operating menu. For a complete list of the block parameters refer to: Diagnostics → Analog inputs → Analog input 1 to 6

Navigation  Diagnostics → Analog inputs → Analog input 1 to 6

Channel	
Navigation	 Diagnostics → Analog inputs → Analog input 1 to 6 → Channel
Description	Standard parameter CHANNEL of the Analog Input Block according to the PROFIBUS Profile.
Selection	<ul style="list-style-type: none"> ■ Level linearized ■ Distance ■ Interface linearized * ■ Interface distance * ■ Thickness upper layer * ■ Terminal voltage ■ Electronic temperature ■ Measured capacitance * ■ Absolute echo amplitude ■ Relative echo amplitude ■ Absolute interface amplitude * ■ Relative interface amplitude * ■ Absolute EOP amplitude ■ Noise of signal ■ EOP shift ■ Calculated DC value * ■ Sensor debug ■ Analog output adv. diagnostics 1 ■ Analog output adv. diagnostics 2
Additional information	Allocates a measured value to the AI block.

Out value	
Navigation	 Diagnostics → Analog inputs → Analog input 1 to 6 → Out value
Description	Element Value of the standard parameter OUT in the Analog Input Block according to the PROFIBUS Profile.
User entry	Signed floating-point number

* Visibility depends on order options or device settings

Additional information	<ul style="list-style-type: none">■ For Mode block actual = Man: Enter the output value of the Analog Input Block.■ Else: Displays the output value of the Analog Input Block.
-------------------------------	--

Out status

Navigation	 Diagnostics → Analog inputs → Analog input 1 to 6 → Out status
Description	Element Status of the standard parameter OUT in the Analog Input Block according to the PROFIBUS Profile.
User interface	<ul style="list-style-type: none">■ Good■ Uncertain■ Bad
Additional information	Only the two quality bits are evaluated in this parameter.



Out status HEX

Navigation	 Diagnostics → Analog inputs → Analog input 1 to 6 → Out status HEX
Description	Element Status of the standard parameter OUT in the Analog Input Block according to the PROFIBUS Profile.
User entry	0 to 255
Additional information	The complete status byte is displayed in the form of a two-digit hexadecimal number in this parameter.

16.4.6 "Data logging" submenu

Navigation   Diagnostics → Data logging

Assign channel 1 to 4

Navigation   Diagnostics → Data logging → Assign chan. 1 to 4

Selection

- Off
- Level linearized
- Distance
- Unfiltered distance
- Interface linearized *
- Interface distance *
- Unfiltered interface distance
- Thickness upper layer *
- Terminal voltage
- Electronic temperature
- Measured capacitance *
- Absolute echo amplitude
- Relative echo amplitude
- Absolute interface amplitude *
- Relative interface amplitude *
- Absolute EOP amplitude
- EOP shift
- Noise of signal
- Calculated DC value *
- Analog output adv. diagnostics 1
- Analog output adv. diagnostics 2



Additional information A total of 1000 measured values can be logged. This means:

- 1000 data points if 1 logging channel is used
- 500 data points if 2 logging channels are used
- 333 data points if 3 logging channels are used
- 250 data points if 4 logging channels are used

If the maximum number of data points is reached, the oldest data points in the data log are cyclically overwritten in such a way that the last 1000, 500, 333 or 250 measured values are always in the log (ring memory principle).

 The logged data are deleted if a new option is selected in this parameter.

Logging interval

Navigation  Diagnostics → Data logging → Logging interval
 Diagnostics → Data logging → Logging interval

User entry 1.0 to 3 600.0 s

* Visibility depends on order options or device settings

Additional information

This parameter defines the interval between the individual data points in the data log, and thus the maximum loggable process time T_{\log} :

- If 1 logging channel is used: $T_{\log} = 1000 \cdot t_{\log}$
- If 2 logging channels are used: $T_{\log} = 500 \cdot t_{\log}$
- If 3 logging channels are used: $T_{\log} = 333 \cdot t_{\log}$
- If 4 logging channels are used: $T_{\log} = 250 \cdot t_{\log}$

Once this time elapses, the oldest data points in the data log are cyclically overwritten such that a time of T_{\log} always remains in the memory (ring memory principle).



The logged data are deleted if this parameter is changed.

*Example***When using 1 logging channel**

- $T_{\log} = 1000 \cdot 1 \text{ s} = 1000 \text{ s} \approx 16.5 \text{ min}$
- $T_{\log} = 1000 \cdot 10 \text{ s} = 10000 \text{ s} \approx 2.75 \text{ h}$
- $T_{\log} = 1000 \cdot 80 \text{ s} = 80000 \text{ s} \approx 22 \text{ h}$
- $T_{\log} = 1000 \cdot 3600 \text{ s} = 3600000 \text{ s} \approx 41 \text{ d}$

Clear logging data**Navigation**

- Diagnostics → Data logging → Clear logging
- Diagnostics → Data logging → Clear logging

Selection

- Cancel
- Clear data

"Display channel 1 to 4" submenu

i The **Display channel 1 to 4** submenus are only available for operation via the local display. When operating via FieldCare, the logging diagram can be displayed in the FieldCare function "Event List / HistoROM" .

The **Display channel 1 to 4** submenus invoke a diagram of the logging history of the respective channel.

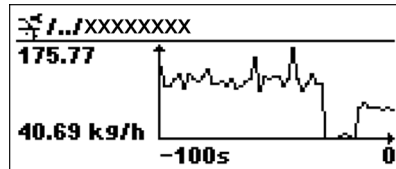

- x-axis: depending on the number of selected channels, 250 to 1000 measured values of a process variable are displayed.
- y-axis: covers the approximate measured value span and constantly adapts this to the measurement.







i To return to the operating menu, press \oplus and \ominus simultaneously.

Navigation ☰ ☰ Diagnostics → Data logging → Displ.channel 1 to 4

16.4.7 "Simulation" submenu







The **Simulation** submenu is used to simulate specific measuring values or other conditions. This helps to check the correct configuration of the device and connected control units.

Conditions which can be simulated

Condition to be simulated	Associated parameters
Specific value of a process variable	<ul style="list-style-type: none">▪ Assign measurement variable (→  166)▪ Value process variable (→  166)
Specific state of the switch output	<ul style="list-style-type: none">▪ Switch output simulation (→  166)▪ Switch status (→  167)
Existence of an alarm	Simulation device alarm (→  167)
Existence of a specific diagnostic message	Simulation diagnostic event (→  167)

Structure of the submenu



Navigation  Expert → Diagnostics → Simulation

► Simulation	
Assign measurement variable	→  166
Value process variable	→  166
Switch output simulation	→  166
Switch status	→  167
Simulation device alarm	→  167
Simulation diagnostic event	→  167



Description of parameters

Navigation  Expert → Diagnostics → Simulation

Assign measurement variable

Navigation	 Expert → Diagnostics → Simulation → Assign meas.var.
Selection	<ul style="list-style-type: none"> ▪ Off ▪ Level ▪ Interface * ▪ Level linearized ▪ Interface linearized ▪ Thickness linearized
Additional information	<ul style="list-style-type: none"> ▪ The value of the variable to be simulated is defined in the Value process variable parameter (→  166). ▪ If Assign measurement variable ≠ Off, a simulation is active. This is indicated by a diagnostic message of the <i>Function check (C)</i> category.

Value process variable

Navigation	 Expert → Diagnostics → Simulation → Value proc. var.
Prerequisite	Assign measurement variable (→  166) ≠ Off
User entry	Signed floating-point number
Additional information	Downstream measured value processing and the signal output use this simulation value. In this way, users can verify whether the measuring device has been configured correctly.



Switch output simulation

Navigation	 Expert → Diagnostics → Simulation → Switch sim.
Description	Switch the simulation of the switch output on and off.
Selection	<ul style="list-style-type: none"> ▪ Off ▪ On

* Visibility depends on order options or device settings



Switch status





Navigation	  Expert → Diagnostics → Simulation → Switch status
Prerequisite	Switch output simulation (→  166) = On
Description	Select the status of the status output for the simulation.
Selection	<ul style="list-style-type: none">■ Open■ Closed
Additional information	The switch status assumes the value defined in this parameter. This helps to check correct operation of connected control units.

Simulation device alarm



Navigation	  Expert → Diagnostics → Simulation → Sim. alarm
Description	Switch the device alarm on and off.
Selection	<ul style="list-style-type: none">■ Off■ On
Additional information	<p>When selecting the On option, the device generates an alarm. This helps to check the correct output behavior of the device in the case of an alarm.</p> <p>An active simulation is indicated by the  C484 Simulation failure mode diagnostic message.</p>

Simulation diagnostic event

Navigation	  Expert → Diagnostics → Simulation → Sim. diag. event
Description	Select a diagnostic event for the simulation process that is activated.
Additional information	When operated via the local display, the selection list can be filtered according to the event categories (Diagnostic event category parameter).

16.4.8 "Device check" submenu

Navigation  Diagnostics → Device check

Start device check

Navigation  Diagnostics → Device check → Start dev. check

Description Start a device check.

Selection

- No
- Yes

Additional information In the case of a lost echo a device check can not be performed.

Result device check

Navigation  Diagnostics → Device check → Result dev.check

Description Displays the result of the device check.

Additional information

Meaning of the display options

- **Installation ok**
Measurement possible without restrictions.
- **Accuracy reduced**
A measurement is possible. However, the measuring accuracy may be reduced due to the signal amplitudes.
- **Measurement capability reduced**
A measurement is currently possible. However, there is the risk of an echo loss. Check the mounting position of the device and the dielectric constant of the medium.
- **Check not done**
No device check has been performed.



Last check time

Navigation  Diagnostics → Device check → Last check time



Description Displays the operating time at which the last device check has been performed.

User interface Character string comprising numbers, letters and special characters

Level signal

Navigation	  Diagnostics → Device check → Level signal
Prerequisite	Device check has been performed.
Description	Displays result of the device check for the level signal.
User interface	<ul style="list-style-type: none">■ Check not done■ Check not OK■ Check OK
Additional information	For Level signal = Check not OK : Check the mounting position of the device and the dielectric constant of the medium.

Launch signal

Navigation	  Diagnostics → Device check → Launch signal
Prerequisite	Device check has been performed.
Description	Displays result of the display check for the launch signal.
User interface	<ul style="list-style-type: none">■ Check not done■ Check not OK■ Check OK
Additional information	For Launch signal = Check not OK : Check the mounting position of the device. In non-metallic vessels use a metal plate or a metal flange.

16.4.9 "Heartbeat" submenu

 The **Heartbeat** submenu is only available via **FieldCare** or **DeviceCare**. It contains the wizards which are part of the **Heartbeat Verification** and **Heartbeat Monitoring** application packages.

Detailed description

SD01872F

Navigation

 Diagnostics → Heartbeat

Index

A

Access authorization to parameters
 Read access 45
 Write access 45
 Access code 45
 Incorrect input 45
 Access status display (Parameter) 108
 Access status tooling (Parameter) 107
 Accessories
 Communication-specific 84
 Device-specific 77
 Service-specific 84
 System components 84
 Activate table (Parameter) 123
 Actual diagnostics (Parameter) 151
 Administration (Submenu) 148
 Advanced process conditions (Parameter) 111
 Advanced setup (Submenu) 107
 Analog input 1 to 6 (Submenu) 105, 159
 Application 9
 Assign channel 1 to 4 (Parameter) 161
 Assign diagnostic behavior (Parameter) 134
 Assign limit (Parameter) 134
 Assign measurement variable (Parameter) 166
 Assign status (Parameter) 133

B

Backlight (Parameter) 144
 Backup state (Parameter) 146
 Bin type (Parameter) 98
 Blocking distance (Parameter) 112, 125
 Bluetooth® wireless technology 43

C

Channel (Parameter) 105, 159
 Cleaning 74
 Clear logging data (Parameter) 162
 Code incorrect (Parameter) 128
 Comparison result (Parameter) 146
 Configuration backup display (Submenu) 145
 Configuration management (Parameter) 145
 Configuration of a level measurement 61
 Configuring level measurement 61
 Configuring the operating language 60
 Confirm access code (Parameter) 150
 Confirm distance (Parameter) 102, 104
 Confirm probe length (Parameter) 130, 131
 Context menu 55
 Contrast display (Parameter) 144
 Customer value (Parameter) 123

D

Data logging (Submenu) 161
 Deactivate WHG (Wizard) 128
 Decimal places 1 (Parameter) 141
 Decimal places menu (Parameter) 143

Define access code (Parameter) 148, 150
 Define access code (Wizard) 150
 Defining the access code 46
 Device address (Parameter) 98
 Device check (Submenu) 168
 Device information (Submenu) 155
 Device name (Parameter) 155
 Device replacement 75
 Device reset (Parameter) 148
 Device tag (Parameter) 98, 155
 Diagnostic event 66
 In the operating tool 67
 Diagnostic events 65
 Diagnostic list 69
 Diagnostic list (Submenu) 153
 Diagnostic message 65
 Diagnostics
 Symbols 65
 Diagnostics (Menu) 151
 Diagnostics 1 (Parameter) 153
 Diameter (Parameter) 120
 DIP switch
 see Write protection switch
 Display (Submenu) 139
 Display and operating module FHX50 42
 Display channel 1 to 4 (Submenu) 163
 Display damping (Parameter) 142
 Display interval (Parameter) 141
 Display module 50
 Display symbols 51
 Disposal 76
 Distance (Parameter) 100, 104, 157
 Distance unit (Parameter) 98
 Document
 Function 5
 Document function 5

E

Electronics housing
 Design 12
 Empty calibration (Parameter) 99
 Enter access code (Parameter) 108
 Envelope curve display 56
 Event history 71
 Event level
 Explanation 66
 Symbols 66
 Event list 71
 Event list (Submenu) 154
 Event logbook (Submenu) 154
 Event text 66
 Extended order code 1 (Parameter) 156
 Exterior cleaning 74

F

Fail safe type (Parameter) 106

- Fail safe value (Parameter) 106
 - Failure mode (Parameter) 137
 - FHX50 42
 - Field of application
 - Residual risks 9
 - Filter options (Parameter) 154
 - Filtering the event logbook 72
 - Firmware version (Parameter) 155
 - Flange 31
 - Format display (Parameter) 139
 - Free text (Parameter) 119
 - Full calibration (Parameter) 99
- H**
- Hardware write protection 47
 - Header (Parameter) 142
 - Header text (Parameter) 142
 - Heartbeat (Submenu) 170
 - Housing
 - Design 12
 - Turning 33
- I**
- Input mask 53
 - Intended use 9
 - Intermediate height (Parameter) 121
 - Invert output signal (Parameter) 137
- K**
- Keypad lock
 - Disabling 48
 - Enabling 48
- L**
- Language (Parameter) 139
 - Last backup (Parameter) 145
 - Last check time (Parameter) 168
 - Launch signal (Parameter) 169
 - Level (Parameter) 100, 122, 123
 - Level (Submenu) 109
 - Level correction (Parameter) 113
 - Level linearized (Parameter) 120, 157
 - Level signal (Parameter) 169
 - Level unit (Parameter) 112
 - Linearization (Submenu) 115, 116, 117
 - Linearization type (Parameter) 117
 - Local display
 - see Diagnostic message
 - see In alarm condition
 - Locking status 51
 - Locking status (Parameter) 107
 - Logging interval (Parameter) 161
- M**
- Maintenance 74
 - Managing the device configuration 63
 - Mapping (Wizard) 104
 - Mapping end point (Parameter) 103, 104
 - Maximum value (Parameter) 120
 - Measured value symbols 52
 - Measured values (Submenu) 157
 - Media 9
 - Medium property (Parameter) 109
 - Medium type (Parameter) 109
 - Menu
 - Diagnostics 151
 - Setup 98
 - Mounting position for level measurements 16
- N**
- Non-metal vessels 27
 - Number format (Parameter) 143
- O**
- Onsite operation 42
 - Operating elements
 - Diagnostic message 66
 - Operating module 50
 - Operating time (Parameter) 145, 152
 - Operating time from restart (Parameter) 152
 - Operational safety 10
 - Order code (Parameter) 156
 - Out status (Parameter) 160
 - Out status HEX (Parameter) 160
 - Out value (Parameter) 159
 - Output echo lost (Parameter) 124
 - Overvoltage protection
 - General information 38
- P**
- Present mapping (Parameter) 103
 - Present probe length (Parameter) 129, 132
 - Previous diagnostics (Parameter) 151
 - Probe grounded (Parameter) 129
 - Probe length correction (Wizard) 131
 - Probe settings (Submenu) 129
 - Process property (Parameter) 110
 - Product security 10
 - PROFIBUS ident number (Parameter) 156
 - PV filter time (Parameter) 105
- R**
- Ramp at echo lost (Parameter) 125
 - Read access 45
 - Record map (Parameter) 103, 104
 - Registered trademarks 8
 - Remedial measures
 - Calling up 67
 - Closing 67
 - Repair concept 75
 - Replacing a device 75
 - Requirements for personnel 9
 - Reset write protection (Parameter) 128
 - Result device check (Parameter) 168
 - Return 76
 - Rod probe
 - Design 11
 - Rod probes
 - Lateral loading capacity 21
 - Shortening 28

- Rope probe
 - Design 11
- Rope probes
 - Installation 31
 - Shortening 28
- S**
- Safety instructions
 - Basic 9
- Safety settings (Submenu) 124
- Securing rod probes 24
- Securing rope probes 24
- Separator (Parameter) 143
- Serial number (Parameter) 155
- Service interface (CDI) 43
- Settings
 - Managing the device configuration 63
 - Operating language 60
- Setup (Menu) 98
- Signal quality (Parameter) 101
- Simulation (Submenu) 165, 166
- Simulation device alarm (Parameter) 167
- Simulation diagnostic event (Parameter) 167
- Spare parts 76
 - Nameplate 76
- Start device check (Parameter) 168
- Status PROFIBUS Master Config (Parameter) 156
- Status signals 51, 65
- Submenu
 - Administration 148
 - Advanced setup 107
 - Analog input 1 to 6 105, 159
 - Configuration backup display 145
 - Data logging 161
 - Device check 168
 - Device information 155
 - Diagnostic list 153
 - Display 139
 - Display channel 1 to 4 163
 - Event list 71, 154
 - Event logbook 154
 - Heartbeat 170
 - Level 109
 - Linearization 115, 116, 117
 - Measured values 157
 - Probe settings 129
 - Safety settings 124
 - Simulation 165, 166
 - Switch output 133
- Switch output (Submenu) 133
- Switch output function (Parameter) 133
- Switch output simulation (Parameter) 166
- Switch status (Parameter) 137, 158, 167
- Switch-off delay (Parameter) 137
- Switch-off value (Parameter) 136
- Switch-on delay (Parameter) 136
- Switch-on value (Parameter) 135
- Symbols
 - For correction 53
 - In the text and numeric editor 53
- System components 84
- T**
- Table mode (Parameter) 121
- Table number (Parameter) 122
- Terminal voltage 1 (Parameter) 158
- Thermal insulation 27
- Threaded connection 30
- Timestamp (Parameter) 151, 152
- Timestamp 1 to 5 (Parameter) 153
- Tool 28
- Transmitter
 - Turning the display 34
 - Turning the display module 34
- Transmitter housing
 - Turning 33
- Troubleshooting 64
- Turning the display 34
- Turning the display module 34
- U**
- Unit after linearization (Parameter) 118
- Use of measuring instrument
 - see Intended use
- Use of the measuring instruments
 - Borderline cases 9
 - Incorrect use 9
- V**
- Value 1 display (Parameter) 141
- Value echo lost (Parameter) 124
- Value process variable (Parameter) 166
- W**
- WHG confirmation (Wizard) 127
- Wizard
 - Deactivate WHG 128
 - Define access code 150
 - Mapping 104
 - Probe length correction 131
 - WHG confirmation 127
- Workplace safety 10
- Write access 45
- Write protection
 - Via access code 46
 - Via write protection switch 47
- Write protection switch 47



www.addresses.endress.com
