

# Operating Instructions

## Levelflex FMP56, FMP57

### FOUNDATION Fieldbus

Guided-wave radar





A0023555

## Table of contents

<b>1</b>	<b>About this document</b> . . . . .	<b>6</b>			
1.1	Document function . . . . .	6			
1.2	Symbols . . . . .	6			
1.2.1	Safety symbols . . . . .	6			
1.2.2	Electrical symbols . . . . .	6			
1.2.3	Tool symbols . . . . .	6			
1.2.4	Symbols for certain types of information and graphics . . . . .	7			
1.3	List of abbreviations . . . . .	7			
1.4	Documentation . . . . .	8			
1.5	Registered trademarks . . . . .	9			
<b>2</b>	<b>Basic safety instructions</b> . . . . .	<b>10</b>			
2.1	Requirements for the personnel . . . . .	10			
2.2	Intended use . . . . .	10			
2.3	Workplace safety . . . . .	11			
2.4	Operational safety . . . . .	11			
2.5	Product security . . . . .	11			
2.5.1	CE mark . . . . .	11			
2.5.2	EAC conformity . . . . .	11			
<b>3</b>	<b>Product description</b> . . . . .	<b>12</b>			
3.1	Product design . . . . .	12			
3.1.1	Levelflex FMP56/FMP57 . . . . .	12			
3.1.2	Electronics housing . . . . .	13			
<b>4</b>	<b>Incoming acceptance and product identification</b> . . . . .	<b>14</b>			
4.1	Incoming acceptance . . . . .	14			
4.2	Product identification . . . . .	14			
4.2.1	Nameplate . . . . .	14			
4.2.2	Manufacturer address . . . . .	15			
<b>5</b>	<b>Storage, transport</b> . . . . .	<b>16</b>			
5.1	Storage temperature . . . . .	16			
5.2	Transporting to the measuring point . . . . .	16			
<b>6</b>	<b>Installation</b> . . . . .	<b>17</b>			
6.1	Mounting requirements . . . . .	17			
6.1.1	Suitable mounting position . . . . .	17			
6.1.2	Mounting under confined conditions . . . . .	18			
6.1.3	Notes on the mechanical load of the probe . . . . .	19			
6.1.4	Information concerning the process connection . . . . .	22			
6.1.5	Securing the probe . . . . .	25			
6.1.6	Special installation situations . . . . .	26			
6.2	Mounting the device . . . . .	29			
6.2.1	Tool list . . . . .	29			
6.2.2	Shortening the probe . . . . .	29			
6.2.3	Mounting the device . . . . .	31			
6.2.4	Mounting the "Sensor, remote" version . . . . .	33			
6.2.5	Turning the transmitter housing . . . . .	34			
6.2.6	Turning the display . . . . .	35			
6.3	Post-mounting check . . . . .	35			
<b>7</b>	<b>Electrical connection</b> . . . . .	<b>37</b>			
7.1	Connecting requirements . . . . .	37			
7.1.1	Terminal assignment . . . . .	37			
7.1.2	Cable specification . . . . .	38			
7.1.3	Device plug . . . . .	38			
7.1.4	Supply voltage . . . . .	39			
7.1.5	Overvoltage protection . . . . .	39			
7.2	Connecting the device . . . . .	40			
7.2.1	Opening cover . . . . .	40			
7.2.2	Connecting . . . . .	40			
7.2.3	Plug-in spring-force terminals . . . . .	41			
7.2.4	Closing the cover of the connection compartment . . . . .	41			
7.3	Post-connection check . . . . .	42			
<b>8</b>	<b>Operation options</b> . . . . .	<b>43</b>			
8.1	Overview of operation options . . . . .	43			
8.1.1	Access to operating menu via local display . . . . .	43			
8.1.2	Access to the operating menu via the operating tool . . . . .	44			
8.2	Structure and function of the operating menu . . . . .	45			
8.2.1	Structure of the operating menu . . . . .	45			
8.2.2	User roles and related access authorization . . . . .	46			
8.2.3	Data access - Security . . . . .	47			
8.3	Display and operating module . . . . .	51			
8.3.1	Display format . . . . .	51			
8.3.2	Operating elements . . . . .	53			
8.3.3	Entering numbers and text . . . . .	54			
8.3.4	Opening the context menu . . . . .	56			
8.3.5	Envelope curve display on the display and operating module . . . . .	57			
<b>9</b>	<b>System integration</b> . . . . .	<b>58</b>			
9.1	Device description file (DD) . . . . .	58			
9.2	Integration into the FF network . . . . .	58			
9.3	Device identification and addressing . . . . .	58			
9.4	Block model . . . . .	59			
9.4.1	Blocks in the device software . . . . .	59			
9.4.2	Block configuration when device is delivered . . . . .	60			
9.5	Assignment of measured values (CHANNEL) in the AI block . . . . .	60			
9.6	Index tables of Endress+Hauser parameters . . . . .	61			
9.6.1	Setup Transducer Block . . . . .	61			
9.6.2	Advanced Setup Transducer Block . . . . .	62			

9.6.3	Display Transducer Block . . . . .	63			
9.6.4	Diagnostic Transducer Block . . . . .	63			
9.6.5	Expert Configuration Transducer Block . . . . .	64			
9.6.6	Expert Information Transducer Block . . . . .	66			
9.6.7	Service Sensor Transducer Block . . . . .	67			
9.6.8	Service Information Transducer Block . . . . .	67			
9.6.9	Data Transfer Transducer Block . . . . .	68			
9.7	Methods . . . . .	69			
<b>10</b>	<b>Commissioning using the wizard . . .</b>	<b>70</b>			
<b>11</b>	<b>Commissioning via operating menu . . . . .</b>	<b>71</b>			
11.1	Installation and function check . . . . .	71			
11.2	Configuring the operating language . . . . .	71			
11.3	Configuring level measurement . . . . .	72			
11.4	Recording the reference echo curve . . . . .	73			
11.5	Configuring the local display . . . . .	73			
11.5.1	Factory setting of local display for level measurements . . . . .	73			
11.5.2	Adjusting the local display . . . . .	73			
11.6	Configuration management . . . . .	73			
11.7	Protecting settings from unauthorized access .	74			
<b>12</b>	<b>Commissioning (block-based operation) . . . . .</b>	<b>75</b>			
12.1	Installation and function check . . . . .	75			
12.2	Block configuration . . . . .	75			
12.2.1	Preliminaries . . . . .	75			
12.2.2	Configuring the Resource Block . . . . .	75			
12.2.3	Configuring the Transducer Blocks . . . . .	75			
12.2.4	Configuring the Analog Input Blocks . . . . .	76			
12.2.5	Additional configuration . . . . .	76			
12.3	Scaling of the measured value in an AI Block . .	76			
12.4	Language selection . . . . .	77			
12.5	Configuring level measurement . . . . .	78			
12.6	Configuring the local display . . . . .	79			
12.6.1	Factory setting of local display for level measurements . . . . .	79			
12.7	Configuration management . . . . .	79			
12.8	Configuration of the event behavior according to the FOUNDATION Fieldbus specification FF912 . . . . .	81			
12.8.1	Event groups . . . . .	82			
12.8.2	Assignment parameters . . . . .	83			
12.8.3	Configurable area . . . . .	85			
12.8.4	Transmission of the event messages to the bus . . . . .	87			
12.9	Protecting settings from unauthorized access .	87			
<b>13</b>	<b>Diagnostics and troubleshooting . . .</b>	<b>88</b>			
13.1	General troubleshooting . . . . .	88			
13.1.1	General errors . . . . .	88			
			13.1.2	Parameter configuration errors . . . . .	88
			13.2	Diagnostic information on local display . . . . .	89
			13.2.1	Diagnostic message . . . . .	89
			13.2.2	Calling up remedial measures . . . . .	91
			13.3	Diagnostic event in the operating tool . . . . .	91
			13.4	Diagnostic messages in the DIAGNOSTIC Transducer Block (TRDDIAG) . . . . .	93
			13.5	Diagnostic list . . . . .	93
			13.6	Event logbook . . . . .	93
			13.6.1	Event history . . . . .	93
			13.6.2	Filtering the event logbook . . . . .	94
			13.6.3	Overview of information events . . . . .	94
			13.7	Firmware history . . . . .	95
			<b>14</b>	<b>Maintenance . . . . .</b>	<b>96</b>
			14.1	Exterior cleaning . . . . .	96
			14.2	General cleaning instructions . . . . .	96
			<b>15</b>	<b>Repair . . . . .</b>	<b>97</b>
			15.1	General information . . . . .	97
			15.1.1	Repair concept . . . . .	97
			15.1.2	Repairs to Ex-approved devices . . . . .	97
			15.1.3	Replacing electronics modules . . . . .	97
			15.1.4	Replacing a device . . . . .	97
			15.2	Spare parts . . . . .	98
			15.3	Return . . . . .	98
			15.4	Disposal . . . . .	98
			<b>16</b>	<b>Accessories . . . . .</b>	<b>99</b>
			16.1	Device-specific accessories . . . . .	99
			16.1.1	Weather protection cover . . . . .	99
			16.1.2	Mounting bracket for electronics housing . . . . .	100
			16.1.3	Rod extension (centering device) HMP40 . . . . .	102
			16.1.4	Mounting kit, insulated . . . . .	102
			16.1.5	Remote display FHX50 . . . . .	103
			16.1.6	Overvoltage protection . . . . .	104
			16.1.7	Bluetooth module BT10 for HART devices . . . . .	105
			16.2	Communication-specific accessories . . . . .	106
			16.3	Service-specific accessories . . . . .	106
			16.4	System components . . . . .	106
			16.4.1	Memograph M RSG45 . . . . .	106
			<b>17</b>	<b>Operating menu . . . . .</b>	<b>108</b>
			17.1	Overview of the operating menu (display module) . . . . .	108
			17.2	Overview of the operating menu (operating tool) . . . . .	114
			17.3	"Setup" menu . . . . .	120
			17.3.1	"Mapping" wizard . . . . .	126
			17.3.2	"Analog input 1 to 5" submenu . . . . .	127
			17.3.3	"Advanced setup" submenu . . . . .	129
			17.4	"Diagnostics" menu . . . . .	171
			17.4.1	"Diagnostic list" submenu . . . . .	173

17.4.2	"Event logbook" submenu . . . . .	174
17.4.3	"Device information" submenu . . . . .	175
17.4.4	"Measured values" submenu . . . . .	177
17.4.5	"Analog input 1 to 5" submenu . . . . .	178
17.4.6	"Data logging" submenu . . . . .	180
17.4.7	"Simulation" submenu . . . . .	183
17.4.8	"Device check" submenu . . . . .	188
17.4.9	"Heartbeat" submenu . . . . .	190
<b>Index</b>	. . . . .	<b>191</b>

# 1 About this document

## 1.1 Document function

These Operating Instructions contain all the information required in the various life cycle phases of the device: from product identification, incoming acceptance and storage, to installation, connection, operation and commissioning, through to troubleshooting, maintenance and disposal.

## 1.2 Symbols

### 1.2.1 Safety symbols

#### DANGER

This symbol alerts you to a dangerous situation. Failure to avoid this situation will result in serious or fatal injury.

#### WARNING

This symbol alerts you to a potentially dangerous situation. Failure to avoid this situation can result in serious or fatal injury.





#### CAUTION

This symbol alerts you to a potentially dangerous situation. Failure to avoid this situation can result in minor or medium injury.

#### NOTICE

This symbol alerts you to a potentially harmful situation. Failure to avoid this situation can result in damage to the product or something in its vicinity.

### 1.2.2 Electrical symbols

Symbol	Meaning
	Direct current
	Alternating current
	Direct and alternating current
	<b>Ground connection</b> A grounded terminal which, as far as the operator is concerned, is grounded via a grounding system.
	<b>Protective earth (PE)</b> Ground terminals that must be connected to ground prior to establishing any other connections.  The ground terminals are located on the interior and exterior of the device: <ul style="list-style-type: none"> <li>▪ Interior ground terminal: protective earth is connected to the mains supply.</li> <li>▪ Exterior ground terminal: device is connected to the plant grounding system.</li> </ul>

### 1.2.3 Tool symbols



Phillips head screwdriver



Flat blade screwdriver



Torx screwdriver



Allen key



Open-ended wrench

### 1.2.4 Symbols for certain types of information and graphics

 **Permitted**

Procedures, processes or actions that are permitted

  **Preferred**

Procedures, processes or actions that are preferred

 **Forbidden**

Procedures, processes or actions that are forbidden

 **Tip**

Indicates additional information



Reference to documentation



Reference to graphic



Notice or individual step to be observed

**1., 2., 3.**

Series of steps



Result of a step



Visual inspection



Operation via operating tool



Write-protected parameter

**1, 2, 3, ...**

Item numbers

**A, B, C, ...**

Views

 →  **Safety instructions**

Observe the safety instructions contained in the associated Operating Instructions



**Temperature resistance of the connection cables**

Specifies the minimum value of the temperature resistance of the connection cables

## 1.3 List of abbreviations

**BA**

Document type "Operating Instructions"

**KA**

Document type "Brief Operating Instructions"

**TI**

Document type "Technical Information"

**SD**

Document type "Special Documentation"

**XA**

Document type "Safety Instructions"

**PN**

Nominal pressure

**MWP**

Maximum working pressure

The MWP is indicated on the nameplate.

**ToF**

Time of Flight

**FieldCare**

Scalable software tool for device configuration and integrated plant asset management solutions

**DeviceCare**

Universal configuration software for Endress+Hauser HART, PROFIBUS, FOUNDATION Fieldbus and Ethernet field devices

**DTM**

Device Type Manager

 **$\epsilon_r$  (Dk value)**

Relative dielectric constant

**PLC**

Programmable logic controller (PLC)

**CDI**

Common Data Interface

**Operating tool**

The term "operating tool" is used in place of the following operating software: SmartBlue (app), for operation using an Android or iOS smartphone or tablet

**BD**

Blocking Distance; no signals are analyzed within the BD.

**PLC**

Programmable logic controller (PLC)

**CDI**

Common Data Interface

**PFS**

Pulse Frequency Status (Switch output)

**MBP**

Manchester Bus Powered

**PDU**

Protocol Data Unit

## 1.4 Documentation



For an overview of the scope of the associated Technical Documentation, refer to the following:

- *Device Viewer* ([www.endress.com/deviceviewer](http://www.endress.com/deviceviewer)): Enter the serial number from the nameplate
- *Endress+Hauser Operations app*: Enter serial number from nameplate or scan matrix code on nameplate.



The following documentation may be available depending on the device version ordered:

Document type	Purpose and content of the document
Technical Information (TI)	<b>Planning aid for your device</b> The document contains all the technical data on the device and provides an overview of the accessories and other products that can be ordered for the device.
Brief Operating Instructions (KA)	<b>Guide that takes you quickly to the 1st measured value</b> The Brief Operating Instructions contain all the essential information from incoming acceptance to initial commissioning.
Operating Instructions (BA)	<b>Your reference document</b> These Operating Instructions contain all the information that is required in the various life cycle phases of the device: from product identification, incoming acceptance and storage, to mounting, connection, operation and commissioning, through to troubleshooting, maintenance and disposal.
Description of Device Parameters (GP)	<b>Reference for your parameters</b> The document provides a detailed explanation of each individual parameter. The description is aimed at those who work with the device over the entire life cycle and perform specific configurations.
Safety Instructions (XA)	Depending on the approval, safety instructions for electrical equipment in hazardous areas are also supplied with the device. The Safety Instructions are a constituent part of the Operating Instructions.  Information on the Safety Instructions (XA) that are relevant for the device is provided on the nameplate.
Supplementary device-dependent documentation (SD/FY)	Always comply strictly with the instructions in the relevant supplementary documentation. The supplementary documentation is a constituent part of the device documentation.

## 1.5 Registered trademarks

### FOUNDATION™ Fieldbus

Registration-pending trademark of the FieldComm Group, Austin, Texas, USA

### Bluetooth®

The *Bluetooth*® word mark and logos are registered trademarks owned by the Bluetooth SIG, Inc. and any use of such marks by Endress+Hauser is under license. Other trademarks and trade names are those of their respective owners.

### Apple®

Apple, the Apple logo, iPhone, and iPod touch are trademarks of Apple Inc., registered in the U.S. and other countries. App Store is a service mark of Apple Inc.

### Android®

Android, Google Play and the Google Play logo are trademarks of Google Inc.

### KALREZ®, VITON®

Registered trademarks of DuPont Performance Elastomers L.L.C., Wilmington, DE USA

### TEFLON®

Registered trademark of E.I. DuPont de Nemours & Co., Wilmington, USA

### TRI-CLAMP®

Registered trademark of Ladish & Co., Inc., Kenosha, USA

## 2 Basic safety instructions

### 2.1 Requirements for the personnel

The personnel for installation, commissioning, diagnostics and maintenance must fulfill the following requirements:

- ▶ Trained, qualified specialists must have a relevant qualification for this specific function and task.
- ▶ Are authorized by the plant owner/operator.
- ▶ Are familiar with federal/national regulations.
- ▶ Before starting work, read and understand the instructions in the manual and supplementary documentation as well as the certificates (depending on the application).
- ▶ Follow instructions and comply with basic conditions.

The operating personnel must fulfill the following requirements:

- ▶ Are instructed and authorized according to the requirements of the task by the facility's owner-operator.
- ▶ Follow the instructions in this manual.

### 2.2 Intended use

#### Application and media

The measuring instrument described in this manual is intended only for the level measurement of bulk solids. Depending on the version ordered, the measuring instrument can also measure potentially explosive, flammable, poisonous and oxidizing media.

If the limit values specified in the "Technical data" and the conditions listed in the instructions and additional documentation are observed, the measuring instrument may be used only for the following measurements:

- ▶ Measured process variables: level
- ▶ Calculable process variables: volume or mass in any shape of vessel (calculated from the level by the linearization functionality)

To ensure that the measuring instrument remains in proper condition for the operation time:

- ▶ Use the measuring instrument only for media to which the process-wetted materials are sufficiently resistant.
- ▶ Observe the limit values in the "Technical data".

#### Incorrect use

The manufacturer is not liable for harm caused by improper or unintended use.

Clarification for borderline cases:

- ▶ For special fluids and fluids for cleaning, Endress+Hauser is glad to provide assistance in verifying the corrosion resistance of fluid-wetted materials, but does not accept any warranty or liability.

#### Residual risks

Due to heat transfer from the process as well as power loss in the electronics, the temperature of the electronics housing and the assemblies contained therein (e.g. display module, main electronics module and I/O electronics module) may rise up to 80 °C (176 °F). When in operation, the sensor may reach a temperature close to the medium temperature.

Danger of burns from contact with surfaces!

- ▶ In the event of elevated fluid temperatures, ensure protection against contact to prevent burns.

## 2.3 Workplace safety

When working on and with the device:

- ▶ Wear the required personal protective equipment as per national regulations.

## 2.4 Operational safety

Risk of injury!

- ▶ Operate the device only if it is in proper technical condition, free from errors and faults.
- ▶ The operator is responsible for ensuring that the device is in good working order.

### Modifications to the device

Unauthorized modifications to the device are not permitted and can lead to unforeseeable dangers:

- ▶ If modifications are nevertheless required, consult with the manufacturer.

### Repair

To ensure continued operational safety and reliability:

- ▶ Carry out repairs on the device only if they are expressly permitted.
- ▶ Observe national regulations pertaining to the repair of an electrical device.
- ▶ Use only original spare parts and accessories from the manufacturer.

### Hazardous area

To eliminate danger to persons or the installation when the device is used in the hazardous area (e.g. explosion protection, pressure vessel safety):

- ▶ Check the nameplate to verify if the device ordered can be put to its intended use in the hazardous area.
- ▶ Observe the specifications in the separate supplementary documentation included as an integral part of these instructions.

## 2.5 Product security

This measuring instrument is designed in accordance with good engineering practice to meet state-of-the-art safety requirements, has been tested, and left the factory in a condition in which it is safe to operate. It meets general safety standards and legal requirements.

### NOTICE

#### Loss of degree of protection by opening of the device in humid environments

- ▶ If the device is opened in a humid environment, the degree of protection indicated on the nameplate is no longer valid. This may also impair the safe operation of the device.

### 2.5.1 CE mark

The measuring system meets the legal requirements of the applicable EU directives. These are listed in the corresponding EU Declaration of Conformity together with the standards applied.

The manufacturer confirms successful testing of the device by affixing to it the CE mark.

### 2.5.2 EAC conformity

The measuring system meets the legal requirements of the applicable EAC guidelines. These are listed in the corresponding EAC Declaration of Conformity along with the standards applied.

The manufacturer confirms successful testing of the device by affixing to it the EAC mark.

## 3 Product description

### 3.1 Product design

#### 3.1.1 Levelflex FMP56/FMP57

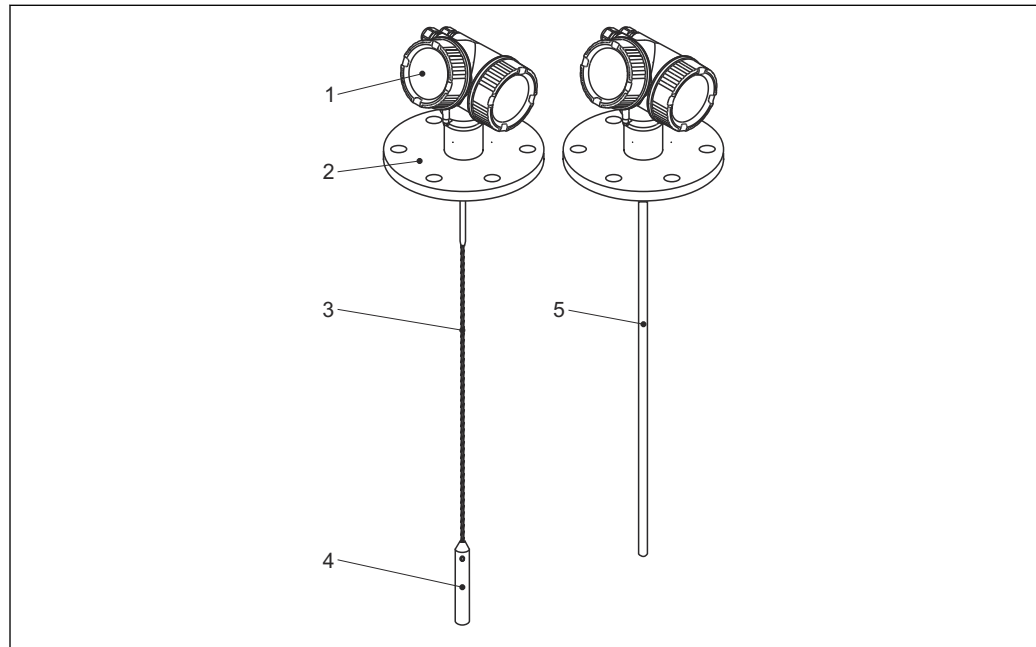

A0012470

#### 1 Design of the Levelflex

- 1 Electronics housing
- 2 Process connection (here as an example: flange)
- 3 Rope probe
- 4 End-of-probe weight
- 5 Rod probe

### 3.1.2 Electronics housing

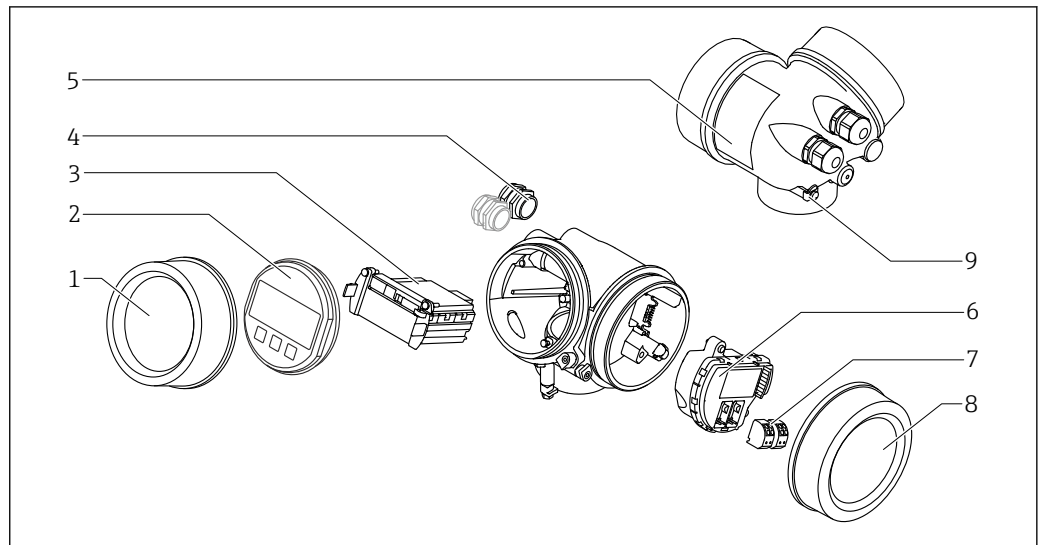

A0012422

#### 2 Design of the electronics housing

- 1 Electronics compartment cover
- 2 Display module
- 3 Main electronics module
- 4 Cable glands (1 or 2, depending on instrument version)
- 5 Nameplate
- 6 I/O electronics module
- 7 Terminals (pluggable spring terminals)
- 8 Connection compartment cover
- 9 Grounding terminal

## 4 Incoming acceptance and product identification

### 4.1 Incoming acceptance

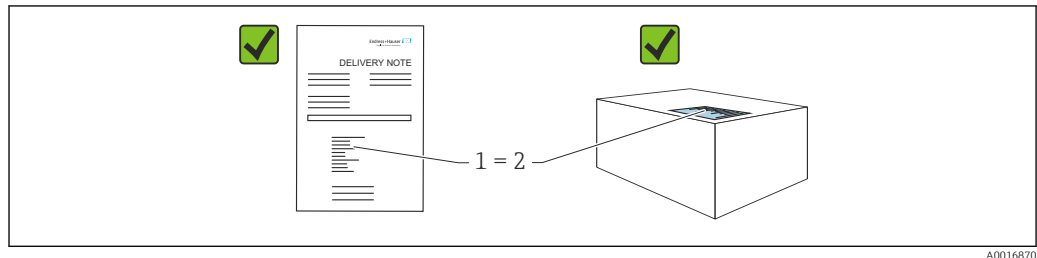

Check the following during incoming acceptance:

- Is the order code on the delivery note (1) identical to the order code on the product sticker (2)?
- Are the goods undamaged?
- Do the data on the nameplate correspond to the order specifications and the delivery note?
- Is the documentation provided?
- If required (see nameplate): are the Safety Instructions (XA) provided?



If one of these conditions is not met, please contact the manufacturer's sales office.

### 4.2 Product identification

The following options are available for identification of the device:

- Nameplate specifications
- Extended order code with breakdown of the device features on the delivery note
- ▶ *Device Viewer* ([www.endress.com/deviceviewer](http://www.endress.com/deviceviewer)); manually enter the serial number from the nameplate.
  - ↳ All the information about the measuring device is displayed.
- ▶ *Endress+Hauser Operations app*; manually enter the serial number indicated on the nameplate or scan the 2D matrix code on the nameplate.
  - ↳ All the information about the measuring device is displayed.

#### 4.2.1 Nameplate

The information that is required by law and is relevant to the device is shown on the nameplate, e.g.:

- Manufacturer identification
- Order number, extended order code, serial number
- Technical data, degree of protection
- Firmware version, hardware version
- Approval-related information, reference to Safety Instructions (XA)
- DataMatrix code (information about the device)

#### **4.2.2 Manufacturer address**

Endress+Hauser SE+Co. KG  
Hauptstraße 1  
79689 Maulburg, Germany  
Place of manufacture: See nameplate.

## 5 Storage, transport

### 5.1 Storage temperature

- Permitted storage temperature:  $-40$  to  $+80$  °C ( $-40$  to  $+176$  °F)
- Use original packaging.

### 5.2 Transporting to the measuring point

#### ⚠ WARNING

Housing or probe may become damaged or break off.

Risk of injury!

- ▶ Transport the measuring instrument to the measuring point in its original packaging or by the process connection.
- ▶ Always secure lifting equipment (slings, eyes, etc.) at the process connection and never lift the device by the electronic housing or probe. Pay attention to the center of gravity of the device so that it does not tilt or slip unintentionally.
- ▶ Follow the safety instructions and transport conditions for devices weighing more than 18 kg (39.6 lbs) (IEC 61010).

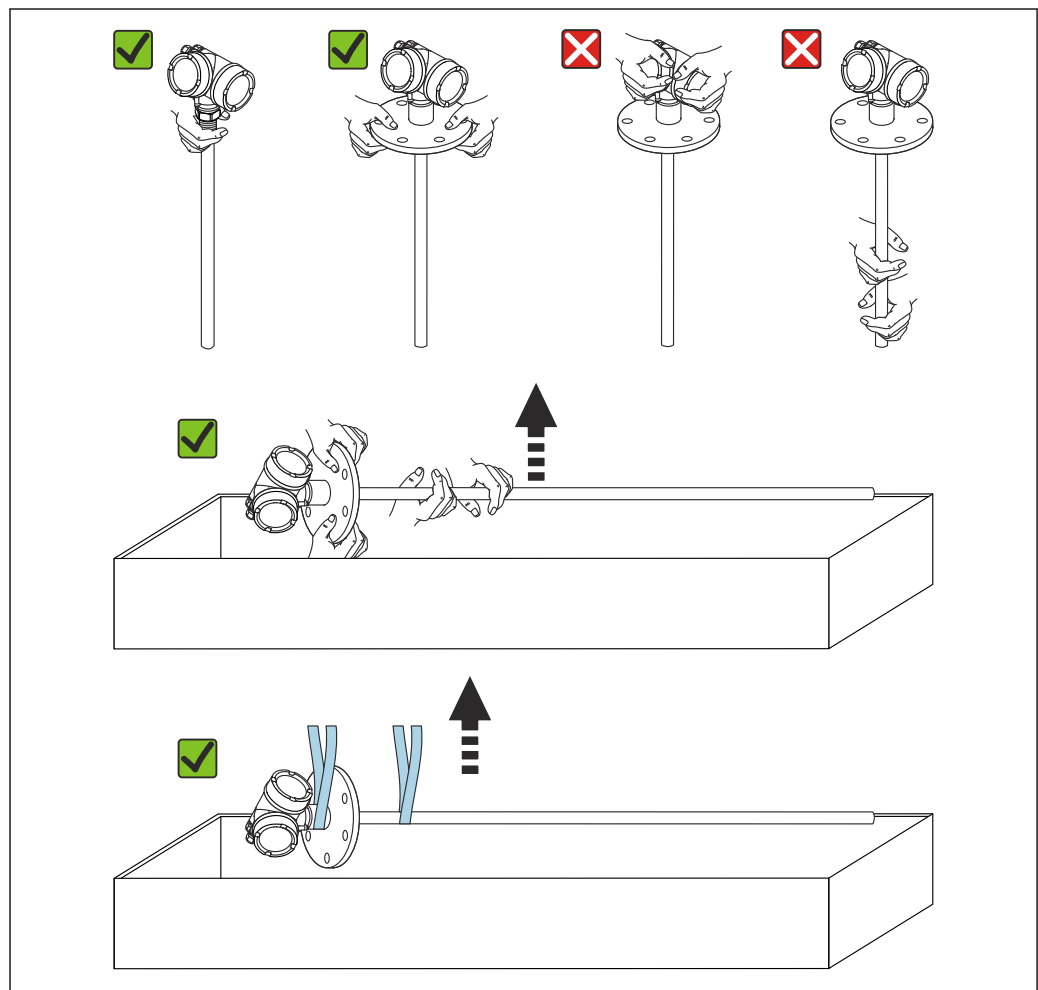

A0043233



## 6 Installation

### 6.1 Mounting requirements

#### 6.1.1 Suitable mounting position

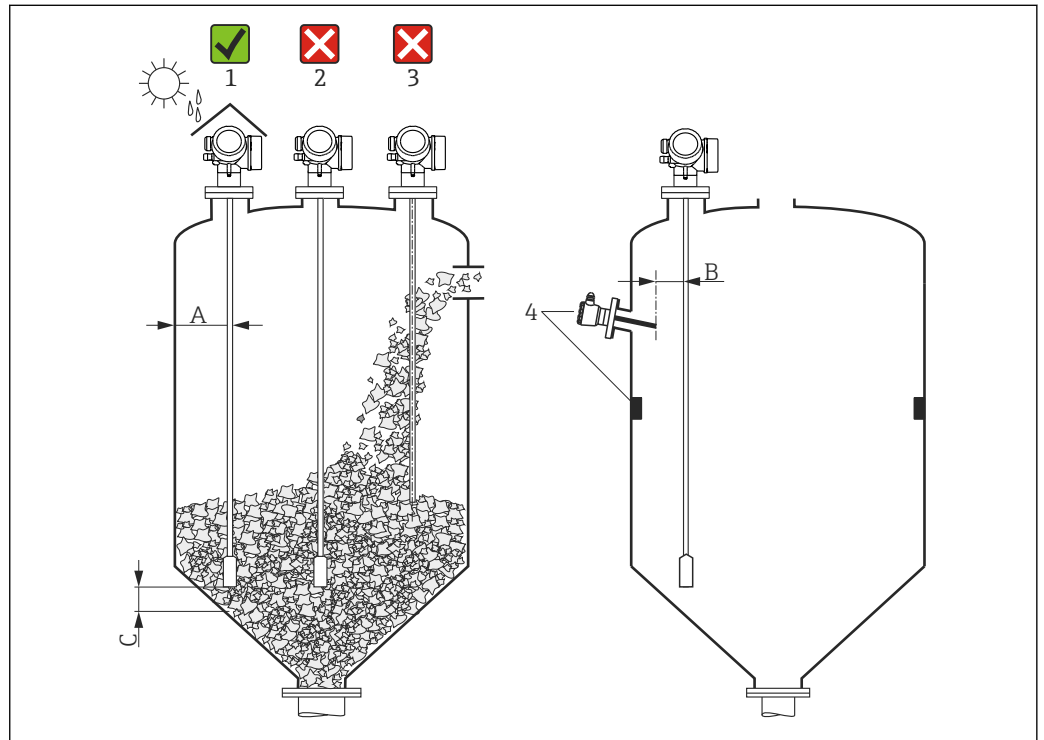

3 Installation positions

A0021468

#### Spacing requirements when mounting

- Distance (A) between the vessel wall and rod and rope probes:
  - For smooth metallic walls: > 50 mm (2 in)
  - For plastic walls: > 300 mm (12 in) to metallic parts outside the vessel
  - For concrete walls: > 500 mm (20 in), otherwise the permitted measuring range may be reduced.
- Distance (B) between rod probes and internal fittings (3): > 300 mm (12 in)
- When using more than one Levelflex:
  - Minimum distance between the sensor axes: 100 mm (3.94 in)
- Distance (C) from the end of the probe to the bottom of the vessel:
  - Rope probe: > 150 mm (6 in)
  - Rod probe: > 10 mm (0.4 in)

### Additional mounting requirements

- When mounting outdoors, a weather protection cover (1) can be used to protect the device against extreme weather conditions.
  - In metallic vessels, preferably do not mount the probe in the center of the vessel (2), as this would lead to increased interference echoes.  
If a central mounting position cannot be avoided, it is essential to perform interference echo suppression (mapping) after commissioning the device.
  - Do not mount the probe in the filling curtain (3).
  - Avoid buckling the rope probe during installation or operation (e.g. as a result of product movement against silo wall) by selecting a suitable mounting location.
  - The probe must be checked regularly for damage during operation.
- i** In the case of freely suspended rope probes (probe end not fixed at the bottom), the distance between the probe rope and internal fittings, which can change due to the movement of the product, must never be less than 300 mm (12 in). Occasional contact between the probe weight and the cone of the vessel, however, does not influence the measurement provided that the relative permittivity is at least  $\epsilon_r = 1.8$ .
- i** When mounting the housing in a recess (e.g. in a concrete ceiling), observe a minimum distance of 100 mm (4 in) between the cover of the connection compartment/electronics compartment and the wall. Otherwise the connection compartment/electronics compartment will not be accessible after installation.

### 6.1.2 Mounting under confined conditions

#### Mounting with remote probe

The device version with a remote probe is suitable for applications with restricted mounting space. In this case, the electronics housing is mounted at a separate position from the probe.

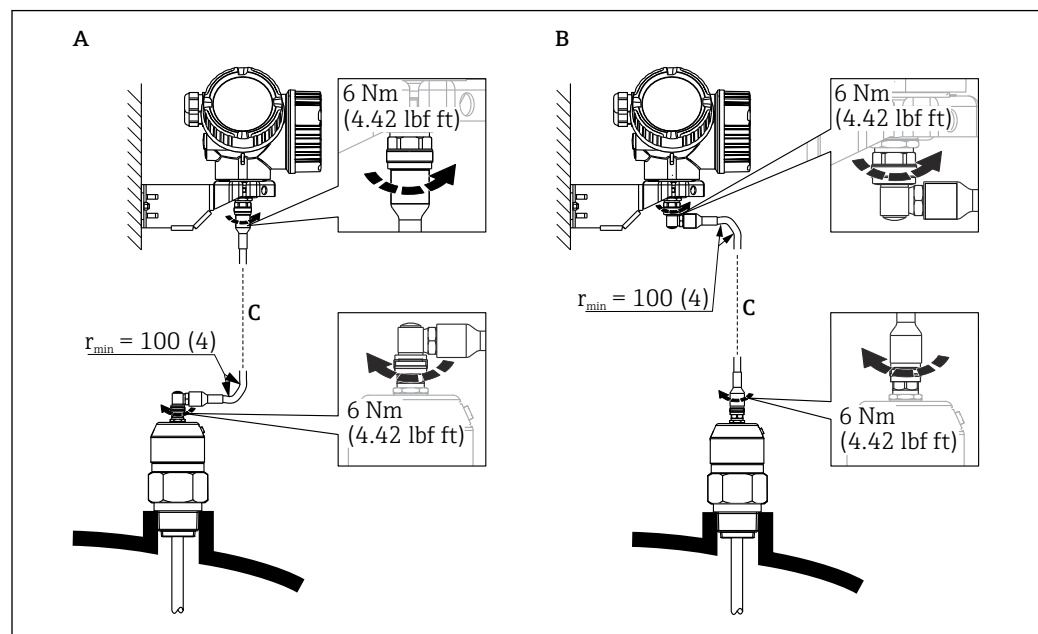

- A Angled plug at the probe  
 B Angled plug at the electronics housing  
 C Length of the remote cable as ordered

A0014794

- Product structure, feature 600 "Probe design":
  - Version MB "Remote sensor, 3 m cable"
  - Version MC "Remote sensor, 6 m cable"
  - Version MD "Remote sensor, 9 m cable"
- The connecting cable is included in the delivery with these versions. Minimum bending radius: 100 mm (4 inch)
- The mounting bracket for the electronics housing is included in the delivery with these versions. Mounting options:
  - Wall mounting
  - Mounting on DN32 to DN50 (1¼ to 2 inch) post or pipe
- The connecting cable has one straight plug and one plug angled at 90°. Depending on the local conditions the angled plug can be connected at the probe or at the electronics housing.

 The probe, electronics and connection cable are mutually compatible and bear a common serial number. Only components with the same serial number may be connected to one another.

### 6.1.3 Notes on the mechanical load of the probe

#### Tensile load

Bulk solids exert tensile forces on rope probes which increase with:

- The probe length, i.e. the maximum cover
- The bulk density of the product
- The silo diameter and
- The diameter of the probe rope

As the tensile forces also depend greatly on the flowability of the product, a higher safety factor is necessary for highly viscous products and if there is a risk of cornice buildup. In critical cases it is better to use a 6 mm (0.24 in) rope instead of a 4 mm (0.16 in) one.

The same forces also act on the silo ceiling. The tensile forces on a fixed rope are always greater, but cannot be calculated. Observe the tensile loading capacity of the probes.

Ways to reduce the tensile forces:

- Shorten the probe.
- If the maximum tensile load is exceeded, check whether it would be possible to use a non-contact ultrasonic or level radar device.

The following diagrams show typical loads for common bulk solids as reference values. The calculation was performed for the following conditions:

- Calculation according to DIN 1055, Part 6 for the cylindrical part of the silo
- Suspended probe (probe end not fixed at the bottom)
- Free-flowing bulk solid, i.e. mass flow. A calculation for core flow is not possible. In the event of collapsing cornices, considerably higher loads can occur.
- The specification for tensile forces contains safety factor 2 (in addition to the safety factors already contained in DIN 1055), which compensates for the normal fluctuation range in pourable bulk solids.

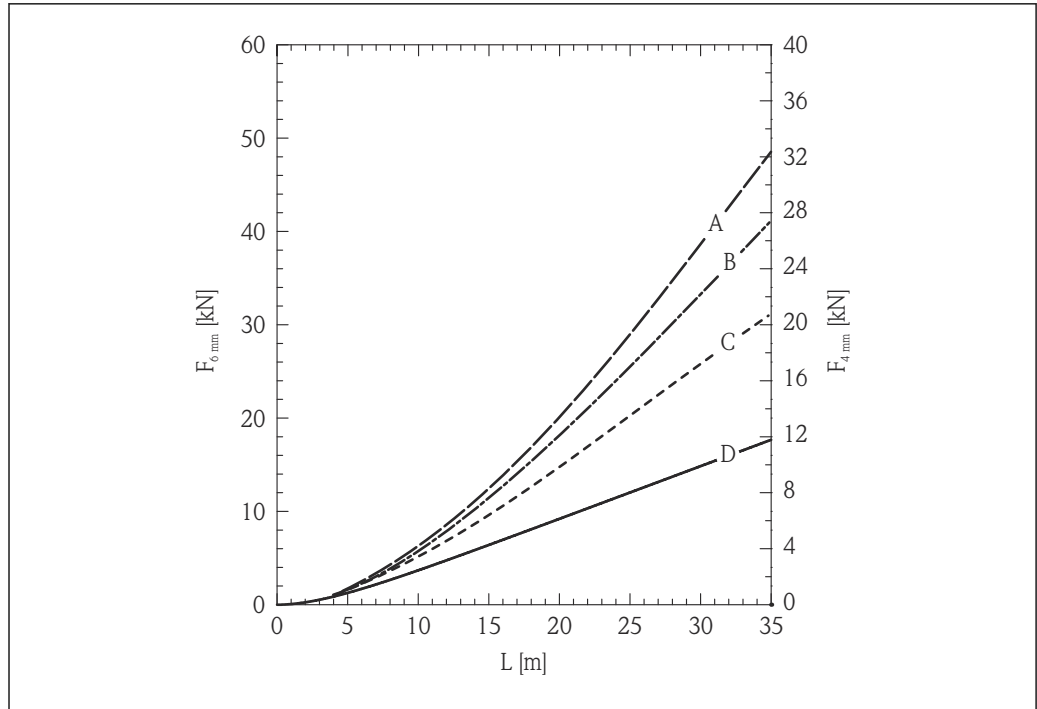

A0017170

4 Silica sand in metal silo with smooth walls; tensile load as a function of level  $L$  for rope diameters 6 mm (0.24 in) and 4 mm (0.16 in)

- A Silo diameter 12 m (40 ft)
- B Silo diameter 9 m (30 ft)
- C Silo diameter 6 m (20 ft)
- D Silo diameter 3 m (10 ft)

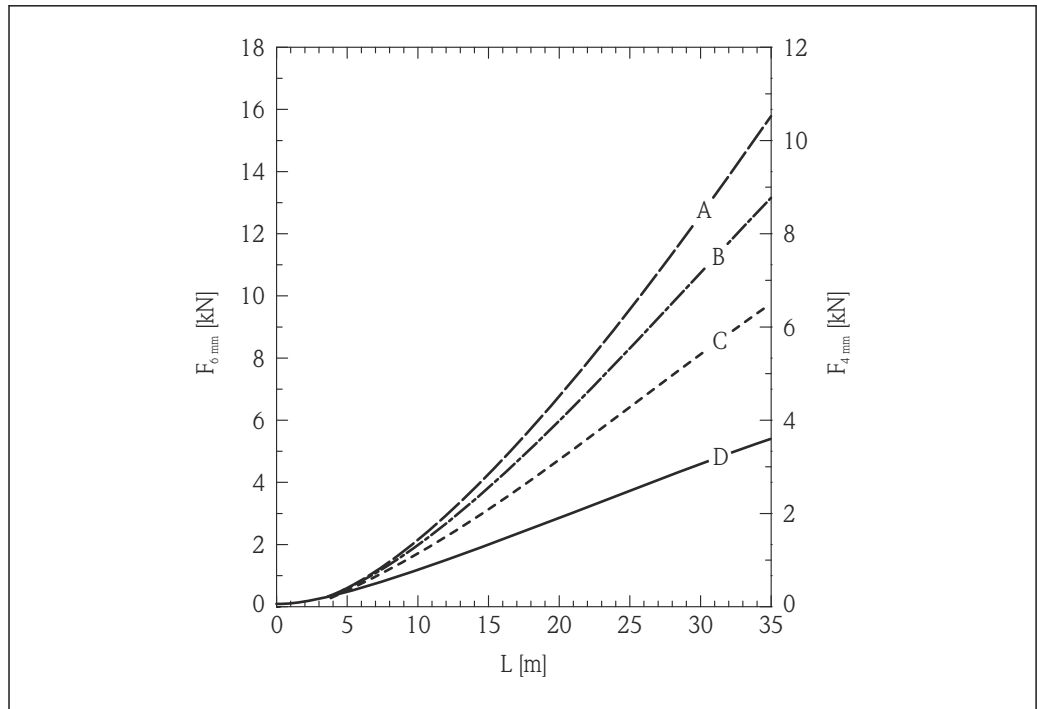

A0017171

5 Polyethylene pellets in metal silo with smooth walls; tensile load as a function of level  $L$  for rope diameters 6 mm (0.24 in) and 4 mm (0.16 in)

- A Silo diameter 12 m (40 ft)
- B Silo diameter 9 m (30 ft)
- C Silo diameter 6 m (20 ft)
- D Silo diameter 3 m (10 ft)

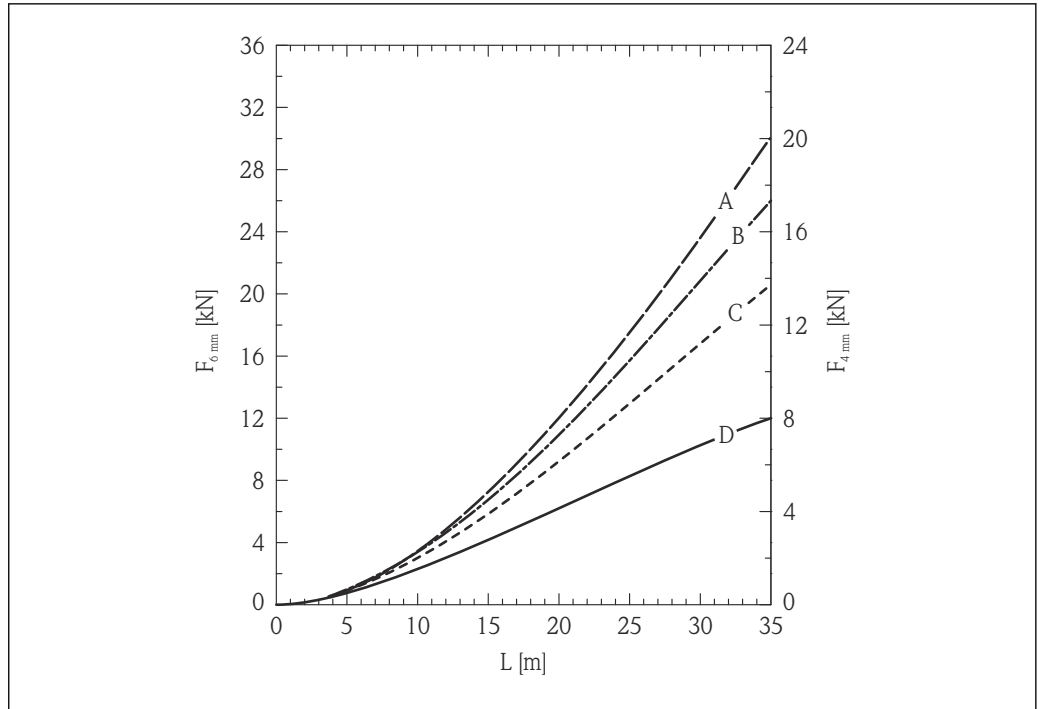

A0017172

6 Wheat in metal silo with smooth walls; tensile load as a function of level L for rope diameters 6 mm (0.24 in) and 4 mm (0.16 in)

- A Silo diameter 12 m (40 ft)
- B Silo diameter 9 m (30 ft)
- C Silo diameter 6 m (20 ft)
- D Silo diameter 3 m (10 ft)

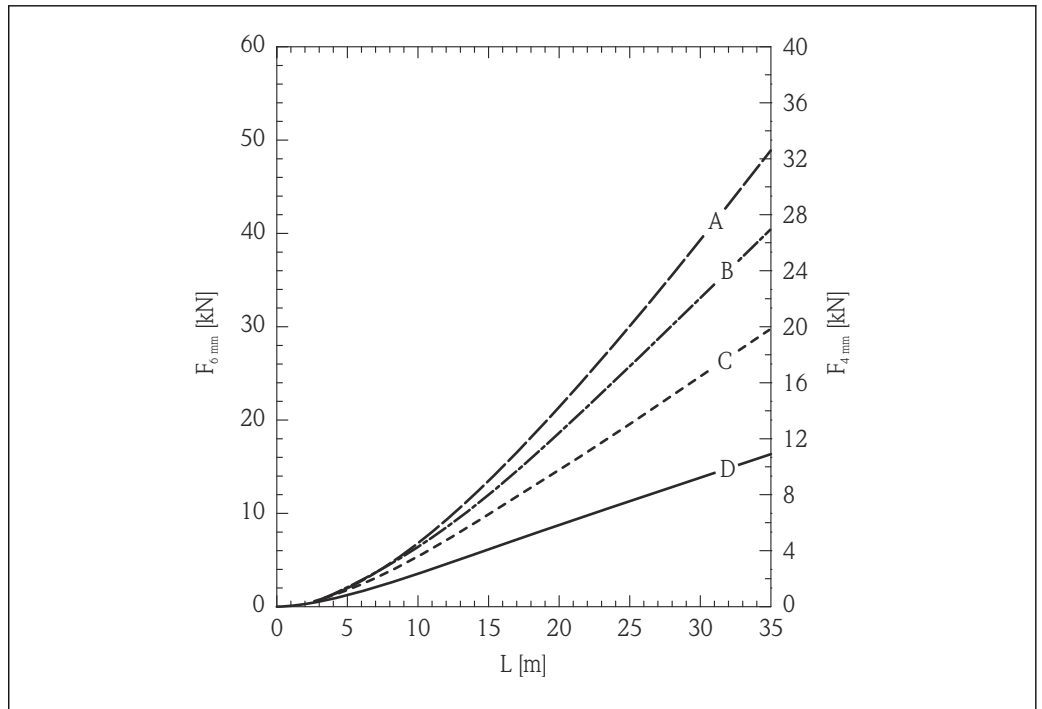

A0017173

7 Cement in metal silo with smooth walls; tensile load as a function of level L for rope diameters 6 mm (0.24 in) and 4 mm (0.16 in)

- A Silo diameter 12 m (40 ft)
- B Silo diameter 9 m (30 ft)
- C Silo diameter 6 m (20 ft)
- D Silo diameter 3 m (10 ft)

### Tensile loading capacity of rope probe and breaking load (silo ceiling)

**i** The ceiling of the silo must be designed to withstand the maximum breaking load.

#### FMP56

##### Rope 4 mm (1/8 in) 316

- Tensile loading capacity 12 kN
- Max. breaking load 20 kN

##### Rope 6 mm (1/4 in) PA>steel

- Tensile loading capacity 12 kN
- Max. breaking load 20 kN

#### FMP57

##### Rope 4 mm (1/8 in) 316

- Tensile loading capacity 12 kN
- Max. breaking load 20 kN

##### Rope 6 mm (1/4 in) 316

- Tensile loading capacity 30 kN
- Max. breaking load 42 kN

##### Rope 6 mm (1/4 in) PA>steel

- Tensile loading capacity 12 kN
- Max. breaking load 20 kN

##### Rope 8 mm (1/3 in) PA>steel

- Tensile loading capacity 30 kN
- Max. breaking load 42 kN

### Lateral loading capacity (flexural strength) of rod probes

#### FMP57

##### Rod 16 mm (0.63 in) 316L

Flexural strength 30 Nm

## 6.1.4 Information concerning the process connection

**i** Probes are mounted on the process connection with threaded connections or flanges. If there is the danger with this installation that the probe end moves so much that it occasionally touches the vessel floor or cone, the probe may need to be shortened at the lower end and fixed in place.

### Threaded connection

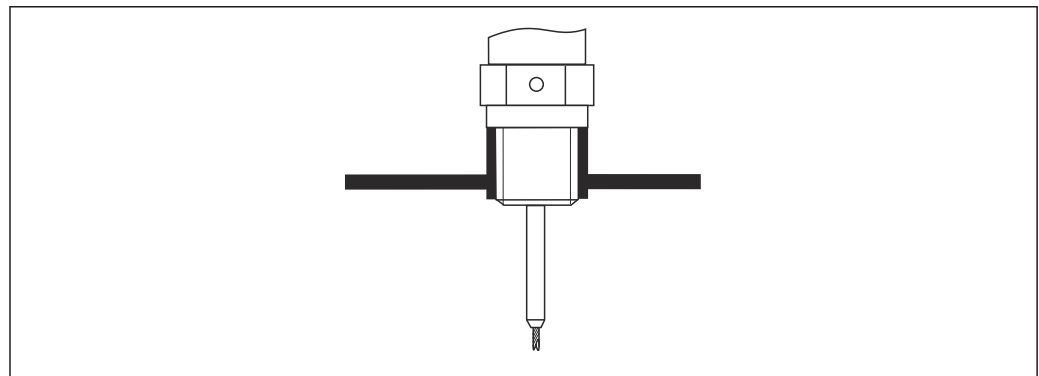

**8** Mounting with threaded connection; flush with the vessel ceiling

A0015121

### Sealing

The thread and the type of seal comply with DIN3852 Part 2, screwed plug, form A.

The following types of sealing ring can be used:

- For thread G $\frac{3}{4}$ " : according to DIN7603 with dimensions 27 mm × 32 mm
- For thread G1 $\frac{1}{2}$ " : according to DIN 7603 with dimensions 48 mm × 55 mm

Use a sealing ring according to this standard in form A, C or D and of a material that offers appropriate resistance for the application.

### Nozzle installation

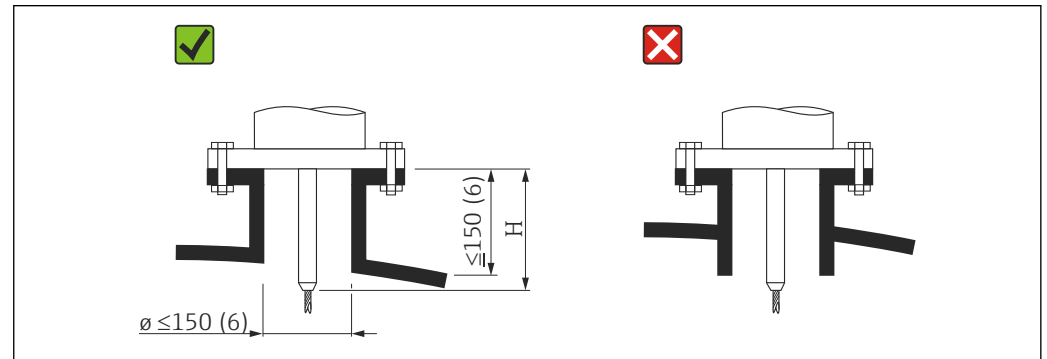

*H* Length of the centering rod or the rigid part of the rope probe

#### FMP56

**Rope,  $\phi$  4 mm (0.16 in)**

Length H 120 mm (4.7 in)

#### FMP57

**Rope,  $\phi$  4 mm (0.16 in)**

Length H 94 mm (3.7 in)

**Rope,  $\phi$  6 mm (0.24 in)**

Length H 135 mm (5.3 in)

- Permissible nozzle diameter:  $\leq 150$  mm (6 in)  
For larger diameters, the near-range measuring capability may be reduced.  
For large nozzles, see the section "Mounting in nozzles  $\geq$ DN300"
- Permissible nozzle height:  $\leq 150$  mm (6 in)  
For larger heights, the near-range measuring capability may be reduced.  
Larger nozzle heights are possible in special cases (on request), see section "Rod extension/centering device HMP40 for FMP57".
- The end of the nozzle should be flush with the tank ceiling in order to avoid ringing effects.

**i** In thermally insulated vessels, the nozzle should also be insulated in order to prevent condensate formation.

*Rod extension/centering device HMP40 for FMP57*

For FMP57 with rope probes, the rod extension/centering device HMP40 is available as an accessory. It must be used if the probe rope would otherwise come into contact with the lower edge of the nozzle.

**i** This accessory consists of the extension rod, corresponding to the nozzle height, on which a centering disk is also mounted if the nozzles are narrow or when used in bulk solids. We deliver this component separately from the device. Please order a correspondingly shorter probe length.

Only use centering disks with small diameters (DN40 and DN50) if there is no significant build-up in the nozzle above the disk. The nozzle must not become clogged with product.

*Mounting in nozzles  $\geq$  DN300*

If installation in nozzles  $\geq$  300 mm (12 in) is unavoidable, installation must be carried out in accordance with the following diagram in order to avoid interference signals in the near range.

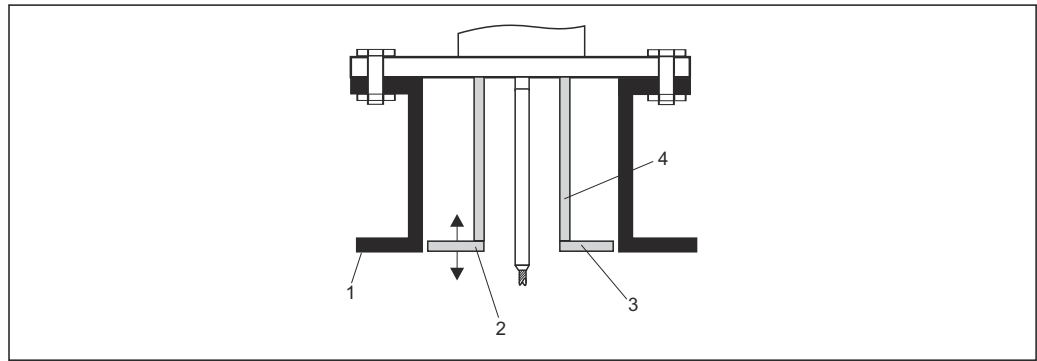

A0014199

- 1 Lower edge of the nozzle
- 2 Approximately flush with the lower edge of the nozzle ( $\pm 50$  mm)
- 3 Plate, nozzle  $\varnothing$  300 mm (12 in) = plate  $\varnothing$  280 mm (11 in); nozzle  $\varnothing$   $\geq$  400 mm (16 in) = plate  $\varnothing$   $\geq$  350 mm (14 in)
- 4 Pipe  $\varnothing$  150 to 180 mm



## 6.1.5 Securing the probe

### Securing rope probes

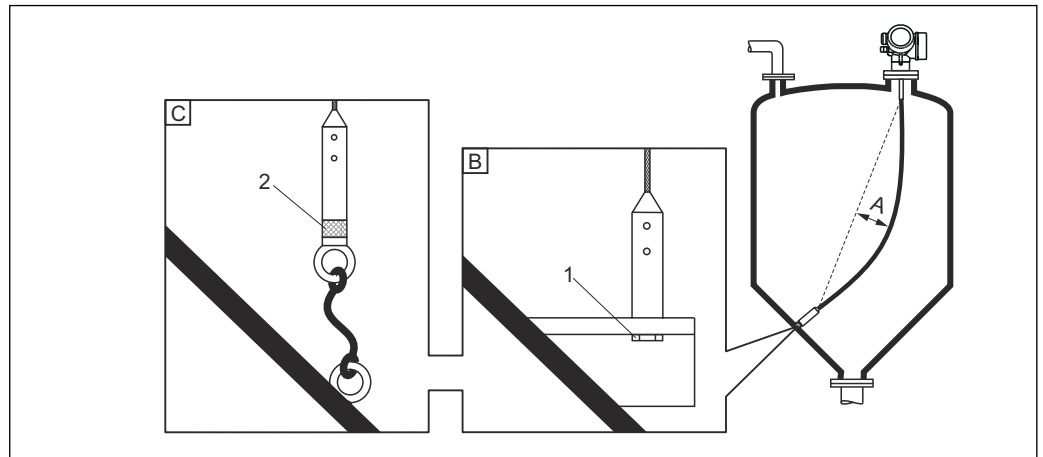

- A Sag:  $\geq 10 \text{ mm/m}$  (0.12 in/ft) probe length  
 B Reliably grounded end of probe  
 C Reliably insulated end of probe  
 1 Fastener in female thread of probe weight  
 2 Insulated fastening kit

- The end of the rope probe must be secured or fixed down under the following conditions:
  - If the probe temporarily comes into contact with the vessel wall, the cone, internal fittings/beams or another part of the installation
  - If the probe comes closer than 0.5 m (1.6 ft) to a concrete wall.
- A female thread is provided in the probe weight to secure the end of the probe:
  - Rope 4 mm ( $\frac{1}{8}$  in), 316: M 14
  - Rope 6 mm ( $\frac{1}{4}$  in), 316: M 20
  - Rope 6 mm ( $\frac{1}{4}$  in), PA>steel: M14
  - Rope 8 mm ( $\frac{1}{2}$  in), PA>steel: M20
- Far higher tensile loads occur on the probe when it is fixed down. It is therefore preferable to use the 6 mm ( $\frac{1}{4}$  in) rope probe.
- When fixed down, the end of the probe must be reliably grounded or reliably insulated. If it is not otherwise possible to secure the probe with a reliably insulated connection, use the insulated fastening kit.
- If the end of the probe is fixed down and grounded, the search for a positive end-of-probe signal must be activated. Otherwise automatic probe length correction is not possible.  
 Navigation: Expert → Sensor → EOP evaluation → EOP search mode  
 Setting: **Positive EOP** option
- To prevent an extremely high tensile load (e.g. due to thermal expansion) and the risk of the rope breaking, the rope must be slack. Required sag:  $\geq 10 \text{ mm/m}$  (0.12 in/ft) rope length.  
 Pay attention to the tensile loading capacity of rope probes.

### Securing rod probes

- In the case of WHG approval: a support is required for probe lengths  $\geq 3 \text{ m}$  (10 ft).
- In general, rod probes must be secured in the event of horizontal flow (e.g. from an agitator) or strong vibrations.
- Only secure rod probes directly at the end of the probe.

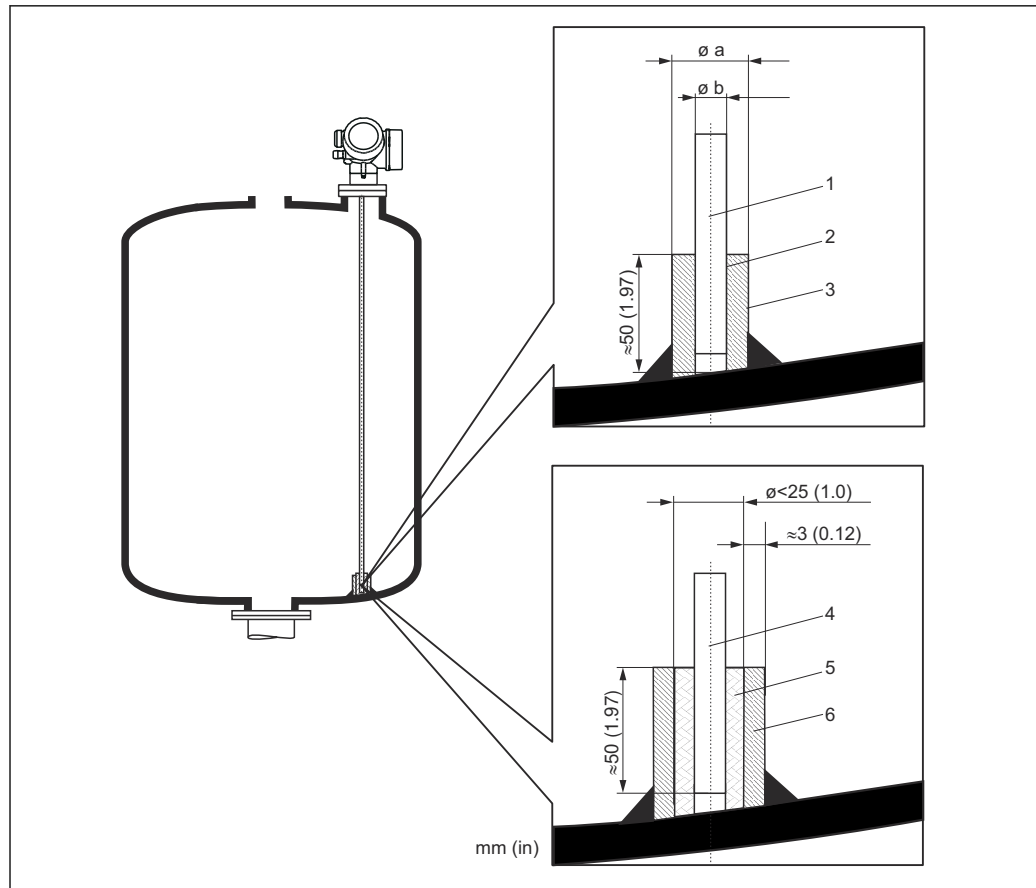

A0012607

Unit of measurement mm (in)

- 1 Probe rod, uncoated
- 2 Sleeve with narrow bore to ensure electrical contact between the sleeve and the rod.
- 3 Short metal pipe, e.g. welded in place
- 4 Probe rod, coated
- 5 Plastic sleeve, e.g. PTFE, PEEK, PPS
- 6 Short metal pipe, e.g. welded in place

#### NOTICE

**Poor grounding of the probe end may cause incorrect measurements.**

- ▶ Use a sleeve with a narrow bore to ensure good electrical contact between the sleeve and the probe rod.

#### NOTICE

**Welding can damage the main electronics module.**

- ▶ Before welding: Ground the probe rod and remove the electronics.

### 6.1.6 Special installation situations

#### Concrete silos

Installation in a thick concrete ceiling, for example, should be flush with the lower edge. Alternatively, the probe can also be installed in a pipe that must not protrude over the lower edge of the silo ceiling. The pipe should be as short as possible. For installation suggestions, see the diagram below.

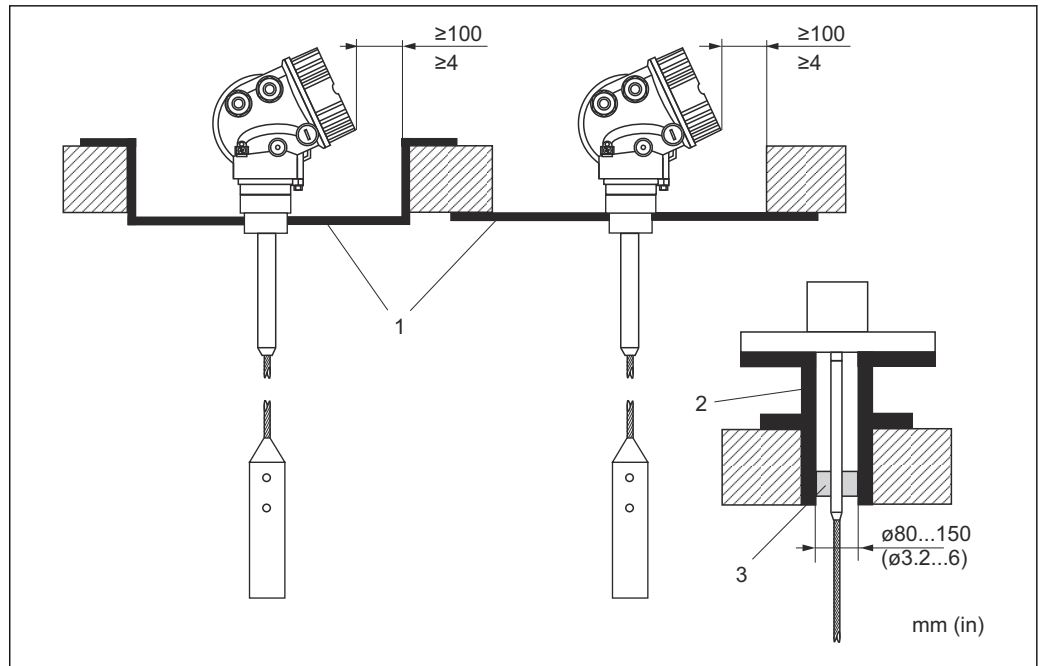

A0014138

- 1 Metal plate
- 2 Metal pipe
- 3 Rod extension/centering device HMP40 (see "Accessories")



**Installation with rod extension/centering device (accessory):**

Strong dust generation can lead to build-up behind the centering disk. This can result in interference echoes. For other installation options, please contact Endress+Hauser.

**Mounting from the side**

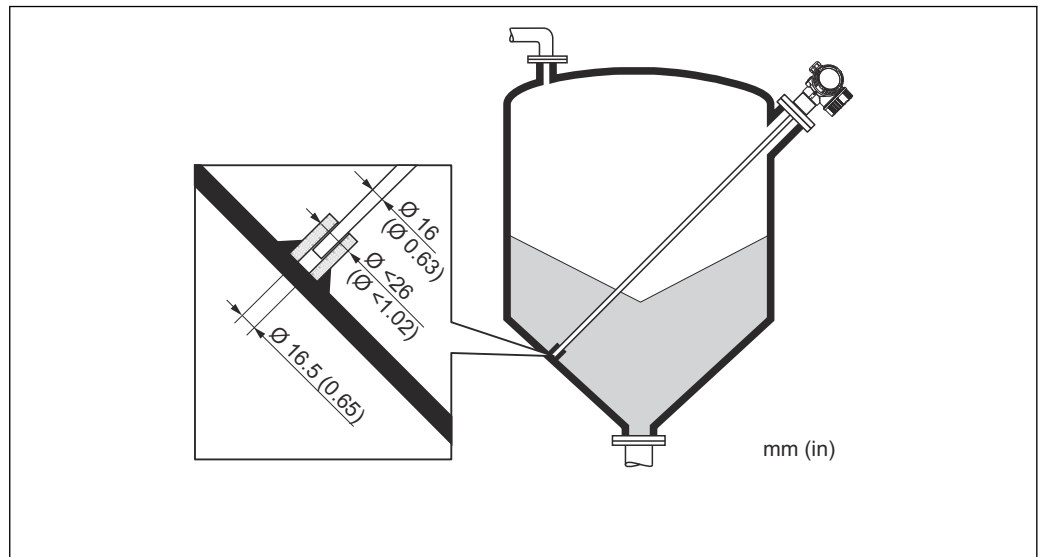

A0014140

- If installation from above is not possible, the device can also be mounted from the side
- Always secure the rope probe in this case
- Support the rod and coaxial probe if the lateral load-bearing capacity is exceeded
- Only secure rod probes at the end of the probe

**Non-metal vessels**

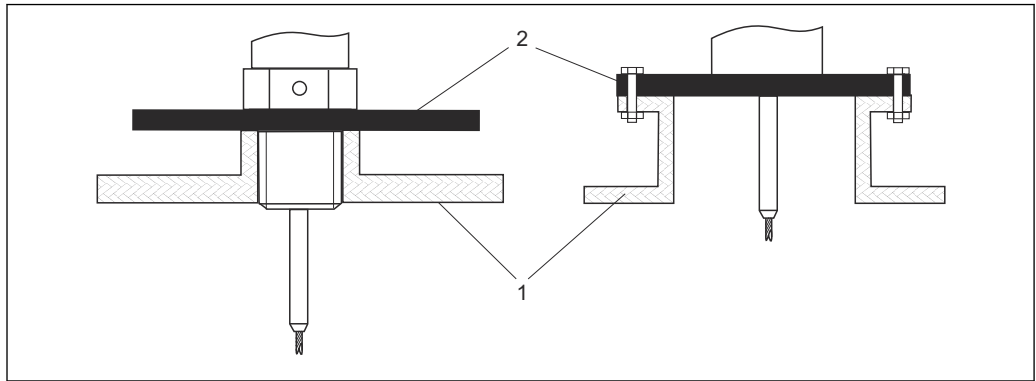

A0012527

- 1 Non-metal vessel
- 2 Metal sheet or metal flange

To ensure good measurement results when mounting on non-metal vessels

- Use a device with a metal flange (minimum size DN50/2").
- Alternatively, mount a metal plate with a diameter of at least 200 mm (8 in) at a right angle to the probe at the process connection.

**Vessel with thermal insulation**

**i** If process temperatures are high, the device must be included in normal vessel insulation (1) in order to prevent the electronics heating up as a result of thermal radiation or convection. The insulation may not go beyond the points labeled "MAX" in the drawings.

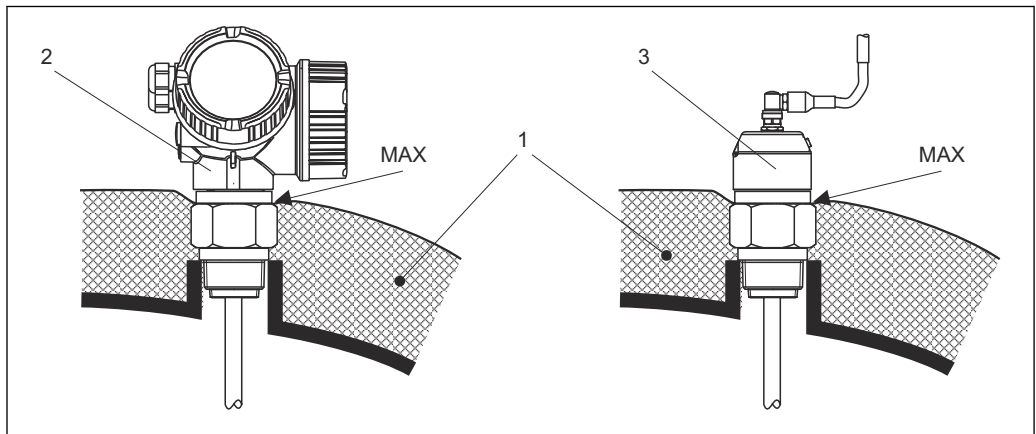

A0014653

- 9 Process connection with thread
- 1 Vessel insulation
- 2 Compact device
- 3 Sensor, remote

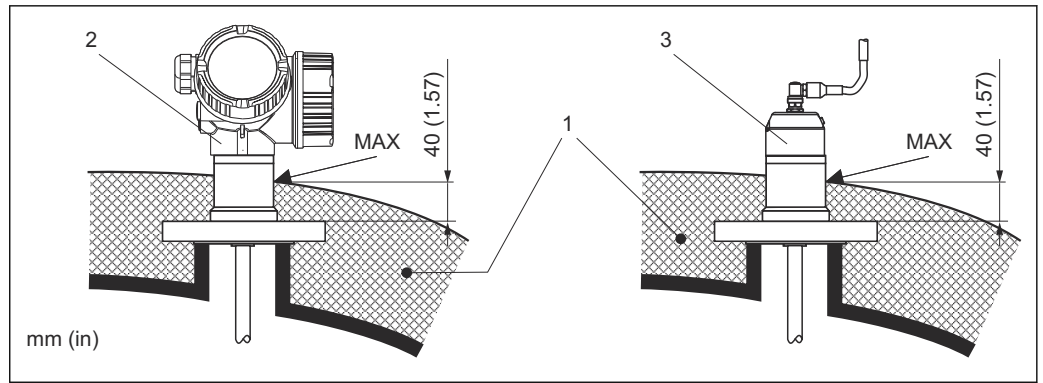

10 Process connection with flange - FMP57

- 1 Vessel insulation
- 2 Compact device
- 3 Sensor, remote

## 6.2 Mounting the device

### 6.2.1 Tool list

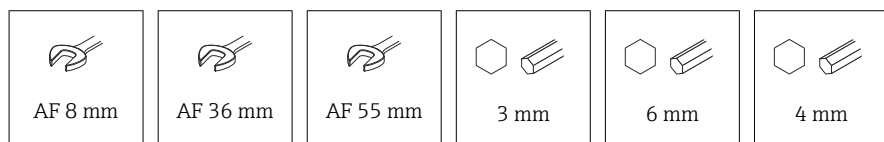

- To shorten rope probes: use a saw or bolt cutters.
- To shorten rod or coaxial probes: use a saw.
- For flanges and other process connections: use an appropriate mounting tool.

### 6.2.2 Shortening the probe

#### Shortening rod probes

Rod probes must be shortened if the distance to the vessel floor or outlet cone is less than 10 mm (0.4 in). To shorten, saw off the bottom end of the rod probe.

#### Shortening rope probes

Rope probes must be shortened if the distance to the vessel floor or outlet cone is less than 150 mm (6 in).

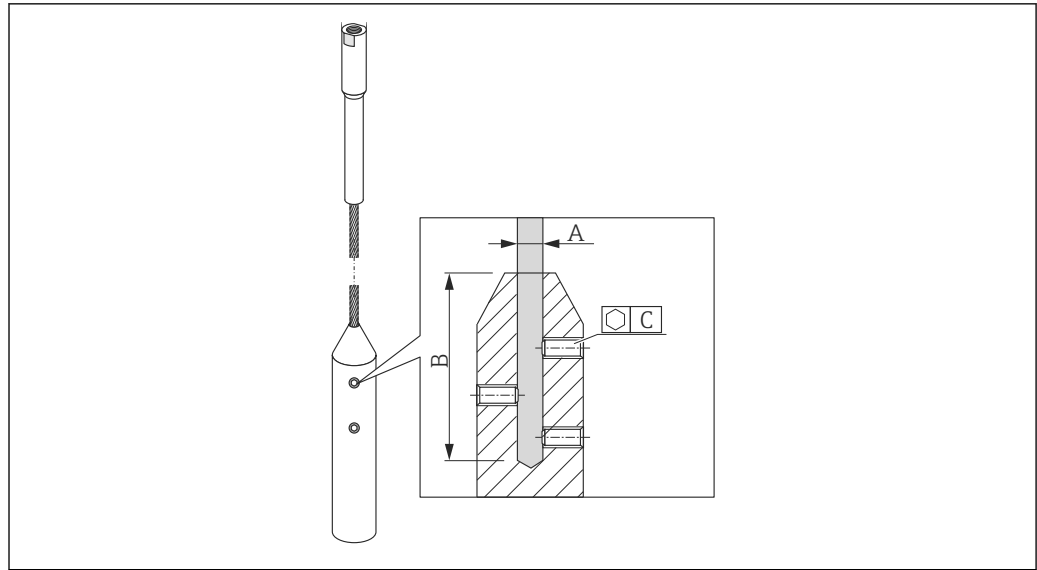

A0021693

**Rope material 316**

- A:  
4 mm (0.16 in)
- B:  
40 mm (1.6 in)
- C:  
3 mm; 5 Nm (3.69 lbf ft)

**Rope material 316**

- A:  
6 mm (0.24 in)
- B:  
70.5 mm (2.78 in)
- C:  
4 mm; 15 Nm (11.06 lbf ft)

**Rope material PA > steel**

- A:  
6 mm (0.24 in)
- B:  
40 mm (1.6 in)
- C:  
3 mm; 5 Nm (3.69 lbf ft)

**Rope material PA > steel**

- A:  
8 mm (0.31 in)
- B:  
70.5 mm (2.78 in)
- C:  
4 mm; 15 Nm (11.06 lbf ft)

1. Using an Allen key, loosen the set screws on the rope weight. Note: The setscrews have a clamping coating in order to prevent them from becoming loose accidentally. A higher torque is therefore required to loosen the screws.
2. Remove the released rope from the weight.
3. Measure off the new rope length.
4. At the point to be shortened, wrap adhesive tape around the rope to prevent it from fraying.

5. Saw off the rope at a right angle or cut it off with a bolt cutter.
6. Insert the rope completely into the weight.
7. Screw the setscrews back into place. Due to the clamping coating of the setscrews, it is not necessary to apply a locking compound.

### Entering the new probe length

After shortening the probe:

1. Switch to the **Probe settings** submenu and perform a probe length correction.
- 2.

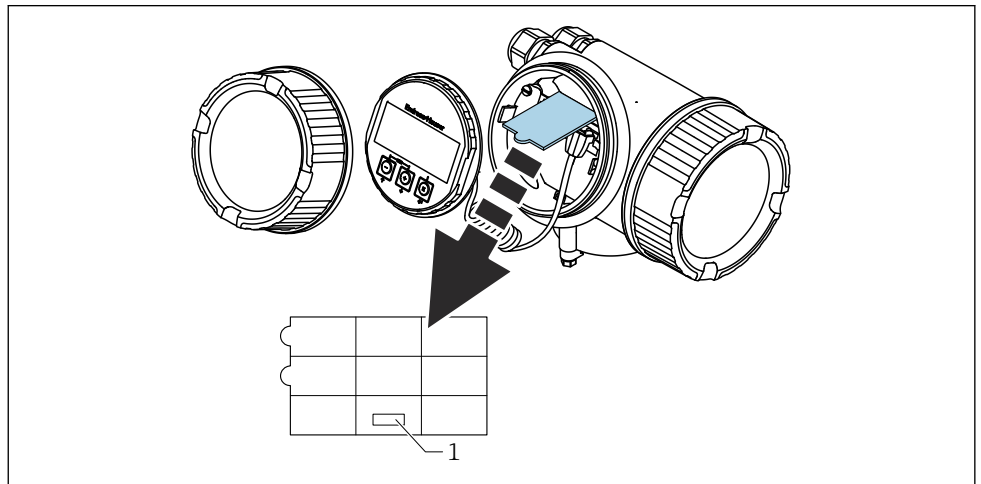

A0014241

1 Field for the new probe length

For documentation purposes, enter the new probe length into the quick reference guide which can be found in the electronics housing behind the display module.

## 6.2.3 Mounting the device

### Mounting devices with a threaded connection

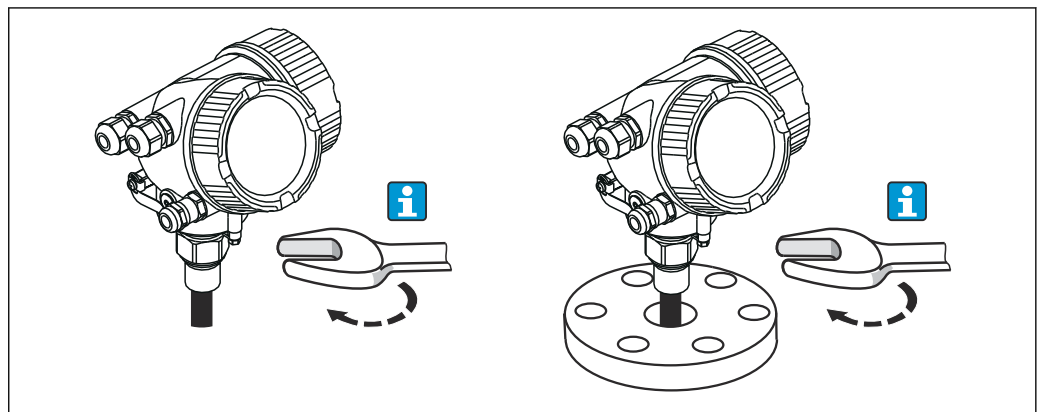

A0012528

Screw the device with the threaded connection into a sleeve or flange and then secure it to the process vessel via the sleeve/flange.

- i**
  - When screwing into place, turn by the hex bolt only:
    - Thread  $\frac{3}{4}$ " :  $\varnothing$  36 mm
    - Thread  $1\frac{1}{2}$ " :  $\varnothing$  55 mm
  - Maximum permissible tightening torque:
    - Thread  $\frac{3}{4}$ " : 45 Nm
    - Thread  $1\frac{1}{2}$ " : 450 Nm
  - Recommended torque when using the supplied aramid fiber seal and 40 bar (580 psi) pressure (FMP51 only; no seal is supplied for FMP54):
    - Thread  $\frac{3}{4}$ " : 25 Nm
    - Thread  $1\frac{1}{2}$ " : 140 Nm
  - When installing in metal vessels, ensure there is good metal contact between the process connection and the vessel.

### Mounting devices with a flange

If a seal is used to mount the device, use uncoated metal screws to ensure good electrical contact between the process flange and the probe flange.

### Mounting rope probes

#### NOTICE

**Electrostatic discharge can damage the electronics.**

- ▶ Ground the housing before lowering the rope probe into the vessel.

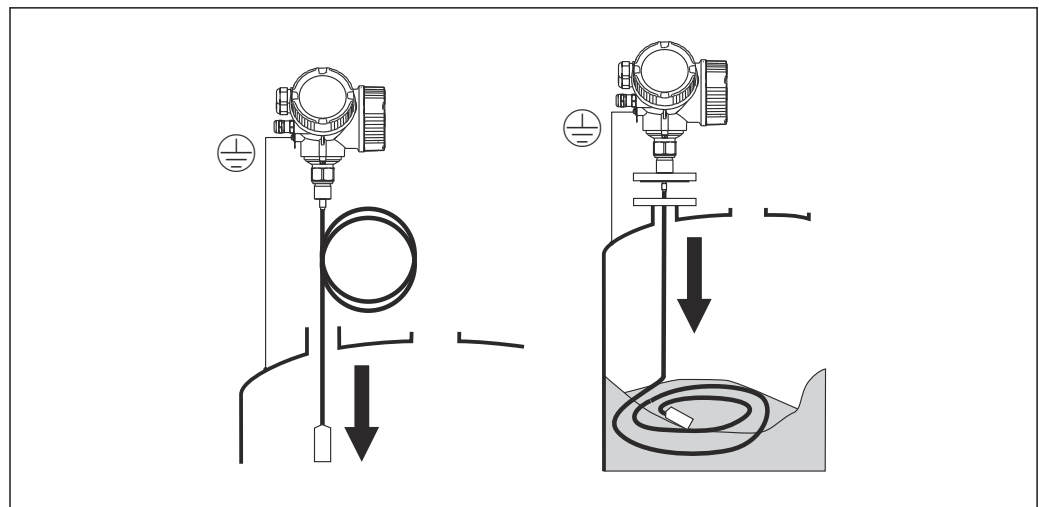

A0012529

Pay attention to the following when introducing the rope probe into the vessel:

- Uncoil the rope slowly and lower it carefully into the vessel.
- Make sure the rope does not bend or buckle.
- Avoid uncontrolled swinging of the weight, as this could damage internal fittings in the vessel.

#### **i** Mounting rope probes in a partially filled silo

If a silo is retrofitted with a Levelflex, it is not always possible to empty the silo. If the vessel is at least  $\frac{2}{3}$  empty, it is possible to mount the rope probe even in a partially filled silo. In this case, if possible perform a visual inspection after mounting: the rope should not become tangled or knotted when the silo is emptied. The probe rope must hang fully extended before an accurate measurement can be performed.



### 6.2.4 Mounting the "Sensor, remote" version

**i** This section only applies for devices with the version "Probe design" = "Sensor, remote" (feature 600, version MB/MC/MD).

The following is included in the delivery with the version "Probe design" = "Remote":

- The probe with process connection
- The electronics housing
- The mounting bracket for mounting the electronics housing on a wall or post
- The connection cable (length as ordered). The cable has one straight plug and one angled at 90°. Depending on the local conditions the angled plug can be connected at the probe or at the electronics housing.

**⚠ CAUTION**

**Mechanical stress can damage the plugs of the connection cable or cause them to become loose.**

- ▶ Mount the probe and the electronics housing securely before connecting the connecting cable.
- ▶ Lay the connecting cable in such a way that it is not exposed to mechanical stress. Minimum bending radius: 100 mm (4 in).
- ▶ When connecting the cable, connect the straight plug before you connect the angled plug. Torque for the union nuts of both plugs: 6 Nm.

**i** The probe, electronics and connection cable are mutually compatible and bear a common serial number. Only components with the same serial number may be connected to one another.

In the event of strong vibrations, a locking compound, e.g. Loctite 243, can also be used on the plug-in connectors.

#### Mounting the electronics housing

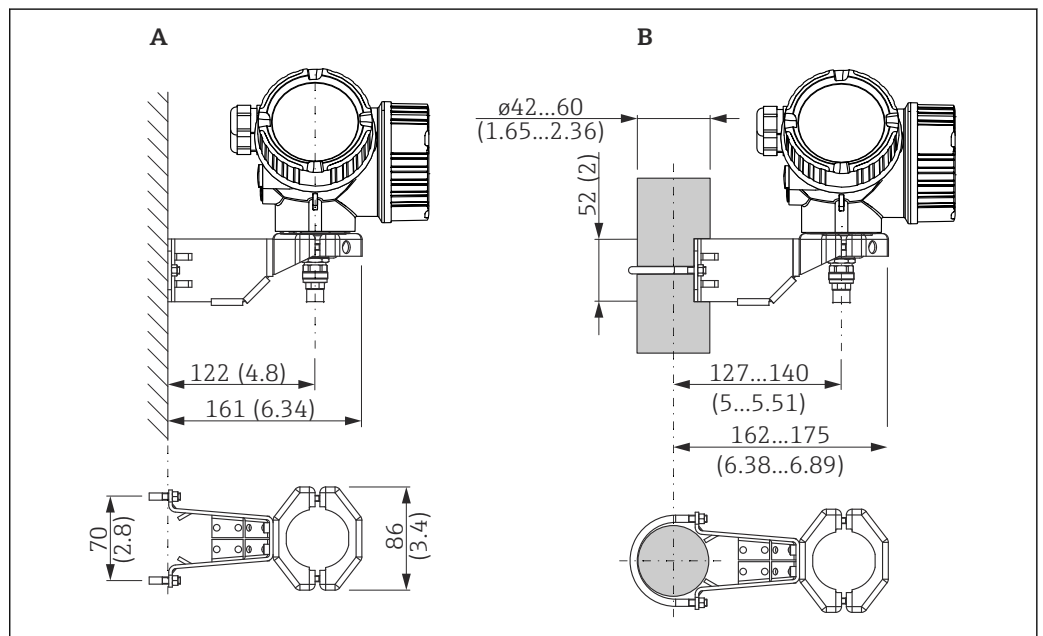

**11** Mounting the electronics housing with the mounting bracket. Unit of measurement mm (in)

- A Wall mounting
- B Post mounting

**Connecting the connecting cable**

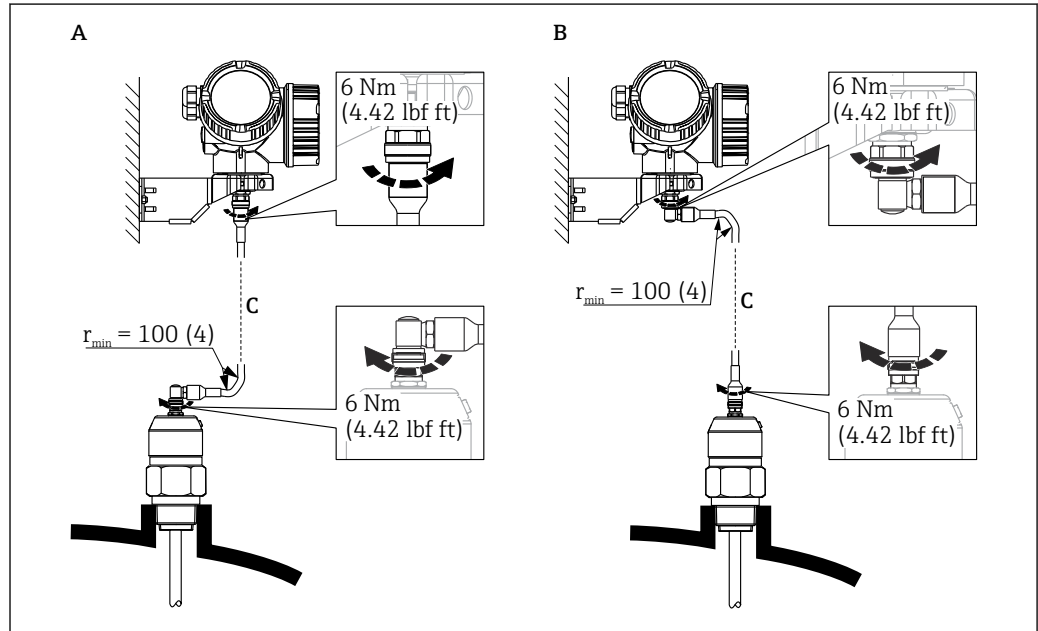
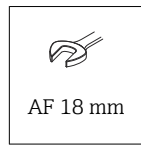

12 Connecting the connecting cable. The cable can be connected in the following ways.: Unit of measurement mm (in)

- A Angled plug at the probe
- B Angled plug at the electronics housing
- C Length of the remote cable as ordered

**6.2.5 Turning the transmitter housing**

To provide easier access to the connection compartment or display module, the transmitter housing can be turned:

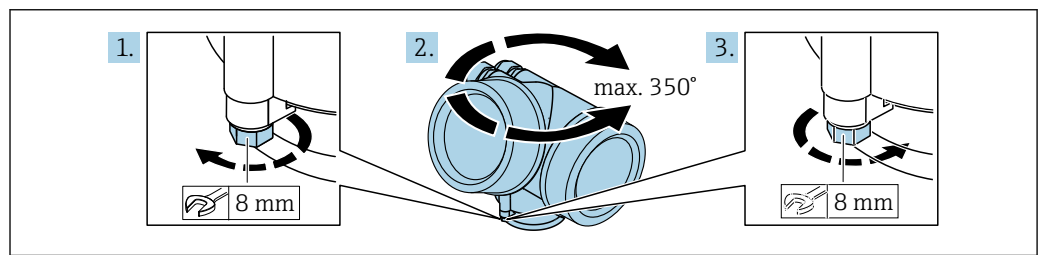

1. Unscrew the securing screw using an open-ended wrench.
2. Rotate the housing in the desired direction.
3. Tighten the securing screw (1.5 Nm for plastic housings; 2.5 Nm for aluminum or stainless steel housing).

## 6.2.6 Turning the display

### Opening the cover

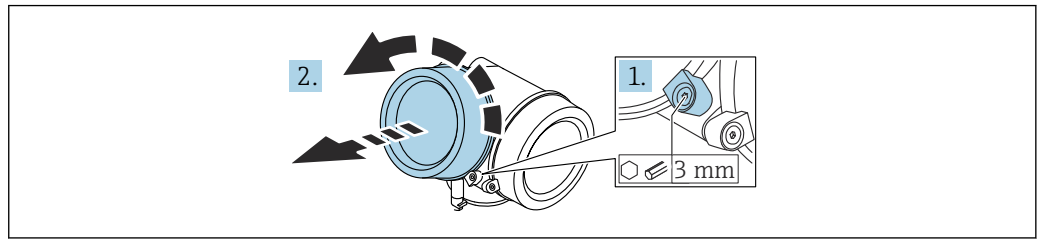

A0021430

1. Loosen the screw of the securing clamp of the electronics compartment cover using an Allen key (3 mm) and turn the clamp 90° counterclockwise.
2. Unscrew the electronics compartment cover and check the cover seal; replace it if necessary.

### Turning the display module

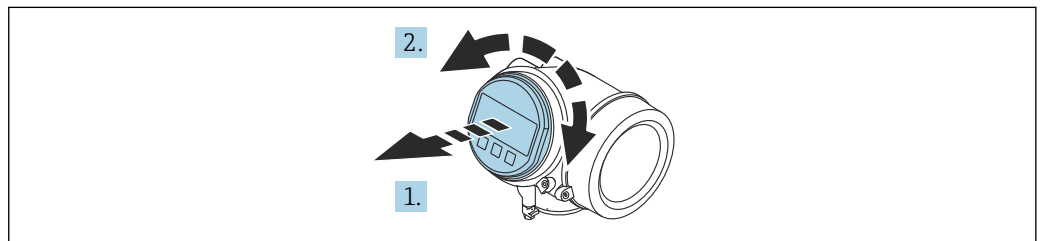

A0036401

1. Pull out the display module with a gentle rotational movement.
2. Turn the display module to the desired position: Max.  $8 \times 45^\circ$  in each direction.
3. Feed the coiled cable into the gap between the housing and main electronics module and plug the display module into the electronics compartment until it engages.

### Closing the cover of the electronics compartment

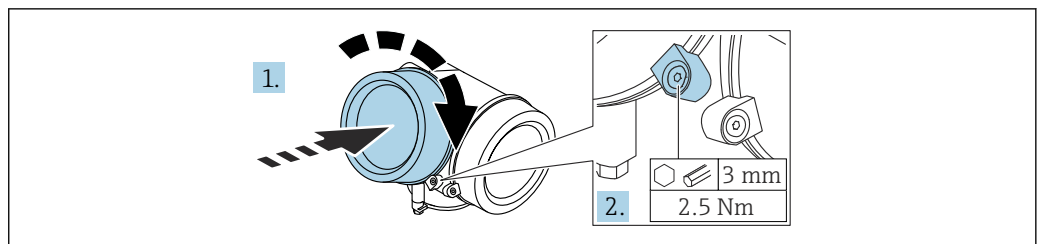

A0021451

1. Screw down the cover of the electronics compartment.
2. Turn the securing clamp 90° in the clockwise direction and, using an Allen key (3 mm), tighten the screw of the securing clamp on the electronics compartment cover with 2.5 Nm.

## 6.3 Post-mounting check

- Is the device free from damage (visual inspection)?
- Are the measuring point identification and labeling correct (visual inspection)?

- Is the measuring device protected against precipitation and sunlight?
- Are the securing screws and cover lock tightened securely?
- Does the measuring device comply with the measuring point specifications?

For example:

- Process temperature
- Process pressure
- Ambient temperature
- Measuring range

## 7 Electrical connection

### 7.1 Connecting requirements

#### 7.1.1 Terminal assignment

##### Terminal assignment, 4-wire: 4 to 20 mA HART (90 to 253 V<sub>AC</sub>)

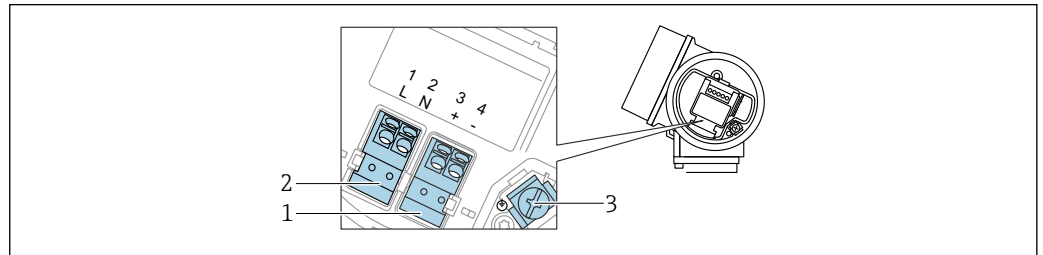

13 Terminal assignment, 4-wire: 4 to 20 mA HART (90 to 253 V<sub>AC</sub>)

- 1 Connection 4 to 20 mA HART (active): terminals 3 and 4
- 2 Power supply connection: terminals 1 and 2
- 3 Terminal for cable shield

#### **CAUTION**

##### To ensure electrical safety:

- ▶ Do not disconnect the protective ground connection.
  - ▶ Disconnect the device from the supply voltage before disconnecting the protective ground.
- i** Connect protective ground to the inner ground terminal (3) before connecting the power supply. If necessary, connect the potential matching line to the outer ground terminal.
  - i** In order to ensure electromagnetic compatibility (EMC): do **not** ground the device exclusively via the protective ground conductor of the supply cable. Instead, the functional grounding must also be connected to the process connection (flange or threaded connection) or to the external ground terminal.
  - i** An easily accessible power switch must be installed in the proximity of the device. The switch must be marked as a disconnecter for the device (61010IEC/).

### Terminal assignment PROFIBUS PA / FOUNDATION Fieldbus

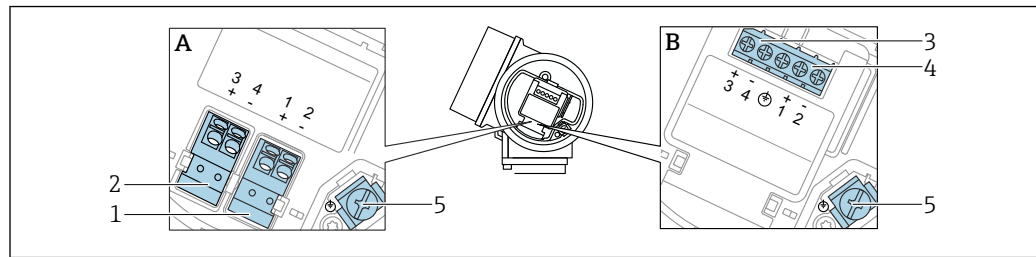

A0036500

14 Terminal assignment PROFIBUS PA / FOUNDATION Fieldbus

A Without integrated overvoltage protection

B With integrated overvoltage protection

1 Connection, PROFIBUS PA / FOUNDATION Fieldbus: terminals 1 and 2, without integrated overvoltage protection

2 Connection, switch output (open collector): terminals 3 and 4, without integrated overvoltage protection

3 Connection, switch output (open collector): terminals 3 and 4, with integrated overvoltage protection

4 Connection, PROFIBUS PA / FOUNDATION Fieldbus: terminals 1 and 2, with integrated overvoltage protection

5 Terminal for cable shield

### Block view PROFIBUS PA / FOUNDATION Fieldbus

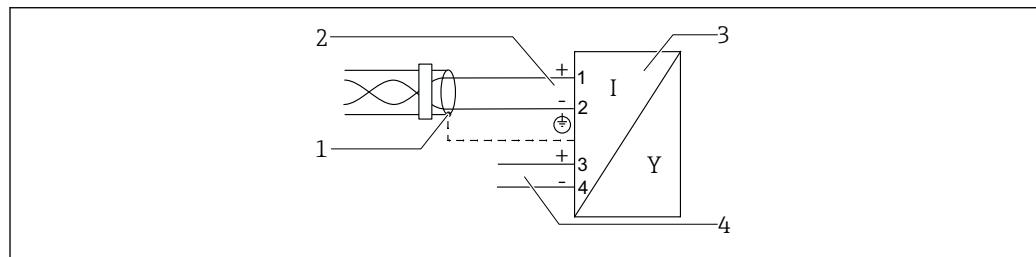

A0036530

15 Block view PROFIBUS PA / FOUNDATION Fieldbus

1 Cable screen; observe cable specification

2 Connection PROFIBUS PA / FOUNDATION Fieldbus

3 Measuring instrument

4 Switch output (open collector)

### 7.1.2 Cable specification

#### ■ Devices without integrated overvoltage protection

Pluggable spring-force terminals for wire cross-sections 0.5 to 2.5 mm<sup>2</sup> (20 to 14 AWG)

#### ■ Devices with integrated overvoltage protection

Screw terminals for wire cross-sections 0.2 to 2.5 mm<sup>2</sup> (24 to 14 AWG)

■ For ambient temperature  $T_U \geq 60^\circ\text{C}$  (140 °F): use cable for temperature  $T_U + 20\text{ K}$ .

### FOUNDATION Fieldbus

Endress+Hauser recommends using twisted, shielded two-wire cables.

**i** For further information on the cable specifications, see Operating Instructions BA00013S "FOUNDATION Fieldbus Overview", FOUNDATION Fieldbus Guideline and IEC 61158-2 (MBP).

### 7.1.3 Device plug

**i** In the case of the device versions with a plug, the housing does not need to be opened to connect the signal cable.

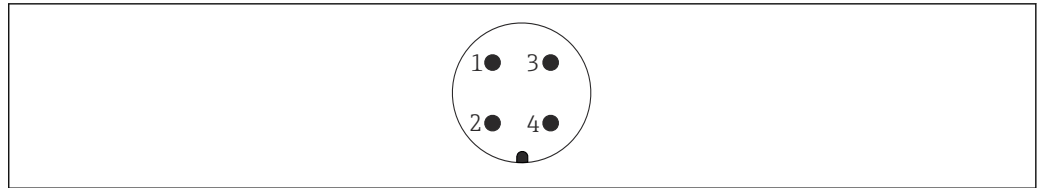

A0011176

16 Pin assignment of 7/8" plug

- 1 Signal -
- 2 Signal +
- 3 Not assigned
- 4 Shielding

### 7.1.4 Supply voltage

#### PROFIBUS PA, FOUNDATION Fieldbus

"Power supply; output" <sup>1)</sup>	"Approval" <sup>2)</sup>	Terminal voltage
<b>E:</b> 2-wire; FOUNDATION Fieldbus, switch output <b>G:</b> 2-wire; PROFIBUS PA, switch output	<ul style="list-style-type: none"> <li>▪ Non-hazardous</li> <li>▪ Ex nA</li> <li>▪ Ex nA[ia]</li> <li>▪ Ex ic</li> <li>▪ Ex ic[ia]</li> <li>▪ Ex d[ia] / XP</li> <li>▪ Ex ta / DIP</li> <li>▪ CSA GP</li> </ul>	9 to 32 V <sup>3)</sup>
	<ul style="list-style-type: none"> <li>▪ Ex ia / IS</li> <li>▪ Ex ia + Ex d[ia] / IS + XP</li> </ul>	9 to 30 V <sup>3)</sup>

- 1) Feature 020 in the product structure
- 2) Feature 010 in the product structure
- 3) Input voltages up to 35 V do not damage the device.

Polarity-dependent	Yes
FISCO/FNICO compliant according to IEC 60079-27	Yes

### 7.1.5 Overvoltage protection

If the device is intended to be used for level measurement of flammable liquids which requires overvoltage protection in accordance with DIN EN 60079-14, test standard 60060-1 (10 kA, pulse <sup>8</sup>/<sub>20</sub> μs): use the overvoltage protection module.

#### Integrated overvoltage protection module

An integrated overvoltage protection module is available for the HART 2-wire devices as well as for PROFIBUS PA and FOUNDATION Fieldbus.

Product structure: Feature 610 "Accessory mounted", option NA "Overvoltage protection".

Resistance per channel	Maximum 2 × 0.5 Ω
DC sparkover voltage	400 to 700 V
Trip surge voltage	< 800 V
Capacity at 1 MHz	< 1.5 pF
Nominal discharge current (8/20 μs)	10 kA

### External overvoltage protection module

The HAW562 or HAW569 for example from Endress+Hauser are suitable options for external overvoltage protection.



More information is provided in the following documents:

- HAW562: TI01012K
- HAW569: TI01013K

## 7.2 Connecting the device

### **⚠ WARNING**

#### Explosion hazard!

- ▶ Comply with applicable national standards.
- ▶ Comply with the specifications in the Safety Instructions (XA).
- ▶ Use specified cable glands only.
- ▶ Check to ensure that the power supply matches the information on the nameplate.
- ▶ Switch off the power supply before connecting the device.
- ▶ Connect the potential matching line to the outer ground terminal before applying the power supply.

#### Required tools/accessories:

- For devices with a cover lock: Allen key AF3
- Wire stripper
- When using stranded cables: One ferrule for every wire to be connected.

### 7.2.1 Opening cover

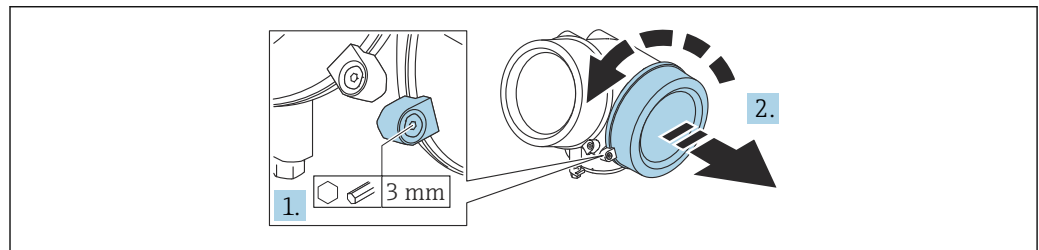

A0021490

1. Loosen the screw of the securing clamp of the connection compartment cover using an Allen key (3 mm) and turn the clamp 90° counterclockwise.
2. Unscrew the connection compartment cover and check the cover seal; replace it if necessary.

### 7.2.2 Connecting

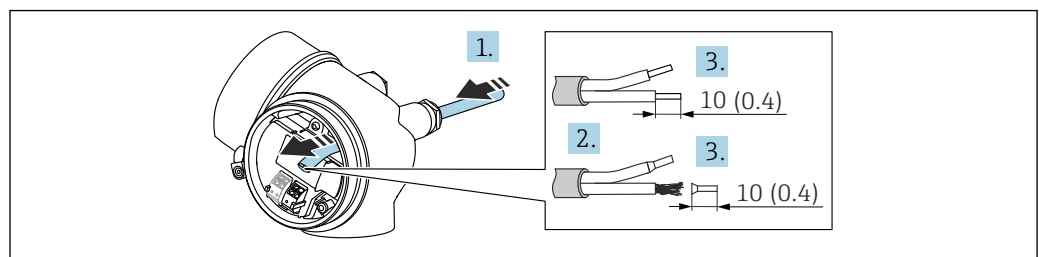

A0036418

17 Unit: mm (in)

1. Push the cable through the cable entry. To ensure tight sealing, do not remove the sealing ring from the cable entry.



2. Remove the cable sheath.
3. Strip the cable ends 10 mm (0.4 in). In the case of stranded cables, also fit ferrules.
4. Firmly tighten the cable glands.
5. Connect the cable according to the terminal assignment.

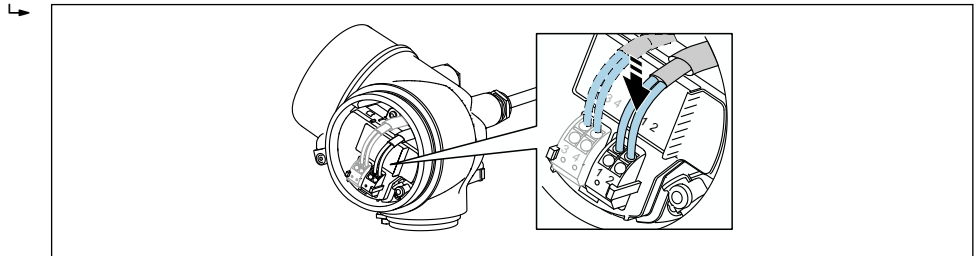

A0034682

6. If using shielded cables: Connect the cable shield to the ground terminal.

### 7.2.3 Plug-in spring-force terminals

The electrical connection of device versions without an integrated overvoltage protection is via plug-in spring-force terminals. Rigid conductors or flexible conductors with ferrules can be inserted directly into the terminal without using the lever, and create a contact automatically.

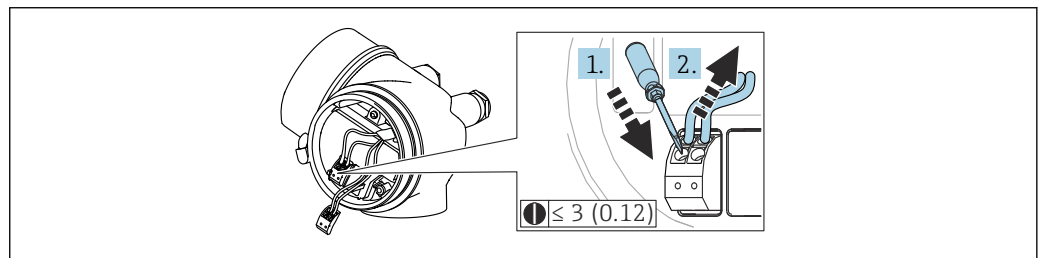

A0013661

18 Unit: mm (in)

To remove the cable from the terminal again:

1. Use a flat-blade screwdriver  $\leq 3$  mm (0.12 in) to press down on the slot between the two terminal holes.
2. Simultaneously pull the cable end out of the terminal.

### 7.2.4 Closing the cover of the connection compartment

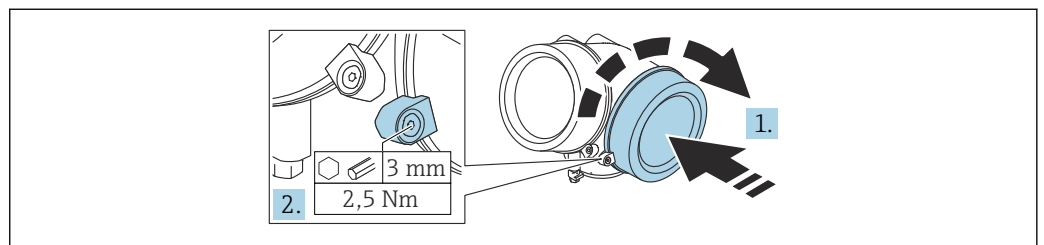

A0021491

1. Screw down the cover of the connection compartment.
2. Turn the securing clamp  $90^\circ$  in the clockwise direction and, using an Allen key (3 mm), tighten the screw of the securing clamp on the connection compartment cover with 2.5 Nm.

### 7.3 Post-connection check

- Is the device or cable undamaged (visual inspection)?
- Do the cables used comply with the requirements?
- Do the mounted cables have adequate strain relief?
- Are all the cable glands installed, firmly tightened and leak-tight?
- Does the supply voltage match the specifications on the nameplate?
- Is the terminal assignment correct?
- If necessary, has a protective ground connection been established?
- If supply voltage is present, is the device ready for operation and do values appear on the display module?
- Are all the housing covers installed and tightened?
- Is the securing clamp firmly tightened?

## 8 Operation options

### 8.1 Overview of operation options

#### 8.1.1 Access to operating menu via local display

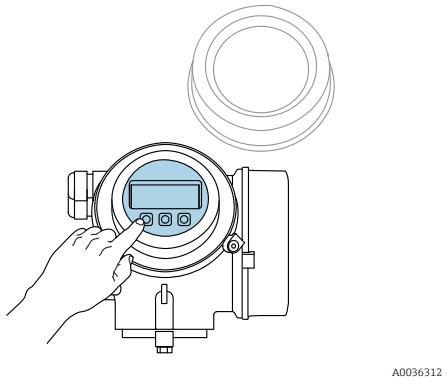
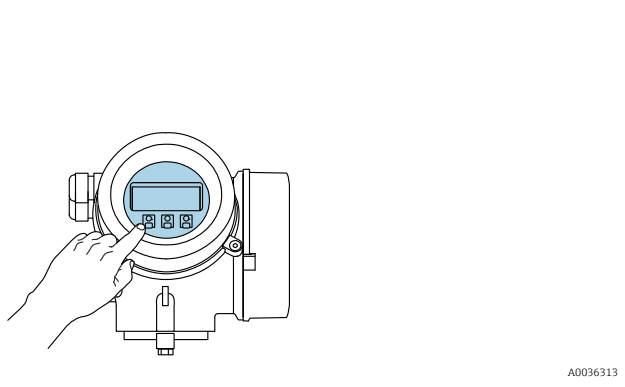
Operation with	Pushbuttons	Touch control
Order code for "Display; operation"	Option C "SD02"	Option E "SD03"
		
Display elements	4-line display	4-line display White background lighting; switches to red in event of device errors
	Format for displaying measured variables and status variables can be individually configured	
	Permitted ambient temperature for the display: -20 to +70 °C (-4 to +158 °F) The readability of the display may be impaired at temperatures outside the temperature range.	
Operating elements	Onsite operation with 3 pushbuttons (⊕, ⊖, ⊞)	External operation via touch control; 3 optical keys: ⊕, ⊖, ⊞
	Operating elements also accessible in various hazardous areas	
Additional functionality	Data backup function The device configuration can be saved in the display module.	
	Data comparison function The device configuration saved in the display module can be compared to the current device configuration.	
	Data transfer function The transmitter configuration can be transmitted to another device using the display module.	

#### Operation with remote display and operating module FHX50

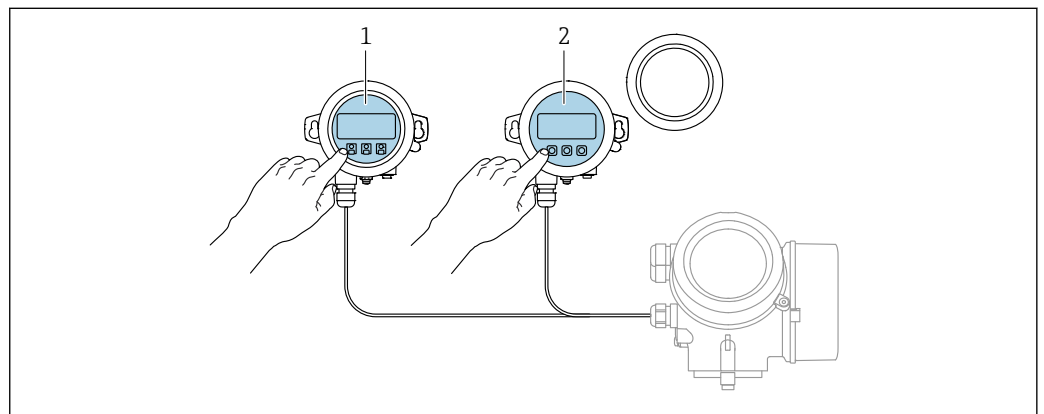

19 FHX50 operating options

- 1 Display and operating module SD03, optical keys; can be operated through the glass of the cover
- 2 Display and operating module SD02, push buttons; cover must be removed

### 8.1.2 Access to the operating menu via the operating tool

#### Via FOUNDATION Fieldbus

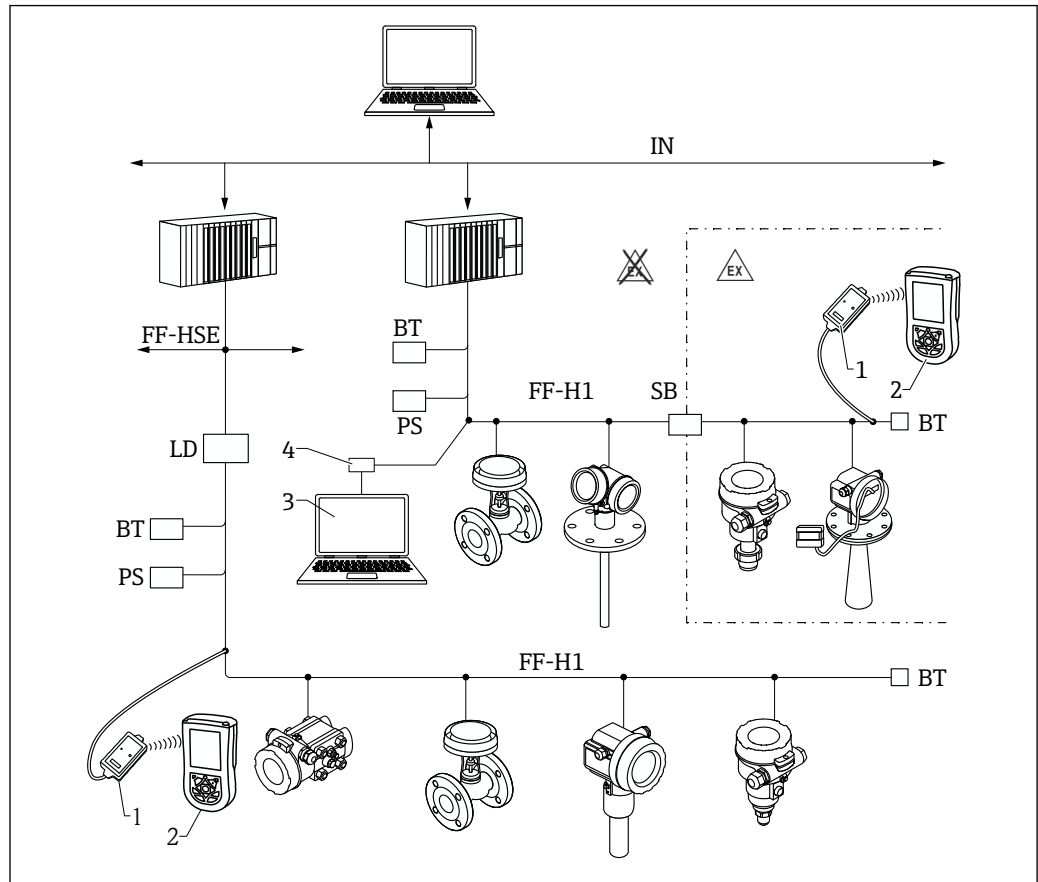

A0017188

20 FOUNDATION Fieldbus system architecture with associated components

- 1 FFblue Bluetooth modem
- 2 Field Xpert
- 3 DeviceCare/FieldCare
- 4 NI-FF interface card
- IN Industrial network
- FF- High Speed Ethernet
- HSE
- FF- FOUNDATION Fieldbus-H1
- H1
- LD Linking Device FF-HSE/FF-H1
- PS Bus Power Supply
- SB Safety barrier
- BT Bus Terminator

#### Via service interface (CDI)

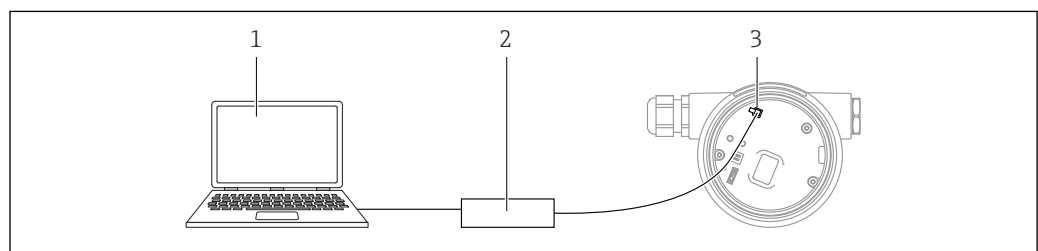

A0039148

- 1 Computer with FieldCare/DeviceCare operating tool
- 2 Commubox
- 3 Service interface (CDI) of the measuring instrument (= Endress+Hauser Common Data Interface)

### Operation via Bluetooth® wireless technology

#### Requirements

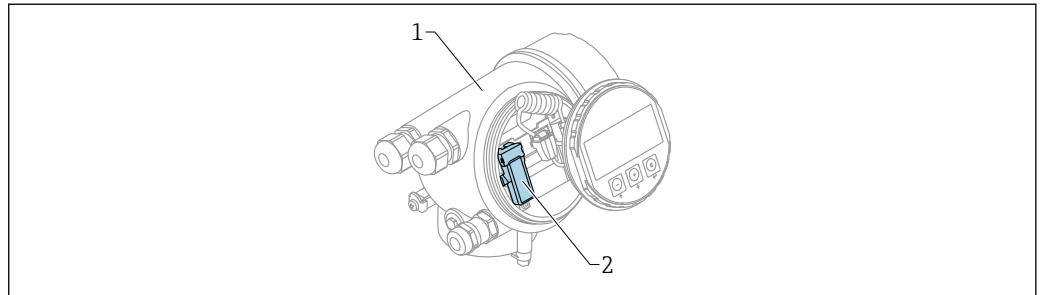

A0036790

21 Device with Bluetooth module

- 1 Electronics housing of the device
- 2 Bluetooth module

This operation option is only available for devices with Bluetooth module. There are the following options:

- The device has been ordered with a Bluetooth module:  
Feature 610 "Accessory Mounted", option NF "Bluetooth"
- The Bluetooth module has been ordered as an accessory (ordering number: 71377355) and has been mounted. See Special Documentation SD02252F.

#### Operation via SmartBlue (app)

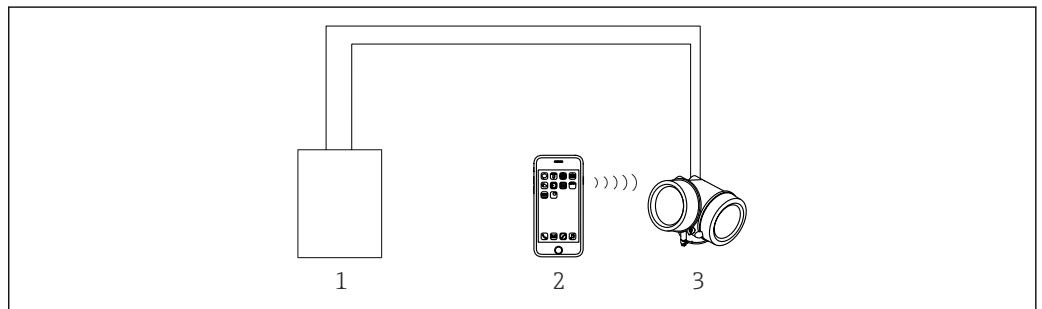

A0034939

22 Operation via SmartBlue (app)

- 1 Transmitter power supply unit
- 2 Smartphone / tablet with SmartBlue (app)
- 3 Transmitter with Bluetooth module

## 8.2 Structure and function of the operating menu

### 8.2.1 Structure of the operating menu

Menu	Submenu / parameter	Meaning
	Language <sup>1)</sup>	Defines the operating language of the local display
Commissioning <sup>2)</sup>		Launches the interactive wizard for guided commissioning. Additional settings generally do not need to be made in the other menus when the wizard is finished.

Menu	Submenu / parameter	Meaning
<b>Setup</b>	Parameter 1 ... Parameter N	Once values have been set for these parameters, the measurement should usually be fully configured.
	<b>Advanced setup</b>	Contains additional submenus and parameters: <ul style="list-style-type: none"> <li>▪ For more accurate configuration of the measurement (adaptation to special measuring conditions).</li> <li>▪ For converting the measured value (scaling, linearization).</li> <li>▪ For scaling the output signal.</li> </ul>
<b>Diagnostics</b>	<b>Diagnostic list</b>	Contains up to 5 currently active error messages.
	<b>Event logbook</b> <sup>3)</sup>	Contains the last 20 messages (which are no longer active).
	<b>Device information</b>	Contains information for identifying the device.
	<b>Measured values</b>	Contains all current measured values.
	<b>Data logging</b>	Contains the history of the individual measured values
	<b>Simulation</b>	Is used to simulate measured values or output values.
	<b>Device check</b>	Contains all parameters needed to check the measurement capability of the device.
<b>Expert</b> <sup>5)</sup> Contains all the parameters of the device (including those already contained in one of the other menus). This menu is organized according to the function blocks of the device. The parameters of the Expert menu are described in: GP01015F (FOUNDATION Fieldbus)	<b>System</b>	Contains all higher-level device parameters that do not affect measurement or measured value communication.
	<b>Sensor</b>	Contains all parameters for configuring the measurement.
	<b>Output</b>	Contains all parameters to configure the switch output (PFS)
	<b>Communication</b>	Contains all parameters needed to configure the digital communication interface.
	<b>Diagnostics</b>	Contains all parameters needed to detect and analyze operational errors.

- 1) If you are operating via operating tools (e.g. FieldCare), the "Language" parameter is located under "Setup → Advanced setup → Display"
- 2) Only if operating via an FDT/DTM system
- 3) Only available if operating via the local display
- 4) Only available if operating via DeviceCare or FieldCare
- 5) When you call up the "Expert" menu, you are always asked for an access code. If a customer-specific access code has not been defined, "0000" must be entered.

## 8.2.2 User roles and related access authorization

The two user roles **Operator** and **Maintenance** have different write access to the parameters if a device-specific access code has been defined. This protects the device configuration via the local display from unauthorized access →  47.

Access authorization to parameters

User role	Read access		Write access	
	Without access code (from the factory)	With access code	Without access code (from the factory)	With access code
Operator	✓	✓	✓	--
Maintenance	✓	✓	✓	✓

If an incorrect access code is entered, the user obtains the access rights of the **Operator** role.

 The user role with which the user is currently logged on is indicated by the **Access status display** parameter (if operating via the local display) or the **Access status tooling** parameter (if operating via an operating tool).

### 8.2.3 Data access - Security

#### Write protection via access code

Using the device-specific access code, the parameters for the measuring instrument configuration are write-protected and their values can no longer be changed via local operation.

#### Defining the access code via the local display

1. Navigate to: Setup → Advanced setup → Administration → Define access code → Define access code
2. Define a max. 4-digit numeric code as an access code.
3. Repeat the numeric code in the **Confirm access code** parameter to confirm it.
  - ↳ The -symbol appears in front of all write-protected parameters.



#### Defining the access code via operating tool (e.g. FieldCare)

1. Navigate to: Setup → Advanced setup → Administration → Define access code
2. Define a max. 4-digit numeric code as an access code.
  - ↳ Write protection is active.

#### Parameters that can always be changed

The write protection does not include certain parameters that do not affect the measurement. Despite the defined access code, these parameters can always be modified even if the other parameters are locked.

The device automatically locks the write-protected parameters again if a key is not pressed for 10 minutes in the navigation and editing view. If the user goes from the navigation and editing mode back to the measured value display mode, the device automatically locks the write-protected parameters after 60 s.

-  If write access is activated via an access code, it can be only be deactivated again via this access code.
- In the "Description of Device Parameters" documents, each write-protected parameter is identified with the -symbol.

#### Disabling write protection via access code

If the  symbol appears in front of a parameter on the local display, the parameter is write-protected by a device-specific access code and its value cannot currently be changed via the local display.

The locking of the write access via local operation can be disabled by entering the device-specific access code.

1. After you press  $\boxed{\text{E}}$ , the input prompt for the access code appears.
2. Enter the access code.
  - ↳ The  $\boxed{\text{E}}$  symbol in front of the parameters disappears; all previously write-protected parameters are now re-enabled.

### Deactivation of the write protection via access code

#### Via local display

1. Navigate to: Setup → Advanced setup → Administration → Define access code → Define access code
2. Enter **0000**.
3. Repeat **0000** in the **Confirm access code** parameter to confirm.
  - ↳ The write protection is deactivated. Parameters can be changed without entering an access code.

#### Via an operating tool (e.g. FieldCare)

1. Navigate to: Setup → Advanced setup → Administration → Define access code
2. Enter **0000**.
  - ↳ The write protection is deactivated. Parameters can be changed without entering an access code.

### Write protection via write protection switch

Unlike parameter write protection via a user-specific access code, this allows the user to lock write access to the entire operating menu - apart from the "**Contrast display**" parameter.

The parameter values are now read only and cannot be edited any more (exception "**Contrast display**" parameter):

- Via local display
- Via FOUNDATION Fieldbus



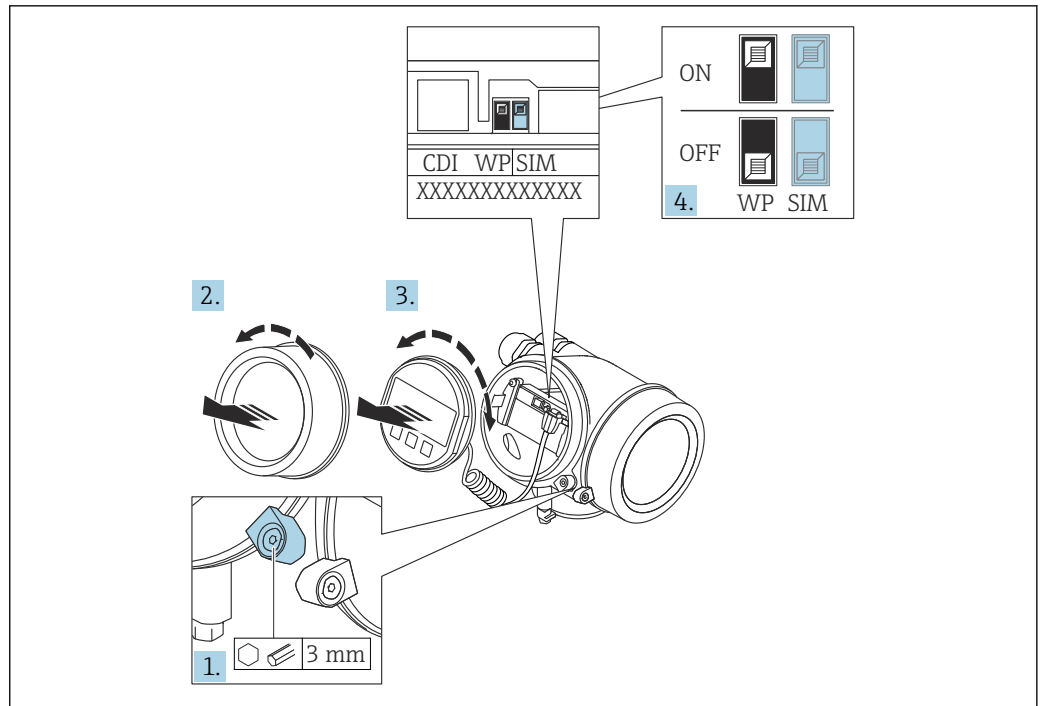

A0021474

1. Loosen the securing clamp.
2. Unscrew the electronics compartment cover.
3. Pull out the display module with a gentle rotational movement. To make it easier to access the write protection switch, attach the display module to the edge of the electronics compartment.

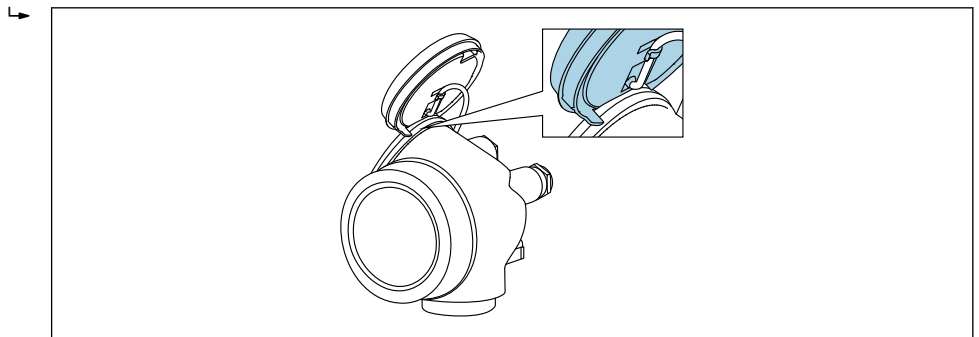

A0036086

4. Setting the write protection switch (WP) on the main electronics module to the **ON** position enables hardware write protection. Setting the write protection switch (WP) on the main electronics module to the **OFF** position (factory setting) disables hardware write protection.
  - ↳ If the hardware write protection is enabled: The **Hardware locked** option is displayed in the **Locking status** parameter. In addition, on the local display the  symbol appears in front of the parameters in the header of the operational display and in the navigation view.

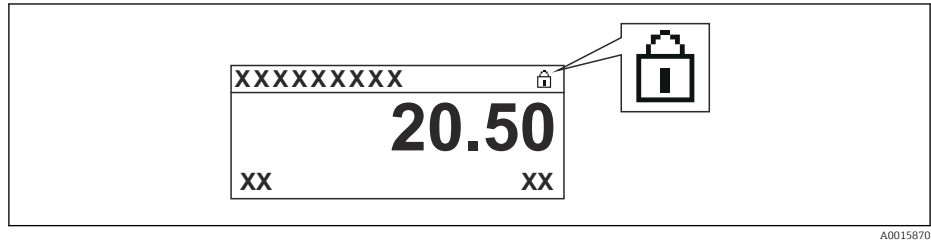

A0015870

If hardware write protection is disabled: No option is displayed in the **Locking status** parameter. On the local display, the  symbol disappears from in front of the parameters in the header of the operational display and in the navigation view.

5. Feed the cable into the gap between the housing and main electronics module and plug the display module into the electronics compartment in the desired direction until it engages.
6. Reassemble the transmitter in the reverse order.

### Enabling and disabling the keypad lock

Access to the entire operating menu via local operation can be locked via the keypad lock. When access is locked, it is no longer possible to navigate through the operating menu or change the values of individual parameters. Users can only read the measured values on the operational display.

The keypad lock is switched on and off via a context menu.

#### Switching on the keypad lock

##### SD03 display module only

The keypad lock is switched on automatically:

- If the device has not been operated via the display for > 1 minute.
- Each time the device is restarted.

#### Switching on the keypad lock manually

1. The device is in the measured value display.  
Press  for at least 2 seconds.  
↳ A context menu appears.
2. Select the **Keylock on** option in the context menu.  
↳ The keypad lock is switched on.

 If the user attempts to access the operating menu while the keypad lock is active, the message **Keylock on** appears.

#### Switching off the keypad lock

1. The keypad lock is switched on.  
Press  for at least 2 seconds.  
↳ A context menu appears.

2. Select the **Keylock off** option in the context menu.
  - ↳ The keypad lock is switched off.

**Bluetooth® wireless technology**

Signal transmission via Bluetooth® wireless technology uses a cryptographic technique tested by the Fraunhofer Institute

- The device is not visible via Bluetooth® wireless technology without the SmartBlue app
- Only one point-to-point connection is established between **one** sensor and **one** smartphone or tablet

## 8.3 Display and operating module



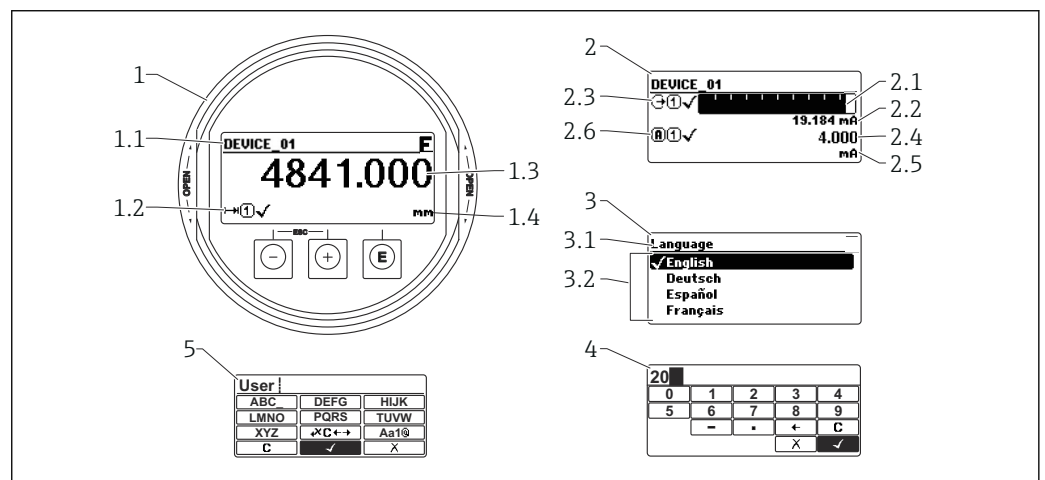

### 8.3.1 Display format



23 Display format on the display and operating module

- 1 Measured value display (1 value max. size)
  - 1.1 Header containing tag and error symbol (if an error is active)
  - 1.2 Measured value symbols
  - 1.3 Measured value
  - 1.4 Unit
- 2 Measured value display (bar graph + 1 value)
  - 2.1 Bargraph for measured value 1
  - 2.2 Measured value 1 (including unit)
  - 2.3 Measured value symbols for measured value 1
  - 2.4 Measured value 2
  - 2.5 Unit for measured value 2
  - 2.6 Measured value symbols for measured value 2
- 3 Parameter display (here: parameter with drop-down list)
  - 3.1 Header containing parameter name and error symbol (if an error is active)
  - 3.2 Drop-down list;  marks the current parameter value.
- 4 Input matrix for numbers
- 5 Input matrix for alphanumeric and special characters



### Display symbols for the submenus

Symbol	Meaning
 <small>A0018367</small>	<b>Display/operat.</b> Is displayed: <ul style="list-style-type: none"> <li>■ In the main menu next to the "Display/operat." selection</li> <li>■ In the header on the left in the "Display/operat." menu</li> </ul>
 <small>A0018364</small>	<b>Setup</b> Is displayed: <ul style="list-style-type: none"> <li>■ In the main menu next to the "Setup" selection</li> <li>■ In the header on the left in the "Setup" menu</li> </ul>
 <small>A0018365</small>	<b>Expert</b> Is displayed: <ul style="list-style-type: none"> <li>■ In the main menu next to the "Expert" selection</li> <li>■ In the header on the left in the "Expert" menu</li> </ul>
 <small>A0018366</small>	<b>Diagnostics</b> Is displayed: <ul style="list-style-type: none"> <li>■ In the main menu next to the "Diagnostics" selection</li> <li>■ In the header on the left in the "Diagnostics" menu</li> </ul>











### Status signals

Symbol	Meaning
<b>F</b> <small>A0032902</small>	<b>"Failure"</b> A device error has occurred. The measured value is no longer valid.
<b>C</b> <small>A0032903</small>	<b>"Function check"</b> The device is in the service mode (e.g. during a simulation).
<b>S</b> <small>A0032904</small>	<b>"Out of specification"</b> The device is operated: <ul style="list-style-type: none"> <li>■ Outside its technical specifications (e.g. during startup or cleaning)</li> <li>■ Outside the configuration performed by the user (e.g. level outside the configured range)</li> </ul>
<b>M</b> <small>A0032905</small>	<b>"Maintenance required"</b> Maintenance is required. The measured value is still valid.



### Display symbols for locking status





Symbol	Meaning
 <small>A0013148</small>	<b>Read-only parameter</b> The parameter shown is only for display purposes and cannot be edited.
 <small>A0013150</small>	<b>Device locked</b> <ul style="list-style-type: none"> <li>■ In front of a parameter name: The device is locked via software and/or hardware.</li> <li>■ In the header of the measured value screen: The device is locked via hardware.</li> </ul>

### Measured value symbols

Symbol	Meaning
<b>Measured values</b>	
 <small>A0032892</small>	Level
 <small>A0032893</small>	Distance
 <small>A0032908</small>	Current output
 <small>A0032894</small>	Measured current
 <small>A0032895</small>	Terminal voltage
 <small>A0032896</small>	Electronics or sensor temperature
<b>Measuring channels</b>	
 <small>A0032897</small>	Measuring channel 1
 <small>A0032898</small>	Measuring channel 2
<b>Status of the measured value</b>	
 <small>A0018361</small>	<b>"Alarm" status</b> Measurement is interrupted. The output assumes the defined alarm condition. A diagnostic message is generated.
 <small>A0018360</small>	<b>"Warning" status</b> The device continues to measure. A diagnostic message is generated.

### 8.3.2 Operating elements

Operating key	Meaning
 <small>A0018330</small>	<b>Minus key</b> <i>In a menu, submenu</i> Moves the selection bar upwards in a picklist. <i>In the text and numeric editor</i> In the input screen, moves the selection bar to the left (backwards).
 <small>A0018329</small>	<b>Plus key</b> <i>In a menu, submenu</i> Moves the selection bar downwards in a picklist. <i>In the text and numeric editor</i> In the input screen, moves the selection bar to the right (forwards).

Operating key	Meaning
 <small>A0018328</small>	<p><b>Enter key</b></p> <p><i>For measured value display</i></p> <ul style="list-style-type: none"> <li>Pressing the key briefly opens the operating menu.</li> <li>Pressing the key for 2 s opens the context menu.</li> </ul> <p><i>In a menu, submenu</i></p> <ul style="list-style-type: none"> <li>Pressing the key briefly: Opens the selected menu, submenu or parameter.</li> <li>Pressing the key for 2 s for parameter: If present, opens the help text for the function of the parameter.</li> </ul> <p><i>In the text and numeric editor</i></p> <ul style="list-style-type: none"> <li>Pressing the key briefly:                             <ul style="list-style-type: none"> <li>Opens the selected group.</li> <li>Carries out the selected action.</li> </ul> </li> <li>Pressing the key for 2 s confirms the edited parameter value.</li> </ul>
 <small>A0032909</small>	<p><b>Escape key combination (press keys simultaneously)</b></p> <p><i>In a menu, submenu</i></p> <ul style="list-style-type: none"> <li>Pressing the key briefly:                             <ul style="list-style-type: none"> <li>Exits the current menu level and takes you to the next higher level.</li> <li>If help text is open, closes the help text of the parameter.</li> </ul> </li> <li>Pressing the key for 2 s returns you to the measured value display ("home position").</li> </ul> <p><i>In the text and numeric editor</i></p> <p>Closes the text or numeric editor without applying changes.</p>
 <small>A0032910</small>	<p><b>Minus/Enter key combination (press and hold down the keys simultaneously)</b></p> <p>Reduces the contrast (brighter setting).</p>
 <small>A0032911</small>	<p><b>Plus/Enter key combination (press and hold down the keys simultaneously)</b></p> <p>Increases the contrast (darker setting).</p>



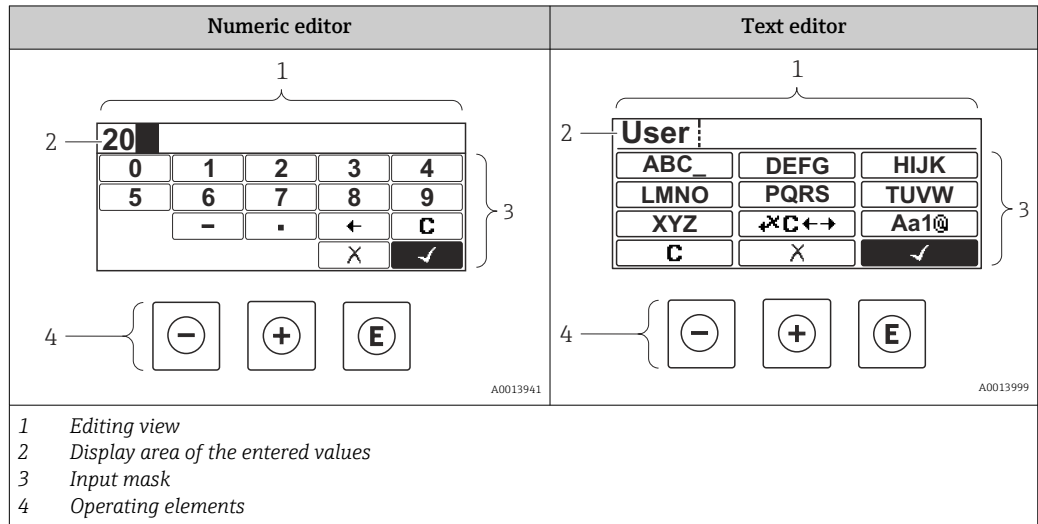



### 8.3.3 Entering numbers and text









#### Input mask

The following input and operating symbols are available in the input mask of the numeric and text editor:



*Numeric editor*



Symbol	Meaning
 <p>A0013998</p>	Selection of numbers from 0 to 9
 <p>A0016619</p>	Inserts decimal separator at the cursor position.
 <p>A0016620</p>	Inserts minus sign at the cursor position.
 <p>A0013985</p>	Confirms selection.
 <p>A0016621</p>	Moves the input position one position to the left.
 <p>A0013986</p>	Exits the input without applying the changes.
 <p>A0014040</p>	Clears all entered characters.

*Text editor*

Symbol	Meaning
 <p>A0013997</p>	Selection of letters from A to Z
 <p>A0013981</p>	Toggle <ul style="list-style-type: none"> <li>▪ Between upper-case and lower-case letters</li> <li>▪ For entering numbers</li> <li>▪ For entering special characters</li> </ul>
 <p>A0013985</p>	Confirms selection.
 <p>A0013987</p>	Switches to the selection of the correction tools.
 <p>A0013986</p>	Exits the input without applying the changes.
 <p>A0014040</p>	Clears all entered characters.

*Text correction under *

Symbol	Meaning
 <p>A0032907</p>	Clears all entered characters.
 <p>A0018324</p>	Moves the input position one position to the right.

 <small>A0018326</small>	Moves the input position one position to the left.
 <small>A0032906</small>	Deletes one character immediately to the left of the input position.

### 8.3.4 Opening the context menu

Using the context menu, the user can call up the following menus quickly and directly from the operational display:

- Setup
- Conf. backup disp.
- Envelope curve
- Keylock on



#### Calling up and closing the context menu

The user is in the operational display.

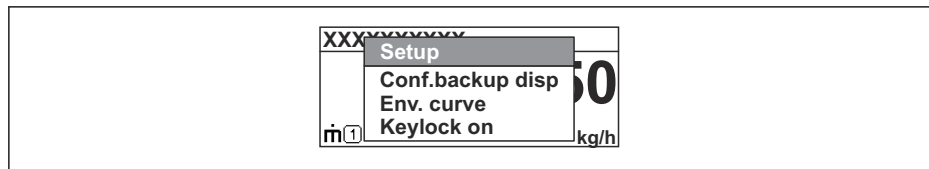

1. Press  for 2 s.
  - ↳ The context menu opens.



A0037872

2. Press  +  simultaneously.
  - ↳ The context menu is closed and the operational display appears.

#### Calling up the menu via the context menu

1. Open the context menu.
2. Press  to navigate to the desired menu.
3. Press  to confirm the selection.
  - ↳ The selected menu opens.



### 8.3.5 Envelope curve display on the display and operating module

In order to assess the measuring signal, the envelope curve and - if a mapping has been recorded - the mapping curve can be shown on the display and operating module:

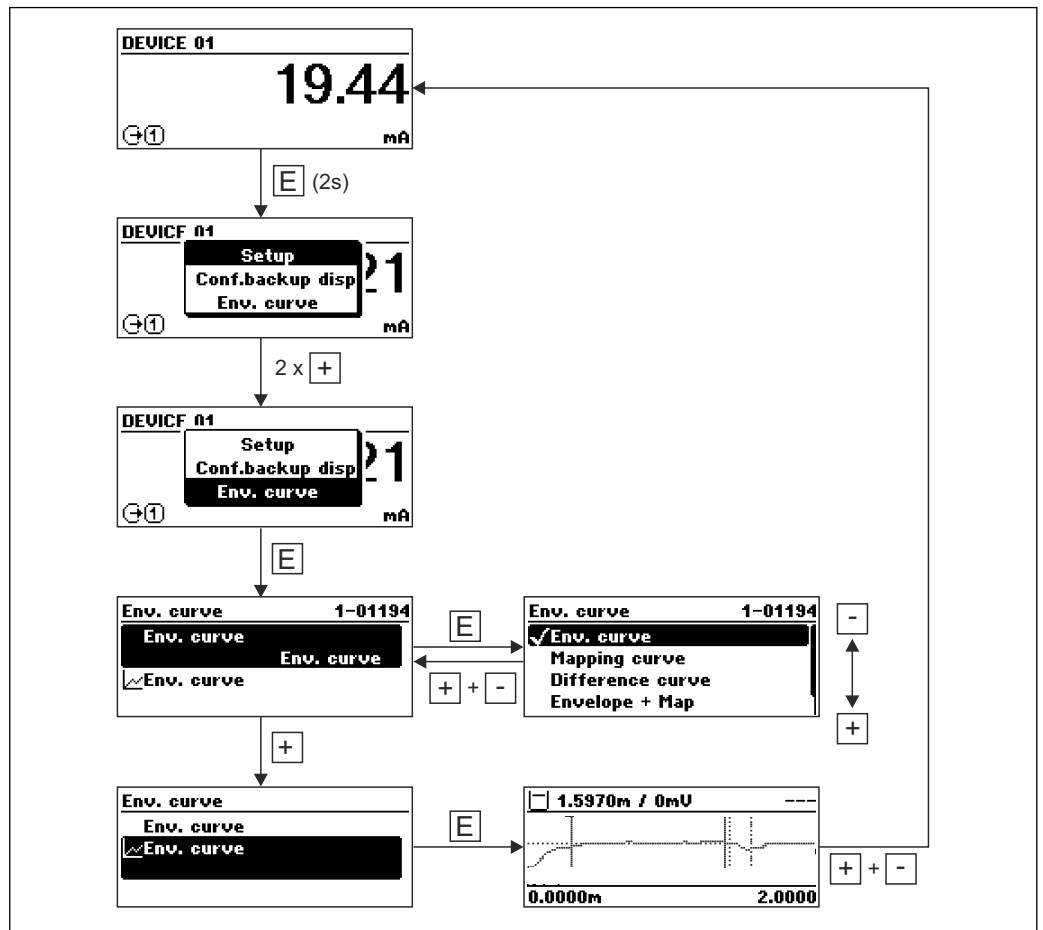

A0014277

## 9 System integration

### 9.1 Device description file (DD)

You require the following to configure a device and integrate it into an FF network:

- An FF configuration program
- The Cff file (Common File Format: \*.cff)
- The device description (DD) is in one of the following formats:
  - Device description format 4 : \*sym, \*ffo
  - Device description format 5 : \*sy5, \*ff5

*Data for device-specific DD*

Manufacturer ID	452B48hex
Device type	100Fhex
Device revision	05hex
DD Revision	Information and files available at:
CFF Revision	<ul style="list-style-type: none"> <li>▪ <a href="http://www.endress.com">www.endress.com</a></li> <li>▪ <a href="http://www.fieldcommgroup.org">www.fieldcommgroup.org</a></li> </ul>

### 9.2 Integration into the FF network

-  For more in-depth information on integrating the device into the FF system, see the description for the configuration software used.
  - When integrating the field devices into the FF system, make sure you are using the right files. You can read out the required version by means of the Device Revision/DEV\_REV and DD Revision/DD\_REV parameters in the Resource Block.

The device is integrated into the FF network as follows:

1. Start the FF configuration program.
2. Download the Cff and device description files (\*.ffo, \*.sym (for format 4) \*ff5, \*sy5 (for format 5) to the system.
3. Configure the interface.
4. Configure the device for the measuring task and for the FF system.

### 9.3 Device identification and addressing

FOUNDATION Fieldbus identifies the device using its identification code (device ID) and automatically assigns it a suitable field address. The identity code cannot be changed. The device appears in the network display once you have started the FF configuration program and integrated the device into the network. The blocks available are displayed under the device name.

If the device description has not yet been loaded, the blocks report "Unknown" or "(UNK)".

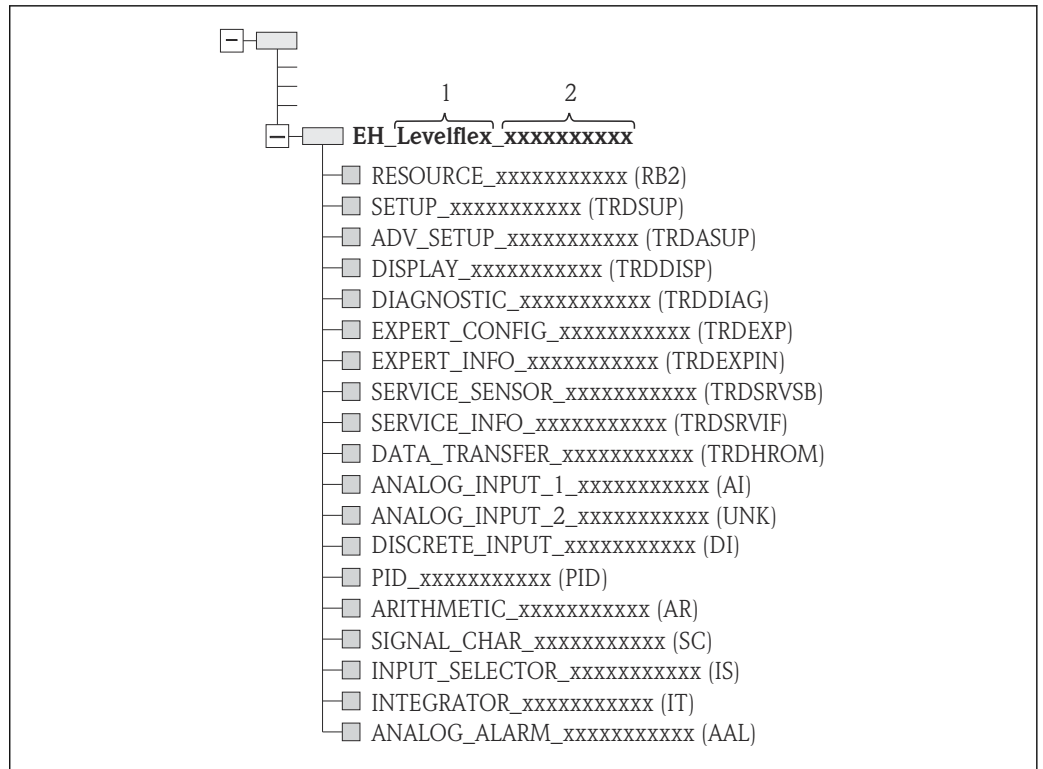

A0017208

24 Typical display in a configuration program after the connection has been established

- 1 Device name
- 2 Serial number

## 9.4 Block model

### 9.4.1 Blocks in the device software

The device has the following blocks:

- Resource Block (device block)
- Transducer Blocks
  - Setup Transducer Block (TRDSUP)
  - Advanced Setup Transducer Block (TRDASUP)
  - Display Transducer Block (TRDDISP)
  - Diagnostic Transducer Block (TRDDIAG)
  - Expert Configuration Transducer Block (TRDEXP)
  - Expert Information Transducer Block (TRDEXPIN)
  - Service Sensor Transducer Block (TRDSRVSB)
  - Service Information Transducer Block (TRDSRVIF)
  - Data Transfer Transducer Block (TRDHROM)
- Function blocks
  - 2 Analog Input Blocks (AI)
  - 1 Discrete Input Block (DI)
  - 1 PID Block (PID)
  - 1 Arithmetic Block (AR)
  - 1 Signal Characterizer Block (SC)
  - 1 Input Selector Block (IS)
  - 1 Integrator Block (IT)
  - 1 Analog Alarm Block (AAL)

In addition to the pre-instantiated blocks already mentioned, the following blocks can also be instantiated:

- 5 Analog Input Blocks (AI)
- 2 Discrete Input Blocks (DI)
- 3 PID Blocks (PID)
- 3 Arithmetic Blocks (AR)
- 2 Signal Characterizer Blocks (SC)
- 5 Input Selector Blocks (IS)
- 3 Integrator Blocks (IT)
- 2 Analog Alarm Blocks (AAL)

Up to 20 blocks can be instantiated in the device altogether, including the blocks already instantiated. For instantiating blocks, see the appropriate Operating Instructions of the configuration program used.

 Endress+Hauser Guideline BA00062S.

The guideline provides an overview of the standard function blocks that are described in FOUNDATION Fieldbus Specifications FF 890 - 894. It is designed as an aid when using these blocks that are implemented in the Endress+Hauser field devices.

### 9.4.2 Block configuration when device is delivered

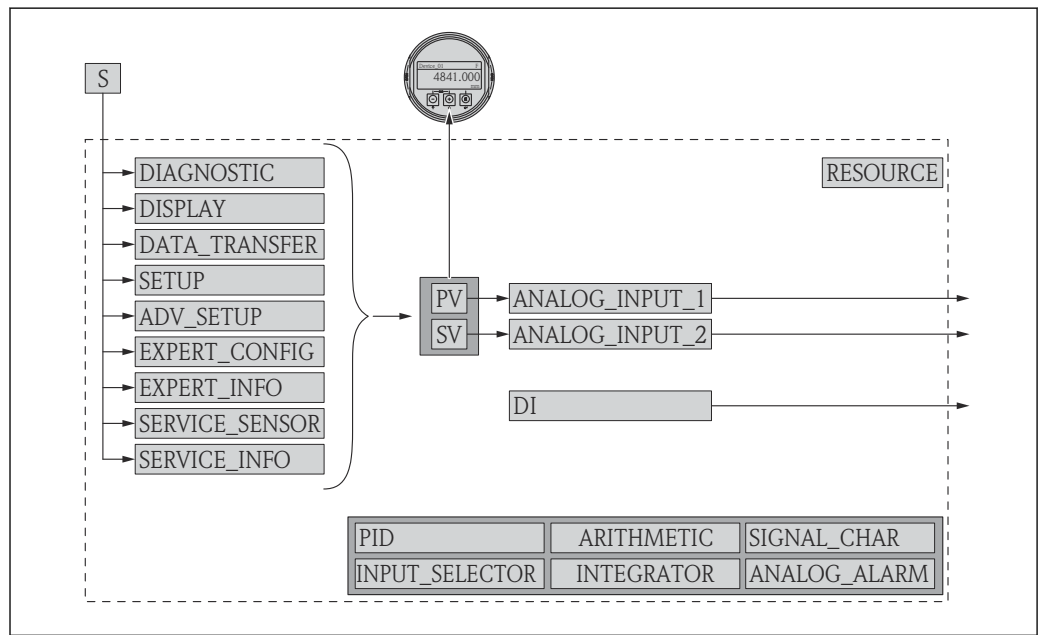

 25 Block configuration when device is delivered

S Sensor  
 PV Primary value: level linearized  
 SV Secondary value: distance

## 9.5 Assignment of measured values (CHANNEL) in the AI block

The input value of an analog input block is determined via the CHANNEL parameter.

Channel	Measured value
0	Uninitialized
89	Measured capacitance
144	EOP shift

Channel	Measured value
145	Interface distance
172	Calculated DC value
211	Terminal voltage
212	Sensor debug
32785	Absolute EOP amplitude
32786	Absolute echo amplitude
32787	Absolute interface amplitude
32856	Distance
32885	Electronics temperature
32938	Interface linearized
32949	Level linearized
33044	Relative echo amplitude
33045	Relative interface amplitude
33070	Noise of signal
33107	Upper interface thickness

## 9.6 Index tables of Endress+Hauser parameters

The manufacturer-specific device parameters of the resource blocks are listed in the following tables. Refer to document BA062S "Guideline - FOUNDATION Fieldbus Function Blocks" for the FOUNDATION fieldbus parameters. This document can be downloaded from the [www.endress.com](http://www.endress.com) web page.

### 9.6.1 Setup Transducer Block

Name	Label	Index	Data type	Size (bytes)	Storage Class	Write access	MODE_BLK	Description
bin_type	Bin type	54	ENUM16	2	Static	x	OOS	→ ⓘ 120
confirm_distance	Confirm distance	82	ENUM16	2	Static	x	OOS	→ ⓘ 123
filtered_dist_val	Distance	76	FLOAT	4	Dynamic			→ ⓘ 122
map_end_x	Present mapping	84	FLOAT	4	Dynamic			→ ⓘ 124
mapping_end_point	Mapping end point	83	FLOAT	4	Static	x	AUTO	→ ⓘ 124
record_map	Record map	86	ENUM16	2	Static	x	OOS	→ ⓘ 125
signal_quality	Signal quality	81	ENUM16	2	Dynamic			→ ⓘ 123
empty_calibration	Empty calibration	56	FLOAT	4	Static	x	OOS	→ ⓘ 120
full_calibration	Full calibration	57	FLOAT	4	Static	x	OOS	→ ⓘ 121
distance_unit	Distance unit	51	ENUM16	2	Static	x	OOS	→ ⓘ 120
level_unit	Level unit	58	ENUM16	2	Static	x	OOS	→ ⓘ 134
output_unit_after_linearization	Unit after linearization	62	ENUM16	2	Static			→ ⓘ 140
level_linearized	Level linearized	64	FLOAT	4	Dynamic			→ ⓘ 142
present_probe_length	Present probe length	87	FLOAT	4	Dynamic	x	AUTO	→ ⓘ 149
level	Level	60	FLOAT	4	Dynamic			→ ⓘ 121
decimal_places_menu_ro	Decimal places	93	ENUM16	2	Static	x	AUTO	→ ⓘ 161

Name	Label	Index	Data type	Size (bytes)	Storage Class	Write access	MODE_BLK	Description
locking_status	Locking status	96	BIT_ENUM16	2	Dynamic			→ ⓘ 129
medium_type_ro	Medium type	92	ENUM16	2	Static	x	OOS	→ ⓘ 131

## 9.6.2 Advanced Setup Transducer Block

Name	Label	Index	Data type	Size (bytes)	Storage Class	Write access	MODE_BLK	Description
blocking_distance	Blocking distance	55	FLOAT	4	Static	x	OOS	→ ⓘ 134
medium_type	Medium type	50	ENUM16	2	Static	x	OOS	→ ⓘ 131
present_probe_length_ro	Present probe length	80	FLOAT	4	Dynamic	x	AUTO	→ ⓘ 149
confirm_probe_length	Confirm probe length	79	ENUM16	2	Static	x	OOS	→ ⓘ 150
process_property	Process property	52	ENUM16	2	Static	x	OOS	→ ⓘ 132
advanced_process_conditions	Advanced process conditions	53	ENUM16	2	Static	x	OOS	→ ⓘ 133
medium_property	Medium property	51	ENUM16	2	Static	x	OOS	→ ⓘ 131
linearization_type	Linearization type	71	ENUM16	2	Static	x	OOS	→ ⓘ 139
activate_table	Activate table	70	ENUM16	2	Static	x	OOS	→ ⓘ 145
table_mode	Table mode	69	ENUM16	2	Static	x	OOS	→ ⓘ 143
custom_table_sel_level	Level	73	FLOAT	4	Static	x	OOS	→ ⓘ 121
custom_table_sel_value	Customer value	74	FLOAT	4	Static	x	OOS	→ ⓘ 145
unit_after_linearization	Unit after linearization	63	ENUM16	2	Static	x	OOS	→ ⓘ 140
free_text	Free text	64	STRING		Static	x	AUTO	→ ⓘ 141
diameter	Diameter	66	FLOAT	4	Static	x	OOS	→ ⓘ 142
output_echo_lost	Output echo lost	76	ENUM16	2	Static	x	OOS	→ ⓘ 146
intermediate_height	Intermediate height	67	FLOAT	4	Static	x	AUTO	→ ⓘ 143
level_correction	Level correction	56	FLOAT	4	Static	x	OOS	→ ⓘ 135
level_unit_ro	Level unit	54	ENUM16	2	Static	x	OOS	→ ⓘ 134
assign_limit	Assign limit	82	ENUM16	2	Static	x	AUTO	→ ⓘ 154
maximum_value	Maximum value	65	FLOAT	4	Static	x	OOS	→ ⓘ 142
assign_diag_behavior	Assign diagnostic behavior	83	ENUM16	2	Static	x	AUTO	→ ⓘ 154
value_echo_lost	Value echo lost	77	FLOAT	4	Static	x	OOS	→ ⓘ 146
ramp_at_echo_lost	Ramp at echo lost	78	FLOAT	4	Static	x	OOS	→ ⓘ 147
switch_output_failure_mode	Failure mode	88	ENUM16	2	Static	x	AUTO	→ ⓘ 157
switch_output_function	Switch output function	81	ENUM16	2	Static	x	AUTO	→ ⓘ 153
switch_status	Switch status	89	ENUM16	2	Dynamic			→ ⓘ 157
switch_off_delay	Switch-off delay	87	FLOAT	4	Static	x	AUTO	→ ⓘ 157
switch_off_value	Switch-off value	86	FLOAT	4	Static	x	AUTO	→ ⓘ 156
switch_on_delay	Switch-on delay	85	FLOAT	4	Static	x	AUTO	→ ⓘ 156
switch_on_value	Switch-on value	84	FLOAT	4	Static	x	AUTO	→ ⓘ 155
table_number	Table number	68	UINT8	1	Static	x	OOS	→ ⓘ 144
level_semiautomatic	Level	75	FLOAT	4	Dynamic			→ ⓘ 145
assign_status	Assign status	91	ENUM16	2	Static	x	AUTO	→ ⓘ 153

Name	Label	Index	Data type	Size (bytes)	Storage Class	Write access	MODE_BLK	Description
locking_status	Locking status	99	BIT_ENUM16	2	Dynamic			→ 129
decimal_places_menu	Decimal places menu	93	ENUM16	2	Static	x	AUTO	→ 163
distance_unit_ro	Distance unit	92	ENUM16	2	Static	x	OOS	→ 120

### 9.6.3 Display Transducer Block

Name	Label	Index	Data type	Size (bytes)	Storage Class	Write access	MODE_BLK	Description
access_status_display	Access status display	51	ENUM16	2	Static			→ 129
display_damping	Display damping	65	FLOAT	4	Static	x	AUTO	→ 162
display_interval	Display interval	64	FLOAT	4	Static	x	AUTO	→ 162
header	Header	66	ENUM16	2	Static	x	AUTO	→ 162
format_display	Format display	55	ENUM16	2	Static	x	AUTO	→ 159
number_format	Number format	69	ENUM16	2	Static	x	AUTO	→ 163
display_separator	Separator	68	ENUM16	2	Static	x	AUTO	→ 163
language	Language	54	ENUM16	2	Static	x	AUTO	→ 159
contrast_display	Contrast display	71	FLOAT	4	Static	x	AUTO	→ 164
header_text	Header text	67	STRING		Static	x	AUTO	→ 163
access_code_for_display	Enter access code	52	UINT16	2	Static	x	AUTO	→ 130
configuration_management	Configuration management	75	ENUM16	2	Static	x	AUTO	→ 165
decimal_places_1	Decimal places 1	57	ENUM16	2	Static	x	AUTO	→ 161
decimal_places_2	Decimal places 2	59	ENUM16	2	Static	x	AUTO	→ 161
decimal_places_3	Decimal places 3	61	ENUM16	2	Static	x	AUTO	→ 161
decimal_places_4	Decimal places 4	63	ENUM16	2	Static	x	AUTO	→ 161
last_backup	Last backup	74	STRING		Static	x	AUTO	→ 165
value_1_display	Value 1 display	56	ENUM16	2	Static	x	AUTO	→ 161
value_2_display	Value 2 display	58	ENUM16	2	Static	x	AUTO	→ 161
value_3_display	Value 3 display	60	ENUM16	2	Static	x	AUTO	→ 161
value_4_display	Value 4 display	62	ENUM16	2	Static	x	AUTO	→ 161
locking_status_display	Locking status	50	ENUM16	2	Static			→ 129
define_access_code	Define access code	53	UINT16	2	Static	x	AUTO	→ 168
comparison_result	Comparison result	76	ENUM16	2	Static	x	AUTO	→ 166
decimal_places_menu	Decimal places menu	70	ENUM16	2	Static	x	AUTO	→ 163
operating_time	Operating time	73	STRING		Dynamic			→ 165
locking_status	Locking status	85	BIT_ENUM16	2	Dynamic			→ 129

### 9.6.4 Diagnostic Transducer Block

Name	Label	Index	Data type	Size (bytes)	Storage Class	Write access	MODE_BLK	Description
operating_time	Operating time	55	STRING		Dynamic			→ 165
diagnostics_1	Diagnostics	56	UINT32	4	Static			→ 173
diagnostics_2	Diagnostics 2	58	UINT32	4	Static			→ 173

Name	Label	Index	Data type	Size (bytes)	Storage Class	Write access	MODE_BLK	Description
diagnostics_3	Diagnostics 3	60	UINT32	4	Static			→ 173
diagnostics_4	Diagnostics 4	62	UINT32	4	Static			→ 173
diagnostics_5	Diagnostics 5	64	UINT32	4	Static			→ 173
operating_time_from_restart	Operating time from restart	54	STRING		Dynamic			→ 172
launch_signal	Launch signal	81	ENUM16	2	Dynamic			→ 189
start_device_check	Start device check	77	ENUM16	2	Static	x	AUTO	→ 188
level_signal	Level signal	80	ENUM16	2	Dynamic			→ 189
simulation_device_alarm	Simulation device alarm	75	ENUM16	2	Static	x	OOS	→ 187
filter_options	Filter options	66	ENUM8	1	Static	x	AUTO	→ 174
previous_diagnostics	Previous diagnostics	52	UINT32	4	Static			→ 171
actual_diagnostics	Actual diagnostics	50	UINT32	4	Static			→ 171
assign_sim_meas	Assign measurement variable	71	ENUM16	2	Static	x	OOS	→ 186
sim_value_process_variable	Process variable value	72	FLOAT	4	Static	x	OOS	→ 186
switch_output_simulation	Switch output simulation	73	ENUM16	2	Static	x	OOS	→ 186
sim_switch_status	Switch status	74	ENUM16	2	Static	x	OOS	→ 187
result_device_check	Result device check	78	ENUM16	2	Dynamic			→ 188
last_check_time	Last check time	79	STRING		Dynamic			→ 188
linearization_type	Linearization type	84	ENUM16	2	Static	x	OOS	→ 139
unit_after_linearization_ro	Unit after linearization	85	STRING		Static	x	AUTO	→ 140
decimal_places_menu	Decimal places menu	88	ENUM16	2	Static	x	AUTO	→ 163
level_unit_ro	Level unit	90	ENUM16	2	Static	x	OOS	→ 134
assign_channel_1	Assign channel 1	92	ENUM16	2	Static	x	AUTO	→ 180
assign_channel_2	Assign channel 2	93	ENUM16	2	Static	x	AUTO	→ 180
assign_channel_3	Assign channel 3	94	ENUM16	2	Static	x	AUTO	→ 180
assign_channel_4	Assign channel 4	95	ENUM16	2	Static	x	AUTO	→ 180
clear_logging_data	Clear logging data	97	ENUM16	2	Static	x	AUTO	→ 181
logging_interval	Logging interval	96	FLOAT	4	Static	x	AUTO	→ 181
display_filter_options	Filter options	99	ENUM8	1	Static	x	AUTO	→ 174
locking_status	Locking status	108	BIT_ENUM16	2	Dynamic			→ 129
distance_unit_ro	Distance unit	89	ENUM16	2	Static	x	OOS	→ 120

### 9.6.5 Expert Configuration Transducer Block

 The parameters of the **Expert Configuration Transducer Block** are described in document GP01015F: "Levelflex FMP5x - Description of Device Parameters - FOUNDATION Fieldbus"

Name	Label	Index	Data type	Size (bytes)	Storage Class	Write access	MODE_BLK
acknowledge_alarm	Reset self holding	81	ENUM16	2	Static	x	AUTO
integration_time	Integration time	67	FLOAT	4	Static	x	OOS
result_self_check	Result self check	77	ENUM16	2	Dynamic		
start_self_check	Start self check	76	ENUM16	2	Static	x	AUTO



Name	Label	Index	Data type	Size (bytes)	Storage Class	Write access	MODE_BLK
broken_probe_detection	Broken probe detection	75	ENUM16	2	Static	x	AUTO
gpc_mode	GPC mode	68	ENUM16	2	Static	x	OOS
reference_echo_threshold	Reference echo threshold	73	FLOAT	4	Static	x	OOS
const_gpc_factor	Const. GPC factor	74	FLOAT	4	Static	x	OOS
build_up_ratio	Buildup ratio	90	FLOAT	4	Dynamic		
build_up_threshold	Buildup thres.	91	FLOAT	4	Static	x	AUTO
delay_time_echo_lost	Delay time echo lost	78	FLOAT	4	Static	x	AUTO
empty_capacity	Empty capacity	92	FLOAT	4	Static	x	AUTO
external_pressure_selector	External pressure selector	69	ENUM16	2	Static	x	OOS
measured_capacity	Measured capacitance	89	FLOAT	4	Dynamic		
gas_phase_compens_factor	Gas phase compensation factor	70	FLOT	4	Static	x	OOS
in_safety_distance	In safety distance	80	ENUM16	2	Static	x	OOS
ratio_amplitude_interface_level	Ratio amplitude interface/level	86	FLOAT	4	Static	x	OOS
interface_criterion	Interface criterion	87	FLOAT	4	Dynamic		
control_measurement	Measurement	106	ENUM16	2	Static	x	AUTO
control_measurement	Control measurement	105	ENUM16	2	Static	x	AUTO
filter_dead_time	Dead time	66	FLOAT	4	Static	x	OOS
present_reference_distance	Present reference distance	72	FLOAT	4	Dynamic		
history_reset	History reset	83	ENUM16	2	Static	x	OOS
safety_distance	Safety distance	79	FLOAT	4	Static	x	OOS
history_learning_control	History learning	85	ENUM16	2	Static	x	AUTO
history_learning_control	History learning control	84	ENUM16	2	Static	x	AUTO
sensor_module	Sensor module	107	ENUM16	2	Static		
evaluation_mode	Evaluation mode	82	ENUM16	2	Static	x	OOS
thin_interface	Thin interface	88	ENUM16	2	Static	x	OOS
calculated_dc_value	Calculated DC value	59	FLOAT	4	Dynamic	x	AUTO
dc_value_expert	DC value	55	FLOAT	4	Static	x	OOS
distance_offset	Distance offset	60	FLOAT	4	Static	x	OOS
level_limit_mode	Level limit mode	62	ENUM16	2	Static	x	OOS
level_high_limit	High limit	63	FLOAT	4	Static	x	OOS
level_low_limit	Low limit	64	FLOAT	4	Static	x	OOS
output_mode	Output mode	65	ENUM16	2	Static	x	OOS
level_external_input_1	Level external input 1	93	ENUM16	2	Static	x	AUTO
level_external_input_2	Level external input 2	96	ENUM16	2	Static	x	AUTO
function_input_1_level	Function Input 1 Level	94	ENUM16	2	Static	x	AUTO
function_input_2_level	Function Input 2 Level	97	ENUM16	2	Static	x	AUTO
fixed_value_inp_1	Fixed value input 1	95	FLOAT	4	Static	x	AUTO
fixed_value_inp_2	Fixed value input 2	98	FLOAT	4	Static	x	AUTO
interface_external_input_1	Interface external input 1	99	ENUM16	2	Static	x	OOS
interface_external_input_2	Interface external input 2	102	ENUM16	2	Static	x	OOS
function_input_1_interface	Function input 1 interface	100	ENUM16	2	Static	x	OOS
function_input_2_interface	Function input 2 interface	103	ENUM16	2	Static	x	OOS
fixed_value_input_1_interface	Fixed value input 1 interface	101	FLOAT	4	Static	x	OOS

Name	Label	Index	Data type	Size (bytes)	Storage Class	Write access	MODE_BLK
fixed_value_input_2_interface	Fixed value input 2 interface	104	FLOAT	4	Static	x	OOS
distance_unit_ro	Distance unit	53	ENUM16	2	Static	x	OOS
level_unit_ro	Level unit	61	ENUM16	2	Static	x	OOS
operating_mode_ro	Operating mode	54	ENUM16	2	Static	x	OOS
enter_access_code	Enter access code	52	UINT16	2	Static	x	AUTO
locking_status	Locking status	50	BIT_ENUM16	2	Dynamic		
access_status_tooling	Access status tooling	51	ENUM16	2	Static		
reference_distance	Reference distance	71	FLOAT	4	Static	x	OOS
sw_option_active_overview	SW option active overview	110	BIT_ENUM32	4	Static		
decimal_places_menu	Decimal places menu	109	ENUM16	2	Static	x	AUTO
fieldbus_type	Fieldbus type	111	ENUM8	1	Static		
interface_property_ro	Interface property	108	ENUM16	2	Static	x	OOS
medium_type_ro	Medium type	112	ENUM16	2	Static	x	OOS
eop_level_evaluation_ro	EOP level evaluation	113	ENUM16	2	Static	x	OOS
sensor_type_ro	Sensor type	114	ENUM16	2	Static	x	OOS
calculated_dc_status_en	Status	58	ENUM8	1	Dynamic		

### 9.6.6 Expert Information Transducer Block



The parameters of the **Expert Information Transducer Block** are described in document GPO1015F: "Levelflex FMP5x - Description of Device Parameters - FOUNDATION Fieldbus"

Name	Label	Index	Data type	Size (bytes)	Storage Class	Write access	MODE_BLK
abs_echo_amp_val	Absolute echo amplitude	51	FLOAT	4	Dynamic		
abs_eop_amp_val	Absolute EOP amplitude	55	FLOAT	4	Dynamic		
absolute_interface_amplitude	Absolute interface amplitude	58	FLOAT	4	Dynamic		
application_parameter	Application parameter	74	ENUM16	2	Dynamic		
electronic_temp_value	Electronics temperature	66	FLOAT	4	Dynamic		
eop_shift_value	EOP shift	69	FLOAT	4	Dynamic		
found_echoes	Found echoes	71	ENUM16	2	Dynamic		
max_electr_temp	Max. electronics temperature	73	FLOAT	4	Dynamic	x	AUTO
time_max_electr_temp	Time max. electronics temperature	75	STRING		Dynamic		
measurement_frequency	Measuring frequency	76	FLOAT	4	Dynamic		
min_electr_temp	Min. electronics temperature	77	FLOAT	4	Dynamic	x	AUTO
time_min_electr_temp	Time min. electronics temperature	78	STRING		Dynamic		
rel_echo_amp_val	Relative echo amplitude	53	FLOAT	4	Dynamic		
relative_interface_amplitude	Relative interface amplitude	60	FLOAT	4	Dynamic		
reset_min_max_temp	Reset min./max. temp.	79	ENUM16	2	Static	x	AUTO
noise_signal_val	Noise of signal	63	FLOAT	4	Dynamic		
used_calculation	Used calculation	80	ENUM16	2	Dynamic		
tank_trace_state	Tank trace state	81	ENUM16	2	Dynamic		
max_draining_speed	Max. draining speed	82	FLOAT	4	Dynamic	x	AUTO
max_filling_speed	L max. fill speed	83	FLOAT	4	Dynamic	x	AUTO

Name	Label	Index	Data type	Size (bytes)	Storage Class	Write access	MODE_BLK
time_max_level	Time max. level	84	STRING		Dynamic		
max_level_value	Max. level	85	FLOAT	4	Dynamic	x	AUTO
time_min_level	Time min. level	86	STRING		Dynamic		
min_level_value	Min. level value	87	FLOAT	4	Dynamic	x	AUTO
reset_min_max	Rest min./max.	94	ENUM16	2	Static	x	AUTO
interf_max_drain_speed	I max. drain speed	88	FLOAT	4	Dynamic	x	AUTO
interf_max_fill_speed	I max. fill speed	89	FLOAT	4	Dynamic	x	AUTO
time_max_interface	Time max. interface	90	STRING		Dynamic		
max_interface_value	Max. interface value	91	FLOAT	4	Dynamic	x	AUTO
time_min_interface	Time min. interface	92	STRING		Dynamic		
min_interface_value	Min. interface value	93	FLOAT	4	Dynamic	x	AUTO
application_parameter	Application parameter	95	ENUM16	2	Dynamic		
operating_mode_ro	Operating mode	108	ENUM16	2	Static	x	OOS
temperature_unit	Temperature unit	72	ENUM16	2	Static	x	AUTO
activate_sw_option	Activate SW option	110	UINT32	4	Static	x	AUTO
target_echo_status	Status	56	ENUM8	1	Dynamic		
iface_target_echo_status	Status	61	ENUM8	1	Dynamic		
signal_noise_status	Status	64	ENUM8	1	Dynamic		
sens_temp_status	Status	67	ENUM8	1	Dynamic		
eop_shift_status	Status	70	ENUM8	1	Dynamic		
terminal_voltage_1	Terminal voltage 1	97	FLOAT	4	Dynamic		
calculated_dc_value	Calculated DC value	100	FLOAT	4	Dynamic	x	AUTO
upper_interface_thickness	Upper interface thickness	103	FLOAT	4	Dynamic		
debug_value	Debug value	106	FLOAT	4	Dynamic	x	AUTO
sw_option_active_overview	SW option active overview	111	BIT_ENUM32	4	Static		
locking_status	Locking status	113	BIT_ENUM16	2	Dynamic		
decimal_places_menu_ro	Decimal places menu	109	ENUM16	2	Static	x	AUTO
linearization_type	Linearization type	104	ENUM16	2	Static	x	OOS
eop_level_evaluation	EOP level evaluation	112	ENUM16	2	Static	x	OOS
access_status_tooling	Access status tooling	114	ENUM16	2	Static		
calculated_dc_status	Status	99	UINT8	1	Dynamic		
status_up_iface_thickness	Customized upper phase thickness status	102	UINT8	1	Dynamic		
debug_status		107	UINT8	1	Dynamic	x	AUTO

### 9.6.7 Service Sensor Transducer Block

The parameters of the **Service Sensor** Transducer Block can only be operated by authorized Endress+Hauser service personnel.

### 9.6.8 Service Information Transducer Block

The parameters of the **Service Information** Transducer Block can only be operated by authorized Endress+Hauser service personnel.

### 9.6.9 Data Transfer Transducer Block

 The parameters of the **Data Transfer Transducer Block** are described in GP01015F: "Levelflex FMP5x - Description of Device Parameters - FOUNDATION Fieldbus"

Name	Label	Index	Data type	Size (bytes)	Storage Class	Write access	MODE_BLK
used_calculation	Used calculation	87	ENUM16	2	Dynamic		
bdt_cfg_rdwr_ctrl		101	UINT16	2	Static	x	AUTO
bdt_transferred_ctrl		102	BYTEARRAY		Static	x	AUTO
bdt_data_trans		103	BYTEARRAY		Static	x	AUTO
bdt_prepare		99	BYTEARRAY		Static	x	AUTO
bdt_status		100	BYTEARRAY		Static		
sw_option_active_overview	SW option active overview	98	BIT_ENUM32	4	Static		
digits_at_0_mVdB		90	FLOAT	4	Dynamic	x	AUTO
digits_per_mVdB		91	FLOAT	4	Dynamic	x	AUTO
actual_diagnostics	Actual diagnostics	97	UINT32	4	Static		
electric_probe_length	Electric probe length	92	FLOAT	4	Dynamic		
empty_calibration_ro	Empty calibration	93	FLOAT	4	Static	x	OOS
full_calibration_ro	Full calibration	94	FLOAT	4	Static	x	OOS
distance_unit_ro	Distance unit	95	ENUM16	2	Static	x	OOS
operating_mode_ro	Operating mode	88	ENUM16	2	Static	x	OOS
present_probe_length_ro	Present probe length	89	FLOAT	4	Dynamic	x	AUTO
trend_operation_hours		104	UINT32	4	Static		
trend_package_size		105	UINT8	1	Static	x	AUTO
trend_storage_time	Trend storage time	106	UINT32	4	Static		
trend_sup_pack_size		107	UINT8	1	Static		
gpc_mode_ro	GPC mode	109	ENUM16	2	Static	x	OOS
eop_level_evaluation_ro	EOP level evaluation	110	ENUM16	2	Static	x	OOS
temperature_unit_ro	Temperature unit	111	ENUM16	2	Static	x	OOS
max_trend_entries		108	UINT16	2	Static		
line_mapping_point_number	Line mapping point number	126	UINT16	2	Static	x	AUTO
line_mapping_array_x	Line mapping array X	127	FLOAT	4	Static	x	AUTO
line_mapping_array_y	Line mapping array Y	128	FLOAT	4	Static	x	AUTO
mapping_end_point_ro	Mapping end point	125	FLOAT	4	Static	x	AUTO
mapping_start_point	Mapping start point	124	FLOAT	4	Static	x	AUTO
function_block_table		143	UINT32	4	Static		
custom_empty_value		112	FLOAT	4	Static		
custom_full_value		113	FLOAT	4	Static		
customized	Customized	121	UINT8	1	Static		
reset_ordered_configuration	Reset ordered configuration	122	ENUM16	2	Static	x	AUTO
empty_scale		114	FLOAT	4	Static	x	AUTO
eop_map_point_number		116	UINT16	2	Static	x	AUTO
factory_data_valid		123	UINT8	1	Static		
fieldbus_type	Fieldbus type	144	ENUM8	1	Static		
full_scale		115	FLOAT	4	Static	x	AUTO

Name	Label	Index	Data type	Size (bytes)	Storage Class	Write access	MODE_BLK
init_map_point_number		117	UINT16	2	Static	x	AUTO
max_not_assoc_track		118	UINT16	2	Static	x	AUTO
ref_max_dist	Ref max. dist.	119	FLOAT	4	Static	x	AUTO
ref_min_dist	Reference min. distance	120	FLOAT	4	Static	x	AUTO
line_mapping_accuracy	Line mapping accuracy	130	FLOAT	4	Static	x	AUTO
mapping_curve_left_margin	Mapping curve left margin	131	FLOAT	4	Static	x	AUTO
device_calib_changed		133	ENUM16	2	Static	x	AUTO
echo_thresh_attenuat_const_ee	Threshold attenuation constant	134	FLOAT	4	Dynamic	x	AUTO
echo_threshold_far_ee		135	FLOAT	4	Static	x	AUTO
echo_thresh_inactive_len		137	FLOAT	4	Static	x	AUTO
echo_threshold_near_ee		136	FLOAT	4	Static	x	AUTO
present_probe_length_ee		138	FLOAT	4	Static	x	AUTO
reset_appl_para_chg_flags		139	ENUM16	2	Static	x	AUTO
reset_dyn_persistent		140	ENUM16	2	Static	x	AUTO
locking_status	Locking status	142	BIT_ENUM16	2	Dynamic		
decimal_places_menu	Decimal places menu	96	ENUM16	2	Static	x	AUTO
access_status_tooling	Access status tooling	141	ENUM16	2	Static		
level_linearized	Level linearized	147	FLOAT	4	Dynamic		
bdt_transferred_ctrl		197	UINT8	1	Static	x	AUTO
bdt_cfg_rdwr_ctrl		196	UINT16	2	Static	x	AUTO

## 9.7 Methods

The FOUNDATION Fieldbus Specification allows for the use of methods to simplify device operation. A method is a sequence of interactive steps to be carried out in the specified order so as to configure certain device functions.

The following methods are available for the devices:

- **Restart**

This method is located in the resource block and is used to configure the **Reset device** parameter. This resets the device parameters to a specific state.

- **ENP Restart**

This method is located in the resource block and allows the parameters of the electronic nameplate (**E**lectronic **N**ame **P**late) to be changed.

- **Setup**

This method is located in the SETUP Transducer Block and is used for basic configuration of the measurement parameters (units, tank or vessel type, medium, empty and full calibration).

- **Linearization**

This method is located in the ADV\_SETUP Transducer Block and allows the linearization table to be managed for the purpose of converting the level measured into a volume, a mass or a flow rate.

- **Self Check**

This method is located in the EXPERT\_CONFIG Transducer Block and is used to perform a device self-test.

## 10 Commissioning using the wizard

FieldCare and DeviceCare have a wizard that guides the user through initial commissioning.

1. Connect the device with FieldCare or DeviceCare.
2. Open the device in FieldCare or DeviceCare.
  - ↳ The dashboard (homepage) of the device is displayed:

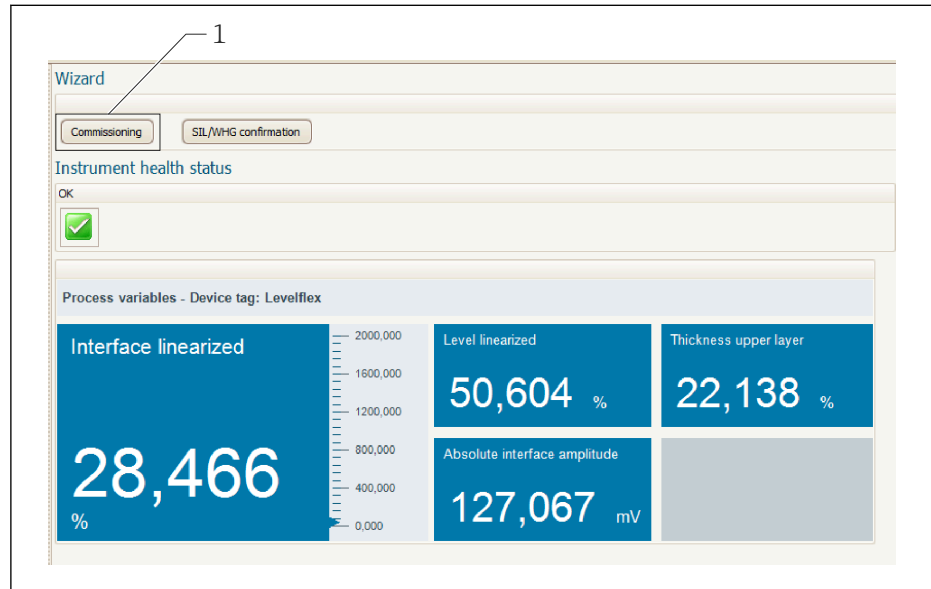

1 "Commissioning" button calls up the wizard

3. Click "Commissioning" to launch the Wizard.
  4. Enter the appropriate value in each parameter or select the appropriate option. These values are written directly to the device.
  5. Click "Next" to go to the next page.
  6. Once all the pages have been completed, click "Finish" to close the Wizard.
- i** If you cancel the Wizard before all the necessary parameters have been entered, the device may be in an undefined state. In such situations, it is advisable to reset the device to the factory default settings.

# 11 Commissioning via operating menu

## 11.1 Installation and function check

Before commissioning the measuring point, check whether the post-installation and post-connection checks have been performed.

Post-mounting check

Post-connection check

## 11.2 Configuring the operating language

Factory setting: English or ordered local language

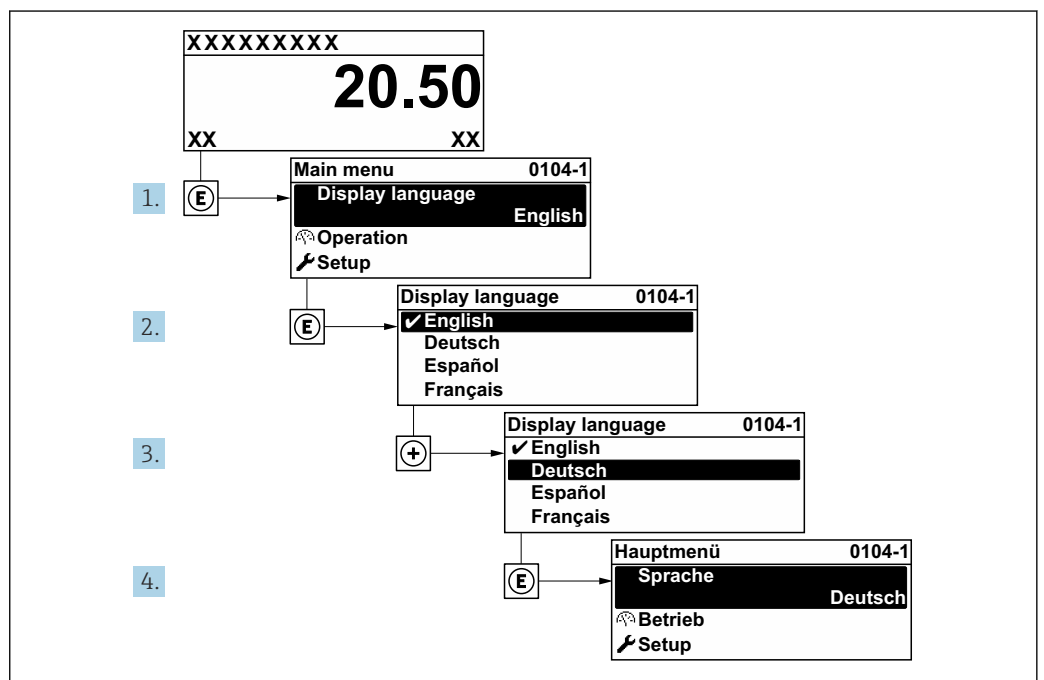

26 Using the example of the local display

A0029420

### 11.3 Configuring level measurement

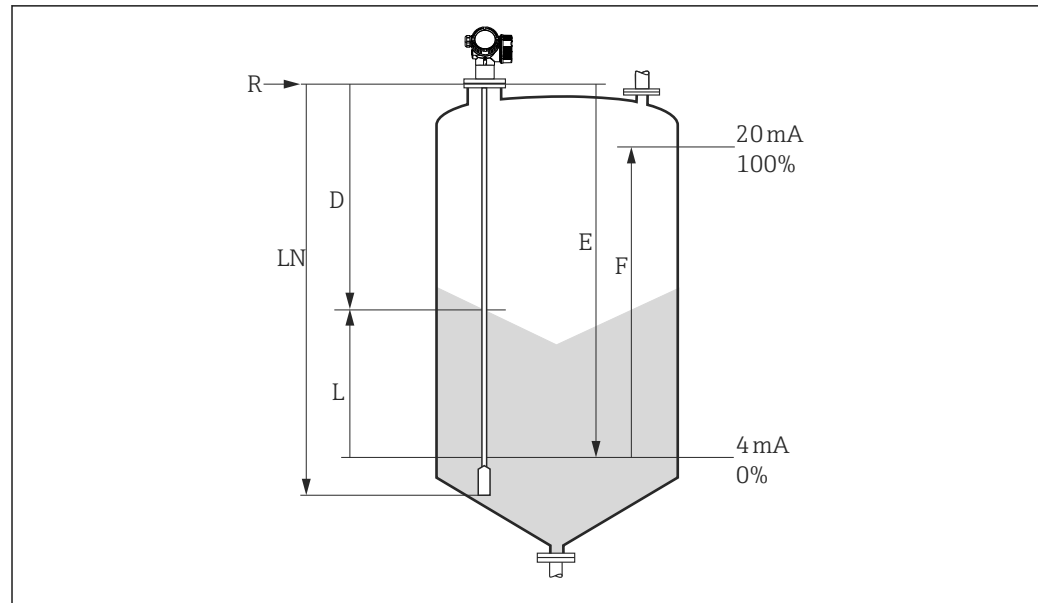

A0012838

27 Configuration parameters for level measurement in bulk solids

- $LN$  Length of probe
- $R$  Reference point of the measurement
- $D$  Distance
- $L$  Level
- $E$  Empty calibration (= zero point)
- $F$  Full calibration (= span)

**i** If the  $\epsilon_r$  value is lower than 7 in the case of rope probes, measurement is not possible in the area of the probe weight. The empty calibration  $E$  should not exceed  $LN - 250$  mm ( $LN - 10$  in) in these cases.

1. Setup → Device tag
  - ↳ Enter the tag name.
2. Navigate to: Setup → Distance unit
  - ↳ Select the length unit.
3. Navigate to: Setup → Bin type
  - ↳ Select bin type.
4. Navigate to: Setup → Empty calibration
  - ↳ Specify empty distance  $E$  (distance from reference point  $R$  to 0% mark).
5. Navigate to: Setup → Full calibration
  - ↳ Specify the full distance  $F$  (distance from the 0% mark to the 100% mark).
6. Navigate to: Setup → Level
  - ↳ Displays the measured level  $L$ .
7. Navigate to: Setup → Distance
  - ↳ Displays the distance  $D$  between the reference point  $R$  and the level  $L$ .
8. Navigate to: Setup → Signal quality
  - ↳ Displays the signal quality of the analyzed level echo.
9. Operation via local display:
  - Navigate to: Setup → Mapping → Confirm distance
    - ↳ Compare the distance displayed with the actual value to start recording an interference echo map if necessary.



- 10. Operation via operating tool:
  - Navigate to: Setup → Confirm distance
    - ↳ Compare the distance displayed with the actual value to start recording an interference echo map if necessary.

## 11.4 Recording the reference echo curve

After the measurement has been configured, it is recommended to record the current envelope curve as a reference echo curve. This can then be used later for diagnostic purposes. The **Save reference curve** parameter is used to record the envelope curve.

### Path in the menu

Expert → Diagnostics → Envelope diagnostics → Save reference curve

### Meaning of the options

- No
  - No action
- Yes
  - The current envelope curve is saved as a reference curve.

 This submenu is only visible for the "Service" user role in devices supplied with software version 01.00.zz.

 The reference echo curve can only be displayed in the envelope curve diagram of FieldCare after it has been loaded from the device into FieldCare. The "Load Reference Curve" function in FieldCare is used for this.

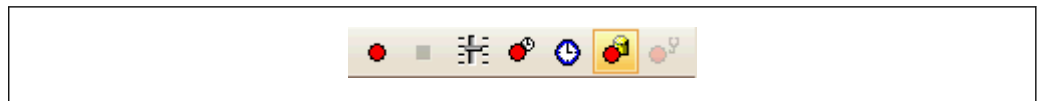

 28 "Load Reference Curve" function

## 11.5 Configuring the local display

### 11.5.1 Factory setting of local display for level measurements

Parameter	Factory setting for devices with 1 current output	Factory setting for devices with 2 current outputs
Format display	1 value, max. size	1 value, max. size
Value 1 display	Level linearized	Level linearized
Value 2 display	Distance	Distance
Value 3 display	Current output 1	Current output 1
Value 4 display	None	Current output 2

### 11.5.2 Adjusting the local display

The local display can be adjusted in the following submenu:  
Setup → Advanced setup → Display

## 11.6 Configuration management

After commissioning, you can save the current device configuration, copy it to another measuring point or restore the previous device configuration. You can do so using the **Configuration management** parameter and the options available.

**Path in the menu**

Setup → Advanced setup → Configuration backup display → Configuration management

**Meaning of the options****■ Cancel**

No action is executed and the user exits the parameter.

**■ Execute backup**

A backup copy of the current device configuration is saved from the HistoROM (integrated in the device) to the display module of the device.

**■ Restore**

The last backup copy of the device configuration is copied from the display module to the HistoROM of the device.

**■ Duplicate**

The transmitter configuration of the device is duplicated to another device using the display module. The following parameters, which characterize the individual measuring point are **not** transferred:

Medium type

**■ Compare**

The device configuration saved in the display module is compared to the current device configuration of the HistoROM. The result of the comparison is displayed in the **Comparison result** parameter.

**■ Clear backup data**

The backup copy of the device configuration is deleted from the display module of the device.



While this action is in progress, the configuration cannot be edited via the local display and a message on the processing status appears on the display.



If an existing backup copy is restored on a device other than the original device using the **Restore** option, in some cases individual device functions may not be available. In some cases it is also not possible to restore the original state by resetting to the "as-delivered" state.

The **Duplicate** option should always be used to copy the configuration to another device.

## 11.7 Protecting settings from unauthorized access

The settings can be protected from unauthorized access in two ways:

- Locking via parameters (software locking)
- Locking via write protection switch (hardware locking)

## 12 Commissioning (block-based operation)

### 12.1 Installation and function check

Before commissioning the measuring point, check whether the post-installation and post-connection checks have been performed.

 Post-mounting check

 Post-connection check

### 12.2 Block configuration

#### 12.2.1 Preliminaries

1. Switch on the measuring instrument.
2. Make a note of the **DEVICE\_ID**.
3. Open the configuration program.
4. Load Cff and device description files into the host system or the configuration program. Make sure you are using the right system files.
5. Identify the device using the **DEVICE\_ID** (see point 2). Assign the desired tag name to the device via the **Pd-tag/FF\_PD\_TAG** parameter.

#### 12.2.2 Configuring the Resource Block

1. Open the Resource Block.
2. If necessary, disable the lock for device operation.
3. If necessary, change the block name. Factory setting: RS-xxxxxxxxxx (RB2)
4. If necessary, assign a description to the block by means of the **Tag Description/TAG\_DESC** parameter.
5. If necessary, change other parameters as required.

#### 12.2.3 Configuring the Transducer Blocks

The measurement and the display module are configured via the Transducer Blocks. The basic procedure is the same for all Transducer Blocks:

1. If necessary, change the block name.
2. Set the block mode to **OOS** via the **Block mode/MODE\_BLK** parameter, **TARGET** element.
3. Configure the device in accordance with the measuring task.
4. Set the block mode to **Auto** via the **Block mode/MODE\_BLK** parameter, **TARGET** element.

 The block mode must be set to **Auto** for the measuring instrument to function correctly.

### 12.2.4 Configuring the Analog Input Blocks

The device has 2 Analog Input Blocks that can be assigned as required to the various process variables.

Factory setting	
Analog Input Block	CHANNEL
AI 1	32949: Level linearized
AI 2	32856: Distance

1. If necessary, change the block name.
2. Set the block mode to **OOS** via the **Block mode/MODE\_BLK** parameter, **TARGET** element.
3. Via the **CHANNEL** parameter, select the process variable which should be used as the input value for the Analog Input Block → 60.
4. Via the **Transducer scale/XD\_SCALE** parameter, select the desired unit and the block input range for the process variable → 76. Make sure that the unit selected suits the process variable selected. If the process variable and unit do not match, the **Block error/ BLOCK\_ERR** parameter reports **Block Configuration Error** and the block mode cannot be set to **Auto**.
5. Via the **Linearization type/L\_TYPE** parameter, select the type of linearization for the input variable (factory setting: **Direct**). In the **Direct** linearization mode, the settings for the **Transducer scale/XD\_SCALE** and **Output scale/OUT\_SCALE** parameters must be identical. If the values and units do not match, the **Block error/ BLOCK\_ERR** parameter reports **Block Configuration Error** and the block mode cannot be set to **Auto**.
6. Enter the alarm and critical alarm messages by means of the **High High Limit/ HI\_HI\_LIM**, **High Limit/ HI\_LIM**, **Low Low Limit/ LO\_LO\_LIM** and **Low Limit/ LO\_LIM** parameters. The limit values entered must be within the value range specified for the **Output scale/OUT\_SCALE** parameter → 76.
7. Specify the alarm priorities via the **Priority for high limit value alarm/ HI\_HI\_PRI**, **Priority for high early warning/ HI\_PRI**, **Priority for low limit value alarm/ LO\_LO\_PRI** and **Priority for low limit value early warning/ LO\_PRI** parameters. Reporting to the field host system only takes place with alarms with a priority greater than 2.
8. Set the block mode to **Auto** via the **Block mode/MODE\_BLK** parameter, **TARGET** element. For this purpose, the Resource Block must also be set to the **Auto** block mode.

### 12.2.5 Additional configuration

1. Link the function blocks and output blocks.
2. After specifying the active LAS, download all the data and parameters to the field device.

## 12.3 Scaling of the measured value in an AI Block

The measured value can be scaled if the **L\_TYPE** = **Indirect** linearization type has been selected in the Analog Input Block. **XD\_SCALE** defines the input range with the **EU\_0** and **EU\_100** elements. This is mapped linearly to the output range, defined by **OUT\_SCALE** also with the elements **EU\_0** and **EU\_100**.

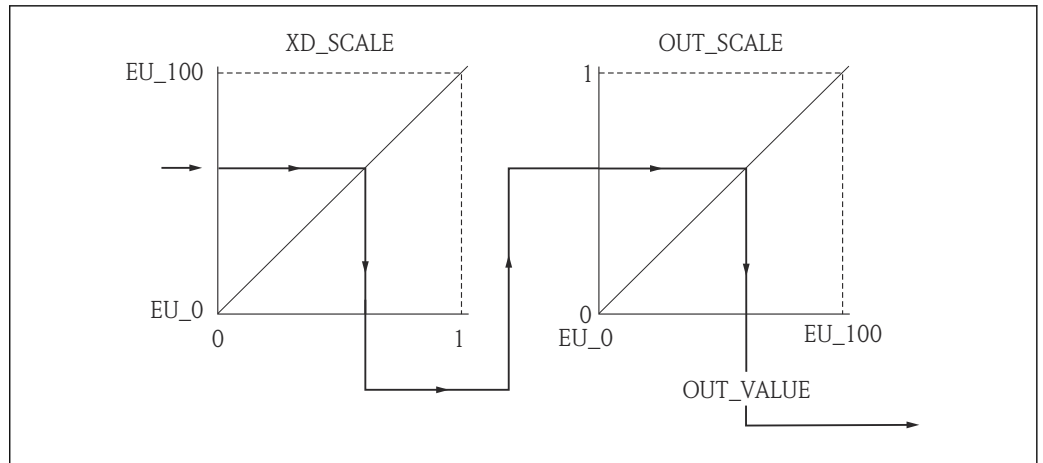

29 Scaling of the measured value in an AI Block

- i

 If you have selected the **Direct** mode in the **L\_TYPE** parameter, you cannot change the values and units for **XD\_SCALE** and **OUT\_SCALE**.
- The **L\_TYPE**, **XD\_SCALE** and **OUT\_SCALE** parameters can only be changed in the OOS block mode.

## 12.4 Language selection

Step	Block	Parameter	Action
1	DISPLAY (TRDDISP)	Language (language)	Select language <sup>1)</sup> . <b>Selection:</b> <ul style="list-style-type: none"> <li>▪ 32805: Arabic</li> <li>▪ 32824: Chinese</li> <li>▪ 32842: Czech</li> <li>▪ 32881: Dutch</li> <li>▪ 32888: English</li> <li>▪ 32917: French</li> <li>▪ 32920: German</li> <li>▪ 32945: Italian</li> <li>▪ 32946: Japanese</li> <li>▪ 32948: Korean</li> <li>▪ 33026: Polish</li> <li>▪ 33027: Portuguese</li> <li>▪ 33062: Russian</li> <li>▪ 33083: Spanish</li> <li>▪ 33103: Thai</li> <li>▪ 33120: Vietnamese</li> <li>▪ 33155: Indonesian</li> <li>▪ 33166: Turkish</li> </ul>

1) When ordering a device the set of available languages is defined. Refer to the product structure, feature 500 "Additional Operation Language".

## 12.5 Configuring level measurement

**i** The **Setup** method can also be used to configure the measurement. It is called up via the SETUP (TRDSUP) Transducer Block.

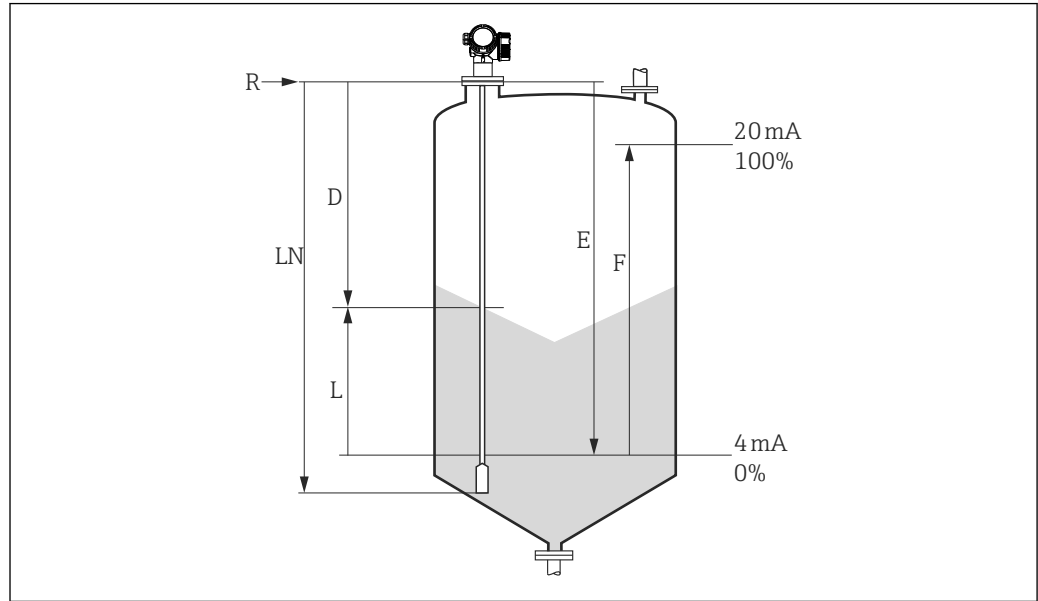

**30** Configuration parameters for level measurement in bulk solids

*LN* = Probe length

*R* = Reference point of measurement

*D* = Distance

*E* = Empty calibration (= zero point)

*L* = Level

*F* = Full calibration (= span)

**i** If the DC value is less than 7 in the case of rope probes, measurement in the area of the probe weight is not possible. The empty calibration *E* should not exceed  $LN - 250\text{ mm}$  ( $LN - 10\text{ in}$ ) in these cases.

Step	Block	Parameter	Action
1	SETUP (TRDSUP)	Distance unit (distance_unit)	Select the length unit. <b>Selection:</b> <ul style="list-style-type: none"> <li>▪ 1010: m</li> <li>▪ 1013: mm</li> <li>▪ 1018: in</li> <li>▪ 1019: ft</li> </ul>
2	SETUP (TRDSUP)	Bin type (bin_type)	Select bin type. <b>Selection:</b> <ul style="list-style-type: none"> <li>▪ 33288: Metallic</li> <li>▪ 33440: Plastic/wood</li> <li>▪ 33465: Concrete</li> <li>▪ 33467: Aluminum</li> </ul>
3	SETUP (TRDSUP)	Empty calibration (empty_calibration)	Specify empty distance <i>E</i> (distance from reference point <i>R</i> to 0% mark).
4	SETUP (TRDSUP)	Full calibration (full_calibration)	Specify the full distance <i>F</i> (distance from the 0% mark to the 100% mark).
5	SETUP (TRDSUP)	Level (level)	Displays the measured level <i>L</i> .
6	SETUP (TRDSUP)	Distance (filtered_dist_val)	Displays the distance <i>D</i> between the reference point <i>R</i> and the level <i>L</i> .

Step	Block	Parameter	Action
7	SETUP (TRDSUP)	Signal quality (signal_quality)	Displays the signal quality of the analyzed level echo.
8	SETUP (TRDSUP)	Confirm distance (confirm_distance)	<p>Compare the distance displayed with the actual value to start recording an interference echo map.</p> <p><b>Selection:</b></p> <ul style="list-style-type: none"> <li>▪ 179: Manual map</li> <li>▪ 32847: Delete all</li> <li>▪ 32859: Distance ok</li> <li>▪ 32860: Distance too big</li> <li>▪ 32861: Distance too small</li> <li>▪ 32862: Distance unknown</li> <li>▪ 33100: Tank empty</li> </ul>

## 12.6 Configuring the local display

### 12.6.1 Factory setting of local display for level measurements

Parameter	Factory setting for devices with 1 current output	Factory setting for devices with 2 current outputs
Format display	1 value, max. size	1 value, max. size
Value 1 display	Level linearized	Level linearized
Value 2 display	Distance	Distance
Value 3 display	Current output 1	Current output 1
Value 4 display	None	Current output 2

 The local display can be adjusted in the **DISPLAY (TRDDISP)** Transducer Block.

## 12.7 Configuration management

After commissioning, you can save the current device configuration, copy it to another measuring point or restore the previous device configuration. You can do so using the **Configuration management** parameter and the options available.

### Path in the menu

Setup → Advanced setup → Conf.backup disp. → Config. managem.

### Block operation

Block: **DISPLAY (TRDDISP)**

Parameter: **Configuration management (configuration\_management)**



### Functions of the parameter options

Options	Description
33097: Execute backup	A backup copy of the current device configuration in the HistoROM is saved to the display module of the device. The backup copy includes the transmitter data of the device.
33057: Restore	The last backup copy of the device configuration is copied from the display module to the HistoROM of the device. The backup copy includes the transmitter data of the device.
33838: Duplicate	The transmitter configuration from another device is duplicated to the device using the display module.

Options	Description
265: Compare	The device configuration saved in the display module is compared to the current device configuration of the HistoROM.
32848: Clear backup data	The backup copy of the device configuration is deleted from the display module of the device.

### *HistoROM*

A HistoROM is a "non-volatile" device memory in the form of an EEPROM.

-  While this action is in progress, the configuration cannot be edited via the local display and a message on the processing status appears on the display.
-  For devices with FOUNDATION Fieldbus communication, the PD Tag parameter is also transmitted when duplicating the parameter configuration. If required change this parameter to the required value after duplicating the set.



## 12.8 Configuration of the event behavior according to the FOUNDATION Fieldbus specification FF912

The device complies with the FOUNDATION Fieldbus specification FF912. This means the following, among other things:

- The diagnostic category as per NAMUR Recommendation NE107 is transmitted over the fieldbus in a format that is independent of the manufacturer:
  - F: Failure
  - C: Function check
  - S: Out of specification
  - M: Maintenance required
- The diagnostic category of pre-defined groups of events can be adjusted by the user according to the requirements of the specific application.
- Certain events can be separated from their group and can be treated separately:
  - 941: Echo lost
  - 942: In safety distance
- Additional information and remedial measures are transmitted together with the event message via the fieldbus.

 The diagnostic messages according to FF912 are available in the host only if the **Multi-bit support** option has been activated in the **FEATURE\_SEL** parameter of the resource block. For reasons of compatibility, this option is **not** activated on delivery:

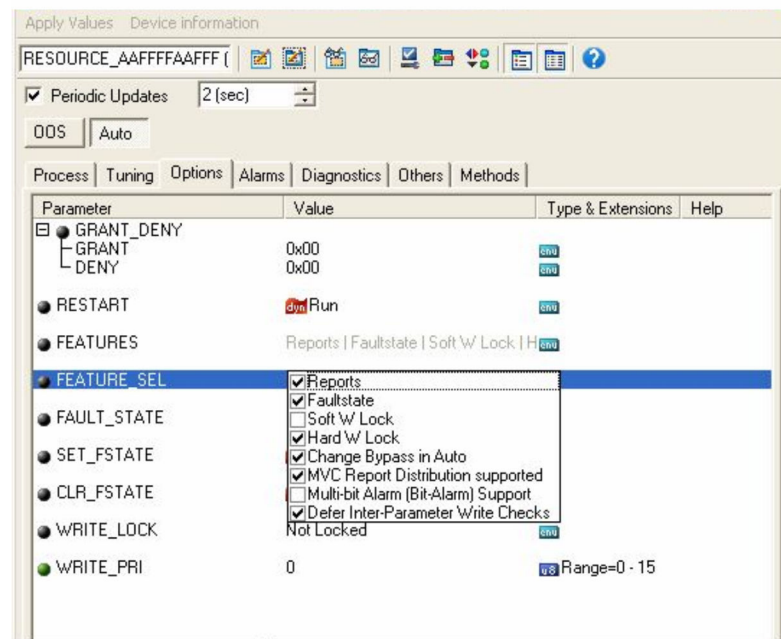

### 12.8.1 Event groups

The diagnostic messages are classified into 16 groups according to the **source** and **severity** of the respective event. A **default diagnostic category** is allocated to each group. Each group is also represented by one bit of the assignment parameters.

Severity of the event	Default diagnostic category	Event source	Bit	Events within this group
Highest severity	Failure (F)	Sensor	31	<ul style="list-style-type: none"> <li>▪ F003: Broken probe detected</li> <li>▪ F046: Buildup detected</li> <li>▪ F083: Memory content</li> <li>▪ F104: HF cable</li> <li>▪ F105: HF cable</li> <li>▪ F106: Sensor</li> </ul>
		Electronics	30	<ul style="list-style-type: none"> <li>▪ F242: Software incompatible</li> <li>▪ F252: Module incompatible</li> <li>▪ F261: Electronics modules</li> <li>▪ F262: Module connecting</li> <li>▪ F270: Main electronics failure</li> <li>▪ F271: Main electronics failure</li> <li>▪ F272: Main electronics failure</li> <li>▪ F273: Main electronics failure</li> <li>▪ F275: I/O module failure</li> <li>▪ F276: I/O module failure</li> <li>▪ F282: Data memory</li> <li>▪ F283: Memory content</li> <li>▪ F311: Memory content</li> </ul>
		Configuration	29	<ul style="list-style-type: none"> <li>▪ F410: Data transfer</li> <li>▪ F411: Up-/Download</li> <li>▪ F435: Linearization</li> <li>▪ F437: Configuration incompatible</li> </ul>
		Process	28	<ul style="list-style-type: none"> <li>▪ F803: Current loop 1</li> <li>▪ F825: Operating temperature</li> <li>▪ F936: EMC interference</li> <li>▪ F941: Echo lost <sup>1)</sup></li> <li>▪ F970: Linearization</li> </ul>

- 1) This event can be removed from the group in order to define its behavior individually; see section "Configurable area".

Severity of the event	Default diagnostic category	Event source	Bit	Events within this group
High severity	Function check (C)	Sensor	27	not used in Levelflex
		Electronics	26	not used in Levelflex
		Configuration	25	<ul style="list-style-type: none"> <li>▪ C411: Up-/Download</li> <li>▪ C431: Trim</li> <li>▪ C484: Simulation failure mode</li> <li>▪ C485: Simulation measured value</li> <li>▪ C491: Simulation current output</li> <li>▪ C585: Simulation distance</li> </ul>
		Process	24	not used in Levelflex

Severity of the event	Default diagnostic category	Event source	Bit	Events within this group
Low severity	Out of specification (S)	Sensor	23	not used in Levelflex
		Electronics	22	not used in Levelflex

Severity of the event	Default diagnostic category	Event source	Bit	Events within this group
		Configuration	21	S441: Current output 1
		Process	20	<ul style="list-style-type: none"> <li>▪ S801: Energy too low</li> <li>▪ S825: Operating temperature</li> <li>▪ S921: Change of reference</li> <li>▪ S942: In safety distance <sup>1)</sup>.</li> <li>▪ S943: In blocking distance</li> <li>▪ S944: Level range</li> <li>▪ S968: Level limited</li> </ul>

1) This event can be removed from the group and treated individually; see the "Configurable area" section

Severity of the event	Default diagnostic category	Event source	Bit	Events within this group
Lowest severity	Maintenance required (M)	Sensor	19	not used in Levelflex
		Electronics	18	<ul style="list-style-type: none"> <li>▪ M270: Main electronics failure</li> <li>▪ M272: Main electronics failure</li> <li>▪ M311: Memory content</li> </ul>
		Configuration	17	M438: Data set
		Process	16	M801: Current loop 1

### 12.8.2 Assignment parameters

The assignment of event categories to event groups is done via four assignment parameters. They reside in the **RESOURCE (RB2)** block:

- **FD\_FAIL\_MAP**: for the **Failure (F)** event category
- **FD\_CHECK\_MAP**: for the **Function check (C)** event category
- **FD\_OFFSPEC\_MAP**: for the **Out of specification (S)** event category
- **FD\_MAINT\_MAP**: for the **Maintenance required (M)** event category

Each of these parameters consists of 32 bits with the following meaning:

- **Bit 0**: reserved by the Fieldbus Foundation
- **Bits 1 to 15**: Configurable area; here, a number of predefined diagnostic events can be allocated irrespective of the group of events they belong to. In this case, they are removed from their group and their behavior can be configured individually. With Levelflex, the following parameters can be assigned to the configurable area:
  - 941: Echo lost
  - 942: In safety distance
- **Bits 16 to 31**: Standard area; these bits are permanently assigned to the event groups. If the bit is set to **1**, this event group is assigned to the respective event category.

The following table represents the default setting of the assignment parameters. In the default setting, there is a clear relationship between the severity of the event and the event category (i.e. its assignment parameter).

Default setting of assignment parameters

Severity of the event	Standard area																Configurable area
	Highest severity				High severity				Low severity				Lowest severity				
Event source <sup>1)</sup>	S	E	C	P	S	E	C	P	S	E	C	P	S	E	C	P	
Bit	31	30	29	28	27	26	25	24	23	22	21	20	19	18	17	16	15 ... 1
FD_FAIL_MAP	1	1	1	1	0	0	0	0	0	0	0	0	0	0	0	0	0
FD_CHECK_MAP	0	0	0	0	1	1	1	1	0	0	0	0	0	0	0	0	0

FD_OFFSPEC_MAP	0	0	0	0	0	0	0	0	0	1	1	1	1	0	0	0	0	0
FD_MAINT_MAP	0	0	0	0	0	0	0	0	0	0	0	0	0	1	1	1	1	0

1) S: Sensor; E: Electronics; C: Configuration; P: Process

In order to change the diagnostic behaviour of an event group, proceed as follows:

1. Open the assignment parameter to which the group is currently allocated.
2. Switch the bit of the event group from **1** to **0**. When operating via FieldCare, this is done by deactivating the corresponding check box (see the following example).
3. Open the assignment parameter which the group should be assigned to.
4. Switch the bit of the event group from **0** to **1**. When operating via FieldCare, this is done by activating the corresponding check box (see the following example).

### Example

The **Highest severity/Configuration error** group contains the messages **410: Data transfer**, **411: Up-/Download**, **435: Linearization** and **437: Configuration incompatible**. These messages are no longer to be classified as **Failure (F)** but as **Function check (C)**.

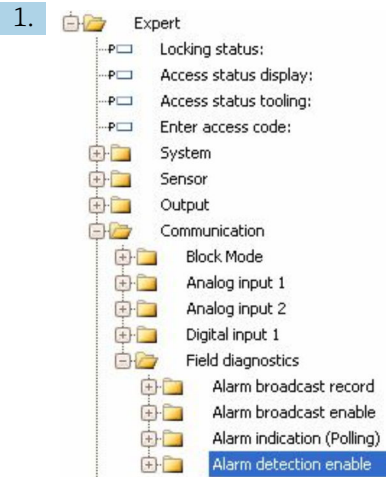

Use the FieldCare navigation window to navigate to the following screen: **Expert** → **Communication** → **Field diagnostics** → **Alarm detection enable**.

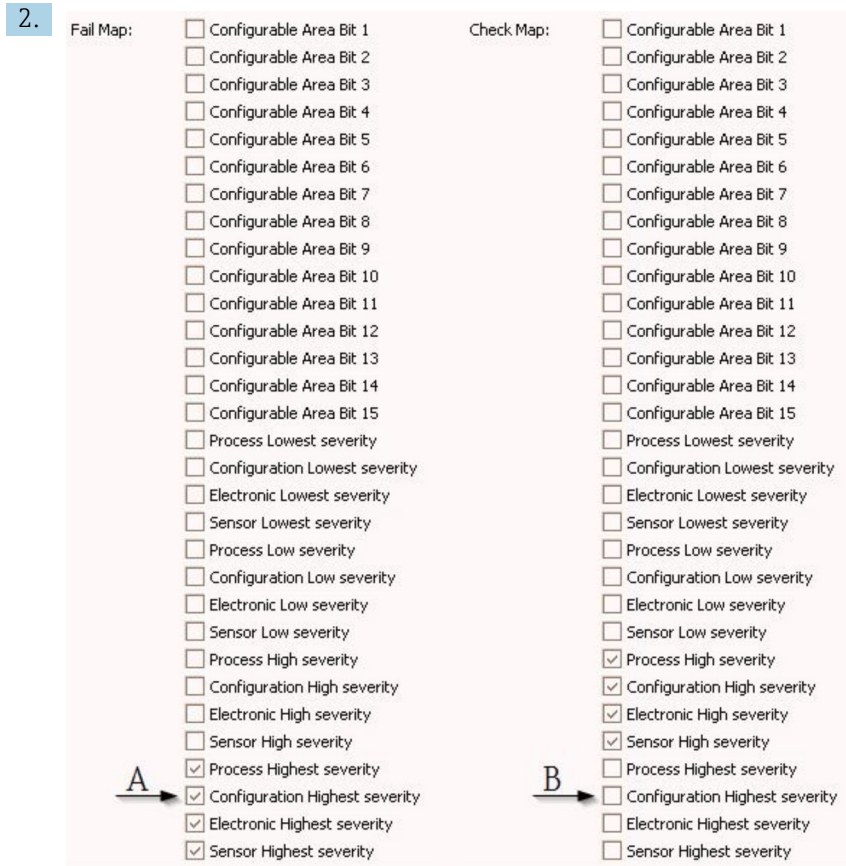

31 Default state of the "Fail Map" and "Check Map" columns

Look for the **Configuration Highest Severity** group in the **Fail Map** column and deactivate the associated check box (A). Activate the corresponding check box in the **Check Map** (B) column. Remember to confirm each change by pressing the Enter key.



32 The "Fail Map" and "Check Map" columns after the change

**i** Make sure that the corresponding bit is set in at least one of the assignment parameters for each event group. Otherwise no event category is transmitted with the event over the bus. As a consequence, the message will not be recognized by the control system.

**i** FieldCare's **Alarm detection enable** screen is used to configure the detection of diagnostic events but not the transmission of event messages to the bus. The latter is configured in the **Alarm broadcast enable** screen, which is operated exactly in the same way as the **Alarm detection enable** screen. Status information is only transmitted to the bus if the Resource Block is in the **Auto** mode.

### 12.8.3 Configurable area

An event category can be individually defined for the following parameters - irrespective of the group of events they belong to by default:

- **F941:** Echo lost
- **S942:** In safety distance

Prior to changing the event category, the event must be allocated to one of the bits 1 to 15. This is done via parameters **FF912 ConfigArea\_1** to **FF912ConfigArea\_15** in the **DIAGNOSTIC (TRDDIAG)** block. Then the corresponding bit can be set from **0** to **1** in the desired assignment parameter.

### Example

Error **942 "In safety distance"** should no longer be categorized as **Out of specification (S)** but rather as **Function check (C)**.

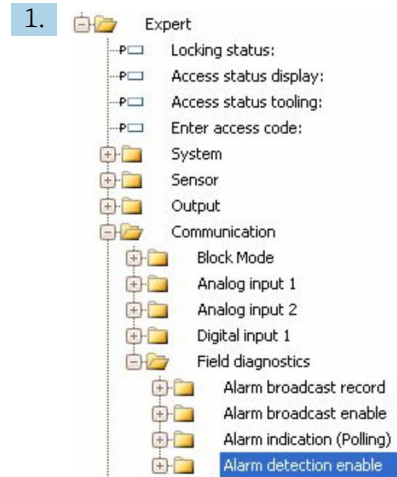

Use the FieldCare navigation window to navigate to the following screen: **Expert** → **Communication** → **Field diagnostics** → **Alarm detection enable**.



By default, all the **Configurable Area Bits** are set to **not used**.



Select one of these bits (in the example: **Configurable Area Bit 1**) and select **In safety distance** from the associated picklist. Confirm the selection by pressing the Enter key.

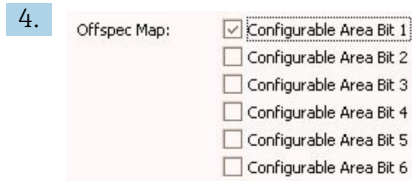

Go to the **Offspec Map** column and activate the check box of the respective bit (in the example: **Configurable Area Bit 1**). Press the Enter key to confirm your entry.

**i** A change of the error category of **In safety distance** does not affect an error that is already present. The new category is only assigned if this error occurs again after the change has been made.

### 12.8.4 Transmission of the event messages to the bus

#### Event priority

Event messages are only transmitted to the bus if their priority is between 2 and 15. Priority 1-events are displayed but are not transmitted over the bus. Events of priority 0 are ignored. By default, the priority is 0 for all events. The priority can be adjusted individually for each assignment parameter. This is done via the following four parameters in the Resource Block:

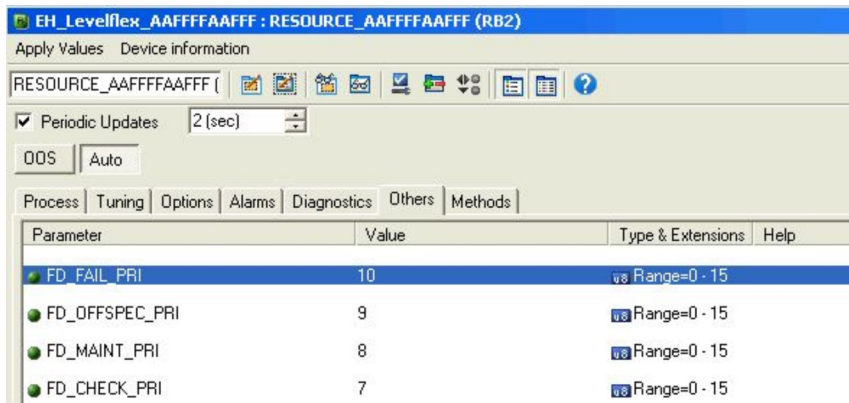

#### Suppressing individual events

It is possible to suppress certain events during transmission over the bus using a mask. While these events are displayed they are not transmitted over the bus. In FieldCare this mask can be found in **Expert → Communication → Field diagnostics → Alarm broadcast enable**. The mask is a negative selection mask, i.e. if a field is selected, the associated diagnostic information is **not** transmitted over the bus.

### 12.9 Protecting settings from unauthorized access





The settings can be protected from unauthorized access in the following ways:

- Locking via write protection switch (hardware locking)
- Locking via operating menu (software locking)
- Locking via block operation:
  - Block: **DISPLAY (TRDDISP)**; parameter: **Define access code**
  - Block: **EXPERT\_CONFIG (TRDEXP)**; parameter: **Enter access code**

## 13 Diagnostics and troubleshooting





### 13.1 General troubleshooting

#### 13.1.1 General errors

Error	Possible cause	Solution
Device does not respond.	Supply voltage not connected.	Connect the correct voltage.
	The cables do not contact the terminals properly.	Ensure electrical contact between the cable and the terminal.
Values on the display invisible	Contrast setting is too weak or too strong.	<ul style="list-style-type: none"> <li>▪ Increase contrast by pressing  and  simultaneously.</li> <li>▪ Decrease contrast by pressing  and  simultaneously.</li> </ul>
	The plug of the display cable is not connected correctly.	Connect the plug correctly.
	Display is defective.	Replace display.
"Communication error" is indicated on the display when starting the device or connecting the display.	Electromagnetic interference	Check grounding of the device.
	Broken display cable or display plug.	Replace display.
Duplication of parameters via display from one device to another not working. Only the "Save" and "Cancel" options are available.	Display with backup is not properly detected if a data backup was not carried out on the new device previously.	Connect display (with backup) and restart device.
CDI communication does not work.	Wrong setting of the COM port on the computer.	Check the setting of the COM port on the computer and change it if necessary.
Device measures incorrectly.	Parameter configuration error	Check and correct the parameter configuration.

#### 13.1.2 Parameter configuration errors

##### *Parameter configuration errors for level measurements*

Error	Possible cause	Solution
Measured value is incorrect	If measured distance (Setup → Distance) matches the real distance: Calibration error	<ul style="list-style-type: none"> <li>▪ Check the <b>Empty calibration</b> parameter (→  120) and correct if necessary.</li> <li>▪ Check the <b>Full calibration</b> parameter (→  121) and correct if necessary.</li> <li>▪ Check the linearization and correct if necessary (<b>Linearization</b> submenu (→  137)).</li> </ul>
	If measured distance (Setup → Distance) does not match the real distance: An interference echo is present.	Carry out mapping ( <b>Confirm distance</b> parameter (→  123)).
No change of measured value on filling/emptying	An interference echo is present.	Carry out mapping ( <b>Confirm distance</b> parameter (→  123)).
	Buildup at the probe.	Clean the probe.
	Error in the echo tracking	Deactivate echo tracking (Expert → Sensor → Echo tracking → Evaluation mode = <b>History off</b> ).



Error	Possible cause	Solution
Echo lost diagnostic message appears after the supply voltage is switched on.	Noise level too high during initialization phase.	Enter a new value for the <b>Empty calibration</b> parameter (→ 120).
Device displays a level when the tank is empty.	Incorrect probe length	<ul style="list-style-type: none"> <li>Perform a probe length correction (<b>Confirm probe length</b> parameter (→ 150)).</li> <li>Carry out mapping over the entire probe length when the tank is empty (<b>Confirm distance</b> parameter (→ 123)).</li> </ul>
Wrong slope of the level over the entire measuring range	Wrong bin property selected.	Select the correct <b>Bin type</b> parameter (→ 120).

## 13.2 Diagnostic information on local display

### 13.2.1 Diagnostic message

Faults detected by the self-monitoring system of the measuring instrument are displayed as a diagnostic message in alternation with the measured value display.

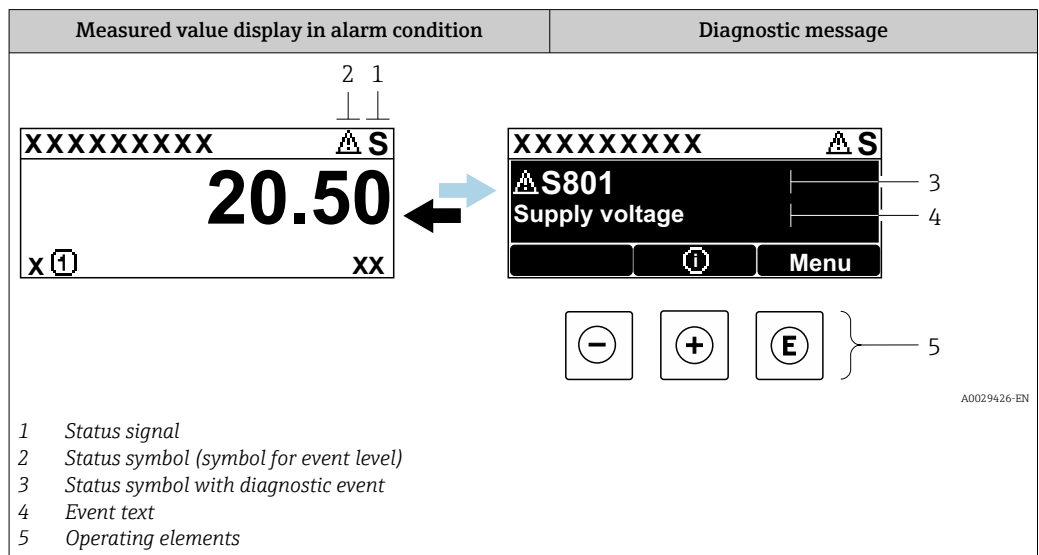

### Status signals

<b>F</b> A0032902	<b>"Failure (F)" option</b> A device error has occurred. The measured value is no longer valid.
<b>C</b> A0032903	<b>"Function check (C)" option</b> The device is in the service mode (e.g. during a simulation).
<b>S</b> A0032904	<b>"Out of specification (S)" option</b> The device is operated: <ul style="list-style-type: none"> <li>Outside its technical specifications (e.g. during startup or cleaning)</li> <li>Outside the configuration performed by the user (e.g. level outside the configured range)</li> </ul>
<b>M</b> A0032905	<b>"Maintenance required (M)" option</b> Maintenance is required. The measured value is still valid.

### Status symbols (symbol for event level)

⊗	<b>"Alarm" status</b> Measurement is interrupted. The signal outputs adopt the defined alarm state. A diagnostic message is generated.
⚠	<b>"Warning" status</b> The device continues to measure. A diagnostic message is generated.

### Diagnostic event and event text

The fault can be identified by means of the diagnostic event. The event text helps you by providing information about the fault. In addition, the associated status symbol is displayed in front of the diagnostic event.

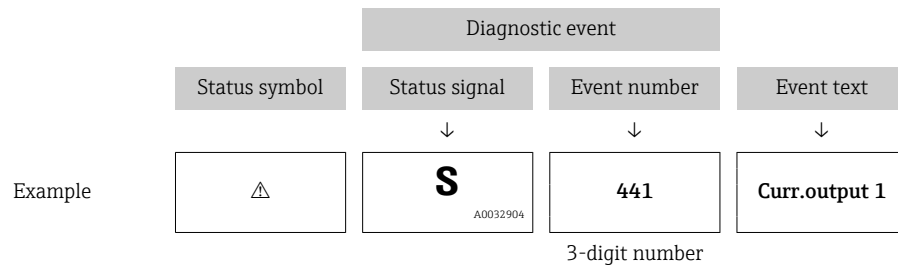

If several diagnostic events are pending at the same time, only the diagnostic message with the highest priority is displayed. Additional queued diagnostic messages can be shown in the **Diagnostic list** submenu.



Past diagnostic messages that are no longer pending are shown as follows:

- On the local display:  
in the **Event logbook** submenu
- In FieldCare:  
via the "Event List/HistoROM" function

### Operating elements

Operating functions in menu, submenu	
+	<b>Plus key</b> Opens the message about the remedial measures.
E	<b>Enter key</b> Opens the operating menu.

### 13.2.2 Calling up remedial measures

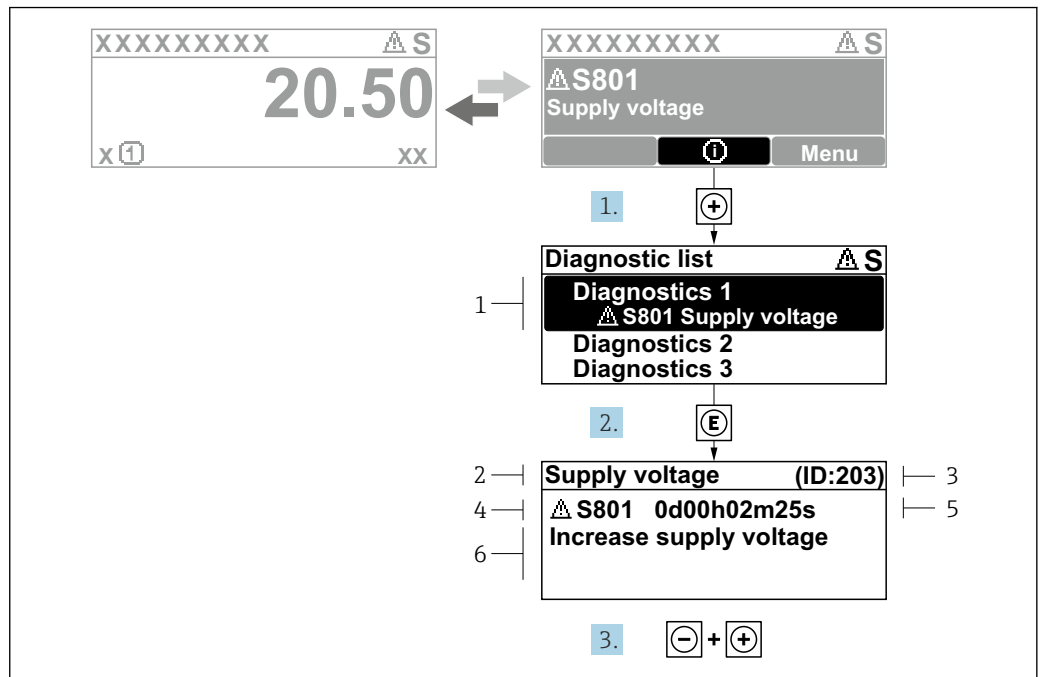

33 Message for remedial measures

- 1 Diagnostic information
- 2 Short text
- 3 Service ID
- 4 Diagnostic behavior with diagnostic code
- 5 Operation time when error occurred
- 6 Remedial measures

The user is in the diagnostic message.

1. Press  $\oplus$  (Ⓢ symbol).
  - ↳ The **Diagnostic list** submenu opens.
2. Select the desired diagnostic event with  $\oplus$  or  $\ominus$  and press  $\oplus$  .
  - ↳ The message for the remedial measures for the selected diagnostic event opens.
3. Press  $\ominus$  +  $\oplus$  simultaneously.
  - ↳ The message about the remedial measures closes.

The user is in the **Diagnostics** menu at an entry for a diagnostics event, e.g. in **Diagnostic list** or in **Previous diagnostics**.

1. Press  $\oplus$ .
  - ↳ The message for the remedial measures for the selected diagnostic event opens.
2. Press  $\ominus$  +  $\oplus$  simultaneously.
  - ↳ The message about the remedial measures closes.

## 13.3 Diagnostic event in the operating tool

If a diagnostic event has occurred in the device, the status signal appears in the top left status area of the operating tool together with the corresponding symbol for the event level according to NAMUR NE 107:

- Failure (F)
- Function check (C)
- Out of specification (S)
- Maintenance required (M)

**A: Via the operating menu**

1. Navigate to the **Diagnostics** menu.
  - ↳ In the **Actual diagnostics** parameter, the diagnostic event is shown with event text.
2. On the right in the display area, hover the cursor over the **Actual diagnostics** parameter.

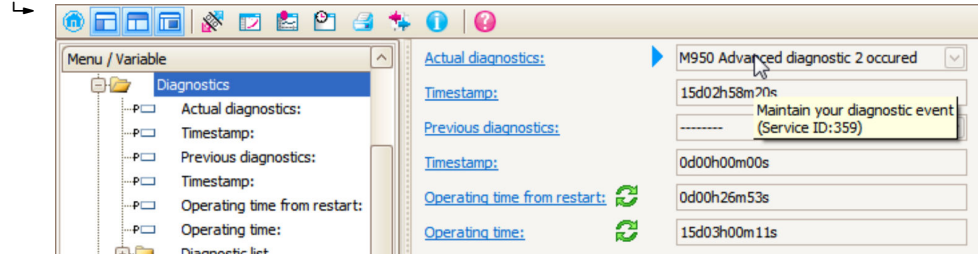

A tool tip with remedy information for the diagnostic event appears.

**B: Via the "Create Documentation" function**

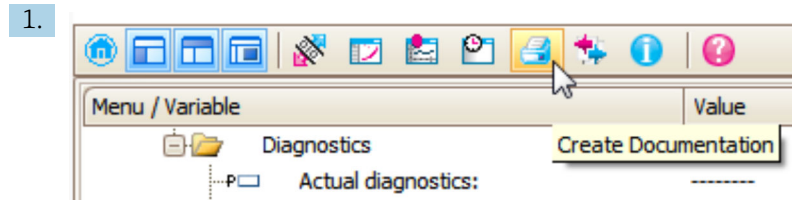

Select the "Create documentation" function.

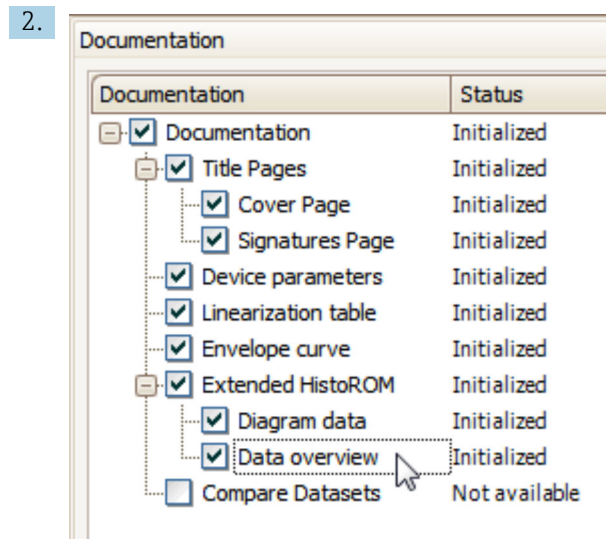

Make sure that "Data overview" is marked.

3. Click "Save as..." and save a PDF of the report.
  - ↳ The report contains the diagnostic messages including remedial measures.

### C: Via the "Event list/Extended HistoROM" function

1.

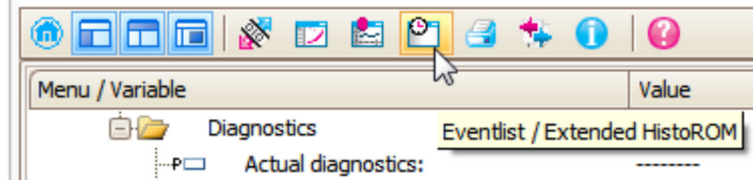

Select the ("Event list/Extended HistoROM") function.

2.

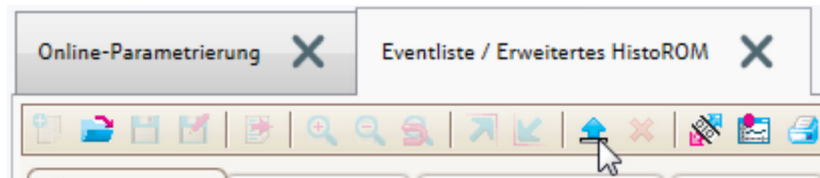

Select the "Load event list" function.

↳ The event list including remedial measures is displayed in the "Data overview" window.

## 13.4 Diagnostic messages in the DIAGNOSTIC Transducer Block (TRDDIAG)

- The **Actual diagnostics** parameter displays the message with the highest priority. Every message is also output as per the FOUNDATION Fieldbus Specification by means of the **XD\_ERROR** and **BLOCK\_ERROR** parameters.
- A list of diagnostic messages is displayed in the **Diagnostics 1** to **Diagnostics 5** parameters. If more than 5 messages are currently active, only those with the highest priority are displayed.
- You can view a list of alarms which are no longer active (event log) via the **Previous diagnostics** parameter.

## 13.5 Diagnostic list

In the **Diagnostic list** submenu submenu, up to 5 currently pending diagnostic messages can be displayed. If more than 5 messages are pending, the messages with the highest priority are shown on the display.

### Navigation path

Diagnostics → Diagnostic list

### Calling up and closing the remedial measures

1. Press .

↳ The message for the remedial measures for the selected diagnostic event opens.

2. Press  +  simultaneously.

↳ The message about the remedial measures closes.

## 13.6 Event logbook

### 13.6.1 Event history

A chronological overview of the event messages that have occurred is provided in the **Event list**

(This submenu only exists if operating via the local display. In the case of operation via FieldCare, the event list can be displayed with the "Event list/HistoROM" functionality of FieldCare.

### Navigation path

Diagnostics → Event logbook → Event list

A maximum of 100 event messages can be displayed in chronological order.

The event history includes entries for:

- Diagnostic events
- Information events

In addition to the operating time when the event occurred, each event is also assigned a symbol that indicates whether the event has occurred or is finished:

- Diagnostic event
  - ☺: Occurrence of the event
  - ☹: End of the event
- Information event
  - ☺: Occurrence of the event

### Calling up and closing the remedial measures

1. Press  $\square$ .
  - ↳ The message for the remedial measures for the selected diagnostic event opens.
2. Press  $\square$  +  $\oplus$  simultaneously.
  - ↳ The message about the remedial measures closes.

## 13.6.2 Filtering the event logbook

Using the **Filter options** parameter, you can define which category of event messages is displayed in the **Event list** submenu.

### Navigation path

Diagnostics → Event logbook → Filter options

### Filter categories

- All
- Failure (F)
- Function check (C)
- Out of specification (S)
- Maintenance required (M)
- Information

## 13.6.3 Overview of information events

Info number	Info name
I1000	----- (Device ok)
I1089	Power on
I1090	Configuration reset
I1091	Configuration changed
I1092	Trend data deleted
I1110	Write protection switch changed
I1137	Electronic changed
I1151	History reset
I1154	Reset terminal voltage min/max
I1155	Reset electronic temperature

Info number	Info name
I1156	Memory error trend
I1157	Memory error event list
I1185	Display backup done
I1186	Restore via display done
I1187	Settings downloaded with display
I1188	Display data cleared
I1189	Backup compared
I1256	Display: access status changed
I1264	Safety sequence aborted
I1335	Firmware changed
I1397	Fieldbus: access status changed
I1398	CDI: access status changed
I1512	Download started
I1513	Download finished
I1514	Upload started
I1515	Upload finished

## 13.7 Firmware history

Date	Firmware version	Modifications	Documentation (FMP56, FMP57, FOUNDATION Fieldbus)		
			Operating Instructions	Description of Device Parameters	Technical Information
04.2012	01.00.zz	Original software	BA01055F/00/EN/01.12	GP01015F/00/EN/01.12	TI01004F/00/EN/14.12
05.2015	01.01.zz	<ul style="list-style-type: none"> <li>▪ Support of SD03</li> <li>▪ Additional languages</li> <li>▪ HistoROM functionality enhanced</li> <li>▪ "Advanced Diagnostics" function block integrated</li> <li>▪ Improvements and bugfixes</li> </ul>	BA01055F/00/EN/03.15 BA01055F/00/EN/04.16 <sup>1)</sup>	GP01015F/00/EN/02.15	TI01004F/00/EN/17.15 TI01004F/00/EN/20.16 <sup>1)</sup>

1) Contains information on the Heartbeat wizards available in the current DTM version for DeviceCare and. FieldCare



The firmware version can explicitly be ordered via the product structure. In this way it is possible to ensure compatibility of the firmware version with an existing or planned system integration.

## **14 Maintenance**

No special maintenance work is required.

### **14.1 Exterior cleaning**

When cleaning the exterior, always use cleaning agents that do not corrode the surface of the housing and the seals.

### **14.2 General cleaning instructions**

Dirt or buildup may form on the probe depending on the application. A thin, even layer has little impact on the measurement. Thick layers can dampen the signal and reduce the measuring range. Very uneven deposit formation or caking (e.g. due to crystallization) can result in incorrect measurements. In such cases, use a non-contact measuring principle, or regularly inspect the probe for contamination.

Cleaning with sodium hydroxide solution (e.g. in CIP procedures): if the coupling is wetted, larger measurement errors can occur than under reference operating conditions. Wetting can cause temporary incorrect measurements.



## 15 Repair

### 15.1 General information

#### 15.1.1 Repair concept

Under the Endress+Hauser repair concept, devices have a modular design and repairs can be carried out by Endress+Hauser Service or by properly trained customers.

Spare parts are grouped into logical kits with the associated replacement instructions.

For more information on service and spare parts, please contact Endress+Hauser Service.

#### 15.1.2 Repairs to Ex-approved devices

**⚠ WARNING**

**Incorrect repair can compromise electrical safety!**

Explosion hazard!

- ▶ Repairs to Ex-approved devices must be carried out by Endress+Hauser Service or by specialist personnel according to national regulations.
- ▶ Relevant standards and national regulations on hazardous areas, safety instructions and certificates must be observed.
- ▶ Use only original Endress+Hauser spare parts.
- ▶ Please note the device designation on the nameplate. Only identical parts may be used as replacements.
- ▶ Carry out repairs according to the instructions.
- ▶ Only the Endress+Hauser service team is permitted to modify a certified device and convert it to another certified version.

#### 15.1.3 Replacing electronics modules

When electronics modules have been replaced the device does not need to be recalibrated as the parameters are saved in the HistoROM inside the housing. It may be necessary when replacing the main electronics to record a new interference echo suppression.

#### 15.1.4 Replacing a device

Once a complete device has been replaced, the parameters can be transferred back into the device using one of the following methods:

- Using the display module  
Prerequisite: The configuration of the old device was saved previously to the display module.
- Via FieldCare  
Prerequisite: The configuration of the old device was saved previously to the computer using FieldCare.

You can continue measuring without performing a new calibration. Only interference echo suppression may need to be carried out once again.

## 15.2 Spare parts

- Some replaceable measuring instrument components are identified by means of a spare part nameplate. This contains information about the spare part.
- In the connection compartment cover of the device there is a spare part nameplate which contains the following information:
  - A list of the most important spare parts for the measuring instrument, including their ordering information.
  - The URL to the *W@M Device Viewer* ([www.endress.com/deviceviewer](http://www.endress.com/deviceviewer)):  
All the spare parts for the measuring instrument, along with the order code, are listed here and can be ordered. If available, users can also download the associated Installation Instructions.

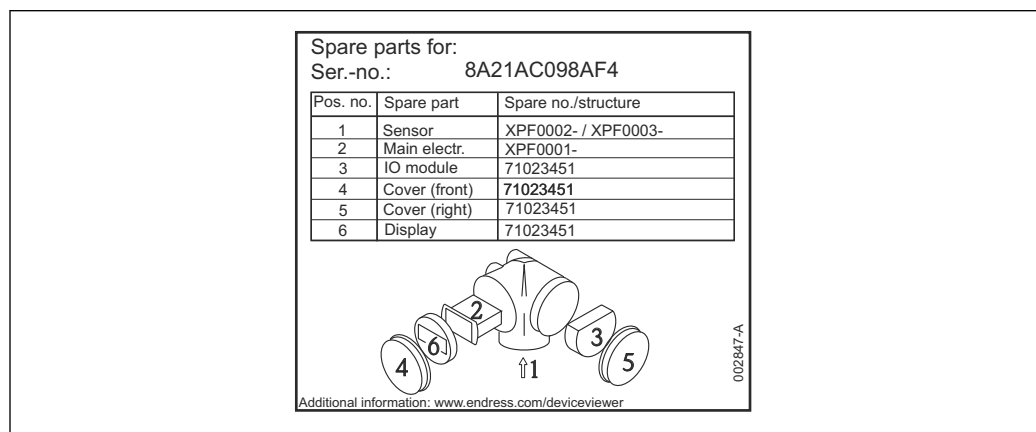

34 Example for spare part nameplate in the connection compartment cover

- i** Measuring instrument serial number:
  - Located on the device and spare part nameplate.
  - Can be read out via the "Serial number" parameter in the "Device information" submenu.

## 15.3 Return

The requirements for safe device return can vary depending on the device type and national legislation.

1. Refer to the web page for information:  
<https://www.endress.com/support/return-material>  
↳ Select the region.
2. If returning the device, pack the device in such a way that it is reliably protected against impact and external influences. The original packaging offers the best protection.

## 15.4 Disposal

-  If required by the Directive 2012/19/EU on waste electrical and electronic equipment (WEEE), the product is marked with the depicted symbol in order to minimize the disposal of WEEE as unsorted municipal waste. Do not dispose of products bearing this marking as unsorted municipal waste. Instead, return them to the manufacturer for disposal under the applicable conditions.

## 16 Accessories

The accessories currently available for the product can be selected at [www.endress.com](http://www.endress.com):

1. Select the product using the filters and search field.
2. Open the product page.
3. Select **Spare parts & Accessories**.

### 16.1 Device-specific accessories

#### 16.1.1 Weather protection cover

The weather protection cover can be ordered together with the device via the "Accessory enclosed" product structure.

It is used to protect against direct sunlight, precipitation and ice.

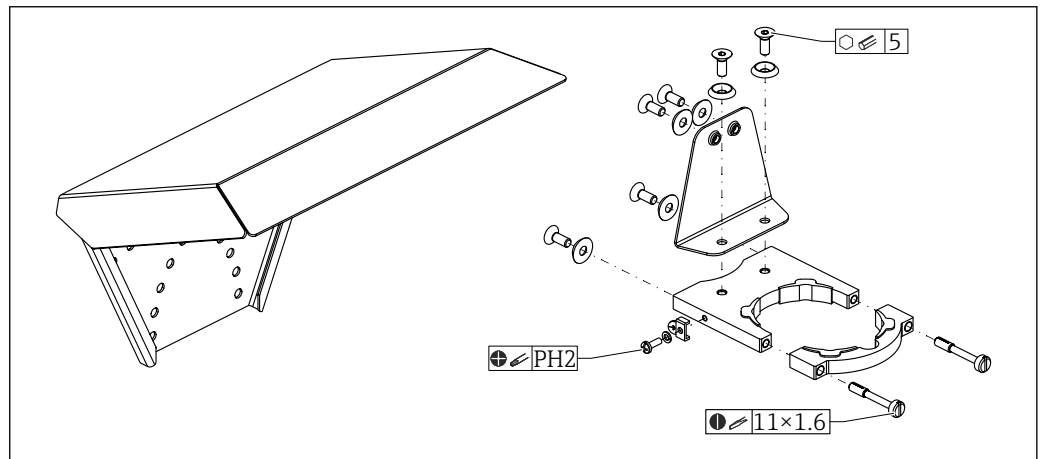

A0051672

35 Overview

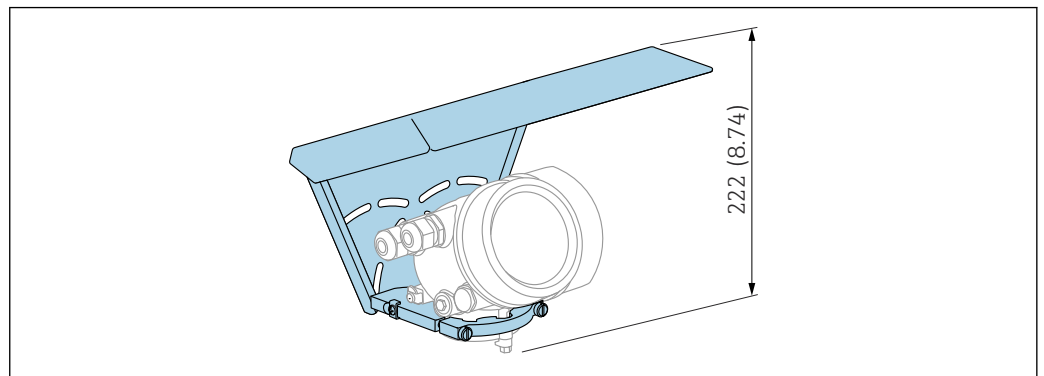

A0015466

36 Height. Unit of measurement mm (in)

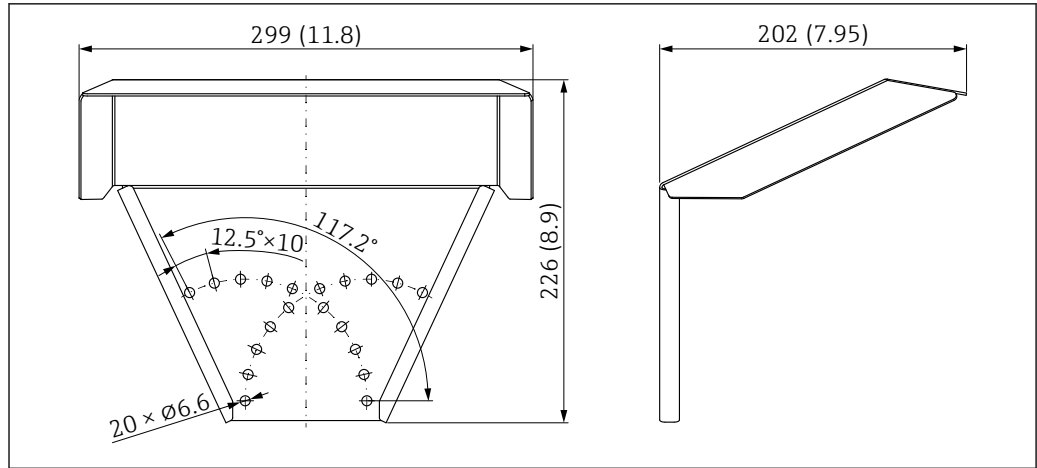

A0015472

37 Dimensions. Unit of measurement mm (in)

**Material**

- Protection cap; 316L (1.4404)
- Bracket; 316L (1.4404)
- Angle bracket; 316L (1.4404)
- Clamping screw; 316L (1.4404) + carbon fiber
- Molded rubber part (4x); EPDM
- Screws; A4
- Disks; A4
- Ground terminal; A4, 316L (1.4404)

**Order number for accessories:**

71162242

**16.1.2 Mounting bracket for electronics housing**

With "remote sensor" device versions (feature 060 in the product structure), the mounting bracket is included in the scope of delivery. It can be ordered as a separate accessory .

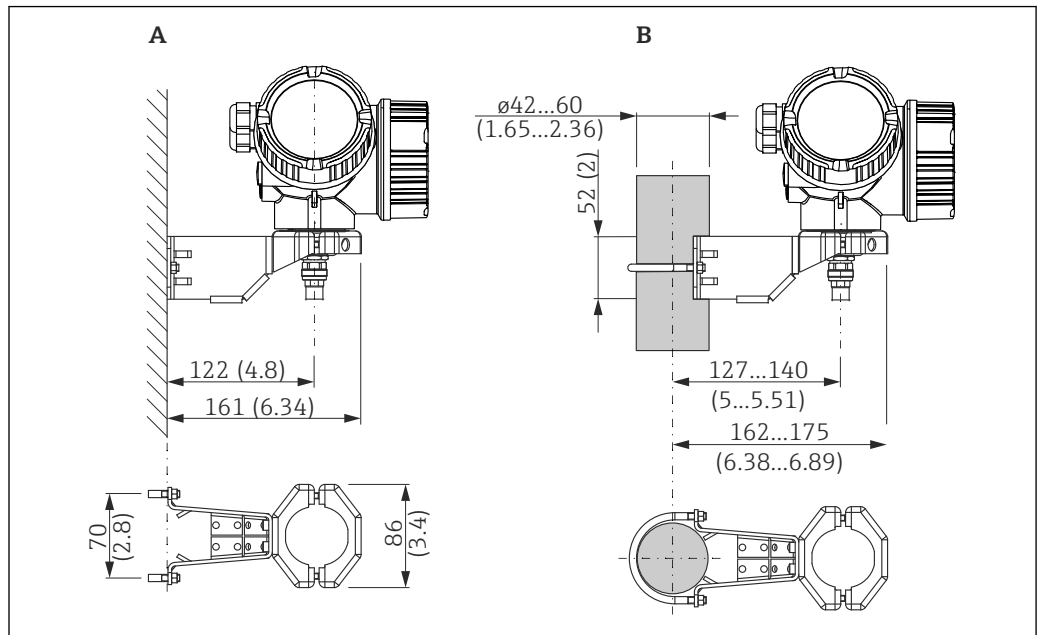

A0014793

38 Mounting bracket for electronics housing; unit: mm (in)

- A Wall mounting
- B Post mounting

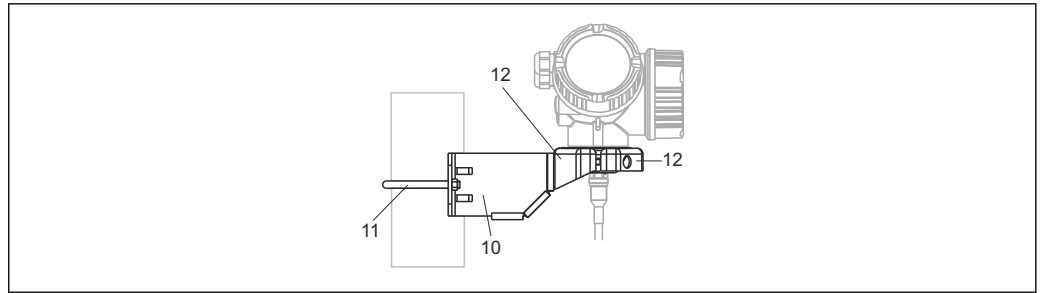

A0015143

39 Material; mounting bracket

10 Bracket, 316L (1.4404)

11 Round bracket, 316L (1.4404); screws/nuts, A4-70; distance sleeves, 316L (1.4404)

12 Half-shells, 316 L (1.4404)

**Order number for accessories:**

71102216

### 16.1.3 Rod extension (centering device) HMP40

The rod extension (centering device) HMP40 is ordered via the Product Configurator.

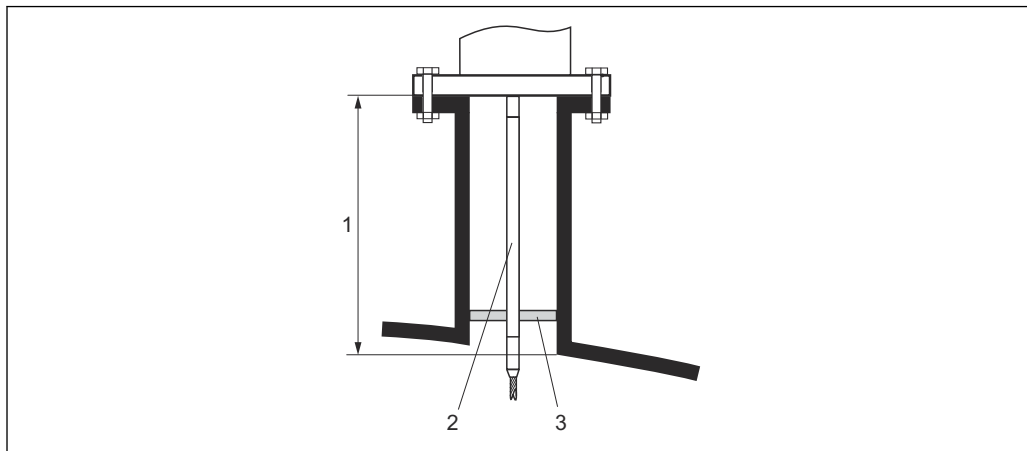

A0013597

- 1 Nozzle height
- 2 Extension rod
- 3 Centering disk

Permitted temperature at lower edge of nozzle:

- Without centering disk, no restriction
- With centering disk,  $-40$  to  $+150$  °C ( $-40$  to  $+302$  °F)



For details, see SD01002F.

### 16.1.4 Mounting kit, insulated

To secure rope probes so that they are reliably insulated.

Maximum process temperature:  $150$  °C ( $300$  °F)

Mounting set, insulated, can be used for:

- FMP56
- FMP57

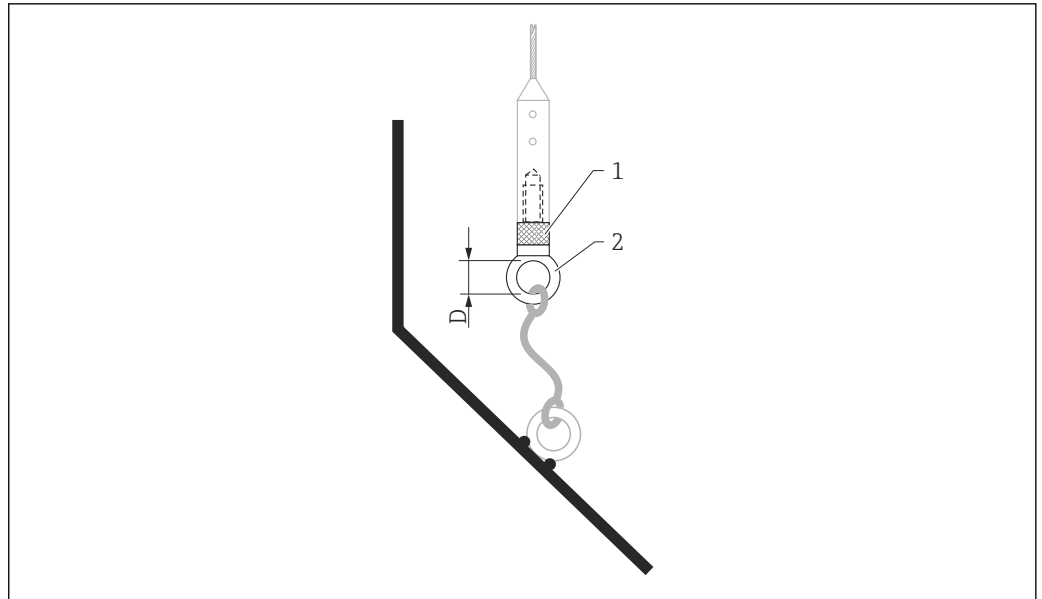

A0013586

**40** Scope of delivery of mounting kit:

- 1 Insulation sleeve
- 2 Ring bolt

For rope probes 4 mm (1/6 in) or 6 mm (1/4 in) with PA > steel:  
Diameter D = 20 mm (0.8 in)

**Order number for accessories:**  
52014249

For rope probes 6 mm (1/4 in) or 8 mm (1/3 in) with PA > steel:  
Diameter D = 25 mm (1 in)

**Order number for accessories:**  
52014250

Due to the risk of electrostatic charge, the insulation sleeve is not suitable for use in hazardous areas! In this case, the probe must be secured so that it is reliably grounded.

**i** The mounting kit can also be ordered directly with the device (Levelflex product structure, feature 620 "Accessory enclosed", version PG "mounting kit, insulated, rope").

### 16.1.5 Remote display FHX50

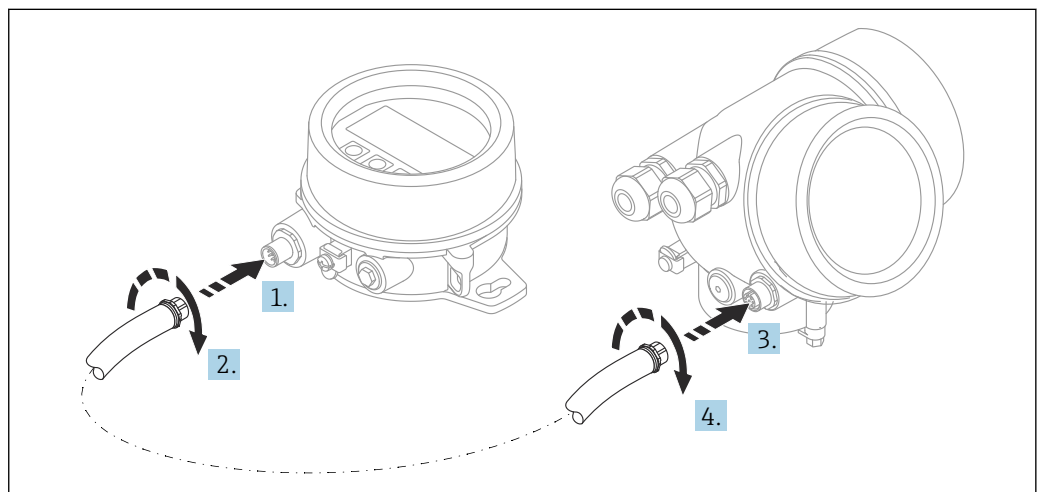

A0019128

**Technical data**

- Material:
    - Plastic PBT
    - 316L/1.4404
    - Aluminum
  - Degree of protection: IP68 / NEMA 6P and IP66 / NEMA 4x
  - Suitable for display modules:
    - SDO2 (push buttons)
    - SDO3 (touch control)
  - Connecting cable:
    - Cable supplied with device up to 30 m (98 ft)
    - Standard cable provided by customer onsite up to 60 m (196 ft)
  - Ambient temperature: -40 to 80 °C (-40 to 176 °F)
  - Ambient temperature, optionally available for order. -50 to 80 °C (-58 to 176 °F)
- NOTICE** If the temperature is permanently below -40 °C (-40 °F), higher failure rates can be expected.

**Ordering information**

- If the remote display is to be used, the device version "Prepared for display FHX50" must be ordered.  
For FHX50, the option "Prepared for display FHX50" must be selected under "Measuring device version".
- If a measuring instrument has not been ordered with the version "Prepared for display FHX50" and is to be retrofitted with an FHX50, the version "Not prepared for display FHX50" must be ordered for the FHX50 under "Measuring device version". In this case, a retrofit kit for the device is supplied with the FHX50. The kit can be used to prepare the device so that the FHX50 can be used.

 Use of the FHX50 may be restricted for transmitters with an approval. A device can only be retrofitted with the FHX50 if the option "Prepared for FHX50" is listed under *Basic specifications*, "Display, operation" in the Safety instructions (XA) for the device.

Also refer to the Safety Instructions (XA) of the FHX50.

Retrofitting is not possible on transmitters with:

- An approval for use in areas with flammable dust (dust ignition-proof approval)
- Type of protection Ex nA

 For details, see "Special Documentation" document SD01007F.

**16.1.6 Overvoltage protection**

The surge arrester for loop-powered devices can be ordered together with the device via the "Accessory mounted" section of the product order structure.

The surge arrester can be used for loop-powered devices.

- 1-channel devices - OVP10
- 2-channel devices - OVP20

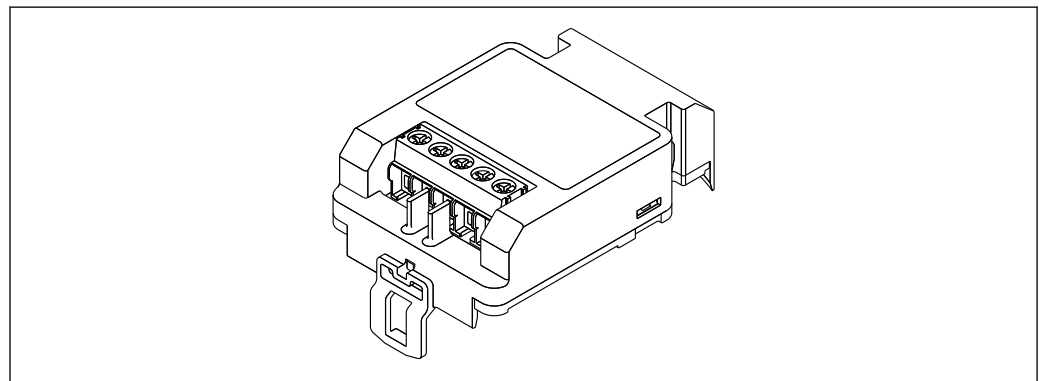

A0021734



**Technical data**

- Resistance per channel:  $2 \times 0.5 \Omega_{\max}$
- Threshold DC voltage: 400 to 700 V
- Threshold surge voltage: < 800 V
- Capacitance at 1 MHz: < 1.5 pF
- Nominal leakage current (8/20  $\mu$ s): 10 kA
- Suitable for conductor cross-sections: 0.2 to 2.5 mm<sup>2</sup> (24 to 14 AWG)

**If retrofitting:**

- Order number for 1-channel devices (OVP10): 71128617
- Order number for 2-channel devices (OVP20): 71128619
- The use of the OVP module may be restricted depending on the transmitter approval. A device may only be retrofitted with the OVP module if the option *NA* (overvoltage protection) is listed under *Optional specifications* in the Safety Instructions (XA) associated with the device.
- In order to keep the necessary safety distances when using the surge arrester module, the housing cover also needs to be replaced when the device is retrofitted. Depending on the housing type, the suitable cover can be ordered using the following order number:
  - Housing GT18: 71185516
  - Housing GT19: 71185518
  - Housing GT20: 71185517



For details, see the "Special Documentation" SD01090F

**16.1.7 Bluetooth module BT10 for HART devices**

The Bluetooth module BT10 can be ordered together with the device via the "Accessory mounted" section of the product order structure.

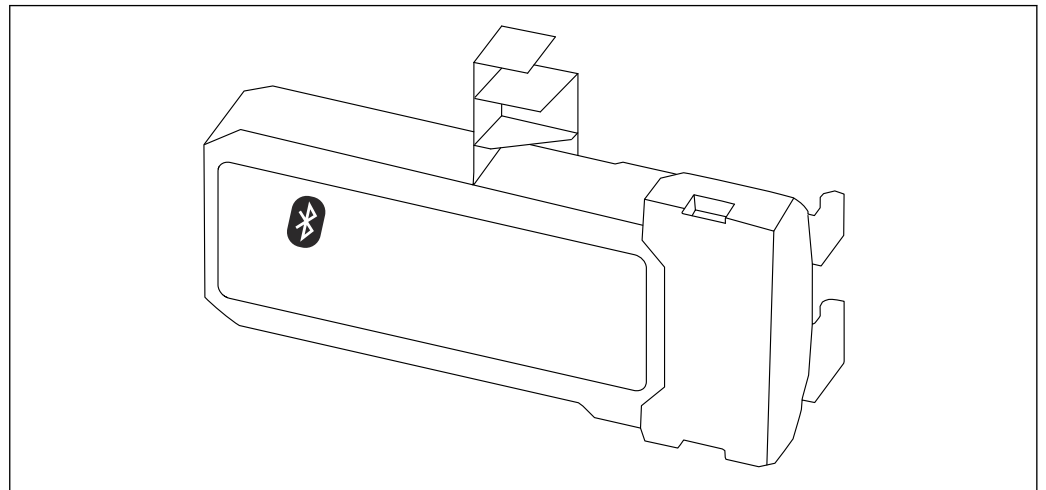

A0036493

**Technical data**

- Quick and easy setup with the SmartBlue app
- No additional tools or adapters needed
- Signal curve via SmartBlue (app)
- Encrypted single point-to-point data transmission (tested by Fraunhofer Institute) and password-protected communication via Bluetooth® wireless technology
- Range under reference conditions:
  - > 10 m (33 ft)
- When the Bluetooth module is used, the minimum supply voltage of the device increases by up to 3 V.

**If retrofitting:**

- Order number: 71377355
- The use of the Bluetooth module may be restricted depending on the transmitter approval. A device may only be retrofitted with the Bluetooth module if the option *NF* (Bluetooth module) is listed under *Optional specifications* in the Safety Instructions (XA) associated with the device.



For details, see the "Special Documentation" SD02252F

## 16.2 Communication-specific accessories

**Commubox FXA291**

Connects Endress+Hauser field devices with a CDI interface (= Endress+Hauser Common Data Interface) and the USB port of a computer or laptop

Order number: 51516983



For details, see "Technical Information" TI00405C

**Field Xpert SFX350**

Field Xpert SFX350 is a mobile computer for commissioning and maintenance. It enables efficient device configuration and diagnostics for HART and FOUNDATION Fieldbus devices in the **non-Ex area**.



For details, see Operating Instructions BA01202S

**Field Xpert SFX370**

Field Xpert SFX370 is a mobile computer for commissioning and maintenance. It enables efficient device configuration and diagnostics for HART and FOUNDATION Fieldbus devices in the **non-Ex area** and the **Ex area**.



For details, see Operating Instructions BA01202S

## 16.3 Service-specific accessories

**DeviceCare SFE100**

Configuration tool for HART, PROFIBUS and FOUNDATION Fieldbus field devices



Technical Information TI01134S

**FieldCare SFE500**

FDT-based plant asset management tool

It can configure all smart field units in your system and helps you manage them. By using the status information, it is also a simple but effective way of checking their status and condition.



Technical Information TI00028S

## 16.4 System components

### 16.4.1 Memograph M RSG45

The Advanced Data Manager is a flexible and powerful system for organizing process values.

The Memograph M is used for electronic acquisition, display, recording, analysis, remote transmission and archiving of analog and digital input signals as well as calculated values.





































Technical Information TI01180R and Operating Instructions BA01338R

# 17 Operating menu

## 17.1 Overview of the operating menu (display module)

Navigation  Operating menu

Language	
<b>Setup</b>	→  127
Distance unit	
Bin type	
Empty calibration	
Full calibration	
Level	
Distance	
Signal quality	
<b>► Mapping</b>	→  126
Confirm distance	→  126
Mapping end point	→  126
Record map	→  126
Distance	→  126
<b>► Analog inputs</b>	
<b>► Analog input 1 to 5</b>	→  127
Block tag	→  127
Channel	→  127
Process Value Filter Time	→  128
<b>► Advanced setup</b>	→  129
Locking status	→  129















Access status display	→  129
Enter access code	→  130
<b>► Level</b>	→  131
Medium type	→  131
Medium property	→  131
Process property	→  132
Advanced process conditions	→  133
Level unit	→  134
Blocking distance	→  134
Level correction	→  135
<b>► Linearization</b>	→  137
Linearization type	→  139
Unit after linearization	→  140
Free text	→  141
Maximum value	→  142
Diameter	→  142
Intermediate height	→  143
Table mode	→  143
<b>► Edit table</b>	
Level	
Customer value	
Activate table	→  145
<b>► Safety settings</b>	→  146
Output echo lost	→  146
Value echo lost	→  146

Ramp at echo lost	→ 147
Blocking distance	→ 134
<b>► Probe settings</b>	→ 149
Probe grounded	→ 149
<b>► Probe length correction</b>	→ 151
Confirm probe length	→ 151
Present probe length	→ 149
<b>► Switch output</b>	→ 153
Switch output function	→ 153
Assign status	→ 153
Assign limit	→ 154
Assign diagnostic behavior	→ 154
Switch-on value	→ 155
Switch-on delay	→ 156
Switch-off value	→ 156
Switch-off delay	→ 157
Failure mode	→ 157
Switch status	→ 157
Invert output signal	→ 157
<b>► Display</b>	→ 159
Language	→ 159
Format display	→ 159
Value 1 to 4 display	→ 161
Decimal places 1 to 4	→ 161
Display interval	→ 162

Display damping	→ 162
Header	→ 162
Header text	→ 163
Separator	→ 163
Number format	→ 163
Decimal places menu	→ 163
Backlight	→ 164
Contrast display	→ 164
<b>► Configuration backup display</b>	→ 165
Operating time	→ 165
Last backup	→ 165
Configuration management	→ 165
Comparison result	→ 166
<b>► Administration</b>	→ 168
<b>► Define access code</b>	→ 170
Define access code	→ 170
Confirm access code	→ 170
Device reset	→ 168
<b>🔍 Diagnostics</b>	→ 171
Actual diagnostics	→ 171
Previous diagnostics	→ 171
Operating time from restart	→ 172
Operating time	→ 165
<b>► Diagnostic list</b>	→ 173
Diagnostics 1 to 5	→ 173











▶ Event logbook	→  174
Filter options	
▶ Event list	→  174
▶ Device information	→  175
Device tag	→  175
Serial number	→  175
Firmware version	→  175
Device name	→  176
Order code	→  176
Extended order code 1 to 3	→  176
▶ Measured values	→  177
Distance	→  122
Level linearized	→  142
Terminal voltage 1	→  178
▶ Analog inputs	
▶ Analog input 1 to 5	→  178
Block tag	→  127
Channel	→  127
Status	→  179
Value	→  179
Units index	→  179
▶ Data logging	→  180
Assign channel 1 to 4	→  180
Logging interval	→  181



























Clear logging data	→  181
► Display channel 1 to 4	→  182
► Simulation	→  185
Assign measurement variable	→  186
Process variable value	→  186
Switch output simulation	→  186
Switch status	→  187
Simulation device alarm	→  187
► Device check	→  188
Start device check	→  188
Result device check	→  188
Last check time	→  188
Level signal	→  189
Launch signal	→  189

## 17.2 Overview of the operating menu (operating tool)

Navigation  Operating menu

<b>Setup</b>		→  127
Distance unit		
Bin type		
Empty calibration		
Full calibration		
Level		
Distance		
Signal quality		
Confirm distance		
Present mapping		
Mapping end point		
Record map		
<b>▶ Analog inputs</b>		
<b>▶ Analog input 1 to 5</b>		→  127
Block tag		→  127
Channel		→  127
Process Value Filter Time		→  128
<b>▶ Advanced setup</b>		→  129
Locking status		→  129
Access status tooling		→  129
Enter access code		→  130
<b>▶ Level</b>		→  131
Medium type		→  131

Medium property	→  131
Process property	→  132
Advanced process conditions	→  133
Level unit	→  134
Blocking distance	→  134
Level correction	→  135
<b>► Linearization</b>	→  137
Linearization type	→  139
Unit after linearization	→  140
Free text	→  141
Level linearized	→  142
Maximum value	→  142
Diameter	→  142
Intermediate height	→  143
Table mode	→  143
Table number	→  144
Level	→  144
Level	→  145
Customer value	→  145
Activate table	→  145
<b>► Safety settings</b>	→  146
Output echo lost	→  146
Value echo lost	→  146
Ramp at echo lost	→  147
Blocking distance	→  134





▶ Probe settings	→ 149
Probe grounded	→ 149
Present probe length	→ 149
Confirm probe length	→ 150
▶ Switch output	→ 153
Switch output function	→ 153
Assign status	→ 153
Assign limit	→ 154
Assign diagnostic behavior	→ 154
Switch-on value	→ 155
Switch-on delay	→ 156
Switch-off value	→ 156
Switch-off delay	→ 157
Failure mode	→ 157
Switch status	→ 157
Invert output signal	→ 157
▶ Display	→ 159
Language	→ 159
Format display	→ 159
Value 1 to 4 display	→ 161
Decimal places 1 to 4	→ 161
Display interval	→ 162
Display damping	→ 162
Header	→ 162
Header text	→ 163

Separator	→ 163
Number format	→ 163
Decimal places menu	→ 163
Backlight	→ 164
Contrast display	→ 164
<b>► Configuration backup display</b>	→ 165
Operating time	→ 165
Last backup	→ 165
Configuration management	→ 165
Backup state	→ 166
Comparison result	→ 166
<b>► Administration</b>	→ 168
Define access code	
Device reset	→ 168
<b>🔍 Diagnostics</b>	→ 171
Actual diagnostics	→ 171
Timestamp	→ 171
Previous diagnostics	→ 171
Timestamp	→ 172
Operating time from restart	→ 172
Operating time	→ 165
<b>► Diagnostic list</b>	→ 173
Diagnostics 1 to 5	→ 173
Timestamp 1 to 5	→ 173

▶ Device information	→ 175
Device tag	→ 175
Serial number	→ 175
Firmware version	→ 175
Device name	→ 176
Order code	→ 176
Extended order code 1 to 3	→ 176
▶ Measured values	→ 177
Distance	→ 122
Level linearized	→ 142
Terminal voltage 1	→ 178
▶ Analog inputs	
▶ Analog input 1 to 5	→ 178
Block tag	→ 127
Channel	→ 127
Status	→ 179
Value	→ 179
Units index	→ 179
▶ Data logging	→ 180
Assign channel 1 to 4	→ 180
Logging interval	→ 181
Clear logging data	→ 181
▶ Simulation	→ 185
Assign measurement variable	→ 186
Process variable value	→ 186

Switch output simulation	→ 186
Switch status	→ 187
Simulation device alarm	→ 187
<b>▶ Device check</b>	→ 188
Start device check	→ 188
Result device check	→ 188
Last check time	→ 188
Level signal	→ 189
Launch signal	→ 189
<b>▶ Heartbeat</b>	→ 190

### 17.3 "Setup" menu



-   : Indicates how to navigate to the parameter using the display and operating module
-  : Indicates how to navigate to the parameter using operating tools (e.g. FieldCare)
-  : Indicates parameters that can be locked via the access code.

Navigation   Setup

---

#### Distance unit

---

**Navigation**   Setup → Distance unit

**Description** Length unit for distance calculation.



**Selection**

<i>SI units</i>	<i>US units</i>
<ul style="list-style-type: none"> <li>▪ mm</li> <li>▪ m</li> </ul>	<ul style="list-style-type: none"> <li>▪ ft</li> <li>▪ in</li> </ul>

---

#### Bin type

---

**Navigation**   Setup → Bin type

**Prerequisite** **Medium type (→  131) = Solid**

**Description** Specify bin type.



**Selection**

- Concrete
- Plastic wood
- Metallic
- Aluminium

---

#### Empty calibration

---

**Navigation**   Setup → Empty calibr.

**Description** Distance process connection to min. level.

**User entry** Depending on the probe

**Factory setting** Depending on the probe



**Additional information**

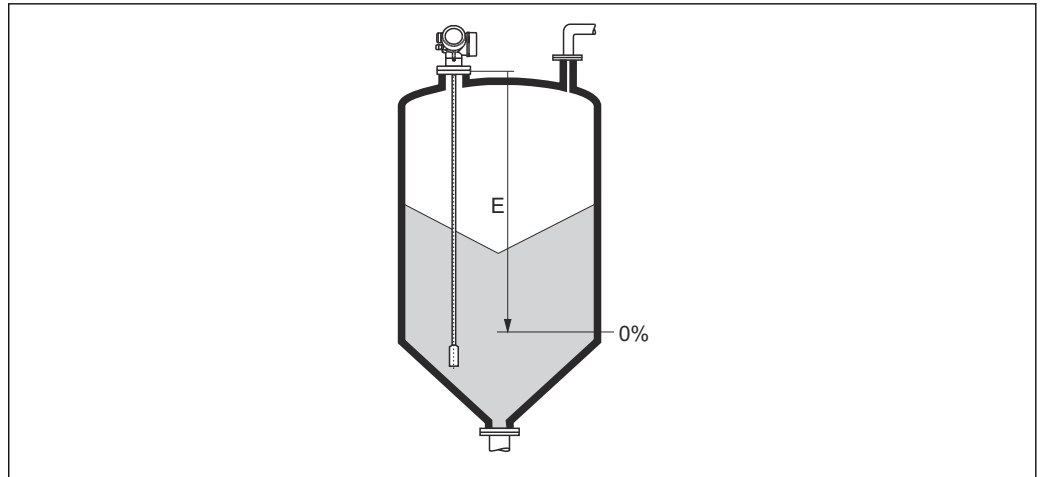

A0013180

41 Empty calibration (E) for level measurements in bulk solids.

**Full calibration**



**Navigation**

Setup → Full calibr.

**Description**

Span: max. level - min level.

**User entry**

Depending on the probe

**Factory setting**

Depending on the probe

**Additional information**

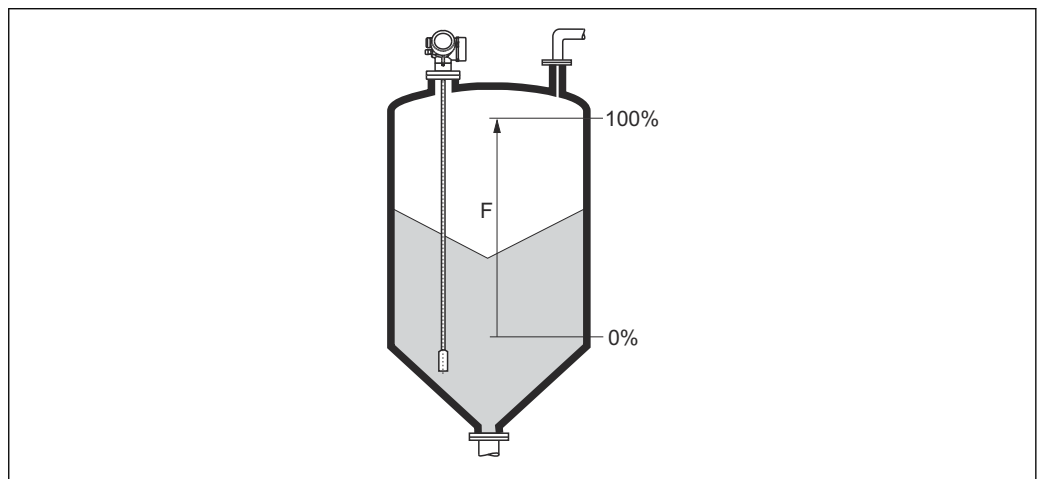

A0013191

42 Full calibration (F) for level measurements in bulk solids

**Level**

**Navigation**

Setup → Level

**Description**

Displays measured level  $L_L$  (before linearization).

**Additional information**

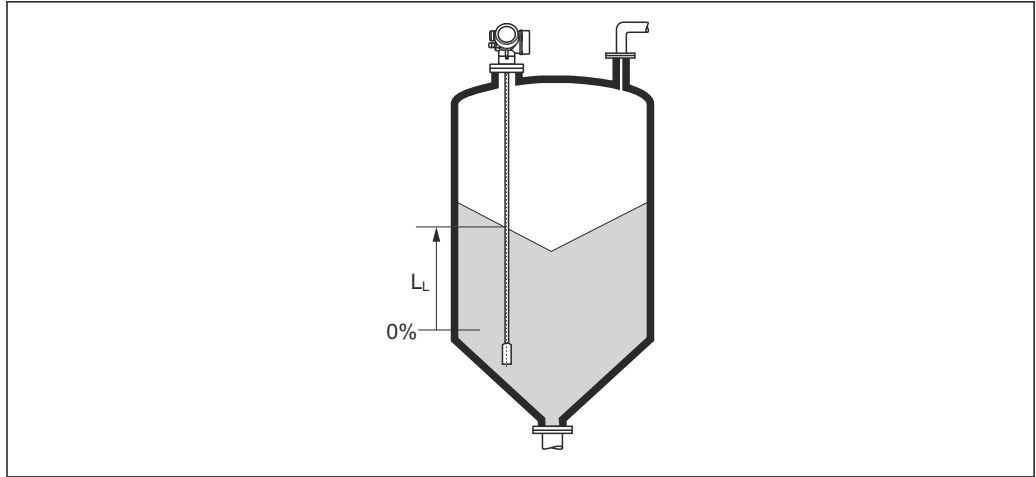

A0013196

43 Level in case of bulk solid measurements

**i** The unit is defined in the **Level unit** parameter (→ 134).

**Distance**

**Navigation**

Setup → Distance

**Description**

Displays the measured distance  $D_L$  between the reference point (lower edge of the flange or threaded connection) and the level.

**Additional information**

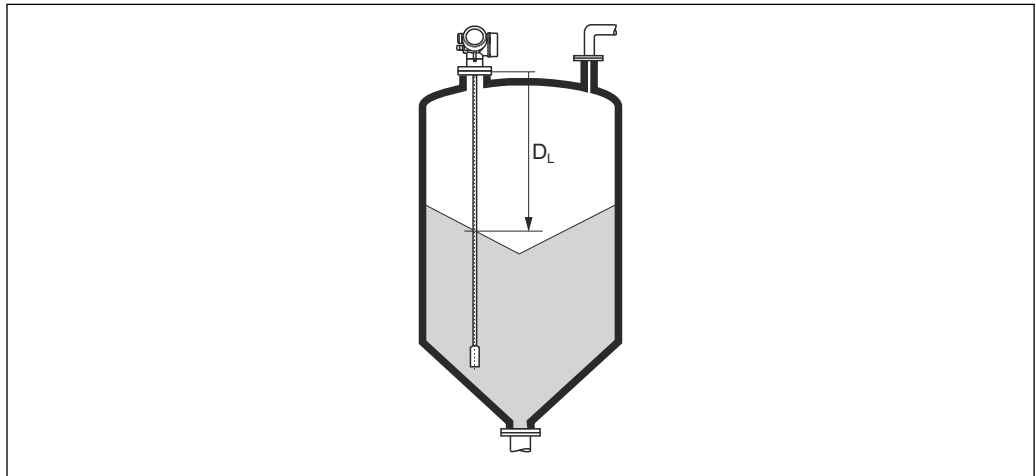

A0013201





44 Distance for bulk solid measurements

**i** The unit is defined in the **Distance unit** parameter (→ 120).

---

**Signal quality**



---

<b>Navigation</b>	  Setup → Signal quality
<b>Description</b>	Displays the signal quality of the evaluated echo.
<b>Additional information</b>	<p><b>Meaning of the display options</b></p> <ul style="list-style-type: none"> <li>▪ <b>Strong</b> The evaluated echo exceeds the threshold by at least 10 mV.</li> <li>▪ <b>Medium</b> The evaluated echo exceeds the threshold by at least 5 mV.</li> <li>▪ <b>Weak</b> The evaluated echo exceeds the threshold by less than 5 mV.</li> <li>▪ <b>No signal</b> The device does not find a usable echo.</li> </ul> <p>The signal quality indicated in this parameter always refers to the currently evaluated echo: either the level/interface echo <sup>1)</sup> or the end-of-probe echo. To differentiate between these two, the quality of the end-of-probe echo is always displayed in brackets.</p> <p> In case of a lost echo (<b>Signal quality = No signal</b>) the device generates the following error message:</p> <ul style="list-style-type: none"> <li>▪ F941, for <b>Output echo lost</b> (→  <b>146</b>) = <b>Alarm</b>.</li> <li>▪ S941, if another option has been selected in <b>Output echo lost</b> (→  <b>146</b>).</li> </ul>

---

**Confirm distance**

---

<b>Navigation</b>	 Setup → Confirm distance
<b>Description</b>	Specify, whether the measured distance matches the real distance. Depending on the selection the device automatically sets the range of mapping.
<b>Selection</b>	<ul style="list-style-type: none"> <li>▪ Manual map</li> <li>▪ Distance ok</li> <li>▪ Distance unknown</li> <li>▪ Distance too small *</li> <li>▪ Distance too big *</li> <li>▪ Tank empty</li> <li>▪ Delete map</li> </ul>
<b>Additional information</b>	<p><b>Meaning of the options</b></p> <ul style="list-style-type: none"> <li>▪ <b>Manual map</b> To be selected if the range of mapping is to be defined manually in the <b>Mapping end point</b> parameter (→  124). In this case it is not necessary to confirm the distance.</li> <li>▪ <b>Distance ok</b> To be selected if the measured distance matches the actual distance. The device performs a mapping.</li> <li>▪ <b>Distance unknown</b> To be selected if the actual distance is unknown. A mapping can not be performed in this case.</li> </ul>

---

1) Of these two echos the one with the lower quality is indicated.

\* Visibility depends on order options or device settings

▪ **Distance too small**

To be selected if the measured distance is smaller than the actual distance. The device searches for the next echo and returns to the **Confirm distance** parameter. The distance is recalculated and displayed. The comparison must be repeated until the displayed distance matches the actual distance. After this, the recording of the map can be started by selecting **Distance ok**.

▪ **Distance too big**<sup>2)</sup>

To be selected if the measured distance exceeds the actual distance. The device adjusts the signal evaluation and returns to the **Confirm distance** parameter. The distance is recalculated and displayed. The comparison must be repeated until the displayed distance matches the actual distance. After this, the recording of the map can be started by selecting **Distance ok**.

▪ **Tank empty**

To be selected if the tank is completely empty. The device records a mapping covering the complete measuring range.

▪ **Factory map**

To be selected if the present mapping curve (if one exists) is to be deleted. The device returns to the **Confirm distance** parameter and a new mapping can be recorded.



When operating via the display module, the measured distance is displayed together with this parameter for reference purposes.



If the teaching procedure with the **Distance too small** option or the **Distance too big** option is quit before the distance has been confirmed, a map is **not** recorded and the teaching procedure is reset after 60 s.

---

**Present mapping**

---

**Navigation**

Setup → Present mapping

**Description**

Indicates up to which distance a mapping has already been recorded.

---

**Mapping end point**

---



**Navigation**

Setup → Map. end point

**Prerequisite**

**Confirm distance** (→ 123) = **Manual map** or **Distance too small**

**Description**

Specify new end of the mapping.

**User entry**

0 to 200 000.0 m

**Additional information**

This parameter defines up to which distance the new mapping is to be recorded. The distance is measured from the reference point, i.e. from the lower edge of the mounting flange or the threaded connection.



For reference purposes the **Present mapping** parameter (→ 124) is displayed together with this parameter. It indicates up to which distance a mapping has already been recorded.

---

2) Only available for "Expert → Sensor → Echo tracking → **Evaluation mode** parameter" = "Short time history" or "Long time history"

---



**Record map**

---



<b>Navigation</b>	Setup → Record map
<b>Prerequisite</b>	<b>Confirm distance</b> (→  123) = <b>Manual map</b> or <b>Distance too small</b>
<b>Description</b>	Start recording of the map.
<b>Selection</b>	<ul style="list-style-type: none"><li>■ No</li><li>■ Record map</li><li>■ Delete map</li></ul>
<b>Additional information</b>	<b>Meaning of the options</b> <ul style="list-style-type: none"><li>■ <b>No</b> The map is not recorded.</li><li>■ <b>Record map</b> The map is recorded. After the recording is completed, the new measured distance and the new mapping range appear on the display. When operating via the local display, these values must be confirmed by pressing .</li><li>■ <b>Delete map</b> The mapping (if one exists) is deleted and the device displays the recalculated measured distance and the mapping range. When operating via the local display, these values must be confirmed by pressing .</li></ul>

### 17.3.1 "Mapping" wizard

 The **Mapping** wizard is only available when operating via the local display. When operating via an operating tool, all parameters concerning the mapping are located directly in the **Setup** menu (→  120).

 In the **Mapping** wizard two parameters are displayed simultaneously on the display module at any one time. The upper parameter can be edited, whereas the lower parameter is displayed for reference purposes only.

*Navigation*       Setup → Mapping

---

#### Confirm distance

**Navigation**       Setup → Mapping → Confirm distance

**Description**      →  123

---

#### Mapping end point

**Navigation**       Setup → Mapping → Map. end point

**Description**      →  124

---

#### Record map

**Navigation**       Setup → Mapping → Record map

**Description**      →  125

---

#### Distance

**Navigation**       Setup → Mapping → Distance

**Description**      →  122

### 17.3.2 "Analog input 1 to 5" submenu

There is an **Analog inputs** submenu for every AI block of the device. The AI block is used to configure the measured value transmission to the bus.

 Only the most basic properties of the AI block can be configured in this submenu. For a detailed configuration of the AI blocks refer to the **Expert** menu.

*Navigation*       Setup → Analog inputs → Analog input 1 to 5

---

#### Block tag

---

##### Navigation

 Setup → Analog inputs → Analog input 1 to 7 → Block tag

##### Description

Defined to be unique throughout the control system at one plant site. The tag may be changed using the FB\_Tag service.

##### User entry

Character string comprising numbers, letters and special characters (32)

---

#### Channel

---

##### Navigation

 Setup → Analog inputs → Analog input 1 to 7 → Channel

##### Description

Use this function to select the input value that should be processed in the Analog Input function block.

##### Selection

- Uninitialized
- Level linearized
- Absolute echo amplitude
- Absolute EOP amplitude
- Absolute interface amplitude \*
- Distance
- Electronic temperature
- EOP shift
- Interface linearized \*
- Interface distance \*
- Measured capacitance \*
- Relative echo amplitude
- Relative interface amplitude \*
- Noise of signal
- Terminal voltage
- Thickness upper layer \*
- Calculated DC value \*
- Analog output adv. diagnostics 2
- Analog output adv. diagnostics 1

---

\* Visibility depends on order options or device settings

---

**Process Value Filter Time**

---

**Navigation** Setup → Analog inputs → Analog input 1 to 7 → PV Filter Time**Description**

Use this function to enter the filter time specification for the filtering of the unconverted input value (PV).

**User entry**

Positive floating-point number

**Additional information**

*Factory setting*



If the value 0 s is entered, filtering will not be performed.







### 17.3.3 "Advanced setup" submenu

Navigation  Setup → Advanced setup

---

#### Locking status





---

<b>Navigation</b>	  Setup → Advanced setup → Locking status
<b>Description</b>	Indicates the write protection with the highest priority that is currently active.
<b>User interface</b>	<ul style="list-style-type: none"> <li>▪ Hardware locked</li> <li>▪ Temporarily locked</li> </ul>
<b>Additional information</b>	<p><b>Meaning and priorities of the types of write protection</b></p> <ul style="list-style-type: none"> <li>▪ <b>Hardware locked (priority 1)</b> The DIP switch for hardware locking is activated on the main electronics module. This locks write access to the parameters.</li> <li>▪ <b>SIL locked (priority 2)</b> The SIL mode is activated. Writing access to the relevant parameters is denied.</li> <li>▪ <b>WHG locked (priority 3)</b> The WHG mode is activated. Writing access to the relevant parameters is denied.</li> <li>▪ <b>Temporarily locked (priority 4)</b> Write access to the parameters is temporarily locked on account of internal processes in progress in the device (e.g. data upload/download, reset etc.). The parameters can be modified as soon as the processes are complete.</li> </ul> <p> On the display module, the -symbol appears in front of parameters that cannot be modified since they are write-protected.</p>

---

#### Access status tooling

---





<b>Navigation</b>	 Setup → Advanced setup → Access stat.tool
<b>Description</b>	Shows the access authorization to the parameters via the operating tool.
<b>Additional information</b>	<p> The access authorization can be changed via the <b>Enter access code</b> parameter (→  130).</p> <p> If additional write protection is active, this restricts the current access authorization even further. The write protection status can be viewed via the <b>Locking status</b> parameter (→  129).</p>

---

#### Access status display

---





<b>Navigation</b>	 Setup → Advanced setup → Access stat.disp
<b>Prerequisite</b>	The device has a local display.

<b>Description</b>	Indicates access authorization to parameters via local display.
<b>Additional information</b>	<p> The access authorization can be changed via the <b>Enter access code</b> parameter (→  130).</p> <p> If additional write protection is active, this restricts the current access authorization even further. The write protection status can be viewed via the <b>Locking status</b> parameter (→  129).</p>

---

### Enter access code



---

<b>Navigation</b>	 Setup → Advanced setup → Ent. access code
<b>Description</b>	Enter access code to disable write protection of parameters.
<b>User entry</b>	0 to 9 999
<b>Additional information</b>	<ul style="list-style-type: none"> <li>■ The customer-specific access code that was defined in the <b>Define access code</b> parameter (→  168) must be entered for local operation.</li> <li>■ If an incorrect access code is entered, users retain their current access authorization.</li> <li>■ The write protection affects all parameters marked with the  symbol in the document. On the local display, the  symbol in front of a parameter indicates that the parameter is write-protected.</li> <li>■ If no key is pressed for 10 minutes or the user goes from the navigation and editing mode back to the measured value display mode, the device automatically locks the write-protected parameters after another 60 s.</li> </ul> <p> Please contact your Endress+Hauser Sales Center if you lose your access code.</p>



**"Level" submenu**

*Navigation*       Setup → Advanced setup → Level

**Medium type** 

<b>Navigation</b>	 Setup → Advanced setup → Level → Medium type
<b>Description</b>	Specify type of medium.
<b>User interface</b>	<ul style="list-style-type: none"> <li>■ Liquid</li> <li>■ Solid</li> </ul>
<b>Factory setting</b>	FMP56, FMP57: <b>Solid</b>
<b>Additional information</b>	 This parameter determines the value of several other parameters and strongly influences the complete signal evaluation. Therefore, it is strongly recommended <b>not to change</b> the factory setting.

**Medium property** 

<b>Navigation</b>	 Setup → Advanced setup → Level → Medium property
<b>Prerequisite</b>	<b>EOP level evaluation ≠ Fix DC</b>
<b>Description</b>	Specify the dielectric constant $\epsilon_r$ of the medium.
<b>Selection</b>	<ul style="list-style-type: none"> <li>■ Unknown</li> <li>■ DC 1.4 ... 1.6</li> <li>■ DC 1.6 ... 1.9</li> <li>■ DC 1.9 ... 2.5</li> <li>■ DC 2.5 ... 4</li> <li>■ DC 4 ... 7</li> <li>■ DC 7 ... 15</li> <li>■ DC &gt; 15</li> </ul>
<b>Factory setting</b>	Depends on the <b>Medium type</b> (→  131) and <b>Medium group</b> parameters.

**Additional information**

*Dependency of "Medium type" and "Medium group"*

Medium type (→ 131)	Medium group	Medium property
Solid		Unknown
Liquid	Water based (DC >= 4)	DC 4 ... 7
	Others	Unknown

**i** For the relative permittivity values ( $\epsilon_r$  values) of many media commonly used in industry, please refer to:

- Relative permittivity ( $\epsilon_r$  value), Compendium CP01076F
- The Endress+Hauser "DC Values app" (available for Android and iOS)

**i** If **EOP level evaluation = Fix DC**, the exact dielectric constant must be specified in the **DC value** parameter. The **Medium property** parameter therefore does not apply in this case.

**Process property**



**Navigation**

Setup → Advanced setup → Level → Process property

**Description**

Specify typical rate of level change.

**Selection**

**For "Medium type" = "Liquid"**

- Very fast > 10 m (400 in)/min
- Fast > 1 m (40 in)/min
- Standard < 1 m (40in) /min
- Medium < 10 cm (4in) /min
- Slow < 1 cm (0.4in) /min
- No filter / test

**For "Medium type" = "Solid"**

- Very fast > 100 m (333 ft) /h
- Fast > 10 m (33 ft) /h
- Standard < 10 m (33 ft) /h
- Medium < 1 m (3ft) /h
- Slow < 0.1 m (0.3ft) /h
- No filter / test

**Additional information**

The device adjusts the signal evaluation filters and the damping of the output signal to the typical rate of level change defined in this parameter:

*For "Operating mode" = "Level" and "Medium type" = "Liquid"*

Process property	Step response time / s
Very fast > 10 m (400 in)/min	5
Fast > 1 m (40 in)/min	5
Standard < 1 m (40in) /min	14
Medium < 10 cm (4in) /min	39
Slow < 1 cm (0.4in) /min	76
No filter / test	< 1

For "Operating mode" = "Level" and "Medium type" = "Solid"

Process property	Step response time / s
Very fast > 100 m (333 ft) /h	37
Fast > 10 m (33 ft) /h	37
Standard < 10 m (33 ft) /h	74
Medium < 1 m (3ft) /h	146
Slow < 0.1 m (0.3ft) /h	290
No filter / test	< 1

For "Operating mode" = "Interface" or "Interface with capacitance"

Process property	Step response time / s
Very fast > 10 m (400 in)/min	5
Fast > 1 m (40 in)/min	5
Standard < 1 m (40in) /min	23
Medium < 10 cm (4in) /min	47
Slow < 1 cm (0.4in) /min	81
No filter / test	2.2

## Advanced process conditions

### Navigation

  Setup → Advanced setup → Level → Adv. conditions

### Description

Specify additional process conditions (if required).

### Selection

- None
- Oil/Water condensate
- Probe near tank bottom
- Build up
- Foam (>5cm/0,16ft)

### Additional information





#### Meaning of the options

- **Oil/Water condensate** (only **Medium type** = **Liquid**)  
Makes sure that in the case of two-phase media only the total level is detected (example: oil/condensate application).
- **Probe near tank bottom** (only for **Medium type** = **Liquid**)  
Improves the empty detection, especially if the probe is mounted close to the tank bottom.
- **Build up**  
Enables a safe empty-detection even if the end-of-probe signal has shifted due to build-up.
- **Foam (>5cm/0,16ft)** (only for **Medium type** = **Liquid**)  
Optimizes the signal evaluation in applications with foam formation.

---

**Level unit**





---

<b>Navigation</b>	 Setup → Advanced setup → Level → Level unit								
<b>Description</b>	Select level unit.								
<b>Selection</b>	<table> <thead> <tr> <th><i>SI units</i></th> <th><i>US units</i></th> </tr> </thead> <tbody> <tr> <td>■ %</td> <td>■ ft</td> </tr> <tr> <td>■ m</td> <td>■ in</td> </tr> <tr> <td>■ mm</td> <td></td> </tr> </tbody> </table>	<i>SI units</i>	<i>US units</i>	■ %	■ ft	■ m	■ in	■ mm	
<i>SI units</i>	<i>US units</i>								
■ %	■ ft								
■ m	■ in								
■ mm									
<b>Additional information</b>	<p>The level unit may differ from the distance unit defined in the <b>Distance unit</b> parameter (→  120):</p> <ul style="list-style-type: none"> <li>■ The unit defined in the <b>Distance unit</b> parameter is used for the basic calibration (<b>Empty calibration</b> (→  120) and <b>Full calibration</b> (→  121)).</li> <li>■ The unit defined in the <b>Level unit</b> parameter is used to display the (unlinearized) level.</li> </ul>								

---

**Blocking distance**

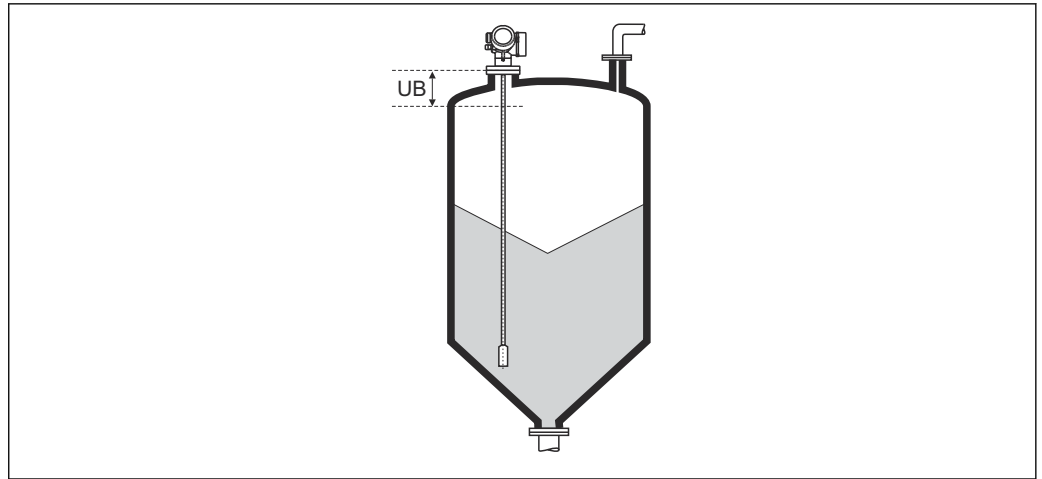

---

<b>Navigation</b>	 Setup → Advanced setup → Level → Blocking dist.
<b>Description</b>	Specify upper blocking distance UB.
<b>User entry</b>	0 to 200 m
<b>Factory setting</b>	<ul style="list-style-type: none"> <li>■ For rod and rope probes up to 8 m (26 ft): 200 mm (8 in)</li> <li>■ For rod and rope probes above 8 m (26 ft): 0.025 * Sondenlänge</li> </ul>
<b>Additional information</b>	<p>Signals in the upper blocking distance are only evaluated if they have been outside the blocking distance when the device was switched on and move into the blocking distance due to a level change during operation. Signals which are already in the blocking distance when the device is switched on, are ignored.</p> <p> This behavior is only valid if the following two conditions are met:</p> <ul style="list-style-type: none"> <li>■ Expert → Sensor → Echo tracking → Evaluation mode = <b>Short time history</b> or <b>Long time history</b>)</li> <li>■ Expert → Sensor → Gas phase compensation → GPC mode= <b>On, Without correction</b> or <b>External correction</b></li> </ul> <p>If one of these conditions is not met, signals in the blocking distance will always be ignored.</p> <p> If required, a different behavior for signals in the blocking distance can be defined by the Endress+Hauser service.</p>



A0013221

45 Blocking distance (UB) for bulk solid measurements

**Level correction**



**Navigation**

Setup → Advanced setup → Level → Level correction

**Description**

Specify level correction (if required).

**User entry**

-200 000.0 to 200 000.0 %

**Additional information**

The value specified in this parameter is added to the measured level (before linearization).

**"Linearization" submenu**

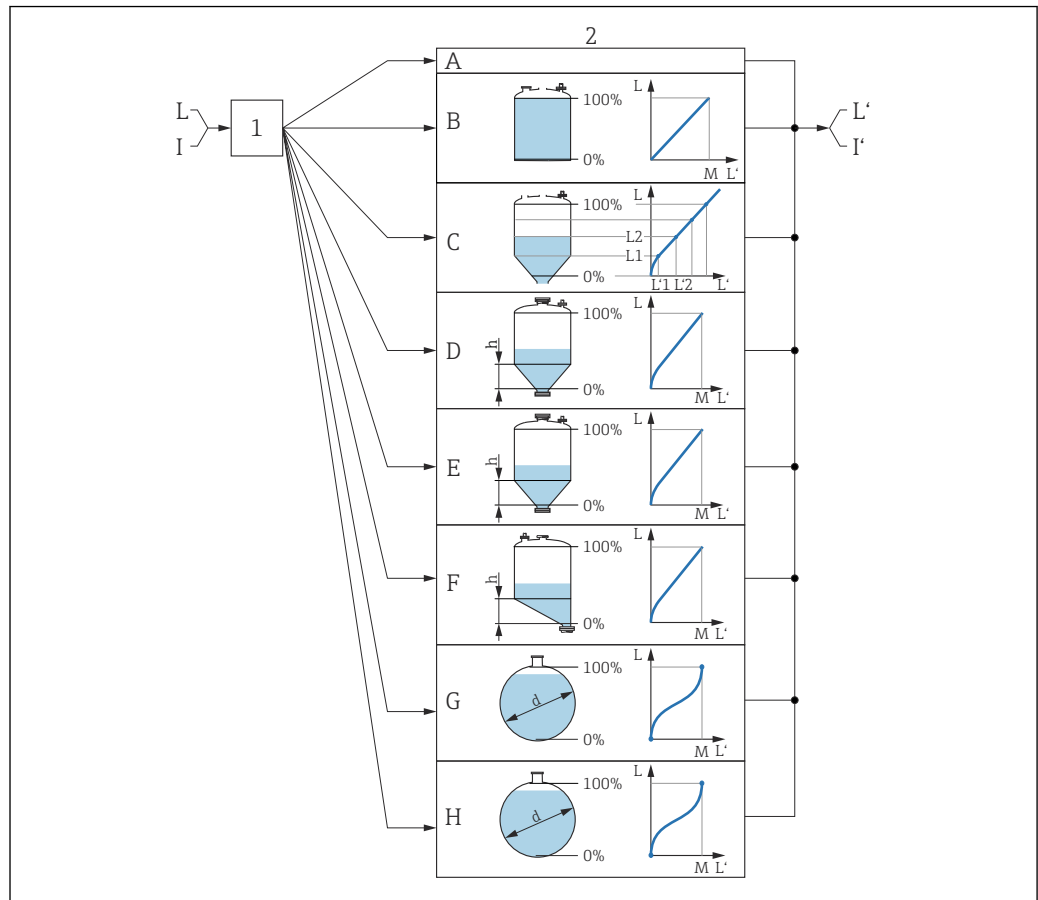

A0016084

46 Linearization: Conversion of the level and, if applicable, interface into a volume or a weight; the conversion depends on the vessel shape

- 1 Selection of linearization type and unit
- 2 Configuration of the linearization
- A Linearization type ( $\rightarrow$  139) = None
- B Linearization type ( $\rightarrow$  139) = Linear
- C Linearization type ( $\rightarrow$  139) = Table
- D Linearization type ( $\rightarrow$  139) = Pyramid bottom
- E Linearization type ( $\rightarrow$  139) = Conical bottom
- F Linearization type ( $\rightarrow$  139) = Angled bottom
- G Linearization type ( $\rightarrow$  139) = Horizontal cylinder
- H Linearization type ( $\rightarrow$  139) = Sphere
- I For "Operating mode" = "Interface" or "Interface with capacitance": interface before linearization (measured in the level unit)
- I' For "Operating mode" = "Interface" or "Interface with capacitance": interface after linearization (corresponds to volume or weight)
- L Level before linearization (measured in level unit)
- L' Level linearized ( $\rightarrow$  142) (corresponds to volume or weight)
- M Maximum value ( $\rightarrow$  142)
- d Diameter ( $\rightarrow$  142)
- h Intermediate height ( $\rightarrow$  143)



*Structure of the submenu on the local display*

Navigation  Setup → Advanced setup → Linearization

► **Linearization**

Linearization type

Unit after linearization

Free text

Maximum value

Diameter

Intermediate height

Table mode

► **Edit table**

Level

Customer value

Activate table

Structure of the submenu in the operating tool (e.g. FieldCare)

Navigation  Setup → Advanced setup → Linearization

▶ Linearization

*Description of the parameters*

Navigation  Setup → Advanced setup → Linearization

**Linearization type** 

**Navigation**  Setup → Advanced setup → Linearization → Lineariz. type

**Description** Select linearization type.

- Selection**
- None
  - Linear
  - Table
  - Pyramid bottom
  - Conical bottom
  - Angled bottom
  - Horizontal cylinder
  - Sphere

**Additional information**

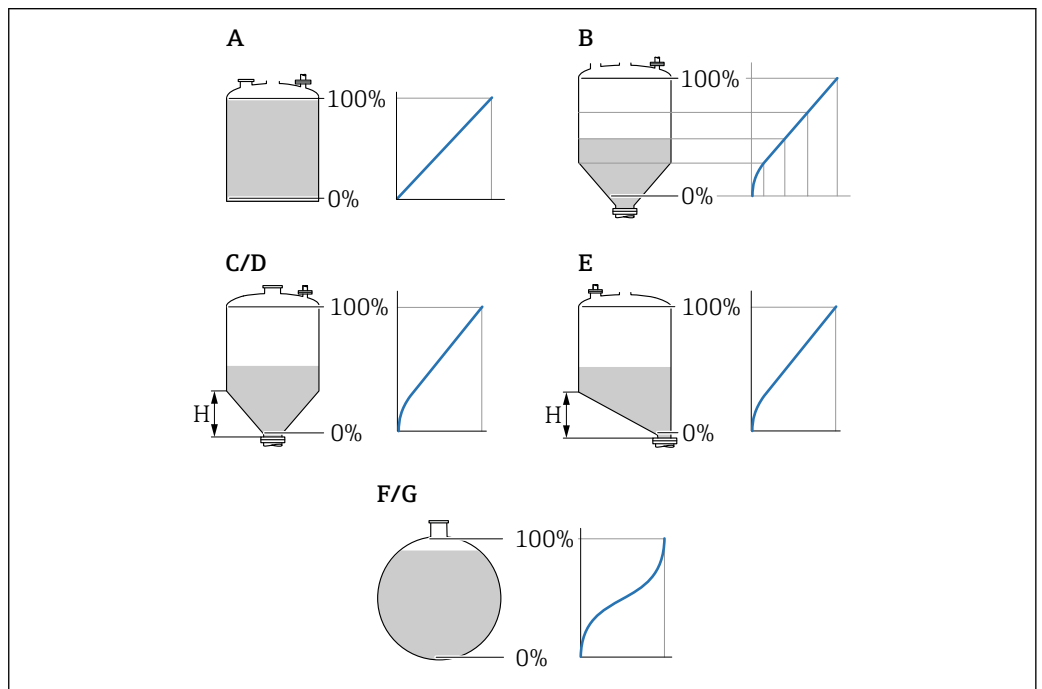

A0021476

 47 Linearization types

- A None
- B Table
- C Pyramid bottom
- D Conical bottom
- E Angled bottom
- F Sphere
- G Horizontal cylinder

**Meaning of the options**

- **None**

The level is output in the level unit without being converted (linearized) beforehand.

- **Linear**

The output value (volume/weight) is proportional to the level L. This applies, for example, to vertical cylindrical tanks and silos. The following parameters must also be specified:

- **Unit after linearization** (→  140)

- **Maximum value** (→  142): maximum volume or weight

- **Table**

The relationship between the measured level L and the output value (volume/weight) is defined by a linearization table consisting of up to 32 pairs of values "level - volume" or "level - weight" respectively. The following parameters must also be specified:

- **Unit after linearization** (→  140)

- **Table mode** (→  143)

- For every point in the table: **Level** (→  144)

- For every point in the table: **Customer value** (→  145)

- **Activate table** (→  145)

- **Pyramid bottom**

The output value corresponds to the volume or weight in a silo with a pyramid bottom.

The following parameters must also be specified:

- **Unit after linearization** (→  140)

- **Maximum value** (→  142): maximum volume or weight

- **Intermediate height** (→  143): the height of the pyramid

- **Conical bottom**

The output value corresponds to the volume or weight in a tank with a conical bottom.

The following parameters must also be specified:

- **Unit after linearization** (→  140)

- **Maximum value** (→  142): maximum volume or weight

- **Intermediate height** (→  143): the height of the cone

- **Angled bottom**

The output value corresponds to the volume or weight in a silo with an angled bottom.

The following parameters must also be specified:

- **Unit after linearization** (→  140)

- **Maximum value** (→  142): maximum volume or weight

- **Intermediate height** (→  143): height of the angled bottom

- **Horizontal cylinder**

The output value corresponds to the volume or weight in a horizontal cylinder. The following parameters must also be specified:

- **Unit after linearization** (→  140)

- **Maximum value** (→  142): maximum volume or weight

- **Diameter** (→  142)

- **Sphere**

The output value corresponds to the volume or weight in a spherical tank. The following parameters must also be specified:



- **Unit after linearization** (→  140)

- **Maximum value** (→  142): maximum volume or weight

- **Diameter** (→  142)

---

**Unit after linearization**
**Navigation**

  Setup → Advanced setup → Linearization → Unit lineariz.

**Prerequisite**



**Linearization type** (→  139) ≠ None

**Description** Select the unit for the linearized value.

**Selection** Selection/input (uint16)

- 1095 = [short Ton]
- 1094 = [lb]
- 1088 = [kg]
- 1092 = [Ton]
- 1048 = [US Gal.]
- 1049 = [Imp. Gal.]
- 1043 = [ft<sup>3</sup>]
- 1571 = [cm<sup>3</sup>]
- 1035 = [dm<sup>3</sup>]
- 1034 = [m<sup>3</sup>]
- 1038 = [l]
- 1041 = [hl]
- 1342 = [%]
- 1010 = [m]
- 1012 = [mm]
- 1018 = [ft]
- 1019 = [inch]
- 1351 = [l/s]
- 1352 = [l/min]
- 1353 = [l/h]
- 1347 = [m<sup>3</sup>/s]
- 1348 = [m<sup>3</sup>/min]
- 1349 = [m<sup>3</sup>/h]
- 1356 = [ft<sup>3</sup>/s]
- 1357 = [ft<sup>3</sup>/min]
- 1358 = [ft<sup>3</sup>/h]
- 1362 = [US Gal./s]
- 1363 = [US Gal./min]
- 1364 = [US Gal./h]
- 1367 = [Imp. Gal./s]
- 1358 = [Imp. Gal./min]
- 1359 = [Imp. Gal./h]
- 32815 = [ML/s]
- 32816 = [ML/min]
- 32817 = [ML/h]
- 1355 = [ML/d]



**Additional information** The selected unit is only used for display purposes. The measured value is **not** converted on the basis of the selected unit.

 Distance-to-distance linearization is also possible, i.e. a linearization from the level unit to another length unit. Select the **Linear** linearization mode for this purpose. To specify the new level unit, select the **Free text** option in the **Unit after linearization** parameter and enter the unit in the **Free text** parameter (→  141).

---

**Free text**



**Navigation**   Setup → Advanced setup → Linearization → Free text

**Prerequisite** **Unit after linearization** (→  140) = **Free text**

**Description** Enter unit symbol.

**User entry** Up to 32 alphanumerical characters (letters, numbers, special characters)

---

### Level linearized

---

**Navigation**  Setup → Advanced setup → Linearization → Level linearized

**Description** Displays linearized level.

**Additional information**  This unit is defined by the **Unit after linearization** parameter.

---

### Maximum value

---



**Navigation**   Setup → Advanced setup → Linearization → Maximum value

**Prerequisite** **Linearization type** (→  139) has one of the following values:

- Linear
- Pyramid bottom
- Conical bottom
- Angled bottom
- Horizontal cylinder
- Sphere



**User entry** -50 000.0 to 50 000.0 %

---

### Diameter

---



**Navigation**   Setup → Advanced setup → Linearization → Diameter

**Prerequisite** **Linearization type** (→  139) has one of the following values:

- Horizontal cylinder
- Sphere

**User entry** 0 to 9 999.999 m

**Additional information** The unit is defined in the **Distance unit** parameter (→  120).

---

**Intermediate height**
**Navigation**

Setup → Advanced setup → Linearization → Intermed. height

**Prerequisite**
**Linearization type** (→ 139) has one of the following values:

- Pyramid bottom
- Conical bottom
- Angled bottom

**User entry**

0 to 200 m

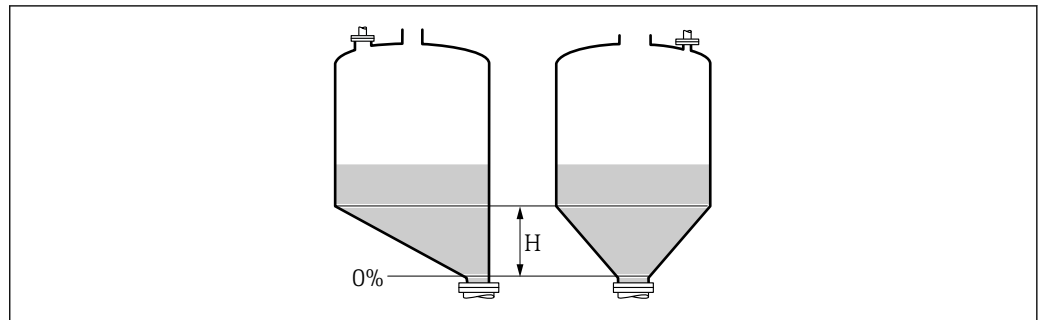
**Additional information**

A0013264

*H* Intermediate height

The unit is defined in the **Distance unit** parameter (→ 120).

---

**Table mode**
**Navigation**

Setup → Advanced setup → Linearization → Table mode

**Prerequisite**
**Linearization type** (→ 139) = Table
**Description**

Select editing mode of the linearization table.

**Selection**

- Manual
- Semiautomatic \*
- Clear table
- Sort table

**Additional information****Meaning of the options**



- **Manual**  
The level and the associated linearized value are entered manually for each linearization point.
- **Semiautomatic**  
The level is measured by the device for each linearization point. The associated linearized value is entered manually.
- **Clear table**  
Deletes the existing linearization table.
- **Sort table**  
Rearranges the linearization points into an ascending order.

---

\* Visibility depends on order options or device settings



**Conditions the linearization table must meet:**



- The table may consist of up to 32 pairs of values "Level - Linearized Value".
- The table must be monotonic (monotonically increasing or decreasing).
- The first linearization point must refer to the minimum level.
- The last linearization point must refer to the maximum level.

 Before entering a linearization table, the values for **Empty calibration** (→  120) and **Full calibration** (→  121) must be set correctly.

If values of the table need to be changed after the full or empty calibration have been changed, a correct evaluation is only ensured if the existing table is deleted and the complete table is entered again. To do so delete the existing table (**Table mode** (→  143) = **Clear table**). Then enter a new table.

**How to enter the table**



- Via FieldCare  
The table points can be entered via the **Table number** (→  144), **Level** (→  144) and **Customer value** (→  145) parameters. As an alternative, the graphic table editor may be used: Device Operation → Device Functions → Additional Functions → Linearization (Online/Offline)
- Via local display  
Select the **Edit table** submenu to call up the graphic table editor. The table is displayed and can be edited line by line.

 The factory setting for the level unit is "%". If you want to enter the linearization table in physical units, you must select the appropriate unit in the **Level unit** parameter (→  134) beforehand.

---

**Table number** 



---

<b>Navigation</b>	 Setup → Advanced setup → Linearization → Table number
<b>Prerequisite</b>	<b>Linearization type</b> (→  139) = <b>Table</b>
<b>Description</b>	Select table point you are going to enter or change.
<b>User entry</b>	1 to 32

---

**Level (Manual)** 

---



<b>Navigation</b>	 Setup → Advanced setup → Linearization → Level
<b>Prerequisite</b>	<ul style="list-style-type: none"> <li>■ <b>Linearization type</b> (→  139) = <b>Table</b></li> <li>■ <b>Table mode</b> (→  143) = <b>Manual</b></li> </ul>
<b>Description</b>	Enter level value of the table point (value before linearization).
<b>User entry</b>	Signed floating-point number



---

**Level (Semiautomatic)**



---

<b>Navigation</b>	 Setup → Advanced setup → Linearization → Level
<b>Prerequisite</b>	<ul style="list-style-type: none"> <li>▪ <b>Linearization type</b> (→  139) = <b>Table</b></li> <li>▪ <b>Table mode</b> (→  143) = <b>Semiautomatic</b></li> </ul>
<b>Description</b>	Displays measured level (value before linearization). This value is transmitted to the table.

---

**Customer value**







---

<b>Navigation</b>	 Setup → Advanced setup → Linearization → Customer value
<b>Prerequisite</b>	<b>Linearization type</b> (→  139) = <b>Table</b>
<b>Description</b>	Enter linearized value for the table point.
<b>User entry</b>	Signed floating-point number

---

**Activate table**





---

<b>Navigation</b>	  Setup → Advanced setup → Linearization → Activate table
<b>Prerequisite</b>	<b>Linearization type</b> (→  139) = <b>Table</b>
<b>Description</b>	Activate (enable) or deactivate (disable) the linearization table.
<b>Selection</b>	<ul style="list-style-type: none"> <li>▪ <b>Disable</b></li> <li>▪ <b>Enable</b></li> </ul>
<b>Additional information</b>	<p><b>Meaning of the options</b></p> <ul style="list-style-type: none"> <li>▪ <b>Disable</b> The measured level is not linearized. If <b>Linearization type</b> (→  139) = <b>Table</b> at the same time, the device issues error message F435.</li> <li>▪ <b>Enable</b> The measured level is linearized according to the table.</li> </ul> <p> When editing the table, the <b>Activate table</b> parameter is automatically reset to <b>Disable</b> and must be reset to <b>Enable</b> after the table has been entered.</p>





**"Safety settings" submenu**

*Navigation*  Setup → Advanced setup → Safety sett.

**Output echo lost** 

<b>Navigation</b>	 Setup → Advanced setup → Safety sett. → Output echo lost
<b>Description</b>	Output signal in case of a lost echo.
<b>Selection</b>	<ul style="list-style-type: none"> <li>■ Last valid value</li> <li>■ Ramp at echo lost</li> <li>■ Value echo lost</li> <li>■ Alarm</li> </ul>
<b>Additional information</b>	<p><b>Meaning of the options</b></p> <ul style="list-style-type: none"> <li>■ <b>Last valid value</b> The last valid value is kept in the case of a lost echo.</li> <li>■ <b>Ramp at echo lost</b> <sup>3)</sup> In the case of a lost echo the output value is continuously shifted towards 0% or 100%. The slope of the ramp is defined in the <b>Ramp at echo lost</b> parameter (→  147).</li> <li>■ <b>Value echo lost</b> <sup>3)</sup> In the case of a lost echo the output assumes the value defined in the <b>Value echo lost</b> parameter (→  146).</li> <li>■ <b>Alarm</b> In the case of a lost echo the device generates an alarm; see the <b>Failure mode</b> parameter</li> </ul>

**Value echo lost** 

<b>Navigation</b>	 Setup → Advanced setup → Safety sett. → Value echo lost
<b>Prerequisite</b>	<b>Output echo lost</b> (→  146) = <b>Value echo lost</b>
<b>Description</b>	Output value in case of a lost echo
<b>User entry</b>	0 to 200 000.0 %
<b>Additional information</b>	<p>Use the unit which has been defined for the measured value output:</p> <ul style="list-style-type: none"> <li>■ without linearization: <b>Level unit</b> (→  134)</li> <li>■ with linearization: <b>Unit after linearization</b> (→  140)</li> </ul>

<sup>3)</sup> Only visible if "Linearization type" (→  139) = "None"

## Ramp at echo lost



<b>Navigation</b>	Setup → Advanced setup → Safety sett. → Ramp echo lost
<b>Prerequisite</b>	<b>Output echo lost (→  146) = Ramp at echo lost</b>
<b>Description</b>	Slope of the ramp in the case of a lost echo
<b>User entry</b>	Signed floating-point number
<b>Additional information</b>	

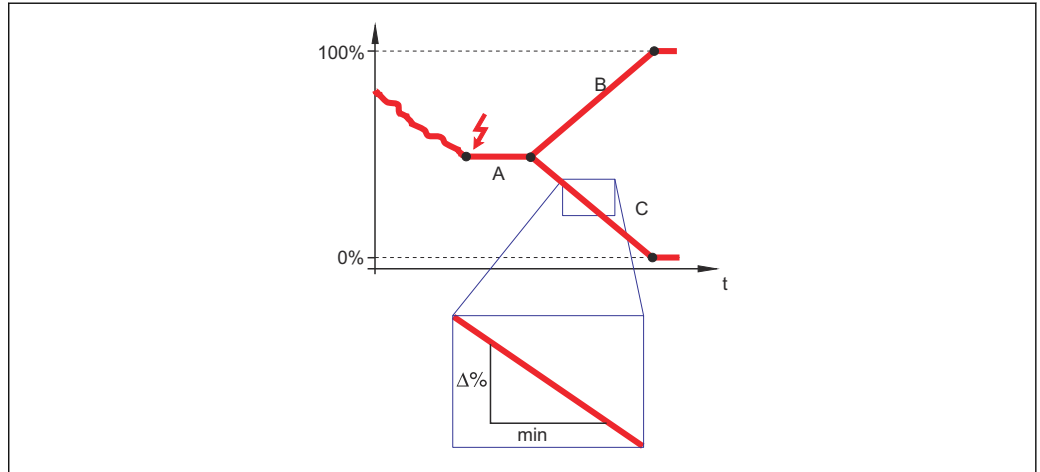

A0013269

- A Delay time echo lost  
 B Ramp at echo lost (→ 147) (positive value)  
 C Ramp at echo lost (→ 147) (negative value)

- The unit for the slope of the ramp is "percentage of the measuring range per minute" (%/min).
- For a negative slope of the ramp: The measured value is continuously decreased until it reaches 0%.
- For a positive slope of the ramp: The measured value is continuously increased until it reaches 100%.

## Blocking distance



<b>Navigation</b>	Setup → Advanced setup → Safety sett. → Blocking dist.
<b>Description</b>	Specify upper blocking distance UB.
<b>User entry</b>	0 to 200 m
<b>Factory setting</b>	<ul style="list-style-type: none"> <li>■ For rod and rope probes up to 8 m (26 ft): 200 mm (8 in)</li> <li>■ For rod and rope probes above 8 m (26 ft): 0.025 * Sondenlänge</li> </ul>
<b>Additional information</b>	Signals in the upper blocking distance are only evaluated if they have been outside the blocking distance when the device was switched on and move into the blocking distance

due to a level change during operation. Signals which are already in the blocking distance when the device is switched on, are ignored.

- i** This behavior is only valid if the following two conditions are met:
- Expert → Sensor → Echo tracking → Evaluation mode = **Short time history** or **Long time history**)
  - Expert → Sensor → Gas phase compensation → GPC mode= **On, Without correction** or **External correction**

If one of these conditions is not met, signals in the blocking distance will always be ignored.

- i** If required, a different behavior for signals in the blocking distance can be defined by the Endress+Hauser service.

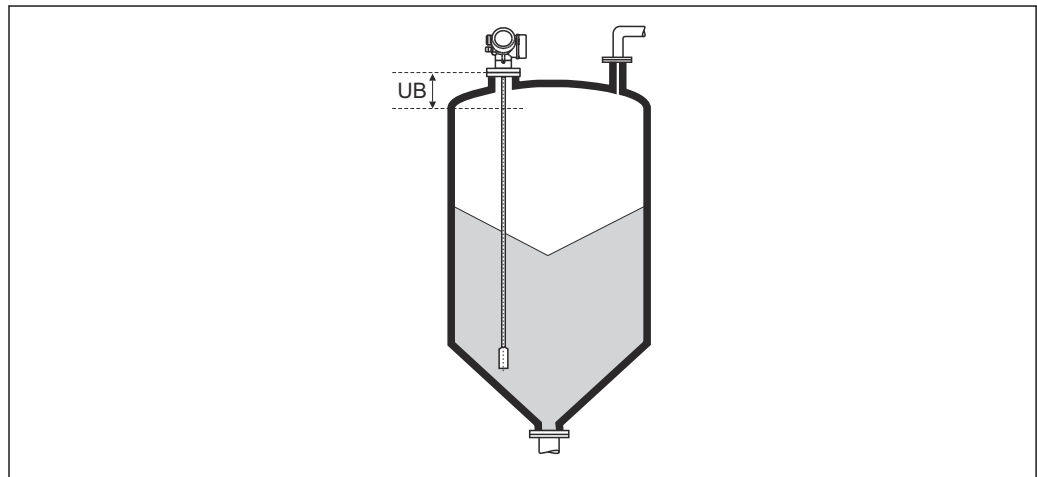









A0013221

**48** Blocking distance (UB) for bulk solid measurements



**"Probe settings" submenu**

The **Probe settings** submenu helps to ensure that the device correctly assigns the end of probe signal within the envelope curve. The assignment is correct if the length of probe indicated by the device matches the actual length of the probe. The automatic probe length correction can only be performed if the probe is installed in the vessel and is completely uncovered (no medium) over the entire length. For partially filled vessels and if the probe length is known, select **Confirm probe length** (→  150) = **Manual input** to enter the value manually.



-  If a mapping has been recorded after shortening the probe, it is no longer possible to perform an automatic probe length correction. There are two options if this occurs:
  - First delete the mapping curve using the **Record map** parameter (→  125) and the probe length correction can then be performed. After the probe length correction, a new mapping curve can be recorded using the **Record map** parameter (→  125).
  - Alternatively, select **Confirm probe length** (→  150) = **Manual input** and manually enter the probe length in the **Present probe length** parameter.
-  An automatic probe length correction is only possible after the correct option has been selected in the **Probe grounded** parameter (→  149).

*Navigation*        Setup → Advanced setup → Probe settings

**Probe grounded** 

<b>Navigation</b>	  Setup → Advanced setup → Probe settings → Probe grounded
<b>Prerequisite</b>	<b>Operating mode = Level</b>
<b>Description</b>	Specify whether the probe is grounded.
<b>Selection</b>	<ul style="list-style-type: none"> <li>▪ No</li> <li>▪ Yes</li> </ul>

**Present probe length** 

<b>Navigation</b>	 Setup → Advanced setup → Probe settings → Pres. length
<b>Description</b>	<ul style="list-style-type: none"> <li>▪ In most cases: Displays the length of the probe according to the currently measured end-of-probe signal.</li> <li>▪ For <b>Confirm probe length</b> (→  150) = <b>Manual input</b>: Enter actual length of probe.</li> </ul>
<b>User entry</b>	0 to 200 m

---

**Confirm probe length**
**Navigation**

Setup → Advanced setup → Probe settings → Confirm length

**Description**

Specify whether the value displayed in the **Present probe length** parameter matches the actual length of the probe. Based on this input, the device performs a probe length correction.

**Selection**

- Probe length OK
- Probe length too small
- Probe length too big
- Probe covered
- Manual input
- Probe length unknown

**Additional information****Meaning of the options**

- **Probe length OK**  
To be selected if the correct probe length is displayed. A correction is not required. The device exits the sequence.
- **Probe length too small**  
To be selected if the displayed length is less than the actual probe length. A different end of probe signal is allocated and the newly calculated length is displayed in the **Present probe length** parameter. This procedure has to be repeated until the displayed value matches the actual length of the probe.
- **Probe length too big**  
To be selected if the displayed length is greater than the actual probe length. A different end of probe signal is allocated and the newly calculated length is displayed in the **Present probe length** parameter. This procedure has to be repeated until the displayed value matches the actual length of the probe.
- **Probe covered**  
To be selected if the probe is (partially or completely) covered. A probe length correction is impossible in this case.
- **Manual input**  
To be selected if no automatic probe length correction is to be performed. Instead, the actual length of the probe must be entered manually in the **Present probe length** parameter.<sup>4)</sup>
- **Probe length unknown**  
To be selected if the actual probe length is unknown. A probe length correction is impossible in this case.

---

4) When operating via FieldCare, the **Manual input** option does not need to be selected explicitly; manual editing of the probe length is always possible here.

*"Probe length correction" wizard*

The **Probe length correction** wizard is only available when operating via the local display. When operating via an operating tool, the parameters for probe length correction are located directly in the **Probe settings** submenu (→ 149).

*Navigation*      Setup → Advanced setup → Probe settings → Prob.length corr

**Confirm probe length****Navigation**

Setup → Advanced setup → Probe settings → Prob.length corr → Confirm length

**Description**

Specify whether the value displayed in the **Present probe length** parameter matches the actual length of the probe. Based on this input, the device performs a probe length correction.

**Selection**

- Probe length OK
- Probe length too small
- Probe length too big
- Probe covered
- Manual input
- Probe length unknown

**Additional information****Meaning of the options**

- **Probe length OK**  
To be selected if the correct probe length is displayed. A correction is not required. The device exits the sequence.
- **Probe length too small**  
To be selected if the displayed length is less than the actual probe length. A different end of probe signal is allocated and the newly calculated length is displayed in the **Present probe length** parameter. This procedure has to be repeated until the displayed value matches the actual length of the probe.
- **Probe length too big**  
To be selected if the displayed length is greater than the actual probe length. A different end of probe signal is allocated and the newly calculated length is displayed in the **Present probe length** parameter. This procedure has to be repeated until the displayed value matches the actual length of the probe.
- **Probe covered**  
To be selected if the probe is (partially or completely) covered. A probe length correction is impossible in this case.
- **Manual input**  
To be selected if no automatic probe length correction is to be performed. Instead, the actual length of the probe must be entered manually in the **Present probe length** parameter.<sup>5)</sup>
- **Probe length unknown**  
To be selected if the actual probe length is unknown. A probe length correction is impossible in this case.

5) When operating via FieldCare, the **Manual input** option does not need to be selected explicitly; manual editing of the probe length is always possible here.

---

**Present probe length**

---

**Navigation**

 Setup → Advanced setup → Probe settings → Prob.length corr → Pres. length

**Description**



- In most cases:  
Displays the length of the probe according to the currently measured end-of-probe signal.
- For **Confirm probe length** (→  150) = **Manual input**:  
Enter actual length of probe.



**User entry**

0 to 200 m





**"Switch output" submenu**

 The **Switch output** submenu (→  153) is only available for devices with a switch output.<sup>6)</sup>

*Navigation*        Setup → Advanced setup → Switch output

**Switch output function****Navigation**

  Setup → Advanced setup → Switch output → Switch out funct





**Description**

Select function for switch output.

**Selection**



- Off
- On
- Diagnostic behavior
- Limit
- Digital Output

**Additional information****Meaning of the options**

- **Off**  
The output is always open (non-conductive).
- **On**  
The output is always closed (conductive).
- **Diagnostic behavior**  
The output is normally closed and is only opened if a diagnostic event is present. The **Assign diagnostic behavior** parameter (→  154) determines for which type of event the output is opened.
- **Limit**  
The output is normally closed and is only opened if a measured variable exceeds or falls below a defined limit. The limit values are defined by the following parameters:
  - **Assign limit** (→  154)
  - **Switch-on value** (→  155)
  - **Switch-off value** (→  156)
- **Digital Output**  
The switching state of the output tracks the output value of a DI function block. The function block is selected in the **Assign status** parameter (→  153).

 The **Off** and **On** options can be used to simulate the switch output.

**Assign status****Navigation**

  Setup → Advanced setup → Switch output → Assign status

**Prerequisite**

**Switch output function** (→  153) = **Digital Output**

**Selection**

- Off
- Digital output AD 1
- Digital output AD 2

6) Order code 020 "Power supply; output", option B, E or G

- Digital output 1
- Digital output 2
- Digital output 3
- Digital output 4
- Digital output 5
- Digital output 6
- Digital output 7
- Digital output 8

**Additional information**

The **Digital output AD 1** and **Digital output AD 2** options refer to the Advanced Diagnostics Blocks. A switch signal generated in these blocks can be output via the switch output.

**Assign limit****Navigation**

Setup → Advanced setup → Switch output → Assign limit

**Prerequisite**

**Switch output function (→ 153) = Limit**

**Selection**

- Off
- Level linearized
- Distance
- Interface linearized \*
- Interface distance \*
- Thickness upper layer \*
- Terminal voltage
- Electronic temperature
- Measured capacitance \*
- Relative echo amplitude
- Relative interface amplitude \*
- Absolute echo amplitude
- Absolute interface amplitude \*

**Assign diagnostic behavior****Navigation**

Setup → Advanced setup → Switch output → Assign diag. beh

**Prerequisite**

**Switch output function (→ 153) = Diagnostic behavior**

**Description**

Select diagnostic behavior for switch output.

**Selection**

- Alarm
- Alarm or warning
- Warning

\* Visibility depends on order options or device settings

---

**Switch-on value**
**Navigation**

Setup → Advanced setup → Switch output → Switch-on value

**Prerequisite****Switch output function** (→ 153) = **Limit****Description**

Enter measured value for the switch-on point.

**User entry**

Signed floating-point number

**Additional information**

The switching behavior depends on the relative position of the **Switch-on value** and **Switch-off value** parameters:

**Switch-on value > Switch-off value**

- The output is closed if the measured value is larger than **Switch-on value**.
- The output is opened if the measured value is smaller than **Switch-off value**.

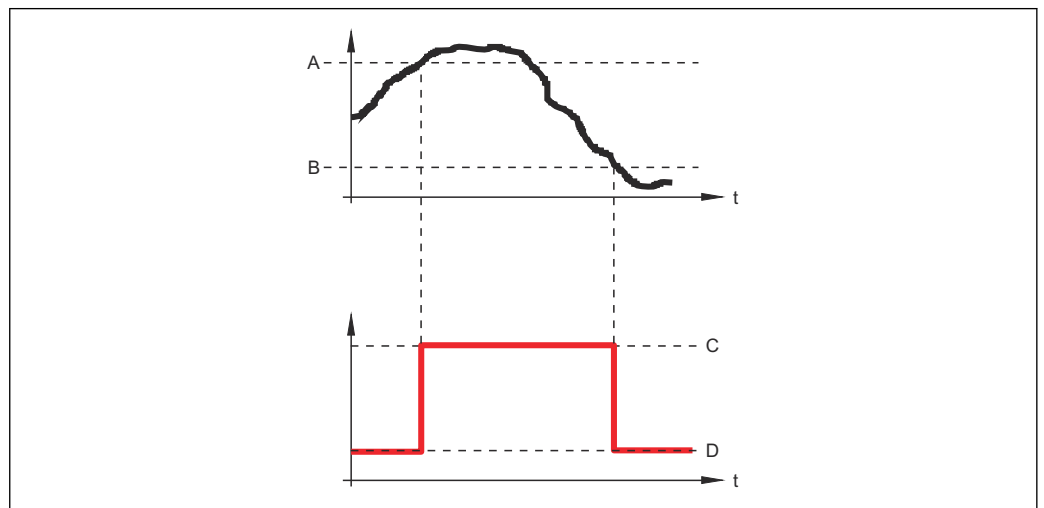

A0015585

- A *Switch-on value*  
 B *Switch-off value*  
 C *Output closed (conductive)*  
 D *Output opened (non-conductive)*

**Switch-on value < Switch-off value**

- The output is closed if the measured value is smaller than **Switch-on value**.
- The output is opened if the measured value is larger than **Switch-off value**.

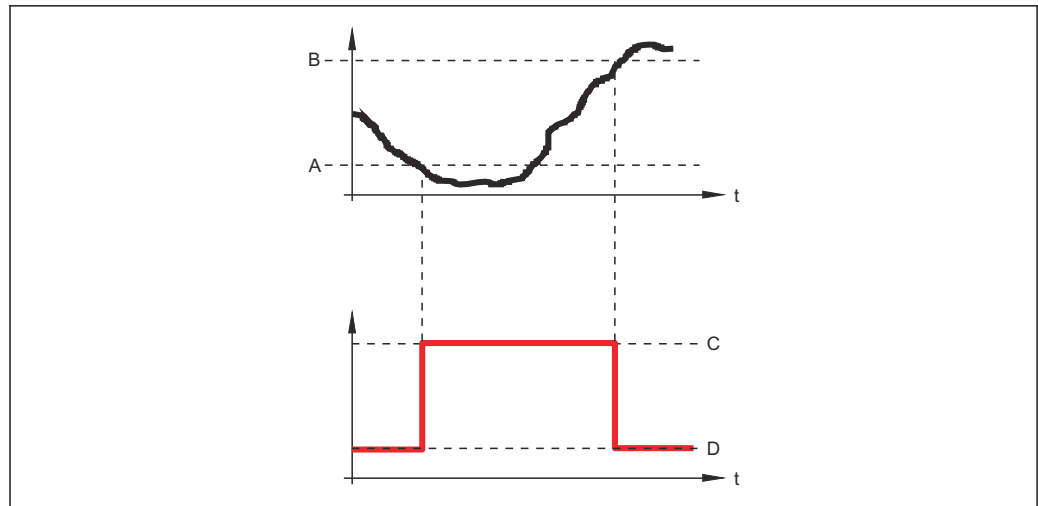

A0015586

- A Switch-on value
- B Switch-off value
- C Output closed (conductive)
- D Output opened (non-conductive)

Switch-on delay



- Navigation** Setup → Advanced setup → Switch output → Switch-on delay
- Prerequisite**
  - **Switch output function** (→ 153) = **Limit**
  - **Assign limit** (→ 154) ≠ **Off**
- Description** Define delay for the switch-on of status output.
- User entry** 0.0 to 100.0 s

Switch-off value



- Navigation** Setup → Advanced setup → Switch output → Switch-off value
- Prerequisite** **Switch output function** (→ 153) = **Limit**
- Description** Enter measured value for the switch-off point.
- User entry** Signed floating-point number
- Additional information** The switching behavior depends on the relative position of the **Switch-on value** and **Switch-off value** parameters; description: see the **Switch-on value** parameter (→ 155).

---

**Switch-off delay**

---



<b>Navigation</b>	Setup → Advanced setup → Switch output → Switch-off delay
<b>Prerequisite</b>	<ul style="list-style-type: none"> <li>▪ <b>Switch output function</b> (→  153) = <b>Limit</b></li> <li>▪ <b>Assign limit</b> (→  154) ≠ <b>Off</b></li> </ul>
<b>Description</b>	Define delay for the switch-off of status output.
<b>User entry</b>	0.0 to 100.0 s

---

**Failure mode**

---



<b>Navigation</b>	Setup → Advanced setup → Switch output → Failure mode
<b>Prerequisite</b>	<b>Switch output function</b> (→  153) = <b>Limit</b> or <b>Digital Output</b>
<b>Description</b>	Define output behavior in alarm condition.
<b>Selection</b>	<ul style="list-style-type: none"> <li>▪ Actual status</li> <li>▪ Open</li> <li>▪ Closed</li> </ul>

**Additional information**

---

**Switch status**

---

<b>Navigation</b>	Setup → Advanced setup → Switch output → Switch status
<b>Description</b>	Shows the current switch output status.

---

**Invert output signal**

---



<b>Navigation</b>	Setup → Advanced setup → Switch output → Invert outp.sig.
<b>Description</b>	Invert the output signal.
<b>Selection</b>	<ul style="list-style-type: none"> <li>▪ No</li> <li>▪ Yes</li> </ul>

**Additional information****Meaning of the options**■ **No**

The behavior of the switch output is as described above.

■ **Yes**

The states **Open** and **Closed** are inverted as compared to the description above.

**"Display" submenu**

**Display** submenu is only visible if a display module is connected to the device.

*Navigation*



Setup → Advanced setup → Display

---

**Language**

---

**Navigation**

Setup → Advanced setup → Display → Language

**Description**

Set display language.

**Selection**

- English
- Deutsch \*
- Français \*
- Español \*
- Italiano \*
- Nederlands \*
- Portuguesa \*
- Polski \*
- русский язык (Russian) \*
- Svenska \*
- Türkçe \*
- 中文 (Chinese) \*
- 日本語 (Japanese) \*
- 한국어 (Korean) \*
- Bahasa Indonesia \*
- tiếng Việt (Vietnamese) \*
- čeština (Czech) \*

**Factory setting**

The language selected in feature 500 of the product structure.  
If no language has been selected: **English**

**Additional information**

---

**Format display**

---

**Navigation**

Setup → Advanced setup → Display → Format display

**Description**

Select how measured values are shown on the display.

**Selection**

- 1 value, max. size
- 1 bargraph + 1 value
- 2 values
- 1 value large + 2 values
- 4 values

---

\* Visibility depends on order options or device settings

Additional information

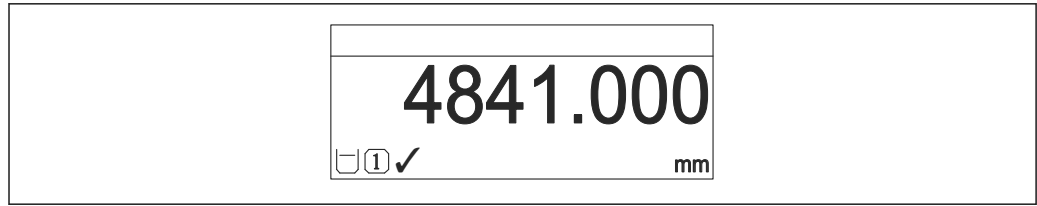

A0019963

49 "Format display" = "1 value, max. size"

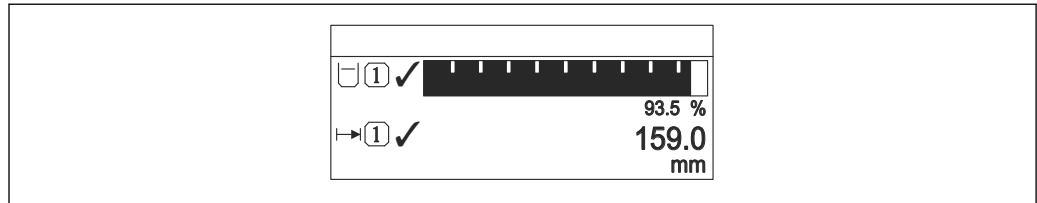

A0019964

50 "Format display" = "1 bargraph + 1 value"

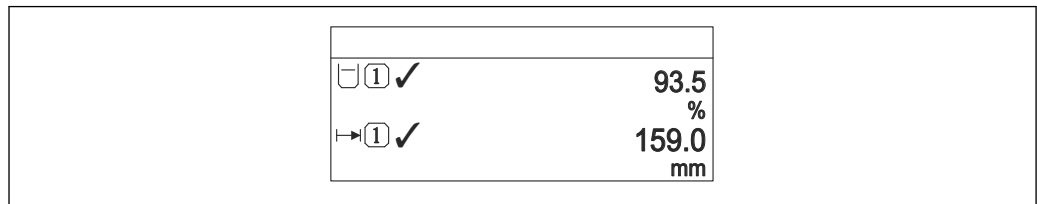

A0019965

51 "Format display" = "2 values"

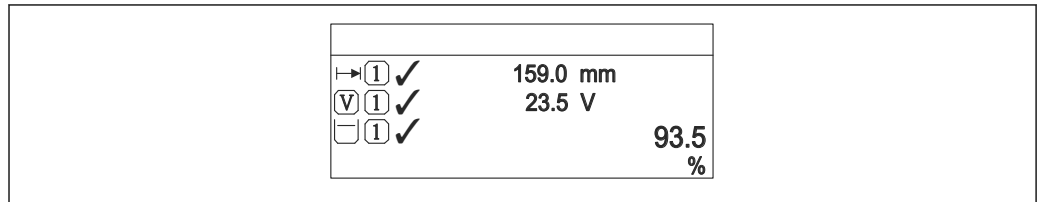

A0019966

52 "Format display" = "1 value large + 2 values"

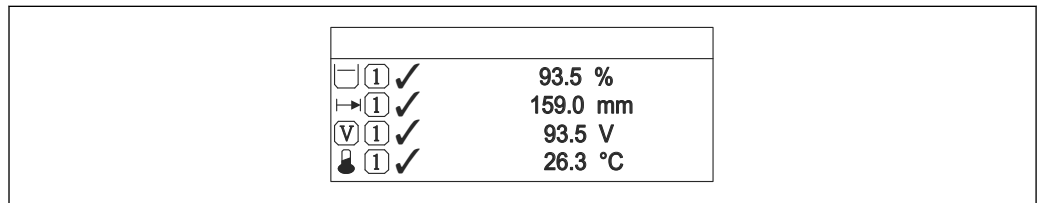

A0019968

53 "Format display" = "4 values"

- i** The **Value 1 to 4 display** parameters are used to specify which measured values are shown on the local display and in what order.
- If more measured values are specified than the display mode selected permits, then the values alternate on the device display. The display time until the next change is configured in the **Display interval** parameter (→ 162).



---

**Value 1 to 4 display**

<b>Navigation</b>	Setup → Advanced setup → Display → Value 1 display
<b>Description</b>	Select the measured value that is shown on the local display.
<b>Selection</b>	<ul style="list-style-type: none"> <li>■ Level linearized</li> <li>■ Distance</li> <li>■ Interface linearized *</li> <li>■ Interface distance *</li> <li>■ Thickness upper layer *</li> <li>■ Terminal voltage</li> <li>■ Electronic temperature</li> <li>■ Measured capacitance *</li> <li>■ Analog output adv. diagnostics 1</li> <li>■ Analog output adv. diagnostics 2</li> <li>■ Analog output 1</li> <li>■ Analog output 2</li> <li>■ Analog output 3</li> <li>■ Analog output 4</li> <li>■ Analog output 5</li> <li>■ Analog output 6</li> <li>■ Analog output 7</li> <li>■ Analog output 8</li> </ul>
<b>Factory setting</b>	<p><b>For level measurements</b></p> <ul style="list-style-type: none"> <li>■ Value 1 display: Level linearized</li> <li>■ Value 2 display: Distance</li> <li>■ Value 3 display: Current output 1</li> <li>■ Value 4 display: None</li> </ul>

---

**Decimal places 1 to 4**

<b>Navigation</b>	Setup → Advanced setup → Display → Decimal places 1
<b>Description</b>	Select the number of decimal places for the display value.
<b>Selection</b>	<ul style="list-style-type: none"> <li>■ x</li> <li>■ x.x</li> <li>■ x.xx</li> <li>■ x.xxx</li> <li>■ x.xxxx</li> </ul>
<b>Additional information</b>	The setting does not affect the measuring or computational accuracy of the device.

---

\* Visibility depends on order options or device settings

### Display interval

<b>Navigation</b>	🏠📄 Setup → Advanced setup → Display → Display interval
<b>Description</b>	Set time measured values are shown on display if display alternates between values.
<b>User entry</b>	1 to 10 s
<b>Additional information</b>	This parameter is only relevant if the number of selected measuring values exceeds the number of values the selected display format can display simultaneously.

### Display damping



<b>Navigation</b>	🏠📄 Setup → Advanced setup → Display → Display damping
<b>Description</b>	Set display reaction time to fluctuations in the measured value.
<b>User entry</b>	0.0 to 999.9 s

### Header



<b>Navigation</b>	🏠📄 Setup → Advanced setup → Display → Header
<b>Description</b>	Select header contents on local display.
<b>Selection</b>	<ul style="list-style-type: none"> <li>▪ Device tag</li> <li>▪ Free text</li> </ul>

**Additional information**

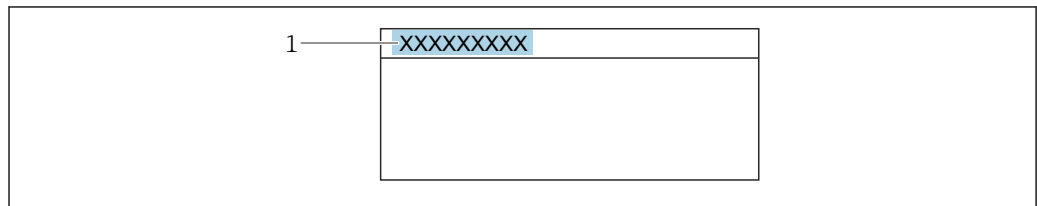

A0029422

1 Position of the header text on the display

*Meaning of the options*

- **Device tag**  
Is defined in the **Device tag** parameter.
- **Free text**  
Is defined in the **Header text** parameter (→ 📄 163).

---

**Header text**

<b>Navigation</b>	Setup → Advanced setup → Display → Header text
<b>Prerequisite</b>	<b>Header (→  162) = Free text</b>
<b>Description</b>	Enter display header text.
<b>User entry</b>	Character string comprising numbers, letters and special characters (12)
<b>Additional information</b>	The number of characters which can be displayed depends on the characters used.

---

**Separator**

<b>Navigation</b>	Setup → Advanced setup → Display → Separator
<b>Description</b>	Select decimal separator for displaying numerical values.
<b>Selection</b>	<ul style="list-style-type: none"> <li>▪ .</li> <li>▪ ,</li> </ul>

---

**Number format**

<b>Navigation</b>	Setup → Advanced setup → Display → Number format
<b>Description</b>	Choose number format for the display.
<b>Selection</b>	<ul style="list-style-type: none"> <li>▪ Decimal</li> <li>▪ ft-in-1/16"</li> </ul>
<b>Additional information</b>	The <b>ft-in-1/16"</b> option is only valid for distance units.

---

**Decimal places menu**



<b>Navigation</b>	Setup → Advanced setup → Display → Dec. places menu
<b>Description</b>	Select number of decimal places for the representation of numbers within the operating menu.
<b>Selection</b>	<ul style="list-style-type: none"> <li>▪ x</li> <li>▪ x.x</li> <li>▪ x.xx</li> <li>▪ x.xxx</li> <li>▪ x.xxxx</li> </ul>

- Additional information**
- Is only valid for numbers in the operating menu (e.g. **Empty calibration**, **Full calibration**), but not for the measured value display. The number of decimal places for the measured value display is defined in the **Decimal places 1 to 4** parameters
  - This setting does not affect the accuracy of the device for measuring or calculating the value

---

## Backlight







---

- Navigation**  Setup → Advanced setup → Display → Backlight
- Prerequisite** The device has the SD03 local display (with optical keys).
- Description** Switch the local display backlight on and off.
- Selection**
- Disable
  - Enable
- Additional information**
- Meaning of the options**
- **Disable**  
Switches the backlight off.
  - **Enable**  
Switches the backlight on.
-  Regardless of the setting in this parameter the backlight may be automatically switched off by the device if the supply voltage is too low.

---

## Contrast display

---

- Navigation**  Setup → Advanced setup → Display → Contrast display
- Description** Adjust local display contrast setting to ambient conditions (e.g. lighting or reading angle).
- User entry** 20 to 80 %
- Factory setting** Dependent on the display.
- Additional information**
-  Setting the contrast via push-buttons:
- Darker: press the   buttons simultaneously.
  - Brighter: press the   buttons simultaneously.

**"Configuration backup display" submenu**

This submenu is only visible if a display module is connected to the device.

The configuration of the device can be saved to the display module at a certain point of time (backup). The saved configuration can be restored to the device if required, e.g. in order to bring the device back into a defined state. The configuration can also be transferred to a different device of the same type using the display module.

*Navigation*      Setup → Advanced setup → Conf.backup disp

**Operating time**

**Navigation**      Setup → Advanced setup → Conf.backup disp → Operating time

**Description**      Indicates how long the device has been in operation.

**Additional information**      *Maximum time*  
9 999 d ( ≈ 27 years)

**Last backup**

**Navigation**      Setup → Advanced setup → Conf.backup disp → Last backup

**Description**      Indicates when the last data backup was saved to the display module.

**Configuration management**

**Navigation**      Setup → Advanced setup → Conf.backup disp → Config. managem.

**Description**      Select action for managing the device data in the display module.

**Selection**

- Cancel
- Execute backup
- Restore
- Duplicate
- Compare
- Clear backup data
- Display incompatible

**Additional information****Meaning of the options**■ **Cancel**

No user is executed and the user exits the parameter.

■ **Execute backup**

A backup copy of the current device configuration in the HistoROM (built-in in the device) is saved to the display module of the device.

■ **Restore**

The last backup copy of the device configuration is copied from the display module to the HistoROM of the device.

■ **Duplicate**

The transmitter configuration is duplicated to another device using the transmitter display module. The following parameters, which characterize the individual measuring point are **not** included in the transmitted configuration:

Medium type

■ **Compare**

The device configuration saved in the display module is compared to the current device configuration of the HistoROM. The result of this comparison is displayed in the **Comparison result** parameter (→  166).

■ **Clear backup data**

The backup copy of the device configuration is deleted from the display module of the device.



While this action is in progress, the configuration cannot be edited via the local display and a message on the processing status appears on the display.



If an existing backup is restored to a different device using the **Restore** option, it may occur that some device functionalities are no longer available. In some cases even a device reset will not restore the original status.

In order to transmit a configuration to a different device, the **Duplicate** option should always be used.

---

**Backup state**

---

**Navigation**

 Setup → Advanced setup → Conf.backup disp → Backup state

**Description**



Displays which backup action is currently in progress.

---

**Comparison result**

---

**Navigation**

  Setup → Advanced setup → Conf.backup disp → Compar. result

**Description**

Comparison between present device data and display backup.

**Additional information****Meaning of the display options****■ Settings identical**

The current device configuration of the HistoROM is identical to the backup copy in the display module.

**■ Settings not identical**

The current device configuration of the HistoROM is not identical to the backup copy in the display module.

**■ No backup available**

There is no backup copy of the device configuration of the HistoROM in the display module.

**■ Backup settings corrupt**

The current device configuration of the HistoROM is corrupt or not compatible with the backup copy in the display module.

**■ Check not done**

The device configuration of the HistoROM has not yet been compared to the backup copy in the display module.

**■ Dataset incompatible**

The data sets are incompatible and can not be compared.





To start the comparison, set **Configuration management** (→  165) = **Compare**.





If the transmitter configuration has been duplicated from a different device by **Configuration management** (→  165) = **Duplicate**, the new device configuration in the HistoROM is only partially identical to the configuration stored in the display module: Sensor specific properties (e.g. the mapping curve) are not duplicated. Thus, the result of the comparison will be **Settings not identical**.

**"Administration" submenu**

Navigation  Setup → Advanced setup → Administration

**Define access code** 

**Navigation**

  Setup → Advanced setup → Administration → Def. access code









**Description**

Define release code for write access to parameters.

**User entry**



0 to 9999

**Additional information**

-  If the factory setting is not changed or if "0" is entered, the parameters are not write-protected and the device configuration data can therefore always be modified. The user is logged on in the "Maintenance" role.
-  The write protection affects all parameters marked with the  symbol in the document. On the local display, the  symbol in front of a parameter indicates that the parameter is write-protected.
-  Once the access code has been defined, write-protected parameters can only be modified if the access code is entered in the **Enter access code** parameter (→  130).
-  Please contact your Endress+Hauser Sales Center if you lose the access code.
-  If operating via the local display: the new access code is only valid once it has been confirmed in the **Confirm access code** parameter (→  170).

**Device reset** 

**Navigation**

-  Setup → Advanced setup → Administration → Device reset
-  Setup → Advanced setup → Administration → Device reset

**Selection**

- Cancel
- To fieldbus defaults
- To factory defaults
- To delivery settings
- Of customer settings
- To transducer defaults
- Restart device

**Additional information**

**Meaning of the options**

- **Cancel**  
No action
- **To factory defaults**  
All parameters are reset to the order-code specific factory setting.
- **To delivery settings**  
All parameters are reset to the delivery setting. The delivery setting may differ from the factory default if customer specific settings have been ordered.  
This option is only visible if customer specific settings have been ordered.



- **Of customer settings**

All customer parameters are reset to their factory setting. Service parameters, however, remain unchanged.

- **To transducer defaults**

Every measurement-related parameter is reset to its factory setting. Service parameters and communication-related parameters, however, remain unchanged.

- **Restart device**

The restart resets every parameter which is stored in the volatile memory (RAM) to the factory setting (e.g. measured value data). The device configuration remains unchanged.

*"Define access code" wizard*

 The **Define access code** wizard is only available when operating via the local display. When operating via an operating tool, the **Define access code** parameter is located directly in the **Administration** submenu. The **Confirm access code** parameter is not available for operation via operating tool.

*Navigation*  Setup → Advanced setup → Administration → Def. access code

---

**Define access code** 

---

**Navigation**  Setup → Advanced setup → Administration → Def. access code → Def. access code

**Description** →  168

---

**Confirm access code** 

---

**Navigation**  Setup → Advanced setup → Administration → Def. access code → Confirm code

**Description** Confirm the entered access code.

**User entry** 0 to 9 999

## 17.4 "Diagnostics" menu

Navigation   Diagnostics

---

### Actual diagnostics

---



**Navigation**   Diagnostics → Actual diagnos.

**Description** Displays current diagnostic message.

**Additional information** The display consists of:

- Symbol for event behavior
- Code for diagnostic behavior
- Operating time of occurrence
- Event text

 If several messages are active at the same time, the messages with the highest priority is displayed.

 Information on what is causing the message, and remedy measures, can be viewed via the  symbol on the display.

---

### Timestamp

---

**Navigation**  Diagnostics → Timestamp

---

### Previous diagnostics



---

**Navigation**   Diagnostics → Prev.diagnostics

**Description** Displays the last diagnostic message which has been active before the current message.

**Additional information** The display consists of:

- Symbol for event behavior
- Code for diagnostic behavior
- Operating time of occurrence
- Event text

 The condition displayed may still apply. Information on what is causing the message, and remedy measures, can be viewed via the  symbol on the display.

---

**Timestamp**

---

**Navigation**  Diagnostics → Timestamp

---

**Operating time from restart**

---

**Navigation**   Diagnostics → Time fr. restart

**Description** Displays the time the device has been in operation since the last device restart.

---

**Operating time**

---

**Navigation**   Diagnostics → Operating time

**Description** Indicates how long the device has been in operation.

**Additional information** *Maximum time*  
9 999 d ( ≈ 27 years)

### 17.4.1 "Diagnostic list" submenu

*Navigation*       Diagnostics → Diagnostic list

---

#### Diagnostics 1 to 5

---

<b>Navigation</b>	 Diagnostics → Diagnostic list → Diagnostics 1
<b>Description</b>	Display the current diagnostics messages with the highest to fifth-highest priority.
<b>Additional information</b>	The display consists of: <ul style="list-style-type: none"><li>■ Symbol for event behavior</li><li>■ Code for diagnostic behavior</li><li>■ Operating time of occurrence</li><li>■ Event text</li></ul>

---

#### Timestamp 1 to 5

---

**Navigation**       Diagnostics → Diagnostic list → Timestamp 1 to 5

## 17.4.2 "Event logbook" submenu

 The **Event logbook** submenu is only available when operating via the local display. When operating via FieldCare, the event list can be displayed in the FieldCare function "Event List / HistoROM".

*Navigation*  Diagnostics → Event logbook

---

### Filter options

#### Navigation

 Diagnostics → Event logbook → Filter options

#### Selection

- All
- Failure (F)
- Function check (C)
- Out of specification (S)
- Maintenance required (M)
- Information (I)



#### Additional information



-  ■ This parameter is only used for operation via the local display.  
 ■ The status signals are categorized according to NAMUR NE 107.

### "Event list" submenu

The **Event list** submenu displays the history of past events of the category selected in the **Filter options** parameter (→  174). A maximum of 100 events are displayed in chronological order.

The following symbols indicate whether an event has occurred or has ended:

- : Event has occurred
- : Event has ended

 Information on what is causing the message, and remedy instructions, can be viewed via the -button.

#### Display format

- For event messages in category I: information event, event text, "recording event" symbol and time the event occurred
- For event messages in category F, M, C, S (status signal): diagnostics event, event text, "recording event" symbol and time the event occurred

*Navigation*  Diagnostics → Event logbook → Event list



### 17.4.3 "Device information" submenu

Navigation  Diagnostics → Device info

---

#### Device tag





---

<b>Navigation</b>	 Diagnostics → Device info → Device tag
	 Diagnostics → Device info → Device tag
<b>Description</b>	Enter tag for measuring point.
<b>User interface</b>	Character string comprising numbers, letters and special characters

---

#### Serial number



---









<b>Navigation</b>	 Diagnostics → Device info → Serial number
	 Diagnostics → Device info → Serial number
<b>Additional information</b>	 <b>Uses of the serial number</b> <ul style="list-style-type: none"> <li>■ To identify the device quickly, e.g. when contacting Endress+Hauser.</li> <li>■ To obtain specific information on the device using the Device Viewer: <a href="http://www.endress.com/deviceviewer">www.endress.com/deviceviewer</a></li> </ul>
	 The serial number is also indicated on the nameplate.

---

#### Firmware version

---

<b>Navigation</b>	 Diagnostics → Device info → Firmware version
	 Diagnostics → Device info → Firmware version
<b>User interface</b>	xx.yy.zz
<b>Additional information</b>	 For firmware versions differing only in the last two digits ("zz") there is no difference concerning functionality or operation.

Device name	
<b>Navigation</b>	<ul style="list-style-type: none"> <li> Diagnostics → Device info → Device name</li> <li> Diagnostics → Device info → Device name</li> </ul>
Order code 	
<b>Navigation</b>	<ul style="list-style-type: none"> <li> Diagnostics → Device info → Order code</li> <li> Diagnostics → Device info → Order code</li> </ul>
<b>User interface</b>	Character string comprising numbers, letters and special characters
<b>Additional information</b>	The order code is generated from the extended order code, which defines all device features of the product structure. In contrast, the device features can not be read directly from the order code.
Extended order code 1 to 3 	
<b>Navigation</b>	<ul style="list-style-type: none"> <li> Diagnostics → Device info → Ext. order cd. 1</li> <li> Diagnostics → Device info → Ext. order cd. 1</li> </ul>
<b>Description</b>	Display the three parts of the extended order code.
<b>User interface</b>	Character string comprising numbers, letters and special characters
<b>Additional information</b>	The extended order code indicates the version of all the features of the product structure and thus uniquely identifies the device.



### 17.4.4 "Measured values" submenu

Navigation  Diagnostics → Measured val.

---

#### Distance

---

Navigation  Diagnostics → Measured val. → Distance

Description Displays the measured distance  $D_L$  between the reference point (lower edge of the flange or threaded connection) and the level.

#### Additional information

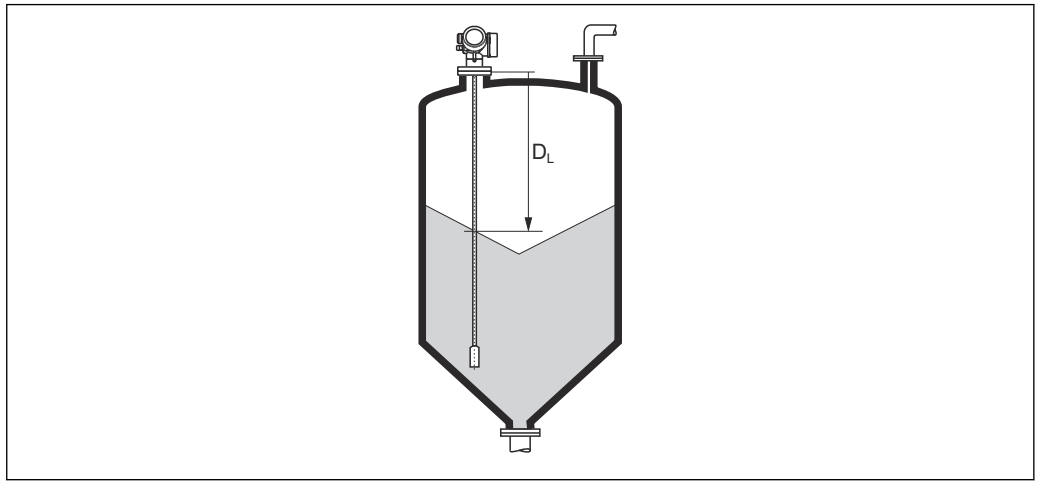

A0013201

 54 Distance for bulk solid measurements

 The unit is defined in the **Distance unit** parameter (→  120).

---

#### Level linearized

---

Navigation  Diagnostics → Measured val. → Level linearized

Description Displays linearized level.

Additional information  This unit is defined by the **Unit after linearization** parameter.

---

**Terminal voltage 1**



---

**Navigation**  Diagnostics → Measured val. → Terminal volt. 1

### 17.4.5 "Analog input 1 to 5" submenu

There is an **Analog inputs** submenu for every AI block of the device. The AI block is used to configure the measured value transmission to the bus.

 Only the most basic properties of the AI block can be configured in this submenu. For a detailed configuration of the AI blocks refer to the **Expert** menu.

*Navigation*  Diagnostics → Analog inputs → Analog input 1 to 5

---

**Block tag**

---

**Navigation**  Diagnostics → Analog inputs → Analog input 1 to 7 → Block tag

**Description** Defined to be unique throughout the control system at one plant site. The tag may be changed using the FB\_Tag service.

**User entry** Character string comprising numbers, letters and special characters (32)

---

**Channel**

---

**Navigation**  Diagnostics → Analog inputs → Analog input 1 to 7 → Channel

**Description** Use this function to select the input value that should be processed in the Analog Input function block.

**Selection**

- Uninitialized
- Level linearized
- Absolute echo amplitude
- Absolute EOP amplitude
- Absolute interface amplitude \*
- Distance
- Electronic temperature
- EOP shift
- Interface linearized \*
- Interface distance \*
- Measured capacitance \*
- Relative echo amplitude
- Relative interface amplitude \*
- Noise of signal

---

\* Visibility depends on order options or device settings

- Terminal voltage
- Thickness upper layer \*
- Calculated DC value \*
- Analog output adv. diagnostics 2
- Analog output adv. diagnostics 1

---

### Status

---

**Navigation**
 Diagnostics → Analog inputs → Analog input 1 to 7 → Status
**Description**

Indicates the status of the output of the AI block according to the FOUNDATION Fieldbus specification.

---

### Value

---

**Navigation**
 Diagnostics → Analog inputs → Analog input 1 to 7 → Value
**Description**

Indicates the output value of the AI block.

---

### Units index

---

**Navigation**
 Diagnostics → Analog inputs → Analog input 1 to 7 → Units index
**Description**

Indicates the unit of the output value.

---

\* Visibility depends on order options or device settings

## 17.4.6 "Data logging" submenu

Navigation  Diagnostics → Data logging

### Assign channel 1 to 4

Navigation  Diagnostics → Data logging → Assign chan. 1 to 4

#### Selection

- Off
- Level linearized
- Distance
- Unfiltered distance
- Interface linearized \*
- Interface distance \*
- Unfiltered interface distance
- Thickness upper layer \*
- Terminal voltage
- Electronic temperature
- Measured capacitance \*
- Absolute echo amplitude
- Relative echo amplitude
- Absolute interface amplitude \*
- Relative interface amplitude \*
- Absolute EOP amplitude
- EOP shift
- Noise of signal
- Calculated DC value \*
- Analog output adv. diagnostics 1
- Analog output adv. diagnostics 2
- Analog output 1
- Analog output 2
- Analog output 3
- Analog output 4

#### Additional information

A total of 1000 measured values can be logged. This means:

- 1000 data points if 1 logging channel is used
- 500 data points if 2 logging channels are used
- 333 data points if 3 logging channels are used
- 250 data points if 4 logging channels are used

If the maximum number of data points is reached, the oldest data points in the data log are cyclically overwritten in such a way that the last 1000, 500, 333 or 250 measured values are always in the log (ring memory principle).

 The logged data are deleted if a new option is selected in this parameter.

\* Visibility depends on order options or device settings

---

**Logging interval**
**Navigation**

- Diagnostics → Data logging → Logging interval
- Diagnostics → Data logging → Logging interval

**User entry**

1.0 to 3 600.0 s

**Additional information**

This parameter defines the interval between the individual data points in the data log, and thus the maximum loggable process time  $T_{\log}$ :

- If 1 logging channel is used:  $T_{\log} = 1000 \cdot t_{\log}$
- If 2 logging channels are used:  $T_{\log} = 500 \cdot t_{\log}$
- If 3 logging channels are used:  $T_{\log} = 333 \cdot t_{\log}$
- If 4 logging channels are used:  $T_{\log} = 250 \cdot t_{\log}$

Once this time elapses, the oldest data points in the data log are cyclically overwritten such that a time of  $T_{\log}$  always remains in the memory (ring memory principle).

The logged data are deleted if this parameter is changed.

*Example***When using 1 logging channel**

- $T_{\log} = 1000 \cdot 1 \text{ s} = 1000 \text{ s} \approx 16.5 \text{ min}$
- $T_{\log} = 1000 \cdot 10 \text{ s} = 1000 \text{ s} \approx 2.75 \text{ h}$
- $T_{\log} = 1000 \cdot 80 \text{ s} = 80000 \text{ s} \approx 22 \text{ h}$
- $T_{\log} = 1000 \cdot 3600 \text{ s} = 3600000 \text{ s} \approx 41 \text{ d}$

---

**Clear logging data**
**Navigation**

- Diagnostics → Data logging → Clear logging
- Diagnostics → Data logging → Clear logging

**Selection**

- Cancel
- Clear data

**"Display channel 1 to 4" submenu**

**i** The **Display channel 1 to 4** submenus are only available for operation via the local display. When operating via FieldCare, the logging diagram can be displayed in the FieldCare function "Event List / HistoROM" .

The **Display channel 1 to 4** submenus invoke a diagram of the logging history of the respective channel.

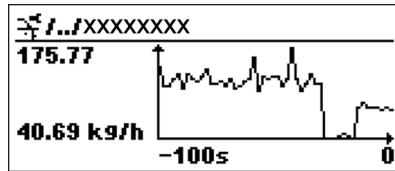

- x-axis: depending on the number of selected channels, 250 to 1000 measured values of a process variable are displayed.
- y-axis: covers the approximate measured value span and constantly adapts this to the measurement.

**i** To return to the operating menu, press **⏏** and **⏏** simultaneously.

*Navigation*

**⏏** **⏏** Diagnostics → Data logging → Displ.channel 1 to 4

### 17.4.7 "Simulation" submenu

The **Simulation** submenu is used to simulate specific measuring values or other conditions. This helps to check the correct configuration of the device and connected control units.

*Conditions which can be simulated*

Condition to be simulated	Associated parameters
Specific value of a process variable	<ul style="list-style-type: none"> <li>▪ Assign measurement variable (→ 186)</li> <li>▪ Process variable value (→ 186)</li> </ul>
Specific state of the switch output	<ul style="list-style-type: none"> <li>▪ Switch output simulation (→ 186)</li> <li>▪ Switch status (→ 187)</li> </ul>
Existence of an alarm	Simulation device alarm (→ 187)

#### Enable/disable simulation

The simulation of measured values can be enabled or disabled via a hardware switch (SIM switch) at the electronics. Simulating a measured value is only possible if the SIM switch is in the ON position.

The switch output can always be simulated, irrespective of the position of the SIM switch.

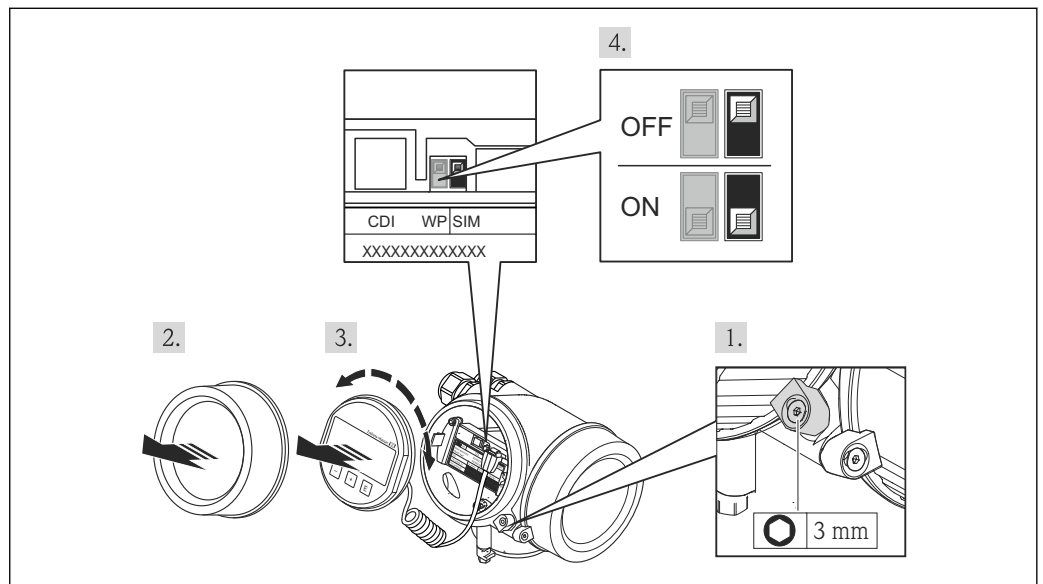

A0025882

1. Loosen the securing clamp.
2. Unscrew the housing cover.

3. Pull out the display module with a gentle rotation movement. To make it easier to access the SIM switch, attach the display module to the edge of the electronics compartment.
  - ↳ Display module is attached to the edge of the electronics compartment.

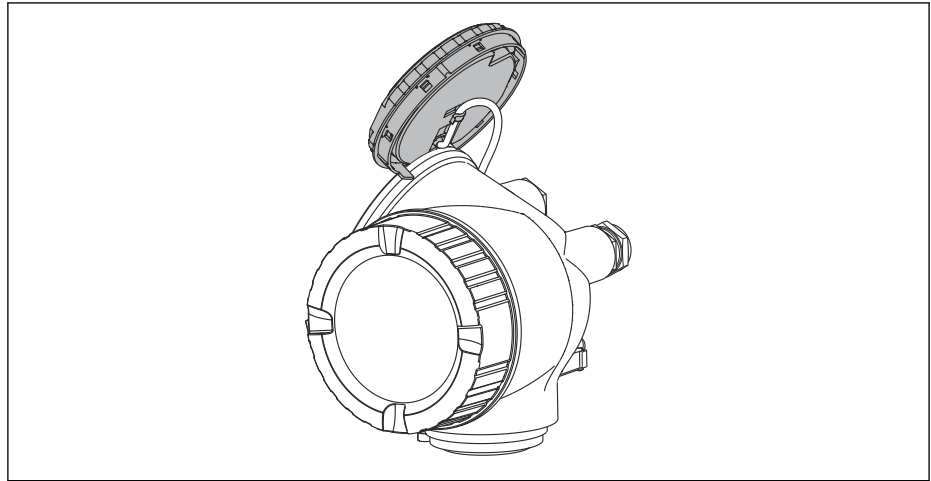





A0013909

4. SIM switch in the **ON** position: measured values can be simulated. SIM switch in the **OFF** position (factory setting): Simulation of measured values is disabled.
5. Feed the spiral cable into the gap between the housing and main electronics module and plug the display module into the electronics compartment in the desired direction until it engages.
6. Screw the electronics compartment cover closed and tighten the securing clamp.



**Structure of the submenu**

*Navigation*            Expert → Diagnostics → Simulation

<b>▶ Simulation</b>		
Assign measurement variable	→	 186
Process variable value	→	 186
Switch output simulation	→	 186
Switch status	→	 187
Simulation device alarm	→	 187



## Description of parameters

*Navigation*  Expert → Diagnostics → Simulation

---

### Assign measurement variable



---

<b>Navigation</b>	 Expert → Diagnostics → Simulation → Assign meas.var.
<b>Selection</b>	<ul style="list-style-type: none"> <li>▪ Off</li> <li>▪ Level</li> <li>▪ Interface *</li> <li>▪ Level linearized</li> <li>▪ Interface linearized</li> <li>▪ Thickness linearized</li> </ul>
<b>Additional information</b>	<ul style="list-style-type: none"> <li>▪ The value of the variable to be simulated is defined in the <b>Process variable value</b> parameter (→  186).</li> <li>▪ If <b>Assign measurement variable</b> ≠ <b>Off</b>, a simulation is active. This is indicated by a diagnostic message of the <i>Function check (C)</i> category.</li> </ul>

---

### Process variable value

---

<b>Navigation</b>	 Expert → Diagnostics → Simulation → Proc. var. value
<b>Prerequisite</b>	<b>Assign measurement variable</b> (→  186) ≠ <b>Off</b>
<b>User entry</b>	Signed floating-point number
<b>Additional information</b>	Downstream measured value processing and the signal output use this simulation value. In this way, users can verify whether the measuring device has been configured correctly.

---

### Switch output simulation

---

<b>Navigation</b>	 Expert → Diagnostics → Simulation → Switch sim.
<b>Description</b>	Switch the simulation of the switch output on and off.
<b>Selection</b>	<ul style="list-style-type: none"> <li>▪ Off</li> <li>▪ On</li> </ul>

---

\* Visibility depends on order options or device settings

---

**Switch status**

<b>Navigation</b>	Expert → Diagnostics → Simulation → Switch status
<b>Prerequisite</b>	<b>Switch output simulation (→  186) = On</b>
<b>Description</b>	Select the status of the status output for the simulation.
<b>Selection</b>	<ul style="list-style-type: none"> <li>■ Open</li> <li>■ Closed</li> </ul>
<b>Additional information</b>	The switch status assumes the value defined in this parameter. This helps to check correct operation of connected control units.

---

**Simulation device alarm**

<b>Navigation</b>	Expert → Diagnostics → Simulation → Sim. alarm
<b>Description</b>	Switch the device alarm on and off.
<b>Selection</b>	<ul style="list-style-type: none"> <li>■ Off</li> <li>■ On</li> </ul>
<b>Additional information</b>	<p>When selecting the <b>On</b> option, the device generates an alarm. This helps to check the correct output behavior of the device in the case of an alarm.</p> <p>An active simulation is indicated by the  <b>C484 Simulation failure mode</b> diagnostic message.</p>

---

**Diagnostic event simulation**

<b>Navigation</b>	Expert → Diagnostics → Simulation → Diag. event sim.
<b>Description</b>	Select a diagnostic event to simulate this event.
<b>Additional information</b>	When operated via the local display, the selection list can be filtered according to the event categories ( <b>Diagnostic event category</b> parameter).

## 17.4.8 "Device check" submenu

*Navigation*       Diagnostics → Device check

---

### Start device check

---

**Navigation**       Diagnostics → Device check → Start dev. check

**Description**      Start a device check.

**Selection**

- No
- Yes

**Additional information**      In the case of a lost echo a device check can not be performed.

---

### Result device check

---

**Navigation**       Diagnostics → Device check → Result dev.check

**Description**      Displays the result of the device check.

**Additional information**      **Meaning of the display options**

- **Installation ok**  
Measurement possible without restrictions.
- **Accuracy reduced**  
A measurement is possible. However, the measuring accuracy may be reduced due to the signal amplitudes.
- **Measurement capability reduced**  
A measurement is currently possible. However, there is the risk of an echo loss. Check the mounting position of the device and the dielectric constant of the medium.
- **Check not done**  
No device check has been performed.

---

### Last check time

---

**Navigation**       Diagnostics → Device check → Last check time



**Description**      Displays the operating time at which the last device check has been performed.

**User interface**      Character string comprising numbers, letters and special characters

---

**Level signal**



---

<b>Navigation</b>	  Diagnostics → Device check → Level signal
<b>Prerequisite</b>	Device check has been performed.
<b>Description</b>	Displays result of the device check for the level signal.
<b>User interface</b>	<ul style="list-style-type: none"><li>■ Check not done</li><li>■ Check not OK</li><li>■ Check OK</li></ul>
<b>Additional information</b>	For <b>Level signal = Check not OK</b> : Check the mounting position of the device and the dielectric constant of the medium.

---

**Launch signal**

---

<b>Navigation</b>	  Diagnostics → Device check → Launch signal
<b>Prerequisite</b>	Device check has been performed.
<b>Description</b>	Displays result of the display check for the launch signal.
<b>User interface</b>	<ul style="list-style-type: none"><li>■ Check not done</li><li>■ Check not OK</li><li>■ Check OK</li></ul>
<b>Additional information</b>	For <b>Launch signal = Check not OK</b> : Check the mounting position of the device. In non-metallic vessels use a metal plate or a metal flange.

### 17.4.9 "Heartbeat" submenu

 The **Heartbeat** submenu is only available via **FieldCare** or **DeviceCare**. It contains the wizards which are part of the **Heartbeat Verification** and **Heartbeat Monitoring** application packages.

#### Detailed description

SD01872F

*Navigation*

 Diagnostics → Heartbeat

## Index

### A

Access authorization to parameters  
     Read access . . . . . 46  
     Write access . . . . . 46  
 Access code . . . . . 46  
     Incorrect input . . . . . 46  
 Access status display (Parameter) . . . . . 129  
 Access status tooling (Parameter) . . . . . 129  
 Accessories  
     Communication-specific . . . . . 106  
     Device-specific . . . . . 99  
     Service-specific . . . . . 106  
     System components . . . . . 106  
 Activate table (Parameter) . . . . . 145  
 Actual diagnostics (Parameter) . . . . . 171  
 Administration (Submenu) . . . . . 168  
 Advanced process conditions (Parameter) . . . . . 133  
 Advanced setup (Submenu) . . . . . 129  
 Analog input 1 to 5 (Submenu) . . . . . 127, 178  
 Application . . . . . 10  
 Assign channel 1 to 4 (Parameter) . . . . . 180  
 Assign diagnostic behavior (Parameter) . . . . . 154  
 Assign limit (Parameter) . . . . . 154  
 Assign measurement variable (Parameter) . . . . . 186  
 Assign status (Parameter) . . . . . 153

### B

Backlight (Parameter) . . . . . 164  
 Backup state (Parameter) . . . . . 166  
 Bin type (Parameter) . . . . . 120  
 Block tag (Parameter) . . . . . 127, 178  
 Blocking distance (Parameter) . . . . . 134, 147  
 Bluetooth® wireless technology . . . . . 45

### C

Channel (Parameter) . . . . . 127, 178  
 Cleaning . . . . . 96  
 Clear logging data (Parameter) . . . . . 181  
 Comparison result (Parameter) . . . . . 166  
 Configuration backup display (Submenu) . . . . . 165  
 Configuration management (Parameter) . . . . . 165  
 Configuration of a level measurement . . . . . 72, 78  
 Configuring level measurement . . . . . 72, 78  
 Configuring the language . . . . . 77  
 Configuring the operating language . . . . . 71  
 Confirm access code (Parameter) . . . . . 170  
 Confirm distance (Parameter) . . . . . 123, 126  
 Confirm probe length (Parameter) . . . . . 150, 151  
 Context menu . . . . . 56  
 Contrast display (Parameter) . . . . . 164  
 Customer value (Parameter) . . . . . 145

### D

Data logging (Submenu) . . . . . 180  
 Decimal places 1 (Parameter) . . . . . 161  
 Decimal places menu (Parameter) . . . . . 163

Define access code (Parameter) . . . . . 168, 170  
 Define access code (Wizard) . . . . . 170  
 Defining the access code . . . . . 47  
 Device check (Submenu) . . . . . 188  
 Device information (Submenu) . . . . . 175  
 Device name (Parameter) . . . . . 176  
 Device replacement . . . . . 97  
 Device reset (Parameter) . . . . . 168  
 Device tag (Parameter) . . . . . 175  
 Diagnostic event . . . . . 90  
     In the operating tool . . . . . 91  
 Diagnostic event simulation (Parameter) . . . . . 187  
 Diagnostic events . . . . . 89  
 Diagnostic list . . . . . 93  
 Diagnostic list (Submenu) . . . . . 173  
 Diagnostic message . . . . . 89  
 Diagnostics  
     Symbols . . . . . 89  
 Diagnostics (Menu) . . . . . 171  
 Diagnostics 1 (Parameter) . . . . . 173  
 Diameter (Parameter) . . . . . 142  
 DIP switch  
     see Write protection switch  
 Disable simulation . . . . . 183  
 Display (Submenu) . . . . . 159  
 Display and operating module FHX50 . . . . . 43  
 Display channel 1 to 4 (Submenu) . . . . . 182  
 Display damping (Parameter) . . . . . 162  
 Display interval (Parameter) . . . . . 162  
 Display module . . . . . 51  
 Display symbols . . . . . 52  
 Disposal . . . . . 98  
 Distance (Parameter) . . . . . 122, 126, 177  
 Distance unit (Parameter) . . . . . 120  
 Document  
     Function . . . . . 6  
 Document function . . . . . 6

### E

Electronics housing  
     Design . . . . . 13  
 Empty calibration (Parameter) . . . . . 120  
 Enable simulation . . . . . 183  
 Enter access code (Parameter) . . . . . 130  
 Envelope curve display . . . . . 57  
 Event history . . . . . 93  
 Event level  
     Explanation . . . . . 90  
     Symbols . . . . . 90  
 Event list . . . . . 93  
 Event list (Submenu) . . . . . 174  
 Event logbook (Submenu) . . . . . 174  
 Event text . . . . . 90  
 Extended order code 1 (Parameter) . . . . . 176  
 Exterior cleaning . . . . . 96

**F**

Failure mode (Parameter) . . . . .	157
FHX50 . . . . .	43
Field of application	
Residual risks . . . . .	10
Filter options (Parameter) . . . . .	174
Filtering the event logbook . . . . .	94
Firmware version (Parameter) . . . . .	175
Flange . . . . .	32
Format display (Parameter) . . . . .	159
Free text (Parameter) . . . . .	141
Full calibration (Parameter) . . . . .	121

**H**

Hardware write protection . . . . .	48
Header (Parameter) . . . . .	162
Header text (Parameter) . . . . .	163
Heartbeat (Submenu) . . . . .	190
HistoROM (description) . . . . .	79
Housing	
Design . . . . .	13
Turning . . . . .	34

**I**

Input mask . . . . .	54
Intended use . . . . .	10
Intermediate height (Parameter) . . . . .	143
Invert output signal (Parameter) . . . . .	157

**K**

Keypad lock	
Disabling . . . . .	50
Enabling . . . . .	50

**L**

Language (Parameter) . . . . .	159
Last backup (Parameter) . . . . .	165
Last check time (Parameter) . . . . .	188
Launch signal (Parameter) . . . . .	189
Level (Parameter) . . . . .	121, 144, 145
Level (Submenu) . . . . .	131
Level correction (Parameter) . . . . .	135
Level linearized (Parameter) . . . . .	142, 177
Level signal (Parameter) . . . . .	189
Level unit (Parameter) . . . . .	134
Linearization (Submenu) . . . . .	137, 138, 139
Linearization type (Parameter) . . . . .	139
Local display	
see Diagnostic message	
see In alarm condition	
Locking status . . . . .	52
Locking status (Parameter) . . . . .	129
Logging interval (Parameter) . . . . .	181

**M**

Maintenance . . . . .	96
Managing the device configuration . . . . .	73, 79
Mapping (Wizard) . . . . .	126
Mapping end point (Parameter) . . . . .	124, 126

Maximum value (Parameter) . . . . .	142
Measured value symbols . . . . .	53
Measured values (Submenu) . . . . .	177
Media . . . . .	10
Medium property (Parameter) . . . . .	131
Medium type (Parameter) . . . . .	131
Menu	
Diagnostics . . . . .	171
Setup . . . . .	120
Mounting position for level measurements . . . . .	17

**N**

Non-metal vessels . . . . .	28
Number format (Parameter) . . . . .	163

**O**

Onsite operation . . . . .	43
Operating elements	
Diagnostic message . . . . .	90
Operating module . . . . .	51
Operating time (Parameter) . . . . .	165, 172
Operating time from restart (Parameter) . . . . .	172
Operational safety . . . . .	11
Order code (Parameter) . . . . .	176
Output echo lost (Parameter) . . . . .	146
Overvoltage protection	
General information . . . . .	39

**P**

Present mapping (Parameter) . . . . .	124
Present probe length (Parameter) . . . . .	149, 152
Previous diagnostics (Parameter) . . . . .	171
Probe grounded (Parameter) . . . . .	149
Probe length correction (Wizard) . . . . .	151
Probe settings (Submenu) . . . . .	149
Process property (Parameter) . . . . .	132
Process Value Filter Time (Parameter) . . . . .	128
Process variable value (Parameter) . . . . .	186
Product security . . . . .	11

**R**

Ramp at echo lost (Parameter) . . . . .	147
Read access . . . . .	46
Record map (Parameter) . . . . .	125, 126
Registered trademarks . . . . .	9
Remedial measures	
Calling up . . . . .	91
Closing . . . . .	91
Repair concept . . . . .	97
Replacing a device . . . . .	97
Requirements for personnel . . . . .	10
Result device check (Parameter) . . . . .	188
Return . . . . .	98
Rod probe	
Design . . . . .	12
Rod probes	
Lateral loading capacity . . . . .	22
Shortening . . . . .	29
Rope probe	
Design . . . . .	12



- Rope probes
  - Installation . . . . . 32
  - Shortening . . . . . 29
- S**
- Safety instructions
  - Basic . . . . . 10
- Safety settings (Submenu) . . . . . 146
- Securing rod probes . . . . . 25
- Securing rope probes . . . . . 25
- Separator (Parameter) . . . . . 163
- Serial number (Parameter) . . . . . 175
- Service interface (CDI) . . . . . 44
- Settings
  - Managing the device configuration . . . . . 73, 79
  - Operating language . . . . . 71
- Setup (Menu) . . . . . 120
- Signal quality (Parameter) . . . . . 123
- SIM switch . . . . . 183
- Simulation (Submenu) . . . . . 185, 186
- Simulation device alarm (Parameter) . . . . . 187
- Spare parts . . . . . 98
  - Nameplate . . . . . 98
- Start device check (Parameter) . . . . . 188
- Status (Parameter) . . . . . 179
- Status signals . . . . . 52, 89
- Submenu
  - Administration . . . . . 168
  - Advanced setup . . . . . 129
  - Analog input 1 to 5 . . . . . 127, 178
  - Configuration backup display . . . . . 165
  - Data logging . . . . . 180
  - Device check . . . . . 188
  - Device information . . . . . 175
  - Diagnostic list . . . . . 173
  - Display . . . . . 159
  - Display channel 1 to 4 . . . . . 182
  - Event list . . . . . 93, 174
  - Event logbook . . . . . 174
  - Heartbeat . . . . . 190
  - Level . . . . . 131
  - Linearization . . . . . 137, 138, 139
  - Measured values . . . . . 177
  - Probe settings . . . . . 149
  - Safety settings . . . . . 146
  - Simulation . . . . . 185, 186
  - Switch output . . . . . 153
- Switch output (Submenu) . . . . . 153
- Switch output function (Parameter) . . . . . 153
- Switch output simulation (Parameter) . . . . . 186
- Switch status (Parameter) . . . . . 157, 187
- Switch-off delay (Parameter) . . . . . 157
- Switch-off value (Parameter) . . . . . 156
- Switch-on delay (Parameter) . . . . . 156
- Switch-on value (Parameter) . . . . . 155
- Symbols
  - For correction . . . . . 54
  - In the text and numeric editor . . . . . 54
- System components . . . . . 106
- T**
- Table mode (Parameter) . . . . . 143
- Table number (Parameter) . . . . . 144
- Terminal voltage 1 (Parameter) . . . . . 178
- Thermal insulation . . . . . 28
- Threaded connection . . . . . 31
- Timestamp (Parameter) . . . . . 171, 172
- Timestamp 1 to 5 (Parameter) . . . . . 173
- Tool . . . . . 29
- Transmitter
  - Turning the display . . . . . 35
  - Turning the display module . . . . . 35
- Transmitter housing
  - Turning . . . . . 34
- Troubleshooting . . . . . 88
- Turning the display . . . . . 35
- Turning the display module . . . . . 35
- U**
- Unit after linearization (Parameter) . . . . . 140
- Units index (Parameter) . . . . . 179
- Use of measuring instrument
  - see Intended use
- Use of the measuring instruments
  - Borderline cases . . . . . 10
  - Incorrect use . . . . . 10
- V**
- Value (Parameter) . . . . . 179
- Value 1 display (Parameter) . . . . . 161
- Value echo lost (Parameter) . . . . . 146
- W**
- Wizard
  - Define access code . . . . . 170
  - Mapping . . . . . 126
  - Probe length correction . . . . . 151
- Workplace safety . . . . . 11
- Write access . . . . . 46
- Write protection
  - Via access code . . . . . 47
  - Via write protection switch . . . . . 48
- Write protection switch . . . . . 48



71664114

[www.addresses.endress.com](http://www.addresses.endress.com)

---