

Operating Instructions

Levelflex FMP51

Modbus

Guided-wave radar





A0023555

Table of contents

1	About this document	5	6.2	Mounting the device	33
1.1	Document function	5	6.2.1	Tool list	33
1.2	Symbols	5	6.2.2	Shortening the probe	33
1.2.1	Safety symbols	5	6.2.3	Mounting the device	35
1.2.2	Electrical symbols	5	6.2.4	Mounting the "Sensor, remote" version	36
1.2.3	Tool symbols	5	6.2.5	Turning the transmitter housing	38
1.2.4	Symbols for certain types of information and graphics	6	6.2.6	Turning the display	39
1.3	List of abbreviations	6	6.3	Post-mounting check	39
1.4	Documentation	7	7	Electrical connection	41
1.5	Registered trademarks	8	7.1	Connecting requirements	41
2	Basic safety instructions	9	7.1.1	Terminal assignment	41
2.1	Requirements for the personnel	9	7.1.2	Cable specification	41
2.2	Intended use	9	7.1.3	Device plug	41
2.3	Workplace safety	10	7.1.4	Supply voltage	41
2.4	Operational safety	10	7.1.5	Overvoltage protection	42
2.5	Product security	10	7.2	Connecting the device	42
2.5.1	CE mark	10	7.2.1	Opening cover	42
2.5.2	EAC conformity	11	7.2.2	Connecting	43
3	Product description	12	7.2.3	Plug-in spring-force terminals	43
3.1	Product design	12	7.2.4	Closing the cover of the connection compartment	44
3.1.1	Levelflex FMP51/FMP52/FMP54/ FMP55	12	7.3	Post-connection check	44
3.1.2	Electronics housing	13	8	Operation options	45
4	Incoming acceptance and product identification	14	8.1	Overview of operation options	45
4.1	Incoming acceptance	14	8.1.1	Access to operating menu via local display	45
4.2	Product identification	14	8.1.2	Access to the operating menu via the operating tool	46
4.2.1	Nameplate	14	8.2	Structure and function of the operating menu	47
4.2.2	Manufacturer address	15	8.2.1	Structure of the operating menu	47
5	Storage, transport	16	8.2.2	User roles and related access authorization	48
5.1	Storage temperature	16	8.2.3	Data access - Security	48
5.2	Transporting to the measuring point	16	8.3	Display and operating module	52
6	Installation	17	8.3.1	Display format	52
6.1	Mounting requirements	17	8.3.2	Operating elements	54
6.1.1	Suitable mounting position	17	8.3.3	Entering numbers and text	55
6.1.2	Mounting under confined conditions	18	8.3.4	Opening the context menu	57
6.1.3	Notes on the mechanical load of the probe	19	8.3.5	Envelope curve display on the display and operating module	58
6.1.4	Lateral loading capacity (flexural strength) of coaxial probes	21	9	Commissioning using the wizard	59
6.1.5	Information concerning the process connection	21	10	Commissioning via operating menu	60
6.1.6	Securing the probe	23	10.1	Function check	60
6.1.7	Special installation situations	26	10.2	Configuring the operating language	60
			10.3	Configuring level measurement	61
			10.4	Configuring interface measurement	63

10.5	Recording the reference echo curve	65	14.3	Service-specific accessories	92
10.6	Configuring the local display	66	14.4	System components	92
	10.6.1 Factory setting of local display for level measurements	66		14.4.1 Memograph M RSG45	92
	10.6.2 Factory setting of local display for interface measurements	66	15	Operating menu	93
	10.6.3 Adjusting the local display	66	15.1	Overview of the operating menu (display module)	93
10.7	Configuring Modbus communication	67	15.2	Overview of the operating menu (operating tool)	100
	10.7.1 Bus parameters	67	15.3	"Setup" menu	106
	10.7.2 Device parameters	67		15.3.1 "Mapping" wizard	119
	10.7.3 Process parameters	67		15.3.2 "Advanced setup" submenu	120
10.8	Configuration management	68	15.4	"Diagnostics" menu	168
10.9	Protecting settings from unauthorized access .	69		15.4.1 "Diagnostic list" submenu	170
				15.4.2 "Event logbook" submenu	171
11	Diagnostics and troubleshooting	70		15.4.3 "Device information" submenu	172
11.1	General troubleshooting	70		15.4.4 "Measured values" submenu	175
	11.1.1 General errors	70		15.4.5 "Data logging" submenu	178
	11.1.2 Parameter configuration errors	70		15.4.6 "Simulation" submenu	181
11.2	Diagnostic information on local display	72		15.4.7 "Device check" submenu	185
	11.2.1 Diagnostic message	72	15.5	Modbus register assignment	187
	11.2.2 Calling up remedial measures	74		15.5.1 Register table	187
11.3	Diagnostic event in the operating tool	74		15.5.2 Format of the diagnostic bytes	188
11.4	Diagnostic list	76		15.5.3 Format of the status bytes	189
11.5	Event logbook	76	Index	190	
	11.5.1 Event history	76			
	11.5.2 Filtering the event logbook	77			
	11.5.3 Overview of information events	77			
11.6	Firmware history	78			
12	Maintenance	79			
12.1	Exterior cleaning	79			
12.2	General cleaning instructions	79			
13	Repair	80			
13.1	General information	80			
	13.1.1 Repair concept	80			
	13.1.2 Repairs to Ex-approved devices	80			
	13.1.3 Replacing electronics modules	80			
	13.1.4 Replacing a device	80			
13.2	Spare parts	81			
13.3	Return	81			
13.4	Disposal	81			
14	Accessories	82			
14.1	Device-specific accessories	82			
	14.1.1 Weather protection cover	82			
	14.1.2 Mounting bracket for electronics housing	83			
	14.1.3 Mounting kit, insulated	84			
	14.1.4 Centering star	85			
	14.1.5 Centering weight	87			
	14.1.6 Remote display FHX50	89			
	14.1.7 Overvoltage protection	90			
	14.1.8 Bluetooth module BT10 for HART devices	91			
14.2	Communication-specific accessories	92			

1 About this document

1.1 Document function

These Operating Instructions contain all the information required in the various life cycle phases of the device: from product identification, incoming acceptance and storage, to installation, connection, operation and commissioning, through to troubleshooting, maintenance and disposal.

1.2 Symbols

1.2.1 Safety symbols

DANGER

This symbol alerts you to a dangerous situation. Failure to avoid this situation will result in serious or fatal injury.

WARNING

This symbol alerts you to a potentially dangerous situation. Failure to avoid this situation can result in serious or fatal injury.





CAUTION

This symbol alerts you to a potentially dangerous situation. Failure to avoid this situation can result in minor or medium injury.

NOTICE

This symbol alerts you to a potentially harmful situation. Failure to avoid this situation can result in damage to the product or something in its vicinity.

1.2.2 Electrical symbols

Symbol	Meaning
	Direct current
	Alternating current
	Direct and alternating current
	Ground connection A grounded terminal which, as far as the operator is concerned, is grounded via a grounding system.
	Protective earth (PE) Ground terminals that must be connected to ground prior to establishing any other connections. The ground terminals are located on the interior and exterior of the device: <ul style="list-style-type: none"> ▪ Interior ground terminal: protective earth is connected to the mains supply. ▪ Exterior ground terminal: device is connected to the plant grounding system.

1.2.3 Tool symbols



Phillips head screwdriver



Flat blade screwdriver



Torx screwdriver



Allen key



Open-ended wrench

1.2.4 Symbols for certain types of information and graphics

 **Permitted**

Procedures, processes or actions that are permitted

  **Preferred**

Procedures, processes or actions that are preferred

 **Forbidden**

Procedures, processes or actions that are forbidden

 **Tip**

Indicates additional information



Reference to documentation



Reference to graphic



Notice or individual step to be observed

1, 2, 3

Series of steps



Result of a step



Visual inspection



Operation via operating tool



Write-protected parameter

1, 2, 3, ...

Item numbers

A, B, C, ...

Views

  **Safety instructions**

Observe the safety instructions contained in the associated Operating Instructions



Temperature resistance of the connection cables

Specifies the minimum value of the temperature resistance of the connection cables

1.3 List of abbreviations

BA

Document type "Operating Instructions"

KA

Document type "Brief Operating Instructions"

TI

Document type "Technical Information"

SD

Document type "Special Documentation"

XA

Document type "Safety Instructions"

PN

Nominal pressure

MWP

Maximum working pressure

The MWP is indicated on the nameplate.

ToF

Time of Flight

ϵ_r (Dk value)

Relative dielectric constant

PLC

Programmable logic controller (PLC)

CDI

Common Data Interface

Operating tool

The term "operating tool" is used in place of the following operating software:

SmartBlue (app), for operation using an Android or iOS smartphone or tablet

RTU

Remote Transmit Unit

BD

Blocking Distance; no signals are analyzed within the BD.

PLC

Programmable logic controller (PLC)

CDI

Common Data Interface

PFS

Pulse Frequency Status (Switch output)

1.4 Documentation

 For an overview of the scope of the associated Technical Documentation, refer to the following:

- *Device Viewer* (www.endress.com/deviceviewer): Enter the serial number from the nameplate
- *Endress+Hauser Operations app*: Enter serial number from nameplate or scan matrix code on nameplate.

The following documentation may be available depending on the device version ordered:

Document type	Purpose and content of the document
Technical Information (TI)	Planning aid for your device The document contains all the technical data on the device and provides an overview of the accessories and other products that can be ordered for the device.
Brief Operating Instructions (KA)	Guide that takes you quickly to the 1st measured value The Brief Operating Instructions contain all the essential information from incoming acceptance to initial commissioning.
Operating Instructions (BA)	Your reference document These Operating Instructions contain all the information that is required in the various life cycle phases of the device: from product identification, incoming acceptance and storage, to mounting, connection, operation and commissioning, through to troubleshooting, maintenance and disposal.

Document type	Purpose and content of the document
Description of Device Parameters (GP)	Reference for your parameters The document provides a detailed explanation of each individual parameter. The description is aimed at those who work with the device over the entire life cycle and perform specific configurations.
Safety Instructions (XA)	Depending on the approval, safety instructions for electrical equipment in hazardous areas are also supplied with the device. The Safety Instructions are a constituent part of the Operating Instructions.  Information on the Safety Instructions (XA) that are relevant for the device is provided on the nameplate.
Supplementary device-dependent documentation (SD/FY)	Always comply strictly with the instructions in the relevant supplementary documentation. The supplementary documentation is a constituent part of the device documentation.

1.5 Registered trademarks

Modbus®

Registered trademark of SCHNEIDER AUTOMATION, INC.

Bluetooth®

The *Bluetooth*® word mark and logos are registered trademarks owned by the Bluetooth SIG, Inc. and any use of such marks by Endress+Hauser is under license. Other trademarks and trade names are those of their respective owners.

Apple®

Apple, the Apple logo, iPhone, and iPod touch are trademarks of Apple Inc., registered in the U.S. and other countries. App Store is a service mark of Apple Inc.

Android®

Android, Google Play and the Google Play logo are trademarks of Google Inc.

KALREZ®, VITON®

Registered trademarks of DuPont Performance Elastomers L.L.C., Wilmington, DE USA

TEFLON®

Registered trademark of E.I. DuPont de Nemours & Co., Wilmington, USA

TRI-CLAMP®

Registered trademark of Ladish & Co., Inc., Kenosha, USA

NORD-LOCK®

Registered trademark of Nord-Lock International AB

FISHER®

Registered trademark of Fisher Controls International LLC, Marshalltown, USA

MASONEILAN®

Registered trademark of Dresser, Inc., Addison, USA

2 Basic safety instructions

2.1 Requirements for the personnel

The personnel for installation, commissioning, diagnostics and maintenance must fulfill the following requirements:

- ▶ Trained, qualified specialists must have a relevant qualification for this specific function and task.
- ▶ Are authorized by the plant owner/operator.
- ▶ Are familiar with federal/national regulations.
- ▶ Before starting work, read and understand the instructions in the manual and supplementary documentation as well as the certificates (depending on the application).
- ▶ Follow instructions and comply with basic conditions.

The operating personnel must fulfill the following requirements:

- ▶ Are instructed and authorized according to the requirements of the task by the facility's owner-operator.
- ▶ Follow the instructions in this manual.

2.2 Intended use

Application and media

The measuring instrument described in this manual is intended only for the level and interface measurement of liquids. Depending on the version ordered, the measuring instrument can also measure potentially explosive, flammable, poisonous and oxidizing media.

If the limit values specified in the "Technical data" and the conditions listed in the instructions and additional documentation are observed, the measuring instrument may be used only for the following measurements:

- ▶ Measured process variables: level and/or interface height
- ▶ Calculable process variables: volume or mass in any shape of vessel (calculated from the level by the linearization functionality)

To ensure that the measuring instrument remains in proper condition for the operation time:

- ▶ Use the measuring instrument only for media to which the process-wetted materials are sufficiently resistant.
- ▶ Observe the limit values in the "Technical data".

Incorrect use

The manufacturer is not liable for harm caused by improper or unintended use.

Clarification for borderline cases:

- ▶ For special fluids and fluids for cleaning, Endress+Hauser is glad to provide assistance in verifying the corrosion resistance of fluid-wetted materials, but does not accept any warranty or liability.

Residual risks

Due to heat transfer from the process as well as power loss in the electronics, the temperature of the electronics housing and the assemblies contained therein (e.g. display module, main electronics module and I/O electronics module) may rise up to 80 °C (176 °F). When in operation, the sensor may reach a temperature close to the medium temperature.

Danger of burns from contact with surfaces!

- ▶ In the event of elevated fluid temperatures, ensure protection against contact to prevent burns.

2.3 Workplace safety

When working on and with the device:

- ▶ Wear the required personal protective equipment as per national regulations.

With separable probe rods, medium may penetrate the joints between the individual parts of the rod. This medium may escape when the joints are loosened. This can cause injuries in the case of dangerous (e.g., aggressive or toxic) media.

- ▶ When loosening the joints between the individual parts of the probe rod, wear appropriate protective equipment according to the medium.

2.4 Operational safety

Risk of injury!

- ▶ Operate the device only if it is in proper technical condition, free from errors and faults.
- ▶ The operator is responsible for ensuring that the device is in good working order.

Modifications to the device

Unauthorized modifications to the device are not permitted and can lead to unforeseeable dangers:

- ▶ If modifications are nevertheless required, consult with the manufacturer.

Repair

To ensure continued operational safety and reliability:

- ▶ Carry out repairs on the device only if they are expressly permitted.
- ▶ Observe national regulations pertaining to the repair of an electrical device.
- ▶ Use only original spare parts and accessories from the manufacturer.

Hazardous area

To eliminate danger to persons or the installation when the device is used in the hazardous area (e.g. explosion protection, pressure vessel safety):

- ▶ Check the nameplate to verify if the device ordered can be put to its intended use in the hazardous area.
- ▶ Observe the specifications in the separate supplementary documentation included as an integral part of these instructions.

2.5 Product security

This measuring instrument is designed in accordance with good engineering practice to meet state-of-the-art safety requirements, has been tested, and left the factory in a condition in which it is safe to operate. It meets general safety standards and legal requirements.

NOTICE

Loss of degree of protection by opening of the device in humid environments

- ▶ If the device is opened in a humid environment, the degree of protection indicated on the nameplate is no longer valid. This may also impair the safe operation of the device.

2.5.1 CE mark

The measuring system meets the legal requirements of the applicable EU directives. These are listed in the corresponding EU Declaration of Conformity together with the standards applied.

The manufacturer confirms successful testing of the device by affixing to it the CE mark.

2.5.2 EAC conformity

The measuring system meets the legal requirements of the applicable EAC guidelines. These are listed in the corresponding EAC Declaration of Conformity along with the standards applied.

The manufacturer confirms successful testing of the device by affixing to it the EAC mark.

3 Product description

3.1 Product design

3.1.1 Levelflex FMP51/FMP52/FMP54/FMP55

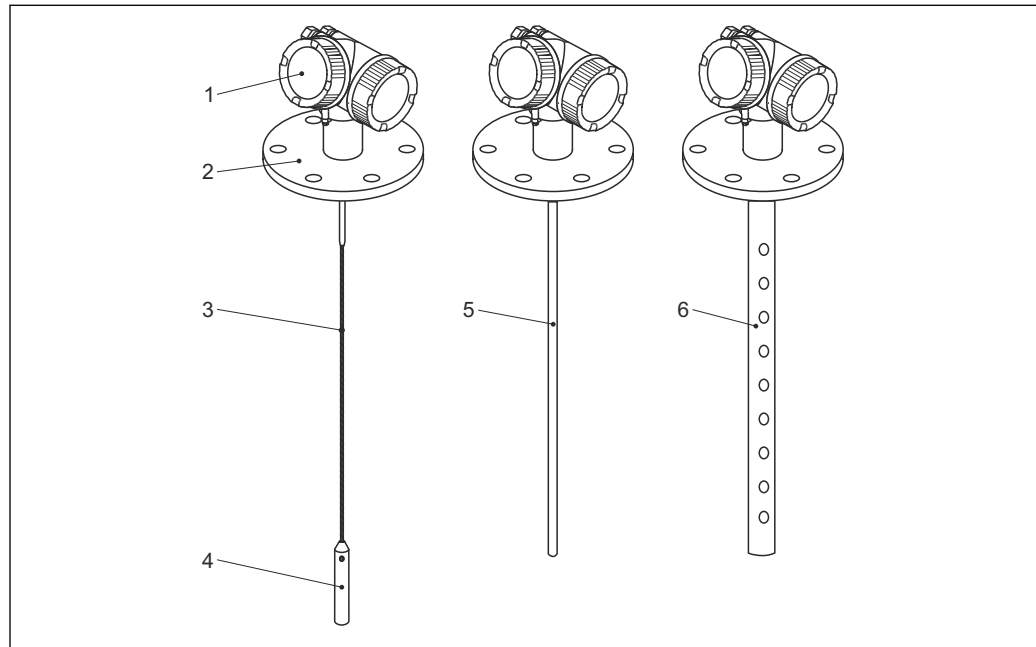

A0012399

1 Design of the Levelflex

- 1 Electronics housing
- 2 Process connection (here as an example: flange)
- 3 Rope probe
- 4 End-of-probe weight
- 5 Rod probe
- 6 Coax probe

3.1.2 Electronics housing

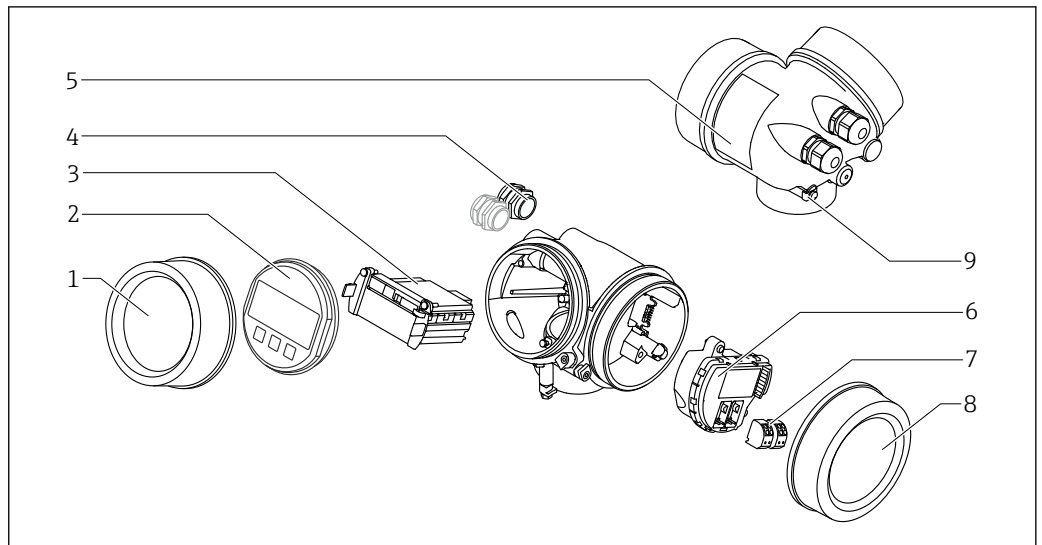

A0012422

2 Design of the electronics housing

- 1 Electronics compartment cover
- 2 Display module
- 3 Main electronics module
- 4 Cable glands (1 or 2, depending on instrument version)
- 5 Nameplate
- 6 I/O electronics module
- 7 Terminals (pluggable spring terminals)
- 8 Connection compartment cover
- 9 Grounding terminal

4 Incoming acceptance and product identification

4.1 Incoming acceptance

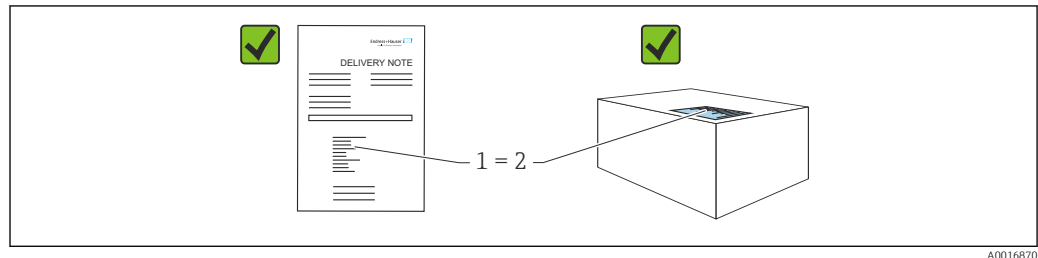

Check the following during incoming acceptance:

- Is the order code on the delivery note (1) identical to the order code on the product sticker (2)?
- Are the goods undamaged?
- Do the data on the nameplate correspond to the order specifications and the delivery note?
- Is the documentation provided?
- If required (see nameplate): are the Safety Instructions (XA) provided?

 If one of these conditions is not met, please contact the manufacturer's sales office.

4.2 Product identification

The following options are available for identification of the device:

- Nameplate specifications
- Extended order code with breakdown of the device features on the delivery note
- ▶ *Device Viewer* (www.endress.com/deviceviewer); manually enter the serial number from the nameplate.
 - ↳ All the information about the measuring device is displayed.
- ▶ *Endress+Hauser Operations app*; manually enter the serial number indicated on the nameplate or scan the 2D matrix code on the nameplate.
 - ↳ All the information about the measuring device is displayed.

4.2.1 Nameplate

The information that is required by law and is relevant to the device is shown on the nameplate, e.g.:

- Manufacturer identification
- Order number, extended order code, serial number
- Technical data, degree of protection
- Firmware version, hardware version
- Approval-related information, reference to Safety Instructions (XA)
- DataMatrix code (information about the device)

4.2.2 Manufacturer address

Endress+Hauser SE+Co. KG
Hauptstraße 1
79689 Maulburg, Germany
Place of manufacture: See nameplate.

5 Storage, transport

5.1 Storage temperature

- Permitted storage temperature: -40 to $+80$ °C (-40 to $+176$ °F)
- Use original packaging.
- Option for FMP51 and FMP54: -50 to $+80$ °C (-58 to $+176$ °F)
This range applies if the option JN "Transmitter ambient temperature" -50 °C (-58 °F) was selected in order code 580 "Test, Certificate". If the temperature is permanently below -40 °C (-40 °F), higher failure rates can be expected.

5.2 Transporting to the measuring point

⚠ WARNING

Housing or probe may become damaged or break off.

Risk of injury!

- ▶ Transport the measuring instrument to the measuring point in its original packaging or by the process connection.
- ▶ Always secure lifting equipment (slings, eyes, etc.) at the process connection and never lift the device by the electronic housing or probe. Pay attention to the center of gravity of the device so that it does not tilt or slip unintentionally.
- ▶ Follow the safety instructions and transport conditions for devices weighing more than 18 kg (39.6 lbs) (IEC 61010).

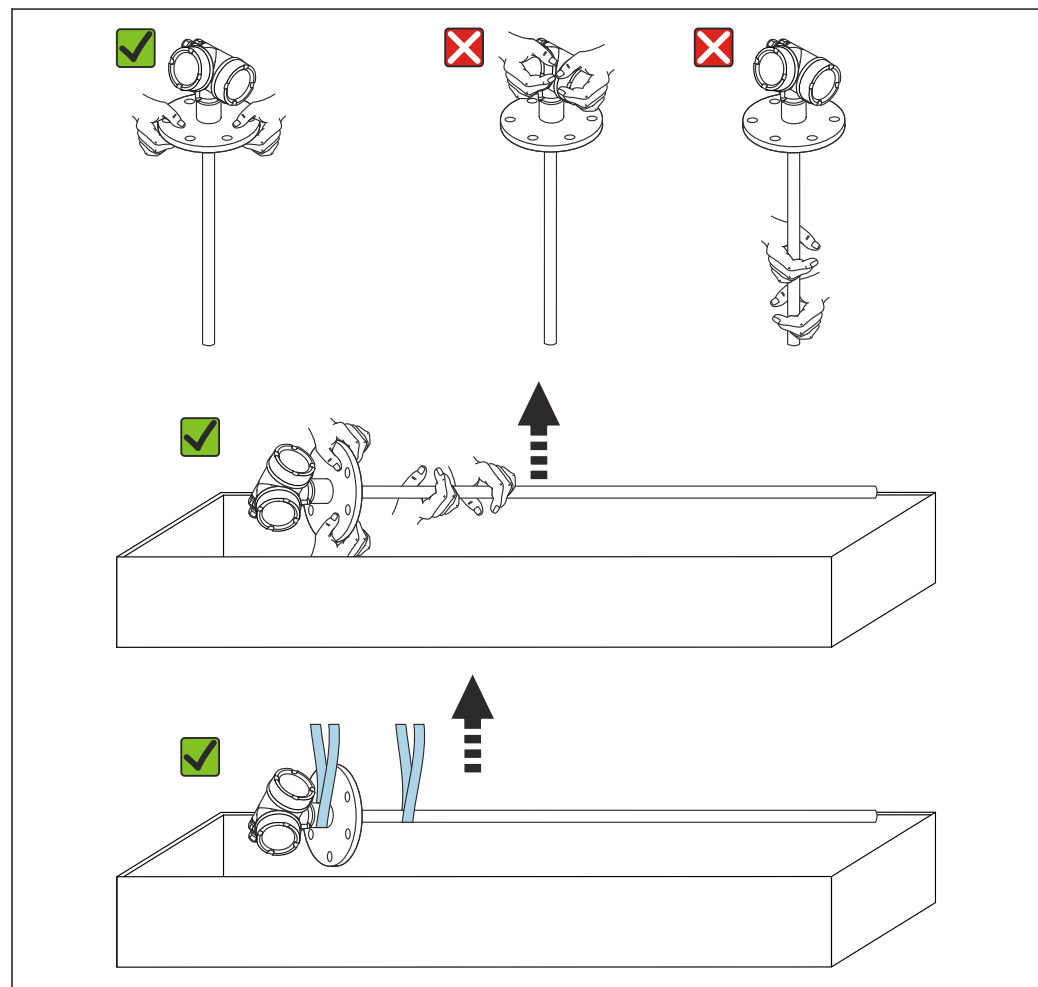

A0013920

6 Installation

6.1 Mounting requirements

6.1.1 Suitable mounting position

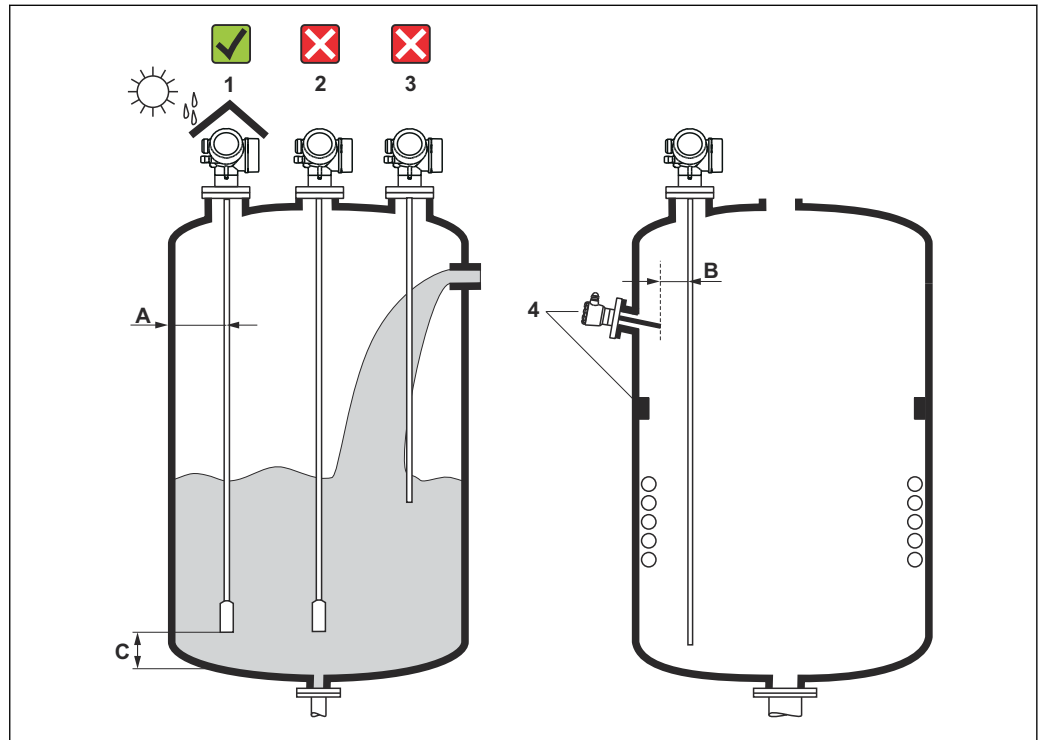

3 Installation positions

A0012606

Spacing requirements when mounting

- Distance (A) between the vessel wall and rod and rope probes:
 - For smooth metallic walls: > 50 mm (2 in)
 - For plastic walls: > 300 mm (12 in) to metallic parts outside the vessel
 - For concrete walls: > 500 mm (20 in), otherwise the permitted measuring range may be reduced.
- Distance (B) between rod probes and internal fittings (3): > 300 mm (12 in)
- When using more than one Levelflex:
 - Minimum distance between the sensor axes: 100 mm (3.94 in)
- Distance (C) from the end of the probe to the bottom of the vessel:
 - Rope probe: > 150 mm (6 in)
 - Rod probe: > 10 mm (0.4 in)
 - Coaxial probe: > 10 mm (0.4 in)

i Coaxial probes can be mounted at any distance to the wall and internal fixtures.

Additional mounting requirements

- When mounting outdoors, a weather protection cover (1) can be used to protect the device against extreme weather conditions.
 - In metallic vessels, preferably do not mount the probe in the center of the vessel (2), as this would lead to increased interference echoes.
If a central mounting position cannot be avoided, it is essential to perform interference echo suppression (mapping) after commissioning the device.
 - Do not mount the probe in the filling curtain (3).
 - Avoid buckling the rope probe during installation or operation (e.g. as a result of product movement against silo wall) by selecting a suitable mounting location.
- i** In the case of freely suspended rope probes (probe end not fixed at the bottom), the distance between the probe rope and internal fittings, which can change due to the movement of the product, must never be less than 300 mm (12 in). Occasional contact between the probe weight and the cone of the vessel, however, does not influence the measurement provided that the relative permittivity is at least $\epsilon_r = 1.8$.
- i** When mounting the housing in a recess (e.g. in a concrete ceiling), observe a minimum distance of 100 mm (4 in) between the cover of the connection compartment/electronics compartment and the wall. Otherwise the connection compartment/electronics compartment will not be accessible after installation.

6.1.2 Mounting under confined conditions

Mounting with remote probe

The device version with a remote probe is suitable for applications with restricted mounting space. In this case, the electronics housing is mounted at a separate position from the probe.

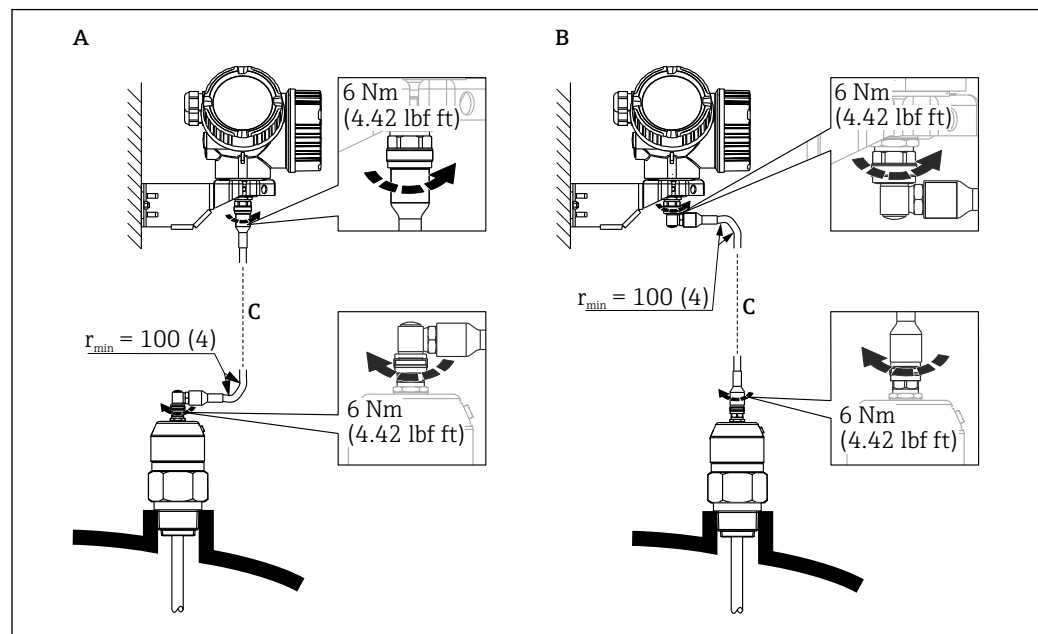

- A Angled plug at the probe
 B Angled plug at the electronics housing
 C Length of the remote cable as ordered

- Product structure, feature 600 "Probe design":
 - Version MB "Remote sensor, 3 m cable"
 - Version MC "Remote sensor, 6 m cable"
 - Version MD "Remote sensor, 9 m cable"
- The connecting cable is included in the delivery with these versions.
Minimum bending radius: 100 mm (4 inch)
- The mounting bracket for the electronics housing is included in the delivery with these versions. Mounting options:
 - Wall mounting
 - Mounting on DN32 to DN50 (1¼ to 2 inch) post or pipe
- The connecting cable has one straight plug and one plug angled at 90°. Depending on the local conditions the angled plug can be connected at the probe or at the electronics housing.

i The probe, electronics and connection cable are mutually compatible and bear a common serial number. Only components with the same serial number may be connected to one another.

Separable probes

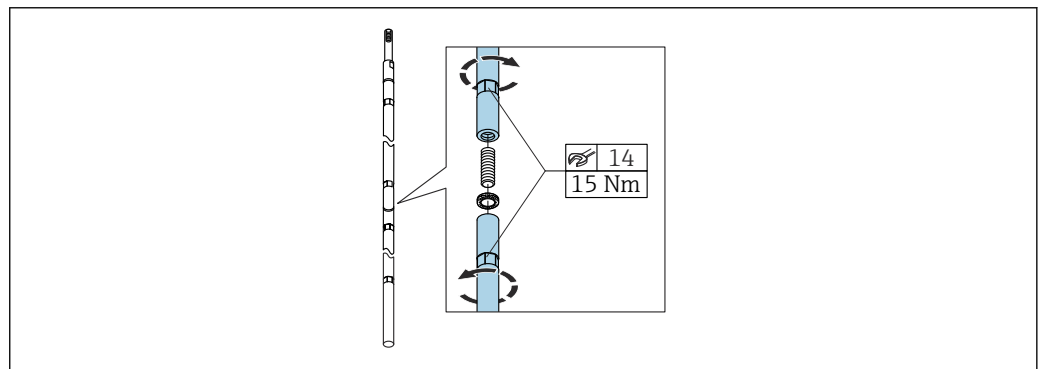

A0021647

In confined mounting conditions (ceiling clearance), the use of separable rod probe (Ø 16 mm) is advisable.

- Max. probe length 10 m (394 in)
- Max. lateral loading capacity 30 Nm
- Probes can be separated several times, with the individual parts having the following lengths:
 - 500 mm (20 in)
 - 1 000 mm (40 in)

i The joints between the individual rod segments are secured by the enclosed Nord Lock washers. Install the pre-assembled washers in pairs, cam face to cam face.

6.1.3 Notes on the mechanical load of the probe

Tensile loading capacity of rope probes

FMP51

Rope 4 mm (1/8 in) 316

Tensile loading capacity 5 kN

Rope 4 mm (1/8 in) Alloy C

Tensile loading capacity 5 kN

Rope 4 mm (1/8 in) PFA>316L

Tensile loading capacity 1 kN

Lateral loading capacity (flexural strength) of rod probes*FMP51***Rod 8 mm (1/3 in) 316L**

10 Nm

Rod 12 mm (1/2 in) 316L

Flexural strength 30 Nm

Rod 12 mm (1/2 in) AlloyC

Flexural strength 30 Nm

Rod 16 mm (0.63 in) 316 L separable

Flexural strength 30 Nm

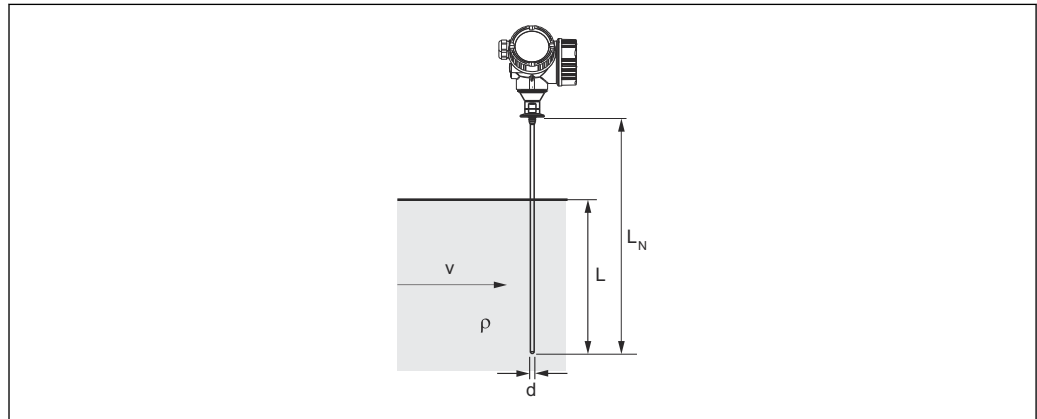
Lateral load (bending moment) from flow conditions

A0014175

 ρ Density of the medium [kg/m³] v Flow velocity [m/s] of the medium, perpendicular to the probe rod d Diameter [m] of probe rod L Level [m] L_N Probe length [m]The formula for calculating the bending moment M acting on the probe:

$$M = c_w \times \rho / 2 \times v^2 \times d \times L \times (L_N - 0.5 \times L)$$

With:

 c_w : coefficient of friction**Sample calculation**Coefficient of friction c_w 0.9 (assuming turbulent flow - high Reynolds number)Density ρ [kg/m³] 1000 (e.g. water)Probe diameter d [m] 0.008 $L = L_N$ (unfavorable conditions)

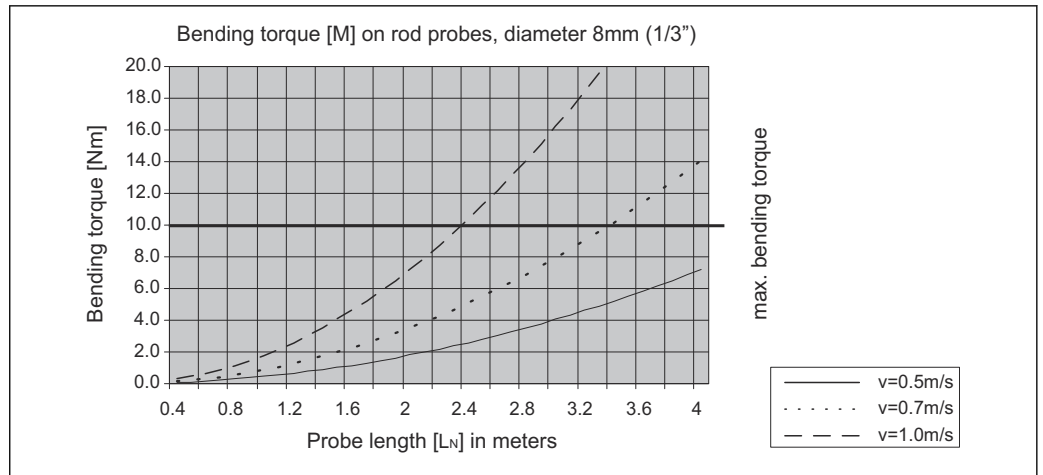

A0014182-EN

6.1.4 Lateral loading capacity (flexural strength) of coaxial probes

FMP51

Probe Ø21.3 mm316L

Flexural strength:60 Nm

Probe Ø42.4 mm316L

Flexural strength:300 Nm

Probe Ø 42.4 mm AlloyC

Flexural strength:300 Nm

6.1.5 Information concerning the process connection

i Probes are mounted on the process connection with threaded connections or flanges. If there is the danger with this installation that the probe end moves so much that it occasionally touches the vessel floor or cone, the probe may need to be shortened at the lower end and fixed in place.

Threaded connection

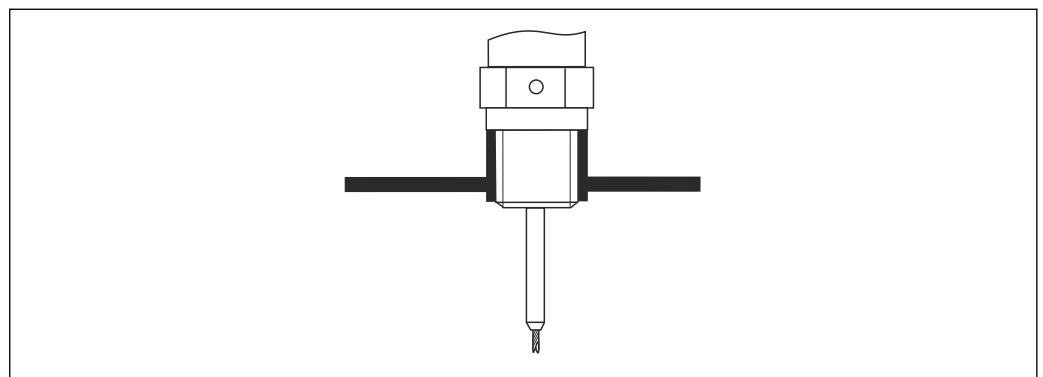

A0015121

4 Mounting with threaded connection; flush with the vessel ceiling

Sealing

The thread and the type of seal comply with DIN3852 Part 2, screwed plug, form A.

The following types of sealing ring can be used:

- For thread G3/4": according to DIN7603 with dimensions 27 mm × 32 mm
- For thread G1½": according to DIN 7603 with dimensions 48 mm × 55 mm

Use a sealing ring according to this standard in form A, C or D and of a material that offers appropriate resistance for the application.

Nozzle installation

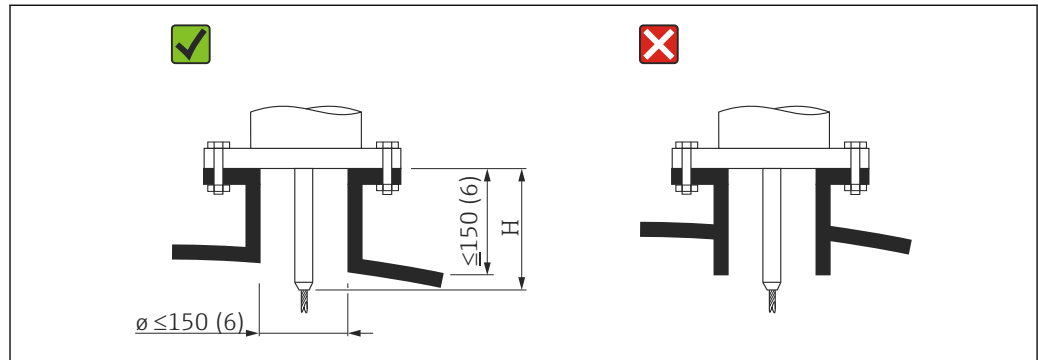

H Length of the centering rod or the rigid part of the rope probe

- Permissible nozzle diameter: ≤ 150 mm (6 in)
For larger diameters, the near-range measuring capability may be reduced.
For large nozzles, see the section "Mounting in nozzles $\geq \text{DN}300$ "
- Permissible nozzle height: ≤ 150 mm (6 in)
For larger heights, the near-range measuring capability may be reduced.
Larger nozzle heights are possible in special cases (on request), see sections "Centering rod for FMP51 and FMP52" and "Rod extension/centering device HMP40 for FMP54".
- The end of the nozzle should be flush with the tank ceiling in order to avoid ringing effects.

i In thermally insulated vessels, the nozzle should also be insulated in order to prevent condensate formation.

Centering rod

In the case of rope probes, it may be necessary to use a version with a centering rod so that the rope does not come in contact with the nozzle wall during the process.

The length of the optional centering rod determines the maximum nozzle height.

Mounting in nozzles $\geq \text{DN}300$

If installation in nozzles ≥ 300 mm (12 in) is unavoidable, installation must be carried out in accordance with the following diagram in order to avoid interference signals in the near range.

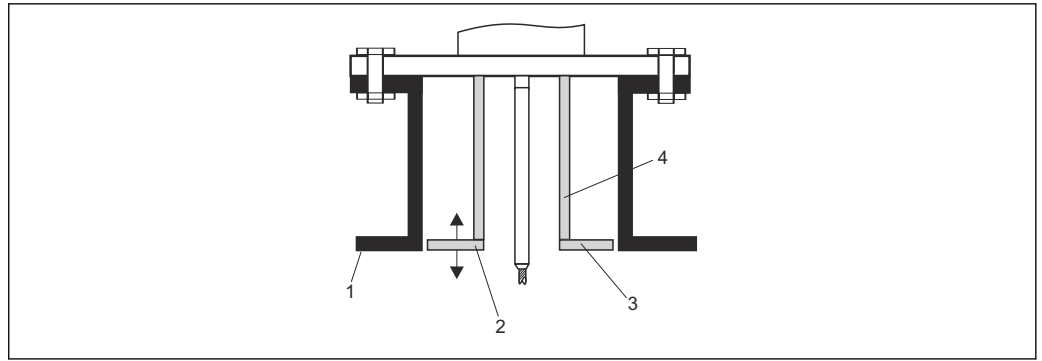

A0014199

- 1 Lower edge of the nozzle
- 2 Approximately flush with the lower edge of the nozzle (± 50 mm)
- 3 Plate, nozzle \varnothing 300 mm (12 in) = plate \varnothing 280 mm (11 in); nozzle \varnothing \geq 400 mm (16 in) = plate \varnothing \geq 350 mm (14 in)
- 4 Pipe \varnothing 150 to 180 mm

6.1.6 Securing the probe

Securing rope probes

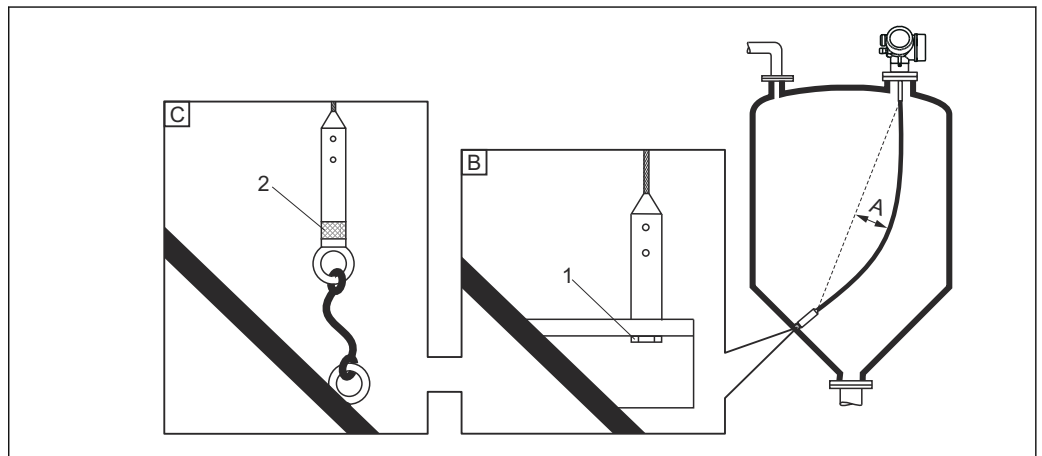

A0012609

- A Sag: ≥ 10 mm/m (0.12 in/ft) probe length
- B Reliably grounded end of probe
- C Reliably insulated end of probe
- 1 Fastener in female thread of probe weight
- 2 Insulated fastening kit

- The end of the rope probe must be secured or fixed down under the following conditions:
 - If the probe temporarily comes into contact with the vessel wall, the cone, internal fittings/beams or another part of the installation
- A female thread is provided in the probe weight to secure the end of the probe:
Rope 4 mm ($\frac{1}{8}$ in), 316: M 14
- When fixed down, the end of the probe must be reliably grounded or reliably insulated.
If it is not otherwise possible to secure the probe with a reliably insulated connection, use the insulated fastening kit.
- If the end of the probe is fixed down and grounded, the search for a positive end-of-probe signal must be activated. Otherwise automatic probe length correction is not possible.
Navigation: Expert → Sensor → EOP evaluation → EOP search mode
Setting: **Positive EOP** option
- To prevent an extremely high tensile load (e.g. due to thermal expansion) and the risk of the rope breaking, the rope must be slack. Required sag: ≥ 10 mm/m (0.12 in/ft) rope length.
Pay attention to the tensile loading capacity of rope probes.

Securing rod probes

- In the case of WHG approval: a support is required for probe lengths ≥ 3 m (10 ft).
- In general, rod probes must be secured in the event of horizontal flow (e.g. from an agitator) or strong vibrations.
- Only secure rod probes directly at the end of the probe.

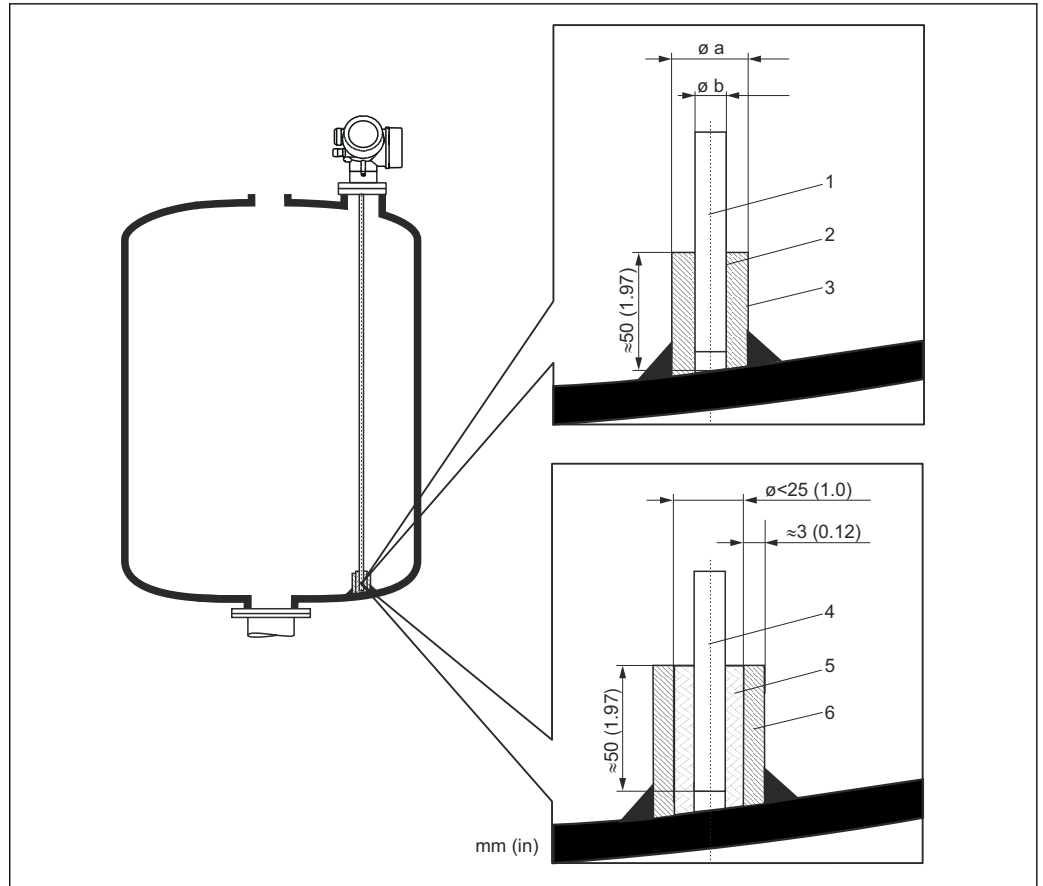

A0012607

Unit of measurement mm (in)

- 1 Probe rod, uncoated
- 2 Sleeve with narrow bore to ensure electrical contact between the sleeve and the rod.
- 3 Short metal pipe, e.g. welded in place
- 4 Probe rod, coated
- 5 Plastic sleeve, e.g. PTFE, PEEK, PPS
- 6 Short metal pipe, e.g. welded in place

Probe \varnothing 8 mm (0.31 in)

- $a < \varnothing$ 14 mm (0.55 in)
- $b = \varnothing$ 8.5 mm (0.34 in)

Probe \varnothing 12 mm (0.47 in)

- $a < \varnothing$ 20 mm (0.78 in)
- $b = \varnothing$ 12.5 mm (0.52 in)

Probe \varnothing 16 mm (0.63 in)

- $a < \varnothing$ 26 mm (1.02 in)
- $b = \varnothing$ 16.5 mm (0.65 in)

NOTICE

Poor grounding of the probe end may cause incorrect measurements.

- ▶ Use a sleeve with a narrow bore to ensure good electrical contact between the sleeve and the probe rod.

NOTICE

Welding can damage the main electronics module.

- ▶ Before welding: Ground the probe rod and remove the electronics.

Securing coaxial probes

For WHG approval: a support is required for probe lengths \geq 3 m (10 ft).

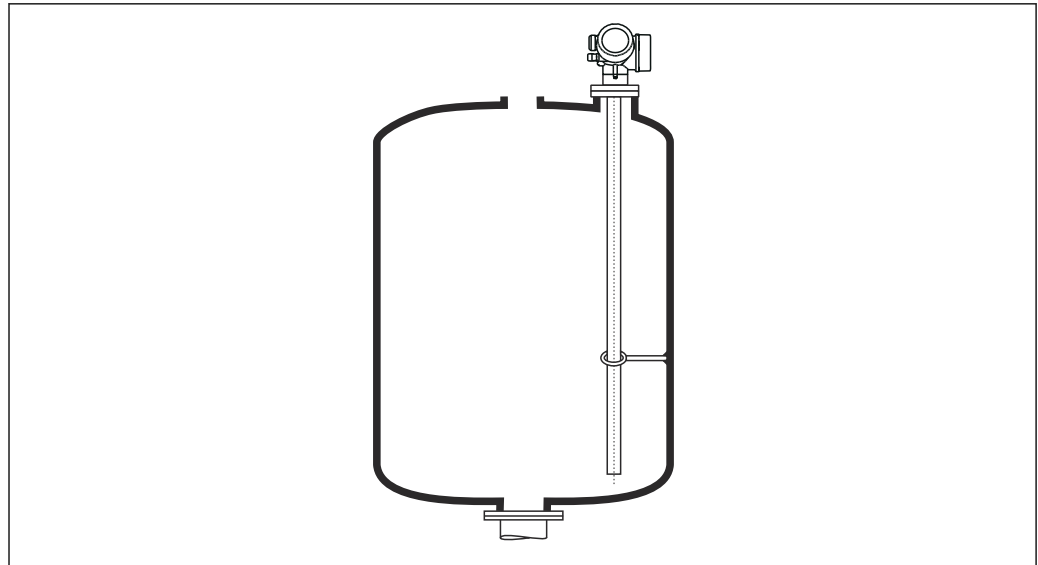

A0012608

Coaxial probes can be secured (fixed) at any point in the ground tube.

6.1.7 Special installation situations

Bypasses and stilling wells

- i** The use of centering disks/stars/weights (available as accessories) is recommended in bypass and stilling well applications.
- i** Since the measuring signal permeates a large number of plastics, incorrect measurements can result when the device is installed in bypasses or stilling wells made of plastic. For this reason use a bypass or stilling well made of metal.

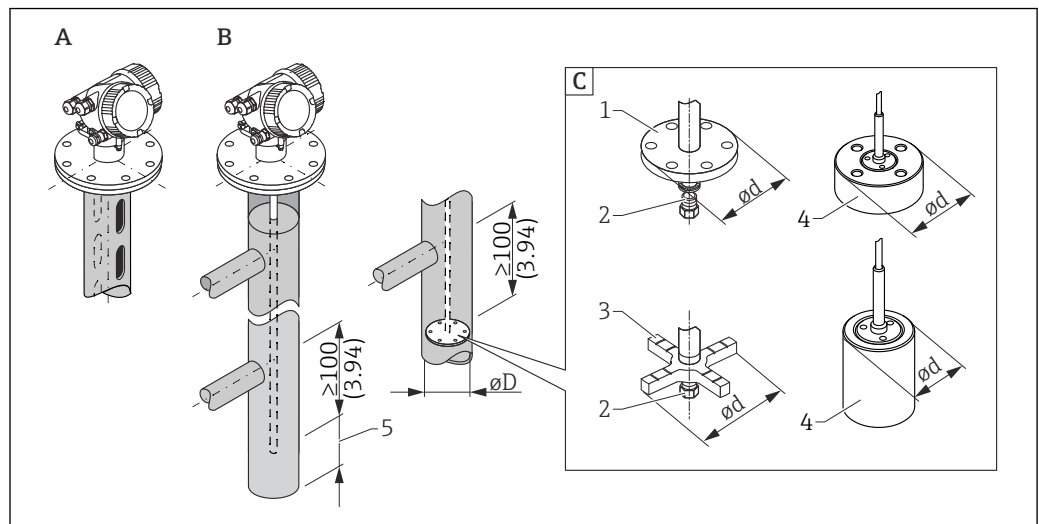

A0039216

5 Unit: mm (in)

- A Mounting in stilling well
- B Mounting in bypass
- C Centering disk/centering star/centering weight
- 1 Metal centering disk (316L) for level measurement
- 2 Securing screw; torque: 25 Nm ± 5 Nm
- 3 Non-metal centering star (PEEK, PFA) preferred for interface measurement
- 4 Metal centering weight (316L) for level measurement
- 5 Minimum distance between probe end and lower edge of bypass 10 mm (0.4 in)

- Pipe diameter: > 40 mm (1.6 in) (for rod probes).
 - A rod probe can be installed in pipes with a diameter of up to 150 mm (6 in). The use of a coaxial probe is recommended for larger pipe diameters.
 - Side outlets, holes, slots and welds - with a maximum inward projection of 5 mm (0.2 in) - do not affect the measurement.
 - There should not be any changes in the diameter of the pipe.
 - The probe must be 100 mm (4 in) longer than the lower outlet.
 - The probes must not touch the pipe wall within the measuring range. Support or brace the probe if necessary. All rope probes are prepared for bracing in vessels (probe weight with anchor hole).
 - If a metal centering disk is mounted at the end of the probe rod, the signal for detecting the end of the probe is reliably defined.
- Note:** The non-metal centering stars made of PEEK or PFA are recommended for interface measurements. When using metal centering disks, it is important to ensure that the lower medium covers the centering disk at all times. Otherwise, incorrect interface measurements can result.
- Coaxial probes can be used within any restrictions provided that the pipe diameter permits their installation.

 For bypasses with condensate formation (water) and a medium with a low relative permittivity (e.g. hydrocarbons):

Over time, the bypass fills with condensate up to the lower outlet. When levels are low, the level echo is masked by the echo of the condensate as a result. In this range, the level of the condensate is output and the correct value is only output when levels are higher. For this reason, ensure that the lower outlet is 100 mm (4 in) below the lowest level to be measured and fit a metal centering disk at the level of the lower edge of the lower outlet.

 In thermally insulated vessels, the bypass should also be insulated in order to prevent condensate formation.

Assignment of centering disk/centering star/centering weight to the pipe diameter

Metal centering disk (316L)

for level measurement

Rod centering disk (Ø d) 45 mm (1.77 in)

for pipe diameters (Ø D)

DN50/2" to DN65/2½"

Rod centering disk (Ø d) 75 mm (2.95 in)

for pipe diameters (Ø D)

DN80/3" to DN100/4"

Rope centering disk (Ø d) 75 mm (2.95 in)

for pipe diameters (Ø D)

DN80/3" to DN100/4"

Metal centering weight (316L)

for level measurement

Rope centering weight (Ø d) 45 mm (1.77 in), h 60 mm (2.36 in)

for pipe diameters (Ø D)

DN50/2"

Rope centering weight (Ø d) 75 mm (2.95 in), h 30 mm (1.81 in)

for pipe diameters (Ø D)

DN80/3"

Rope centering weight (Ø d) 95 mm (3.74 in), h 30 mm (1.81 in)

for pipe diameters (Ø D)

DN100/4"

Non-metal centering star (PEEK)

For level and interface measurement, operating temperature:
 -60 to +250 °C (-76 to 482 °F)

Rod centering star (∅ d) 48 to 95 mm (1.89 to 3.74 in)
 for pipe diameters (∅ D)
 ≥ DN50/2"

Non-metal centering star (PFA)

for level and interface measurement, operating temperature:
 -200 to +250 °C (-328 to +482 °F)

Rod centering star (∅ d) 37 mm (1.46 in)
 for pipe diameters (∅ D)
 ≥ 40 mm (1.57 in)

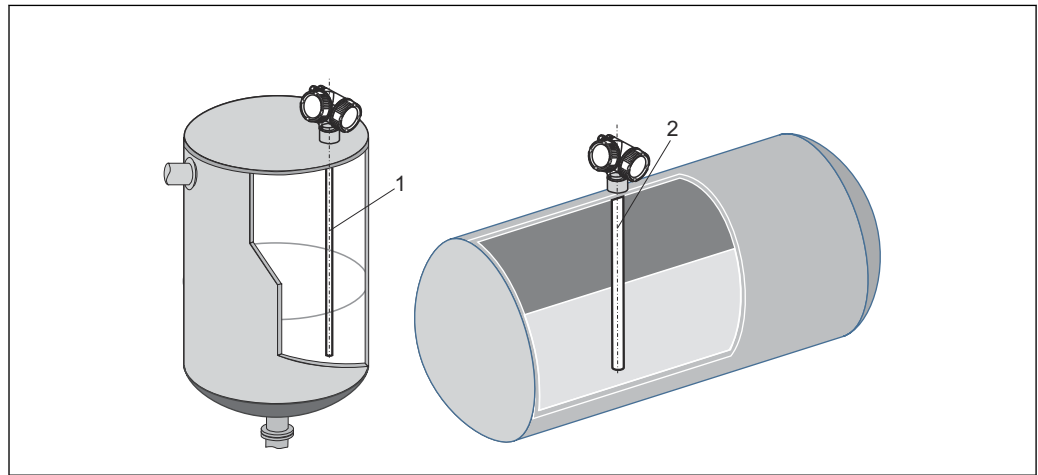
Horizontal cylindrical and vertical tanks

A0014141

1 Coaxial probe

- Any distance from wall provided occasional contact is avoided.
- Use a coaxial probe (1) if installing in tanks with many internal fixtures or internal fixtures located close to the probe.

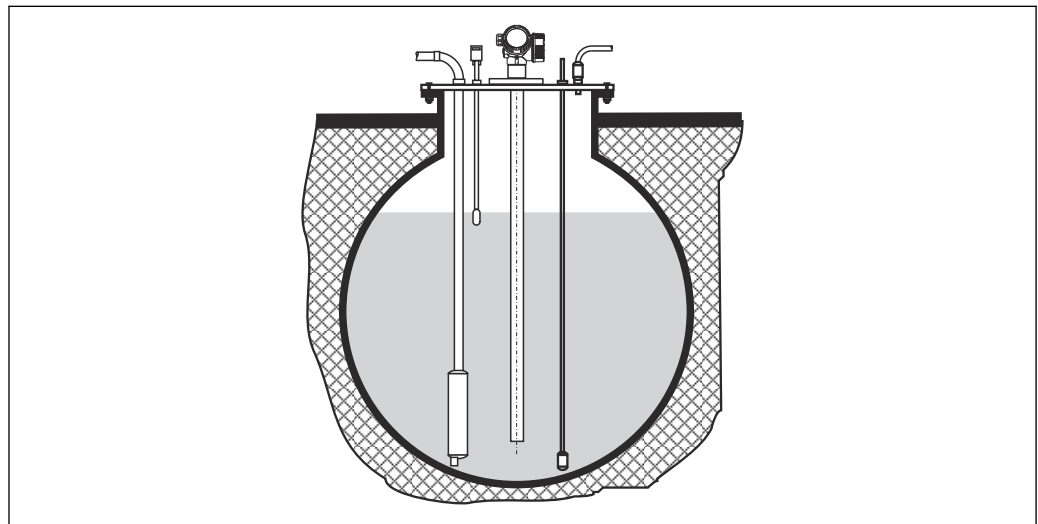
Underground tanks

A0014142

In the case of nozzles with large diameters, use a coaxial probe to avoid reflections at the nozzle wall.

Mounting at an angle

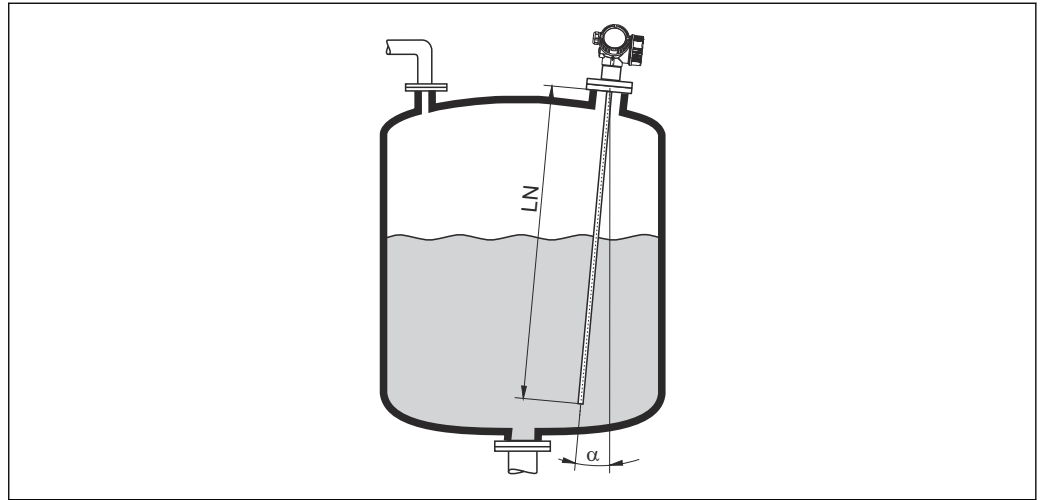

A0014145

- For mechanical reasons, the probe should be installed as vertically as possible.
- If the probe is installed at an angle, the length of the probe must be reduced depending on the angle of installation.
 - α 5°: LN_{max} 4 m (13.1 ft)
 - α 10°: LN_{max} 2 m (6.6 ft)
 - α 30°: LN_{max} 1 m (3.3 ft)

Non-metal vessels

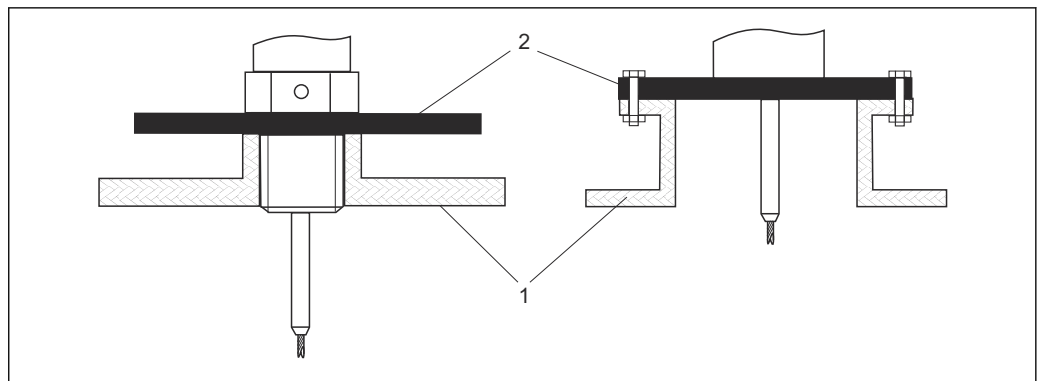

A0012527

- 1 Non-metal vessel
- 2 Metal sheet or metal flange

To ensure good measurement results when mounting on non-metal vessels

- Use a device with a metal flange (minimum size DN50/2").
- Alternatively, mount a metal plate with a diameter of at least 200 mm (8 in) at a right angle to the probe at the process connection.

i A metal surface is not required at the process connection in the case of coaxial probes.

Plastic and glass vessels: Mounting the probe on the outside wall

In the case of plastic and glass vessels, the probe can also be mounted on the outside wall under certain conditions.

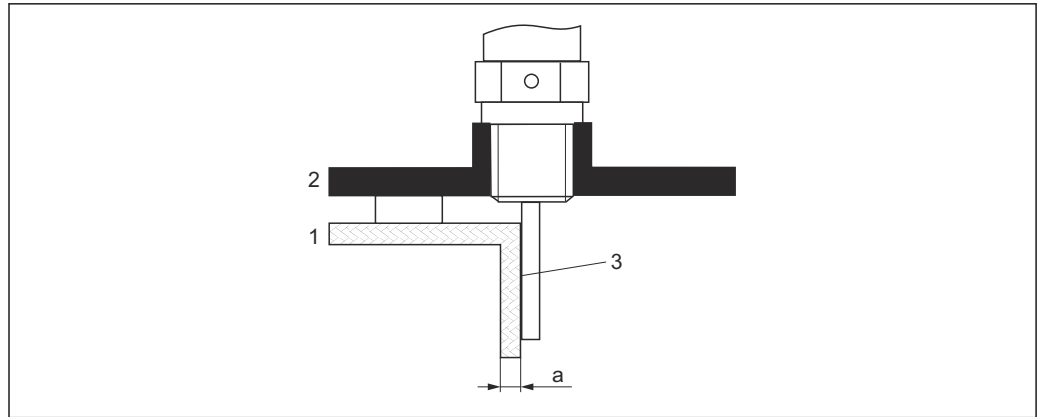

A0014150

- 1 Plastic or glass vessel
- 2 Metal plate with screw-in sleeve
- 3 No space between vessel wall and probe!

Requirements

- Relative permittivity of medium: $\epsilon_r > 7$
- Non-conductive vessel wall.
- Maximum wall thickness (a):
 - Plastic: < 15 mm (0.6 in)
 - Glass: < 10 mm (0.4 in)
- No metal reinforcements on the vessel

Note the following when mounting the device:

- Mount the probe directly on the tank wall without any clearance.
- To protect against interference with the measurement, fit a plastic half pipe with a minimum diameter of 200 mm (8 in) or a similar protective unit on the probe.
- If the vessel diameter is less than 300 mm (12 in):
 - On the opposite side of the vessel, fit a grounding plate that is conductively connected to the process connection and covers around half of the vessel's circumference.
- If the vessel diameter is 300 mm (12 in) or higher:
 - At the process connection, fit a metal plate with a diameter of at least 200 mm (8 in) at a right angle to the probe (see above).

Adjustment when mounting on the vessel exterior

When the probe is mounted on the outside of the vessel wall, the wave velocity of the signal is reduced. There are two ways to compensate for this.

Compensation via gas phase compensation factor

The effect of the dielectric wall is comparable to the effect of a dielectric gas phase and can therefore be corrected in the same way. The correction factor is calculated as the quotient of the actual probe length LN and the probe length measured when the vessel is empty.

i The device determines the position of the end-of-probe signal in the differential curve. Therefore, the value of the measured probe length depends on the mapping curve. In order to obtain a more accurate value, it is advisable to determine the measured probe length manually using the envelope curve display in FieldCare.

1. Parameter Expert → Sensor → Gas phase compensation → GPC mode
 - ↳ Select **Const. GPC factor** option.
2. Parameter Expert → Sensor → Gas phase compensation → Const. GPC factor
 - ↳ Quotient: Enter "(actual probe length)/(measured probe length)".

Compensation via the calibration parameters

If it is necessary to actually compensate for a gas phase, the gas phase compensation function is not available for the correction of external mounting. In this case, the

calibration parameters (**Empty calibration** and **Full calibration**) must be adjusted. In addition, a value that is greater than the actual probe length must be entered in the **Present probe length** parameter. In all three cases, the correction factor is the quotient of the probe length measured when the vessel is empty and the actual probe LN.

i The device searches for the end-of-probe signal in the differential curve. Therefore, the value of the measured probe length depends on the mapping curve. In order to obtain a more accurate value, it is advisable to determine the measured probe length manually using the envelope curve display in FieldCare.

1. Parameter Setup → Empty calibration
 - ↳ Increase the parameter value by the factor "(measured probe length)/(actual probe length)".
2. Parameter Setup → Full calibration
 - ↳ Increase the parameter value by the factor "(measured probe length)/(actual probe length)".
3. Parameter Setup → Advanced setup → Probe settings → Probe length correction → Confirm probe length
 - ↳ Select **Manual input** option.
4. Parameter Setup → Advanced setup → Probe settings → Probe length correction → Present probe length
 - ↳ Enter the measured probe length.

Vessel with thermal insulation

i If process temperatures are high, the device must be included in normal vessel insulation (1) in order to prevent the electronics heating up as a result of thermal radiation or convection. The insulation may not go beyond the points labeled "MAX" in the drawings.

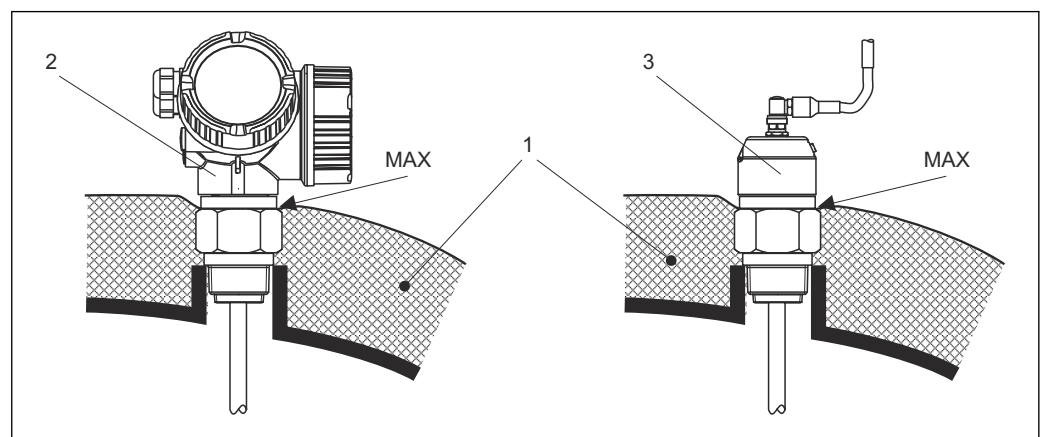

6 Process connection with thread

- 1 Vessel insulation
- 2 Compact device
- 3 Sensor, remote

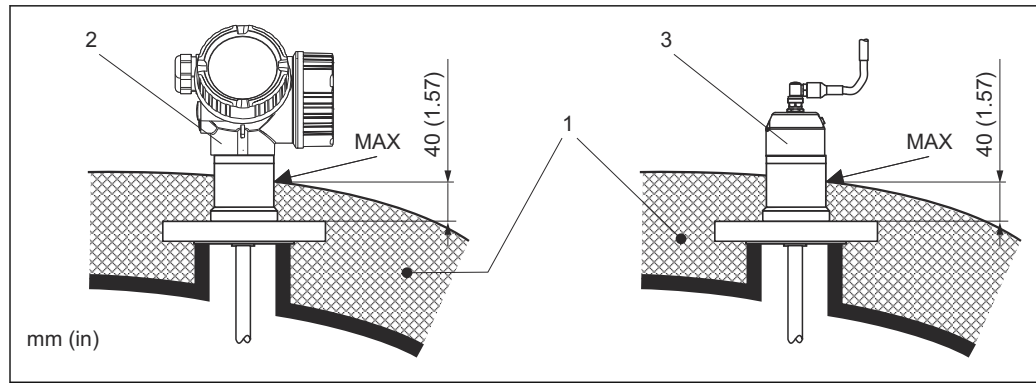

A0014654

7 Process connection with flange

- 1 Vessel insulation
- 2 Compact device
- 3 Sensor, remote

Replacing a displacer system in an existing displacer chamber

FMP51 and FMP54 are a perfect replacement for a conventional displacer system in an existing displacer chamber. Flanges that suit Fisher and Masoneilan displacer chambers are available for this purpose (special product for FMP51; feature 100 of the product structure, options LNJ, LPJ, LQJ for FMP54). Thanks to menu-guided local operation, commissioning the Levelflex only takes a few minutes. Replacement is also possible when partially filled, and wet calibration is not required.

Your benefits:

- No moving parts, therefore zero-maintenance operation.
- Not affected by process influences such as temperature, density, turbulence and vibrations.
- The rod probes can be easily shortened or replaced. Therefore, the probe can also be easily adjusted on site.

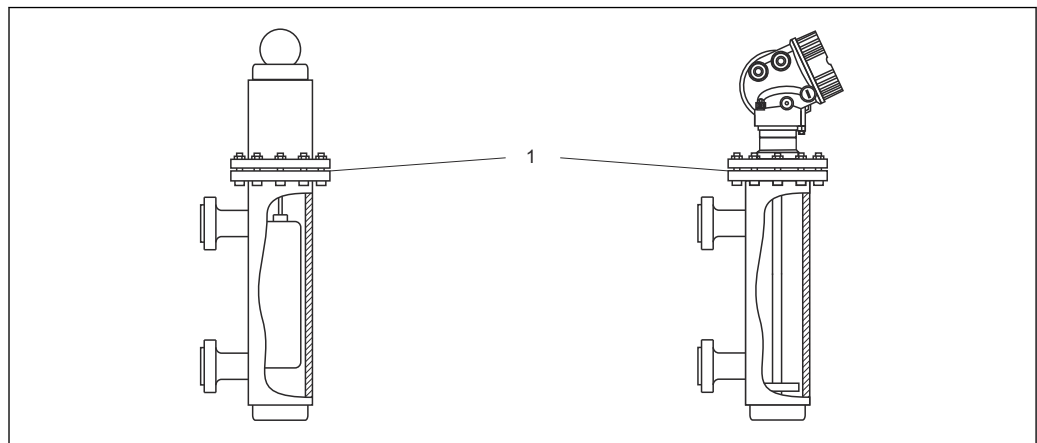

A0014153

1 Flange of the displacer chamber

Planning instructions:

- In normal cases, use a rod probe. When installing into a metal displacer chamber up to 150 mm (5.91 in), you have all the advantages of a coaxial probe.
- Contact between the probe and the side wall must be avoided. Where necessary, use a centering disk or centering star at the bottom end of the probe.
- The centering disk or centering star must be adapted as accurately as possible to the internal diameter of the displacer chamber to also ensure correct operation around the probe end.

Additional information regarding interface measurement

- In the case of oil and water, the centering star should be positioned at the lower edge of the lower outlet (water level).
- There should not be any changes in the diameter of the pipe. Use the coaxial probe if necessary.
- It must be ensured that rod probes do not come into contact with the wall. Where necessary, use a centering star at the end of the probe.
- The non-metal centering stars made of PEEK or PFA are recommended for interface measurements. When using metal centering disks, it is important to ensure that the lower medium covers the centering disk at all times. Otherwise, incorrect interface measurements can result.

6.2 Mounting the device

6.2.1 Tool list

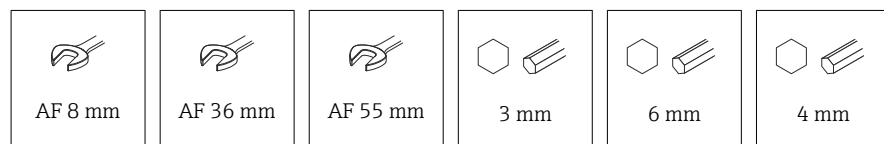

- To shorten rope probes: use a saw or bolt cutters.
- To shorten rod or coaxial probes: use a saw.
- For flanges and other process connections: use an appropriate mounting tool.

6.2.2 Shortening the probe

Shortening rod probes

Rod probes must be shortened if the distance to the vessel floor or outlet cone is less than 10 mm (0.4 in). To shorten, saw off the bottom end of the rod probe.

Shortening rope probes

Rope probes must be shortened if the distance to the vessel floor or outlet cone is less than 150 mm (6 in).

-  Coated rope probes **cannot** be shortened.

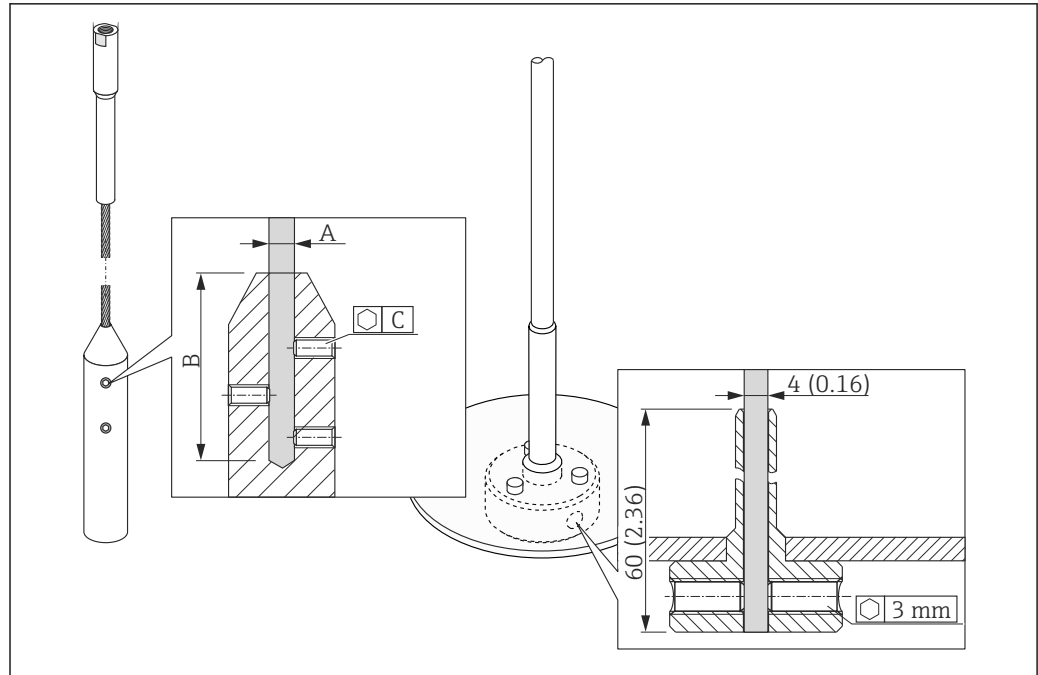

Rope material 316

- A:
4 mm (0.16 in)
- B:
40 mm (1.6 in)
- C:
3 mm; 5 Nm (3.69 lbf ft)

1. Using the Allen key, loosen the setscrews on the rope weight or on the fastener for the centering disk. Note: The setscrews have a clamping coating in order to prevent them from becoming loose accidentally. A higher torque is therefore required to loosen the screws.
2. Remove the released rope from the weight or from the sleeve.
3. Measure off the new rope length.
4. At the point to be shortened, wrap adhesive tape around the rope to prevent it from fraying.
5. Saw off the rope at a right angle or cut it off with a bolt cutter.
6. Insert the rope completely into the weight or sleeve.
7. Screw the setscrews back into place. Due to the clamping coating of the setscrews, it is not necessary to apply a locking compound.

Shortening coaxial probes

Coaxial probes must be shortened if the distance to the vessel floor or outlet cone is less than 10 mm (0.4 in).

- i** Coaxial probes can be shortened by a maximum of 80 mm (3.2 in) from below. They have centering devices on the inside to secure the rod centrally in the pipe. A raised edge holds the centering devices in place on the rod. It is possible to shorten the probe up to approx. 10 mm (0.4 in) below the centering device.

To shorten, saw off the bottom end of the coaxial probe.

Entering the new probe length

After shortening the probe:

1. Switch to the **Probe settings** submenu and perform a probe length correction.
- 2.

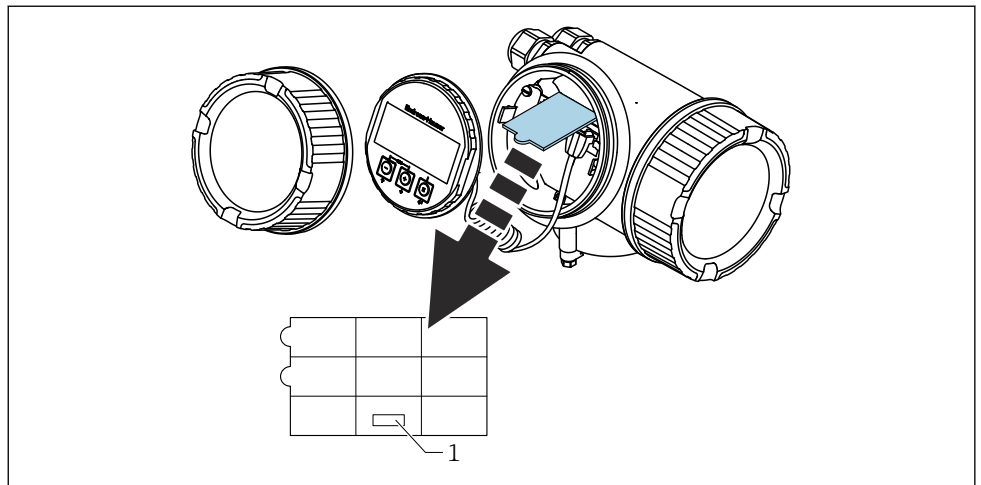

1 Field for the new probe length

For documentation purposes, enter the new probe length into the quick reference guide which can be found in the electronics housing behind the display module.

6.2.3 Mounting the device

Mounting devices with a threaded connection

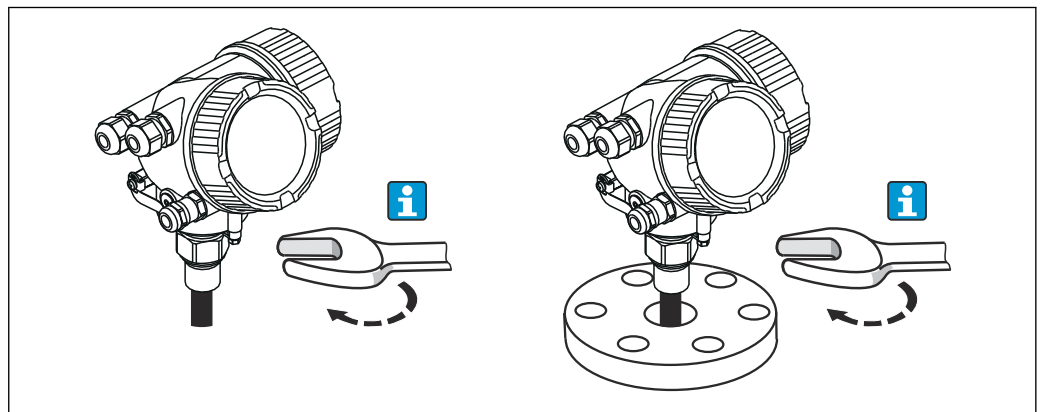

Screw the device with the threaded connection into a sleeve or flange and then secure it to the process vessel via the sleeve/flange.

- i** When screwing into place, turn by the hex bolt only:
 - Thread $\frac{3}{4}$ " : 36 mm
 - Thread $1\frac{1}{2}$ " : 55 mm
- Maximum permissible tightening torque:
 - Thread $\frac{3}{4}$ " : 45 Nm
 - Thread $1\frac{1}{2}$ " : 450 Nm
- Recommended torque when using the supplied aramid fiber seal and 40 bar (580 psi) pressure (FMP51 only; no seal is supplied for FMP54):
 - Thread $\frac{3}{4}$ " : 25 Nm
 - Thread $1\frac{1}{2}$ " : 140 Nm
- When installing in metal vessels, ensure there is good metal contact between the process connection and the vessel.

Mounting devices with a flange

If a seal is used to mount the device, use uncoated metal screws to ensure good electrical contact between the process flange and the probe flange.

Mounting rope probes

NOTICE

Electrostatic discharge can damage the electronics.

- ▶ Ground the housing before lowering the rope probe into the vessel.

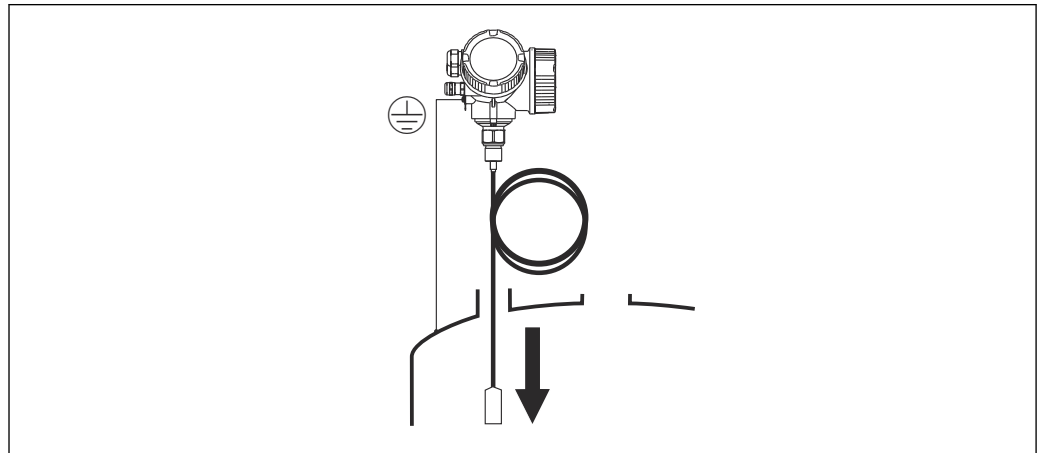

A0012852

Pay attention to the following when introducing the rope probe into the vessel:

- Uncoil the rope slowly and lower it carefully into the vessel.
- Make sure the rope does not bend or buckle.
- Avoid uncontrolled swinging of the weight, as this could damage internal fittings in the vessel.

6.2.4 Mounting the "Sensor, remote" version

i This section only applies for devices with the version "Probe design" = "Sensor, remote" (feature 600, version MB/MC/MD).

The following is included in the delivery with the version "Probe design" = "Remote":

- The probe with process connection
- The electronics housing
- The mounting bracket for mounting the electronics housing on a wall or post
- The connection cable (length as ordered). The cable has one straight plug and one angled at 90°. Depending on the local conditions the angled plug can be connected at the probe or at the electronics housing.

⚠ CAUTION

Mechanical stress can damage the plugs of the connection cable or cause them to become loose.

- ▶ Mount the probe and the electronics housing securely before connecting the connecting cable.
- ▶ Lay the connecting cable in such a way that it is not exposed to mechanical stress. Minimum bending radius: 100 mm (4 in).
- ▶ When connecting the cable, connect the straight plug before you connect the angled plug. Torque for the union nuts of both plugs: 6 Nm.

i The probe, electronics and connection cable are mutually compatible and bear a common serial number. Only components with the same serial number may be connected to one another.

In the event of strong vibrations, a locking compound, e.g. Loctite 243, can also be used on the plug-in connectors.

Mounting the electronics housing

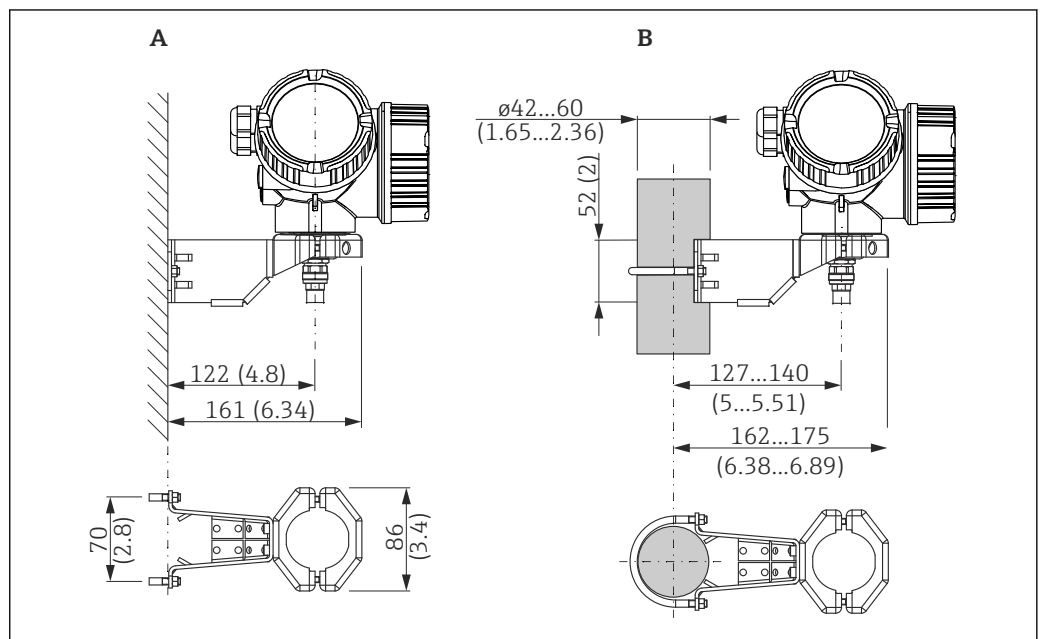

8 Mounting the electronics housing with the mounting bracket. Unit of measurement mm (in)

A Wall mounting

B Post mounting

Connecting the connecting cable



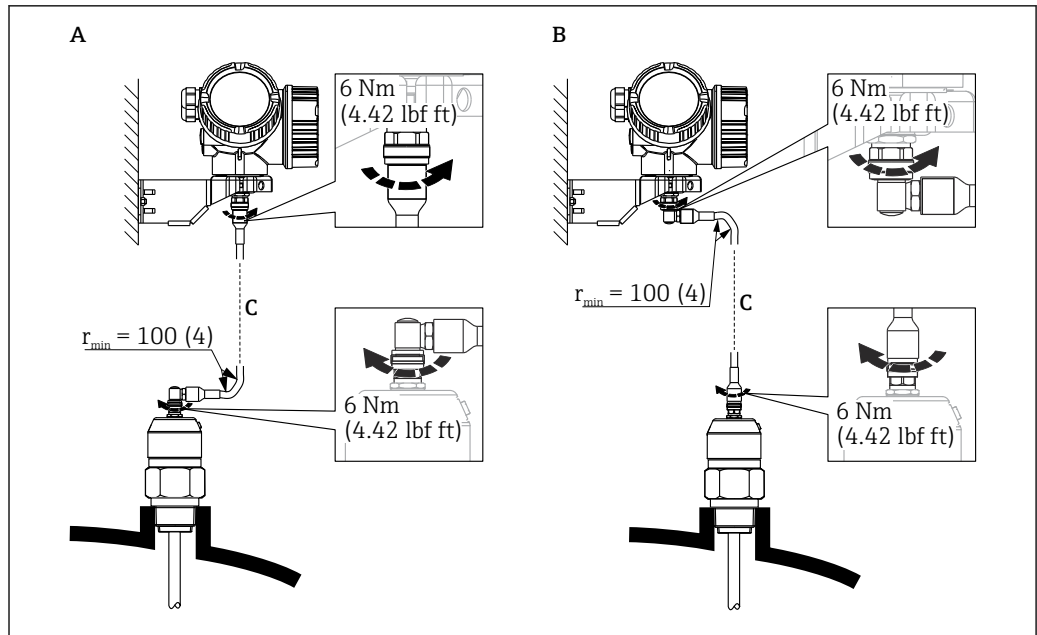

A0014794

9 Connecting the connecting cable. The cable can be connected in the following ways: Unit of measurement mm (in)

- A Angled plug at the probe
- B Angled plug at the electronics housing
- C Length of the remote cable as ordered

6.2.5 Turning the transmitter housing

To provide easier access to the connection compartment or display module, the transmitter housing can be turned:

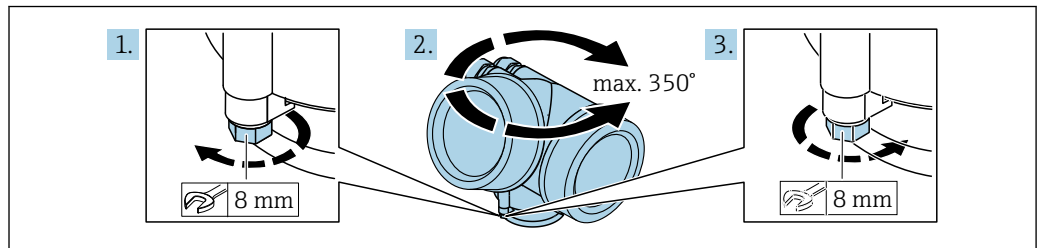

A0032242

1. Unscrew the securing screw using an open-ended wrench.
2. Rotate the housing in the desired direction.
3. Tighten the securing screw (1.5 Nm for plastic housings; 2.5 Nm for aluminum or stainless steel housing).

6.2.6 Turning the display

Opening the cover

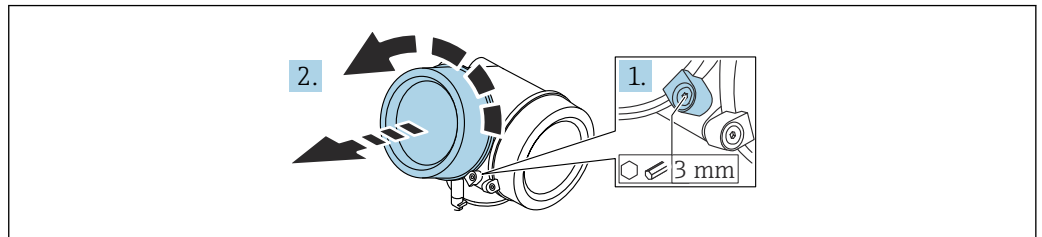

A0021430

1. Loosen the screw of the securing clamp of the electronics compartment cover using an Allen key (3 mm) and turn the clamp 90° counterclockwise.
2. Unscrew the electronics compartment cover and check the cover seal; replace it if necessary.

Turning the display module

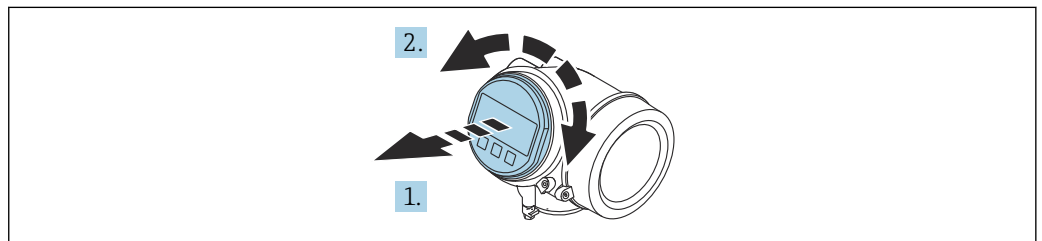

A0036401

1. Pull out the display module with a gentle rotational movement.
2. Turn the display module to the desired position: Max. $8 \times 45^\circ$ in each direction.
3. Feed the coiled cable into the gap between the housing and main electronics module and plug the display module into the electronics compartment until it engages.

Closing the cover of the electronics compartment

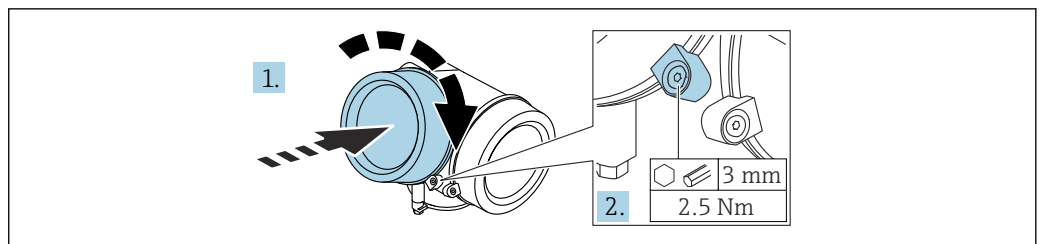

A0021451

1. Screw down the cover of the electronics compartment.
2. Turn the securing clamp 90° in the clockwise direction and, using an Allen key (3 mm), tighten the screw of the securing clamp on the electronics compartment cover with 2.5 Nm.

6.3 Post-mounting check

- Is the device free from damage (visual inspection)?
- Are the measuring point identification and labeling correct (visual inspection)?

- Is the measuring device protected against precipitation and sunlight?
- Are the securing screws and cover lock tightened securely?
- Does the measuring device comply with the measuring point specifications?

For example:

- Process temperature
- Process pressure
- Ambient temperature
- Measuring range

7 Electrical connection

7.1 Connecting requirements

7.1.1 Terminal assignment

Terminal assignment, 4-wire: 4 to 20 mA HART (90 to 253 V_{AC})

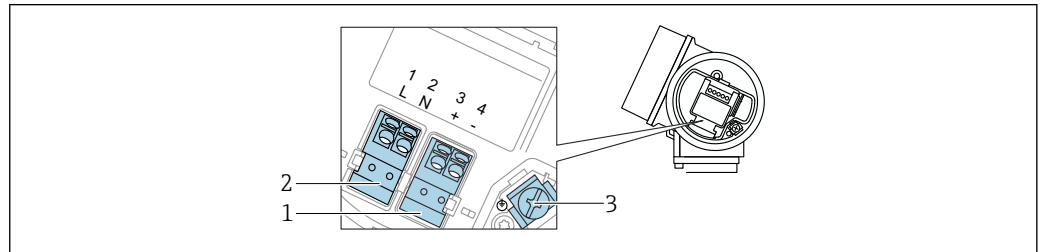

10 Terminal assignment, 4-wire: 4 to 20 mA HART (90 to 253 V_{AC})

- 1 Connection 4 to 20 mA HART (active): terminals 3 and 4
- 2 Power supply connection: terminals 1 and 2
- 3 Terminal for cable shield

CAUTION

To ensure electrical safety:

- ▶ Do not disconnect the protective ground connection.
 - ▶ Disconnect the device from the supply voltage before disconnecting the protective ground.
- i** Connect protective ground to the inner ground terminal (3) before connecting the power supply. If necessary, connect the potential matching line to the outer ground terminal.
 - i** In order to ensure electromagnetic compatibility (EMC): do **not** ground the device exclusively via the protective ground conductor of the supply cable. Instead, the functional grounding must also be connected to the process connection (flange or threaded connection) or to the external ground terminal.
 - i** An easily accessible power switch must be installed in the proximity of the device. The switch must be marked as a disconnecter for the device (61010IEC/).

7.1.2 Cable specification

- Power line: Standard device cable
- Modbus connection : A shielded cable is recommended. Observe grounding concept of the plant.

7.1.3 Device plug

- i** In the case of the device versions with a plug, the housing does not need to be opened to connect the signal cable.

7.1.4 Supply voltage

Supply voltage	10.5 to 29 V _{DC}
Ripple	1 V _{SS} (< 100 Hz); 10 mV _{SS} (> 100 Hz)

7.1.5 Overvoltage protection

If the device is intended to be used for level measurement of flammable liquids which requires overvoltage protection in accordance with DIN EN 60079-14, test standard 60060-1 (10 kA, pulse $\frac{8}{20}$ μ s): use the overvoltage protection module.

Integrated overvoltage protection module

An integrated overvoltage protection module is available for the HART 2-wire devices as well as for PROFIBUS PA and FOUNDATION Fieldbus.

Product structure: Feature 610 "Accessory mounted", option NA "Overvoltage protection".

Resistance per channel	Maximum $2 \times 0.5 \Omega$
DC sparkover voltage	400 to 700 V
Trip surge voltage	< 800 V
Capacity at 1 MHz	< 1.5 pF
Nominal discharge current (8/20 μ s)	10 kA

External overvoltage protection module

The HAW562 or HAW569 for example from Endress+Hauser are suitable options for external overvoltage protection.



More information is provided in the following documents:

- HAW562: TI01012K
- HAW569: TI01013K

7.2 Connecting the device

⚠ WARNING

Explosion hazard!

- ▶ Comply with applicable national standards.
- ▶ Comply with the specifications in the Safety Instructions (XA).
- ▶ Use specified cable glands only.
- ▶ Check to ensure that the power supply matches the information on the nameplate.
- ▶ Switch off the power supply before connecting the device.
- ▶ Connect the potential matching line to the outer ground terminal before applying the power supply.

Required tools/accessories:

- For devices with a cover lock: Allen key AF3
- Wire stripper
- When using stranded cables: One ferrule for every wire to be connected.

7.2.1 Opening cover

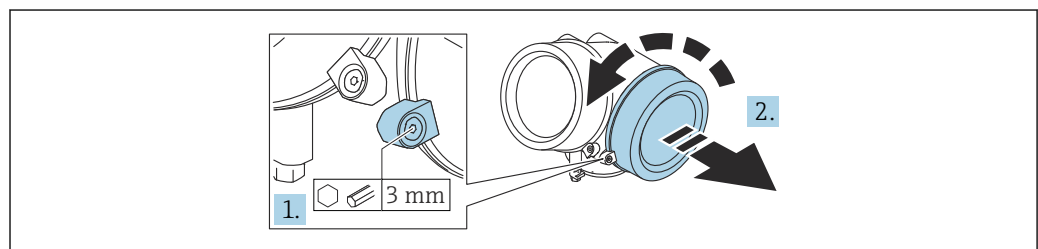

A0021490

1. Loosen the screw of the securing clamp of the connection compartment cover using an Allen key (3 mm) and turn the clamp 90 ° counterclockwise.
2. Unscrew the connection compartment cover and check the cover seal; replace it if necessary.

7.2.2 Connecting

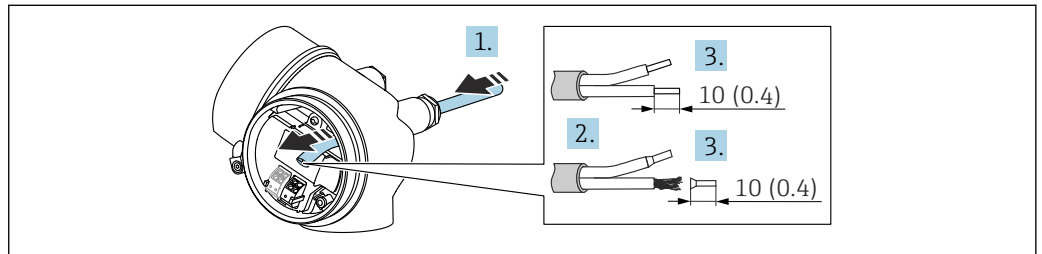

A0036418

11 Unit: mm (in)

1. Push the cable through the cable entry . To ensure tight sealing, do not remove the sealing ring from the cable entry.
2. Remove the cable sheath.
3. Strip the cable ends 10 mm (0.4 in). In the case of stranded cables, also fit ferrules.
4. Firmly tighten the cable glands.
5. Connect the cable according to the terminal assignment.

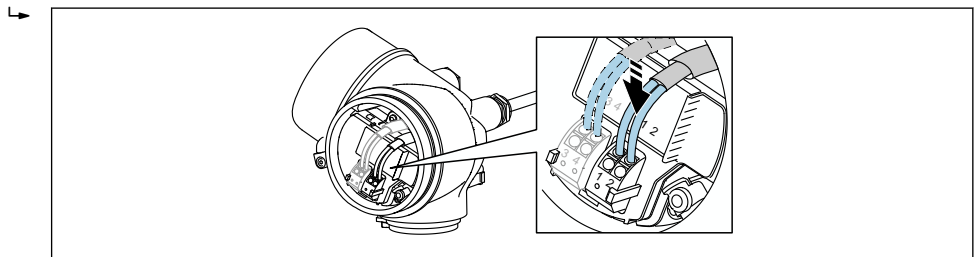

A0034682

6. If using shielded cables: Connect the cable shield to the ground terminal.

7.2.3 Plug-in spring-force terminals

The electrical connection of device versions without an integrated overvoltage protection is via plug-in spring-force terminals. Rigid conductors or flexible conductors with ferrules can be inserted directly into the terminal without using the lever, and create a contact automatically.

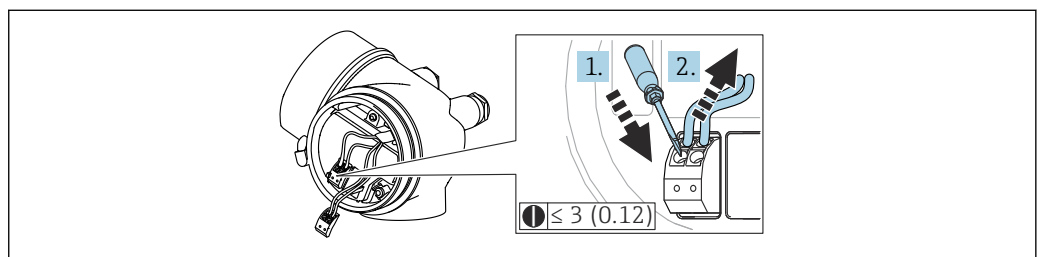

A0013661

12 Unit: mm (in)

To remove the cable from the terminal again:

1. Use a flat-blade screwdriver ≤ 3 mm (0.12 in) to press down on the slot between the two terminal holes.
2. Simultaneously pull the cable end out of the terminal.

7.2.4 Closing the cover of the connection compartment

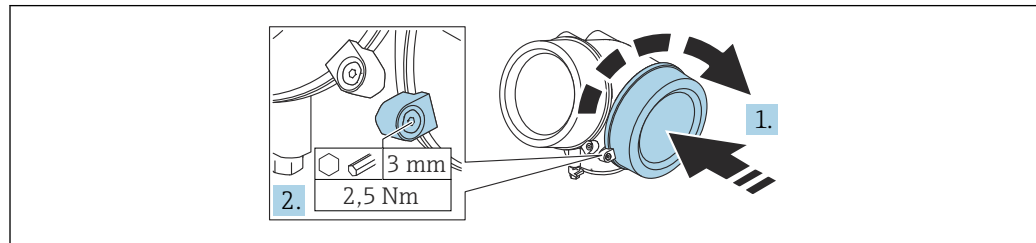

A0021491

1. Screw down the cover of the connection compartment.
2. Turn the securing clamp 90° in the clockwise direction and, using an Allen key (3 mm), tighten the screw of the securing clamp on the connection compartment cover with 2.5 Nm.

7.3 Post-connection check

- Is the device or cable undamaged (visual inspection)?
- Do the cables used comply with the requirements?
- Do the mounted cables have adequate strain relief?
- Are all the cable glands installed, firmly tightened and leak-tight?
- Does the supply voltage match the specifications on the nameplate?
- Is the terminal assignment correct?
- If necessary, has a protective ground connection been established?
- If supply voltage is present, is the device ready for operation and do values appear on the display module?
- Are all the housing covers installed and tightened?
- Is the securing clamp firmly tightened?

8 Operation options

8.1 Overview of operation options

8.1.1 Access to operating menu via local display

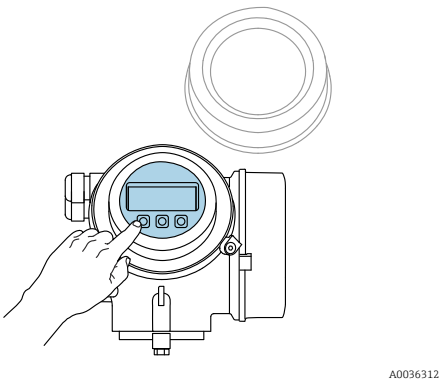
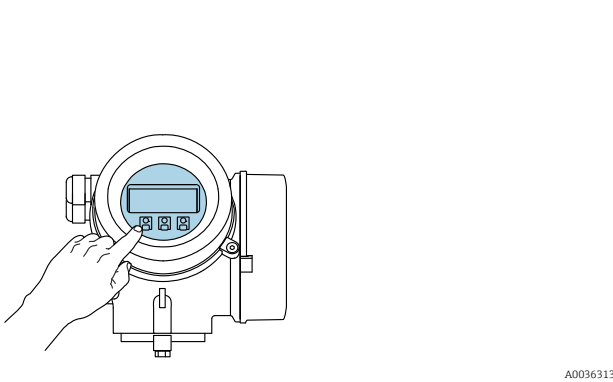
Operation with	Pushbuttons	Touch control
Order code for "Display; operation"	Option C "SD02"	Option E "SD03"
		
Display elements	4-line display Format for displaying measured variables and status variables can be individually configured Permitted ambient temperature for the display: -20 to +70 °C (-4 to +158 °F) The readability of the display may be impaired at temperatures outside the temperature range.	4-line display White background lighting; switches to red in event of device errors
Operating elements	Onsite operation with 3 pushbuttons (⊕, ⊖, ⊞) Operating elements also accessible in various hazardous areas	External operation via touch control; 3 optical keys: ⊕, ⊖, ⊞
Additional functionality	Data backup function The device configuration can be saved in the display module. Data comparison function The device configuration saved in the display module can be compared to the current device configuration. Data transfer function The transmitter configuration can be transmitted to another device using the display module.	

Operation with remote display and operating module FHX50

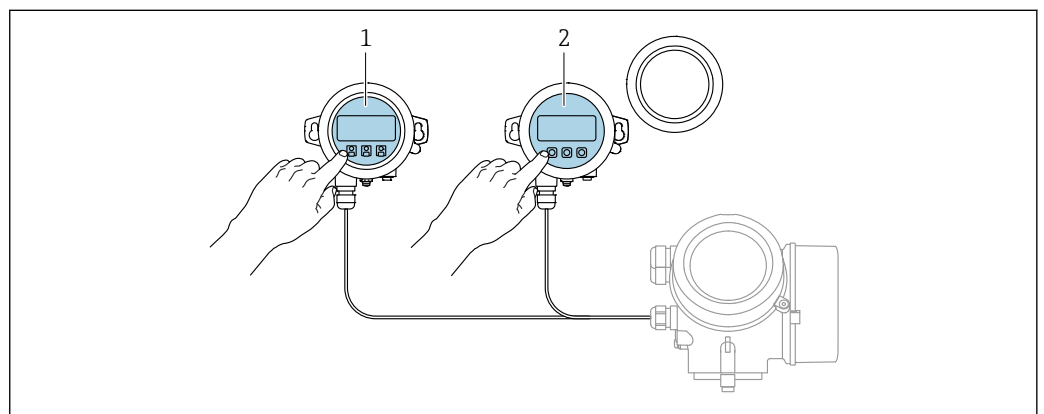

13 FHX50 operating options

- 1 Display and operating module SD03, optical keys; can be operated through the glass of the cover
- 2 Display and operating module SD02, push buttons; cover must be removed

8.1.2 Access to the operating menu via the operating tool

Via service interface (CDI)

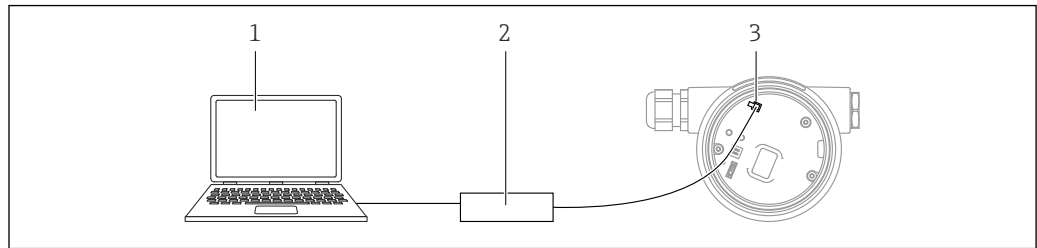

A0039148

- 1 Computer with FieldCare/DeviceCare operating tool
- 2 Commubox
- 3 Service interface (CDI) of the measuring instrument (= Endress+Hauser Common Data Interface)

Operation via Bluetooth® wireless technology

Requirements

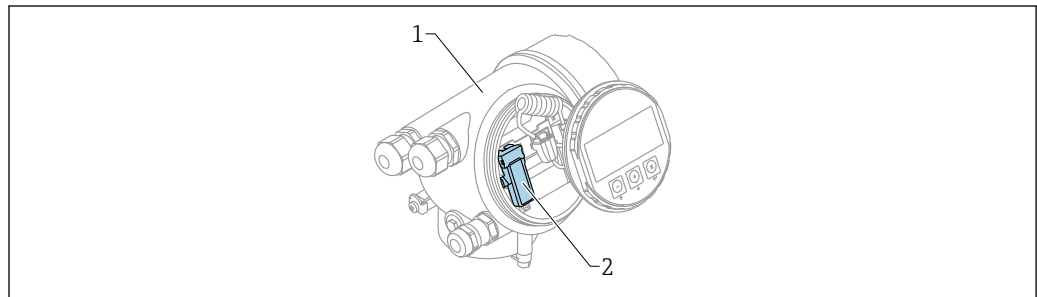

A0036790

14 Device with Bluetooth module

- 1 Electronics housing of the device
- 2 Bluetooth module

This operation option is only available for devices with Bluetooth module. There are the following options:

- The device has been ordered with a Bluetooth module:
Feature 610 "Accessory Mounted", option NF "Bluetooth"
- The Bluetooth module has been ordered as an accessory (ordering number: 71377355) and has been mounted. See Special Documentation SD02252F.

Operation via SmartBlue (app)

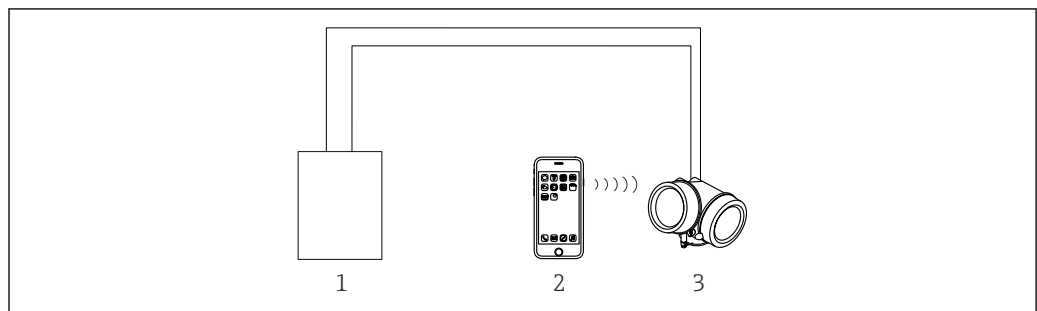

A0034939

15 Operation via SmartBlue (app)

- 1 Transmitter power supply unit
- 2 Smartphone / tablet with SmartBlue (app)
- 3 Transmitter with Bluetooth module

8.2 Structure and function of the operating menu

8.2.1 Structure of the operating menu

Menu	Submenu / parameter	Meaning
	Language ¹⁾	Defines the operating language of the local display
Commissioning ²⁾		Launches the interactive wizard for guided commissioning. Additional settings generally do not need to be made in the other menus when the wizard is finished.
Setup	Parameter 1 ... Parameter N	Once values have been set for these parameters, the measurement should usually be fully configured.
	Advanced setup	Contains additional submenus and parameters: <ul style="list-style-type: none"> ■ For more accurate configuration of the measurement (adaptation to special measuring conditions). ■ For converting the measured value (scaling, linearization). ■ For scaling the output signal.
Diagnostics	Diagnostic list	Contains up to 5 currently active error messages.
	Event logbook ³⁾	Contains the last 20 messages (which are no longer active).
	Device information	Contains information for identifying the device.
	Measured values	Contains all current measured values.
	Data logging	Contains the history of the individual measured values
	Simulation	Is used to simulate measured values or output values.
	Device check	Contains all parameters needed to check the measurement capability of the device.
	Heartbeat ⁴⁾	Contains all the wizards for the Heartbeat Verification and Heartbeat Monitoring application packages.
Expert ⁵⁾ Contains all the parameters of the device (including those already contained in one of the other menus). This menu is organized according to the function blocks of the device. The parameters of the Expert menu are described in:	System	Contains all higher-level device parameters that do not affect measurement or measured value communication.
	Sensor	Contains all parameters for configuring the measurement.
	Output	Contains all parameters to configure the switch output (PFS)

Menu	Submenu / parameter	Meaning
	Communication	Contains all parameters needed to configure the digital communication interface.
	Diagnostics	Contains all parameters needed to detect and analyze operational errors.

- 1) If you are operating via operating tools (e.g. FieldCare), the "Language" parameter is located under "Setup → Advanced setup → Display"
- 2) Only if operating via an FDT/DTM system
- 3) Only available if operating via the local display
- 4) Only available if operating via DeviceCare or FieldCare
- 5) When you call up the "Expert" menu, you are always asked for an access code. If a customer-specific access code has not been defined, "0000" must be entered.

8.2.2 User roles and related access authorization

The two user roles **Operator** and **Maintenance** have different write access to the parameters if a device-specific access code has been defined. This protects the device configuration via the local display from unauthorized access → 48.

Access authorization to parameters

User role	Read access		Write access	
	Without access code (from the factory)	With access code	Without access code (from the factory)	With access code
Operator	✓	✓	✓	--
Maintenance	✓	✓	✓	✓

If an incorrect access code is entered, the user obtains the access rights of the **Operator** role.

 The user role with which the user is currently logged on is indicated by the **Access status display** parameter (if operating via the local display) or the **Access status tooling** parameter (if operating via an operating tool).

8.2.3 Data access - Security

Write protection via access code

Using the device-specific access code, the parameters for the measuring instrument configuration are write-protected and their values can no longer be changed via local operation.

Defining the access code via the local display

1. Navigate to: Setup → Advanced setup → Administration → Define access code → Define access code
2. Define a max. 4-digit numeric code as an access code.
3. Repeat the numeric code in the **Confirm access code** parameter to confirm it.
 - ↳ The -symbol appears in front of all write-protected parameters.



Defining the access code via operating tool (e.g. FieldCare)

1. Navigate to: Setup → Advanced setup → Administration → Define access code
2. Define a max. 4-digit numeric code as an access code.
 - ↳ Write protection is active.

Parameters that can always be changed

The write protection does not include certain parameters that do not affect the measurement. Despite the defined access code, these parameters can always be modified even if the other parameters are locked.



The device automatically locks the write-protected parameters again if a key is not pressed for 10 minutes in the navigation and editing view. If the user goes from the navigation and editing mode back to the measured value display mode, the device automatically locks the write-protected parameters after 60 s.

-  If write access is activated via an access code, it can be only be deactivated again via this access code.
- In the "Description of Device Parameters" documents, each write-protected parameter is identified with the -symbol.

Disabling write protection via access code

If the  symbol appears in front of a parameter on the local display, the parameter is write-protected by a device-specific access code and its value cannot currently be changed via the local display.

The locking of the write access via local operation can be disabled by entering the device-specific access code.

1. After you press , the input prompt for the access code appears.
2. Enter the access code.
 - ↳ The  symbol in front of the parameters disappears; all previously write-protected parameters are now re-enabled.

Deactivation of the write protection via access code

Via local display

1. Navigate to: Setup → Advanced setup → Administration → Define access code → Define access code
2. Enter **0000**.
3. Repeat **0000** in the **Confirm access code** parameter to confirm.
 - ↳ The write protection is deactivated. Parameters can be changed without entering an access code.

Via an operating tool (e.g. FieldCare)

1. Navigate to: Setup → Advanced setup → Administration → Define access code
2. Enter **0000**.
 - ↳ The write protection is deactivated. Parameters can be changed without entering an access code.

Write protection via write protection switch

Unlike parameter write protection via a user-specific access code, this allows the user to lock write access to the entire operating menu - apart from the **"Contrast display" parameter**.

The parameter values are now read only and cannot be edited any more (exception **"Contrast display" parameter**):

- Via local display
- Via MODBUS RS485 protocol

1. Loosen the securing clamp.
2. Unscrew the electronics compartment cover.

3. Pull out the display module with a gentle rotational movement. To make it easier to access the write protection switch, attach the display module to the edge of the electronics compartment.

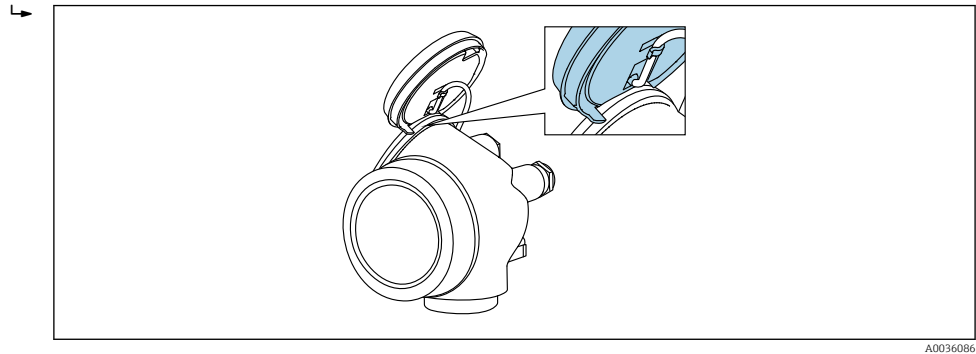

4. Setting the write protection switch (WP) on the main electronics module to the **ON** position enables hardware write protection. Setting the write protection switch (WP) on the main electronics module to the **OFF** position (factory setting) disables hardware write protection.

↳ If the hardware write protection is enabled: The **Hardware locked** option is displayed in the **Locking status** parameter. In addition, on the local display the  symbol appears in front of the parameters in the header of the operational display and in the navigation view.

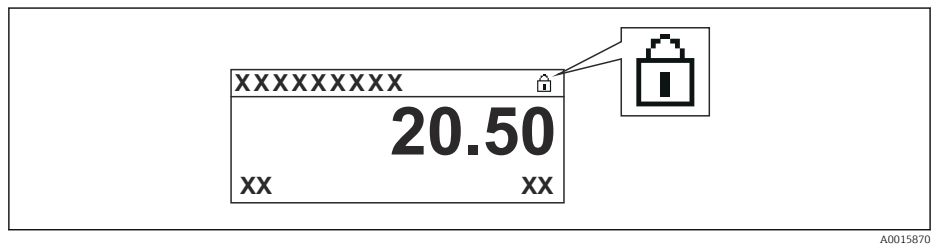

If hardware write protection is disabled: No option is displayed in the **Locking status** parameter. On the local display, the  symbol disappears from in front of the parameters in the header of the operational display and in the navigation view.

5. Feed the cable into the gap between the housing and main electronics module and plug the display module into the electronics compartment in the desired direction until it engages.
6. Reassemble the transmitter in the reverse order.

Enabling and disabling the keypad lock

Access to the entire operating menu via local operation can be locked via the keypad lock. When access is locked, it is no longer possible to navigate through the operating menu or change the values of individual parameters. Users can only read the measured values on the operational display.

The keypad lock is switched on and off via a context menu.

Switching on the keypad lock

SD03 display module only

The keypad lock is switched on automatically:

- If the device has not been operated via the display for > 1 minute.
- Each time the device is restarted.

Switching on the keypad lock manually

1. The device is in the measured value display.
Press  for at least 2 seconds.
 - ↳ A context menu appears.
2. Select the **Keylock on** option in the context menu.
 - ↳ The keypad lock is switched on.

 If the user attempts to access the operating menu while the keypad lock is active, the message **Keylock on** appears.

Switching off the keypad lock

1. The keypad lock is switched on.
Press  for at least 2 seconds.
 - ↳ A context menu appears.
2. Select the **Keylock off** option in the context menu.
 - ↳ The keypad lock is switched off.

Bluetooth® wireless technology

Signal transmission via Bluetooth® wireless technology uses a cryptographic technique tested by the Fraunhofer Institute

- The device is not visible via *Bluetooth*® wireless technology without the SmartBlue app
- Only one point-to-point connection is established between **one** sensor and **one** smartphone or tablet

8.3 Display and operating module

8.3.1 Display format

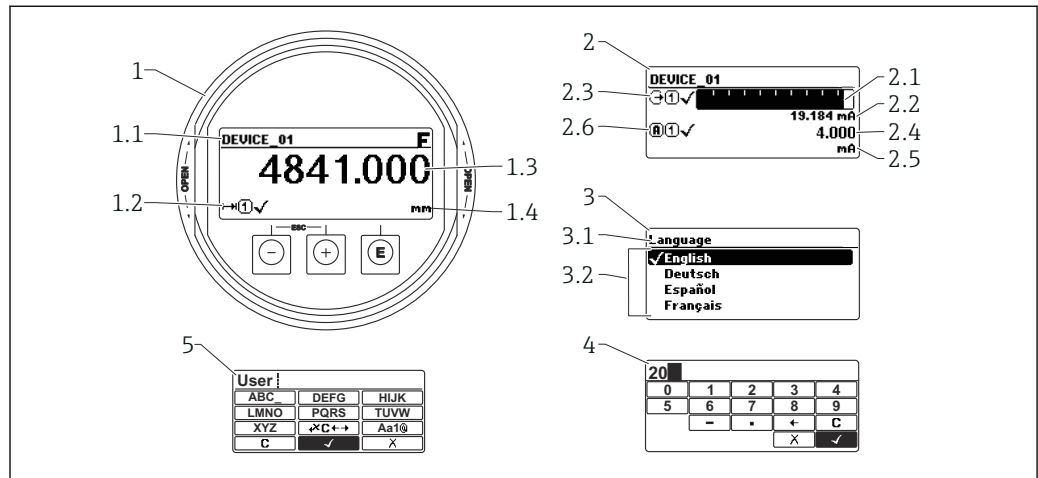





A0012635

 16 Display format on the display and operating module

- 1 Measured value display (1 value max. size)
- 1.1 Header containing tag and error symbol (if an error is active)
- 1.2 Measured value symbols
- 1.3 Measured value
- 1.4 Unit
- 2 Measured value display (bar graph + 1 value)
- 2.1 Bargraph for measured value 1
- 2.2 Measured value 1 (including unit)
- 2.3 Measured value symbols for measured value 1
- 2.4 Measured value 2
- 2.5 Unit for measured value 2
- 2.6 Measured value symbols for measured value 2
- 3 Parameter display (here: parameter with drop-down list)
- 3.1 Header containing parameter name and error symbol (if an error is active)
- 3.2 Drop-down list; marks the current parameter value.
- 4 Input matrix for numbers
- 5 Input matrix for alphanumeric and special characters



Display symbols for the submenus

Symbol	Meaning
 <small>A0018367</small>	Display/operat. Is displayed: <ul style="list-style-type: none"> ▪ In the main menu next to the "Display/operat." selection ▪ In the header on the left in the "Display/operat." menu
 <small>A0018364</small>	Setup Is displayed: <ul style="list-style-type: none"> ▪ In the main menu next to the "Setup" selection ▪ In the header on the left in the "Setup" menu
 <small>A0018365</small>	Expert Is displayed: <ul style="list-style-type: none"> ▪ In the main menu next to the "Expert" selection ▪ In the header on the left in the "Expert" menu
 <small>A0018366</small>	Diagnostics Is displayed: <ul style="list-style-type: none"> ▪ In the main menu next to the "Diagnostics" selection ▪ In the header on the left in the "Diagnostics" menu











Status signals

Symbol	Meaning
F <small>A0032902</small>	"Failure" A device error has occurred. The measured value is no longer valid.
C <small>A0032903</small>	"Function check" The device is in the service mode (e.g. during a simulation).
S <small>A0032904</small>	"Out of specification" The device is operated: <ul style="list-style-type: none"> ▪ Outside its technical specifications (e.g. during startup or cleaning) ▪ Outside the configuration performed by the user (e.g. level outside the configured range)
M <small>A0032905</small>	"Maintenance required" Maintenance is required. The measured value is still valid.



Display symbols for locking status





Symbol	Meaning
 <small>A0013148</small>	Read-only parameter The parameter shown is only for display purposes and cannot be edited.
 <small>A0013150</small>	Device locked <ul style="list-style-type: none"> ▪ In front of a parameter name: The device is locked via software and/or hardware. ▪ In the header of the measured value screen: The device is locked via hardware.

Measured value symbols

Symbol	Meaning
Measured values	
 A0032892	Level
 A0032893	Distance
 A0032908	Current output
 A0032894	Measured current
 A0032895	Terminal voltage
 A0032896	Electronics or sensor temperature
Measuring channels	
 A0032897	Measuring channel 1
 A0032898	Measuring channel 2
Status of the measured value	
 A0018361	"Alarm" status Measurement is interrupted. The output assumes the defined alarm condition. A diagnostic message is generated.
 A0018360	"Warning" status The device continues to measure. A diagnostic message is generated.

8.3.2 Operating elements

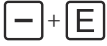
Operating key	Meaning
 A0018330	Minus key <i>In a menu, submenu</i> Moves the selection bar upwards in a picklist. <i>In the text and numeric editor</i> In the input screen, moves the selection bar to the left (backwards).
 A0018329	Plus key <i>In a menu, submenu</i> Moves the selection bar downwards in a picklist. <i>In the text and numeric editor</i> In the input screen, moves the selection bar to the right (forwards).

Operating key	Meaning
 <small>A0018328</small>	<p>Enter key</p> <p><i>For measured value display</i></p> <ul style="list-style-type: none"> Pressing the key briefly opens the operating menu. Pressing the key for 2 s opens the context menu. <p><i>In a menu, submenu</i></p> <ul style="list-style-type: none"> Pressing the key briefly: <ul style="list-style-type: none"> Opens the selected menu, submenu or parameter. Pressing the key for 2 s for parameter: <ul style="list-style-type: none"> If present, opens the help text for the function of the parameter. <p><i>In the text and numeric editor</i></p> <ul style="list-style-type: none"> Pressing the key briefly: <ul style="list-style-type: none"> Opens the selected group. Carries out the selected action. Pressing the key for 2 s confirms the edited parameter value.
 <small>A0032909</small>	<p>Escape key combination (press keys simultaneously)</p> <p><i>In a menu, submenu</i></p> <ul style="list-style-type: none"> Pressing the key briefly: <ul style="list-style-type: none"> Exits the current menu level and takes you to the next higher level. If help text is open, closes the help text of the parameter. Pressing the key for 2 s returns you to the measured value display ("home position"). <p><i>In the text and numeric editor</i></p> <p>Closes the text or numeric editor without applying changes.</p>
 <small>A0032910</small>	<p>Minus/Enter key combination (press and hold down the keys simultaneously)</p> <p>Reduces the contrast (brighter setting).</p>
 <small>A0032911</small>	<p>Plus/Enter key combination (press and hold down the keys simultaneously)</p> <p>Increases the contrast (darker setting).</p>



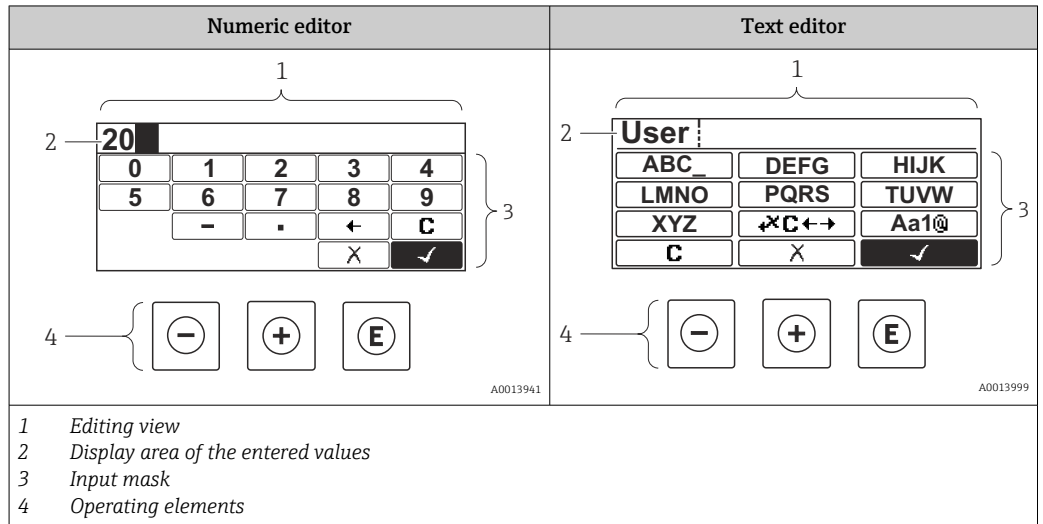



8.3.3 Entering numbers and text









Input mask

The following input and operating symbols are available in the input mask of the numeric and text editor:

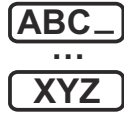

Numeric editor



Symbol	Meaning
 <small>A0013998</small>	Selection of numbers from 0 to 9
 <small>A0016619</small>	Inserts decimal separator at the cursor position.
 <small>A0016620</small>	Inserts minus sign at the cursor position.
 <small>A0013985</small>	Confirms selection.
 <small>A0016621</small>	Moves the input position one position to the left.
 <small>A0013986</small>	Exits the input without applying the changes.
 <small>A0014040</small>	Clears all entered characters.

Text editor

Symbol	Meaning
 <small>A0013997</small>	Selection of letters from A to Z
 <small>A0013981</small>	Toggle <ul style="list-style-type: none"> ▪ Between upper-case and lower-case letters ▪ For entering numbers ▪ For entering special characters
 <small>A0013985</small>	Confirms selection.
 <small>A0013987</small>	Switches to the selection of the correction tools.
 <small>A0013986</small>	Exits the input without applying the changes.
 <small>A0014040</small>	Clears all entered characters.

Text correction under 

Symbol	Meaning
 <small>A0032907</small>	Clears all entered characters.
 <small>A0018324</small>	Moves the input position one position to the right.

 <small>A0018326</small>	Moves the input position one position to the left.
 <small>A0032906</small>	Deletes one character immediately to the left of the input position.

8.3.4 Opening the context menu

Using the context menu, the user can call up the following menus quickly and directly from the operational display:

- Setup
- Conf. backup disp.
- Envelope curve
- Keylock on



Calling up and closing the context menu

The user is in the operational display.

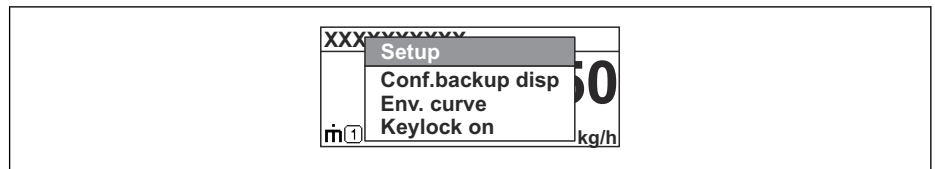

1. Press  for 2 s.
 - ↳ The context menu opens.



A0037872

2. Press  +  simultaneously.
 - ↳ The context menu is closed and the operational display appears.

Calling up the menu via the context menu

1. Open the context menu.
2. Press  to navigate to the desired menu.
3. Press  to confirm the selection.
 - ↳ The selected menu opens.

8.3.5 Envelope curve display on the display and operating module

In order to assess the measuring signal, the envelope curve and - if a mapping has been recorded - the mapping curve can be shown on the display and operating module:

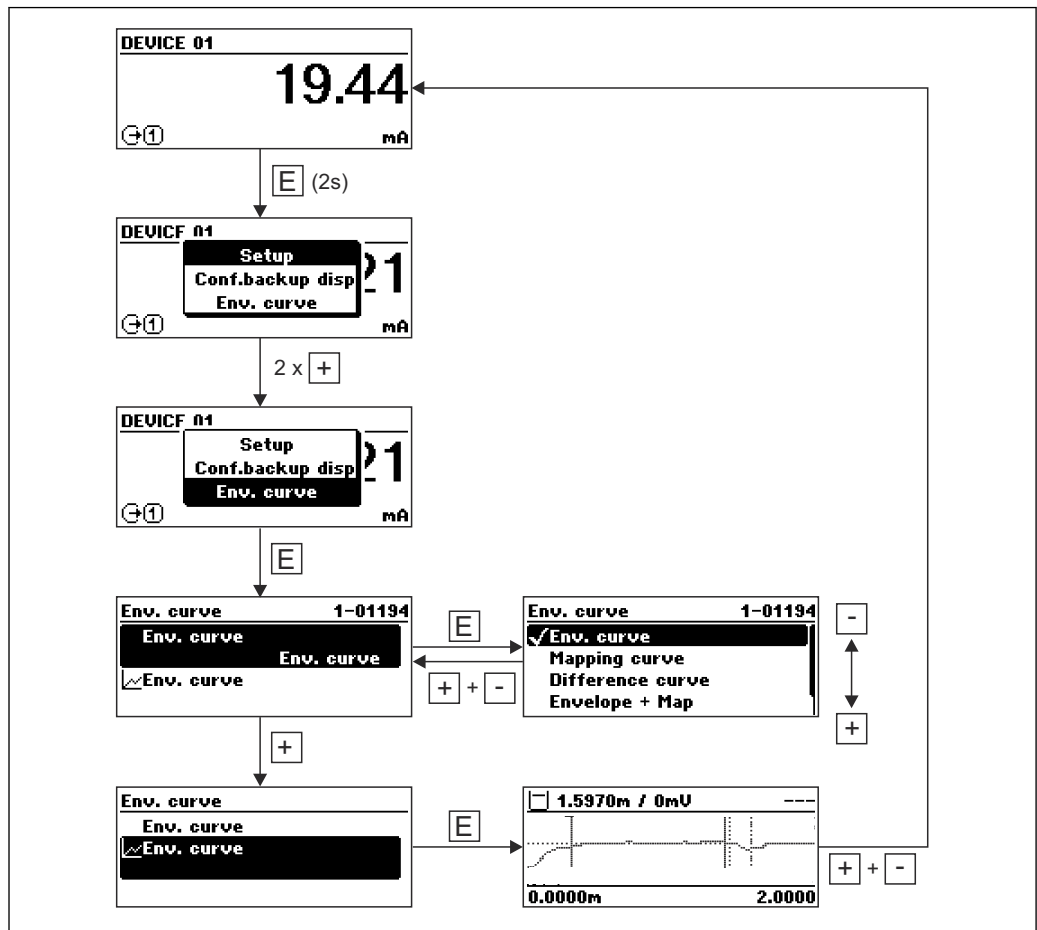

A0014277

9 Commissioning using the wizard

FieldCare and DeviceCare have a wizard that guides the user through initial commissioning.

i Modbus communication must be configured in advance.

1. Connect the device with FieldCare or DeviceCare → 46.
2. Open the device in FieldCare or DeviceCare.
 - ↳ The dashboard (homepage) of the device is displayed:

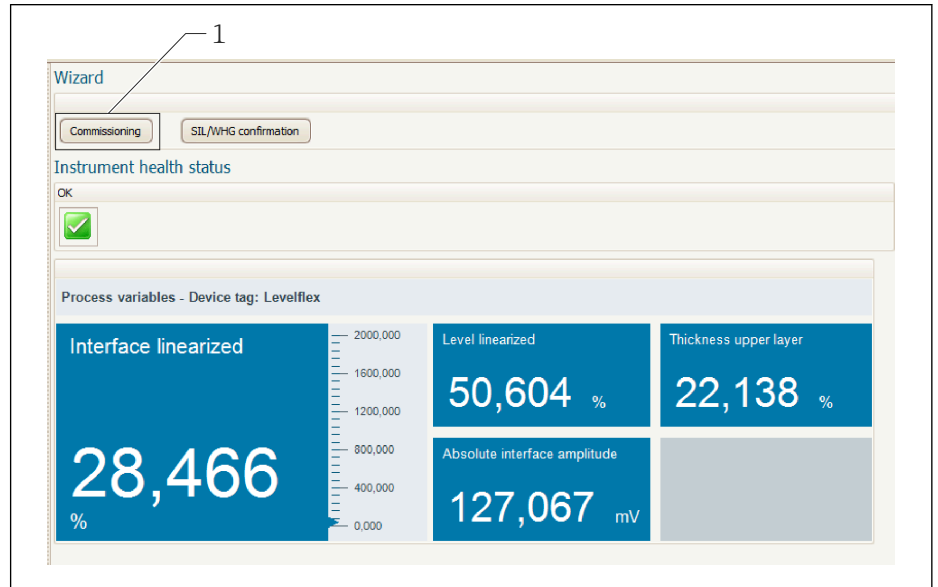

A0025866

1 "Commissioning" button calls up the wizard

3. Click "Commissioning" to launch the Wizard.
 4. Enter the appropriate value in each parameter or select the appropriate option. These values are written directly to the device.
 5. Click "Next" to go to the next page.
 6. Once all the pages have been completed, click "Finish" to close the Wizard.
- i** If you cancel the Wizard before all the necessary parameters have been entered, the device may be in an undefined state. In such situations, it is advisable to reset the device to the factory default settings.

10 Commissioning via operating menu

10.1 Function check

Before commissioning your measuring point, ensure that the post-installation and post-connection checks have been performed:

- "Post-installation check" checklist
- "Post-connection check" checklist

10.2 Configuring the operating language

Factory setting: English or ordered local language

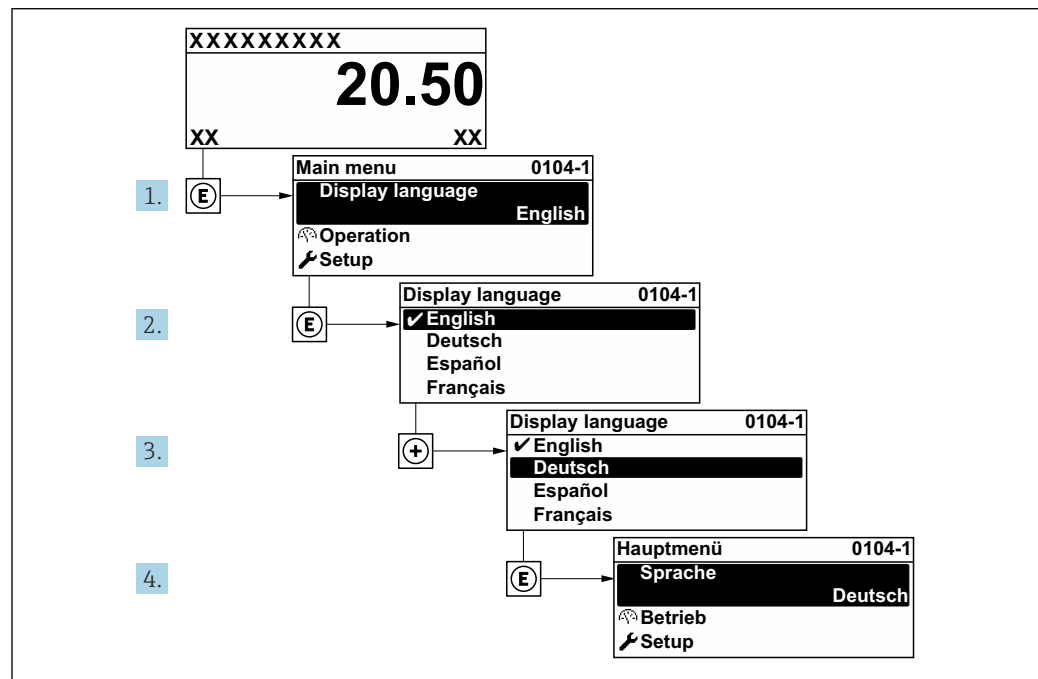

A0029420

17 Using the example of the local display

10.3 Configuring level measurement

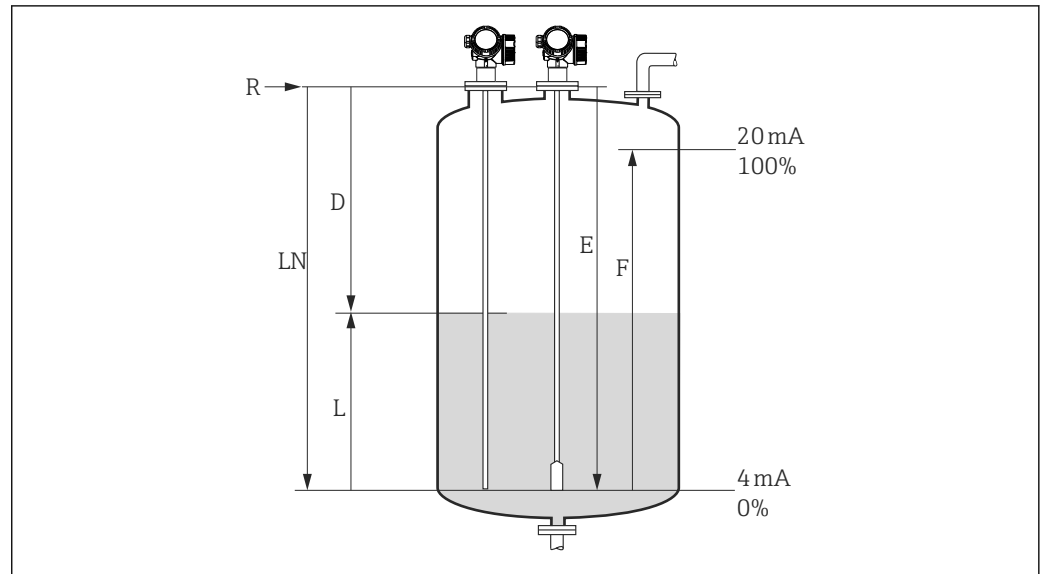

A0011360

18 Configuration parameters for level measurement in liquids

- LN Length of probe
- R Reference point of the measurement
- D Distance
- L Level
- E Empty calibration (= zero point)
- F Full calibration (= span)

i If the DC value is less than 7 in the case of rope probes, measurement in the area of the tensioning weight is not possible. In such cases, the empty calibration *E* should not exceed $LN - 250$ mm ($LN - 10$ in).

1. Setup → Device tag
 - ↳ Enter device tag.
2. For devices in the "Interface measurement" application package:
 - ↳ Navigate to: Setup → Operating mode
 - ↳ Select the **Level** option.
3. Navigate to: Setup → Distance unit
 - ↳ Select the length unit.
4. Navigate to: Setup → Tank type
 - ↳ Select tank type.
5. For **Tank type** parameter = Bypass / pipe:
 - ↳ Navigate to: Setup → Tube diameter
 - ↳ Specify the diameter of the bypass or stilling well.
6. Navigate to: Setup → Medium group
 - ↳ Specify the medium group: (**Water based (DC ≥ 4)** or **Others**)
7. Navigate to: Setup → Empty calibration
 - ↳ Specify empty distance *E* (distance from reference point *R* to 0% mark).
8. Navigate to: Setup → Full calibration
 - ↳ Specify the full distance *F* (distance from the 0% mark to the 100% mark).
9. Navigate to: Setup → Level
 - ↳ Displays the measured level *L*.

10. Navigate to: Setup → Distance
 - ↳ Displays the distance D between the reference point R and the level L.
11. Navigate to: Setup → Signal quality
 - ↳ Displays the signal quality of the analyzed level echo.
12. Operation via local display:
Navigate to: Setup → Mapping → Confirm distance
 - ↳ Compare the distance displayed with the actual value to start recording an interference echo map if necessary.
13. Operation via operating tool:
Navigate to: Setup → Confirm distance
 - ↳ Compare the distance displayed with the actual value to start recording an interference echo map (where applicable).

10.4 Configuring interface measurement

i An interface measurement is only possible if the device has the corresponding software option. In the product structure: feature 540 "Application Package", option EB "Interface measurement".

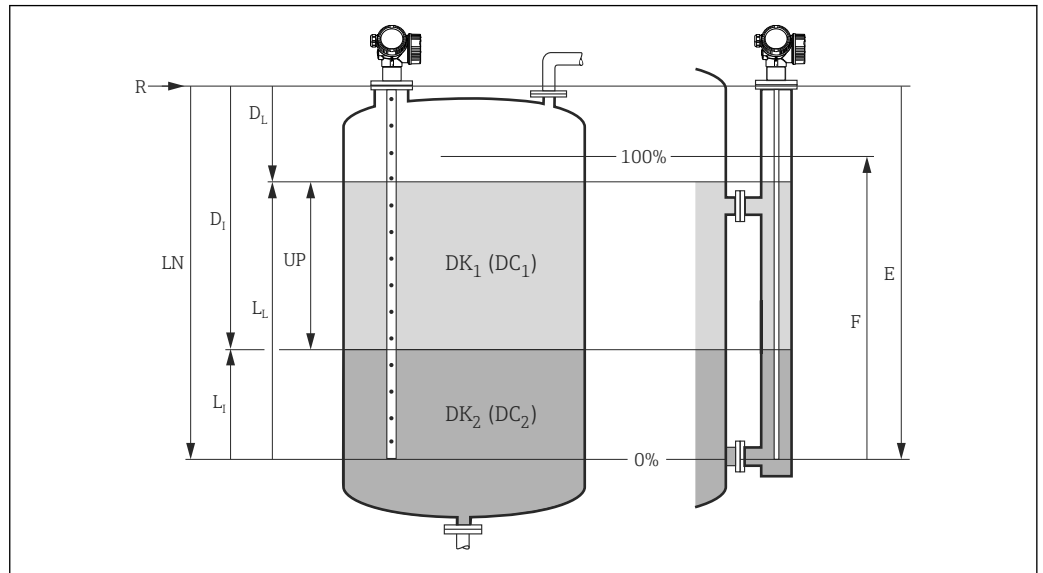

19 Configuration parameters for interface measurement

- LN Length of probe
- R Reference point of the measurement
- DI Interface distance (distance from flange to lower medium)
- LI Interface
- DL Distance
- LL Level
- UP Thickness upper layer
- E Empty calibration (= zero point)
- F Full calibration (= span)

1. Navigate to: Setup → Device tag
 - ↳ Enter device tag.
2. Navigate to: Setup → Operating mode
 - ↳ Select the **Interface** option.
3. Navigate to: Setup → Distance unit
 - ↳ Select the length unit.
4. Navigate to: Setup → Tank type
 - ↳ Select tank type.
5. For **Tank type** parameter = Bypass / pipe:
 - Navigate to: Setup → Tube diameter
 - ↳ Specify the diameter of the bypass or stilling well.
6. Navigate to: Setup → Tank level
 - ↳ Specify the filling level (**Fully flooded** or **Partially filled**)
7. Navigate to: Setup → Distance to upper connection
 - ↳ In bypasses: Specify the distance from the reference point R to the lower edge of the upper outflow. In all other cases, retain the factory setting.
8. Navigate to: Setup → DC value
 - ↳ Specify the relative permittivity (ϵ_r) of the upper medium.

9. Navigate to: Setup → Empty calibration
 - ↳ Specify empty distance E (distance from reference point R to 0% mark).
10. Navigate to: Setup → Full calibration
 - ↳ Specify the full distance F (distance from the 0% mark to the 100% mark).
11. Navigate to: Setup → Level
 - ↳ Displays the measured level L_L .
12. Navigate to: Setup → Interface
 - ↳ Displays the interface height L_I .
13. Navigate to: Setup → Distance
 - ↳ Displays the distance D_L between the reference point R and the level L_L .
14. Navigate to: Setup → Interface distance
 - ↳ Displays the distance D_I between the reference point R and the interface L_I .
15. Navigate to: Setup → Signal quality
 - ↳ Displays the signal quality of the analyzed level echo.
16. Operation via local display:
 - Navigate to: Setup → Mapping → Confirm distance
 - ↳ Compare the distance displayed with the actual value to start recording an interference echo map if necessary.
17. Via an operating tool (e.g. FieldCare):
 - Navigate to: Setup → Confirm distance
 - ↳ Compare the distance displayed with the actual value to start recording an interference echo map (where applicable).

10.5 Recording the reference echo curve

After the measurement has been configured, it is recommended to record the current envelope curve diagram as a reference echo curve. This can then be used later for diagnostic purposes. The **Save reference curve** parameter is used to record the envelope curve.

Path in the menu

Expert → Diagnostics → Envelope diagnostics → Save reference curve

Meaning of the options

- No
No action
- Yes
The current envelope curve is saved as a reference curve.

 The reference echo curve can only be displayed in the envelope curve diagram of FieldCare after it has been loaded from the device into FieldCare. The "Load Reference Curve" function in FieldCare is used for this.



 20 "Load Reference Curve" function

10.6 Configuring the local display

10.6.1 Factory setting of local display for level measurements

Parameter	Factory setting for devices with 1 current output	Factory setting for devices with 2 current outputs
Format display	1 value, max. size	1 value, max. size
Value 1 display	Level linearized	Level linearized
Value 2 display	Distance	Distance
Value 3 display	Current output 1	Current output 1
Value 4 display	None	Current output 2

10.6.2 Factory setting of local display for interface measurements

Parameter	Factory setting for devices with 1 current output	Factory setting for devices with 2 current outputs
Format display	1 value, max. size	1 value, max. size
Value 1 display	Interface linearized	Interface linearized
Value 2 display	Level linearized	Level linearized
Value 3 display	Thickness upper layer	Current output 1
Value 4 display	Current output 1	Current output 2

10.6.3 Adjusting the local display

The local display can be adjusted in the following submenu:
Setup → Advanced setup → Display

10.7 Configuring Modbus communication

10.7.1 Bus parameters

Bus parameter	Setting
Baud rate	Detected automatically; no setting required.
Parity	Detected automatically; no setting required.
Modbus address of the device	To be configured using the HART address parameter: Expert → Communication → Configuration → HART address Value range: 1 to 63

10.7.2 Device parameters

The following parameters are fixed. Any change by the user is reversed immediately by the device.

- **Current span = Fixed current**
- **Fixed current = 10 mA**

10.7.3 Process parameters

Process parameters that should be transmitted via the bus must be assigned one of the following HART variables:

Expert → Communication → Output

- Assign PV
- Assign SV
- Assign TV
- Assign QV

These HART variables can be accessed via certain Modbus registers: →  187.

10.8 Configuration management

After commissioning, it is possible to save the current device configuration, copy it to another measuring point or restore the previous device configuration. You can do so using the **Configuration management** parameter and the options available.

Path in the menu

Setup → Advanced setup → Configuration backup display → Configuration management

Meaning of the options

- **Cancel**

No action is executed and the user exits the parameter.

- **Execute backup**

A backup copy of the current device configuration is saved from the HistoROM (integrated in the device) to the display module of the device.

- **Restore**

The last backup copy of the device configuration is copied from the display module to the HistoROM of the device.

- **Duplicate**

The transmitter configuration of the device is duplicated to another device using the display module. The following parameters, which characterize the individual measuring point are **not** transferred:

- HART date code
- HART short tag
- HART message
- HART descriptor
- HART address
- Device tag
- Medium type



- **Compare**

The device configuration saved in the display module is compared to the current device configuration of the HistoROM. The result of the comparison is displayed in the **Comparison result** parameter.

- **Clear backup data**

The backup copy of the device configuration is deleted from the display module of the device.

 While this action is in progress, the configuration cannot be edited via the local display and a message on the processing status appears on the display.

 If an existing backup copy is restored on a device other than the original device using the **Restore** option, in some cases individual device functions may not be available. In some cases it is also not possible to restore the original state by resetting to the "as-delivered" state →  166.

The **Duplicate** option should always be used to copy the configuration to another device.

10.9 Protecting settings from unauthorized access





The settings can be protected from unauthorized access in two ways:

- Locking via parameters (software locking)
- Locking via write protection switch (hardware locking)

11 Diagnostics and troubleshooting





11.1 General troubleshooting

11.1.1 General errors

Error	Possible cause	Solution
Device does not respond.	Supply voltage not connected.	Connect the correct voltage.
	The cables do not contact the terminals properly.	Ensure electrical contact between the cable and the terminal.
Values on the display invisible	Contrast setting is too weak or too strong.	<ul style="list-style-type: none"> ▪ Increase contrast by pressing  and  simultaneously. ▪ Decrease contrast by pressing  and  simultaneously.
	The plug of the display cable is not connected correctly.	Connect the plug correctly.
	Display is defective.	Replace display.
"Communication error" is indicated on the display when starting the device or connecting the display.	Electromagnetic interference	Check grounding of the device.
	Broken display cable or display plug.	Replace display.
Duplication of parameters via display from one device to another not working. Only the "Save" and "Cancel" options are available.	Display with backup is not properly detected if a data backup was not carried out on the new device previously.	Connect display (with backup) and restart device.
CDI communication does not work.	Wrong setting of the COM port on the computer.	Check the setting of the COM port on the computer and change it if necessary.
Device measures incorrectly.	Parameter configuration error	Check and correct the parameter configuration.

11.1.2 Parameter configuration errors

Parameter configuration errors for level measurements

Error	Possible cause	Solution
Measured value is incorrect	If measured distance (Setup → Distance) matches the real distance: Calibration error	<ul style="list-style-type: none"> ▪ Check the Empty calibration parameter (→  108) and correct if necessary. ▪ Check the Full calibration parameter (→  109) and correct if necessary. ▪ Check the linearization and correct if necessary (Linearization submenu (→  134)).
	If measured distance (Setup → Distance) does not match the real distance: An interference echo is present.	Carry out mapping (Confirm distance parameter (→  116)).
No change of measured value on filling/emptying	An interference echo is present.	Carry out mapping (Confirm distance parameter (→  116)).
	Buildup at the probe.	Clean the probe.
	Error in the echo tracking	Deactivate echo tracking (Expert → Sensor → Echo tracking → Evaluation mode = History off).

Error	Possible cause	Solution
Echo lost diagnostic message appears after the supply voltage is switched on.	Echo threshold too high.	Check the Medium group parameter (→ 108). If necessary, select a more detailed setting with the Medium property parameter (→ 122).
	Level echo suppressed.	Delete the map and record it again if necessary (Record map parameter (→ 118)).
Device displays a level when the tank is empty.	Incorrect probe length	Perform a probe length correction (Confirm probe length parameter (→ 148)).
	Interference echo	Carry out mapping over the entire probe length when the tank is empty (Confirm distance parameter (→ 116)).
Wrong slope of the level over the entire measuring range	Wrong tank type selected.	Select the correct Tank type parameter (→ 107).

Parameter configuration errors for interface measurements

Error	Possible cause	Solution
With the setting Tank level = Fully flooded , the interface level displayed jumps to higher values when the tank is emptied.	The total level is detected outside the upper blocking distance.	Increase the blocking distance (Blocking distance parameter (→ 125)).
		Set Tank level parameter (→ 113) = Partially filled .
With the setting Tank level = Partially filled , the total level displayed jumps to lower values when the tank is filled.	The total level goes to the upper blocking distance	Reduce the blocking distance (Blocking distance parameter (→ 125)).
Incorrect slope of the interface measured value	The dielectric constant (DC value) of the upper medium is incorrectly set.	Enter the correct dielectric constant (DC value) of the upper medium (DC value parameter (→ 114)).
The measured value for the interface and the total level are identical.	The echo threshold for the total level is too high due to an incorrect dielectric constant.	Enter the correct dielectric constant (DC value) of the upper medium (DC value parameter (→ 114)).
The total level jumps to the interface level in the case of thin interfaces.	The thickness of the upper medium is lower than 60 mm.	Measurement of the interface is only possible for interface heights greater than 60 mm.
Interface measured value jumps.	Emulsion layer present.	Emulsion layers impair the measurement. Contact Endress+Hauser.

11.2 Diagnostic information on local display

11.2.1 Diagnostic message

Faults detected by the self-monitoring system of the measuring instrument are displayed as a diagnostic message in alternation with the measured value display.

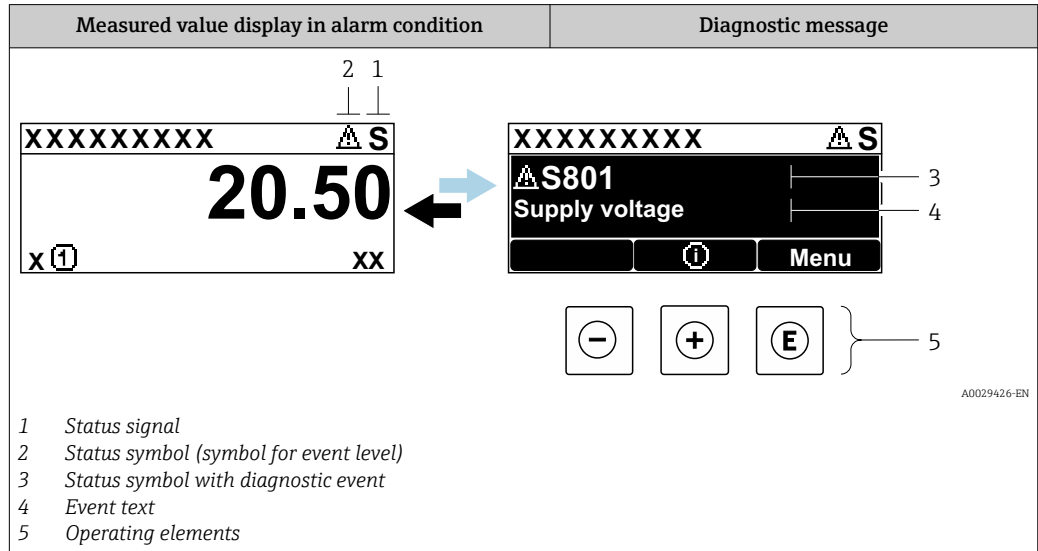

Status signals

F <small>A0032902</small>	"Failure (F)" option A device error has occurred. The measured value is no longer valid.
C <small>A0032903</small>	"Function check (C)" option The device is in the service mode (e.g. during a simulation).
S <small>A0032904</small>	"Out of specification (S)" option The device is operated: <ul style="list-style-type: none"> ▪ Outside its technical specifications (e.g. during startup or cleaning) ▪ Outside the configuration performed by the user (e.g. level outside the configured range)
M <small>A0032905</small>	"Maintenance required (M)" option Maintenance is required. The measured value is still valid.

Status symbols (symbol for event level)

⊗	"Alarm" status Measurement is interrupted. The signal outputs adopt the defined alarm state. A diagnostic message is generated.
⚠	"Warning" status The device continues to measure. A diagnostic message is generated.

Diagnostic event and event text

The fault can be identified by means of the diagnostic event. The event text helps you by providing information about the fault. In addition, the associated status symbol is displayed in front of the diagnostic event.

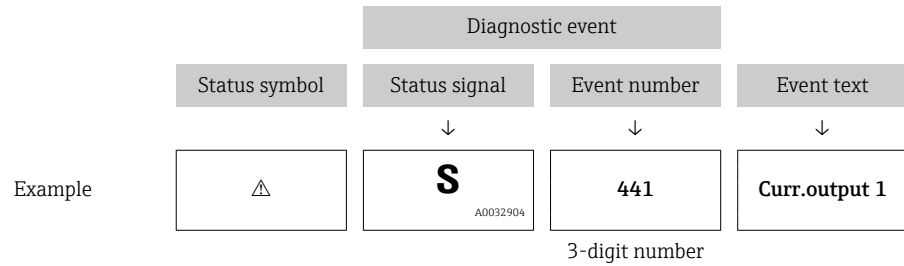

If several diagnostic events are pending at the same time, only the diagnostic message with the highest priority is displayed. Additional queued diagnostic messages can be shown in the **Diagnostic list** submenu.

-  Past diagnostic messages that are no longer pending are shown as follows:
 - On the local display:
 - in the **Event logbook** submenu
 - In FieldCare:
 - via the "Event List/HistoROM" function

Operating elements

Operating functions in menu, submenu	
+	Plus key Opens the message about the remedial measures.
E	Enter key Opens the operating menu.

11.2.2 Calling up remedial measures

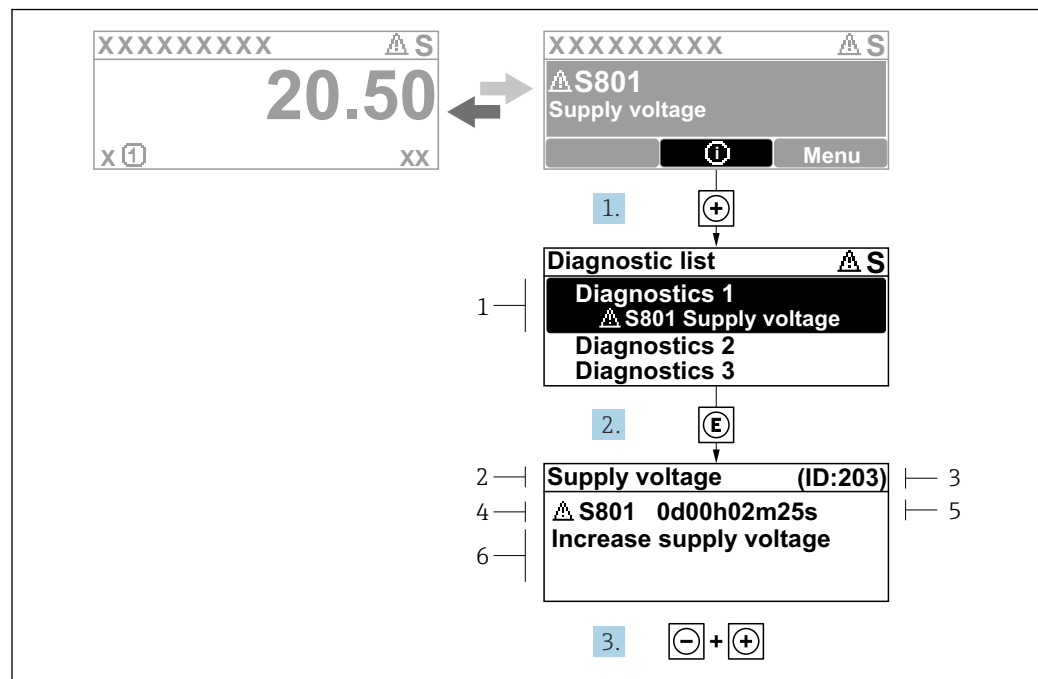

21 Message for remedial measures

- 1 Diagnostic information
- 2 Short text
- 3 Service ID
- 4 Diagnostic behavior with diagnostic code
- 5 Operation time when error occurred
- 6 Remedial measures

The user is in the diagnostic message.

1. Press \oplus ($\text{\textcircled{1}}$ symbol).
 ↳ The **Diagnostic list** submenu opens.
2. Select the desired diagnostic event with \oplus or \ominus and press $\text{\textcircled{E}}$.
 ↳ The message for the remedial measures for the selected diagnostic event opens.
3. Press $\ominus + \oplus$ simultaneously.
 ↳ The message about the remedial measures closes.

The user is in the **Diagnostics** menu at an entry for a diagnostics event, e.g. in **Diagnostic list** or in **Previous diagnostics**.

1. Press $\text{\textcircled{E}}$.
 ↳ The message for the remedial measures for the selected diagnostic event opens.
2. Press $\ominus + \oplus$ simultaneously.
 ↳ The message about the remedial measures closes.

11.3 Diagnostic event in the operating tool

If a diagnostic event has occurred in the device, the status signal appears in the top left status area of the operating tool together with the corresponding symbol for the event level according to NAMUR NE 107:

- Failure (F)
- Function check (C)
- Out of specification (S)
- Maintenance required (M)

A: Via the operating menu

1. Navigate to the **Diagnostics** menu.
 - ↳ In the **Actual diagnostics** parameter, the diagnostic event is shown with event text.
2. On the right in the display area, hover the cursor over the **Actual diagnostics** parameter.

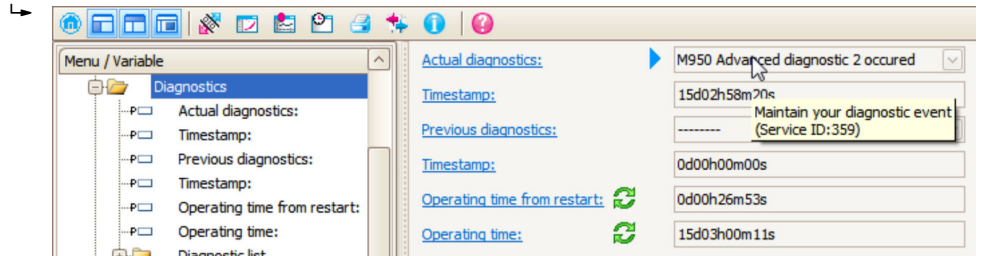

A tool tip with remedy information for the diagnostic event appears.

B: Via the "Create Documentation" function

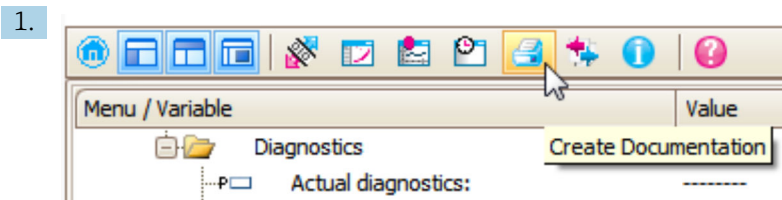

Select the "Create documentation" function.

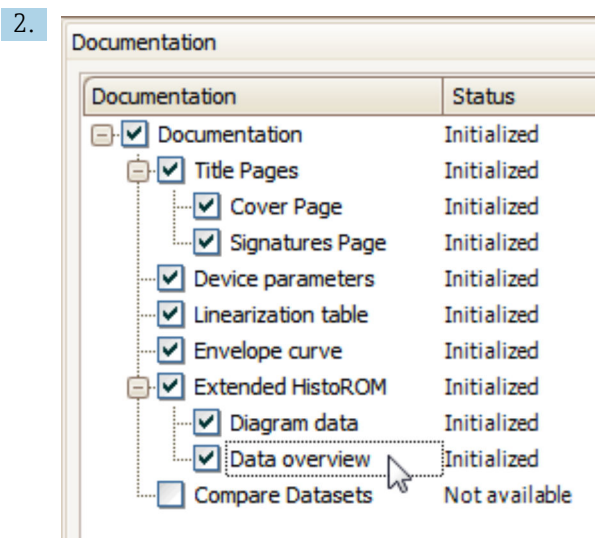

Make sure that "Data overview" is marked.

3. Click "Save as..." and save a PDF of the report.
 - ↳ The report contains the diagnostic messages including remedial measures.

C: Via the "Event list/Extended HistoROM" function

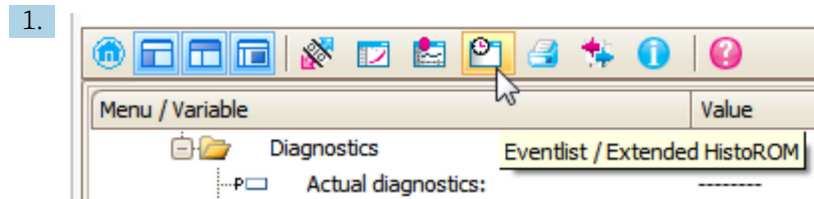

Select the ("Event list/Extended HistoROM") function.

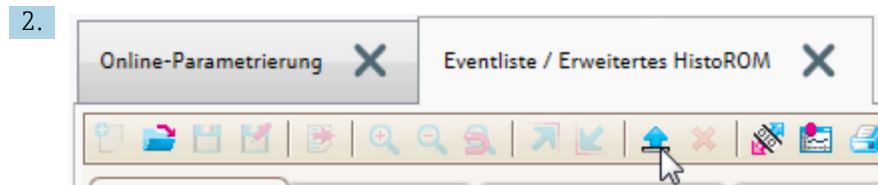

Select the "Load event list" function.

- ↳ The event list including remedial measures is displayed in the "Data overview" window.

11.4 Diagnostic list

In the **Diagnostic list** submenu submenu, up to 5 currently pending diagnostic messages can be displayed. If more than 5 messages are pending, the messages with the highest priority are shown on the display.

Navigation path

Diagnostics → Diagnostic list

Calling up and closing the remedial measures

1. Press \square .
 - ↳ The message for the remedial measures for the selected diagnostic event opens.
2. Press \square + \oplus simultaneously.
 - ↳ The message about the remedial measures closes.

11.5 Event logbook

11.5.1 Event history

A chronological overview of the event messages that have occurred is provided in the **Event list**

(This submenu only exists if operating via the local display. In the case of operation via FieldCare, the event list can be displayed with the "Event list/HistoROM" functionality of FieldCare.

Navigation path

Diagnostics → Event logbook → Event list

A maximum of 100 event messages can be displayed in chronological order.



The event history includes entries for:

- Diagnostic events
- Information events

In addition to the operating time when the event occurred, each event is also assigned a symbol that indicates whether the event has occurred or is finished:

- Diagnostic event
 - ☺: Occurrence of the event
 - ☹: End of the event
- Information event
 - ☺: Occurrence of the event

Calling up and closing the remedial measures

1. Press .
 - ↳ The message for the remedial measures for the selected diagnostic event opens.
2. Press  +  simultaneously.
 - ↳ The message about the remedial measures closes.

11.5.2 Filtering the event logbook

Using the **Filter options** parameter, you can define which category of event messages is displayed in the **Event list** submenu.

Navigation path

Diagnostics → Event logbook → Filter options

Filter categories

- All
- Failure (F)
- Function check (C)
- Out of specification (S)
- Maintenance required (M)
- Information

11.5.3 Overview of information events

Info number	Info name
I1000	----- (Device ok)
I1089	Power on
I1090	Configuration reset
I1091	Configuration changed
I1092	Embedded HistoROM deleted
I1110	Write protection switch changed
I1137	Electronic changed
I1151	History reset
I1154	Reset terminal voltage min/max
I1155	Reset electronic temperature
I1156	Memory error trend
I1157	Memory error event list
I1184	Display connected
I1185	Display backup done
I1186	Restore via display done
I1187	Settings downloaded with display
I1188	Display data cleared

Info number	Info name
I1189	Backup compared
I1256	Display: access status changed
I1264	Safety sequence aborted
I1335	Firmware changed
I1397	Fieldbus: access status changed
I1398	CDI: access status changed
I1512	Download started
I1513	Download finished
I1514	Upload started
I1515	Upload finished
I1554	Safety sequence started
I1555	Safety sequence confirmed
I1556	Safety mode off

11.6 Firmware history

 The firmware version can explicitly be ordered via the product structure. In this way it is possible to ensure compatibility of the firmware version with an existing or planned system integration.

12 Maintenance

No special maintenance work is required.

12.1 Exterior cleaning

When cleaning the exterior, always use cleaning agents that do not corrode the surface of the housing and the seals.

12.2 General cleaning instructions

Dirt or buildup may form on the probe depending on the application. A thin, even layer has little impact on the measurement. Thick layers can dampen the signal and reduce the measuring range. Very uneven deposit formation or caking (e.g. due to crystallization) can result in incorrect measurements. In such cases, use a non-contact measuring principle, or regularly inspect the probe for contamination.

Cleaning with sodium hydroxide solution (e.g. in CIP procedures): if the coupling is wetted, larger measurement errors can occur than under reference operating conditions. Wetting can cause temporary incorrect measurements.

13 Repair

13.1 General information

13.1.1 Repair concept

Under the Endress+Hauser repair concept, devices have a modular design and repairs can be carried out by Endress+Hauser Service or by properly trained customers.

Spare parts are grouped into logical kits with the associated replacement instructions.

For more information on service and spare parts, please contact Endress+Hauser Service.

13.1.2 Repairs to Ex-approved devices

⚠ WARNING

Incorrect repair can compromise electrical safety!

Explosion hazard!

- ▶ Repairs to Ex-approved devices must be carried out by Endress+Hauser Service or by specialist personnel according to national regulations.
- ▶ Relevant standards and national regulations on hazardous areas, safety instructions and certificates must be observed.
- ▶ Use only original Endress+Hauser spare parts.
- ▶ Please note the device designation on the nameplate. Only identical parts may be used as replacements.
- ▶ Carry out repairs according to the instructions.
- ▶ Only the Endress+Hauser service team is permitted to modify a certified device and convert it to another certified version.

13.1.3 Replacing electronics modules

When electronics modules have been replaced the device does not need to be recalibrated as the parameters are saved in the HistoROM inside the housing. It may be necessary when replacing the main electronics to record a new interference echo suppression.

13.1.4 Replacing a device

Once a complete device has been replaced, the parameters can be transferred back into the device using one of the following methods:

- Using the display module
Prerequisite: The configuration of the old device was saved previously to the display module.
- Via FieldCare
Prerequisite: The configuration of the old device was saved previously to the computer using FieldCare.

You can continue measuring without performing a new calibration. Only interference echo suppression may need to be carried out once again.

13.2 Spare parts

- Some replaceable measuring instrument components are identified by means of a spare part nameplate. This contains information about the spare part.
- In the connection compartment cover of the device there is a spare part nameplate which contains the following information:
 - A list of the most important spare parts for the measuring instrument, including their ordering information.
 - The URL to the *W@M Device Viewer* (www.endress.com/deviceviewer):
All the spare parts for the measuring instrument, along with the order code, are listed here and can be ordered. If available, users can also download the associated Installation Instructions.

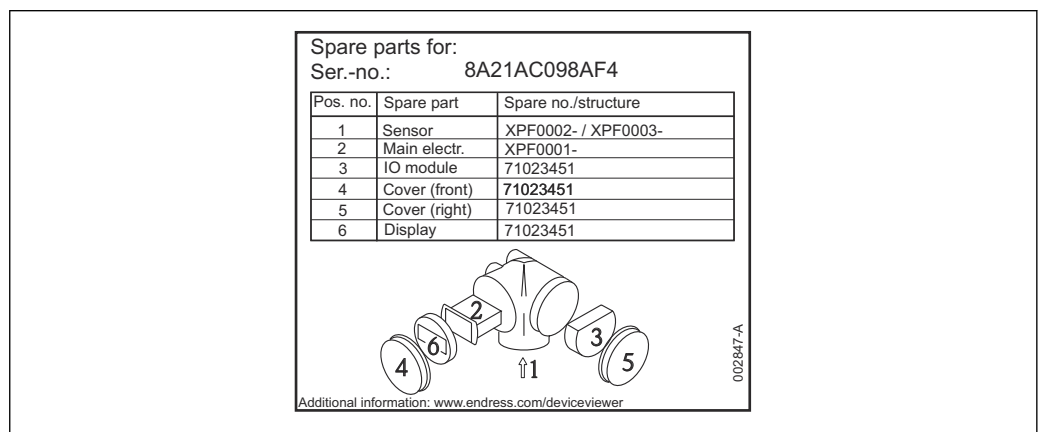

22 Example for spare part nameplate in the connection compartment cover

- i** Measuring instrument serial number:
 - Located on the device and spare part nameplate.
 - Can be read out via the "Serial number" parameter in the "Device information" submenu.

13.3 Return

The requirements for safe device return can vary depending on the device type and national legislation.

1. Refer to the web page for information:
<https://www.endress.com/support/return-material>
↳ Select the region.
2. If returning the device, pack the device in such a way that it is reliably protected against impact and external influences. The original packaging offers the best protection.

13.4 Disposal

-  If required by the Directive 2012/19/EU on waste electrical and electronic equipment (WEEE), the product is marked with the depicted symbol in order to minimize the disposal of WEEE as unsorted municipal waste. Do not dispose of products bearing this marking as unsorted municipal waste. Instead, return them to the manufacturer for disposal under the applicable conditions.

14 Accessories

The accessories currently available for the product can be selected at www.endress.com:

1. Select the product using the filters and search field.
2. Open the product page.
3. Select **Spare parts & Accessories**.

14.1 Device-specific accessories

14.1.1 Weather protection cover

The weather protection cover can be ordered together with the device via the "Accessory enclosed" product structure.

It is used to protect against direct sunlight, precipitation and ice.

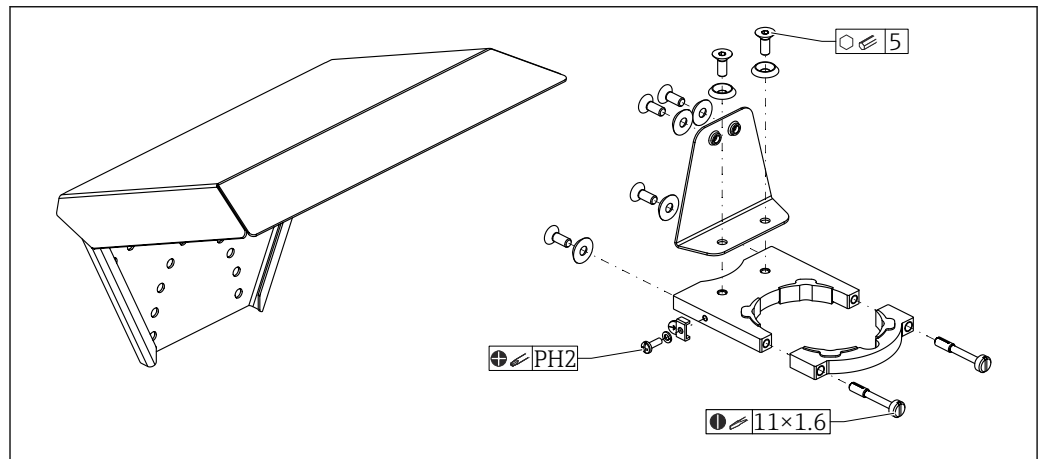

A0051672

23 Overview

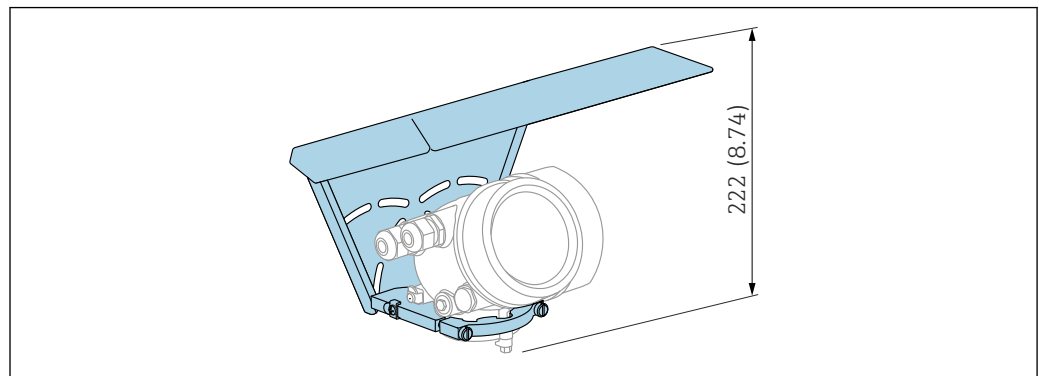

A0015466

24 Height. Unit of measurement mm (in)

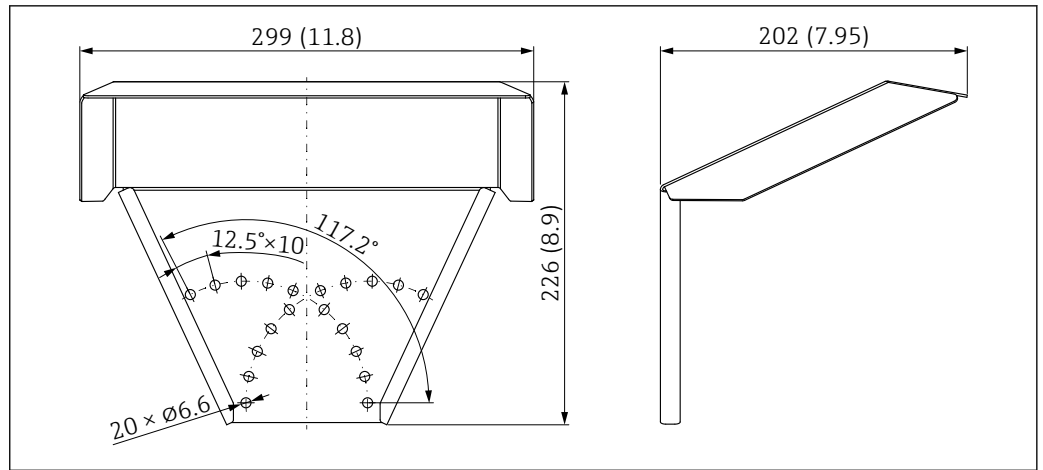

A0015472

25 Dimensions. Unit of measurement mm (in)

Material

- Protection cap; 316L (1.4404)
- Bracket; 316L (1.4404)
- Angle bracket; 316L (1.4404)
- Clamping screw; 316L (1.4404) + carbon fiber
- Molded rubber part (4x); EPDM
- Screws; A4
- Disks; A4
- Ground terminal; A4, 316L (1.4404)

Order number for accessories:

71162242

14.1.2 Mounting bracket for electronics housing

With "remote sensor" device versions (feature 060 in the product structure), the mounting bracket is included in the scope of delivery. It can be ordered as a separate accessory .

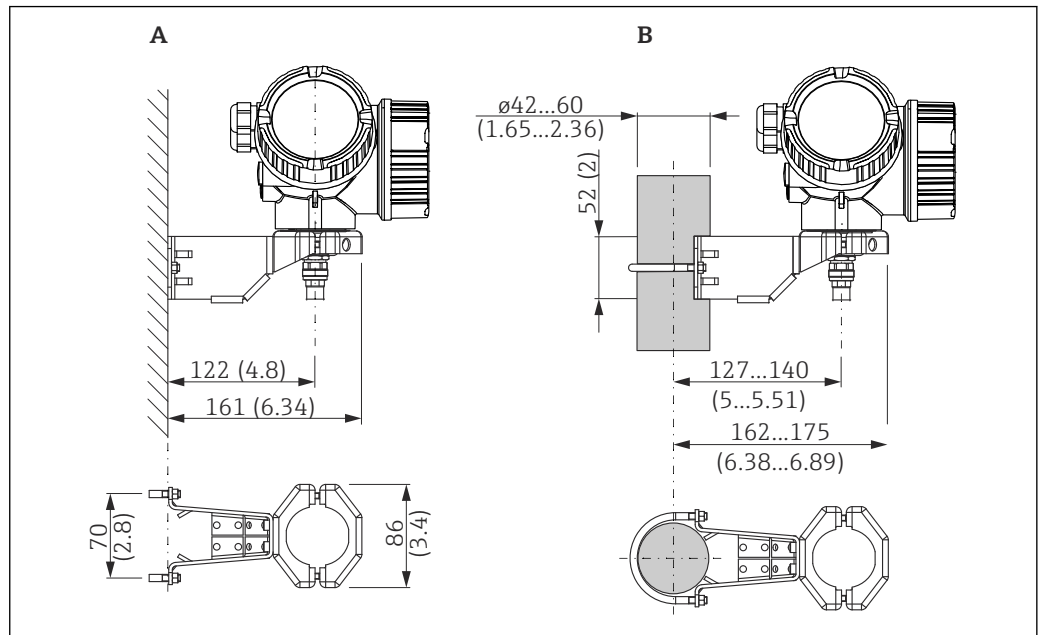

A0014793

26 Mounting bracket for electronics housing; unit: mm (in)

- A Wall mounting
- B Post mounting

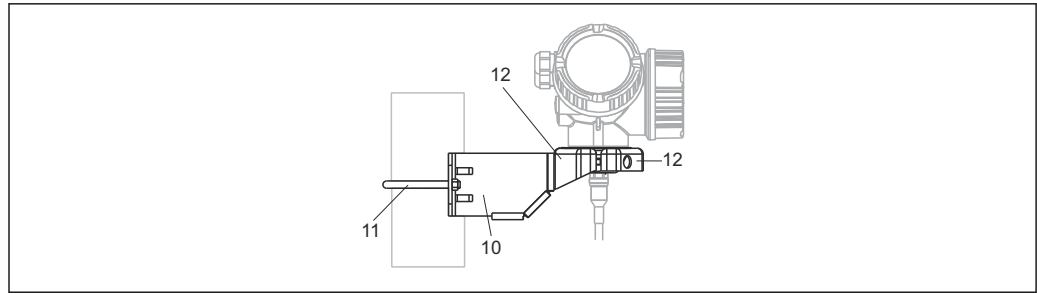

A0015143

☑ 27 *Material; mounting bracket*

10 *Bracket, 316L (1.4404)*

11 *Round bracket, 316L (1.4404); screws/nuts, A4-70; distance sleeves, 316L (1.4404)*

12 *Half-shells, 316 L (1.4404)*

Order number for accessories:

71102216

14.1.3 Mounting kit, insulated

To secure rope probes so that they are reliably insulated.

Maximum process temperature: 150 °C (300 °F)

Mounting set, insulated, can be used for:

FMP51

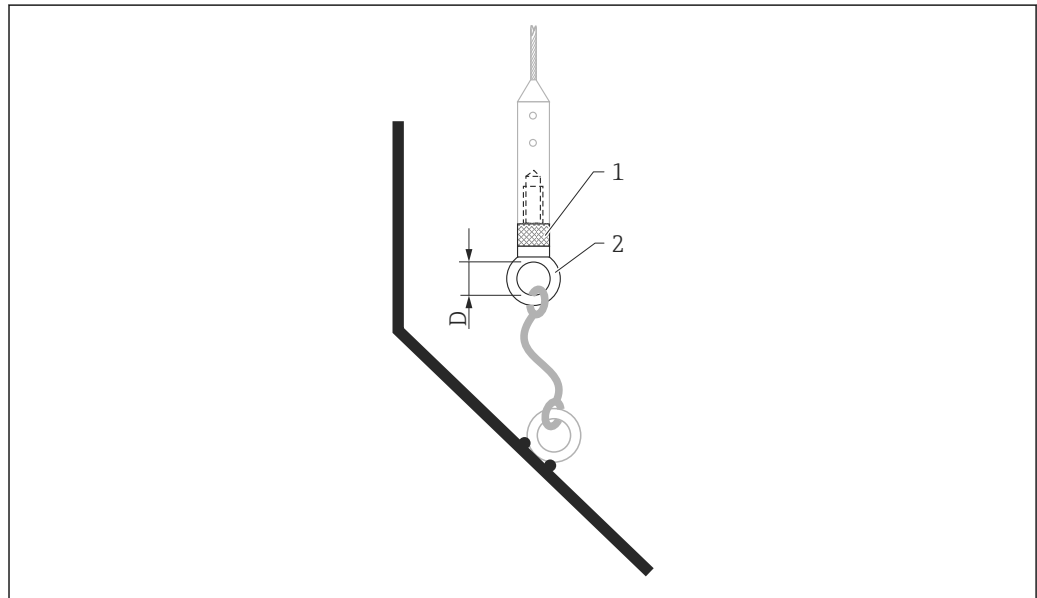

A0013586

☑ 28 *Scope of delivery of mounting kit:*

1 *Insulation sleeve*

2 *Ring bolt*

For rope probes 4 mm ($\frac{1}{8}$ in) or 6 mm ($\frac{1}{4}$ in) with PA > steel:
Diameter D = 20 mm (0.8 in)

Order number for accessories:

52014249

For rope probes 6 mm ($\frac{1}{4}$ in) or 8 mm ($\frac{1}{2}$ in) with PA > steel:
Diameter D = 25 mm (1 in)

Order number for accessories:

52014250

Due to the risk of electrostatic charge, the insulation sleeve is not suitable for use in hazardous areas! In this case, the probe must be secured so that it is reliably grounded.

i The mounting kit can also be ordered directly with the device (Levelflex product structure, feature 620 "Accessory enclosed", version PG "mounting kit, insulated, rope").

14.1.4 Centering star

Centering star PEEK, \varnothing 48 to 95 mm (1.89 to 3.74 in)

Suitable for:

- FMP51
-

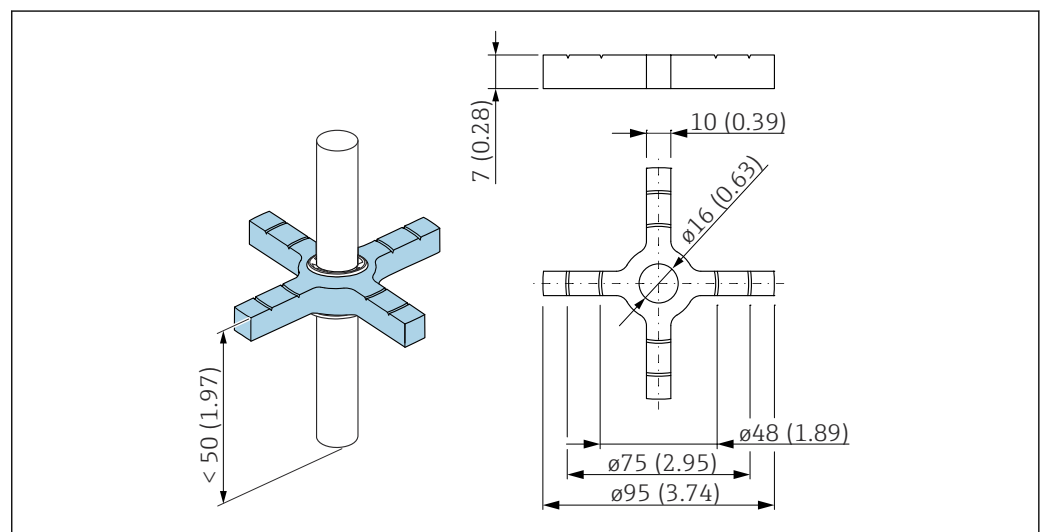

29 Dimensions; centering star PEEK \varnothing 48 to 95 mm (1.89 to 3.74 in)

The centering star is suitable for probes with a rod diameter of 16 mm (0.6 in) and can be used in pipes from DN50 to DN100. The markings make it easier to cut to size, ensuring that the centering star can be adjusted to the pipe diameter.

i For details, see SD02316F.

- Material of centering star: PEEK
- Material of retaining rings: PH15-7Mo (UNS S15700)
- Permitted process temperature range: -60 to $+250$ °C (-76 to $+482$ °F)

Order number for accessories:

71069064

i If the centering star is used in a bypass, it must be positioned below the lower bypass outlet. This must be taken into account when choosing the probe length. In general, the centering star should not be mounted more than 50 mm (1.97") above the probe tip. It is advised not to use the PEEK centering star in the measuring range of the rod probe.

i The PEEK centering star can also be ordered directly with the device (Levelflex product structure, feature 610 "Accessory mounted", option OD). In this case, it is not secured to the rod using the retaining rings, but instead is secured using a hexagonal-headed bolt (A4-70) and a Nord Lock washer (1.4547) at the tip of the probe rod.

Centering star PFA

Suitable for:
FMP51

Available versions:

- \varnothing 16.4 mm (0.65 in)
- \varnothing 37 mm (1.46 in)

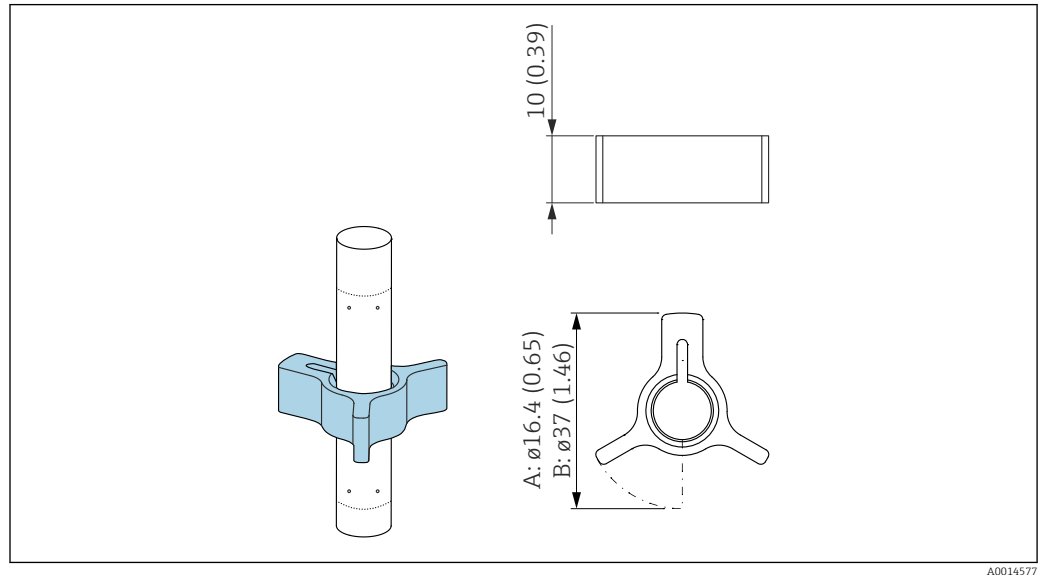

A For probe 8 mm (0.3 in)

B For probes 12 mm (0.47 in) and 16 mm (0.63 in)

The centering star is suitable for probes with a rod diameter of 8 mm (0.3 in), 12 mm (0.47 in) and 16 mm (0.63 in) (including coated rod probes) and can be used in pipes from DN40 to DN50.



For details, see BA00378F.

- Material: PFA
- Permitted process temperature range: -200 to $+250$ °C (-328 to $+482$ °F)

Order number for accessories:

- Probe 8 mm (0.3 in)
71162453
- Probe 12 mm (0.47 in)
71157270
- Probe 16 mm (0.63 in)
71069065



The PFA centering star can also be ordered directly with the device (Levelflex product structure, feature 610 "Accessory mounted", option OE).

Centering star PEEK, \varnothing 48 to 95 mm (1.9 to 3.7 in)

Suitable for:
FMP51

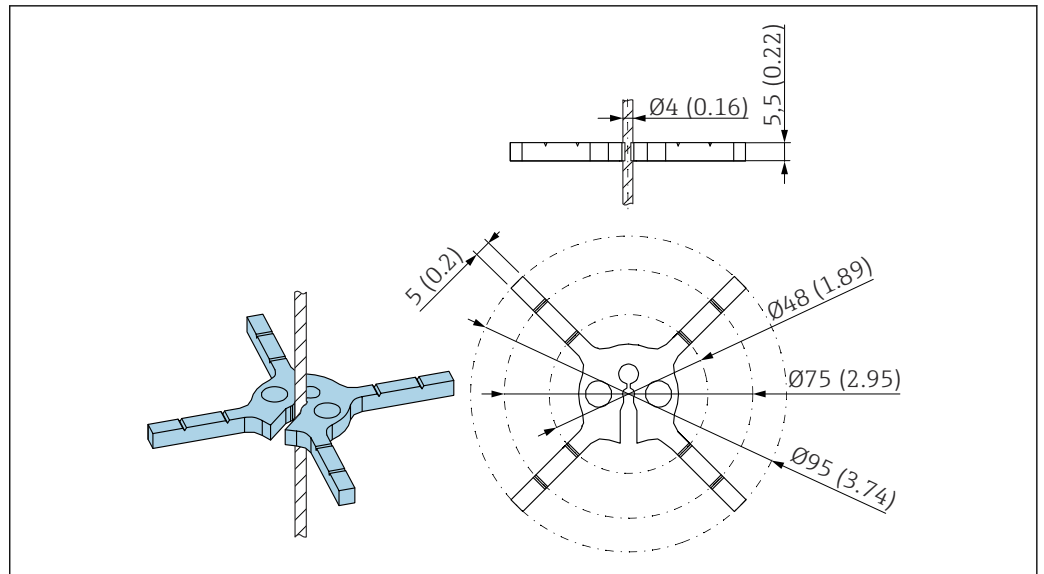

A0035182

The centering star is suitable for probes with a rope diameter of 4 mm ($\frac{1}{8}$ in) (including coated rope probes).

 For details, see SD01961F.

- Material: PEEK
- Permitted process temperature range: -60 to $+250$ °C (-76 to $+482$ °F)

Order number for accessories:

- 71373490 (1x)
- 71373492 (5x)

14.1.5 Centering weight

Centering weight 316 L for DN50/2" pipes

Suitable for:

- FMP51
-

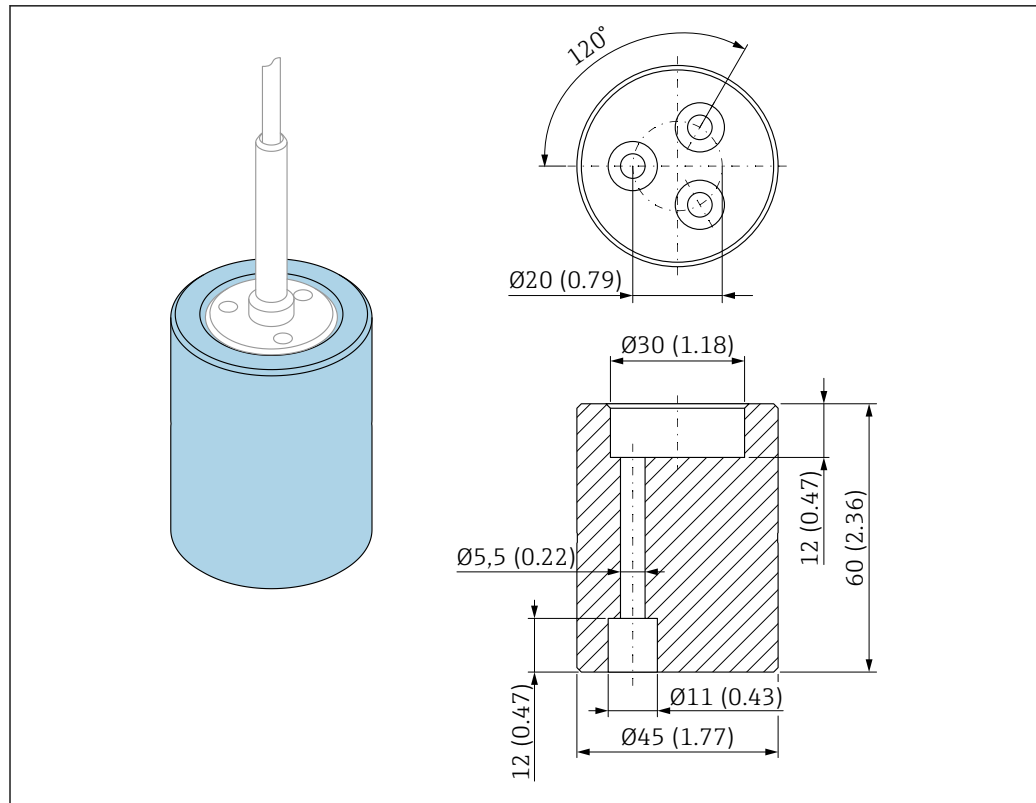

A0038923

The centering weight is suitable for probes with a rope diameter of 4 mm ($\frac{1}{8}$ in) and can be used in DN50/2" pipes.

The centering weight can be ordered directly with the device (product structure Levelflex) or as a probe without a process connection (product structure XPF0005-) using feature 610 "Accessory mounted", version **OK** (for pipe DN50/2").

Centering weight 316 L for pipes \geq DN80/3"

Suitable for:

- FMP51
-

Available versions:

- \varnothing 75 mm (2.95 in)
- \varnothing 95 mm (3.7 in)

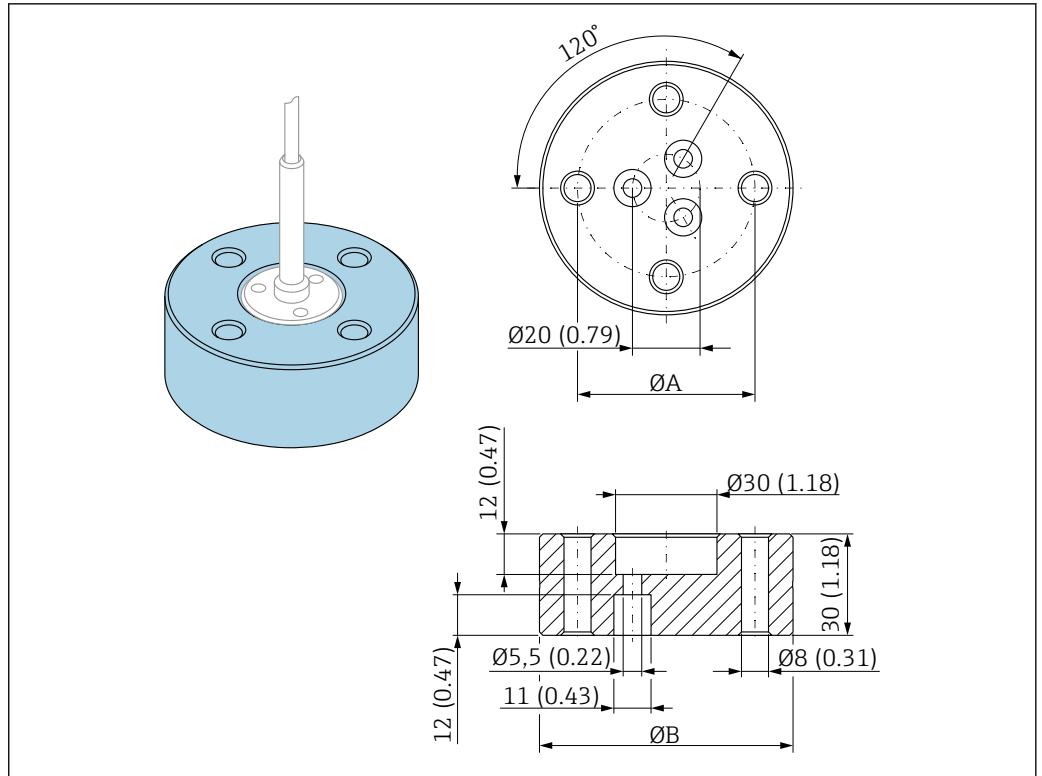

A0038924

- Ø A = 52.5 mm (2.07 in) for DN80/3" pipe
- = 62.5 mm (2.47 in) for DN100/4" pipe
- Ø B = 75 mm (2.95 in) for DN80/3" pipe
- = 95 mm (3.7 in) for DN100/4" pipe

The centering weight is suitable for probes with a rope diameter of 4 mm (1/6 in) and can be used in DN80/3" or DN100/4" pipes.

The centering weight can be ordered directly with the device (product structure Levelflex) or as a probe without a process connection (product structure XPF0005-) using feature 610 "Accessory mounted", version **OL** (for pipe DN80/3") or **OM** (for pipe DN100/4").

14.1.6 Remote display FHX50

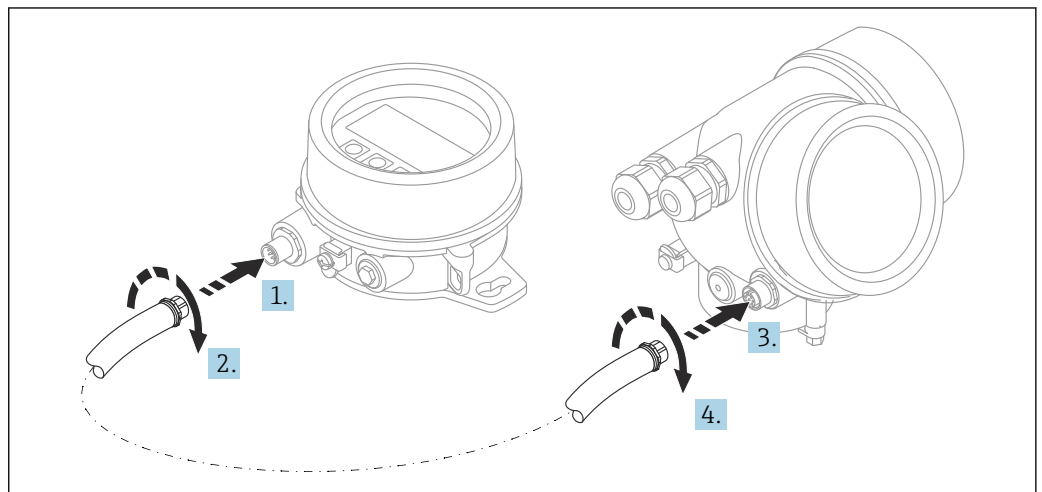

A0019128

Technical data

- Material:
 - Plastic PBT
 - 316L/1.4404
 - Aluminum
 - Degree of protection: IP68 / NEMA 6P and IP66 / NEMA 4x
 - Suitable for display modules:
 - SDO2 (push buttons)
 - SDO3 (touch control)
 - Connecting cable:
 - Cable supplied with device up to 30 m (98 ft)
 - Standard cable provided by customer onsite up to 60 m (196 ft)
 - Ambient temperature: -40 to 80 °C (-40 to 176 °F)
 - Ambient temperature, optionally available for order. -50 to 80 °C (-58 to 176 °F)
- NOTICE** If the temperature is permanently below -40 °C (-40 °F), higher failure rates can be expected.

Ordering information

- If the remote display is to be used, the device version "Prepared for display FHX50" must be ordered.
For FHX50, the option "Prepared for display FHX50" must be selected under "Measuring device version".
- If a measuring instrument has not been ordered with the version "Prepared for display FHX50" and is to be retrofitted with an FHX50, the version "Not prepared for display FHX50" must be ordered for the FHX50 under "Measuring device version". In this case, a retrofit kit for the device is supplied with the FHX50. The kit can be used to prepare the device so that the FHX50 can be used.

 Use of the FHX50 may be restricted for transmitters with an approval. A device can only be retrofitted with the FHX50 if the option "Prepared for FHX50" is listed under *Basic specifications*, "Display, operation" in the Safety instructions (XA) for the device.

Also refer to the Safety Instructions (XA) of the FHX50.

Retrofitting is not possible on transmitters with:

- An approval for use in areas with flammable dust (dust ignition-proof approval)
- Type of protection Ex nA

 For details, see "Special Documentation" document SD01007F.

14.1.7 Overvoltage protection

The surge arrester for loop-powered devices can be ordered together with the device via the "Accessory mounted" section of the product order structure.

The surge arrester can be used for loop-powered devices.

- 1-channel devices - OVP10
- 2-channel devices - OVP20

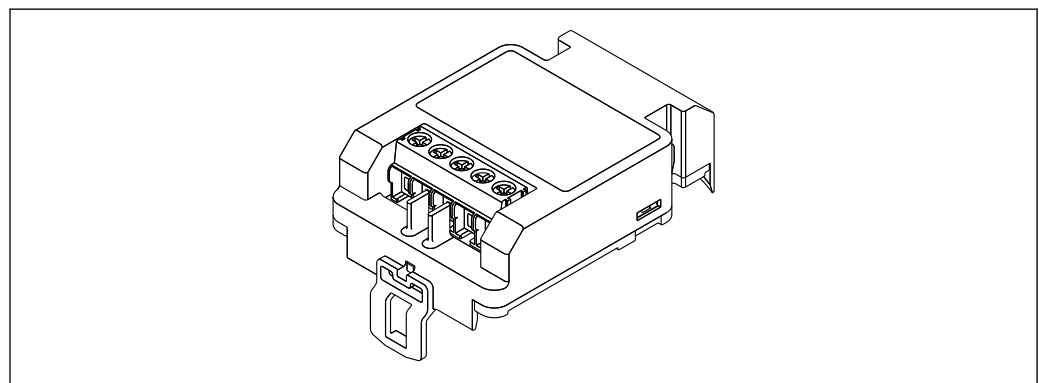

A0021734

Technical data

- Resistance per channel: $2 \times 0.5 \Omega_{\max}$
- Threshold DC voltage: 400 to 700 V
- Threshold surge voltage: < 800 V
- Capacitance at 1 MHz: < 1.5 pF
- Nominal leakage current (8/20 μ s): 10 kA
- Suitable for conductor cross-sections: 0.2 to 2.5 mm² (24 to 14 AWG)

If retrofitting:

- Order number for 1-channel devices (OVP10): 71128617
- Order number for 2-channel devices (OVP20): 71128619
- The use of the OVP module may be restricted depending on the transmitter approval. A device may only be retrofitted with the OVP module if the option *NA* (overvoltage protection) is listed under *Optional specifications* in the Safety Instructions (XA) associated with the device.
- In order to keep the necessary safety distances when using the surge arrester module, the housing cover also needs to be replaced when the device is retrofitted. Depending on the housing type, the suitable cover can be ordered using the following order number:
 - Housing GT18: 71185516
 - Housing GT19: 71185518
 - Housing GT20: 71185517



For details, see the "Special Documentation" SD01090F

14.1.8 Bluetooth module BT10 for HART devices

The Bluetooth module BT10 can be ordered together with the device via the "Accessory mounted" section of the product order structure.

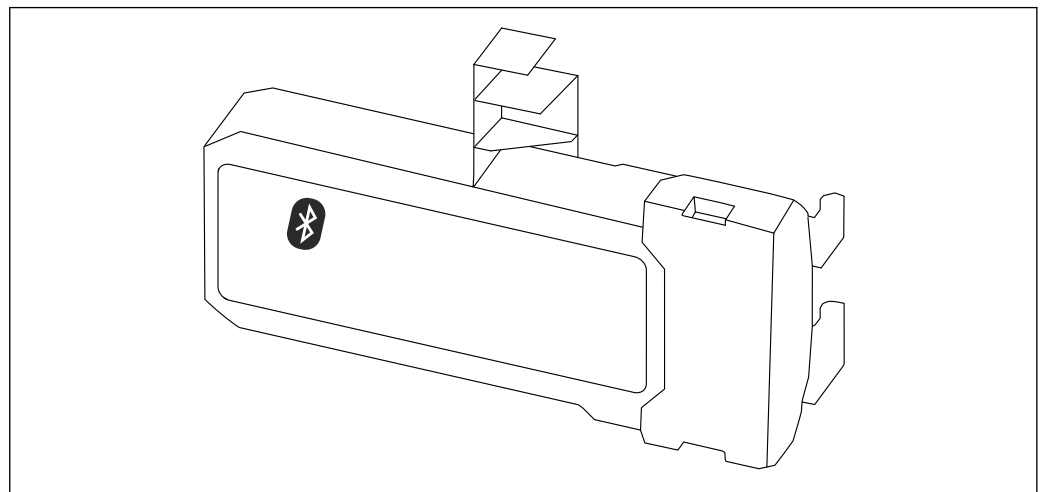

A0036493

Technical data

- Quick and easy setup with the SmartBlue app
- No additional tools or adapters needed
- Signal curve via SmartBlue (app)
- Encrypted single point-to-point data transmission (tested by Fraunhofer Institute) and password-protected communication via Bluetooth® wireless technology
- Range under reference conditions:
 - > 10 m (33 ft)
- When the Bluetooth module is used, the minimum supply voltage of the device increases by up to 3 V.

If retrofitting:

- Order number: 71377355
- The use of the Bluetooth module may be restricted depending on the transmitter approval. A device may only be retrofitted with the Bluetooth module if the option *NF* (Bluetooth module) is listed under *Optional specifications* in the Safety Instructions (XA) associated with the device.



For details, see the "Special Documentation" SD02252F

14.2 Communication-specific accessories

Commubox FXA291

Connects Endress+Hauser field devices with a CDI interface (= Endress+Hauser Common Data Interface) and the USB port of a computer or laptop

Order number: 51516983



For details, see "Technical Information" TI00405C

14.3 Service-specific accessories

DeviceCare SFE100

Configuration tool for HART, PROFIBUS and FOUNDATION Fieldbus field devices



Technical Information TI01134S

FieldCare SFE500

FDT-based plant asset management tool

It can configure all smart field units in your system and helps you manage them. By using the status information, it is also a simple but effective way of checking their status and condition.



Technical Information TI00028S

14.4 System components

14.4.1 Memograph M RSG45

The Advanced Data Manager is a flexible and powerful system for organizing process values.

The Memograph M is used for electronic acquisition, display, recording, analysis, remote transmission and archiving of analog and digital input signals as well as calculated values.























Technical Information TI01180R and Operating Instructions BA01338R

15 Operating menu

























15.1 Overview of the operating menu (display module)

Navigation  Operating menu

























Language	
Setup	→  106
Device tag	→  106
Operating mode	→  106
Distance unit	→  107
Tank type	→  107
Tube diameter	→  107
Tank level	→  113
Distance to upper connection	→  114
DC value	→  114
Medium group	→  108
Empty calibration	→  108
Full calibration	→  109
Level	→  110
Interface	→  115
Distance	→  111
Interface distance	→  116
Signal quality	→  112
► Mapping	→  119
Confirm distance	→  119
Mapping end point	→  119

Record map	→ 📖 119
Distance	→ 📖 119
▶ Advanced setup	→ 📖 120
Locking status	→ 📖 120
Access status display	→ 📖 121
Enter access code	→ 📖 121
▶ Level	→ 📖 122
Medium type	→ 📖 122
Medium property	→ 📖 122
Process property	→ 📖 123
Advanced process conditions	→ 📖 124
Level unit	→ 📖 125
Blocking distance	→ 📖 125
Level correction	→ 📖 126
▶ Interface	→ 📖 127
Process property	→ 📖 127
DC value lower medium	→ 📖 127
Level unit	→ 📖 128
Blocking distance	→ 📖 128
Level correction	→ 📖 129
▶ Automatic DC calculation	→ 📖 132
Manual thickness upper layer	→ 📖 132
DC value	→ 📖 132
Use calculated DC value	→ 📖 132

▶ Linearization	→ 📄 134
Linearization type	→ 📄 136
Unit after linearization	→ 📄 137
Free text	→ 📄 138
Maximum value	→ 📄 139
Diameter	→ 📄 140
Intermediate height	→ 📄 140
Table mode	→ 📄 140
▶ Edit table	
Level	
Customer value	
Activate table	→ 📄 142
▶ Safety settings	→ 📄 144
Output echo lost	→ 📄 144
Value echo lost	→ 📄 144
Ramp at echo lost	→ 📄 145
Blocking distance	→ 📄 125
▶ Probe settings	→ 📄 147
Probe grounded	→ 📄 147
▶ Probe length correction	→ 📄 149
Confirm probe length	→ 📄 149
Present probe length	→ 📄 147
▶ Switch output	→ 📄 151
Switch output function	→ 📄 151
Assign status	→ 📄 152

Assign limit	→  152
Assign diagnostic behavior	→  152
Switch-on value	→  153
Switch-on delay	→  154
Switch-off value	→  154
Switch-off delay	→  155
Failure mode	→  155
Switch status	→  155
Invert output signal	→  155
► Display	→  157
Language	→  157
Format display	→  157
Value 1 to 4 display	→  159
Decimal places 1 to 4	→  159
Display interval	→  160
Display damping	→  160
Header	→  160
Header text	→  161
Separator	→  161
Number format	→  161
Decimal places menu	→  161
Backlight	→  162
Contrast display	→  162
► Configuration backup display	→  163
Operating time	→  163

Last backup	→ 📄 163
Configuration management	→ 📄 163
Comparison result	→ 📄 164
▶ Administration	→ 📄 166
▶ Define access code	→ 📄 168
Define access code	→ 📄 168
Confirm access code	→ 📄 168
Device reset	→ 📄 166
🔍 Diagnostics	→ 📄 168
Actual diagnostics	→ 📄 168
Previous diagnostics	→ 📄 169
Operating time from restart	→ 📄 169
Operating time	→ 📄 163
▶ Diagnostic list	→ 📄 170
Diagnostics 1 to 5	→ 📄 170
▶ Event logbook	→ 📄 171
Filter options	
▶ Event list	→ 📄 171
▶ Device information	→ 📄 172
Device tag	→ 📄 172
Serial number	→ 📄 172
Firmware version	→ 📄 172
Device name	→ 📄 172
Order code	→ 📄 173
Extended order code 1 to 3	→ 📄 173

Device revision	→  173
Device ID	→  173
Device type	→  174
Manufacturer ID	→  174
▶ Measured values	→  175
Distance	→  111
Level linearized	→  139
Interface distance	→  116
Interface linearized	→  139
Thickness upper layer	→  177
Terminal voltage 1	→  177
▶ Data logging	→  178
Assign channel 1 to 4	→  178
Logging interval	→  179
Clear logging data	→  179
▶ Display channel 1 to 4	→  180
▶ Simulation	→  182
Assign measurement variable	→  183
Process variable value	→  183
Switch output simulation	→  183
Switch status	→  184
Device alarm simulation	→  184
▶ Device check	→  185
Start device check	→  185
Result device check	→  185

Last check time	→ 📄 185
Level signal	→ 📄 186
Launch signal	→ 📄 186
Interface signal	→ 📄 186

15.2 Overview of the operating menu (operating tool)

Navigation



Operating menu

























Setup	→ 106
Device tag	→ 106
Operating mode	→ 106
Distance unit	→ 107
Tank type	→ 107
Tube diameter	→ 107
Medium group	→ 108
Empty calibration	→ 108
Full calibration	→ 109
Level	→ 110
Distance	→ 111
Signal quality	→ 112
Tank level	→ 113
Distance to upper connection	→ 114
DC value	→ 114
Interface	→ 115
Interface distance	→ 116
Confirm distance	→ 116
Present mapping	→ 117
Mapping end point	→ 118
Record map	→ 118
▶ Advanced setup	→ 120
Locking status	→ 120

Access status tooling	→ 120
Enter access code	→ 121
► Level	→ 122
Medium type	→ 122
Medium property	→ 122
Process property	→ 123
Advanced process conditions	→ 124
Level unit	→ 125
Blocking distance	→ 125
Level correction	→ 126
► Interface	→ 127
Process property	→ 127
DC value lower medium	→ 127
Level unit	→ 128
Blocking distance	→ 128
Level correction	→ 129
Manual thickness upper layer	→ 129
Measured thickness upper layer	→ 130
DC value	→ 130
Calculated DC value	→ 130
Use calculated DC value	→ 131
► Linearization	→ 134
Linearization type	→ 136
Unit after linearization	→ 137
Free text	→ 138

Level linearized	→ 📖 139
Interface linearized	→ 📖 139
Maximum value	→ 📖 139
Diameter	→ 📖 140
Intermediate height	→ 📖 140
Table mode	→ 📖 140
Table number	→ 📖 141
Level	→ 📖 142
Level	→ 📖 142
Customer value	→ 📖 142
Activate table	→ 📖 142
► Safety settings	→ 📖 144
Output echo lost	→ 📖 144
Value echo lost	→ 📖 144
Ramp at echo lost	→ 📖 145
Blocking distance	→ 📖 125
► Probe settings	→ 📖 147
Probe grounded	→ 📖 147
Present probe length	→ 📖 147
Confirm probe length	→ 📖 148
► Switch output	→ 📖 151
Switch output function	→ 📖 151
Assign status	→ 📖 152
Assign limit	→ 📖 152
Assign diagnostic behavior	→ 📖 152

Switch-on value	→ 153
Switch-on delay	→ 154
Switch-off value	→ 154
Switch-off delay	→ 155
Failure mode	→ 155
Switch status	→ 155
Invert output signal	→ 155
► Display	→ 157
Language	→ 157
Format display	→ 157
Value 1 to 4 display	→ 159
Decimal places 1 to 4	→ 159
Display interval	→ 160
Display damping	→ 160
Header	→ 160
Header text	→ 161
Separator	→ 161
Number format	→ 161
Decimal places menu	→ 161
Backlight	→ 162
Contrast display	→ 162
► Configuration backup display	→ 163
Operating time	→ 163
Last backup	→ 163
Configuration management	→ 163

Backup state	→ 164
Comparison result	→ 164
▶ Administration	→ 166
Define access code	
Device reset	→ 166
🔍 Diagnostics	→ 168
Actual diagnostics	→ 168
Timestamp	→ 169
Previous diagnostics	→ 169
Timestamp	→ 169
Operating time from restart	→ 169
Operating time	→ 163
▶ Diagnostic list	→ 170
Diagnostics 1 to 5	→ 170
Timestamp 1 to 5	→ 170
▶ Device information	→ 172
Device tag	→ 172
Serial number	→ 172
Firmware version	→ 172
Device name	→ 172
Order code	→ 173
Extended order code 1 to 3	→ 173
Device revision	→ 173
Device ID	→ 173

Device type	→  174
Manufacturer ID	→  174
► Measured values	→  175
Distance	→  111
Level linearized	→  139
Interface distance	→  116
Interface linearized	→  139
Thickness upper layer	→  177
Terminal voltage 1	→  177
► Data logging	→  178
Assign channel 1 to 4	→  178
Logging interval	→  179
Clear logging data	→  179
► Simulation	→  182
Assign measurement variable	→  183
Process variable value	→  183
Switch output simulation	→  183
Switch status	→  184
Device alarm simulation	→  184
► Device check	→  185
Start device check	→  185
Result device check	→  185
Last check time	→  185
Level signal	→  186

Launch signal	→ 186
Interface signal	→ 186
▶ Heartbeat	

15.3 "Setup" menu

- : Indicates how to navigate to the parameter using the display and operating module
- : Indicates how to navigate to the parameter using operating tools (e.g. FieldCare)
- : Indicates parameters that can be locked via the access code

Navigation Setup

Device tag

Navigation Setup → Device tag

Description Enter a unique name for the measuring point to identify the device quickly within the plant.

User entry Character string comprising numbers, letters and special characters (32)

Operating mode

Navigation Setup → Operating mode

Prerequisite The device has the "interface measurement" application package (available for FMP51, FMP52, FMP54) ¹⁾.



Description Select operating mode.

- Selection**
- Level
 - Interface with capacitance *
 - Interface *



Factory setting FMP51/FMP52/FMP54: **Level**

1) Product structure: Feature 540 "Application Package", Option EB "Interface measurement"
 * Visibility depends on order options or device settings



Distance unit

Navigation	  Setup → Distance unit	
Description	Used for the basic calibration (Empty / Full).	
Selection	<i>SI units</i> <ul style="list-style-type: none"> ▪ mm ▪ m 	<i>US units</i> <ul style="list-style-type: none"> ▪ ft ▪ in

Tank type

Navigation	  Setup → Tank type	
Prerequisite	Medium type (→  122) = Liquid	
Description	Select tank type.	
Selection	<ul style="list-style-type: none"> ▪ Metallic ▪ Bypass / pipe ▪ Non metallic ▪ Mounted outside ▪ Coaxial 	
Factory setting	Depending on the probe	
Additional information	<ul style="list-style-type: none"> ▪ Depending on the probe some of the options mentioned above may not be available or there may be additional options. ▪ For coax probes and probes with metallic center washer Tank type parameter corresponds to the type of probe and cannot be changed. 	

Tube diameter

Navigation	  Setup → Tube diameter	
Prerequisite	Tank type (→  107) = Bypass / pipe	
Description	Specify diameter of bypass or stilling well.	
User entry	0 to 9.999 m	

Medium group



Navigation

Setup → Medium group

Prerequisite

- For FMP51/FMP52/FMP54/FMP55: **Operating mode** (→ 106) = **Level**
- **Medium type** (→ 122) = **Liquid**

Description

Select medium group.

Selection

- Others
- Water based (DC >= 4)

Additional information

This parameter roughly specifies the dielectric constant (DC) of the medium. For a more detailed definition of the DC use the **Medium property** parameter (→ 122).

The **Medium group** parameter presets the **Medium property** parameter (→ 122) as follows:

Medium group	Medium property (→ 122)
Others	Unknown
Water based (DC >= 4)	DC 4 ... 7

The **Medium property** parameter can be changed at a later point of time. However, when doing so, the **Medium group** parameter retains its value. Only the **Medium property** parameter is relevant for the signal evaluation.

The measuring range may be reduced for small dielectric constants. For details refer to the Technical Information (TI) of the respective device.

Empty calibration



Navigation

Setup → Empty calibr.

Description

Distance between process connection and minimum level (0%).

User entry

Depending on the probe

Factory setting

Depending on the probe

Additional information

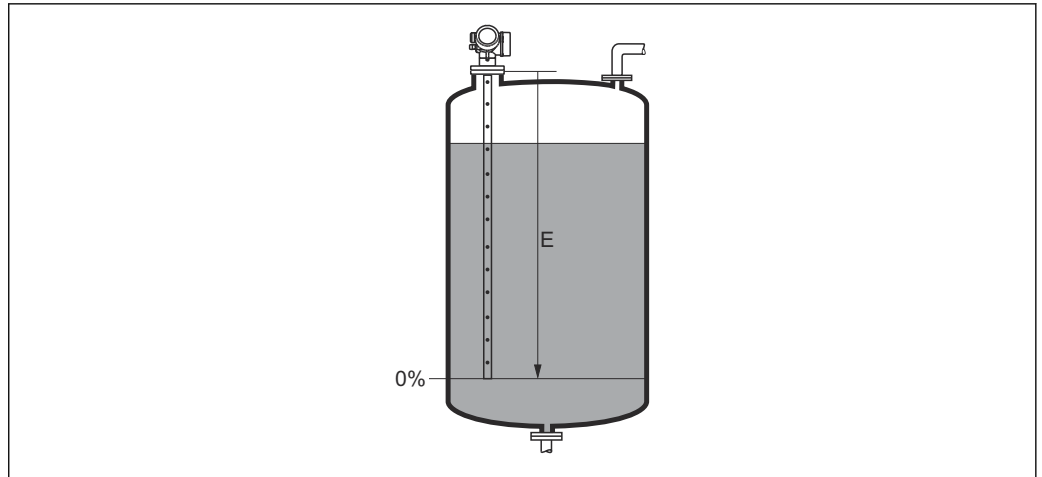

A0013176

30 Empty calibration (E) for level measurements in liquids

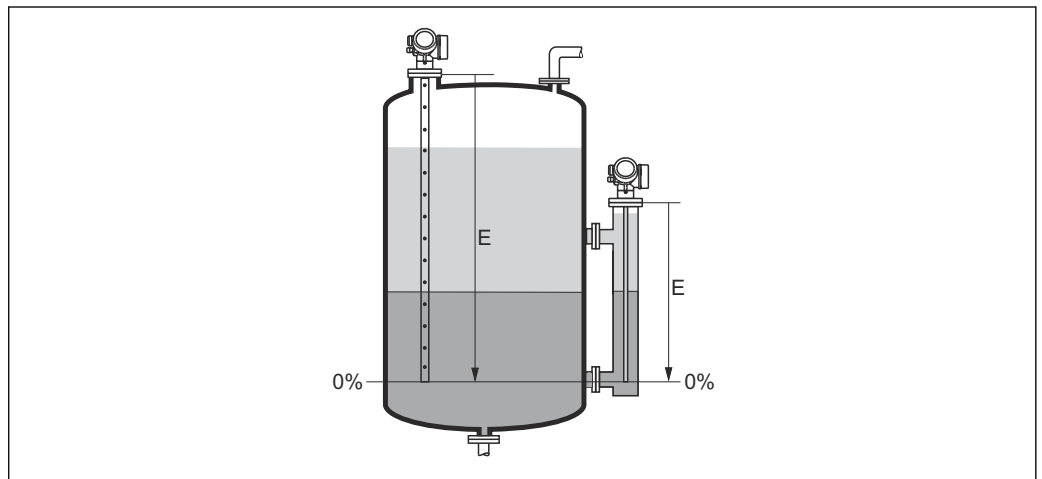

A0013177

31 Empty calibration (E) for interface measurements

i In the case of interface measurements the **Empty calibration** parameter is valid for both, the total and the interface level.

Full calibration



Navigation

Setup → Full calibr.

Description

Distance between minimum level (0%) and maximum level (100%).

User entry

Depending on the probe

Factory setting

Depending on the probe

Additional information

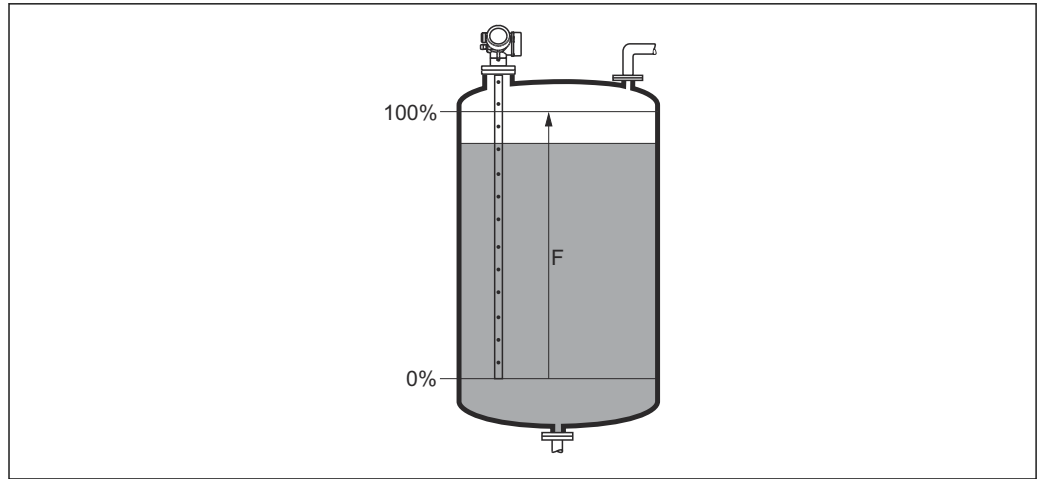

A0013186

32 Full calibration (F) for level measurements in liquids

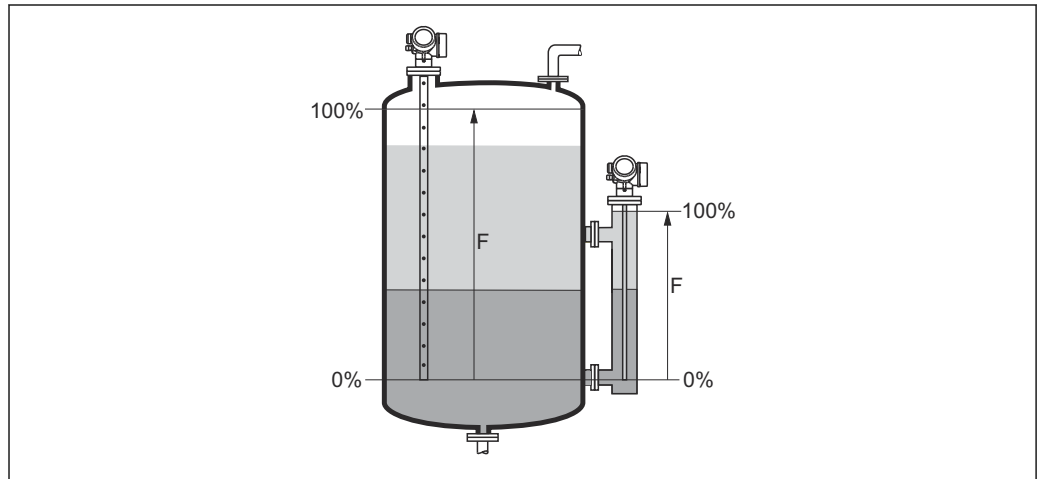

A0013188

33 Full calibration (F) for interface measurements

i In the case of interface measurements the **Full calibration** parameter is valid for both, the total and the interface level.

Level

Navigation

☰ ☰ Setup → Level

Description

Displays measured level L_L (before linearization).

Additional information

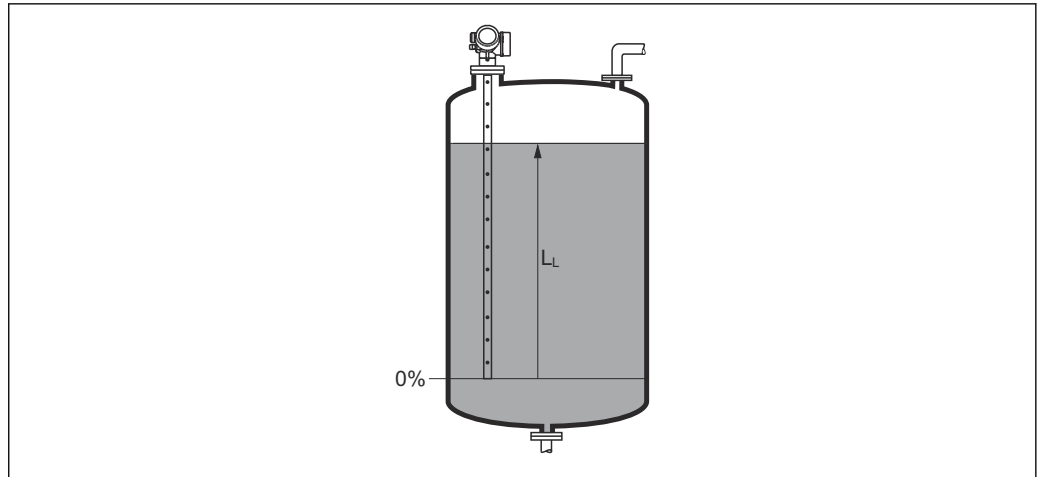

A0013194

34 Level in case of liquid measurements

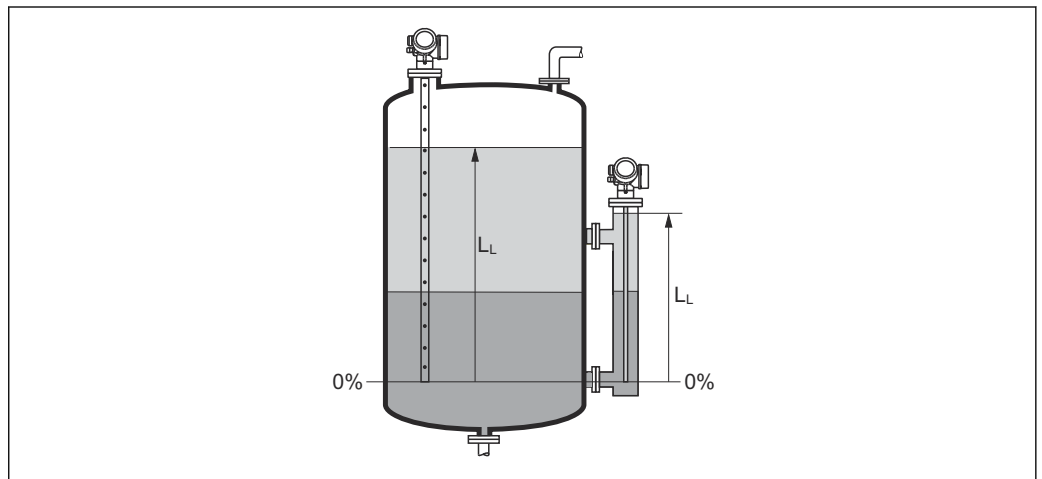

A0013195

35 Level in case of interface measurements

- i

 ■ The unit is defined in the **Level unit** parameter (→ 125).
 ■ In case of interface measurements, this parameter always refers to the total level.

Distance

Navigation

☰☰ Setup → Distance

Description

Displays the measured distance D_L between the reference point (lower edge of the flange or threaded connection) and the level.

Additional information

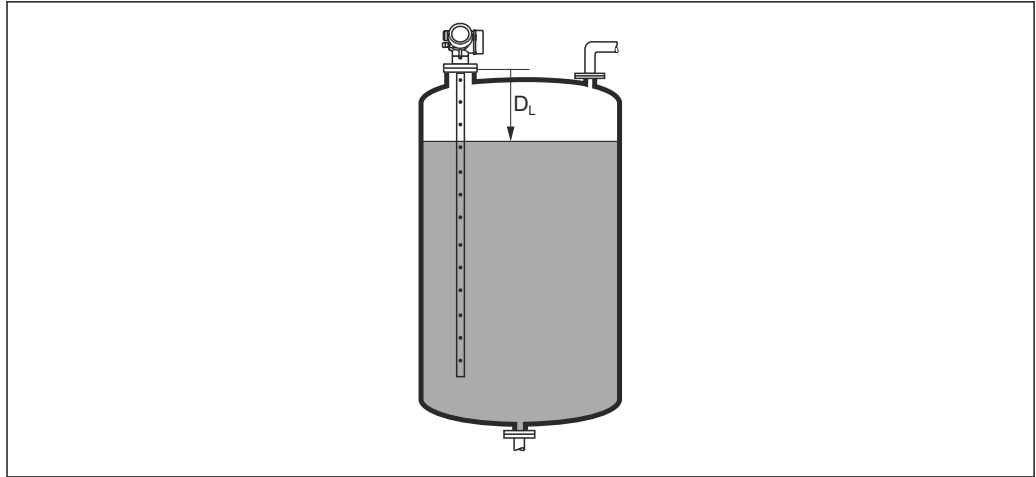

A0013196

36 Distance for liquid measurements

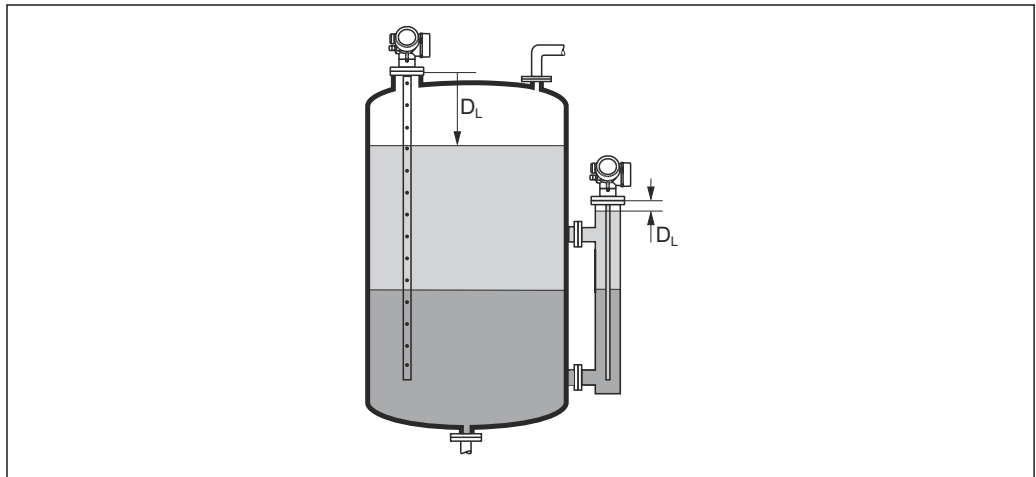

A0013199

37 Distance for interface measurements

The unit is defined in the **Distance unit** parameter (→ 107).

Signal quality

Navigation

Setup → Signal quality

Description

Displays the signal quality of the evaluated echo.

Additional information

Meaning of the display options

- **Strong**
The evaluated echo exceeds the threshold by at least 10 mV.
- **Medium**
The evaluated echo exceeds the threshold by at least 5 mV.
- **Weak**
The evaluated echo exceeds the threshold by less than 5 mV.
- **No signal**
The device does not find a usable echo.

The signal quality indicated in this parameter always refers to the currently evaluated echo: either the level/interface echo ²⁾ or the end-of-probe echo. To differentiate between these two, the quality of the end-of-probe echo is always displayed in brackets.

i In case of a lost echo (**Signal quality = No signal**) the device generates the following error message:

- F941, for **Output echo lost** (→ **144**) = **Alarm**.
- S941, if another option has been selected in **Output echo lost** (→ **144**).

Tank level 🔒

Navigation

🏠📄 Setup → Tank level

Prerequisite

Operating mode (→ **106**) = **Interface**

Description

Specify whether the tank or bypass is completely flooded or not.

Selection

- Partially filled
- Fully flooded

Additional information

Meaning of the options

▪ Partially filled

The device searches for 2 echo signals, one for the interface and one for the total level.

▪ Fully flooded

The device searches for the interface level only. With this setting it is essential that the upper level signal always is within the upper blocking distance (UB) in order to avoid that it is evaluated by mistake.

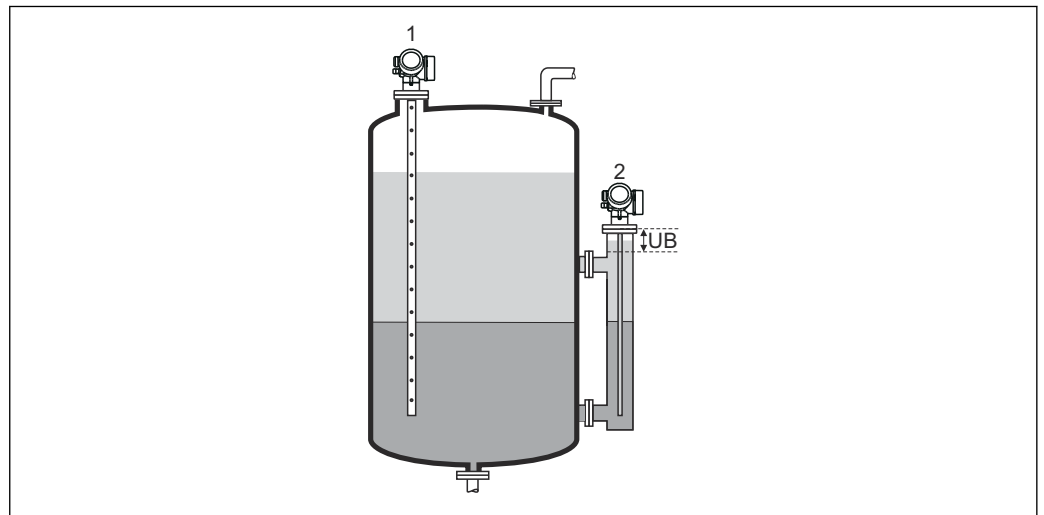

- 1 Partially filled
 2 Fully flooded
 UB Upper blocking distance

A0013173

2) Of these two echos the one with the lower quality is indicated.

Distance to upper connection
**Navigation**

Setup → Dist. up.connect

PrerequisiteThe device has the "Interface measurement" application package ³⁾.**Description**Specify distance D_U to upper connection.**User entry**

0 to 200 m

Factory setting

- For Tank level (→ 113) = **Partially filled**: 0 mm (0 in)
- For Tank level (→ 113) = **Fully flooded**: 250 mm (9.8 in)

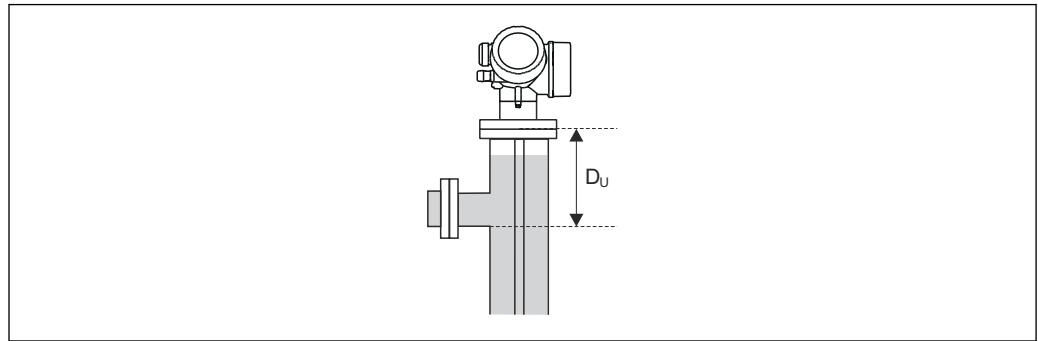
Additional information

A0013174

Dependence on the "Tank level" parameter

- **Tank level (→ 113) = Partially filled:**
In this case the **Distance to upper connection** parameter does not influence the measurement. Thus, the default setting needs not to be changed.
- **Tank level (→ 113) = Fully flooded:**
In this case enter the distance D_U between the reference point and the lower edge of the upper connection.

DC value
**Navigation**

Setup → DC value

PrerequisiteThe device has the "Interface measurement" application package ⁴⁾.**Description**Specify the relative dielectric constant ϵ_r of the upper medium (DC_1).**User entry**

1.0 to 100

3) Product structure: Feature 540 "Application Package", Option EB "Interface measurement"

4) Product structure: feature 540 "Application packages", option EB "Interface measurement"

Additional information

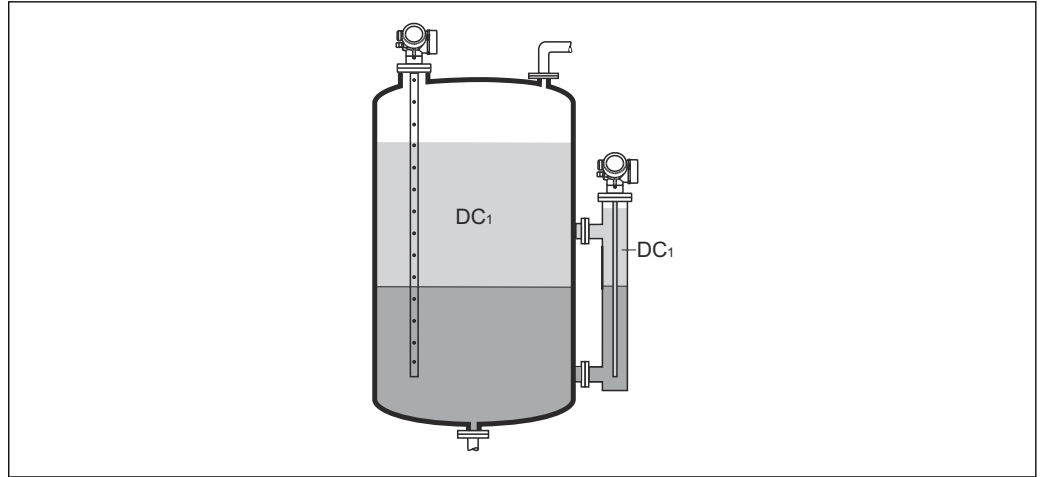

A0013181

DC1 Relative dielectric constant of the upper medium.

- i** For the relative permittivity values (ϵ_r values) of many media commonly used in industry, please refer to:
 - Relative permittivity (ϵ_r value), Compendium CP01076F
 - The Endress+Hauser "DC Values app" (available for Android and iOS)

Interface

Navigation

Setup → Interface

Prerequisite

Operating mode (→ 106) = **Interface** or **Interface with capacitance**

Description

Displays the measured interface level L_1 (before linearization).

Additional information

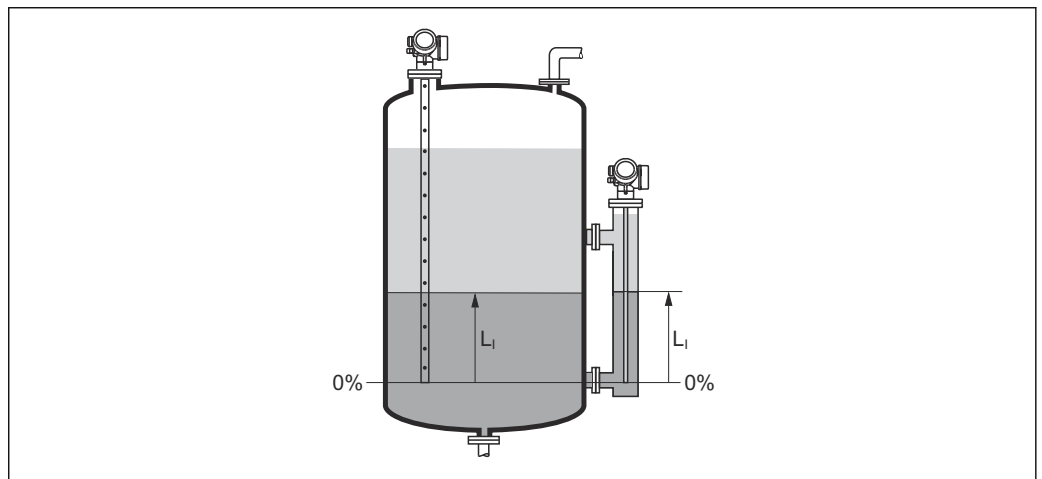

A0013197

- i** The unit is defined in the **Level unit** parameter (→ 125).

Interface distance

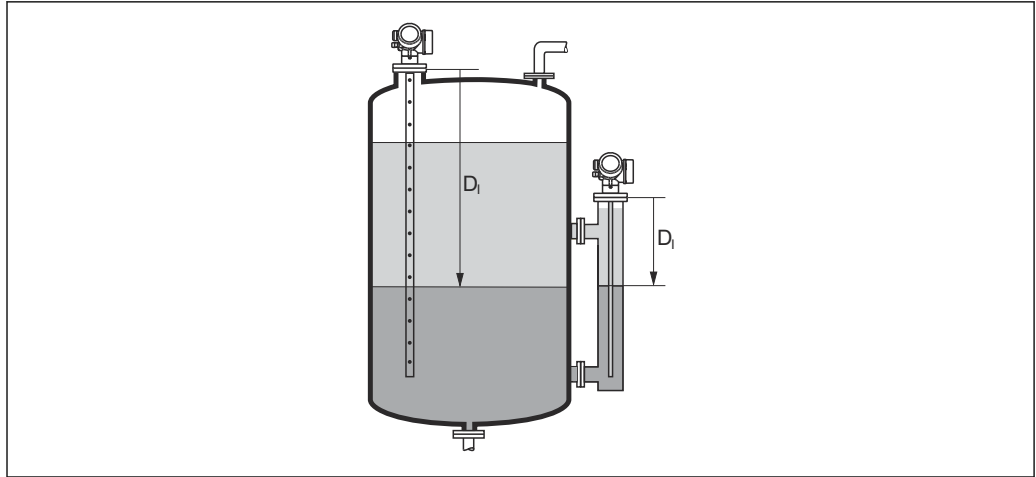
Navigation
 Setup → Interface dist.
Prerequisite
Operating mode (→  106) = **Interface** or **Interface with capacitance**
Description
 Displays the measured distance D_1 between the reference point (lower edge of flange or threaded connection) and the interface.
Additional information

A0013202

 The unit is defined in the **Distance unit** parameter (→  107).

Confirm distance

**Navigation**
 Setup → Confirm distance
Description

Specify, whether the measured distance matches the real distance.

Depending on the selection the device automatically sets the range of mapping.

Selection

- Manual map
- Distance ok
- Distance unknown
- Distance too small*
- Distance too big*
- Tank empty
- Delete map

 * Visibility depends on order options or device settings

Additional information**Meaning of the options**

- **Manual map**

To be selected if the range of mapping is to be defined manually in the **Mapping end point** parameter (→  118). In this case it is not necessary to confirm the distance.

- **Distance ok**

To be selected if the measured distance matches the actual distance. The device performs a mapping.

- **Distance unknown**

To be selected if the actual distance is unknown. A mapping can not be performed in this case.

- **Distance too small**

To be selected if the measured distance is smaller than the actual distance. The device searches for the next echo and returns to the **Confirm distance** parameter. The distance is recalculated and displayed. The comparison must be repeated until the displayed distance matches the actual distance. After this, the recording of the map can be started by selecting **Distance ok**.

- **Distance too big**⁵⁾

To be selected if the measured distance exceeds the actual distance. The device adjusts the signal evaluation and returns to the **Confirm distance** parameter. The distance is recalculated and displayed. The comparison must be repeated until the displayed distance matches the actual distance. After this, the recording of the map can be started by selecting **Distance ok**.

- **Tank empty**

To be selected if the tank is completely empty. The device records a mapping covering the complete measuring range.

To be selected if the tank is completely empty. The device records a mapping covering the complete measuring range minus **Map gap to LN**.

- **Factory map**

To be selected if the present mapping curve (if one exists) is to be deleted. The device returns to the **Confirm distance** parameter and a new mapping can be recorded.



When operating via the display module, the measured distance is displayed together with this parameter for reference purposes.



For interface measurements the distance always refers to the total level (not the interface level).



If the teaching procedure with the **Distance too small** option or the **Distance too big** option is quit before the distance has been confirmed, a map is **not** recorded and the teaching procedure is reset after 60 s.

Present mapping

Navigation

 Setup → Present mapping

Description

Indicates up to which distance a mapping has already been recorded.

5) Only available for "Expert → Sensor → Echo tracking → **Evaluation mode** parameter" = "Short time history" or "Long time history"

Mapping end point

Navigation Setup → Map. end point

Prerequisite **Confirm distance** (→ 116) = **Manual map** or **Distance too small**

Description Specify new end of the mapping.

User entry 0 to 200 000.0 m

Additional information This parameter defines up to which distance the new mapping is to be recorded. The distance is measured from the reference point, i.e. from the lower edge of the mounting flange or the threaded connection.



For reference purposes the **Present mapping** parameter (→ 117) is displayed together with this parameter. It indicates up to which distance a mapping has already been recorded.

Record map

Navigation Setup → Record map

Prerequisite **Confirm distance** (→ 116) = **Manual map** or **Distance too small**

Description Start recording of the map.



Selection

- No
- Record map
- Delete map

Additional information **Meaning of the options**

- **No**
The map is not recorded.
- **Record map**
The map is recorded. After the recording is completed, the new measured distance and the new mapping range appear on the display. When operating via the local display, these values must be confirmed by pressing .
- **Delete map**
The mapping (if one exists) is deleted and the device displays the recalculated measured distance and the mapping range. When operating via the local display, these values must be confirmed by pressing .

15.3.1 "Mapping" wizard

-  The **Mapping** wizard is only available when operating via the local display. When operating via an operating tool, all parameters concerning the mapping are located directly in the **Setup** menu (→  106).
-  In the **Mapping** wizard two parameters are displayed simultaneously on the display module at any one time. The upper parameter can be edited, whereas the lower parameter is displayed for reference purposes only.

Navigation  Setup → Mapping

Confirm distance

Navigation  Setup → Mapping → Confirm distance

Description →  116

Mapping end point

Navigation  Setup → Mapping → Map. end point

Description →  118

Record map

Navigation  Setup → Mapping → Record map

Description →  118

Distance





Navigation  Setup → Mapping → Distance

Description →  111





15.3.2 "Advanced setup" submenu

Navigation  Setup → Advanced setup





Locking status

Navigation	  Setup → Advanced setup → Locking status
Description	Indicates the write protection with the highest priority that is currently active.
User interface	<ul style="list-style-type: none"> ▪ Hardware locked ▪ SIL locked ▪ CT active - defined parameters ▪ WHG locked ▪ Temporarily locked
Additional information	<p>Meaning and priorities of the types of write protection</p> <ul style="list-style-type: none"> ▪ Hardware locked (priority 1) The DIP switch for hardware locking is activated on the main electronics module. This locks write access to the parameters. ▪ SIL locked (priority 2) The SIL mode is activated. Writing access to the relevant parameters is denied. ▪ WHG locked (priority 3) The WHG mode is activated. Writing access to the relevant parameters is denied. ▪ Temporarily locked (priority 4) Write access to the parameters is temporarily locked on account of internal processes in progress in the device (e.g. data upload/download, reset etc.). The parameters can be modified as soon as the processes are complete. <p> On the display module, the -symbol appears in front of parameters that cannot be modified since they are write-protected.</p>





Access status tooling

Navigation	 Setup → Advanced setup → Access stat.tool
Description	Shows the access authorization to the parameters via the operating tool.
Additional information	<p> The access authorization can be changed via the Enter access code parameter (→  121).</p> <p> If additional write protection is active, this restricts the current access authorization even further. The write protection status can be viewed via the Locking status parameter (→  120).</p>



Access status display

Navigation	 Setup → Advanced setup → Access stat.disp
Prerequisite	The device has a local display.
Description	Indicates access authorization to parameters via local display.
Additional information	<p> The access authorization can be changed via the Enter access code parameter (→  121).</p> <p> If additional write protection is active, this restricts the current access authorization even further. The write protection status can be viewed via the Locking status parameter (→  120).</p>

Enter access code





Navigation	 Setup → Advanced setup → Ent. access code
Description	Enter access code to disable write protection of parameters.
User entry	0 to 9999
Additional information	<ul style="list-style-type: none"> ▪ The customer-specific access code that was defined in the Define access code parameter (→  166) must be entered for local operation. ▪ If an incorrect access code is entered, users retain their current access authorization. ▪ The write protection affects all parameters marked with the  symbol in the document. On the local display, the  symbol in front of a parameter indicates that the parameter is write-protected. ▪ If no key is pressed for 10 minutes or the user goes from the navigation and editing mode back to the measured value display mode, the device automatically locks the write-protected parameters after another 60 s. <p> Please contact your Endress+Hauser Sales Center if you lose your access code.</p>

"Level" submenu





 **Level** submenu (→  122) is only visible for **Operating mode** (→  106) = **Level**

Navigation   Setup → Advanced setup → Level

Medium type 

Navigation	  Setup → Advanced setup → Level → Medium type
Description	Specify type of medium.
User interface	<ul style="list-style-type: none"> ▪ Liquid ▪ Solid
Factory setting	FMP50, FMP51, FMP52, FMP53, FMP54, FMP55: Liquid
Additional information	<p>The Solid option is only available for Operating mode (→  106) = Level</p> <p> This parameter determines the value of several other parameters and strongly influences the complete signal evaluation. Therefore, it is strongly recommended not to change the factory setting.</p>

Medium property 

Navigation	  Setup → Advanced setup → Level → Medium property
Prerequisite	<ul style="list-style-type: none"> ▪ Operating mode (→  106) = Level ▪ EOP level evaluation ≠ Fix DC
Description	Specify the dielectric constant ϵ_r of the medium.
Selection	<ul style="list-style-type: none"> ▪ Unknown ▪ DC 1.4 ... 1.6 ▪ DC 1.6 ... 1.9 ▪ DC 1.9 ... 2.5 ▪ DC 2.5 ... 4 ▪ DC 4 ... 7 ▪ DC 7 ... 15 ▪ DC > 15
Factory setting	Depends on the Medium type (→  122) and Medium group (→  108) parameters.

Additional information

Dependency of "Medium type" and "Medium group"

Medium type (→ ⓘ 122)	Medium group (→ ⓘ 108)	Medium property
Solid		Unknown
Liquid	Water based (DC >= 4)	DC 4 ... 7
	Others	Unknown

i For the relative permittivity values (ϵ_r values) of many media commonly used in industry, please refer to:

- Relative permittivity (ϵ_r value), Compendium CP01076F
- The Endress+Hauser "DC Values app" (available for Android and iOS)

i If **EOP level evaluation = Fix DC**, the exact dielectric constant must be specified in the **DC value** parameter (→ ⓘ 114). The **Medium property** parameter therefore does not apply in this case.

Process property



Navigation

☰☰ Setup → Advanced setup → Level → Process property

Description

Specify typical rate of level change.

Selection

For "Medium type" = "Liquid"

- Very fast > 10 m (400 in)/min
- Fast > 1 m (40 in)/min
- Standard < 1 m (40in) /min
- Medium < 10 cm (4in) /min
- Slow < 1 cm (0.4in) /min
- No filter / test

For "Medium type" = "Solid"

- Very fast > 100 m (333 ft) /h
- Fast > 10 m (33 ft) /h
- Standard < 10 m (33 ft) /h
- Medium < 1 m (3ft) /h
- Slow < 0.1 m (0.3ft) /h
- No filter / test

Additional information

The device adjusts the signal evaluation filters and the damping of the output signal to the typical rate of level change defined in this parameter:

For "Operating mode" = "Level" and "Medium type" = "Liquid"

Process property	Step response time / s
Very fast > 10 m (400 in)/min	5
Fast > 1 m (40 in)/min	5
Standard < 1 m (40in) /min	14
Medium < 10 cm (4in) /min	39
Slow < 1 cm (0.4in) /min	76
No filter / test	< 1

For "Operating mode" = "Level" and "Medium type" = "Solid"

Process property	Step response time / s
Very fast > 100 m (333 ft) /h	37
Fast > 10 m (33 ft) /h	37
Standard < 10 m (33 ft) /h	74
Medium < 1 m (3ft) /h	146
Slow < 0.1 m (0.3ft) /h	290
No filter / test	< 1

For "Operating mode" = "Interface" or "Interface with capacitance"

Process property	Step response time / s
Very fast > 10 m (400 in)/min	5
Fast > 1 m (40 in)/min	5
Standard < 1 m (40in) /min	23
Medium < 10 cm (4in) /min	47
Slow < 1 cm (0.4in) /min	81
No filter / test	2.2

Advanced process conditions



Navigation

Setup → Advanced setup → Level → Adv. conditions

Prerequisite

Operating mode (→ 106) = Level

Description

Specify additional process conditions (if required).

Selection

- None
- Oil/Water condensate
- Probe near tank bottom
- Build up
- Foam (>5cm/0,16ft)

Additional information

Meaning of the options

- **Oil/Water condensate** (only **Medium type = Liquid**)
Makes sure that in the case of two-phase media only the total level is detected (example: oil/condensate application).
- **Probe near tank bottom** (only for **Medium type = Liquid**)
Improves the empty detection, especially if the probe is mounted close to the tank bottom.
- **Build up**
Increases **EOP range upper area** in order to ensure a safe empty-detection even if the end-of-probe signal has shifted due to build-up.
Enables a safe empty-detection even if the end-of-probe signal has shifted due to build-up.
- **Foam (>5cm/0,16ft)** (only for **Medium type = Liquid**)
Optimizes the signal evaluation in applications with foam formation.

Level unit



Navigation Setup → Advanced setup → Level → Level unit

Description Select level unit.

Selection

<i>SI units</i>	<i>US units</i>
▪ %	▪ ft
▪ m	▪ in
▪ mm	

Additional information The level unit may differ from the distance unit defined in the **Distance unit** parameter (→ 107):

- The unit defined in the **Distance unit** parameter is used for the basic calibration (**Empty calibration** (→ 108) and **Full calibration** (→ 109)).
- The unit defined in the **Level unit** parameter is used to display the (nonlinearized) level.

Blocking distance



Navigation Setup → Advanced setup → Level → Blocking dist.

Description Specify upper blocking distance UB.

User entry 0 to 200 m

Factory setting

- For coax probes: 0 mm (0 in)
- For rod and rope probes up to 8 m (26 ft): 200 mm (8 in)
- For rod and rope probes above 8 m (26 ft): 0.025 * Sondenlänge

For FMP51/FMP52/FMP54 with the **Interface measurement** application package⁶⁾ and for FMP55:
100 mm (3.9 in) for all antenna types

Additional information Signals in the upper blocking distance are only evaluated if they have been outside the blocking distance when the device was switched on and move into the blocking distance due to a level change during operation. Signals which are already in the blocking distance when the device is switched on, are ignored.

- This behavior is only valid if the following two conditions are met:
 - Expert → Sensor → Echo tracking → Evaluation mode = **Short time history** or **Long time history**
 - Expert → Sensor → Gas phase compensation → GPC mode= **On, Without correction** or **External correction**

If one of these conditions is not met, signals in the blocking distance will always be ignored.

- A different behavior for signals in the blocking distance can be defined in the **Blocking distance evaluation mode** parameter.

- If required, a different behavior for signals in the blocking distance can be defined by the Endress+Hauser service.

6) Ordering feature 540 "Application Package", option EB "Interface measurement"

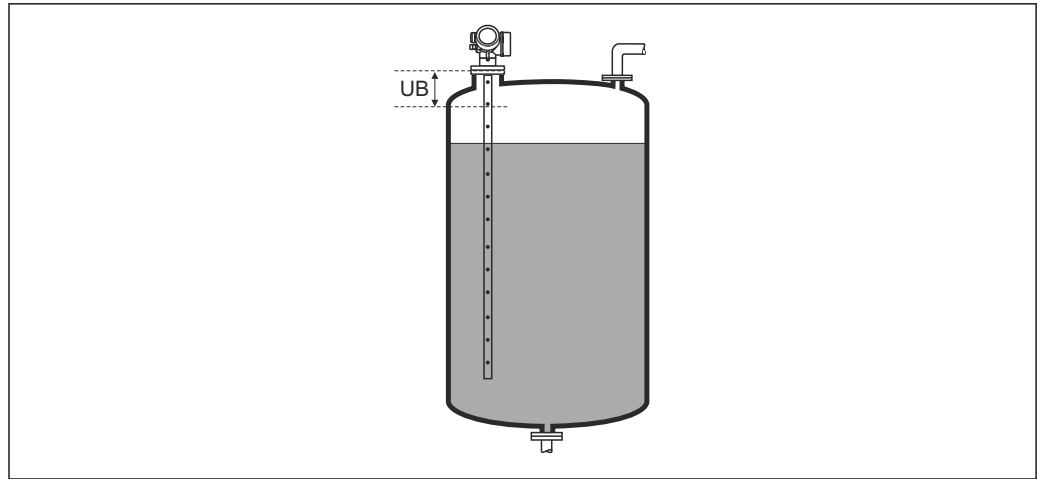

A0013219

38 Blocking distance (UB) for liquid measurements

Level correction



Navigation

  Setup → Advanced setup → Level → Level correction

Description

Specify level correction (if required).

User entry

-200 000.0 to 200 000.0 %

Additional information

The value specified in this parameter is added to the measured level (before linearization).

"Interface" submenu

Navigation  Setup → Advanced setup → Interface

Process property 

Navigation  Setup → Advanced setup → Interface → Process property

Description Specify typical rate of change for the interface position.

- Selection**
- Fast > 1 m (40 in)/min
 - Standard < 1 m (40in) /min
 - Medium < 10 cm (4in) /min
 - Slow < 1 cm (0.4in) /min
 - No filter / test

Additional information The device adjusts the signal evaluation filters and the damping of the output signal to the typical rate of level change defined in this parameter:

Process property	Step response time / s
Fast > 1 m (40 in)/min	5
Standard < 1 m (40in) /min	15
Medium < 10 cm (4in) /min	40
Slow < 1 cm (0.4in) /min	74
No filter / test	2.2



DC value lower medium 

Navigation  Setup → Advanced setup → Interface → DC lower medium

Prerequisite **Operating mode** (→  106) = **Interface** or **Interface with capacitance**

Description Specify the dielectric constant ϵ_r of the lower medium.

User entry 1 to 100

- Additional information**
-  For the relative permittivity values (ϵ_r values) of many media commonly used in industry, please refer to:
 - Relative permittivity (ϵ_r value), Compendium CP01076F
 - The Endress+Hauser "DC Values app" (available for Android and iOS)
 -  The factory setting, $\epsilon_r = 80$, applies for water at 20 °C (68 °F).

Level unit

Navigation	Setup → Advanced setup → Interface → Level unit	
Description	Select level unit.	
Selection	<i>SI units</i> <ul style="list-style-type: none"> ■ % ■ m ■ mm 	<i>US units</i> <ul style="list-style-type: none"> ■ ft ■ in
Additional information	<p>The level unit may differ from the distance unit defined in the Distance unit parameter (→ 107):</p> <ul style="list-style-type: none"> ■ The unit defined in the Distance unit parameter is used for the basic calibration (Empty calibration (→ 108) and Full calibration (→ 109)). ■ The unit defined in the Level unit parameter is used to display the (nonlinearized) level and interface position. 	

Blocking distance

Navigation	Setup → Advanced setup → Interface → Blocking dist.	
Description	Specify upper blocking distance UB.	
User entry	0 to 200 m	
Factory setting	<ul style="list-style-type: none"> ■ For coax probes: 100 mm (3.9 in) ■ For rod and rope probes up to 8 m (26 ft): 200 mm (8 in) ■ For rod and rope probes above 8 m (26 ft): 0.025 * length of probe 	
Additional information	<p>Echoes from within the blocking distance are not taken into account in the signal evaluation. The upper blocking distance is used</p> <ul style="list-style-type: none"> ■ to suppress interference echoes at the top end of the probe. ■ to suppress the echo of the total level in the case of flooded bypasses. 	

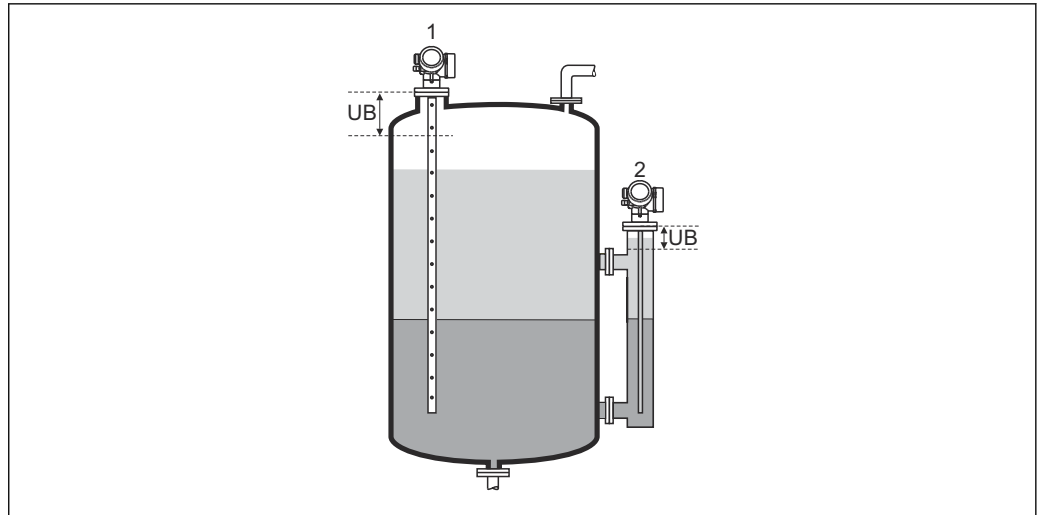

A0013220

- 1 Suppression of interference echoes at the top end of the probe.
- 2 Suppression of the level signal in case of a flooded bypass.
- UB Upper blocking distance

Level correction 🔒

Navigation	🏠📄 Setup → Advanced setup → Interface → Level correction
Description	Specify level correction (if required).
User entry	-200 000.0 to 200 000.0 %
Additional information	The value specified in this parameter is added to the measured total and interface levels (before linearization).

Manual thickness upper layer 🔒

Navigation	📄 Setup → Advanced setup → Interface → Man.thick.up.lay
Description	Specify the manually determined interface thickness UP (i.e. the thickness of the upper medium).
User entry	0 to 200 m

Additional information

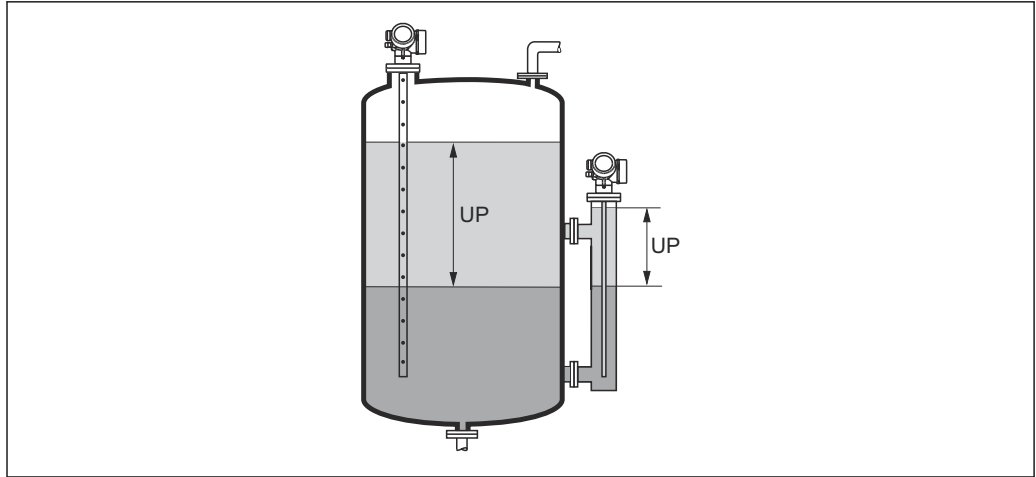

A0013313

UP Interface thickness (= thickness of upper medium)

 On the local display, the measured interface thickness is indicated together with the manual interface thickness. By comparing these two values the device can automatically adjust the dielectric constant of the upper medium.

Measured thickness upper layer

Navigation  Setup → Advanced setup → Interface → Meas.thick.u.lay

Description Displays the measured interface thickness. (Thickness UP of the upper medium).

DC value



Navigation  Setup → Advanced setup → Interface → DC value

Description Displays relative dielectric constant ϵ_r of the upper medium (DC₁) before correction.

Calculated DC value

Navigation  Setup → Advanced setup → Interface → Calc. DC value

Description Displays calculated (i.e. corrected) relative dielectric constant ϵ_r (DC1) of the upper medium.

Use calculated DC value

**Navigation**

Setup → Advanced setup → Interface → Use calc. DC

Description

Specify whether the calculated dielectric constant is to be used.

Selection



- Save and exit
- Cancel and exit

Additional information**Meaning of the options**

- Save and exit
The calculated constant is assumed to be the correct one.
- Cancel and exit
The calculated dielectric constant is rejected; the previous dielectric constant remains active.

On the local display, the **Calculated DC value** parameter (→ 130) is displayed together with this parameter.

"Automatic DC calculation" wizard

 The **Automatic DC calculation** wizard is only available when operating via the local display. When operating via an operating tool, the parameters for automatic DC calculation are located directly in **Interface** submenu (→  127)

 In the **Automatic DC calculation** wizard, one or two parameters are displayed simultaneously on the display module at any one time. The upper parameter can be edited, whereas the lower parameter is displayed for reference purposes only.

Navigation  Setup → Advanced setup → Interface → Autom. DC calc.

Manual thickness upper layer 

Navigation  Setup → Advanced setup → Interface → Autom. DC calc. → Man.thick.up.lay

Description Specify the manually determined interface thickness UP (i.e. the thickness of the upper medium).

DC value 

Navigation  Setup → Advanced setup → Interface → Autom. DC calc. → DC value

Description Displays relative dielectric constant ϵ_r of the upper medium (DC₁) before correction.

Use calculated DC value 



Navigation  Setup → Advanced setup → Interface → Autom. DC calc. → Use calc. DC

Description Specify whether the calculated dielectric constant should be used.

- Selection**
- Save and exit
 - Cancel and exit

Additional information **Meaning of the options**

- Save and exit
The calculated dielectric constant is adopted.
- Cancel and exit
The calculated dielectric constant is rejected; the previous dielectric constant remains active.

 The **Calculated DC value** parameter (→  130) is displayed on the local display together with this parameter.

"Linearization" submenu

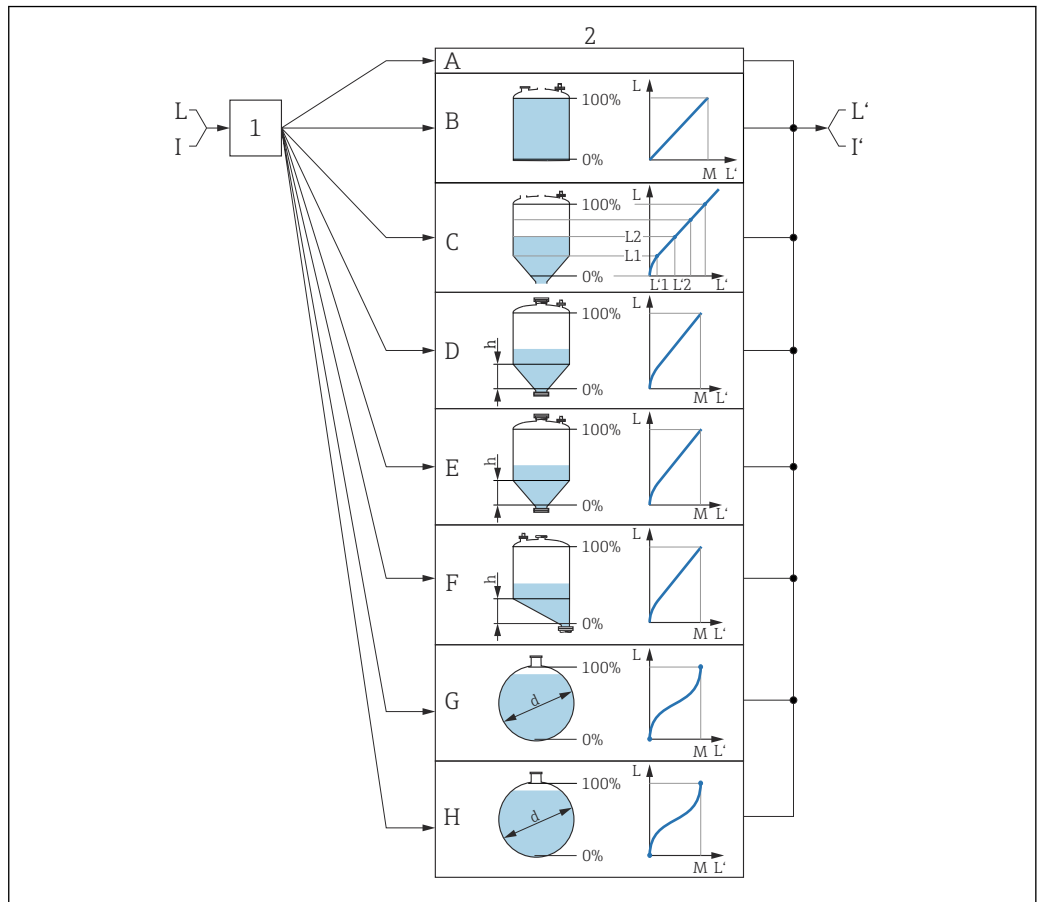

A0016084

39 Linearization: Conversion of the level and, if applicable, interface into a volume or a weight; the conversion depends on the vessel shape

- 1 Selection of linearization type and unit
- 2 Configuration of the linearization
- A Linearization type (→ 136) = None
- B Linearization type (→ 136) = Linear
- C Linearization type (→ 136) = Table
- D Linearization type (→ 136) = Pyramid bottom
- E Linearization type (→ 136) = Conical bottom
- F Linearization type (→ 136) = Angled bottom
- G Linearization type (→ 136) = Horizontal cylinder
- H Linearization type (→ 136) = Sphere
- I For "Operating mode (→ 106)" = "Interface" or "Interface with capacitance": interface before linearization (measured in the level unit)
- I' For "Operating mode (→ 106)" = "Interface" or "Interface with capacitance": interface after linearization (corresponds to volume or weight)
- L Level before linearization (measured in level unit)
- L' Level linearized (→ 139) (corresponds to volume or weight)
- M Maximum value (→ 139)
- d Diameter (→ 140)
- h Intermediate height (→ 140)

Structure of the submenu on the local display

Navigation  Setup → Advanced setup → Linearization

▶ **Linearization**

Linearization type

Unit after linearization

Free text

Maximum value

Diameter

Intermediate height

Table mode

▶ **Edit table**

Level

Customer value

Activate table

Structure of the submenu in the operating tool (e.g. FieldCare)

Navigation  Setup → Advanced setup → Linearization

► **Linearization**

Linearization type

Unit after linearization

Free text

Level linearized

Interface linearized

Maximum value

Diameter

Intermediate height

Table mode

Table number

Level

Level

Customer value

Activate table

Description of the parameters

Navigation  Setup → Advanced setup → Linearization

Linearization type 

Navigation  Setup → Advanced setup → Linearization → Lineariz. type

Description Select linearization type.

- Selection**
- None
 - Linear
 - Table
 - Pyramid bottom
 - Conical bottom
 - Angled bottom
 - Horizontal cylinder
 - Sphere

Additional information

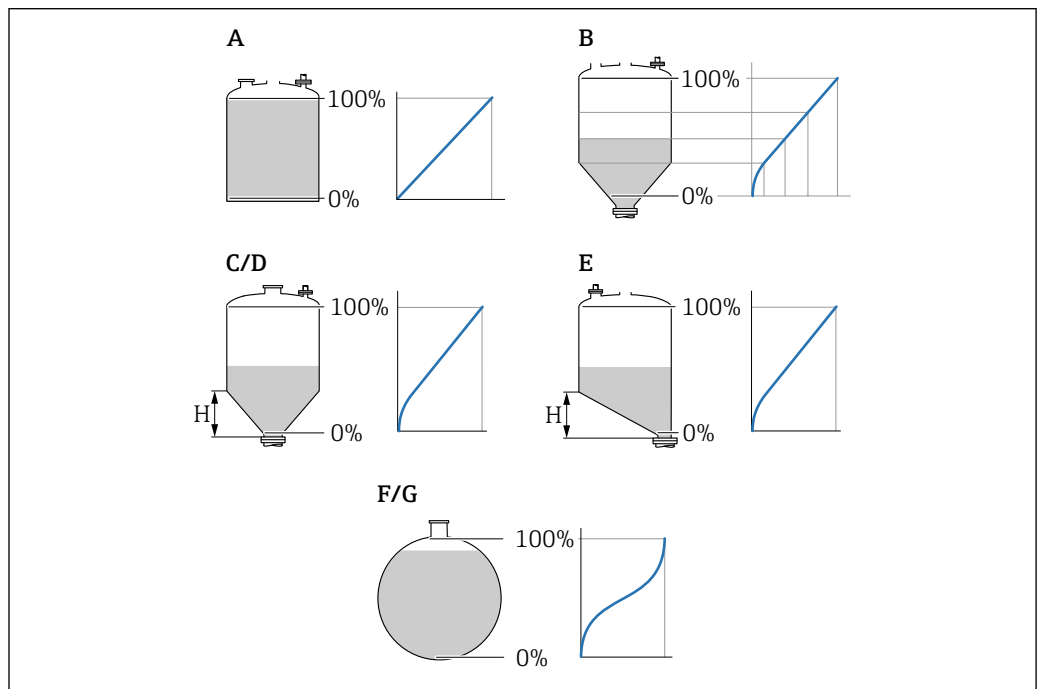

A0021476

 40 *Linearization types*

- A None
- B Table
- C Pyramid bottom
- D Conical bottom
- E Angled bottom
- F Sphere
- G Horizontal cylinder



Meaning of the options

■ None

The level is output in the level unit without being converted (linearized) beforehand.





■ Linear

The output value (volume/weight) is proportional to the level L. This applies, for example, to vertical cylindrical tanks and silos. The following parameters must also be specified:

- **Unit after linearization** (→  137)
- **Maximum value** (→  139): maximum volume or weight



■ Table

The relationship between the measured level L and the output value (volume/weight) is defined by a linearization table consisting of up to 32 pairs of values "level - volume" or "level - weight" respectively. The following parameters must also be specified:

- **Unit after linearization** (→  137)
- **Table mode** (→  140)
- For every point in the table: **Level** (→  142)
- For every point in the table: **Customer value** (→  142)
- **Activate table** (→  142)



■ Pyramid bottom

The output value corresponds to the volume or weight in a silo with a pyramid bottom. The following parameters must also be specified:

- **Unit after linearization** (→  137)
- **Maximum value** (→  139): maximum volume or weight
- **Intermediate height** (→  140): the height of the pyramid



■ Conical bottom

The output value corresponds to the volume or weight in a tank with a conical bottom. The following parameters must also be specified:

- **Unit after linearization** (→  137)
- **Maximum value** (→  139): maximum volume or weight
- **Intermediate height** (→  140): the height of the cone



■ Angled bottom

The output value corresponds to the volume or weight in a silo with an angled bottom. The following parameters must also be specified:

- **Unit after linearization** (→  137)
- **Maximum value** (→  139): maximum volume or weight
- **Intermediate height** (→  140): height of the angled bottom



■ Horizontal cylinder

The output value corresponds to the volume or weight in a horizontal cylinder. The following parameters must also be specified:

- **Unit after linearization** (→  137)
- **Maximum value** (→  139): maximum volume or weight
- **Diameter** (→  140)

■ Sphere



The output value corresponds to the volume or weight in a spherical tank. The following parameters must also be specified:

- **Unit after linearization** (→  137)
- **Maximum value** (→  139): maximum volume or weight
- **Diameter** (→  140)

Unit after linearization



Navigation

  Setup → Advanced setup → Linearization → Unit lineariz.

Prerequisite



Linearization type (→  136) ≠ None

Description Select the unit for the linearized value.



Selection Selection/input (uint16)

- 1095 = [short Ton]
- 1094 = [lb]
- 1088 = [kg]
- 1092 = [Ton]
- 1048 = [US Gal.]
- 1049 = [Imp. Gal.]
- 1043 = [ft³]
- 1571 = [cm³]
- 1035 = [dm³]
- 1034 = [m³]
- 1038 = [l]
- 1041 = [hl]
- 1342 = [%]
- 1010 = [m]
- 1012 = [mm]
- 1018 = [ft]
- 1019 = [inch]
- 1351 = [l/s]
- 1352 = [l/min]
- 1353 = [l/h]
- 1347 = [m³/s]
- 1348 = [m³/min]
- 1349 = [m³/h]
- 1356 = [ft³/s]
- 1357 = [ft³/min]
- 1358 = [ft³/h]
- 1362 = [US Gal./s]
- 1363 = [US Gal./min]
- 1364 = [US Gal./h]
- 1367 = [Imp. Gal./s]
- 1358 = [Imp. Gal./min]
- 1359 = [Imp. Gal./h]
- 32815 = [Ml/s]
- 32816 = [Ml/min]
- 32817 = [Ml/h]
- 1355 = [Ml/d]

Additional information The selected unit is only used for display purposes. The measured value is **not** converted on the basis of the selected unit.

 Distance-to-distance linearization is also possible, i.e. a linearization from the level unit to another length unit. Select the **Linear** linearization mode for this purpose. To specify the new level unit, select the **Free text** option in the **Unit after linearization** parameter and enter the unit in the **Free text** parameter (→  138).

Free text 

Navigation   Setup → Advanced setup → Linearization → Free text

Prerequisite **Unit after linearization** (→  137) = **Free text**

Description Enter unit symbol.

User entry Up to 32 alphanumerical characters (letters, numbers, special characters)

Level linearized

Navigation  Setup → Advanced setup → Linearization → Level linearized

Description Displays linearized level.

Additional information 

- This unit is defined by the **Unit after linearization** parameter.
- In the case of interface measurements, this parameter always refers to the total level.

Interface linearized

Navigation  Setup → Advanced setup → Linearization → Interf. lineariz

Prerequisite **Operating mode** (→  106) = **Interface** or **Interface with capacitance**

Description Displays the linearized interface height.

Additional information  This unit is defined by the **Unit after linearization** parameter.

Maximum value

Navigation   Setup → Advanced setup → Linearization → Maximum value

Prerequisite **Linearization type** (→  136) has one of the following values:

- Linear
- Pyramid bottom
- Conical bottom
- Angled bottom
- Horizontal cylinder
- Sphere

Description Linearized value corresponding to a level of 100%.

User entry -50 000.0 to 50 000.0 %

Diameter
**Navigation**

Setup → Advanced setup → Linearization → Diameter

Prerequisite
Linearization type (→ 136) has one of the following values:

- Horizontal cylinder
- Sphere

Description

Diameter of the cylindrical or spherical tank.

User entry

0 to 9999.999 m

Additional informationThe unit is defined in the **Distance unit** parameter (→ 107).

Intermediate height
**Navigation**

Setup → Advanced setup → Linearization → Intermed. height

Prerequisite
Linearization type (→ 136) has one of the following values:

- Pyramid bottom
- Conical bottom
- Angled bottom

Description

Height of the pyramid, conical or angled bottom.

User entry

0 to 200 m

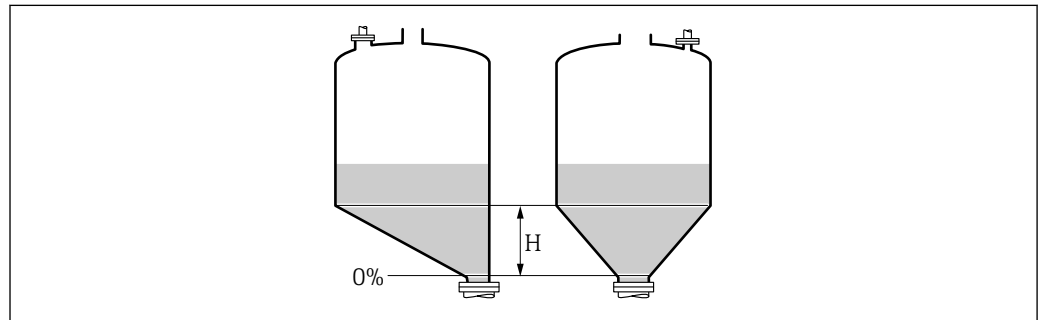
Additional information

A0013264

H Intermediate height

The unit is defined in the **Distance unit** parameter (→ 107).

Table mode
**Navigation**

Setup → Advanced setup → Linearization → Table mode

Prerequisite
Linearization type (→ 136) = Table
Description

Select editing mode of the linearization table.

Selection

- Manual
- Semiautomatic
- Clear table
- Sort table

Additional information**Meaning of the options**

- **Manual**

The level and the associated linearized value are entered manually for each linearization point.

- **Semiautomatic**

The level is measured by the device for each linearization point. The associated linearized value is entered manually.

- **Clear table**

Deletes the existing linearization table.

- **Sort table**

Rearranges the linearization points into an ascending order.

Conditions the linearization table must meet:

- The table may consist of up to 32 pairs of values "Level - Linearized Value".
- The table must be monotonic (monotonically increasing or decreasing).
- The first linearization point must refer to the minimum level.
- The last linearization point must refer to the maximum level.



Before entering a linearization table, the values for **Empty calibration** (→ 108) and **Full calibration** (→ 109) must be set correctly.

If values of the table need to be changed after the full or empty calibration have been changed, a correct evaluation is only ensured if the existing table is deleted and the complete table is entered again. To do so delete the existing table (**Table mode** (→ 140) = **Clear table**). Then enter a new table.

How to enter the table

- Via FieldCare

The table points can be entered via the **Table number** (→ 141), **Level** (→ 142) and **Customer value** (→ 142) parameters. As an alternative, the graphic table editor may be used: Device Operation → Device Functions → Additional Functions → Linearization (Online/Offline)

- Via local display

Select the **Edit table** submenu to call up the graphic table editor. The table is displayed and can be edited line by line.



The factory setting for the level unit is "%". If you want to enter the linearization table in physical units, you must select the appropriate unit in the **Level unit** parameter (→ 125) beforehand.

Table number**Navigation**

Setup → Advanced setup → Linearization → Table number

Prerequisite

Linearization type (→ 136) = **Table**

Description

Select table point you are going to enter or change.

User entry

1 to 32

Level (Manual)



Navigation	Setup → Advanced setup → Linearization → Level
Prerequisite	<ul style="list-style-type: none"> ▪ Linearization type (→ 136) = Table ▪ Table mode (→ 140) = Manual
Description	Enter level value of the table point (value before linearization).
User entry	Signed floating-point number

Level (Semiautomatic)

Navigation	Setup → Advanced setup → Linearization → Level
Prerequisite	<ul style="list-style-type: none"> ▪ Linearization type (→ 136) = Table ▪ Table mode (→ 140) = Semiautomatic
Description	Displays measured level (value before linearization). This value is transmitted to the table.

Customer value



Navigation	Setup → Advanced setup → Linearization → Customer value
Prerequisite	Linearization type (→ 136) = Table
Description	Enter linearized value for the table point.
User entry	Signed floating-point number

Activate table



Navigation	Setup → Advanced setup → Linearization → Activate table
Prerequisite	Linearization type (→ 136) = Table
Description	Activate (enable) or deactivate (disable) the linearization table.
Selection	<ul style="list-style-type: none"> ▪ Disable ▪ Enable

Additional information**Meaning of the options****■ Disable**

The measured level is not linearized.

If **Linearization type** (→  **136**) = **Table** at the same time, the device issues error message F435.

■ Enable

The measured level is linearized according to the table.







When editing the table, the **Activate table** parameter is automatically reset to **Disable** and must be reset to **Enable** after the table has been entered.





"Safety settings" submenu

Navigation  Setup → Advanced setup → Safety sett.

Output echo lost 

Navigation	 Setup → Advanced setup → Safety sett. → Output echo lost
Description	Output signal in case of a lost echo.
Selection	<ul style="list-style-type: none"> ■ Last valid value ■ Ramp at echo lost ■ Value echo lost ■ Alarm
Additional information	<p>Meaning of the options</p> <ul style="list-style-type: none"> ■ Last valid value The last valid value is kept in the case of a lost echo. ■ Ramp at echo lost ⁷⁾ In the case of a lost echo the output value is continuously shifted towards 0% or 100%. The slope of the ramp is defined in the Ramp at echo lost parameter (→  145). ■ Value echo lost ⁷⁾ In the case of a lost echo the output assumes the value defined in the Value echo lost parameter (→  144). ■ Alarm In the case of a lost echo the device generates an alarm; see the Failure mode parameter

Value echo lost 

Navigation	 Setup → Advanced setup → Safety sett. → Value echo lost
Prerequisite	Output echo lost (→  144) = Value echo lost
Description	Output value in case of a lost echo
User entry	0 to 200 000.0 %
Additional information	<p>Use the unit which has been defined for the measured value output:</p> <ul style="list-style-type: none"> ■ without linearization: Level unit (→  125) ■ with linearization: Unit after linearization (→  137)

7) Only visible if "Linearization type (→  136)" = "None"

Ramp at echo lost



Navigation Setup → Advanced setup → Safety sett. → Ramp echo lost

Prerequisite **Output echo lost (→ 144) = Ramp at echo lost**

Description Slope of the ramp in the case of a lost echo

User entry Signed floating-point number

Additional information

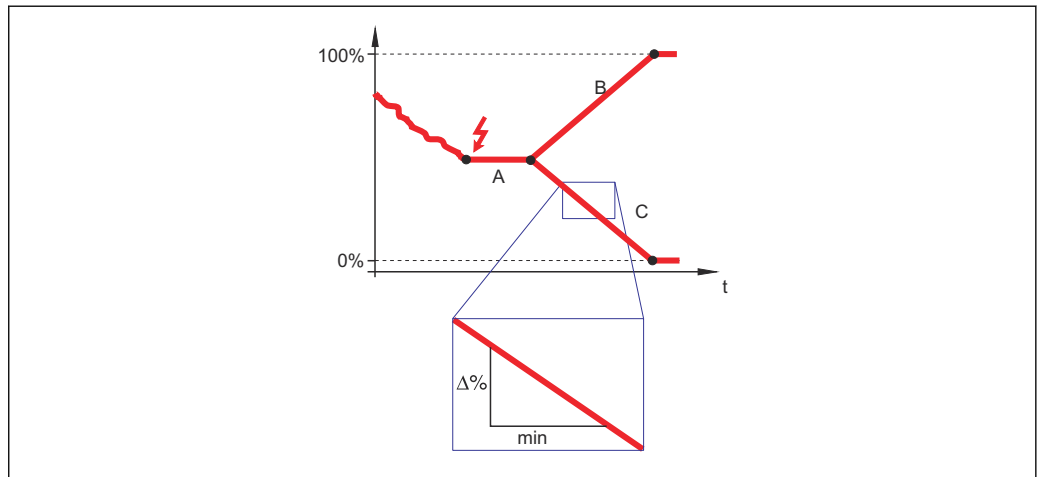

A0013269

- A Delay time echo lost
- B Ramp at echo lost (→ 145) (positive value)
- C Ramp at echo lost (→ 145) (negative value)

- The unit for the slope of the ramp is "percentage of the measuring range per minute" (%/min).
- For a negative slope of the ramp: The measured value is continuously decreased until it reaches 0%.
- For a positive slope of the ramp: The measured value is continuously increased until it reaches 100%.

Blocking distance



Navigation Setup → Advanced setup → Safety sett. → Blocking dist.

Description Specify upper blocking distance UB.

User entry 0 to 200 m

- Factory setting**
- For coax probes: 0 mm (0 in)
 - For rod and rope probes up to 8 m (26 ft): 200 mm (8 in)
 - For rod and rope probes above 8 m (26 ft): 0.025 * Sondenlänge

For FMP51/FMP52/FMP54 with the **Interface measurement** application package ⁸⁾ and for FMP55:
100 mm (3.9 in) for all antenna types

Additional information

Signals in the upper blocking distance are only evaluated if they have been outside the blocking distance when the device was switched on and move into the blocking distance due to a level change during operation. Signals which are already in the blocking distance when the device is switched on, are ignored.

- i** This behavior is only valid if the following two conditions are met:
- Expert → Sensor → Echo tracking → Evaluation mode = **Short time history** or **Long time history**)
 - Expert → Sensor → Gas phase compensation → GPC mode= **On, Without correction** or **External correction**

If one of these conditions is not met, signals in the blocking distance will always be ignored.

- i** A different behavior for signals in the blocking distance can be defined in the **Blocking distance evaluation mode** parameter.

- i** If required, a different behavior for signals in the blocking distance can be defined by the Endress+Hauser service.

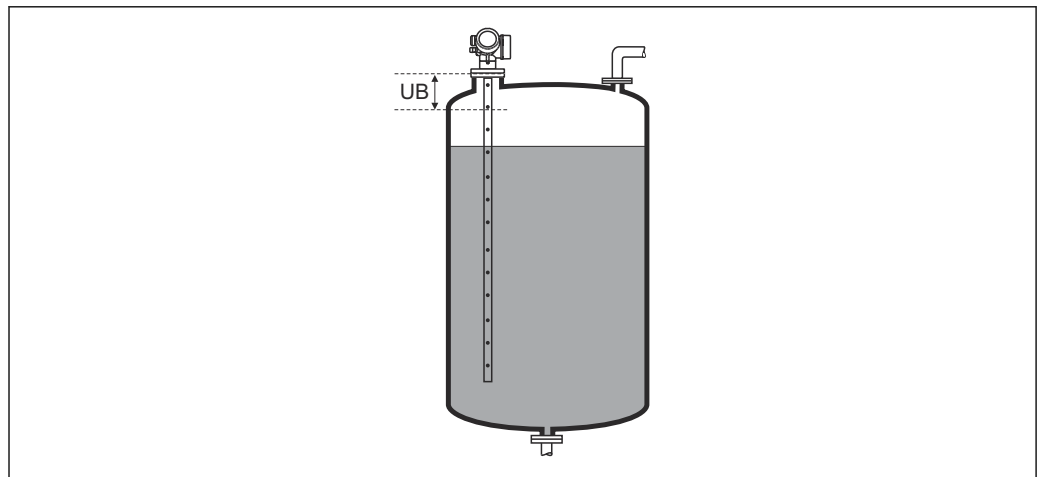







A0013219



41 Blocking distance (UB) for liquid measurements





8) Ordering feature 540 "Application Package", option EB "Interface measurement"



"Probe settings" submenu

The **Probe settings** submenu helps to ensure that the device correctly assigns the end of probe signal within the envelope curve. The assignment is correct if the length of probe indicated by the device matches the actual length of the probe. The automatic probe length correction can only be performed if the probe is installed in the vessel and is completely uncovered (no medium) over the entire length. For partially filled vessels and if the probe length is known, select **Confirm probe length** (→  **148**) = **Manual input** to enter the value manually.

-  If a mapping has been recorded after shortening the probe, it is no longer possible to perform an automatic probe length correction. There are two options if this occurs:
 - First delete the mapping curve using the **Record map** parameter (→  118) and the probe length correction can then be performed. After the probe length correction, a new mapping curve can be recorded using the **Record map** parameter (→  118).
 - Alternatively, select **Confirm probe length** (→  **148**) = **Manual input** and manually enter the probe length in the **Present probe length** parameter.
-  An automatic probe length correction is only possible after the correct option has been selected in the **Probe grounded** parameter (→  147).

Navigation   Setup → Advanced setup → Probe settings

Probe grounded	
<hr/>	
Navigation	  Setup → Advanced setup → Probe settings → Probe grounded
Prerequisite	Operating mode (→  106) = Level
Description	Specify whether the probe is grounded.
Selection	<ul style="list-style-type: none"> ▪ No ▪ Yes

Present probe length	
<hr/>	
Navigation	 Setup → Advanced setup → Probe settings → Pres. length
Description	<ul style="list-style-type: none"> ▪ In most cases: Displays the length of the probe according to the currently measured end-of-probe signal. ▪ For Confirm probe length (→  148) = Manual input: Enter actual length of probe.
User entry	0 to 200 m

Confirm probe length
**Navigation**

Setup → Advanced setup → Probe settings → Confirm length

Description

Specify whether the value displayed in the **Present probe length** parameter matches the actual length of the probe. Based on this input, the device performs a probe length correction.

Selection



- Probe length OK
- Probe length too small
- Probe length too big
- Probe covered
- Manual input
- Probe length unknown

Additional information**Meaning of the options**

- **Probe length OK**
To be selected if the correct probe length is displayed. A correction is not required. The device exits the sequence.
- **Probe length too small**
To be selected if the displayed length is less than the actual probe length. A different end of probe signal is allocated and the newly calculated length is displayed in the **Present probe length** parameter. This procedure has to be repeated until the displayed value matches the actual length of the probe.
- **Probe length too big**
To be selected if the displayed length is greater than the actual probe length. A different end of probe signal is allocated and the newly calculated length is displayed in the **Present probe length** parameter. This procedure has to be repeated until the displayed value matches the actual length of the probe.
- **Probe covered**
To be selected if the probe is (partially or completely) covered. A probe length correction is impossible in this case.
- **Manual input**
To be selected if no automatic probe length correction is to be performed. Instead, the actual length of the probe must be entered manually in the **Present probe length** parameter.⁹⁾
- **Probe length unknown**
To be selected if the actual probe length is unknown. A probe length correction is impossible in this case.

9) When operating via FieldCare, the **Manual input** option does not need to be selected explicitly; manual editing of the probe length is always possible here.

"Probe length correction" wizard

 The **Probe length correction** wizard is only available when operating via the local display. When operating via an operating tool, the parameters for probe length correction are located directly in the **Probe settings** submenu (→  147).

Navigation  Setup → Advanced setup → Probe settings → Prob.length corr

Confirm probe length**Navigation**

 Setup → Advanced setup → Probe settings → Prob.length corr → Confirm length

Description

Specify whether the value displayed in the **Present probe length** parameter matches the actual length of the probe. Based on this input, the device performs a probe length correction.

Selection

- Probe length OK
- Probe length too small
- Probe length too big
- Probe covered
- Manual input
- Probe length unknown

Additional information**Meaning of the options**

- **Probe length OK**
To be selected if the correct probe length is displayed. A correction is not required. The device exits the sequence.
- **Probe length too small**
To be selected if the displayed length is less than the actual probe length. A different end of probe signal is allocated and the newly calculated length is displayed in the **Present probe length** parameter. This procedure has to be repeated until the displayed value matches the actual length of the probe.
- **Probe length too big**
To be selected if the displayed length is greater than the actual probe length. A different end of probe signal is allocated and the newly calculated length is displayed in the **Present probe length** parameter. This procedure has to be repeated until the displayed value matches the actual length of the probe.
- **Probe covered**
To be selected if the probe is (partially or completely) covered. A probe length correction is impossible in this case.
- **Manual input**
To be selected if no automatic probe length correction is to be performed. Instead, the actual length of the probe must be entered manually in the **Present probe length** parameter.¹⁰⁾
- **Probe length unknown**
To be selected if the actual probe length is unknown. A probe length correction is impossible in this case.

10) When operating via FieldCare, the **Manual input** option does not need to be selected explicitly; manual editing of the probe length is always possible here.

Present probe length

**Navigation**

Setup → Advanced setup → Probe settings → Prob.length corr → Pres. length



Description



- In most cases:
Displays the length of the probe according to the currently measured end-of-probe signal.
- For **Confirm probe length** (→ 148) = **Manual input**:
Enter actual length of probe.

User entry



0 to 200 m

"Switch output" submenu

 The **Switch output** submenu (→  151) is only available for devices with a switch output.¹¹⁾

Navigation   Setup → Advanced setup → Switch output

Switch output function**Navigation**

  Setup → Advanced setup → Switch output → Switch out funct

Description

Defines the function of the switch output.

'Off'

The switch output is always open (non-conductive)

'On'

The switch output is always closed (conductive).

'Diagnostic behavior'

The switch output is normally closed and is only opened if a diagnostic event is present.

'Limit'

The switch output is normally closed and is only opened if a measured variable exceeds a defined limit.

'Digital output'

The switch output is controlled by one of the digital output blocks of the device.

Selection

- Off
- On
- Diagnostic behavior
- Limit
- Digital Output

Additional information**Meaning of the options**

- **Off**

The output is always open (non-conductive).

- **On**

The output is always closed (conductive).

- **Diagnostic behavior**

The output is normally closed and is only opened if a diagnostic event is present. The **Assign diagnostic behavior** parameter (→  152) determines for which type of event the output is opened.

- **Limit**

The output is normally closed and is only opened if a measured variable exceeds or falls below a defined limit. The limit values are defined by the following parameters:

- **Assign limit** (→  152)

- **Switch-on value** (→  153)

- **Switch-off value** (→  154)



- **Digital Output**

The switching state of the output tracks the output value of a DI function block. The function block is selected in the **Assign status** parameter (→  152).



 The **Off** and **On** options can be used to simulate the switch output.

11) Order code 020 "Power supply; output", option B, E or G



Assign status

Navigation	  Setup → Advanced setup → Switch output → Assign status
Prerequisite	Switch output function (→  151) = Digital Output
Description	Assigns a Discrete Output Block or an Advanced Diagnostic Block to the switch output.
Selection	<ul style="list-style-type: none"> ▪ Off ▪ Digital output AD 1 ▪ Digital output AD 2
Additional information	The Digital output AD 1 and Digital output AD 2 options refer to the Advanced Diagnostics Blocks. A switch signal generated in these blocks can be output via the switch output.

Assign limit

Navigation	  Setup → Advanced setup → Switch output → Assign limit
Prerequisite	Switch output function (→  151) = Limit
Description	Defines which process variable will be checked for limit violation.
Selection	<ul style="list-style-type: none"> ▪ Off ▪ Level linearized ▪ Distance ▪ Interface linearized * ▪ Interface distance * ▪ Thickness upper layer * ▪ Terminal voltage ▪ Electronic temperature ▪ Measured capacitance * ▪ Relative echo amplitude ▪ Relative interface amplitude * ▪ Absolute echo amplitude ▪ Absolute interface amplitude *

Assign diagnostic behavior

Navigation	  Setup → Advanced setup → Switch output → Assign diag. beh
Prerequisite	Switch output function (→  151) = Diagnostic behavior
Description	Defines to which behavior of diagnostic events the switch output reacts.

* Visibility depends on order options or device settings

- Selection**
- Alarm
 - Alarm or warning
 - Warning

Switch-on value



Navigation Setup → Advanced setup → Switch output → Switch-on value

Prerequisite **Switch output function (→ 151) = Limit**

Description Defines the switch-on point.
The output is closed if the assigned process variable rises above this point.

User entry Signed floating-point number

Additional information The switching behavior depends on the relative position of the **Switch-on value** and **Switch-off value** parameters:

Switch-on value > Switch-off value

- The output is closed if the measured value is larger than **Switch-on value**.
- The output is opened if the measured value is smaller than **Switch-off value**.

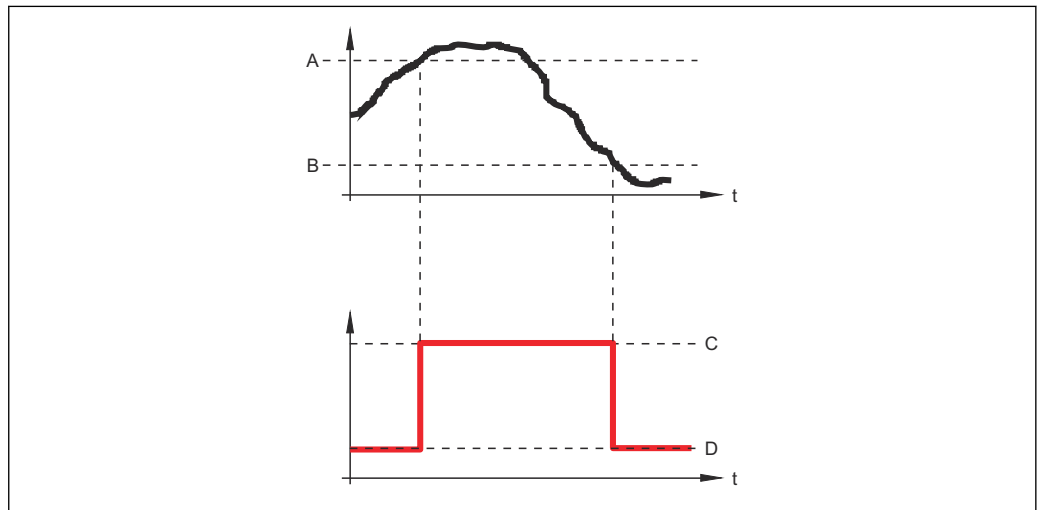

A0015585

- A *Switch-on value*
- B *Switch-off value*
- C *Output closed (conductive)*
- D *Output opened (non-conductive)*

Switch-on value < Switch-off value

- The output is closed if the measured value is smaller than **Switch-on value**.
- The output is opened if the measured value is larger than **Switch-off value**.

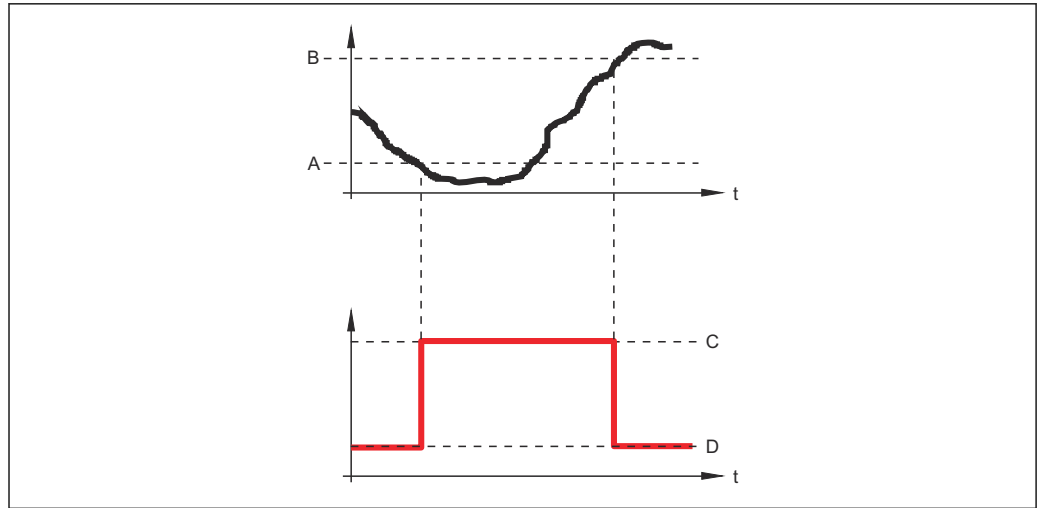

A0015586

- A Switch-on value
- B Switch-off value
- C Output closed (conductive)
- D Output opened (non-conductive)

Switch-on delay



Navigation

Setup → Advanced setup → Switch output → Switch-on delay

Prerequisite

- Switch output function (→ 151) = Limit
- Assign limit (→ 152) ≠ Off

Description

Defines the delay applied before the output is switched on.

User entry

0.0 to 100.0 s

Switch-off value



Navigation

Setup → Advanced setup → Switch output → Switch-off value

Prerequisite

Switch output function (→ 151) = Limit

Description

Defines the switch-off point.
The output is opened if the assigned process variable falls below this point.

User entry

Signed floating-point number

Additional information

The switching behavior depends on the relative position of the **Switch-on value** and **Switch-off value** parameters; description: see the **Switch-on value** parameter (→ 153).

Switch-off delay

Navigation	Setup → Advanced setup → Switch output → Switch-off delay
Prerequisite	<ul style="list-style-type: none"> ▪ Switch output function (→ 151) = Limit ▪ Assign limit (→ 152) ≠ Off
Description	Defines the delay applied before the output is switched off.
User entry	0.0 to 100.0 s

Failure mode

Navigation	Setup → Advanced setup → Switch output → Failure mode
Prerequisite	Switch output function (→ 151) = Limit or Digital Output
Description	Defines the state of the switch output in case of an error.
Selection	<ul style="list-style-type: none"> ▪ Actual status ▪ Open ▪ Closed

Additional information

Switch status

Navigation	Setup → Advanced setup → Switch output → Switch status
Description	Current status of the switch output.

Invert output signal

Navigation	Setup → Advanced setup → Switch output → Invert outp.sig.
Description	<p>'No' The switch output behaves as per its parameter setting.</p> <p>'Yes' The switching behavior is inverted as compared to its parameter setting.</p>
Selection	<ul style="list-style-type: none"> ▪ No ▪ Yes

Additional information**Meaning of the options**■ **No**

The behavior of the switch output is as described above.

■ **Yes**

The states **Open** and **Closed** are inverted as compared to the description above.

"Display" submenu

Display submenu is only visible if a display module is connected to the device.

Navigation



Setup → Advanced setup → Display

Language**Navigation**

Setup → Advanced setup → Display → Language

Description

Set display language.

Selection

- English
- Deutsch *
- Français *
- Español *
- Italiano *
- Nederlands *
- Portuguesa *
- Polski *
- русский язык (Russian) *
- Svenska *
- Türkçe *
- 中文 (Chinese) *
- 日本語 (Japanese) *
- 한국어 (Korean) *
- Bahasa Indonesia *
- tiếng Việt (Vietnamese) *
- čeština (Czech) *

Factory setting

The language selected in feature 500 of the product structure.
If no language has been selected: **English**

Additional information**Format display****Navigation**

Setup → Advanced setup → Display → Format display

Description

Select how measured values are shown on the display.

Selection

- 1 value, max. size
- 1 bargraph + 1 value
- 2 values
- 1 value large + 2 values
- 4 values

* Visibility depends on order options or device settings

Additional information

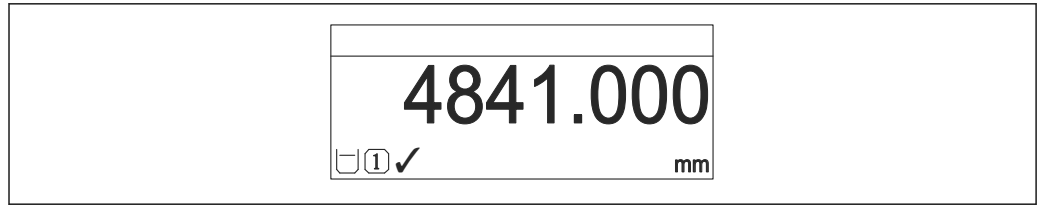

A0019963

42 "Format display" = "1 value, max. size"

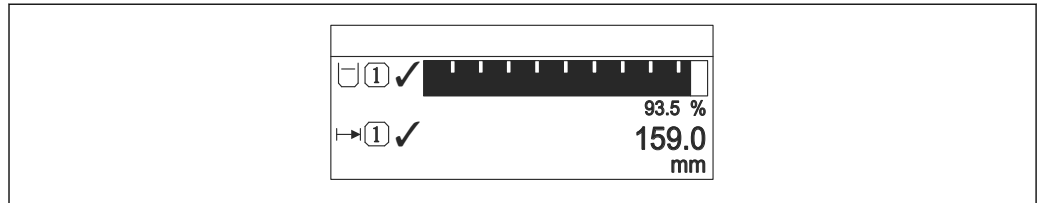

A0019964

43 "Format display" = "1 bargraph + 1 value"

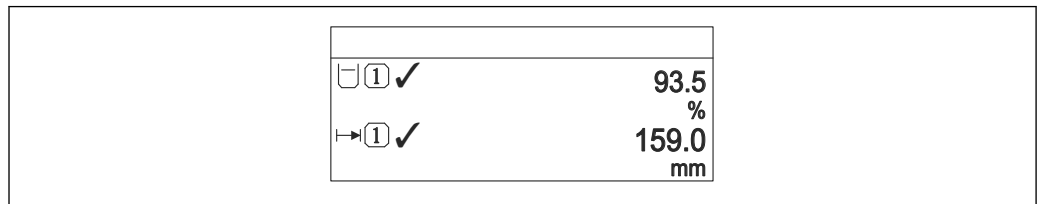

A0019965

44 "Format display" = "2 values"

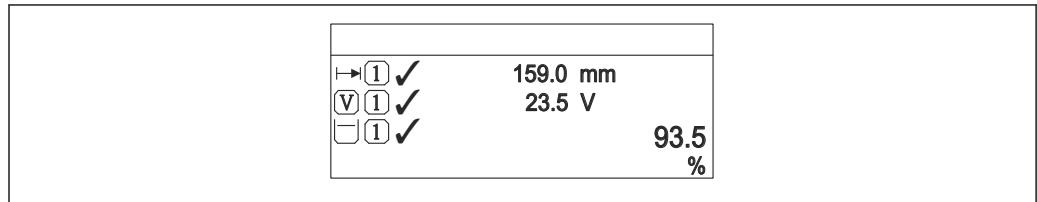

A0019966

45 "Format display" = "1 value large + 2 values"

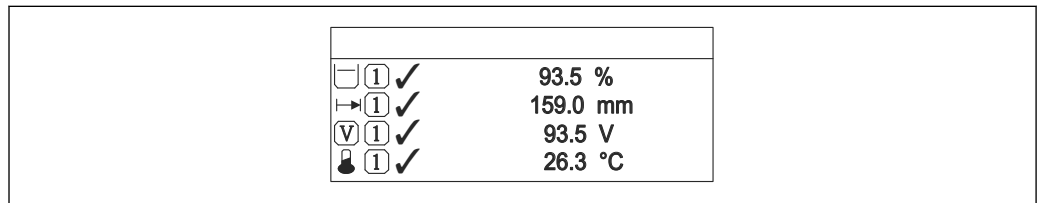

A0019968

46 "Format display" = "4 values"

- i** The **Value 1 to 4 display** parameters are used to specify which measured values are shown on the local display and in what order.
- If more measured values are specified than the display mode selected permits, then the values alternate on the device display. The display time until the next change is configured in the **Display interval** parameter (→ 160).

Value 1 to 4 display



Navigation	Setup → Advanced setup → Display → Value 1 display
Description	Select the measured value that is shown on the local display.
Selection	<ul style="list-style-type: none"> ■ Level linearized ■ Distance ■ Interface linearized * ■ Interface distance * ■ Thickness upper layer * ■ Current output 1 ■ Measured current ■ Current output 2 * ■ Terminal voltage ■ Electronic temperature ■ Measured capacitance * ■ Analog output adv. diagnostics 1 ■ Analog output adv. diagnostics 2

Factory setting	<p>For level measurements</p> <ul style="list-style-type: none"> ■ Value 1 display: Level linearized ■ Value 2 display: Distance ■ Value 3 display: Current output 1 ■ Value 4 display: None <p>For interface measurements and one current output</p> <ul style="list-style-type: none"> ■ Value 1 display: Interface linearized ■ Value 2 display: Level linearized ■ Value 3 display: Thickness upper layer ■ Value 4 display: Current output 1 <p>For interface measurements and two current outputs</p> <ul style="list-style-type: none"> ■ Value 1 display: Interface linearized ■ Value 2 display: Level linearized ■ Value 3 display: Current output 1 ■ Value 4 display: Current output 2
------------------------	-------------------------------------------------------------------------------------------------------------------------------------------------------------------------------------------------------------------------------------------------------------------------------------------------------------------------------------------------------------------------------------------------------------------------------------------------------------------------------------------------------------------------------------------------------------------------------------------------------------------------------------------------------------------------------------------------------------------------------------------------------------------------------------------------------------------------------------------------------

Decimal places 1 to 4



Navigation	Setup → Advanced setup → Display → Decimal places 1
Description	This selection does not affect the measurement and calculation accuracy of the device.
Selection	<ul style="list-style-type: none"> ■ x ■ x.x ■ x.xx ■ x.xxx ■ x.xxxx
Additional information	The setting does not affect the measuring or computational accuracy of the device.

* Visibility depends on order options or device settings

Display interval

Navigation	🏠🏠 Setup → Advanced setup → Display → Display interval
Description	Set time measured values are shown on display if display alternates between values.
User entry	1 to 10 s
Additional information	This parameter is only relevant if the number of selected measuring values exceeds the number of values the selected display format can display simultaneously.

Display damping



Navigation	🏠🏠 Setup → Advanced setup → Display → Display damping
Description	Set display reaction time to fluctuations in the measured value.
User entry	0.0 to 999.9 s

Header



Navigation	🏠🏠 Setup → Advanced setup → Display → Header
Description	Select header contents on local display.
Selection	<ul style="list-style-type: none"> ■ Device tag ■ Free text

Additional information

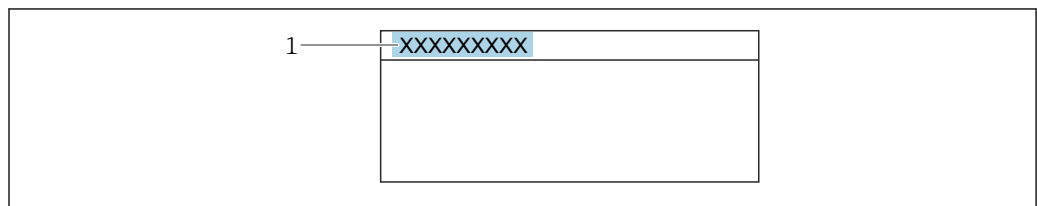



A0029422

1 Position of the header text on the display



Meaning of the options

- **Device tag**
Is defined in the **Device tag** parameter (→ 📄 106).
- **Free text**
Is defined in the **Header text** parameter (→ 📄 161).



Header text



Navigation	  Setup → Advanced setup → Display → Header text
Prerequisite	Header (→  160) = Free text
Description	Enter display header text.
User entry	Character string comprising numbers, letters and special characters (12)
Additional information	The number of characters which can be displayed depends on the characters used.



Separator

Navigation	  Setup → Advanced setup → Display → Separator
Description	Select decimal separator for displaying numerical values.
Selection	<ul style="list-style-type: none"> ▪ . ▪ ,

Number format



Navigation	  Setup → Advanced setup → Display → Number format
Description	Choose number format for the display.
Selection	<ul style="list-style-type: none"> ▪ Decimal ▪ ft-in-1/16"
Additional information	The ft-in-1/16" option is only valid for distance units.

Decimal places menu







Navigation	  Setup → Advanced setup → Display → Dec. places menu
Description	Select number of decimal places for the representation of numbers within the operating menu.
Selection	<ul style="list-style-type: none"> ▪ x ▪ x.x ▪ x.xx ▪ x.xxx ▪ x.xxxx

Additional information	<ul style="list-style-type: none"> ■ Is only valid for numbers in the operating menu (e.g. Empty calibration, Full calibration), but not for the measured value display. The number of decimal places for the measured value display is defined in the Decimal places 1 to 4 parameters ■ This setting does not affect the accuracy of the device for measuring or calculating the value
-------------------------------	---------------------------------------------------------------------------------------------------------------------------------------------------------------------------------------------------------------------------------------------------------------------------------------------------------------------------------------------------------------------------------------------------------------------------------------

Backlight

Navigation	 Setup → Advanced setup → Display → Backlight
Prerequisite	The device has the SD03 local display (with optical keys).
Description	Switch the local display backlight on and off.
Selection	<ul style="list-style-type: none"> ■ Disable ■ Enable
Additional information	<p>Meaning of the options</p> <ul style="list-style-type: none"> ■ Disable Switches the backlight off. ■ Enable Switches the backlight on. <p> Regardless of the setting in this parameter the backlight may be automatically switched off by the device if the supply voltage is too low.</p>



Contrast display



Navigation	 Setup → Advanced setup → Display → Contrast display
Description	Adjust local display contrast setting to ambient conditions (e.g. lighting or reading angle).
User entry	20 to 80 %
Factory setting	Dependent on the display.
Additional information	<p> Setting the contrast via push-buttons:</p> <ul style="list-style-type: none"> ■ Darker: press the   buttons simultaneously. ■ Brighter: press the   buttons simultaneously.

"Configuration backup display" submenu



 This submenu is only visible if a display module is connected to the device.

The configuration of the device can be saved to the display module at a certain point of time (backup). The saved configuration can be restored to the device if required, e.g. in order to bring the device back into a defined state. The configuration can also be transferred to a different device of the same type using the display module.

 Configurations can only be exchanged between devices which are in the same operating mode (see the **Operating mode** parameter (→  106)).

Navigation   Setup → Advanced setup → Conf.backup disp

Operating time

Navigation   Setup → Advanced setup → Conf.backup disp → Operating time

Description Indicates how long the device has been in operation.

Additional information *Maximum time*
 9 999 d (≈ 27 years)

Last backup

Navigation   Setup → Advanced setup → Conf.backup disp → Last backup

Description Indicates when the last data backup was saved to the display module.



Configuration management





Navigation   Setup → Advanced setup → Conf.backup disp → Config. managem.

Description Select action for managing the device data in the display module.



- Selection**
- Cancel
 - Execute backup
 - Restore
 - Duplicate
 - Compare
 - Clear backup data

Additional information	<p>Meaning of the options</p> <ul style="list-style-type: none"> ▪ Cancel No user is executed and the user exits the parameter. ▪ Execute backup A backup copy of the current device configuration in the HistoROM (built-in in the device) is saved to the display module of the device. ▪ Restore The last backup copy of the device configuration is copied from the display module to the HistoROM of the device. ▪ Duplicate The transmitter configuration is duplicated to another device using the transmitter display module. The following parameters, which characterize the individual measuring point are not included in the transmitted configuration: <ul style="list-style-type: none"> ▪ HART date code ▪ HART short tag ▪ HART message ▪ HART descriptor ▪ HART address ▪ Device tag ▪ Medium type ▪ Compare The device configuration saved in the display module is compared to the current device configuration of the HistoROM. The result of this comparison is displayed in the Comparison result parameter (→  164). ▪ Clear backup data The backup copy of the device configuration is deleted from the display module of the device. <p> While this action is in progress, the configuration cannot be edited via the local display and a message on the processing status appears on the display.</p> <p> If an existing backup is restored to a different device using the Restore option, it may occur that some device functionalities are no longer available. In some cases even a device reset will not restore the original status.</p> <p>In order to transmit a configuration to a different device, the Duplicate option should always be used.</p>
-------------------------------	------------------------------------------------------------------------------------------------------------------------------------------------------------------------------------------------------------------------------------------------------------------------------------------------------------------------------------------------------------------------------------------------------------------------------------------------------------------------------------------------------------------------------------------------------------------------------------------------------------------------------------------------------------------------------------------------------------------------------------------------------------------------------------------------------------------------------------------------------------------------------------------------------------------------------------------------------------------------------------------------------------------------------------------------------------------------------------------------------------------------------------------------------------------------------------------------------------------------------------------------------------------------------------------------------------------------------------------------------------------------------------------------------------------------------------------------------------------------------------------------------------------------------------------------------------------------------------------------------------------------------------------------------------------------------------------------------------------------------------------------------------------------------------------------------------------------------------------------------------------------------------------------------------------------------------------------------------------------------------------------------------------------------------------------------------------------------------------------------------------------------------------------------------------------------------

Backup state

Navigation	  Setup → Advanced setup → Conf.backup disp → Backup state
Description	Displays which backup action is currently in progress.

Comparison result

Navigation	  Setup → Advanced setup → Conf.backup disp → Compar. result
Description	Comparison between present device data and display backup.

Additional information**Meaning of the display options****■ Settings identical**

The current device configuration of the HistoROM is identical to the backup copy in the display module.

■ Settings not identical

The current device configuration of the HistoROM is not identical to the backup copy in the display module.

■ No backup available

There is no backup copy of the device configuration of the HistoROM in the display module.

■ Backup settings corrupt

The current device configuration of the HistoROM is corrupt or not compatible with the backup copy in the display module.

■ Check not done

The device configuration of the HistoROM has not yet been compared to the backup copy in the display module.

■ Dataset incompatible

The data sets are incompatible and can not be compared.





To start the comparison, set **Configuration management** (→  163) = **Compare**.













If the transmitter configuration has been duplicated from a different device by **Configuration management** (→  163) = **Duplicate**, the new device configuration in the HistoROM is only partially identical to the configuration stored in the display module: Sensor specific properties (e.g. the mapping curve) are not duplicated. Thus, the result of the comparison will be **Settings not identical**.



"Administration" submenu

Navigation  Setup → Advanced setup → Administration

Define access code 

Navigation	 Setup → Advanced setup → Administration → Def. access code
Description	Define release code for write access to parameters.
User entry	0 to 9999
Additional information	<p> If the factory setting is not changed or if "0" is entered, the parameters are not write-protected and the device configuration data can therefore always be modified. The user is logged on in the "Maintenance" role.</p> <p> The write protection affects all parameters marked with the  symbol in the document. On the local display, the  symbol in front of a parameter indicates that the parameter is write-protected.</p> <p> Once the access code has been defined, write-protected parameters can only be modified if the access code is entered in the Enter access code parameter (→  121).</p> <p> Please contact your Endress+Hauser Sales Center if you lose the access code.</p> <p> If operating via the local display: the new access code is only valid once it has been confirmed in the Confirm access code parameter (→  168).</p>

Device reset 

Navigation	  Setup → Advanced setup → Administration → Device reset
Description	Reset the device configuration - either entirely or in part - to a defined state.
Selection	<ul style="list-style-type: none"> ■ Cancel ■ To fieldbus defaults ** ■ To factory defaults ■ To delivery settings ■ Of customer settings ■ To transducer defaults ■ Restart device

** Visibility depends on communication

Additional information**Meaning of the options****■ Cancel**

No action

■ To factory defaults

All parameters are reset to the order-code specific factory setting.

■ To delivery settings

All parameters are reset to the delivery setting. The delivery setting may differ from the factory default if customer specific settings have been ordered.

This option is only visible if customer specific settings have been ordered.

■ Of customer settings

All customer parameters are reset to their factory setting. Service parameters, however, remain unchanged.

■ To transducer defaults

Every measurement-related parameter is reset to its factory setting. Service parameters and communication-related parameters, however, remain unchanged.

■ Restart device

The restart resets every parameter which is stored in the volatile memory (RAM) to the factory setting (e.g. measured value data). The device configuration remains unchanged.

"Define access code" wizard

 The **Define access code** wizard is only available when operating via the local display. When operating via an operating tool, the **Define access code** parameter is located directly in the **Administration** submenu. The **Confirm access code** parameter is not available for operation via operating tool.

Navigation  Setup → Advanced setup → Administration → Def. access code

Define access code 

Navigation  Setup → Advanced setup → Administration → Def. access code → Def. access code

Description →  166

Confirm access code 

Navigation  Setup → Advanced setup → Administration → Def. access code → Confirm code

Description Confirm the entered access code.

User entry 0 to 9999

15.4 "Diagnostics" menu

Navigation  Diagnostics

Actual diagnostics

Navigation  Diagnostics → Actual diagnos.

Description Displays current diagnostic message.

Additional information The display consists of:

- Symbol for event behavior
- Code for diagnostic behavior
- Operating time of occurrence
- Event text





 If several messages are active at the same time, the messages with the highest priority is displayed.

 Information on what is causing the message, and remedy measures, can be viewed via the  symbol on the display.

Timestamp

Navigation	 Diagnostics → Timestamp
Description	Displays the timestamp for the currently active diagnostic message.



Previous diagnostics

Navigation	  Diagnostics → Prev.diagnostics
Description	Displays the last diagnostic message which has been active before the current message.
Additional information	<p>The display consists of:</p> <ul style="list-style-type: none"> ■ Symbol for event behavior ■ Code for diagnostic behavior ■ Operating time of occurrence ■ Event text <p> The condition displayed may still apply. Information on what is causing the message, and remedy measures, can be viewed via the  symbol on the display.</p>



Timestamp

Navigation	 Diagnostics → Timestamp
Description	Shows the timestamp of the previous diagnostic message.

Operating time from restart

Navigation	  Diagnostics → Time fr. restart
Description	Displays the time the device has been in operation since the last device restart.

Operating time

Navigation	  Diagnostics → Operating time
Description	Indicates how long the device has been in operation.
Additional information	<p><i>Maximum time</i></p> <p>9999 d (≈ 27 years)</p>

15.4.1 "Diagnostic list" submenu

Navigation  Diagnostics → Diagnostic list

Diagnostics 1 to 5

Navigation	 Diagnostics → Diagnostic list → Diagnostics 1
Description	Display the current diagnostics messages with the highest to fifth-highest priority.
Additional information	The display consists of: <ul style="list-style-type: none">■ Symbol for event behavior■ Code for diagnostic behavior■ Operating time of occurrence■ Event text

Timestamp 1 to 5

Navigation	 Diagnostics → Diagnostic list → Timestamp 1 to 5
Description	Timestamp of the diagnostic message.

15.4.2 "Event logbook" submenu

 The **Event logbook** submenu is only available when operating via the local display. When operating via FieldCare, the event list can be displayed in the FieldCare function "Event List / HistoROM".

Navigation  Diagnostics → Event logbook

Filter options

Navigation

 Diagnostics → Event logbook → Filter options

Description

Define which category of event messages is shown in the Events list submenu.

Selection

- All
- Failure (F)
- Function check (C)
- Out of specification (S)
- Maintenance required (M)
- Information (I)



Additional information



-  ▪ This parameter is only used for operation via the local display.
 ▪ The status signals are categorized according to NAMUR NE 107.

"Event list" submenu

The **Event list** submenu displays the history of past events of the category selected in the **Filter options** parameter (→  171). A maximum of 100 events are displayed in chronological order.

The following symbols indicate whether an event has occurred or has ended:

- : Event has occurred
- : Event has ended

 Information on what is causing the message, and remedy instructions, can be viewed via the -button.

Display format

- For event messages in category I: information event, event text, "recording event" symbol and time the event occurred
- For event messages in category F, M, C, S (status signal): diagnostics event, event text, "recording event" symbol and time the event occurred

Navigation  Diagnostics → Event logbook → Event list



15.4.3 "Device information" submenu

Navigation  Diagnostics → Device info



Device tag

Navigation	 Diagnostics → Device info → Device tag
Description	Enter the name for the measuring point.
User interface	Character string comprising numbers, letters and special characters

Serial number

Navigation	 Diagnostics → Device info → Serial number
Description	Shows the serial number of the measuring device.
Additional information	<p> Uses of the serial number</p> <ul style="list-style-type: none"> ▪ To identify the device quickly, e.g. when contacting Endress+Hauser. ▪ To obtain specific information on the device using the Device Viewer: www.endress.com/deviceviewer <p> The serial number is also indicated on the nameplate.</p>

Firmware version

Navigation	 Diagnostics → Device info → Firmware version
Description	Shows the device firmware version installed.
User interface	xx.yy.zz
Additional information	<p> For firmware versions differing only in the last two digits ("zz") there is no difference concerning functionality or operation.</p>

Device name

Navigation	 Diagnostics → Device info → Device name
Description	Shows the name of the transmitter.

Order code



Navigation	Diagnostics → Device info → Order code
Description	Shows the device order code.
User interface	Character string comprising numbers, letters and special characters
Additional information	The order code is generated from the extended order code, which defines all device features of the product structure. In contrast, the device features can not be read directly from the order code.

Extended order code 1 to 3



Navigation	Diagnostics → Device info → Ext. order cd. 1
Description	Display the three parts of the extended order code.
User interface	Character string comprising numbers, letters and special characters
Additional information	The extended order code indicates the version of all the features of the product structure and thus uniquely identifies the device.

Device revision

Navigation	Diagnostics → Device info → Device revision
Description	Shows the device revision with which the device is registered with the HART Communication Foundation.
Additional information	The device revision is used to allocate the correct Device Description file (DD) to the device.

Device ID

Navigation	Diagnostics → Device info → Device ID
Description	Shows the device ID for identifying the device in a HART network.
Additional information	In addition to the Device type and Manufacturer ID, the Device ID is part of the unique device identification (Unique ID) which characterizes each HART device unambiguously.

Device type

Navigation Diagnostics → Device info → Device type**Description**

Shows the device type with which the measuring device is registered with the HART Communication Foundation.

Additional information

Manufacturer ID

Navigation Diagnostics → Device info → Manufacturer ID**Description**

Use this function to view the manufacturer ID with which the measuring device is registered with the HART Communication Foundation.

User interface

2-digit hexadecimal number

Factory setting

0x11 (for Endress+Hauser)

15.4.4 "Measured values" submenu

Navigation  Diagnostics → Measured val.

Distance

Navigation

 Diagnostics → Measured val. → Distance

Description

Displays the measured distance D_L between the reference point (lower edge of the flange or threaded connection) and the level.

Additional information

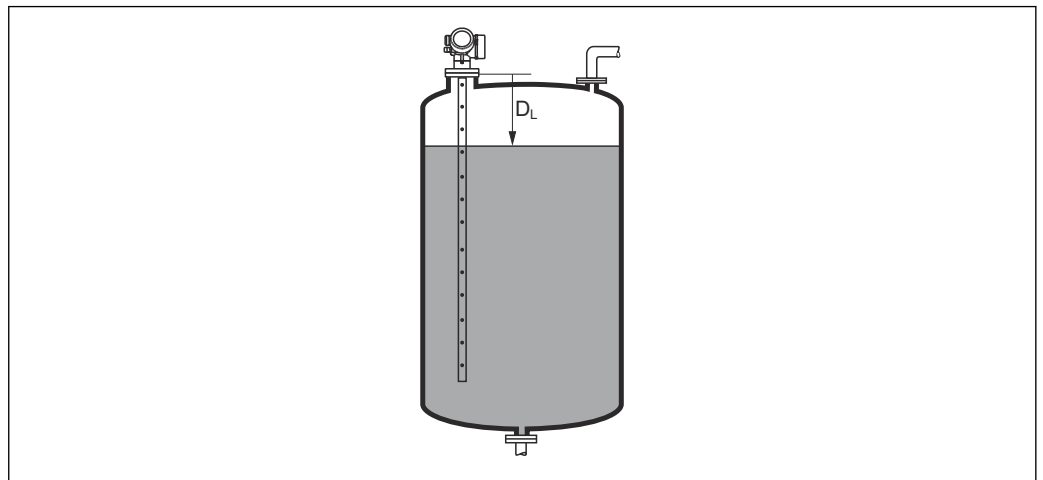

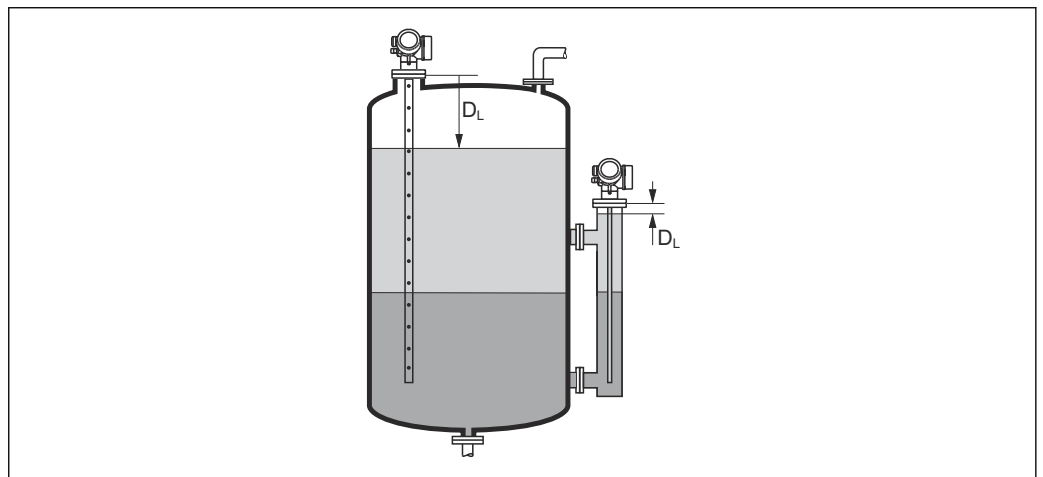

A0013198

 47 Distance for liquid measurements





A0013199



 48 Distance for interface measurements

 The unit is defined in the **Distance unit** parameter (→  107).

Level linearized

Navigation	  Diagnostics → Measured val. → Level linearized
Description	Displays linearized level.
Additional information	 <ul style="list-style-type: none"> ▪ This unit is defined by the Unit after linearization parameter. ▪ In the case of interface measurements, this parameter always refers to the total level.

Interface distance



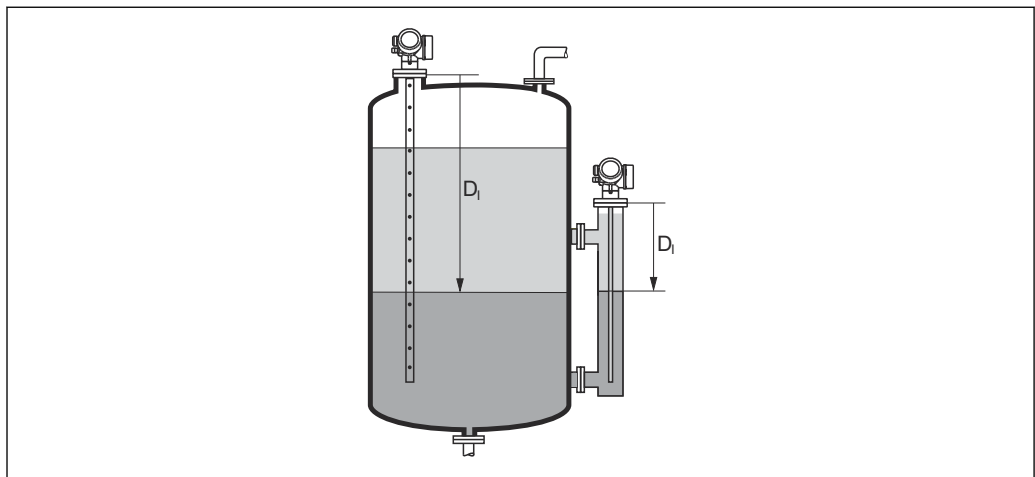

Navigation	  Diagnostics → Measured val. → Interface dist.
Prerequisite	Operating mode (→  106) = Interface or Interface with capacitance
Description	Displays the measured distance D_1 between the reference point (lower edge of flange or threaded connection) and the interface.

Additional information



A0013202

 The unit is defined in the **Distance unit** parameter (→  107).

Interface linearized

Navigation	  Diagnostics → Measured val. → Interf. lineariz
Prerequisite	Operating mode (→  106) = Interface or Interface with capacitance
Description	Displays the linearized interface height.
Additional information	 This unit is defined by the Unit after linearization parameter.

Thickness upper layer

Navigation  Diagnostics → Measured val. → Thickn.upper layer**Prerequisite****Operating mode** (→  106) = **Interface** or **Interface with capacitance****Description**

Displays the upper interface thickness (UP).

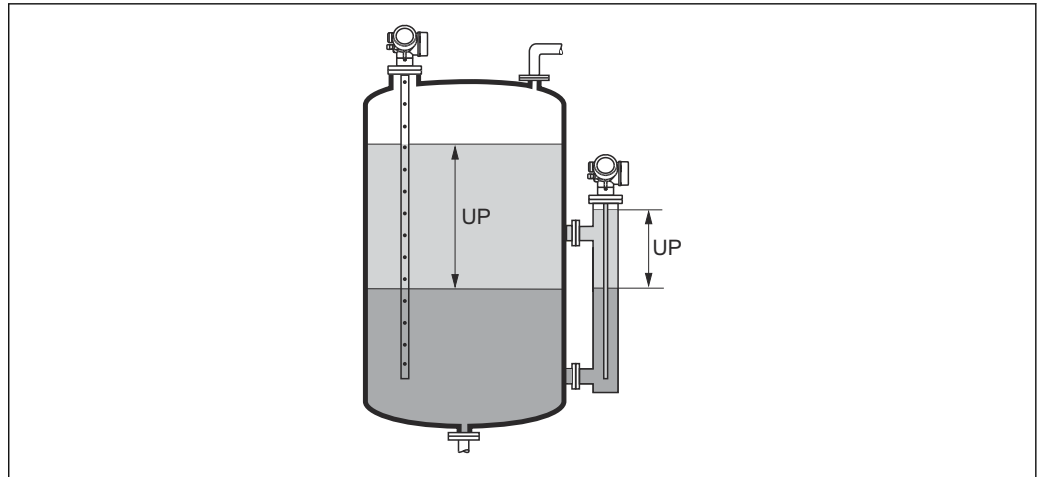
Additional information

A0013313

UP Thickness upper layer The unit is defined by the **Unit after linearization** parameter →  137.

Terminal voltage 1

Navigation  Diagnostics → Measured val. → Terminal volt. 1**Description**

Shows the current terminal voltage that is applied at the output.

15.4.5 "Data logging" submenu

Navigation  Diagnostics → Data logging

Assign channel 1 to 4

Navigation  Diagnostics → Data logging → Assign chan. 1 to 4

Description Assign a process variable to logging channel.

Selection

- Off
- Level linearized
- Distance
- Unfiltered distance
- Interface linearized^{*}
- Interface distance^{*}
- Unfiltered interface distance
- Thickness upper layer^{*}
- Current output 1
- Measured current
- Current output 2^{*}
- Terminal voltage
- Electronic temperature
- Measured capacitance^{*}
- Absolute echo amplitude
- Relative echo amplitude
- Absolute interface amplitude^{*}
- Relative interface amplitude^{*}
- Absolute EOP amplitude
- EOP shift
- Noise of signal
- Calculated DC value^{*}
- Analog output adv. diagnostics 1
- Analog output adv. diagnostics 2

Additional information A total of 1000 measured values can be logged. This means:



- 1000 data points if 1 logging channel is used
- 500 data points if 2 logging channels are used
- 333 data points if 3 logging channels are used
- 250 data points if 4 logging channels are used

If the maximum number of data points is reached, the oldest data points in the data log are cyclically overwritten in such a way that the last 1000, 500, 333 or 250 measured values are always in the log (ring memory principle).

 The logged data are deleted if a new option is selected in this parameter.

* Visibility depends on order options or device settings

Logging interval
**Navigation**

-  Diagnostics → Data logging → Logging interval
-  Diagnostics → Data logging → Logging interval

Description

Define the logging interval t_{log} for data logging. This value defines the time interval between the individual data points in the memory.

User entry

1.0 to 3 600.0 s

Additional information

This parameter defines the interval between the individual data points in the data log, and thus the maximum loggable process time T_{log} :

- If 1 logging channel is used: $T_{log} = 1000 \cdot t_{log}$
- If 2 logging channels are used: $T_{log} = 500 \cdot t_{log}$
- If 3 logging channels are used: $T_{log} = 333 \cdot t_{log}$
- If 4 logging channels are used: $T_{log} = 250 \cdot t_{log}$

Once this time elapses, the oldest data points in the data log are cyclically overwritten such that a time of T_{log} always remains in the memory (ring memory principle).





The logged data are deleted if this parameter is changed.

*Example***When using 1 logging channel**

- $T_{log} = 1000 \cdot 1 \text{ s} = 1000 \text{ s} \approx 16.5 \text{ min}$
- $T_{log} = 1000 \cdot 10 \text{ s} = 10000 \text{ s} \approx 2.75 \text{ h}$
- $T_{log} = 1000 \cdot 80 \text{ s} = 80000 \text{ s} \approx 22 \text{ h}$
- $T_{log} = 1000 \cdot 3600 \text{ s} = 3600000 \text{ s} \approx 41 \text{ d}$

Clear logging data
**Navigation**

-  Diagnostics → Data logging → Clear logging
-  Diagnostics → Data logging → Clear logging

Description

Clear the entire logging data.

Selection

- Cancel
- Clear data

"Display channel 1 to 4" submenu

i The **Display channel 1 to 4** submenus are only available for operation via the local display. When operating via FieldCare, the logging diagram can be displayed in the FieldCare function "Event List / HistoROM" .

The **Display channel 1 to 4** submenus invoke a diagram of the logging history of the respective channel.

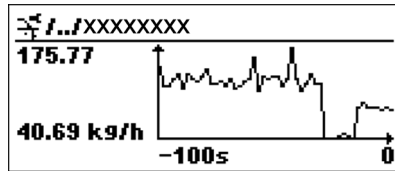

- x-axis: depending on the number of selected channels, 250 to 1000 measured values of a process variable are displayed.
- y-axis: covers the approximate measured value span and constantly adapts this to the measurement.







i To return to the operating menu, press \oplus and \ominus simultaneously.

Navigation ☰ ☰ Diagnostics → Data logging → Displ.channel 1 to 4

15.4.6 "Simulation" submenu







The **Simulation** submenu is used to simulate specific measuring values or other conditions. This helps to check the correct configuration of the device and connected control units.

Conditions which can be simulated

Condition to be simulated	Associated parameters
Specific value of a process variable	<ul style="list-style-type: none"> ▪ Assign measurement variable (→  183) ▪ Process variable value (→  183)
Specific state of the switch output	<ul style="list-style-type: none"> ▪ Switch output simulation (→  183) ▪ Switch status (→  184)
Existence of an alarm	Device alarm simulation (→  184)
Existence of a specific diagnostic message	Diagnostic event simulation (→  184)

Structure of the submenu

Navigation  Expert → Diagnostics → Simulation

▶ Simulation	
Assign measurement variable	→  183
Process variable value	→  183
Switch output simulation	→  183
Switch status	→  184
Device alarm simulation	→  184
Diagnostic event simulation	→  184

Description of parameters

Navigation  Expert → Diagnostics → Simulation

Assign measurement variable

Navigation  Expert → Diagnostics → Simulation → Assign meas.var.

Description Defines the process variable to be simulated.

Selection

- Off
- Level
- Interface *
- Thickness upper layer *
- Level linearized
- Interface linearized
- Thickness linearized

Additional information

- The value of the variable to be simulated is defined in the **Process variable value** parameter (→  183).
- If **Assign measurement variable** ≠ **Off**, a simulation is active. This is indicated by a diagnostic message of the *Function check (C)* category.

Process variable value

Navigation  Expert → Diagnostics → Simulation → Proc. var. value

Prerequisite **Assign measurement variable** (→  183) ≠ **Off**

Description Defines the value of the selected variable.
The outputs assume values or states according to this value.

User entry Signed floating-point number

Additional information Downstream measured value processing and the signal output use this simulation value. In this way, users can verify whether the measuring device has been configured correctly.

Switch output simulation



Navigation  Expert → Diagnostics → Simulation → Switch sim.

Description Switch the simulation of the switch output on and off.

* Visibility depends on order options or device settings

- Selection**
- Off
 - On

Switch status

Navigation   Expert → Diagnostics → Simulation → Switch status



Prerequisite **Switch output simulation (→  183) = On**

Description Current status of the switch output.

- Selection**
- Open
 - Closed

Additional information The switch status assumes the value defined in this parameter. This helps to check correct operation of connected control units.

Device alarm simulation

Navigation   Expert → Diagnostics → Simulation → Dev. alarm sim.



Description Switch the device alarm on and off.

- Selection**
- Off
 - On

Additional information When selecting the **On** option, the device generates an alarm. This helps to check the correct output behavior of the device in the case of an alarm.

An active simulation is indicated by the  **C484 Failure mode simulation** diagnostic message.

Diagnostic event simulation

Navigation   Expert → Diagnostics → Simulation → Diag. event sim.

Description Select the diagnostic event to be simulated.



Note:
To terminate the simulation, select 'Off'.

Additional information When operated via the local display, the selection list can be filtered according to the event categories (**Diagnostic event category** parameter).



15.4.7 "Device check" submenu

Navigation   Diagnostics → Device check



Start device check

Navigation	  Diagnostics → Device check → Start dev. check
Description	Start a device check.
Selection	<ul style="list-style-type: none"> ▪ No ▪ Yes
Additional information	In the case of a lost echo a device check can not be performed.



Result device check

Navigation	  Diagnostics → Device check → Result dev.check
Description	Displays the result of the device check.
Additional information	<p>Meaning of the display options</p> <ul style="list-style-type: none"> ▪ Installation ok Measurement possible without restrictions. ▪ Accuracy reduced A measurement is possible. However, the measuring accuracy may be reduced due to the signal amplitudes. ▪ Measurement capability reduced A measurement is currently possible. However, there is the risk of an echo loss. Check the mounting position of the device and the dielectric constant of the medium. ▪ Check not done No device check has been performed.



Last check time

Navigation	  Diagnostics → Device check → Last check time
Description	Displays the operating time at which the last device check has been performed.
User interface	Character string comprising numbers, letters and special characters



Level signal

Navigation	  Diagnostics → Device check → Level signal
Prerequisite	Device check has been performed.
Description	Displays result of the device check for the level signal.
User interface	<ul style="list-style-type: none"> ▪ Check not done ▪ Check not OK ▪ Check OK
Additional information	For Level signal = Check not OK : Check the mounting position of the device and the dielectric constant of the medium.

Launch signal

Navigation	  Diagnostics → Device check → Launch signal
Prerequisite	Device check has been performed.
Description	Displays result of the display check for the launch signal.
User interface	<ul style="list-style-type: none"> ▪ Check not done ▪ Check not OK ▪ Check OK
Additional information	For Launch signal = Check not OK : Check the mounting position of the device. In non-metallic vessels use a metal plate or a metal flange.

Interface signal

Navigation	  Diagnostics → Device check → Interface signal
Prerequisite	<ul style="list-style-type: none"> ▪ Operating mode (→  106) = Interface or Interface with capacitance ▪ Device check has been performed.
Description	Displays result of the device check for the interface signal.
User interface	<ul style="list-style-type: none"> ▪ Check not done ▪ Check not OK ▪ Check OK

15.5 Modbus register assignment

15.5.1 Register table

Register	Parameter	Data type	Swap mode	Description
10	Main version	UINT16	-	Main firmware version code
11	Major version	UINT16	-	Major firmware version code
12	Minor version	UINT16	-	Minor firmware version code
13	Build no. software	UINT16	-	Firmware build number
100	Old status	UINT32	-	Only zeros
102	Primary variable (PV)	UINT32	CDAB	First HART variable
104	Secondary variable (SV)	UINT32	CDAB	Second HART variable
106	Tertiary variable (TV)	UINT32	CDAB	Third HART variable
108	Quaternary variable (QV)	UINT32	CDAB	Fourth HART variable
110	Status	UINT64	-	See "Format of the status bytes" → 189
114	Diagnostics	UINT64	CDAB	See "Format of the diagnostic bytes" → 188
118	PV unit	UINT16	-	Unit of the first HART variable
119	SV unit	UINT16	-	Unit of the second HART variable
120	TV unit	UINT16	-	Unit of the third HART variable
121	QV unit	UINT16	-	Unit of the fourth HART variable
122	Variable 19 unit	UINT16	-	Unit of variable 19
123	Variable 20 unit	UINT16	-	Unit of variable 20
199	Additional status	UINT16	-	<ul style="list-style-type: none"> ▪ 1: Device locked ▪ 2: Device unlocked
1300	Old status	UINT32	-	All zeros
1302	Primary variable (PV)	UINT32	CDAB	First HART variable
1304	Secondary variable (SV)	UINT32	CDAB	Second HART variable
1306	Tertiary variable (TV)	UINT32	CDAB	Third HART variable
1308	Quaternary variable (QV)	UINT32	CDAB	Fourth HART variable
1310	Status	UINT64	-	See "Format of the status bytes" → 189
1314	Diagnostics	UINT64	CDAB	See "Format of the diagnostic bytes" → 188
1400	Old status	UINT32	-	All zeros
1402	Primary variable (PV)	UINT32	CDAB	First HART variable
1404	Status	UINT64	-	See "Format of the status bytes" → 189
1414	Secondary variable (SV)	UINT32	CDAB	Second HART variable
1416	Status	UINT64	-	See "Format of the status bytes" → 189
1426	Tertiary variable (TV)	UINT32	CDAB	Third HART variable
1428	Status	UINT64	-	See "Format of the status bytes" → 189
1438	Quaternary variable (QV)	UINT32	CDAB	Fourth HART variable
1440	Status	UINT64	-	See "Format of the status bytes" → 189
2000	Old status	UINT32	-	All zeros
2002	Primary variable (PV)	UINT32	ABCD	First HART variable
2004	Secondary variable (SV)	UINT32	ABCD	Second HART variable
2006	Tertiary variable (TV)	UINT32	ABCD	Third HART variable

Register	Parameter	Data type	Swap mode	Description
2008	Quaternary variable (QV)	UINT32	ABCD	Fourth HART variable
2010	Status	UINT64	-	See "Format of the status bytes" → 189
2014	Diagnostics	UINT64	ABCD	See "Format of the diagnostic bytes" → 188
2100	Old status	UINT32	-	All zeros
2102	Primary variable (PV)	UINT32	DCBA	First HART variable
2104	Secondary variable (SV)	UINT32	DCBA	Second HART variable
2106	Tertiary variable (TV)	UINT32	DCBA	Third HART variable
2108	Quaternary variable (QV)	UINT32	DCBA	Fourth HART variable
2110	Status	UINT64	-	See "Format of the status bytes" → 189
2114	Diagnostics	UINT64	DCBA	See "Format of the diagnostic bytes" → 188
2200	Old status	UINT32	-	All zeros
2202	Primary variable (PV)	UINT32	BADC	First HART variable
2204	Secondary variable (SV)	UINT32	BADC	Second HART variable
2206	Tertiary variable (TV)	UINT32	BADC	Third HART variable
2208	Quaternary variable (QV)	UINT32	BADC	Fourth HART variable
2210	Status	UINT64	-	See "Format of the status bytes" → 189
2214	Diagnostics	UINT64	BADC	See "Format of the diagnostic bytes" → 188

15.5.2 Format of the diagnostic bytes

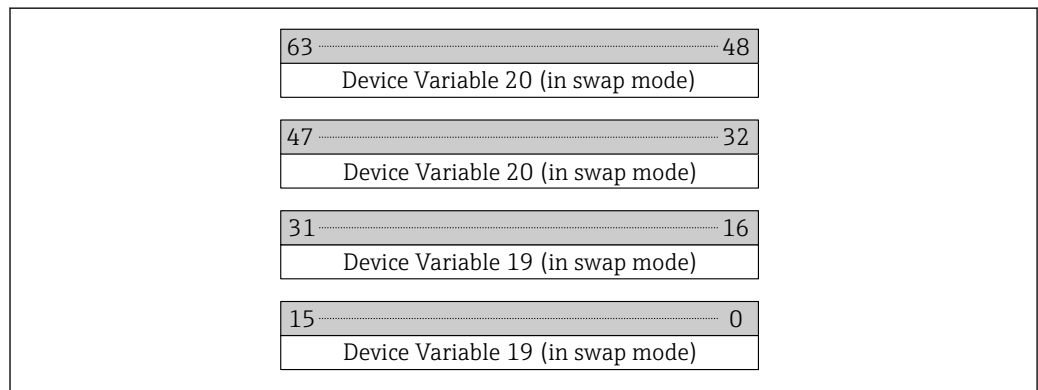

A0043330

 "Device Variable 19" and "Device Variable 20" are derived from HART Command 9.

15.5.3 Format of the status bytes

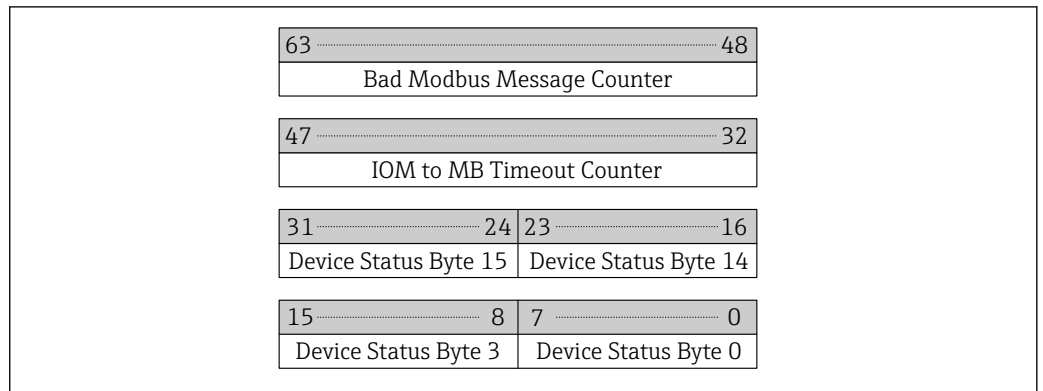

A0043329

 The device status is determined from HART Command 48.

If one of the following status bits is set by the device, the measured value changes to 9999.99. This is intended to alert the user to the fact that there is a problem with the device.

Byte	Bit	Meaning
3	5	⊗F273 Main electronic failure
3	6	⊗F275 I/O module failure
14	1	⊗F104 HF cable
14	2	⊗F105 HF cable
14	3	⊗F106 Sensor
15	4	⊗F270 Main electronic failure
15	5	⊗F271 Main electronic failure
15	6	⊗F272 Main electronic failure

Index

A

- Access authorization to parameters
 - Read access 48
 - Write access 48
- Access code 48
 - Incorrect input 48
- Access status display (Parameter) 121
- Access status tooling (Parameter) 120
- Accessories
 - Communication-specific 92
 - Device-specific 82
 - Service-specific 92
 - System components 92
- Activate table (Parameter) 142
- Actual diagnostics (Parameter) 168
- Administration (Submenu) 166
- Advanced process conditions (Parameter) 124
- Advanced setup (Submenu) 120
- Application 9
- Assign channel 1 to 4 (Parameter) 178
- Assign diagnostic behavior (Parameter) 152
- Assign limit (Parameter) 152
- Assign measurement variable (Parameter) 183
- Assign status (Parameter) 152
- Automatic DC calculation (Wizard) 132

B

- Backlight (Parameter) 162
- Backup state (Parameter) 164
- Blocking distance (Parameter) 125, 128, 145
- Bluetooth® wireless technology 46
- Bypass 26

C

- Calculated DC value (Parameter) 130
- Cleaning 79
- Clear logging data (Parameter) 179
- Coax probe
 - Design 12
- Coaxial probes
 - Lateral loading capacity 21
 - Shortening 34
- Comparison result (Parameter) 164
- Configuration backup display (Submenu) 163
- Configuration management (Parameter) 163
- Configuration of a level measurement 61
- Configuration of an interface measurement 63
- Configuring interface measurement 63
- Configuring level measurement 61
- Configuring the operating language 60
- Confirm access code (Parameter) 168
- Confirm distance (Parameter) 116, 119
- Confirm probe length (Parameter) 148, 149
- Context menu 57
- Contrast display (Parameter) 162
- Customer value (Parameter) 142

D

- Data logging (Submenu) 178
- DC value (Parameter) 114, 130, 132
- DC value lower medium (Parameter) 127
- Decimal places 1 (Parameter) 159
- Decimal places menu (Parameter) 161
- Define access code (Parameter) 166, 168
- Define access code (Wizard) 168
- Defining the access code 48
- Device alarm simulation (Parameter) 184
- Device check (Submenu) 185
- Device ID (Parameter) 173
- Device information (Submenu) 172
- Device name (Parameter) 172
- Device replacement 80
- Device reset (Parameter) 166
- Device revision (Parameter) 173
- Device tag (Parameter) 106, 172
- Device type (Parameter) 174
- Diagnostic event 73
 - In the operating tool 74
- Diagnostic event simulation (Parameter) 184
- Diagnostic events 72
- Diagnostic list 76
- Diagnostic list (Submenu) 170
- Diagnostic message 72
- Diagnostics
 - Symbols 72
- Diagnostics (Menu) 168
- Diagnostics 1 (Parameter) 170
- Diameter (Parameter) 140
- DIP switch
 - see Write protection switch
- Display (Submenu) 157
- Display and operating module FHX50 45
- Display channel 1 to 4 (Submenu) 180
- Display damping (Parameter) 160
- Display interval (Parameter) 160
- Display module 52
- Display symbols 53
- Disposal 81
- Distance (Parameter) 111, 119, 175
- Distance to upper connection (Parameter) 114
- Distance unit (Parameter) 107
- Document
 - Function 5
- Document function 5

E

- Electronics housing
 - Design 13
- Empty calibration (Parameter) 108
- Enter access code (Parameter) 121
- Envelope curve display 58
- Event history 76

Event level
 Explanation 72
 Symbols 72
 Event list 76
 Event list (Submenu) 171
 Event logbook (Submenu) 171
 Event text 73
 Extended order code 1 (Parameter) 173
 Exterior cleaning 79

F
 Failure mode (Parameter) 155
 FHX50 45
 Field of application
 Residual risks 9
 Filter options (Parameter) 171
 Filtering the event logbook 77
 Firmware version (Parameter) 172
 Flange 36
 Format display (Parameter) 157
 Free text (Parameter) 138
 Full calibration (Parameter) 109

H
 Hardware write protection 49
 Header (Parameter) 160
 Header text (Parameter) 161
 Housing
 Design 13
 Turning 38

I
 Input mask 55
 Intended use 9
 Interface (Parameter) 115
 Interface (Submenu) 127
 Interface distance (Parameter) 116, 176
 Interface linearized (Parameter) 139, 176
 Interface signal (Parameter) 186
 Intermediate height (Parameter) 140
 Invert output signal (Parameter) 155

K
 Keypad lock
 Disabling 50
 Enabling 50

L
 Language (Parameter) 157
 Last backup (Parameter) 163
 Last check time (Parameter) 185
 Launch signal (Parameter) 186
 Level (Parameter) 110, 142
 Level (Submenu) 122
 Level correction (Parameter) 126, 129
 Level linearized (Parameter) 139, 176
 Level signal (Parameter) 186
 Level unit (Parameter) 125, 128
 Linearization (Submenu) 134, 135, 136
 Linearization type (Parameter) 136

Local display
 see Diagnostic message
 see In alarm condition
 Locking status 53
 Locking status (Parameter) 120
 Logging interval (Parameter) 179

M
 Maintenance 79
 Managing the device configuration 68
 Manual thickness upper layer (Parameter) 129, 132
 Manufacturer ID (Parameter) 174
 Mapping (Wizard) 119
 Mapping end point (Parameter) 118, 119
 Maximum value (Parameter) 139
 Measured thickness upper layer (Parameter) 130
 Measured value symbols 54
 Measured values (Submenu) 175
 Media 9
 Medium group (Parameter) 108
 Medium property (Parameter) 122
 Medium type (Parameter) 122
 Menu
 Diagnostics 168
 Setup 106
 Mounting outside the vessel 29
 Mounting position for level measurements 17

N
 Non-metal vessels 29
 Number format (Parameter) 161

O
 Onsite operation 45
 Operating elements
 Diagnostic message 73
 Operating mode (Parameter) 106
 Operating module 52
 Operating time (Parameter) 163, 169
 Operating time from restart (Parameter) 169
 Operational safety 10
 Order code (Parameter) 173
 Output echo lost (Parameter) 144
 Overvoltage protection
 General information 42

P
 Present mapping (Parameter) 117
 Present probe length (Parameter) 147, 150
 Previous diagnostics (Parameter) 169
 Probe grounded (Parameter) 147
 Probe length correction (Wizard) 149
 Probe settings (Submenu) 147
 Process property (Parameter) 123, 127
 Process variable value (Parameter) 183
 Product security 10

R
 Ramp at echo lost (Parameter) 145
 Read access 48

- Record map (Parameter) 118, 119
- Registered trademarks 8
- Remedial measures
 - Calling up 74
 - Closing 74
- Repair concept 80
- Replacing a device 80
- Requirements for personnel 9
- Result device check (Parameter) 185
- Return 81
- Rod probe
 - Design 12
- Rod probes
 - Lateral loading capacity 20
 - Shortening 33
- Rope probe
 - Design 12
- Rope probes
 - Installation 36
 - Shortening 33
 - Tensile loading capacity 19
- S**
- Safety instructions
 - Basic 9
- Safety settings (Submenu) 144
- Securing coaxial probes 25
- Securing rod probes 24
- Securing rope probes 23
- Separator (Parameter) 161
- Serial number (Parameter) 172
- Service interface (CDI) 46
- Settings
 - Managing the device configuration 68
 - Operating language 60
- Setup (Menu) 106
- Signal quality (Parameter) 112
- Simulation (Submenu) 182, 183
- Spare parts 81
 - Nameplate 81
- Start device check (Parameter) 185
- Status signals 53, 72
- Stilling well 26
- Submenu
 - Administration 166
 - Advanced setup 120
 - Configuration backup display 163
 - Data logging 178
 - Device check 185
 - Device information 172
 - Diagnostic list 170
 - Display 157
 - Display channel 1 to 4 180
 - Event list 76, 171
 - Event logbook 171
 - Interface 127
 - Level 122
 - Linearization 134, 135, 136
 - Measured values 175
 - Probe settings 147
 - Safety settings 144
 - Simulation 182, 183
 - Switch output 151
 - Switch output (Submenu) 151
 - Switch output function (Parameter) 151
 - Switch output simulation (Parameter) 183
 - Switch status (Parameter) 155, 184
 - Switch-off delay (Parameter) 155
 - Switch-off value (Parameter) 154
 - Switch-on delay (Parameter) 154
 - Switch-on value (Parameter) 153
- Symbols
 - For correction 55
 - In the text and numeric editor 55
- System components 92
- T**
- Table mode (Parameter) 140
- Table number (Parameter) 141
- Tank level (Parameter) 113
- Tank type (Parameter) 107
- Terminal voltage 1 (Parameter) 177
- Thermal insulation 31
- Thickness upper layer (Parameter) 177
- Threaded connection 35
- Timestamp (Parameter) 169
- Timestamp 1 to 5 (Parameter) 170
- Tool 33
- Transmitter
 - Turning the display 39
 - Turning the display module 39
- Transmitter housing
 - Turning 38
- Troubleshooting 70
- Tube diameter (Parameter) 107
- Turning the display 39
- Turning the display module 39
- U**
- Underground tanks 28
- Unit after linearization (Parameter) 137
- Use calculated DC value (Parameter) 131, 132
- Use of measuring instrument
 - see Intended use
- Use of the measuring instruments
 - Borderline cases 9
 - Incorrect use 9
- V**
- Value 1 display (Parameter) 159
- Value echo lost (Parameter) 144
- W**
- Wizard
 - Automatic DC calculation 132
 - Define access code 168
 - Mapping 119
 - Probe length correction 149
- Workplace safety 10

- Write access 48
- Write protection
 - Via access code 48
 - Via write protection switch 49
- Write protection switch 49



www.addresses.endress.com
