

# Operating Instructions

## Liquicap M

### FTI52

Capacitance  
Point level switch for liquids





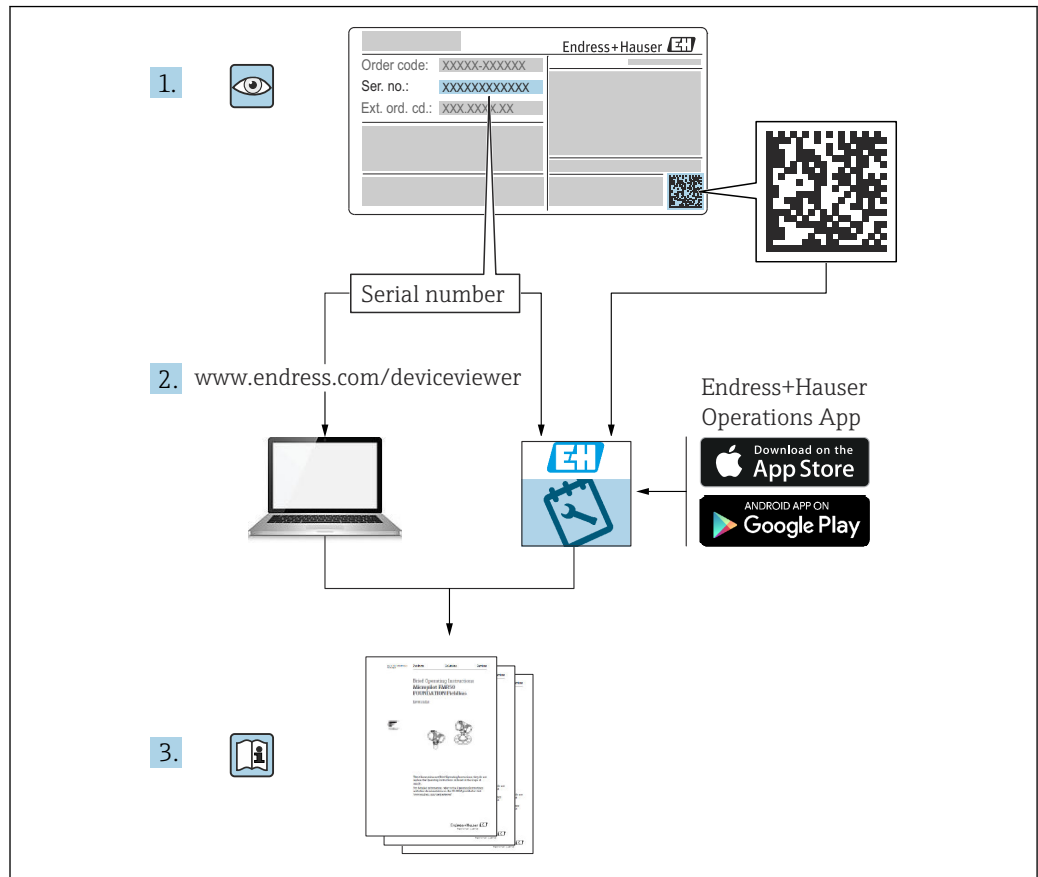

## Related documents



A0023555

## Table of contents

<b>1</b>	<b>About this document</b> .....	<b>5</b>		
1.1	Document function .....	5		
1.2	Document conventions .....	5		
1.2.1	Safety symbols .....	5		
1.2.2	Electrical symbols .....	5		
1.2.3	Tool symbols .....	5		
1.2.4	Symbols for certain types of information and graphics .....	6		
1.3	Documentation .....	7		
1.3.1	Supplementary device-dependent documentation .....	7		
1.4	Registered trademarks .....	8		
<b>2</b>	<b>Basic safety instructions</b> .....	<b>9</b>		
2.1	Requirements for the personnel .....	9		
2.2	Intended use .....	9		
2.3	Workplace safety .....	9		
2.4	Operational safety .....	9		
2.4.1	Ex-area .....	9		
2.5	Product safety .....	9		
<b>3</b>	<b>Incoming acceptance and product identification</b> .....	<b>10</b>		
3.1	Incoming acceptance .....	10		
3.2	Product identification .....	10		
3.2.1	Nameplate .....	10		
3.2.2	Manufacturer address .....	10		
3.3	Storage and transport .....	10		
<b>4</b>	<b>Mounting</b> .....	<b>11</b>		
4.1	Mounting requirements .....	11		
4.1.1	Mounting the sensor .....	11		
4.2	Measuring conditions .....	11		
4.3	Installation examples .....	12		
4.3.1	Rope probes .....	12		
4.3.2	Rope shortening .....	13		
4.3.3	Tensioning weight with tension .....	14		
4.4	Probe with separate housing .....	14		
4.4.1	Extension heights: separate housing .	15		
4.4.2	Wall bracket .....	16		
4.4.3	Wall mounting .....	16		
4.4.4	Pipe mounting .....	17		
4.4.5	Shortening the connecting cable . . . .	17		
4.5	Installation instructions .....	20		
4.5.1	Probe installation .....	21		
4.5.2	Aligning the housing .....	22		
4.5.3	Sealing the probe housing .....	22		
4.6	Post-installation check .....	22		
<b>5</b>	<b>Electrical connection</b> .....	<b>23</b>		
5.1	Connecting requirements .....	23		
5.1.1	Potential equalization .....	23		
5.1.2	Cable specification .....	23		
5.1.3	Connector .....	23		
5.1.4	Cable entry .....	24		
5.2	Wiring and connecting .....	24		
5.2.1	Connection compartment .....	24		
5.3	Connecting the measuring device .....	25		
5.3.1	2-wire AC electronic insert FEI51 . . . .	25		
5.3.2	DC PNP electronic insert FEI52 . . . . .	26		
5.3.3	3-wire electronic insert FEI53 . . . . .	27		
5.3.4	AC and DC with relay output electronic insert FEI54 .....	28		
5.3.5	SIL2 / SIL3 electronic insert FEI55 . . .	30		
5.3.6	PFM electronic insert FEI57S . . . . .	31		
5.3.7	NAMUR electronic insert FEI58 . . . . .	32		
5.4	Post-connection check .....	33		
<b>6</b>	<b>Operation options</b> .....	<b>34</b>		
6.1	Human interface and display elements for FEI51, FEI52, FEI54, FEI55 .....	34		
6.2	Human interface and display elements for FEI53, FEI57S .....	35		
6.3	Human interface and display elements for FEI58 .....	36		
<b>7</b>	<b>Commissioning</b> .....	<b>38</b>		
7.1	Installation and function check .....	38		
7.2	Commissioning the electronic inserts FEI51, FEI52, FEI54 and FEI55 .....	38		
7.2.1	Setting the measuring range .....	38		
7.2.2	 Carrying out empty calibration . . . .	39		
7.2.3	 Carrying out full calibration . . . . .	40		
7.2.4	Carrying out empty and full calibration .....	41		
7.2.5	Reset: Calibration and switch-point adjustment .....	43		
7.2.6	Setting the switch point adjustment . .	44		
7.2.7	Configuring two-point control and buildup mode .....	45		
7.2.8	 Setting the switching delay . . . . .	47		
7.2.9	 Activating the self-test . . . . .	48		
7.2.10	Setting the MIN, MAX and SIL fail- safe mode .....	50		
7.2.11	Restoring factory settings .....	54		
7.2.12	 Upload and download sensor DAT (EEPROM) .....	55		
7.2.13	Output signals .....	57		
7.3	Commissioning with electronic inserts FEI53 or FEI57S .....	58		
7.3.1	Setting the alarm response if the measuring range is exceeded .....	59		
7.3.2	Setting the measuring range .....	59		
7.3.3	Output signals .....	60		

7.4	Commissioning with the electronic insert FEI58 .....	60	12.4	Performance characteristics .....	77
7.4.1	Function keys A, B, C .....	61	12.4.1	Ambient temperature effect .....	77
7.4.2	Performing calibration .....	61	12.5	Operating conditions: Environment .....	78
7.4.3	Setting the switch point adjustment ..	63	12.5.1	Ambient temperature range .....	78
7.4.4	Setting the switching delay .....	64	12.5.2	Climate class .....	78
7.4.5	MIN and MAX fail-save mode .....	64	12.5.3	Vibration resistance .....	78
7.4.6	Display calibration situation .....	65	12.5.4	Shock resistance .....	78
7.4.7	Displaying the diagnostic code .....	65	12.5.5	Cleaning .....	78
7.4.8	Test key C .....	65	12.5.6	Degree of protection .....	78
7.4.9	Output signals .....	66	12.5.7	Electromagnetic compatibility (EMC) .....	79
<b>8</b>	<b>Diagnostics and troubleshooting ...</b>	<b>67</b>	12.6	Operating conditions: Process .....	79
8.1	Activating fault diagnostics FEI51, FEI52, FEI54 and FEI55 .....	67	12.6.1	Process temperature range .....	79
8.2	Fault diagnostics FEI53 and FEI57S .....	69	12.6.2	Process pressure limits .....	81
8.3	Activating fault diagnostics FEI58 .....	69	12.6.3	Pressure and temperature derating ..	82
8.4	Firmware history .....	70	<b>Index .....</b>	<b>84</b>	
<b>9</b>	<b>Maintenance .....</b>	<b>72</b>			
9.1	External cleaning .....	72			
9.2	Cleaning the probe .....	72			
9.3	Seals .....	72			
9.4	Endress+Hauser services .....	72			
<b>10</b>	<b>Repair .....</b>	<b>73</b>			
10.1	General notes .....	73			
10.2	Spare parts .....	73			
10.3	Repairing Ex-certified devices .....	73			
10.4	Replacement .....	74			
10.5	Return .....	74			
10.6	Disposal .....	74			
10.6.1	Removing the measuring device .....	74			
10.6.2	Disposing of the measuring device ...	74			
<b>11</b>	<b>Accessories .....</b>	<b>75</b>			
11.1	Shortening kit for FTI52 .....	75			
11.2	Protective cover .....	75			
11.3	Surge arresters .....	75			
11.3.1	HAW562 .....	75			
11.3.2	HAW569 .....	75			
11.4	Weld-in adapter .....	75			
<b>12</b>	<b>Technical data .....</b>	<b>76</b>			
12.1	Capacitance values of the probe .....	76			
12.1.1	Additional capacitance .....	76			
12.2	Input .....	76			
12.2.1	Measuring range .....	76			
12.2.2	Minimum probe length for nonconductive media < 1 µS/cm ....	76			
12.3	Output .....	77			
12.3.1	Switch behavior .....	77			
12.3.2	Switch-on behaviour .....	77			
12.3.3	Fail-safe mode .....	77			
12.3.4	Galvanic isolation .....	77			

# 1 About this document

## 1.1 Document function

These Operating Instructions contain all the information required in the various life cycle phases of the device: from product identification, incoming acceptance and storage, to installation, connection, operation and commissioning, through to troubleshooting, maintenance and disposal.

## 1.2 Document conventions

### 1.2.1 Safety symbols

#### DANGER

This symbol alerts you to a dangerous situation. Failure to avoid this situation will result in serious or fatal injury.

#### WARNING

This symbol alerts you to a dangerous situation. Failure to avoid this situation can result in serious or fatal injury.

#### CAUTION

This symbol alerts you to a dangerous situation. Failure to avoid this situation can result in minor or medium injury.

#### NOTICE

This symbol contains information on procedures and other facts which do not result in personal injury.

### 1.2.2 Electrical symbols



Alternating current



Direct current and alternating current



Direct current



Ground connection

A grounded terminal which, as far as the operator is concerned, is grounded via a grounding system.

#### Protective earth (PE)

Ground terminals that must be connected to ground prior to establishing any other connections.

The ground terminals are located on the interior and exterior of the device:

- Interior ground terminal: protective earth is connected to the mains supply.
- Exterior ground terminal: device is connected to the plant grounding system.

### 1.2.3 Tool symbols



Phillips head screwdriver

 Flat blade screwdriver



 Torx screwdriver

 Allen key

 Open-ended wrench

#### 1.2.4 Symbols for certain types of information and graphics

 **Permitted**  
Procedures, processes or actions that are permitted

  **Preferred**  
Procedures, processes or actions that are preferred

 **Forbidden**  
Procedures, processes or actions that are forbidden

 **Tip**  
Indicates additional information

 Reference to documentation

 Reference to page

 Reference to graphic

 Notice or individual step to be observed

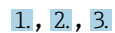
 Series of steps

 Result of a step

 Help in the event of a problem

 Visual inspection

 Operation via operating tool

 Write-protected parameter

**1, 2, 3, ...**  
Item numbers

**A, B, C, ...**  
Views

 **Hazardous area**  
Indicates the hazardous area

 **Safe area (non-hazardous area)**  
Indicates the non-hazardous area

   **Safety instructions**  
Observe the safety instructions contained in the associated Operating Instructions

 **Temperature resistance of the connection cables**

Specifies the minimum value of the temperature resistance of the connection cables



LED not lit



LED lit



LED flashes

## 1.3 Documentation

All available documents can be downloaded using:

- the serial number of the device (see cover page for description) or
- the data matrix code of the device (see cover page for description) or
- the "Downloads" area of the website [www.endress.com](http://www.endress.com)

### 1.3.1 Supplementary device-dependent documentation

Additional documents are supplied depending on the device version ordered: Always comply strictly with the instructions in the supplementary documentation. The supplementary documentation is an integral part of the device documentation.

## 1.4 Registered trademarks

### **HART®**

Registered trademark of the FieldComm Group, Austin, USA

### **TRI CLAMP®**

Registered trademark of Alfa Laval Inc., Kenosha, USA

### **KALREZ®, VITON®, TEFLON®**

Registered trademarks of E.I. Du Pont de Nemours & Co., Wilmington, USA



## 2 Basic safety instructions

### 2.1 Requirements for the personnel

The personnel must fulfill the following requirements to carry out the necessary tasks:

- ▶ Are trained and qualified to perform specific functions and tasks.
- ▶ Are authorized by the plant owner or operator to perform specific tasks.
- ▶ Are familiar with federal or national regulations.
- ▶ Have read and understood the instructions in the manual and supplementary documentation.
- ▶ They follow instructions and comply with conditions.

### 2.2 Intended use

The Liquicap M FTI52 is a compact point level switches for the capacitance point level detection of liquids.

### 2.3 Workplace safety

For work on and with the device:

- ▶ Wear the required protective equipment according to federal or national regulations.

### 2.4 Operational safety

When performing configuration, testing, and maintenance work on the device, alternative supervisory measures must be taken to guarantee the operational safety and process safety.

#### 2.4.1 Ex-area

When using the measuring system in Ex-areas, the appropriate national standards and regulations must be observed. Separate Ex-documentation, which constitutes an integral part of this documentation, is supplied with the device. The installation procedures, connection data and safety instructions it contains must be observed.

- Make sure that the technical staff has adequate training.
- The special measuring and safety-related requirements for the measuring points must be observed.

### 2.5 Product safety

This measuring device is designed following good engineering practice to meet state-of-the-art safety requirements, has been tested, and left the factory in a condition in which it is safe to operate.

It meets general safety standards and legal requirements. It is compliant with the EC directives listed in the device-specific EC Declaration of Conformity. Endress+Hauser confirms this by affixing the CE mark to the device.

## **3 Incoming acceptance and product identification**

### **3.1 Incoming acceptance**

Check whether the packaging or content is damaged. Check that the goods delivered are complete and compare the scope of delivery with the information in your order.

### **3.2 Product identification**

#### **3.2.1 Nameplate**

Different nameplates are used depending on the device version.

The nameplates contain the following information:

- Manufacturer name and device name
- Address of the certificate holder and country of manufacture
- Order code and serial number
- Technical data
- Approval-specific information

Compare the data on the nameplate with your order.

#### **3.2.2 Manufacturer address**

Endress+Hauser SE+Co. KG  
Hauptstraße 1  
79689 Maulburg, Germany

Place of manufacture: See nameplate.

### **3.3 Storage and transport**

For storage and transportation, pack the device to protect it against impact. The original packing offers the best protection for this. The permitted storage temperature is  $-50$  to  $+85$  °C ( $-58$  to  $+185$  °F).

## 4 Mounting

### 4.1 Mounting requirements

#### 4.1.1 Mounting the sensor

The Liquicap M FTI52 can be installed from the top only.

- i** Make sure that:
- the probe is not installed in the area of the filling curtain
  - the probe is not in contact with the container wall
  - the distance from the container floor is  $\geq 10$  mm (0.39 in)
  - multiple probes are mounted next to each other at the minimum distance between the probes of 500 mm (19.7 in)

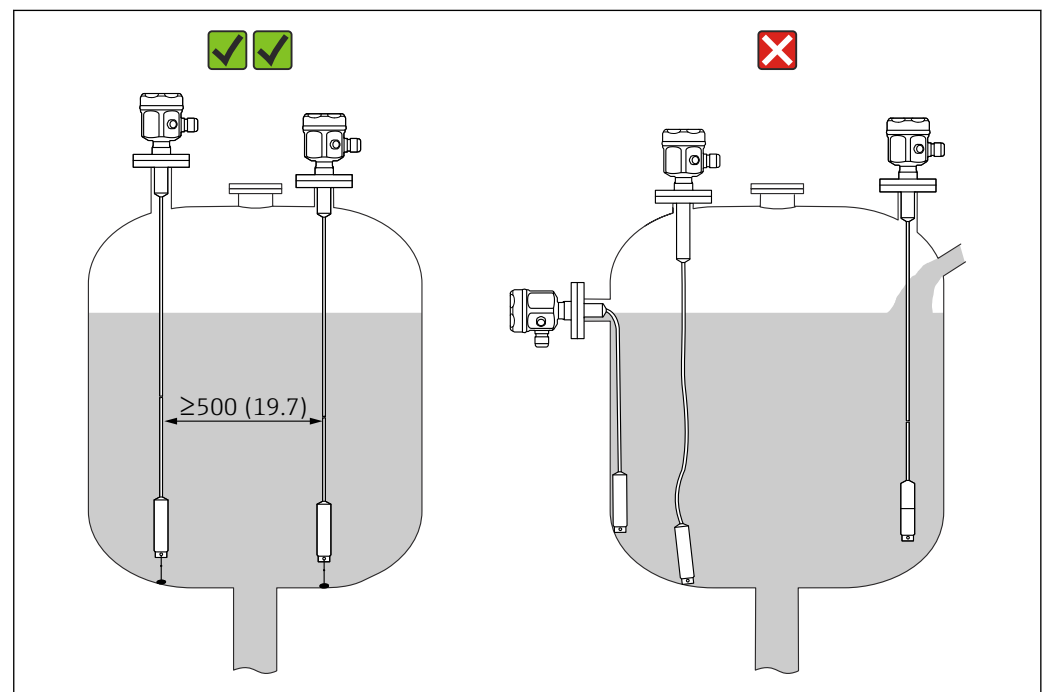

**1** Proper probe mounting. Unit of measurement mm (in)

A0040578

### 4.2 Measuring conditions

- i** When installing in a nozzle, use inactive length (L3).

Probes with active buildup compensation must be used for high-viscosity liquids that tend to form buildup.

Fully insulated rope probes must be used for pump control ( $\Delta s$  operation).

The switch-on and switch-off points are determined by the empty and full calibration.

The maximum length depends on the probe used.

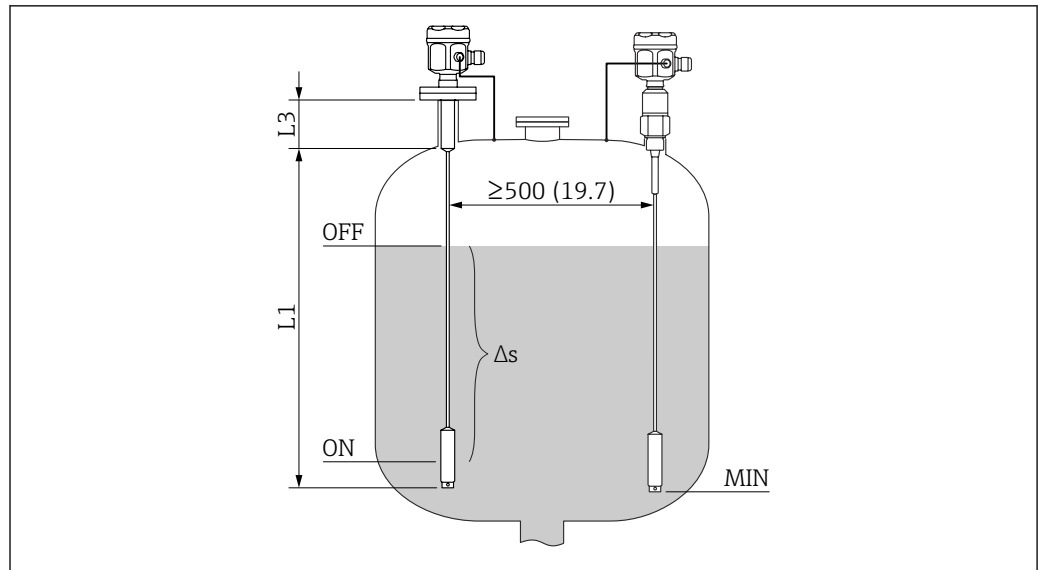

A0042380

2 Measuring conditions. Unit of measurement mm (in)

- L1 Active length
- L3 Inactive length
- $\Delta s$  Two-point control
- MIN Minimum measuring level

The 0 % and 100 % calibration can be inverted.

## 4.3 Installation examples

### 4.3.1 Rope probes

**i** The application examples show vertical installation of rope probes for MIN point level detection.

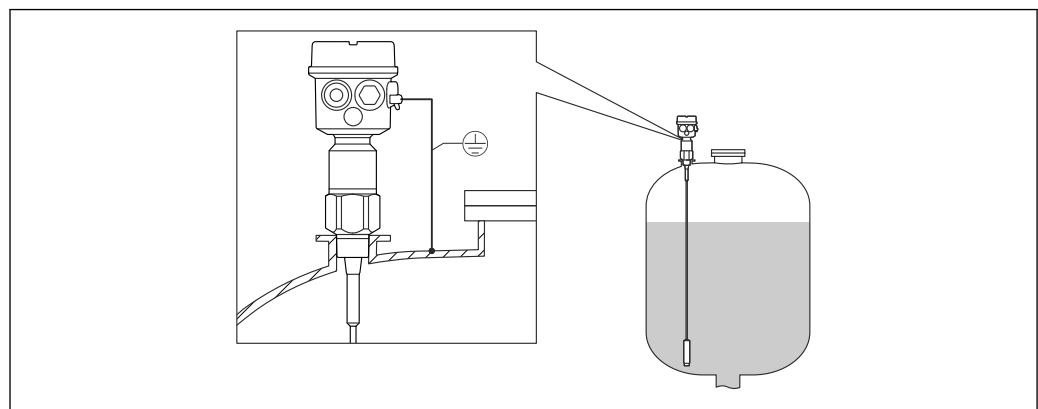

A0040451

3 A probe with conductive tanks

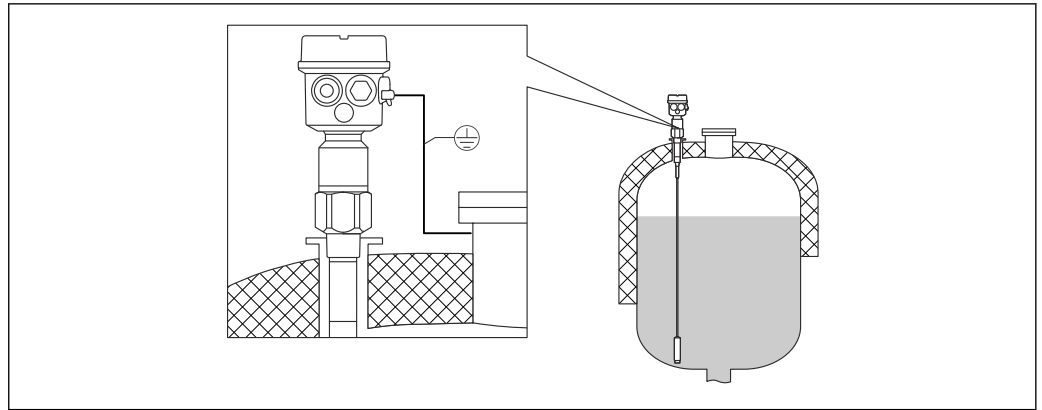

A0040452

4 A probe with inactive length for the insulated tanks

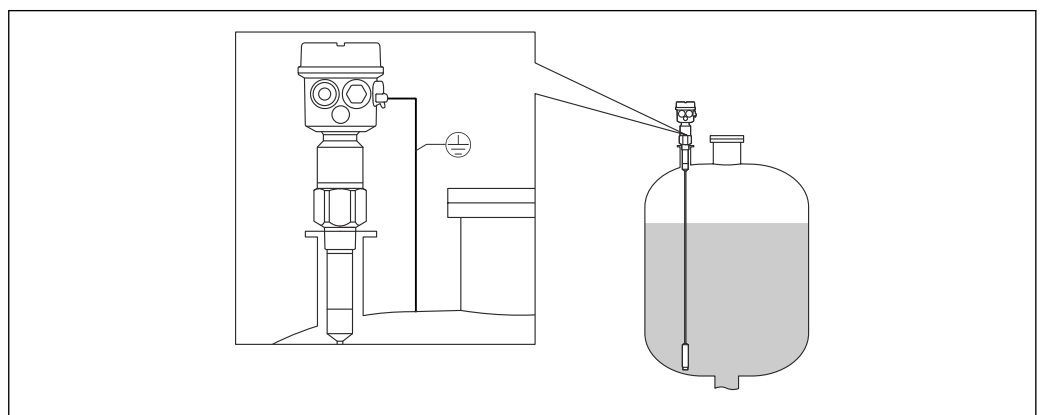

A004453

5 A probe with fully insulated inactive length

### 4.3.2 Rope shortening

Both versions of the rope probes can be shortened. The weight must be removed from the rope first. See Operating Instructions.

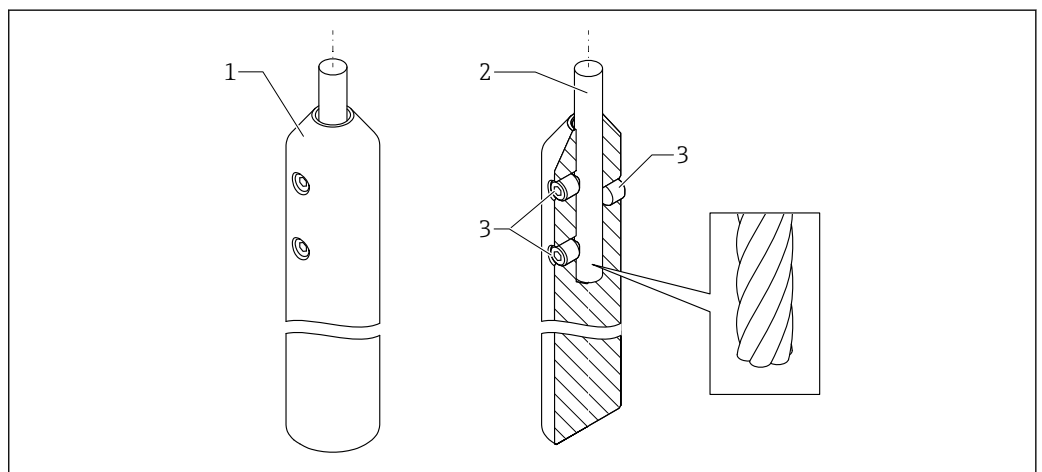

A0044101

6 The tension weight overview

- 1 The tension weight
- 2 The rope
- 3 The locking screws

### 4.3.3 Tensioning weight with tension

The end of the probe needs to be secured if the probe would otherwise touch the silo wall or another part in the tank. This is what the internal thread in the probe weight is intended for. The bracing can be conductive or insulating to the tank wall.

To avoid too high tensile load, the rope should be loose or guyed with a spring. The maximum tensile load may not exceed 200 Nm (147.5 lbf ft).

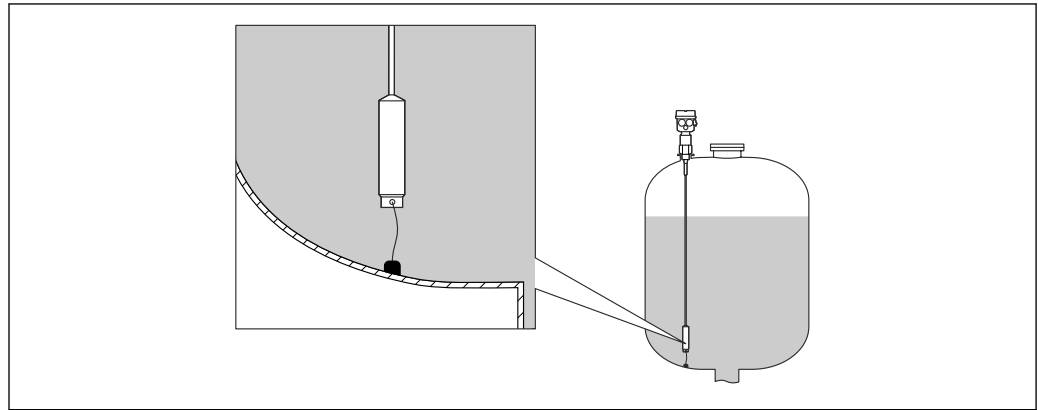

A0040462

### 4.4 Probe with separate housing

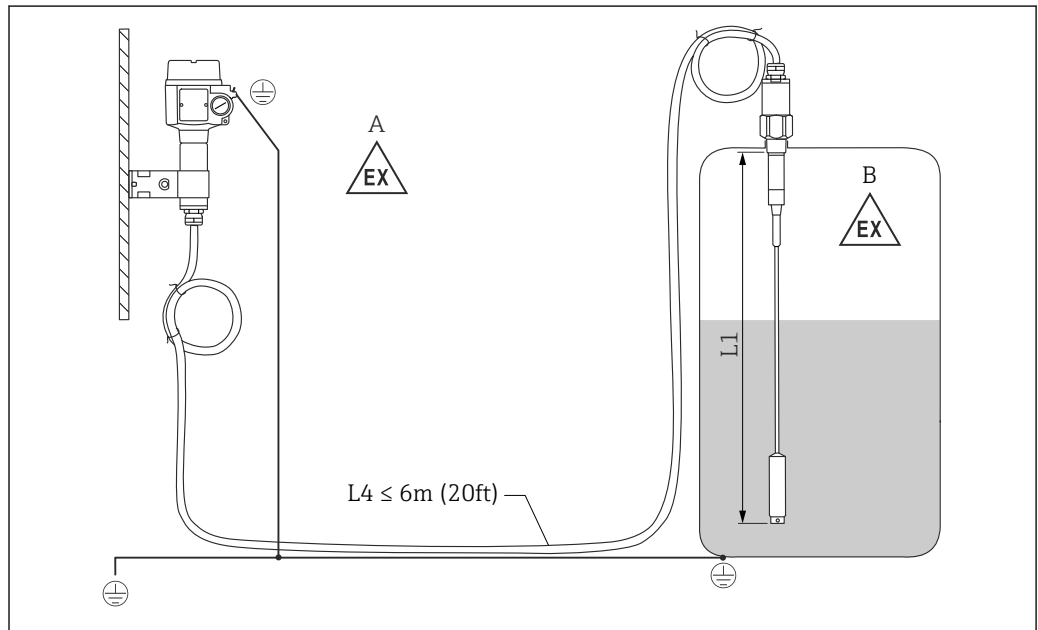

A0040473

7 Connection of the probe and separate housing. Unit of measurement mm (in)

- A Explosive zone 1
- B Explosive zone 0
- L1 Rope length: max. 9.7 m (32 ft)
- L4 Cable length

The maximum cable length L4 and rope length L1 cannot exceed 10 m (33 ft).

- i** The maximum cable length between the probe and separate housing is 6 m (20 ft). The required cable length must be indicated in the ordering process of a Liquicap M with separate housing.

If the cable connection has to be shortened or led through a wall, then it must be separated from the process connection. For more information, see chapter "Shortening the connecting cable" → 17

#### 4.4.1 Extension heights: separate housing

- i** The cable:

- has a minimum bending radius of  $r \geq 100$  mm (3.94 in)
- $\varnothing$  10.5 mm (0.41 in)
- outer jacket made of silicone, notch resistance

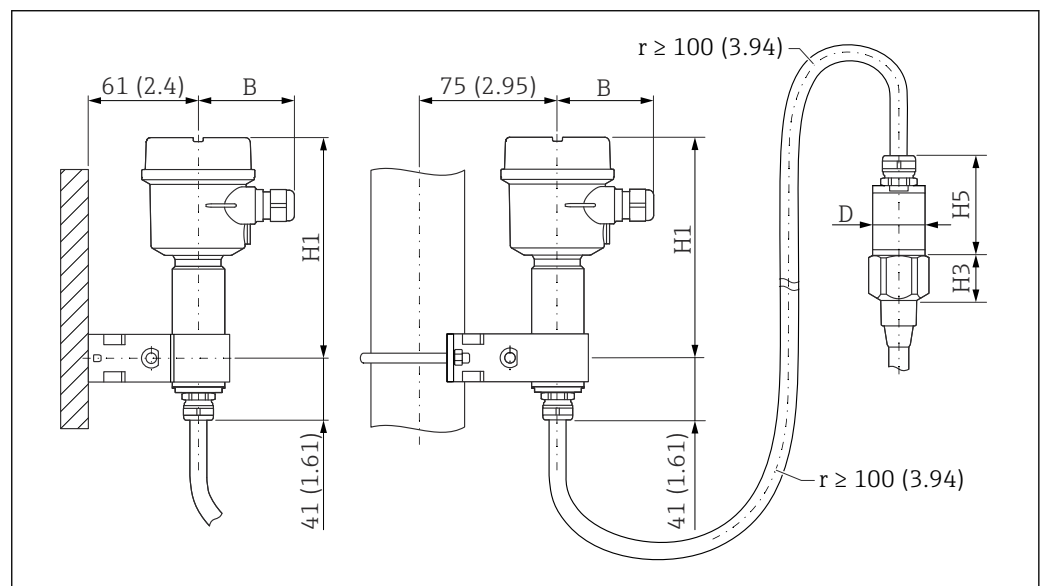

**8** Housing side: wall mounting, pipe mounting, and sensor side. Unit of measurement mm (in)

Values of parameters <sup>1)</sup>:

##### Polyester housing (F16)

- B: 76 mm (2.99 in)
- H1: 172 mm (6.77 in)

##### Polyester housing (F15)

- B: 64 mm (2.52 in)
- H1: 166 mm (6.54 in)

##### Aluminum housing (F17)

- B: 65 mm (2.56 in)
- H1: 177 mm (6.97 in)

1) See parameters on the drawings.

**D and H5 parameter**

- rope probe without fully insulated inactive length and threads G $\frac{3}{4}$ ", G1", NPT $\frac{3}{4}$ ", NPT1", Clamp 1", Clamp 1 $\frac{1}{2}$ ", Universal  $\varnothing$ 44 mm (1.73 in), flange < DN50, ANSI 2", 10K50:
  - D: 38 mm (1.5 in)
  - H5: 66 mm (2.6 in)
- rope probe without fully insulated inactive length and threads G1 $\frac{1}{2}$ ", NPT1 $\frac{1}{2}$ ", Clamp 2", DIN 11851, flange  $\geq$  DN50, ANSI 2", 10K50
  - D: 50 mm (1.97 in)
  - H5: 89 mm (3.5 in)
- rope probe with fully insulated inactive length:
  - D: 38 mm (1.5 in)
  - H5: 89 mm (3.5 in)

**4.4.2 Wall bracket**

- i** ■ The wall bracket is a part of the scope of delivery.
- To use the wall bracket as a drill template, the wall bracket must be first screwed to the separate housing.
- The distance between the holes is reduced by screwing it to the separate housing.

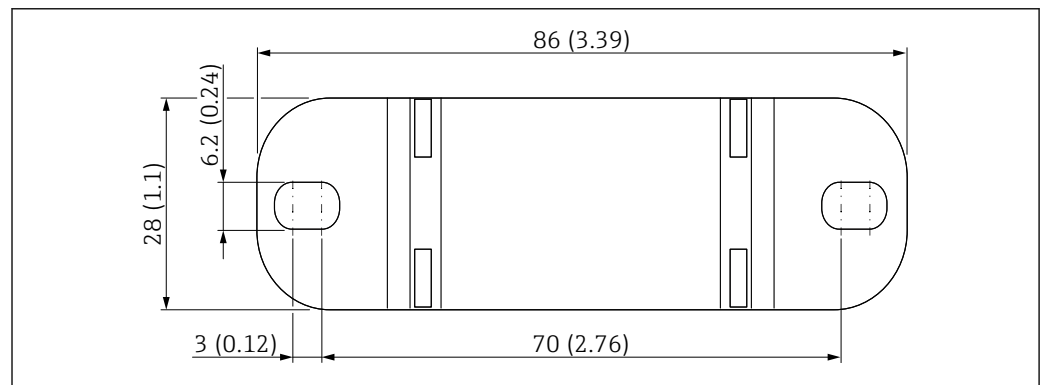

A0033881

9 Wall bracket overview. Unit of measurement mm (in)

**4.4.3 Wall mounting**

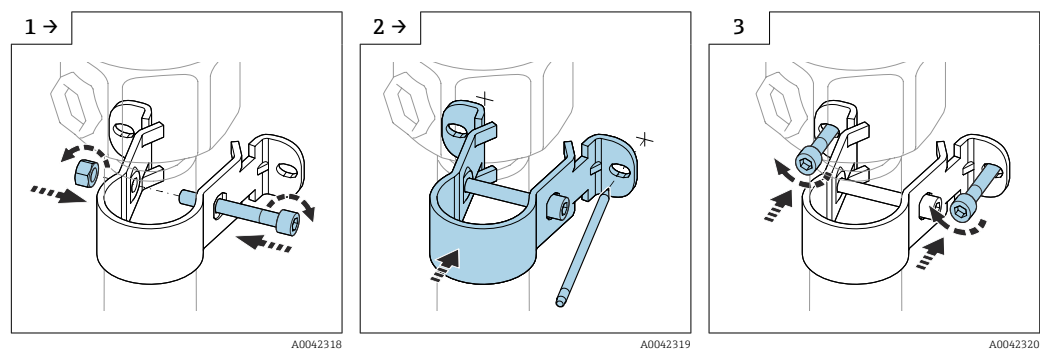

- ▶ Screw together the wall bracket on the tube.
- ▶ Mark the distance between the holes on the wall before drilling.
- ▶ Screw the separate housing on the wall.



#### 4.4.4 Pipe mounting

**i** The maximum pipe diameter is 50.8 mm (2 in).

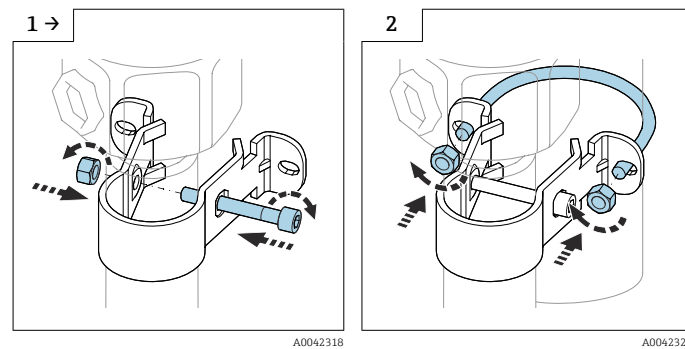

▶ Screw together the wall bracket on the tube.

▶ Screw the separate housing on a pipe.

#### 4.4.5 Shortening the connecting cable

##### NOTICE

Risk of damage to connections and cable.

▶ Make sure that the connecting cable and the probe are not turning with the pressing screw!

**i** The maximum total length of the rope L1 and the cable L4 is 10 m (33 ft) → 14. The maximum connection length between the probe and the separate housing is 6 m (20 ft).

When ordering a device with separate housing, the desired length must be specified.

**i** We recommend reusing all strands with ring terminals in case of shortening the connecting cable.

To avoid the risk of short-circuiting when the strands are not to be reused, the connections of the new ring terminals fitted must be isolated with a heat shrinking sleeve.

Use heat-shrink tubes to insulate all soldered joints.

If the cable connection has to be shortened or led through a wall, it must be separated from the process connection.

**Probe without active buildup compensation**

Disconnecting the connection cable

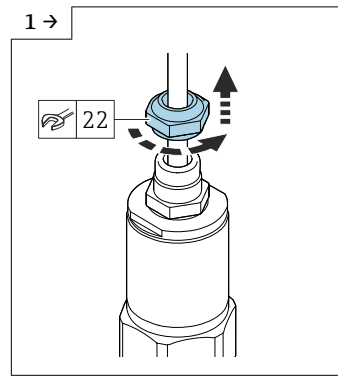

A0042111

- ▶ Loosen the pressing screw with an open-end wrench AF22.

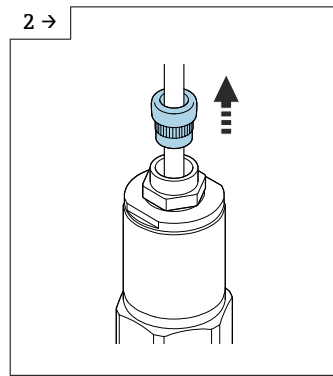

A0042112

- ▶ Pull the insert seal out of the cable gland.

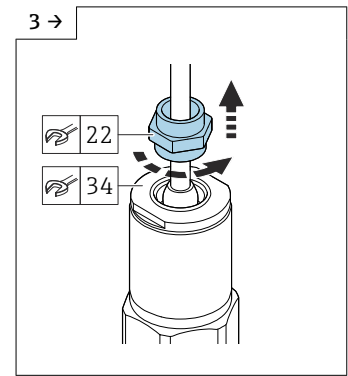

A0042113

- ▶ Block the adapter disk with the open-end wrench AF34 and loosen the cable gland with the open-end wrench AF22.

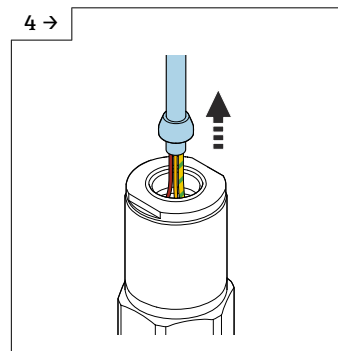

A0042114

- ▶ Pull out the cable with the cone.

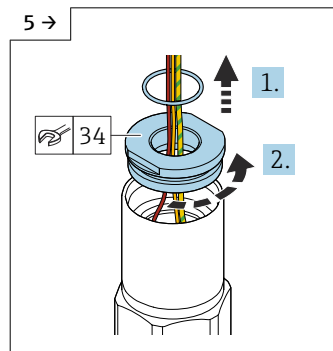

A0042115

- ▶ Remove the seal and loosen the adapter disk with the open-end wrench AF34.

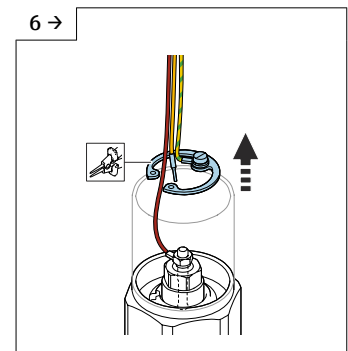

A0042545

- ▶ Remove the snap ring with a snap ring pliers.

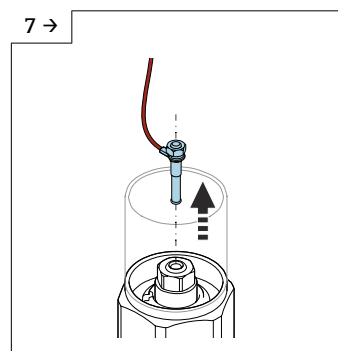

A0042117

- ▶ Remove the blade plug from the socket.

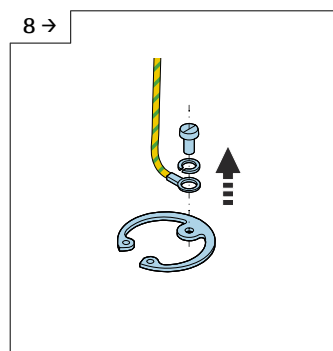

A0042546

- ▶ Loosen the screw to disconnect the yellow-green cable.

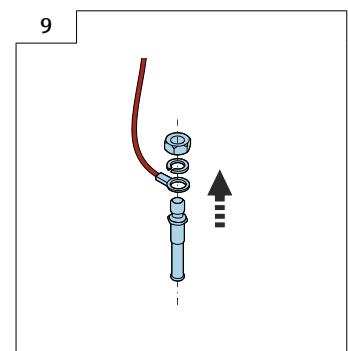

A0042119

- ▶ Loosen the nut (M4) of the blade plug.

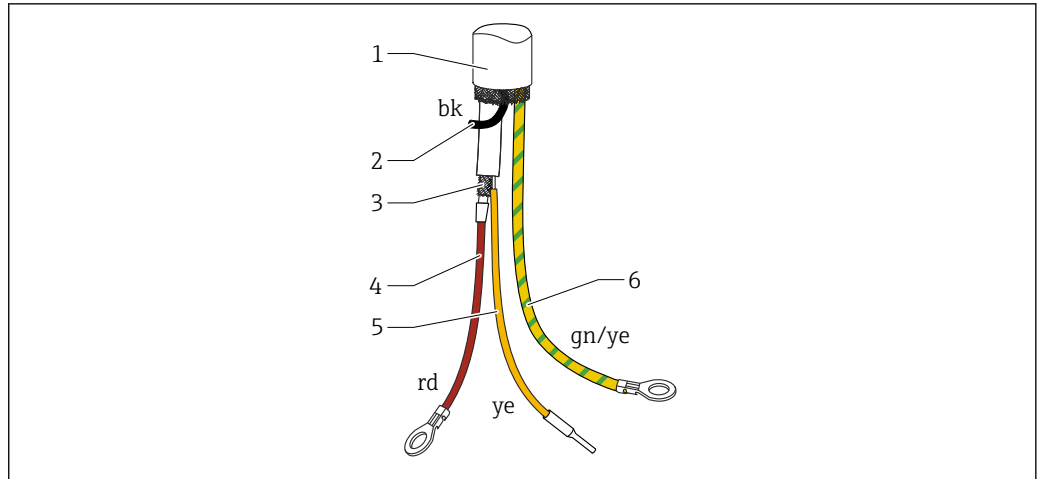

A0042544

10 Cable connections

- 1 External screening (not required)
- 2 Strand black (bk) (not required)
- 3 Coaxial cable with central core and screen
- 4 Solder the red (rd) strand with the central core of the coaxial cable (probe)
- 5 Insulated strand (ye) with the heat shrinking sleeve
- 6 Strand yellow and green (gn/ye) with a ring terminal

Probe with active buildup compensation

Disconnecting the connection cable

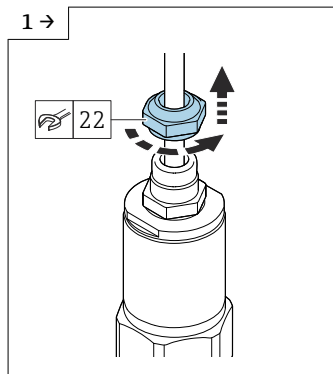

A0042111

- Loosen the pressing screw with an open-end wrench AF22.

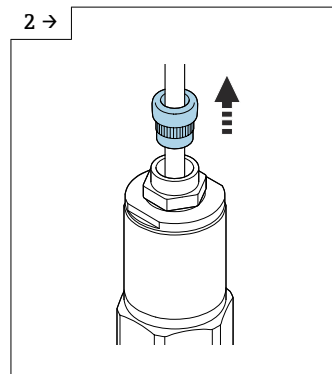

A0042112

- Pull the insert seal out of the cable gland.

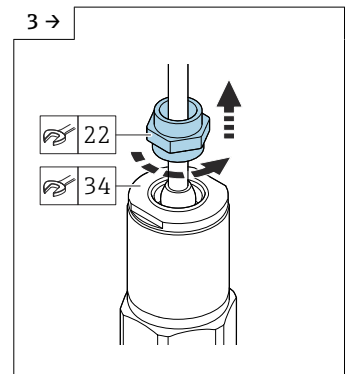

A0042113

- Block the adapter disk with the open-end wrench AF34 and loosen the cable gland with the open-end wrench AF22.

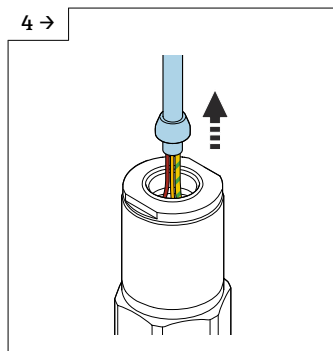

A0042114

- Pull out the cable with the cone.

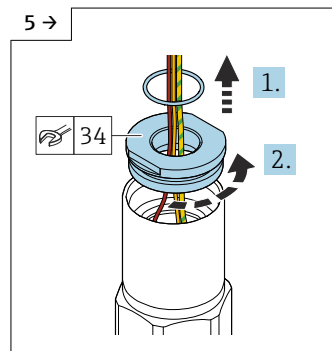

A0042115

- Remove the seal and loosen the adapter disk with the open-end wrench AF34.

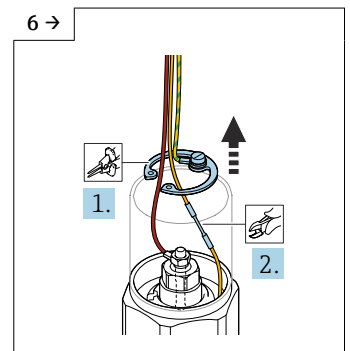

A0042548

- Remove the snap ring with a snap ring pliers and cut the yellow cable.

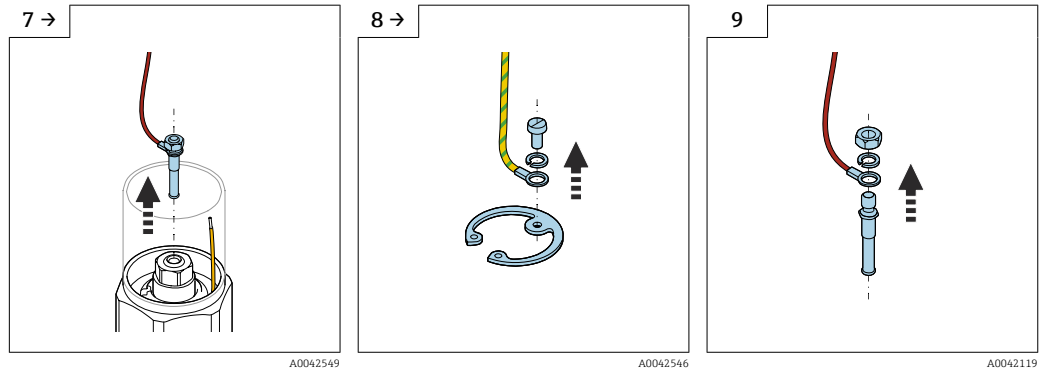

▶ Remove the blade plug from the socket.

▶ Loosen the screw to disconnect the yellow-green cable.

▶ Loosen the nut (M4) of the blade plug.

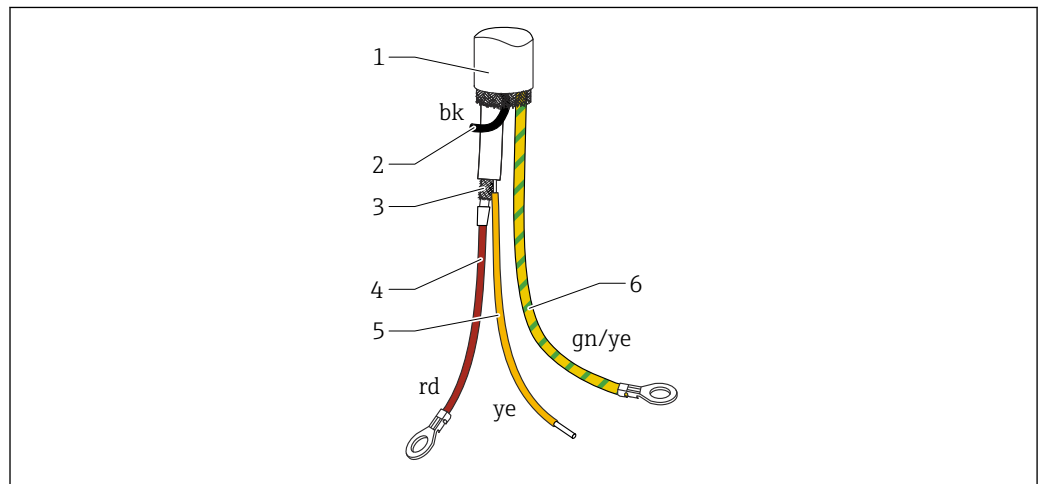

11 Cable connections

- 1 External screening (not required)
- 2 Strand black (bk) (not required)
- 3 Coaxial cable with central core and screening
- 4 Solder the red (rd) strand with the central core of the coaxial cable (probe)
- 5 Solder the strand with the screening of the yellow (ye) coaxial cable (ground)
- 6 Strand yellow and green (gn/ye) with a ring terminal

### 4.5 Installation instructions

**NOTICE**

**Do not damage the probe insulation during installation!**

- ▶ Check the rope insulation.

**NOTICE**

**Do not screw the probe using the probe housing!**

- ▶ Use an open-end wrench to screw the probe.

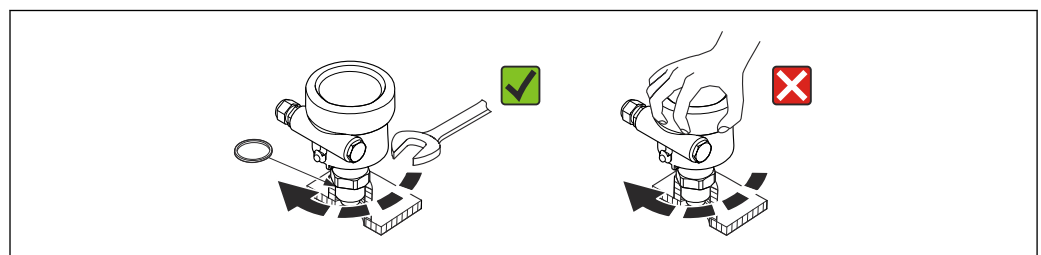

### 4.5.1 Probe installation

#### Probe with thread

*Cylindrical threads G $\frac{1}{2}$ , G $\frac{3}{4}$ , G1, G1 $\frac{1}{2}$*

To be used with the elastomer fiber seal supplied or another chemically resistant seal. Make sure that the temperature resistance of a seal is correct.

 The following applies to probes with a parallel thread and supplied seal:

##### Thread G $\frac{1}{2}$

- for pressures up to 25 bar (362.5 psi): 25 Nm (18.4 lbf ft)
- maximum torque: 80 Nm (59.0 lbf ft)

##### Thread G $\frac{3}{4}$

- for pressures up to 25 bar (362.5 psi): 30 Nm (22.1 lbf ft)
- maximum torque: 100 Nm (73.8 lbf ft)

##### Thread G1

- for pressures up to 25 bar (362.5 psi): 50 Nm (36.9 lbf ft)
- maximum torque: 180 Nm (132.8 lbf ft)

##### Thread G1 $\frac{1}{2}$

- for pressures up to 100 bar (1 450 psi): 300 Nm (221.3 lbf ft)
- maximum torque: 500 Nm (368.8 lbf ft)

*Conical threads  $\frac{1}{2}$  NPT,  $\frac{3}{4}$  NPT, 1 NPT, 1 $\frac{1}{2}$  NPT*

Wrap the thread with a suitable sealing material. Use conductive sealing material only.

#### Probe with Tri-Clamp, sanitary connection or flange

The process seal must meet the specifications of the application. Check the seal's resistance to temperature and medium.

If the flange is PTFE-clad, this generally suffices as the seal up to the permitted operating pressure.

#### Probe with PTFE-clad flange

 Use spring washers!

Depending on process pressure and process temperature, check and re-tighten the screws at regular intervals.

Recommended torque: 60 to 100 Nm (44.3 to 73.8 lbf ft).

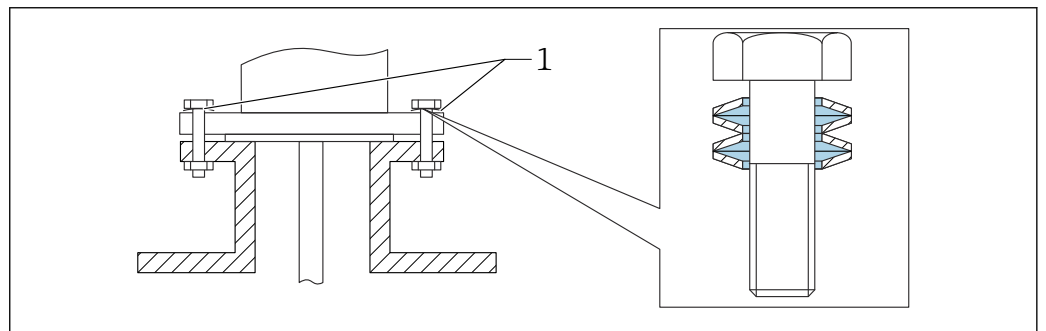

 12 Spring washer mounting

1 Spring washer

### 4.5.2 Aligning the housing

The housing can be rotated 270 ° to align the cable entry. To prevent moisture penetration, route the connecting cable downwards in front of the cable gland and secure it with a cable tie. This is particularly recommended for outdoor mounting.

Aligning the housing

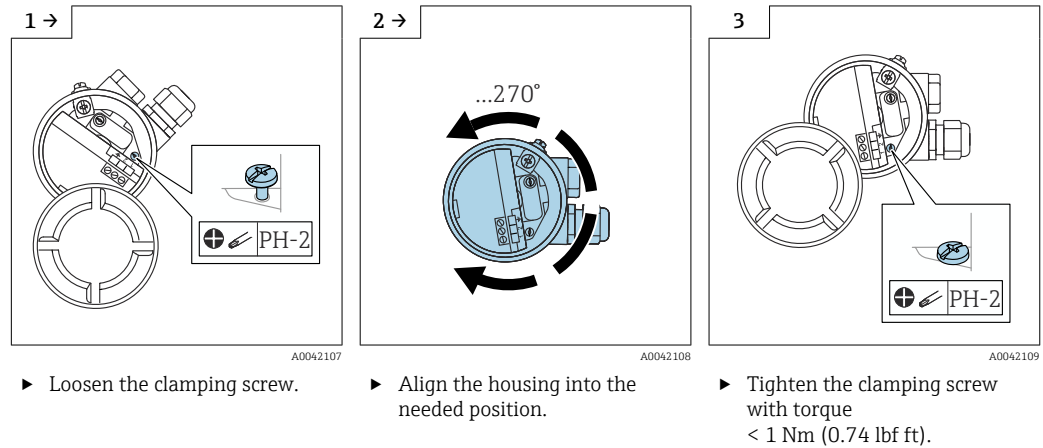

**i** The clamping screw for aligning the housing type T13 is located in the electronics compartment.

### 4.5.3 Sealing the probe housing

Make sure that the cover is sealed. Water cannot enter into the device when performing installation, connection and configuration tasks. Always seal the housing cover and cable entries securely.

The O-ring seal on the housing cover is shipped with a coat of special lubricant applied. In this way, the cover can be sealed tight and the aluminum thread does not bite when screwing down.

Never use mineral oil-based grease as this destroys the O-ring.

## 4.6 Post-installation check

After installing the measuring device, carry out the following checks:

- Do a visual check for damages.
- Make sure that the device meets the specifications at the measuring point with regard to process temperature and pressure, ambient temperature, measuring range.
- Make sure that the process connection been tightened with the tightening torque?
- Check if the measuring points are correctly labeled.
- Make sure that the device is adequately protected against precipitation and direct sunlight.

## 5 Electrical connection

- i** Before connecting the power supply, note the following:
- the supply voltage must match the data specified on the nameplate
  - switch off the supply voltage before connecting the device
  - connect the potential equalization to the ground terminal on the sensor
- i** When using the probe in hazardous areas, the relevant national standards and the information in the safety instructions (XA) must be observed.
- Use the specified cable gland only.

### 5.1 Connecting requirements

#### 5.1.1 Potential equalization



##### Risk of explosion!

- ▶ Connect the cable screen on the sensor side only if installing the probe in Ex-areas!

Connect the potential equalization to the outer ground terminal of the housing (T13, F13, F16, F17, F27). In the case of the stainless steel housing F15, the ground terminal can also be located in the housing. For further safety instructions, please refer to the separate documentation for applications in hazardous areas.

#### 5.1.2 Cable specification

Connect the electronic inserts by using commercially available instrument cables. If a potential equalization is present, and the shielded instrument cables are used, connect the shielding on both sides to optimize the shielding effect.

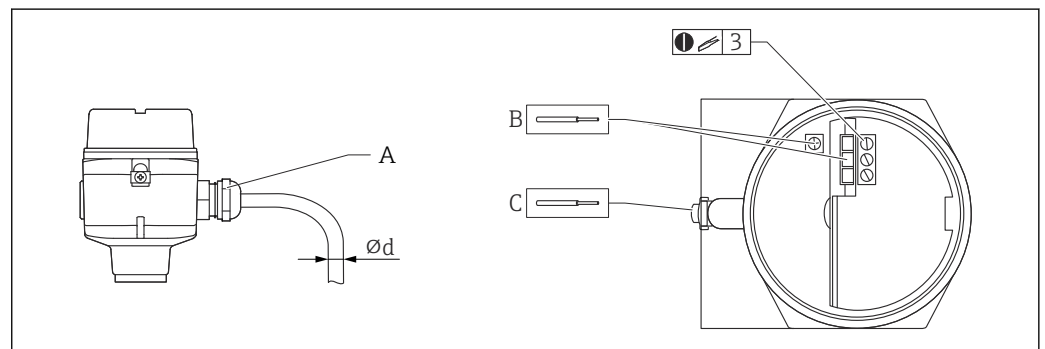

13 Probe and electronic insert connection

- A Cable entry  
 B Electronic insert connections: cable size max. 2.5 mm<sup>2</sup> (14 AWG)  
 C The ground connection outside the housing, cable size max. 4 mm<sup>2</sup> (12 AWG)  
 ød Cable diameter

#### Cable entries

- Nickel-plated brass: ød = 7 to 10.5 mm (0.28 to 0.41 in)
- Synthetic material: ød = 5 to 10 mm (0.2 to 0.38 in)
- Stainless steel: ød = 7 to 12 mm (0.28 to 0.47 in)

#### 5.1.3 Connector

For the version with a connector M12, the housing does not have to be opened for connecting the signal line.

### PIN assignment for M12 connector

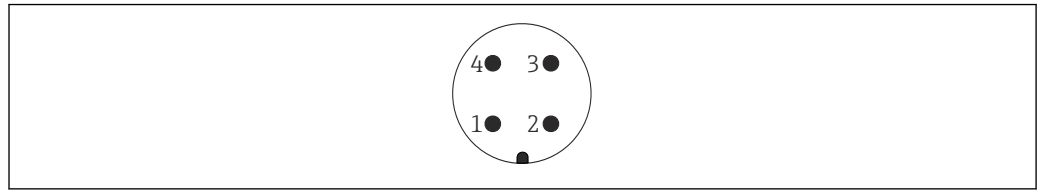

A0011175

14 M12 connector with 2-wire-electronic insert FEI55, FEI57, FEI58, FEI57C

- 1 Positive potential
- 2 Not used
- 3 Negative potential
- 4 Ground

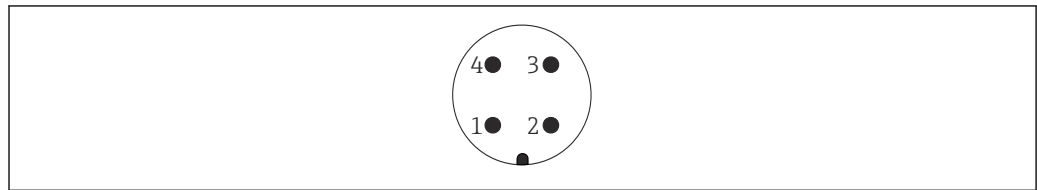

A0011175

15 M12 connector with 3-wire-electronic insert FEI52, FEI53

- 1 Positive potential
- 2 Not used
- 3 Negative potential
- 4 External load / signal

## 5.1.4 Cable entry

### Cable gland

M20x1.5 for Ex d only cable entry M20

Two cable glands are included in scope of delivery.

### Cable entry

- G<sup>1</sup>/<sub>2</sub>
- NPT<sup>1</sup>/<sub>2</sub>
- NPT<sup>3</sup>/<sub>4</sub>

## 5.2 Wiring and connecting

### 5.2.1 Connection compartment

Depending on explosion protection, the connection compartment is available in the following variants:

#### Standard protection, Ex ia protection

- polyester housing F16
- stainless steel housing F15
- aluminum housing F17
- aluminum housing F13 with gas-tight process seal
- aluminum housing T13, with the separate connection compartment

#### Ex d protection, Gas-tight process seal

- aluminum housing F13 with gas-tight process seal
- aluminum housing T13, with the separate connection compartment



Connecting the electronic insert to the power supply:

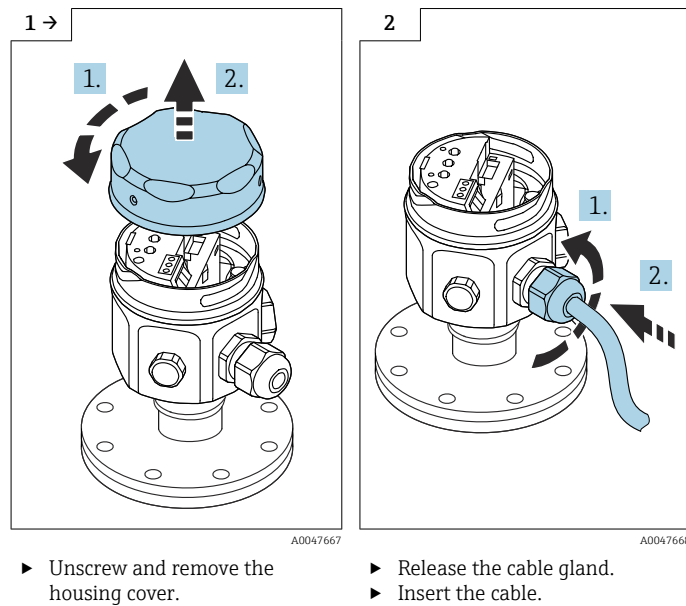

Connecting the electronic insert to the power supply mounted in the housing T13:

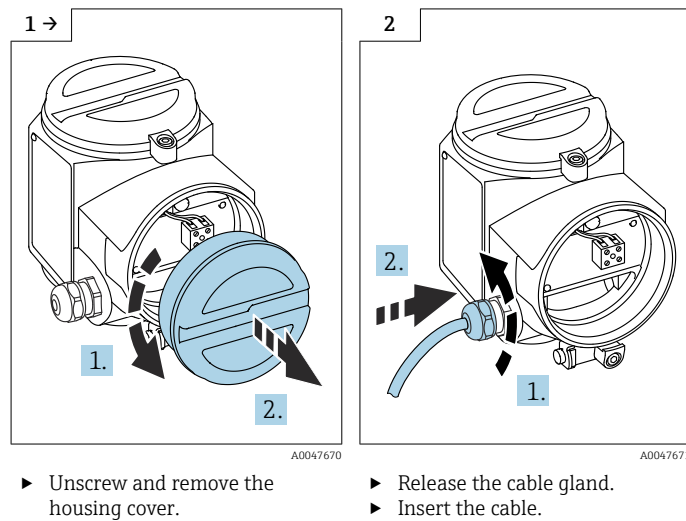

**i** Screw terminal for conductor cross-sections 0.5 to 2.5 mm.

## 5.3 Connecting the measuring device

### 5.3.1 2-wire AC electronic insert FEI51

**i** Connect the electronic insert in series with an external load.

#### Power supply

- Supply voltage: 19 to 253 V<sub>AC</sub>
- Power consumption: < 1.5 W
- Residual current consumption: < 3.8 mA
- Short-circuit protection: overvoltage category II

**Signal on alarm**

The output signal on power failure or in the event of damage to the sensor: < 3.8 mA

**Connectable load**

- For relays with a minimum holding power or rated power:
  - > 2.5 VA at 253 V<sub>AC</sub> (10 mA)
  - > 0.5 VA at 24 V<sub>AC</sub> (20 mA)
- Relays with a lower holding power or rated power can be operated using an RC module connected in parallel.
- For relays with a maximum holding power or rated power:
  - < 89 VA at 253 V<sub>AC</sub>
  - < 8.4 VA at 24 V<sub>AC</sub>
- The voltage drop across FEI51: maximum 12 V
- Residual current with blocked thyristor: maximum 3.8 mA
- Load switched directly into the power supply circuit via the thyristor.

**i** Do not switch on the supply voltage until you have learned about the device functions as described in section "Operation options" → 34. This will ensure that you do not accidentally trigger any processes by switching on the supply voltage.

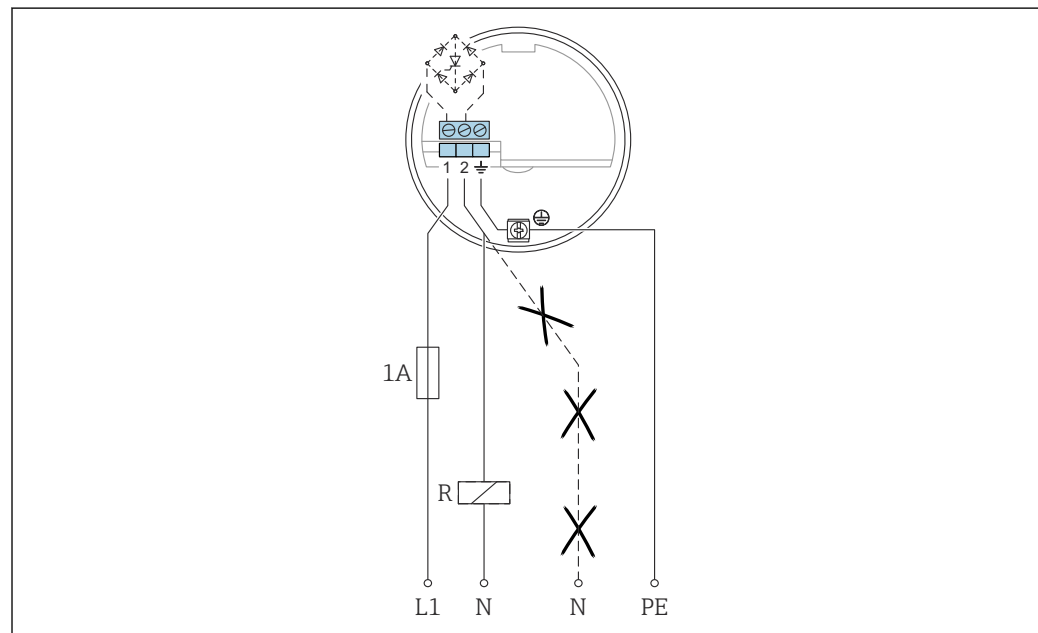
**Connecting the FEI51**

L1 L1 phase cable  
 N Neutral cable  
 PE Grounding cable  
 R External load

1. Connect the FEI51 according to the schema.
2. Tighten the cable gland.
3. Set the function switch to position 1.
4. Switch on the supply voltage.

**5.3.2 DC PNP electronic insert FEI52**

The three-wire DC connection should, wherever possible, be connected as follows:

- to programmable logic controllers (PLCs)
- to DI modules in accordance with EN 61131-2

A positive signal is present at the switch output of the electronic system (PNP).

**Power supply**



- Supply voltage: 10 to 55 V<sub>DC</sub>
- Ripple: maximum 1.7 V, 0 to 400 Hz
- Current consumption: < 20 mA
- Power consumption without load: maximum 0.9 W
- Power consumption with a full load (350 mA): 1.6 W
- Reverse polarity protection: yes
- Separation voltage: 3.7 kV
- Overvoltage category: II

**Signal on alarm**

The output signal on power failure or in the event of device failure:  $I_R < 100 \mu\text{A}$

**Connectable load**

- Load switched via transistor and separate PNP connection: maximum 55 V
- Load current: maximum 350 mA cyclical overload and short-circuit protection
- Residual current: < 100  $\mu\text{A}$  with transistor blocked
- Capacitance load:
  - maximum 0.5  $\mu\text{F}$  at 55 V
  - maximum 1  $\mu\text{F}$  at 24 V
- Residual voltage: < 3 V for transistor switched through

 Do not switch on the supply voltage until you have familiarized yourself with the device functions as described in the section "Operation option" →  34. This will ensure that you do not accidentally trigger any processes by switching on the supply voltage.

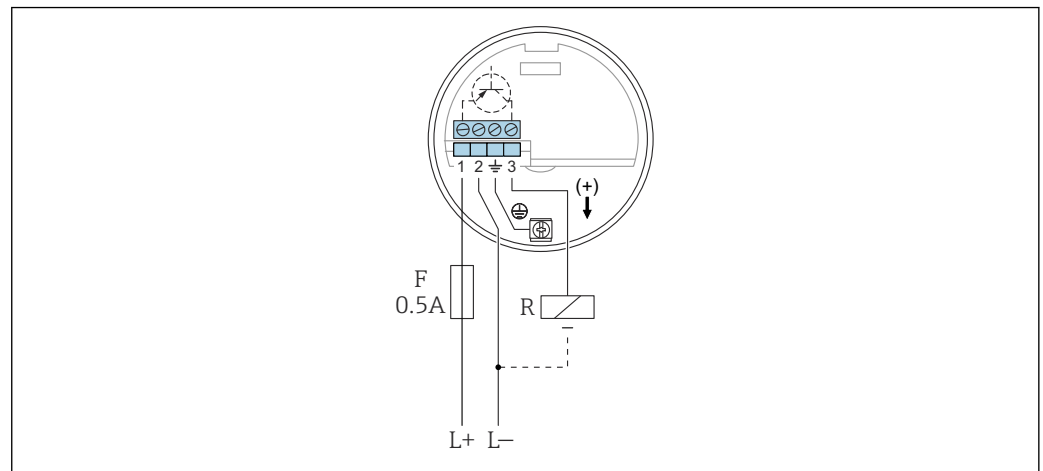
**Connecting the FEI52**

A0042388

L+ Power input +

L- Power input -

F Fuse

R External load:  $I_{max} = 350 \text{ mA}$ ,  $U_{max} = 55 \text{ V}_{DC}$

1. Connect the FEI52 regarding to the schema.
2. Tighten the cable gland.
3. Set the function switch to position 1.
4. Switch on the supply voltage.

**5.3.3 3-wire electronic insert FEI53**

The 3-wire DC connection is used in conjunction with the Nivotester switching device FTC325 3-WIRE from Endress+Hauser. The switching device's communication signal operates at 3 to 12 V<sub>DC</sub>.

The failsafe mode (MIN) / (MAX) and the point level adjustment are configured on the Nivotester.

#### Power supply

- Supply voltage: 14.5 V<sub>DC</sub>
- Current consumption: < 15 mA
- Power consumption: maximum 230 mW
- Reverse polarity protection: yes
- Separation voltage: 0.5 kV

#### Signal on alarm

The voltage at terminal 3 opposite terminal 1: < 2.7 V

#### Connectable load

- floating relay contacts in the connected switching unit Nivotester FTC325 3-WIRE
- for the contact load capacity, refer to the technical data of the switching device

**i** Do not switch on the supply voltage until you have learned about the device functions as described in section "Operation option" → 35. This will ensure that you do not accidentally trigger any processes by switching on the supply voltage.

Connecting the FEI53

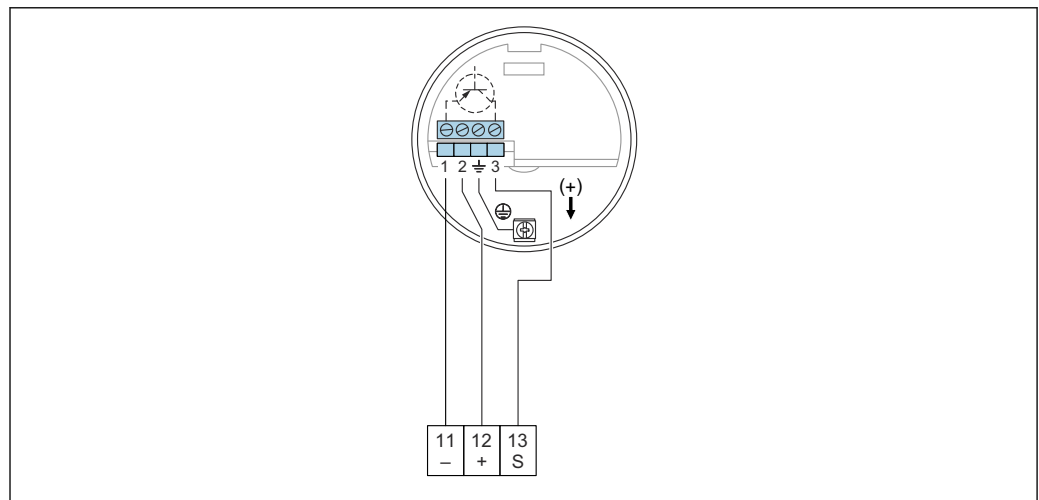

- 11 Negative terminal in Nivotester FTC325  
 12 Positive terminal in Nivotester FTC325  
 S Signal terminal in Nivotester FTC325

1. Connect the FEI53 according to the schema.
2. Tighten the cable gland.
3. Set the function switch to position 1.
4. Switch on the supply voltage.

#### 5.3.4 AC and DC with relay output electronic insert FEI54

The universal voltage connection with relay output (DPDT) operates in two different voltage ranges (AC and DC).

**i** When connecting devices with a high inductance, use a spark suppression system to protect the relay contacts.

**Power supply**

- Supply voltage:
  - 19 to 253 V<sub>AC</sub>, 50 to 60 Hz
  - 19 to 55 V<sub>DC</sub>
- Power consumption: 1.6 W
- Reverse polarity protection: yes
- Separation voltage: 3.7 kV
- Overvoltage category: II

**Signal on alarm**

The output signal on power failure or in the event of device failure: relay de-energized

**Connectable load**

- Loads switched via 2 floating changeover contacts (DPDT)
- maximum values (AC):
  - $I_{\max} = 6 \text{ A}$
  - $U_{\max} = 253 \text{ V}_{AC}$
  - $P_{\max} = 1\,500 \text{ VA}$  at  $\cos\varphi = 1$
  - $P_{\max} = 750 \text{ VA}$  at  $\cos\varphi > 0.7$
- maximum values (DC):
  - $I_{\max} = 6 \text{ A}$  at 30 V<sub>DC</sub>
  - $I_{\max} = 0.2 \text{ A}$  at 125 V<sub>DC</sub>
- The following applies when connecting a functional low-voltage circuit with double isolation as per IEC 1010: the sum of voltages of relay output and power supply maximum 300 V

**i** Do not switch on the supply voltage until you have learned about the device functions as described in section "Operation option" → 34. This will ensure that you do not accidentally trigger any processes by switching on the supply voltage.

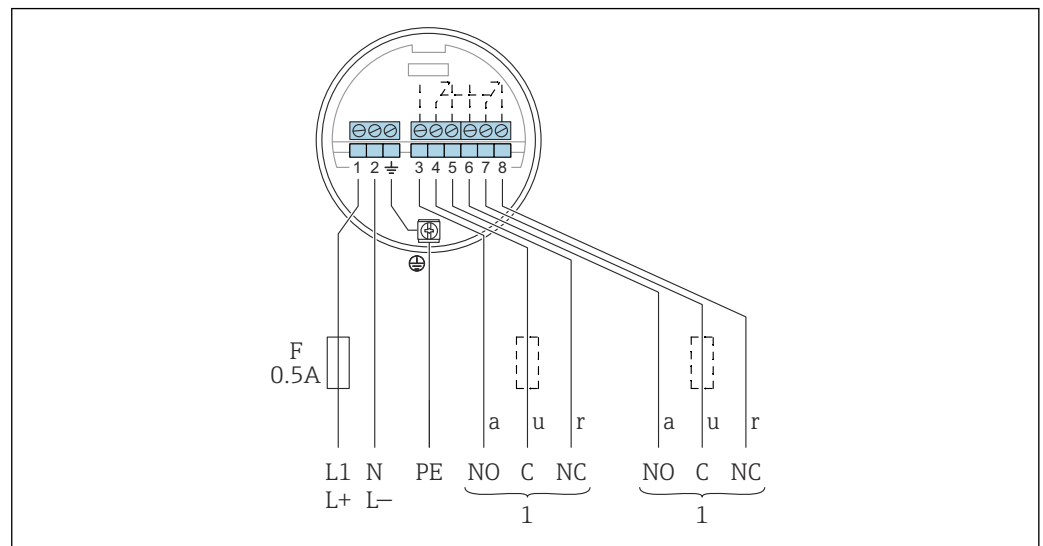
**Connecting the FEI54**

A0042390

- F* Fuse  
*L1* Phase (AC) terminal  
*L+* The positive (DC) terminal  
*N* Neutral (AC) terminal  
*L-* The negative (DC) terminal  
*PE* Grounding cable  
*1* Refer also to connectable load

1. Connect the FEI51 according to the schema.
2. Tighten the cable gland.
3. Set the function switch to position 1.

4. Switch on the supply voltage.

### 5.3.5 SIL2 / SIL3 electronic insert FEI55

The two-wire DC connection should, if possible, be connected as follows:

- to programmable logic controllers (PLC)
- to AI modules 4 to 20 mA in accordance with EN 61131-2

The point level signal is sent via an output signal jump from 8 to 16 mA.

#### Power supply

- Supply voltage: 11 to 36 V<sub>DC</sub>
- Power consumption: < 600 mW
- Reverse polarity protection: yes
- Separation voltage: 0.5 kV

#### Signal on alarm

The output signal on power failure or in the event of device failure: < 3.6 mA

#### Connectable load

- U<sub>max</sub>:
  - 11 to 36 V<sub>DC</sub> for non-hazardous area and Ex ia
  - 14.4 to 30 V<sub>DC</sub> for Ex d
- I<sub>max</sub> = 16 mA

- i** Do not switch on the supply voltage until you have learned about the device functions as described in section "Operation operation" → 34. This will ensure that you do not accidentally trigger any processes by switching on the supply voltage.

Connecting the FEI55

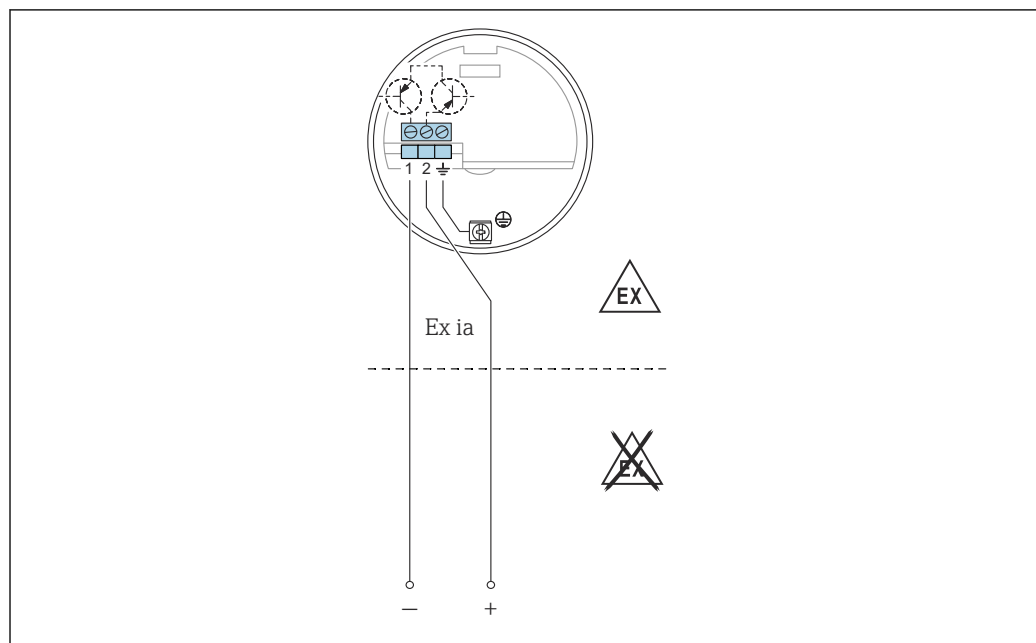

A0042391

1. Connect the FEI51 according to the schema.
2. Tighten the cable gland.
3. Set the function switch to position 1.
4. Switch on the supply voltage.

### Functional safety (SIL)

The electronic insert FEI55 meets the requirements of SIL2 or SIL3 in accordance with IEC 61508, IEC 61511-1 and can be used in the safety systems with the corresponding requirements.



An exact description of the requirements in terms of functional safety can be found in document FY01073F.

### 5.3.6 PFM electronic insert FEI57S

The two-wire DC connection is used in conjunction with the following Nivotester switching device from Endress+Hauser:

FTC325 PFM

The PFM signal is between 17 to 185 Hz.

The failsafe mode (MIN) / (MAX) and the point level adjustment are configured on the Nivotester.

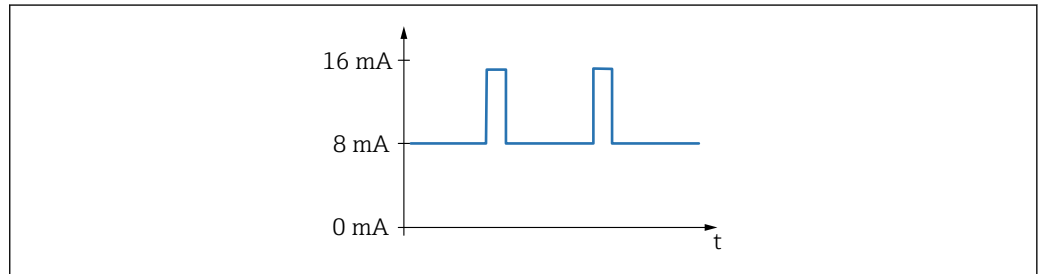

A0040777

16 Frequency: 17 to 185 Hz

### Power supply

- Supply voltage: 9.5 to 12.5 V<sub>DC</sub>
- Power consumption: < 150 mW
- Reverse polarity protection: yes
- Separation voltage: 0.5 kV

### Output signal

PFM 17 to 185 Hz

### Connectable load

- floating relay contacts in the connected switching unit Nivotester: FTC325 PFM
- for the contact load capacity, refer to the technical data of the switching device



Do not switch on the supply voltage until you have learned about the device functions as described in section "Operation option" → 35. This will ensure that you do not accidentally trigger any processes by switching on the supply voltage.

Connecting the FEI57S

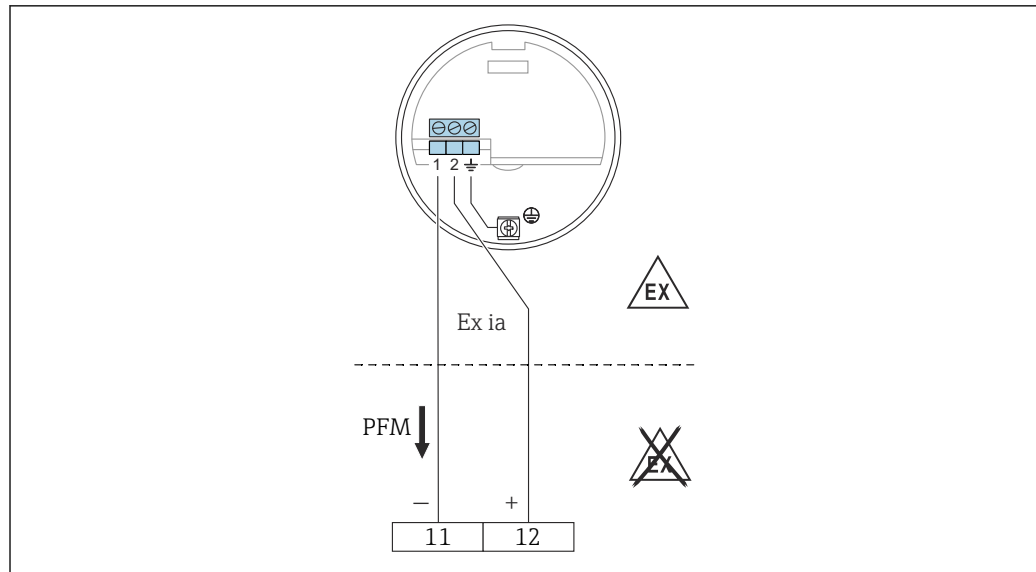

11 The negative terminal in Nivotester FTC325

12 The positive terminal in Nivotester FTC325

1. Connect the FEI51 according to the schema.
2. Tighten the cable gland.
3. Switch on the supply voltage.

### 5.3.7 NAMUR electronic insert FEI58

The two-wire connection for a separate switching unit in accordance with NAMUR specifications (IEC 60947-5-6), e.g. Nivotester FTL325N from Endress+Hauser.

Change in the output signal from high to low current in event of point level detection.

Additional function: test key on the electronic insert.

Press the key to breaks the connection to the isolating amplifier.

**i** In the case of Ex d operation, the additional function can only be used if the housing is not exposed to an explosive atmosphere.

When connecting to Multiplexer: set 3 s as the cycle time at least.

#### Power supply

- Power consumption:
  - < 6 mW at  $I < 1$  mA
  - < 38 mW at  $I = 2.2$  to 4 mA
- Interface connection data: IEC 60947-5-6

#### Signal on alarm

The output signal in the event of damage to the sensor: < 1.0 mA

#### Connectable load

- The technical data of the connected isolating amplifier as per IEC 60947-5-6 (NAMUR)
- The connection also to isolating amplifiers which have special safety circuits  $I > 3.0$  mA

**i** Do not switch on the supply voltage until you have learned about the device functions as described in section "Operation option" → 36. This will ensure that you do not accidentally trigger any processes by switching on the supply voltage.

Connecting the FEI58



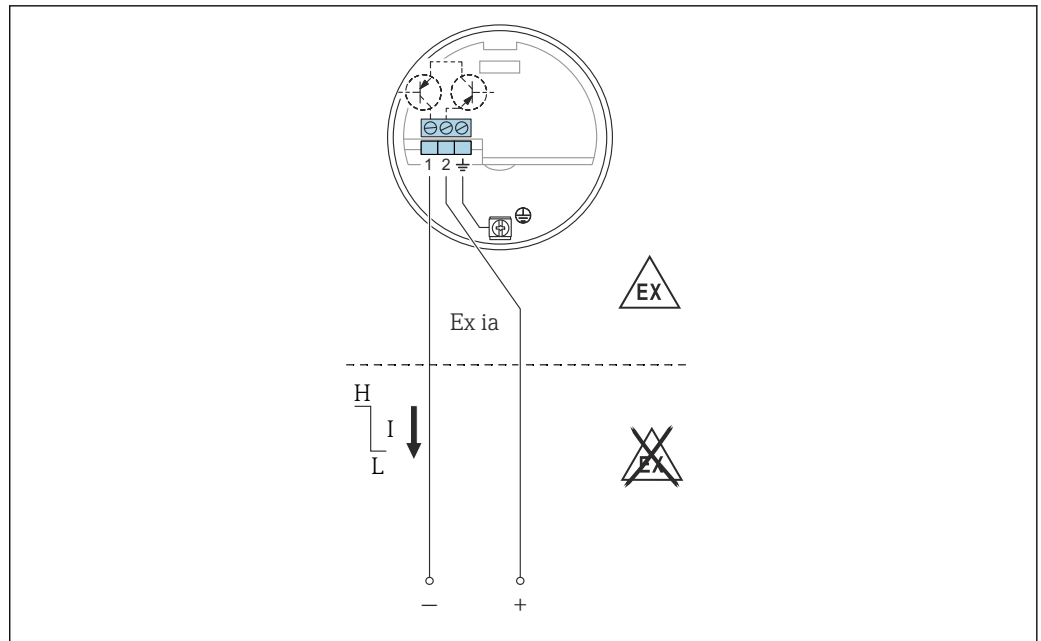

A0042393

17 Terminals must be connected to the isolating amplifier (NAMUR) IEC 60947-5-6

1. Connect the FEI51 according to the schema.
2. Tighten the cable gland.
3. Switch on the supply voltage.

## 5.4 Post-connection check

After wiring the measuring device, carry out the following checks:

- Make sure that the terminal assignment is correct?
- Make sure that the cable gland is sealed tight?
- Make sure that the housing cover is fully screwed?
- Make sure that the device is operational and the green LED flashing when the device is on.

## 6 Operation options

### 6.1 Human interface and display elements for FEI51, FEI52, FEI54, FEI55

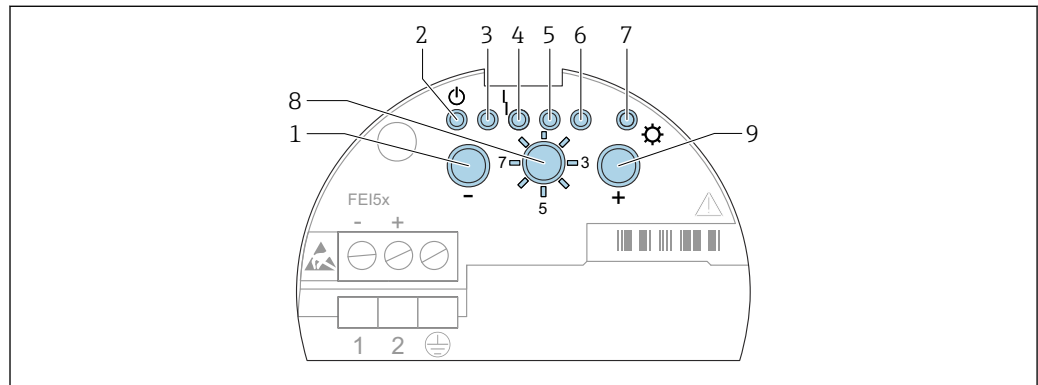



A0042394

18 FEI51, FEI52, FEI54, FEI55 human interface

- 1 Key
- 2 Green LED - operational status
- 3 Green LED
- 4 Red LED - fault
- 5 Green LED
- 6 Green LED
- 7 Yellow LED - switching state
- 8 Mode switch
- 9 Key

1. Operation - select for normal operation
2. Restor factory settings:
  - ↳ press and for 20 s restore factory settings
3. Calibration
  - ↳ press to set empty calibration
  - press to set full calibration
  - press and for 10 s to reset the calibration and switch-point adjustment
4. Switch-point adjustment
  - ↳ press to decrease the switch-point
  - press to increase the switch-point
5. Measuring modes
  - ↳ press to decrease the measuring range
  - press once to set the two-point control  $\Delta s$
  - press twice to activate the build-up mode
6. Switching delay
  - ↳ press to decrease the delay
  - press to increase to delay
7. Self-test
  - ↳ press and to activate the self-test
8. Setting MIN/MAX failsafe mode or SIL mode
  - ↳ press for minimum
  - press for maximum
  - press and to lock or unlock the SIL mode

9. Upload sensor DAT (EEPROM)

- ↳ press  for download
- press  for upload

## 6.2 Human interface and display elements for FEI53, FEI57S

The electronic inserts FEI53 and FEI57S are used in conjunction with Nivotester switching devices.

 A description of the human interface and display elements of the Nivotester switching device is provided in the documentation that accompanies the device.

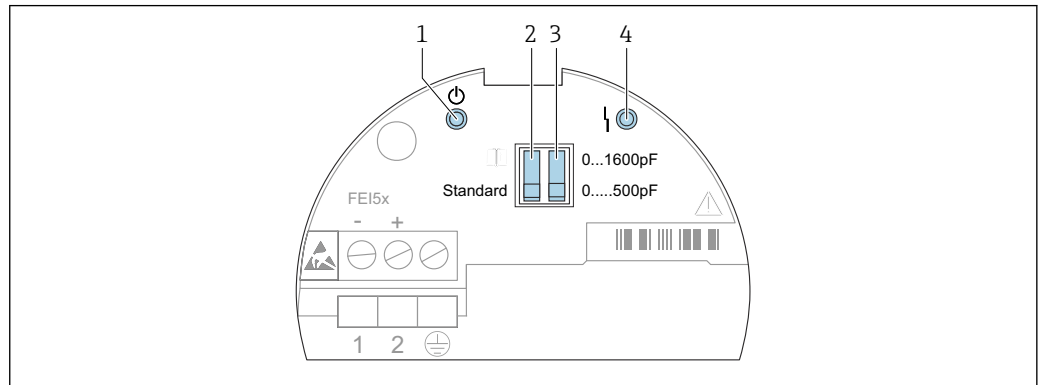

A0042395

 19 FEI53 and FEI57S human interface

- 1 Green LED - operational status
- 2 Standard or alarm DIP switch
- 3 Measuring range DIP switch
- 4 Red LED - fault

The operating status of the device is indicated by LEDs on the electronic insert and provides information on operational readiness and, where applicable, the type of fault.

### The functions of the DIP switches:

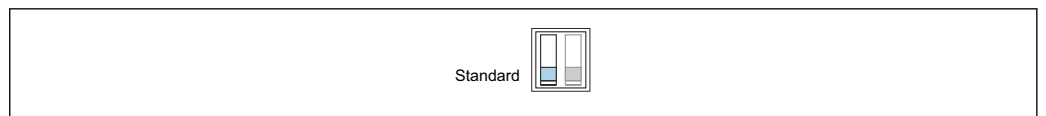

A0042400

 20 Standard: if the measuring range is exceeded no alarm is output

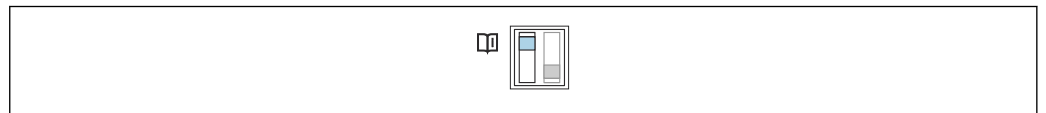

A0042401

 21 Alarm: if the measuring range is exceeded an alarm is output

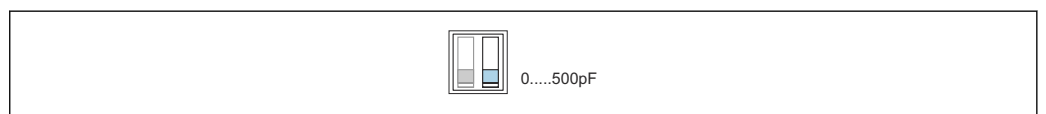

A0042402

 22 Measuring range: the measuring range is between 0 to 500 pF. Span: the span is between 0 to 500 pF

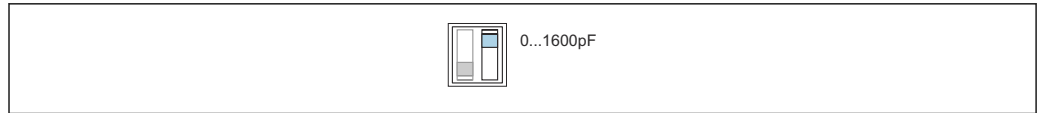

A0042403

23 Measuring range: the measuring range is between 5 to 1 600 pF. Span: the span is between 5 to 1 600 pF

### 6.3 Human interface and display elements for FEI58

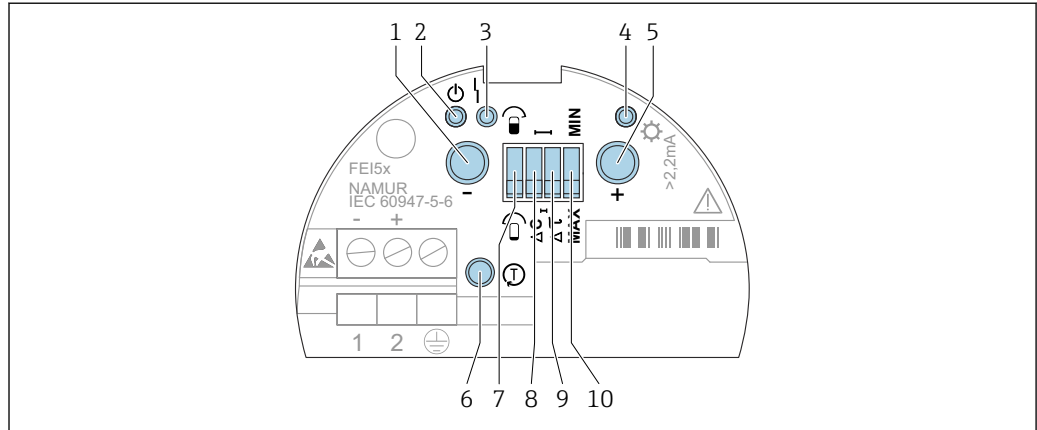

A0042396

24 FEI58 human interface

- 1 Function key A
- 2 Green LED - operational status
- 3 Red LED - fault
- 4 Yellow LED - switching state
- 5 Function key B
- 6 Test key
- 7 Calibration DIP switch
- 8 Switch-point DIP switch
- 9 Delay DIP switch
- 10 Fail-safe mode DIP switch

#### The functions of the DIP switches

Calibration DIP switch:

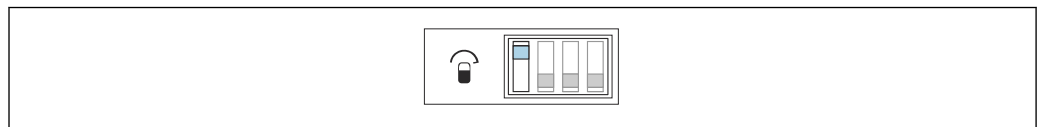

A0042404

25 The probe is covered during calibration

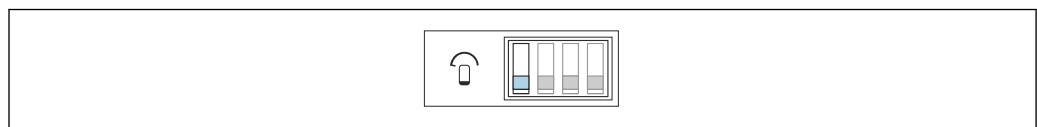

A0042405

26 The probe is uncovered during calibration

Switch-point adjustment:

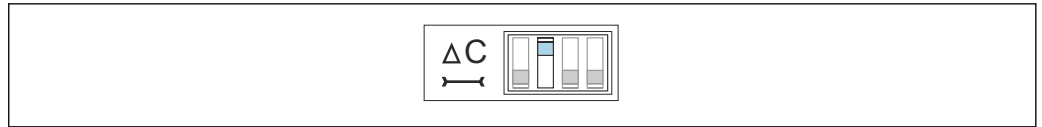

A0042406

▣ 27 10 pF

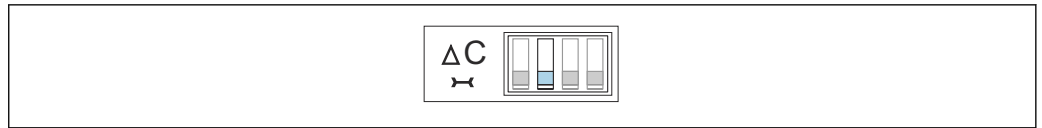

A0042407

▣ 28 2 pF

Switching delay:

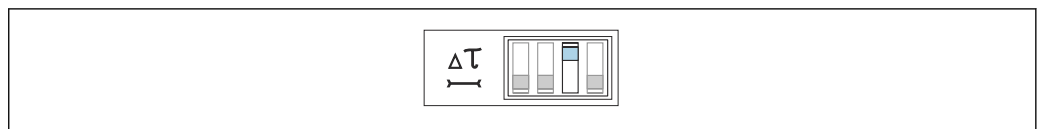

A0042408

▣ 29 5 s



A0042409

▣ 30 1 s

Fail-safe mode:



A0042410

▣ 31 The output switches safety-oriented when the probe is uncovered. It can be used in cases such as dry run protection and pump protection.

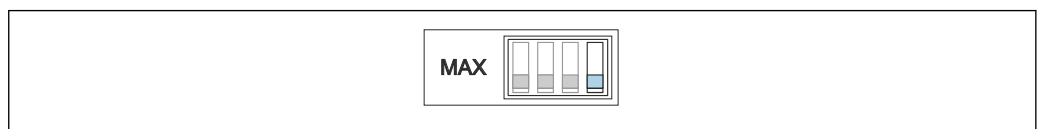

A0042411

▣ 32 The output switches safety-oriented when the probe is covered. It can be used in cases such as overflow protection.

### Function key

- Key A: displays diagnostic code
- Key B: displays calibration situation
- Test key: disconnects the transmitter from the switching unit
- Keys A and B pressed during:
  - operation: perform calibration
  - startup: delete calibration points

## 7 Commissioning

### 7.1 Installation and function check

Make sure that the post-installation check and final check have been completed before you start your measuring point:

- see the chapter "Post-installation check" →  22
- see the chapter "Post-connection check" →  33

### 7.2 Commissioning the electronic inserts FEI51, FEI52, FEI54 and FEI55

 Due to the first start-up of the device the output is in safe status. This is signaled by the flashing yellow LED.

 The device is not operational until you have carried out a calibration. To attain maximum operational safety, carry out an empty and a full calibration. This is particularly recommended for critical applications.

Refer to the following subchapters for information on how to carry out the calibration.

Setting the measuring range →  38.

Carrying out empty calibration →  39.

Carrying out full calibration →  40.

Carrying out empty and full calibration →  41.

Operation →  34.

 The yellow LED 7:

- flashes fast if a calibration or switching point are not set
- shows the switching status according to the selected application and the fail-safe mode

#### 7.2.1 Setting the measuring range

 The choice of measuring range (0 to 500 pF and 0 to 1 600 pF) depends on the function of the probe.

- If the probe is used as a point level switch, it is possible to retain the factory setting of 0 to 500 pF
- If the probe is used for two-point control, the following settings are recommended for vertical installation:
  - measuring range from 0 to 500 pF for probe lengths up to 1 m (3.3 ft)
  - measuring range from 0 to 1 600 pF for probe lengths up to 10 m (33 ft)

Partially insulated probes are only suitable for nonconductive bulk solids.

To set the range to 0 to 1 600 pF:

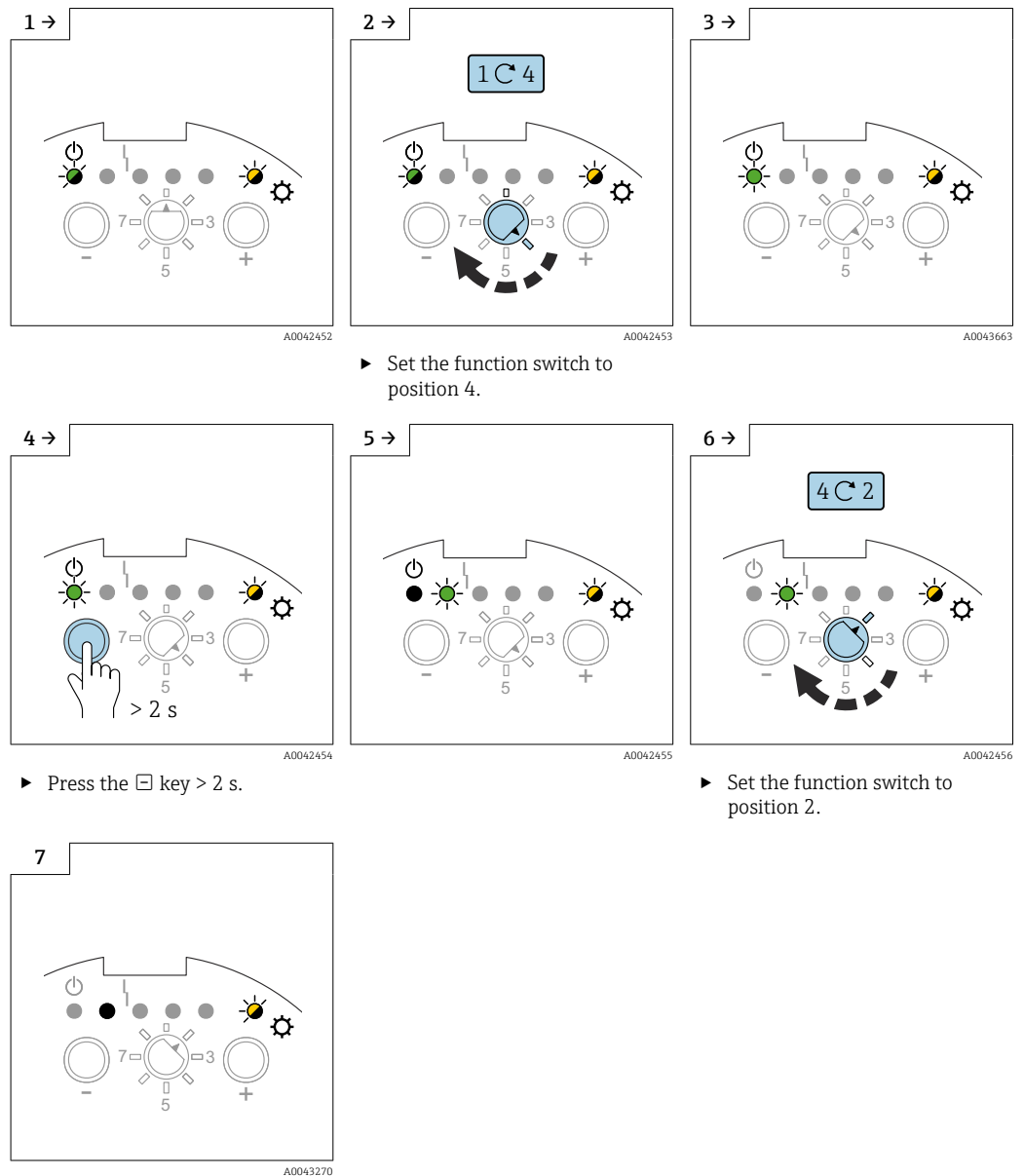

### 7.2.2 Carrying out empty calibration

The empty calibration stores the capacitance value of the probe when the tank is empty. If the measured capacitance value is, for example, 50 pF (empty calibration), a switching threshold of 2 pF is added to this value. In this case, the capacitance value of the switch point would be 52 pF.

The switching threshold depends on the value set for the switch point adjustment  
→ 44.

#### Carrying out empty calibration

Make sure that the probe is not covered with the product.

To carry out an empty calibration, set the measuring range first → 38.

1 → A0042458

2 → A0042821

3 → A0042459

4 → A0042460

5 → A0042647

6 → A0043647

- ▶ Press the key > 2 s.
- ▶ Release the key when the green LED 1 starts to flash.
- ▶ The process of saving the empty calibration is finished. The green LED 1 lits.
- ▶ Set the function switch to position 1.

### 7.2.3 Carrying out full calibration

The full calibration measures the capacitance value of the probe when the tank is full. If the measured capacitance value is, for example, 100 pF (full calibration), a switching threshold of 2 pF is subtracted from this value. The capacitance value of the switch point is thus 98 pF.

The switching threshold depends on the value set for the switch point adjustment → 44.

#### To carrying out full calibration

1 → A0042452



2 → A0042457

3 → A0043650

- ▶ Set the function switch to position 2.

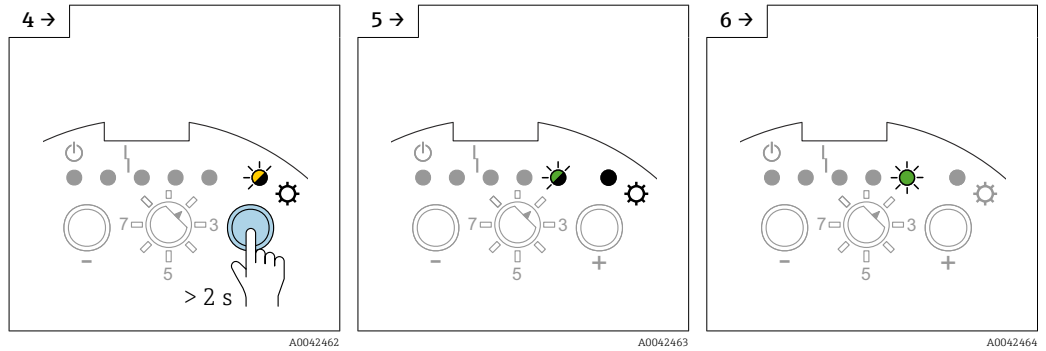



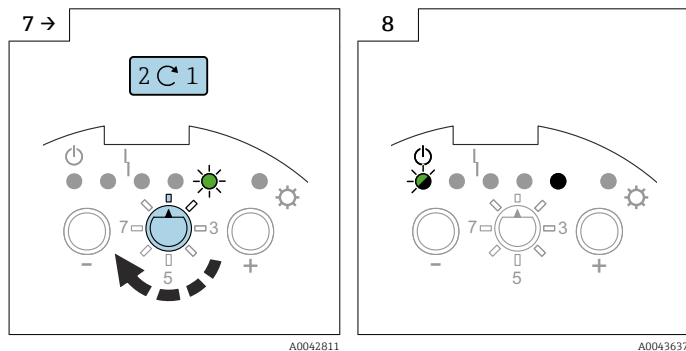

- ▶ Press the  key > 2 s.
- ▶ Release the  key when the green LED 5 starts to flash.
- ▶ The process of saving the full calibration is complete when the green LED 5 lights up.



- ▶ Set the function switch to position 1.

### 7.2.4 Carrying out empty and full calibration

-  An empty and full calibration provides the greatest possible operational security. This is strongly recommended for critical applications.
-  The empty and full calibration measures the capacitance values of the probes when the tank is full and when it is empty. For example: if the measured capacitance value of the empty calibration is 50 pF and that of the full calibration is 100 pF, the average capacitance value of 75 pF is stored as the switch-point.

#### Empty calibration

-  Mak sure that the probe is not covered with the product.

#### Setting the empty calibration

To carry out an empty calibration:

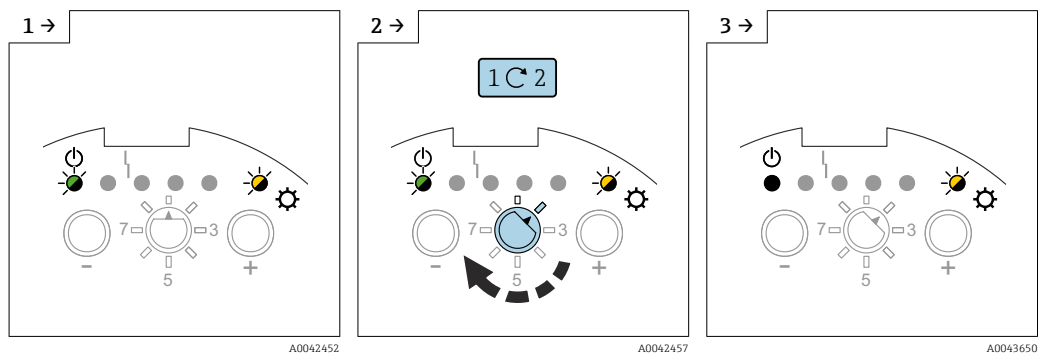

- ▶ Set the function switch to position 2.

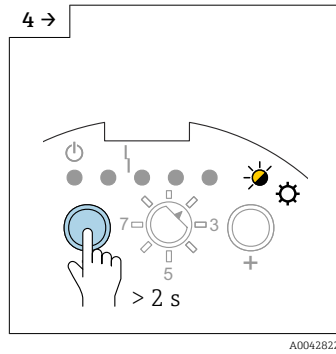

▶ Press the  key > 2 s.

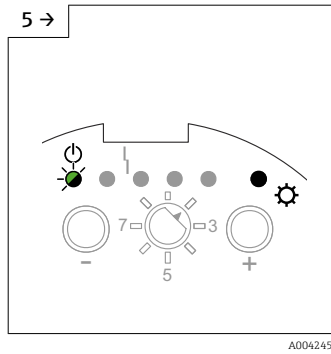

▶ Release the  key when the green LED 1 starts to flash.

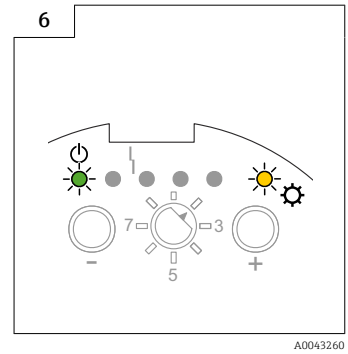



▶ The process of saving the empty calibration is finished when the green LED 1 lits.

### Full calibration

 Make sure that the probe is covered by the medium up to the desired switch-point.

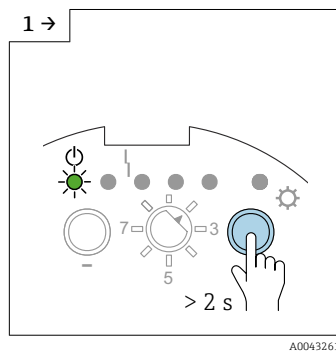
### Carrying out full calibration



▶ Press the  key > 2 s.

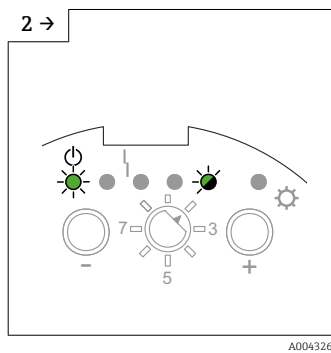

▶ Release the  key when the green LED 5 starts to flash.

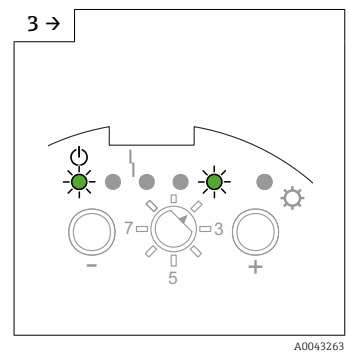

▶ The process of saving the full calibration is complete when the green LED 5 lights up.

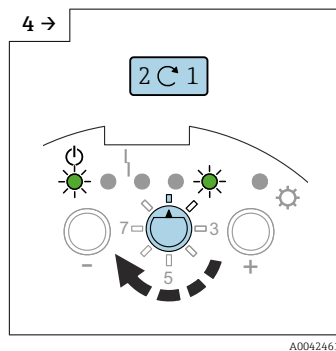

▶ Set the function switch to position 1.

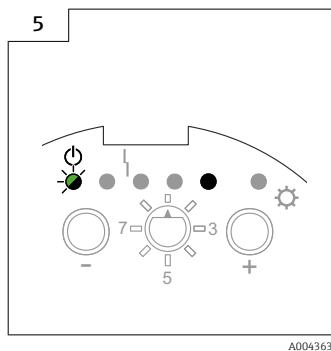

### 7.2.5 Reset: Calibration and switch-point adjustment

Resetting the calibration or switch-point shift (all the other settings remain unchanged)

**i** The switch-point adjustment is reset to the factory setting of 2 pF.

**1 →** A0043647

**2 →** A0043264

**3 →** A0043260

► Set the function switch to position 2.

**4 →** A0042466

**5 →** A0043268

**6 →** A0043651

► Press the and keys.

► All LEDs light up sequentially in time > 10 s.

**7 →** A0042467

**8 →** A0042468

**9** A0042452

► The yellow LED 5 flashes, the reset calibration has been carried out and saved.

► Set the function switch to position 1.

**i** The device is not operational until you have carried out a new calibration.

## 7.2.6 Setting the switch point adjustment

- i** If only one calibration (empty or full) was carried out, and if buildup forms on the rope probe while the probe is in operation, the device may no longer respond to changes in level. A switch point adjustment (e.g. 4 pF, 8 pF, 16 pF, 32 pF) compensates for this condition and ensures that you obtain a constant switch point again.
- i** For media that do not have a tendency to build up, we recommend a setting of 2 pF, as the probe is most sensitive to changes in level at this setting.
- i** For media with heavy buildup (e.g. plaster), we recommend using probes with active buildup compensation.
- i** A switch point adjustment can be carried out only if a full or empty calibration has been carried out first.
- i** A switch point adjustment is not possible if an empty and a full calibration have been carried out.
- i** The switch point adjustment is disabled if you switch on the two-point control  
→  45.

### Setting the switch point adjustment

- i** The factory setting is 2 pF.

To adjust the switch point:

1 →

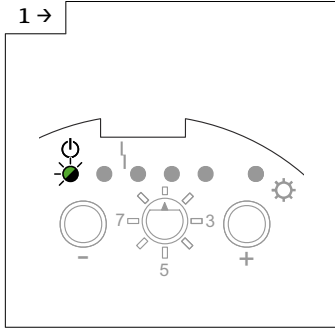

A0042483

2 →

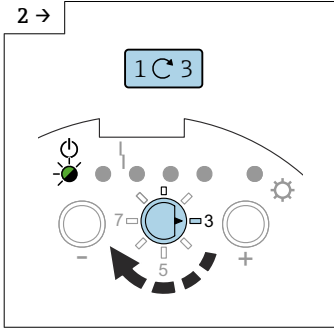

A0042469

3 →

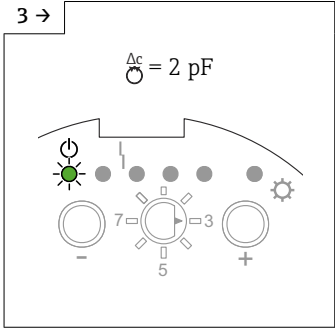

A0042817

▶ Set the function switch to position 3.

4 →

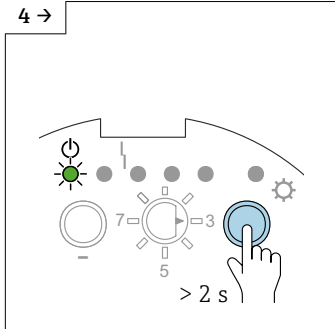

A0042470

5 →

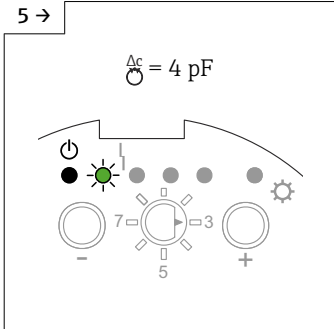

A0042471

6 →

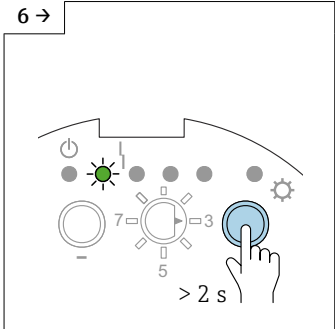

A0042818

▶ Press the **+** key > 2 s to increase the value.

▶ Press the **+** key > 2 s to increase the value.

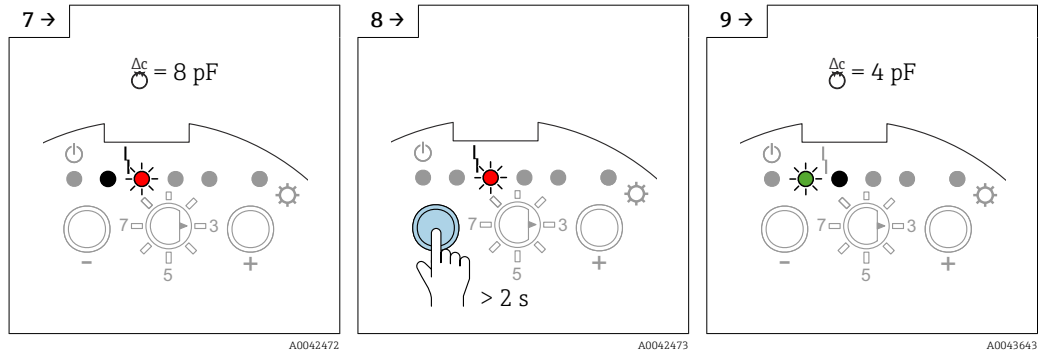

► Press the  key > 2 s to decrease the value.

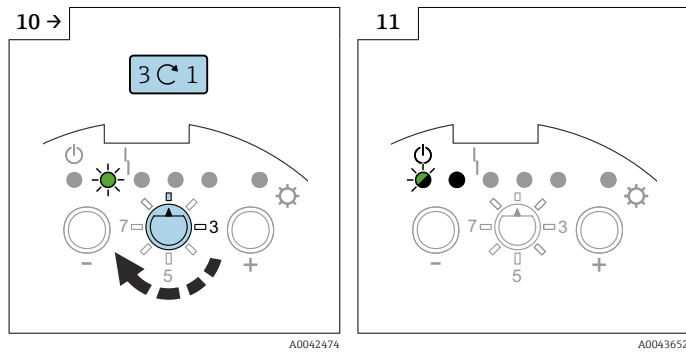

► Set the function switch to position 1.

$\Delta C$	GN	GN	RD	GN	GN	YE
2 pF						
4 pF						
8 pF						
16 pF						
32 pF						

☐ 33 LED sequence regarding the switch point capacitance value

### 7.2.7 Configuring two-point control and buildup mode

It is possible to use the probe rope of a fully insulated and vertically installed probe for pump control as a two-point control. The switch points of the empty and full calibration activate, for example, a conveyor unit.

To use the two-point control:

- set the necessary measuring range, see "Setting the measuring range" → ☐ 38.
- perform empty and full calibration
- set the failsafe mode (MIN/MAX) in accordance with your requirements, see → ☐ 50.

To switch on the two-point control (Ds- mode), the switch point adjustment is disabled. The switch points correspond to the calibration points.

The "Buildup mode" ensures that a safe switch point is output even if the probe is not fully released from the conductive medium (> 1 000  $\mu\text{S}/\text{cm}$ ). Deposits or buildup on the rope are compensated for.

### Configuring two-point control

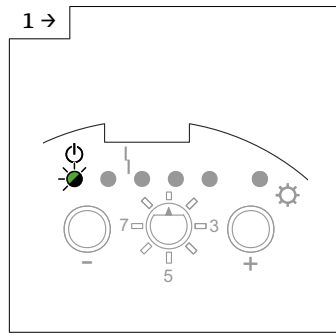

A0042483

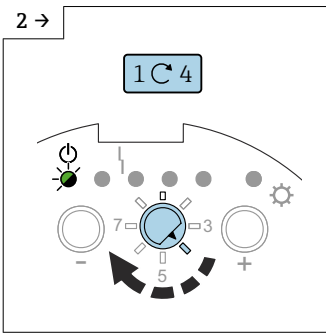

A0043269

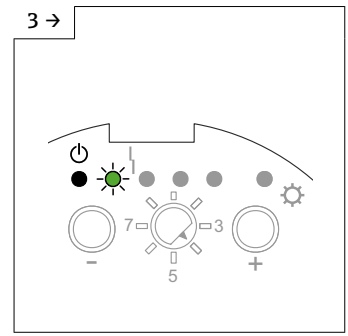

A0043654

- ▶ Set the function switch to position 4.

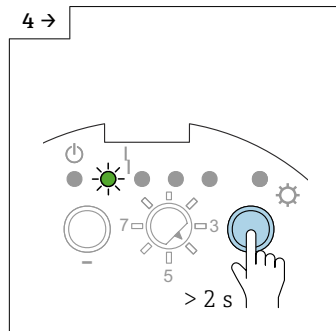

A0042475

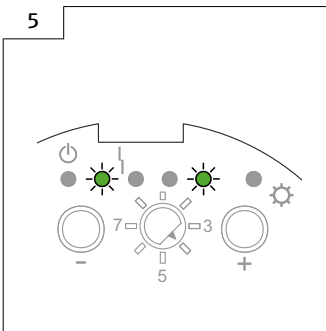

A0042476

- ▶ Press the + key > 2 s.
- ▶ The buildup two-point control is on.

### Configuring the buildup control

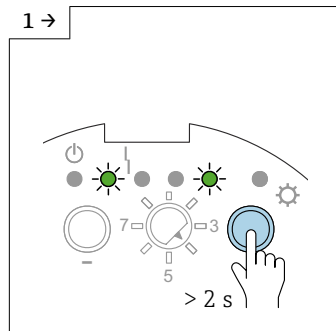

A0042477

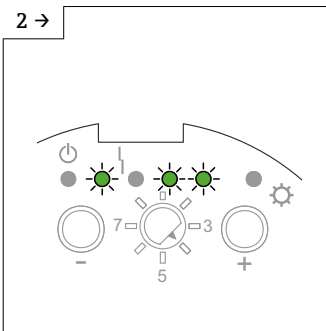

A0042478

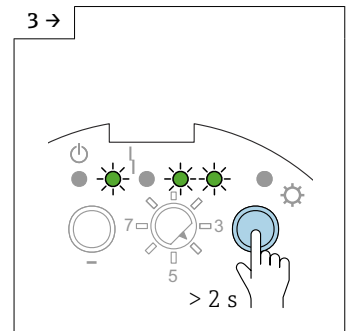

A0042479

- ▶ Press the + key > 2 s.
- ▶ The buildup control is on.
- ▶ Press the + key > 2 s.

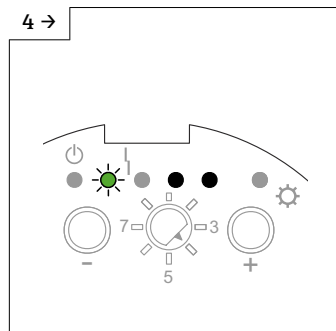

A0042480

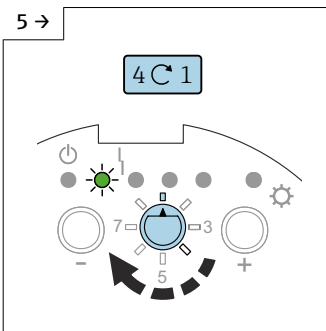

A0042481

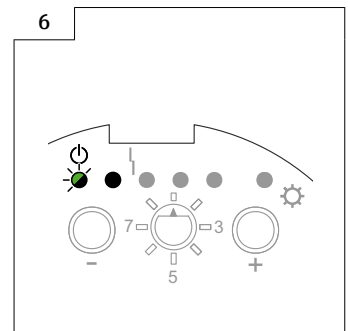

A0043652

- ▶ The buildup control is off.
- ▶ Set the function switch to position 1.

### 7.2.8 Setting the switching delay

**NOTICE**

The tank can overflow if the switching delay is set for too long.



**i** The switching delay causes the device to signal the point level after a delay. This is highly useful in tanks with turbulent medium surfaces caused, for example, by the filling process or by collapsing mounds. By doing so, you ensure that the filling of the tank does not end until the probe is continuously covered by the medium.

**i** A switching delay that is too short may, for example, cause the filling process to be restarted as soon as the medium surface settles.

#### Setting the switching delay

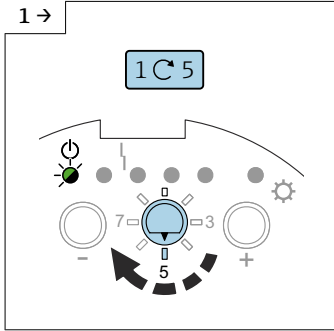
**1** →  A0042740

▶ Set the function switch to position 5.

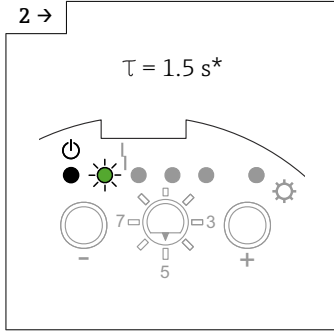
**2** →  A0042741

▶ The green LED 2 shows the factory setting 1.5 s.

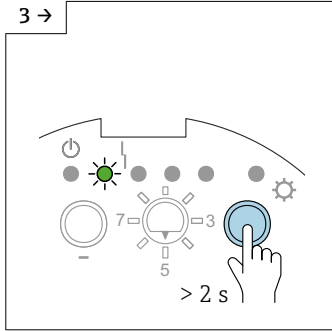
**3** →  A0042742

▶ Press the  to increase the switching delay time.

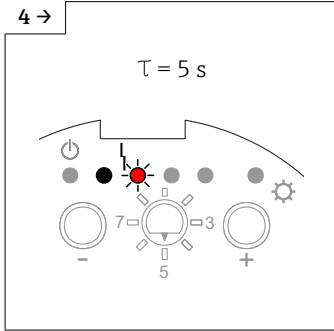
**4** →  A0042743

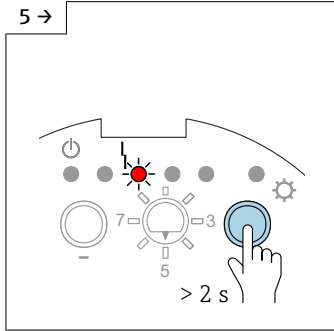
**5** →  A0042744

▶ Press the  to increase the switching delay time.

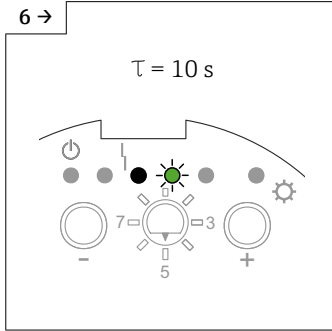
**6** →  A0042745

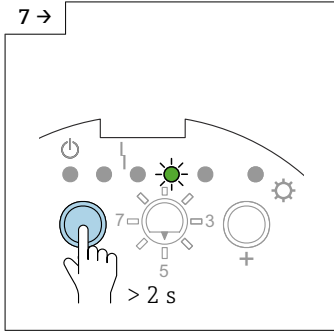
**7** →  A0042746

▶ Press the  key to decrease the value.

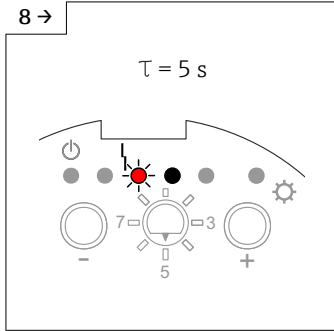
**8** →  A0043655

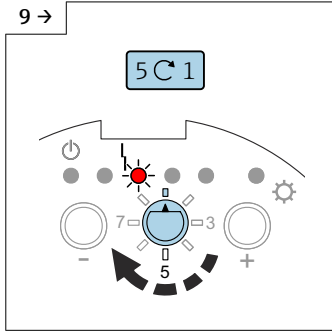
**9** →  A0042747

▶ Set the function switch to position 1.

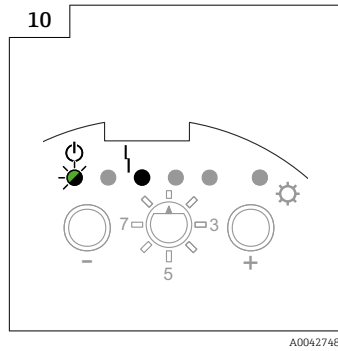

	GN	GN	RD	GN	GN	YE
$\tau$	⏻		⏻			⚙️
0.3 s	●	●	●	●	●	●
1.5 s	●	●	●	●	●	●
5 s	●	●	●	●	●	●
10 s	●	●	●	●	●	●

34 The LED sequence regarding the switching delay value.

### 7.2.9 Activating the self-test

**NOTICE**

**Accidental process run!**

This could result, for example, in overflowing the tank.

- ▶ Make sure that you do not accidentally activate any processes with the self-test!

**i** The self-test simulates switching states:

- probe not covered
- probe covered

This allows you to check if the connected devices are activated correctly.

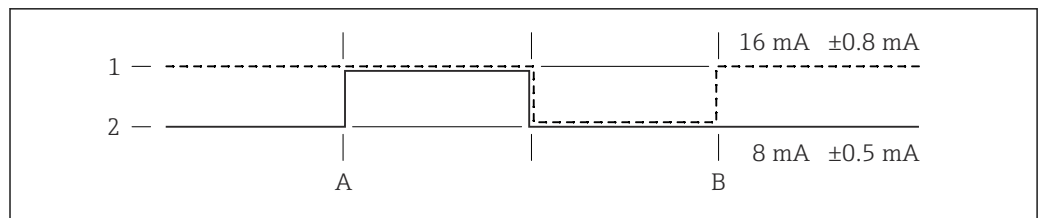

35 Start point covered

- 1 MIN safety
- 2 MAX safety
- A Proof test START point
- B Proof test END point



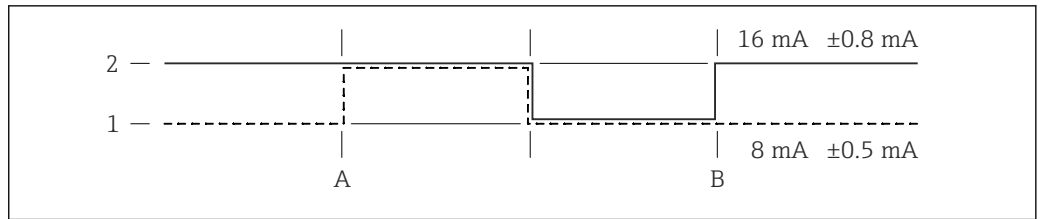

A0042398

36 Start point uncovered

- 1 MIN safety
- 2 MAX safety
- A Proof test START point
- B Proof test END point

Activating the self-test

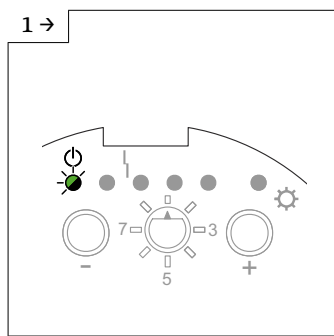

A0042483

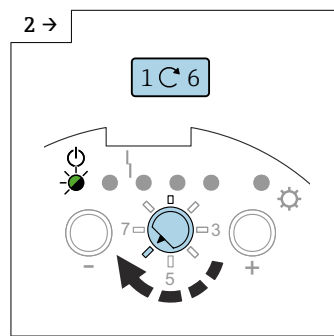

A0042488

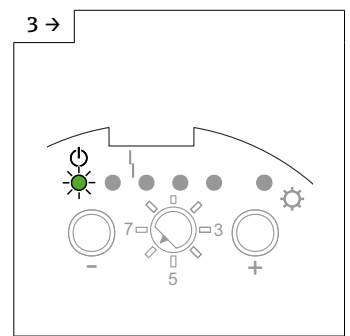

A0043656

- ▶ Set the function switch to position 6.

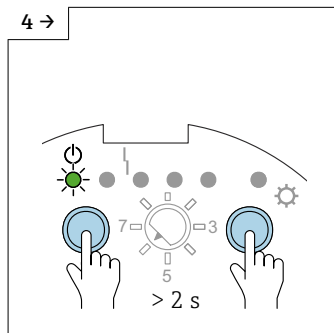

A0042489

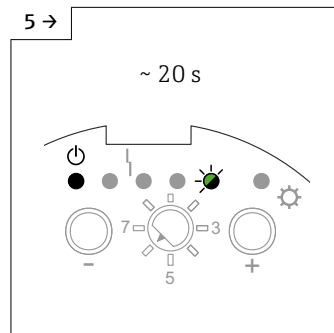

A0042490

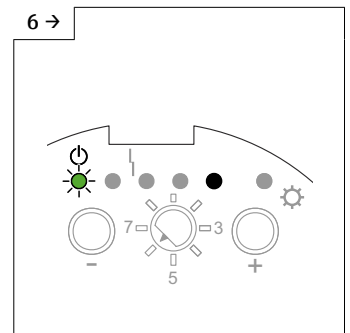

A0042491

- ▶ Press the □ and ⊕ keys > 2 s.
- ▶ The green LED 5 flashes for 20 s
- ▶ The test is completed when the green LED 1 lits.

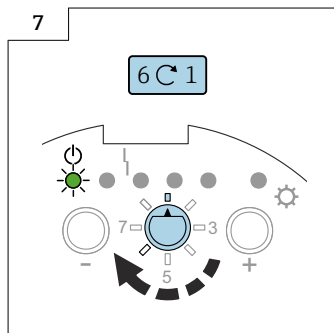

A0042482

- ▶ Set the function switch to position 1.

### 7.2.10 Setting the MIN, MAX and SIL fail-safe mode

**i** The SIL mode function is only available in conjunction with electronic insert FEI55.

By selecting the fail-safe mode correctly, you ensure that the output always operates safely with the quiescent current.

#### Minimum fail-safe mode (MIN)

The output switches if the switch-point is undershot (probe uncovered), a fault occurs or the line voltage fails.

#### Maximum fail-safe mode (MAX)

The output switches if the switch-point is exceeded (probe covered), a fault occurs or the line voltage fails.

#### Setting the MIN fail-safe mode:

**i** The factory setting is set to MAX fail-safe mode.

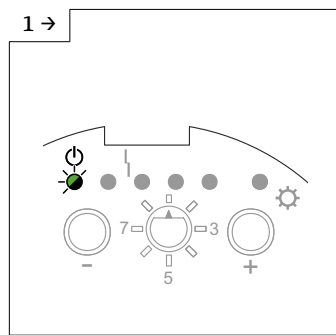

A0042483

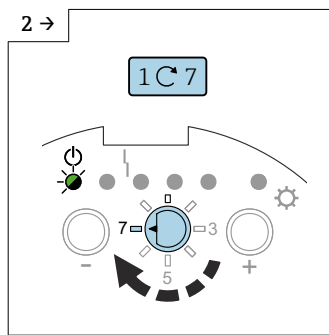

A0042492

► Set the function switch to position 7.

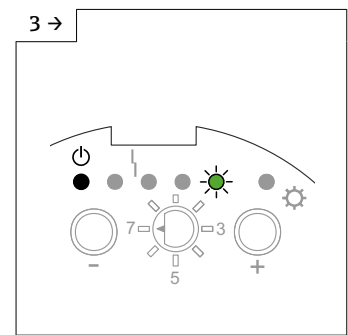

A0042496

► The green LED 5 shows the factory setting.

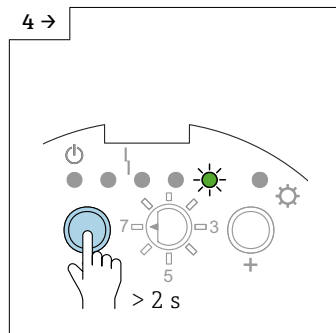

A0042493

► Press the  key > 2 s to set the MIN fail-safe mode.

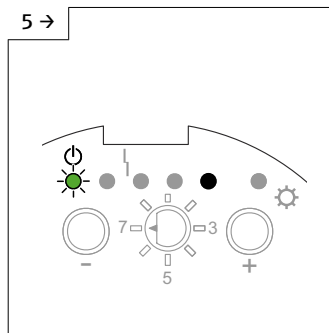

A0043657

► The MIN fail-safe mode is set.

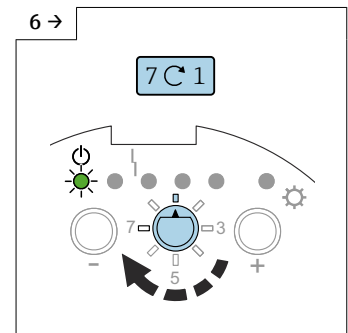

A0042649

► Set the function switch to position 1.

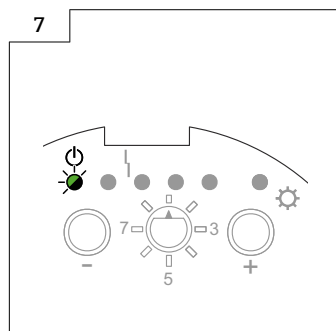

A0042483

To set the MAX fail-safe mode:

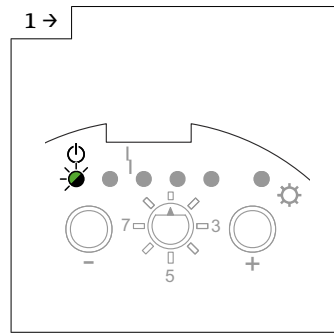

A0042483

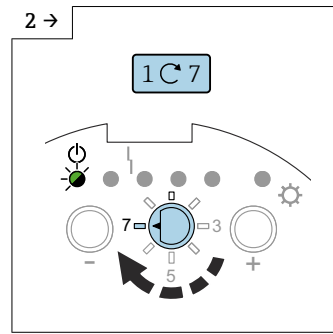

A0042492

► Set the function switch to position 7.

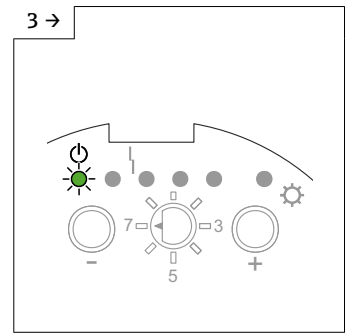

A0042494

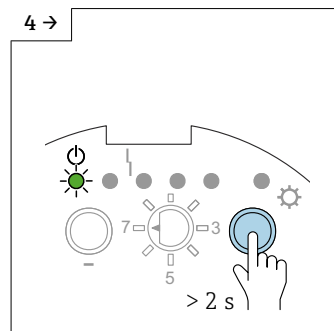

A0042495

► Press the  key > 2 s to set the MAX fail-safe mode.

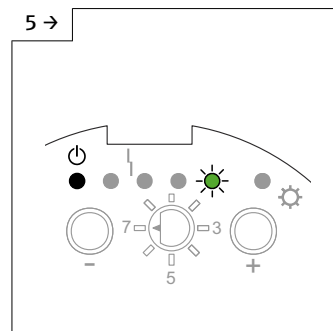

A0042496

► The MAX fail-safe mode is set.

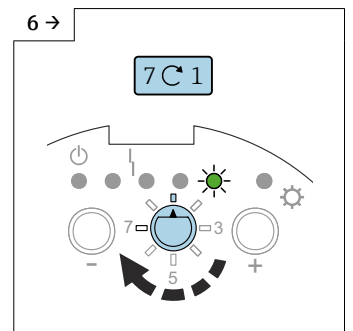

A0042465

► Set the function switch to position 1.

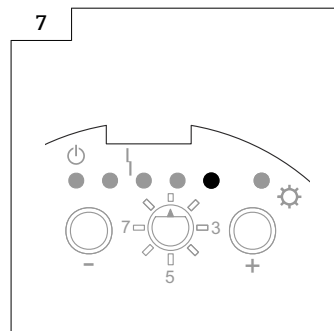

A0043658

 Locking in the "Lock SIL mode" activates the fault message at the current output ( $I < 3.6 \text{ mA}$ ), and it is signaled by the red LED 4.

**Setting the MAX fail-safe mode and lock the SIL mode:**

**i** The factory setting is set to MIN-SIL mode.

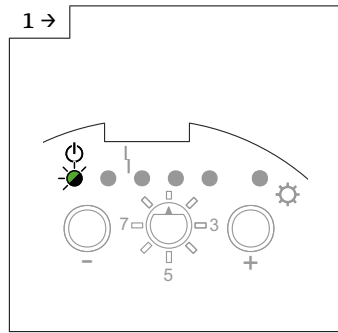

A0042483

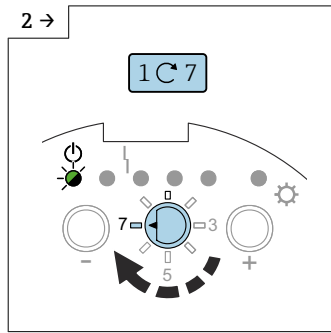

A0042492

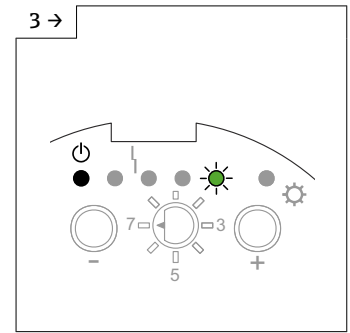

A0042496

► Set the function switch to position 7.

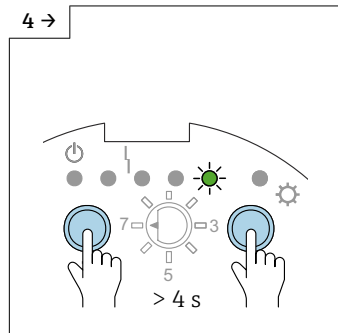

A0042499

► Press the and keys > 4 s.

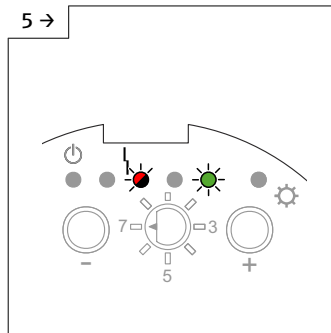

A0042500

► The MAX-SIL mode is set.

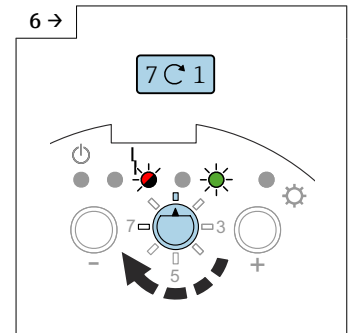

A0042633

► Set the function switch to position 1.

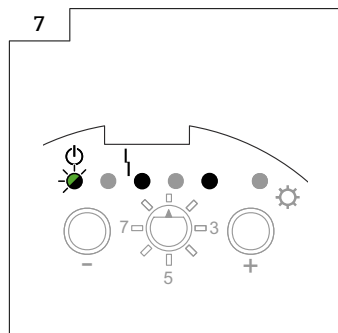

A0043659

**To set the MIN fail-safe mode and lock the SIL mode (only with the electronic inset FEI55):**

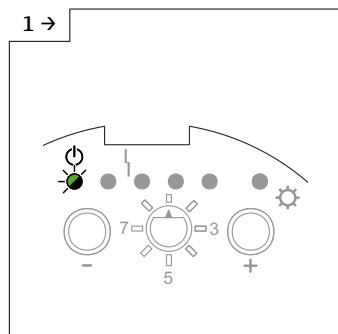

A0042483

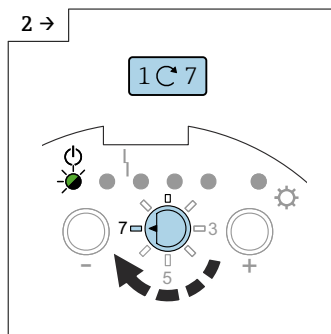

A0042492

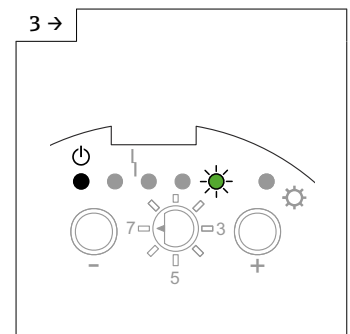

A0042496

► Set the function switch to position 7.

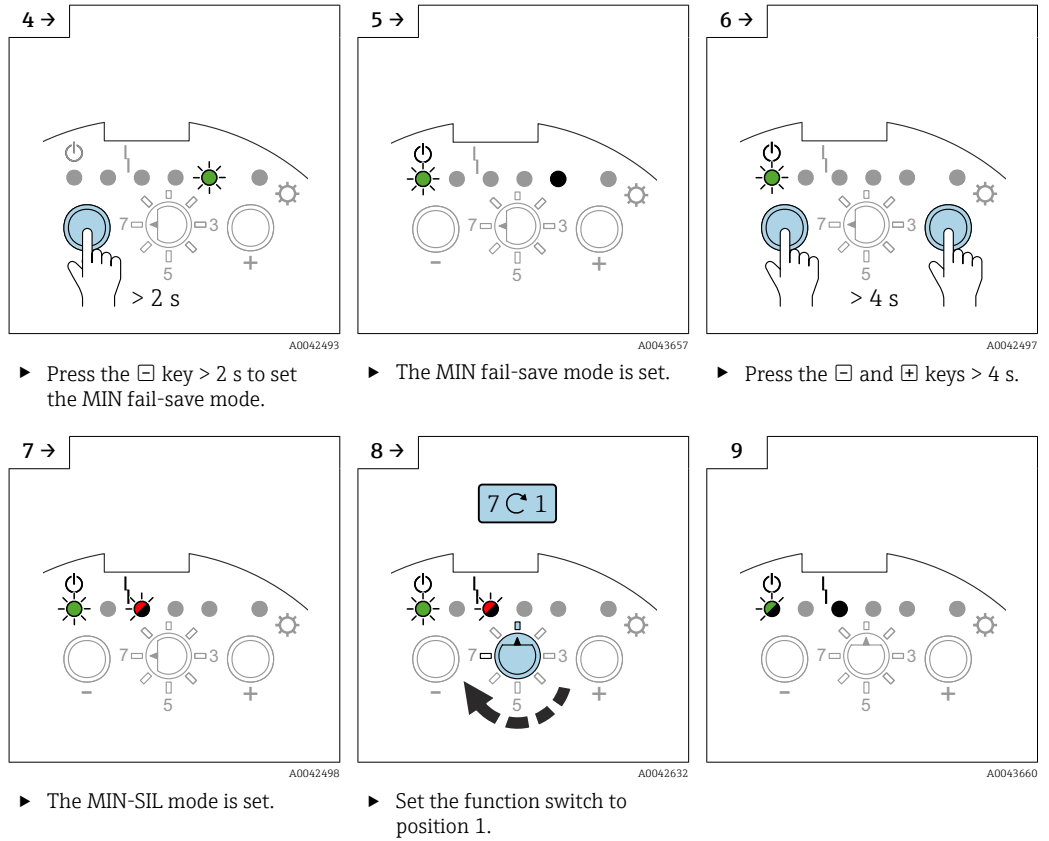

To unlock the SIL mode and set the MAX fail-save mode (only with electronic insert FEI55):

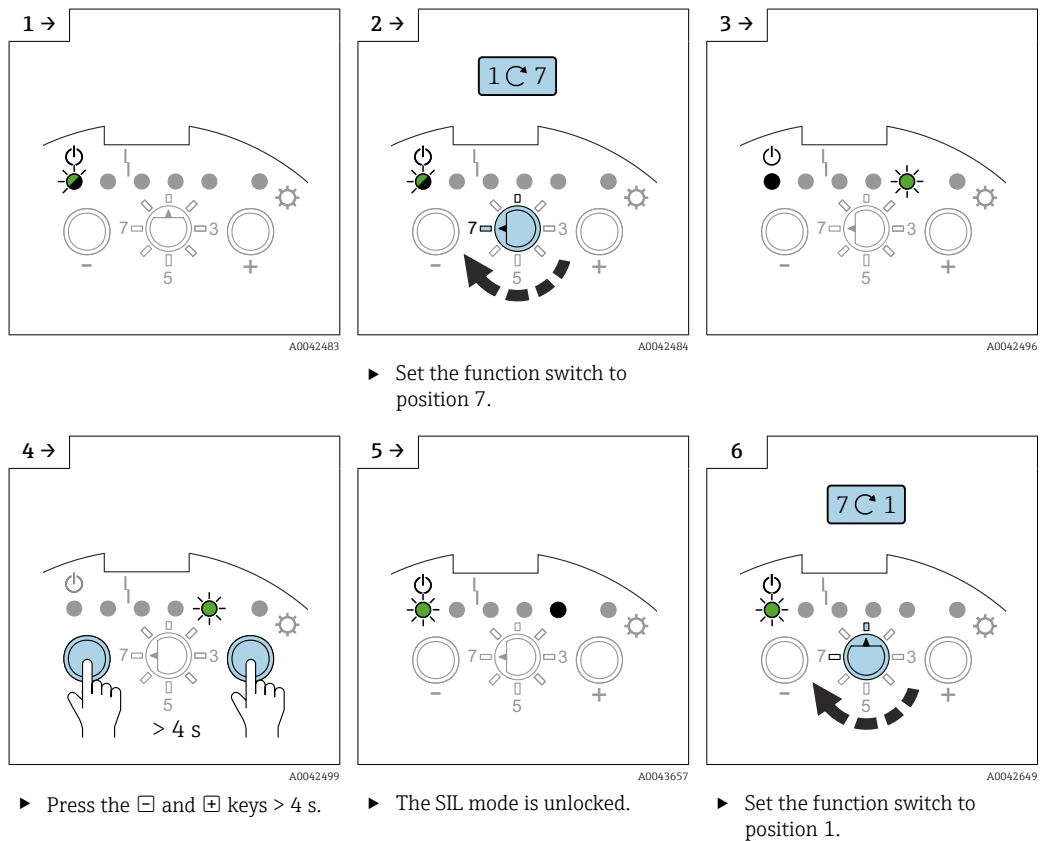

To unlock the SIL mode and set the MIN fail-save mode:

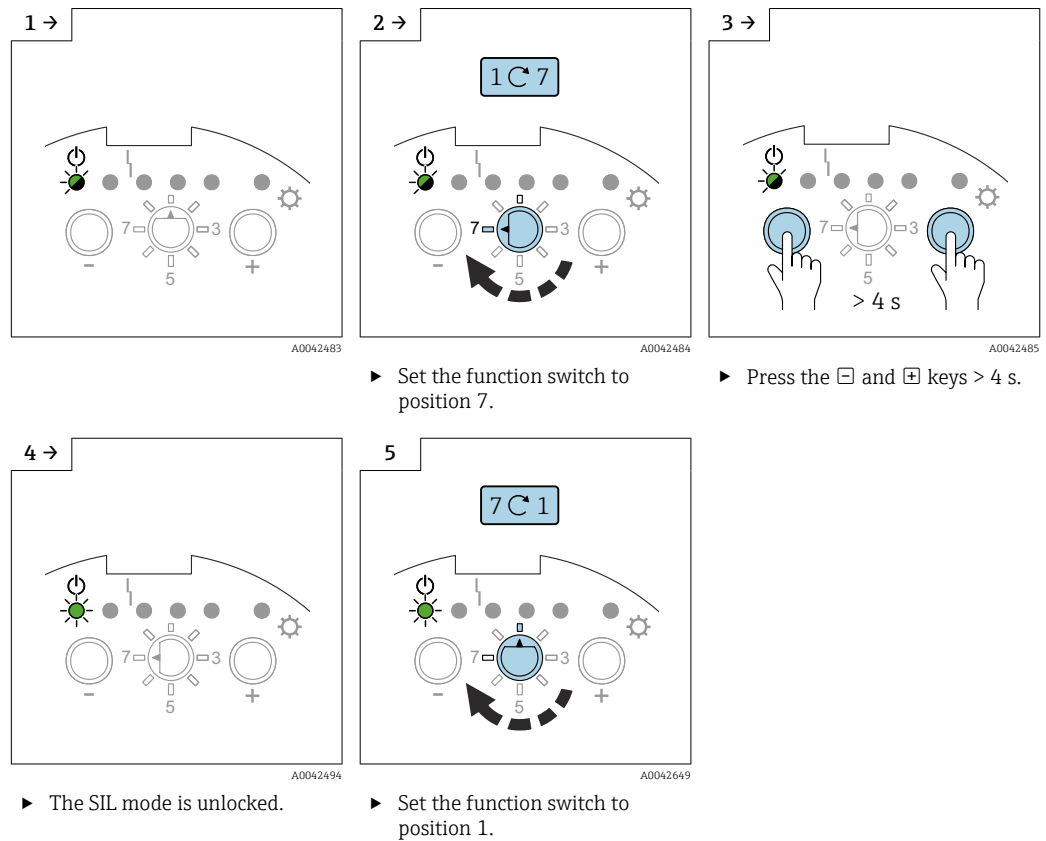

### 7.2.11 Restoring factory settings

This function allows you to restore the factory settings. This is particularly useful if the device has already been calibrated once and, for example, there is a fundamental change in the medium in the tank.

After restoring the factory settings, you must repeat the calibration.

#### Restoring factory settings

The device is set into the factory settings and it is possible to continue with setting the measuring range and the calibration.

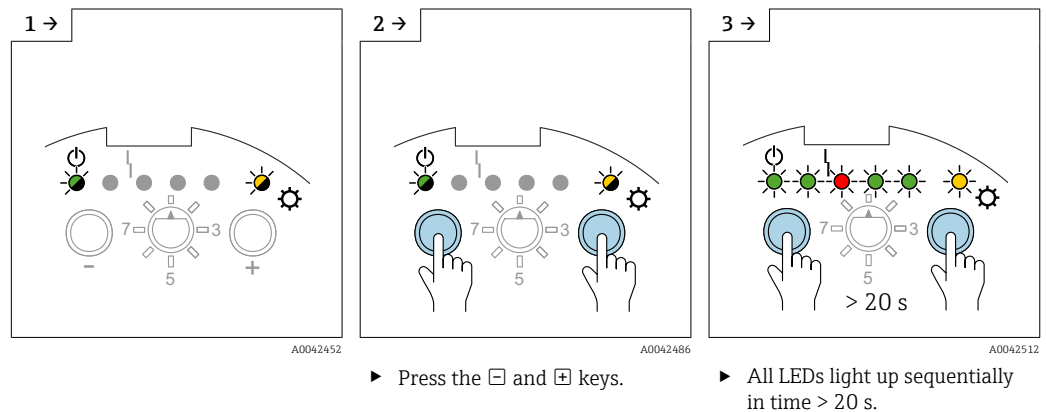

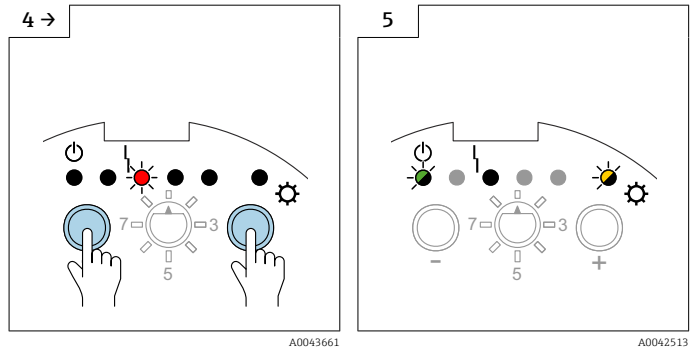

► The factory settings have been successfully restored.

### 7.2.12 Upload and download sensor DAT (EEPROM)

- The customer-specific settings of the electronic insert (e.g. empty and full calibration, switch-point adjustment) are stored automatically in the sensor DAT (EEPROM) and the electronic insert.
- The sensor DAT (EEPROM) is updated automatically each time a parameter is changed in the electronic insert.
- If replacing the electronic insert, all the data are transferred into the electronic insert using a manual upload. No additional settings are required.
- After installing the electronic insert, the manual download must be carried out to transfer the customer-specific settings of the electronic insert.

#### Upload

An upload transfers the saved data from the sensor DAT (EEPROM) to the electronic insert. The electronic insert does not have to be configured any more, and the device is then operational.

#### Download

A download transfers the saved data from the electronic insert to the sensor DAT (EEPROM).

#### Downloading the data

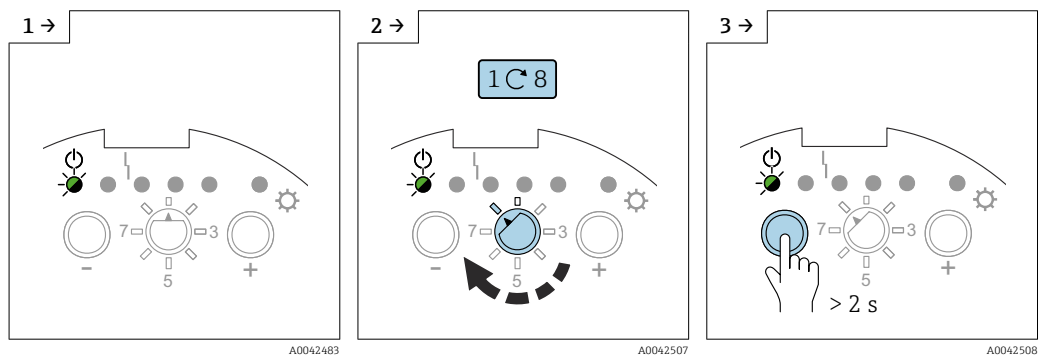

► Set the function switch to position 8.

► Press the key > 2 s.

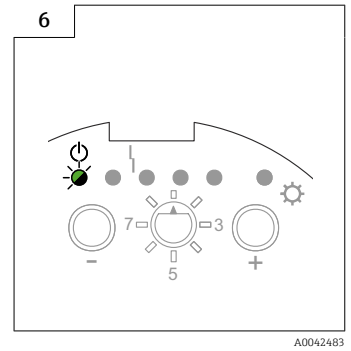
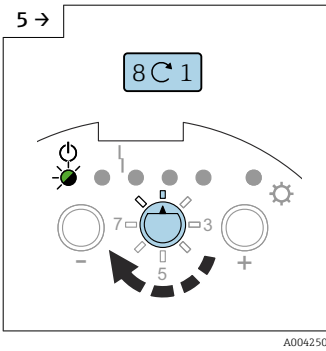
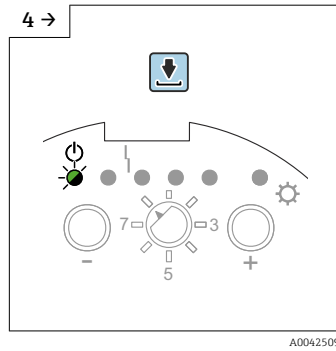

► Set the function switch to position 1.

Uploading the data

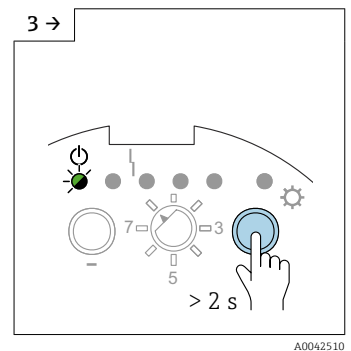
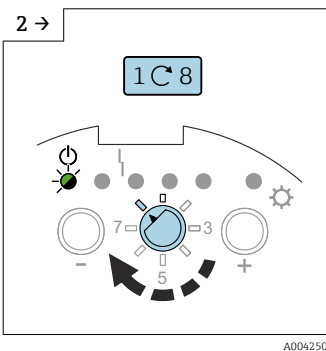
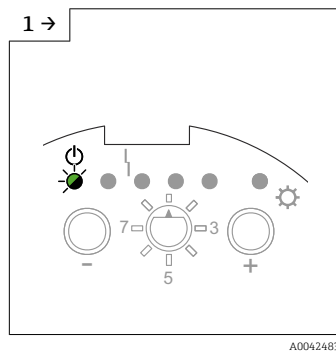

► Set the function switch to position 8.

► Press the  $\oplus$  key > 2 s.

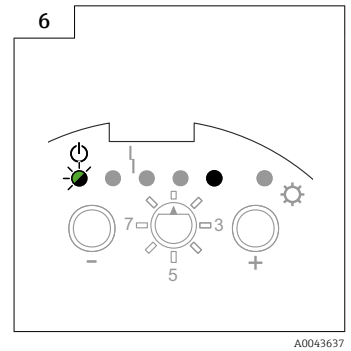
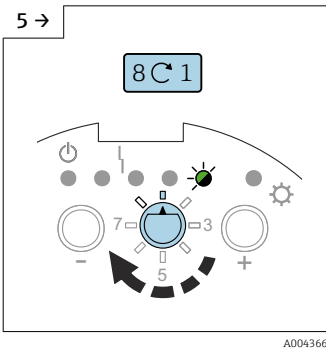
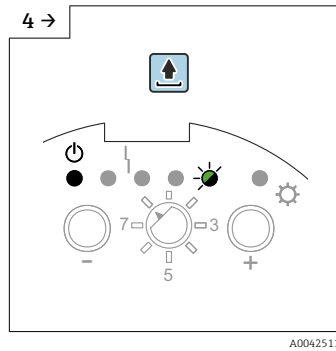

► Set the function switch to position 1.



### 7.2.13 Output signals

#### Output signal FEI51

		GN	GN	RD	GN	GN	YE	
MAX								$L+ \text{ [1] } \xrightarrow{I_L} \text{ [3] } +$
								$\text{ [1] } \text{---} < 3.8 \text{ mA} \text{---} \text{ [3] }$
MIN								$L+ \text{ [1] } \xrightarrow{I_L} \text{ [3] } +$
								$\text{ [1] } \text{---} < 3.8 \text{ mA} \text{---} \text{ [3] }$
								$\text{ [1] } \text{---} I_L / < 3.8 \text{ mA} \text{---} \text{ [3] }$
								$\text{ [1] } \text{---} < 3.8 \text{ mA} \text{---} \text{ [3] }$

A0042586

#### Output signal FEI52

		GN	GN	RD	GN	GN	YE	
MAX								$L+ \text{ [1] } \xrightarrow{I_L} \text{ [3] } +$
								$\text{ [1] } \text{---} I_R \text{---} \text{ [3] }$
MIN								$L+ \text{ [1] } \xrightarrow{I_L} \text{ [3] } +$
								$\text{ [1] } \text{---} I_R \text{---} \text{ [3] }$
								$\text{ [1] } \text{---} I_L / I_R \text{---} \text{ [3] }$
								$\text{ [1] } \text{---} I_R \text{---} \text{ [3] }$

A0042587

Output signal FEI54

		GN	GN	RD	GN	GN	YE	⊖ →
MAX								
MIN								

A0042528

Output signal FEI55

		GN	GN	RD	GN	GN	YE	⊖ →
MAX								+ [2] ~16 mA → [1]
								+ [2] ~8 mA → [1]
MIN								+ [2] ~16 mA → [1]
								+ [2] ~8 mA → [1]
								+ [2] ~8/16 mA → [1]
								+ [2] < 3.6 mA → [1]

A0042529

### 7.3 Commissioning with electronic inserts FEI53 or FEI57S

This chapter describes the process for commissioning the device with electronic insert versions FEI53 and FEI57S.

The measuring system is not operational until you have carried out a calibration at the switching unit.

For information on how to carry out the calibration, refer to the documentation for the Nivotester switching device: FTC325 3-Wire, FTC325 PFM.

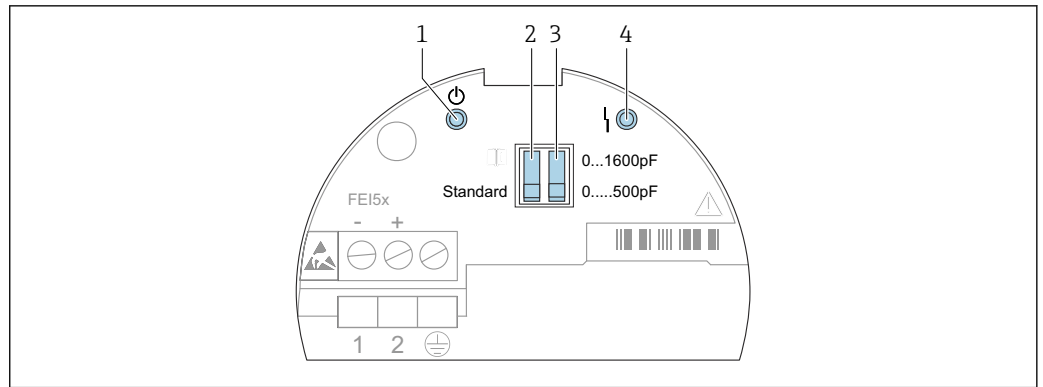

A0042395

37 FEI53 and FEI57S human interface

- 1 Green LED - operational status
- 2 Standard or alarm DIP switch
- 3 Measuring range DIP switch
- 4 Red LED - fault

### 7.3.1 Setting the alarm response if the measuring range is exceeded

The functions of the DIP switches:

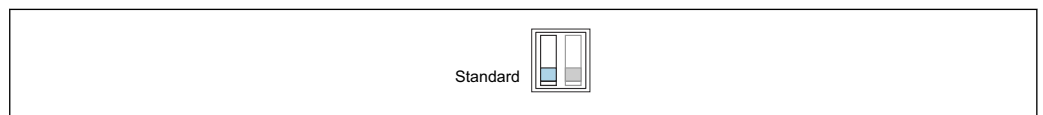

A0042400

38 Standard: if the measuring range is exceeded no alarm is output



A0042401

39 Alarm: if the measuring range is exceeded an alarm is output

- i** With this setting, it is possible to determine the alarm response of the measuring system when the measuring range is exceeded. It is possible to switch the alarm on or off if the measuring range is exceeded.
- i** All other settings concerning the alarm response have to be configured on the respective Nivotester switching device.

### 7.3.2 Setting the measuring range

The functions of the DIP switches:

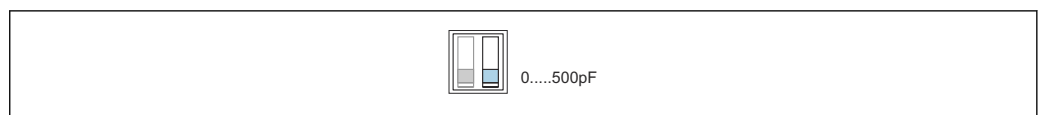

A0042402

40 Measuring range: the measuring range is between 0 to 500 pF. Span: the span is between 0 to 500 pF

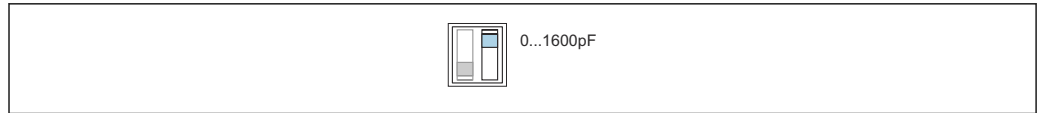

A0042403

41 Measuring range: the measuring range is between 5 to 1 600 pF. Span: the span is between 5 to 1 600 pF

**i** The choice of measuring range (0 to 500 pF and 0 to 1 600 pF) depends on the function of the probe. If the probe is used as a point level switch, you can retain the factory setting of 0 to 500 pF.

**i** If the probe is used for two-point control, the following settings are recommended for vertical installation:

- measuring range from 0 to 500 pF for probe lengths up to 1 m (3.3 ft)
- measuring range from 0 to 1 600 pF for probe lengths up to 4 m (13 ft)

All other settings must be made on the respective Nivotester switching device.

### 7.3.3 Output signals

#### Output signal FEI53

	GN	RD	⊖ →
			3 3 ... 12 V
			3 3 ... 12 V
			3 <2.7 V

A0042588

#### Output signal FEI57S

	GN	RD	⊖ →
			+ 1 60 ... 185 Hz → 2
			+ 1 60 ... 185 Hz → 2
			+ 1 <20 Hz → 2

A0042589

## 7.4 Commissioning with the electronic insert FEI58

This chapter describes the process of commissioning the device with electronic insert FEI58.

**i** The measuring system is not operational until you have carried out a calibration.

**i** Additional functions associated with the switching unit are described in the documentation for the switching unit, e.g. Nivotester FTC325N.

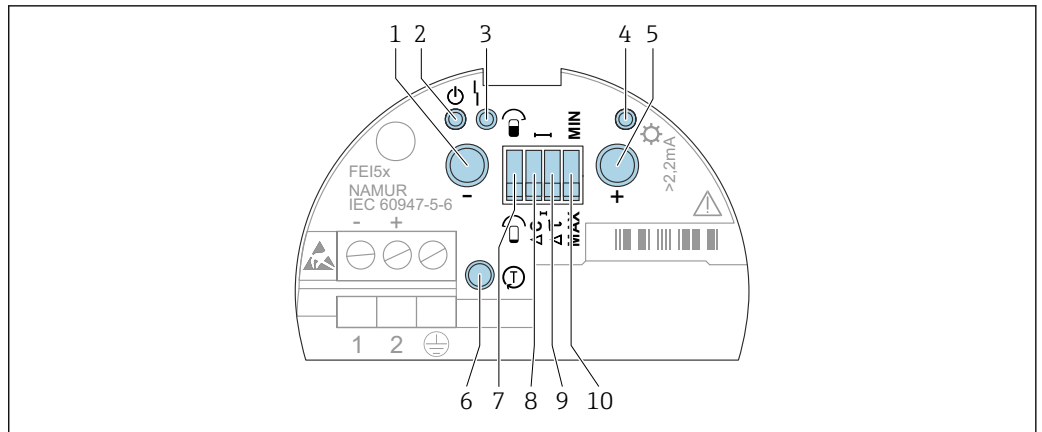

A0042396

42 FEI58 human interface

- 1 Function key A
- 2 Green LED - operational status
- 3 Red LED - fault
- 4 Yellow LED - switching state
- 5 Function key B
- 6 Test key
- 7 Calibration DIP switch
- 8 Switch point SIP switch
- 9 Delay DIP switch
- 10 Fail-safe mode DIP switch

### 7.4.1 Function keys A, B, C

**i** To prevent unintentional operation of the device, wait for approximately 2 s after the keys were pressed, to elapse before the system evaluates and executes a function commanded when a key is pressed (keys A and B). Test key C disconnects the power supply immediately.

**i** Both keys (A and B) have to be pressed simultaneously to trigger switch-point adjustment.

#### Function key

- Key A: displays diagnostic code
- Key B: displays calibration situation
- Test key C: disconnects the transmitter from the switching unit
- Keys A and B pressed during:
  - operation - perform calibration
  - startup - delete calibration points

### 7.4.2 Performing calibration

**i** An empty and full calibration provides the greatest possible operational security. This is highly recommended for critical applications.

**i** The empty and full calibration measures the capacitance values of the probes when the tank is full and when it is empty. For example: if the measured capacitance value of the empty calibration is 50 pF and that of the full calibration is 100 pF, the average capacitance value, 75 pF is stored as the switch-point.

Calibration DIP switch:

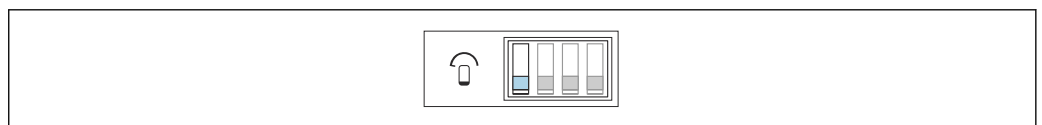

A0042405

43 The probe is uncovered during calibration

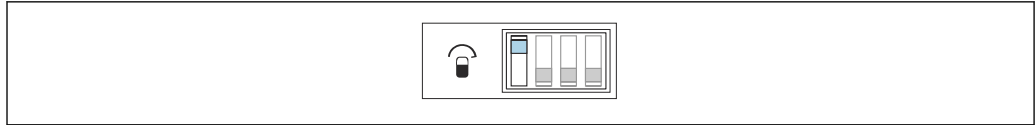

A0042404

44 The probe is covered during calibration

**i** Make sure that the probe is not covered with product.

**Carrying out empty calibration**

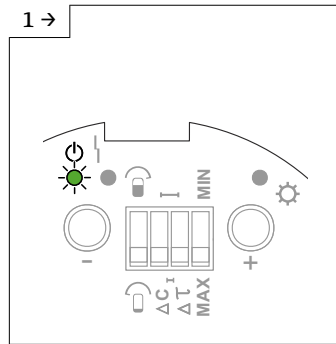

A0042514

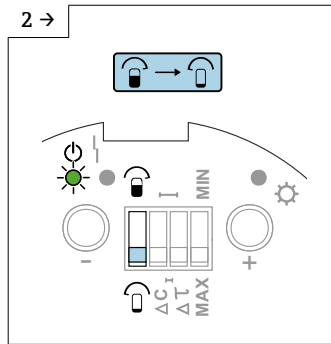

A0042515

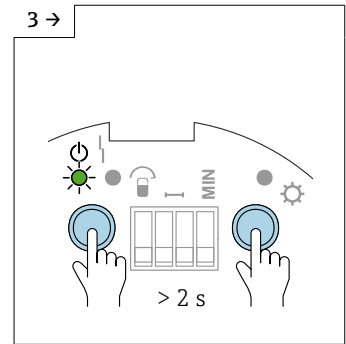

A0042516

► Make sure that the calibration DIP switch is in position "Uncovered".

► Press the A and B keys > 2 s.

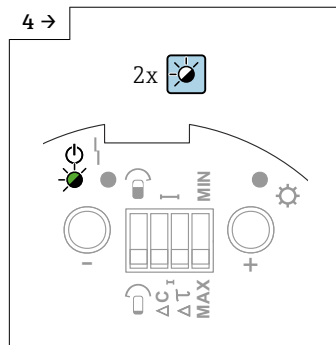

A0042517

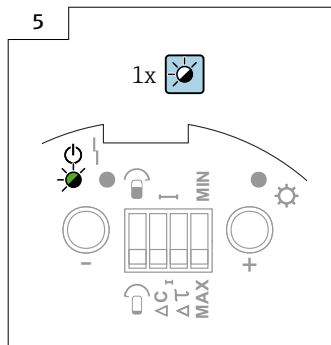

A0042518

► The green LED 1 flashes quickly to indicate that the value has been saved correctly.

► The process of saving the empty calibration value is finished when the green LED 1 flashes slowly.

**i** Make sure that the probe is covered by the medium up to the desired switch-point.

### Carrying out full calibration

- ▶ Make sure that the calibration DIP switch is in position "Covered".
- ▶ Press the A and B keys > 2 s.
- ▶ The green LED 1 flashes quickly to indicate that the value has been saved correctly.
- ▶ The process of saving the full calibration value is finished when the green LED 1 flashes slowly.

### 7.4.3 Setting the switch point adjustment

- i** If only one calibration (empty or full) was carried out, and if buildup forms on the rope probe while the probe is in operation, the device may no longer respond to changes in level. A switch point adjustment compensates for this condition and ensures that you obtain a constant switch point again.
- i** For media that do not have a tendency to buildup, we recommend a setting of 2 pF, as the probe is most sensitive to changes in level at this setting.
- i** For media with heavy buildup, it is recommended to use the probes with active buildup compensation with the setting of 10 pF.

Switch point adjustment:



45 10 pF



46 2 pF

### 7.4.4 Setting the switching delay

#### NOTICE

The tank can overflow if the switching delay is set for too long.



**i** The switching delay causes the device to signal the point level after a delay. This is useful in tanks with turbulent medium surfaces caused by the filling process or by collapsing mounds. Ensure that the filling of the tank does not end until the probe is continuously covered by the medium.

**i** A switching delay that is too short can cause the filling process to be restarted as soon as the medium surface settles.

Switching delay:

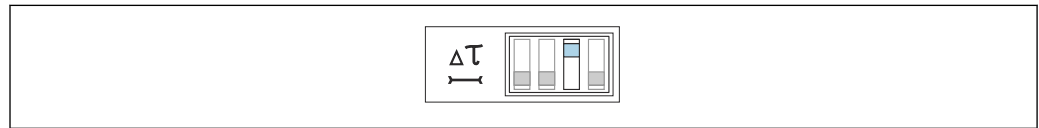

47 5 s



48 1 s

### 7.4.5 MIN and MAX fail-safe mode

**i** By selecting the fail-safe mode correctly, you ensure that the output always operates safely with the quiescent current.

#### Minimum fail-safe mode (MIN)

The output switches if the switch point is undershot (rope uncovered), a fault occurs or the line voltage fails.

#### Maximum fail-safe mode (MAX)

The output switches if the switch point is exceeded (rope covered), a fault occurs or the line voltage fails.

Fail-safe mode:



49 *The output switches safety-oriented when the probe is uncovered. It can be used in cases such as dry run protection and pump protection.*



50 *The output switches safety-oriented when the probe is covered. It can be used in cases such as overflow protection.*



## 7.4.6 Display calibration situation

Use this function to see what calibrations have been performed on the device. The calibration situation is indicated by the three LEDs.

### Displaying calibration situation

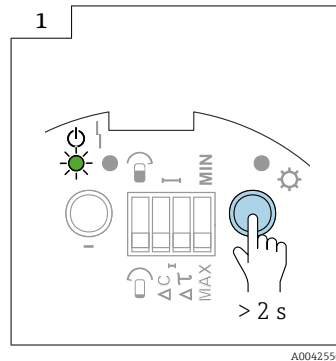

- ▶ Press the  key > 2 s



-  51 *No calibration*

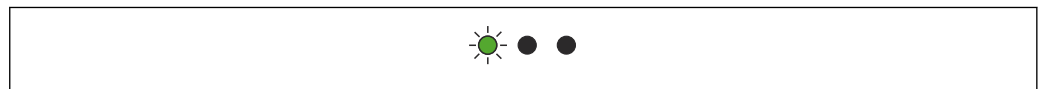

-  52 *Empty calibration performed*

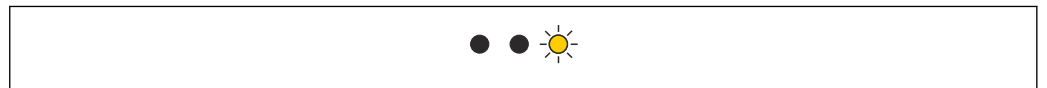

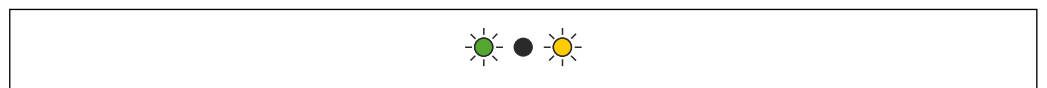

-  53 *Full calibration performed*



-  54 *Empty and full calibration performed*

## 7.4.7 Displaying the diagnostic code

This function makes it possible to interpret faults using the three LEDs. If the system detects more than one fault, the fault with the highest priority is shown on the display.

 More information is provided in the section "Fault diagnostics" →  69.

## 7.4.8 Test key C

 This test can be used to activate safety-specific measures in the plant like the alarms!

Pressing test key C disconnects the supply voltage. If the power supply is disconnected, a supply unit like Nivotester FTC325N reacts that the alarm relay outputs an error and appropriate responses are triggered in any slave devices connected.

To perform the function test:

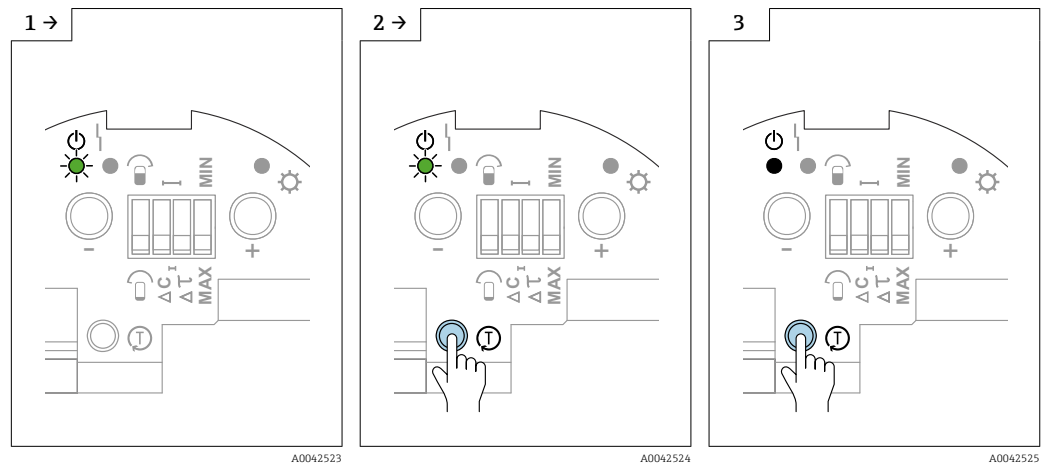

- ▶ Press the C key for the entire duration of the test.
- ▶ The safety functions configured for the supply unit are activated.
- ▶ Release the C key to end the function test.

### 7.4.9 Output signals

#### Output signal FEI58

		GN	RD	YE	⊕ →
MAX ↑					+ 2 → 2.2 ... 3.5 mA → 1
					+ 2 → 0.6 ... 1.0 mA → 1
MIN ↓					+ 2 → 2.2 ... 3.5 mA → 1
					+ 2 → → 1
					+ 2 → 0.6 ... 1.0 mA → 1 2.2 ... 3.5 mA
					+ 2 → 0.6 ... 1.0 mA → 1

A0042590

## 8 Diagnostics and troubleshooting

**i** In the event of faults during commissioning or operation of the device, you can carry out fault diagnostics on the electronic insert. This function is supported by the electronic inserts FEI51, FEI52, FEI54, FEI55.

**i** The electronic inserts FEI53, FEI57S and FEI58 signal two types of faults:

- the red LED flashes - faults that can be rectified
- the red LED is lit continuously - faults that cannot be rectified

### 8.1 Activating fault diagnostics FEI51, FEI52, FEI54 and FEI55

**i** The diagnostics provide information about the operating status of the device. The results of the diagnostics are displayed by LEDs. If the diagnostics detect multiple faults, these are shown according to their priority. A serious fault (e.g. priority 3) is always displayed before a less serious fault (e.g. priority 5).

#### Activating fault diagnostics

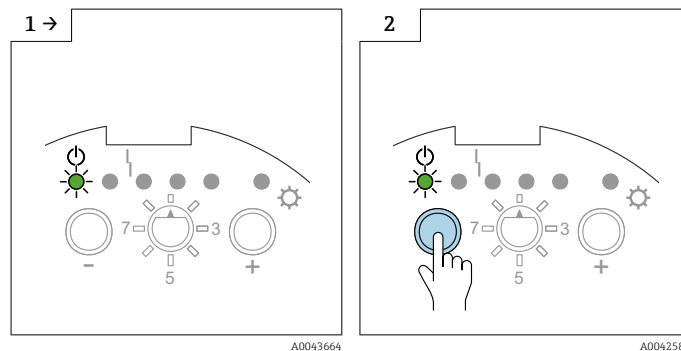

- ▶ Make sure the function switch is set to position 1.
- ▶ Press the key.

#### No fault



#### Internal fault - priority 1



Replace the electronic insert

#### The calibration point or points are outside the measuring range - priority 2



Recalibrate

#### The calibration points have been accidentally interchanged - priority 3



A0042558

Recalibrate

**The calibration point is too close to the measuring range limit - priority 4**

A0042559

Reduce the switch-point or select a new installation location

**No calibration has yet been carried out - priority 5**

A0042560

Carry out empty and full calibration

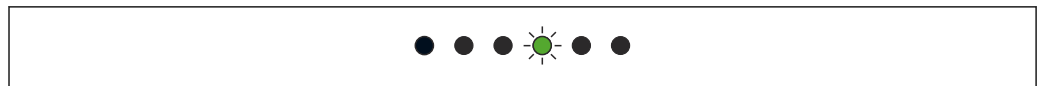
**The DC PNP output is overloaded (FEI52) - priority 6**

A0042561

Reduce the connected load

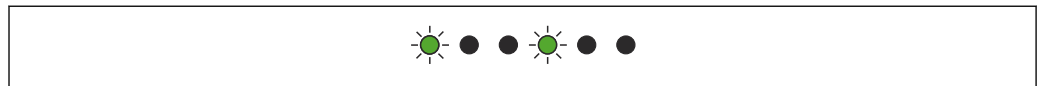
**The capacitance change from "Probe not covered" to "Probe covered" is too small - priority 7**

A0042565

Contact Endress+Hauser Service

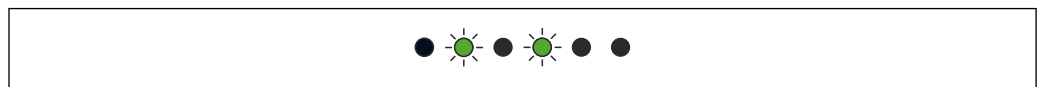
**Sensor DAT (EEPROM) data are invalid - priority 8**

A0042566

Carry out download from the electronic insert

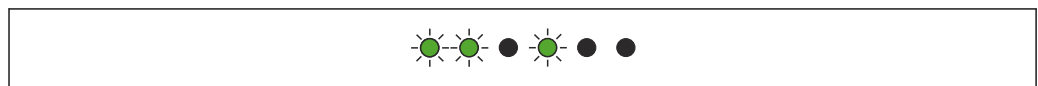
**The probe is not detected, the connection to the sensor DAT (EEPROM) could not be established - priority 9**

A0042567

The probe type is not compatible

**The measured temperature is outside the permitted temperature range - priority 10**

A0042568

Operate the device in the specified temperature range only

## 8.2 Fault diagnostics FEI53 and FEI57S

### The device does not switch

Check the connection and the supply voltage

### Alarm LED flashes

The ambient temperature of the electronics is outside the permitted range or the connection to the probe is interrupted

## 8.3 Activating fault diagnostics FEI58

This function makes it possible to interpret faults using the three LEDs. If the system has detected more than one fault, the fault with the highest priority is shown on the display.

To display the diagnostic code:

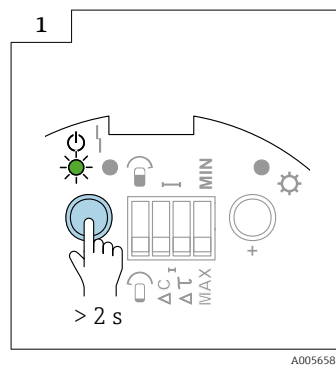

A0056585

- ▶ Press the  key > 2 s

### No fault



A0042551

### Internal fault - priority 1

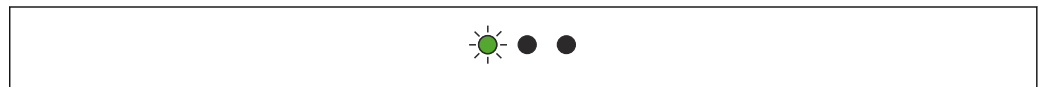

A0042552

The device is defective

### The calibration point is too close to the measuring range limit - priority 2



A0042571

 55

Reduce the switch-point or select a new installation location

### Calibration points have been accidentally interchanged - priority 3

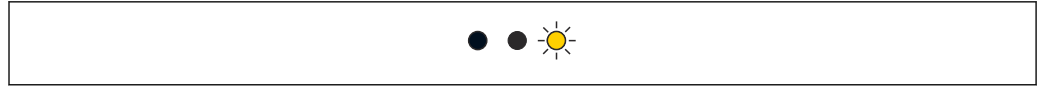

A0042572

Perform uncovered calibration with the probe uncovered, and covered calibration with the probe covered

**No calibration has yet been carried out** - priority 4

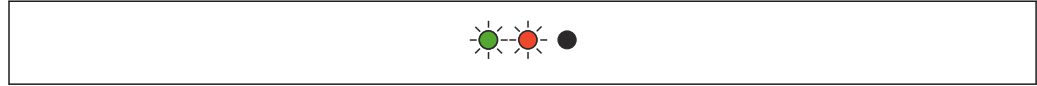

A0042573

Carry out empty and full calibration

**The change in capacitance from uncovered probe to covered probe is too small** - priority 5

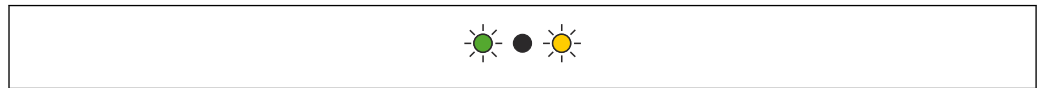

A0042554

The capacitance change between the uncovered and covered probe must be higher than 2 pF

**Probe not detected** - priority 6

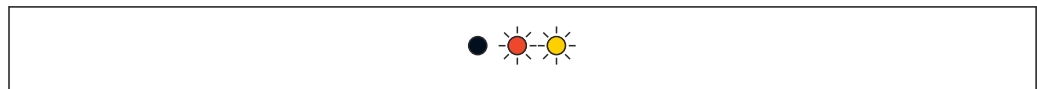

A0042575

 56 *Probe not detected*

Connect the probe

**The measured temperature is outside the permitted range** - priority 7

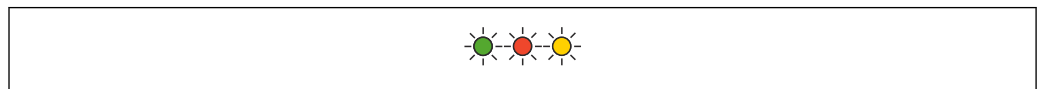

A0042576

 57 *The measured temperature is outside the permitted range*

The device can be operated in the specified temperature range only

## 8.4 Firmware history

### FEI51

- Release date: 10/2007
- Software version: V 01.00.zz
- Software change: original software

### FEI52

- Release date: 07/2006
- Software version: V 01.00.zz
- Software change: original software

### FEI53

- Release date: 07/2006
- Software version: V 01.00.zz
- Software change: original software

**FEI54**

- Release date: 07/2006
- Software version: V 01.00.zz
- Software change: original software

**FEI55**

- Release date: 11/2008
- Software version: V 02.00.zz
- Software change: extended to include SIL functionality

**FEI57S**

- Release date: 07/2006
- Software version: V 01.00.zz
- Software change: original software

**FEI58**

- Release date: 01/2010
- Software version: V 01.00.zz
- Software change: original software

## 9 Maintenance

No special maintenance work is required for the Liquicap M level transmitter.

### 9.1 External cleaning

Do not use a corrosive or aggressive cleaning agent to clean the housing surface and seals.

### 9.2 Cleaning the probe

Depending on the application, buildup of contamination or soiling can form on the probe rope. A high level of material buildup can affect the measurement result.

The regular cleaning of the probe rope is recommended if the medium tends to create a high level of buildup.

Make sure that the insulation of the probe rope is not damaged if hosing down or during mechanical cleaning.

Make sure that the probe rope insulation is resistant to cleaning agents.

### 9.3 Seals

The process seals of the sensor must be replaced periodically, especially when using molded aseptic seals! The intervals between seal replacement depend on the frequency of the cleaning cycles and on the fluid and cleaning temperature.

### 9.4 Endress+Hauser services

Endress+Hauser offers a wide range of services.



Your Endress+Hauser Sales Center can provide detailed information on the services.



## 10 Repair

### 10.1 General notes

The Endress+Hauser repair and conversion concept provides the following:

- The measuring devices have a modular design
- Spare parts are grouped into logical kits with the associated Installation Instructions
- Repairs are carried out by Endress+Hauser Service or by appropriately trained customers
- Certified devices can only be converted to other certified devices by Endress+Hauser Service or at the factory

### 10.2 Spare parts

#### Find spare parts

Check whether it is possible to use the spare part for the measuring device.

1. Launch the Endress+Hauser Device Viewer via a web browser:  
[www.endress.com/deviceviewer](http://www.endress.com/deviceviewer)
2. Enter the order code or the product root in the respective field.
  - ↳ Once the order code or the product root has been entered, all the suitable spare parts are listed.  
The product status is displayed.  
Available drawings of the spare parts are displayed.
3. Locate the order code of the spare part set (on the product label on the package).
  - ↳ **NOTE!**  
The order code of the spare part set (on the product label on the package) can differ from the production number (on the label directly on the spare part)!
4. Check whether the order code of the spare part set appears in the list of the spare parts displayed:
  - ↳ **YES:** The spare part set may be used for the measuring device.  
**NO:** The spare part set may not be used for the measuring device.  
If you have any questions please contact your Endress+Hauser Service organization.
5. On the **Spare parts** tab click the PDF symbol in the **MH** column.
  - ↳ The Installation Instructions attached to the listed spare part are opened as a PDF file and can also be saved as a PDF file.
6. Click one of the drawings shown on the **Spare part drawings** tab.
  - ↳ The corresponding exploded drawing is opened as a PDF file and can also be saved as a PDF file.

### 10.3 Repairing Ex-certified devices

If repairing Ex-certified devices remember that:

- Ex-certified devices may only be repaired by experienced and skilled staff or by Endress+Hauser Service
- observe all applicable standards, certificates, national Ex-area regulations and all Safety Instructions (XA)
- use only genuine spare parts from Endress+Hauser
- note the device designation on the nameplate to order the spare parts
- replace the component by the same type
- carry out the replacing in accordance with the instructions

- carry out the individual test for the device
- change the device only with a device certificated by Endress+Hauser
- report every change and repair of the device

## 10.4 Replacement

After replacing a probe or the electronic insert, the calibration values must be transferred to the replacement device.

### Options:

- if the probe is replaced, the calibration values in the electronic insert can be transferred to the sensor DAT (EEPROM) module via a manual download
- if the electronic insert is replaced, the calibration values of the sensor DAT (EEPROM) module can be transferred to the electronics via a manual upload

It is possible to restart the device without having to carry out a new calibration.

## 10.5 Return

The requirements for safe device return can vary depending on the device type and national legislation.

1. Refer to the website for more information:  
<http://www.endress.com/support/return-material>
2. Return the device if repairs or a factory calibration are required, or if the wrong device was ordered or delivered.

## 10.6 Disposal

### 10.6.1 Removing the measuring device

1. Switch off the device.

#### **WARNING**

#### **Danger to personnel from process conditions.**

- ▶ Beware of hazardous process conditions such as pressure in the measuring device, high temperatures or aggressive fluids.

2. Carry out the mounting and connection steps from the "Mounting the measuring device" and "Connecting the measuring device" sections in reverse order. Observe the safety instructions.

### 10.6.2 Disposing of the measuring device

#### **WARNING**

#### **Danger to personnel and environment from fluids that are hazardous to health.**

- ▶ Ensure that the measuring device and all cavities are free of fluid residues that are hazardous to health or the environment, e.g. substances that have permeated into crevices or diffused through plastic.

Observe the following notes during disposal:

- ▶ Observe valid federal or national regulations.
- ▶ Ensure proper separation and reuse of the device components.

## 11 Accessories

### 11.1 Shortening kit for FTI52

Order number: 942901-0001

### 11.2 Protective cover

**Protective cover for F13, F17 and F27 housing (without display)**

order number: 71040497

**Protective cover for F16 housing**

order number: 71127760

### 11.3 Surge arresters

#### 11.3.1 HAW562



- For supply lines: BA00302K.
- For signal lines: BA00303K.

#### 11.3.2 HAW569



- For signal lines in field housing: BA00304K.
- For signal or supply lines in field housing: BA00305K.

### 11.4 Weld-in adapter

All available weld-in adapters are described in the document TI00426F.

The documentation is available in the Download section on Endress+Hauser web site:  
[www.endress.com](http://www.endress.com)

## 12 Technical data

### 12.1 Capacitance values of the probe

Basic capacitance: approximately 18 pF.

#### 12.1.1 Additional capacitance

Mount the probe at a minimum distance of 50 mm (1.97 in) from a conductive container wall: approximately 1.0 pF/100 mm (3.94 in) in the air for a rope probe.

Fully insulated probe rope in water: approximately 19 pF/100 mm (3.94 in).

### 12.2 Input

#### 12.2.1 Measuring range

##### Measuring frequency

500 Hz

##### Span

- $\Delta C = 5$  to 1 600 pF
- FEI58:  $\Delta C = 5$  to 500 pF

##### Final capacitance

$C_E =$  maximum 1 600 pF

##### Adjustable initial capacitance

- range 1 - factory setting  
 $C_A = 5$  to 500 pF
- range 2 - not available with FEI58  
 $C_A = 5$  to 1 600 pF

##### The minimum change in capacitance for point level detection

$\geq 5$  pF

#### 12.2.2 Minimum probe length for nonconductive media $< 1 \mu\text{S}/\text{cm}$

The minimum probe length can be calculated using the formula:

$$l_{\min} = \frac{\Delta C_{\min}}{C_s \cdot (\epsilon_r - 1)}$$



A0040204

$l_{\min}$  minimum probe length

$\Delta C_{\min}$  5 pF

$C_s$  probe capacitance in air

$\epsilon_r$  dielectric constant, e.g. oil = 2.0

 To check the probe capacitance in the air, see the chapter "Additional capacitance" →  76.

## 12.3 Output

### 12.3.1 Switch behavior

Binary or  $\Delta s$  operation.

 The pump control is not possible with FEI58.

### 12.3.2 Switch-on behaviour

When the power supply is switched on, the switching status of the outputs corresponds to the signal on the alarm.

The correct switch condition is reached after a maximum of 3 s.

### 12.3.3 Fail-safe mode

Minimum and maximum quiescent current safety can be switched at the electronic insert <sup>2)</sup>.

#### MIN

Minimum safety: the output switches safety-oriented when the probe is uncovered <sup>3)</sup> (signal on alarm).

#### MAX

Maximum safety: the output switches safety-oriented when the probe is covered <sup>4)</sup> (signal on alarm).

### 12.3.4 Galvanic isolation

#### FEI51 and FEI52

between the rope probe and power supply

#### FEI54

between the rope probe, power supply and load

#### FEI53, FEI55, FEI57S and FEI58

see connected switching device <sup>5)</sup>

## 12.4 Performance characteristics

### According to DIN 61298-2

- Uncertainty: maximum  $\pm 0.3$  %
- Non-repeatability: maximum  $\pm 0.1$  %

### 12.4.1 Ambient temperature effect

#### Electronic insert

< 0.06 % per 10 K related to the full-scale value

#### Separate housing

capacitance change of connecting cable per meter 0.15 pF per 10 K

2) For FEI53 and FEI57S only on the associated Nivotester: FTC325.

3) E.g. for dry running protection and pump protection.

4) E.g. for use with overflow protection.

5) Functional galvanic isolation in the electronic insert.

## 12.5 Operating conditions: Environment

### 12.5.1 Ambient temperature range

- F16 housing: -40 to +70 °C (-40 to +158 °F)
- remaining housing: -50 to +70 °C (-58 to +158 °F)
- observe derating
- use a protective cover, when operating outdoors

### 12.5.2 Climate class

DIN EN 60068-2-38/IEC 68-2-38: Z/AD check

### 12.5.3 Vibration resistance

DIN EN 60068-2-64/IEC 68-2-64: 20 to 2 000 Hz, 0.01 g<sup>2</sup>/Hz

### 12.5.4 Shock resistance

DIN EN 60068-2-27/IEC 68-2-27: 30 g acceleration

### 12.5.5 Cleaning

#### Housing:

Make sure that the housing surface and seals are resistant to cleaning agents.

#### Probe:

Depending on the application, buildup of contamination or soiling can form on the probe. A high level of material buildup can affect the measurement result.

The regular cleaning of the probe is recommended if the medium tends to create a high level of buildup.

Make sure that the insulation of the probe is not damaged if hosing down or during mechanical cleaning.

### 12.5.6 Degree of protection

-  All protection degree regarding EN60529.  
Type4X protection degree regarding NEMA250.

#### Polyester housing F16

Protection degree:

- IP66
- IP67
- Type4X

#### Stainless steel housing F15

Protection degree:

- IP66
- IP67
- Type4X

#### Aluminum housing F17

Protection degree:

- IP66
- IP67
- Type4X

**Aluminum housing F13 with gas-tight process seal**

Protection degree:

- IP66
- IP68 <sup>6)</sup>
- Type4X

**Stainless steel housing F27 with gas-tight process seal**

Protection degree:

- IP66
- IP67
- IP68 <sup>6)</sup>
- Type4X

**Aluminum housing T13 with gas-tight process seal and separate connection compartment (Ex d)**

Protection degree:

- IP66
- IP68 <sup>6)</sup>
- Type4X

**Separate housing**

Protection degree:

- IP66
- IP68 <sup>6)</sup>
- Type4X

**12.5.7 Electromagnetic compatibility (EMC)**

Interference emission to EN 61326, Electrical Equipment Class B. Interference immunity to EN 61326, Annex A (Industrial) and NAMUR Recommendation NE 21 (EMC).

A standard commercial instrument cable can be used.

**12.6 Operating conditions: Process****12.6.1 Process temperature range**

The following diagrams apply for:

- insulation
  - PTFE
  - PFA
  - FEP
- standard applications outside hazardous areas

 The temperature is restricted to  $T_a -40\text{ °C}$  ( $-40\text{ °F}$ ) when the polyester housing F16 is used.

6) Only with M20 cable entry or G½ thread.

**Probe with compact housing**

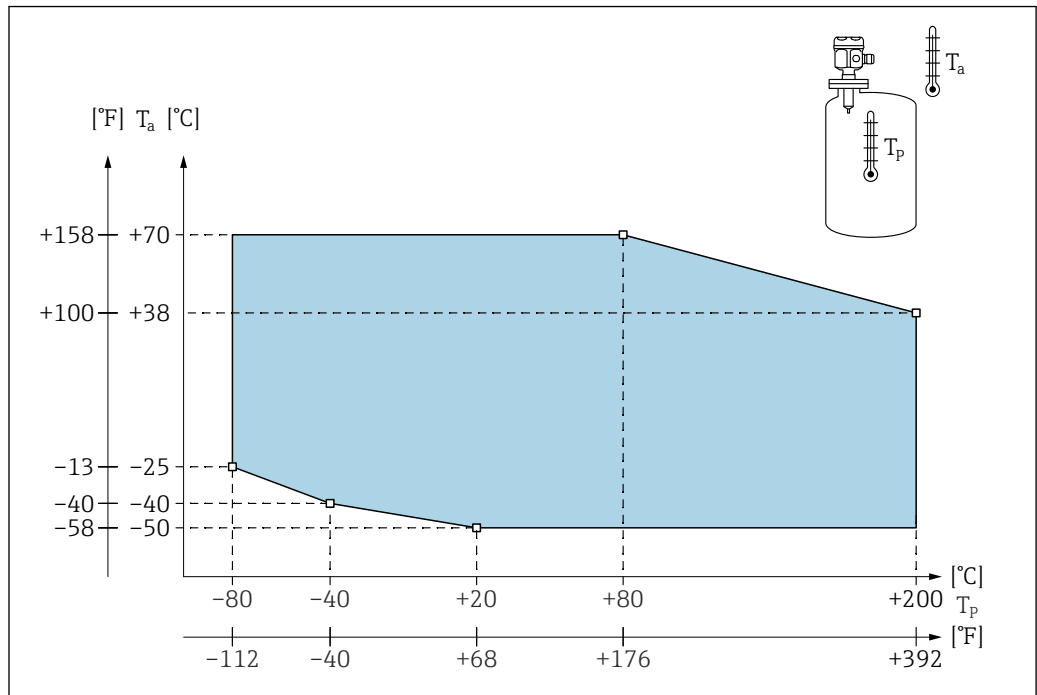

A0043638

58 Process pressure range diagram: probe with compact housing

$T_a$  Ambient temperature

$T_p$  Process temperature



### Probe with separate housing

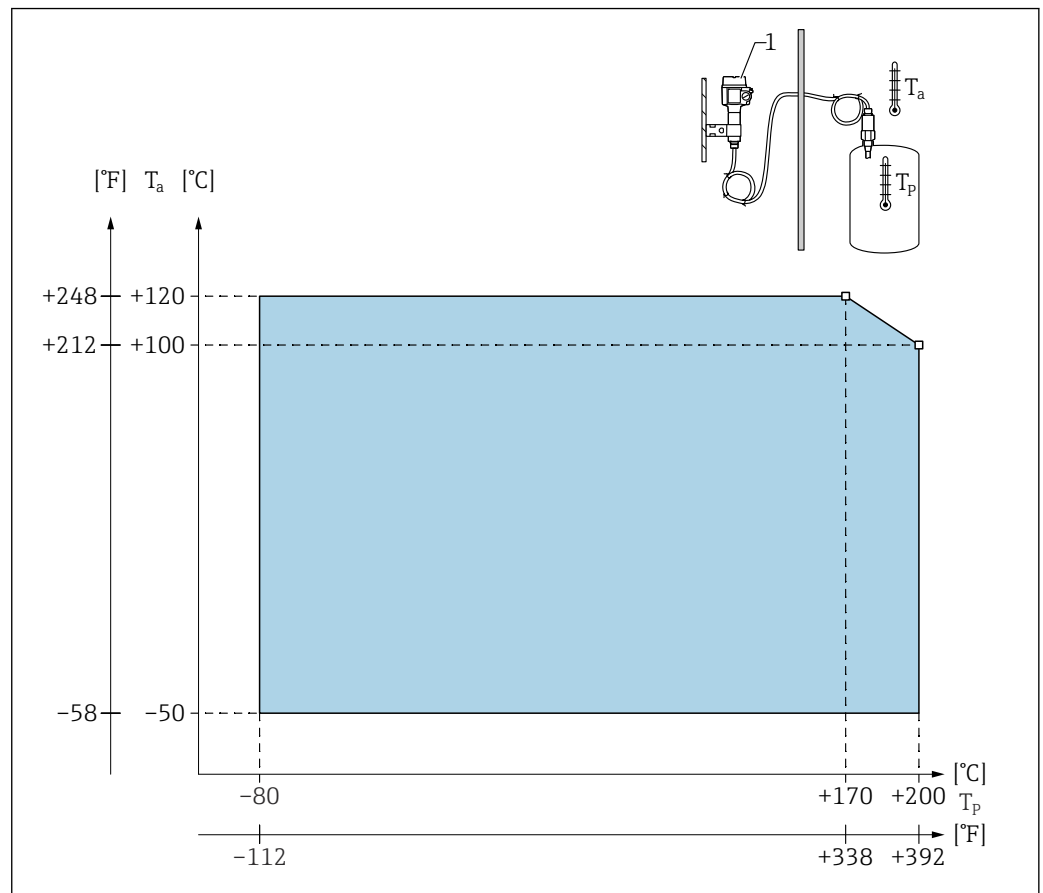

59 Process pressure range diagram: probe with separate housing

$T_a$  Ambient temperature

$T_p$  Process temperature

1 The permitted ambient temperature at the separate housing is the same as indicated for the compact housing.

### Influence of process temperature

Error in case of fully insulated probes typically 0.13 %/K related to the full-scale value.

### 12.6.2 Process pressure limits

**i** The process pressure limits depends on process connections.

**b** See also chapter "Process connections" in TI01521F.

### Rope probe without inactive length or with inactive length in 316L

**i** E+H Configurator settings:

- Feature: 20
- Options: 1, 2, 5
- -1 to 25 bar (-14.5 to 362.5 psi)
- -1 to 100 bar (-14.5 to 1450 psi)
- in regards to an inactive length, the maximum permitted process pressure is 63 bar (913.5 psi)
- for CRN approval and inactive length: the maximum permitted process pressure is 32 bar (464 psi)

**Rope probe with fully insulated inactive length**

**i E+H Configurator settings:**

- Feature: 20
- Options: 3, 6

-1 to 50 bar (-14.5 to 725 psi)

Refer to the following standards for the pressure values permitted at higher temperatures:

- EN 1092-1: 2005 Table, Appendix G2  
With regard to its resistance and temperature property, the material 1.4435 is identical to 1.4404 (AISI 316L) which is grouped under 13E0 in EN 1092-1 Tab. 18. The chemical composition of the two materials can be identical.
- ASME B 16.5a - 1998 Tab. 2-2.2 F316
- ASME B 16.5a - 1998 Tab. 2.3.8 N10276
- JIS B 2220

The lowest value from the derating curves of the device and the selected flange applies.

**12.6.3 Pressure and temperature derating**

For rope probes without inactive length or with inactive length in 316L, process connections ¾", 1", flanges <DN50, <ANSI 2", <JIS 10K and process connections ¾", 1", flanges <DN50, <ANSI 2", <JIS 10K

Rope insulation: FEP, PFA

**i E+H Configurator settings:**

- Feature: 20
- Options: 1, 2, 5

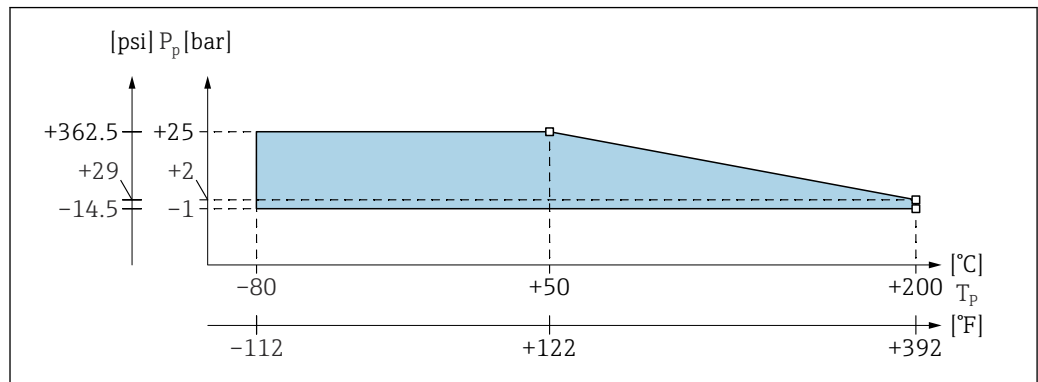

60 Pressure and temperature derating diagram for rope probes without inactive length or with inactive length

$P_p$  Process pressure  
 $T_p$  Process temperature

**For rope probes without inactive length or with inactive length in 316L, process connections 1½", flanges ≥DN50, ≥ANSI 2", ≥JIS 50A**

Rope insulation: FEP, PFA

**i E+H Configurator settings:**

- Feature: 20
- Options: 1, 2, 5

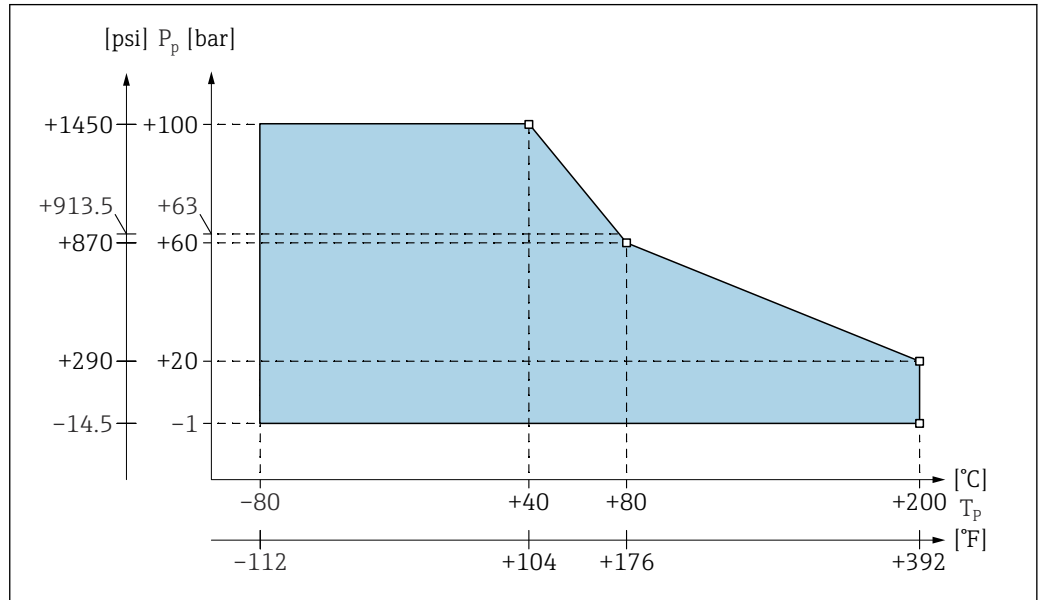

A0043641

**61** Pressure and temperature derating diagram for rope probes without inactive length or with inactive length

$P_p$  Process pressure

$T_p$  Process temperature

63 Process pressure for probes with an inactive length

**For rope probe with a fully insulated inactive length**

Rope insulation: FEP, PFA

**i E+H Configurator settings:**

- Feature: 20
- Options: 3, 6

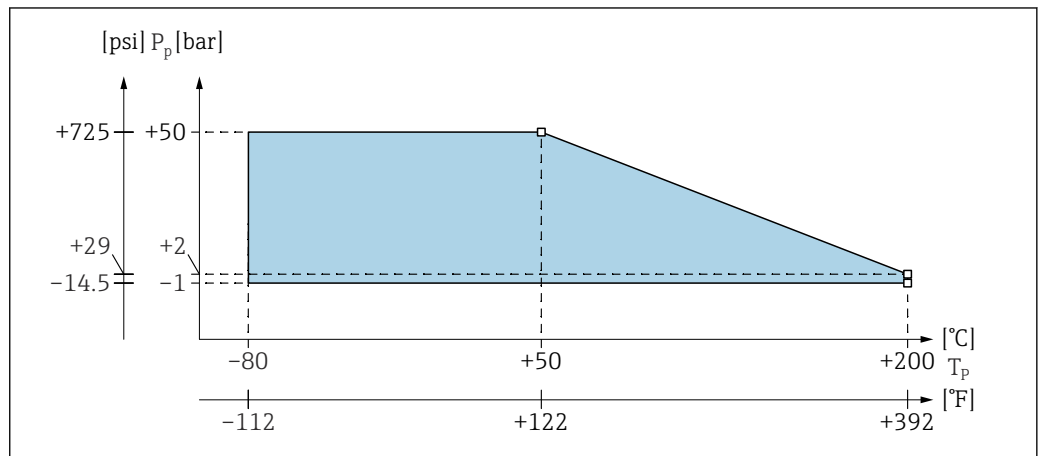

A0043642

**62** Pressure and temperature derating diagram for fully insulated inactive length rope probes

$P_p$  Process pressure

$T_p$  Process temperature

# Index

## A

About this document	5
Accessories	75
Additional capacitance	76
Aligning the housing	22
Ambient temperature effect	77
Ambient temperature range	78

## B

Basic safety instructions	9
---------------------------	---

## C

Cable entry	24
Cable specification	23
Carrying out empty calibration	39
CE mark	9
Cleaning the probe	72, 78
Climate class	78
Commissioning	38
Conical threads	21
Connecting requirements	23
Connection compartment	24
Connector	23
Cylindrical threads	21

## D

Declaration of Conformity	9
Degree of protection	78
Device documentation	
Supplementary documentation	7
Diagnostics and troubleshooting	
and troubleshooting	67
Disposal	74
Document	
Function	5
Document conventions	5
Document function	5

## E

Electrical connection	23
Electromagnetic compatibility	79
Endress+Hauser services	
Repair	72
Environment	78
Ex-area	
Explosive area	9
Extension heights: separate housing	15
External cleaning	72

## F

Fail-safe mode	77
Firmware history	70

## G

Galvanic isolation	77
--------------------	----

## I

Incoming acceptance	10
Input	76
Installation and function check	38
Installation examples	12
Installation instructions	20

## M

M12 connector	24
Maintenance	72
Measuring condition	11
Measuring device	
Conversion	73
Disposal	74
Removing	74
Repairs	73
Measuring range	76
Minimum probe length for nonconductive media	76
Mounting	11
Mounting requirements	11
Mounting the sensor	11

## N

Nameplate	10
-----------	----

## O

Operating conditions	78
Operating conditions: Process	79
Operation options	34
Operational safety	9
Output	77

## P

Performance characteristics	77
Pipe mounting	17
Post-connection check	33
Post-installation check	22
Potential equalization	23
Pressure and temperature derating	82
Probe installation	21
Probe with PTFE-clad flange	21
Probe with separate housing	14
Probe with Tri-Clamp	21
Process pressure limits	81
Process temperature range	79
Product identification	10
Product safety	9
Protective cover	75

## R

Registered trademarks	8
Repair	73
Repairing Ex-certified devices	73
Replacement	74
Device components	73
Requirements for the personnel	9
Return	74

**S**

Sealing the probe housing . . . . .	22
Setting the measuring range . . . . .	38
Shock resistance . . . . .	78
Shortening the connecting cable . . . . .	17
Spare parts . . . . .	73
Storage . . . . .	10
Surge arrester . . . . .	75
Switch behavior . . . . .	77
Switch-on behaviour . . . . .	77
Symbols for certain types of information and graphics . . . . .	6

**T**

Technical data . . . . .	76
Transport . . . . .	10
Two-point control Buildup mode . . . . .	45

**V**

Vibration resistance . . . . .	78
--------------------------------	----

**W**

Wall bracket . . . . .	16
Wall mounting . . . . .	16
Weld-in adapter . . . . .	75
Wiring and connecting . . . . .	24
Workplace safety . . . . .	9







71673375

[www.addresses.endress.com](http://www.addresses.endress.com)

---