

Operating Instructions

Solicap M

FTI56

Capacitance
Point level switch for bulk solids





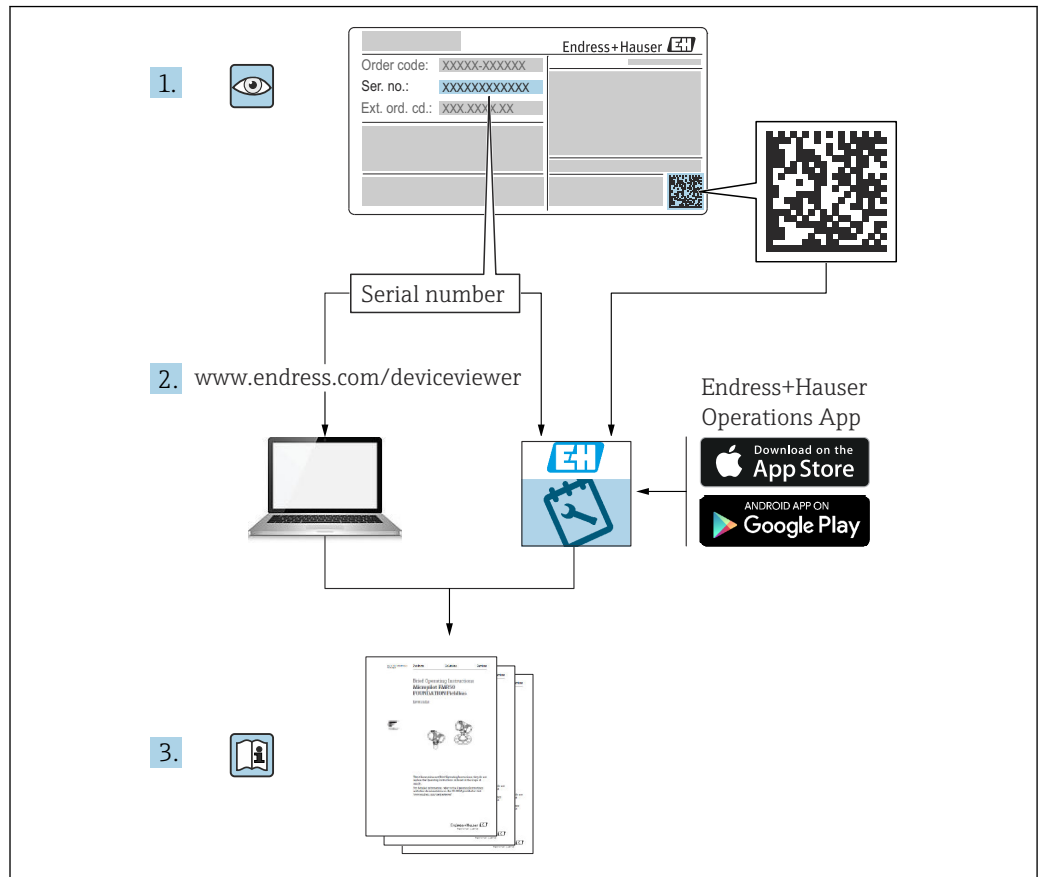

Related documents



A0023555

Table of contents

1	About this document	5	5.3	Connecting the measuring device	28
1.1	Document function	5	5.3.1	2-wire AC electronic insert FEI51	28
1.2	Symbols	5	5.3.2	DC PNP electronic insert FEI52	29
1.2.1	Safety symbols	5	5.3.3	3-wire electronic insert FEI53	30
1.2.2	Electrical symbols	5	5.3.4	AC and DC with relay output electronic insert FEI54	31
1.2.3	Tool symbols	5	5.3.5	SIL2 / SIL3 electronic insert FEI55	33
1.2.4	Symbols for certain types of information and graphics	6	5.3.6	PFM electronic insert FEI57S	34
1.3	Documentation	7	5.3.7	NAMUR electronic insert FEI58	35
1.3.1	Supplementary device-dependent documentation	7	5.4	Post-connection check	36
2	Basic safety instructions	8	6	Operation options	37
2.1	Requirements for the personnel	8	6.1	Human interface and display elements for FEI51, FEI52, FEI54, FEI55	37
2.2	Intended use	8	6.2	Human interface and display elements for FEI53, FEI57S	38
2.3	Workplace safety	8	6.3	Human interface and display elements for FEI58	39
2.4	Operational safety	8	7	Commissioning	41
2.4.1	Ex-area	8	7.1	Installation and function check	41
2.5	Product safety	8	7.2	Commissioning the electronic inserts FEI51, FEI52, FEI54 and FEI55	41
3	Incoming acceptance and product identification	9	7.2.1	Setting the measuring range	41
3.1	Incoming acceptance	9	7.2.2	 Carrying out empty calibration	42
3.2	Product identification	9	7.2.3	 Carrying out full calibration	43
3.2.1	Nameplate	9	7.2.4	Carrying out empty and full calibration	44
3.2.2	Manufacturer address	9	7.2.5	Reset: Calibration and switch-point adjustment	46
3.3	Storage and transport	9	7.2.6	Setting the switch point adjustment	47
4	Mounting	10	7.2.7	Configuring two-point control and buildup mode	48
4.1	Mounting requirements	10	7.2.8	 Setting the switching delay	50
4.1.1	General notes and precautions	10	7.2.9	 Activating the self-test	51
4.1.2	Mounting the sensor	11	7.2.10	Setting the MIN, MAX and SIL fail- safe mode	53
4.1.3	Range of sensor lengths	15	7.2.11	Restoring factory settings	57
4.1.4	Rope shortening	15	7.2.12	 Upload and download sensor DAT (EEPROM)	58
4.1.5	Measuring conditions	16	7.2.13	Output signals	60
4.1.6	Installation instructions	17	7.3	Commissioning with electronic inserts FEI53 or FEI57S	61
4.2	Probe with separate housing	19	7.3.1	Setting the alarm response if the measuring range is exceeded	62
4.2.1	Extension heights: separate housing	19	7.3.2	Setting the measuring range	62
4.2.2	Wall bracket	20	7.3.3	Output signals	63
4.2.3	Wall mounting	21	7.4	Commissioning with the electronic insert FEI58	63
4.2.4	Pipe mounting	21	7.4.1	Function keys A, B, C	64
4.2.5	Shortening the connecting cable	22	7.4.2	Performing calibration	64
4.3	Post-installation check	24	7.4.3	Setting the switch point adjustment	66
5	Electrical connection	26	7.4.4	Setting the switching delay	67
5.1	Connecting requirements	26	7.4.5	MIN and MAX fail-save mode	67
5.1.1	Potential equalization	26			
5.1.2	Cable specification	26			
5.1.3	Connector	26			
5.1.4	Cable entry	27			
5.2	Wiring and connecting	27			
5.2.1	Connection compartment	27			

7.4.6	Display calibration situation	68	12.5	Operating conditions: Process	82
7.4.7	Displaying the diagnostic code	68	12.5.1	Process temperature range	82
7.4.8	Test key C	68	12.5.2	Process pressure and temperature derating	83
7.4.9	Output signals	69	12.5.3	Temperature-derating separate housing	84
8	Diagnostics and troubleshooting	70	Index	86	
8.1	Activating fault diagnostics FEI51, FEI52, FEI54 and FEI55	70			
8.2	Fault diagnostics FEI53 and FEI57S	72			
8.3	Activating fault diagnostics FEI58	72			
8.4	Firmware history	73			
9	Maintenance	75			
9.1	External cleaning	75			
9.2	Cleaning the probe	75			
9.3	Seals	75			
9.4	Endress+Hauser services	75			
10	Repair	76			
10.1	General notes	76			
10.2	Spare parts	76			
10.3	Repairing Ex-certified devices	76			
10.4	Replacement	77			
10.5	Return	77			
10.6	Disposal	77			
	10.6.1 Removing the measuring device	77			
	10.6.2 Disposing of the measuring device	77			
11	Accessories	78			
11.1	Protective cover	78			
11.2	Seal set for stainless steel housing	78			
11.3	Surge arresters	78			
	11.3.1 HAW562	78			
	11.3.2 HAW569	78			
11.4	Technical information	78			
12	Technical data	79			
12.1	Input	79			
	12.1.1 Measuring range	79			
12.2	Output	79			
	12.2.1 Switch behavior	79			
	12.2.2 Switch-on behaviour	79			
	12.2.3 Fail-safe mode	79			
	12.2.4 Galvanic isolation	80			
12.3	Performance characteristics	80			
	12.3.1 Ambient temperature effect	80			
12.4	Operating conditions: Environment	80			
	12.4.1 Ambient temperature range	80			
	12.4.2 Climate class	80			
	12.4.3 Vibration resistance	80			
	12.4.4 Shock resistance	80			
	12.4.5 Cleaning	80			
	12.4.6 Degree of protection	81			
	12.4.7 Electromagnetic compatibility (EMC)	81			

1 About this document

1.1 Document function

These Operating Instructions contain all the information required in the various life cycle phases of the device: from product identification, incoming acceptance and storage, to installation, connection, operation and commissioning, through to troubleshooting, maintenance and disposal.

1.2 Symbols

1.2.1 Safety symbols

DANGER

This symbol alerts you to a dangerous situation. Failure to avoid this situation will result in serious or fatal injury.

WARNING

This symbol alerts you to a dangerous situation. Failure to avoid this situation can result in serious or fatal injury.

CAUTION

This symbol alerts you to a dangerous situation. Failure to avoid this situation can result in minor or medium injury.

NOTICE

This symbol contains information on procedures and other facts which do not result in personal injury.

1.2.2 Electrical symbols



Alternating current



Direct current and alternating current



Direct current



Ground connection

A grounded terminal which, as far as the operator is concerned, is grounded via a grounding system.

Protective earth (PE)

Ground terminals that must be connected to ground prior to establishing any other connections.

The ground terminals are located on the interior and exterior of the device:

- Interior ground terminal: protective earth is connected to the mains supply.
- Exterior ground terminal: device is connected to the plant grounding system.

1.2.3 Tool symbols



Phillips head screwdriver



Flat blade screwdriver



Torx screwdriver



Allen key



Open-ended wrench

1.2.4 Symbols for certain types of information and graphics



Permitted

Procedures, processes or actions that are permitted



Preferred

Procedures, processes or actions that are preferred

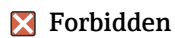

Forbidden

Procedures, processes or actions that are forbidden



Tip

Indicates additional information



Reference to documentation



Reference to page



Reference to graphic



Notice or individual step to be observed

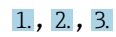

Series of steps



Result of a step



Help in the event of a problem



Visual inspection



Operation via operating tool



Write-protected parameter

1, 2, 3, ...

Item numbers

A, B, C, ...

Views



Hazardous area

Indicates the hazardous area

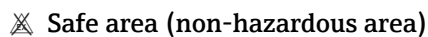

Safe area (non-hazardous area)

Indicates the non-hazardous area



Safety instructions

Observe the safety instructions contained in the associated Operating Instructions

**Temperature resistance of the connection cables**

Specifies the minimum value of the temperature resistance of the connection cables



LED not lit



LED lit



LED flashes

1.3 Documentation

All available documents can be downloaded using:

- the serial number of the device (see cover page for description) or
- the data matrix code of the device (see cover page for description) or
- the "Downloads" area of the website www.endress.com

1.3.1 Supplementary device-dependent documentation

Additional documents are supplied depending on the device version ordered: Always comply strictly with the instructions in the supplementary documentation. The supplementary documentation is an integral part of the device documentation.

2 Basic safety instructions

2.1 Requirements for the personnel

The personnel must fulfill the following requirements to carry out the necessary tasks:

- ▶ Are trained and qualified to perform specific functions and tasks.
- ▶ Are authorized by the plant owner or operator to perform specific tasks.
- ▶ Are familiar with federal or national regulations.
- ▶ Have read and understood the instructions in the manual and supplementary documentation.
- ▶ They follow instructions and comply with conditions.

2.2 Intended use

The Solicap M FTI56 is a compact point level switch devices for capacitive level limit detection in bulk solids.

2.3 Workplace safety

For work on and with the device:

- ▶ Wear the required protective equipment according to federal or national regulations.

2.4 Operational safety

When performing configuration, testing, and maintenance work on the device, alternative supervisory measures must be taken to guarantee the operational safety and process safety.

2.4.1 Ex-area

When using the measuring system in Ex-areas, the appropriate national standards and regulations must be observed. Separate Ex-documentation, which constitutes an integral part of this documentation, is supplied with the device. The installation procedures, connection data and safety instructions it contains must be observed.

- Make sure that the technical staff has adequate training.
- The special measuring and safety-related requirements for the measuring points must be observed.

2.5 Product safety

This measuring device is designed following good engineering practice to meet state-of-the-art safety requirements, has been tested, and left the factory in a condition in which it is safe to operate.

It meets general safety standards and legal requirements. It is compliant with the EC directives listed in the device-specific EC Declaration of Conformity. Endress+Hauser confirms this by affixing the CE mark to the device.

3 Incoming acceptance and product identification

3.1 Incoming acceptance

Check whether the packaging or content is damaged. Check that the goods delivered are complete and compare the scope of delivery with the information in your order.

3.2 Product identification

3.2.1 Nameplate

Different nameplates are used depending on the device version.

The nameplates contain the following information:

- Manufacturer name and device name
- Address of the certificate holder and country of manufacture
- Order code and serial number
- Technical data
- Approval-specific information

Compare the data on the nameplate with your order.

3.2.2 Manufacturer address

Endress+Hauser SE+Co. KG
Hauptstraße 1
79689 Maulburg, Germany

Place of manufacture: See nameplate.

3.3 Storage and transport

For storage and transportation, pack the device to protect it against impact. The original packing offers the best protection for this. The permitted storage temperature is -50 to +85 °C (-58 to +185 °F).

4 Mounting

4.1 Mounting requirements

4.1.1 General notes and precautions

NOTICE**Filling the silo.**

- ▶ The filling stream must not be directed onto the probe.

NOTICE**Angle of material flow.**

- ▶ Take care to the expected angle of the material flow and the outlet funnel when determining the mounting location or probe length.

NOTICE**Distance between probes.**

- ▶ The minimum distance of 500 mm (19.7 in) between the probes must be observed.

NOTICE**Threaded coupling for mounting.**

- ▶ The threaded coupling must be as short as possible. Condensation or product residue can occur in a long threaded coupling and interfere with the correct operation of the probe.

NOTICE**Heat insulation**

- ▶ Insulate the external silo wall to avoid exceeding the permitted temperature of the Solicap M housing.
- ▶ Insulate the silo wall to prevent the condensation and reduce buildup in the threaded coupling area.

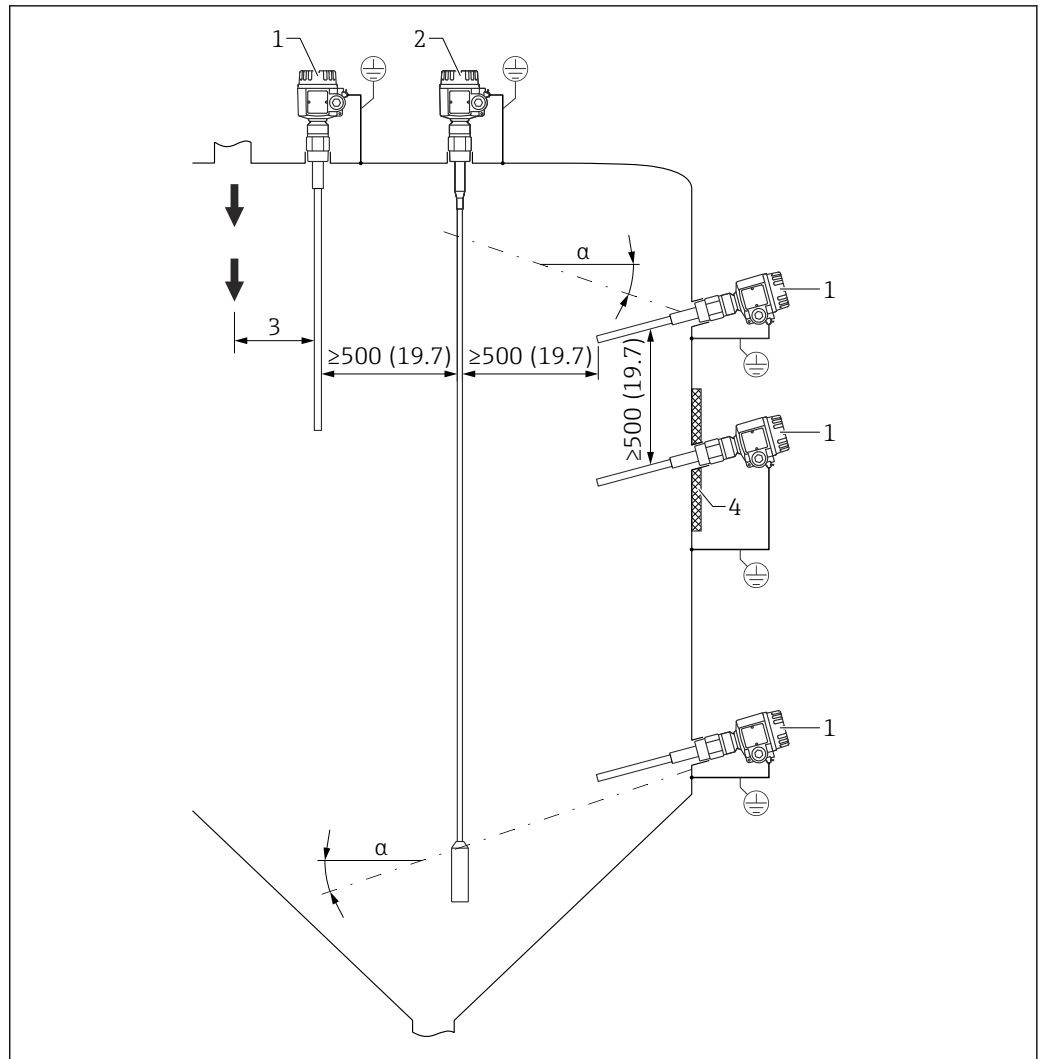

A0043999

1 Mounting examples. Unit of measurement mm (in)

α Angle of the slope

1 FTI55

2 FTI56

3 Distance from the loading point

4 Heat insulation

4.1.2 Mounting the sensor

NOTICE

Mounting the probe rope in the loading curtain area can cause an incorrect device operation!

- Mount the probe away from the loading curtain.

NOTICE

The probe rope cannot touch the metal container wall!

- Make sure that the probe rope is insulated from the metal container wall.

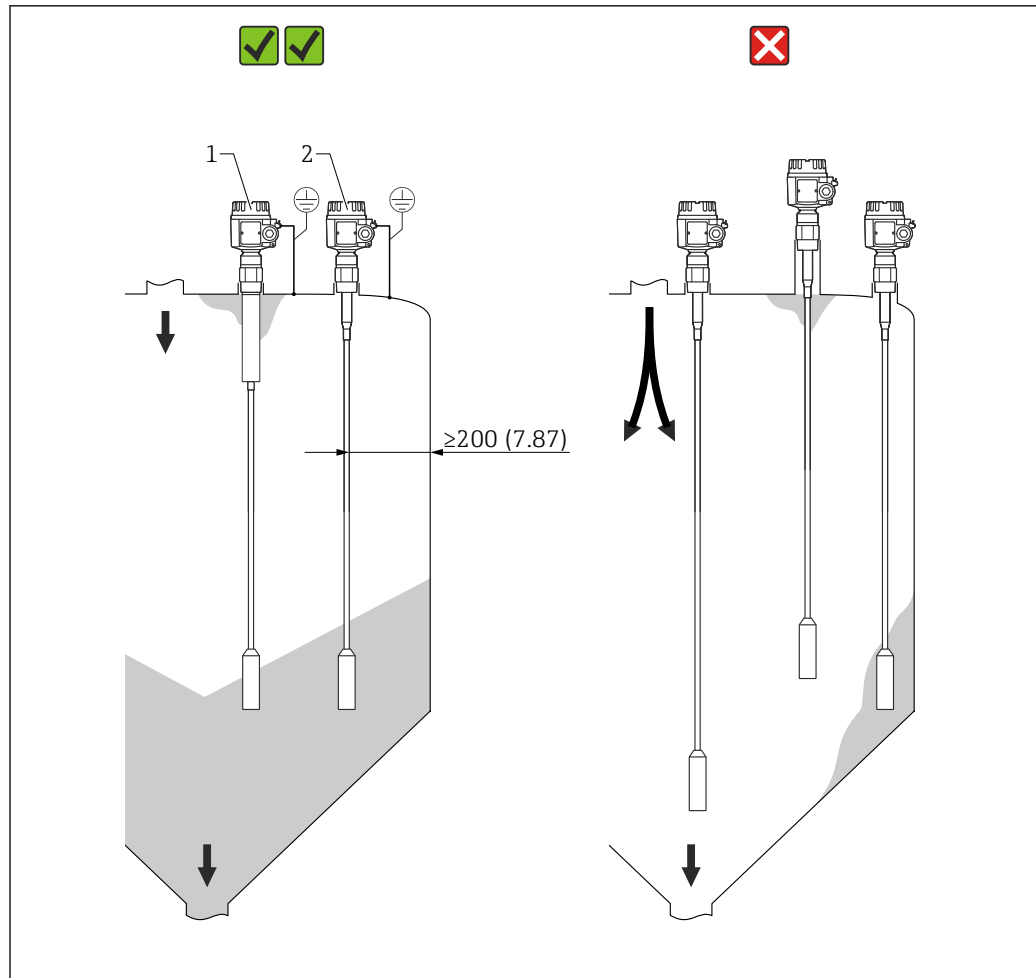

2 Mounting examples. Unit of measurement mm (in)

- 1 FTI56 with inactive length in the event of condensation and material buildup
 2 The correct distance from the silo wall, the material inlet and the material outlet

Silo roof

Ensure that the silo roof is of a sufficiently stable construction. High tensile forces can occur when material is being extracted, particularly in the case of heavy and powdery bulk solids which have a tendency to form buildup.

Coarse-grained bulk solids

In silos with extremely coarse-grained or extremely abrasive bulk solids, the use of a Solicap M FTI56 is recommended only for maximum detection.

Distance between the rope probes

To rule out mutual probe interference, you must maintain a minimum distance of 0.5 m between the rope probes. This also applies if you are installing several Solicap M units in adjacent silos with nonconductive walls.

Installation in the case of condensation

Use the Solicap M with inactive length. The inactive length prevents moisture and buildup forming between the active part of the probe and the silo roof.

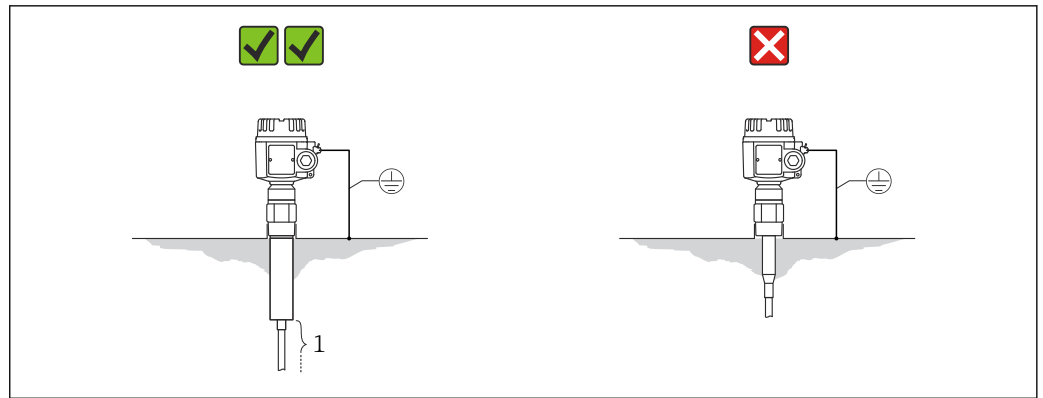

A0044005

3 Silo with walls that conduct electricity

1 Active part of the probe

The threaded coupling must be projected into the silo to reduce the effects of condensation and buildup. The maximum thread length is 25 mm (0.98 in).

Heat insulation reduces condensation and therefore buildup on the steel plate.

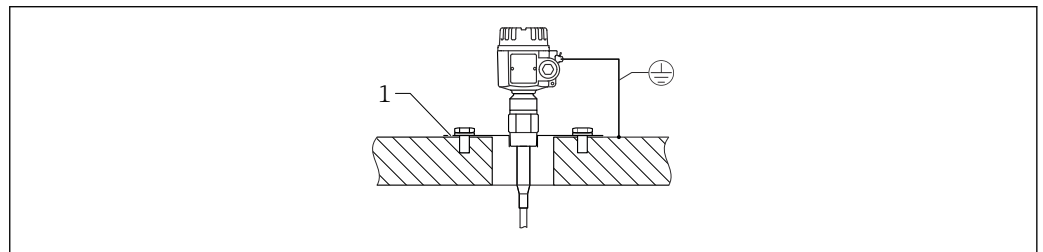

A0044006

4 Mounting in the concrete silo wall

1 Steel plate connected to the reinforcing steel

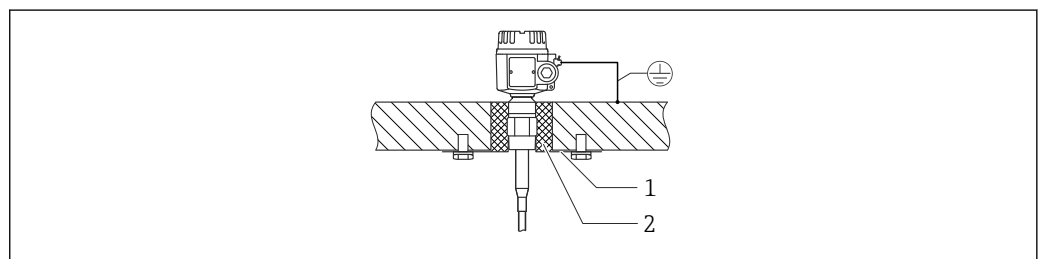

A0044007

5 Mounting in the concrete silo wall in case of condensation

1 Steel plate

2 Heat insulation

Installation in plastic tanks

If installing in a silo made of plastic, a counter electrode must be mounted on the silo exterior at the same height as the tensioning weight. The length of the edge of the metal counter electrode should be approximately the same length as the distance between the tensioning weight and the silo wall.

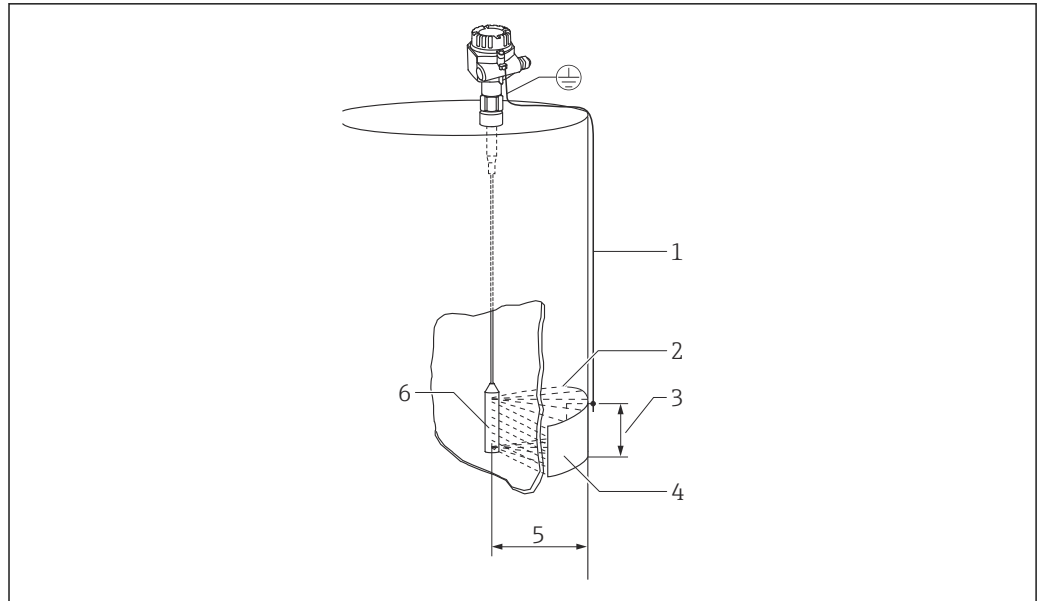

A0044009

6 Mounting the probe in plastic tanks

- 1 Ground connection
- 2 Electrical HF field
- 3 Surface area e.g. 1 m² (10.7 ft²)
- 4 Metal counter electrode
- 5 Distance of 1 m (3.3 ft)
- 6 Tensioning weight

4.1.3 Range of sensor lengths

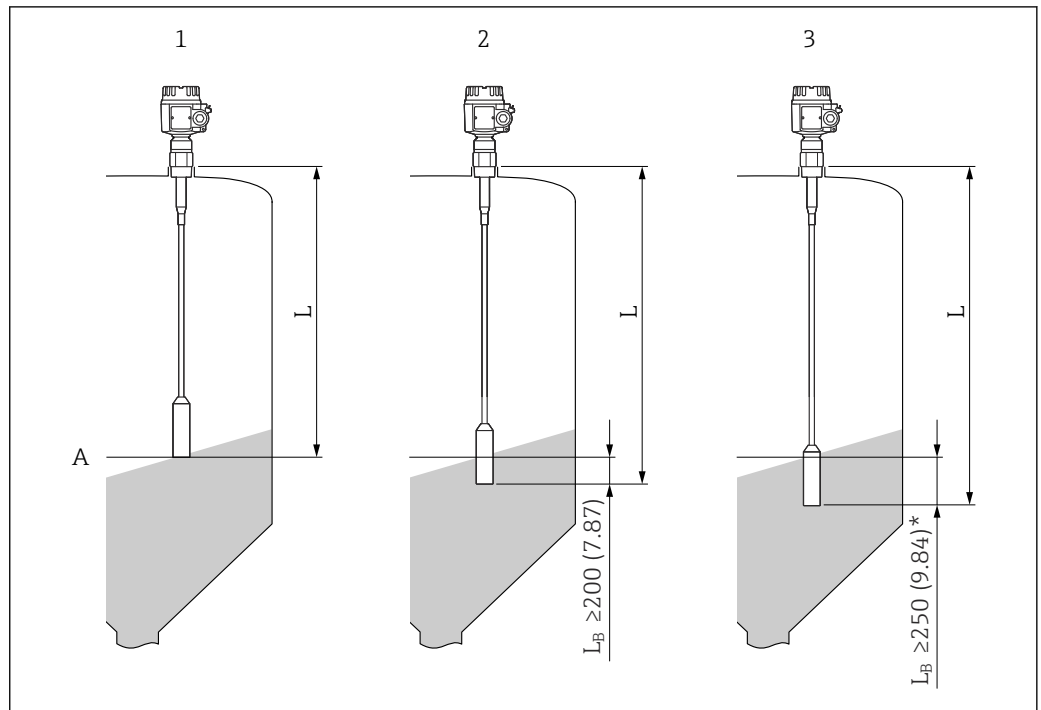

7 Rope length in correlation with the material. Unit of measurement mm (in)

A Level

L_B Covered length

1 Rope length (L) for electrically conductive bulk solids, e.g. coal

2 Rope length (L) for bulk solids with high dielectric constant, e.g. rock salt

3 Rope length (L) for bulk solids with low dielectric constant, e.g. dried grain

i The covered length (L_B) must be 5 % longer than the distance between the tank roof and the limit level, and no shorter than 250 mm (9.84 in) for non-conductive bulk solids with a low dielectric constant (ϵ_r).

4.1.4 Rope shortening

Both versions of the rope probes can be shortened. The weight must be removed from the rope first.

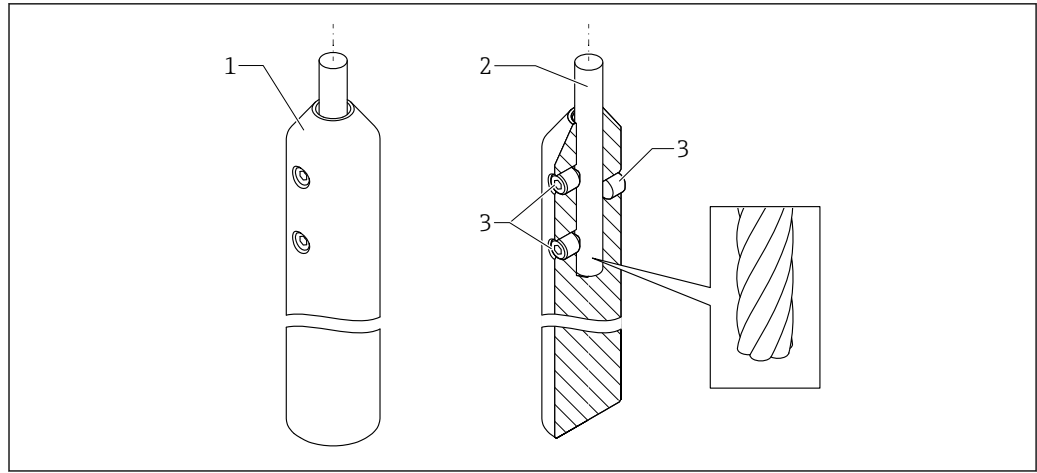

A0044101

8 The tension weight overview

- 1 The tension weight
- 2 The rope
- 3 The locking screws

The rope shortening procedure

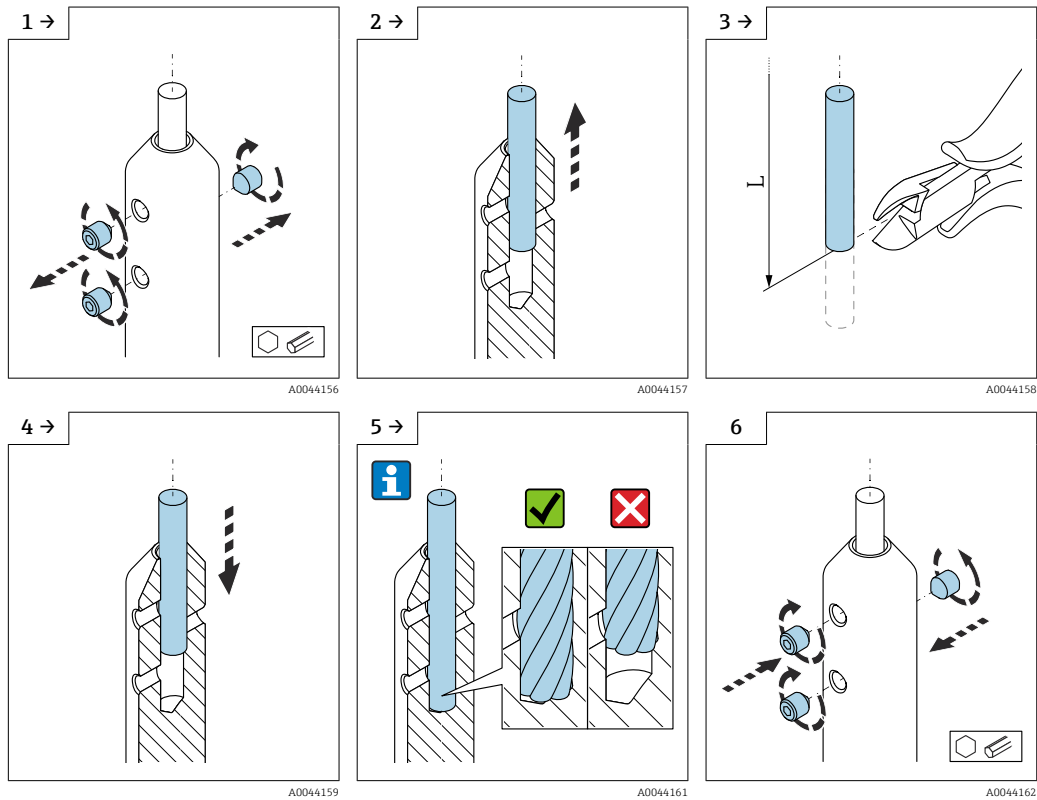

A0044156

A0044157

A0044158

A0044159

A0044161

A0044162

4.1.5 Measuring conditions

When installing in a nozzle, use inactive length L3. The rope probes can be used to control a screw conveyor (Δs mode). The on-value and off-value are determined by the empty and full calibration. Partially insulated probes are only suitable for nonconductive bulk solids.

- $DK > 10$: measuring range up to 4 m (13 ft)
- $5 < DK < 10$: measuring range up to 12 m (39 ft)
- $2 < DK < 5$: measuring range up to 20 m (66 ft)

The minimum capacitance change for point level detection must be ≥ 5 pF.

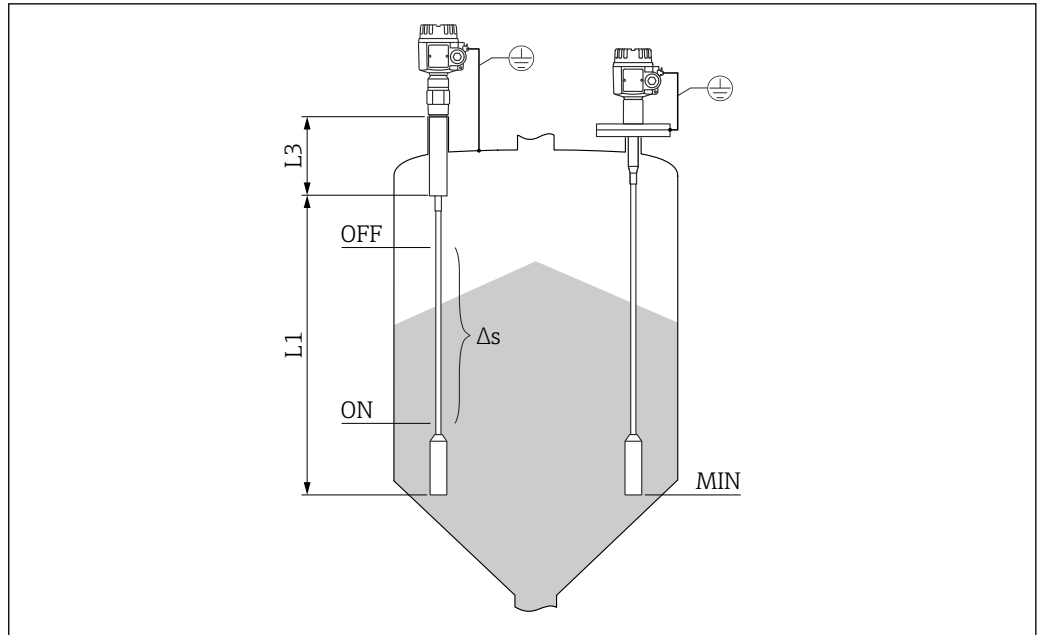

A0043997

9 Measuring conditions

- L1 Active length
- L3 Inactive length
- Δs Two-point control
- MIN Minimum measuring level

Minimum probe length for nonconductive media < 1 μS/cm

The minimum probe length can be calculated using the formula:

$$l_{\min} = \frac{\Delta C_{\min}}{C_s \cdot (\epsilon_r - 1)}$$

A0040204

l_{\min}	minimum probe length
ΔC_{\min}	5 pF
C_s	probe capacitance in air
ϵ_r	relative dielectric constant, e.g. for dried grain = 3.0

4.1.6 Installation instructions

NOTICE

Do not damage the probe insulation during installation!

- ▶ Check the rope insulation.

NOTICE

Do not screw the probe using the probe housing!

- ▶ Use an open-end wrench to screw the probe.

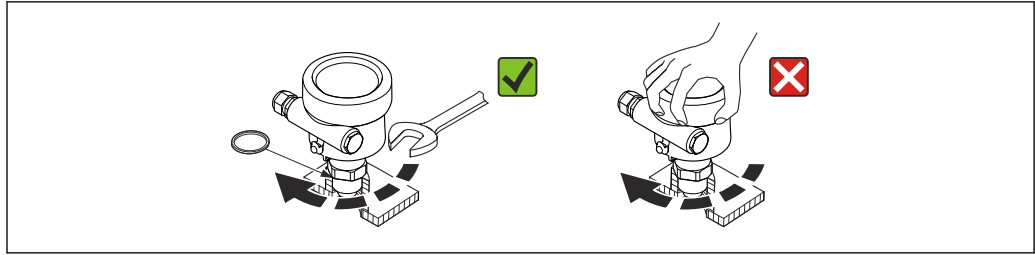

A0040476

10 Proper probe installation

Aligning the housing

The housing can be rotated 270° to align the cable entry. To prevent moisture penetration, route the connecting cable downwards in front of the cable gland and secure it with a cable tie. This is particularly recommended for outdoor mounting.

Aligning the housing

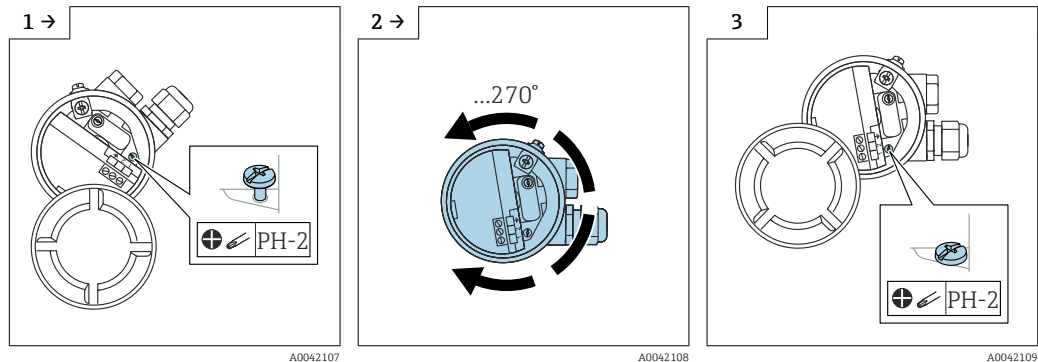

A0042107

A0042108

A0042109

▶ Loosen the clamping screw.

▶ Align the housing into the needed position.

▶ Tighten the clamping screw with torque < 1 Nm (0.74 lbf ft).

i The clamping screw for aligning the housing type T13 is located in the electronics compartment.

Sealing the probe housing

Make sure that the cover is sealed. Water cannot enter into the device when performing installation, connection and configuration tasks. Always seal the housing cover and cable entries securely.

The O-ring seal on the housing cover is shipped with a coat of special lubricant applied. In this way, the cover can be sealed tight and the aluminum thread does not bite when screwing down.

Never use mineral oil-based grease as this destroys the O-ring.

4.2 Probe with separate housing

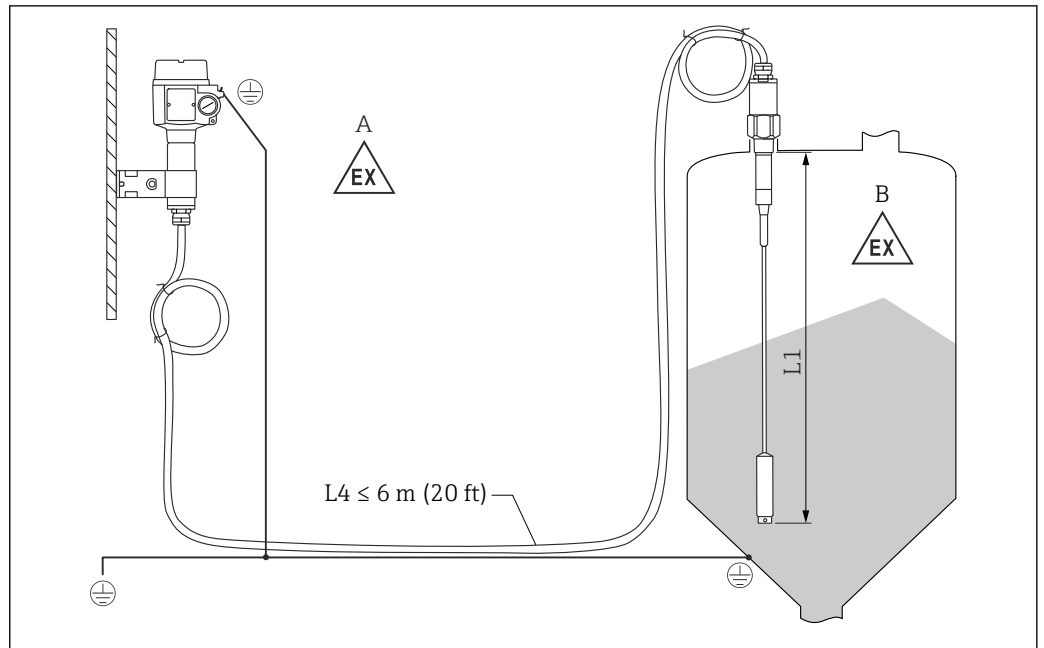

11 Connection of the probe and separate housing

- A Explosive zone 1
- B Explosive zone 0
- L1 Rope length: max. 19.7 m (65 ft)
- L4 Cable length

The maximum cable length L4 and rope length L1 cannot exceed 20 m (66 ft).

- i** The maximum cable length between the probe and separate housing is 19.7 m (65 ft).
 - The required cable length must be indicated in the ordering process of a Liquicap M with separate housing.
 - If the cable connection has to be shortened or led through a wall, then it must be separated from the process connection.

4.2.1 Extension heights: separate housing

- i** The cable has:
 - a minimum bending radius of $r \geq 100 \text{ mm (3.94 in)}$
 - $\varnothing 10.5 \text{ mm (0.14 in)}$
 - outer jacket made of silicone, notch resistance

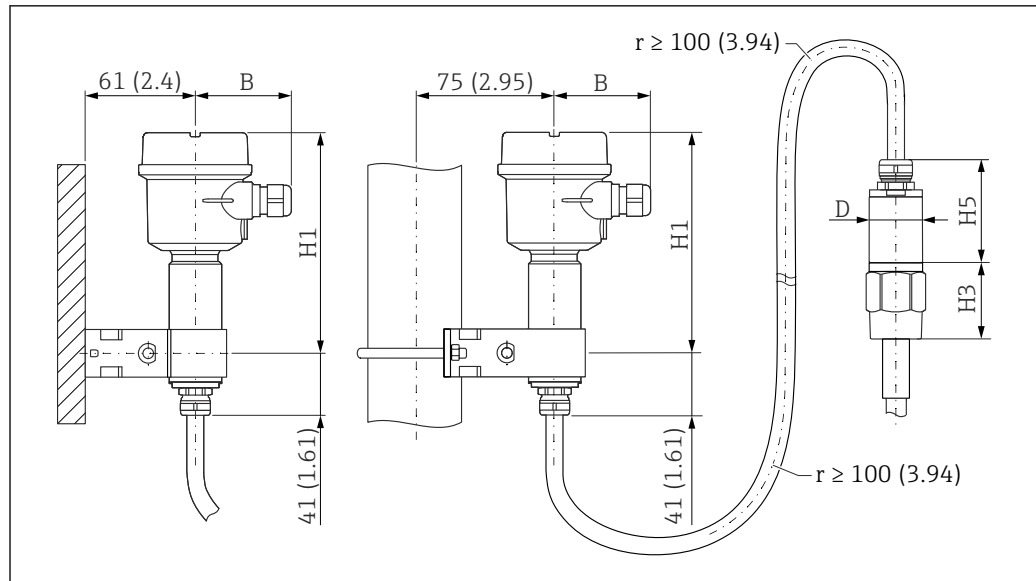

A0044370

12 Housing side: wall mounting, pipe mounting, and sensor side. Unit of measurement mm (in)

Values of parameters ¹⁾:

B parameter

- polyester housing (F16): 76 mm (2.99 in)
- stainless steel housing (F15): 64 mm (2.52 in)
- aluminum housing (F17): 65 mm (2.56 in)

H1 parameter

- polyester housing (F16): 172 mm (6.77 in)
- stainless steel housing (F15): 166 mm (6.54 in)
- aluminum housing (F17): 177 mm (6.97 in)

D parameter

∅ 50 mm (1.97 in)

H5 parameter

∅62 mm (2.44 in)

H3 parameter value

The height H3 depends on the type of process connection.

4.2.2 Wall bracket

- i** The wall bracket is a part of the scope of delivery.
- To use the wall bracket as a drill template, the wall bracket must be first screwed to the separate housing.
- The distance between the holes is reduced by screwing it to the separate housing.

1) See parameters on the drawings.

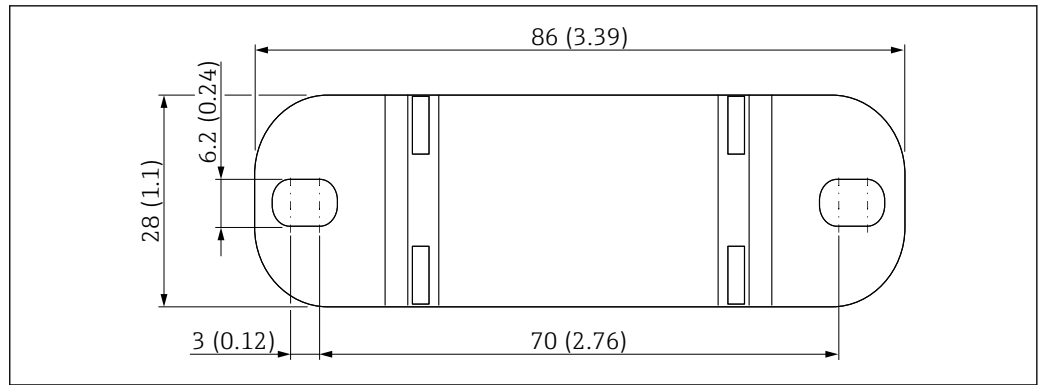

A0033881

13 Wall bracket overview. Unit of measurement mm (in)

4.2.3 Wall mounting

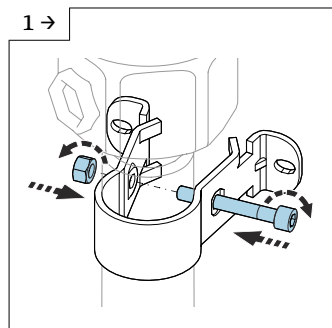

A0042318

- ▶ Screw together the wall bracket on the tube.

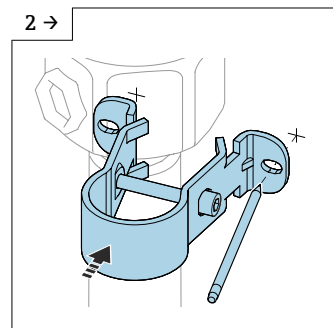

A0042319

- ▶ Mark the distance between the holes on the wall before drilling.

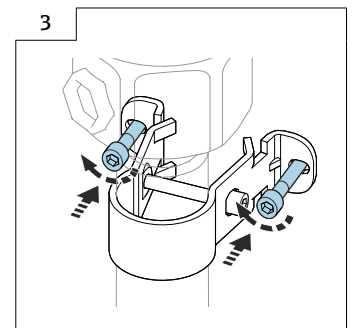

A0042320

- ▶ Screw the separate housing on the wall.

4.2.4 Pipe mounting

i The maximum pipe diameter is 50.8 mm (2 in).

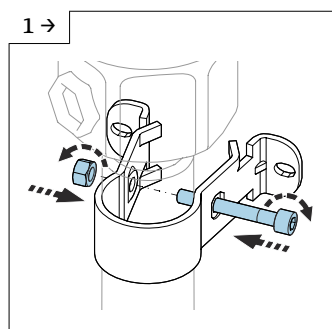

A0042318

- ▶ Screw together the wall bracket on the tube.

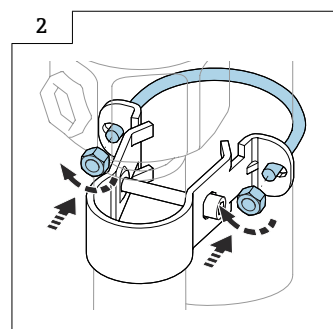

A0042321

- ▶ Screw the separate housing on a pipe.

4.2.5 Shortening the connecting cable

NOTICE

Risk of damage to connections and cable.

- ▶ Make sure that neither the connecting cable nor the probe is turning with the pressing screw!

- i** ▶ The maximum connection length between the probe and the separate housing is 6 m (20 ft).
 - When ordering a device with separate housing, the desired length must be specified.
- i** ▶ We recommend reusing all strands with ring terminals in case of shortening the connecting cable.
 - To avoid the risk of short-circuiting when the strands are not to be reused, the connections of the new ring terminals fitted must be isolated with a heat shrinking sleeve.
 - Use heat-shrink tubes to insulate all soldered joints.

If the cable connection has to be shortened or led through a wall, it must be separated from the process connection.

Probe without active buildup compensation

Disconnecting the connection cable

1 → A0042111

▶ Loosen the pressing screw with an open-end wrench AF22.

2 → A0042112

▶ Pull the insert seal out of the cable gland.

3 → A0042113

▶ Block the adapter disk with the open-end wrench AF34 and loosen the cable gland with the open-end wrench AF22.

4 → A0042114

▶ Pull out the cable with the cone.

5 → A0042115

▶ Remove the seal and loosen the adapter disk with the open-end wrench AF34.

6 → A0042545

▶ Remove the snap ring with a snap ring pliers.

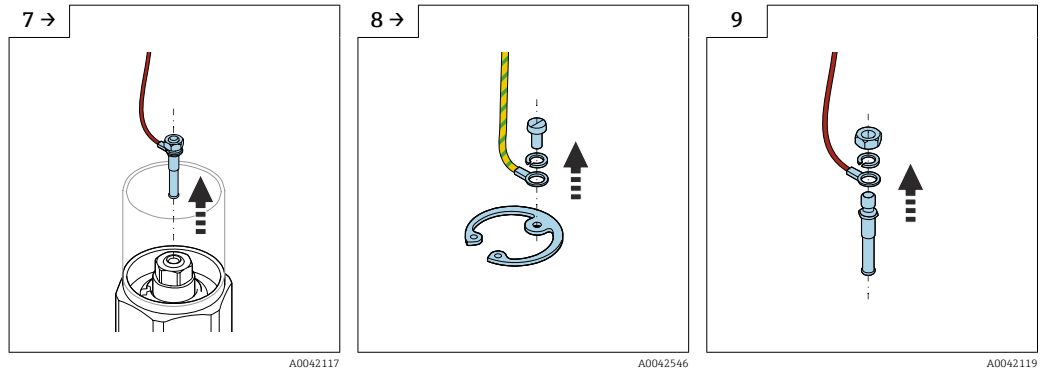

- ▶ Remove the blade plug from the socket.
- ▶ Loosen the screw to disconnect the yellow-green cable.
- ▶ Loosen the nut (M4) of the blade plug.

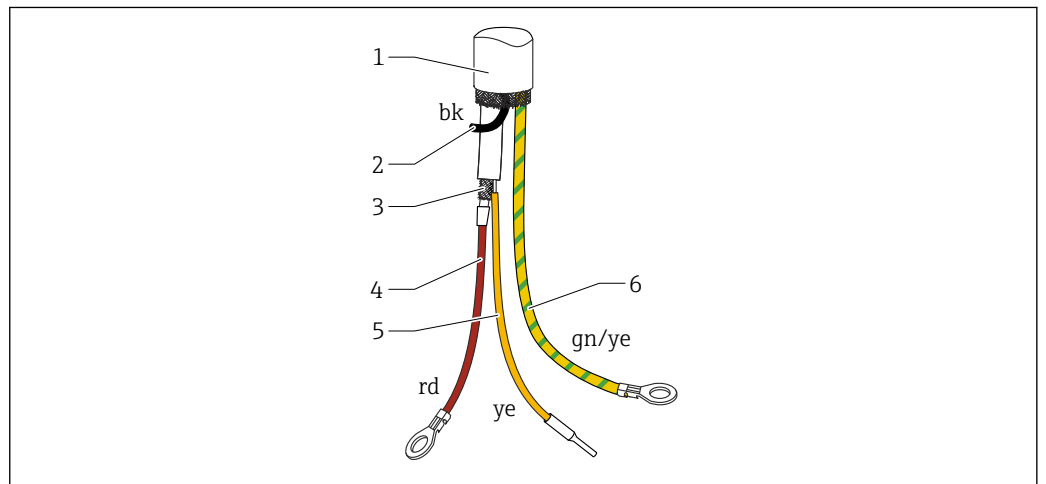

14 Cable connections

- 1 External screening (not required)
- 2 Strand black (bk) (not required)
- 3 Coaxial cable with central core and screen
- 4 Solder the red (rd) strand with the central core of the coaxial cable (probe)
- 5 Insulated strand (ye) with the heat shrinking sleeve
- 6 Strand yellow and green (gn/ye) with a ring terminal

Probe with active buildup compensation

Disconnecting the connection cable

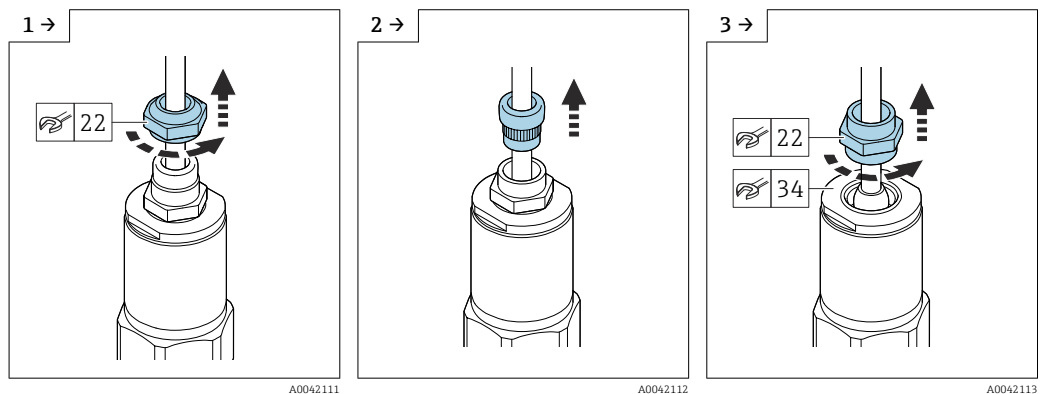

- ▶ Loosen the pressing screw with an open-end wrench AF22.
- ▶ Pull the insert seal out of the cable gland.
- ▶ Block the adapter disk with the open-end wrench AF34 and loosen the cable gland with the open-end wrench AF22.

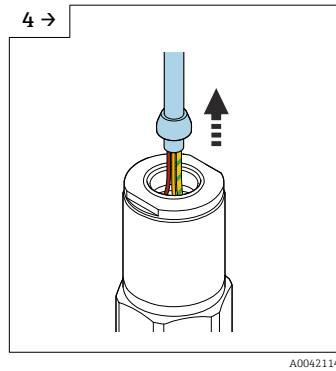

► Pull out the cable with the cone.

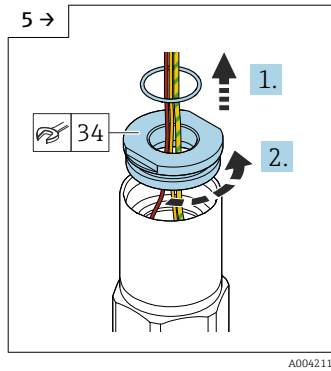

► Remove the seal and loosen the adapter disk with the open-end wrench AF34.

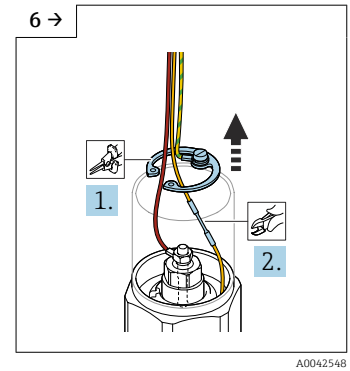

► Remove the snap ring with a snap ring pliers and cut the yellow cable.

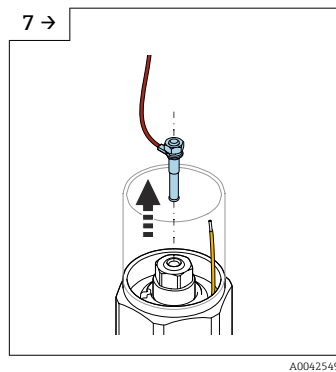

► Remove the blade plug from the socket.

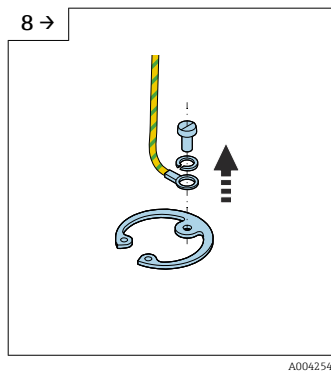

► Loosen the screw to disconnect the yellow-green cable.

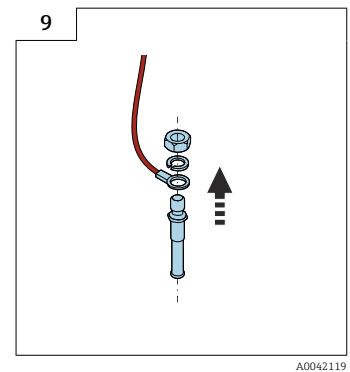

► Loosen the nut (M4) of the blade plug.

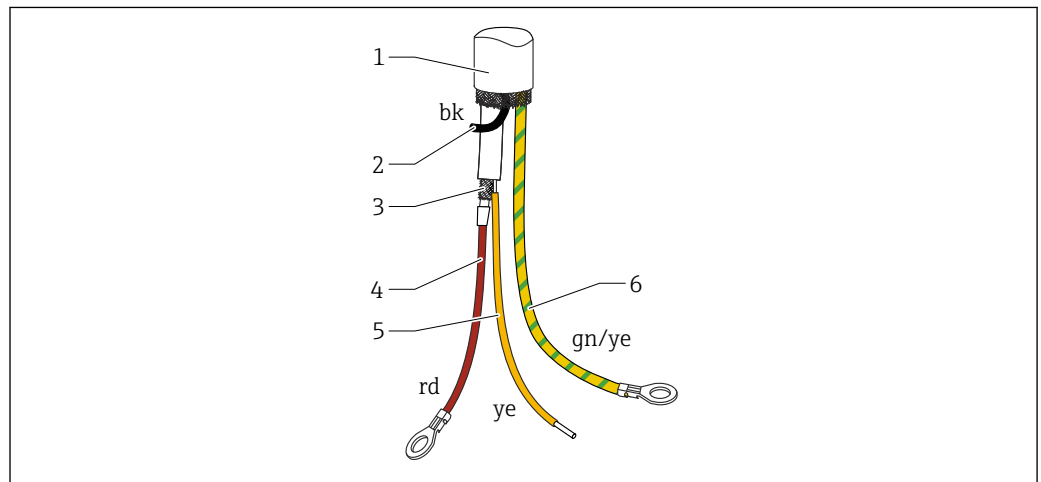

15 Cable connections

- 1 External screening (not required)
- 2 Strand black (bk) (not required)
- 3 Coaxial cable with central core a screening
- 4 Solder the red (rd) strand with the central core of the coaxial cable (probe)
- 5 Solder the strand with the screening of the yellow (ye) coaxial cable (ground)
- 6 Strand yellow and green (gn/ye) with a ring terminal

4.3 Post-installation check

After installing the measuring device, carry out the following checks:

- Do a visual check for damages.

- Make sure that the device meets the specifications at the measuring point with regard to process temperature and pressure, ambient temperature, measuring range.
- Make sure that the process connection been tightened with the tightening torque?
- Check if the measuring points are correctly labeled.
- Make sure that the device is adequately protected against precipitation and direct sunlight.

5 Electrical connection

i Before connecting the power supply, note the following:

- the supply voltage must match the data specified on the nameplate
- switch off the supply voltage before connecting the device
- connect the potential equalization to the ground terminal on the sensor

i When using the probe in hazardous areas, the relevant national standards and the information in the safety instructions (XA) must be observed.

Use the specified cable gland only.

5.1 Connecting requirements

5.1.1 Potential equalization

⚠ DANGER

Risk of explosion!

- ▶ Connect the cable screen on the sensor side only if installing the probe in Ex-areas!

Connect the potential equalization to the outer ground terminal of the housing (T13, F13, F16, F17, F27). In the case of the stainless steel housing F15, the ground terminal can also be located in the housing. For further safety instructions, please refer to the separate documentation for applications in hazardous areas.

5.1.2 Cable specification

Connect the electronic inserts by using commercially available instrument cables. If a potential equalization is present, and the shielded instrument cables are used, connect the shielding on both sides to optimize the shielding effect.

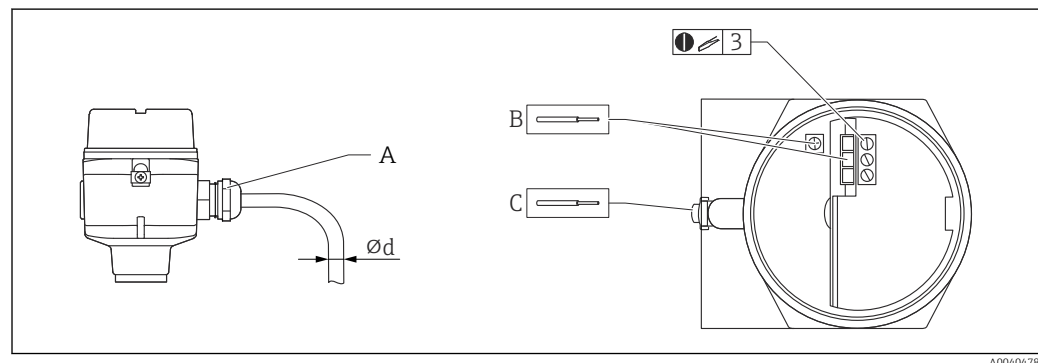

16 Probe and electronic insert connection

A Cable entry

B Electronic insert connections: cable size max. 2.5 mm² (14 AWG)

C The ground connection outside the housing, cable size max. 4 mm² (12 AWG)

Ød Cable diameter

Cable entries

- Nickel-plated brass: Ød = 7 to 10.5 mm (0.28 to 0.41 in)
- Synthetic material: Ød = 5 to 10 mm (0.2 to 0.38 in)
- Stainless steel: Ød = 7 to 12 mm (0.28 to 0.47 in)

5.1.3 Connector

For the version with a connector M12, the housing does not have to be opened for connecting the signal line.

PIN assignment for M12 connector

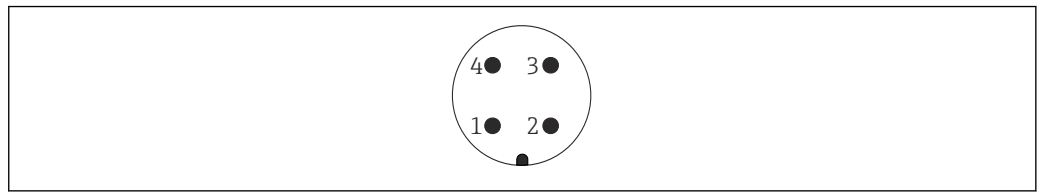

A0011175

▣ 17 M12 connector with 2-wire-electronic insert FEI55, FEI57, FEI58, FEI57C

- 1 Positive potential
- 2 Not used
- 3 Negative potential
- 4 Ground

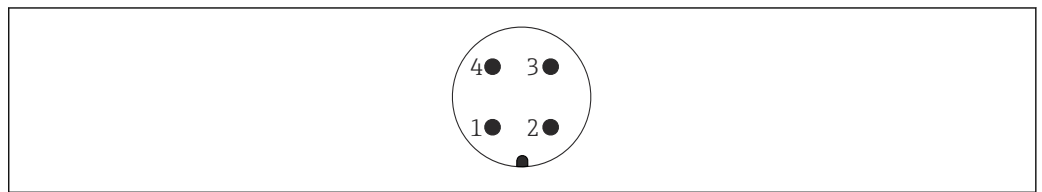

A0011175

▣ 18 M12 connector with 3-wire-electronic insert FEI52, FEI53

- 1 Positive potential
- 2 Not used
- 3 Negative potential
- 4 External load / signal

5.1.4 Cable entry

Cable gland

M20x1.5 for Ex d only cable entry M20

Two cable glands are included in scope of delivery.

Cable entry

- G $\frac{1}{2}$
- NPT $\frac{1}{2}$
- NPT $\frac{3}{4}$

5.2 Wiring and connecting

5.2.1 Connection compartment

Depending on explosion protection, the connection compartment is available in the following variants:

Standard protection, Ex ia protection

- polyester housing F16
- stainless steel housing F15
- aluminum housing F17
- aluminum housing F13 with gas-tight process seal
- aluminum housing T13, with the separate connection compartment

Ex d protection, Gas-tight process seal

- aluminum housing F13 with gas-tight process seal
- aluminum housing T13, with the separate connection compartment

Connecting the electronic insert to the power supply:

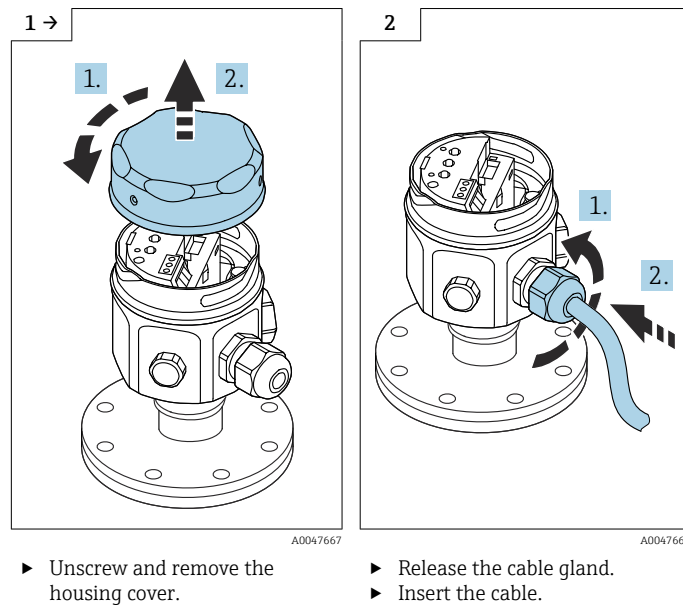

Connecting the electronic insert to the power supply mounted in the housing T13:

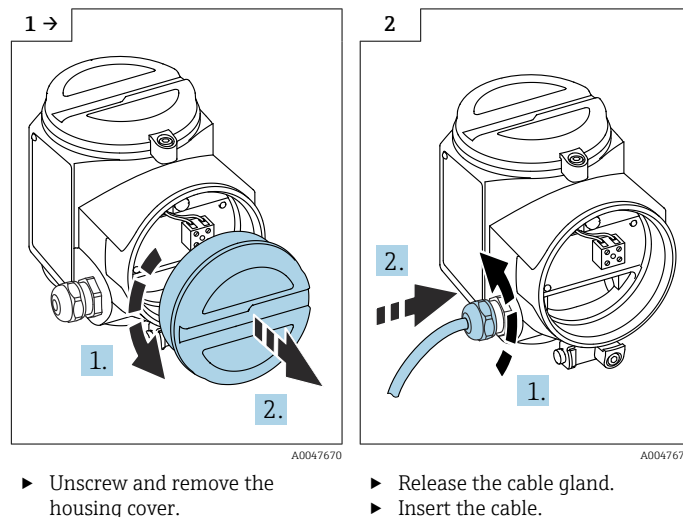

i Screw terminal for conductor cross-sections 0.5 to 2.5 mm.

5.3 Connecting the measuring device

5.3.1 2-wire AC electronic insert FEI51

i Connect the electronic insert in series with an external load.

Power supply

- Supply voltage: 19 to 253 V_{AC}
- Power consumption: < 1.5 W
- Residual current consumption: < 3.8 mA
- Short-circuit protection: overvoltage category II

Signal on alarm

The output signal on power failure or in the event of damage to the sensor: < 3.8 mA

Connectable load

- For relays with a minimum holding power or rated power:
 - > 2.5 VA at 253 V_{AC} (10 mA)
 - > 0.5 VA at 24 V_{AC} (20 mA)
- Relays with a lower holding power or rated power can be operated using an RC module connected in parallel.
- For relays with a maximum holding power or rated power:
 - < 89 VA at 253 V_{AC}
 - < 8.4 VA at 24 V_{AC}
- The voltage drop across FEI51: maximum 12 V
- Residual current with blocked thyristor: maximum 3.8 mA
- Load switched directly into the power supply circuit via the thyristor.

i Do not switch on the supply voltage until you have learned about the device functions as described in section "Operation options" → 37. This will ensure that you do not accidentally trigger any processes by switching on the supply voltage.

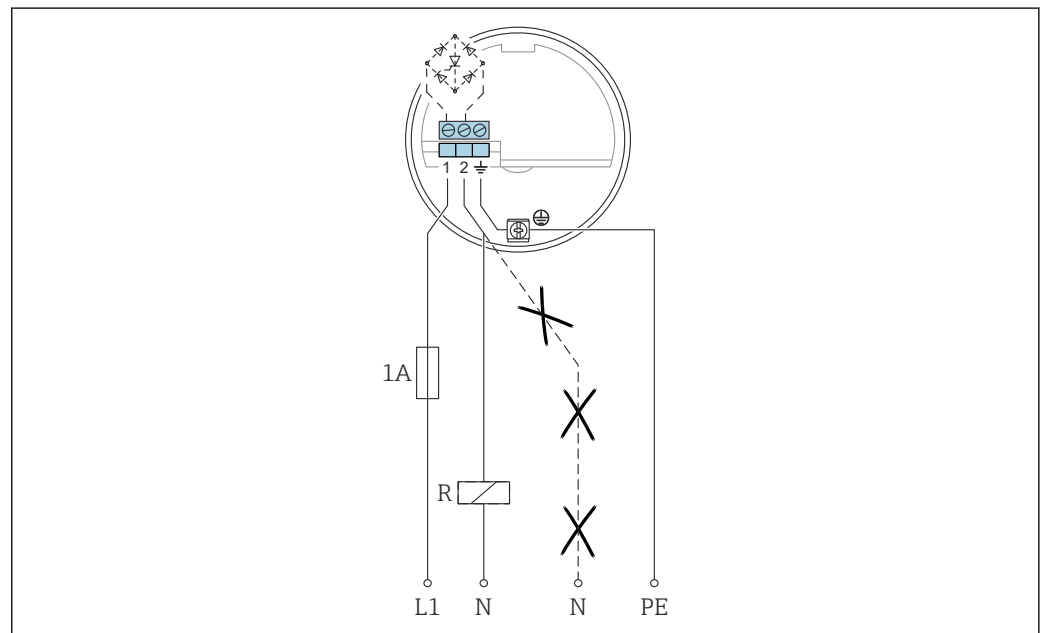
Connecting the FEI51

L1 L1 phase cable
 N Neutral cable
 PE Grounding cable
 R External load

1. Connect the FEI51 according to the schema.
2. Tighten the cable gland.
3. Set the function switch to position 1.
4. Switch on the supply voltage.

5.3.2 DC PNP electronic insert FEI52

The three-wire DC connection should, wherever possible, be connected as follows:

- to programmable logic controllers (PLCs)
- to DI modules in accordance with EN 61131-2

A positive signal is present at the switch output of the electronic system (PNP).

Power supply

- Supply voltage: 10 to 55 V_{DC}
- Ripple: maximum 1.7 V, 0 to 400 Hz
- Current consumption: < 20 mA
- Power consumption without load: maximum 0.9 W
- Power consumption with a full load (350 mA): 1.6 W
- Reverse polarity protection: yes
- Separation voltage: 3.7 kV
- Overvoltage category: II

Signal on alarm

The output signal on power failure or in the event of device failure: $I_R < 100 \mu\text{A}$

Connectable load

- Load switched via transistor and separate PNP connection: maximum 55 V
- Load current: maximum 350 mA cyclical overload and short-circuit protection
- Residual current: < 100 μA with transistor blocked
- Capacitance load:
 - maximum 0.5 μF at 55 V
 - maximum 1 μF at 24 V
- Residual voltage: < 3 V for transistor switched through

i Do not switch on the supply voltage until you have familiarized yourself with the device functions as described in the section "Operation option" → 37. This will ensure that you do not accidentally trigger any processes by switching on the supply voltage.

Connecting the FEI52

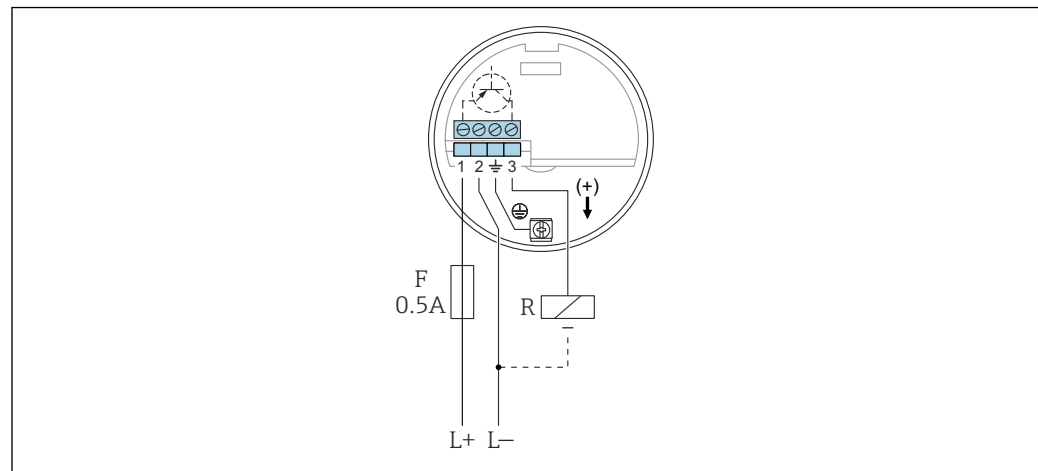

A0042388

- L+* Power input +
L- Power input -
F Fuse
R External load: $I_{max} = 350 \text{ mA}$, $U_{max} = 55 \text{ V}_{DC}$

1. Connect the FEI52 regarding to the schema.
2. Tighten the cable gland.
3. Set the function switch to position 1.
4. Switch on the supply voltage.

5.3.3 3-wire electronic insert FEI53

The 3-wire DC connection is used in conjunction with the Nivotester switching device FTC325 3-WIRE from Endress+Hauser. The switching device's communication signal operates at 3 to 12 V_{DC}.

The failsafe mode (MIN) / (MAX) and the point level adjustment are configured on the Nivotester.

Power supply

- Supply voltage: 14.5 V_{DC}
- Current consumption: < 15 mA
- Power consumption: maximum 230 mW
- Reverse polarity protection: yes
- Separation voltage: 0.5 kV

Signal on alarm

The voltage at terminal 3 opposite terminal 1: < 2.7 V

Connectable load

- floating relay contacts in the connected switching unit Nivotester FTC325 3-WIRE
- for the contact load capacity, refer to the technical data of the switching device

i Do not switch on the supply voltage until you have learned about the device functions as described in section "Operation option" → 38. This will ensure that you do not accidentally trigger any processes by switching on the supply voltage.

Connecting the FEI53

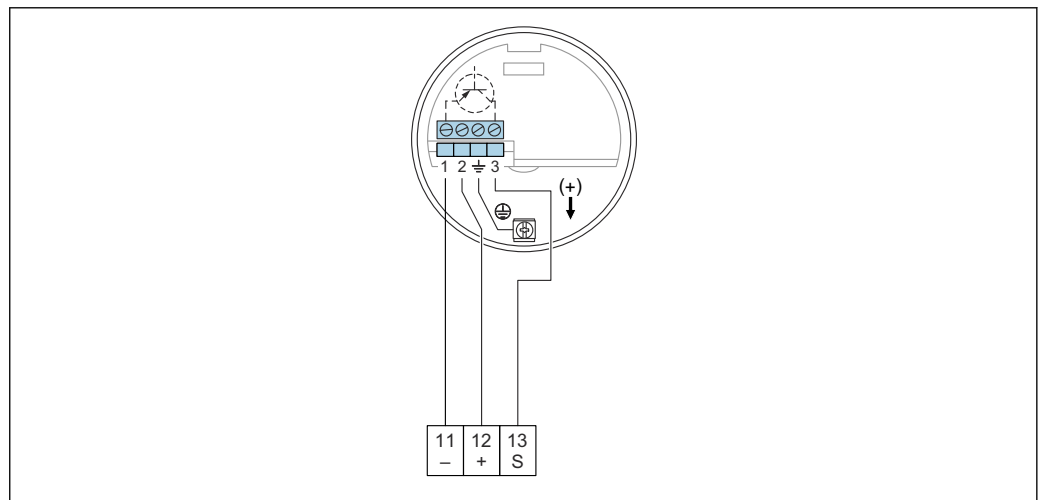

- 11 Negative terminal in Nivotester FTC325
 12 Positive terminal in Nivotester FTC325
 S Signal terminal in Nivotester FTC325

1. Connect the FEI53 according to the schema.
2. Tighten the cable gland.
3. Set the function switch to position 1.
4. Switch on the supply voltage.

5.3.4 AC and DC with relay output electronic insert FEI54

The universal voltage connection with relay output (DPDT) operates in two different voltage ranges (AC and DC).

i When connecting devices with a high inductance, use a spark suppression system to protect the relay contacts.

Power supply

- Supply voltage:
 - 19 to 253 V_{AC}, 50 to 60 Hz
 - 19 to 55 V_{DC}
- Power consumption: 1.6 W
- Reverse polarity protection: yes
- Separation voltage: 3.7 kV
- Overvoltage category: II

Signal on alarm

The output signal on power failure or in the event of device failure: relay de-energized

Connectable load

- Loads switched via 2 floating changeover contacts (DPDT)
- maximum values (AC):
 - $I_{\max} = 6 \text{ A}$
 - $U_{\max} = 253 \text{ V}_{AC}$
 - $P_{\max} = 1\,500 \text{ VA}$ at $\cos\varphi = 1$
 - $P_{\max} = 750 \text{ VA}$ at $\cos\varphi > 0.7$
- maximum values (DC):
 - $I_{\max} = 6 \text{ A}$ at 30 V_{DC}
 - $I_{\max} = 0.2 \text{ A}$ at 125 V_{DC}
- The following applies when connecting a functional low-voltage circuit with double isolation as per IEC 1010: the sum of voltages of relay output and power supply maximum 300 V

i Do not switch on the supply voltage until you have learned about the device functions as described in section "Operation option" → 37. This will ensure that you do not accidentally trigger any processes by switching on the supply voltage.

Connecting the FEI54

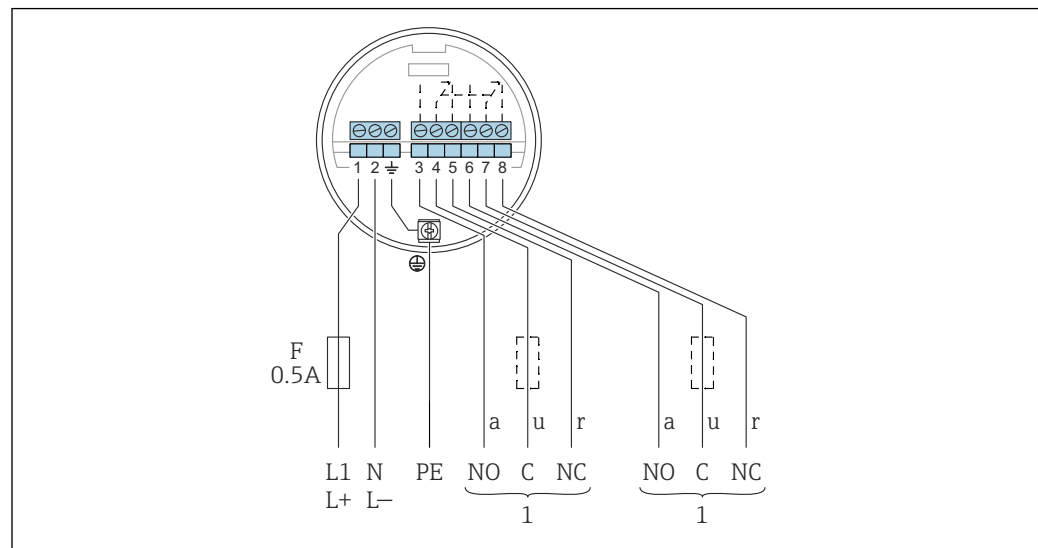

A0042390

- F* Fuse
L1 Phase (AC) terminal
L+ The positive (DC) terminal
N Neutral (AC) terminal
L- The negative (DC) terminal
PE Grounding cable
1 Refer also to connectable load

1. Connect the FEI51 according to the schema.
2. Tighten the cable gland.
3. Set the function switch to position 1.

4. Switch on the supply voltage.

5.3.5 SIL2 / SIL3 electronic insert FEI55

The two-wire DC connection should, if possible, be connected as follows:

- to programmable logic controllers (PLC)
- to AI modules 4 to 20 mA in accordance with EN 61131-2

The point level signal is sent via an output signal jump from 8 to 16 mA.

Power supply

- Supply voltage: 11 to 36 V_{DC}
- Power consumption: < 600 mW
- Reverse polarity protection: yes
- Separation voltage: 0.5 kV

Signal on alarm

The output signal on power failure or in the event of device failure: < 3.6 mA

Connectable load

- U_{max}:
 - 11 to 36 V_{DC} for non-hazardous area and Ex ia
 - 14.4 to 30 V_{DC} for Ex d
- I_{max} = 16 mA

-  Do not switch on the supply voltage until you have learned about the device functions as described in section "Operation operation" → 37. This will ensure that you do not accidentally trigger any processes by switching on the supply voltage.

Connecting the FEI55

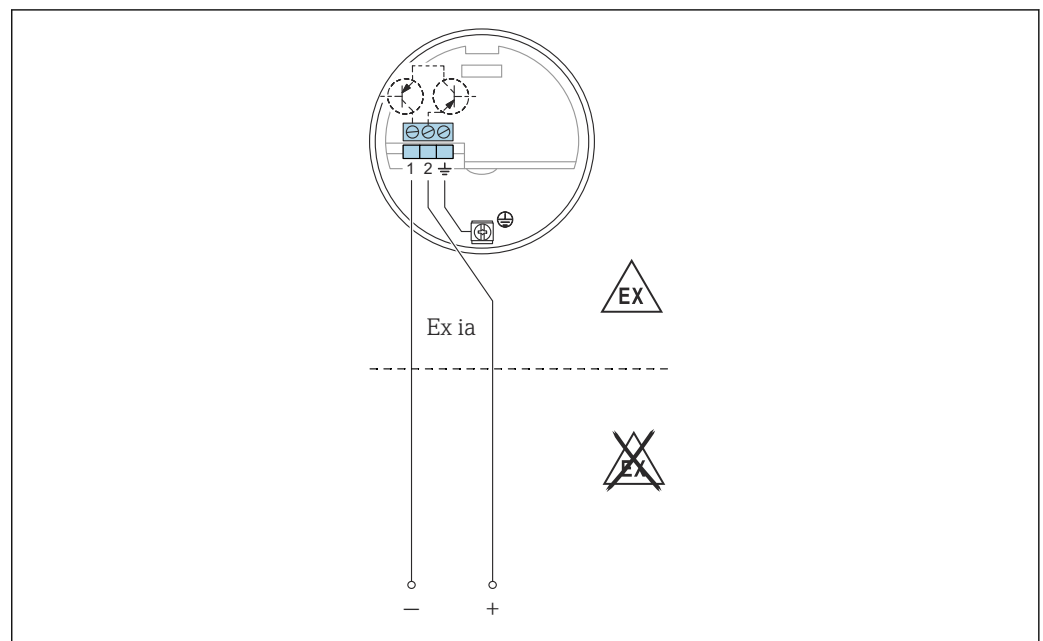

A0042391

1. Connect the FEI51 according to the schema.
2. Tighten the cable gland.
3. Set the function switch to position 1.
4. Switch on the supply voltage.

Functional safety (SIL)

The electronic insert FEI55 meets the requirements of SIL2 or SIL3 in accordance with IEC 61508, IEC 61511-1 and can be used in the safety systems with the corresponding requirements.



An exact description of the requirements in terms of functional safety can be found in document FY01075F.

5.3.6 PFM electronic insert FEI57S

The two-wire DC connection is used in conjunction with the following Nivotester switching device from Endress+Hauser:

FTC325 PFM

The PFM signal is between 17 to 185 Hz.

The failsafe mode (MIN) / (MAX) and the point level adjustment are configured on the Nivotester.

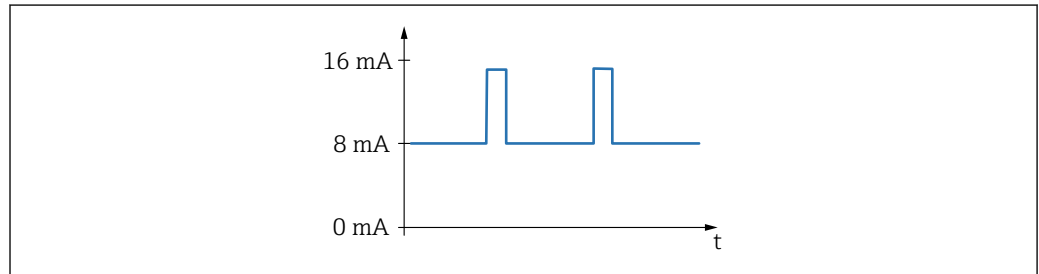

A0040777

19 Frequency: 17 to 185 Hz

Power supply

- Supply voltage: 9.5 to 12.5 V_{DC}
- Power consumption: < 150 mW
- Reverse polarity protection: yes
- Separation voltage: 0.5 kV

Output signal

PFM 17 to 185 Hz

Connectable load

- floating relay contacts in the connected switching unit Nivotester:
FTC325 PFM
- for the contact load capacity, refer to the technical data of the switching device



Do not switch on the supply voltage until you have learned about the device functions as described in section "Operation option" → 38. This will ensure that you do not accidentally trigger any processes by switching on the supply voltage.

Connecting the FEI57S

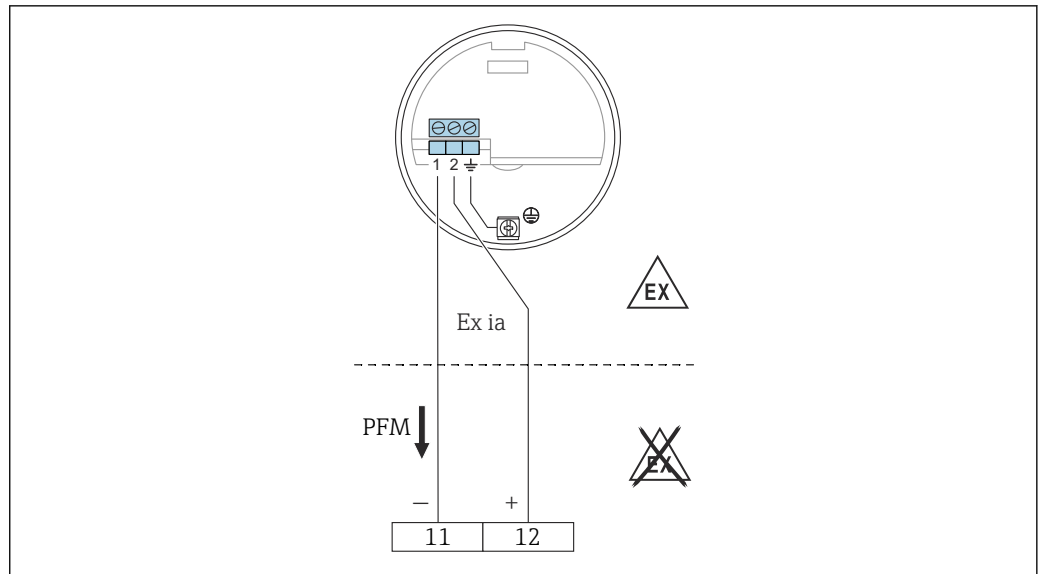

A0050141

- 11 The negative terminal in Nivotester FTC325
 12 The positive terminal in Nivotester FTC325

1. Connect the FEI51 according to the schema.
2. Tighten the cable gland.
3. Switch on the supply voltage.

5.3.7 NAMUR electronic insert FEI58

The two-wire connection for a separate switching unit in accordance with NAMUR specifications (IEC 60947-5-6), e.g. Nivotester FTL325N from Endress+Hauser.

Change in the output signal from high to low current in event of point level detection.

Additional function: test key on the electronic insert.

Press the key to breaks the connection to the isolating amplifier.

i In the case of Ex d operation, the additional function can only be used if the housing is not exposed to an explosive atmosphere.

When connecting to Multiplexer: set 3 s as the cycle time at least.

Power supply

- Power consumption:
 - < 6 mW at $I < 1 \text{ mA}$
 - < 38 mW at $I = 2.2 \text{ to } 4 \text{ mA}$
- Interface connection data: IEC 60947-5-6

Signal on alarm

The output signal in the event of damage to the sensor: < 1.0 mA

Connectable load

- The technical data of the connected isolating amplifier as per IEC 60947-5-6 (NAMUR)
- The connection also to isolating amplifiers which have special safety circuits $I > 3.0 \text{ mA}$

i Do not switch on the supply voltage until you have learned about the device functions as described in section "Operation option" → 39. This will ensure that you do not accidentally trigger any processes by switching on the supply voltage.

Connecting the FEI58

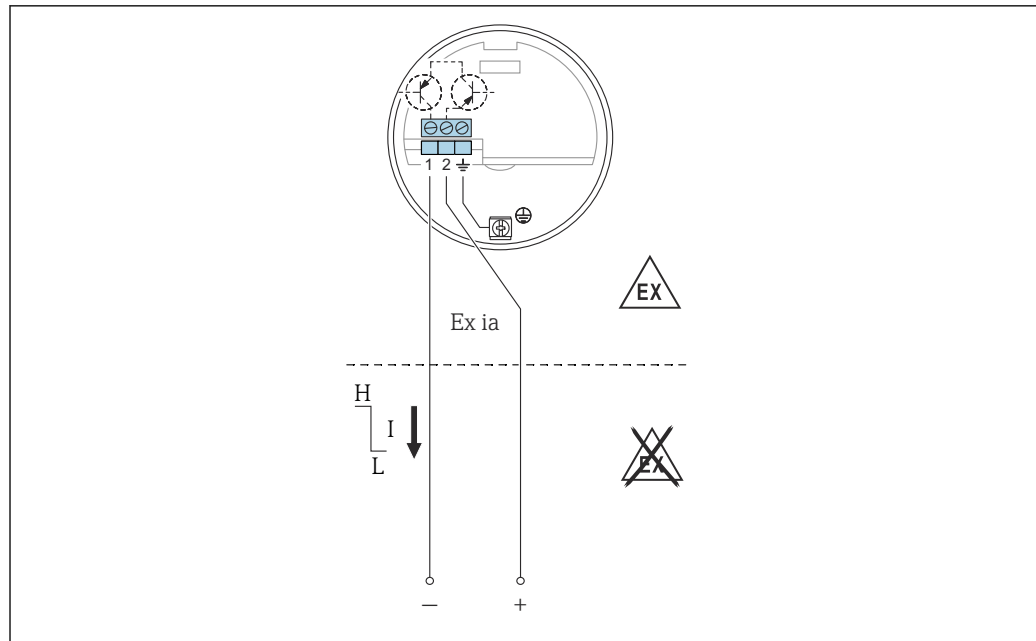

A0042393

20 Terminals must be connected to the isolating amplifier (NAMUR) IEC 60947-5-6

1. Connect the FEI51 according to the schema.
2. Tighten the cable gland.
3. Switch on the supply voltage.

5.4 Post-connection check

After wiring the measuring device, carry out the following checks:

- Make sure that the terminal assignment is correct?
- Make sure that the cable gland is sealed tight?
- Make sure that the housing cover is fully screwed?
- Make sure that the device is operational and the green LED flashing when the device is on.

6 Operation options

6.1 Human interface and display elements for FEI51, FEI52, FEI54, FEI55

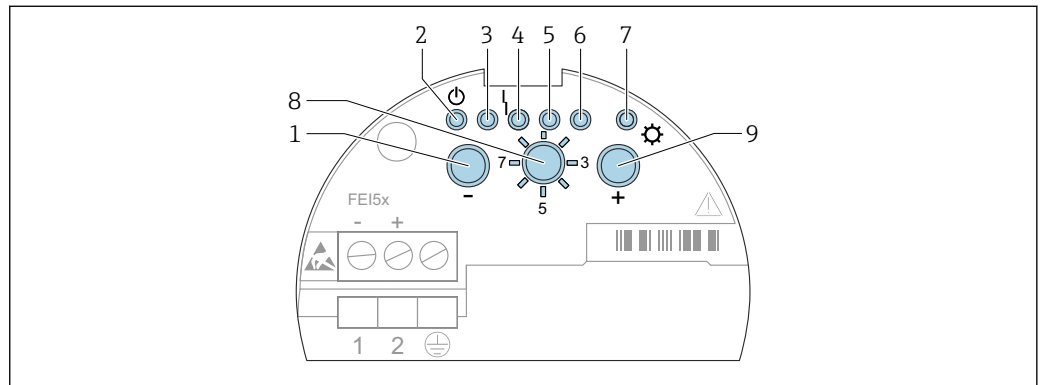



21 FEI51, FEI52, FEI54, FEI55 human interface

- 1 Key
- 2 Green LED - operational status
- 3 Green LED
- 4 Red LED - fault
- 5 Green LED
- 6 Green LED
- 7 Yellow LED - switching state
- 8 Mode switch
- 9 Key

1. Operation - select for normal operation
2. Restor factory settings:
 - ↳ press and for 20 s restore factory settings
3. Calibration
 - ↳ press to set empty calibration
 - press to set full calibration
 - press and for 10 s to reset the calibration and switch-point adjustment
4. Switch-point adjustment
 - ↳ press to decrease the switch-point
 - press to increase the switch-point
5. Measuring modes
 - ↳ press to decrease the measuring range
 - press once to set the two-point control Δs
 - press twice to activate the build-up mode
6. Switching delay
 - ↳ press to decrease the delay
 - press to increase to delay
7. Self-test
 - ↳ press and to activate the self-test
8. Setting MIN/MAX failsafe mode or SIL mode
 - ↳ press for minimum
 - press for maximum
 - press and to lock or unlock the SIL mode

9. Upload sensor DAT (EEPROM)

- ↳ press  for download
- press  for upload

6.2 Human interface and display elements for FEI53, FEI57S

The electronic inserts FEI53 and FEI57S are used in conjunction with Nivotester switching devices.

 A description of the human interface and display elements of the Nivotester switching device is provided in the documentation that accompanies the device.

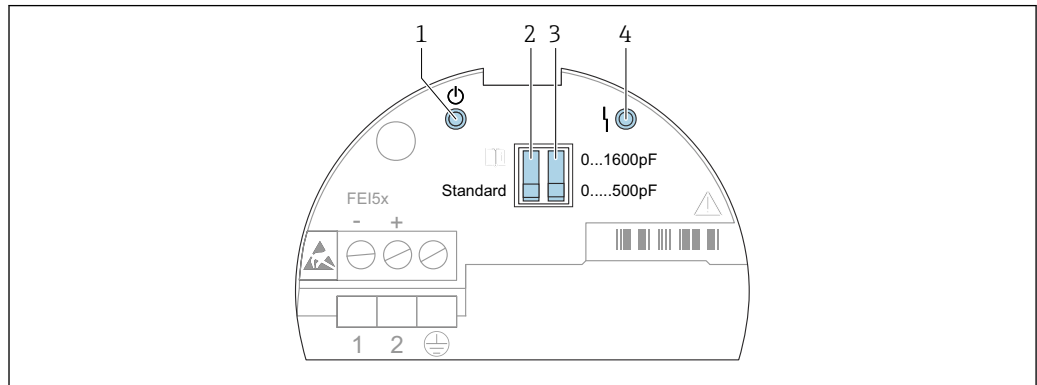

A0042395

 22 FEI53 and FEI57S human interface

- 1 Green LED - operational status
- 2 Standard or alarm DIP switch
- 3 Measuring range DIP switch
- 4 Red LED - fault

The operating status of the device is indicated by LEDs on the electronic insert and provides information on operational readiness and, where applicable, the type of fault.

The functions of the DIP switches:

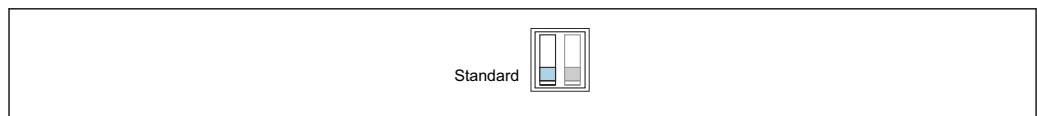

A0042400

 23 Standard: if the measuring range is exceeded no alarm is output

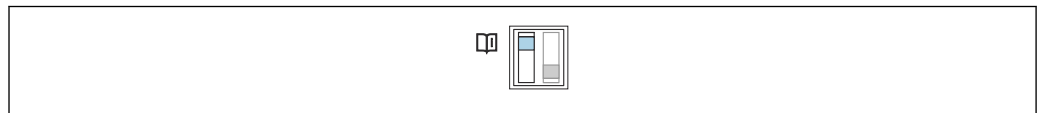

A0042401

 24 Alarm: if the measuring range is exceeded an alarm is output

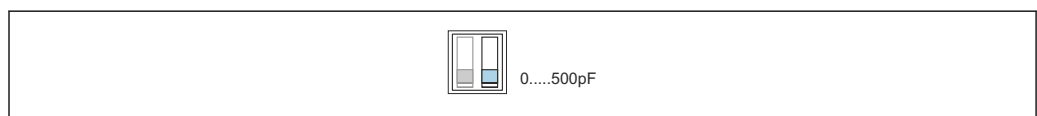

A0042402

 25 Measuring range: the measuring range is between 0 to 500 pF. Span: the span is between 0 to 500 pF

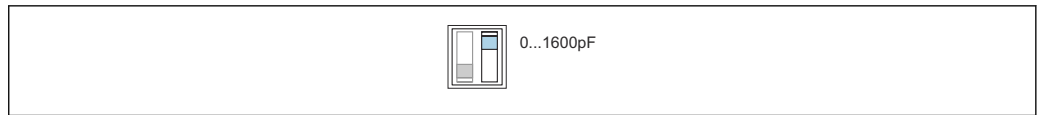

26 Measuring range: the measuring range is between 5 to 1 600 pF. Span: the span is between 5 to 1 600 pF

6.3 Human interface and display elements for FEI58

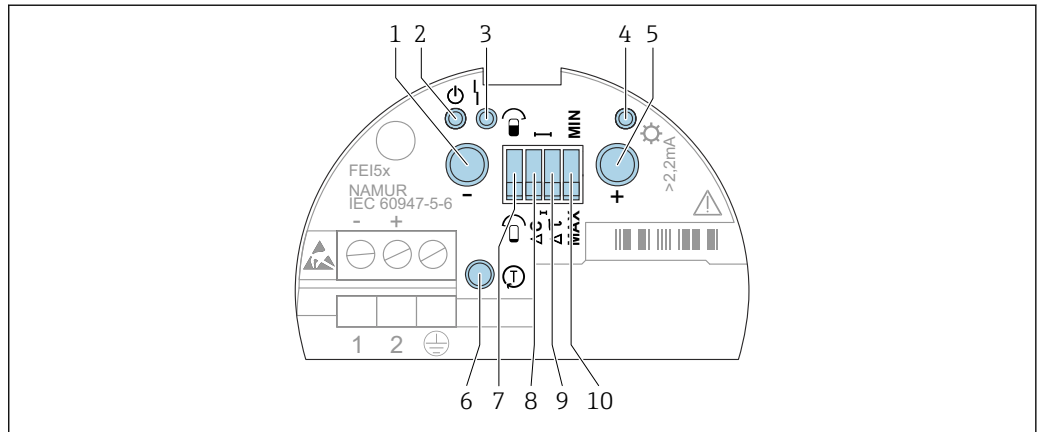

27 FEI58 human interface

- 1 Function key A
- 2 Green LED - operational status
- 3 Red LED - fault
- 4 Yellow LED - switching state
- 5 Function key B
- 6 Test key
- 7 Calibration DIP switch
- 8 Switch-point DIP switch
- 9 Delay DIP switch
- 10 Fail-safe mode DIP switch

The functions of the DIP switches

Calibration DIP switch:

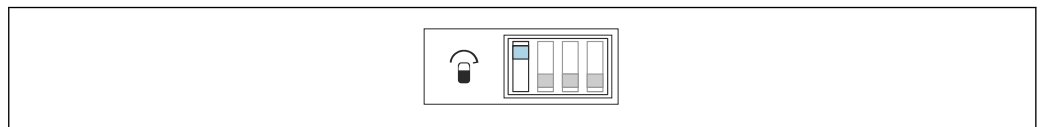

28 The probe is covered during calibration

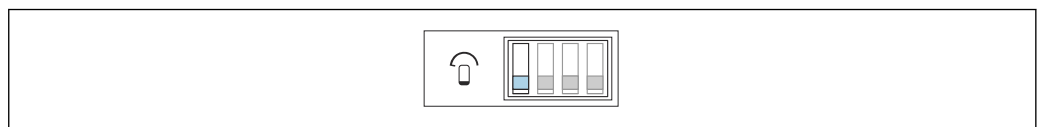

29 The probe is uncovered during calibration

Switch-point adjustment:

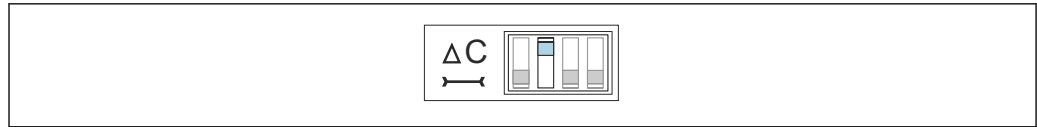

A0042406

30 10 pF

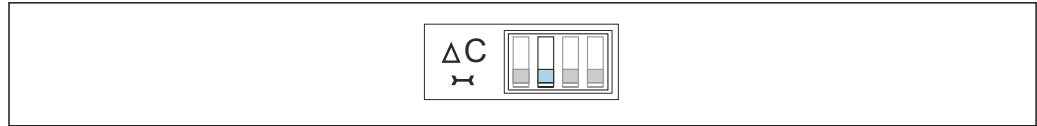

A0042407

31 2 pF

Switching delay:



A0042408

32 5 s



A0042409

33 1 s

Fail-safe mode:



A0042410

34 The output switches safety-oriented when the probe is uncovered. It can be used in cases such as dry run protection and pump protection.



A0042411

35 The output switches safety-oriented when the probe is covered. It can be used in cases such as overflow protection.

Function key

- Key A: displays diagnostic code
- Key B: displays calibration situation
- Test key: disconnects the transmitter from the switching unit
- Keys A and B pressed during:
 - operation: perform calibration
 - startup: delete calibration points

7 Commissioning

7.1 Installation and function check

Make sure that the post-installation check and final check have been completed before you start your measuring point:

- see the chapter "Post-installation check" →  24
- see the chapter "Post-connection check" →  36

7.2 Commissioning the electronic inserts FEI51, FEI52, FEI54 and FEI55

 Due to the first start-up of the device the output is in safe status. This is signaled by the flashing yellow LED.

 The device is not operational until you have carried out a calibration. To attain maximum operational safety, carry out an empty and a full calibration. This is particularly recommended for critical applications.

Refer to the following subchapters for information on how to carry out the calibration.

Setting the measuring range →  41.

Carrying out empty calibration →  42.

Carrying out full calibration →  43.

Carrying out empty and full calibration →  44.

Operation →  37.

 The yellow LED 7:

- flashes fast if a calibration or switching point are not set
- shows the switching status according to the selected application and the fail-safe mode

7.2.1 Setting the measuring range

 The choice of measuring range (0 to 500 pF and 0 to 1 600 pF) depends on the function of the probe.

- If the probe is used as a point level switch, it is possible to retain the factory setting of 0 to 500 pF
- If the probe is used for two-point control, the following settings are recommended for vertical installation:
 - measuring range from 0 to 500 pF for probe lengths up to 1 m (3.3 ft)
 - measuring range from 0 to 1 600 pF for probe lengths up to 10 m (33 ft)

Partially insulated probes are only suitable for nonconductive bulk solids.

To set the range to 0 to 1 600 pF:

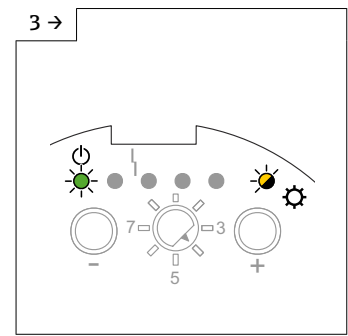
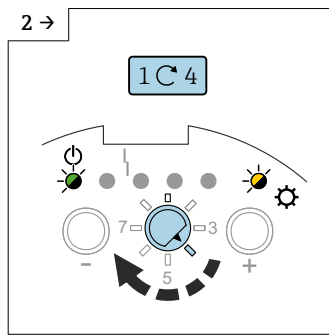
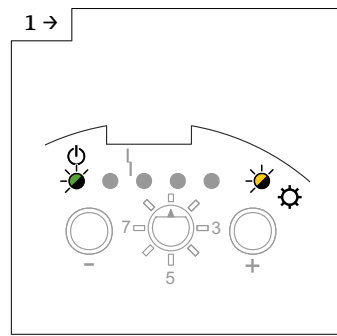

► Set the function switch to position 4.

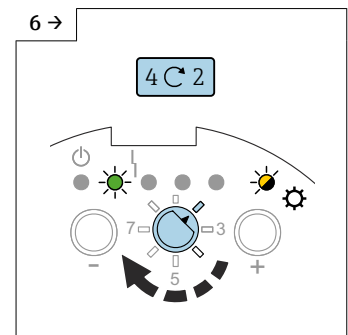
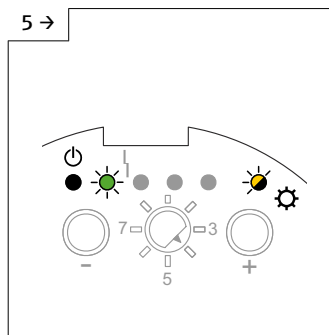
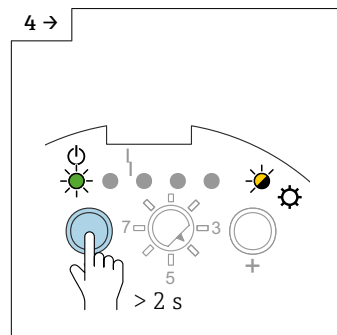

► Press the key > 2 s.

► Set the function switch to position 2.

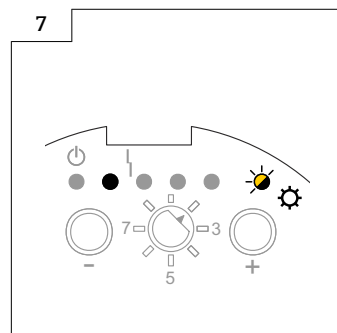

7.2.2 Carrying out empty calibration

i The empty calibration stores the capacitance value of the probe when the tank is empty. If the measured capacitance value is, for example, 50 pF (empty calibration), a switching threshold of 2 pF is added to this value. In this case, the capacitance value of the switch point would be 52 pF.

i The switching threshold depends on the value set for the switch point adjustment
→ 47.

Carrying out empty calibration

i Make sure that the probe is not covered with the product.

To carry out an empty calibration, set the measuring range first → 41.

1 → A0042458

2 → A0042821

3 → A0042459

4 → A0042460

5 → A0042647

6 A0043647

- ▶ Press the key > 2 s.
- ▶ Release the key when the green LED 1 starts to flash.
- ▶ The process of saving the empty calibration is finished. The green LED 1 lits.
- ▶ Set the function switch to position 1.

7.2.3 Carrying out full calibration

The full calibration measures the capacitance value of the probe when the tank is full. If the measured capacitance value is, for example, 100 pF (full calibration), a switching threshold of 2 pF is subtracted from this value. The capacitance value of the switch point is thus 98 pF.

The switching threshold depends on the value set for the switch point adjustment → 47.

To carrying out full calibration

1 → A0042452

2 → A0042457

3 → A0043650

- ▶ Set the function switch to position 2.

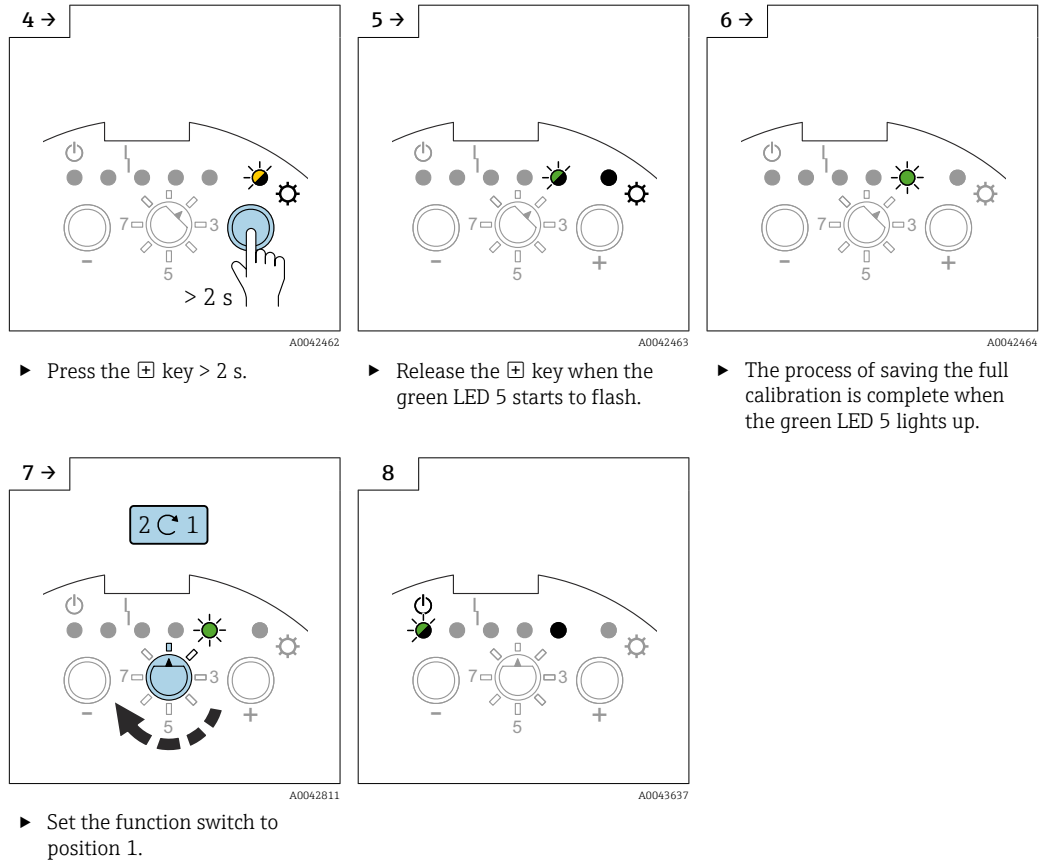

7.2.4 Carrying out empty and full calibration

- i** An empty and full calibration provides the greatest possible operational security. This is strongly recommended for critical applications.
- i** The empty and full calibration measures the capacitance values of the probes when the tank is full and when it is empty. For example: if the measured capacitance value of the empty calibration is 50 pF and that of the full calibration is 100 pF, the average capacitance value of 75 pF is stored as the switch-point.

Empty calibration

- i** Mak sure that the probe is not covered with the product.

f Setting the empty calibration

To carry out an empty calibration:

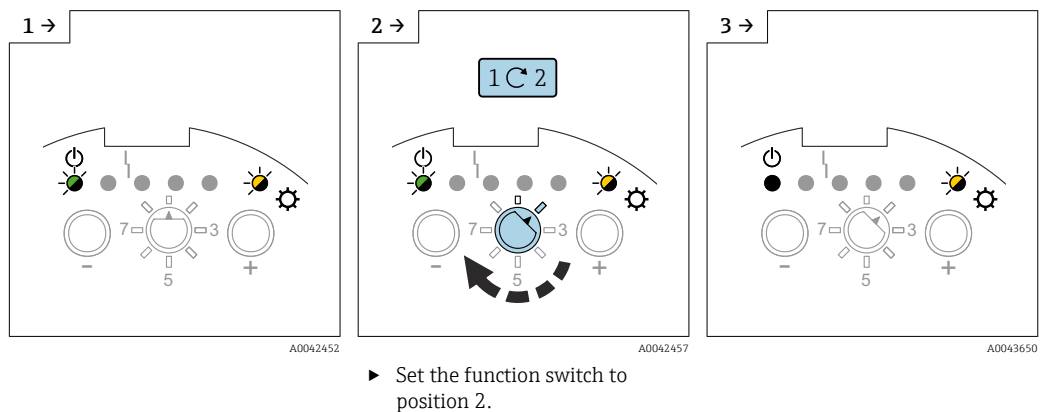

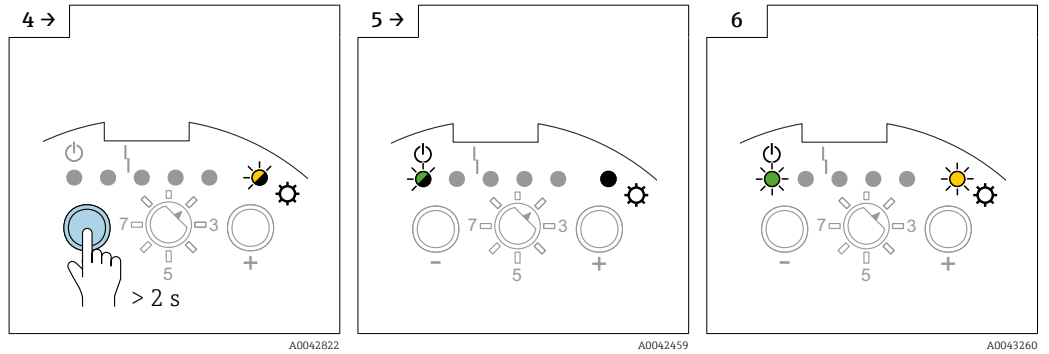

- ▶ Press the \square key > 2 s.
- ▶ Release the \square key when the green LED 1 starts to flash.
- ▶ The process of saving the empty calibration is finished when the green LED 1 lits.

Full calibration

i Make sure that the probe is covered by the medium up to the desired switch-point.

Carrying out full calibration

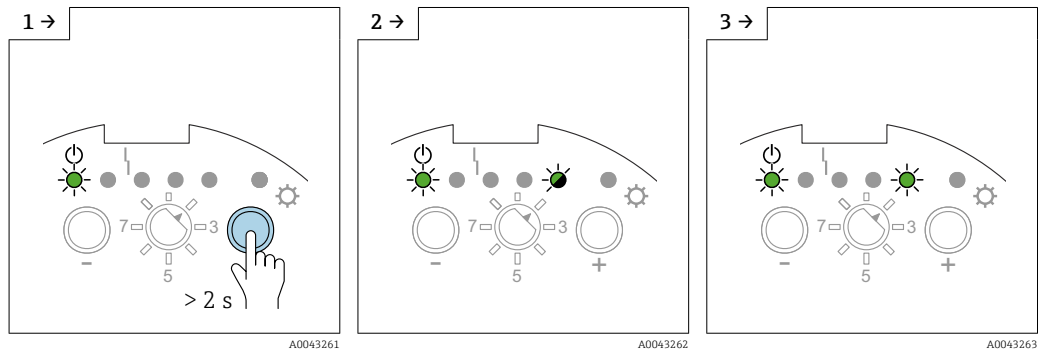

- ▶ Press the $\square+$ key > 2 s.
- ▶ Release the $\square+$ key when the green LED 5 starts to flash.
- ▶ The process of saving the full calibration is complete when the green LED 5 lights up.

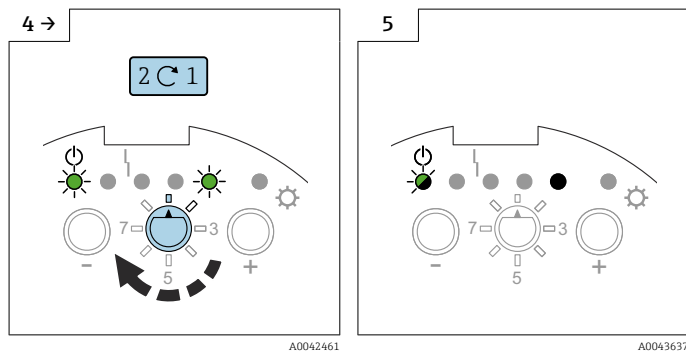

- ▶ Set the function switch to position 1.

7.2.5 Reset: Calibration and switch-point adjustment

Resetting the calibration or switch-point shift (all the other settings remain unchanged)

i The switch-point adjustment is reset to the factory setting of 2 pF.

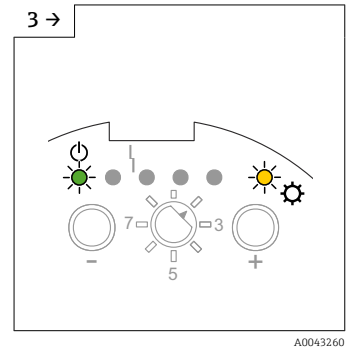
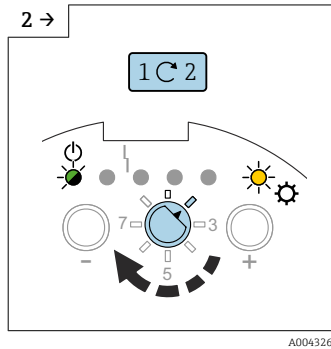
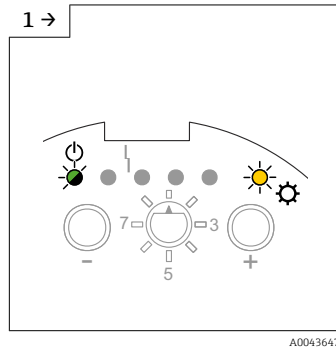

► Set the function switch to position 2.

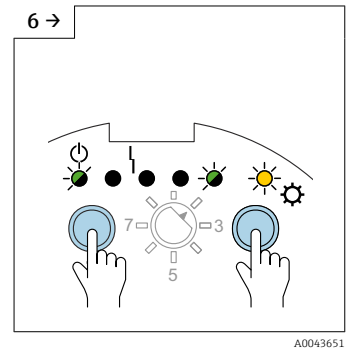
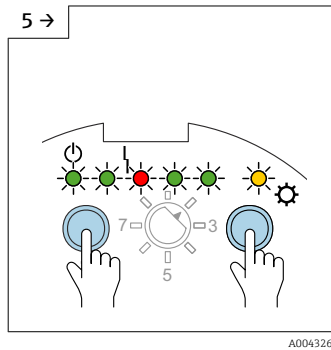
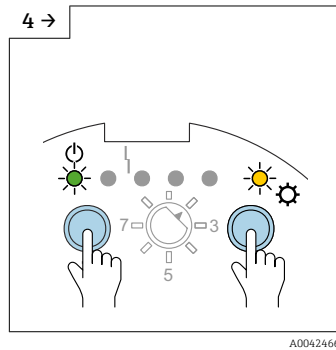

► Press the **-** and **+** keys.

► All LEDs light up sequentially in time > 10 s.

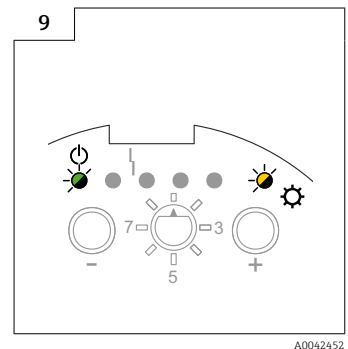
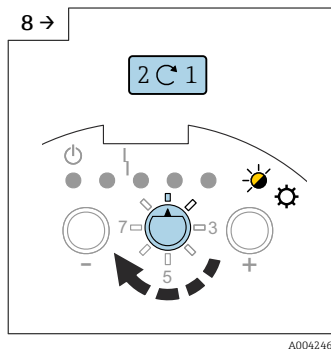
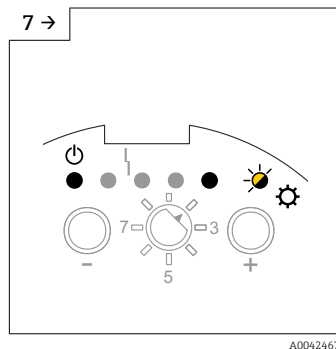

► The yellow LED 5 flashes, the reset calibration has been carried out and saved.

► Set the function switch to position 1.

i The device is not operational until you have carried out a new calibration.

7.2.6 Setting the switch point adjustment

- i** If only one calibration (empty or full) was carried out, and if buildup forms on the rope probe while the probe is in operation, the device may no longer respond to changes in level. A switch point adjustment (e.g. 4 pF, 8 pF, 16 pF, 32 pF) compensates for this condition and ensures that you obtain a constant switch point again.
- i** For media that do not have a tendency to build up, we recommend a setting of 2 pF, as the probe is most sensitive to changes in level at this setting.
- i** For media with heavy buildup (e.g. plaster), we recommend using probes with active buildup compensation.
- i** A switch point adjustment can be carried out only if a full or empty calibration has been carried out first.
- i** A switch point adjustment is not possible if an empty and a full calibration have been carried out.
- i** The switch point adjustment is disabled if you switch on the two-point control → 48.

Setting the switch point adjustment

- i** The factory setting is 2 pF.

To adjust the switch point:

1 →

2 →

3 →

▶ Set the function switch to position 3.

4 →

5 →

6 →

▶ Press the \oplus key > 2 s to increase the value.

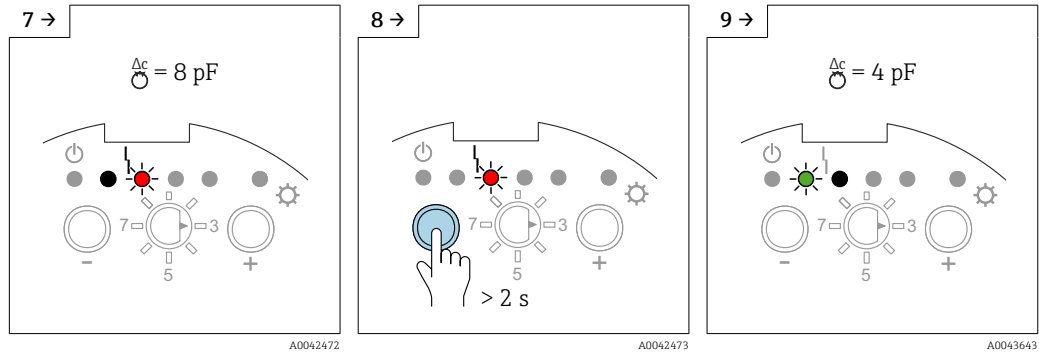

► Press the  key > 2 s to decrease the value.

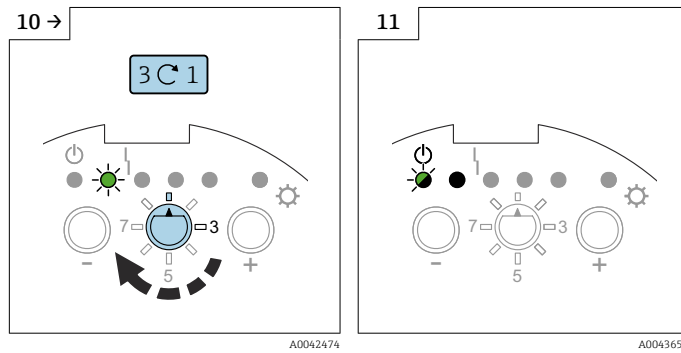

► Set the function switch to position 1.

Δc	GN	GN	RD	GN	GN	YE
2 pF						
4 pF						
8 pF						
16 pF						
32 pF						



A0042526

 36 LED sequence regarding the switch point capacitance value

7.2.7 Configuring two-point control and buildup mode

It is possible to use the probe rope of a fully insulated and vertically installed probe for pump control as a two-point control. The switch points of the empty and full calibration activate, for example, a conveyor unit.

To use the two-point control:

- set the necessary measuring range, see "Setting the measuring range" →  41.
- perform empty and full calibration
- set the failsafe mode (MIN/MAX) in accordance with your requirements, see →  53.

To switch on the two-point control (Ds- mode), the switch point adjustment is disabled. The switch points correspond to the calibration points.

The "Buildup mode" ensures that a safe switch point is output even if the probe is not fully released from the conductive medium (> 1 000 $\mu\text{S}/\text{cm}$). Deposits or buildup on the rope are compensated for.

Configuring two-point control

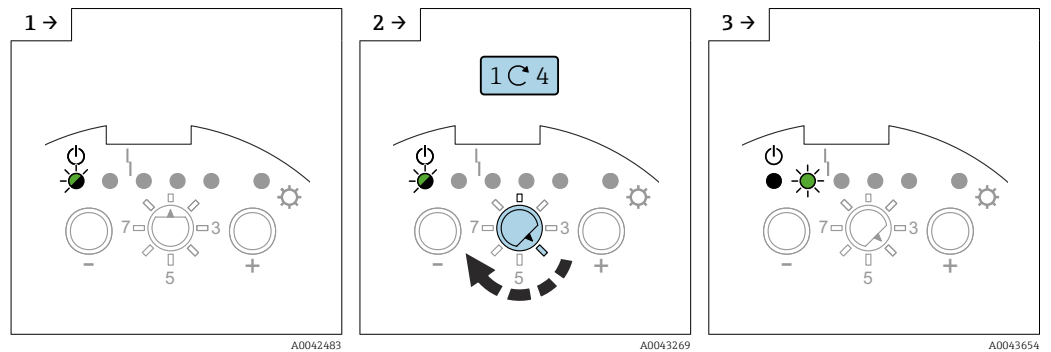

► Set the function switch to position 4.

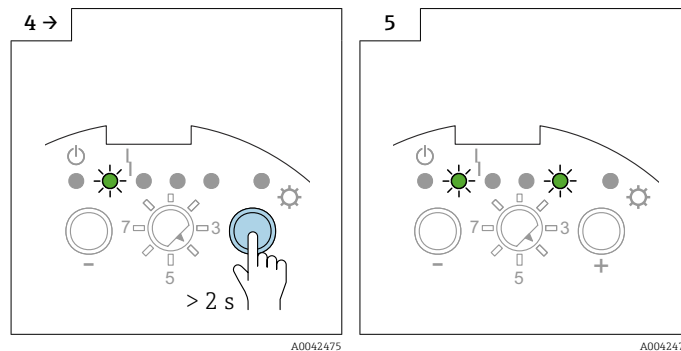

► Press the \oplus key > 2 s.

► The buildup two-point control is on.

Configuring the buildup control

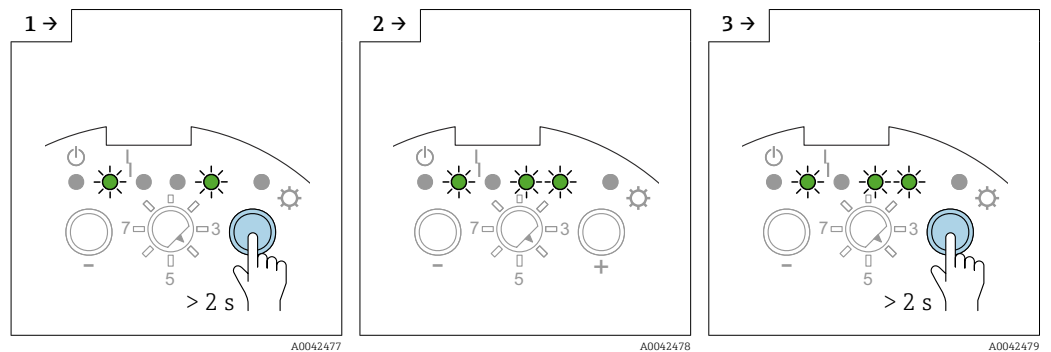

► Press the \oplus key > 2 s.

► The buildup control is on.

► Press the \oplus key > 2 s.

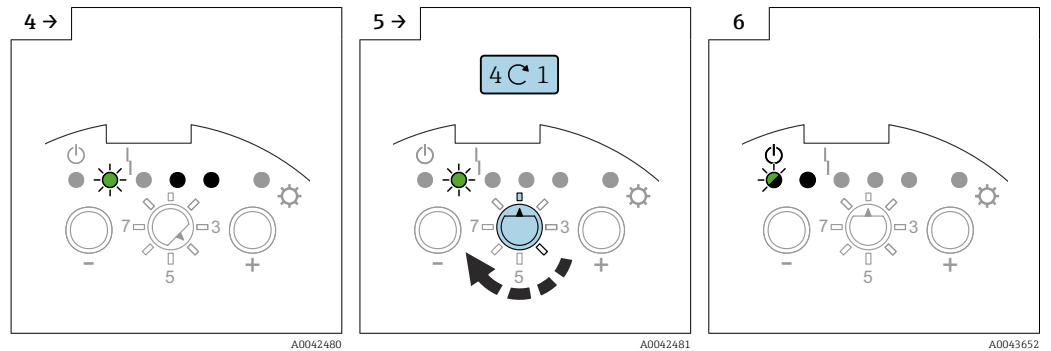

► The buildup control is off.

► Set the function switch to position 1.

7.2.8 Setting the switching delay

NOTICE

The tank can overflow if the switching delay is set for too long.



 The switching delay causes the device to signal the point level after a delay. This is highly useful in tanks with turbulent medium surfaces caused, for example, by the filling process or by collapsing mounds. By doing so, you ensure that the filling of the tank does not end until the probe is continuously covered by the medium.

 A switching delay that is too short may, for example, cause the filling process to be restarted as soon as the medium surface settles.

Setting the switching delay

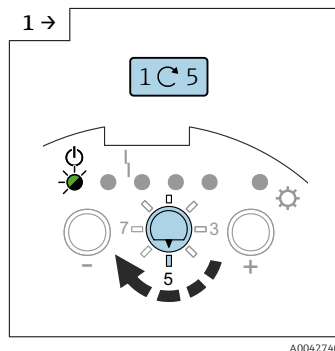

- ▶ Set the function switch to position 5.

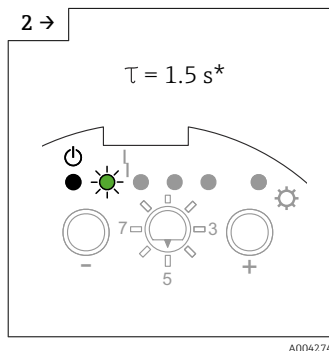

- ▶ The green LED 2 shows the factory setting 1.5 s.

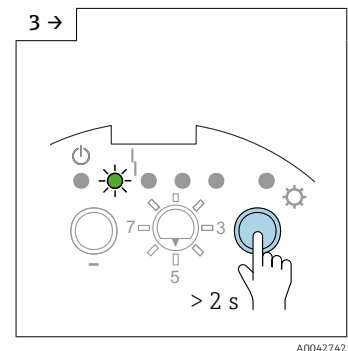

- ▶ Press the  to increase the switching delay time.

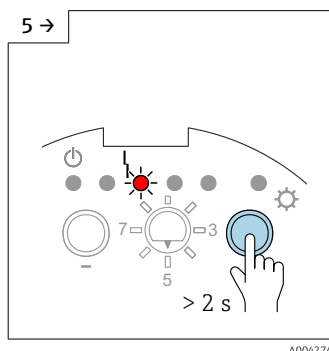
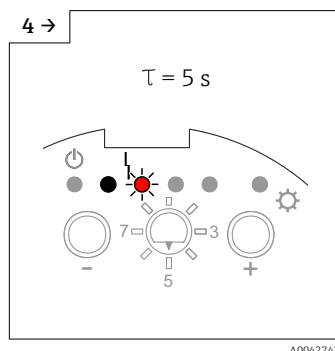

- ▶ Press the  to increase the switching delay time.

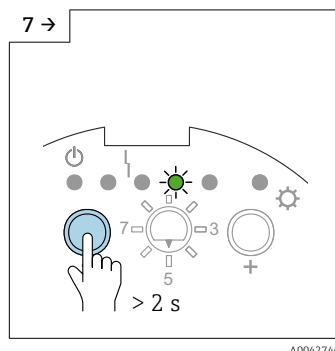
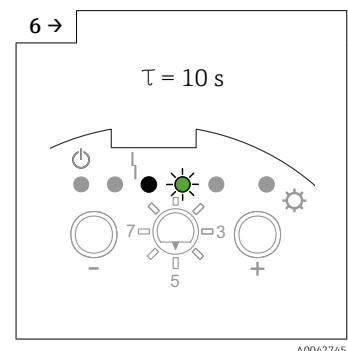

- ▶ Press the  key to decrease the value.

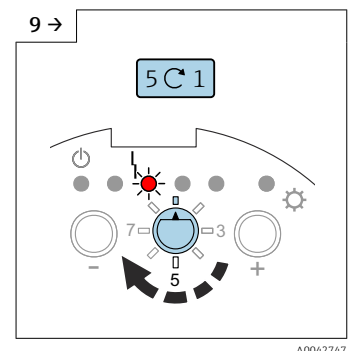
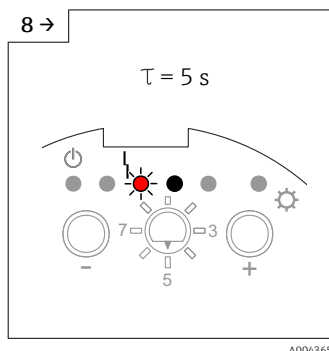

- ▶ Set the function switch to position 1.

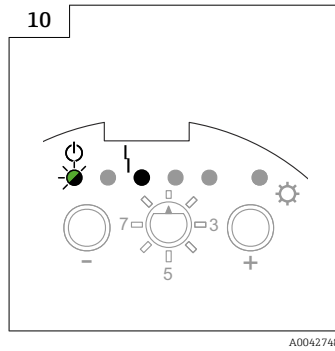

	GN	GN	RD	GN	GN	YE
τ	⏻					⚙️
0.3 s	🟢	●	●	●	●	●
1.5 s	●	🟢	●	●	●	●
5 s	●	●	🔴	●	●	●
10 s	●	●	●	🟢	●	●

37 The LED sequence regarding the switching delay value.

7.2.9 Activating the self-test

NOTICE

Accidental process run!

This could result, for example, in overflowing the tank.

- Make sure that you do not accidentally activate any processes with the self-test!

i The self-test simulates switching states:

- probe not covered
- probe covered

This allows you to check if the connected devices are activated correctly.

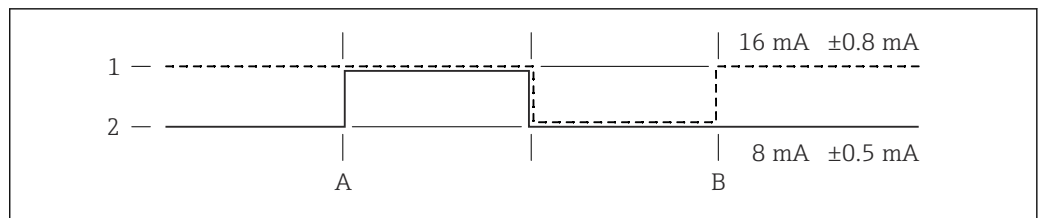

38 Start point covered

- 1 MIN safety
- 2 MAX safety
- A Proof test START point
- B Proof test END point

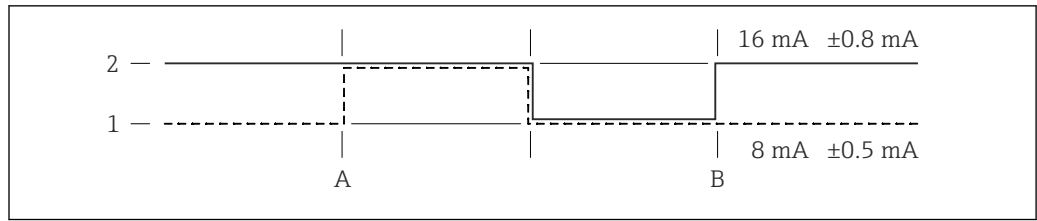

A0042398

39 Start point uncovered

- 1 MIN safety
- 2 MAX safety
- A Proof test START point
- B Proof test END point

Activating the self-test

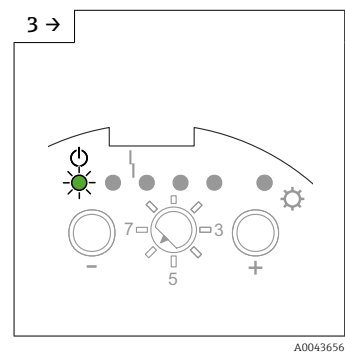
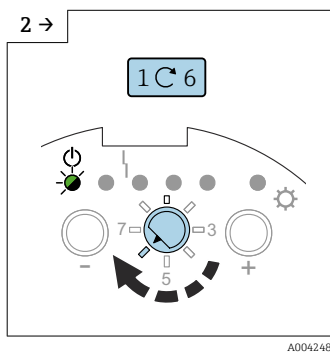
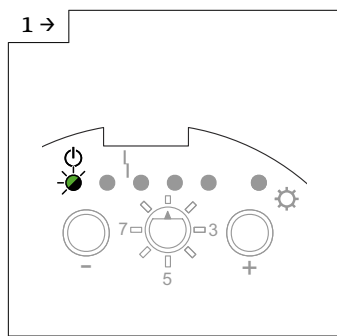

- ▶ Set the function switch to position 6.

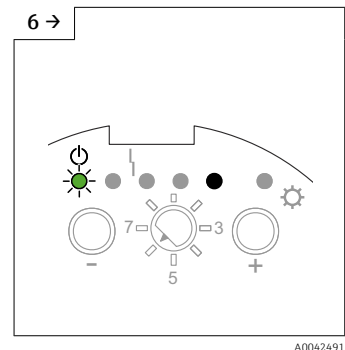
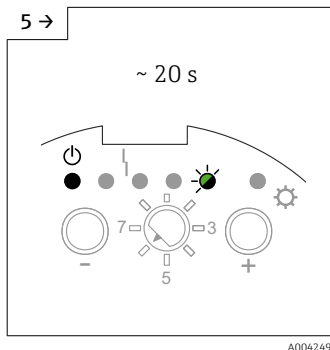
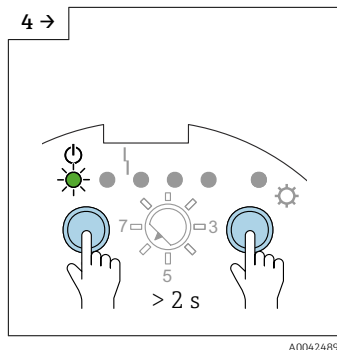

- ▶ Press the □ and + keys > 2 s.
- ▶ The green LED 5 flashes for 20 s
- ▶ The test is completed when the green LED 1 lits.

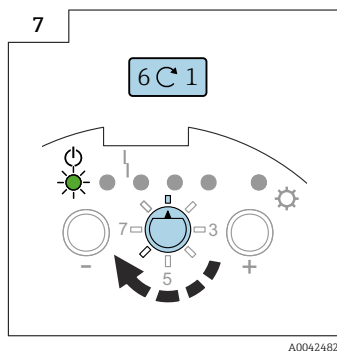

- ▶ Set the function switch to position 1.

7.2.10 Setting the MIN, MAX and SIL fail-safe mode

i The SIL mode function is only available in conjunction with electronic insert FEI55.
 By selecting the fail-safe mode correctly, you ensure that the output always operates safely with the quiescent current.

Minimum fail-safe mode (MIN)

The output switches if the switch-point is undershot (probe uncovered), a fault occurs or the line voltage fails.

Maximum fail-safe mode (MAX)

The output switches if the switch-point is exceeded (probe covered), a fault occurs or the line voltage fails.

Setting the MIN fail-safe mode:

i The factory setting is set to MAX fail-safe mode.

1 → A0042483

2 → A0042492

3 → A0042496

► Set the function switch to position 7.

► The green LED 5 shows the factory setting.

4 → A0042493

5 → A0043657

6 → A0042649

► Press the key > 2 s to set the MIN fail-safe mode.

► The MIN fail-safe mode is set.

► Set the function switch to position 1.

7 A0042483

To set the MAX fail-safe mode:

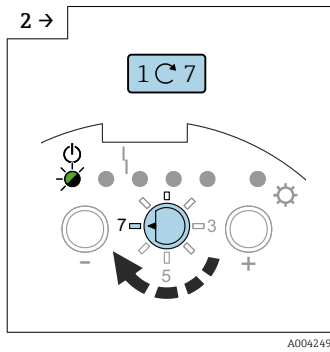
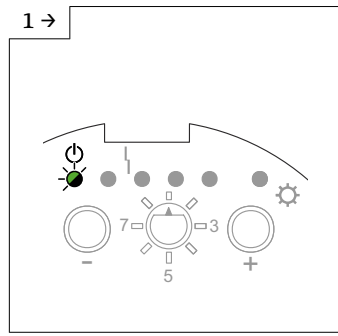

► Set the function switch to position 7.

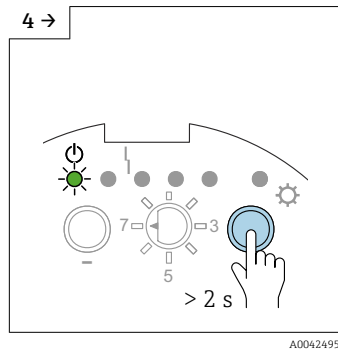
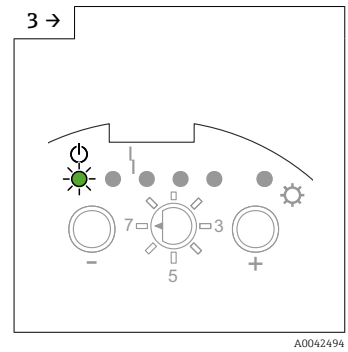

► Press the  key > 2 s to set the MAX fail-safe mode.

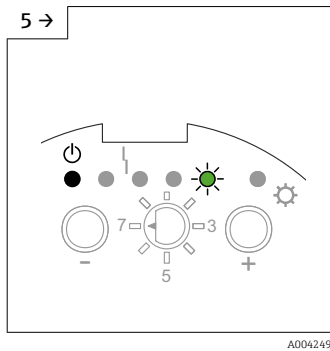

► The MAX fail-safe mode is set.

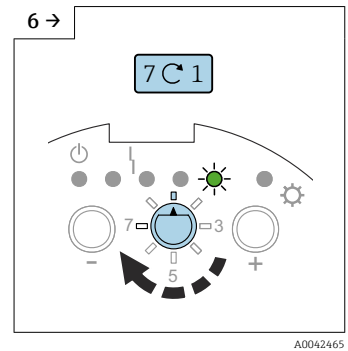

► Set the function switch to position 1.

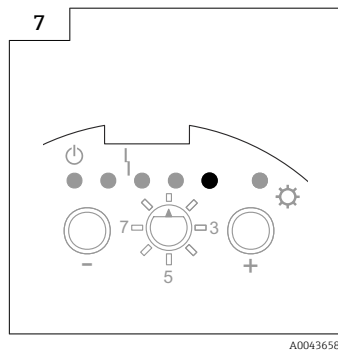

 Locking in the "Lock SIL mode" activates the fault message at the current output ($I < 3.6 \text{ mA}$), and it is signaled by the red LED 4.

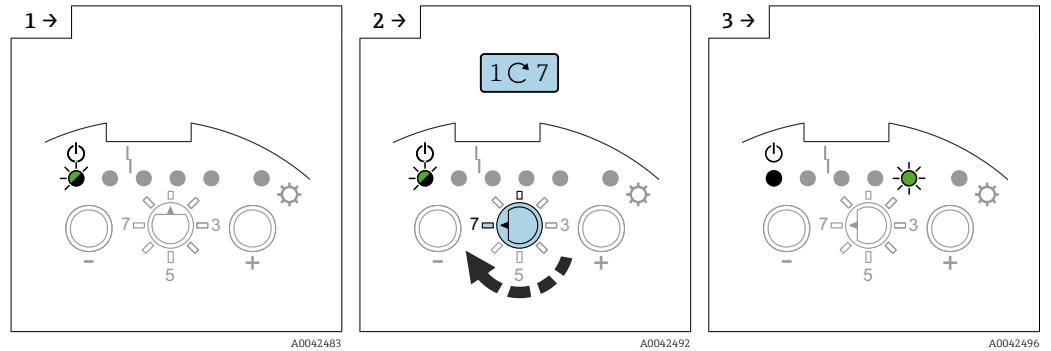

Setting the MAX fail-safe mode and lock the SIL mode:

 The factory setting is set to MIN-SIL mode.

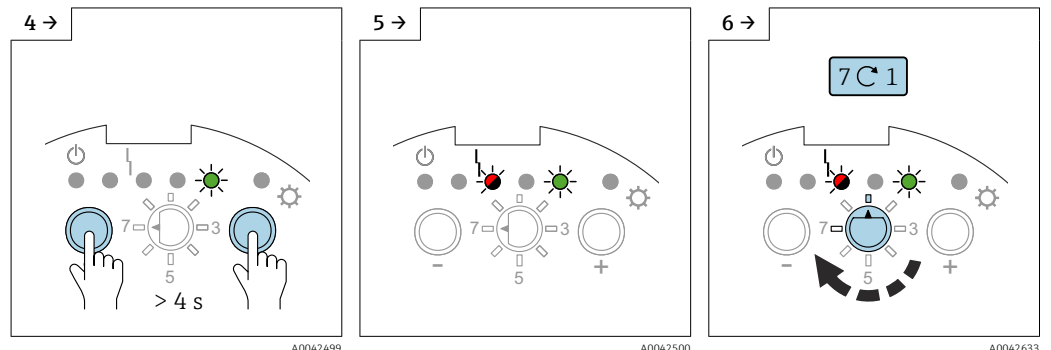

► Set the function switch to position 7.



► Press the  and  keys > 4 s.

► The MAX-SIL mode is set.

► Set the function switch to position 1.

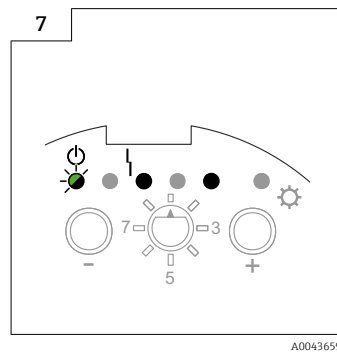

To set the MIN fail-safe mode and lock the SIL mode (only with the electronic insret FEI55):

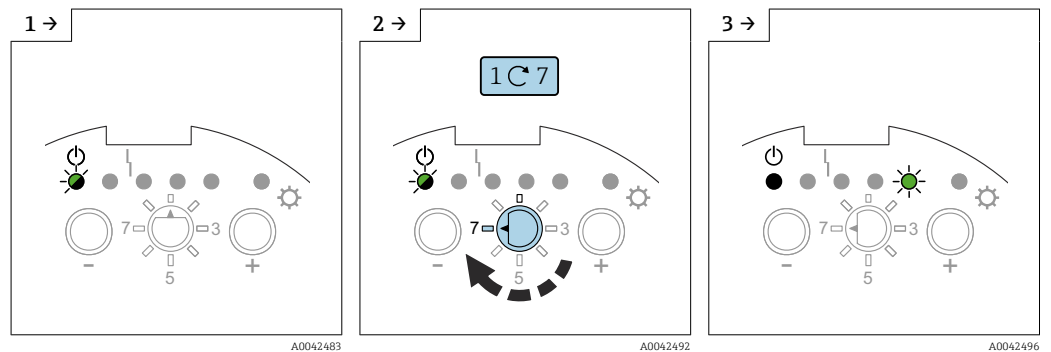

► Set the function switch to position 7.

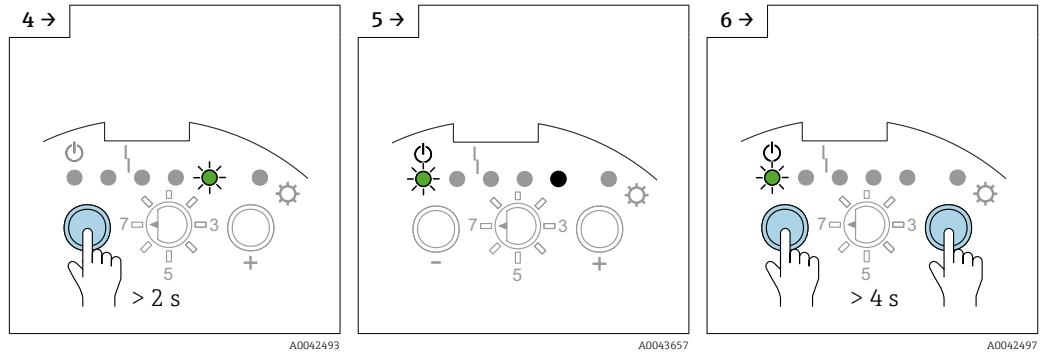

- ▶ Press the **MIN** key > 2 s to set the MIN fail-save mode.
- ▶ The MIN fail-save mode is set.
- ▶ Press the **MIN** and **MAX** keys > 4 s.

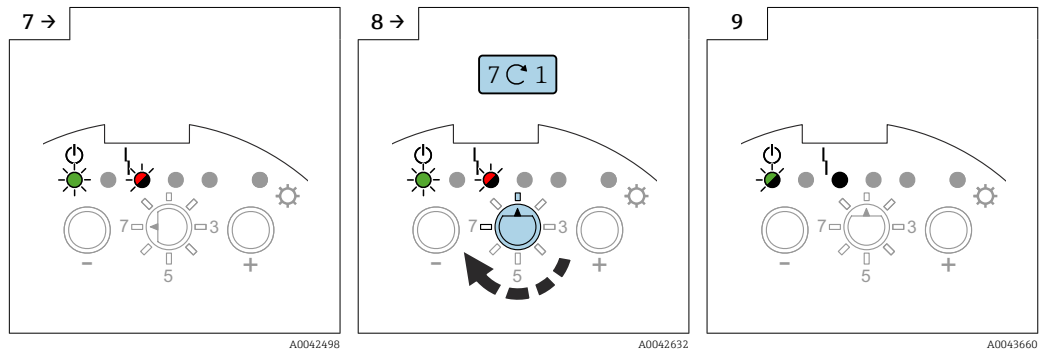

- ▶ The MIN-SIL mode is set.
- ▶ Set the function switch to position 1.

To unlock the SIL mode and set the MAX fail-save mode (only with electronic insert FEI55):

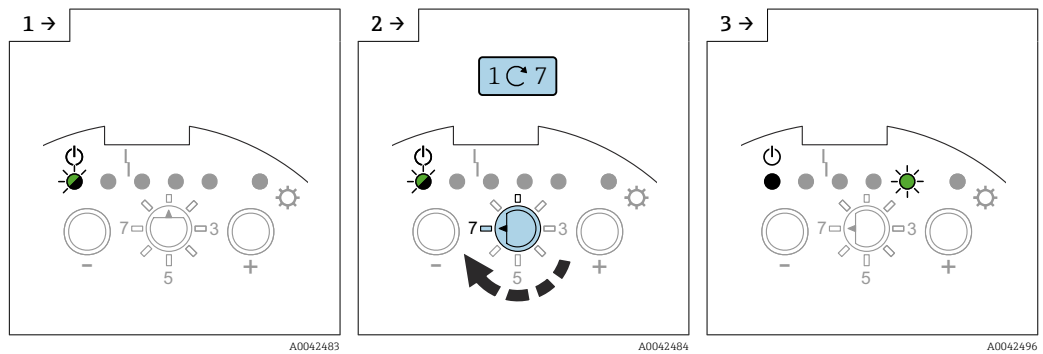

- ▶ Set the function switch to position 7.

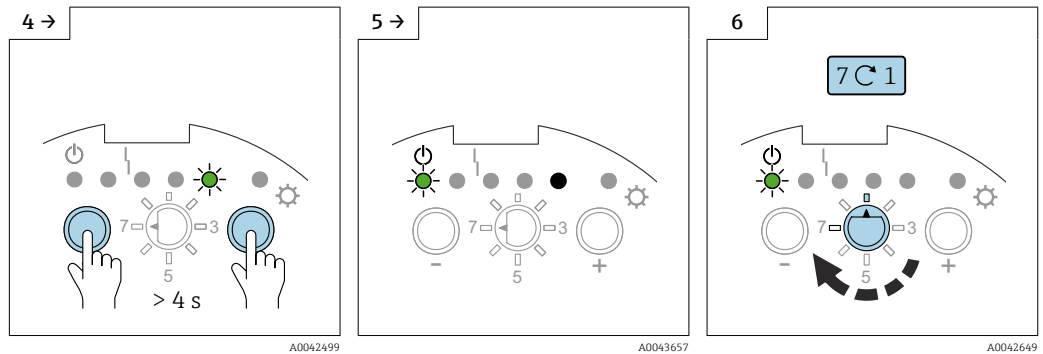

- ▶ Press the **MIN** and **MAX** keys > 4 s.
- ▶ The SIL mode is unlocked.
- ▶ Set the function switch to position 1.

To unlock the SIL mode and set the MIN fail-save mode:

1 → A0042483

2 → A0042484

3 → A0042485

4 → A0042494

5 → A0042649

- ▶ Set the function switch to position 7.
- ▶ Press the and keys > 4 s.
- ▶ The SIL mode is unlocked.
- ▶ Set the function switch to position 1.

7.2.11 Restoring factory settings

- This function allows you to restore the factory settings. This is particularly useful if the device has already been calibrated once and, for example, there is a fundamental change in the medium in the tank.
- After restoring the factory settings, you must repeat the calibration.

Restoring factory settings

- The device is set into the factory settings and it is possible to continue with setting the measuring range and the calibration.

1 → A0042452

2 → A0042486



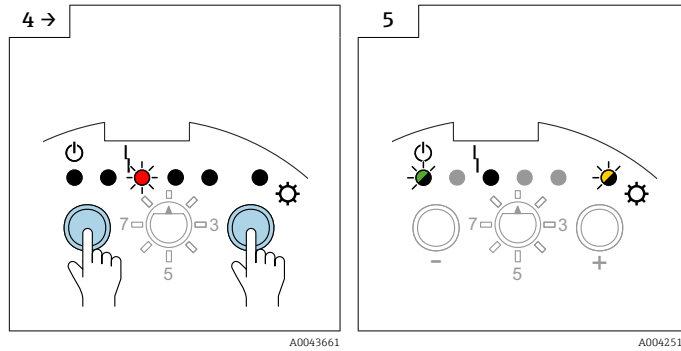

3 → A0042512

- ▶ Press the and keys.
- ▶ All LEDs light up sequentially in time > 20 s.



► The factory settings have been successfully restored.

7.2.12 Upload and download sensor DAT (EEPROM)

-  The customer-specific settings of the electronic insert (e.g. empty and full calibration, switch-point adjustment) are stored automatically in the sensor DAT (EEPROM) and the electronic insert.
-  The sensor DAT (EEPROM) is updated automatically each time a parameter is changed in the electronic insert.
-  If replacing the electronic insert, all the data are transferred into the electronic insert using a manual upload. No additional settings are required.
-  After installing the electronic insert, the manual download must be carried out to transfer the customer-specific settings of the electronic insert.

Upload

An upload transfers the saved data from the sensor DAT (EEPROM) to the electronic insert. The electronic insert does not have to be configured any more, and the device is then operational.

Download

A download transfers the saved data from the electronic insert to the sensor DAT (EEPROM).

Downloading the data

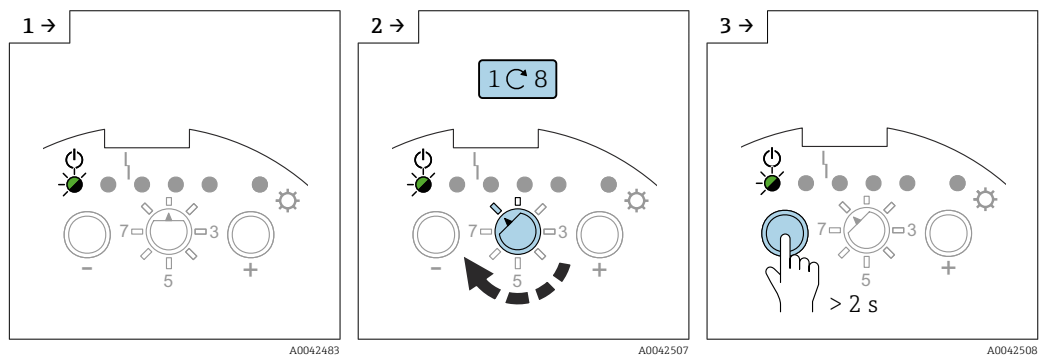

► Set the function switch to position 8.

► Press the  key > 2 s.

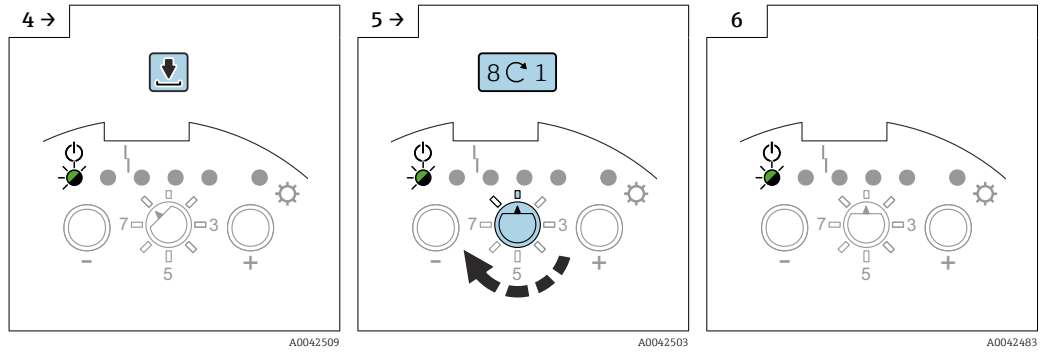

► Set the function switch to position 1.

Uploading the data

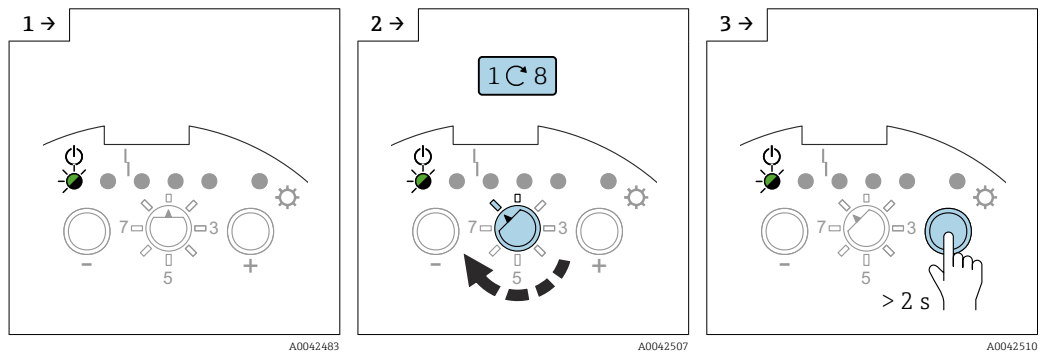

► Set the function switch to position 8.

► Press the  key > 2 s.

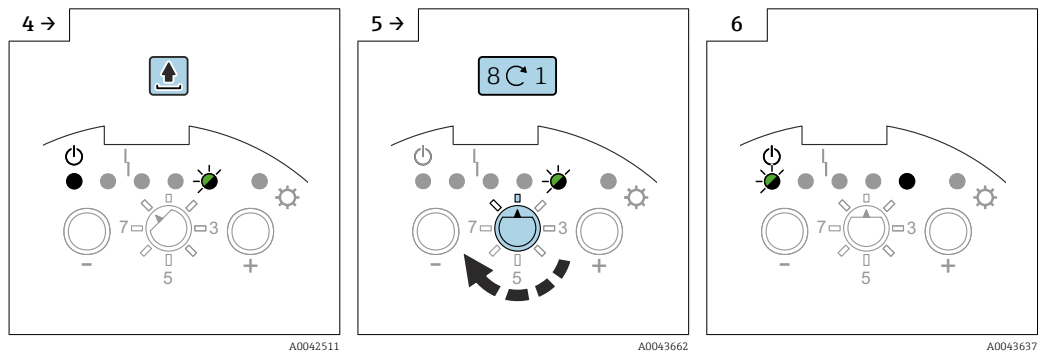

► Set the function switch to position 1.

7.2.13 Output signals

Output signal FEI51

		GN	GN	RD	GN	GN	YE	
MAX								$L+ \text{ [1] } \xrightarrow{I_L} \text{ [3] } +$
								$\text{ [1] } \xrightarrow{<3,8 \text{ mA}} \text{ [3] }$
MIN								$L+ \text{ [1] } \xrightarrow{I_L} \text{ [3] } +$
								$\text{ [1] } \xrightarrow{<3,8 \text{ mA}} \text{ [3] }$
								$\text{ [1] } \xrightarrow{I_L / <3,8 \text{ mA}} \text{ [3] }$
								$\text{ [1] } \xrightarrow{<3,8 \text{ mA}} \text{ [3] }$

A0042586

Output signal FEI52

		GN	GN	RD	GN	GN	YE	
MAX								$L+ \text{ [1] } \xrightarrow{I_L} \text{ [3] } +$
								$\text{ [1] } \xrightarrow{I_R} \text{ [3] }$
MIN								$L+ \text{ [1] } \xrightarrow{I_L} \text{ [3] } +$
								$\text{ [1] } \xrightarrow{I_R} \text{ [3] }$
								$\text{ [1] } \xrightarrow{I_L / I_R} \text{ [3] }$
								$\text{ [1] } \xrightarrow{I_R} \text{ [3] }$

A0042587

Output signal FEI54

		GN	GN	RD	GN	GN	YE	⊙ →
MAX								
MIN								

A0042528

Output signal FEI55

		GN	GN	RD	GN	GN	YE	⊙ →
MAX								+ 2 $\xrightarrow{\sim 16 \text{ mA}}$ 1
								+ 2 $\xrightarrow{\sim 8 \text{ mA}}$ 1
MIN								+ 2 $\xrightarrow{\sim 16 \text{ mA}}$ 1
								+ 2 $\xrightarrow{\sim 8 \text{ mA}}$ 1
								+ 2 $\xrightarrow{\sim 8/16 \text{ mA}}$ 1
								+ 2 $\xrightarrow{< 3.6 \text{ mA}}$ 1

A0042529

7.3 Commissioning with electronic inserts FEI53 or FEI57S

This chapter describes the process for commissioning the device with electronic insert versions FEI53 and FEI57S.

The measuring system is not operational until you have carried out a calibration at the switching unit.

For information on how to carry out the calibration, refer to the documentation for the Nivotester switching device: FTC325 3-Wire, FTC325 PFM.

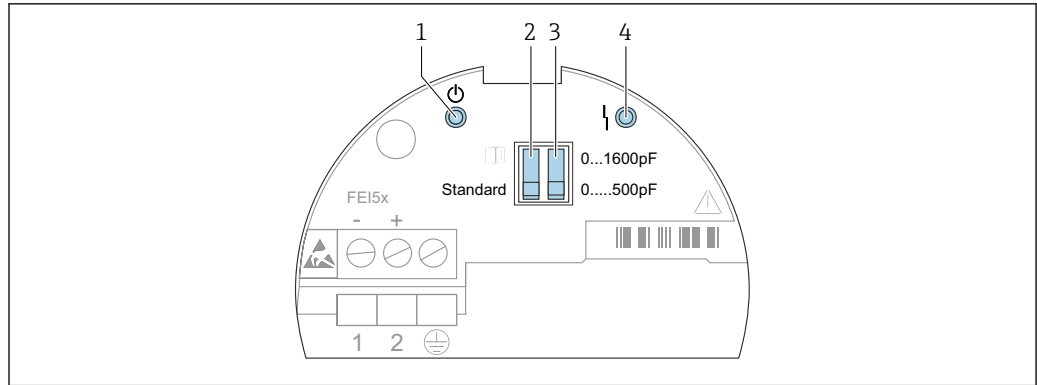

A0042395

40 FEI53 and FEI57S human interface

- 1 Green LED - operational status
- 2 Standard or alarm DIP switch
- 3 Measuring range DIP switch
- 4 Red LED - fault

7.3.1 Setting the alarm response if the measuring range is exceeded

The functions of the DIP switches:

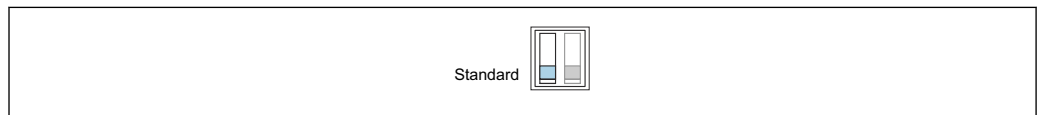

A0042400

41 Standard: if the measuring range is exceeded no alarm is output



A0042401

42 Alarm: if the measuring range is exceeded an alarm is output

i With this setting, it is possible to determine the alarm response of the measuring system when the measuring range is exceeded. It is possible to switch the alarm on or off if the measuring range is exceeded.

i All other settings concerning the alarm response have to be configured on the respective Nivotester switching device.

7.3.2 Setting the measuring range

The functions of the DIP switches:

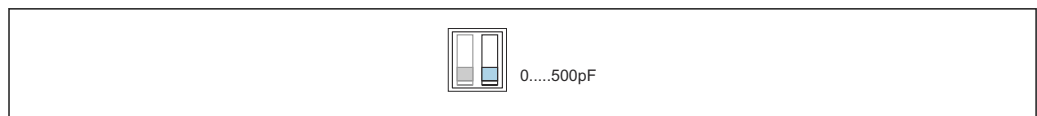

A0042402

43 Measuring range: the measuring range is between 0 to 500 pF. Span: the span is between 0 to 500 pF

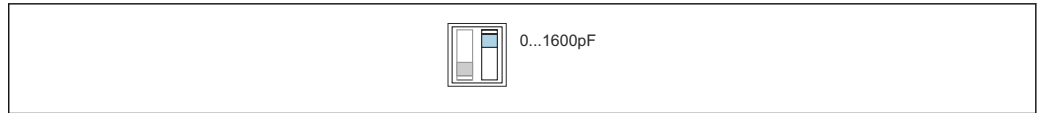

44 Measuring range: the measuring range is between 5 to 1 600 pF. Span: the span is between 5 to 1 600 pF

- i** The choice of measuring range (0 to 500 pF and 0 to 1 600 pF) depends on the function of the probe. If the probe is used as a point level switch, you can retain the factory setting of 0 to 500 pF.
- i** If the probe is used for two-point control, the following settings are recommended for vertical installation:
 - measuring range from 0 to 500 pF for probe lengths up to 1 m (3.3 ft)
 - measuring range from 0 to 1 600 pF for probe lengths up to 4 m (13 ft)

All other settings must be made on the respective Nivotester switching device.

7.3.3 Output signals

Output signal FEI53

	GN	RD	→
			[3] 3 ... 12 V
			[3] 3 ... 12 V
			[3] <2.7 V

Output signal FEI57S

	GN	RD	→
			+ [1] 60 ... 185 Hz → [2]
			+ [1] 60 ... 185 Hz → [2]
			+ [1] <20 Hz → [2]

7.4 Commissioning with the electronic insert FEI58

This chapter describes the process of commissioning the device with electronic insert FEI58.

- i** The measuring system is not operational until you have carried out a calibration.
- i** Additional functions associated with the switching unit are described in the documentation for the switching unit, e.g. Nivotester FTC325N.

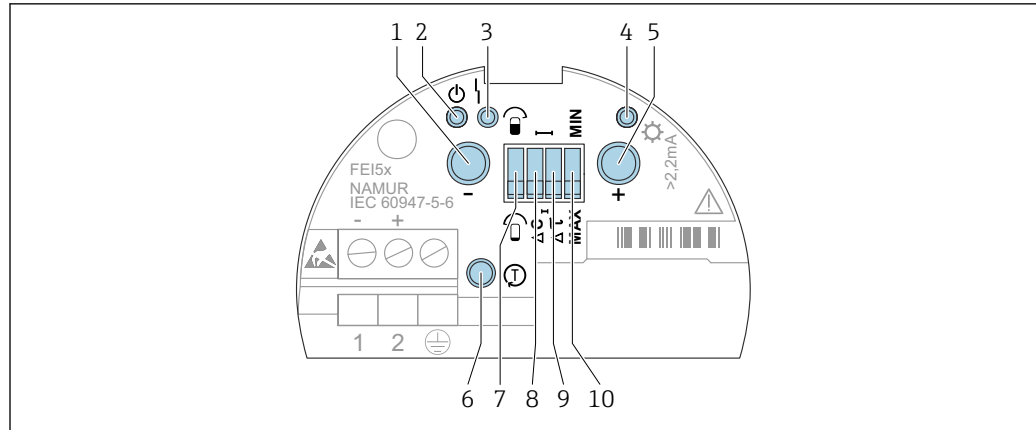

A0042396

45 FEI58 human interface

- 1 Function key A
- 2 Green LED - operational status
- 3 Red LED - fault
- 4 Yellow LED - switching state
- 5 Function key B
- 6 Test key
- 7 Calibration DIP switch
- 8 Switch point SIP switch
- 9 Delay DIP switch
- 10 Fail-safe mode DIP switch

7.4.1 Function keys A, B, C

i To prevent unintentional operation of the device, wait for approximately 2 s after the keys were pressed, to elapse before the system evaluates and executes a function commanded when a key is pressed (keys A and B). Test key C disconnects the power supply immediately.

i Both keys (A and B) have to be pressed simultaneously to trigger switch-point adjustment.

Function key

- Key A: displays diagnostic code
- Key B: displays calibration situation
- Test key C: disconnects the transmitter from the switching unit
- Keys A and B pressed during:
 - operation - perform calibration
 - startup - delete calibration points

7.4.2 Performing calibration

i An empty and full calibration provides the greatest possible operational security. This is highly recommended for critical applications.

i The empty and full calibration measures the capacitance values of the probes when the tank is full and when it is empty. For example: if the measured capacitance value of the empty calibration is 50 pF and that of the full calibration is 100 pF, the average capacitance value, 75 pF is stored as the switch-point.

Calibration DIP switch:

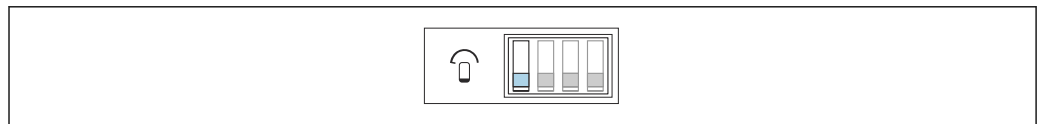

A0042405

46 The probe is uncovered during calibration

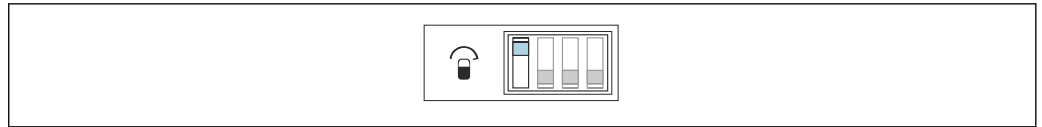

A0042404

47 The probe is covered during calibration

i Make sure that the probe is not covered with product.

Carrying out empty calibration

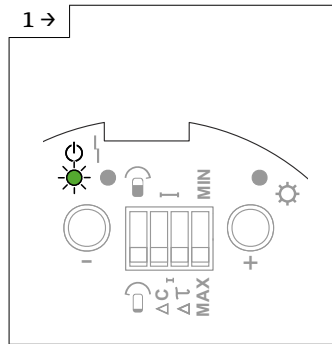

A0042514

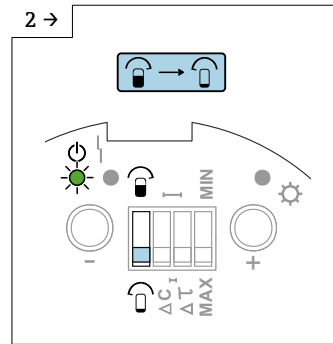

A0042515

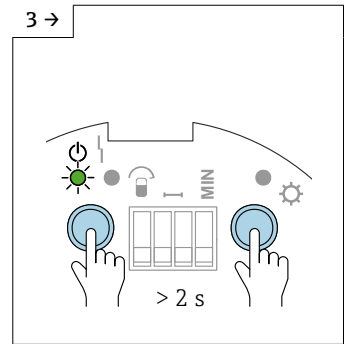

A0042516

► Make sure that the calibration DIP switch is in position "Uncovered".

► Press the A and B keys > 2 s.

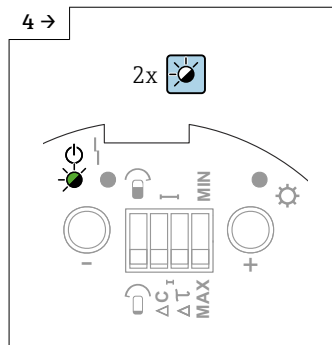

A0042517

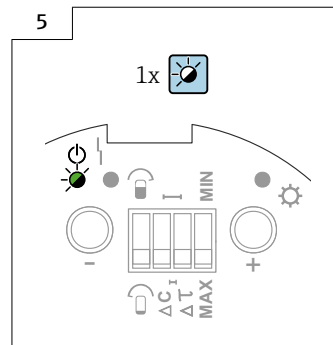

A0042518

► The green LED 1 flashes quickly to indicate that the value has been saved correctly.

► The process of saving the empty calibration value is finished when the green LED 1 flashes slowly.

i Make sure that the probe is covered by the medium up to the desired switch-point.

Carrying out full calibration

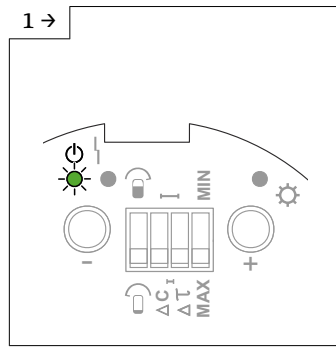

A0042514

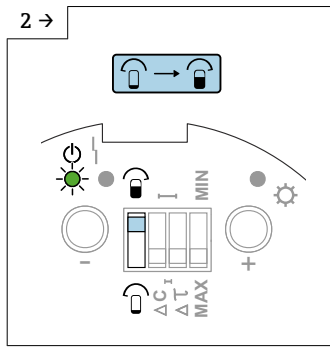

A0042519

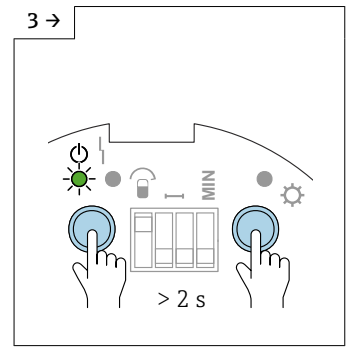

A0042520

► Make sure that the calibration DIP switch is in position "Covered".

► Press the A and B keys > 2 s.

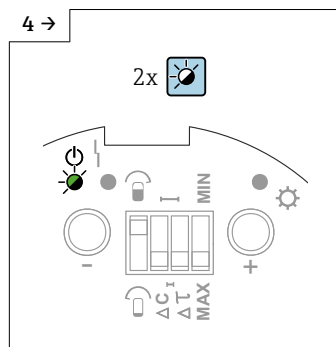

A0042521

► The green LED 1 flashes quickly to indicate that the value has been saved correctly.

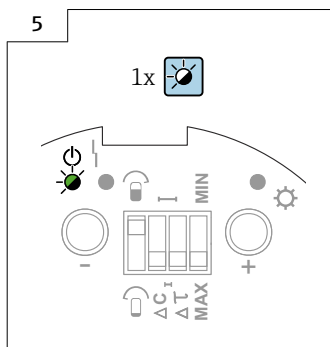

A0042522

► The process of saving the full calibration value is finished when the green LED 1 flashes slowly.

7.4.3 Setting the switch point adjustment

i If only one calibration (empty or full) was carried out, and if buildup forms on the rope probe while the probe is in operation, the device may no longer respond to changes in level. A switch point adjustment compensates for this condition and ensures that you obtain a constant switch point again.

i For media that do not have a tendency to buildup, we recommend a setting of 2 pF, as the probe is most sensitive to changes in level at this setting.

i For media with heavy buildup, it is recommended to use the probes with active buildup compensation with the setting of 10 pF.

Switch point adjustment:

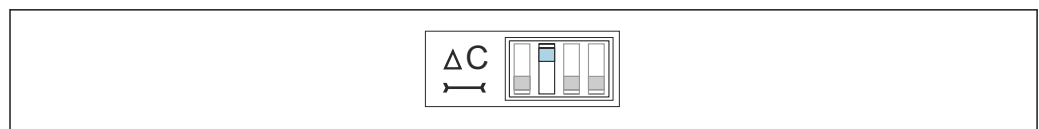

A0042406

48 10 pF

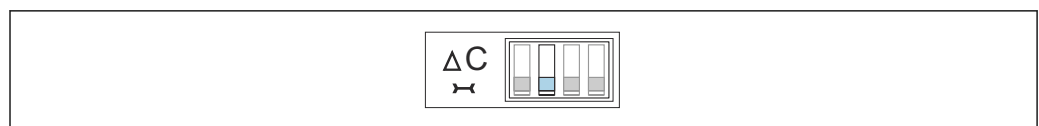

A0042407



49 2 pF

7.4.4 Setting the switching delay

NOTICE

The tank can overflow if the switching delay is set for too long.



-  The switching delay causes the device to signal the point level after a delay. This is useful in tanks with turbulent medium surfaces caused by the filling process or by collapsing mounds. Ensure that the filling of the tank does not end until the probe is continuously covered by the medium.
-  A switching delay that is too short can cause the filling process to be restarted as soon as the medium surface settles.

Switching delay:

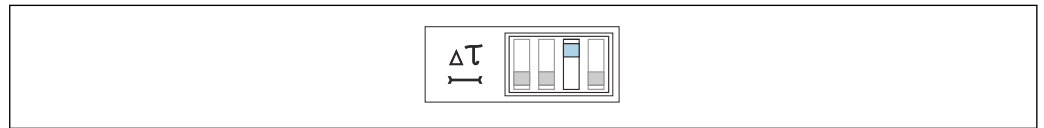

A0042408

 50 5 s

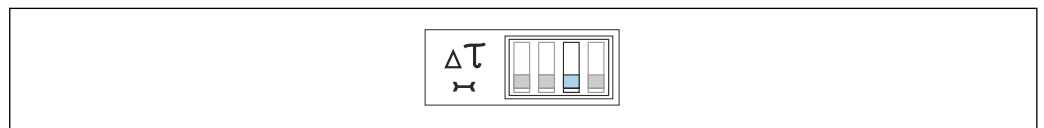

A0042409

 51 1 s

7.4.5 MIN and MAX fail-safe mode

-  By selecting the fail-safe mode correctly, you ensure that the output always operates safely with the quiescent current.

Minimum fail-safe mode (MIN)

The output switches if the switch point is undershot (rope uncovered), a fault occurs or the line voltage fails.

Maximum fail-safe mode (MAX)

The output switches if the switch point is exceeded (rope covered), a fault occurs or the line voltage fails.

Fail-safe mode:



A0042410

-  52 The output switches safety-oriented when the probe is uncovered. It can be used in cases such as dry run protection and pump protection.



A0042411

-  53 The output switches safety-oriented when the probe is covered. It can be used in cases such as overflow protection.

7.4.6 Display calibration situation

Use this function to see what calibrations have been performed on the device. The calibration situation is indicated by the three LEDs.

Displaying calibration situation

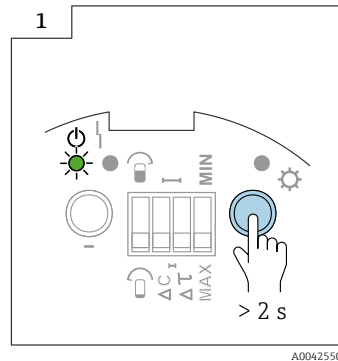

- ▶ Press the  key > 2 s

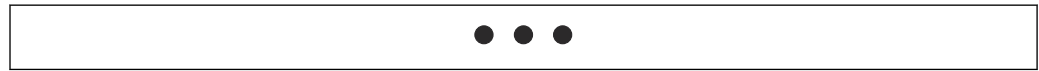

-  54 *No calibration*

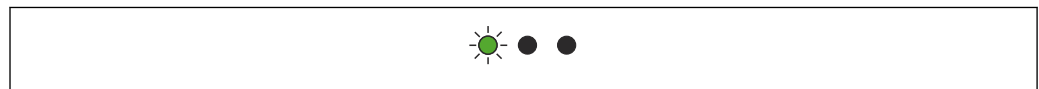

-  55 *Empty calibration performed*

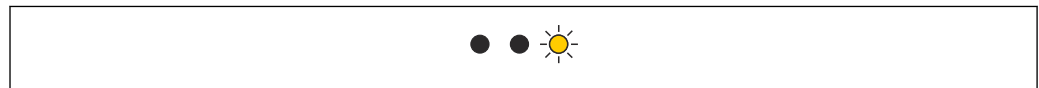

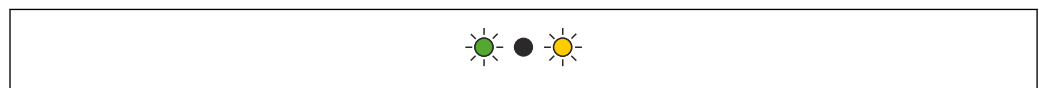

-  56 *Full calibration performed*



-  57 *Empty and full calibration performed*

7.4.7 Displaying the diagnostic code

This function makes it possible to interpret faults using the three LEDs. If the system detects more than one fault, the fault with the highest priority is shown on the display.

 More information is provided in the section "Fault diagnostics" →  72.

7.4.8 Test key C

 This test can be used to activate safety-specific measures in the plant like the alarms!

Pressing test key C disconnects the supply voltage. If the power supply is disconnected, a supply unit like Nivotester FTC325N reacts that the alarm relay outputs an error and appropriate responses are triggered in any slave devices connected.

To perform the function test:

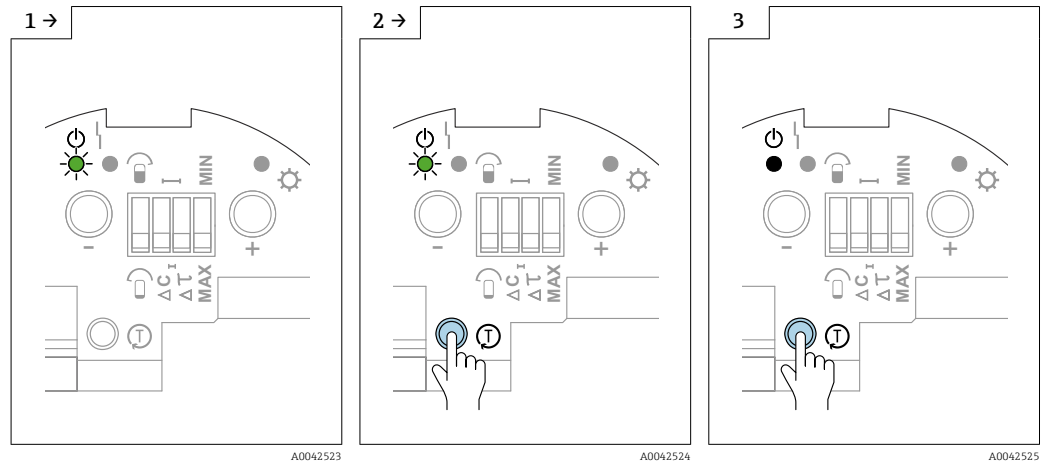

- ▶ Press the C key for the entire duration of the test.
- ▶ The safety functions configured for the supply unit are activated.
- ▶ Release the C key to end the function test.

7.4.9 Output signals

Output signal FEI58

		GN	RD	YE	↻
MAX 					+ [2] 2.2 ... 3.5 mA → [1]
					+ [2] 0.6 ... 1.0 mA → [1]
MIN 					+ [2] 2.2 ... 3.5 mA → [1]
					+ [2] ————— → [1]
					+ [2] 0.6 ... 1.0 mA 2.2 ... 3.5 mA → [1]
					+ [2] 0.6 ... 1.0 mA → [1]

A0042590

8 Diagnostics and troubleshooting

i In the event of faults during commissioning or operation of the device, you can carry out fault diagnostics on the electronic insert. This function is supported by the electronic inserts FEI51, FEI52, FEI54, FEI55.

i The electronic inserts FEI53, FEI57S and FEI58 signal two types of faults:

- the red LED flashes - faults that can be rectified
- the red LED is lit continuously - faults that cannot be rectified

8.1 Activating fault diagnostics FEI51, FEI52, FEI54 and FEI55

i The diagnostics provide information about the operating status of the device. The results of the diagnostics are displayed by LEDs. If the diagnostics detect multiple faults, these are shown according to their priority. A serious fault (e.g. priority 3) is always displayed before a less serious fault (e.g. priority 5).

Activating fault diagnostics

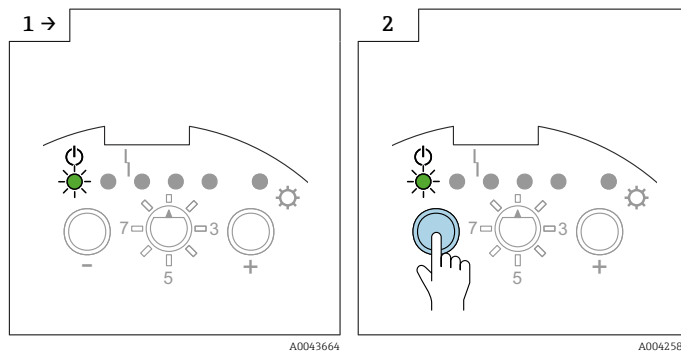

► Make sure the function switch is set to position 1.

► Press the key.

No fault



A0042555

Internal fault - priority 1



A0042556

Replace the electronic insert

The calibration point or points are outside the measuring range - priority 2



A0042557

Recalibrate

The calibration points have been accidentally interchanged - priority 3



A0042558

Recalibrate

The calibration point is too close to the measuring range limit - priority 4



A0042559

Reduce the switch-point or select a new installation location

No calibration has yet been carried out - priority 5

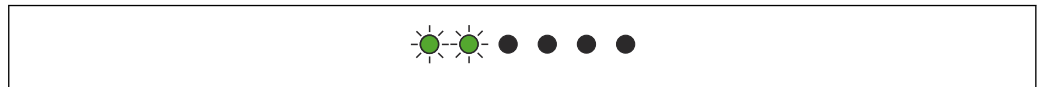

A0042560

Carry out empty and full calibration

The DC PNP output is overloaded (FEI52) - priority 6

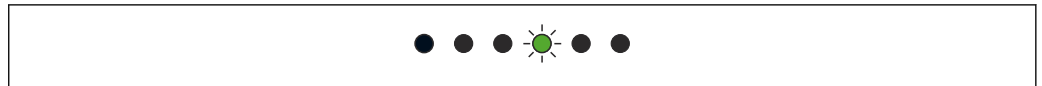

A0042561

Reduce the connected load

The capacitance change from "Probe not covered" to "Probe covered" is too small - priority 7

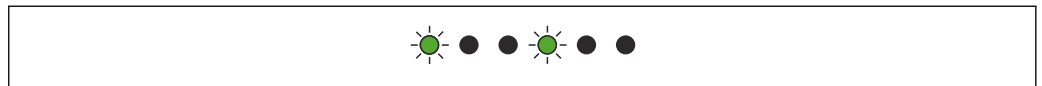

A0042565

Contact Endress+Hauser Service

Sensor DAT (EEPROM) data are invalid - priority 8

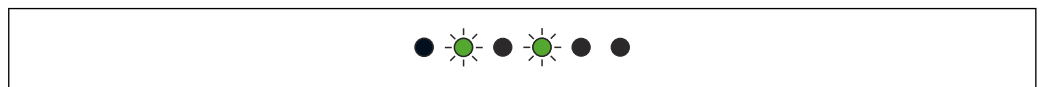

A0042566

Carry out download from the electronic insert

The probe is not detected, the connection to the sensor DAT (EEPROM) could not be established - priority 9

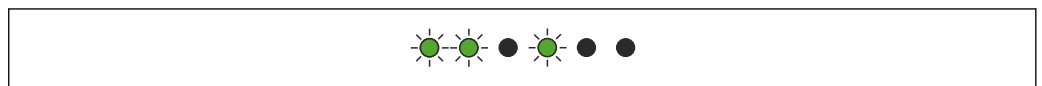

A0042567

The probe type is not compatible

The measured temperature is outside the permitted temperature range - priority 10



A0042568

Operate the device in the specified temperature range only

8.2 Fault diagnostics FEI53 and FEI57S

The device does not switch

Check the connection and the supply voltage

Alarm LED flashes

The ambient temperature of the electronics is outside the permitted range or the connection to the probe is interrupted

8.3 Activating fault diagnostics FEI58

This function makes it possible to interpret faults using the three LEDs. If the system has detected more than one fault, the fault with the highest priority is shown on the display.

To display the diagnostic code:

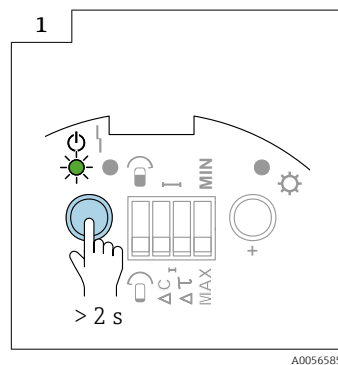

- ▶ Press the  key > 2 s

No fault



Internal fault - priority 1

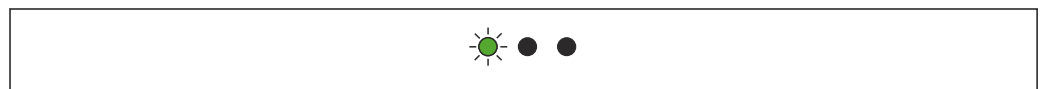

The device is defective

The calibration point is too close to the measuring range limit - priority 2

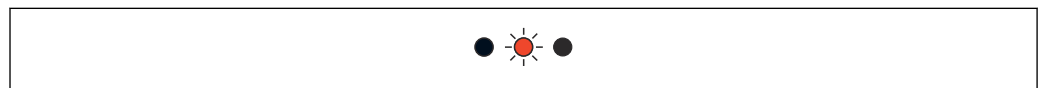

 58

Reduce the switch-point or select a new installation location

Calibration points have been accidentally interchanged - priority 3

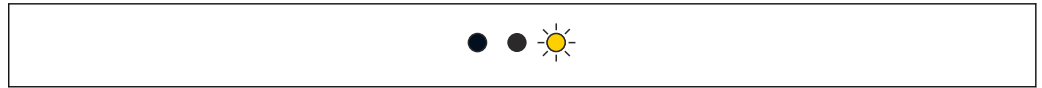

A0042572

Perform uncovered calibration with the probe uncovered, and covered calibration with the probe covered

No calibration has yet been carried out - priority 4

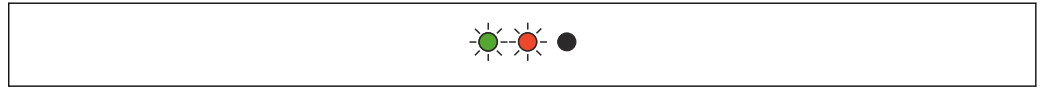

A0042573

Carry out empty and full calibration

The change in capacitance from uncovered probe to covered probe is too small - priority 5

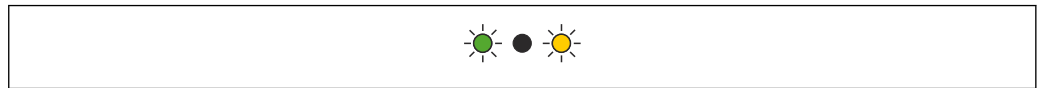

A0042554

The capacitance change between the uncovered and covered probe must be higher than 2 pF

Probe not detected - priority 6

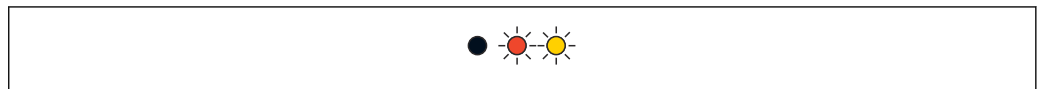

A0042575

59 Probe not detected

Connect the probe

The measured temperature is outside the permitted range - priority 7

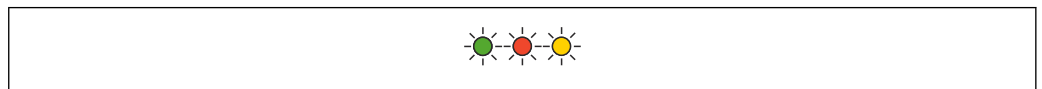

A0042576

60 The measured temperature is outside the permitted range

The device can be operated in the specified temperature range only

8.4 Firmware history

FEI51

- Release date: 10/2007
- Software version: V 01.00.zz
- Software change: original software

FEI52

- Release date: 07/2006
- Software version: V 01.00.zz
- Software change: original software

FEI53

- Release date: 07/2006
- Software version: V 01.00.zz
- Software change: original software

FEI54

- Release date: 07/2006
- Software version: V 01.00.zz
- Software change: original software

FEI55

- Release date: 11/2008
- Software version: V 02.00.zz
- Software change: extended to include SIL functionality

FEI57S

- Release date: 07/2006
- Software version: V 01.00.zz
- Software change: original software

FEI58

- Release date: 01/2010
- Software version: V 01.00.zz
- Software change: original software

9 Maintenance

No special maintenance work is required.

9.1 External cleaning

Do not use a corrosive or aggressive cleaning agent to clean the housing surface and seals.

9.2 Cleaning the probe

Depending on the application, buildup of contamination or soiling can form on the probe rope. A high level of material buildup can affect the measurement result.

The regular cleaning of the probe rope is recommended if the medium tends to create a high level of buildup.

Make sure that the insulation of the probe rope is not damaged if hosing down or during mechanical cleaning.

Make sure that the probe rope insulation is resistant to cleaning agents.

9.3 Seals

The process seals of the sensor must be replaced periodically, especially when using molded aseptic seals! The intervals between seal replacement depend on the frequency of the cleaning cycles and on the fluid and cleaning temperature.

9.4 Endress+Hauser services

Endress+Hauser offers a wide range of services.



Your Endress+Hauser Sales Center can provide detailed information on the services.

10 Repair

10.1 General notes

The Endress+Hauser repair and conversion concept provides the following:

- The measuring devices have a modular design
- Spare parts are grouped into logical kits with the associated Installation Instructions
- Repairs are carried out by Endress+Hauser Service or by appropriately trained customers
- Certified devices can only be converted to other certified devices by Endress+Hauser Service or at the factory

10.2 Spare parts

Find spare parts

Check whether it is possible to use the spare part for the measuring device.

1. Launch the Endress+Hauser Device Viewer via a web browser:
www.endress.com/deviceviewer
2. Enter the order code or the product root in the respective field.
 - ↳ Once the order code or the product root has been entered, all the suitable spare parts are listed.
The product status is displayed.
Available drawings of the spare parts are displayed.
3. Locate the order code of the spare part set (on the product label on the package).
 - ↳ **NOTE!**
The order code of the spare part set (on the product label on the package) can differ from the production number (on the label directly on the spare part)!
4. Check whether the order code of the spare part set appears in the list of the spare parts displayed:
 - ↳ **YES:** The spare part set may be used for the measuring device.
NO: The spare part set may not be used for the measuring device.
If you have any questions please contact your Endress+Hauser Service organization.
5. On the **Spare parts** tab click the PDF symbol in the **MH** column.
 - ↳ The Installation Instructions attached to the listed spare part are opened as a PDF file and can also be saved as a PDF file.
6. Click one of the drawings shown on the **Spare part drawings** tab.
 - ↳ The corresponding exploded drawing is opened as a PDF file and can also be saved as a PDF file.

10.3 Repairing Ex-certified devices

If repairing Ex-certified devices remember that:

- Ex-certified devices may only be repaired by experienced and skilled staff or by Endress+Hauser Service
- observe all applicable standards, certificates, national Ex-area regulations and all Safety Instructions (XA)
- use only genuine spare parts from Endress+Hauser
- note the device designation on the nameplate to order the spare parts
- replace the component by the same type
- carry out the replacing in accordance with the instructions

- carry out the individual test for the device
- change the device only with a device certificated by Endress+Hauser
- report every change and repair of the device

10.4 Replacement

After replacing a probe or the electronic insert, the calibration values must be transferred to the replacement device.

Options:

- if the probe is replaced, the calibration values in the electronic insert can be transferred to the sensor DAT (EEPROM) module via a manual download
- if the electronic insert is replaced, the calibration values of the sensor DAT (EEPROM) module can be transferred to the electronics via a manual upload

It is possible to restart the device without having to carry out a new calibration.

10.5 Return

The requirements for safe device return can vary depending on the device type and national legislation.

1. Refer to the website for more information:
<http://www.endress.com/support/return-material>
2. Return the device if repairs or a factory calibration are required, or if the wrong device was ordered or delivered.

10.6 Disposal

10.6.1 Removing the measuring device

1. Switch off the device.

WARNING

Danger to personnel from process conditions.

- ▶ Beware of hazardous process conditions such as pressure in the measuring device, high temperatures or aggressive fluids.

2. Carry out the mounting and connection steps from the "Mounting the measuring device" and "Connecting the measuring device" sections in reverse order. Observe the safety instructions.

10.6.2 Disposing of the measuring device

WARNING

Danger to personnel and environment from fluids that are hazardous to health.

- ▶ Ensure that the measuring device and all cavities are free of fluid residues that are hazardous to health or the environment, e.g. substances that have permeated into crevices or diffused through plastic.

Observe the following notes during disposal:

- ▶ Observe valid federal or national regulations.
- ▶ Ensure proper separation and reuse of the device components.

11 Accessories

11.1 Protective cover

Protective cover for F13, F17 and F27 housing (without display)
order number: 71040497

Protective cover for F16 housing
order number: 71127760

11.2 Seal set for stainless steel housing

Seal set for stainless steel housing F15 with 5 sealing rings
Part number: 52028179

11.3 Surge arresters

11.3.1 HAW562



- For supply lines: BA00302K.
- For signal lines: BA00303K.

11.3.2 HAW569



- For signal lines in field housing: BA00304K.
- For signal or supply lines in field housing: BA00305K.

11.4 Technical information

Nivotester FTC325
TI00380F

12 Technical data

12.1 Input

12.1.1 Measuring range

Measuring frequency

500 kHz

Span

- $\Delta C = 5$ to 1 600 pF
- FEI58
 $\Delta C = 5$ to 500 pF

Final capacitance

$C_E =$ maximum 1 600 pF

Adjustable initial capacitance

- range 1 - factory setting
 $C_A = 5$ to 500 pF
- range 2 - not available with FEI58
 $C_A = 5$ to 1 600 pF

12.2 Output

12.2.1 Switch behavior

Binary or Δs operation.



The pump control is not possible with FEI58.

12.2.2 Switch-on behaviour

When the power supply is switched on, the switching status of the outputs corresponds to the signal on the alarm.

The correct switch condition is reached after a maximum of 3 s.

12.2.3 Fail-safe mode

Minimum and maximum quiescent current safety can be switched at the electronic insert ²⁾.

MIN

Minimum safety: the output switches safety-oriented when the probe is uncovered ³⁾ (signal on alarm).

MAX

Maximum safety: the output switches safety-oriented when the probe is covered ⁴⁾ (signal on alarm).

2) For FEI53 and FEI57S only on the associated Nivotester: FTC325.

3) E.g. for dry running protection and pump protection.

4) E.g. for use with overflow protection.

12.2.4 Galvanic isolation

FEI51 and FEI52

between the rope probe and power supply

FEI54

between the rope probe, power supply and load

FEI53, FEI55, FEI57S and FEI58

see connected switching device ⁵⁾

12.3 Performance characteristics

According to DIN 61298-2

- Uncertainty: maximum ± 0.3 %
- Non-repeatability: maximum ± 0.1 %

12.3.1 Ambient temperature effect

Electronic insert

< 0.06 % per 10 K related to the full-scale value

Separate housing

capacitance change of connecting cable per meter 0.15 pF per 10 K

12.4 Operating conditions: Environment

12.4.1 Ambient temperature range

- F16 housing: -40 to $+70$ °C (-40 to $+158$ °F)
- remaining housing: -50 to $+70$ °C (-58 to $+158$ °F)
- observe derating
- use a protective cover, when operating outdoors

12.4.2 Climate class

DIN EN 60068-2-38/IEC 68-2-38: Z/AD check

12.4.3 Vibration resistance

DIN EN 60068-2-64/IEC 68-2-64: 20 to 2 000 Hz, 0.01 g^2/Hz

12.4.4 Shock resistance

DIN EN 60068-2-27/IEC 68-2-27: 30 g acceleration

12.4.5 Cleaning

Housing:

Make sure that the housing surface and seals are resistant to cleaning agents.

Probe:

Depending on the application, buildup of contamination or soiling can form on the probe. A high level of material buildup can affect the measurement result.

5) Functional galvanic isolation in the electronic insert.

The regular cleaning of the probe is recommended if the medium tends to create a high level of buildup.

Make sure that the insulation of the probe is not damaged if hosing down or during mechanical cleaning.

12.4.6 Degree of protection

 All protection degree regarding EN60529.

Type4X protection degree regarding NEMA250.

Polyester housing F16

Protection degree:

- IP66
- IP67
- Type4X

Stainless steel housing F15

Protection degree:

- IP66
- IP67
- Type4X

Aluminum housing F17

Protection degree:

- IP66
- IP67
- Type4X

Aluminum housing F13 with gas-tight process seal

Protection degree:

- IP66
- IP68 ⁶⁾
- Type4X

Stainless steel housing F27 with gas-tight process seal

Protection degree:

- IP66
- IP67
- IP68 ⁶⁾
- Type4X

Aluminum housing T13 with gas-tight process seal and separate connection compartment (Ex d)

Protection degree:

- IP66
- IP68 ⁶⁾
- Type4X

Separate housing

Protection degree:

- IP66
- IP68 ⁶⁾
- Type4X

12.4.7 Electromagnetic compatibility (EMC)

Interference emission to EN 61326, Electrical Equipment Class B. Interference immunity to EN 61326, Annex A (Industrial) and NAMUR Recommendation NE 21 (EMC).

A standard commercial instrument cable can be used.

6) Only with M20 cable entry or G½ thread.

12.5 Operating conditions: Process

12.5.1 Process temperature range

The following process temperature ranges only apply for standard applications outside hazardous areas.

 Regulations for use in hazardous areas are provided in the Supplementary Documentation that is available for the product and can be selected via the Product Configurator at www.endress.com.

Permitted ambient temperature T_a at the housing depending on the process temperature T_p in the tank.

Rope probe

Partially insulated (PTFE)

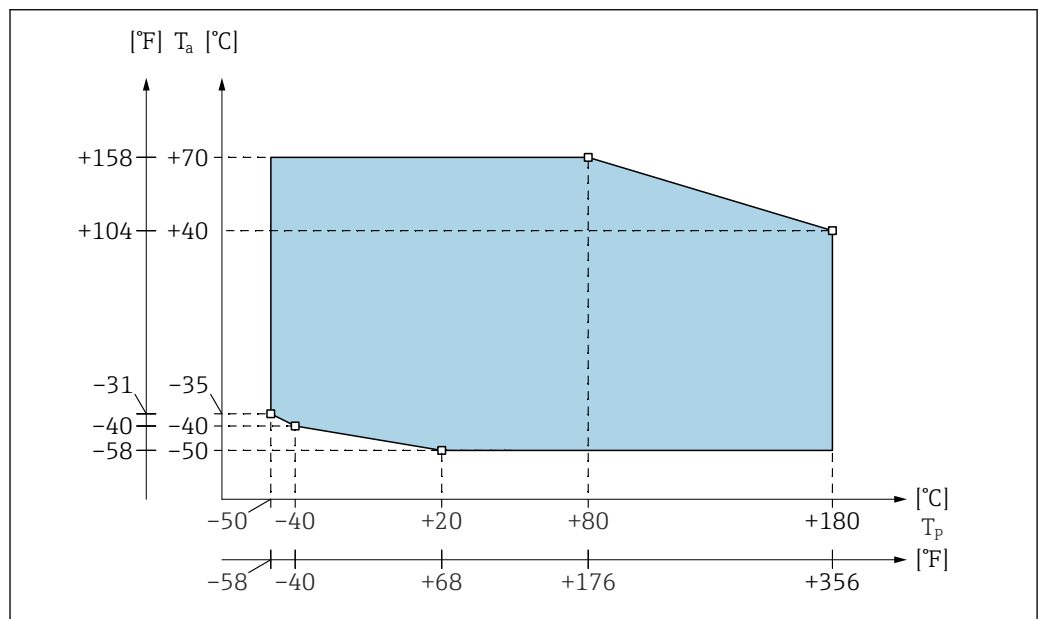

 61 Process temperature range diagram: partially insulated probe

Fully insulated (PA)

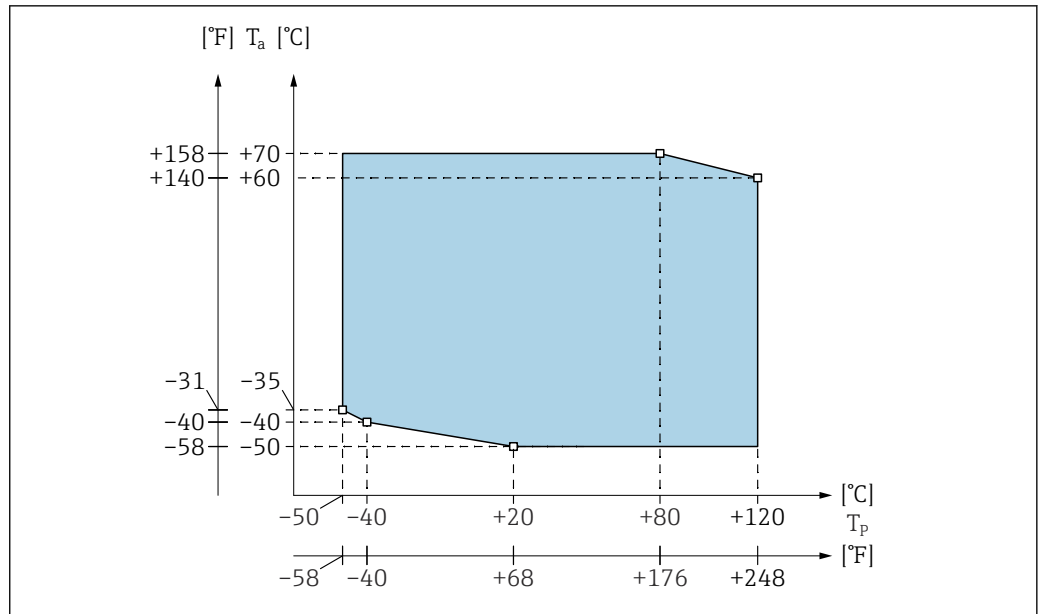

62 Process temperature range diagram: fully insulated probe

12.5.2 Process pressure and temperature derating

The lowest value from the derating curves of the device and the selected flange applies. In the case of flange process connections, the maximum pressure is limited by the nominal pressure of the flange.

Rope probe

Partially insulated (PTFE)

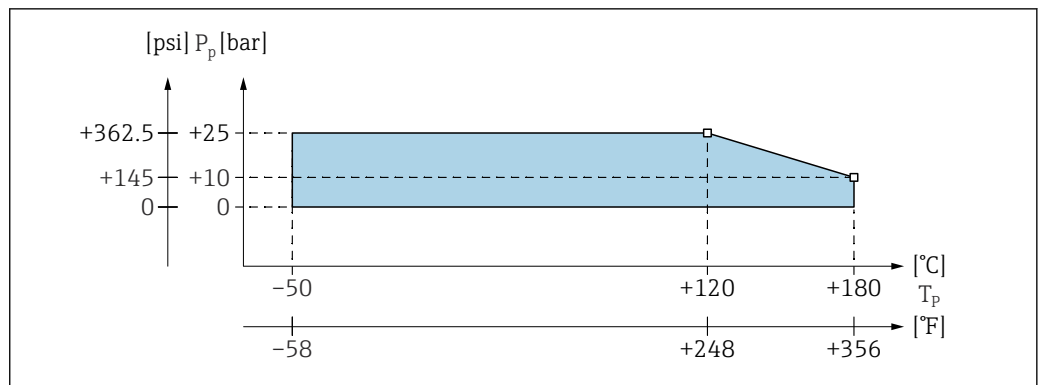

63 Process pressure and temperature derating diagram: partially insulated probe

Fully insulated (PA)

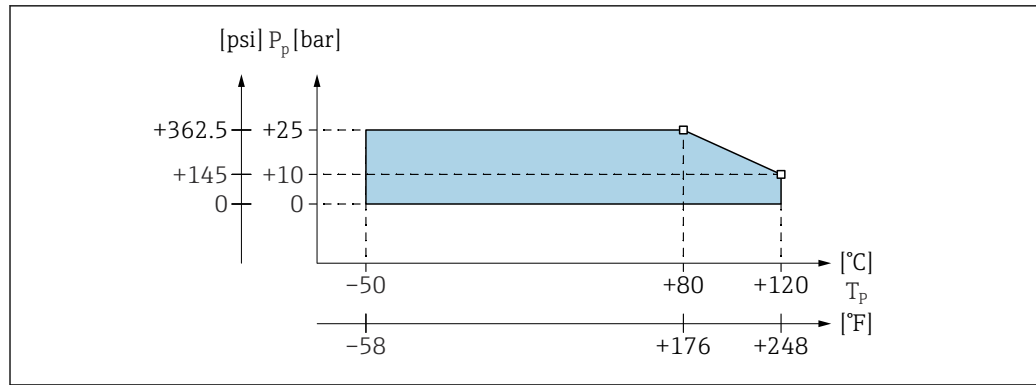

A0044019

64 Process pressure and temperature derating diagram: Fully insulated probe

Process pressure limits

Process pressure limits: -1 to 25 bar (-14.5 to 362.5 psi).

The lowest value from the derating curves of the device and the selected flange applies.

Refer to the following standards for the pressure values permitted at higher temperatures:

- pR EN 1092-1: 2005 Table, Appendix G2

With regard to its resistance and temperature property, the material 1.4435 is identical to 1.4404 (AISI 316L) which is grouped under 13E0 in EN 1092-1 Tab. 18. The chemical make-up of the two materials can be identical.

- ASME B 16.5a - 1998 Tab. 2-2.2 F316
- ASME B 16.5a - 1998 Tab. 2.3.8 N10276
- JIS B 2220

12.5.3 Temperature-derating separate housing

i The temperature at the separate housing must not exceed 70 °C (158 °F).

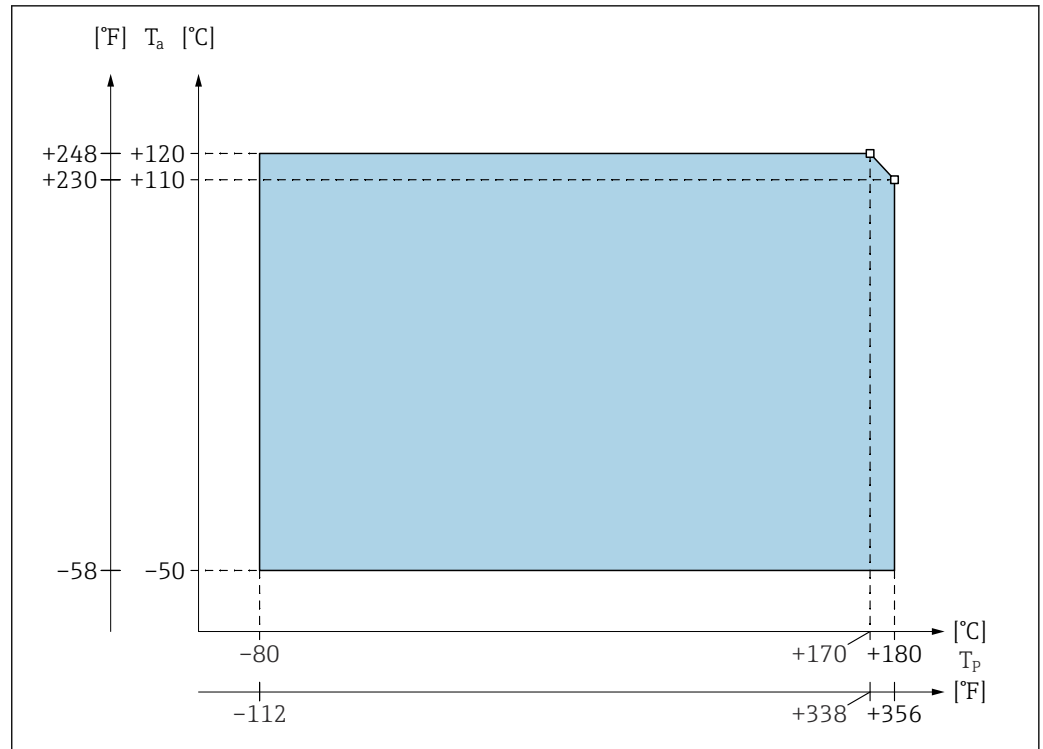

A0044013

65 Process pressure range diagram

T_a Ambient temperature

T_p Process temperature

The maximum connection length between the probe and the separate housing is 6 m (L4). When ordering a device with a separate housing, the desired length must be specified. If the connecting cable is to be shortened or passed through a wall, it must be separated from the process connection, see operating instructions.

Index

A

About this document	5
Accessories	78
Aligning the housing	18
Ambient temperature effect	80
Ambient temperature range	80

B

Basic safety instructions	8
-------------------------------------	---

C

Cable entry	27
Cable specification	26
Carrying out empty calibration	42
CE mark	8
Cleaning the probe	75, 80
Climate class	80
Commissioning	41
Connecting requirements	26
Connection compartment	27
Connector	26

D

Declaration of Conformity	8
Degree of protection	81
Device documentation	
Supplementary documentation	7
Diagnostics and troubleshooting	
and troubleshooting	70
Disposal	77
Document	
Function	5
Document function	5

E

Electrical connection	26
Electromagnetic compatibility	81
Endress+Hauser services	
Repair	75
Environment	80
Ex-area	
Explosive area	8
Extension heights: separate housing	19
External cleaning	75

F

Fail-safe mode	79
Firmware history	73

G

Galvanic isolation	80
------------------------------	----

I

Incoming acceptance	9
Input	79
Installation and function check	41
Installation instructions	17

M

M12 connector	27
Maintenance	75
Measuring device	
Conversion	76
Disposal	77
Removing	77
Repairs	76
Measuring range	79
Minimum probe length for nonconductive media	17
Mounting	10
Mounting requirements	10

N

Nameplate	9
---------------------	---

O

Operating conditions	80
Operating conditions: Process	82
Operation options	37
Operational safety	8
Output	79

P

Performance characteristics	80
Pipe mounting	21
Post-connection check	36
Post-installation check	24
Potential equalization	26
Probe with separate housing	19
Product identification	9
Product safety	8
Protective cover	78

R

Repair	76
Repairing Ex-certified devices	76
Replacement	77
Device components	76
Requirements for the personnel	8
Return	77

S

Sealing the probe housing	18
Setting the measuring range	41
Shock resistance	80
Shortening the connecting cable	22
Spare parts	76
Storage	9
Surge arrester	78
Switch behavior	79
Switch-on behaviour	79
Symbols	5
Symbols for certain types of information and graphics	6

T

Technical data	79
--------------------------	----

Technical information	78
Transport	9
Two-point control	
Buildup mode	48
V	
Vibration resistance	80
W	
Wall bracket	20
Wall mounting	21
Wiring and connecting	27
Workplace safety	8



71673384

www.addresses.endress.com
