

# Operating Instructions

## Proline Promass P 100

### HART

Coriolis flowmeter

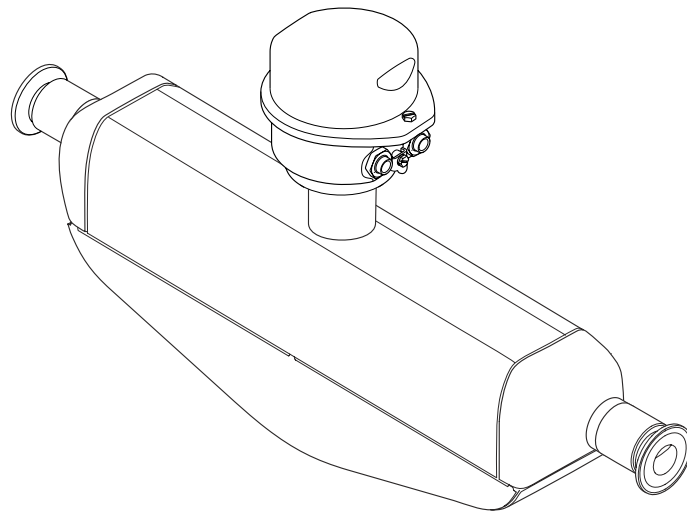

- Make sure the document is stored in a safe place such that it is always available when working on or with the device.
- To avoid danger to individuals or the facility, read the "Basic safety instructions" section carefully, as well as all other safety instructions in the document that are specific to working procedures.
- The manufacturer reserves the right to modify technical data without prior notice. Your Endress+Hauser sales organization will supply you with current information and updates to this manual.

## Table of contents

<b>1</b>	<b>About this document</b> . . . . .	<b>6</b>			
1.1	Document function . . . . .	6			
1.2	Symbols . . . . .	6			
1.2.1	Safety symbols . . . . .	6			
1.2.2	Electrical symbols . . . . .	6			
1.2.3	Tool symbols . . . . .	6			
1.2.4	Symbols for certain types of information . . . . .	7			
1.2.5	Symbols in graphics . . . . .	7			
1.3	Documentation . . . . .	7			
1.4	Registered trademarks . . . . .	8			
<b>2</b>	<b>Safety instructions</b> . . . . .	<b>9</b>			
2.1	Requirements for the personnel . . . . .	9			
2.2	Intended use . . . . .	9			
2.3	Workplace safety . . . . .	10			
2.4	Operational safety . . . . .	10			
2.5	Product safety . . . . .	10			
2.6	IT security . . . . .	10			
<b>3</b>	<b>Product description</b> . . . . .	<b>11</b>			
3.1	Product design . . . . .	11			
3.1.1	Device version with HART communication protocol . . . . .	11			
<b>4</b>	<b>Incoming acceptance and product identification</b> . . . . .	<b>12</b>			
4.1	Incoming acceptance . . . . .	12			
4.2	Product identification . . . . .	12			
4.2.1	Transmitter nameplate . . . . .	13			
4.2.2	Sensor nameplate . . . . .	14			
4.2.3	Symbols on the device . . . . .	15			
<b>5</b>	<b>Storage and transport</b> . . . . .	<b>16</b>			
5.1	Storage conditions . . . . .	16			
5.2	Transporting the product . . . . .	16			
5.2.1	Measuring devices without lifting lugs . . . . .	16			
5.2.2	Measuring devices with lifting lugs . .	17			
5.2.3	Transporting with a fork lift . . . . .	17			
5.3	Packaging disposal . . . . .	17			
<b>6</b>	<b>Installation</b> . . . . .	<b>18</b>			
6.1	Installation requirements . . . . .	18			
6.1.1	Installation position . . . . .	18			
6.1.2	Environmental and process requirements . . . . .	20			
6.1.3	Special installation instructions . . . .	22			
6.2	Installing the measuring instrument . . . .	24			
6.2.1	Required tools . . . . .	24			
6.2.2	Preparing the measuring instrument .	24			
6.2.3	Mounting the measuring device . . . . .	24			
6.2.4	Turning the display module . . . . .	24			
6.3	Post-installation check . . . . .	25			
<b>7</b>	<b>Electrical connection</b> . . . . .	<b>26</b>			
7.1	Electrical safety . . . . .	26			
7.2	Connecting requirements . . . . .	26			
7.2.1	Required tools . . . . .	26			
7.2.2	Requirements for connecting cable . .	26			
7.2.3	Terminal assignment . . . . .	27			
7.2.4	Pin assignment, device plug . . . . .	28			
7.2.5	Preparing the measuring device . . . .	28			
7.3	Connecting the measuring instrument . . . .	28			
7.3.1	Connecting the transmitter . . . . .	29			
7.4	Potential equalization . . . . .	30			
7.4.1	Requirements . . . . .	30			
7.5	Special connection instructions . . . . .	31			
7.5.1	Connection examples . . . . .	31			
7.6	Ensuring the degree of protection . . . . .	33			
7.7	Post-connection check . . . . .	33			
<b>8</b>	<b>Operation options</b> . . . . .	<b>35</b>			
8.1	Overview of operation options . . . . .	35			
8.2	Structure and function of the operating menu . . . . .	36			
8.2.1	Structure of the operating menu . . . .	36			
8.2.2	Operating philosophy . . . . .	37			
8.3	Displaying the measured values via the local display (optionally available) . . . . .	38			
8.3.1	Operational display . . . . .	38			
8.3.2	User roles and related access authorization . . . . .	39			
8.4	Access to operating menu via web browser . .	40			
8.4.1	Function range . . . . .	40			
8.4.2	Prerequisites . . . . .	40			
8.4.3	Connecting the device . . . . .	41			
8.4.4	Logging on . . . . .	42			
8.4.5	User interface . . . . .	43			
8.4.6	Disabling the Web server . . . . .	44			
8.4.7	Logging out . . . . .	44			
8.5	Access to the operating menu via the operating tool . . . . .	45			
8.5.1	Connecting the operating tool . . . . .	45			
8.5.2	Field Xpert SFX350, SFX370 . . . . .	46			
8.5.3	FieldCare . . . . .	46			
8.5.4	DeviceCare . . . . .	47			
8.5.5	AMS Device Manager . . . . .	47			
8.5.6	SIMATIC PDM . . . . .	48			
8.5.7	Field Communicator 475 . . . . .	48			
<b>9</b>	<b>System integration</b> . . . . .	<b>49</b>			
9.1	Overview of device description files . . . . .	49			
9.1.1	Current version data for the device . .	49			
9.1.2	Operating tools . . . . .	49			

9.2	Measured variables via HART protocol . . . . .	49	12.4	Diagnostic information in FieldCare or DeviceCare . . . . .	94
9.2.1	Device variables . . . . .	50	12.4.1	Diagnostic options . . . . .	94
9.3	Other settings . . . . .	51	12.4.2	Calling up remedy information . . . . .	95
<b>10</b>	<b>Commissioning . . . . .</b>	<b>54</b>	12.5	Adapting the diagnostic information . . . . .	95
10.1	Post-mounting and post-connection check . . . . .	54	12.5.1	Adapting the diagnostic behavior . . . . .	95
10.2	Setting the operating language . . . . .	54	12.5.2	Adapting the status signal . . . . .	96
10.3	Configuring the measuring instrument . . . . .	54	12.6	Overview of diagnostic information . . . . .	96
10.3.1	Defining the tag name . . . . .	54	12.7	Pending diagnostic events . . . . .	99
10.3.2	Selecting and setting the medium . . . . .	56	12.8	Diagnostics list . . . . .	100
10.3.3	Configuring the current output . . . . .	58	12.9	Event logbook . . . . .	100
10.3.4	Configuring the pulse/frequency/ switch output . . . . .	60	12.9.1	Reading out the event logbook . . . . .	100
10.3.5	Configuring the HART input . . . . .	65	12.9.2	Filtering the event logbook . . . . .	101
10.3.6	Configuring the output conditioning . . . . .	66	12.9.3	Overview of information events . . . . .	101
10.3.7	Configuring the low flow cut off . . . . .	69	12.10	Resetting the measuring device . . . . .	102
10.3.8	Configuring partially filled pipe detection . . . . .	70	12.10.1	Function range of "Device reset" parameter . . . . .	102
10.4	Advanced settings . . . . .	71	12.11	Device information . . . . .	103
10.4.1	Using the parameter to enter the access code . . . . .	71	12.12	Firmware history . . . . .	105
10.4.2	Setting the system units . . . . .	71	<b>13</b>	<b>Maintenance . . . . .</b>	<b>106</b>
10.4.3	Calculated process variables . . . . .	73	13.1	Maintenance work . . . . .	106
10.4.4	Carrying out a sensor adjustment . . . . .	75	13.1.1	Exterior cleaning . . . . .	106
10.4.5	Configuring the totalizer . . . . .	78	13.1.2	Internal cleaning . . . . .	106
10.4.6	Using parameters for device administration . . . . .	79	13.2	Measuring and test equipment . . . . .	106
10.5	Simulation . . . . .	80	13.3	Endress+Hauser services . . . . .	106
10.6	Protecting settings from unauthorized access . . . . .	82	<b>14</b>	<b>Repair . . . . .</b>	<b>107</b>
10.6.1	Write protection via access code . . . . .	82	14.1	General notes . . . . .	107
10.6.2	Write protection via write protection switch . . . . .	83	14.1.1	Repair and conversion concept . . . . .	107
<b>11</b>	<b>Operation . . . . .</b>	<b>84</b>	14.1.2	Notes for repair and conversion . . . . .	107
11.1	Reading the device locking status . . . . .	84	14.2	Spare parts . . . . .	107
11.2	Adjusting the operating language . . . . .	84	14.3	Endress+Hauser services . . . . .	107
11.3	Configuring the display . . . . .	84	14.4	Return . . . . .	107
11.4	Reading off measured values . . . . .	84	14.5	Disposal . . . . .	108
11.4.1	"Measured variables" submenu . . . . .	84	14.5.1	Removing the measuring device . . . . .	108
11.4.2	"Totalizer" submenu . . . . .	86	14.5.2	Disposing of the measuring device . . . . .	108
11.4.3	Output variables . . . . .	87	<b>15</b>	<b>Accessories . . . . .</b>	<b>109</b>
11.5	Adapting the measuring device to the process conditions . . . . .	88	15.1	Device-specific accessories . . . . .	109
11.6	Performing a totalizer reset . . . . .	88	15.1.1	For the sensor . . . . .	109
11.6.1	Function scope of "Control Totalizer" parameter . . . . .	89	15.2	Communication-specific accessories . . . . .	109
11.6.2	Function range of "Reset all totalizers" parameter . . . . .	89	15.3	Service-specific accessories . . . . .	110
<b>12</b>	<b>Diagnostics and troubleshooting . . . . .</b>	<b>90</b>	15.4	System components . . . . .	111
12.1	General troubleshooting . . . . .	90	<b>16</b>	<b>Technical data . . . . .</b>	<b>112</b>
12.2	Diagnostic information via LEDs . . . . .	91	16.1	Application . . . . .	112
12.2.1	Transmitter . . . . .	91	16.2	Function and system design . . . . .	112
12.3	Diagnostic information in the web browser . . . . .	92	16.3	Input . . . . .	113
12.3.1	Diagnostic options . . . . .	92	16.4	Output . . . . .	114
12.3.2	Calling up remedy information . . . . .	94	16.5	Power supply . . . . .	117
			16.6	Performance characteristics . . . . .	118
			16.7	Mounting . . . . .	122
			16.8	Environment . . . . .	122
			16.9	Process . . . . .	123
			16.10	Mechanical construction . . . . .	125

16.11 Operability .....	128
16.12 Certificates and approvals .....	130
16.13 Application packages .....	132
16.14 Accessories .....	133
16.15 Supplementary documentation .....	133
<b>Index .....</b>	<b>135</b>

# 1 About this document

## 1.1 Document function

These Operating Instructions contain all the information required in the various life cycle phases of the device: from product identification, incoming acceptance and storage, to installation, connection, operation and commissioning, through to troubleshooting, maintenance and disposal.

## 1.2 Symbols

### 1.2.1 Safety symbols

#### DANGER

This symbol alerts you to a dangerous situation. Failure to avoid this situation will result in serious or fatal injury.

#### WARNING

This symbol alerts you to a potentially dangerous situation. Failure to avoid this situation can result in serious or fatal injury.





#### CAUTION

This symbol alerts you to a potentially dangerous situation. Failure to avoid this situation can result in minor or medium injury.



#### NOTICE

This symbol alerts you to a potentially harmful situation. Failure to avoid this situation can result in damage to the product or something in its vicinity.













### 1.2.2 Electrical symbols

Symbol	Meaning
	Direct current
	Alternating current
	Direct current and alternating current
	<b>Ground connection</b> A grounded terminal which, as far as the operator is concerned, is grounded via a grounding system.
	<b>Potential equalization connection (PE: protective earth)</b> Ground terminals that must be connected to ground prior to establishing any other connections.  The ground terminals are located on the interior and exterior of the device: <ul style="list-style-type: none"> <li>▪ Interior ground terminal: potential equalization is connected to the supply network.</li> <li>▪ Exterior ground terminal: device is connected to the plant grounding system.</li> </ul>







### 1.2.3 Tool symbols

Symbol	Meaning
	Allen key
	Open-ended wrench

### 1.2.4 Symbols for certain types of information

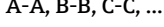
Symbol	Meaning
	<b>Permitted</b> Procedures, processes or actions that are permitted.
	<b>Preferred</b> Procedures, processes or actions that are preferred.
	<b>Forbidden</b> Procedures, processes or actions that are forbidden.
	<b>Tip</b> Indicates additional information.
	Reference to documentation
	Reference to page
	Reference to graphic
	Notice or individual step to be observed
	Series of steps
	Result of a step
	Help in the event of a problem
	Visual inspection

### 1.2.5 Symbols in graphics

Symbol	Meaning
	Item numbers
	Series of steps
	Views
	Sections
	Hazardous area
	Safe area (non-hazardous area)
	Flow direction

## 1.3 Documentation

-  For an overview of the scope of the associated Technical Documentation, refer to the following:
- *Device Viewer* ([www.endress.com/deviceviewer](http://www.endress.com/deviceviewer)): Enter the serial number from the nameplate
  - *Endress+Hauser Operations app*: Enter serial number from nameplate or scan matrix code on nameplate.

The following documentation may be available depending on the device version ordered:

Document type	Purpose and content of the document
Technical Information (TI)	<b>Planning aid for your device</b> The document contains all the technical data on the device and provides an overview of the accessories and other products that can be ordered for the device.
Brief Operating Instructions (KA)	<b>Guide that takes you quickly to the 1st measured value</b> The Brief Operating Instructions contain all the essential information from incoming acceptance to initial commissioning.
Operating Instructions (BA)	<b>Your reference document</b> These Operating Instructions contain all the information that is required in the various life cycle phases of the device: from product identification, incoming acceptance and storage, to mounting, connection, operation and commissioning, through to troubleshooting, maintenance and disposal.
Description of Device Parameters (GP)	<b>Reference for your parameters</b> The document provides a detailed explanation of each individual parameter. The description is aimed at those who work with the device over the entire life cycle and perform specific configurations.
Safety Instructions (XA)	Depending on the approval, safety instructions for electrical equipment in hazardous areas are also supplied with the device. The Safety Instructions are a constituent part of the Operating Instructions.  Information on the Safety Instructions (XA) that are relevant for the device is provided on the nameplate.
Supplementary device-dependent documentation (SD/FY)	Always comply strictly with the instructions in the relevant supplementary documentation. The supplementary documentation is a constituent part of the device documentation.

## 1.4 Registered trademarks

### **HART®**

Registered trademark of the FieldComm Group, Austin, Texas USA

### **TRI-CLAMP®**

Registered trademark of Ladish & Co., Inc., Kenosha, USA



## 2 Safety instructions

### 2.1 Requirements for the personnel

The personnel for installation, commissioning, diagnostics and maintenance must fulfill the following requirements:

- ▶ Trained, qualified specialists must have a relevant qualification for this specific function and task.
- ▶ Are authorized by the plant owner/operator.
- ▶ Are familiar with federal/national regulations.
- ▶ Before starting work, read and understand the instructions in the manual and supplementary documentation as well as the certificates (depending on the application).
- ▶ Follow instructions and comply with basic conditions.

The operating personnel must fulfill the following requirements:

- ▶ Are instructed and authorized according to the requirements of the task by the facility's owner-operator.
- ▶ Follow the instructions in this manual.

### 2.2 Intended use

#### Application and media

The measuring instrument described in this manual is intended only for the flow measurement of liquids.

Depending on the version ordered, the measuring instrument can also be used to measure potentially explosive <sup>1)</sup>, flammable, toxid and oxidizing media.

Measuring instruments for use in hazardous areas, in hygienic applications, or where there is an increased risk due to pressure, are specially labeled on the nameplate.

To ensure that the measuring instrument is in perfect condition during operation:

- ▶ Only use the measuring instrument in full compliance with the data on the nameplate and the general conditions listed in the Operating Instructions and supplementary documentation.
- ▶ Using the nameplate, check whether the ordered device is permitted for the intended use in the hazardous area (e.g. explosion protection, pressure vessel safety).
- ▶ Use the measuring instrument only for media to which the process-wetted materials are sufficiently resistant.
- ▶ Keep within the specified pressure and temperature range.
- ▶ Keep within the specified ambient temperature range.
- ▶ Protect the measuring instrument permanently against corrosion from environmental influences.

#### Incorrect use

Non-designated use can compromise safety. The manufacturer is not liable for damage caused by improper or non-designated use.

#### **WARNING**

#### **Danger of breakage due to corrosive or abrasive fluids and ambient conditions!**

- ▶ Verify the compatibility of the process fluid with the sensor material.
- ▶ Ensure the resistance of all fluid-wetted materials in the process.
- ▶ Keep within the specified pressure and temperature range.

---

1) Not applicable for IO-Link measuring instruments

**NOTICE****Verification for borderline cases:**

- ▶ For special fluids and fluids for cleaning, Endress+Hauser is glad to provide assistance in verifying the corrosion resistance of fluid-wetted materials, but does not accept any warranty or liability as minute changes in the temperature, concentration or level of contamination in the process can alter the corrosion resistance properties.

**Residual risks****⚠ CAUTION**

**Risk of hot or cold burns! The use of media and electronics with high or low temperatures can produce hot or cold surfaces on the device.**

- ▶ Mount suitable touch protection.

## 2.3 Workplace safety

When working on and with the device:

- ▶ Wear the required personal protective equipment as per national regulations.

## 2.4 Operational safety

Damage to the device!

- ▶ Operate the device in proper technical condition and fail-safe condition only.
- ▶ The operator is responsible for the interference-free operation of the device.

**Modifications to the device**

Unauthorized modifications to the device are not permitted and can lead to unforeseeable dangers!

- ▶ If modifications are nevertheless required, consult with the manufacturer.

**Repair**

To ensure continued operational safety and reliability:

- ▶ Carry out repairs on the device only if they are expressly permitted.
- ▶ Observe federal/national regulations pertaining to the repair of an electrical device.
- ▶ Use only original spare parts and accessories.

## 2.5 Product safety

This measuring device is designed in accordance with good engineering practice to meet state-of-the-art safety requirements, has been tested, and left the factory in a condition in which it is safe to operate.

It meets general safety standards and legal requirements. It also complies with the EU directives listed in the device-specific EU Declaration of Conformity. The manufacturer confirms this by affixing the CE mark to the device..

## 2.6 IT security

Our warranty is valid only if the product is installed and used as described in the Operating Instructions. The product is equipped with security mechanisms to protect it against any inadvertent changes to the settings.

IT security measures, which provide additional protection for the product and associated data transfer, must be implemented by the operators themselves in line with their security standards.

### 3 Product description

The device consists of a transmitter and a sensor.

The device is available as a compact version:

The transmitter and sensor form a mechanical unit.

#### 3.1 Product design

##### 3.1.1 Device version with HART communication protocol

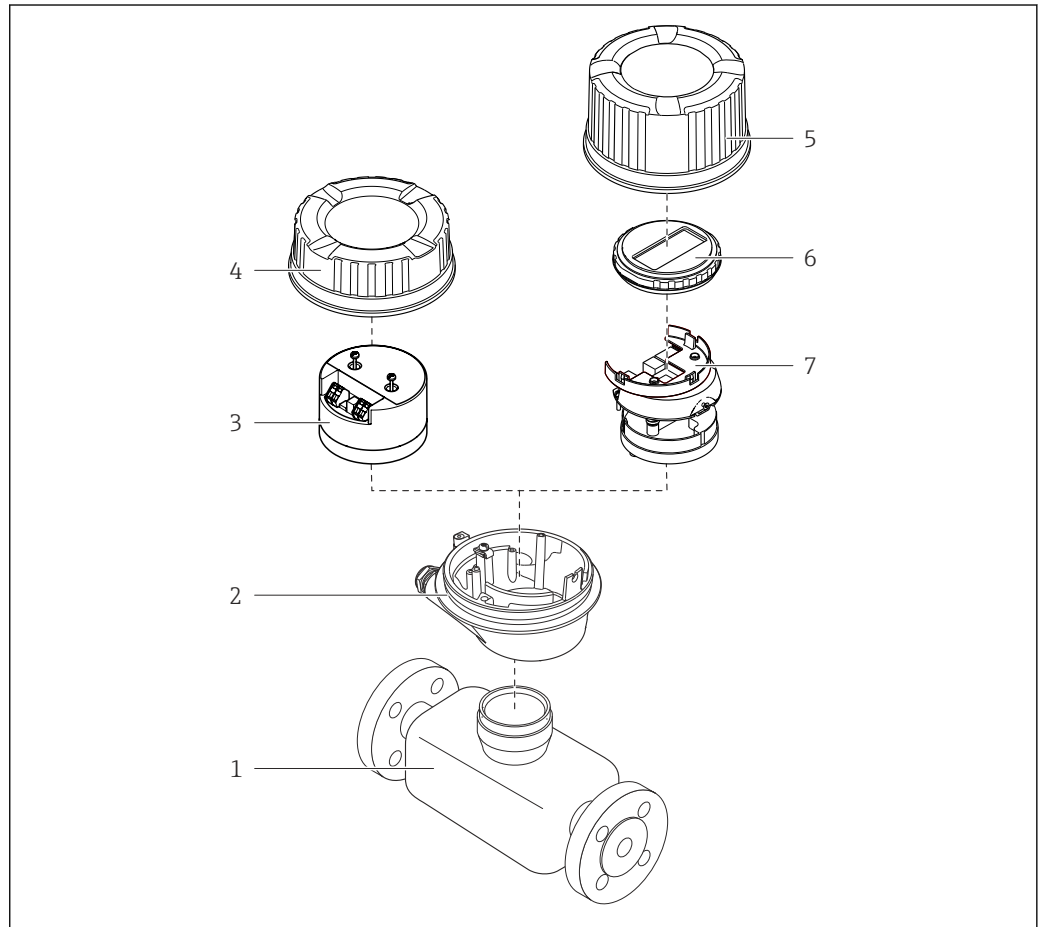

A0023153

1 Important components of a measuring device

- 1 Sensor
- 2 Transmitter housing
- 3 Main electronics module
- 4 Transmitter housing cover
- 5 Transmitter housing cover (version for optional local display)
- 6 Local display (optional)
- 7 Main electronics module (with bracket for optional local display)

## 4 Incoming acceptance and product identification

### 4.1 Incoming acceptance

On receipt of the delivery:

1. Check the packaging for damage.
  - ↳ Report all damage immediately to the manufacturer.  
Do not install damaged components.
2. Check the scope of delivery using the delivery note.
3. Compare the data on the nameplate with the order specifications on the delivery note.
4. Check the technical documentation and all other necessary documents, e.g. certificates, to ensure they are complete.

 If one of the conditions is not satisfied, contact the manufacturer.

### 4.2 Product identification

The device can be identified in the following ways:

- Nameplate
- Order code with details of the device features on the delivery note
- Enter the serial numbers from the nameplates in the *Device Viewer* ([www.endress.com/deviceviewer](http://www.endress.com/deviceviewer)): all the information about the device is displayed.
- Enter the serial numbers from the nameplates into the *Endress+Hauser Operations app* or scan the DataMatrix code on the nameplate with the *Endress+Hauser Operations app*: all the information about the device is displayed.

For an overview of the scope of the associated Technical Documentation, refer to the following:

- The "Additional standard device documentation" and "Supplementary device-dependent documentation" sections
- The *Device Viewer*: Enter the serial number from the nameplate ([www.endress.com/deviceviewer](http://www.endress.com/deviceviewer))
- The *Endress+Hauser Operations app*: Enter the serial number from the nameplate or scan the DataMatrix code on the nameplate.

### 4.2.1 Transmitter nameplate

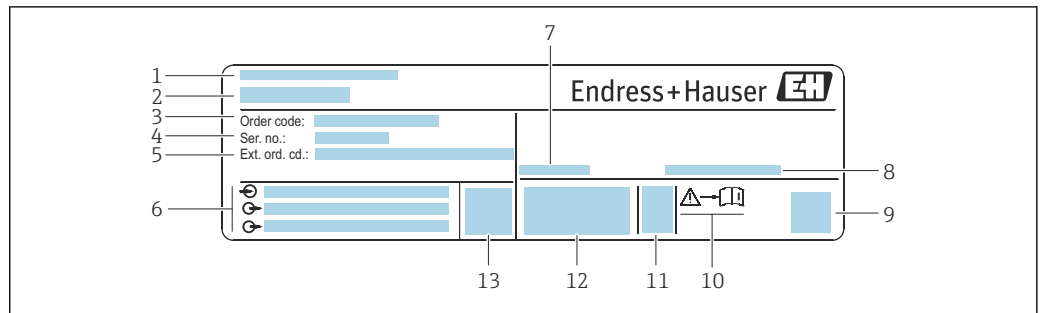

A0030222

 2 Example of a transmitter nameplate

- 1 Manufacturer address/certificate holder
- 2 Name of the transmitter
- 3 Order code
- 4 Serial number
- 5 Extended order code
- 6 Electrical connection data, e.g. available inputs and outputs, supply voltage
- 7 Permitted ambient temperature ( $T_a$ )
- 8 Degree of protection
- 9 2-D matrix code
- 10 Document number of safety-related supplementary documentation →  134
- 11 Date of manufacture: year-month
- 12 CE mark, RCM-Tick mark
- 13 Firmware version (FW)

## 4.2.2 Sensor nameplate

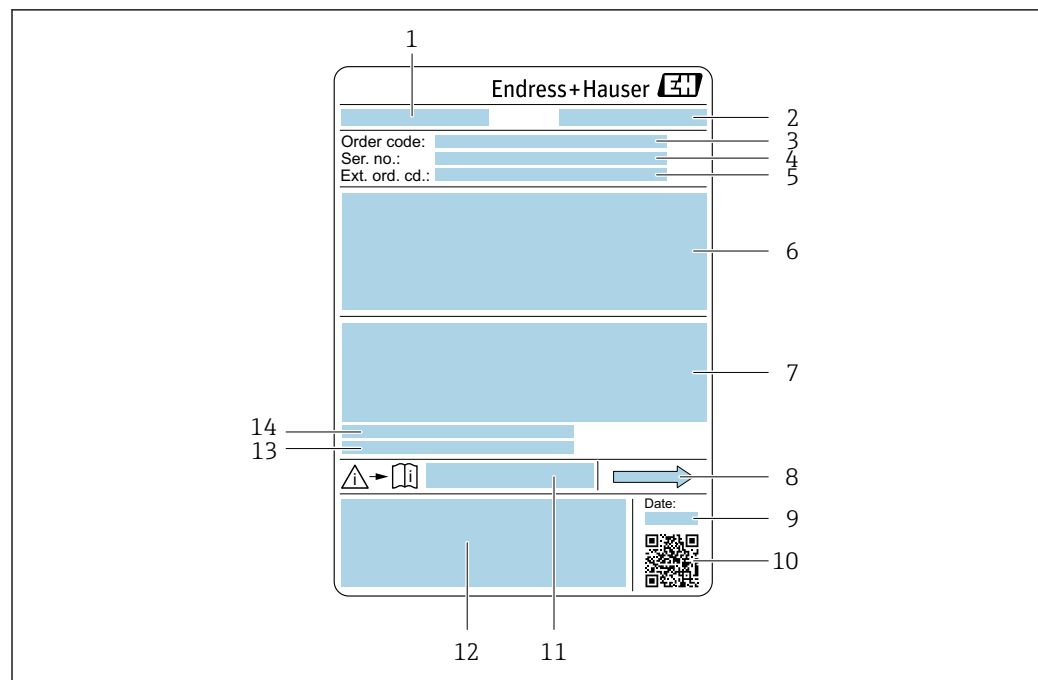

A0029199

 3 Example of a sensor nameplate

- 1 Name of the sensor
- 2 Manufacturer address/certificate holder
- 3 Order code
- 4 Serial number (Ser. no.)
- 5 Extended order code (Ext. ord. cd.)
- 6 Nominal diameter of the sensor; flange nominal diameter/nominal pressure; sensor test pressure; medium temperature range; material of measuring tube and manifold; sensor-specific information: e.g. pressure range of sensor housing, wide-range density specification (special density calibration)
- 7 Approval information for explosion protection, Pressure Equipment Directive and degree of protection
- 8 Flow direction
- 9 Date of manufacture: year-month
- 10 2-D matrix code
- 11 Document number of safety-related supplementary documentation
- 12 CE mark, RCM-Tick mark
- 13 Surface roughness
- 14 Allowable ambient temperature ( $T_a$ )



### Order code

The measuring device is reordered using the order code.

#### Extended order code

- The device type (product root) and basic specifications (mandatory features) are always listed.
- Of the optional specifications (optional features), only the safety and approval-related specifications are listed (e.g. LA). If other optional specifications are also ordered, these are indicated collectively using the # placeholder symbol (e.g. #LA#).
- If the ordered optional specifications do not include any safety and approval-related specifications, they are indicated by the + placeholder symbol (e.g. XXXXXX-ABCDE+).

### 4.2.3 Symbols on the device

Symbol	Meaning
	<b>WARNING!</b> This symbol alerts you to a dangerous situation. Failure to avoid this situation can result in serious or fatal injury. Please consult the documentation for the measuring instrument to discover the type of potential danger and measures to avoid it.
	<b>Reference to documentation</b> Refers to the corresponding device documentation.
	<b>Protective ground connection</b> A terminal that must be connected to the ground prior to establishing any other connections.

## 5 Storage and transport

### 5.1 Storage conditions

Observe the following notes for storage:

- ▶ Store in the original packaging to ensure protection from shock.
- ▶ Do not remove protective covers or protective caps installed on process connections. They prevent mechanical damage to the sealing surfaces and contamination in the measuring tube.
- ▶ Protect from direct sunlight. Avoid unacceptably high surface temperatures.
- ▶ Store in a dry and dust-free place.
- ▶ Do not store outdoors.

Storage temperature → 📄 122

### 5.2 Transporting the product

Transport the measuring device to the measuring point in the original packaging.

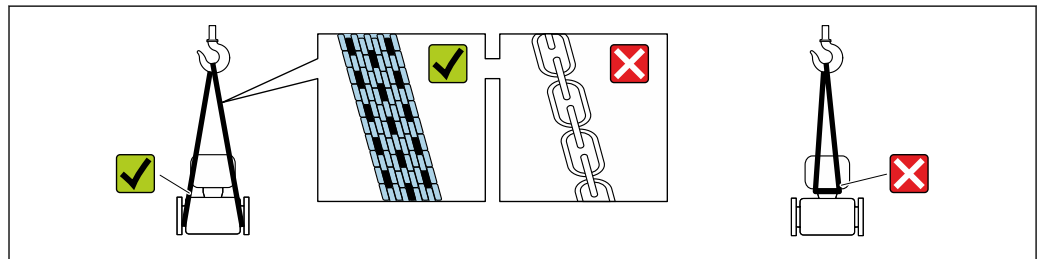

A0029252

**i** Do not remove protective covers or caps installed on process connections. They prevent mechanical damage to the sealing surfaces and contamination in the measuring tube.

#### 5.2.1 Measuring devices without lifting lugs

##### **⚠ WARNING**

**Center of gravity of the measuring device is higher than the suspension points of the webbing slings.**

Risk of injury if the measuring device slips.

- ▶ Secure the measuring device against slipping or turning.
- ▶ Observe the weight specified on the packaging (stick-on label).

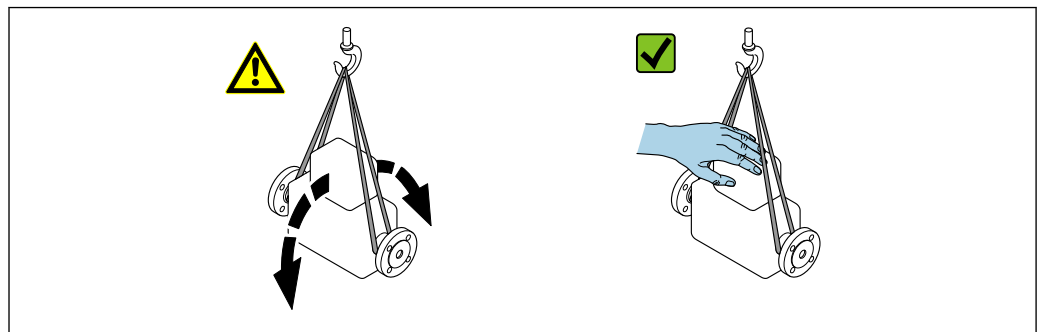

A0029214



### 5.2.2 Measuring devices with lifting lugs

**⚠ CAUTION**

**Special transportation instructions for devices with lifting lugs**

- ▶ Only use the lifting lugs fitted on the device or flanges to transport the device.
- ▶ The device must always be secured at two lifting lugs at least.

### 5.2.3 Transporting with a fork lift

If transporting in wood crates, the floor structure enables the crates to be lifted lengthwise or at both sides using a forklift.

## 5.3 Packaging disposal

All packaging materials are environmentally friendly and 100% recyclable:

- Outer packaging of device
  - Stretch wrap made of polymer in accordance with EU Directive 2002/95/EC (RoHS)
- Packaging
  - Wood crate treated in accordance with ISPM 15 standard, confirmed by IPPC logo
  - Cardboard box in accordance with European packaging guideline 94/62/EC, recyclability confirmed by Resy symbol
- Transport material and fastening fixtures
  - Disposable plastic pallet
  - Plastic straps
  - Plastic adhesive strips
- Filler material
  - Paper pads

## 6 Installation

### 6.1 Installation requirements

#### 6.1.1 Installation position

##### Installation point

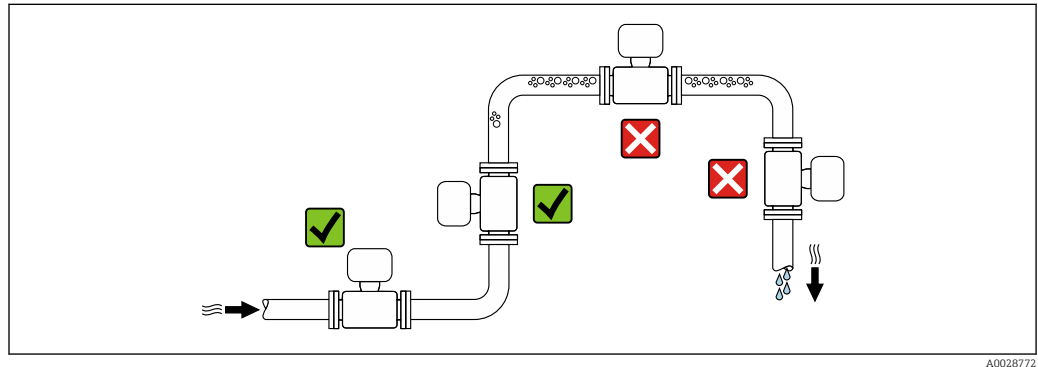



To prevent measuring errors arising from accumulation of gas bubbles in the measuring pipe, avoid the following mounting locations in the piping:

- Highest point of a pipeline.
- Directly upstream of a free pipe outlet in a down pipe.

##### Installation in down pipes

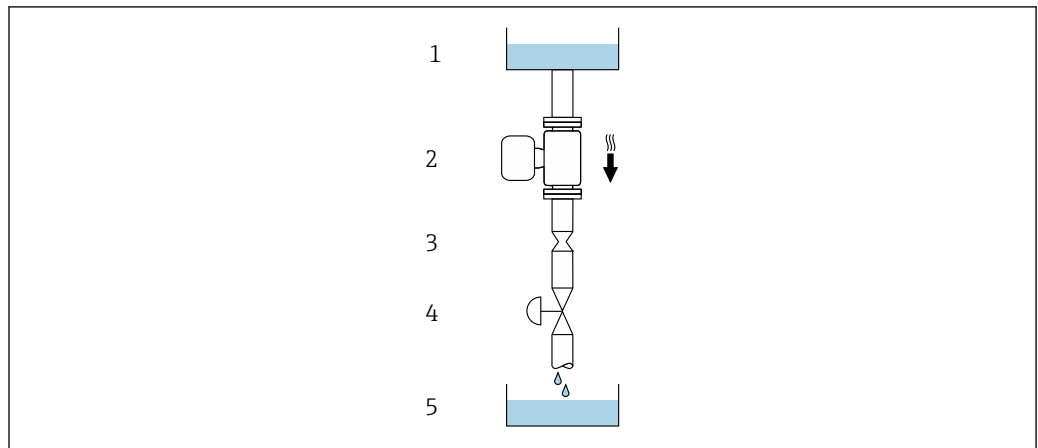
However, the following installation suggestion allows for installation in an open vertical pipeline. Pipe restrictions or the use of an orifice with a smaller cross-section than the nominal diameter prevent the sensor running empty while measurement is in progress.





 4 Installation in a down pipe (e.g. for batching applications)

- 1 Supply tank
- 2 Sensor
- 3 Orifice plate, pipe restriction
- 4 Valve
- 5 Filling vessel

DN		Ø orifice plate, pipe restriction	
[mm]	[in]	[mm]	[in]
8	3/8	6	0.24
15	1/2	10	0.40
25	1	14	0.55
40	1 1/2	22	0.87
50	2	28	1.10

**Orientation**

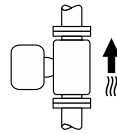
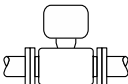
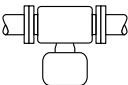
The direction of the arrow on the sensor nameplate helps you to install the sensor according to the flow direction (direction of medium flow through the piping).

Orientation			Recommendation
<b>A</b>	Vertical orientation	 <small>A0015591</small>	✓✓ <sup>1)</sup>
<b>B</b>	Horizontal orientation, transmitter at top	 <small>A0015589</small>	✓✓ <sup>2)</sup> Exception: → ☒ 5, 📄 19
<b>C</b>	Horizontal orientation, transmitter at bottom	 <small>A0015590</small>	✓✓ <sup>3)</sup> Exception: → ☒ 5, 📄 19
<b>D</b>	Horizontal orientation, transmitter at side	 <small>A0015592</small>	✓✓

- 1) This orientation is recommended to ensure self-draining.
- 2) Applications with low process temperatures may reduce the ambient temperature. To maintain the minimum ambient temperature for the transmitter, this orientation is recommended.
- 3) Applications with high process temperatures may increase the ambient temperature. To maintain the maximum ambient temperature for the transmitter, this orientation is recommended.

If a sensor is installed horizontally with a curved measuring tube, match the position of the sensor to the fluid properties.

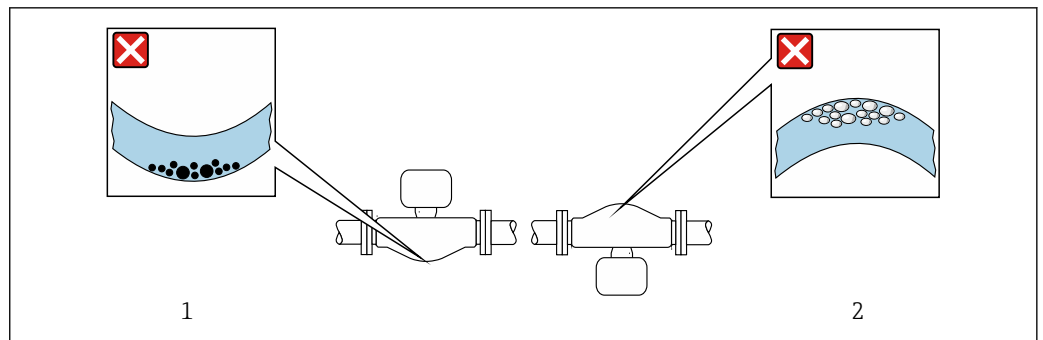

☒ 5 Orientation of sensor with curved measuring tube

- 1 Avoid this orientation for fluids with entrained solids: Risk of solids accumulating
- 2 Avoid this orientation for outgassing fluids: Risk of gas accumulating

**Inlet and outlet runs**

No special precautions need to be taken for fittings that create turbulence, such as valves, elbows or T-pieces, as long as no cavitation occurs → 20.

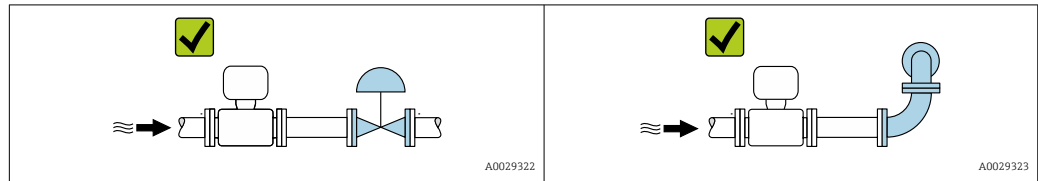

*Installation dimensions*

 For the dimensions and installation lengths of the device, see the "Technical Information" document, "Mechanical construction" section

**6.1.2 Environmental and process requirements**

**Ambient temperature range**

<b>Measuring device</b>	<ul style="list-style-type: none"> <li>■ -40 to +60 °C (-40 to +140 °F)</li> <li>■ Order code for "Test, certificate", option JM: -50 to +60 °C (-58 to +140 °F)</li> </ul>
-------------------------	---

- ▶ If operating outdoors:  
Avoid direct sunlight, particularly in warm climatic regions.

**Static pressure**

It is important that cavitation does not occur, or that gases entrained in the liquids do not outgas.

Cavitation is caused if the pressure drops below the vapor pressure:

- In liquids that have a low boiling point (e.g. hydrocarbons, solvents, liquefied gases)
- In suction lines

- ▶ Ensure the static pressure is sufficiently high to prevent cavitation and outgassing.

For this reason, the following mounting locations are recommended:

- At the lowest point in a vertical pipe
- Downstream from pumps (no danger of vacuum)

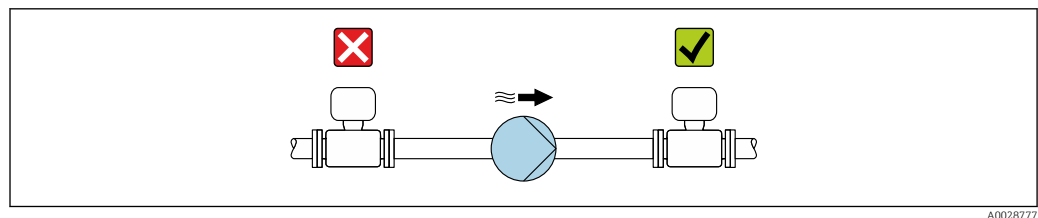

**Thermal insulation**

In the case of some fluids, it is important to keep the heat radiated from the sensor to the transmitter to a low level. A wide range of materials can be used for the required insulation.

The following device versions are recommended for versions with thermal insulation:

- Version with extended neck for insulation:  
Order code for "Sensor option", option CG with an extended neck length of 105 mm (4.13 in).
- Extended temperature version:  
Order code for "Measuring tube material", option TD or TG with an extended neck length of 105 mm (4.13 in).

#### NOTICE

#### Electronics overheating on account of thermal insulation!

- ▶ Recommended orientation: horizontal orientation, transmitter housing pointing downwards.
- ▶ Do not insulate the transmitter housing .
- ▶ Maximum permissible temperature at the lower end of the transmitter housing: 80 °C (176 °F)
- ▶ Regarding thermal insulation with an exposed extended neck: We advise against insulating the extended neck to ensure optimal heat dissipation.

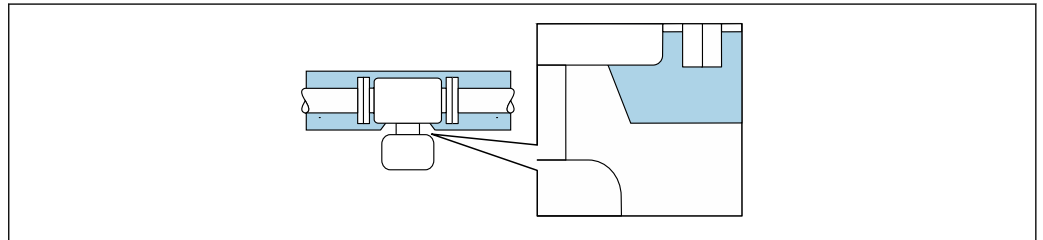

6 Thermal insulation with exposed extended neck

A0034391

#### Heating

#### NOTICE

#### Electronics can overheat due to elevated ambient temperature!

- ▶ Observe maximum permitted ambient temperature for the transmitter.
- ▶ Depending on the medium temperature, take the device orientation requirements into account.

#### NOTICE

#### Danger of overheating when heating

- ▶ Ensure that the temperature at the lower end of the transmitter housing does not exceed 80 °C (176 °F).
- ▶ Ensure that sufficient convection takes place at the transmitter neck.
- ▶ Ensure that a sufficiently large area of the transmitter neck remains exposed. The uncovered part serves as a radiator and protects the electronics from overheating and excessive cooling.
- ▶ When using in potentially explosive atmospheres, observe the information in the device-specific Ex documentation. For detailed information on the temperature tables, see the separate document entitled "Safety Instructions" (XA) for the device.
- ▶ Consider the "830 ambient temperature too high" and "832 electronics temperature too high" process diagnostics if overheating cannot be ruled out based on a suitable system design.

### Heating options

If a fluid requires that no heat loss should occur at the sensor, users can avail of the following heating options:

- Electrical heating, e.g. with electric band heaters <sup>2)</sup>
- Via pipes carrying hot water or steam
- Via heating jackets

### Vibrations

The high oscillation frequency of the measuring tubes ensures that the correct operation of the measuring system is not influenced by plant vibrations.

## 6.1.3 Special installation instructions

### Drainability

When installed vertically, the measuring tube can be drained completely and protected against buildup.

When the sensor is installed in a horizontal line, eccentric clamps can be used to ensure complete drainability. When the system is pitched in a specific direction and at a specific slope, gravity can be used to achieve complete drainability. The sensor must be mounted in the correct position to ensure full drainability in the horizontal position. Markings on the sensor show the correct mounting position to optimize drainability.

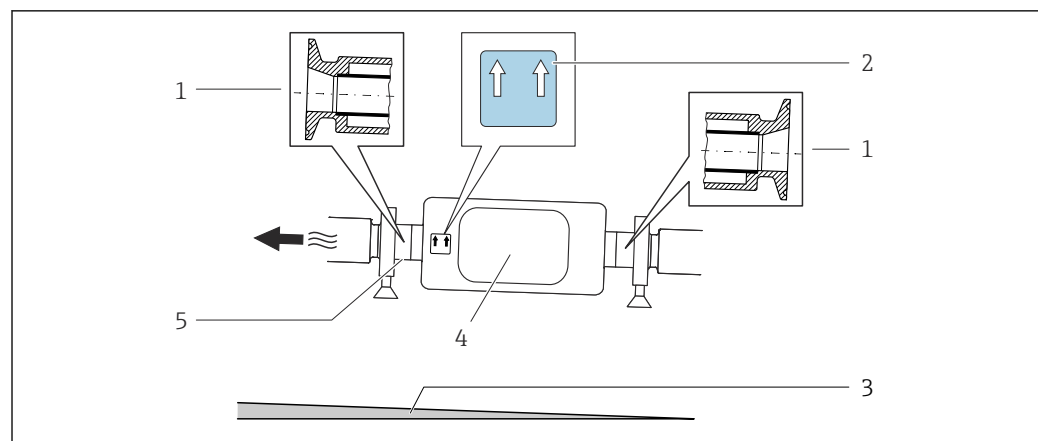

- 1 Eccentric clamp connection
- 2 "This side up" label indicates which side is up
- 3 For DN 8 to 25 (3/8 to 1"): Gradient: approx. 2% or 21 mm/m (0.24 in/ft); for DN 40 to 50 (1½ to 2"): Gradient approx. 2° or 35 mm/m (0.42 in/ft)
- 4 Transmitter
- 5 Line on the underside indicates the lowest point of the eccentric process connection.

### Hygienic compatibility

**i** When installing in hygienic applications, please refer to the information in the "Certificates and approvals/hygienic compatibility" section → 130

### Securing with mounting clamp in the case of hygiene connections

It is not necessary to provide additional support for the sensor for operational performance purposes. If, however, additional support is required for installation purposes, the following dimensions must be observed.

2) The use of parallel electric band heaters is generally recommended (bidirectional electricity flow). Particular considerations must be made if a single-wire heating cable is to be used. For additional information, refer to EA01339D "Installation Instructions for Electrical Trace Heating Systems".

Use mounting clamp with lining between clamp and measuring instrument.

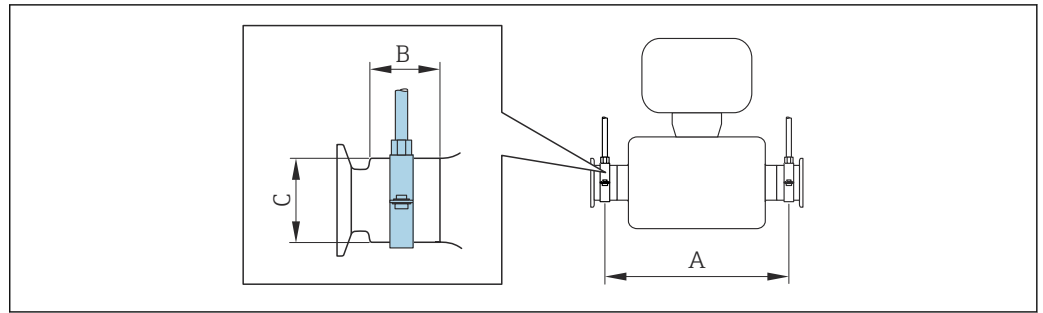

A0030298

DN		A		B		C	
[mm]	[in]	[mm]	[in]	[mm]	[in]	[mm]	[in]
8	3/8	298	11.73	33	1.3	28	1.1
15	1/2	402	15.83	33	1.3	28	1.1
25	1	542	21.34	33	1.3	38	1.5
40	1 1/2	658	25.91	36.5	1.44	56	2.2
50	2	772	30.39	44.1	1.74	75	2.95

### Zero verification and zero adjustment

All measuring instruments are calibrated in accordance with state-of-the-art technology. Calibration takes place under reference conditions → 118. Therefore, a zero adjustment in the field is generally not required.

Experience shows that zero adjustment is advisable only in special cases:

- To achieve maximum measurement accuracy even with low flow rates.
- Under extreme process or operating conditions (e.g. very high process temperatures or very high-viscosity fluids).
- For gas applications with low pressure

**i** To achieve the highest possible measurement accuracy at low flow rates, the installation must protect the sensor from mechanical stresses during operation.

To get a representative zero point, ensure that:

- any flow in the device is prevented during the adjustment
- the process conditions (e.g. pressure, temperature) are stable and representative

Verification and adjustment cannot be carried out if the following process conditions are present:

- Gas pockets

Ensure that the system has been sufficiently flushed with the medium. Repeat flushing can help to eliminate gas pockets

- Thermal circulation

In the event of temperature differences (e.g. between the measuring tube inlet and outlet section), induced flow can occur even if the valves are closed due to thermal circulation in the device

- Leaks at the valves

If the valves are not leak-tight, flow is not sufficiently prevented when determining the zero point

If these conditions cannot be avoided, it is advisable to keep the factory setting for the zero point.

## 6.2 Installing the measuring instrument

### 6.2.1 Required tools

#### For sensor

For flanges and other process connections: Use a suitable mounting tool.

### 6.2.2 Preparing the measuring instrument

1. Remove all remaining transport packaging.
2. Remove any protective covers or protective caps present from the sensor.
3. Remove stick-on label on the electronics compartment cover.

### 6.2.3 Mounting the measuring device

#### **⚠ WARNING**

#### **Danger due to improper process sealing!**

- ▶ Ensure that the inside diameters of the gaskets are greater than or equal to that of the process connections and piping.
- ▶ Ensure that the seals are clean and undamaged.
- ▶ Secure the seals correctly.

1. Ensure that the direction of the arrow on the nameplate of the sensor matches the flow direction of the medium.
2. Install the measuring device or turn the transmitter housing so that the cable entries do not point upwards.

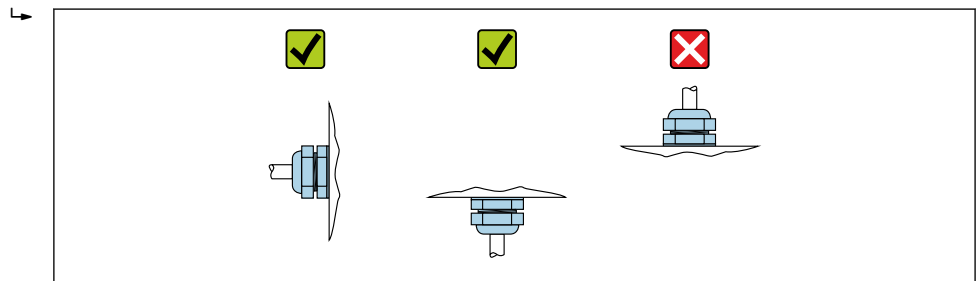

A0029263

### 6.2.4 Turning the display module

The local display is only available with the following device version:

Order code for "Display; Operation", option **B**: 4-line; lit, via communication

The display module can be turned to optimize display readability.



**Aluminum housing version, AlSi10Mg, coated**

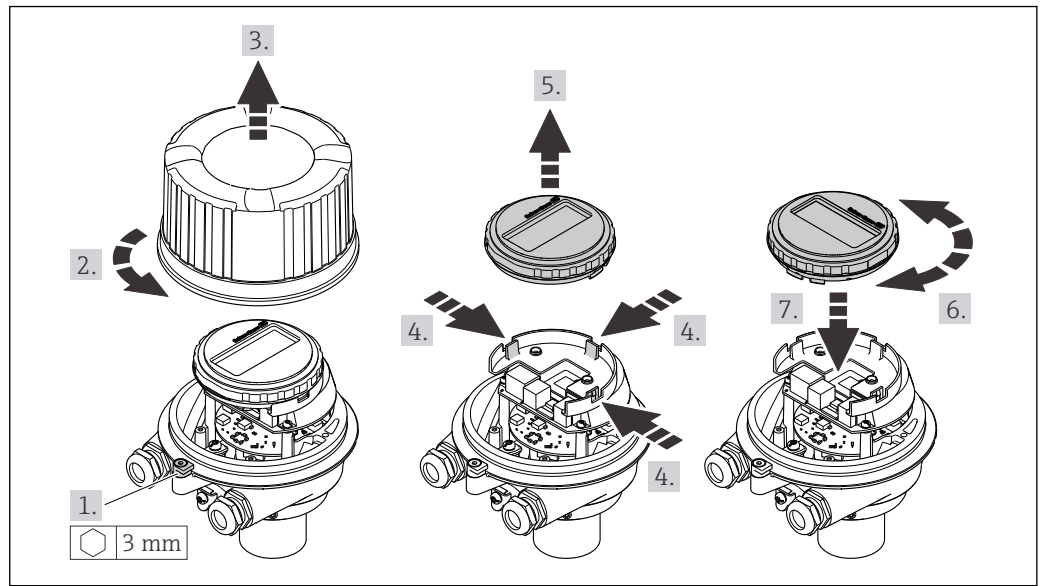

A0023192

**Compact and ultra-compact housing version, hygienic, stainless**

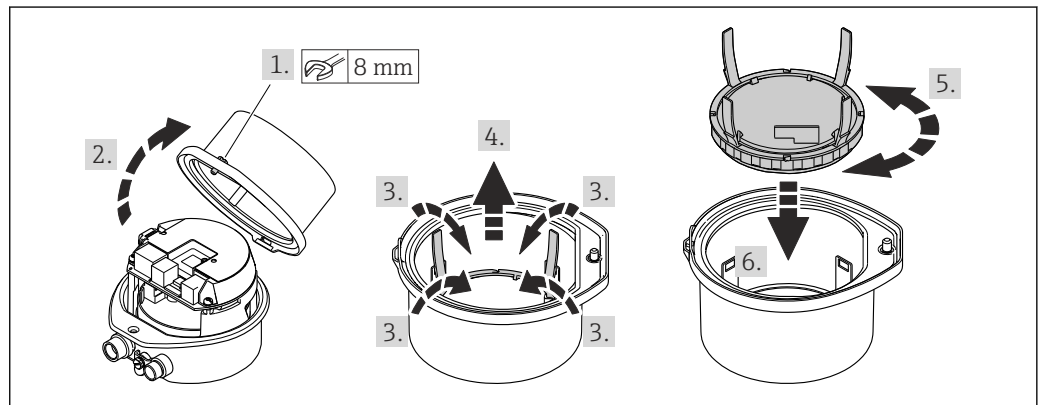

A0023195

**6.3 Post-installation check**

Is the device undamaged (visual inspection)?	<input type="checkbox"/>
Does the measuring instrument correspond to the measuring point specifications? For example: <ul style="list-style-type: none"> <li>▪ Process temperature → 123</li> <li>▪ Pressure (refer to the "Pressure-temperature ratings" section of the "Technical Information" document).</li> <li>▪ Ambient temperature → 122</li> <li>▪ Measuring range</li> </ul>	<input type="checkbox"/>
Has the correct orientation for the sensor been selected → 19? <ul style="list-style-type: none"> <li>▪ According to sensor type</li> <li>▪ According to medium temperature</li> <li>▪ According to medium properties (outgassing, with entrained solids)</li> </ul>	<input type="checkbox"/>
Does the arrow on the sensor match the direction of flow of the medium? → 19?	<input type="checkbox"/>
Is the tag name and labeling correct (visual inspection)?	<input type="checkbox"/>
Is the device sufficiently protected from precipitation and direct sunlight?	<input type="checkbox"/>
Are the securing screw and securing clamp tightened securely?	<input type="checkbox"/>

## 7 Electrical connection

### WARNING

**Live parts! Incorrect work performed on the electrical connections can result in an electric shock.**

- ▶ Set up a disconnecting device (switch or power-circuit breaker) to easily disconnect the device from the supply voltage.
- ▶ In addition to the device fuse, include an overcurrent protection unit with max. 16 A in the plant installation.

### 7.1 Electrical safety

In accordance with applicable national regulations.

### 7.2 Connecting requirements

#### 7.2.1 Required tools

- For cable entries: Use corresponding tools
- For securing clamp (on aluminum housing): Allen screw 3 mm
- For securing screw (for stainless steel housing): open-ended wrench 8 mm
- Wire stripper
- When using stranded cables: crimper for wire end ferrule

#### 7.2.2 Requirements for connecting cable

The connecting cables provided by the customer must fulfill the following requirements.

##### Permitted temperature range

- The installation guidelines that apply in the country of installation must be observed.
- The cables must be suitable for the minimum and maximum temperatures to be expected.

##### Power supply cable (incl. conductor for the inner ground terminal)

Standard installation cable is sufficient.

##### Signal cable

-  For custody transfer, all signal lines must be shielded cables (tinned copper braiding, optical coverage  $\geq 85\%$ ). The cable shield must be connected on both sides.

*Current output 4 to 20 mA HART*

Shielded twisted-pair cable.

-  See <https://www.fieldcommgroup.org> "HART PROTOCOL SPECIFICATIONS".

*Pulse /frequency /switch output*

Standard installation cable is sufficient.

##### Cable diameter

- Cable glands supplied:  
M20  $\times$  1.5 with cable  $\varnothing$  6 to 12 mm (0.24 to 0.47 in)
- Spring terminals:  
Wire cross-sections 0.5 to 2.5 mm<sup>2</sup> (20 to 14 AWG)



### 7.2.3 Terminal assignment

#### Transmitter

Connection version 4-20 mA HART with pulse/frequency/switch output

Order code for "Output", option **B**

Depending on the housing version, the transmitters can be ordered with terminals or device plugs.

Order code "Housing"	Connection methods available		Possible options for order code "Electrical connection"
	Outputs	Power supply	
Options <b>A, B</b>	Terminals	Terminals	<ul style="list-style-type: none"> <li>▪ Option <b>A</b>: coupling M20x1</li> <li>▪ Option <b>B</b>: thread M20x1</li> <li>▪ Option <b>C</b>: thread G ½"</li> <li>▪ Option <b>D</b>: thread NPT ½"</li> </ul>
Options <b>A, B</b>	Device plugs →  28	Terminals	<ul style="list-style-type: none"> <li>▪ Option <b>L</b>: plug M12x1 + thread NPT ½"</li> <li>▪ Option <b>N</b>: plug M12x1 + coupling M20</li> <li>▪ Option <b>P</b>: plug M12x1 + thread G ½"</li> <li>▪ Option <b>U</b>: plug M12x1 + thread M20</li> </ul>
Options <b>A, B, C</b>	Device plugs →  28	Device plugs →  28	Option <b>Q</b> : 2 x plug M12x1
Order code for "Housing": <ul style="list-style-type: none"> <li>▪ Option <b>A</b>: compact, coated aluminum</li> <li>▪ Option <b>B</b>: compact, hygienic, stainless</li> <li>▪ Option <b>C</b>: ultra-compact, hygienic, stainless</li> </ul>			

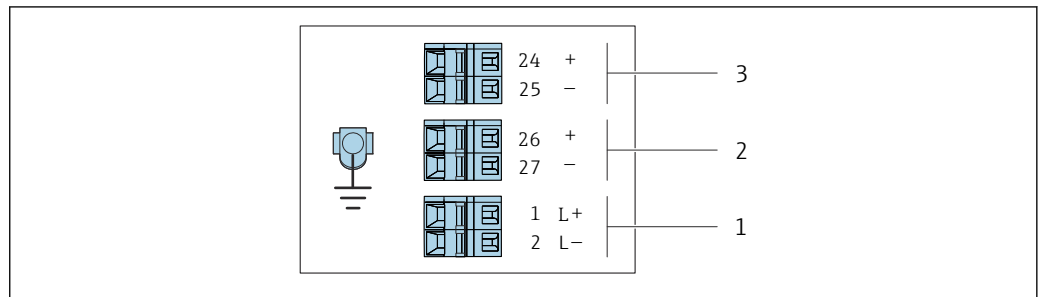

A0016888

 7 Terminal assignment 4-20 mA HART with pulse/frequency/switch output

- 1 Power supply: DC 24 V
- 2 Output 1: 4-20 mA HART (active)
- 3 Output 2: pulse/frequency/switch output (passive)

Order code "Output"	Terminal number					
	Power supply		Output 1		Output 2	
	2 (L-)	1 (L+)	27 (-)	26 (+)	25 (-)	24 (+)
Option <b>B</b>	DC 24 V		4-20 mA HART (active)		Pulse/frequency/switch output (passive)	
Order code for "Output": Option <b>B</b> : 4-20 mA HART with pulse/frequency/switch output						

## 7.2.4 Pin assignment, device plug

### Supply voltage

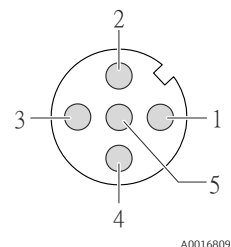
 A0016809	Pin	Assignment	
	1	L+	DC 24 V
	2		Not assigned
	3		Not assigned
	4	L-	DC 24 V
	5		Grounding/shielding
Coding		Plug/socket	
A		Plug	

### Device plug for signal transmission (device side)

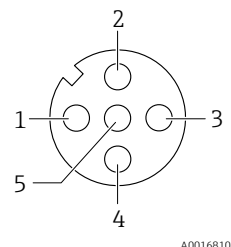
 A0016810	Pin	Assignment	
	1	+	4-20 mA HART (active)
	2	-	4-20 mA HART (active)
	3	+	Pulse/frequency/switch output (passive)
	4	-	Pulse/frequency/switch output (passive)
	5		Grounding/shielding
Coding		Plug/socket	
A		Socket	

## 7.2.5 Preparing the measuring device

### NOTICE

#### Insufficient sealing of the housing!

Operational reliability of the measuring device could be compromised.

- Use suitable cable glands corresponding to the degree of protection.

1. Remove dummy plug if present.
2. If the measuring device is supplied without cable glands:  
Provide suitable cable gland for corresponding connecting cable.
3. If the measuring device is supplied with cable glands:  
Observe requirements for connecting cables → 26.

## 7.3 Connecting the measuring instrument

### NOTICE

#### An incorrect connection compromises electrical safety!

- Only properly trained specialist staff may perform electrical connection work.
- Observe applicable federal/national installation codes and regulations.
- Comply with local workplace safety regulations.
- Always connect the protective ground cable ⊕ before connecting additional cables.
- When using in potentially explosive atmospheres, observe the information in the device-specific Ex documentation.

### 7.3.1 Connecting the transmitter

The connection of the transmitter depends on the following order codes:

- Housing version: compact or ultra-compact
- Connection version: device plug or terminals

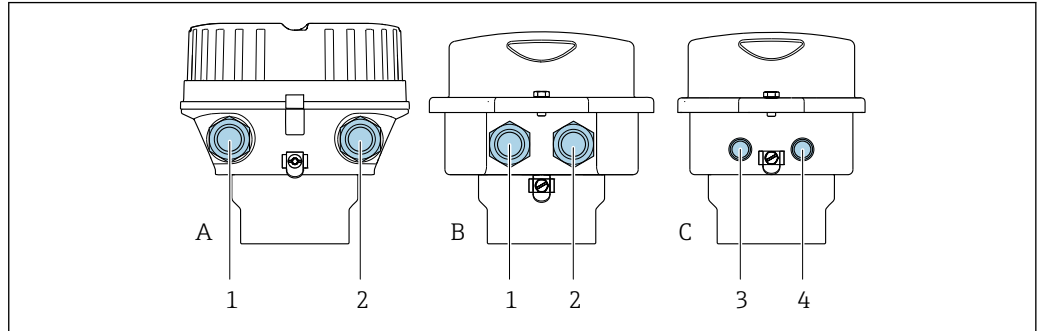

A0016924

8 Housing versions and connection versions

- A Housing version: compact, coated, aluminum
- B Housing version: compact, hygienic, stainless
- 1 Cable entry or device plug for signal transmission
- 2 Cable entry or device plug for supply voltage
- C Housing version: ultra-compact, hygienic, stainless
- 3 Device plug for signal transmission
- 4 Device plug for supply voltage

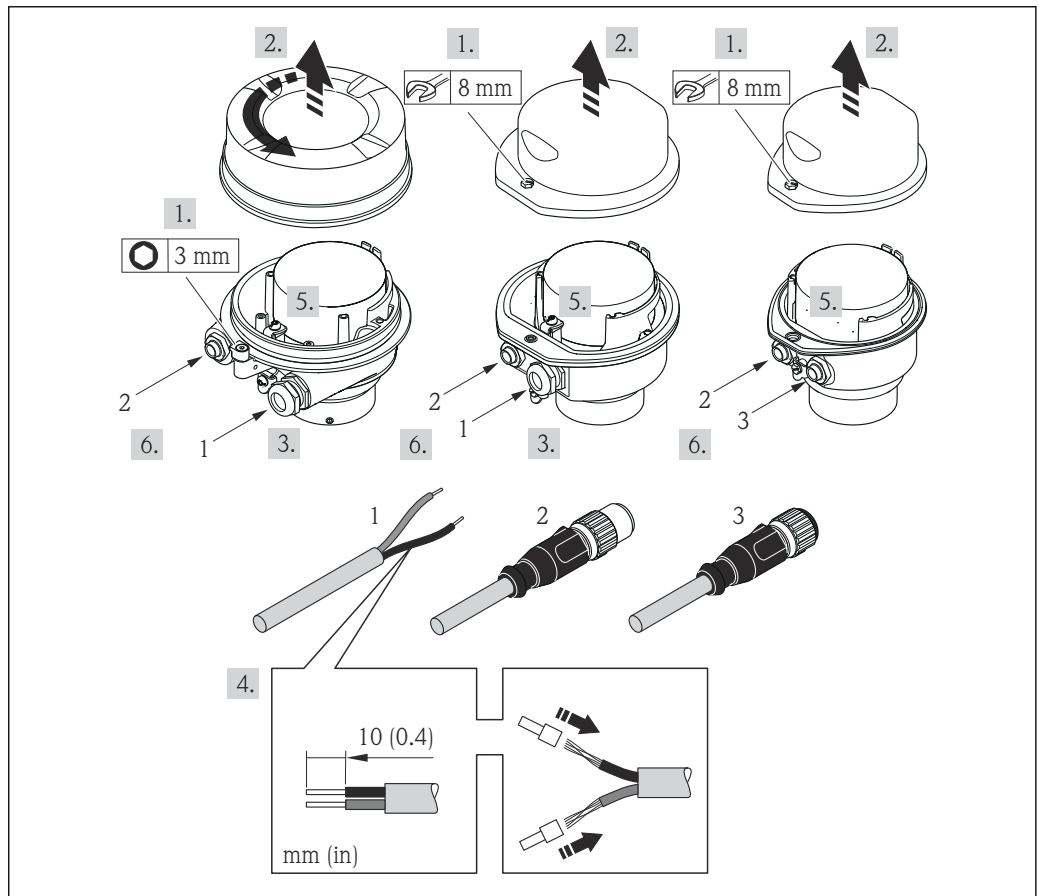



A0017844

9 Device versions with connection examples

- 1 Cable
- 2 Device plug for signal transmission
- 3 Device plug for supply voltage

For device version with device plug: follow step 6 only.

1. Depending on the housing version, loosen the securing clamp or fixing screw of the housing cover.
2. Depending on the housing version, unscrew or open the housing cover and disconnect the local display from the main electronics module where necessary  
→  128.
3. Push the cable through the cable entry . To ensure tight sealing, do not remove the sealing ring from the cable entry.
4. Strip the cable and cable ends. In the case of stranded cables, also fit ferrules.
5. Connect the cable in accordance with the terminal assignment or the device plug pin assignment .
6. Depending on the device version, tighten the cable glands or plug in the device plug and tighten .
7.  **WARNING**  
**Housing degree of protection may be voided due to insufficient sealing of the housing.**
  - ▶ Screw in the screw without using any lubricant. The threads on the cover are coated with a dry lubricant.

Reverse the removal procedure to reassemble the transmitter.

## 7.4 Potential equalization

### 7.4.1 Requirements

For potential equalization:

- Pay attention to in-house grounding concepts
- Take account of operating conditions, such as the pipe material and grounding
- Connect the medium, sensor and transmitter to the same electric potential
- Use a ground cable with a minimum cross-section of 6 mm<sup>2</sup> (10 AWG) and a cable lug for potential equalization connections

## 7.5 Special connection instructions

### 7.5.1 Connection examples

#### Current output 4 to 20 mA HART

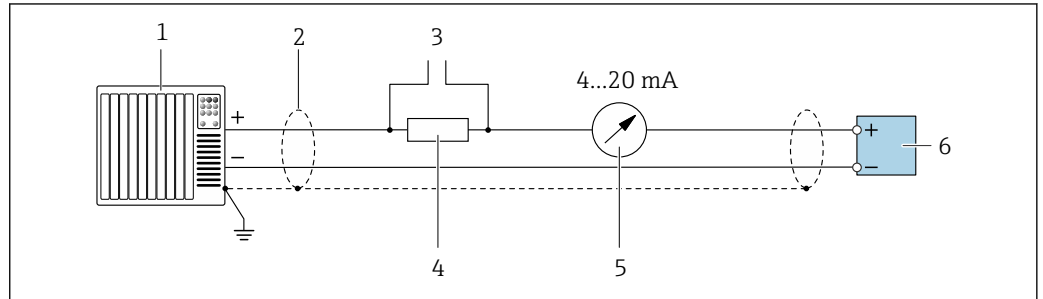

A0029055

10 Connection example for 4 to 20 mA HART current output (active)

- 1 Automation system with current input (e.g. PLC)
- 2 Cable shield provided at one end. The cable shield must be grounded at both ends to comply with EMC requirements; observe cable specifications
- 3 Connection for HART operating devices → 45
- 4 Resistor for HART communication ( $\geq 250 \Omega$ ): observe maximum load
- 5 Analog display unit: observe maximum load
- 6 Transmitter

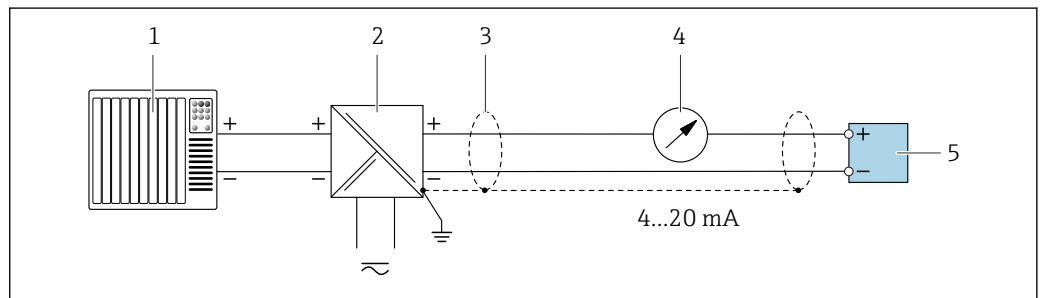

A0028762

11 Connection example for 4 to 20 mA HART current output (passive)

- 1 Automation system with current input (e.g. PLC)
- 2 Power supply
- 3 Cable shield provided at one end. The cable shield must be grounded at both ends to comply with EMC requirements; observe cable specifications
- 4 Analog display unit: observe maximum load
- 5 Transmitter

### Pulse/frequency output

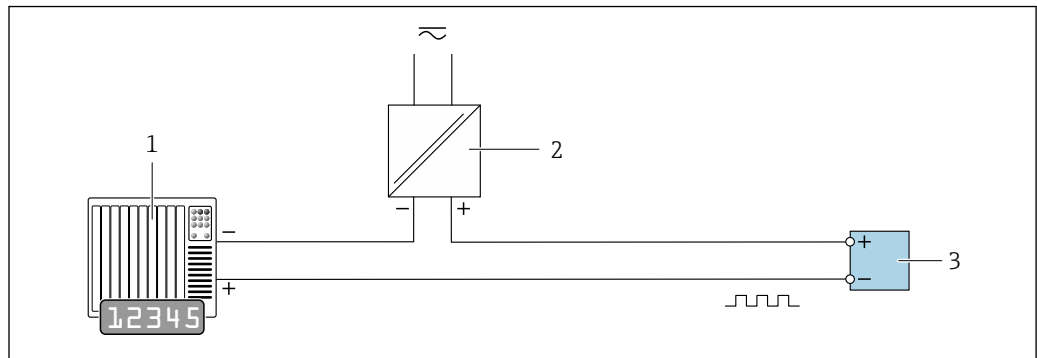

A0028761

12 Connection example for pulse/frequency output (passive)

- 1 Automation system with pulse/frequency input (e.g. PLC with 10 k $\Omega$  pull-up or pull-down resistor)
- 2 Power supply
- 3 Transmitter: observe input values

### Switch output

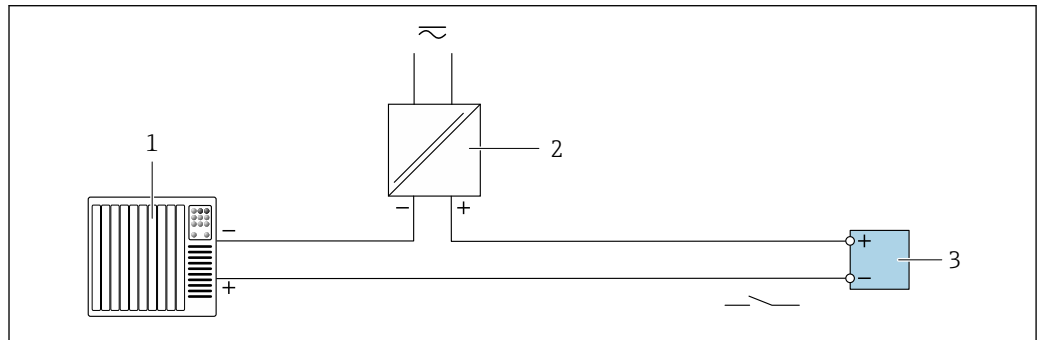

A0028760

13 Connection example for switch output (passive)

- 1 Automation system with switch input (e.g. PLC with a 10 k $\Omega$  pull-up or pull-down resistor)
- 2 Power supply
- 3 Transmitter: observe input values

### HART input

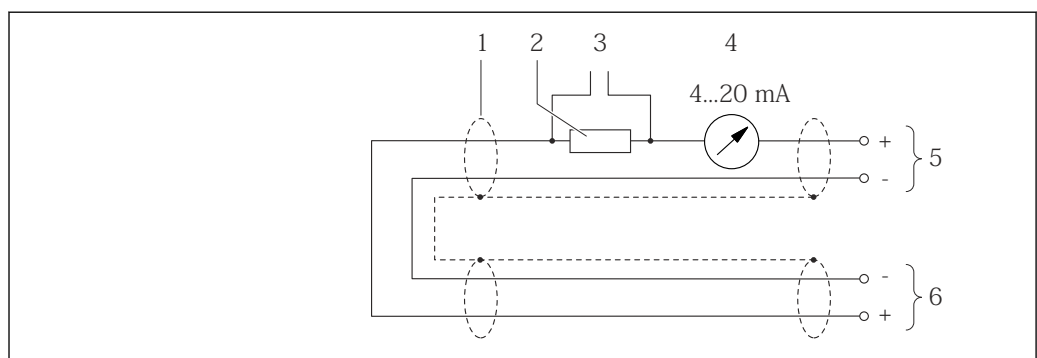

A0019828

14 Connection example for HART input (burst mode) via current output (active)

- 1 Cable shield provided at one end. Observe cable specifications
- 2 Resistor for HART communication ( $\geq 250 \Omega$ ): observe maximum load
- 3 Connection for HART operating devices
- 4 Analog display unit
- 5 Transmitter
- 6 Sensor for external measured variable



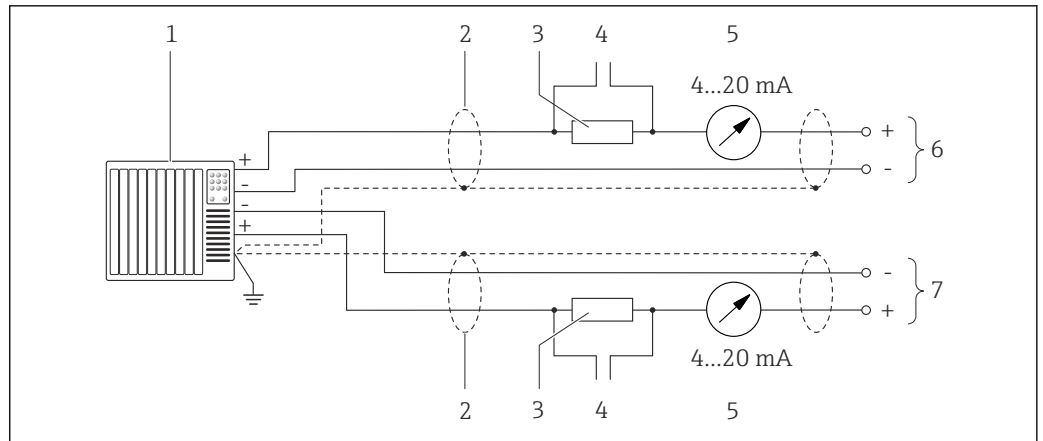

15 Connection example for HART input (master mode) via current output (active)

- 1 Automation system with current input (e.g. PLC).  
Prerequisite: automation system with HART version 6, HART commands 113 and 114 can be processed.
- 2 Cable shield provided at one end. Observe cable specifications
- 3 Resistor for HART communication ( $\geq 250 \Omega$ ): observe maximum load
- 4 Connection for HART operating devices
- 5 Analog display unit
- 6 Transmitter
- 7 Sensor for external measured variable

## 7.6 Ensuring the degree of protection

The measuring instrument fulfills all the requirements for the degree of protection IP66/67, Type 4X enclosure.

To guarantee the degree of protection IP66/67, Type 4X enclosure, carry out the following steps after the electrical connection:



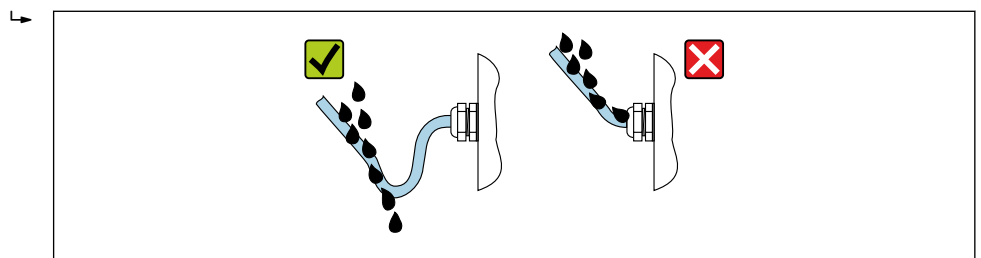



1. Check that the housing seals are clean and fitted correctly.
2. Dry, clean or replace the seals if necessary.
3. Tighten all housing screws and screw covers.
4. Firmly tighten the cable glands.
5. To ensure that moisture does not enter the cable entry:  
Route the cable so that it loops down before the cable entry ("water trap").



6. The cable glands supplied do not ensure housing protection when not in use. They must therefore be replaced by dummy plugs corresponding to the housing protection.

## 7.7 Post-connection check

Are the device and cable undamaged (visual inspection)?	<input type="checkbox"/>
Do the cables used comply with the requirements → 26?	<input type="checkbox"/>
Are the installed cables strain-relieved and securely routed?	<input type="checkbox"/>

Are all cable glands installed, securely tightened and leak-tight? Cable run with "water trap" →  33?	<input type="checkbox"/>
Depending on the device version: Are all connectors securely tightened →  29?	<input type="checkbox"/>
Does the supply voltage match the specifications on the transmitter nameplate →  117?	<input type="checkbox"/>
Is the terminal assignment →  27 or the device plug pin assignment →  28 correct?	<input type="checkbox"/>
If supply voltage is present: Is the power LED on the transmitter electronics module lit in green →  11?	<input type="checkbox"/>
Depending on the device version: <ul style="list-style-type: none"> <li>▪ Have the fixing screws been tightened with the correct tightening torque?</li> <li>▪ Is the securing clamp securely tightened?</li> </ul>	<input type="checkbox"/>

## 8 Operation options

### 8.1 Overview of operation options

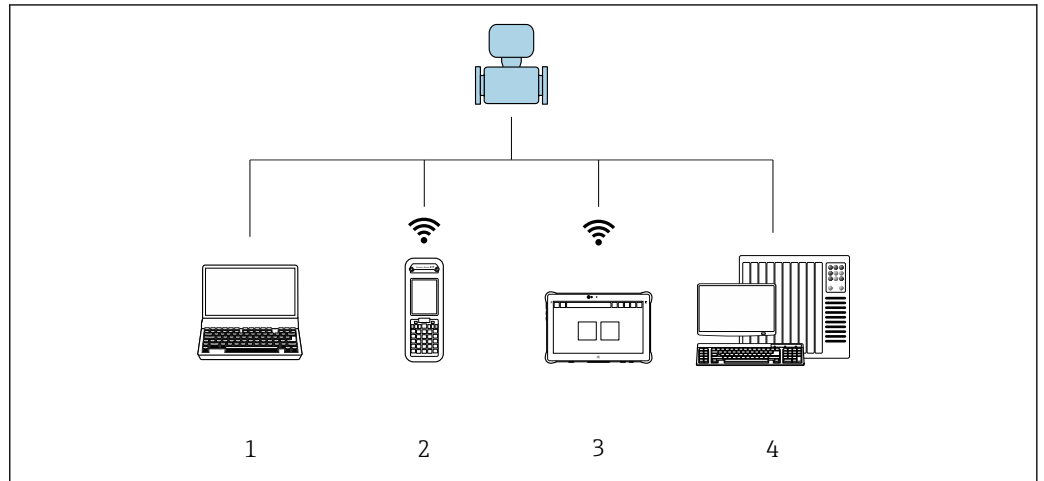



A0019598

- 1 Computer with web browser or with operating tool (e.g. FieldCare, AMS Device Manager, SIMATIC PDM)
- 2 Field Xpert SFX350 or SFX370
- 3 Field Xpert SMT70
- 4 Automation system (e.g. PLC)

## 8.2 Structure and function of the operating menu

### 8.2.1 Structure of the operating menu

 For an overview of the operating menu for experts: see the "Description of Device Parameters" document supplied with the device →  133

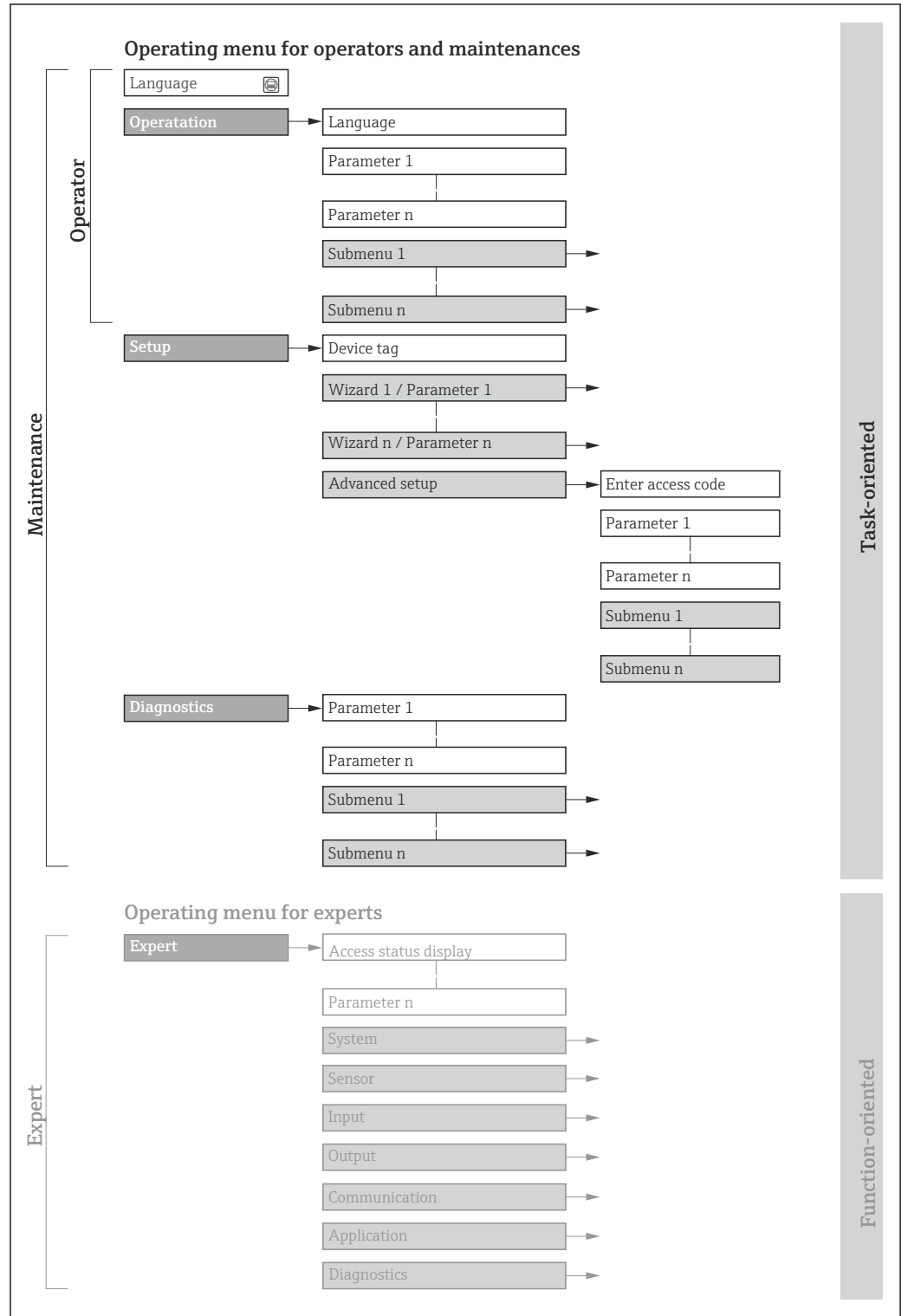

A0018237-EN

 16 Schematic structure of the operating menu

### 8.2.2 Operating philosophy

The individual parts of the operating menu are assigned to certain user roles (e.g. operator, maintenance etc.). Each user role contains typical tasks within the device life cycle.

Menu/parameter		User role and tasks	Content/meaning
Language	Task-oriented	<b>Role "Operator", "Maintenance"</b> Tasks during operation: <ul style="list-style-type: none"> <li>▪ Configuration of the operational display</li> <li>▪ Reading measured values</li> </ul>	<ul style="list-style-type: none"> <li>▪ Defining the operating language</li> <li>▪ Defining the Web server operating language</li> <li>▪ Resetting and controlling totalizers</li> </ul>
Operation			<ul style="list-style-type: none"> <li>▪ Configuration of the operational display (e.g. display format, display contrast)</li> <li>▪ Resetting and controlling totalizers</li> </ul>
Setup		<b>"Maintenance" role</b> Commissioning: <ul style="list-style-type: none"> <li>▪ Configuration of the measurement</li> <li>▪ Configuration of the outputs</li> </ul>	Submenus for fast commissioning: <ul style="list-style-type: none"> <li>▪ Configuring the system units</li> <li>▪ Definition of the medium</li> <li>▪ Configuring the outputs</li> <li>▪ Configuration of the operational display</li> <li>▪ Definition of output conditioning</li> <li>▪ Configuring the low flow cut off</li> <li>▪ Configuring partial and empty pipe detection</li> </ul> Advanced setup <ul style="list-style-type: none"> <li>▪ For more customized configuration of the measurement (adaptation to special measuring conditions)</li> <li>▪ Configuration of totalizers</li> <li>▪ Administration (define access code, reset measuring device)</li> </ul>
Diagnostics	<b>"Maintenance" role</b> Troubleshooting: <ul style="list-style-type: none"> <li>▪ Diagnostics and elimination of process and device errors</li> <li>▪ Measured value simulation</li> </ul>	Contains all parameters for error detection and analyzing process and device errors: <ul style="list-style-type: none"> <li>▪ Diagnostic list Contains up to 5 currently pending diagnostic messages.</li> <li>▪ Event logbook Contains event messages that have occurred.</li> <li>▪ Device information Contains information for identifying the device</li> <li>▪ Measured values Contains all current measured values.</li> <li>▪ Heartbeat Technology Verification of device functionality on request and documentation of verification results</li> <li>▪ Simulation Used to simulate measured values or output values.</li> </ul>	
Expert	Function-oriented	Tasks that require detailed knowledge of the function of the device: <ul style="list-style-type: none"> <li>▪ Commissioning measurements under difficult conditions</li> <li>▪ Optimal adaptation of the measurement to difficult conditions</li> <li>▪ Detailed configuration of the communication interface</li> <li>▪ Error diagnostics in difficult cases</li> </ul>	Contains all of the device parameters and allows direct access to these by means of an access code. The structure of this menu is based on the function blocks of the device: <ul style="list-style-type: none"> <li>▪ System Contains all higher-level device parameters that do not affect measurement or measured value communication</li> <li>▪ Sensor Configuration of the measurement.</li> <li>▪ Output Configuration of the analog current outputs as well as the pulse/frequency and switch output</li> <li>▪ Communication Configuration of the digital communication interface and the Web server</li> <li>▪ Application Configuration of the functions that go beyond the actual measurement (e.g. totalizer)</li> <li>▪ Diagnostics Error detection and analysis of process and device errors and for device simulation and Heartbeat Technology.</li> </ul>

## 8.3 Displaying the measured values via the local display (optionally available)

### 8.3.1 Operational display

 The local display is optionally available:

Order code for "Display; operation", option B "4-line, illuminated; via communication".

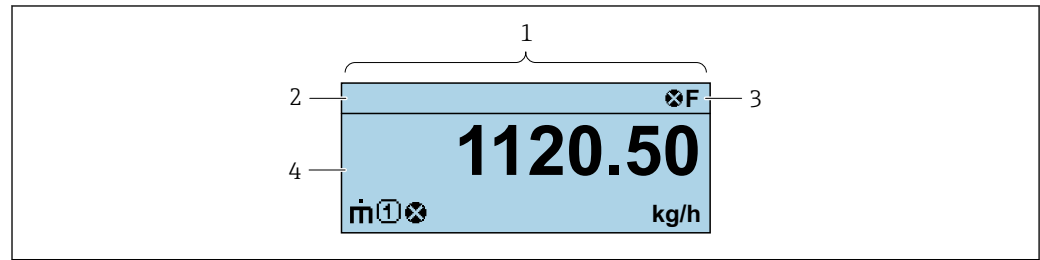





A0037831

- 1 Operational display
- 2 Tag name
- 3 Status area
- 4 Display area for measured values (4-line)



#### Status area

The following symbols appear in the status area of the operational display at the top right:



- Status signals
  - **F**: Failure
  - **C**: Function check
  - **S**: Out of specification
  - **M**: Maintenance required
- Diagnostic behavior
  - : Alarm
  - : Warning
  - : Locking (the device is locked via the hardware )
  - : Communication (communication via remote operation is active)







#### Display area

In the display area, each measured value is prefaced by certain symbol types for further description:

	Measured variable	Measurement channel number	Diagnostic behavior
	↓	↓	↓
Example			
			Appears only if a diagnostics event is present for this measured variable.

#### Measured variables

Symbol	Meaning
	Mass flow
	<ul style="list-style-type: none"> <li>▪ Volume flow</li> <li>▪ Corrected volume flow</li> </ul>

	<ul style="list-style-type: none"> <li>▪ Density</li> <li>▪ Reference density</li> </ul>
	Temperature
	Totalizer  The measurement channel number indicates which of the three totalizers is displayed.
	Output 

*Measurement channel numbers*

Symbol	Meaning
	Measurement channel 1 to 4
The measurement channel number is displayed only if more than one channel is present for the same measured variable type (e.g. Totalizer 1 to 3).	

*Diagnostic behavior*

The diagnostic behavior pertains to a diagnostic event that is relevant to the displayed measured variable. For information on the symbols

 The number and display format of the measured values can only be configured via the control system or Web server.

### 8.3.2 User roles and related access authorization

The two user roles "Operator" and "Maintenance" have different write access to the parameters if the customer defines a user-specific access code. This protects the device configuration from unauthorized access .

#### Defining access authorization for user roles

An access code is not yet defined when the device is delivered from the factory. Access authorization (read and write access) to the device is not restricted and corresponds to the "Maintenance" user role.

- ▶ Define the access code.
  - ↳ The "Operator" user role is redefined in addition to the "Maintenance" user role. Access authorization differs for the two user roles.

*Access authorization to parameters: "Maintenance" user role*

Access code status	Read access	Write access
An access code has not yet been defined (factory setting).	✓	✓
After an access code has been defined.	✓	✓ <sup>1)</sup>

1) The user only has write access after entering the access code.

*Access authorization to parameters: "Operator" user role*

Access code status	Read access	Write access
After an access code has been defined.	✓	– 1)

- 1) Despite the defined access code, certain parameters can always be modified and thus are excluded from the write protection as they do not affect the measurement: write protection via access code

 The user role with which the user is currently logged on is indicated by the .  
Navigation path:

## 8.4 Access to operating menu via web browser

### 8.4.1 Function range

With the integrated web server, the device can be operated and configured via a web browser service interface (CDI-RJ45) WLAN interface. In addition to the measured values, status information on the device is displayed and can be used to monitor device health. Furthermore the device data can be managed and the network parameters can be configured.



 For additional information on the web server, see the Special Documentation for the device.

### 8.4.2 Prerequisites

*Computer hardware*

Hardware	Interface	
	CDI-RJ45	WLAN
Interface	The computer must have an RJ45 interface.	The operating unit must have a WLAN interface.
Connection	Standard Ethernet cable with RJ45 connector.	Connection via Wireless LAN.
Display	Recommended size: ≥12" (depends on the screen resolution)	

*Computer software*

Software	Interface	
	CDI-RJ45	WLAN
Recommended operating systems	<ul style="list-style-type: none"> <li>▪ Microsoft Windows 8 or higher.</li> <li>▪ Mobile operating systems:                             <ul style="list-style-type: none"> <li>▪ iOS</li> <li>▪ Android</li> </ul> </li> </ul> <p> Microsoft Windows XP is supported.</p> <p> Microsoft Windows 7 is supported.</p>	
Web browsers supported	<ul style="list-style-type: none"> <li>▪ Microsoft Internet Explorer 8 or higher</li> <li>▪ Microsoft Edge</li> <li>▪ Mozilla Firefox</li> <li>▪ Google Chrome</li> <li>▪ Safari</li> </ul>	





*Computer settings*

User rights	Appropriate user rights (e.g. administrator rights) for TCP/IP and proxy server settings are necessary (for adjusting the IP address, subnet mask etc.).
Proxy server settings of the Web browser	The web browser setting <i>Use a Proxy Server for Your LAN</i> must be <b>deselected</b> .
JavaScript	JavaScript must be enabled.  If JavaScript cannot be enabled: Enter http://XXX.XXX.X.XX/servlet/basic.html in the address bar of the web browser, e.g. http://192.168.1.212/servlet/basic.html. A fully functional but simplified version of the operating menu structure starts in the web browser.
Network connections	Only the active network connections to the measuring device should be used. Switch off all other network connections.

 In the event of connection problems: →  90

*Measuring device: Via CDI-RJ45 service interface*

Device	CDI-RJ45 service interface
Measuring device	The measuring device has an RJ45 interface.
Web server	Web server must be enabled; factory setting: ON  For information on enabling the Web server →  44

### 8.4.3 Connecting the device

#### Via service interface (CDI-RJ45)

*Preparing the measuring device*

*Configuring the Internet protocol of the computer*

The following information refers to the default Ethernet settings of the device.

IP address of the device: 192.168.1.212 (factory setting)

1. Switch on the measuring device.
2. Connect the computer to the RJ45 plug via the standard Ethernet cable →  129.
3. If a 2nd network card is not used, close all the applications on the notebook.
  - ↳ Applications requiring Internet or a network, such as e-mail, SAP applications, Internet or Windows Explorer.
4. Close any open Internet browsers.
5. Configure the properties of the Internet protocol (TCP/IP) as defined in the table:

IP address	192.168.1.XXX; for XXX all numerical sequences except: 0, 212 and 255 → e.g. 192.168.1.213
Subnet mask	255.255.255.0
Default gateway	192.168.1.212 or leave cells empty

#### Starting the web browser

1. Start the web browser on the computer.

2. Enter the IP address of the web server in the address line of the web browser:  
192.168.1.212  
↳ The login page appears.

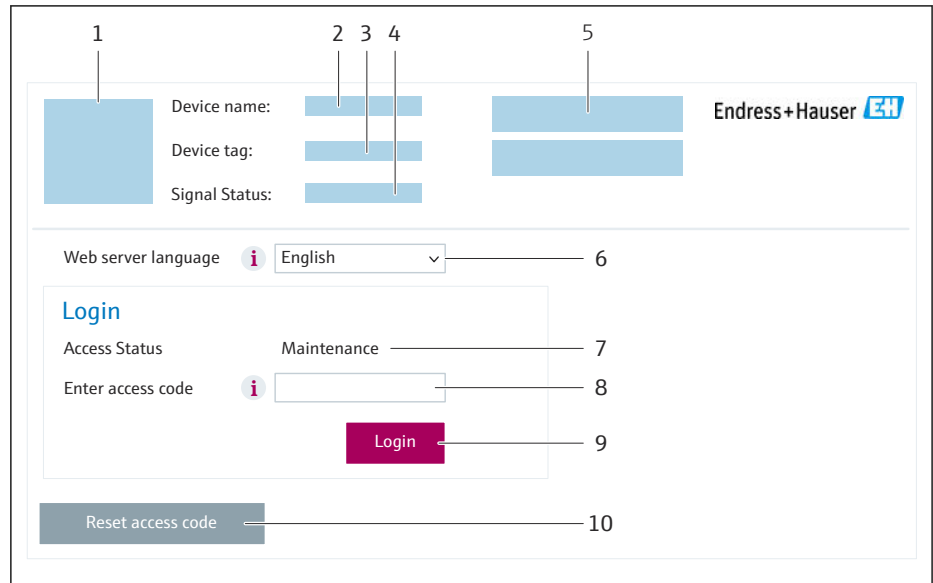

- 1 Picture of device
- 2 Device name
- 3 Device tag (→ ⓘ 55)
- 4 Status signal
- 5 Current measured values
- 6 Operating language
- 7 User role
- 8 Access code
- 9 Login
- 10 Reset access code (→ ⓘ 80)

**i** If a login page does not appear, or if the page is incomplete → ⓘ 90

### 8.4.4 Logging on

1. Select the preferred operating language for the Web browser.
2. Enter the user-specific access code.
3. Press **OK** to confirm your entry.

<b>Access code</b>	0000 (factory setting); can be changed by customer
--------------------	--

**i** If no action is performed for 10 minutes, the Web browser automatically returns to the login page.

### 8.4.5 User interface

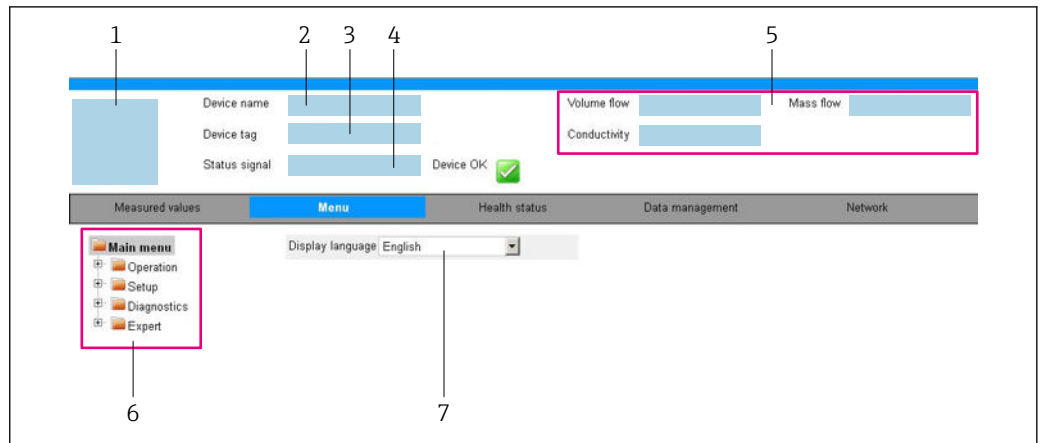

A0032879

- 1 Picture of device
- 2 Device name
- 3 Device tag
- 4 Status signal
- 5 Current measured values
- 6 Navigation area
- 7 Local display language

#### Header

The following information appears in the header:

- Device name
- Device tag
- Device status with status signal → 📄 93
- Current measured values

#### Function row

Functions	Meaning
Measured values	Displays the measured values of the device
Menu	<ul style="list-style-type: none"> <li>■ Access to the operating menu from the measuring device</li> <li>■ The structure of the operating menu is the same as for the operating tools</li> <li>📖 Detailed information on the operating menu structure: Description of Device Parameters</li> </ul>
Device status	Displays the diagnostic messages currently pending, listed in order of priority
Data management	Data exchange between computer and measuring device: <ul style="list-style-type: none"> <li>■ Device configuration:                             <ul style="list-style-type: none"> <li>■ Load settings from the device (XML format, save configuration)</li> <li>■ Save settings to the device (XML format, restore configuration)</li> </ul> </li> <li>■ Logbook - Export Event logbook (.csv file)</li> <li>■ Documents - Export documents:                             <ul style="list-style-type: none"> <li>■ Export backup data record (.csv file, create documentation of the measuring point configuration)</li> <li>■ Verification report (PDF file, only available with the "Heartbeat Verification" application package)</li> </ul> </li> </ul>
Network	Configuration and checking of all the parameters required for establishing the connection to the measuring device: <ul style="list-style-type: none"> <li>■ Network settings (e.g. IP address, MAC address)</li> <li>■ Device information (e.g. serial number, firmware version)</li> </ul>
Logout	End the operation and call up the login page

**Navigation area**

The menus, the associated submenus and parameters can be selected in the navigation area.

**Working area**

Depending on the selected function and the related submenus, various actions can be performed in this area:

- Configuring parameters
- Reading measured values
- Calling up help text
- Starting an upload/download

**8.4.6 Disabling the Web server**

The Web server of the measuring device can be switched on and off as required using the **Web server functionality** parameter.

**Navigation**

"Expert" menu → Communication → Web server

**Parameter overview with brief description**

Parameter	Description	Selection
Web server functionality	Switch the Web server on and off.	<ul style="list-style-type: none"> <li>▪ Off</li> <li>▪ On</li> </ul>

**Function scope of the "Web server functionality" parameter**

Option	Description
Off	<ul style="list-style-type: none"> <li>▪ The Web server is completely disabled.</li> <li>▪ Port 80 is locked.</li> </ul>
On	<ul style="list-style-type: none"> <li>▪ The complete Web server functionality is available.</li> <li>▪ JavaScript is used.</li> <li>▪ The password is transferred in an encrypted state.</li> <li>▪ Any change to the password is also transferred in an encrypted state.</li> </ul>

**Enabling the Web server**

If the Web server is disabled it can only be re-enabled with the **Web server functionality** parameter via the following operating options:

- Via Bedientool "FieldCare"
- Via "DeviceCare" operating tool

**8.4.7 Logging out**

 Before logging out, perform a data backup via the **Data management** function (upload configuration from device) if necessary.

1. Select the **Logout** entry in the function row.
  - ↳ The home page with the Login box appears.
2. Close the Web browser.
3. If no longer needed:
  - Reset the modified properties of the Internet protocol (TCP/IP) →  41.

## 8.5 Access to the operating menu via the operating tool

### 8.5.1 Connecting the operating tool

#### Via HART protocol

This communication interface is available in device versions with a HART output.

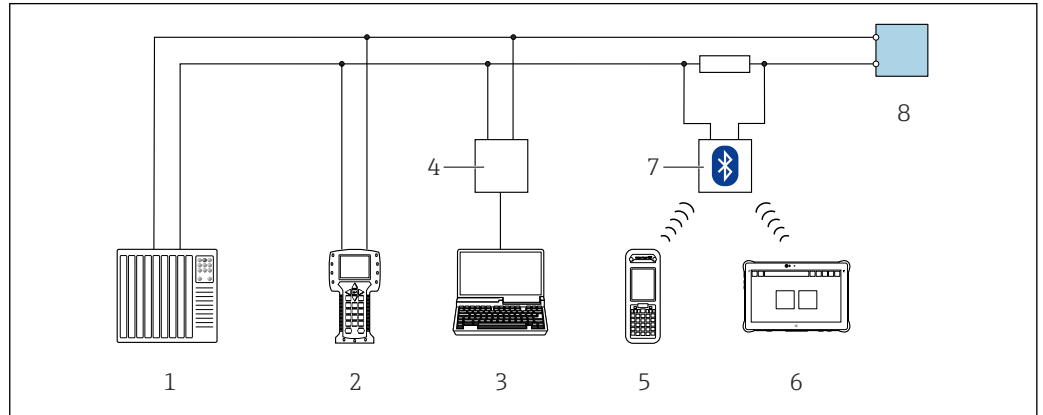

A0028747

17 Options for remote operation via HART protocol

- 1 Control system (e.g. PLC)
- 2 Field Communicator 475
- 3 Computer with operating tool (e.g. FieldCare, AMS Device Manager, SIMATIC PDM)
- 4 Commubox FXA195 (USB)
- 5 Field Xpert SFX350 or SFX370
- 6 Field Xpert SMT70
- 7 VIATOR Bluetooth modem with connecting cable
- 8 Transmitter

#### Via service interface (CDI-RJ45)

##### HART

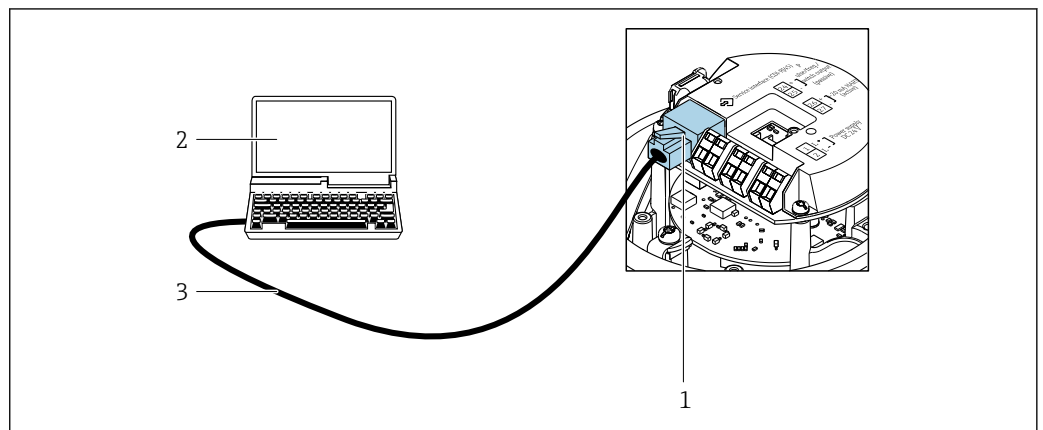

A0016926

18 Connection for the order code for "Output", option B: 4-20 mA HART, pulse/frequency/switch output

- 1 Service interface (CDI-RJ45) of the measuring device with access to the integrated web server
- 2 Computer with web browser (e.g. Internet Explorer) for accessing the integrated web server or with "FieldCare" operating tool with COM DTM "CDI Communication TCP/IP"
- 3 Standard Ethernet connecting cable with RJ45 plug

## 8.5.2 Field Xpert SFX350, SFX370

### Function scope

Field Xpert SFX350 and Field Xpert SFX370 are mobile computers for commissioning and maintenance. They enable efficient device configuration and diagnostics for HART and FOUNDATION Fieldbus devices in the **non-hazardous area** (SFX350, SFX370) and **hazardous area** (SFX370).



For details, see Operating Instructions BA01202S

### Source for device description files

See information → 49

## 8.5.3 FieldCare

### Function range

FDT-based (Field Device Technology) plant asset management tool from Endress+Hauser. It can configure all smart field units in a system and helps you manage them. By using the status information, it is also a simple but effective way of checking their status and condition.

Access is via:

- HART protocol
- CDI-RJ45 service interface

Typical functions:

- Transmitter parameter configuration
- Loading and saving of device data (upload/download)
- Documentation of the measuring point
- Visualization of the measured value memory (line recorder) and event logbook



- Operating Instructions BA00027S
- Operating Instructions BA00059S



Source for device description files → 49

### Establishing a connection

1. Start FieldCare and launch the project.
2. In the network: Add a device.
  - ↳ The **Add device** window opens.
3. Select the **CDI Communication TCP/IP** option from the list and press **OK** to confirm.
4. Right-click **CDI Communication TCP/IP** and select the **Add device** option in the context menu that opens.
5. Select the desired device from the list and press **OK** to confirm.
  - ↳ The **CDI Communication TCP/IP (Configuration)** window opens.
6. Enter the device address in the **IP address** field and press **Enter** to confirm: 192.168.1.212 (factory setting); if the IP address is not known .
7. Establish the online connection to the device.



- Operating Instructions BA00027S
- Operating Instructions BA00059S

## User interface

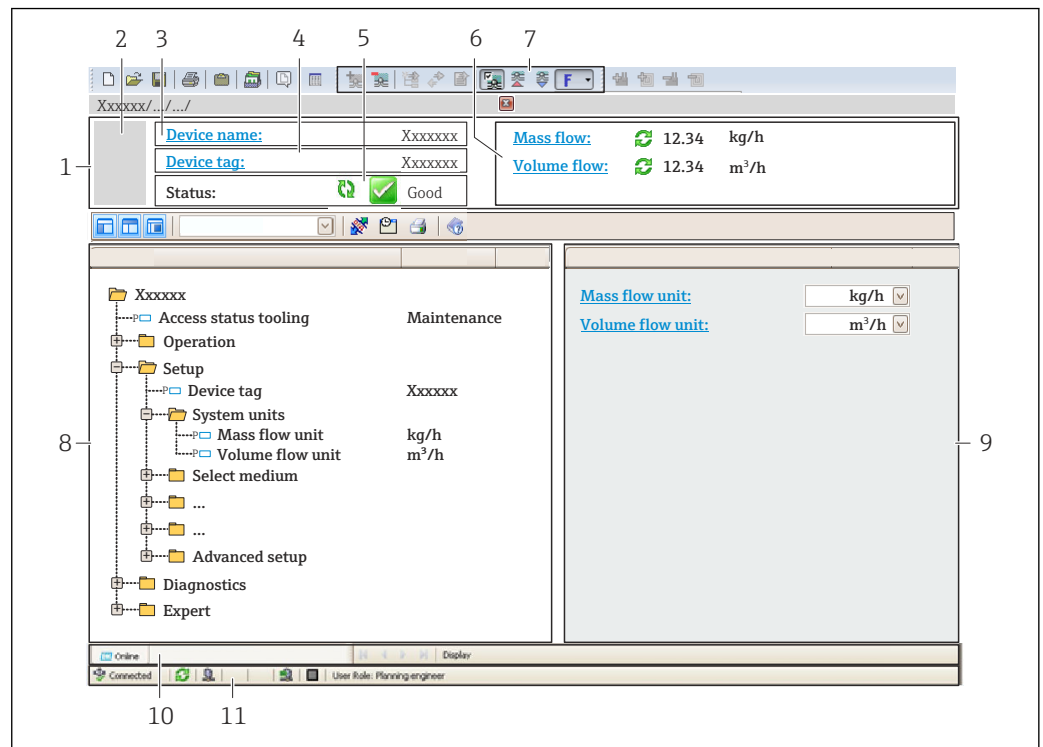

A0021051-EN

- 1 Header
- 2 Picture of device
- 3 Device name
- 4 Device tag
- 5 Status area with status signal → 93
- 6 Display area for current measured values
- 7 Editing toolbar with additional functions such as save/load, event list and create documentation
- 8 Navigation area with operating menu structure
- 9 Work area
- 10 Action area
- 11 Status area

### 8.5.4 DeviceCare

#### Function range

Tool for connecting and configuring Endress+Hauser field devices.

The fastest way to configure Endress+Hauser field devices is with the dedicated "DeviceCare" tool. Together with the device type managers (DTMs) it presents a convenient, comprehensive solution.

 Innovation brochure IN01047S

 Source for device description files → 49

### 8.5.5 AMS Device Manager

#### Function range



Program from Emerson Process Management for operating and configuring measuring devices via the HART protocol.

 Source for device description files → 49

## 8.5.6 SIMATIC PDM

### Function range

SIMATIC PDM is a standardized, manufacturer-independent program from Siemens for the operation, configuration, maintenance and diagnosis of intelligent field devices via HART protocol.

 Source for device description files →  49

## 8.5.7 Field Communicator 475

### Function scope

Industrial handheld terminal from Emerson Process Management for remote configuration and measured value display via HART protocol.

### Source for device description files

See information →  49





## 9 System integration

### 9.1 Overview of device description files

#### 9.1.1 Current version data for the device

Firmware version	01.01.zz	<ul style="list-style-type: none"> <li>▪ On the title page of the manual</li> <li>▪ On the transmitter nameplate</li> <li>▪ Firmware version Diagnostics → Device information → Firmware version</li> </ul>
Release date of firmware version	10.2014	---
Manufacturer ID	0x11	Manufacturer ID Diagnostics → Device information → Manufacturer ID
Device type code	0x4A	Device type Diagnostics → Device information → Device type
HART protocol revision	7	---
Device revision	2	<ul style="list-style-type: none"> <li>▪ On the transmitter nameplate</li> <li>▪ Device revision Diagnostics → Device information → Device revision</li> </ul>

 For an overview of the various firmware versions for the device →  105

#### 9.1.2 Operating tools

The suitable device description file for the individual operating tools is listed in the table below, along with information on where the file can be acquired.

Operating tool via HART protocol	Sources for obtaining device descriptions
FieldCare	<ul style="list-style-type: none"> <li>▪ <a href="http://www.endress.com">www.endress.com</a> → Downloads area</li> <li>▪ USB stick (contact Endress+Hauser)</li> <li>▪ DVD (contact Endress+Hauser)</li> </ul>
DeviceCare	<ul style="list-style-type: none"> <li>▪ <a href="http://www.endress.com">www.endress.com</a> → Downloads area</li> <li>▪ CD-ROM (contact Endress+Hauser)</li> <li>▪ DVD (contact Endress+Hauser)</li> </ul>
<ul style="list-style-type: none"> <li>▪ Field Xpert SMT70</li> <li>▪ Field Xpert SMT77</li> </ul>	Use update function of handheld terminal
AMS Device Manager (Emerson Process Management)	<a href="http://www.endress.com">www.endress.com</a> → Downloads area
SIMATIC PDM (Siemens)	<a href="http://www.endress.com">www.endress.com</a> → Downloads area
Field Communicator 475 (Emerson Process Management)	Use update function of handheld terminal

## 9.2 Measured variables via HART protocol

The following measured variables (HART device variables) are assigned to the dynamic variables at the factory:

Dynamic variables	Measured variables (HART device variables)
Primary dynamic variable (PV)	Mass flow
Secondary dynamic variable (SV)	Totalizer 1

Dynamic variables	Measured variables (HART device variables)
Tertiary dynamic variable (TV)	Density
Quaternary dynamic variable (QV)	Temperature

The assignment of the measured variables to the dynamic variables can be modified and assigned as desired via the operating tool using the following parameters:

- Expert → Communication → HART output → Output → Assign PV
- Expert → Communication → HART output → Output → Assign SV
- Expert → Communication → HART output → Output → Assign TV
- Expert → Communication → HART output → Output → Assign QV

The following measured variables can be assigned to the dynamic variables:

#### Measured variables for PV (primary dynamic variable)

- Off
- Mass flow
- Volume flow
- Corrected volume flow
- Density
- Reference density
- Temperature
- Carrier pipe temperature
- Electronic temperature
- Oscillation frequency 0
- Frequency fluctuation 0
- Oscillation damping 0
- Oscillation damping fluctuation 0
- Signal asymmetry
- Exciter current 0

#### Measured variables for SV, TV, QV (secondary, tertiary and quaternary dynamic variable)

- Mass flow
- Volume flow
- Corrected volume flow
- Density
- Reference density
- Temperature
- Electronic temperature
- Oscillation frequency
- Oscillation amplitude
- Oscillation damping
- Signal asymmetry
- External pressure
- Totalizer 1...3

### 9.2.1 Device variables

Device variables are permanently assigned. A maximum of eight device variables can be transmitted.

Assignment	Device variables
0	Mass flow
1	Volume flow
2	Corrected volume flow
3	Density
4	Reference density

Assignment	Device variables
5	Temperature
6	Totalizer 1
7	Totalizer 2
8	Totalizer 3
13	Target mass flow <sup>1)</sup>
14	Carrier mass flow <sup>1)</sup>
15	Concentration <sup>1)</sup>

1) Visible depending on the order options or device settings

### 9.3 Other settings

Burst mode functionality in accordance with HART 7 Specification:

#### Navigation

"Expert" menu → Communication → HART output → Burst configuration → Burst configuration 1 to n

▶ Burst configuration 1 to n

Burst mode 1 to n	→ ⓘ 52
Burst command 1 to n	→ ⓘ 52
Burst variable 0	→ ⓘ 52
Burst variable 1	→ ⓘ 52
Burst variable 2	→ ⓘ 52
Burst variable 3	→ ⓘ 52
Burst variable 4	→ ⓘ 52
Burst variable 5	→ ⓘ 52
Burst variable 6	→ ⓘ 52
Burst variable 7	→ ⓘ 52
Burst trigger mode	→ ⓘ 52
Burst trigger level	→ ⓘ 52
Min. update period	→ ⓘ 53
Max. update period	→ ⓘ 53

## Parameter overview with brief description

Parameter	Description	Selection / User entry
Burst mode 1 to n	Activate the HART burst mode for burst message X.	<ul style="list-style-type: none"> <li>▪ Off</li> <li>▪ On</li> </ul>
Burst command 1 to n	Select the HART command that is sent to the HART master.	<ul style="list-style-type: none"> <li>▪ Command 1</li> <li>▪ Command 2</li> <li>▪ Command 3</li> <li>▪ Command 9</li> <li>▪ Command 33</li> <li>▪ Command 48</li> </ul>
Burst variable 0	For HART command 9 and 33: select the HART device variable or the process variable.	<ul style="list-style-type: none"> <li>▪ Mass flow</li> <li>▪ Volume flow</li> <li>▪ Corrected volume flow</li> <li>▪ Target mass flow<sup>*</sup></li> <li>▪ Carrier mass flow<sup>*</sup></li> <li>▪ Density</li> <li>▪ Reference density</li> <li>▪ Concentration<sup>*</sup></li> <li>▪ Temperature</li> <li>▪ Totalizer 1</li> <li>▪ Totalizer 2</li> <li>▪ Totalizer 3</li> <li>▪ Sensor integrity</li> <li>▪ Pressure</li> <li>▪ HART input</li> <li>▪ Percent of range</li> <li>▪ Measured current</li> <li>▪ Primary variable (PV)</li> <li>▪ Secondary variable (SV)</li> <li>▪ Tertiary variable (TV)</li> <li>▪ Quaternary variable (QV)</li> <li>▪ Not used</li> </ul>
Burst variable 1	For HART command 9 and 33: select the HART device variable or the process variable.	See the <b>Burst variable 0</b> parameter.
Burst variable 2	For HART command 9 and 33: select the HART device variable or the process variable.	See the <b>Burst variable 0</b> parameter.
Burst variable 3	For HART command 9 and 33: select the HART device variable or the process variable.	See the <b>Burst variable 0</b> parameter.
Burst variable 4	For HART command 9: select the HART device variable or the process variable.	See the <b>Burst variable 0</b> parameter.
Burst variable 5	For HART command 9: select the HART device variable or the process variable.	See the <b>Burst variable 0</b> parameter.
Burst variable 6	For HART command 9: select the HART device variable or the process variable.	See the <b>Burst variable 0</b> parameter.
Burst variable 7	For HART command 9: select the HART device variable or the process variable.	See the <b>Burst variable 0</b> parameter.
Burst trigger mode	Select the event that triggers burst message X.	<ul style="list-style-type: none"> <li>▪ Continuous</li> <li>▪ Window</li> <li>▪ Rising</li> <li>▪ Falling</li> <li>▪ On change</li> </ul>
Burst trigger level	Enter the burst trigger value. Together with the option selected in the <b>Burst trigger mode</b> parameter the burst trigger value determines the time of burst message X.	Positive floating-point number



Parameter	Description	Selection / User entry
Min. update period	Enter the minimum time span between two burst commands of burst message X.	Positive integer
Max. update period	Enter the maximum time span between two burst commands of burst message X.	Positive integer

\* Visibility depends on order options or device settings

## 10 Commissioning

### 10.1 Post-mounting and post-connection check

Before commissioning the device:

- ▶ Make sure that the post-installation and post-connection checks have been performed successfully.
- Checklist for "Post-installation" check →  25
- Checklist for "Post-connection" check →  33

### 10.2 Setting the operating language

Factory setting: English or ordered local language

The operating language can be set in FieldCare, DeviceCare or via the Web server:  
Operation → Display language

### 10.3 Configuring the measuring instrument

The **Setup** menu with its submenus contains all the parameters needed for standard operation.

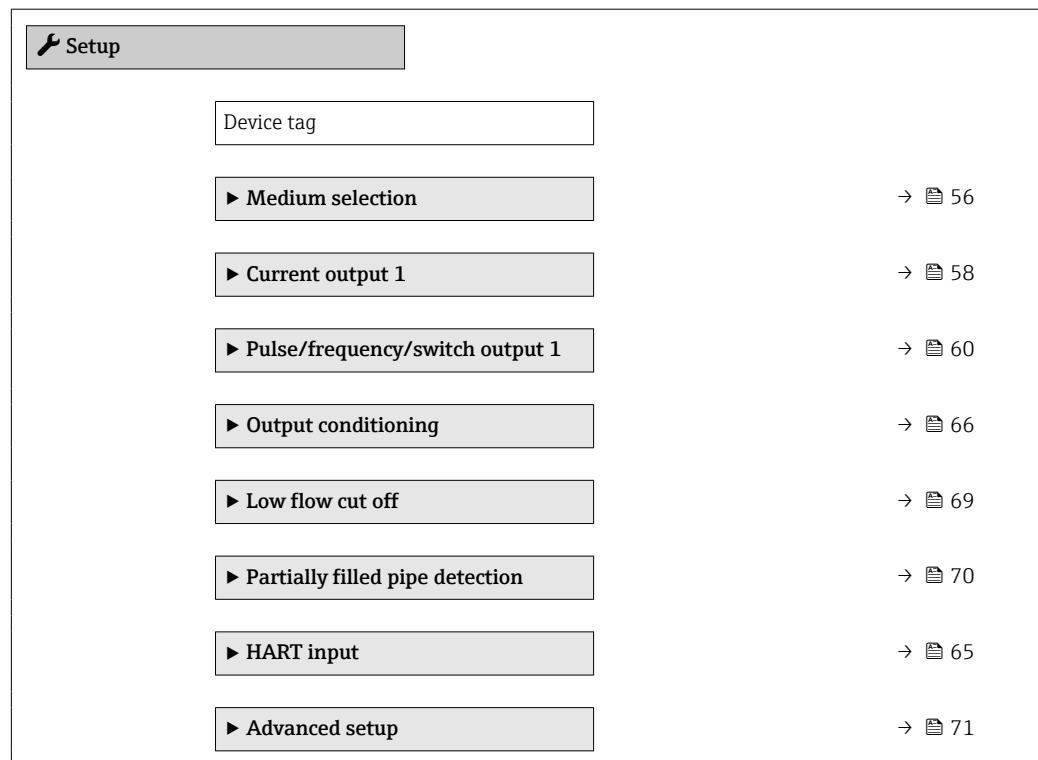

#### 10.3.1 Defining the tag name

To enable fast identification of the measuring point within the system, you can enter a unique designation using the **Device tag** parameter and thus change the factory setting.

 Enter the tag name in the "FieldCare" operating tool →  47

#### Navigation

"Setup" menu → Device tag

**Parameter overview with brief description**

Parameter	Description	User entry
Device tag	Enter the name for the measuring point.	Max. 32 characters, such as letters, numbers or special characters (e.g. @, %, /).

### 10.3.2 Selecting and setting the medium

The **Select medium** wizard submenu contains parameters that must be configured in order to select and set the medium.

#### Navigation

"Setup" menu → Medium selection

► Medium selection	
Select medium	→ 56
Select gas type	→ 56
Reference sound velocity	→ 57
Temperature coefficient sound velocity	→ 57
Pressure compensation	→ 57
Pressure value	→ 57
External pressure	→ 57

#### Parameter overview with brief description

Parameter	Prerequisite	Description	Selection / User entry / User interface
Select medium	–	Use this function to select the type of medium: "Gas" or "Liquid". Select the "Other" option in exceptional cases in order to enter the properties of the medium manually (e.g. for highly compressive liquids such as sulfuric acid).	<ul style="list-style-type: none"> <li>▪ Liquid</li> <li>▪ Gas</li> </ul>
Select gas type	In the <b>Medium selection</b> submenu, the <b>Gas</b> option is selected.	Select measured gas type.	<ul style="list-style-type: none"> <li>▪ Air</li> <li>▪ Ammonia NH<sub>3</sub></li> <li>▪ Argon Ar</li> <li>▪ Sulfur hexafluoride SF<sub>6</sub></li> <li>▪ Oxygen O<sub>2</sub></li> <li>▪ Ozone O<sub>3</sub></li> <li>▪ Nitrogen oxide NO<sub>x</sub></li> <li>▪ Nitrogen N<sub>2</sub></li> <li>▪ Nitrous oxide N<sub>2</sub>O</li> <li>▪ Methane CH<sub>4</sub></li> <li>▪ Hydrogen H<sub>2</sub></li> <li>▪ Helium He</li> <li>▪ Hydrogen chloride HCl</li> <li>▪ Hydrogen sulfide H<sub>2</sub>S</li> <li>▪ Ethylene C<sub>2</sub>H<sub>4</sub></li> <li>▪ Carbon dioxide CO<sub>2</sub></li> <li>▪ Carbon monoxide CO</li> <li>▪ Chlorine Cl<sub>2</sub></li> <li>▪ Butane C<sub>4</sub>H<sub>10</sub></li> <li>▪ Propane C<sub>3</sub>H<sub>8</sub></li> <li>▪ Propylene C<sub>3</sub>H<sub>6</sub></li> <li>▪ Ethane C<sub>2</sub>H<sub>6</sub></li> <li>▪ Others</li> </ul>



Parameter	Prerequisite	Description	Selection / User entry / User interface
Reference sound velocity	In the <b>Select gas type</b> parameter, the <b>Others</b> option is selected.	Enter sound velocity of gas at 0 °C (32 °F).	1 to 99 999.9999 m/s
Temperature coefficient sound velocity	In the <b>Select gas type</b> parameter, the <b>Others</b> option is selected.	Enter temperature coefficient for the gas sound velocity.	Positive floating-point number
Pressure compensation	–	Select pressure compensation type.	<ul style="list-style-type: none"> <li>■ Off</li> <li>■ Fixed value</li> <li>■ External value</li> </ul>
Pressure value	In the <b>Pressure compensation</b> parameter, the <b>Fixed value</b> option or the <b>Current input 1...n</b> option is selected.	Enter process pressure to be used for pressure correction.	Positive floating-point number
External pressure	In the <b>Pressure compensation</b> parameter, the <b>External value</b> option is selected.		

### 10.3.3 Configuring the current output

The **Current output** submenu guides you systematically through all the parameters that have to be set for configuring the current output.





#### Navigation

"Setup" menu → Current output 1

#### Structure of the submenu

▶ Current output 1	
Assign current output	→ 59
Current span	→ 59
0/4 mA value	→ 59
20 mA value	→ 59
Failure mode	→ 59
Failure current	→ 59

## Parameter overview with brief description

Parameter	Prerequisite	Description	Selection / User entry	Factory setting
Assign current output	–	Select process variable for current output.	<ul style="list-style-type: none"> <li>■ Off</li> <li>■ Mass flow</li> <li>■ Volume flow</li> <li>■ Corrected volume flow</li> <li>■ Target mass flow *</li> <li>■ Carrier mass flow *</li> <li>■ Density</li> <li>■ Reference density</li> <li>■ Concentration *</li> <li>■ Temperature</li> <li>■ Carrier pipe temperature *</li> <li>■ Electronic temperature</li> <li>■ Oscillation frequency 0</li> <li>■ Oscillation amplitude 0 *</li> <li>■ Frequency fluctuation 0</li> <li>■ Oscillation damping 0</li> <li>■ Tube damping fluctuation 0</li> <li>■ Signal asymmetry</li> <li>■ Exciter current 0</li> </ul>	–
Current span	–	Select current range for process value output and upper/lower level for alarm signal.	<ul style="list-style-type: none"> <li>■ 4...20 mA NAMUR</li> <li>■ 4...20 mA US</li> <li>■ 4...20 mA</li> <li>■ 0...20 mA</li> <li>■ Fixed current</li> </ul>	Depends on country: <ul style="list-style-type: none"> <li>■ 4...20 mA NAMUR</li> <li>■ 4...20 mA US</li> </ul>
0/4 mA value	In <b>Current span</b> parameter (→  59), one of the following options is selected: <ul style="list-style-type: none"> <li>■ 4...20 mA NAMUR</li> <li>■ 4...20 mA US</li> <li>■ 4...20 mA</li> <li>■ 0...20 mA</li> </ul>	Enter 4 mA value.	Signed floating-point number	Depends on country: <ul style="list-style-type: none"> <li>■ 0 kg/h</li> <li>■ 0 lb/min</li> </ul>
20 mA value	In <b>Current span</b> parameter (→  59), one of the following options is selected: <ul style="list-style-type: none"> <li>■ 4...20 mA NAMUR</li> <li>■ 4...20 mA US</li> <li>■ 4...20 mA</li> <li>■ 0...20 mA</li> </ul>	Enter 20 mA value.	Signed floating-point number	Depends on country and nominal diameter
Failure mode	A process variable is selected in the <b>Assign current output</b> parameter (→  59) and one of the following options is selected in the <b>Current span</b> parameter (→  59): <ul style="list-style-type: none"> <li>■ 4...20 mA NAMUR</li> <li>■ 4...20 mA US</li> <li>■ 4...20 mA</li> <li>■ 0...20 mA</li> </ul>	Define output behavior in alarm condition.	<ul style="list-style-type: none"> <li>■ Min.</li> <li>■ Max.</li> <li>■ Last valid value</li> <li>■ Actual value</li> <li>■ Defined value</li> </ul>	–
Failure current	The <b>Defined value</b> option is selected in the <b>Failure mode</b> parameter.	Enter current output value in alarm condition.	0 to 22.5 mA	–

\* Visibility depends on order options or device settings

### 10.3.4 Configuring the pulse/frequency/switch output

The **Pulse/frequency/switch output** submenu contains all the parameters that must be configured for the configuration of the selected output type.

#### Navigation

"Setup" menu → Pulse/frequency/switch output 1

#### Structure of the "Pulse/frequency/switch output 1" submenu

▶ Pulse/frequency/switch output 1	
Operating mode	→ 61
Assign pulse output	→ 61
Assign frequency output	→ 62
Switch output function	→ 64
Assign diagnostic behavior	→ 64
Assign limit	→ 64
Assign flow direction check	→ 64
Assign status	→ 64
Value per pulse	→ 61
Pulse width	→ 61
Failure mode	→ 61
Minimum frequency value	→ 62
Maximum frequency value	→ 62
Measuring value at minimum frequency	→ 62
Measuring value at maximum frequency	→ 62
Failure mode	→ 63
Failure frequency	→ 63
Switch-on value	→ 64
Switch-off value	→ 65

Failure mode	→ 65
Invert output signal	→ 61

### Configuring the pulse output

#### Navigation

"Setup" menu → Pulse/frequency/switch output 1

#### Parameter overview with brief description

Parameter	Prerequisite	Description	Selection / User entry	Factory setting
Operating mode	–	Define the output as a pulse, frequency or switch output.	<ul style="list-style-type: none"> <li>▪ Pulse</li> <li>▪ Frequency</li> <li>▪ Switch</li> </ul>	–
Assign pulse output	The <b>Pulse</b> option is selected in the <b>Operating mode</b> parameter.	Select process variable for pulse output.	<ul style="list-style-type: none"> <li>▪ Off</li> <li>▪ Mass flow</li> <li>▪ Volume flow</li> <li>▪ Corrected volume flow</li> <li>▪ Target mass flow *</li> <li>▪ Carrier mass flow *</li> </ul>	–
Value per pulse	The <b>Pulse</b> option is selected in the <b>Operating mode</b> parameter (→ 61) and a process variable is selected in the <b>Assign pulse output</b> parameter (→ 61).	Enter measured value at which a pulse is output.	Positive floating point number	Depends on country and nominal diameter
Pulse width	The <b>Pulse</b> option is selected in the <b>Operating mode</b> parameter (→ 61) and a process variable is selected in the <b>Assign pulse output</b> parameter (→ 61).	Define time width of the output pulse.	0.05 to 2000 ms	–
Failure mode	The <b>Pulse</b> option is selected in the <b>Operating mode</b> parameter (→ 61) and a process variable is selected in the <b>Assign pulse output</b> parameter (→ 61).	Define output behavior in alarm condition.	<ul style="list-style-type: none"> <li>▪ Actual value</li> <li>▪ No pulses</li> </ul>	–
Invert output signal	–	Invert the output signal.	<ul style="list-style-type: none"> <li>▪ No</li> <li>▪ Yes</li> </ul>	–

\* Visibility depends on order options or device settings

### Configuring the frequency output

#### Navigation

"Setup" menu → Pulse/frequency/switch output 1

## Parameter overview with brief description

Parameter	Prerequisite	Description	Selection / User entry	Factory setting
Operating mode	–	Define the output as a pulse, frequency or switch output.	<ul style="list-style-type: none"> <li>▪ Pulse</li> <li>▪ Frequency</li> <li>▪ Switch</li> </ul>	–
Assign frequency output	The <b>Frequency</b> option is selected in <b>Operating mode</b> parameter (→ 61).	Select process variable for frequency output.	<ul style="list-style-type: none"> <li>▪ Off</li> <li>▪ Mass flow</li> <li>▪ Volume flow</li> <li>▪ Corrected volume flow</li> <li>▪ Target mass flow *</li> <li>▪ Carrier mass flow *</li> <li>▪ Density</li> <li>▪ Reference density</li> <li>▪ Concentration *</li> <li>▪ Temperature</li> <li>▪ Carrier pipe temperature *</li> <li>▪ Electronic temperature</li> <li>▪ Oscillation frequency 0</li> <li>▪ Frequency fluctuation 0</li> <li>▪ Oscillation amplitude 0 *</li> <li>▪ Oscillation damping 0</li> <li>▪ Tube damping fluctuation 0</li> <li>▪ Signal asymmetry</li> <li>▪ Exciter current 0</li> </ul>	–
Minimum frequency value	The <b>Frequency</b> option is selected in the <b>Operating mode</b> parameter (→ 61) and a process variable is selected in the <b>Assign frequency output</b> parameter (→ 62).	Enter minimum frequency.	0.0 to 10 000.0 Hz	–
Maximum frequency value	The <b>Frequency</b> option is selected in the <b>Operating mode</b> parameter (→ 61) and a process variable is selected in the <b>Assign frequency output</b> parameter (→ 62).	Enter maximum frequency.	0.0 to 10 000.0 Hz	–
Measuring value at minimum frequency	The <b>Frequency</b> option is selected in the <b>Operating mode</b> parameter (→ 61) and a process variable is selected in the <b>Assign frequency output</b> parameter (→ 62).	Enter measured value for minimum frequency.	Signed floating-point number	Depends on country and nominal diameter
Measuring value at maximum frequency	The <b>Frequency</b> option is selected in the <b>Operating mode</b> parameter (→ 61) and a process variable is selected in the <b>Assign frequency output</b> parameter (→ 62).	Enter measured value for maximum frequency.	Signed floating-point number	Depends on country and nominal diameter

Parameter	Prerequisite	Description	Selection / User entry	Factory setting
Damping output	The <b>Frequency</b> option is selected in the <b>Operating mode</b> parameter and one of the following options is selected in the <b>Assign frequency output</b> parameter (→ 62): <ul style="list-style-type: none"> <li>▪ Mass flow</li> <li>▪ Volume flow</li> <li>▪ Corrected volume flow</li> <li>▪ Target mass flow<sup>*</sup></li> <li>▪ Carrier mass flow<sup>*</sup></li> <li>▪ Density</li> <li>▪ Reference density</li> <li>▪ Concentration<sup>*</sup></li> <li>▪ Temperature</li> <li>▪ Carrier pipe temperature<sup>*</sup></li> <li>▪ Electronic temperature</li> <li>▪ Oscillation frequency 0</li> <li>▪ Frequency fluctuation 0</li> <li>▪ Oscillation amplitude 0<sup>*</sup></li> <li>▪ Oscillation damping 0</li> <li>▪ Oscillation damping fluctuation 0</li> <li>▪ Signal asymmetry</li> <li>▪ Exciter current 0</li> </ul>	Set reaction time for output signal to fluctuations in the measured value.	0 to 999.9 s	–
Failure mode	The <b>Frequency</b> option is selected in the <b>Operating mode</b> parameter (→ 61) and a process variable is selected in the <b>Assign frequency output</b> parameter (→ 62).	Define output behavior in alarm condition.	<ul style="list-style-type: none"> <li>▪ Actual value</li> <li>▪ Defined value</li> <li>▪ 0 Hz</li> </ul>	–
Failure frequency	In the <b>Operating mode</b> parameter (→ 61), the <b>Frequency</b> option is selected, in the <b>Assign frequency output</b> parameter (→ 62) a process variable is selected, and in the <b>Failure mode</b> parameter, the <b>Defined value</b> option is selected.	Enter frequency output value in alarm condition.	0.0 to 12 500.0 Hz	–
Invert output signal	–	Invert the output signal.	<ul style="list-style-type: none"> <li>▪ No</li> <li>▪ Yes</li> </ul>	–

\* Visibility depends on order options or device settings

## Configuring the switch output

### Navigation

"Setup" menu → Pulse/frequency/switch output 1

## Parameter overview with brief description

Parameter	Prerequisite	Description	Selection / User entry	Factory setting
Operating mode	–	Define the output as a pulse, frequency or switch output.	<ul style="list-style-type: none"> <li>▪ Pulse</li> <li>▪ Frequency</li> <li>▪ Switch</li> </ul>	–
Switch output function	The <b>Switch</b> option is selected in the <b>Operating mode</b> parameter.	Select function for switch output.	<ul style="list-style-type: none"> <li>▪ Off</li> <li>▪ On</li> <li>▪ Diagnostic behavior</li> <li>▪ Limit</li> <li>▪ Flow direction check</li> <li>▪ Status</li> </ul>	–
Assign diagnostic behavior	<ul style="list-style-type: none"> <li>▪ In the <b>Operating mode</b> parameter, the <b>Switch</b> option is selected.</li> <li>▪ In the <b>Switch output function</b> parameter, the <b>Diagnostic behavior</b> option is selected.</li> </ul>	Select diagnostic behavior for switch output.	<ul style="list-style-type: none"> <li>▪ Alarm</li> <li>▪ Alarm or warning</li> <li>▪ Warning</li> </ul>	–
Assign limit	<ul style="list-style-type: none"> <li>▪ The <b>Switch</b> option is selected in <b>Operating mode</b> parameter.</li> <li>▪ The <b>Limit</b> option is selected in <b>Switch output function</b> parameter.</li> </ul>	Select process variable for limit function.	<ul style="list-style-type: none"> <li>▪ Mass flow</li> <li>▪ Volume flow</li> <li>▪ Corrected volume flow</li> <li>▪ Target mass flow<sup>*</sup></li> <li>▪ Carrier mass flow<sup>*</sup></li> <li>▪ Density</li> <li>▪ Reference density<sup>*</sup></li> <li>▪ Concentration<sup>*</sup></li> <li>▪ Temperature</li> <li>▪ Totalizer 1</li> <li>▪ Totalizer 2</li> <li>▪ Totalizer 3</li> <li>▪ Measuring tube damping</li> </ul>	–
Assign flow direction check	<ul style="list-style-type: none"> <li>▪ The <b>Switch</b> option is selected in the <b>Operating mode</b> parameter.</li> <li>▪ The <b>Flow direction check</b> option is selected in the <b>Switch output function</b> parameter.</li> </ul>	Select process variable for flow direction monitoring.		–
Assign status	<ul style="list-style-type: none"> <li>▪ The <b>Switch</b> option is selected in <b>Operating mode</b> parameter.</li> <li>▪ The <b>Status</b> option is selected in <b>Switch output function</b> parameter.</li> </ul>	Select device status for switch output.	<ul style="list-style-type: none"> <li>▪ Partially filled pipe detection</li> <li>▪ Low flow cut off</li> </ul>	–
Switch-on value	<ul style="list-style-type: none"> <li>▪ The <b>Switch</b> option is selected in the <b>Operating mode</b> parameter.</li> <li>▪ The <b>Limit</b> option is selected in the <b>Switch output function</b> parameter.</li> </ul>	Enter measured value for the switch-on point.	Signed floating-point number	Depends on country: <ul style="list-style-type: none"> <li>▪ 0 kg/h</li> <li>▪ 0 lb/min</li> </ul>
Switch-on delay	<ul style="list-style-type: none"> <li>▪ The <b>Switch</b> option is selected in the <b>Operating mode</b> parameter.</li> <li>▪ The <b>Limit</b> option is selected in the <b>Switch output function</b> parameter.</li> </ul>	Define delay for the switch-on of status output.	0.0 to 100.0 s	–



Parameter	Prerequisite	Description	Selection / User entry	Factory setting
Switch-off value	<ul style="list-style-type: none"> <li>■ The <b>Switch</b> option is selected in the <b>Operating mode</b> parameter.</li> <li>■ The <b>Limit</b> option is selected in the <b>Switch output function</b> parameter.</li> </ul>	Enter measured value for the switch-off point.	Signed floating-point number	Depends on country: <ul style="list-style-type: none"> <li>■ 0 kg/h</li> <li>■ 0 lb/min</li> </ul>
Switch-off delay	<ul style="list-style-type: none"> <li>■ The <b>Switch</b> option is selected in the <b>Operating mode</b> parameter.</li> <li>■ The <b>Limit</b> option is selected in the <b>Switch output function</b> parameter.</li> </ul>	Define delay for the switch-off of status output.	0.0 to 100.0 s	–
Failure mode	–	Define output behavior in alarm condition.	<ul style="list-style-type: none"> <li>■ Actual status</li> <li>■ Open</li> <li>■ Closed</li> </ul>	–
Invert output signal	–	Invert the output signal.	<ul style="list-style-type: none"> <li>■ No</li> <li>■ Yes</li> </ul>	–

\* Visibility depends on order options or device settings

### 10.3.5 Configuring the HART input

The **HART input** wizard contains all the parameters that must be configured for the configuration of the HART input.

#### Navigation

"Setup" menu → HART input

▶ HART input

Capture mode	→ ⓘ 66
Device ID	→ ⓘ 66
Device type	→ ⓘ 66
Manufacturer ID	→ ⓘ 66
Burst command	→ ⓘ 66
Slot number	→ ⓘ 66
Timeout	→ ⓘ 66
Failure mode	→ ⓘ 66
Failure value	→ ⓘ 66

### Parameter overview with brief description

Parameter	Prerequisite	Description	Selection / User entry	Factory setting
Capture mode	–	Select capture mode via burst or master communication.	<ul style="list-style-type: none"> <li>▪ Off</li> <li>▪ Burst network</li> <li>▪ Master network</li> </ul>	–
Device ID	The <b>Master network</b> option is selected in the <b>Capture mode</b> parameter.	Enter device ID of external device.	6-digit value: <ul style="list-style-type: none"> <li>▪ Via local operation: enter as hexadecimal or decimal number</li> <li>▪ Via operating tool: enter as decimal number</li> </ul>	–
Device type	In the <b>Capture mode</b> parameter, the <b>Master network</b> option is selected.	Enter device type of external device.	2-digit hexadecimal number	0x00
Manufacturer ID	The <b>Master network</b> option is selected in the <b>Capture mode</b> parameter.	Enter manufacture ID of external device.	2-digit value: <ul style="list-style-type: none"> <li>▪ Via local operation: enter as hexadecimal or decimal number</li> <li>▪ Via operating tool: enter as decimal number</li> </ul>	–
Burst command	The <b>Burst network</b> option or the <b>Master network</b> option are selected in the <b>Capture mode</b> parameter.	Select command to read in external process variable.	<ul style="list-style-type: none"> <li>▪ Command 1</li> <li>▪ Command 3</li> <li>▪ Command 9</li> <li>▪ Command 33</li> </ul>	–
Slot number	The <b>Burst network</b> option or the <b>Master network</b> option is selected in the <b>Capture mode</b> parameter.	Define position of external process variable in burst command.	1 to 4	–
Timeout	The <b>Burst network</b> option or the <b>Master network</b> option is selected in the <b>Capture mode</b> parameter.	Enter deadline for process variable of external device.  If the waiting time is exceeded, the <b>F410 Data transfer</b> diagnostic message is displayed.	1 to 120 s	–
Failure mode	In the <b>Capture mode</b> parameter, the <b>Burst network</b> option or <b>Master network</b> option is selected.	Define behavior if external process variable is missed.	<ul style="list-style-type: none"> <li>▪ Alarm</li> <li>▪ Last valid value</li> <li>▪ Defined value</li> </ul>	–
Failure value	The following conditions are met: <ul style="list-style-type: none"> <li>▪ In the <b>Capture mode</b> parameter, the <b>Burst network</b> option or <b>Master network</b> option is selected.</li> <li>▪ In the <b>Failure mode</b> parameter, the <b>Defined value</b> option is selected.</li> </ul>	Enter value to be used by the device if input value from external device is missing.	Signed floating-point number	–

### 10.3.6 Configuring the output conditioning

The **Output conditioning** submenu contains all the parameters that must be configured for the configuration of output conditioning.

**Navigation**

"Setup" menu → Output conditioning

**Structure of the "Output conditioning" submenu**

▶ Output conditioning		
Assign current output	→	67
Damping output 1	→	67
Measuring mode output 1	→	67
Assign frequency output	→	68
Damping output 1	→	68
Measuring mode output 1	→	68
Assign pulse output	→	68
Measuring mode output 1	→	68
Operating mode totalizer 1	→	68

**Parameter overview with brief description**

Parameter	Prerequisite	Description	Selection / User entry
Assign current output	–	Select process variable for current output.	<ul style="list-style-type: none"> <li>■ Off</li> <li>■ Mass flow</li> <li>■ Volume flow</li> <li>■ Corrected volume flow</li> <li>■ Target mass flow *</li> <li>■ Carrier mass flow *</li> <li>■ Density</li> <li>■ Reference density</li> <li>■ Concentration *</li> <li>■ Temperature</li> <li>■ Carrier pipe temperature *</li> <li>■ Electronic temperature</li> <li>■ Oscillation frequency 0</li> <li>■ Oscillation amplitude 0 *</li> <li>■ Frequency fluctuation 0</li> <li>■ Oscillation damping 0</li> <li>■ Tube damping fluctuation 0</li> <li>■ Signal asymmetry</li> <li>■ Exciter current 0</li> </ul>
Damping output	–	Set reaction time for output signal to fluctuations in the measured value.	0 to 999.9 s
Measuring mode output	–	Select measuring mode for output.	<ul style="list-style-type: none"> <li>■ Forward flow</li> <li>■ Forward/Reverse flow</li> <li>■ Reverse flow compensation</li> </ul>

Parameter	Prerequisite	Description	Selection / User entry
Assign frequency output	The <b>Frequency</b> option is selected in <b>Operating mode</b> parameter (→ 61).	Select process variable for frequency output.	<ul style="list-style-type: none"> <li>■ Off</li> <li>■ Mass flow</li> <li>■ Volume flow</li> <li>■ Corrected volume flow</li> <li>■ Target mass flow<sup>*</sup></li> <li>■ Carrier mass flow<sup>*</sup></li> <li>■ Density</li> <li>■ Reference density</li> <li>■ Concentration<sup>*</sup></li> <li>■ Temperature</li> <li>■ Carrier pipe temperature<sup>*</sup></li> <li>■ Electronic temperature</li> <li>■ Oscillation frequency 0</li> <li>■ Frequency fluctuation 0</li> <li>■ Oscillation amplitude 0<sup>*</sup></li> <li>■ Oscillation damping 0</li> <li>■ Tube damping fluctuation 0</li> <li>■ Signal asymmetry</li> <li>■ Exciter current 0</li> </ul>
Damping output	–	Set reaction time for output signal to fluctuations in the measured value.	0 to 999.9 s
Measuring mode output	–	Select measuring mode for output.	<ul style="list-style-type: none"> <li>■ Forward flow</li> <li>■ Forward/Reverse flow</li> <li>■ Reverse flow</li> <li>■ Reverse flow compensation</li> </ul>
Assign pulse output	The <b>Pulse</b> option is selected in <b>Operating mode</b> parameter.	Select process variable for pulse output.	<ul style="list-style-type: none"> <li>■ Off</li> <li>■ Mass flow</li> <li>■ Volume flow</li> <li>■ Corrected volume flow</li> <li>■ Target mass flow<sup>*</sup></li> <li>■ Carrier mass flow<sup>*</sup></li> </ul>
Measuring mode output	–	Select measuring mode for output.	<ul style="list-style-type: none"> <li>■ Forward flow</li> <li>■ Forward/Reverse flow</li> <li>■ Reverse flow</li> <li>■ Reverse flow compensation</li> </ul>
Operating mode totalizer	–	Select totalizer calculation mode.	<ul style="list-style-type: none"> <li>■ Net flow total</li> <li>■ Forward flow total</li> <li>■ Reverse flow total</li> </ul>

\* Visibility depends on order options or device settings

### 10.3.7 Configuring the low flow cut off

The **Low flow cut off** submenu contains the parameters that must be set in order to configure the low flow cut off.

#### Navigation

"Setup" menu → Low flow cut off

► Low flow cut off	
Assign process variable	→ 69
On value low flow cutoff	→ 69
Off value low flow cutoff	→ 69
Pressure shock suppression	→ 69

#### Parameter overview with brief description

Parameter	Prerequisite	Description	Selection / User entry	Factory setting
Assign process variable	–	Select process variable for low flow cut off.	<ul style="list-style-type: none"> <li>■ Off</li> <li>■ Mass flow</li> <li>■ Volume flow</li> <li>■ Corrected volume flow</li> </ul>	–
On value low flow cutoff	A process variable is selected in the <b>Assign process variable</b> parameter (→ 69).	Enter on value for low flow cut off.	Positive floating-point number	Depends on country and nominal diameter
Off value low flow cutoff	A process variable is selected in the <b>Assign process variable</b> parameter (→ 69).	Enter off value for low flow cut off.	0 to 100.0 %	–
Pressure shock suppression	A process variable is selected in the <b>Assign process variable</b> parameter (→ 69).	Enter time frame for signal suppression (= active pressure shock suppression).	0 to 100 s	–

### 10.3.8 Configuring partially filled pipe detection

The **Partially filled pipe detection** submenu contains parameters that have to be set for configuring empty pipe detection.

#### Navigation

"Setup" menu → Partially filled pipe detection

▶ Partially filled pipe detection	
Assign process variable	→ 70
Low value partial filled pipe detection	→ 70
High value partial filled pipe detection	→ 70
Response time part. filled pipe detect.	→ 70

#### Parameter overview with brief description

Parameter	Prerequisite	Description	Selection / User entry	Factory setting
Assign process variable	–	Select process variable for partially filled pipe detection.	<ul style="list-style-type: none"> <li>▪ Off</li> <li>▪ Density</li> <li>▪ Reference density</li> </ul>	Density
Low value partial filled pipe detection	A process variable is selected in the <b>Assign process variable</b> parameter (→ 70).	Enter lower limit value for deactivating partially filled pipe detection.	Signed floating-point number	Depends on country: <ul style="list-style-type: none"> <li>▪ 200 kg/m<sup>3</sup></li> <li>▪ 12.5 lb/ft<sup>3</sup></li> </ul>
High value partial filled pipe detection	A process variable is selected in the <b>Assign process variable</b> parameter (→ 70).	Enter upper limit value for deactivating partially filled pipe detection.	Signed floating-point number	Depends on country: <ul style="list-style-type: none"> <li>▪ 6 000 kg/m<sup>3</sup></li> <li>▪ 374.6 lb/ft<sup>3</sup></li> </ul>
Response time part. filled pipe detect.	A process variable is selected in the <b>Assign process variable</b> parameter (→ 70).	Use this function to enter the minimum time (hold time) the signal must be present before diagnostic message S962 "Pipe only partly filled" is triggered in the event of a partially filled or empty measuring pipe.	0 to 100 s	–

## 10.4 Advanced settings

The **Advanced setup** submenu with its submenus contains parameters for specific settings.

 The number of submenus can vary depending on the device version, e.g. viscosity is available only with the Promass I.

### Navigation

"Setup" menu → Advanced setup

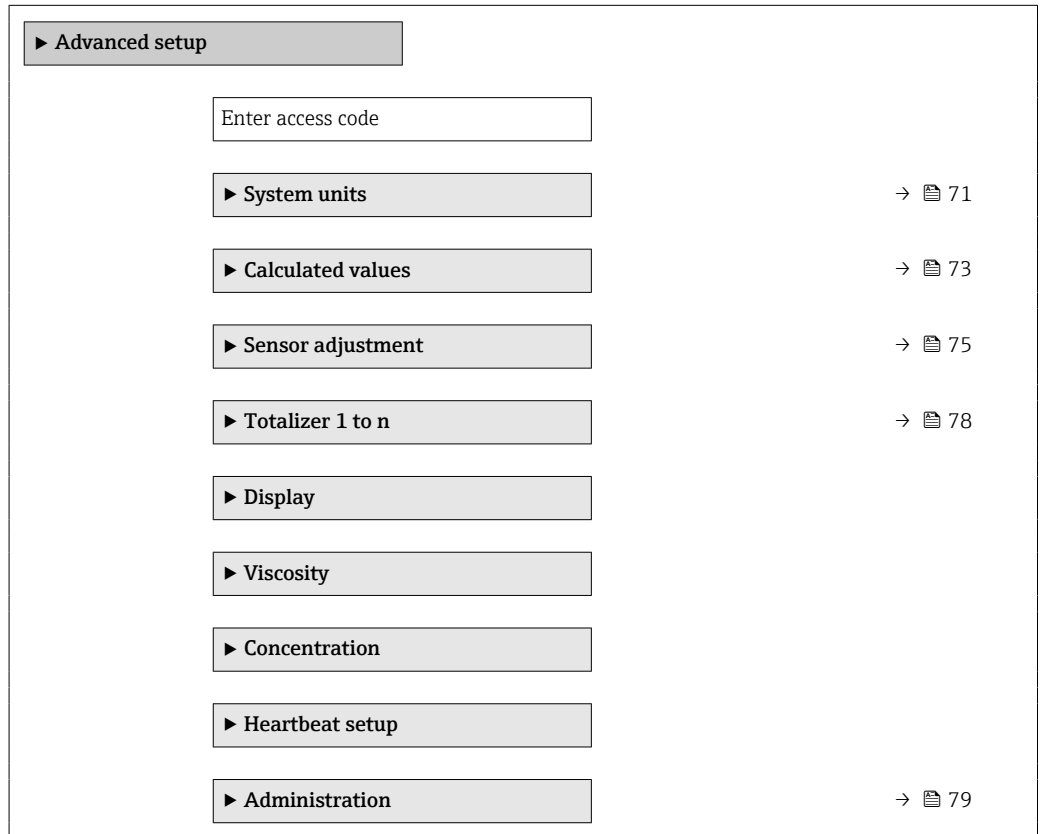

### 10.4.1 Using the parameter to enter the access code

#### Navigation

"Setup" menu → Advanced setup

#### Parameter overview with brief description

Parameter	Description	User entry
Enter access code	Enter access code to disable write protection of parameters.	Max. 16-digit character string comprising numbers, letters and special characters

### 10.4.2 Setting the system units

In the **System units** submenu the units of all the measured values can be set.

 The number of submenus and parameters can vary depending on the device version. Certain submenus and parameters in these submenus are not described in the Operating Instructions. Instead a description is provided in the Special Documentation for the device ("Supplementary documentation").

**Navigation**

"Setup" menu → Advanced setup → System units

► System units	
Mass flow unit	→ 72
Mass unit	→ 72
Volume flow unit	→ 72
Volume unit	→ 72
Corrected volume flow unit	→ 73
Corrected volume unit	→ 73
Density unit	→ 73
Reference density unit	→ 73
Density 2 unit	→ 73
Temperature unit	→ 73
Pressure unit	→ 73

**Parameter overview with brief description**

Parameter	Description	Selection	Factory setting
Mass flow unit	Select mass flow unit. <i>Effect</i> The selected unit applies to: <ul style="list-style-type: none"> <li>▪ Output</li> <li>▪ Low flow cut off</li> <li>▪ Simulation process variable</li> </ul>	Unit choose list	Country-specific: <ul style="list-style-type: none"> <li>▪ kg/h</li> <li>▪ lb/min</li> </ul>
Mass unit	Select mass unit.	Unit choose list	Country-specific: <ul style="list-style-type: none"> <li>▪ kg</li> <li>▪ lb</li> </ul>
Volume flow unit	Select volume flow unit. <i>Effect</i> The selected unit applies to: <ul style="list-style-type: none"> <li>▪ Output</li> <li>▪ Low flow cut off</li> <li>▪ Simulation process variable</li> </ul>	Unit choose list	Country-specific: <ul style="list-style-type: none"> <li>▪ l/h</li> <li>▪ gal/min (us)</li> </ul>
Volume unit	Select volume unit.	Unit choose list	Country-specific: <ul style="list-style-type: none"> <li>▪ 1 (DN &gt; 150 (6"): m<sup>3</sup> option)</li> <li>▪ gal (us)</li> </ul>



Parameter	Description	Selection	Factory setting
Corrected volume flow unit	Select corrected volume flow unit. <i>Effect</i> The selected unit applies to: <b>Corrected volume flow</b> parameter (→ ☰ 85)	Unit choose list	Country-specific: <ul style="list-style-type: none"> <li>■ NI/h</li> <li>■ Sft<sup>3</sup>/min</li> </ul>
Corrected volume unit	Select corrected volume unit.	Unit choose list	Country-specific: <ul style="list-style-type: none"> <li>■ NI</li> <li>■ Sft<sup>3</sup></li> </ul>
Density unit	Select density unit. <i>Effect</i> The selected unit applies to: <ul style="list-style-type: none"> <li>■ Output</li> <li>■ Simulation process variable</li> <li>■ Density adjustment (<b>Expert</b> menu)</li> </ul>	Unit choose list	Country-specific: <ul style="list-style-type: none"> <li>■ kg/l</li> <li>■ lb/ft<sup>3</sup></li> </ul>
Reference density unit	Select reference density unit.	Unit choose list	Country-specific <ul style="list-style-type: none"> <li>■ kg/NI</li> <li>■ lb/Sft<sup>3</sup></li> </ul>
Density 2 unit	Select second density unit.	Unit choose list	Country-specific: <ul style="list-style-type: none"> <li>■ kg/l</li> <li>■ lb/ft<sup>3</sup></li> </ul>
Temperature unit	Select temperature unit. <i>Effect</i> The selected unit applies to: <ul style="list-style-type: none"> <li>■ <b>Electronic temperature</b> parameter (6053)</li> <li>■ <b>Maximum value</b> parameter (6051)</li> <li>■ <b>Minimum value</b> parameter (6052)</li> <li>■ <b>External temperature</b> parameter (6080)</li> <li>■ <b>Maximum value</b> parameter (6108)</li> <li>■ <b>Minimum value</b> parameter (6109)</li> <li>■ <b>Carrier pipe temperature</b> parameter (6027)</li> <li>■ <b>Maximum value</b> parameter (6029)</li> <li>■ <b>Minimum value</b> parameter (6030)</li> <li>■ <b>Reference temperature</b> parameter (1816)</li> <li>■ <b>Temperature</b> parameter</li> </ul>	Unit choose list	Country-specific: <ul style="list-style-type: none"> <li>■ °C</li> <li>■ °F</li> </ul>
Pressure unit	Select process pressure unit. <i>Effect</i> The unit is taken from: <ul style="list-style-type: none"> <li>■ <b>Pressure value</b> parameter (→ ☰ 57)</li> <li>■ <b>External pressure</b> parameter (→ ☰ 57)</li> <li>■ Pressure value</li> </ul>	Unit choose list	Country-specific: <ul style="list-style-type: none"> <li>■ bar a</li> <li>■ psi a</li> </ul>

### 10.4.3 Calculated process variables

The **Calculated values** submenu contains parameters for calculating the corrected volume flow.

#### Navigation

"Setup" menu → Advanced setup → Calculated values

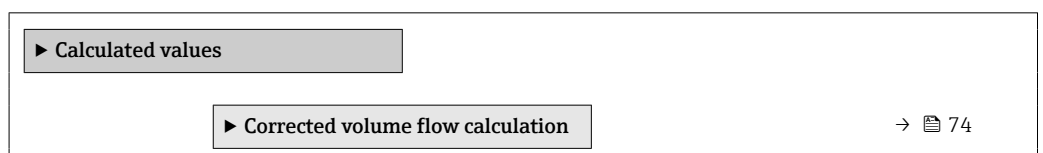

**"Corrected volume flow calculation" submenu****Navigation**

"Setup" menu → Advanced setup → Calculated values → Corrected volume flow calculation

▶ Corrected volume flow calculation	
Corrected volume flow calculation (1812)	→ 74
External reference density (6198)	→ 74
Fixed reference density (1814)	→ 74
Reference temperature (1816)	→ 74
Linear expansion coefficient (1817)	→ 74
Square expansion coefficient (1818)	→ 74

**Parameter overview with brief description**

Parameter	Prerequisite	Description	Selection / User interface / User entry	Factory setting
Corrected volume flow calculation	–	Select reference density for calculating the corrected volume flow.	<ul style="list-style-type: none"> <li>■ Fixed reference density</li> <li>■ Calculated reference density</li> <li>■ Reference density by API table 53</li> </ul>	–
External reference density	–	Shows external reference density.	Floating point number with sign	–
Fixed reference density	The <b>Fixed reference density</b> option is selected in the <b>Corrected volume flow calculation</b> parameter parameter.	Enter fixed value for reference density.	Positive floating-point number	–
Reference temperature	The <b>Calculated reference density</b> option is selected in the <b>Corrected volume flow calculation</b> parameter parameter.	Enter reference temperature for calculating the reference density.	–273.15 to 99 999 °C	Country-specific: <ul style="list-style-type: none"> <li>■ +20 °C</li> <li>■ +68 °F</li> </ul>
Linear expansion coefficient	The <b>Calculated reference density</b> option is selected in the <b>Corrected volume flow calculation</b> parameter parameter.	Enter linear, medium-specific expansion coefficient for calculating the reference density.	Signed floating-point number	–
Square expansion coefficient	The <b>Calculated reference density</b> option is selected in the <b>Corrected volume flow calculation</b> parameter parameter.	For media with a non-linear expansion pattern: enter the quadratic, medium-specific expansion coefficient for calculating the reference density.	Signed floating-point number	–

### 10.4.4 Carrying out a sensor adjustment

The **Sensor adjustment** submenu contains parameters that pertain to the functionality of the sensor.

#### Navigation

"Setup" menu → Advanced setup → Sensor adjustment

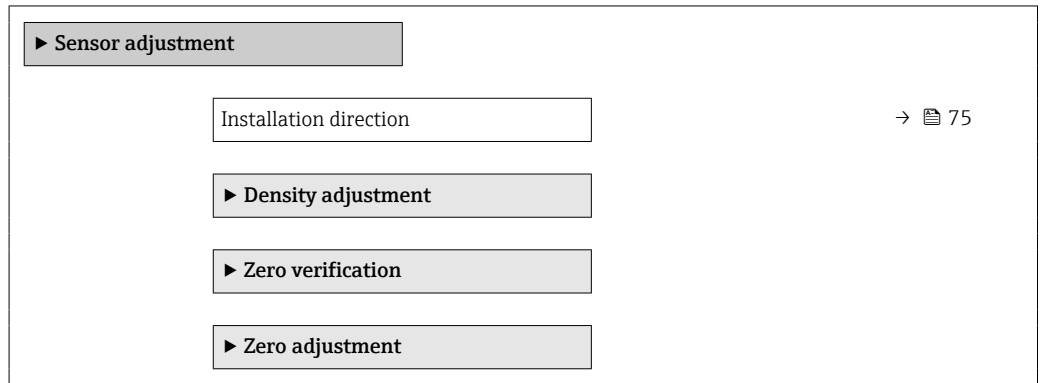

#### Parameter overview with brief description

Parameter	Description	Selection
Installation direction	Set sign of flow direction to match the direction of the arrow on the sensor.	<ul style="list-style-type: none"> <li>■ Flow in arrow direction</li> <li>■ Flow against arrow direction</li> </ul>

#### Density adjustment

**i** With density adjustment, a high level of accuracy is achieved only at the point of adjustment and at the relevant density and temperature. However, the accuracy of a density adjustment is only ever as good as the quality of the reference measuring data provided. Therefore it is not a substitute for special density calibration.

#### Performing density adjustment

- i** Note the following before performing the adjustment:
- A density adjustment only makes sense if there is little variation in the operating conditions and the density adjustment is performed under the operating conditions.
  - The density adjustment scales the internally computed density value with a user-specific slope and offset.
  - A 1-point or 2-point density adjustment can be performed.
  - For a 2-point density adjustment, there must be a difference of at least 0.2 kg/l between the two target density values.
  - The reference media must be gas-free or pressurized so that any gas they contain is compressed.
  - The reference density measurements must be performed at the same medium temperature that prevails in the process, as otherwise the density adjustment will not be accurate.
  - The correction resulting from the density adjustment can be deleted with the **Restore original** option.

#### "1 point adjustment" option

1. In the **Density adjustment mode** parameter, select the **1 point adjustment** option and confirm.

2. In the **Density setpoint 1** parameter, enter the density value and confirm.
  - ↳ In the **Execute density adjustment** parameter the following options are now available:
    - Ok
    - Measure density 1** option
    - Restore original
3. Select the **Measure density 1** option and confirm.
4. If 100% was reached in the **Progress** parameter on the display and the **Ok** option is displayed in the **Execute density adjustment** parameter, then confirm.
  - ↳ In the **Execute density adjustment** parameter the following options are now available:
    - Ok
    - Calculate
    - Cancel
5. Select the **Calculate** option and confirm.

If the adjustment was completed successfully, the **Density adjustment factor** parameter and the **Density adjustment offset** parameter and the values calculated for them are shown on the display.

#### "2 point adjustment" option

1. In the **Density adjustment mode** parameter, select the **2 point adjustment** option and confirm.
2. In the **Density setpoint 1** parameter, enter the density value and confirm.
3. In the **Density setpoint 2** parameter, enter the density value and confirm.
  - ↳ In the **Execute density adjustment** parameter the following options are now available:
    - Ok
    - Measure density 1
    - Restore original
4. Select the **Measure density 1** option and confirm.
  - ↳ In the **Execute density adjustment** parameter the following options are now available:
    - Ok
    - Measure density 2
    - Restore original
5. Select the **Measure density 2** option and confirm.
  - ↳ In the **Execute density adjustment** parameter the following options are now available:
    - Ok
    - Calculate
    - Cancel
6. Select the **Calculate** option and confirm.

If the **Density adjust failure** option is displayed in the **Execute density adjustment** parameter, call up the options and select the **Cancel** option. The density adjustment is canceled and can be repeated.

If the adjustment was completed successfully, the **Density adjustment factor** parameter and the **Density adjustment offset** parameter and the values calculated for them are shown on the display.

**Navigation**

"Expert" menu → Sensor → Sensor adjustment → Density adjustment

► Density adjustment		
Density adjustment mode		→ 77
Density setpoint 1		→ 77
Density setpoint 2		→ 77
Execute density adjustment		→ 77
Progress		→ 77
Density adjustment factor		→ 77
Density adjustment offset		→ 77

**Parameter overview with brief description**

Parameter	Prerequisite	Description	Selection / User entry / User interface	Factory setting
Density adjustment mode	-		<ul style="list-style-type: none"> <li>■ 1 point adjustment</li> <li>■ 2 point adjustment</li> </ul>	-
Density setpoint 1	-		The entry depends on the unit selected in the <b>Density unit</b> parameter (0555).	-
Density setpoint 2	In the <b>Density adjustment mode</b> parameter, the <b>2 point adjustment</b> option is selected.		The entry depends on the unit selected in the <b>Density unit</b> parameter (0555).	-
Execute density adjustment	-		<ul style="list-style-type: none"> <li>■ Cancel</li> <li>■ Busy</li> <li>■ Ok</li> <li>■ Density adjust failure</li> <li>■ Measure density 1</li> <li>■ Measure density 2</li> <li>■ Calculate</li> <li>■ Restore original</li> </ul>	-
Progress	-	Shows the progress of the process.	0 to 100 %	-
Density adjustment factor	-		Signed floating-point number	-
Density adjustment offset	-		Signed floating-point number	-

**Zero verification and zero adjustment**

All measuring instruments are calibrated in accordance with state-of-the-art technology. Calibration takes place under reference conditions → 118. Therefore, a zero adjustment in the field is generally not required.

Experience shows that zero adjustment is advisable only in special cases:

- To achieve maximum measurement accuracy even with low flow rates.
- Under extreme process or operating conditions (e.g. very high process temperatures or very high-viscosity fluids).
- For gas applications with low pressure

To achieve the highest possible measurement accuracy at low flow rates, the installation must protect the sensor from mechanical stresses during operation.

To get a representative zero point, ensure that:

- any flow in the device is prevented during the adjustment
- the process conditions (e.g. pressure, temperature) are stable and representative

Zero verification and zero adjustment cannot be performed if the following process conditions are present:

- Gas pockets  
Ensure that the system has been sufficiently flushed with the medium. Repeat flushing can help to eliminate gas pockets
- Thermal circulation  
In the event of temperature differences (e.g. between the measuring tube inlet and outlet section), induced flow can occur even if the valves are closed due to thermal circulation in the device
- Leaks at the valves  
If the valves are not leak-tight, flow is not sufficiently prevented when determining the zero point

If these conditions cannot be avoided, it is advisable to keep the factory setting for the zero point.

**Navigation**

"Setup" menu → Advanced setup → Sensor adjustment → Zero point adjustment

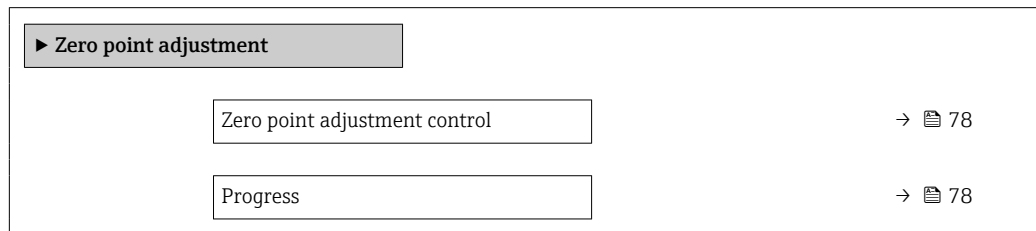

**Parameter overview with brief description**

Parameter	Description	Selection / User interface	Factory setting
Zero point adjustment control	Start zero point adjustment.	<ul style="list-style-type: none"> <li>▪ Cancel</li> <li>▪ Busy</li> <li>▪ Zero point adjust failure</li> <li>▪ Start</li> </ul>	–
Progress	Shows the progress of the process.	0 to 100 %	–

**10.4.5 Configuring the totalizer**

In the "Totalizer 1 to n" submenu, you can configure the specific totalizer.

**Navigation**

"Setup" menu → Advanced setup → Totalizer 1 to n

▶ **Totalizer 1 to n**

Assign process variable	→ ⓘ 79
Unit totalizer	→ ⓘ 79
Totalizer operation mode	→ ⓘ 79
Failure mode	→ ⓘ 79

**Parameter overview with brief description**

Parameter	Prerequisite	Description	Selection	Factory setting
Assign process variable	–	Select process variable for totalizer.	<ul style="list-style-type: none"> <li>▪ Off</li> <li>▪ Volume flow</li> <li>▪ Mass flow</li> <li>▪ Corrected volume flow</li> <li>▪ Target mass flow *</li> <li>▪ Carrier mass flow *</li> </ul>	–
Unit totalizer	A process variable is selected in the <b>Assign process variable</b> parameter (→ ⓘ 79) of the <b>Totalizer 1 to n</b> submenu.	Select process variable totalizer unit.	Unit choose list	Depends on country: <ul style="list-style-type: none"> <li>▪ kg</li> <li>▪ lb</li> </ul>
Totalizer operation mode	A process variable is selected in the <b>Assign process variable</b> parameter (→ ⓘ 79) of the <b>Totalizer 1 to n</b> submenu.	Select totalizer calculation mode.	<ul style="list-style-type: none"> <li>▪ Net flow total</li> <li>▪ Forward flow total</li> <li>▪ Reverse flow total</li> </ul>	–
Failure mode	A process variable is selected in the <b>Assign process variable</b> parameter (→ ⓘ 79) of the <b>Totalizer 1 to n</b> submenu.	Define totalizer behavior in alarm condition.	<ul style="list-style-type: none"> <li>▪ Stop</li> <li>▪ Actual value</li> <li>▪ Last valid value</li> </ul>	–

\* Visibility depends on order options or device settings

**10.4.6 Using parameters for device administration**

The **Administration** submenu systematically guides the user through all the parameters that can be used for device administration purposes.

**Navigation**

"Setup" menu → Advanced setup → Administration

▶ **Administration**

Define access code	
Device reset	→ ⓘ 80

### Parameter overview with brief description

Parameter	Description	User entry / User interface / Selection
Define access code	Restrict write-access to parameters to protect the configuration of the device against unintentional changes.	Max. 16-digit character string comprising numbers, letters and special characters
Confirm access code	Confirm the entered access code.	Max. 16-digit character string comprising numbers, letters and special characters
Operating time	Indicates how long the device has been in operation.	Days (d), hours (h), minutes (m) and seconds (s)
Reset access code	Reset access code to factory settings.  For a reset code, contact your Endress+Hauser service organization.  The reset code can only be entered via: <ul style="list-style-type: none"> <li>▪ Web browser</li> <li>▪ DeviceCare, FieldCare (via CDI-RJ45 service interface)</li> <li>▪ Fieldbus</li> </ul>	Character string comprising numbers, letters and special characters
Device reset	Reset the device configuration - either entirely or in part - to a defined state.	<ul style="list-style-type: none"> <li>▪ Cancel</li> <li>▪ To delivery settings</li> <li>▪ Restart device</li> </ul>

## 10.5 Simulation

Via the **Simulation** submenu, it is possible to simulate various process variables in the process and the device alarm mode and verify downstream signal chains (switching valves or closed-control loops). The simulation can be performed without a real measurement (no flow of medium through the device).

### Navigation

"Diagnostics" menu → Simulation

► Simulation	
Assign simulation process variable	→ 81
Value process variable	→ 81
Simulation current output 1	→ 81
Value current output 1	→ 81
Frequency simulation 1	→ 81
Frequency value 1	→ 81
Pulse simulation 1	→ 81
Pulse value 1	→ 81
Switch output simulation 1	→ 81
Switch status 1	→ 81



Simulation device alarm	→ ⓘ 81
Diagnostic event category	→ ⓘ 82
Simulation diagnostic event	→ ⓘ 82

**Parameter overview with brief description**



Parameter	Prerequisite	Description	Selection / User entry
Assign simulation process variable	–	Select a process variable for the simulation process that is activated.	<ul style="list-style-type: none"> <li>▪ Off</li> <li>▪ Mass flow</li> <li>▪ Volume flow</li> <li>▪ Corrected volume flow</li> <li>▪ Density</li> <li>▪ Reference density</li> <li>▪ Temperature</li> <li>▪ Concentration *</li> <li>▪ Target mass flow *</li> <li>▪ Carrier mass flow *</li> </ul>
Value process variable	A process variable is selected in the <b>Assign simulation process variable</b> parameter (→ ⓘ 81).	Enter the simulation value for the selected process variable.	Depends on the process variable selected
Simulation current output 1	–	Switch the simulation of the current output on and off.	<ul style="list-style-type: none"> <li>▪ Off</li> <li>▪ On</li> </ul>
Value current output 1	In the <b>Simulation current output</b> parameter, the <b>On</b> option is selected.	Enter the current value for simulation.	3.59 to 22.5 mA
Frequency simulation 1	In the <b>Operating mode</b> parameter, the <b>Frequency</b> option is selected.	Switch the simulation of the frequency output on and off.	<ul style="list-style-type: none"> <li>▪ Off</li> <li>▪ On</li> </ul>
Frequency value 1	In the <b>Frequency simulation</b> parameter, the <b>On</b> option is selected.	Enter the frequency value for the simulation.	0.0 to 12 500.0 Hz
Pulse simulation 1	In the <b>Operating mode</b> parameter, the <b>Pulse</b> option is selected.	Set and switch off the pulse output simulation.  For <b>Fixed value</b> option: <b>Pulse width</b> parameter (→ ⓘ 61) defines the pulse width of the pulses output.	<ul style="list-style-type: none"> <li>▪ Off</li> <li>▪ Fixed value</li> <li>▪ Down-counting value</li> </ul>
Pulse value 1	In the <b>Pulse simulation</b> parameter (→ ⓘ 81), the <b>Down-counting value</b> option is selected.	Enter the number of pulses for simulation.	0 to 65 535
Switch output simulation 1	In the <b>Operating mode</b> parameter, the <b>Switch</b> option is selected.	Switch the simulation of the switch output on and off.	<ul style="list-style-type: none"> <li>▪ Off</li> <li>▪ On</li> </ul>
Switch status 1	In the <b>Switch output simulation</b> parameter (→ ⓘ 81) <b>Switch output simulation 1 to n</b> parameter <b>Switch output simulation 1 to n</b> parameter, the <b>On</b> option is selected.	Select the status of the status output for the simulation.	<ul style="list-style-type: none"> <li>▪ Open</li> <li>▪ Closed</li> </ul>
Simulation device alarm	–	Switch the device alarm on and off.	<ul style="list-style-type: none"> <li>▪ Off</li> <li>▪ On</li> </ul>

Parameter	Prerequisite	Description	Selection / User entry
Diagnostic event category	–	Select a diagnostic event category.	<ul style="list-style-type: none"> <li>■ Sensor</li> <li>■ Electronics</li> <li>■ Configuration</li> <li>■ Process</li> </ul>
Simulation diagnostic event	–	Select a diagnostic event for the simulation process that is activated.	<ul style="list-style-type: none"> <li>■ Off</li> <li>■ Diagnostic event picklist (depends on the category selected)</li> </ul>

\* Visibility depends on order options or device settings

## 10.6 Protecting settings from unauthorized access

The following options exist for protecting the configuration of the measuring device from unintentional modification after commissioning:

- Write protection via access code for Web browser →  82
- Write protection via write protection switch →  83

### 10.6.1 Write protection via access code

With the customer-specific access code, access to the measuring instrument via the Web browser is protected, as are the parameters for the measuring instrument configuration.

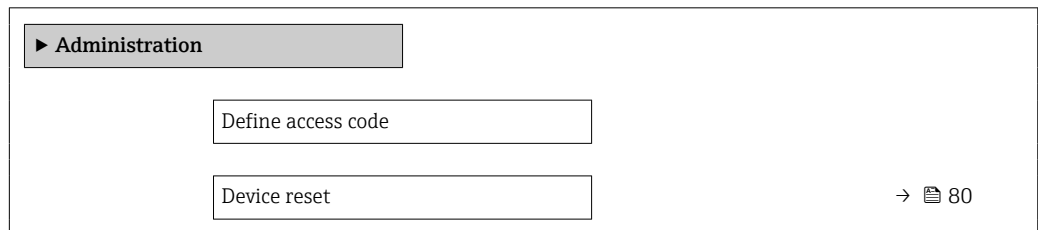

#### Navigation

"Setup" menu → Advanced setup → Administration → Define access code



#### Defining the access code via the web browser

1. Navigate to the **Define access code** parameter (→  80).
2. Define a 16-digit (max.) numeric code as the access code.
3. Enter the access code again in the to confirm.
  - ↳ The web browser switches to the login page.

-  ■ Disabling parameter write protection via access code .
- If the access code is lost: Resetting the access code .
- The **Access status tooling** parameter shows which user role the user is currently logged in with.
  - Navigation path: Operation → Access status tooling
  - User roles and their access rights →  39

If no action is performed for 10 minutes, the web browser automatically returns to the login page.

### 10.6.2 Write protection via write protection switch

The write protection switch makes it possible to block write access to the entire operating menu with the exception of the following parameters:

- External pressure
- External temperature
- Reference density
- All parameters for configuring the totalizer

The parameter values are now read only and cannot be edited any more:

- Via service interface (CDI)
- Via HART protocol

1. Depending on the housing version, loosen the securing clamp or fixing screw of the housing cover.
2. Depending on the housing version, unscrew or open the housing cover and disconnect the local display from the main electronics module where necessary → 128.

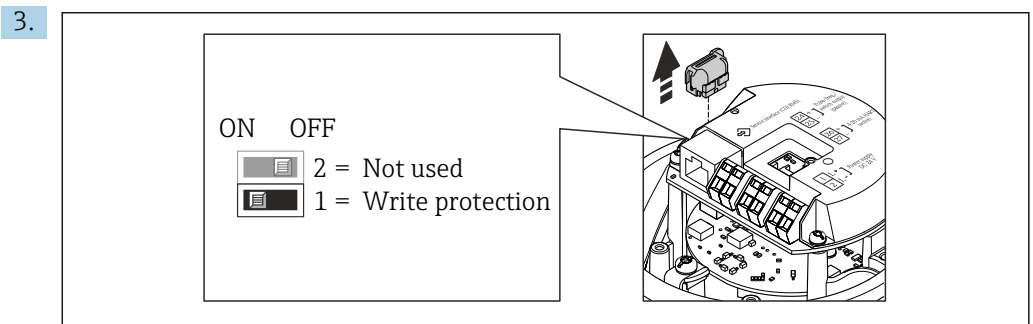

Disconnect the T-DAT from the main electronics module.

4. Setting the write protection switch on the main electronics module to the **On** position enables hardware write protection. Setting the write protection switch on the main electronics module to the **Off** position (factory setting) disables hardware write protection.
  - ↳ If hardware write protection is enabled: the **Locking status** parameter displays the **Hardware locked** option ; if disabled, the **Locking status** parameter does not display any option .
5. Reverse the removal procedure to reassemble the transmitter.

# 11 Operation

## 11.1 Reading the device locking status

Device active write protection: **Locking status** parameter

### Navigation



"Operation" menu → Locking status

*Function scope of "Locking status" parameter*

Options	Description
Hardware locked	The locking switch (DIP switch) for locking the hardware is activated on the main electronic module. This prevents write access to the parameters .
Temporarily locked	Write access to the parameters is temporarily locked on account of internal processes running in the device (e.g. data upload/download, reset etc.). Once the internal processing has been completed, the parameters can be changed once again.

## 11.2 Adjusting the operating language

 Detailed information:

- To configure the operating language →  54
- For information on the operating languages supported by the measuring device →  129

## 11.3 Configuring the display

Detailed information:



On the advanced settings for the local display

## 11.4 Reading off measured values

With the **Measured values** submenu, it is possible to read all the measured values.

### Navigation

"Diagnostics" menu → Measured values

▶ Measured values	
▶ Process variables	→  84
▶ Totalizer	→  86
▶ Output values	→  87

### 11.4.1 "Measured variables" submenu

The **Process variables** submenu contains all the parameters needed to display the current measured values for each process variable.



**Navigation**

"Diagnostics" menu → Measured values → Measured variables

► Measured variables	
Mass flow	→ ⓘ 85
Volume flow	→ ⓘ 85
Corrected volume flow	→ ⓘ 85
Density	→ ⓘ 86
Reference density	→ ⓘ 86
Temperature	→ ⓘ 86
Pressure	→ ⓘ 86
Concentration	→ ⓘ 86
Target mass flow	→ ⓘ 86
Carrier mass flow	→ ⓘ 86
Target corrected volume flow	→ ⓘ 86
Carrier corrected volume flow	→ ⓘ 86
Target volume flow	→ ⓘ 86
Carrier volume flow	→ ⓘ 86

**Parameter overview with brief description**

Parameter	Prerequisite	Description	User interface
Mass flow	–	Displays the mass flow that is currently measured. <i>Dependency</i> The unit is taken from: <b>Mass flow unit</b> parameter (→ ⓘ 72)	Signed floating-point number
Volume flow	–	Displays the volume flow that is currently calculated. <i>Dependency</i> The unit is taken from the <b>Volume flow unit</b> parameter (→ ⓘ 72).	Signed floating-point number
Corrected volume flow	–	Displays the corrected volume flow that is currently calculated. <i>Dependency</i> The unit is taken from: <b>Corrected volume flow unit</b> parameter (→ ⓘ 73)	Signed floating-point number

Parameter	Prerequisite	Description	User interface
Density	–	Shows the density currently measured. <i>Dependency</i> The unit is taken from the <b>Density unit</b> parameter (→ 73).	Signed floating-point number
Reference density	–	Displays the reference density that is currently calculated. <i>Dependency</i> The unit is taken from: <b>Reference density unit</b> parameter (→ 73)	Signed floating-point number
Temperature	–	Shows the medium temperature currently measured. <i>Dependency</i> The unit is taken from: <b>Temperature unit</b> parameter (→ 73)	Signed floating-point number
Pressure value	–	Displays either a fixed or external pressure value. <i>Dependency</i> The unit is taken from the <b>Pressure unit</b> parameter (→ 73).	Signed floating-point number
Concentration	For the following order code: Order code for "Application package", option <b>ED</b> "Concentration"  The software options currently enabled are displayed in the <b>Software option overview</b> parameter.	Displays the concentration that is currently calculated. <i>Dependency</i> The unit is taken from the <b>Concentration unit</b> parameter.	Signed floating-point number
Target mass flow	With the following conditions: Order code for "Application package", option <b>ED</b> "Concentration"  The software options currently enabled are displayed in the <b>Software option overview</b> parameter.	Displays the mass flow that is currently measured for the target medium. <i>Dependency</i> The unit is taken from: <b>Mass flow unit</b> parameter (→ 72)	Signed floating-point number
Carrier mass flow	With the following conditions: Order code for "Application package", option <b>ED</b> "Concentration"  The software options currently enabled are displayed in the <b>Software option overview</b> parameter.	Displays the mass flow of the carrier medium that is currently measured. <i>Dependency</i> The unit is taken from: <b>Mass flow unit</b> parameter (→ 72)	Signed floating-point number
Target corrected volume flow	–		Signed floating-point number
Carrier corrected volume flow	–		Signed floating-point number
Target volume flow	–		Signed floating-point number
Carrier volume flow	–		Signed floating-point number

### 11.4.2 "Totalizer" submenu

The **Totalizer** submenu contains all the parameters needed to display the current measured values for every totalizer.

**Navigation**

"Diagnostics" menu → Measured values → Totalizer

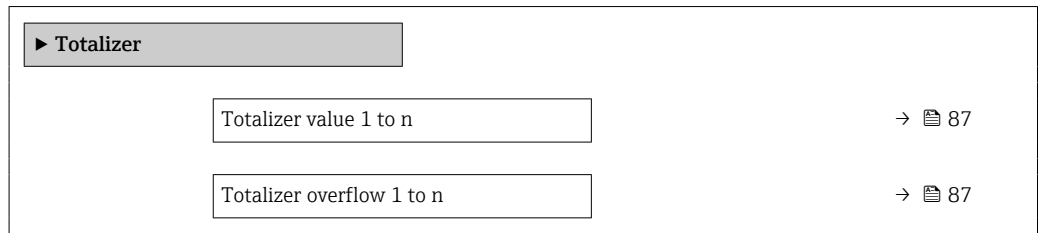

**Parameter overview with brief description**

Parameter	Prerequisite	Description	User interface
Totalizer value 1 to n	One of the following options is selected in the <b>Assign process variable</b> parameter (→ 87) of the <b>Totalizer 1 to n</b> submenu: <ul style="list-style-type: none"> <li>▪ Volume flow</li> <li>▪ Mass flow</li> <li>▪ Corrected volume flow</li> <li>▪ Target mass flow*</li> <li>▪ Carrier mass flow*</li> </ul>	Displays the current totalizer counter value.	Signed floating-point number
Totalizer overflow 1 to n	One of the following options is selected in the <b>Assign process variable</b> parameter (→ 87) of the <b>Totalizer 1 to n</b> submenu: <ul style="list-style-type: none"> <li>▪ Volume flow</li> <li>▪ Mass flow</li> <li>▪ Corrected volume flow</li> <li>▪ Target mass flow*</li> <li>▪ Carrier mass flow*</li> </ul>	Displays the current totalizer overflow.	Integer with sign

\* Visibility depends on order options or device settings

**11.4.3 Output variables**

The **Output values** submenu contains all the parameters needed to display the current measured values for every output.

**Navigation**

"Diagnostics" menu → Measured values → Output values

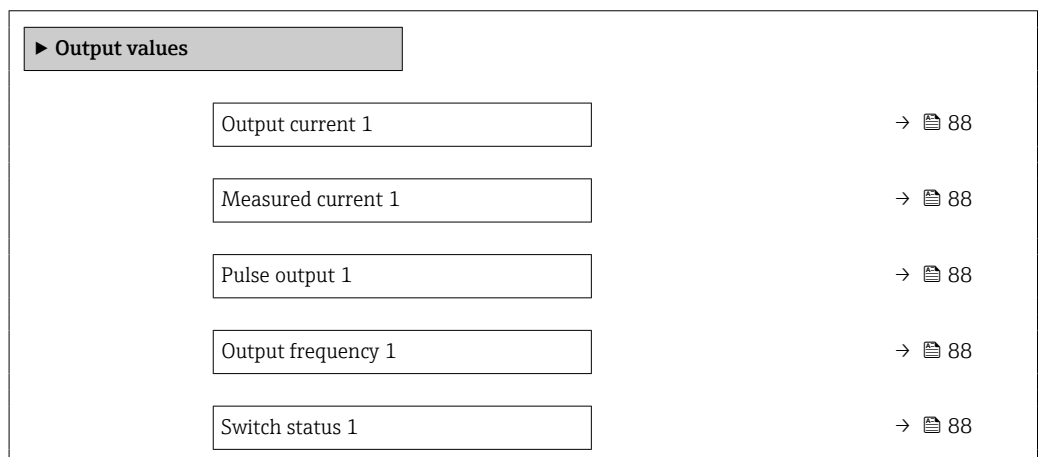



### Parameter overview with brief description

Parameter	Prerequisite	Description	User interface
Output current 1	–	Displays the current value currently calculated for the current output.	3.59 to 22.5 mA
Measured current 1	–	Displays the current value currently measured for the current output.	0 to 30 mA
Pulse output 1	The <b>Pulse</b> option is selected in the <b>Operating mode</b> parameter parameter.	Displays the pulse frequency currently output.	Positive floating-point number
Output frequency 1	In the <b>Operating mode</b> parameter, the <b>Frequency</b> option is selected.	Displays the value currently measured for the frequency output.	0.0 to 12 500.0 Hz
Switch status 1	The <b>Switch</b> option is selected in the <b>Operating mode</b> parameter.	Displays the current switch output status.	<ul style="list-style-type: none"> <li>▪ Open</li> <li>▪ Closed</li> </ul>

## 11.5 Adapting the measuring device to the process conditions

The following are available for this purpose:

- Basic settings using the **Setup** menu (→  54)
- Advanced settings using the **Advanced setup** submenu (→  71)





## 11.6 Performing a totalizer reset

The totalizers are reset in the **Operation** submenu:

- Control Totalizer
- Reset all totalizers

### Navigation

"Operation" menu → Totalizer handling

► Totalizer handling	
Control Totalizer 1 to n	→  89
Preset value 1 to n	→  89
Totalizer value 1 to n	→  89
Reset all totalizers	→  89



**Parameter overview with brief description**

Parameter	Prerequisite	Description	Selection / User entry / User interface	Factory setting
Control Totalizer 1 to n	A process variable is selected in the <b>Assign process variable</b> parameter (→ 79) of the <b>Totalizer 1 to n</b> submenu.	Control totalizer value.	<ul style="list-style-type: none"> <li>■ Totalize</li> <li>■ Reset + hold</li> <li>■ Preset + hold</li> <li>■ Reset + totalize</li> <li>■ Preset + totalize</li> </ul>	–
Preset value 1 to n	A process variable is selected in the <b>Assign process variable</b> parameter (→ 79) of the <b>Totalizer 1 to n</b> submenu.	Specify start value for totalizer. <i>Dependency</i>  The unit of the selected process variable is defined in the <b>Unit totalizer</b> parameter (→ 79) for the totalizer.	Signed floating-point number	Depends on country: <ul style="list-style-type: none"> <li>■ 0 kg</li> <li>■ 0 lb</li> </ul>
Totalizer value	One of the following options is selected in the <b>Assign process variable</b> parameter (→ 79) of the <b>Totalizer 1 to n</b> submenu: <ul style="list-style-type: none"> <li>■ Volume flow</li> <li>■ Mass flow</li> <li>■ Corrected volume flow</li> <li>■ Target mass flow*</li> <li>■ Carrier mass flow*</li> </ul>	Displays the current totalizer counter value.	Signed floating-point number	–
Reset all totalizers	–	Reset all totalizers to 0 and start.	<ul style="list-style-type: none"> <li>■ Cancel</li> <li>■ Reset + totalize</li> </ul>	–

\* Visibility depends on order options or device settings

**11.6.1 Function scope of "Control Totalizer" parameter**

Options	Description
Totalize	The totalizer is started or continues running.
Reset + hold	The totaling process is stopped and the totalizer is reset to 0.
Preset + hold <sup>1)</sup>	The totaling process is stopped and the totalizer is set to its defined start value from the <b>Preset value</b> parameter.
Reset + totalize	The totalizer is reset to 0 and the totaling process is restarted.
Preset + totalize <sup>1)</sup>	The totalizer is set to the defined start value in the <b>Preset value</b> parameter and the totaling process is restarted.

1) Visible depending on the order options or device settings

**11.6.2 Function range of "Reset all totalizers" parameter**

Options	Description
Cancel	No action is executed and the user exits the parameter.
Reset + totalize	Resets all totalizers to 0 and restarts the totaling process. This deletes all the previously aggregated flow values.

## 12 Diagnostics and troubleshooting

### 12.1 General troubleshooting

#### For local display

Error	Possible causes	Remedial action
Local display is dark, but signal output is within the valid range	The cable of the display module is not plugged in correctly.	Insert the plug correctly into the main electronics module and display module.
Local display dark and no output signals	Supply voltage does not match the voltage specified on the nameplate.	Apply the correct supply voltage → 29.
Local display dark and no output signals	Supply voltage has incorrect polarity.	Reverse polarity of supply voltage.
Local display dark and no output signals	No contact between connecting cables and terminals.	Ensure electrical contact between the cable and the terminal.
Local display dark and no output signals	<ul style="list-style-type: none"> <li>▪ Terminals are not plugged into the I/O electronics module correctly.</li> <li>▪</li> </ul>	Check terminals.
Local display dark and no output signals	<ul style="list-style-type: none"> <li>▪ I/O electronics module is defective.</li> <li>▪</li> </ul>	Order spare part → 107.
Local display cannot be read, but signal output is within the valid range	Display is set too bright or too dark.	<ul style="list-style-type: none"> <li>▪ Set the display brighter by simultaneously pressing <math>\boxplus</math> + <math>\boxminus</math>.</li> <li>▪ Set the display darker by simultaneously pressing <math>\boxminus</math> + <math>\boxplus</math>.</li> </ul>
Local display is dark, but signal output is within the valid range	Display module is defective.	Order spare part → 107.
Backlighting of local display is red	Diagnostic event with "Alarm" diagnostic behavior has occurred.	Take remedial measures → 96
Message on local display: "Communication Error" "Check Electronics"	Communication between the display module and the electronics is interrupted.	<ul style="list-style-type: none"> <li>▪ Check the cable and the connector between the main electronics module and display module.</li> <li>▪ Order spare part → 107.</li> </ul>

#### For output signals

Error	Possible causes	Remedial action
Green power LED on the main electronics module of the transmitter is dark	Supply voltage does not match the voltage specified on the nameplate.	Apply the correct supply voltage → 29.
Device measures incorrectly.	Configuration error or device is operated outside the application.	<ol style="list-style-type: none"> <li>1. Check and correct parameter configuration.</li> <li>2. Observe limit values specified in the "Technical Data".</li> </ol>

#### For access

Fault	Possible causes	Remedial action
Write access to parameters is not possible.	Hardware write protection is enabled.	Set the write protection switch on the main electronics module to the <b>OFF</b> position → 83.
Connection via HART protocol is not possible.	Missing or incorrectly installed communication resistor	Install the communication resistor (250 $\Omega$ ) correctly. Observe the maximum load .
Connection via HART protocol is not possible.	Commubox <ul style="list-style-type: none"> <li>▪ Incorrectly connected.</li> <li>▪ Incorrectly configured.</li> <li>▪ Driver is not installed correctly.</li> <li>▪ The USB port on the PC is incorrectly configured.</li> </ul>	Refer to the documentation on Commubox FXA195 HART:  Technical Information TI00404F

Fault	Possible causes	Remedial action
Unable to connect to the web server.	Web server is disabled.	Using the "FieldCare" or "DeviceCare" operating tool, check whether the web server of the device is enabled, and enable it if necessary → 44.
	The Ethernet interface on the PC is incorrectly configured.	<ul style="list-style-type: none"> <li>▶ Check the properties of the Internet protocol (TCP/IP).</li> <li>▶ Check the network settings with the IT manager.</li> </ul>
Unable to connect to the web server.	The IP address on the PC is incorrectly configured.	Check the IP address: 192.168.1.212 → 41
Web browser frozen and operation no longer possible	Data transfer is active.	Wait until data transfer or current action is finished.
	Connection lost	<ul style="list-style-type: none"> <li>▶ Check cable connection and power supply.</li> <li>▶ Refresh the web browser and restart if necessary.</li> </ul>
Display of web browser content is difficult to read or incomplete.	Web browser version used is not optimal.	<ul style="list-style-type: none"> <li>▶ Use correct web browser version → 40.</li> <li>▶ Empty the web browser cache.</li> <li>▶ Restart the web browser.</li> </ul>
	Unsuitable view settings.	Change the font size/display ratio of the Web browser.
Incomplete or no display of content in the web browser	<ul style="list-style-type: none"> <li>▪ JavaScript is not enabled.</li> <li>▪ JavaScript cannot be enabled.</li> </ul>	<ul style="list-style-type: none"> <li>▶ Enable JavaScript.</li> <li>▶ Enter http://XXX.XXX.X.XX/servlet/basic.html as the IP address.</li> </ul>
Operation with FieldCare or DeviceCare via service interface CDI-RJ45 (port 8000) is not possible.	Firewall of the PC or network is blocking communication.	Depending on the settings of the firewall used on the PC or in the network, the firewall must be adapted or disabled to allow FieldCare/ DeviceCare access.
Flashing the firmware with FieldCare or DeviceCare via service interface CDI-RJ45 (port 8000 or TFTP ports) is not possible.	Firewall of the PC or network is blocking communication.	Depending on the settings of the firewall used on the PC or in the network, the firewall must be adapted or disabled to allow FieldCare/ DeviceCare access.

## 12.2 Diagnostic information via LEDs

### 12.2.1 Transmitter

Different LEDs in the transmitter provide information on the device status.

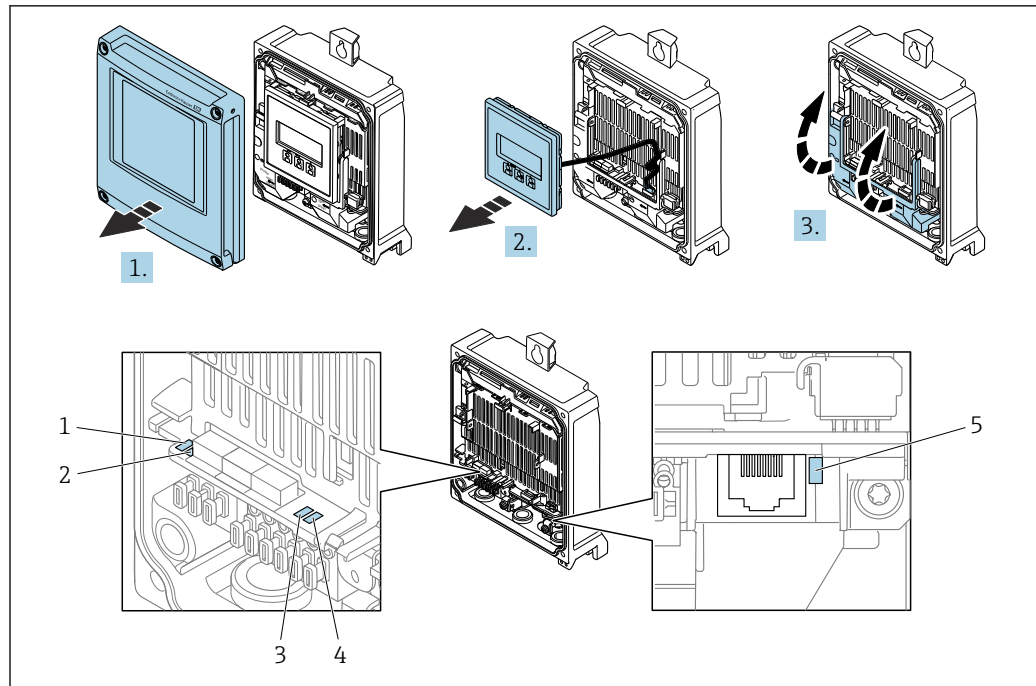

A0029689

- 1 Supply voltage
- 2 Device status
- 3 Not used
- 4 Communication
- 5 Service interface (CDI) active

1. Open the housing cover.
2. Remove the display module.
3. Fold open the terminal cover.

LED	Color	Meaning
Supply voltage	Off	Supply voltage is off or too low
	Green	Supply voltage is ok
Device status	Green	Device status is ok
	Flashing red	A device error of diagnostic behavior "Warning" has occurred
	Red	A device error of diagnostic behavior "Alarm" has occurred
	Alternately flashing red/green	Boot loader is active
Link/Activity	Orange	Link available but no activity
	Flashing orange	Activity present
Communication	Flashing white	HART communication is active.

## 12.3 Diagnostic information in the web browser

### 12.3.1 Diagnostic options

Any faults detected by the measuring device are displayed in the Web browser on the home page once the user has logged on.

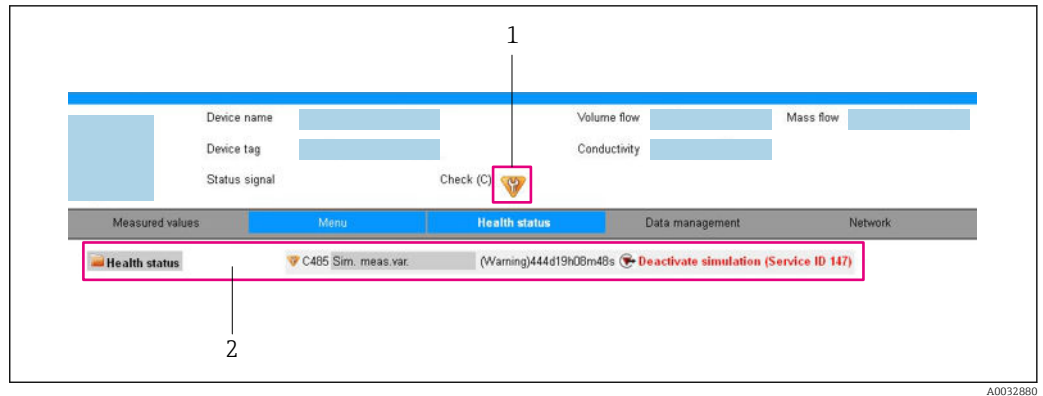

- 1 Status area with status signal
- 2 Diagnostics information → 93 and remedial measures with service ID

**i** In addition, diagnostic events which have occurred can be shown in the **Diagnostics** menu:

- Via parameter → 99
- Via submenu → 100

### Status signals

The status signals provide information on the state and reliability of the device by categorizing the cause of the diagnostic information (diagnostic event).

Symbol	Meaning
	<b>Failure</b> A device error has occurred. The measured value is no longer valid.
	<b>Function check</b> The device is in service mode (e.g. during a simulation).
	<b>Out of specification</b> The device is being operated: <ul style="list-style-type: none"> <li>▪ Outside its technical specification limits (e.g. outside the process temperature range)</li> <li>▪ Outside of the configuration carried out by the user (e.g. maximum flow in parameter 20 mA value)</li> </ul>
	<b>Maintenance required</b> Maintenance is required. The measured value remains valid.

**i** The status signals are categorized in accordance with VDI/VDE 2650 and NAMUR Recommendation NE 107.

### Diagnostic information

The fault can be identified using the diagnostic information. The short text helps you by providing information about the fault.

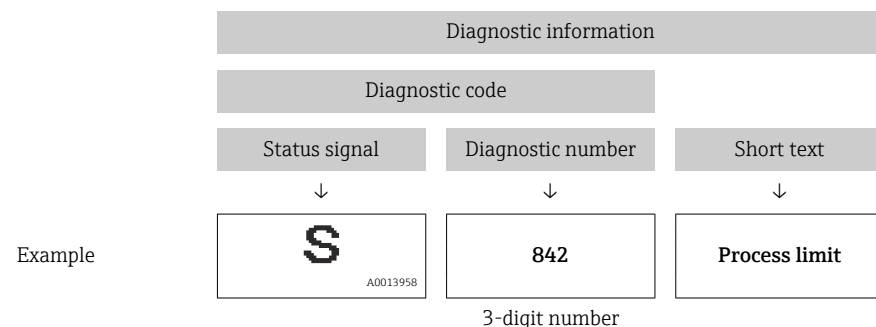

### 12.3.2 Calling up remedy information

Remedy information is provided for every diagnostic event to ensure that problems can be rectified quickly. These measures are displayed in red along with the diagnostic event and the related diagnostic information.

## 12.4 Diagnostic information in FieldCare or DeviceCare

### 12.4.1 Diagnostic options

Any faults detected by the measuring device are displayed on the home page of the operating tool once the connection has been established.

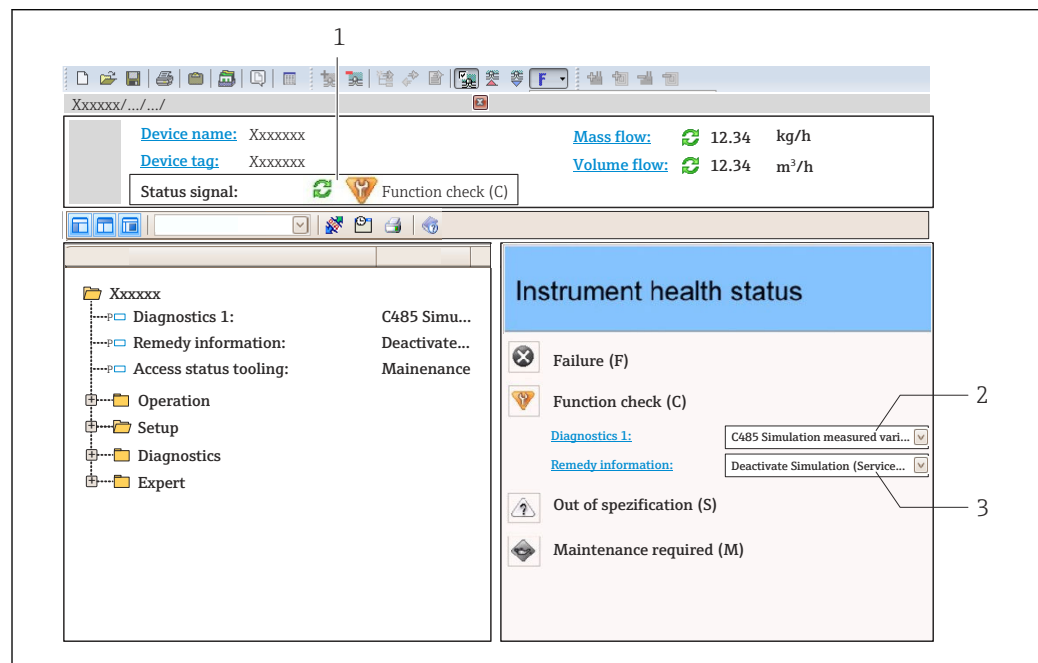

A0021799-EN

- 1 Status area with status signal
- 2 Diagnostic information → 93
- 3 Remedial measures with service ID



**i** In addition, diagnostic events which have occurred can be shown in the **Diagnostics** menu:

- Via parameter → 99
- Via submenu → 100

### Status signals

The status signals provide information on the state and reliability of the device by categorizing the cause of the diagnostic information (diagnostic event).

Symbol	Meaning
	<b>Failure</b> A device error has occurred. The measured value is no longer valid.
	<b>Function check</b> The device is in service mode (e.g. during a simulation).

Symbol	Meaning
	<p><b>Out of specification</b>                      The device is being operated:</p> <ul style="list-style-type: none"> <li>▪ Outside its technical specification limits (e.g. outside the process temperature range)</li> <li>▪ Outside of the configuration carried out by the user (e.g. maximum flow in parameter <b>20 mA value</b>)</li> </ul>
	<p><b>Maintenance required</b>                      Maintenance is required. The measured value remains valid.</p>

 The status signals are categorized in accordance with VDI/VDE 2650 and NAMUR Recommendation NE 107.

### Diagnostic information

The fault can be identified using the diagnostic information. The short text helps you by providing information about the fault.

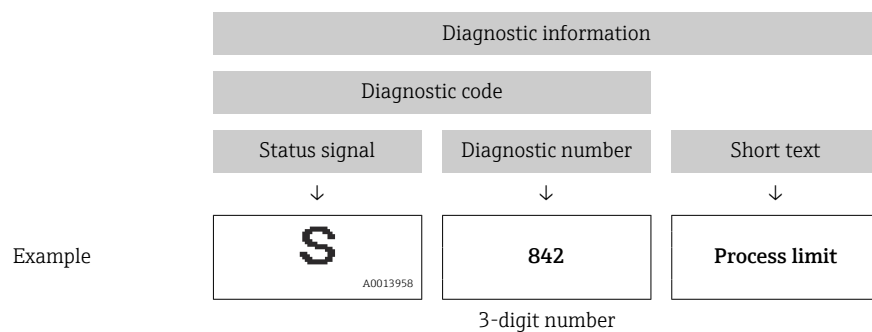

### 12.4.2 Calling up remedy information

Remedy information is provided for every diagnostic event to ensure that problems can be rectified quickly:

- On the home page  
 Remedy information is displayed in a separate field below the diagnostics information.
- In the **Diagnostics** menu  
 Remedy information can be called up in the working area of the user interface.

The user is in the **Diagnostics** menu.

1. Call up the desired parameter.
2. On the right in the working area, mouse over the parameter.  
 ↳ A tool tip with remedy information for the diagnostic event appears.

## 12.5 Adapting the diagnostic information

### 12.5.1 Adapting the diagnostic behavior

Each item of diagnostic information is assigned a specific diagnostic behavior at the factory. The user can change this assignment for specific diagnostic information in the **Diagnostic behavior** submenu.

Expert → System → Diagnostic handling → Diagnostic behavior

You can assign the following options to the diagnostic number as the diagnostic behavior:

Options	Description
Alarm	The device stops measurement. The signal outputs and totalizers assume the defined alarm condition. A diagnostic message is generated.
Warning	The device continues to measure. The signal outputs and totalizers are not affected. A diagnostic message is generated.
Logbook entry only	The device continues to measure. The diagnostic message is entered only in the <b>Event logbook</b> submenu ( <b>Event list</b> submenu) and is not displayed in alternating sequence with the measured value display. The device continues to measure. The diagnostic message is entered only in the <b>Event logbook</b> submenu.
Off	The diagnostic event is ignored, and no diagnostic message is generated or entered.

## 12.5.2 Adapting the status signal

Each item of diagnostic information is assigned a specific status signal at the factory. The user can change this assignment for specific diagnostic information in the **Diagnostic event category** submenu.





Expert → Communication → Diagnostic event category

### Available status signals

Configuration as per HART 7 Specification (Condensed Status), in accordance with NAMUR NE107.

Symbol	Meaning
<b>F</b> A0013956	<b>Failure</b> A device error has occurred. The measured value is no longer valid.
<b>C</b> A0013959	<b>Function check</b> The device is in service mode (e.g. during a simulation).
<b>S</b> A0013958	<b>Out of specification</b> The device is being operated: <ul style="list-style-type: none"> <li>▪ Outside its technical specification limits (e.g. outside the process temperature range)</li> <li>▪ Outside of the configuration carried out by the user (e.g. maximum flow in parameter <b>20 mA value</b>)</li> </ul>
<b>M</b> A0013957	<b>Maintenance required</b> Maintenance is required. The measured value remains valid.
<b>N</b> A0023076	Has no effect on the condensed status.

## 12.6 Overview of diagnostic information

-  The amount of diagnostic information and the number of measured variables affected increase if the measuring device has one or more application packages.
-  In the case of some items of diagnostic information, the status signal and the diagnostic behavior can be changed. Change the diagnostic information →  95
-  In the case of some items of diagnostic information, the diagnostic behavior can be changed. Adapting the diagnostic information



Diagnostic number	Short text	Remedy instructions	Status signal [from the factory]	Diagnostic behavior [from the factory]
<b>Diagnostic of sensor</b>				
022	Sensor temperature	1. Change main electronic module 2. Change sensor	F	Alarm
046	Sensor limit exceeded	1. Inspect sensor 2. Check process condition	S	Alarm
062	Sensor connection	1. Change main electronic module 2. Change sensor	F	Alarm
082	Data storage	1. Check module connections 2. Contact service	F	Alarm
083	Memory content	1. Restart device 2. Contact service	F	Alarm
140	Sensor signal	1. Check or change main electronics 2. Change sensor	S	Alarm
144	Measuring error too high	1. Check or change sensor 2. Check process conditions	F	Alarm
190	Special event 1	Contact service	F	Alarm
191	Special event 5	Contact service	F	Alarm
192	Special event 9	Contact service	F	Alarm <sup>1)</sup>
<b>Diagnostic of electronic</b>				
201	Device failure	1. Restart device 2. Contact service	F	Alarm
242	Software incompatible	1. Check software 2. Flash or change main electronics module	F	Alarm
252	Modules incompatible	1. Check electronic modules 2. Change electronic modules	F	Alarm
262	Module connection	1. Check module connections 2. Change main electronics	F	Alarm
270	Main electronic failure	Change main electronic module	F	Alarm
271	Main electronic failure	1. Restart device 2. Change main electronic module	F	Alarm
272	Main electronic failure	1. Restart device 2. Contact service	F	Alarm
273	Main electronic failure	Change electronic	F	Alarm
274	Main electronic failure	Change electronic	S	Warning
283	Memory content	1. Reset device 2. Contact service	F	Alarm
311	Electronic failure	1. Reset device 2. Contact service	F	Alarm
311	Electronic failure	1. Do not reset device 2. Contact service	M	Warning
375	I/O communication failed	1. Restart device 2. Change main electronic module	F	Alarm
382	Data storage	1. Insert DAT module 2. Change DAT module	F	Alarm

Diagnostic number	Short text	Remedy instructions	Status signal [from the factory]	Diagnostic behavior [from the factory]
383	Memory content	1. Restart device 2. Check or change DAT module 3. Contact service	F	Alarm
390	Special event 2	Contact service	F	Alarm
391	Special event 6	Contact service	F	Alarm
392	Special event 10	Contact service	F	Alarm <sup>1)</sup>
<b>Diagnostic of configuration</b>				
410	Data transfer	1. Check connection 2. Retry data transfer	F	Alarm
411	Up-/download active	Up-/download active, please wait	C	Warning
431	Trim 1	Carry out trim	C	Warning
437	Configuration incompatible	1. Restart device 2. Contact service	F	Alarm
438	Dataset	1. Check data set file 2. Check device configuration 3. Up- and download new configuration	M	Warning
441	Current output 1	1. Check process 2. Check current output settings	S	Warning <sup>1)</sup>
442	Frequency output	1. Check process 2. Check frequency output settings	S	Warning <sup>1)</sup>
443	Pulse output	1. Check process 2. Check pulse output settings	S	Warning <sup>1)</sup>
453	Flow override	Deactivate flow override	C	Warning
484	Simulation failure mode	Deactivate simulation	C	Alarm
485	Simulation measured variable	Deactivate simulation	C	Warning
491	Simulation current output 1	Deactivate simulation	C	Warning
492	Simulation frequency output	Deactivate simulation frequency output	C	Warning
493	Simulation pulse output	Deactivate simulation pulse output	C	Warning
494	Switch output simulation	Deactivate simulation switch output	C	Warning
495	Simulation diagnostic event	Deactivate simulation	C	Warning
537	Configuration	1. Check IP addresses in network 2. Change IP address	F	Warning
590	Special event 3	Contact service	F	Alarm
591	Special event 7	Contact service	F	Alarm
592	Special event 11	Contact service	F	Alarm <sup>1)</sup>
<b>Diagnostic of process</b>				
803	Current loop	1. Check wiring 2. Change I/O module	F	Alarm
830	Sensor temperature too high	Reduce ambient temp. around the sensor housing	S	Warning



Diagnostic number	Short text	Remedy instructions	Status signal [from the factory]	Diagnostic behavior [from the factory]
831	Sensor temperature too low	Increase ambient temp. around the sensor housing	S	Warning
832	Electronic temperature too high	Reduce ambient temperature	S	Warning <sup>1)</sup>
833	Electronic temperature too low	Increase ambient temperature	S	Warning <sup>1)</sup>
834	Process temperature too high	Reduce process temperature	S	Warning <sup>1)</sup>
835	Process temperature too low	Increase process temperature	S	Warning <sup>1)</sup>
842	Process limit	Low flow cut off active! 1. Check low flow cut off configuration	S	Warning
843	Process limit	Check process conditions	S	Warning
862	Partly filled pipe	1. Check for gas in process 2. Adjust detection limits	S	Warning
882	Input signal	1. Check input configuration 2. Check external device or process conditions	F	Alarm
910	Tubes not oscillating	1. Check electronic 2. Inspect sensor	F	Alarm
912	Medium inhomogeneous	1. Check process cond. 2. Increase system pressure	S	Warning
912	Inhomogeneous		S	Warning
913	Medium unsuitable	1. Check process conditions 2. Check electronic modules or sensor	S	Alarm
944	Monitoring failed	Check process conditions for Heartbeat Monitoring	S	Warning
948	Tube damping too high	Check process conditions	S	Warning
990	Special event 4	Contact service	F	Alarm
991	Special event 8	Contact service	F	Alarm
992	Special event 12	Contact service	F	Alarm <sup>1)</sup>



1) Diagnostic behavior can be changed.

## 12.7 Pending diagnostic events

The **Diagnostics** menu allows the user to view the current diagnostic event and the previous diagnostic event separately.

 To call up the measures to rectify a diagnostic event:

- Via web browser →  94
- Via "FieldCare" operating tool →  95
- Via "DeviceCare" operating tool →  95

 Other pending diagnostic events can be displayed in the **Diagnostic list** submenu →  100.

**Navigation**

"Diagnostics" menu

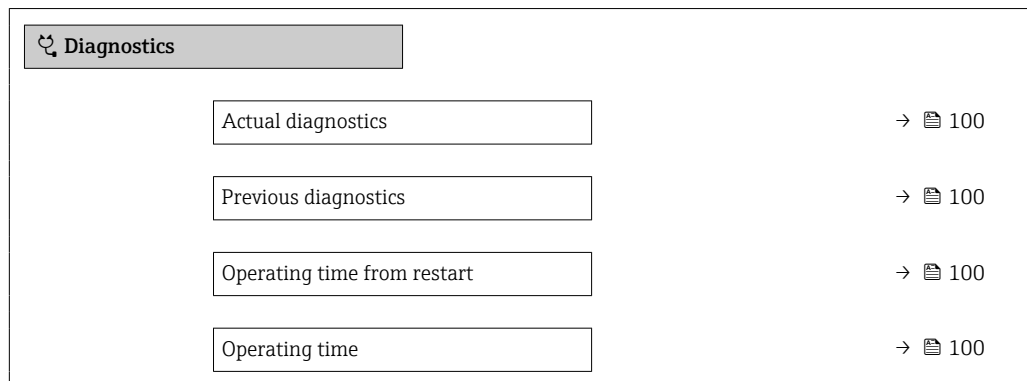
**Parameter overview with brief description**

Parameter	Prerequisite	Description	User interface
Actual diagnostics	A diagnostic event has occurred.	Shows the current occurred diagnostic event along with its diagnostic information. If two or more messages occur simultaneously, the message with the highest priority is shown on the display.	Symbol for diagnostic behavior, diagnostic code and short message.
Previous diagnostics	Two diagnostic events have already occurred.	Shows the diagnostic event that occurred prior to the current diagnostic event along with its diagnostic information.	Symbol for diagnostic behavior, diagnostic code and short message.
Operating time from restart	-	Shows the time the device has been in operation since the last device restart.	Days (d), hours (h), minutes (m) and seconds (s)
Operating time	-	Indicates how long the device has been in operation.	Days (d), hours (h), minutes (m) and seconds (s)

## 12.8 Diagnostics list

Up to 5 currently pending diagnostic events can be displayed in the **Diagnostic list** submenu along with the associated diagnostic information. If more than 5 diagnostic events are pending, the events with the highest priority are shown on the display.

**Navigation path**

Diagnostics → Diagnostic list

To call up the measures to rectify a diagnostic event:

- Via web browser → 94
- Via "FieldCare" operating tool → 95
- Via "DeviceCare" operating tool → 95

## 12.9 Event logbook



### 12.9.1 Reading out the event logbook

A chronological overview of the event messages that have occurred is provided in the **Events list** submenu.



**Navigation path**

**Diagnostics** menu → **Event logbook** submenu → Events list



The event history includes entries for:



- Diagnostic events →  96
- Information events →  101

In addition to the operating time when the event occurred, each event is also assigned a symbol that indicates whether the event has occurred or is finished:

- Diagnostics event
  - : Occurrence of the event
  - : End of the event
- Information event
  - : Occurrence of the event

 To call up the measures to rectify a diagnostic event:

- Via web browser →  94
- Via "FieldCare" operating tool →  95
- Via "DeviceCare" operating tool →  95

 For filtering the displayed event messages →  101

**12.9.2 Filtering the event logbook**

Using the **Filter options** parameter you can define which category of event message is displayed in the **Events list** submenu.

**Navigation path**

Diagnostics → Event logbook → Filter options

**Filter categories**

- All
- Failure (F)
- Function check (C)
- Out of specification (S)
- Maintenance required (M)
- Information (I)

**12.9.3 Overview of information events**

Unlike a diagnostic event, an information event is displayed in the event logbook only and not in the diagnostic list.

Info number	Info name
I1000	------(Device ok)
I1089	Power on
I1090	Configuration reset
I1091	Configuration changed
I1110	Write protection switch changed
I1111	Density adjust failure
I1137	Electronic changed
I1151	History reset
I1155	Reset electronic temperature
I1157	Memory error event list
I1185	Display backup done
I1186	Restore via display done

Info number	Info name
I1187	Settings downloaded with display
I1188	Display data cleared
I1189	Backup compared
I1209	Density adjustment ok
I1221	Zero point adjust failure
I1222	Zero point adjustment ok
I1256	Display: access status changed
I1264	Safety sequence aborted
I1278	I/O module reset detected
I1335	Firmware changed
I1361	Web server: login failed
I1397	Fieldbus: access status changed
I1398	CDI: access status changed
I1444	Device verification passed
I1445	Device verification failed
I1446	Device verification active
I1447	Record application reference data
I1448	Application reference data recorded
I1449	Recording application ref. data failed
I1450	Monitoring off
I1451	Monitoring on
I1457	Failed:Measured error verification
I1459	Failed: I/O module verification
I1460	Failed: Sensor integrity verification
I1461	Failed: Sensor verification
I1462	Failed:Sensor electronic module verific.

## 12.10 Resetting the measuring device

The entire device configuration or some of the configuration can be reset to a defined state with the **Device reset** parameter (→  80).

### 12.10.1 Function range of "Device reset" parameter

Options	Description
Cancel	No action is executed and the user exits the parameter.
To delivery settings	Every parameter for which a customer-specific default setting was ordered is reset to the customer-specific value. All other parameters are reset to the factory setting.  This option is not visible if no customer-specific settings have been ordered.
Restart device	The restart resets every parameter with data stored in volatile memory (RAM) to the factory setting (e.g. measured value data). The device configuration remains unchanged.

## 12.11 Device information





The **Device information** submenu contains all parameters that display different information for device identification.

### Navigation

"Diagnostics" menu → Device information

► Device information	
Device tag	→ ⓘ 104
Serial number	→ ⓘ 104
Firmware version	→ ⓘ 104
Device name	→ ⓘ 104
Order code	→ ⓘ 104
Extended order code 1	→ ⓘ 104
Extended order code 2	→ ⓘ 104
Extended order code 3	→ ⓘ 104
ENP version	→ ⓘ 104
Device revision	→ ⓘ 104
Device ID	→ ⓘ 104
Device type	
Manufacturer ID	
IP address	→ ⓘ 104
Subnet mask	→ ⓘ 104
Default gateway	→ ⓘ 104

## Parameter overview with brief description

Parameter	Description	User interface	Factory setting
Device tag	Shows name of measuring point.	Max. 32 characters, such as letters, numbers or special characters (e.g. @, %, /).	–
Serial number	Shows the serial number of the measuring device.	Max. 11-digit character string comprising letters and numbers.	–
Firmware version	Shows the device firmware version installed.	Character string in the format xx.yy.zz	–
Device name	Shows the name of the transmitter.  The name can be found on the nameplate of the transmitter.	Max. 32 characters such as letters or numbers.	–
Order code	Shows the device order code.  The order code can be found on the nameplate of the sensor and transmitter in the "Order code" field.	Character string composed of letters, numbers and certain punctuation marks (e.g. /).	–
Extended order code 1	Shows the 1st part of the extended order code.  The extended order code can also be found on the nameplate of the sensor and transmitter in the "Ext. ord. cd." field.	Character string	–
Extended order code 2	Shows the 2nd part of the extended order code.  The extended order code can also be found on the nameplate of the sensor and transmitter in the "Ext. ord. cd." field.	Character string	–
Extended order code 3	Shows the 3rd part of the extended order code.  The extended order code can also be found on the nameplate of the sensor and transmitter in the "Ext. ord. cd." field.	Character string	–
ENP version	Shows the version of the electronic nameplate (ENP).	Character string	–
Device revision	Shows the device revision with which the device is registered with the HART Communication Foundation.	2-digit hexadecimal number	–
Device ID	Enter device ID of external device.	6-digit hexadecimal number	–
IP address	IP address of the Web server integrated in the measuring device. If the DHCP client is switched off and write access is enabled, the IP address can also be entered.	4 octet: 0 to 255 (in the particular octet)	–
Subnet mask	Displays the subnet mask. If the DHCP client is switched off and write access is enabled, the Subnet mask can also be entered.	4 octet: 0 to 255 (in the particular octet)	–
Default gateway	Displays the default gateway. If the DHCP client is switched off and write access is enabled, the Default gateway can also be entered.	4 octet: 0 to 255 (in the particular octet)	–





## 12.12 Firmware history

Release date	Firmware version	Order code for "Firmware version"	Firmware Changes	Documentation type	Documentation
04.2013	01.00.00	Option 76	Original firmware	Operating instructions	BA01192D/06/EN/01.13
10.2014	01.01.zz	Option 70	<ul style="list-style-type: none"> <li>▪ In accordance with HART 7 Specification</li> <li>▪ Integration of optional local display</li> <li>▪ New unit "Beer Barrel (BBL)"</li> <li>▪ Monitoring of measuring tube damping</li> <li>▪ Simulation of diagnostic events</li> <li>▪ External verification of the current and PFS output via the Heartbeat Technology application package</li> <li>▪ Fixed value for simulation pulses</li> </ul>	Operating instructions	BA01192D/06/EN/02.14

 It is possible to flash the firmware to the current version or the previous version using the service interface.

It is possible to flash the firmware to the current version or the previous version using the service interface.

 For the compatibility of the firmware version with the previous version, the installed device description files and operating tools, observe the information about the device in the "Manufacturer's information" document.

 The manufacturer's information is available:

- In the Download Area of the Endress+Hauser web site: [www.endress.com](http://www.endress.com) → Downloads
- Specify the following details:
  - Product root, e.g. 8E1B  
The product root is the first part of the order code: see the nameplate on the device.
  - Text search: Manufacturer's information
  - Media type: Documentation – Technical Documentation

## 13 Maintenance

### 13.1 Maintenance work

No special maintenance work is required.

#### 13.1.1 Exterior cleaning

When cleaning the exterior of measuring devices, always use cleaning agents that do not attack the surface of the housing or the seals.

#### 13.1.2 Internal cleaning

Observe the following points for CIP and SIP cleaning:

- Use only cleaning agents to which the process-wetted materials are adequately resistant.
- Observe the maximum permitted medium temperature for the measuring device .

Observe the following point for cleaning with pigs:

Observe the inside diameter of the measuring tube and process connection.

### 13.2 Measuring and test equipment

Endress+Hauser offers a variety of measuring and testing equipment, such as Netilion or device tests.

 Your Endress+Hauser Sales Center can provide detailed information on the services.

List of some of the measuring and testing equipment: →  110

### 13.3 Endress+Hauser services

Endress+Hauser offers a wide variety of services for maintenance such as recalibration, maintenance service or device tests.

 Your Endress+Hauser Sales Center can provide detailed information on the services.

## 14 Repair

### 14.1 General notes

#### 14.1.1 Repair and conversion concept

The Endress+Hauser repair and conversion concept provides for the following:

- The measuring devices have a modular design.
- Spare parts are grouped into logical kits with the associated Installation Instructions.
- Repairs are carried out by Endress+Hauser Service or by appropriately trained customers.
- Certified devices can only be converted to other certified devices by Endress+Hauser Service or at the factory.

#### 14.1.2 Notes for repair and conversion

For repair and conversion of a measuring device, observe the following notes:

- ▶ Use only original Endress+Hauser spare parts.
- ▶ Carry out the repair according to the Installation Instructions.
- ▶ Observe the applicable standards, federal/national regulations, Ex documentation (XA) and certificates.
- ▶ Document all repairs and conversions and enter the details in Netilion Analytics.

### 14.2 Spare parts

*Device Viewer* ([www.endress.com/deviceviewer](http://www.endress.com/deviceviewer)):

All the spare parts for the measuring device, along with the order code, are listed here and can be ordered. If available, users can also download the associated Installation Instructions.



Measuring device serial number:

- Is located on the nameplate of the device.
- Can be read out via the **Serial number** parameter (→ 104) in the **Device information** submenu.

### 14.3 Endress+Hauser services

Endress+Hauser offers a wide range of services.



Your Endress+Hauser Sales Center can provide detailed information on the services.

### 14.4 Return

The requirements for safe device return can vary depending on the device type and national legislation.

1. Refer to the web page for information:  
<https://www.endress.com/support/return-material>  
↳ Select the region.
2. If returning the device, pack the device in such a way that it is reliably protected against impact and external influences. The original packaging offers the best protection.

## 14.5 Disposal



If required by the Directive 2012/19/EU on waste electrical and electronic equipment (WEEE), the product is marked with the depicted symbol in order to minimize the disposal of WEEE as unsorted municipal waste. Do not dispose of products bearing this marking as unsorted municipal waste. Instead, return them to the manufacturer for disposal under the applicable conditions.

### 14.5.1 Removing the measuring device

1. Switch off the device.

#### **WARNING**

##### **Danger to persons from process conditions!**

- ▶ Beware of hazardous process conditions such as pressure in the measuring device, high temperatures or aggressive media.

2. Carry out the mounting and connection steps from the "Mounting the measuring device" and "Connecting the measuring device" sections in reverse order. Observe the safety instructions.

### 14.5.2 Disposing of the measuring device

#### **WARNING**

##### **Danger to personnel and environment from fluids that are hazardous to health.**

- ▶ Ensure that the measuring device and all cavities are free of fluid residues that are hazardous to health or the environment, e.g. substances that have permeated into crevices or diffused through plastic.

Observe the following notes during disposal:



- ▶ Observe valid federal/national regulations.
- ▶ Ensure proper separation and reuse of the device components.

## 15 Accessories





Various accessories, which can be ordered with the device or subsequently from Endress+Hauser, are available for the device. Detailed information on the order code in question is available from your local Endress+Hauser sales center or on the product page of the Endress+Hauser website: [www.endress.com](http://www.endress.com).



### 15.1 Device-specific accessories

#### 15.1.1 For the sensor



Accessories	Description
Heating jacket	<p>Is used to stabilize the temperature of the fluids in the sensor. Water, water vapor and other non-corrosive liquids are permitted for use as fluids.</p> <p> If using oil as a heating medium, please consult with Endress+Hauser.</p> <ul style="list-style-type: none"> <li>▪ If ordered together with the measuring device:           <ul style="list-style-type: none"> <li>Order code for "Accessory enclosed"               <ul style="list-style-type: none"> <li>▪ Option RB "Heating jacket, G 1/2" female thread"</li> <li>▪ Option RC "Heating jacket, G 3/4" female thread"</li> <li>▪ Option RD "Heating jacket, NPT 1/2" female thread"</li> <li>▪ Option RE "Heating jacket, NPT 3/4" female thread"</li> </ul> </li> </ul> </li> <li>▪ If ordered subsequently:           <ul style="list-style-type: none"> <li>Use the order code with the product root DK8003.</li> </ul> </li> </ul> <p> Special Documentation SD02160D</p>

### 15.2 Communication-specific accessories



Accessories	Description
Commubox FXA195 HART	<p>For intrinsically safe HART communication with FieldCare via the USB port.</p> <p> Technical Information TI00404F</p>
Commubox FXA291	<p>Connects Endress+Hauser field devices with a CDI interface (= Endress+Hauser Common Data Interface) and the USB port of a computer or laptop.</p> <p> Technical Information TI00405C</p>
HART loop converter HMX50	<p>Is used to evaluate and convert dynamic HART process variables to analog current signals or limit values.</p> <p> <ul style="list-style-type: none"> <li>▪ Technical Information TI00429F</li> <li>▪ Operating Instructions BA00371F</li> </ul> </p>
Wireless HART adapter SWA70	<p>Is used for the wireless connection of field devices. The WirelessHART adapter can be easily integrated into field devices and existing infrastructures, offers data protection and transmission safety and can be operated in parallel with other wireless networks with minimum cabling complexity.</p> <p> Operating Instructions BA00061S</p>
Fieldgate FXA42	<p>Transmission of the measured values of connected 4 to 20 mA analog measuring instruments, as well as digital measuring instruments</p> <p> <ul style="list-style-type: none"> <li>▪ Technical Information TI01297S</li> <li>▪ Operating Instructions BA01778S</li> <li>▪ Product page: <a href="http://www.endress.com/fxa42">www.endress.com/fxa42</a></li> </ul> </p>

Field Xpert SMT50	<p>The Field Xpert SMT50 tablet PC for device configuration enables mobile plant asset management in the non-hazardous areas. It is suitable for commissioning and maintenance staff to manage field instruments with a digital communication interface and to record progress.</p> <p>This tablet PC is designed as an all-in-one solution with a preinstalled driver library and is an easy-to-use, touch-sensitive tool which can be used to manage the field instruments throughout their entire life cycle.</p>  <ul style="list-style-type: none"> <li>▪ Technical Information TI01555S</li> <li>▪ Operating Instructions BA02053S</li> <li>▪ Product page: <a href="http://www.endress.com/smt50">www.endress.com/smt50</a></li> </ul>
Field Xpert SMT70	<p>The Field Xpert SMT70 tablet PC for device configuration enables mobile plant asset management in hazardous and non-hazardous areas. It is suitable for commissioning and maintenance staff to manage field instruments with a digital communication interface and to record progress.</p> <p>This tablet PC is designed as an all-in-one solution with a preinstalled driver library and is an easy-to-use, touch-sensitive tool which can be used to manage the field instruments throughout their entire life cycle.</p>  <ul style="list-style-type: none"> <li>▪ Technical Information TI01342S</li> <li>▪ Operating Instructions BA01709S</li> <li>▪ Product page: <a href="http://www.endress.com/smt70">www.endress.com/smt70</a></li> </ul>
Field Xpert SMT77	<p>The Field Xpert SMT77 tablet PC for device configuration enables mobile plant asset management in areas categorized as Ex Zone 1.</p>  <ul style="list-style-type: none"> <li>▪ Technical Information TI01418S</li> <li>▪ Operating Instructions BA01923S</li> <li>▪ Product page: <a href="http://www.endress.com/smt77">www.endress.com/smt77</a></li> </ul>

### 15.3 Service-specific accessories

Accessories	Description
Applicator	<p>Software for selecting and sizing Endress+Hauser measuring instruments:</p> <ul style="list-style-type: none"> <li>▪ Choice of measuring instruments for industrial requirements</li> <li>▪ Calculation of all the necessary data for identifying the optimum flowmeter: e.g. nominal diameter, pressure loss, flow velocity and measurement accuracy.</li> <li>▪ Graphic display of the calculation results</li> <li>▪ Determination of the partial order code, administration, documentation and access to all project-related data and parameters over the entire life cycle of a project.</li> </ul> <p>Applicator is available: Via the Internet: <a href="https://portal.endress.com/webapp/applicator">https://portal.endress.com/webapp/applicator</a></p>
Netilion	<p>IIoT ecosystem: Unlock knowledge</p> <p>With the Netilion IIoT ecosystem, Endress+Hauser allows you to optimize your plant performance, digitize workflows, share knowledge, and enhance collaboration.</p> <p>Drawing upon decades of experience in process automation, Endress+Hauser offers the process industry an IIoT ecosystem designed to effortlessly extract insights from data. These insights allow process optimization, leading to increased plant availability, efficiency, and reliability - ultimately resulting in a more profitable plant.</p> <p><a href="http://www.netilion.endress.com">www.netilion.endress.com</a></p>
FieldCare	<p>FDT-based plant asset management tool from Endress+Hauser. It can configure all intelligent field units in your system and helps you manage them. By using the status information, it is also a simple but effective way of checking their status and condition.</p>  <ul style="list-style-type: none"> <li>▪ Operating Instructions BA00027S and BA00059S</li> </ul>
DeviceCare	<p>Tool to connect and configure Endress+Hauser field devices.</p>  <ul style="list-style-type: none"> <li>▪ Innovation brochure IN01047S</li> </ul>

## 15.4 System components

Accessories	Description
Memograph M graphic data manager	<p>The Memograph M graphic data manager provides information on all the relevant measured variables. Measured values are recorded correctly, limit values are monitored and measuring points analyzed. The data are stored in the 256 MB internal memory and also on a SD card or USB stick.</p> <ul style="list-style-type: none"> <li> Technical Information TI00133R</li> <li> Operating Instructions BA00247R</li> </ul>
iTEMP	<p>The temperature transmitters can be used in all applications and are suitable for the measurement of gases, steam and liquids. They can be used to read in the medium temperature.</p> <ul style="list-style-type: none"> <li> "Fields of Activity" document FA00006T</li> </ul>

## 16 Technical data

### 16.1 Application

The measuring device is intended only for the flow measurement of liquids.

Depending on the version ordered, the measuring device can also measure potentially explosive, flammable, poisonous and oxidizing media.

To ensure that the device remains in proper operating condition for its service life, use the measuring device only for media against which the process-wetted materials are sufficiently resistant.

### 16.2 Function and system design

---

Measuring principle	Mass flow measurement based on the Coriolis measuring principle
Measuring system	<p>The device consists of a transmitter and a sensor.</p> <p>The device is available as a compact version: The transmitter and sensor form a mechanical unit.</p> <p>For information on the structure of the measuring instrument →  11</p>

---



## 16.3 Input

### Measured variable

#### Direct measured variables

- Mass flow
- Density
- Temperature

#### Calculated measured variables



- Volume flow
- Corrected volume flow
- Reference density

### Measuring range

#### Measuring range for liquids

DN		Measuring range full scale values $\dot{m}_{\min(F)}$ to $\dot{m}_{\max(F)}$	
[mm]	[in]	[kg/h]	[lb/min]
8	$\frac{3}{8}$	0 to 2 000	0 to 73.50
15	$\frac{1}{2}$	0 to 6 500	0 to 238.9
25	1	0 to 18 000	0 to 661.5
40	$1\frac{1}{2}$	0 to 45 000	0 to 1 654
50	2	0 to 70 000	0 to 2 573

#### Recommended measuring range

 Flow limit →  124

### Operable flow range

Over 1000 : 1.

Flow rates above the preset full scale value do not override the electronics unit, with the result that the totalizer values are registered correctly.

### Input signal

#### External measured values

To increase the measurement accuracy of certain measured variables or to calculate the corrected volume flow for gases, the automation system can continuously write different measured values to the measuring instrument:

- Operating pressure to increase measurement accuracy (Endress+Hauser recommends the use of a pressure measuring instrument for absolute pressure, e.g. Cerabar M or Cerabar S)
- Medium temperature to increase measurement accuracy (e.g. iTEMP)
- Reference density for calculating the corrected volume flow for gases

 Various pressure transmitters and temperature measuring instruments can be ordered from Endress+Hauser: see "Accessories" section →  111

It is recommended to read in external measured values to calculate the following measured variables:

- Mass flow
- Corrected volume flow

*HART protocol*

The measured values are written from the automation system to the measuring device via the HART protocol. The pressure transmitter must support the following protocol-specific functions:

- HART protocol
- Burst mode

## 16.4 Output



Output signal

### Current output

<b>Current output</b>	4-20 mA HART (active)
<b>Maximum output values</b>	<ul style="list-style-type: none"> <li>▪ DC 24 V (no flow)</li> <li>▪ 22.5 mA</li> </ul>
<b>Load</b>	0 to 700 Ω
<b>Resolution</b>	0.38 μA
<b>Damping</b>	Adjustable: 0.07 to 999 s
<b>Assignable measured variables</b>	<ul style="list-style-type: none"> <li>▪ Mass flow</li> <li>▪ Volume flow</li> <li>▪ Corrected volume flow</li> <li>▪ Density</li> <li>▪ Reference density</li> <li>▪ Temperature</li> </ul> <p> The range of options increases if the measuring device has one or more application packages.</p>

### Pulse/frequency/switch output

<b>Function</b>	Can be set to pulse, frequency or switch output
<b>Version</b>	Passive, open collector
<b>Maximum input values</b>	<ul style="list-style-type: none"> <li>▪ DC 30 V</li> <li>▪ 25 mA</li> </ul>
<b>Voltage drop</b>	For 25 mA: ≤ DC 2 V
<b>Pulse output</b>	
<b>Pulse width</b>	Adjustable: 0.05 to 2 000 ms
<b>Maximum pulse rate</b>	10 000 Impulse/s
<b>Pulse value</b>	Adjustable
<b>Assignable measured variables</b>	<ul style="list-style-type: none"> <li>▪ Mass flow</li> <li>▪ Volume flow</li> <li>▪ Corrected volume flow</li> </ul>
<b>Frequency output</b>	
<b>Output frequency</b>	Adjustable: 0 to 12 500 Hz
<b>Damping</b>	Adjustable: 0 to 999 s
<b>Pulse/pause ratio</b>	1:1

<b>Assignable measured variables</b>	<ul style="list-style-type: none"> <li>▪ Mass flow</li> <li>▪ Volume flow</li> <li>▪ Corrected volume flow</li> <li>▪ Density</li> <li>▪ Reference density</li> <li>▪ Temperature</li> </ul> <p> The range of options increases if the measuring device has one or more application packages.</p>
<b>Switch output</b>	
<b>Switching behavior</b>	Binary, conductive or non-conductive
<b>Switching delay</b>	Adjustable: 0 to 100 s
<b>Number of switching cycles</b>	Unlimited
<b>Assignable functions</b>	<ul style="list-style-type: none"> <li>▪ Off</li> <li>▪ On</li> <li>▪ Diagnostic behavior</li> <li>▪ Limit value                             <ul style="list-style-type: none"> <li>▪ Mass flow</li> <li>▪ Volume flow</li> <li>▪ Corrected volume flow</li> <li>▪ Density</li> <li>▪ Reference density</li> <li>▪ Temperature</li> <li>▪ Totalizer 1-3</li> </ul> </li> <li>▪ Flow direction monitoring</li> <li>▪ Status                             <ul style="list-style-type: none"> <li>▪ Partially filled pipe detection</li> <li>▪ Low flow cut off</li> </ul> </li> </ul> <p> The range of options increases if the measuring device has one or more application packages.</p>

Signal on alarm

Depending on the interface, failure information is displayed as follows.

**Current output 4 to 20 mA**

*4 to 20 mA*

<b>Failure mode</b>	<p>Choose from:</p> <ul style="list-style-type: none"> <li>▪ 4 to 20 mA in accordance with NAMUR recommendation NE 43</li> <li>▪ 4 to 20 mA in accordance with US</li> <li>▪ Min. value: 3.59 mA</li> <li>▪ Max. value: 22.5 mA</li> <li>▪ Definable value between: 3.59 to 22.5 mA</li> <li>▪ Actual value</li> <li>▪ Last valid value</li> </ul>
---------------------	--

**Pulse/frequency/switch output**

<b>Pulse output</b>	
<b>Fault mode</b>	<p>Choose from:</p> <ul style="list-style-type: none"> <li>▪ Actual value</li> <li>▪ No pulses</li> </ul>
<b>Frequency output</b>	
<b>Fault mode</b>	<p>Choose from:</p> <ul style="list-style-type: none"> <li>▪ Actual value</li> <li>▪ 0 Hz</li> <li>▪ Definable value between: 0 to 12 500 Hz</li> </ul>

Switch output	
Fault mode	Choose from: <ul style="list-style-type: none"> <li>■ Current status</li> <li>■ Open</li> <li>■ Closed</li> </ul>

**Local display**

Plain text display	With information on cause and remedial measures
Backlight	Red backlighting indicates a device error.

 Status signal as per NAMUR recommendation NE 107

**Interface/protocol**

- Via digital communication:  
HART protocol
- Via service interface  
CDI-RJ45 service interface

Plain text display	With information on cause and remedial measures
--------------------	---

**Web browser**

Plain text display	With information on cause and remedial measures
--------------------	---

**Light emitting diodes (LED)**

Status information	Status indicated by various light emitting diodes The following information is displayed depending on the device version: <ul style="list-style-type: none"> <li>■ Supply voltage active</li> <li>■ Data transmission active</li> <li>■ Device alarm/error has occurred</li> </ul>  Diagnostic information via light emitting diodes
--------------------	--

Low flow cut off                      The switch points for low flow cut off are user-selectable.

Galvanic isolation                      The following connections are galvanically isolated from each other:

- Outputs
- Power supply

Protocol-specific data                      **Protocol-specific data**

- For information on the device description files
- For information on the dynamic variables and measured variables (HART device variables) →  49

## 16.5 Power supply

Terminal assignment ■ →  27  
■

Supply voltage The power unit must be tested to ensure it meets safety requirements (e.g. PELV, SELV).

### Transmitter

DC 20 to 30 V

Power consumption **Transmitter**

Order code for "Output"	Maximum Power consumption
Option B: 4-20 mA HART with pulse/frequency/switch output	3.5 W

Current consumption **Transmitter**

Order code for "Output"	Maximum Current consumption	Maximum switch-on current
Option B: 4-20mA HART, pul./freq./switch output	145 mA	18 A (< 0.125 ms)

Device fuse Fine-wire fuse (slow-blow) T2A

Power supply failure

- Totalizers stop at the last value measured.
- Depending on the device version, the configuration is retained in the device memory or in the pluggable data memory (HistoROM DAT).
- Error messages (incl. total operated hours) are stored.

Electrical connection →  28

Potential equalization →  30

Terminals **Transmitter**  
Spring terminals for wire cross-sections 0.5 to 2.5 mm<sup>2</sup> (20 to 14 AWG)

Cable entries



- Cable gland: M20 × 1.5 with cable Ø 6 to 12 mm (0.24 to 0.47 in)
- Thread for cable entry:
  - M20
  - G ½"
  - NPT ½"

Cable specification →  26

## 16.6 Performance characteristics

Reference operating conditions

- Error limits based on ISO 11631
- Water
  - +15 to +45 °C (+59 to +113 °F)
  - 2 to 6 bar (29 to 87 psi)
- Data as indicated in the calibration protocol
- Accuracy based on accredited calibration rigs according to ISO 17025

 To obtain measured errors, use the *Applicator* sizing tool →  110

Maximum measurement error

o.r. = of reading; 1 g/cm<sup>3</sup> = 1 kg/l; T = medium temperature

### Base accuracy

 Design fundamentals →  121

*Mass flow and volume flow (liquids)*

±0.10 % o.r.

*Density (liquids)*

Under reference conditions	Standard density calibration <sup>1)</sup>	Wide-range Density specification <sup>2) 3)</sup>
[g/cm <sup>3</sup> ]	[g/cm <sup>3</sup> ]	[g/cm <sup>3</sup> ]
±0.0005	±0.01	±0.002

- 1) Valid over the entire temperature and density range
- 2) Valid range for special density calibration: 0 to 2 g/cm<sup>3</sup>, +10 to +80 °C (+50 to +176 °F)
- 3) order code for "Application package", option EE "Special density"

*Temperature*

±0.5 °C ± 0.005 · T °C (±0.9 °F ± 0.003 · (T - 32) °F)

### Zero point stability

DN		Zero point stability	
[mm]	[in]	[kg/h]	[lb/min]
8	<sup>3</sup> / <sub>8</sub>	0.20	0.007
15	<sup>1</sup> / <sub>2</sub>	0.65	0.024
25	1	1.80	0.066
40	1 <sup>1</sup> / <sub>2</sub>	4.50	0.165
50	2	7.0	0.257

### Flow values

Flow values as turndown parameters depending on nominal diameter.

*SI units*

DN	1:1	1:10	1:20	1:50	1:100	1:500
[mm]	[kg/h]	[kg/h]	[kg/h]	[kg/h]	[kg/h]	[kg/h]
8	2 000	200	100	40	20	4
15	6 500	650	325	130	65	13
25	18 000	1 800	900	360	180	36
40	45 000	4 500	2 250	900	450	90
50	70 000	7 000	3 500	1 400	700	140

*US units*

DN	1:1	1:10	1:20	1:50	1:100	1:500
[inch]	[lb/min]	[lb/min]	[lb/min]	[lb/min]	[lb/min]	[lb/min]
$\frac{3}{8}$	73.50	7.350	3.675	1.470	0.735	0.147
$\frac{1}{2}$	238.9	23.89	11.95	4.778	2.389	0.478
1	661.5	66.15	33.08	13.23	6.615	1.323
1½	1 654	165.4	82.70	33.08	16.54	3.308
2	2 573	257.3	128.7	51.46	25.73	5.146

**Accuracy of outputs**

 The output accuracy must be factored into the measurement error if analog outputs are used; but can be ignored for fieldbus outputs (e.g. Modbus RS485, EtherNet/IP).

The outputs have the following base accuracy specifications.

*Current output*

Accuracy	Max. $\pm 5 \mu\text{A}$
----------	--------------------------

*Pulse/frequency output*

o.r. = of reading

Accuracy	Max. $\pm 50 \text{ ppm o.r.}$ (over the entire ambient temperature range)
----------	--

**Repeatability**

o.r. = of reading;  $1 \text{ g/cm}^3 = 1 \text{ kg/l}$ ; T = medium temperature

**Base repeatability**

 Design fundamentals →  121

*Mass flow and volume flow (liquids)*

$\pm 0.05 \%$  o.r.

*Density (liquids)*

$\pm 0.00025 \text{ g/cm}^3$

*Temperature*

$\pm 0.25 \text{ }^\circ\text{C} \pm 0.0025 \cdot T \text{ }^\circ\text{C}$  ( $\pm 0.45 \text{ }^\circ\text{F} \pm 0.0015 \cdot (T-32) \text{ }^\circ\text{F}$ )

Response time                      The response time depends on the configuration (damping).

Influence of ambient temperature                      **Current output**  
o.r. = of reading

<b>Temperature coefficient</b>	Max. $\pm 0.005$ % o.r./°C
--------------------------------	----------------------------

**Pulse/frequency output**

<b>Temperature coefficient</b>	No additional effect. Included in accuracy.
--------------------------------	---

Influence of medium temperature                      **Mass flow**  
o.f.s. = of full scale value

If there is a difference between the temperature during zero adjustment and the process temperature, the additional measurement error of the sensors is typically  $\pm 0.0002$  %o.f.s./°C ( $\pm 0.0001$  % o. f.s./°F).

The influence is reduced when the zero adjustment is performed at process temperature.

**Density**

If there is a difference between the density calibration temperature and the process temperature, the measurement error of the sensors is typically  $\pm 0.0001$  g/cm<sup>3</sup>/°C ( $\pm 0.00005$  g/cm<sup>3</sup>/°F). Field density adjustment is possible.

**Wide-range density specification (special density calibration)**

If the process temperature is outside the valid range ( $\rightarrow$   118) the measurement error is  $\pm 0.0001$  g/cm<sup>3</sup> /°C ( $\pm 0.00005$  g/cm<sup>3</sup> /°F)

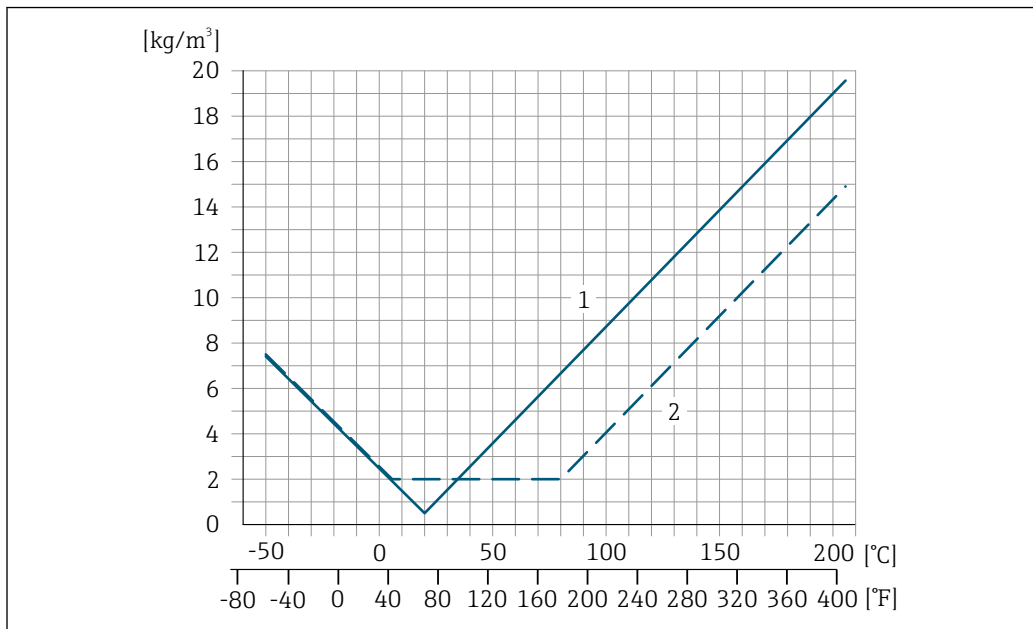

A0016610

- 1 Field density adjustment, for example at +20 °C (+68 °F)
- 2 Special density calibration

**Temperature**

$\pm 0.005 \cdot T$  °C ( $\pm 0.005 \cdot (T - 32)$  °F)



Influence of medium pressure

The following shows how the process pressure (gauge pressure) affects the accuracy of the mass flow.

o.r. = of reading



It is possible to compensate for the effect by:

- Reading in the current pressure measured value via the current input or a digital input.
- Specifying a fixed value for the pressure in the device parameters.



Operating Instructions .

DN		[% o.r./bar]	[% o.r./psi]
[mm]	[in]		
8	3/8	-0.002	-0.0001
15	1/2	-0.006	-0.0004
25	1	-0.005	-0.0003
40	1 1/2	-0.007	-0.0005
50	2	-0.006	-0.0004

Design fundamentals

o.r. = of reading, o.f.s. = of full scale value

BaseAccu = base accuracy in % o.r., BaseRepeat = base repeatability in % o.r.

MeasValue = measured value; ZeroPoint = zero point stability

*Calculation of the maximum measured error as a function of the flow rate*

Flow rate	Maximum measured error in % o.r.
$\geq \frac{\text{ZeroPoint}}{\text{BaseAccu}} \cdot 100$ <small>A0021332</small>	$\pm \text{BaseAccu}$ <small>A0021339</small>
$< \frac{\text{ZeroPoint}}{\text{BaseAccu}} \cdot 100$ <small>A0021333</small>	$\pm \frac{\text{ZeroPoint}}{\text{MeasValue}} \cdot 100$ <small>A0021334</small>

*Calculation of the maximum repeatability as a function of the flow rate*

Flow rate	Maximum repeatability in % o.r.
$\geq \frac{1/2 \cdot \text{ZeroPoint}}{\text{BaseRepeat}} \cdot 100$ <small>A0021335</small>	$\pm \text{BaseRepeat}$ <small>A0021340</small>
$< \frac{1/2 \cdot \text{ZeroPoint}}{\text{BaseRepeat}} \cdot 100$ <small>A0021336</small>	$\pm 1/2 \cdot \frac{\text{ZeroPoint}}{\text{MeasValue}} \cdot 100$ <small>A0021337</small>

**Example of maximum measurement error**

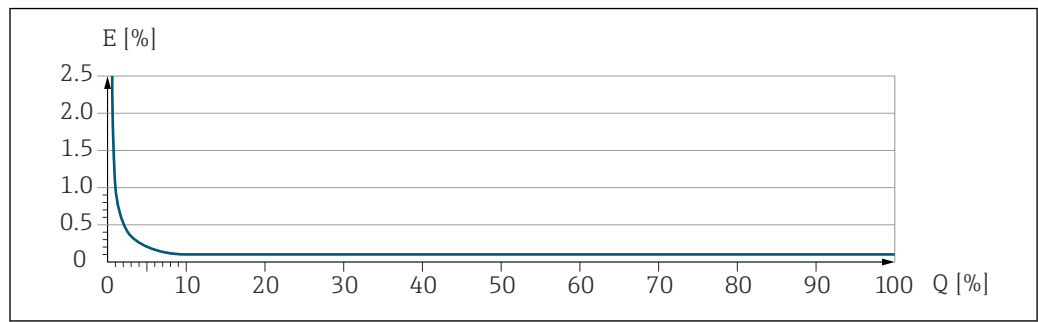

A0030317

E Maximum measurement error in % o.r. (example)  
 Q Flow rate in % of maximum full scale value

**16.7 Mounting**

Mounting requirements → ⓘ 18

**16.8 Environment**

Ambient temperature range → ⓘ 20 → ⓘ 20

**Temperature tables**

- ⓘ Observe the interdependencies between the permitted ambient and fluid temperatures when operating the device in hazardous areas.
- ⓘ For detailed information on the temperature tables, see the separate document entitled "Safety Instructions" (XA) for the device.

Storage temperature -40 to +80 °C (-40 to +176 °F), preferably at +20 °C (+68 °F) (standard version)  
 -50 to +80 °C (-58 to +176 °F) (Order code for "Test, certificate", option JM)

Climate class DIN EN 60068-2-38 (test Z/AD)

Degree of protection **Transmitter and sensor**

- Standard: IP66/67, Type 4X enclosure, suitable for pollution degree 4
- With the order code for "Sensor options", option CM: IP69 can also be ordered
- When the housing is open: IP20, Type 1 enclosure, suitable for pollution degree 2
- Display module: IP20, Type 1 enclosure, suitable for pollution degree 2

Shock and vibration resistance **Vibration sinusoidal, in accordance with IEC 60068-2-6**

- 2 to 8.4 Hz, 3.5 mm peak
- 8.4 to 2 000 Hz, 1 g peak

**Vibration broad-band random, according to IEC 60068-2-64**

- 10 to 200 Hz, 0.003 g<sup>2</sup>/Hz
- 200 to 2 000 Hz, 0.001 g<sup>2</sup>/Hz
- Total: 1.54 g rms

**Shock half-sine, according to IEC 60068-2-27**

6 ms 30 g

**Rough handling shocks according to IEC 60068-2-31**

## Internal cleaning

- CIP cleaning
- SIP cleaning
- Cleaning with pigs

**Options**

Oil- and grease-free version for wetted parts, without declaration  
Order code for "Service", option HA <sup>3)</sup>

## Electromagnetic compatibility (EMC)

- As per IEC/EN 61326 and NAMUR Recommendation 21 (NE 21)
- As per IEC/EN 61000-6-2 and IEC/EN 61000-6-4
- Complies with emission limits for industry as per EN 55011 (Class A)



Details are provided in the Declaration of Conformity.



This unit is not intended for use in residential environments and cannot guarantee adequate protection of the radio reception in such environments.

**16.9 Process**

## Medium temperature range

Standard version	-50 to +150 °C (-58 to +302 °F)	Order code for "Measuring tube mat., wetted surface", option BB, BC, BD
Extended temperature version	-50 to +205 °C (-58 to +401 °F)	Order code for "Measuring tube mat., wetted surface", option TD, TG

## Pressure-temperature ratings



For an overview of the pressure-temperature ratings for the process connections, see the Technical Information

## Sensor housing

The sensor housing is filled with dry nitrogen gas and protects the electronics and mechanics inside.



If a measuring tube fails (e.g. due to process characteristics like corrosive or abrasive fluids), the fluid will initially be contained by the sensor housing.

If the sensor is to be purged with gas (gas detection), it should be equipped with purge connections.



Do not open the purge connections unless the containment can be filled immediately with a dry, inert gas. Use only low pressure to purge.

Maximum pressure: 5 bar (72.5 psi)

**Burst pressure of the sensor housing**

The following sensor housing burst pressures are only valid for standard devices and/or devices equipped with closed purge connections (not opened/as delivered).

<sup>3)</sup> The cleaning refers to the measuring instrument only. Any accessories supplied are not cleaned.

If a device fitted with purge connections (order code for "Sensor option", option CH "Purge connection") is connected to the purge system, the maximum pressure is determined by the purge system itself or by the device, depending on which component has the lower pressure classification.



The sensor housing burst pressure refers to a typical internal pressure which is reached prior to mechanical failure of the sensor housing and which was determined during type testing. The corresponding type test declaration can be ordered with the device (order code for "Additional approval", option LN "Sensor housing burst pressure, type test").

DN		Sensor housing burst pressure	
[mm]	[in]	[bar]	[psi]
8	3/8	190	2755
15	1/2	175	2538
25	1	165	2392
40	1 1/2	152	2204
50	2	103	1494



 For information on the dimensions: see the "Mechanical construction" section of the "Technical Information" document

Flow limit



Select the nominal diameter by optimizing between the required flow range and permissible pressure loss.

 For an overview of the full scale values for the measuring range, see the "Measuring range" section →  113

- The minimum recommended full scale value is approx. 1/20 of the maximum full scale value
- In most applications, 20 to 50 % of the maximum full scale value can be considered ideal
- A low full scale value must be selected for abrasive media (such as liquids with entrained solids): flow velocity < 1 m/s (< 3 ft/s).

 To calculate the flow limit, use the *Applicator* sizing tool →  110

Pressure loss

 To calculate the pressure loss, use the *Applicator* sizing tool →  110

System pressure

→  20

## 16.10 Mechanical construction

### Design, dimensions



For the dimensions and installation lengths of the device, see the "Technical Information" document, "Mechanical construction" section

### Weight

All values (weight exclusive of packaging material) refer to devices with EN/DIN PN 40 flanges. Weight specifications including transmitter: order code for "Housing", option A "Compact, aluminum coated".

#### Weight in SI units

DN [mm]	Weight [kg]
8	12
15	14
25	20
40	36
50	59

#### Weight in US units

DN [in]	Weight [lbs]
3/8	26
1/2	31
1	44
1 1/2	79
2	130

### Materials

#### Transmitter housing

- Order code for "Housing", option **A** "Compact, aluminum coated":  
Aluminum, AlSi10Mg, coated
- Order code for "Housing", option **B** "Compact, hygienic, stainless":  
Hygienic version, stainless steel 1.4301 (304)
- Order code for "Housing", option **C** "Ultra-compact, hygienic, stainless":  
Hygienic version, stainless steel 1.4301 (304)
- Window material for optional local display (→ 128):
  - For order code for "Housing", option **A**: glass
  - For order code for "Housing", option **B** and **C**: plastic

### Cable entries/cable glands

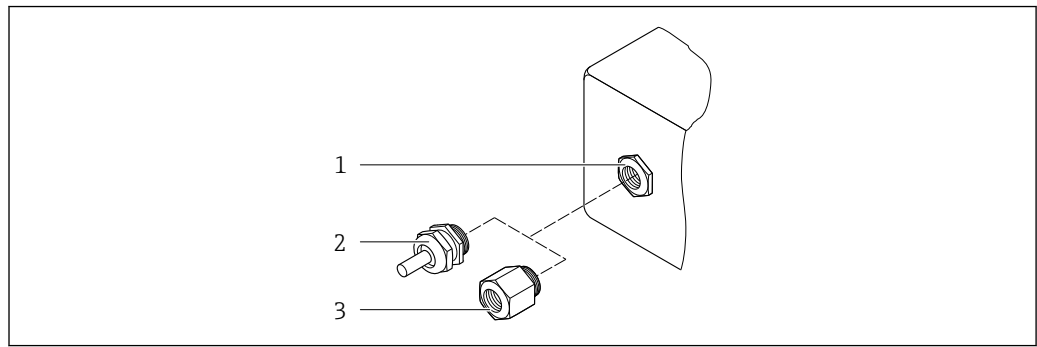

A0020640

19 Possible cable entries/cable glands

- 1 Female thread M20 × 1.5
- 2 Cable gland M20 × 1.5
- 3 Adapter for cable entry with female thread G ½" or NPT ½"

Order code for "Housing", option A "Compact, aluminum, coated"

The various cable entries are suitable for hazardous and non-hazardous areas.

Cable entry/cable gland	Material
Cable gland M20 × 1.5	Nickel-plated brass
Adapter for cable entry with internal thread G ½"	
Adapter for cable entry with internal thread NPT ½"	

Order code for "Housing", option B "Compact, hygienic, stainless"

The various cable entries are suitable for hazardous and non-hazardous areas.

Cable entry/cable gland	Material
Cable gland M20 × 1.5	Stainless steel, 1.4404 (316L)
Adapter for cable entry with internal thread G ½"	
Adapter for cable entry with internal thread NPT ½"	

### Device plug

Electrical connection	Material
Plug M12x1	<ul style="list-style-type: none"> <li>■ Socket: Stainless steel, 1.4404 (316L)</li> <li>■ Contact housing: Polyamide</li> <li>■ Contacts: Gold-plated brass</li> </ul>

### Sensor housing



- Acid and alkali-resistant outer surface
- Stainless steel 1.4301 (304)

### Measuring tubes

Stainless steel, 1.4435 BN2 (316L)

### Process connections

- Flanges according to EN 1092-1 (DIN 2501) / according to ASME B16.5 / according to JIS B2220:  
Stainless steel, 1.4404 (F316/F316L)
- All other process connections:  
Stainless steel, 1.4435 BN2 (316L)

 Available process connections →  127

### Seals

Welded process connections without internal seals

### Accessories

*Protective cover*

Stainless steel, 1.4404 (316L)

*Safety Barrier Promass 100*

Housing: Polyamide

---

### Process connections

- Fixed flange connections:
  - EN 1092-1 (DIN 2501) flange
  - EN 1092-1 (DIN 2512N) flange
  - ASME B16.5 flange
  - JIS B2220 flange
  - DIN 11864-2 Form A flange, DIN 11866 series A, flange with notch
  - BBS flange small (sterile orbital), DIN 11866 series A, female
  - BBS flange small (sterile orbital), DIN 11866 series B, female
- Clamp connections:
  - Tri-Clamp (OD tubes), DIN 11866 series C
  - DIN 11864-3 Form A clamp, DIN 11866 series A, with notch
  - DIN 32676 clamp, DIN 11866 series A
  - ISO 2852 clamp, ISO 2037
  - ISO 2852 clamp, DIN 11866 series B
  - BBS Quick-Connect (sterile orbital), DIN 11866 series A, female
  - BBS Quick-Connect (sterile orbital), DIN 11866 series B, female
  - Neumo BioConnect clamp, DIN 11866 series A, clamp form R
- Eccentric clamp connections:
  - Eccen. Tri-Clamp, DIN 11866 series C
  - DIN 11864-3 Form A clamp, DIN 11866 series A, with notch
  - DIN 32676 clamp, DIN 11866 series A
  - ISO 2852 clamp, DIN 11866 series B
  - BBS Quick-Connect (sterile orbital), DIN 11866 series A, female
  - BBS Quick-Connect (sterile orbital), DIN 11866 series B, female
  - Neumo BioConnect clamp, DIN 11866 series A, clamp form R
- Thread:
  - DIN 11851 thread, DIN 11866 series A
  - SMS 1145 thread
  - ISO 2853 thread, ISO 2037
  - DIN 11864-1 Form A thread, DIN 11866 series A
  - BBS thread (sterile orbital), DIN 11866 series A
  - BBS thread (sterile orbital), DIN 11866 series B

 Process connection materials

Surface roughness

All data refer to parts in contact with the medium.

*The following surface roughness categories can be ordered:*

Category	Method	Option(s) order code "Measuring tube mat., wetted surface"
Ra ≤ 0.76 μm (30 μin) <sup>1)</sup>	Mechanically polished	BB, TD
Ra ≤ 0.38 μm (15 μin) <sup>1)</sup>	Mechanical and electropolished	BC, TG

1) Ra according to ISO 21920

## 16.11 Operability

Local display

The local display is only available with the following device order code:  
Order code for "Display; operation", option **B**: 4-line; illuminated, via communication

**Display element**

- 4-line liquid crystal display with 16 characters per line.
- White background lighting; switches to red in event of device errors.
- Format for displaying measured variables and status variables can be individually configured.
- Permitted ambient temperature for the display: -20 to +60 °C (-4 to +140 °F). The readability of the display may be impaired at temperatures outside the temperature range.

**Disconnecting the local display from the main electronics module**

 In the case of the "Compact, aluminum coated" housing version, the local display must only be disconnected manually from the main electronics module. In the case of the "Compact, hygienic, stainless" and "Ultra-compact, hygienic, stainless" housing versions, the local display is integrated in the housing cover and is disconnected from the main electronics module when the housing cover is opened.

*"Compact, aluminum coated" housing version*

The local display is plugged onto the main electronics module. The electronic connection between the local display and main electronics module is established via a connecting cable.

For some work performed on the measuring device (e.g. electrical connection), it is advisable to disconnect the local display from the main electronics module:

1. Press in the side latches of the local display.
2. Remove the local display from the main electronics module. Pay attention to the length of the connecting cable when doing so.

Once the work is completed, plug the local display back on.

Remote operation

**Via HART protocol**

This communication interface is available in device versions with a HART output.



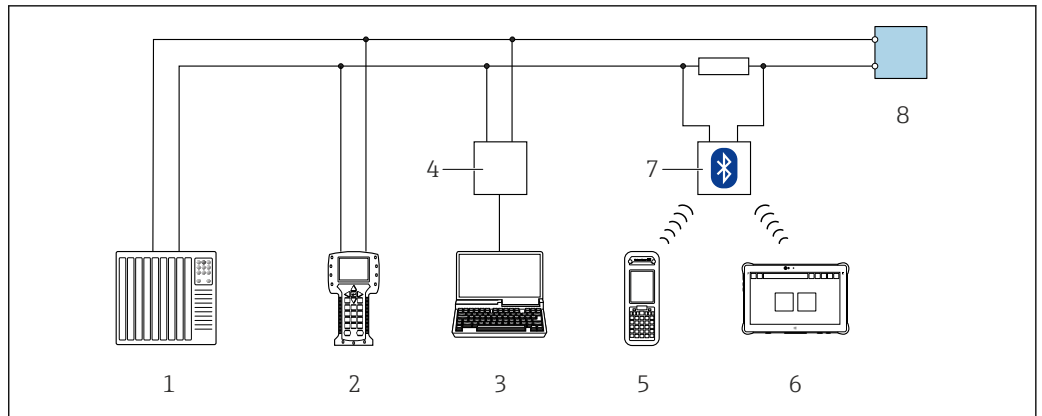

A0028747

20 Options for remote operation via HART protocol

- 1 Control system (e.g. PLC)
- 2 Field Communicator 475
- 3 Computer with operating tool (e.g. FieldCare, AMS Device Manager, SIMATIC PDM)
- 4 Commubox FXA195 (USB)
- 5 Field Xpert SFX350 or SFX370
- 6 Field Xpert SMT70
- 7 VIATOR Bluetooth modem with connecting cable
- 8 Transmitter

Service interface

Via service interface (CDI-RJ45)

HART

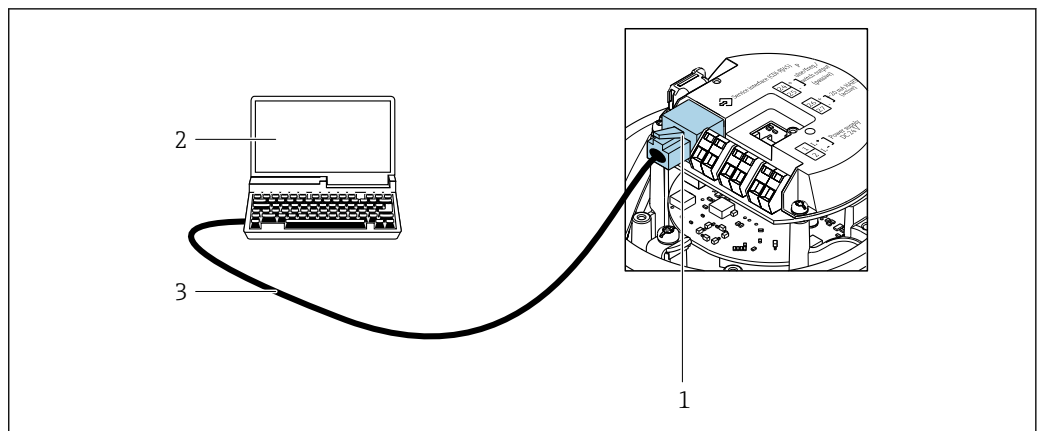

A0016926

21 Connection for the order code for "Output", option B: 4-20 mA HART, pulse/frequency/switch output

- 1 Service interface (CDI-RJ45) of the measuring device with access to the integrated web server
- 2 Computer with web browser (e.g. Internet Explorer) for accessing the integrated web server or with "FieldCare" operating tool with COM DTM "CDI Communication TCP/IP"
- 3 Standard Ethernet connecting cable with RJ45 plug

Languages

Can be operated in the following languages:

- Via "FieldCare" operating tool: English, German, French, Spanish, Italian, Chinese, Japanese
- Via Web browser: English, German, French, Spanish, Italian, Dutch, Portuguese, Polish, Russian, Turkish, Chinese, Japanese, Bahasa (Indonesian), Vietnamese, Czech, Swedish, Korean

## 16.12 Certificates and approvals

Current certificates and approvals for the product are available at [www.endress.com](http://www.endress.com) on the relevant product page:

1. Select the product using the filters and search field.
2. Open the product page.
3. Select **Downloads**.

---

**CE mark** The device meets the legal requirements of the applicable EU Directives. These are listed in the corresponding EU Declaration of Conformity along with the standards applied.  
Endress+Hauser confirms successful testing of the device by affixing to it the CE mark.

---

**UKCA marking** The device meets the legal requirements of the applicable UK regulations (Statutory Instruments). These are listed in the UKCA Declaration of Conformity along with the designated standards. By selecting the order option for UKCA marking, Endress+Hauser confirms a successful evaluation and testing of the device by affixing the UKCA mark.  
  
Contact address Endress+Hauser UK:  
Endress+Hauser Ltd.  
Floats Road  
Manchester M23 9NF  
United Kingdom  
[www.uk.endress.com](http://www.uk.endress.com)

---

**RCM marking** The measuring system meets the EMC requirements of the "Australian Communications and Media Authority (ACMA)".

---

**Ex-approval** The devices are certified for use in hazardous areas and the relevant safety instructions are provided in the separate "Safety Instructions" (XA) document. Reference is made to this document on the nameplate.

---

**Hygienic compatibility**

- 3-A approval
  - Only measuring instruments with the order code for "Additional approval", option LP "3A" have 3-A approval.
  - The 3-A approval refers to the measuring instrument.
  - When installing the measuring instrument, ensure that no liquid can accumulate on the outside of the measuring instrument.  
A remote display module must be installed in accordance with the 3-A Standard.
  - Accessories (e.g. heating jacket, weather protection cover, wall holder unit) must be installed in accordance with the 3-A Standard.  
Each accessory can be cleaned. Disassembly may be necessary under certain circumstances.
- EHEDG-tested  
Only devices with the order code for "Additional approval", option LT "EHEDG" have been tested and meet the requirements of the EHEDG.  
To meet the requirements for EHEDG certification, the device must be used with process connections in accordance with the EHEDG position paper entitled "Easy cleanable Pipe couplings and Process connections" ([www.ehedg.org](http://www.ehedg.org)).  
To meet the requirements for EHEDG certification, the device must be installed in a position that ensures drainability.

 Observe the special installation instructions



Pharmaceutical compatibility	<ul style="list-style-type: none"> <li>■ FDA 21 CFR 177</li> <li>■ USP &lt;87&gt;</li> <li>■ USP &lt;88&gt; Class VI 121 °C</li> <li>■ TSE/BSE Certificate of Suitability</li> </ul>
HART certification	<p><b>HART interface</b></p> <p>The measuring device is certified and registered by the FieldComm Group. The measuring system meets all the requirements of the following specifications:</p> <ul style="list-style-type: none"> <li>■ Certified according to HART 7</li> <li>■ The device can also be operated with certified devices of other manufacturers (interoperability)</li> </ul>
Pressure Equipment Directive	<ul style="list-style-type: none"> <li>■ With the marking <ul style="list-style-type: none"> <li>a) PED/G1/x (x = category) or</li> <li>b) PESR/G1/x (x = category)</li> </ul> on the sensor nameplate, Endress+Hauser confirms compliance with the "Essential Safety Requirements" <ul style="list-style-type: none"> <li>a) specified in Annex I of the Pressure Equipment Directive 2014/68/EU or</li> <li>b) Schedule 2 of Statutory Instruments 2016 No. 1105.</li> </ul> </li> <li>■ Devices not bearing this marking (without PED or PESR) are designed and manufactured according to sound engineering practice. They meet the requirements of <ul style="list-style-type: none"> <li>a) Art. 4 Para. 3 of the Pressure Equipment Directive 2014/68/EU or</li> <li>b) Part 1, Para. 8 of Statutory Instruments 2016 No. 1105.</li> </ul> The scope of application is indicated <ul style="list-style-type: none"> <li>a) in diagrams 6 to 9 in Annex II of the Pressure Equipment Directive 2014/68/EU or</li> <li>b) Schedule 3, Para. 2 of Statutory Instruments 2016 No. 1105.</li> </ul> </li> </ul>
External standards and guidelines	<ul style="list-style-type: none"> <li>■ EN 60529 Degrees of protection provided by enclosures (IP code)</li> <li>■ IEC/EN 60068-2-6 Environmental influences: Test procedure - Test Fc: vibrate (sinusoidal).</li> <li>■ IEC/EN 60068-2-31 Environmental influences: Test procedure - Test Ec: shocks due to rough handling, primarily for devices.</li> <li>■ EN 61010-1 Safety requirements for electrical equipment for measurement, control and laboratory use - general requirements</li> <li>■ EN 61326-1/-2-3 EMC requirements for electrical equipment for measurement, control and laboratory use</li> <li>■ NAMUR NE 21 Electromagnetic compatibility (EMC) of industrial process and laboratory control equipment</li> <li>■ NAMUR NE 32 Data retention in the event of a power failure in field and control instruments with microprocessors</li> <li>■ NAMUR NE 43 Standardization of the signal level for the breakdown information of digital transmitters with analog output signal.</li> <li>■ NAMUR NE 53 Software of field devices and signal-processing devices with digital electronics</li> <li>■ NAMUR NE 80 The application of the pressure equipment directive to process control devices</li> <li>■ NAMUR NE 105 Specifications for integrating fieldbus devices in engineering tools for field devices</li> <li>■ NAMUR NE 107 Self-monitoring and diagnosis of field devices</li> </ul>

- NAMUR NE 131  
Requirements for field devices for standard applications
- NAMUR NE 132  
Coriolis mass meter
- ETSI EN 300 328  
Guidelines for 2.4 GHz radio components.
- EN 301489  
Electromagnetic compatibility and radio spectrum matters (ERM).

## 16.13 Application packages

Many different application packages are available to enhance the functionality of the device. Such packages might be needed to address safety aspects or specific application requirements.

The application packages can be ordered with the device or subsequently from Endress+Hauser. Detailed information on the order code in question is available from your local Endress+Hauser sales center or on the product page of the Endress+Hauser website: [www.endress.com](http://www.endress.com).

 Detailed information on the application packages:  
Special Documentation →  134

---

### Heartbeat Technology

Order code for "Application package", option EB "Heartbeat Verification + Monitoring"

#### Heartbeat Verification

Meets the requirement for traceable verification to DIN ISO 9001:2008 Chapter 7.6 a) "Control of monitoring and measuring equipment".

- Functional testing in the installed state without interrupting the process.
- Traceable verification results on request, including a report.
- Simple testing process via local operation or other operating interfaces.
- Clear measuring point assessment (pass/fail) with high test coverage within the framework of manufacturer specifications.
- Extension of calibration intervals according to operator's risk assessment.

#### Heartbeat Monitoring

Continuously supplies data, which are characteristic of the measuring principle, to an external condition monitoring system for the purpose of preventive maintenance or process analysis. These data enable the operator to:

- Draw conclusions - using these data and other information - about the impact process influences (e.g. corrosion, abrasion, buildup etc.) have on the measuring performance over time.
- Schedule servicing in time.
- Monitor the process or product quality, e.g. gas pockets .

 For detailed information, see the Special Documentation for the device.

---

### Concentration measurement

Order code for "Application package", option ED "Concentration"

Calculation and outputting of fluid concentrations.

The measured density is converted to the concentration of a substance of a binary mixture using the "Concentration" application package:

- Choice of predefined fluids (e.g. various sugar solutions, acids, alkalis, salts, ethanol etc.).
- Common or user-defined units (°Brix, °Plato, % mass, % volume, mol/l etc.) for standard applications.
- Concentration calculation from user-defined tables.

The measured values are output via the digital and analog outputs of the device.



For detailed information, see the Special Documentation for the device.

### Special density

Order code for "Application package", option EE "Special density"

Many applications use density as a key measured value for monitoring quality or controlling processes. The measuring instrument measures the density of the fluid as standard and makes this value available to the control system.

The "Special Density" application package offers high-precision density measurement over a wide density and temperature range particularly for applications subject to varying process conditions.



For detailed information, see the Operating Instructions for the device.

## 16.14 Accessories



Overview of accessories available to order →  109

## 16.15 Supplementary documentation



For an overview of the scope of the associated Technical Documentation, refer to the following:

- *Device Viewer* ([www.endress.com/deviceviewer](http://www.endress.com/deviceviewer)): Enter the serial number from the nameplate
- *Endress+Hauser Operations app*: Enter serial number from nameplate or scan matrix code on nameplate.

### Standard documentation

#### Brief Operating instructions

*Brief Operating Instructions for the sensor*

Measuring instrument	Documentation code
Proline Promass P	KA01286D

*Transmitter Brief Operating Instructions*

Measuring device	Documentation code
Proline Promass 100	KA01334D

#### Technical Information

Measuring device	Documentation code
Proline Promass P 100	TI01036D

#### Description of Device Parameters

Measuring device	Documentation code
Proline Promass 100	GP01033D

Supplementary device-  
dependent documentation



### Safety Instructions

Content	Documentation code
ATEX/IECEX Ex i	XA00159D
ATEX/IECEX Ex nA	XA01029D
cCSAus IS	XA00160D
INMETRO Ex i	XA01219D
INMETRO Ex nA	XA01220D
NEPSI Ex i	XA01249D
NEPSI Ex nA	XA01262D

### Special Documentation

Content	Documentation code
Information on the Pressure Equipment Directive	SD00142D
Concentration measurement	SD01152D
Heartbeat Technology	SD01153D
Web server	SD01820D

### Installation instructions

Contents	Note
Installation instructions for spare part sets and accessories	<ul style="list-style-type: none"> <li>▪ Access the overview of all the available spare part sets via <i>Device Viewer</i> →  107</li> <li>▪ Accessories available for order with Installation Instructions →  109</li> </ul>

# Index

## 0 ... 9

3-A approval . . . . . 130

## A

Access authorization to parameters

    Read access . . . . . 39

    Write access . . . . . 39

Access code . . . . . 39

    Incorrect input . . . . . 39

Adapting the diagnostic behavior . . . . . 95

Adapting the status signal . . . . . 96

Ambient conditions

    Shock and vibration resistance . . . . . 122

    Storage temperature . . . . . 122

Ambient temperature

    Influence . . . . . 120

AMS Device Manager . . . . . 47

    Function . . . . . 47

Application . . . . . 112

Application packages . . . . . 132

Approvals . . . . . 130

## B

Burst mode . . . . . 51

## C

Cable entries

    Technical data . . . . . 117

Cable entry

    Degree of protection . . . . . 33

CE mark . . . . . 10, 130

Certificates . . . . . 130

cGMP . . . . . 131

Checklist

    Post-connection check . . . . . 33

    Post-installation check . . . . . 25

CIP cleaning . . . . . 123

Cleaning

    CIP cleaning . . . . . 106

    Exterior cleaning . . . . . 106

    Internal cleaning . . . . . 106

    SIP cleaning . . . . . 106

Climate class . . . . . 122

Commissioning . . . . . 54

    Advanced settings . . . . . 71

    Configuring the measuring instrument . . . . . 54

Communication-specific data . . . . . 49

Connecting cable . . . . . 26

Connecting the measuring instrument . . . . . 28

Connection

    see Electrical connection

Connection preparations . . . . . 28

Connection tools . . . . . 26

Current consumption . . . . . 117

## D

Date of manufacture . . . . . 13, 14

Declaration of Conformity . . . . . 10

Defining the access code . . . . . 82

Degree of protection . . . . . 33, 122

Density adjustment . . . . . 75

Design

    Measuring device . . . . . 11

    Operating menu . . . . . 36

Design fundamentals

    Measurement error . . . . . 121

    Repeatability . . . . . 121

Device components . . . . . 11

Device description files . . . . . 49

Device fuse . . . . . 117

Device locking, status . . . . . 84

Device name

    Sensor . . . . . 14

    Transmitter . . . . . 13

Device repair . . . . . 107

Device revision . . . . . 49

Device type code . . . . . 49

Device Viewer . . . . . 107

DeviceCare . . . . . 47

    Device description file . . . . . 49

Diagnostic information

    Design, description . . . . . 93, 95

    DeviceCare . . . . . 94

    FieldCare . . . . . 94

    LEDs . . . . . 91

    Overview . . . . . 96

    Remedial measures . . . . . 96

    Web browser . . . . . 92

Diagnostics list . . . . . 100

DIP switch

    see Write protection switch

Disabling write protection . . . . . 82

Display area

    For operational display . . . . . 38

Display values

    For locking status . . . . . 84

Disposal . . . . . 108

Document

    Function . . . . . 6

    Symbols . . . . . 6

Document function . . . . . 6

Down pipe . . . . . 18

## E

EHEDG-tested . . . . . 130

Electrical connection

    Commubox FXA195 (USB) . . . . . 45, 128

    Degree of protection . . . . . 33

    Field Communicator 475 . . . . . 45, 128

    Field Xpert SFX350/SFX370 . . . . . 45, 128

    Measuring instrument . . . . . 26

    Operating tool (e.g. FieldCare, AMS Device

    Manager, SIMATIC PDM) . . . . . 45, 128

- Operating tools
  - Via HART protocol . . . . . 45, 128
  - Via service interface (CDI-RJ45) . . . . . 45, 129
- VIATOR Bluetooth modem . . . . . 45, 128
- Web server . . . . . 45, 129
- Electromagnetic compatibility . . . . . 123
- Enabling write protection . . . . . 82
- Endress+Hauser services
  - Maintenance . . . . . 106
  - Repair . . . . . 107
- Error messages
  - see Diagnostic messages
- Event logbook . . . . . 100
- Events list . . . . . 100
- Ex-approval . . . . . 130
- Extended order code
  - Sensor . . . . . 14
  - Transmitter . . . . . 13
- Exterior cleaning . . . . . 106
- F**
- FDA . . . . . 130, 131
- Field Communicator
  - Function . . . . . 48
- Field Communicator 475 . . . . . 48
- Field of application
  - Residual risks . . . . . 10
- Field Xpert
  - Function . . . . . 46
- Field Xpert SFX350 . . . . . 46
- FieldCare . . . . . 46
  - Device description file . . . . . 49
  - Establishing a connection . . . . . 46
  - Function . . . . . 46
  - User interface . . . . . 47
- Filtering the event logbook . . . . . 101
- Firmware
  - Release date . . . . . 49
  - Version . . . . . 49
- Firmware history . . . . . 105
- Flow direction . . . . . 19, 24
- Flow limit . . . . . 124
- Food Contact Materials Regulation . . . . . 130
- Function range
  - AMS Device Manager . . . . . 47
  - SIMATIC PDM . . . . . 48
- Function scope
  - Field Communicator . . . . . 48
  - Field Communicator 475 . . . . . 48
  - Field Xpert . . . . . 46
- Functions
  - see Parameters
- G**
- Galvanic isolation . . . . . 116
- H**
- Hardware write protection . . . . . 83
- HART certification . . . . . 131
- HART input
  - Settings . . . . . 65
- HART protocol
  - Device variables . . . . . 49
  - Measured variables . . . . . 49
- Hygienic compatibility . . . . . 130
- I**
- I/O electronics module . . . . . 11, 29
- Identifying the measuring instrument . . . . . 12
- Incoming acceptance . . . . . 12
- Indication
  - Current diagnostic event . . . . . 99
  - Previous diagnostic event . . . . . 99
- Influence
  - Ambient temperature . . . . . 120
  - Medium pressure . . . . . 121
  - Medium temperature . . . . . 120
- Information about this document . . . . . 6
- Inlet runs . . . . . 20
- Input variables . . . . . 113
- Inspection
  - Connection . . . . . 33
  - Installation . . . . . 25
  - Received goods . . . . . 12
- Installation . . . . . 18
- Installation dimensions . . . . . 20
- Installation point . . . . . 18
- Intended use . . . . . 9
- Internal cleaning . . . . . 106, 123
- L**
- Languages, operation options . . . . . 129
- Local display
  - see Operational display
- Low flow cut off . . . . . 116
- M**
- Main electronics module . . . . . 11
- Maintenance work . . . . . 106
- Manufacturer ID . . . . . 49
- Materials . . . . . 125
- Maximum measurement error . . . . . 118
- Measured variables
  - see Process variables
- Measurement accuracy . . . . . 118
- Measuring and test equipment . . . . . 106
- Measuring device
  - Conversion . . . . . 107
  - Design . . . . . 11
  - Disposal . . . . . 108
  - Mounting the sensor . . . . . 24
  - Preparing for electrical connection . . . . . 28
  - Removing . . . . . 108
  - Repairs . . . . . 107
- Measuring instrument
  - Configuring . . . . . 54
  - Preparing for mounting . . . . . 24
- Measuring principle . . . . . 112



- Measuring range
  - For liquids . . . . . 113
- Measuring range, recommended . . . . . 124
- Measuring system . . . . . 112
- Medium pressure
  - Influence . . . . . 121
- Medium temperature
  - Influence . . . . . 120
- Menu
  - Diagnostics . . . . . 99
  - Operation . . . . . 84
  - Setup . . . . . 54
- Menus
  - For measuring instrument configuration . . . . . 54
  - For specific settings . . . . . 71
- Mounting dimensions
  - see Installation dimensions
- Mounting preparations . . . . . 24
- Mounting requirements
  - Down pipe . . . . . 18
  - Inlet and outlet runs . . . . . 20
  - Installation dimensions . . . . . 20
  - Installation point . . . . . 18
  - Orientation . . . . . 19
  - Sensor heating . . . . . 21
  - Static pressure . . . . . 20
  - Thermal insulation . . . . . 20
  - Vibrations . . . . . 22
- Mounting tools . . . . . 24
- N**
- Nameplate
  - Sensor . . . . . 14
  - Transmitter . . . . . 13
- Netilion . . . . . 106
- O**
- Operable flow range . . . . . 113
- Operating menu
  - Design . . . . . 36
  - Menus, submenus . . . . . 36
  - Submenus and user roles . . . . . 37
- Operating philosophy . . . . . 37
- Operation . . . . . 84
- Operation options . . . . . 35
- Operational display . . . . . 38
- Operational safety . . . . . 10
- Order code . . . . . 13, 14
- Orientation (vertical, horizontal) . . . . . 19
- Outlet runs . . . . . 20
- Output signal . . . . . 114
- Output variables . . . . . 114
- P**
- Packaging disposal . . . . . 17
- Parameter settings
  - Administration (Submenu) . . . . . 79
  - Advanced setup (Submenu) . . . . . 71
  - Burst configuration 1 to n (Submenu) . . . . . 51
  - Corrected volume flow calculation (Submenu) . . . . . 74
  - Current output 1 (Submenu) . . . . . 58
  - Density adjustment (Wizard) . . . . . 75
  - Device information (Submenu) . . . . . 103
  - Diagnostics (Menu) . . . . . 99
  - HART input (Submenu) . . . . . 65
  - Low flow cut off (Wizard) . . . . . 69
  - Measured variables (Submenu) . . . . . 84
  - Medium selection (Submenu) . . . . . 56
  - Output conditioning (Wizard) . . . . . 66
  - Output values (Submenu) . . . . . 87
  - Partially filled pipe detection (Wizard) . . . . . 70
  - Pulse/frequency/switch output 1 (Submenu) . . 61, 63
  - Sensor adjustment (Submenu) . . . . . 75
  - Setup (Menu) . . . . . 54
  - Simulation (Submenu) . . . . . 80
  - System units (Submenu) . . . . . 71
  - Totalizer (Submenu) . . . . . 86
  - Totalizer 1 to n (Submenu) . . . . . 78
  - Totalizer handling (Submenu) . . . . . 88
  - Web server (Submenu) . . . . . 44
  - Zero point adjustment (Submenu) . . . . . 78
- Performance characteristics . . . . . 118
- Performing density adjustment . . . . . 75
- Pharmaceutical compatibility . . . . . 131
- Post-connection check . . . . . 54
- Post-connection check (checklist) . . . . . 33
- Post-installation check . . . . . 54
- Post-installation check (checklist) . . . . . 25
- Potential equalization . . . . . 30
- Power consumption . . . . . 117
- Power supply failure . . . . . 117
- Pressure Equipment Directive . . . . . 131
- Pressure loss . . . . . 124
- Pressure-temperature ratings . . . . . 123
- Process connections . . . . . 127
- Process variables
  - Calculated . . . . . 113
  - Measured . . . . . 113
- Product safety . . . . . 10
- Protecting parameter settings . . . . . 82
- R**
- RCM marking . . . . . 130
- Read access . . . . . 39
- Reading off measured values . . . . . 84
- Recalibration . . . . . 106
- Reference operating conditions . . . . . 118
- Registered trademarks . . . . . 8
- Remote operation . . . . . 128
- Repair . . . . . 107
  - Notes . . . . . 107
- Repair of a device . . . . . 107
- Repeatability . . . . . 119
- Replacement
  - Device components . . . . . 107
- Requirements for personnel . . . . . 9
- Response time . . . . . 120
- Return . . . . . 107

**S**

Safety	9
Sensor	
Installing	24
Sensor heating	21
Sensor housing	123
Serial number	13, 14
Setting the operating language	54
Settings	
Adapting the measuring device to the process conditions	88
Administration	79
Current output	58
HART input	65
Low flow cut off	69
Medium	56
Operating language	54
Output conditioning	66
Partially filled pipe detection	70
Pulse output	61
Pulse/frequency/switch output	60, 61
Resetting the device	102
Resetting the totalizer	88
Sensor adjustment	75
Simulation	80
Switch output	63
System units	71
Tag name	54
Totalizer	78
Totalizer reset	88
Shock and vibration resistance	122
Signal on alarm	115
SIMATIC PDM	48
Function	48
SIP cleaning	123
Software release	49
Spare part	107
Spare parts	107
Special connection instructions	31
Special mounting instructions	
Hygienic compatibility	22
Standards and guidelines	131
Static pressure	20
Status area	
For operational display	38
Status signals	93, 94
Storage conditions	16
Storage temperature	16
Storage temperature range	122
Submenu	
Administration	79
Advanced setup	71
Burst configuration 1 to n	51
Calculated values	73
Corrected volume flow calculation	74
Current output 1	58
Device information	103
Events list	100
HART input	65

Measured values	84
Measured variables	84
Medium selection	56
Output values	87
Overview	37
Process variables	73
Pulse/frequency/switch output 1	60, 61, 63
Sensor adjustment	75
Simulation	80
System units	71
Totalizer	86
Totalizer 1 to n	78
Totalizer handling	88
Web server	44
Zero point adjustment	78
Supply voltage	117
Surface roughness	128
Symbols	
For communication	38
For diagnostic behavior	38
For locking	38
For measured variable	38
For measurement channel number	38
For status signal	38
In the status area of the local display	38
System design	
Measuring system	112
see Measuring device design	
System integration	49
<b>T</b>	
Technical data, overview	112
Temperature range	
Medium temperature	123
Storage temperature	16
Terminal assignment	27, 29
Terminals	117
Thermal insulation	20
Tool	
Transport	16
Tools	
Electrical connection	26
For mounting	24
Totalizer	
Configuring	78
Transmitter	
Connecting the signal cables	29
Turning the display module	24
Transporting the measuring device	16
Troubleshooting	
General	90
TSE/BSE Certificate of Suitability	131
Turning the display module	24
<b>U</b>	
UKCA marking	130
Use of measuring device	
Borderline cases	9
Incorrect use	9

Use of measuring instrument see Intended use	
User roles . . . . .	37
USP Class VI . . . . .	131
<b>V</b>	
Version data for the device . . . . .	49
Vibrations . . . . .	22
<b>W</b>	
W@M Device Viewer . . . . .	12
Weight	
SI units . . . . .	125
Transport (notes) . . . . .	16
US units . . . . .	125
Wizard	
Define access code . . . . .	82
Density adjustment . . . . .	75
Low flow cut off . . . . .	69
Output conditioning . . . . .	66
Partially filled pipe detection . . . . .	70
Workplace safety . . . . .	10
Write access . . . . .	39
Write protection	
Via access code . . . . .	82
Via write protection switch . . . . .	83
Write protection switch . . . . .	83



71674452

[www.addresses.endress.com](http://www.addresses.endress.com)

---