

Operating Instructions

Proline Promass I 100

Coriolis flowmeter
PROFIBUS DP

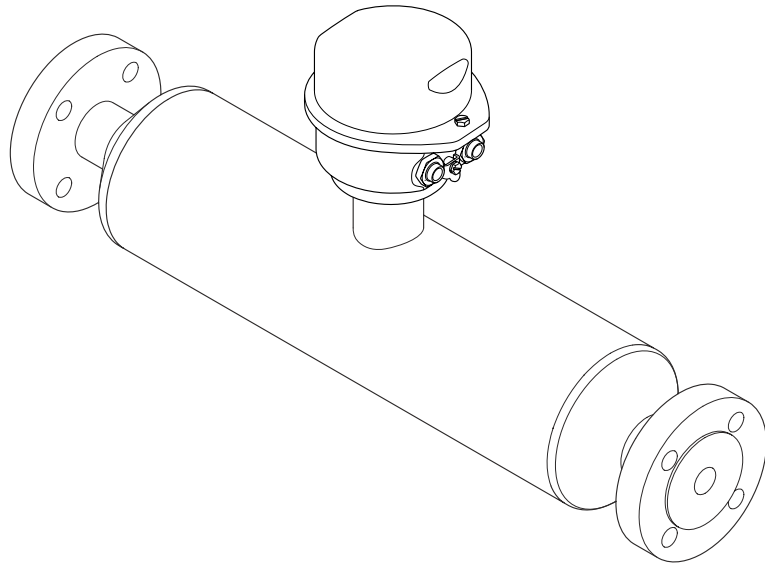

- Make sure the document is stored in a safe place such that it is always available when working on or with the device.
- To avoid danger to individuals or the facility, read the "Basic safety instructions" section carefully, as well as all other safety instructions in the document that are specific to working procedures.
- The manufacturer reserves the right to modify technical data without prior notice. Your Endress+Hauser sales organization will supply you with current information and updates to this manual.

Table of contents

1	About this document	6			
1.1	Document function	6			
1.2	Symbols	6			
1.2.1	Safety symbols	6			
1.2.2	Electrical symbols	6			
1.2.3	Tool symbols	6			
1.2.4	Symbols for certain types of information	7			
1.2.5	Symbols in graphics	7			
1.3	Documentation	7			
1.4	Registered trademarks	8			
2	Safety instructions	9			
2.1	Requirements for the personnel	9			
2.2	Intended use	9			
2.3	Workplace safety	10			
2.4	Operational safety	10			
2.5	Product safety	10			
2.6	IT security	10			
3	Product description	11			
3.1	Product design	11			
3.1.1	Device version with PROFIBUS DP communication protocol	11			
4	Incoming acceptance and product identification	12			
4.1	Incoming acceptance	12			
4.2	Product identification	12			
4.2.1	Transmitter nameplate	13			
4.2.2	Sensor nameplate	14			
4.2.3	Symbols on the device	15			
5	Storage and transport	16			
5.1	Storage conditions	16			
5.2	Transporting the product	16			
5.2.1	Measuring devices without lifting lugs	16			
5.2.2	Measuring devices with lifting lugs . .	17			
5.2.3	Transporting with a fork lift	17			
5.3	Packaging disposal	17			
6	Installation	18			
6.1	Installation requirements	18			
6.1.1	Installation position	18			
6.1.2	Environmental and process requirements	20			
6.1.3	Special installation instructions	21			
6.2	Installing the measuring instrument	23			
6.2.1	Required tools	23			
6.2.2	Preparing the measuring instrument .	23			
6.2.3	Mounting the measuring device	24			
6.2.4	Turning the display module	24			
6.3	Post-installation check	25			
7	Electrical connection	26			
7.1	Electrical safety	26			
7.2	Connecting requirements	26			
7.2.1	Required tools	26			
7.2.2	Requirements for connecting cable . . .	26			
7.2.3	Terminal assignment	27			
7.2.4	Pin assignment, device plug	28			
7.2.5	Preparing the measuring device	28			
7.3	Connecting the measuring instrument	28			
7.3.1	Connecting the transmitter	29			
7.4	Potential equalization	30			
7.4.1	Requirements	30			
7.5	Special connection instructions	31			
7.5.1	Connection examples	31			
7.6	Hardware settings	31			
7.6.1	Setting the device address	31			
7.6.2	Enabling the terminating resistor	32			
7.7	Ensuring the degree of protection	33			
7.8	Post-connection check	33			
8	Operation options	35			
8.1	Overview of operation options	35			
8.2	Structure and function of the operating menu	36			
8.2.1	Structure of the operating menu	36			
8.2.2	Operating philosophy	37			
8.3	Displaying the measured values via the local display (optionally available)	38			
8.3.1	Operational display	38			
8.3.2	User roles and related access authorization	39			
8.4	Access to operating menu via web browser . .	40			
8.4.1	Function range	40			
8.4.2	Prerequisites	40			
8.4.3	Connecting the device	41			
8.4.4	Logging on	42			
8.4.5	User interface	43			
8.4.6	Disabling the Web server	44			
8.4.7	Logging out	44			
8.5	Access to the operating menu via the operating tool	45			
8.5.1	Connecting the operating tool	45			
8.5.2	FieldCare	46			
8.5.3	DeviceCare	47			
9	System integration	48			
9.1	Overview of device description files	48			
9.1.1	Current version data for the device . . .	48			
9.1.2	Operating tools	48			

9.2	Device master file (GSD)	48			
9.2.1	Manufacturer-specific GSD	49			
9.2.2	Profile GSD	49			
9.3	Integration into a PROFIBUS network	50			
9.3.1	Block model	50			
9.3.2	Assignment of the measured values in the function blocks	50			
9.3.3	Totalizer control SET_TOT	51			
9.4	Cyclic data transmission	52			
9.4.1	Block model	52			
9.4.2	Description of the modules	52			
10	Commissioning	58			
10.1	Post-mounting and post-connection check	58			
10.2	Connecting via FieldCare	58			
10.3	Setting the operating language	58			
10.4	Configuring the measuring instrument	58			
10.4.1	Defining the tag name	59			
10.4.2	Setting the system units	59			
10.4.3	Selecting and setting the medium	62			
10.4.4	Configuring communication interface	63			
10.4.5	Configuration of the Analog Inputs	64			
10.4.6	Configuring the low flow cut off	66			
10.4.7	Configuring partially filled pipe detection	67			
10.5	Advanced settings	68			
10.5.1	Using the parameter to enter the access code	68			
10.5.2	Calculated process variables	68			
10.5.3	Carrying out a sensor adjustment	70			
10.5.4	Configuring the totalizer	74			
10.5.5	Using parameters for device administration	75			
10.6	Simulation	76			
10.7	Protecting settings from unauthorized access	77			
10.7.1	Write protection via access code	77			
10.7.2	Write protection via write protection switch	78			
11	Operation	79			
11.1	Reading the device locking status	79			
11.2	Adjusting the operating language	79			
11.3	Configuring the display	79			
11.4	Reading off measured values	79			
11.4.1	"Measured variables" submenu	79			
11.4.2	"Totalizer" submenu	82			
11.5	Adapting the measuring device to the process conditions	83			
11.6	Performing a totalizer reset	83			
12	Diagnostics and troubleshooting	85			
12.1	General troubleshooting	85			
12.2	Diagnostic information via LEDs	86			
12.2.1	Transmitter	86			
12.3	Diagnostic information in the web browser	87			
12.3.1	Diagnostic options	87			
12.3.2	Calling up remedy information	89			
12.4	Diagnostic information in FieldCare or DeviceCare	89			
12.4.1	Diagnostic options	89			
12.4.2	Calling up remedy information	90			
12.5	Adapting the diagnostic information	90			
12.5.1	Adapting the diagnostic behavior	90			
12.6	Overview of diagnostic information	93			
12.6.1	Diagnostic of sensor	93			
12.6.2	Diagnostic of electronic	97			
12.6.3	Diagnostic of configuration	105			
12.6.4	Diagnostic of process	111			
12.7	Pending diagnostic events	118			
12.8	Diagnostics list	119			
12.9	Event logbook	119			
12.9.1	Reading out the event logbook	119			
12.9.2	Filtering the event logbook	120			
12.9.3	Overview of information events	120			
12.10	Resetting the measuring device	121			
12.10.1	Function range of "Device reset" parameter	121			
12.11	Device information	122			
12.12	Firmware history	124			
13	Maintenance	125			
13.1	Maintenance work	125			
13.1.1	Exterior cleaning	125			
13.1.2	Internal cleaning	125			
13.2	Measuring and test equipment	125			
13.3	Endress+Hauser services	125			
14	Repair	126			
14.1	General notes	126			
14.1.1	Repair and conversion concept	126			
14.1.2	Notes for repair and conversion	126			
14.2	Spare parts	126			
14.3	Endress+Hauser services	126			
14.4	Return	126			
14.5	Disposal	127			
14.5.1	Removing the measuring device	127			
14.5.2	Disposing of the measuring device	127			
15	Accessories	128			
15.1	Device-specific accessories	128			
15.1.1	For the sensor	128			
15.2	Communication-specific accessories	128			
15.3	Service-specific accessories	129			
15.4	System components	130			
16	Technical data	131			
16.1	Application	131			
16.2	Function and system design	131			
16.3	Input	132			
16.4	Output	134			
16.5	Power supply	136			
16.6	Performance characteristics	137			

16.7	Mounting	141
16.8	Environment	141
16.9	Process	142
16.10	Mechanical construction	145
16.11	Operability	148
16.12	Certificates and approvals	150
16.13	Application packages	152
16.14	Accessories	153
16.15	Supplementary documentation	153
Index	155

1 About this document

1.1 Document function

These Operating Instructions contain all the information required in the various life cycle phases of the device: from product identification, incoming acceptance and storage, to installation, connection, operation and commissioning, through to troubleshooting, maintenance and disposal.

1.2 Symbols

1.2.1 Safety symbols

DANGER

This symbol alerts you to a dangerous situation. Failure to avoid this situation will result in serious or fatal injury.

WARNING

This symbol alerts you to a potentially dangerous situation. Failure to avoid this situation can result in serious or fatal injury.





CAUTION

This symbol alerts you to a potentially dangerous situation. Failure to avoid this situation can result in minor or medium injury.



NOTICE

This symbol alerts you to a potentially harmful situation. Failure to avoid this situation can result in damage to the product or something in its vicinity.













1.2.2 Electrical symbols

Symbol	Meaning
	Direct current
	Alternating current
	Direct current and alternating current
	Ground connection A grounded terminal which, as far as the operator is concerned, is grounded via a grounding system.
	Potential equalization connection (PE: protective earth) Ground terminals that must be connected to ground prior to establishing any other connections. The ground terminals are located on the interior and exterior of the device: <ul style="list-style-type: none"> ▪ Interior ground terminal: potential equalization is connected to the supply network. ▪ Exterior ground terminal: device is connected to the plant grounding system.



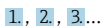

1.2.3 Tool symbols

Symbol	Meaning
	Allen key
	Open-ended wrench

1.2.4 Symbols for certain types of information

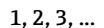
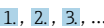
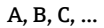
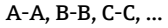
Symbol	Meaning
	Permitted Procedures, processes or actions that are permitted.
	Preferred Procedures, processes or actions that are preferred.
	Forbidden Procedures, processes or actions that are forbidden.
	Tip Indicates additional information.
	Reference to documentation
	Reference to page
	Reference to graphic
	Notice or individual step to be observed
	Series of steps
	Result of a step
	Help in the event of a problem
	Visual inspection

1.2.5 Symbols in graphics

Symbol	Meaning
	Item numbers
	Series of steps
	Views
	Sections
	Hazardous area
	Safe area (non-hazardous area)
	Flow direction

1.3 Documentation

 For an overview of the scope of the associated Technical Documentation, refer to the following:

- *Device Viewer* (www.endress.com/deviceviewer): Enter the serial number from the nameplate
- *Endress+Hauser Operations app*: Enter serial number from nameplate or scan matrix code on nameplate.

The following documentation may be available depending on the device version ordered:

Document type	Purpose and content of the document
Technical Information (TI)	Planning aid for your device The document contains all the technical data on the device and provides an overview of the accessories and other products that can be ordered for the device.
Brief Operating Instructions (KA)	Guide that takes you quickly to the 1st measured value The Brief Operating Instructions contain all the essential information from incoming acceptance to initial commissioning.
Operating Instructions (BA)	Your reference document These Operating Instructions contain all the information that is required in the various life cycle phases of the device: from product identification, incoming acceptance and storage, to mounting, connection, operation and commissioning, through to troubleshooting, maintenance and disposal.
Description of Device Parameters (GP)	Reference for your parameters The document provides a detailed explanation of each individual parameter. The description is aimed at those who work with the device over the entire life cycle and perform specific configurations.
Safety Instructions (XA)	Depending on the approval, safety instructions for electrical equipment in hazardous areas are also supplied with the device. The Safety Instructions are a constituent part of the Operating Instructions.  Information on the Safety Instructions (XA) that are relevant for the device is provided on the nameplate.
Supplementary device-dependent documentation (SD/FY)	Always comply strictly with the instructions in the relevant supplementary documentation. The supplementary documentation is a constituent part of the device documentation.

1.4 Registered trademarks

PROFIBUS®

Registered trademark of the PROFIBUS Nutzerorganisation e.V. (PROFIBUS User Organization), Karlsruhe, Germany

TRI-CLAMP®

Registered trademark of Ladish & Co., Inc., Kenosha, USA

2 Safety instructions

2.1 Requirements for the personnel

The personnel for installation, commissioning, diagnostics and maintenance must fulfill the following requirements:

- ▶ Trained, qualified specialists must have a relevant qualification for this specific function and task.
- ▶ Are authorized by the plant owner/operator.
- ▶ Are familiar with federal/national regulations.
- ▶ Before starting work, read and understand the instructions in the manual and supplementary documentation as well as the certificates (depending on the application).
- ▶ Follow instructions and comply with basic conditions.

The operating personnel must fulfill the following requirements:

- ▶ Are instructed and authorized according to the requirements of the task by the facility's owner-operator.
- ▶ Follow the instructions in this manual.

2.2 Intended use

Application and media

The measuring instrument described in this manual is intended only for the flow measurement of liquids and gases.

Depending on the version ordered, the measuring instrument can also be used to measure potentially explosive ¹⁾, flammable, toxid and oxidizing media.

Measuring instruments for use in hazardous areas, in hygienic applications, or where there is an increased risk due to pressure, are specially labeled on the nameplate.

To ensure that the measuring instrument is in perfect condition during operation:

- ▶ Only use the measuring instrument in full compliance with the data on the nameplate and the general conditions listed in the Operating Instructions and supplementary documentation.
- ▶ Using the nameplate, check whether the ordered device is permitted for the intended use in the hazardous area (e.g. explosion protection, pressure vessel safety).
- ▶ Use the measuring instrument only for media to which the process-wetted materials are sufficiently resistant.
- ▶ Keep within the specified pressure and temperature range.
- ▶ Keep within the specified ambient temperature range.
- ▶ Protect the measuring instrument permanently against corrosion from environmental influences.

Incorrect use

Non-designated use can compromise safety. The manufacturer is not liable for damage caused by improper or non-designated use.

WARNING

Danger of breakage due to corrosive or abrasive fluids and ambient conditions!

- ▶ Verify the compatibility of the process fluid with the sensor material.
- ▶ Ensure the resistance of all fluid-wetted materials in the process.
- ▶ Keep within the specified pressure and temperature range.

1) Not applicable for IO-Link measuring instruments

NOTICE**Verification for borderline cases:**

- ▶ For special fluids and fluids for cleaning, Endress+Hauser is glad to provide assistance in verifying the corrosion resistance of fluid-wetted materials, but does not accept any warranty or liability as minute changes in the temperature, concentration or level of contamination in the process can alter the corrosion resistance properties.

Residual risks**⚠ CAUTION**

Risk of hot or cold burns! The use of media and electronics with high or low temperatures can produce hot or cold surfaces on the device.

- ▶ Mount suitable touch protection.

2.3 Workplace safety

When working on and with the device:

- ▶ Wear the required personal protective equipment as per national regulations.

2.4 Operational safety

Damage to the device!

- ▶ Operate the device in proper technical condition and fail-safe condition only.
- ▶ The operator is responsible for the interference-free operation of the device.

Modifications to the device

Unauthorized modifications to the device are not permitted and can lead to unforeseeable dangers!

- ▶ If modifications are nevertheless required, consult with the manufacturer.

Repair

To ensure continued operational safety and reliability:

- ▶ Carry out repairs on the device only if they are expressly permitted.
- ▶ Observe federal/national regulations pertaining to the repair of an electrical device.
- ▶ Use only original spare parts and accessories.

2.5 Product safety

This measuring device is designed in accordance with good engineering practice to meet state-of-the-art safety requirements, has been tested, and left the factory in a condition in which it is safe to operate.

It meets general safety standards and legal requirements. It also complies with the EU directives listed in the device-specific EU Declaration of Conformity. The manufacturer confirms this by affixing the CE mark to the device..

2.6 IT security

Our warranty is valid only if the product is installed and used as described in the Operating Instructions. The product is equipped with security mechanisms to protect it against any inadvertent changes to the settings.

IT security measures, which provide additional protection for the product and associated data transfer, must be implemented by the operators themselves in line with their security standards.

3 Product description

The device consists of a transmitter and a sensor.

The device is available as a compact version:

The transmitter and sensor form a mechanical unit.

3.1 Product design

3.1.1 Device version with PROFIBUS DP communication protocol

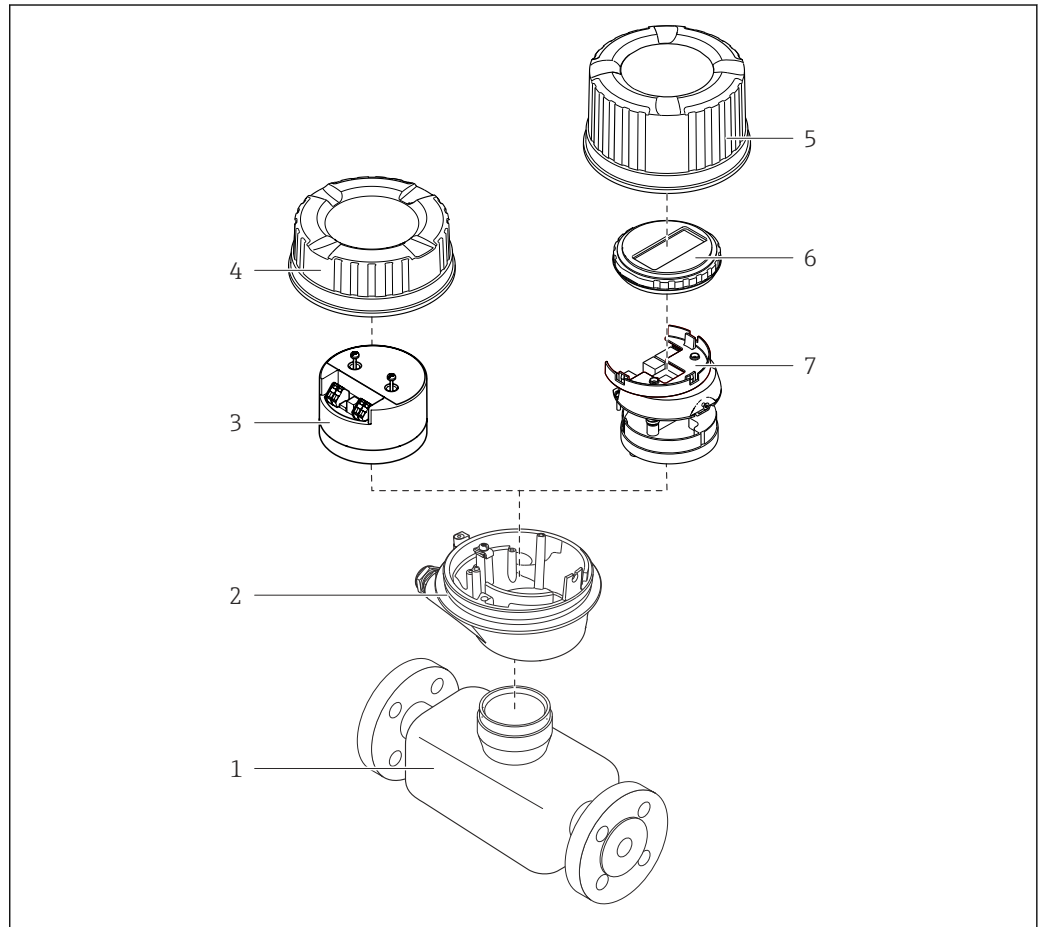

A0023153

1 Important components of a measuring device

- 1 Sensor
- 2 Transmitter housing
- 3 Main electronics module
- 4 Transmitter housing cover
- 5 Transmitter housing cover (version for optional local display)
- 6 Local display (optional)
- 7 Main electronics module (with bracket for optional local display)

4 Incoming acceptance and product identification

4.1 Incoming acceptance

On receipt of the delivery:

1. Check the packaging for damage.
 - ↳ Report all damage immediately to the manufacturer.
Do not install damaged components.
2. Check the scope of delivery using the delivery note.
3. Compare the data on the nameplate with the order specifications on the delivery note.
4. Check the technical documentation and all other necessary documents, e.g. certificates, to ensure they are complete.

 If one of the conditions is not satisfied, contact the manufacturer.

4.2 Product identification

The device can be identified in the following ways:

- Nameplate
- Order code with details of the device features on the delivery note
- Enter the serial numbers from the nameplates in the *Device Viewer* (www.endress.com/deviceviewer): all the information about the device is displayed.
- Enter the serial numbers from the nameplates into the *Endress+Hauser Operations app* or scan the DataMatrix code on the nameplate with the *Endress+Hauser Operations app*: all the information about the device is displayed.

For an overview of the scope of the associated Technical Documentation, refer to the following:

- The "Additional standard device documentation" and "Supplementary device-dependent documentation" sections
- The *Device Viewer*: Enter the serial number from the nameplate (www.endress.com/deviceviewer)
- The *Endress+Hauser Operations app*: Enter the serial number from the nameplate or scan the DataMatrix code on the nameplate.

4.2.1 Transmitter nameplate

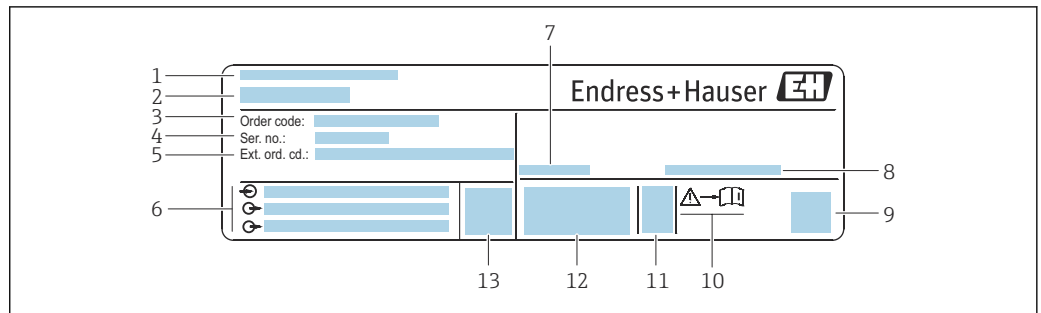

A0030222

 2 Example of a transmitter nameplate

- 1 Manufacturer address/certificate holder
- 2 Name of the transmitter
- 3 Order code
- 4 Serial number
- 5 Extended order code
- 6 Electrical connection data, e.g. available inputs and outputs, supply voltage
- 7 Permitted ambient temperature (T_a)
- 8 Degree of protection
- 9 2-D matrix code
- 10 Document number of safety-related supplementary documentation →  154
- 11 Date of manufacture: year-month
- 12 CE mark, RCM-Tick mark
- 13 Firmware version (FW)

4.2.2 Sensor nameplate

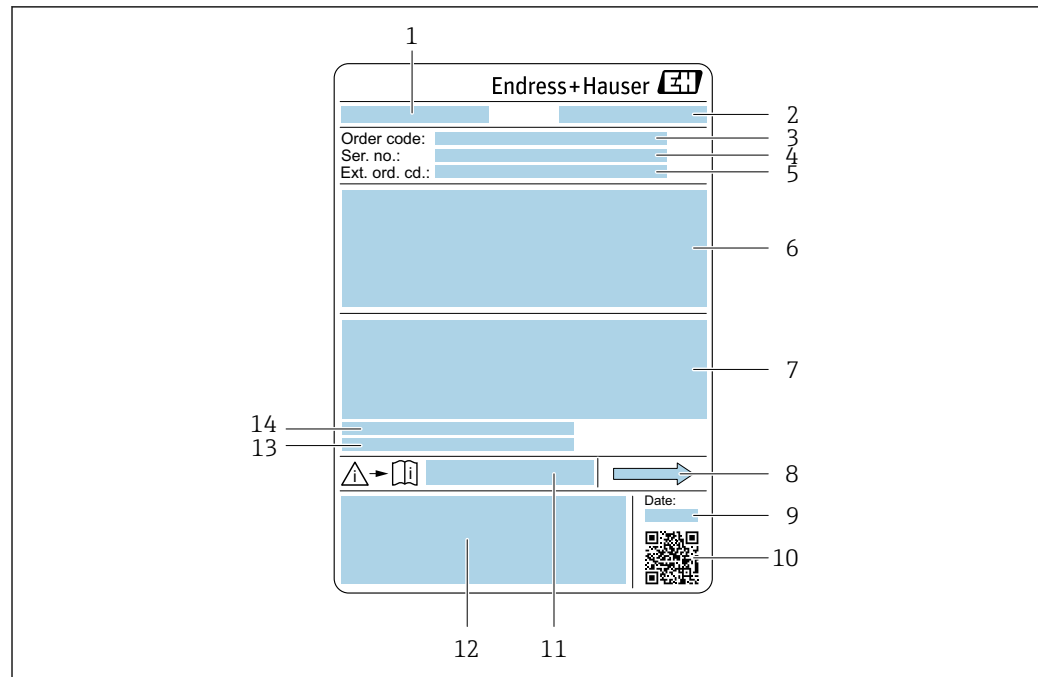

A0029199

 3 Example of a sensor nameplate

- 1 Name of the sensor
- 2 Manufacturer address/certificate holder
- 3 Order code
- 4 Serial number (Ser. no.)
- 5 Extended order code (Ext. ord. cd.)
- 6 Nominal diameter of the sensor; flange nominal diameter/nominal pressure; sensor test pressure; medium temperature range; material of measuring tube and manifold; sensor-specific information: e.g. pressure range of sensor housing, wide-range density specification (special density calibration)
- 7 Approval information for explosion protection, Pressure Equipment Directive and degree of protection
- 8 Flow direction
- 9 Date of manufacture: year-month
- 10 2-D matrix code
- 11 Document number of safety-related supplementary documentation
- 12 CE mark, RCM-Tick mark
- 13 Surface roughness
- 14 Allowable ambient temperature (T_a)



Order code

The measuring device is reordered using the order code.

Extended order code

- The device type (product root) and basic specifications (mandatory features) are always listed.
- Of the optional specifications (optional features), only the safety and approval-related specifications are listed (e.g. LA). If other optional specifications are also ordered, these are indicated collectively using the # placeholder symbol (e.g. #LA#).
- If the ordered optional specifications do not include any safety and approval-related specifications, they are indicated by the + placeholder symbol (e.g. XXXXXX-ABCDE+).

4.2.3 Symbols on the device

Symbol	Meaning
	WARNING! This symbol alerts you to a dangerous situation. Failure to avoid this situation can result in serious or fatal injury. Please consult the documentation for the measuring instrument to discover the type of potential danger and measures to avoid it.
	Reference to documentation Refers to the corresponding device documentation.
	Protective ground connection A terminal that must be connected to the ground prior to establishing any other connections.

5 Storage and transport

5.1 Storage conditions

Observe the following notes for storage:

- ▶ Store in the original packaging to ensure protection from shock.
- ▶ Do not remove protective covers or protective caps installed on process connections. They prevent mechanical damage to the sealing surfaces and contamination in the measuring tube.
- ▶ Protect from direct sunlight. Avoid unacceptably high surface temperatures.
- ▶ Store in a dry and dust-free place.
- ▶ Do not store outdoors.

Storage temperature →  141

5.2 Transporting the product

Transport the measuring device to the measuring point in the original packaging.

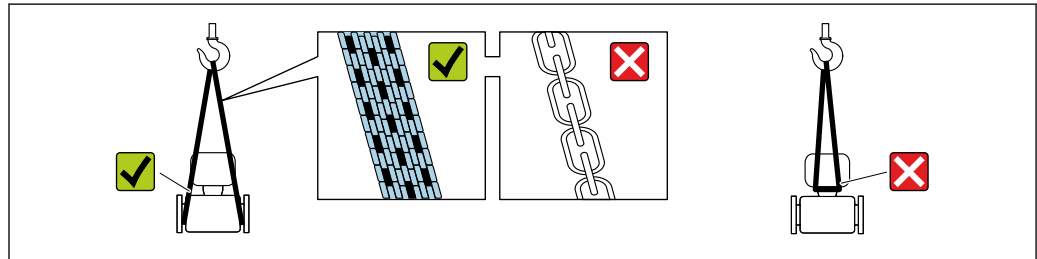

A0029252

-  Do not remove protective covers or caps installed on process connections. They prevent mechanical damage to the sealing surfaces and contamination in the measuring tube.

5.2.1 Measuring devices without lifting lugs

WARNING

Center of gravity of the measuring device is higher than the suspension points of the webbing slings.

Risk of injury if the measuring device slips.

- ▶ Secure the measuring device against slipping or turning.
- ▶ Observe the weight specified on the packaging (stick-on label).

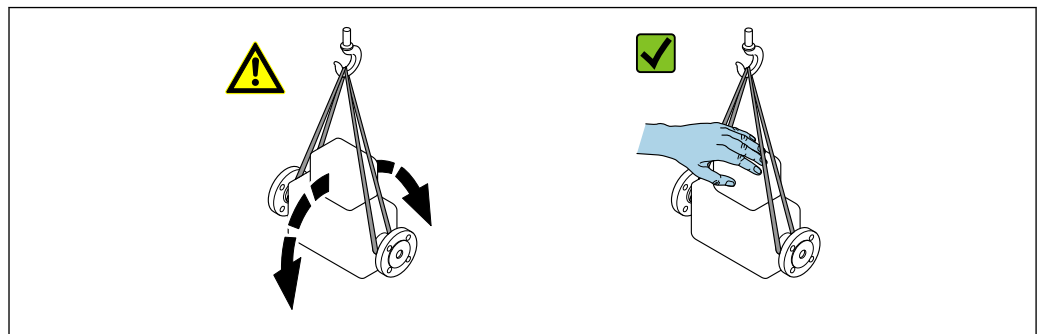

A0029214

5.2.2 Measuring devices with lifting lugs

⚠ CAUTION

Special transportation instructions for devices with lifting lugs

- ▶ Only use the lifting lugs fitted on the device or flanges to transport the device.
- ▶ The device must always be secured at two lifting lugs at least.

5.2.3 Transporting with a fork lift

If transporting in wood crates, the floor structure enables the crates to be lifted lengthwise or at both sides using a forklift.

5.3 Packaging disposal

All packaging materials are environmentally friendly and 100% recyclable:

- Outer packaging of device
 - Stretch wrap made of polymer in accordance with EU Directive 2002/95/EC (RoHS)
- Packaging
 - Wood crate treated in accordance with ISPM 15 standard, confirmed by IPPC logo
 - Cardboard box in accordance with European packaging guideline 94/62/EC, recyclability confirmed by Resy symbol
- Transport material and fastening fixtures
 - Disposable plastic pallet
 - Plastic straps
 - Plastic adhesive strips
- Filler material
 - Paper pads

6 Installation

6.1 Installation requirements

6.1.1 Installation position

Installation point

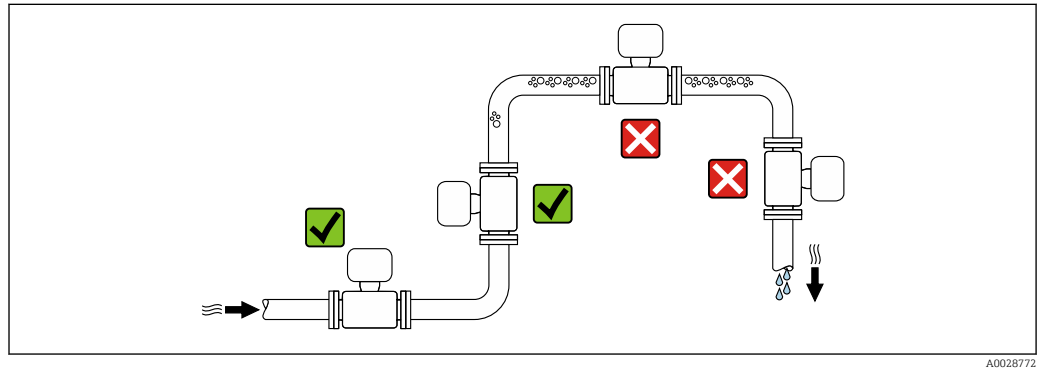



To prevent measuring errors arising from accumulation of gas bubbles in the measuring pipe, avoid the following mounting locations in the piping:

- Highest point of a pipeline.
- Directly upstream of a free pipe outlet in a down pipe.

Installation in down pipes

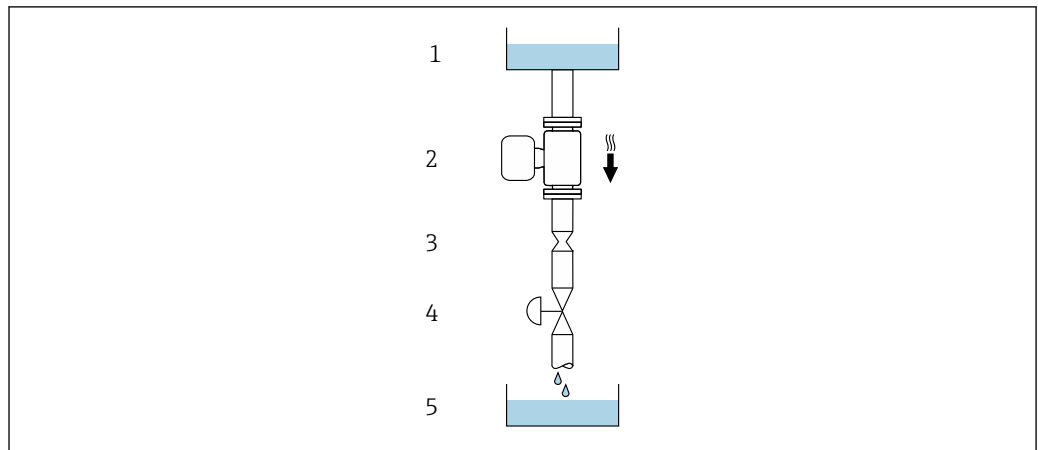
However, the following installation suggestion allows for installation in an open vertical pipeline. Pipe restrictions or the use of an orifice with a smaller cross-section than the nominal diameter prevent the sensor running empty while measurement is in progress.



 4 Installation in a down pipe (e.g. for batching applications)



- 1 Supply tank
- 2 Sensor
- 3 Orifice plate, pipe restriction
- 4 Valve
- 5 Filling vessel

DN		Ø orifice plate, pipe restriction	
[mm]	[in]	[mm]	[in]
8	3/8	6	0.24
15	1/2	10	0.40
15 FB	1/2 FB	15	0.60
25	1	14	0.55
25 FB	1 FB	24	0.95
40	1 1/2	22	0.87
40 FB	1 1/2 FB	35	1.38
50	2	28	1.10
50 FB	2 FB	54	2.13
80	3	50	1.97

FB = Full bore

Orientation

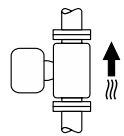
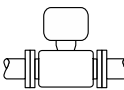
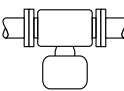
The direction of the arrow on the sensor nameplate helps you to install the sensor according to the flow direction (direction of medium flow through the piping).

Orientation			Recommendation
A	Vertical orientation	 A0015591	☑☑☑ ¹⁾ ☑☑
B	Horizontal orientation, transmitter at top	 A0015589	☑☑☑ ²⁾
C	Horizontal orientation, transmitter at bottom	 A0015590	☑☑☑ ³⁾
D	Horizontal orientation, transmitter at side	 A0015592	☑☑

- 1) This orientation is recommended to ensure self-draining.
- 2) Applications with low process temperatures may reduce the ambient temperature. To maintain the minimum ambient temperature for the transmitter, this orientation is recommended.
- 3) Applications with high process temperatures may increase the ambient temperature. To maintain the maximum ambient temperature for the transmitter, this orientation is recommended.

Inlet and outlet runs

No special precautions need to be taken for fittings that create turbulence, such as valves, elbows or T-pieces, as long as no cavitation occurs → 20.

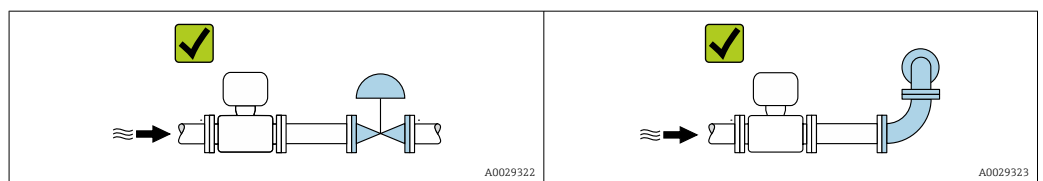

Installation dimensions

For the dimensions and installation lengths of the device, see the "Technical Information" document, "Mechanical construction" section

6.1.2 Environmental and process requirements**Ambient temperature range**

Measuring device	<ul style="list-style-type: none"> ■ -40 to +60 °C (-40 to +140 °F) ■ Order code for "Test, certificate", option JM: -50 to +60 °C (-58 to +140 °F)
------------------	---

- ▶ If operating outdoors:
Avoid direct sunlight, particularly in warm climatic regions.

Static pressure

It is important that cavitation does not occur, or that gases entrained in the liquids do not outgas.

Cavitation is caused if the pressure drops below the vapor pressure:

- In liquids that have a low boiling point (e.g. hydrocarbons, solvents, liquefied gases)
- In suction lines
- ▶ Ensure the static pressure is sufficiently high to prevent cavitation and outgassing.

For this reason, the following mounting locations are recommended:

- At the lowest point in a vertical pipe
- Downstream from pumps (no danger of vacuum)

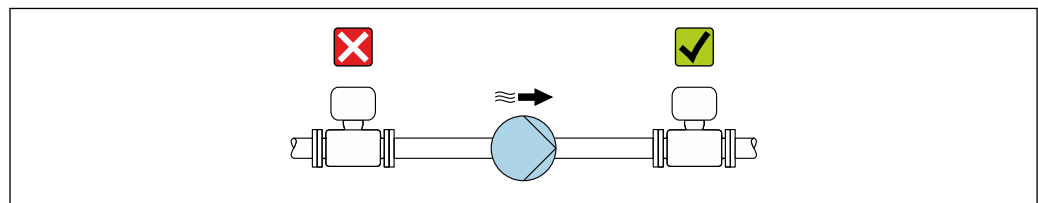

A0028777

Thermal insulation

In the case of some fluids, it is important to keep the heat radiated from the sensor to the transmitter to a low level. A wide range of materials can be used for the required insulation.

The following device versions are recommended for versions with thermal insulation:

Version with extended neck for insulation:

Order code for "Sensor option", option CG with an extended neck length of 105 mm (4.13 in).

NOTICE**Electronics overheating on account of thermal insulation!**

- ▶ Recommended orientation: horizontal orientation, transmitter housing pointing downwards.
- ▶ Do not insulate the transmitter housing .
- ▶ Maximum permissible temperature at the lower end of the transmitter housing: 80 °C (176 °F)
- ▶ Regarding thermal insulation with an exposed extended neck: We advise against insulating the extended neck to ensure optimal heat dissipation.

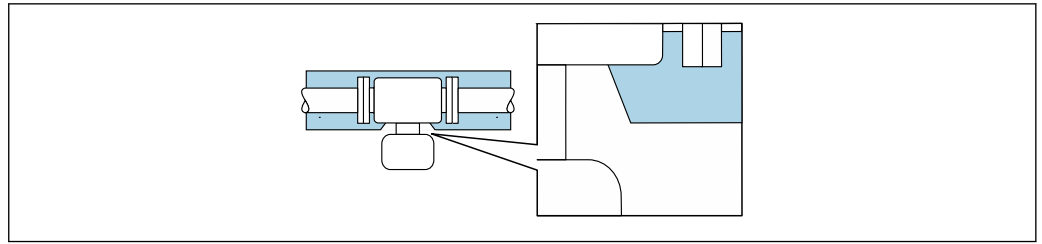

5 Thermal insulation with exposed extended neck

Heating

NOTICE

Electronics can overheat due to elevated ambient temperature!

- ▶ Observe maximum permitted ambient temperature for the transmitter.
- ▶ Depending on the medium temperature, take the device orientation requirements into account.

NOTICE

Danger of overheating when heating

- ▶ Ensure that the temperature at the lower end of the transmitter housing does not exceed 80 °C (176 °F).
- ▶ Ensure that sufficient convection takes place at the transmitter neck.
- ▶ Ensure that a sufficiently large area of the transmitter neck remains exposed. The uncovered part serves as a radiator and protects the electronics from overheating and excessive cooling.
- ▶ When using in potentially explosive atmospheres, observe the information in the device-specific Ex documentation. For detailed information on the temperature tables, see the separate document entitled "Safety Instructions" (XA) for the device.
- ▶ Consider the "830 ambient temperature too high" and "832 electronics temperature too high" process diagnostics if overheating cannot be ruled out based on a suitable system design.

Heating options

If a fluid requires that no heat loss should occur at the sensor, users can avail of the following heating options:

- Electrical heating, e.g. with electric band heaters²⁾
- Via pipes carrying hot water or steam
- Via heating jackets

Vibrations

The high oscillation frequency of the measuring tubes ensures that the correct operation of the measuring system is not influenced by plant vibrations.

6.1.3 Special installation instructions

Drainability

When installed vertically, the measuring tube can be drained completely and protected against buildup.

When the sensor is installed in a horizontal line, eccentric clamps can be used to ensure complete drainability. When the system is pitched in a specific direction and at a specific slope, gravity can be used to achieve complete drainability. The sensor must be mounted in

2) The use of parallel electric band heaters is generally recommended (bidirectional electricity flow). Particular considerations must be made if a single-wire heating cable is to be used. For additional information, refer to EA01339D "Installation Instructions for Electrical Trace Heating Systems".

the correct position to ensure full drainability in the horizontal position. Markings on the sensor show the correct mounting position to optimize drainability.

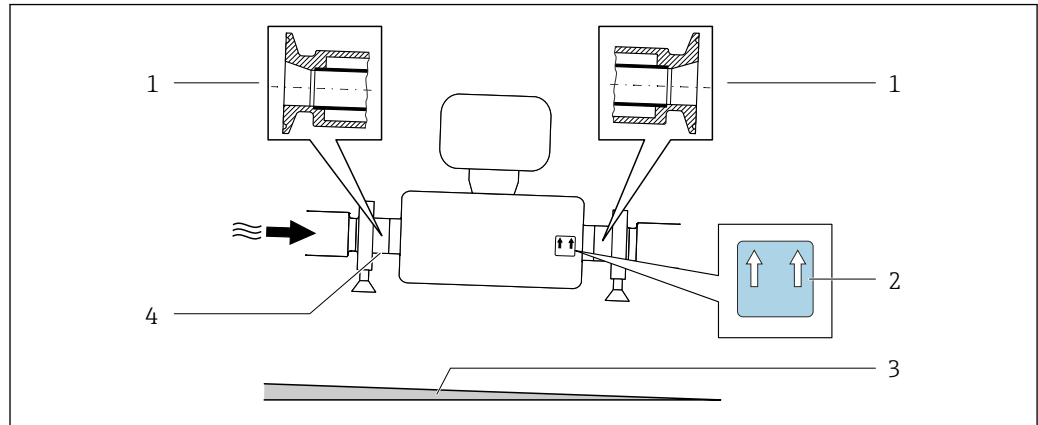

A0030297

- 1 Eccentric clamp connection
- 2 "This side up" label indicates which side is up
- 3 Slope the device in accordance with the hygiene guidelines. Slope: approx. 2 % or 21 mm/m (0.24 in/feet)
- 4 Line on the underside indicates the lowest point of the eccentric process connection.

Hygienic compatibility

i When installing in hygienic applications, please refer to the information in the "Certificates and approvals/hygienic compatibility" section → 150

Securing with mounting clamp in the case of hygiene connections

It is not necessary to provide additional support for the sensor for operational performance purposes. If, however, additional support is required for installation purposes, the following dimensions must be observed.

Use mounting clamp with lining between clamp and measuring instrument.

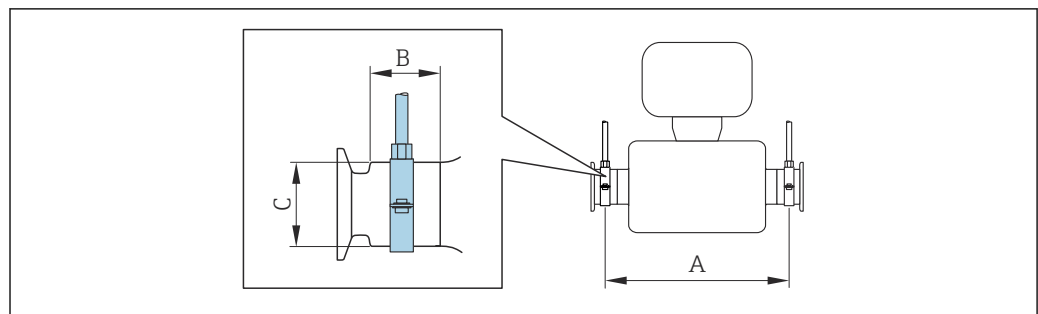

A0030298

DN		A		B		C	
[mm]	[in]	[mm]	[in]	[mm]	[in]	[mm]	[in]
8	8	373	14.69	20	0.79	40	1.57
15	15	409	16.1	20	0.79	40	1.57
15 FB	15 FB	539	21.22	30	1.18	44.5	1.75
25	25	539	21.22	30	1.18	44.5	1.75
25 FB	25 FB	668	26.3	28	1.1	60	2.36
40	40	668	26.3	28	1.1	60	2.36
40 FB	40 FB	780	30.71	35	1.38	80	3.15
50	50	780	30.71	35	1.38	80	3.15

DN		A		B		C	
[mm]	[in]	[mm]	[in]	[mm]	[in]	[mm]	[in]
50 FB	50 FB	1 152	45.35	57	2.24	90	3.54
80	80	1 152	45.35	57	2.24	90	3.54

Zero verification and zero adjustment

All measuring instruments are calibrated in accordance with state-of-the-art technology. Calibration takes place under reference conditions →  137. Therefore, a zero adjustment in the field is generally not required.

Experience shows that zero adjustment is advisable only in special cases:

- To achieve maximum measurement accuracy even with low flow rates.
- Under extreme process or operating conditions (e.g. very high process temperatures or very high-viscosity fluids).
- For gas applications with low pressure

 To achieve the highest possible measurement accuracy at low flow rates, the installation must protect the sensor from mechanical stresses during operation.

To get a representative zero point, ensure that:

- any flow in the device is prevented during the adjustment
- the process conditions (e.g. pressure, temperature) are stable and representative

Verification and adjustment cannot be carried out if the following process conditions are present:

- Gas pockets
Ensure that the system has been sufficiently flushed with the medium. Repeat flushing can help to eliminate gas pockets
- Thermal circulation
In the event of temperature differences (e.g. between the measuring tube inlet and outlet section), induced flow can occur even if the valves are closed due to thermal circulation in the device
- Leaks at the valves
If the valves are not leak-tight, flow is not sufficiently prevented when determining the zero point

If these conditions cannot be avoided, it is advisable to keep the factory setting for the zero point.

6.2 Installing the measuring instrument

6.2.1 Required tools

For sensor

For flanges and other process connections: Use a suitable mounting tool.

6.2.2 Preparing the measuring instrument

1. Remove all remaining transport packaging.
2. Remove any protective covers or protective caps present from the sensor.
3. Remove stick-on label on the electronics compartment cover.

6.2.3 Mounting the measuring device

⚠ WARNING

Danger due to improper process sealing!

- ▶ Ensure that the inside diameters of the gaskets are greater than or equal to that of the process connections and piping.
- ▶ Ensure that the seals are clean and undamaged.
- ▶ Secure the seals correctly.

1. Ensure that the direction of the arrow on the nameplate of the sensor matches the flow direction of the medium.
2. Install the measuring device or turn the transmitter housing so that the cable entries do not point upwards.

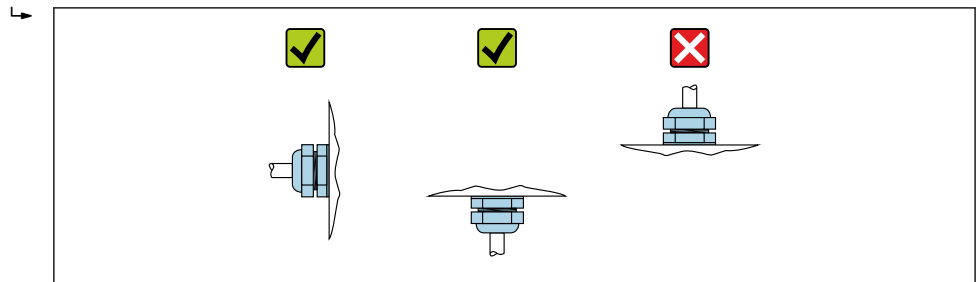

A0029263

6.2.4 Turning the display module

The local display is only available with the following device version:

Order code for "Display; Operation", option B: 4-line; lit, via communication

The display module can be turned to optimize display readability.

Aluminum housing version, AlSi10Mg, coated

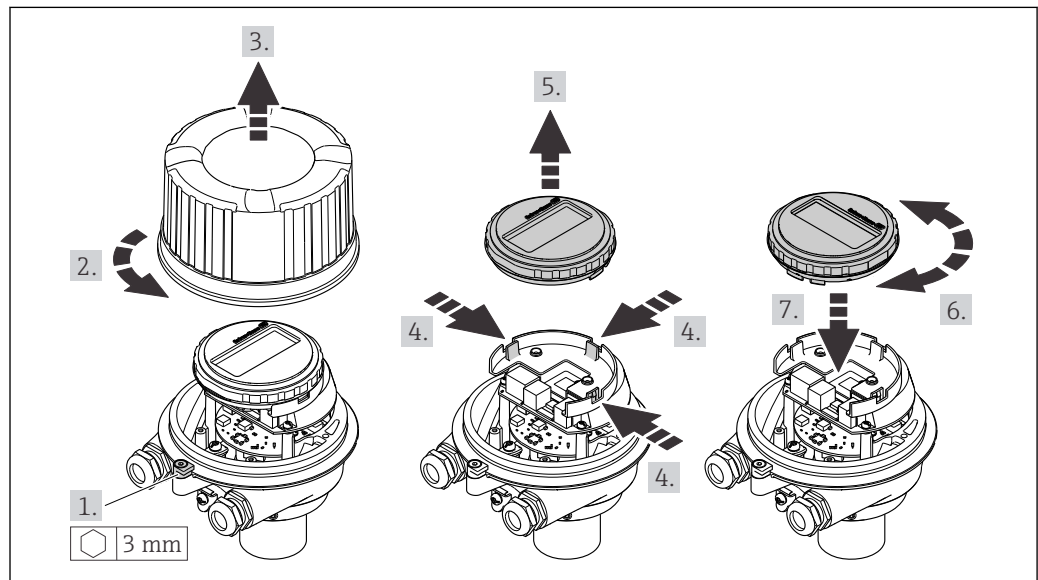

A0023192

Compact and ultra-compact housing version, hygienic, stainless

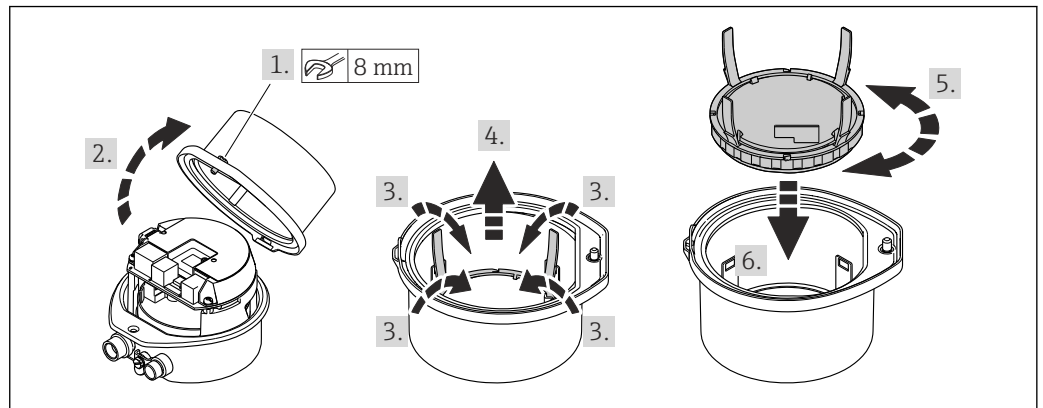

A0023195

6.3 Post-installation check

Is the device undamaged (visual inspection)?	<input type="checkbox"/>
Does the measuring instrument correspond to the measuring point specifications? For example: <ul style="list-style-type: none"> ▪ Process temperature → 142 ▪ Pressure (refer to the "Pressure-temperature ratings" section of the "Technical Information" document). ▪ Ambient temperature → 141 ▪ Measuring range 	<input type="checkbox"/>
Has the correct orientation for the sensor been selected → 19? <ul style="list-style-type: none"> ▪ According to sensor type ▪ According to medium temperature ▪ According to medium properties (outgassing, with entrained solids) 	<input type="checkbox"/>
Does the arrow on the sensor match the direction of flow of the medium? → 19?	<input type="checkbox"/>
Is the tag name and labeling correct (visual inspection)?	<input type="checkbox"/>
Is the device sufficiently protected from precipitation and direct sunlight?	<input type="checkbox"/>
Are the securing screw and securing clamp tightened securely?	<input type="checkbox"/>

7 Electrical connection

WARNING

Live parts! Incorrect work performed on the electrical connections can result in an electric shock.

- ▶ Set up a disconnecting device (switch or power-circuit breaker) to easily disconnect the device from the supply voltage.
- ▶ In addition to the device fuse, include an overcurrent protection unit with max. 16 A in the plant installation.

7.1 Electrical safety

In accordance with applicable national regulations.

7.2 Connecting requirements

7.2.1 Required tools

- For cable entries: Use corresponding tools
- For securing clamp (on aluminum housing): Allen screw 3 mm
- For securing screw (for stainless steel housing): open-ended wrench 8 mm
- Wire stripper
- When using stranded cables: crimper for wire end ferrule

7.2.2 Requirements for connecting cable

The connecting cables provided by the customer must fulfill the following requirements.

Permitted temperature range

- The installation guidelines that apply in the country of installation must be observed.
- The cables must be suitable for the minimum and maximum temperatures to be expected.

Power supply cable (incl. conductor for the inner ground terminal)

Standard installation cable is sufficient.

Signal cable

-  For custody transfer, all signal lines must be shielded cables (tinned copper braiding, optical coverage $\geq 85\%$). The cable shield must be connected on both sides.

PROFIBUS DP

Shielded twisted-pair cable. Cable type A is recommended.

-  See <https://www.profibus.com> "PROFIBUS Installation Guidelines".

Cable diameter

- Cable glands supplied:
 - M20 \times 1.5 with cable \varnothing 6 to 12 mm (0.24 to 0.47 in)
- Spring terminals:
 - Wire cross-sections 0.5 to 2.5 mm² (20 to 14 AWG)

7.2.3 Terminal assignment



Transmitter

PROFIBUS DP connection version

 For use in the non-hazardous area and Zone 2/Div. 2

Order code for "Output", option L

Depending on the housing version, the transmitters can be ordered with terminals or device plugs.

Order code "Housing"	Connection methods available		Possible options for order code "Electrical connection"
	Output	Power supply	
Options A, B	Terminals	Terminals	<ul style="list-style-type: none"> Option A: coupling M20x1 Option B: thread M20x1 Option C: thread G 1/2" Option D: thread NPT 1/2"
Options A, B	Device plug connectors →  28	Terminals	<ul style="list-style-type: none"> Option L: plug M12x1 + thread NPT 1/2" Option N: plug M12x1 + coupling M20 Option P: plug M12x1 + thread G 1/2" Option U: plug M12x1 + thread M20
Options A, B, C	Device plug connectors →  28	Device plug connectors →  28	Option Q: 2 x plug M12x1

Order code for "Housing":

- Option A: compact, coated aluminum
- Option B: compact, hygienic, stainless
- Option C: ultra-compact, hygienic, stainless

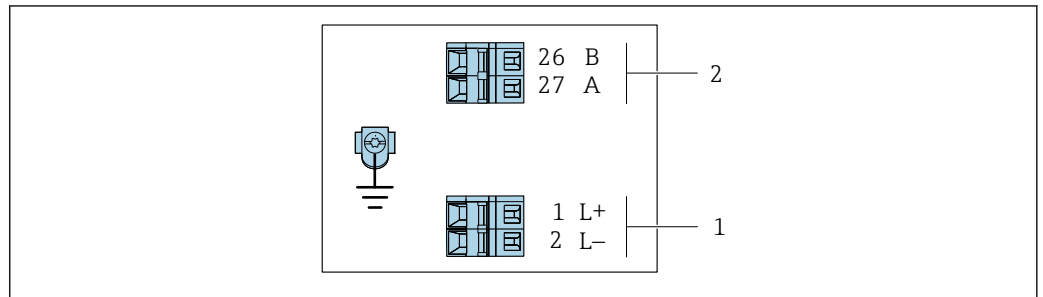

A0022716

 6 PROFIBUS DP terminal assignment

- 1 Power supply: DC 24 V
- 2 PROFIBUS DP

Order code "Output"	Terminal number			
	Power supply		Output	
	2 (L-)	1 (L+)	26 (RxD/TxD-P)	27 (RxD/TxD-N)
Option L	DC 24 V		B	A

Order code for "Output":
Option L: PROFIBUS DP, for use in non-hazardous areas and Zone 2/Div. 2

7.2.4 Pin assignment, device plug

Supply voltage

i For use in the non-hazardous area and Zone 2/Div. 2.

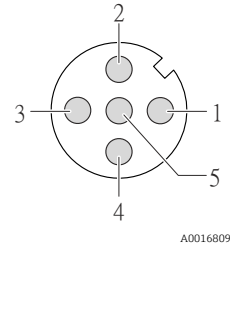
	Pin	Assignment	
	1	L+	DC 24 V
	2		Not assigned
	3		Not assigned
	4	L-	DC 24 V
	5		Grounding/shielding
Coding		Plug/socket	
A		Plug	

Device plug for signal transmission (device side)

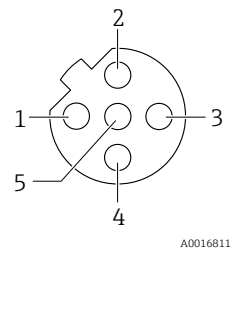
	Pin	Assignment	
	1		Not assigned
	2	A	PROFIBUS DP
	3		Not assigned
	4	B	PROFIBUS DP
	5		Grounding/shielding
Coding		Plug/socket	
B		Socket	

7.2.5 Preparing the measuring device

NOTICE

Insufficient sealing of the housing!

Operational reliability of the measuring device could be compromised.

► Use suitable cable glands corresponding to the degree of protection.

1. Remove dummy plug if present.
2. If the measuring device is supplied without cable glands:
Provide suitable cable gland for corresponding connecting cable.
3. If the measuring device is supplied with cable glands:
Observe requirements for connecting cables →  26.

7.3 Connecting the measuring instrument

NOTICE

An incorrect connection compromises electrical safety!

- Only properly trained specialist staff may perform electrical connection work.
- Observe applicable federal/national installation codes and regulations.
- Comply with local workplace safety regulations.
- Always connect the protective ground cable \ominus before connecting additional cables.
- When using in potentially explosive atmospheres, observe the information in the device-specific Ex documentation.

7.3.1 Connecting the transmitter

The connection of the transmitter depends on the following order codes:

- Housing version: compact or ultra-compact
- Connection version: device plug or terminals

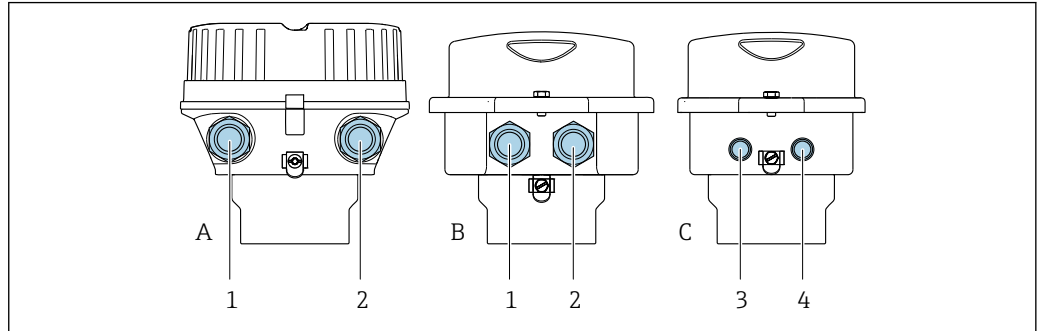

A0016924

7 Housing versions and connection versions

- A Housing version: compact, coated, aluminum
- B Housing version: compact, hygienic, stainless
- 1 Cable entry or device plug for signal transmission
- 2 Cable entry or device plug for supply voltage
- C Housing version: ultra-compact, hygienic, stainless
- 3 Device plug for signal transmission
- 4 Device plug for supply voltage

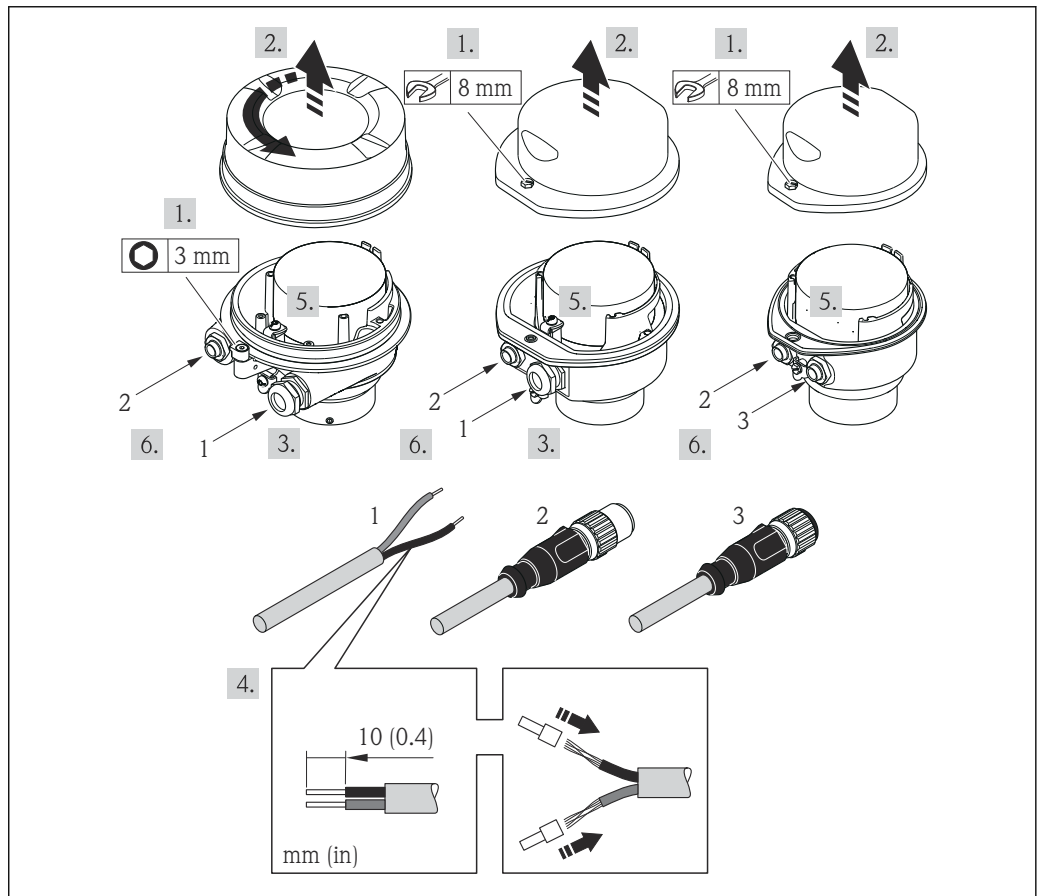



A0017844

8 Device versions with connection examples

- 1 Cable
- 2 Device plug for signal transmission
- 3 Device plug for supply voltage

For device version with device plug: follow step 6 only.

1. Depending on the housing version, loosen the securing clamp or fixing screw of the housing cover.
2. Depending on the housing version, unscrew or open the housing cover and disconnect the local display from the main electronics module where necessary
→  148.
3. Push the cable through the cable entry . To ensure tight sealing, do not remove the sealing ring from the cable entry.
4. Strip the cable and cable ends. In the case of stranded cables, also fit ferrules.
5. Connect the cable in accordance with the terminal assignment or the device plug pin assignment .
6. Depending on the device version, tighten the cable glands or plug in the device plug and tighten .
7.  **WARNING**
Housing degree of protection may be voided due to insufficient sealing of the housing.
 - ▶ Screw in the screw without using any lubricant. The threads on the cover are coated with a dry lubricant.

Reverse the removal procedure to reassemble the transmitter.

7.4 Potential equalization

7.4.1 Requirements

For potential equalization:

- Pay attention to in-house grounding concepts
- Take account of operating conditions, such as the pipe material and grounding
- Connect the medium, sensor and transmitter to the same electric potential
- Use a ground cable with a minimum cross-section of 6 mm² (10 AWG) and a cable lug for potential equalization connections

7.5 Special connection instructions

7.5.1 Connection examples

PROFIBUS DP

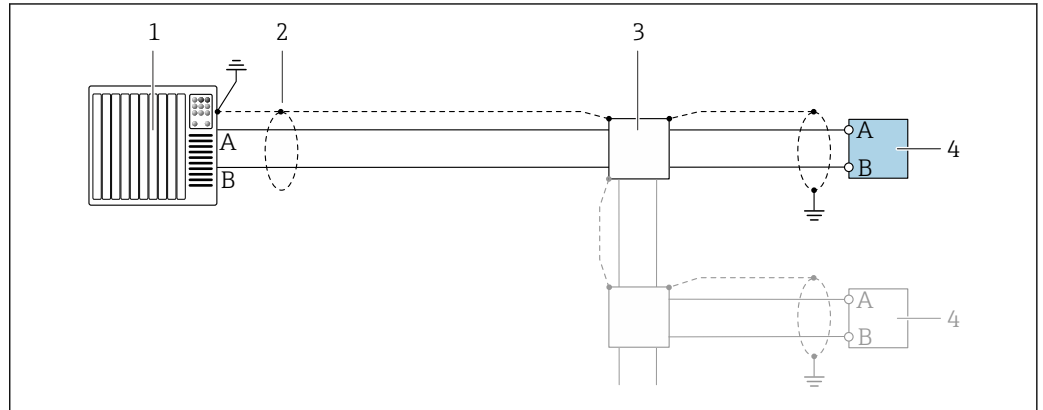

A0028765

9 Connection example for PROFIBUS DP, non-hazardous area and Zone 2/Div. 2

- 1 Control system (e.g. PLC)
- 2 Cable shield provided at one end. The cable shield must be grounded at both ends to comply with EMC requirements; observe cable specifications
- 3 Distribution box
- 4 Transmitter

i If baud rates > 1.5 MBaud an EMC cable entry must be used and the cable shield must continue as far as the terminal wherever possible.

7.6 Hardware settings

7.6.1 Setting the device address

PROFIBUS DP

The address must always be configured for a PROFIBUS DP/PA device. The valid address range is between 1 and 126. In a PROFIBUS DP/PA network, each address can only be assigned once. If an address is not configured correctly, the device is not recognized by the master. All measuring devices are delivered from the factory with the device address 126 and with the software addressing method.

Setting the address

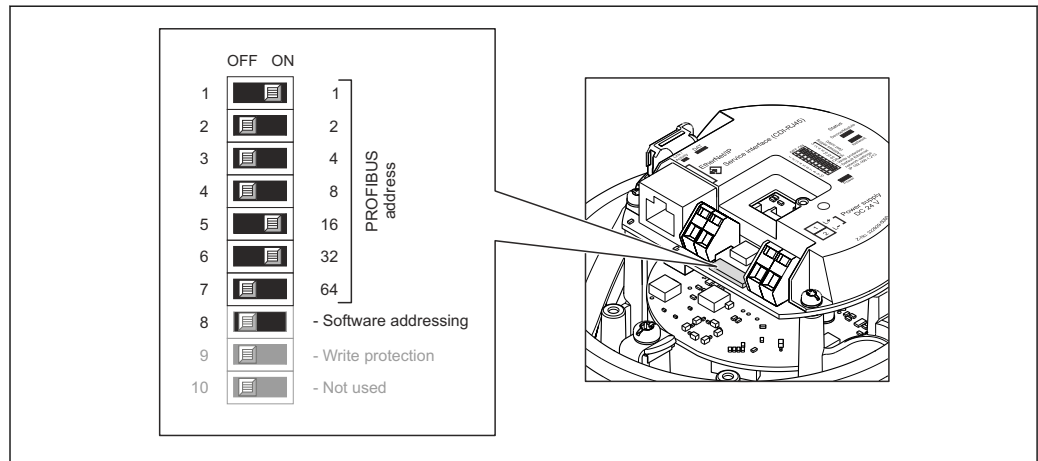

A0021265

10 Addressing using DIP switches on the I/O electronics module

1. Depending on the housing version, loosen the securing clamp or fixing screw of the housing cover.
2. Depending on the housing version, unscrew or open the housing cover and disconnect the local display from the main electronics module where necessary
→ 148.
3. Disable software addressing via DIP switch 8 (OFF).
4. Set the desired device address via the corresponding DIP switches.
↳ Example → 10, 32: $1 + 16 + 32 = \text{device address } 49$
The device demands rebooting after 10 s. After rebooting, hardware addressing is enabled with the configured IP address.
5. Reverse the removal procedure to reassemble the transmitter.

7.6.2 Enabling the terminating resistor

PROFIBUS DP

To avoid incorrect communication transmission caused by impedance mismatch, terminate the PROFIBUS DP cable correctly at the start and end of the bus segment.

- If the device is operated with a baud rate of 1.5 MBaud and under:
For the last transmitter on the bus, terminate via DIP switch 2 (bus termination) and DIP switch 1 and 3 (bus polarization). Setting: ON – ON – ON → 11, 33.
- For baud rates > 1.5 MBaud:
Due to the capacitance load of the user and the line reflections generated as a result, ensure that an external bus terminator is used.

i It is generally advisable to use an external bus terminator as the entire segment can fail if a device that is terminated internally is defective.

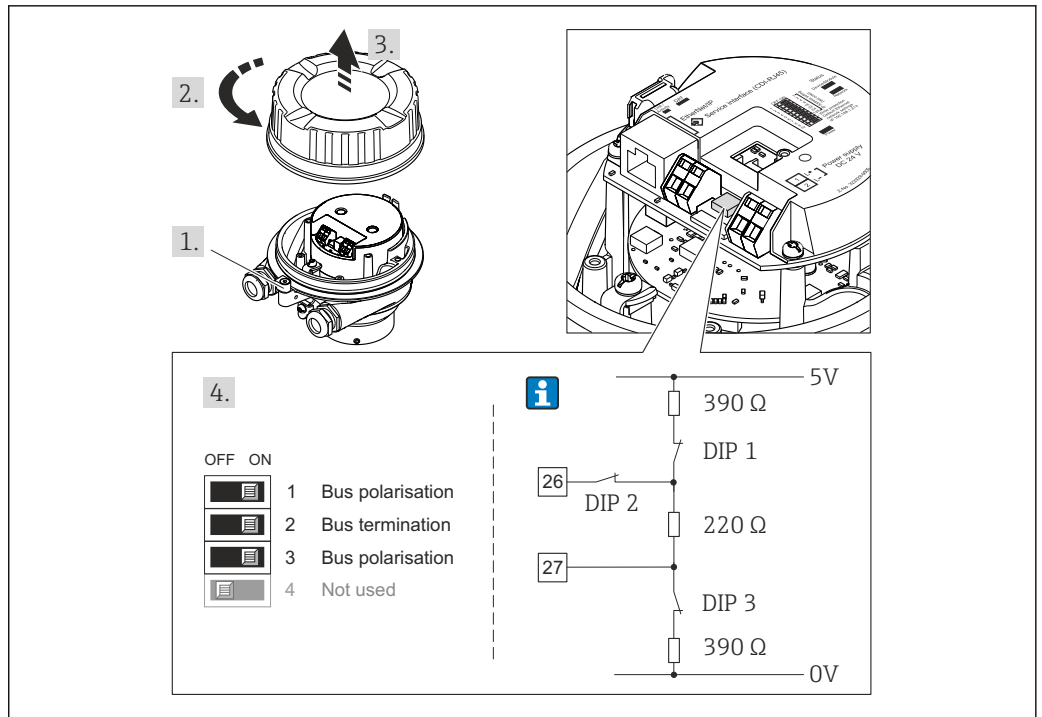

11 Termination using DIP switches on the I/O electronics module (for baud rates < 1.5 Mbaud)

7.7 Ensuring the degree of protection

The measuring instrument fulfills all the requirements for the degree of protection IP66/67, Type 4X enclosure.

To guarantee the degree of protection IP66/67, Type 4X enclosure, carry out the following steps after the electrical connection:



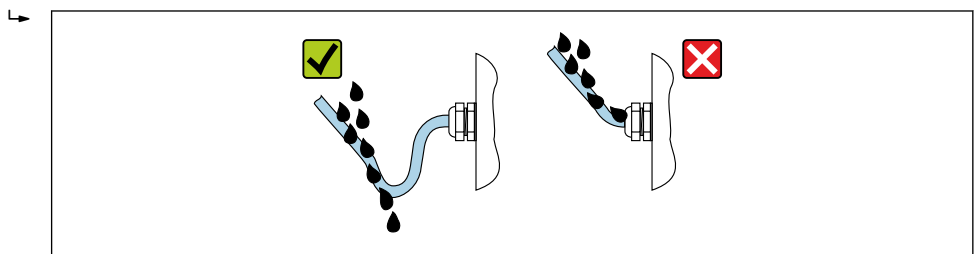



1. Check that the housing seals are clean and fitted correctly.
2. Dry, clean or replace the seals if necessary.
3. Tighten all housing screws and screw covers.
4. Firmly tighten the cable glands.
5. To ensure that moisture does not enter the cable entry:
Route the cable so that it loops down before the cable entry ("water trap").



6. The cable glands supplied do not ensure housing protection when not in use. They must therefore be replaced by dummy plugs corresponding to the housing protection.

7.8 Post-connection check

Are the device and cable undamaged (visual inspection)?	<input type="checkbox"/>
Do the cables used comply with the requirements → 26?	<input type="checkbox"/>

Are the installed cables strain-relieved and securely routed?	<input type="checkbox"/>
Are all cable glands installed, securely tightened and leak-tight? Cable run with "water trap" →  33?	<input type="checkbox"/>
Depending on the device version: Are all connectors securely tightened →  29?	<input type="checkbox"/>
Does the supply voltage match the specifications on the transmitter nameplate →  136?	<input type="checkbox"/>
Is the terminal assignment →  27 or the device plug pin assignment →  28 correct?	<input type="checkbox"/>
If supply voltage is present: Is the power LED on the transmitter electronics module lit in green →  11?	<input type="checkbox"/>
Depending on the device version: <ul style="list-style-type: none"> ■ Have the fixing screws been tightened with the correct tightening torque? ■ Is the securing clamp securely tightened? 	<input type="checkbox"/>

8 Operation options

8.1 Overview of operation options

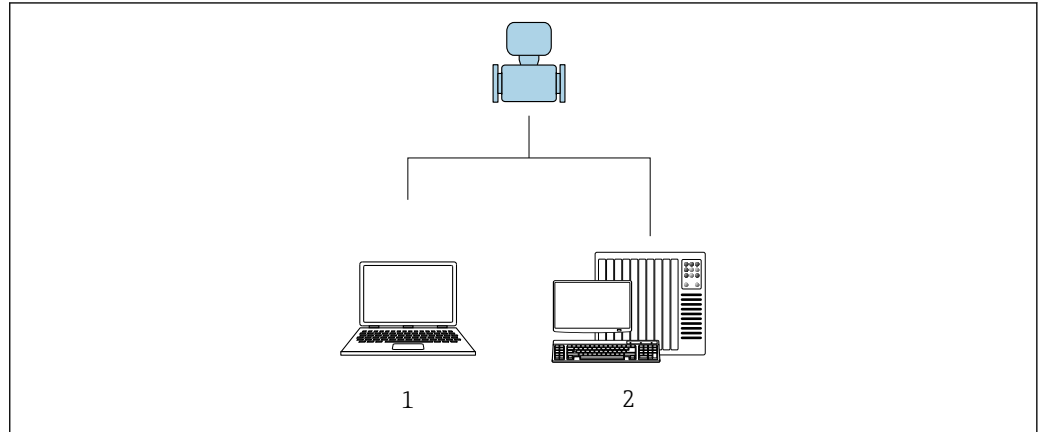



- 1 Computer with web browser or with "FieldCare" operating tool
- 2 Automation system, e.g. "RSLogix" (Rockwell Automation) and work station for measuring instrument operation with Add-on Profile Level 3 for "RSLogix 5000" software (Rockwell Automation)

A0017760

8.2 Structure and function of the operating menu

8.2.1 Structure of the operating menu

 For an overview of the operating menu for experts: see the "Description of Device Parameters" document supplied with the device →  154



 12 Schematic structure of the operating menu

A0018237-EN

8.2.2 Operating philosophy

The individual parts of the operating menu are assigned to certain user roles (e.g. operator, maintenance etc.). Each user role contains typical tasks within the device life cycle.

Menu/parameter		User role and tasks	Content/meaning
Language	Task-oriented	Role "Operator", "Maintenance" Tasks during operation: <ul style="list-style-type: none"> ▪ Configuration of the operational display ▪ Reading measured values 	<ul style="list-style-type: none"> ▪ Defining the operating language ▪ Defining the Web server operating language ▪ Resetting and controlling totalizers
Operation			<ul style="list-style-type: none"> ▪ Configuration of the operational display (e.g. display format, display contrast) ▪ Resetting and controlling totalizers
Setup		"Maintenance" role Commissioning: Configuration of the measurement	Submenus for fast commissioning: <ul style="list-style-type: none"> ▪ Configuring the system units ▪ Definition of the medium ▪ Configuration of the operational display ▪ Configuring the low flow cut off ▪ Configuring partial and empty pipe detection Advanced setup <ul style="list-style-type: none"> ▪ For more customized configuration of the measurement (adaptation to special measuring conditions) ▪ Configuration of totalizers ▪ Administration (define access code, reset measuring device)
Diagnostics		"Maintenance" role Troubleshooting: <ul style="list-style-type: none"> ▪ Diagnostics and elimination of process and device errors ▪ Measured value simulation 	Contains all parameters for error detection and analyzing process and device errors: <ul style="list-style-type: none"> ▪ Diagnostic list Contains up to 5 currently pending diagnostic messages. ▪ Event logbook Contains event messages that have occurred. ▪ Device information Contains information for identifying the device ▪ Measured values Contains all current measured values. ▪ Analog inputs Is used to display the analog input. ▪ Heartbeat Technology Verification of device functionality on request and documentation of verification results ▪ Simulation Used to simulate measured values or output values.
Expert	Function-oriented	Tasks that require detailed knowledge of the function of the device: <ul style="list-style-type: none"> ▪ Commissioning measurements under difficult conditions ▪ Optimal adaptation of the measurement to difficult conditions ▪ Detailed configuration of the communication interface ▪ Error diagnostics in difficult cases 	Contains all of the device parameters and allows direct access to these by means of an access code. The structure of this menu is based on the function blocks of the device: <ul style="list-style-type: none"> ▪ System Contains all higher-level device parameters that do not affect measurement or measured value communication ▪ Sensor Configuration of the measurement. ▪ Communication Configuration of the digital communication interface and the Web server ▪ Submenus for function blocks (e.g. "Analog Inputs") Configuration of function blocks ▪ Application Configuration of the functions that go beyond the actual measurement (e.g. totalizer) ▪ Diagnostics Error detection and analysis of process and device errors and for device simulation and Heartbeat Technology.

8.3 Displaying the measured values via the local display (optionally available)

8.3.1 Operational display

 The local display is optionally available:

Order code for "Display; operation", option B "4-line, illuminated; via communication".

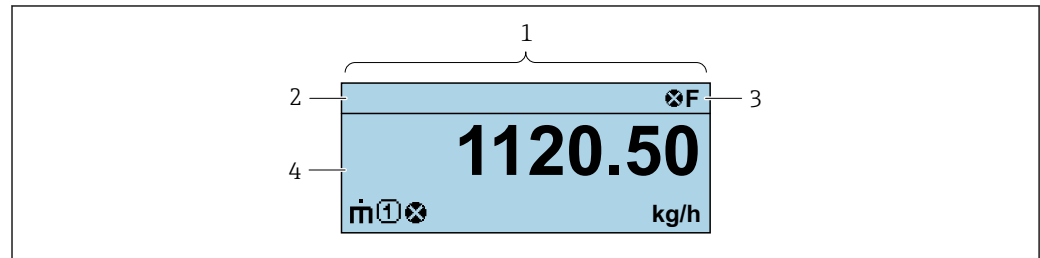





A0037831

- 1 Operational display
- 2 Tag name
- 3 Status area
- 4 Display area for measured values (4-line)

Status area

The following symbols appear in the status area of the operational display at the top right:

- Status signals
 - **F**: Failure
 - **C**: Function check
 - **S**: Out of specification
 - **M**: Maintenance required
- Diagnostic behavior
 - : Alarm
 - : Warning
 - : Locking (the device is locked via the hardware)
 - : Communication (communication via remote operation is active)



Display area

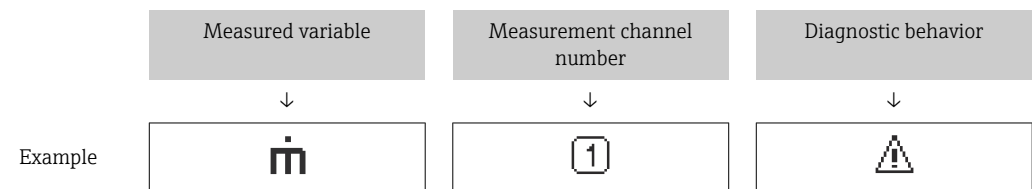



In the display area, each measured value is prefaced by certain symbol types for further description:



Appears only if a diagnostics event is present for this measured variable.

Measured variables

Symbol	Meaning
	Mass flow
	<ul style="list-style-type: none"> ▪ Volume flow ▪ Corrected volume flow

	<ul style="list-style-type: none"> ▪ Density ▪ Reference density
	Temperature
	Totalizer  The measurement channel number indicates which of the three totalizers is displayed.

Measurement channel numbers

Symbol	Meaning
	Measurement channel 1 to 4
The measurement channel number is displayed only if more than one channel is present for the same measured variable type (e.g. Totalizer 1 to 3).	

Diagnostic behavior

The diagnostic behavior pertains to a diagnostic event that is relevant to the displayed measured variable. For information on the symbols

 The number and display format of the measured values can only be configured via the control system or Web server.

8.3.2 User roles and related access authorization

The two user roles "Operator" and "Maintenance" have different write access to the parameters if the customer defines a user-specific access code. This protects the device configuration from unauthorized access .

Defining access authorization for user roles

An access code is not yet defined when the device is delivered from the factory. Access authorization (read and write access) to the device is not restricted and corresponds to the "Maintenance" user role.

- ▶ Define the access code.
 - ↳ The "Operator" user role is redefined in addition to the "Maintenance" user role. Access authorization differs for the two user roles.

Access authorization to parameters: "Maintenance" user role

Access code status	Read access	Write access
An access code has not yet been defined (factory setting).	✓	✓
After an access code has been defined.	✓	✓ ¹⁾

1) The user only has write access after entering the access code.

Access authorization to parameters: "Operator" user role

Access code status	Read access	Write access
After an access code has been defined.	✓	– ¹⁾

1) Despite the defined access code, certain parameters can always be modified and thus are excluded from the write protection as they do not affect the measurement: write protection via access code

 The user role with which the user is currently logged on is indicated by the .
 Navigation path:

8.4 Access to operating menu via web browser

8.4.1 Function range

With the integrated web server, the device can be operated and configured via a web browser service interface (CDI-RJ45) WLAN interface. In addition to the measured values, status information on the device is displayed and can be used to monitor device health. Furthermore the device data can be managed and the network parameters can be configured.



For additional information on the web server, see the Special Documentation for the device.

8.4.2 Prerequisites

Computer hardware

Hardware	Interface	
	CDI-RJ45	WLAN
Interface	The computer must have an RJ45 interface.	The operating unit must have a WLAN interface.
Connection	Standard Ethernet cable with RJ45 connector.	Connection via Wireless LAN.
Display	Recommended size: ≥12" (depends on the screen resolution)	

Computer software

Software	Interface	
	CDI-RJ45	WLAN
Recommended operating systems	<ul style="list-style-type: none"> ▪ Microsoft Windows 8 or higher. ▪ Mobile operating systems: <ul style="list-style-type: none"> ▪ iOS ▪ Android <p> Microsoft Windows XP is supported.</p> <p> Microsoft Windows 7 is supported.</p>	
Web browsers supported	<ul style="list-style-type: none"> ▪ Microsoft Internet Explorer 8 or higher ▪ Microsoft Edge ▪ Mozilla Firefox ▪ Google Chrome ▪ Safari 	



Computer settings

User rights	Appropriate user rights (e.g. administrator rights) for TCP/IP and proxy server settings are necessary (for adjusting the IP address, subnet mask etc.).
Proxy server settings of the Web browser	The web browser setting <i>Use a Proxy Server for Your LAN</i> must be deselected .
JavaScript	<p>JavaScript must be enabled.</p> <p> If JavaScript cannot be enabled: Enter <code>http://XXX.XXX.X.XX/servlet/basic.html</code> in the address bar of the web browser, e.g. <code>http://192.168.1.212/servlet/basic.html</code>. A fully functional but simplified version of the operating menu structure starts in the web browser.</p>

Network connections	Only the active network connections to the measuring device should be used.
	Switch off all other network connections.

 In the event of connection problems: →  85

Measuring device: Via CDI-RJ45 service interface

Device	CDI-RJ45 service interface
Measuring device	The measuring device has an RJ45 interface.
Web server	Web server must be enabled; factory setting: ON  For information on enabling the Web server →  44

8.4.3 Connecting the device

Via service interface (CDI-RJ45)

Preparing the measuring device

Configuring the Internet protocol of the computer

The following information refers to the default Ethernet settings of the device.

IP address of the device: 192.168.1.212 (factory setting)

1. Switch on the measuring device.
2. Connect the computer to the RJ45 plug via the standard Ethernet cable →  149.
3. If a 2nd network card is not used, close all the applications on the notebook.
 - ↳ Applications requiring Internet or a network, such as e-mail, SAP applications, Internet or Windows Explorer.
4. Close any open Internet browsers.
5. Configure the properties of the Internet protocol (TCP/IP) as defined in the table:

IP address	192.168.1.XXX; for XXX all numerical sequences except: 0, 212 and 255 → e.g. 192.168.1.213
Subnet mask	255.255.255.0
Default gateway	192.168.1.212 or leave cells empty

Starting the web browser

1. Start the web browser on the computer.

2. Enter the IP address of the web server in the address line of the web browser:
192.168.1.212
↳ The login page appears.

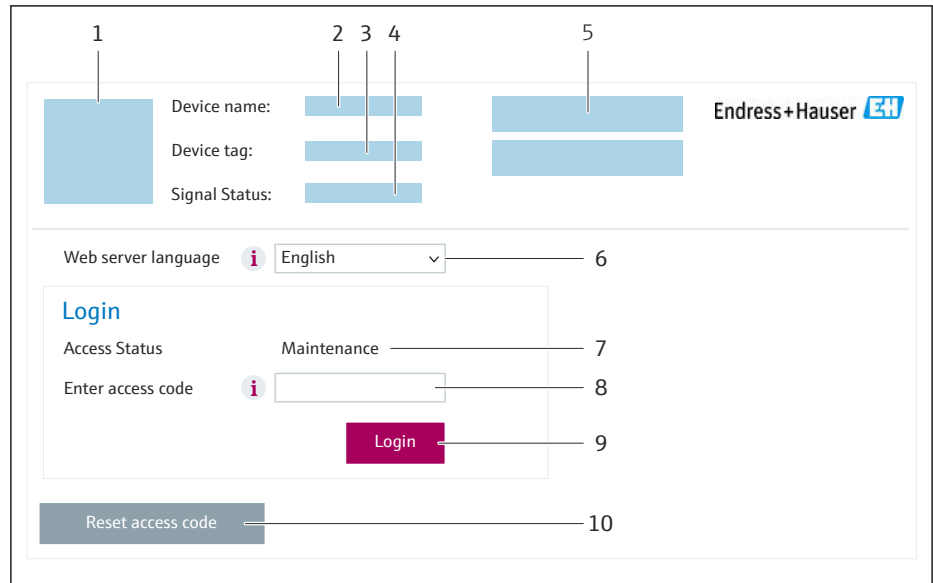

- 1 Picture of device
- 2 Device name
- 3 Device tag
- 4 Status signal
- 5 Current measured values
- 6 Operating language
- 7 User role
- 8 Access code
- 9 Login
- 10 Reset access code

i If a login page does not appear, or if the page is incomplete → 85

8.4.4 Logging on

1. Select the preferred operating language for the Web browser.
2. Enter the user-specific access code.
3. Press **OK** to confirm your entry.

Access code	0000 (factory setting); can be changed by customer
--------------------	--

i If no action is performed for 10 minutes, the Web browser automatically returns to the login page.

8.4.5 User interface

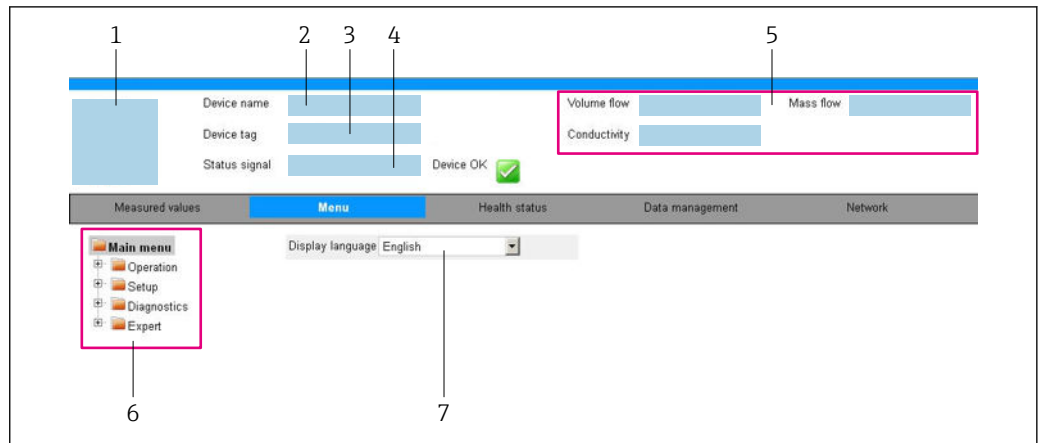

A0032879

- 1 Picture of device
- 2 Device name
- 3 Device tag
- 4 Status signal
- 5 Current measured values
- 6 Navigation area
- 7 Local display language

Header

The following information appears in the header:

- Device name
- Device tag
- Device status with status signal → 88
- Current measured values

Function row

Functions	Meaning
Measured values	Displays the measured values of the device
Menu	<ul style="list-style-type: none"> ■ Access to the operating menu from the measuring device ■ The structure of the operating menu is the same as for the operating tools Detailed information on the operating menu structure: Description of Device Parameters
Device status	Displays the diagnostic messages currently pending, listed in order of priority
Data management	Data exchange between computer and measuring device: <ul style="list-style-type: none"> ■ Device configuration: <ul style="list-style-type: none"> ■ Load settings from the device (XML format, save configuration) ■ Save settings to the device (XML format, restore configuration) ■ Logbook - Export Event logbook (.csv file) ■ Documents - Export documents: <ul style="list-style-type: none"> ■ Export backup data record (.csv file, create documentation of the measuring point configuration) ■ Verification report (PDF file, only available with the "Heartbeat Verification" application package) ■ File for system integration - If using fieldbuses, upload device drivers for system integration from the measuring device: PROFIBUS DP: GSD file

Functions	Meaning
Network	Configuration and checking of all the parameters required for establishing the connection to the measuring device: <ul style="list-style-type: none"> ▪ Network settings (e.g. IP address, MAC address) ▪ Device information (e.g. serial number, firmware version)
Logout	End the operation and call up the login page

Navigation area

The menus, the associated submenus and parameters can be selected in the navigation area.

Working area

Depending on the selected function and the related submenus, various actions can be performed in this area:

- Configuring parameters
- Reading measured values
- Calling up help text
- Starting an upload/download

8.4.6 Disabling the Web server

The Web server of the measuring device can be switched on and off as required using the **Web server functionality** parameter.

Navigation

"Expert" menu → Communication → Web server

Parameter overview with brief description

Parameter	Description	Selection
Web server functionality	Switch the Web server on and off.	<ul style="list-style-type: none"> ▪ Off ▪ On

Function scope of the "Web server functionality" parameter

Option	Description
Off	<ul style="list-style-type: none"> ▪ The Web server is completely disabled. ▪ Port 80 is locked.
On	<ul style="list-style-type: none"> ▪ The complete Web server functionality is available. ▪ JavaScript is used. ▪ The password is transferred in an encrypted state. ▪ Any change to the password is also transferred in an encrypted state.

Enabling the Web server

If the Web server is disabled it can only be re-enabled with the **Web server functionality** parameter via the following operating options:

- Via Bedientool "FieldCare"
- Via "DeviceCare" operating tool

8.4.7 Logging out

 Before logging out, perform a data backup via the **Data management** function (upload configuration from device) if necessary.

1. Select the **Logout** entry in the function row.
↳ The home page with the Login box appears.
2. Close the Web browser.
3. If no longer needed:
Reset the modified properties of the Internet protocol (TCP/IP) → 41.

8.5 Access to the operating menu via the operating tool

8.5.1 Connecting the operating tool

Via PROFIBUS DP network

This communication interface is available in device versions with PROFIBUS DP.

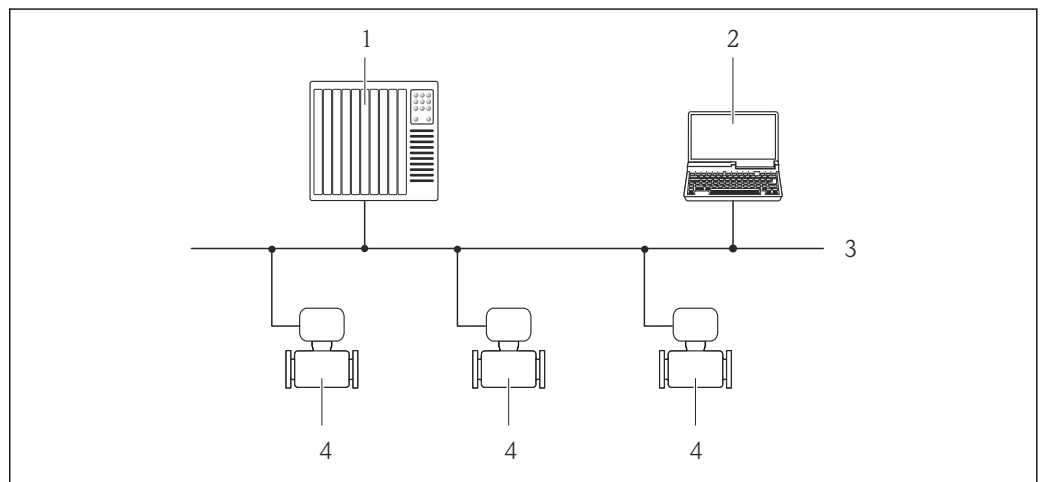

13 Options for remote operation via PROFIBUS DP network

- 1 Automation system
- 2 Computer with PROFIBUS network card
- 3 PROFIBUS DP network
- 4 Measuring device

Via service interface (CDI-RJ45)

PROFIBUS DP

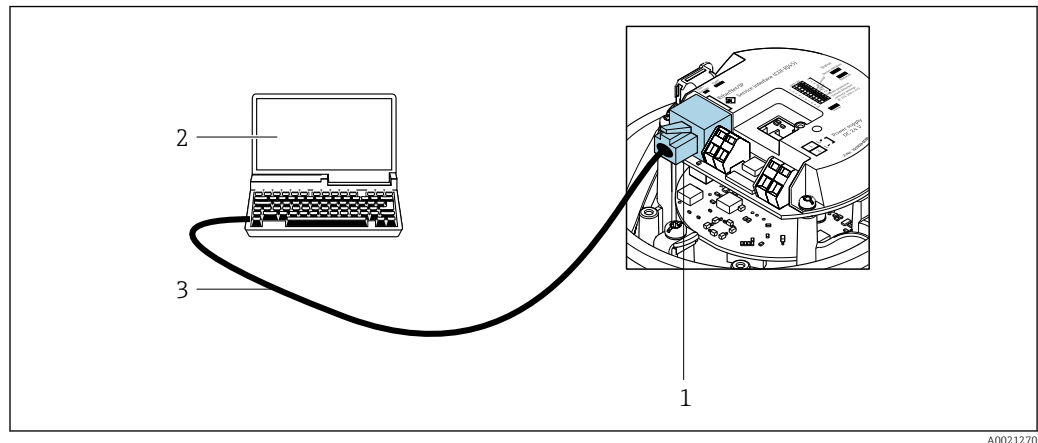

14 Connection for order code for "Output", option L: PROFIBUS DP

- 1 Service interface (CDI-RJ45) of the measuring device with access to the integrated web server
- 2 Computer with web browser (e.g. Internet Explorer) for accessing the integrated web server or with "FieldCare" operating tool with COM DTM "CDI Communication TCP/IP"
- 3 Standard Ethernet connecting cable with RJ45 plug

8.5.2 FieldCare

Function range

FDT-based (Field Device Technology) plant asset management tool from Endress+Hauser. It can configure all smart field units in a system and helps you manage them. By using the status information, it is also a simple but effective way of checking their status and condition.

Access is via:
CDI-RJ45 service interface

Typical functions:

- Transmitter parameter configuration
- Loading and saving of device data (upload/download)
- Documentation of the measuring point
- Visualization of the measured value memory (line recorder) and event logbook



- Operating Instructions BA00027S
- Operating Instructions BA00059S



Source for device description files → 48

Establishing a connection

1. Start FieldCare and launch the project.
2. In the network: Add a device.
 - ↳ The **Add device** window opens.
3. Select the **CDI Communication TCP/IP** option from the list and press **OK** to confirm.
4. Right-click **CDI Communication TCP/IP** and select the **Add device** option in the context menu that opens.
5. Select the desired device from the list and press **OK** to confirm.
 - ↳ The **CDI Communication TCP/IP (Configuration)** window opens.
6. Enter the device address in the **IP address** field and press **Enter** to confirm: 192.168.1.212 (factory setting); if the IP address is not known .

7. Establish the online connection to the device.

- Operating Instructions BA00027S
- Operating Instructions BA00059S

User interface

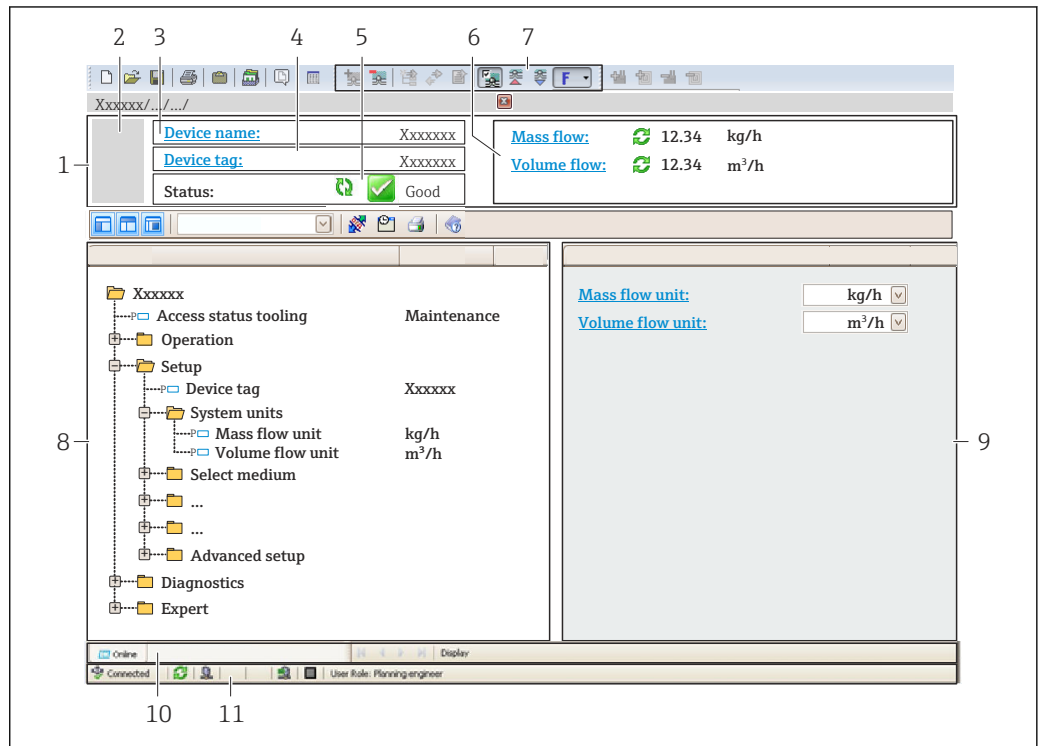

A0021051-EN

- 1 Header
- 2 Picture of device
- 3 Device name
- 4 Device tag
- 5 Status area with status signal → 88
- 6 Display area for current measured values
- 7 Editing toolbar with additional functions such as save/load, event list and create documentation
- 8 Navigation area with operating menu structure
- 9 Work area
- 10 Action area
- 11 Status area

8.5.3 DeviceCare

Function range

Tool for connecting and configuring Endress+Hauser field devices.

The fastest way to configure Endress+Hauser field devices is with the dedicated "DeviceCare" tool. Together with the device type managers (DTMs) it presents a convenient, comprehensive solution.

- Innovation brochure IN01047S
- Source for device description files → 48

9 System integration

9.1 Overview of device description files

9.1.1 Current version data for the device

Firmware version	01.01.zz	<ul style="list-style-type: none"> ▪ On the title page of the manual ▪ On the transmitter nameplate ▪ Parameter: Firmware version parameter Diagnostics → Device information → Firmware version
Release date of firmware version	10.2014	---
Manufacturer ID	0x11	Parameter: Manufacturer ID parameter Diagnostics → Device information → Manufacturer ID
Device type ID	0x1561	Parameter: Device type parameter Diagnostics → Device information → Device type
Profile version	3.02	---



For an overview of the various firmware versions for the device

9.1.2 Operating tools

The suitable device description file for the individual operating tools is listed in the table below, along with information on where the file can be acquired.

Operating tool via PROFIBUS protocol	Sources for obtaining device descriptions
FieldCare	<ul style="list-style-type: none"> ▪ www.endress.com → Downloads area ▪ USB stick (contact Endress+Hauser) ▪ DVD (contact Endress+Hauser)
DeviceCare	<ul style="list-style-type: none"> ▪ www.endress.com → Downloads area ▪ CD-ROM (contact Endress+Hauser) ▪ DVD (contact Endress+Hauser)

9.2 Device master file (GSD)

In order to integrate field devices into a bus system, the PROFIBUS system needs a description of the device parameters, such as output data, input data, data format, data volume and supported transmission rate.

These data are available in the device master file (GSD) which is provided to the PROFIBUS master when the communication system is commissioned. In addition device bit maps, which appear as icons in the network structure, can also be integrated.

With the Profile 3.02 device master file (GSD) it is possible to exchange field devices made by different manufacturers without having to reconfigure.

Generally speaking, it is possible to use two different GSDs with Profile 3.02 and higher: the manufacturer-specific GSD and the Profile GSD.



- Before configuring, the user must decide which GSD should be used to operate the system.
- The setting can be changed via a class 2 master.

9.2.1 Manufacturer-specific GSD

This GSD guarantees the unrestricted functionality of the measuring device. Device-specific process parameters and functions are therefore available.

Manufacturer-specific GSD	ID number	File name
PROFIBUS DP	0x1561	EH3x1561.gsd

The fact that the manufacturer-specific GSD should be used is specified in the **Ident number selector** parameter by selecting the **Manufacturer** option.



Where to acquire the manufacturer-specific GSD:

www.endress.com → Download Area

9.2.2 Profile GSD

Differs in terms of the number of Analog Input blocks (AI) and the measured values. If a system is configured with a Profile GSD, it is possible to exchange devices made by different manufacturers. However, it is essential to ensure that the order of the cyclic process values is correct.

ID number	Supported blocks	Supported channels
0x9740	<ul style="list-style-type: none"> ▪ 1 Analog Input ▪ 1 Totalizer 	<ul style="list-style-type: none"> ▪ Channel Analog Input: volume flow ▪ Channel totalizer: volume flow
0x9741	<ul style="list-style-type: none"> ▪ 2 Analog Input ▪ 1 Totalizer 	<ul style="list-style-type: none"> ▪ Channel Analog Input 1: volume flow ▪ Channel Analog Input 2: mass flow ▪ Channel totalizer: volume flow
0x9742	<ul style="list-style-type: none"> ▪ 3 Analog Input ▪ 1 Totalizer 	<ul style="list-style-type: none"> ▪ Channel Analog Input 1: volume flow ▪ Channel Analog Input 2: mass flow ▪ Channel Analog Input 3: corrected volume flow ▪ Channel totalizer: volume flow

The Profile GSD that is to be used is specified in the **Ident number selector** parameter by selecting the **Profile 0x9740** option, **Profile 0x9741** option or **Profile 0x9742** option.

9.3 Integration into a PROFIBUS network

9.3.1 Block model

- Physical block
- Function blocks
 - Analog Input Block
 - Analog Output Block
 - Discrete Input Block
 - Discrete Output Block
 - Totalizer Block



Technical values for the individual blocks → 135

9.3.2 Assignment of the measured values in the function blocks

The input value of a function block is defined via the CHANNEL parameter.

Analog Input 1 to 8 (AI)

Channel	Measured variable
33122	Volume flow
32961	Mass flow
33093	Corrected volume flow
708	Flow velocity
901	Target mass flow
793	Carrier mass flow
32850	Density
33092	Reference density
794	Concentration
1039	Dynamic viscosity
1032	Kinematic viscosity
904	Temperature compensated dynamic viscosity
905	Temperature compensated kinematic viscosity
33101	Temperature
263	Carrier pipe temperature
1042	Electronics temperature
1066	Oscillation frequency 0
1067	Oscillation frequency 1
1124	Oscillation amplitude 0
876	Oscillation amplitude 1
1062	Frequency fluctuation 0
1063	Frequency fluctuation 1
1117	Oscillation damping 0
1118	Oscillation damping 1
1054	Tube damping fluctuation 0
1055	Tube damping fluctuation 1
1125	Signal asymmetry

Channel	Measured variable
1056	Exciter current 0
1057	Exciter current 1
1440	HBSI

Analog Output 1 to 3 (AO)

Channel	Measured variable
306	External pressure ¹⁾
307	External temperature
488	External reference density

1) The compensation variables must be transmitted to the device in the SI basic unit.

The measured variable is accessed via Expert → Sensor → External compensation

Digital Input 1 to 2 (DI)

Channel	Signal
894	Empty pipe detection
895	Low flow cut off
1430	Verification status

Digital Output 1 to 3 (DO)

Channel	Signal
890	Zero adjustment
891	Flow override
1429	Start the verification

Totalizer 1 to 3 (TOT)

Channel	Signal
33122	Volume flow
32961	Mass flow
33093	Corrected volume flow
901	Target mass flow
793	Carrier mass flow

9.3.3 Totalizer control SET_TOT

Value	Behavior
0	Totalize
1	Reset + hold
2	Preset + hold

9.4 Cyclic data transmission

Cyclic data transmission when using the device master file (GSD).

9.4.1 Block model

The block model shows which input and output data the measuring device makes available for cyclic data exchange. Cyclic data exchange takes place with a PROFIBUS master (Class 1), e.g. a control system.

Measuring device			Control system
Transducer Block	Analog Input block 1 to 8 → 53	Output value AI	→
		Output value TOTAL	→
	Totalizer block 1 to 3 → 54	Controller SETTOT	←
		Configuration MODETOT	←
	Analog Output block 1 to 3 → 56	Input values AO	←
	Discrete Input block 1 to 2 → 56	Output values DI	→
	Discrete Output block 1 to 3 → 57	Input values DO	←
			PROFIBUS DP

Defined order of modules

The measuring device works as a modular PROFIBUS slave. In contrast to a compact slave, a modular slave has a variable design and consists of several individual modules. The device master file (GSD) contains a description of the individual modules (input and output data) along with their individual properties.

The modules are permanently assigned to the slots, i.e. when configuring the modules, the order and the arrangement of the modules must be respected.

Slot	Module	Function block
1...8	AI	Analog Input block 1 to 8
9	TOTAL or SETTOT_TOTAL or SETTOT_MODETOT_TOTAL	Totalizer block 1
10		Totalizer block 2
11		Totalizer block 3
12...14	AO	Analog Output block 1 to 3
15...16	DI	Discrete Input block 1 to 2
17...19	DO	Discrete Output block 1 to 3

To optimize the data throughput rate of the PROFIBUS network, it is advisable to only configure modules that are processed in the PROFIBUS master system. If this results in gaps between the configured modules, these gaps must be assigned to the EMPTY_MODULE.

9.4.2 Description of the modules

The data structure is described from the perspective of the PROFIBUS master:

- Input data: Are sent from the measuring device to the PROFIBUS master.
- Output data: Are sent from the PROFIBUS master to the measuring device.

AI module (Analog Input)

Transmit an input variable from the measuring device to the PROFIBUS master (Class 1).

The selected input variable including its status is cyclically transmitted to the PROFIBUS master (Class 1) via the AI module. The input variable is depicted in the first four bytes in the form of a floating point number as per the IEEE 754 standard. The fifth byte contains standardized status information pertaining to the input variable.

Eight Analog Input blocks are available (slot 1 to 8).

Selection: input variable

The input variable can be specified using the CHANNEL parameter.

CHANNEL	Input variable
32961	Mass flow
33122	Volume flow
33093	Corrected volume flow
708	Flow velocity
32850	Density
33092	Reference density
33101	Temperature
1042	Electronics temperature
901	Target mass flow ¹⁾
793	Carrier mass flow ¹⁾
794	Concentration ¹⁾
1039	Dynamic viscosity ²⁾
1032	Kinematic viscosity ²⁾
904	Temperature-compensated dynamic viscosity ²⁾
905	Temperature-compensated kinematic viscosity ²⁾
263	Carrier tube temperature ³⁾

1) Only available with the Concentration application package

2) Only available with the Viscosity application package

3) Only available with the Heartbeat Verification application package

Factory setting

Function block	Factory setting
AI 1	Mass flow
AI 2	Density
AI 3	Temperature
AI 4	Volume flow
AI 5	Corrected volume flow
AI 6	Reference density
AI 7	Mass flow
AI 8	Mass flow

*Data structure**Input data of Analog Input*

Byte 1	Byte 2	Byte 3	Byte 4	Byte 5
Measured value: floating point number (IEEE 754)				Status

TOTAL module

Transmit a totalizer value from the measuring device to the PROFIBUS master (Class 1).

A selected totalizer value, along with the status, is cyclically transmitted to a PROFIBUS Master (Class 1) via the TOTAL module. The totalizer value is depicted in the first four bytes in the form of a floating point number as per the IEEE 754 standard. The fifth byte contains standardized status information pertaining to the totalizer value.

Three Totalizer blocks are available (slot 9 to 11).

Selection: totalizer value

The totalizer value can be specified using the CHANNEL parameter.

CHANNEL	Input variable
32961	Mass flow
33122	Volume flow
33093	Corrected volume flow
901	Target fluid mass flow ¹⁾
793	Carrier mass flow ¹⁾

1) Only available with the "Concentration" application package

Factory setting

Function block	Factory setting: TOTAL
Totalizer 1, 2 and 3	Mass flow

*Data structure**Input data of TOTAL*

Byte 1	Byte 2	Byte 3	Byte 4	Byte 5
Measured value: floating point number (IEEE 754)				Status

SETTOT_TOTAL module

The module combination consists of the SET_TOT and TOTAL functions:

- SETTOT: Control the totalizers via the PROFIBUS master.
- TOTAL: Transmit totalizer value incl. status to PROFIBUS master.

Three Totalizer blocks are available (slot 9 to 11).

Selection: control totalizer

Value SETTOT	Control totalizer
0	Totalize
1	Reset + hold
2	Preset + hold

Factory setting

Function block	Factory setting: Value SETTOT (meaning)
Totalizer 1, 2 and 3	0 (totalizing)

Data structure

Output data of SETTOT

Byte 1
Control variable 1

Input data of TOTAL

Byte 1	Byte 2	Byte 3	Byte 4	Byte 5
Measured value: floating point number (IEEE 754)				Status

SETTOT_MODETOT_TOTAL module

The module combination consists of the SETTOT, MODETOT and TOTAL functions:

- SETTOT: Control the totalizers via the PROFIBUS master.
- MODETOT: Configure the totalizers via the PROFIBUS master.
- TOTAL: Transmit totalizer value, along with the status, to the PROFIBUS master.

Three Totalizer blocks are available (slot 9 to 11).

Selection: totalizer configuration

MODETOT value	Totalizer configuration
0	Balancing
1	Balance the positive flow
2	Balance the negative flow
3	Stop totalizing

Factory setting

Function block	Factory setting: Value MODETOT (meaning)
Totalizer 1, 2 and 3	0 (balancing)

Data structure

Output data of SETTOT and MODETOT

Byte 1	Byte 2
Control variable 1: SETTOT	Control variable 2: MODETOT

Input data of TOTAL

Byte 1	Byte 2	Byte 3	Byte 4	Byte 5
Measured value: floating point number (IEEE 754)				Status

AO module (Analog Output)

Transmit a compensation value from the PROFIBUS master (class 1) to the measuring device.

A compensation value, including the status, is cyclically transmitted from the PROFIBUS master (class 1) to the measuring device via the AO module. The compensation value is depicted in the first four bytes in the form of a floating point number as per the IEEE 754 standard. The fifth byte contains standardized status information pertaining to the compensation value.

Three Analog Output blocks are available (slot 12 to 14).

Assigned compensation values

A compensation value is permanently assigned to the individual Analog Output blocks.

CHANNEL	Function block	Compensation value
306	AO 1	External pressure ¹⁾
307	AO 2	External temperature ¹⁾
488	AO 3	External reference density

1) The compensation values must be transmitted to the device in the SI basic unit



The selection is made via: Expert → Sensor → External compensation

Data structure

Output data of Analog Output

Byte 1	Byte 2	Byte 3	Byte 4	Byte 5
Measured value: floating point number (IEEE 754)				Status ¹⁾

1) Status coding

DI module (Discrete Input)

Transmit discrete input values from the measuring device to the PROFIBUS master (class 1). Discrete input values are used by the measuring device to transmit the state of device functions to the PROFIBUS master (class 1).

The DI module cyclically transmits the discrete input value, including the status, to the PROFIBUS master (class 1). The discrete input value is depicted in the first byte. The second byte contains standardized status information pertaining to the input value.

Two Discrete Input blocks are available (slot 15 to 16).

Selection: device function

The device function can be specified using the CHANNEL parameter.

CHANNEL	Device function	Factory setting: Status (meaning)
893	Status switch output	<ul style="list-style-type: none"> ▪ 0 (device function not active) ▪ 1 (device function active)
894	Empty pipe detection	
895	Low flow cut off	
1430	Verification status ¹⁾	

1) Only available with the Heartbeat Verification application package

Factory setting

Function block	Factory setting
DI 1	Empty pipe detection
DI 2	Low flow cut off

Data structure

Input data of Discrete Input

Byte 1	Byte 2
Discrete	Status

DO module (Discrete Output)

Transmit discrete output values from the PROFIBUS master (class 1) to the measuring device. Discrete output values are used by the PROFIBUS master (class 1) to enable and disable device functions.

The DO module cyclically transmits the discrete output value, including the status, to the measuring device. The discrete output value is depicted in the first byte. The second byte contains standardized status information pertaining to the output value.

Three Discrete Output blocks are available (slot 17 to 19).

Assigned device functions

A device function is permanently assigned to the individual Discrete Output blocks.

CHANNEL	Function block	Device function	Values: control (meaning)
891	DO 1	Flow override	<ul style="list-style-type: none"> ▪ 0 (disable device function) ▪ 1 (enable device function)
890	DO 2	Zero adjustment	
1429	DO 3	Start verification ¹⁾	

1) Only available with the Heartbeat Verification application package

Data structure

Output data of Discrete Output

Byte 1	Byte 2
Discrete	Status

EMPTY_MODULE module

This module is used to assign empty spaces arising from modules not being used in the slots .



The measuring device works as a modular PROFIBUS slave. In contrast to a compact slave, a modular PROFIBUS slave has a variable design and consists of several individual modules. The GSD file contains a description of the individual modules along with their individual properties.

The modules are permanently assigned to the slots. When configuring the modules, it is absolutely essential to observe the sequence/arrangement of the modules. Any gaps between the configured modules must be filled with the EMPTY_MODULE.



10 Commissioning

10.1 Post-mounting and post-connection check

Before commissioning the device:

- ▶ Make sure that the post-installation and post-connection checks have been performed successfully.
- Checklist for "Post-installation" check →  25
- Checklist for "Post-connection" check →  33

10.2 Connecting via FieldCare

- For connecting FieldCare
- For connecting via FieldCare →  46
- For user interface of FieldCare →  47









10.3 Setting the operating language

Factory setting: English or ordered local language

The operating language can be set in FieldCare, DeviceCare or via the Web server:
Operation → Display language

10.4 Configuring the measuring instrument

The **Setup** menu with its submenus contains all the parameters needed for standard operation.

 Setup	
Device tag	→  59
▶ System units	→  59
▶ Medium selection	→  62
▶ Communication	→  63
▶ Analog inputs	→  64
▶ Low flow cut off	→  66
▶ Partially filled pipe detection	→  67
▶ Advanced setup	→  68

10.4.1 Defining the tag name

To enable fast identification of the measuring point within the system, you can enter a unique designation using the **Device tag** parameter and thus change the factory setting.

 Enter the tag name in the "FieldCare" operating tool →  47

Navigation

"Setup" menu → Device tag

Parameter overview with brief description

Parameter	Description	User entry
Device tag	Enter the name for the measuring point.	Max. 32 characters, such as letters, numbers or special characters (e.g. @, %, /).

10.4.2 Setting the system units











In the **System units** submenu the units of all the measured values can be set.

 The number of submenus and parameters can vary depending on the device version. Certain submenus and parameters in these submenus are not described in the Operating Instructions. Instead a description is provided in the Special Documentation for the device ("Supplementary documentation").

Navigation

"Setup" menu → Advanced setup → System units

▶ System units

Mass flow unit	→  60
Mass unit	→  60
Volume flow unit	→  60
Volume unit	→  60
Corrected volume flow unit	→  60
Corrected volume unit	→  60
Density unit	→  60
Reference density unit	→  60
Temperature unit	→  61
Pressure unit	→  61

Parameter overview with brief description

Parameter	Description	Selection	Factory setting
Mass flow unit	Select mass flow unit. <i>Effect</i> The selected unit applies to: <ul style="list-style-type: none"> ▪ Output ▪ Low flow cut off ▪ Simulation process variable 	Unit choose list	Country-specific: <ul style="list-style-type: none"> ▪ kg/h ▪ lb/min
Mass unit	Select mass unit.	Unit choose list	Country-specific: <ul style="list-style-type: none"> ▪ kg ▪ lb
Volume flow unit	Select volume flow unit. <i>Effect</i> The selected unit applies to: <ul style="list-style-type: none"> ▪ Output ▪ Low flow cut off ▪ Simulation process variable 	Unit choose list	Country-specific: <ul style="list-style-type: none"> ▪ l/h ▪ gal/min (us)
Volume unit	Select volume unit.	Unit choose list	Country-specific: <ul style="list-style-type: none"> ▪ l (DN > 150 (6'': m³ option) ▪ gal (us)
Corrected volume flow unit	Select corrected volume flow unit. <i>Effect</i> The selected unit applies to: Corrected volume flow parameter (→  81)	Unit choose list	Country-specific: <ul style="list-style-type: none"> ▪ NI/h ▪ Sft³/min
Corrected volume unit	Select corrected volume unit.	Unit choose list	Country-specific: <ul style="list-style-type: none"> ▪ NI ▪ Sft³
Density unit	Select density unit. <i>Effect</i> The selected unit applies to: <ul style="list-style-type: none"> ▪ Output ▪ Simulation process variable ▪ Density adjustment (Expert menu) 	Unit choose list	Country-specific: <ul style="list-style-type: none"> ▪ kg/l ▪ lb/ft³
Reference density unit	Select reference density unit.	Unit choose list	Country-specific <ul style="list-style-type: none"> ▪ kg/NI ▪ lb/Sft³
Density 2 unit	Select second density unit.	Unit choose list	Country-specific: <ul style="list-style-type: none"> ▪ kg/l ▪ lb/ft³

Parameter	Description	Selection	Factory setting
Temperature unit	Select temperature unit. <i>Effect</i> The selected unit applies to: <ul style="list-style-type: none"> ▪ Electronic temperature parameter (6053) ▪ Maximum value parameter (6051) ▪ Minimum value parameter (6052) ▪ Maximum value parameter (6108) ▪ Minimum value parameter (6109) ▪ Carrier pipe temperature parameter (6027) ▪ Maximum value parameter (6029) ▪ Minimum value parameter (6030) ▪ Reference temperature parameter (1816) ▪ Temperature parameter 	Unit choose list	Country-specific: <ul style="list-style-type: none"> ▪ °C ▪ °F
Pressure unit	Select process pressure unit. <i>Effect</i> The unit is taken from: <ul style="list-style-type: none"> ▪ Pressure value parameter (→ ⓘ 63) ▪ External pressure parameter (→ ⓘ 63) ▪ Pressure value 	Unit choose list	Country-specific: <ul style="list-style-type: none"> ▪ bar a ▪ psi a

10.4.3 Selecting and setting the medium

The **Select medium** wizard submenu contains parameters that must be configured in order to select and set the medium.

Navigation

"Setup" menu → Medium selection

► Medium selection	
Select medium	→ 62
Select gas type	→ 62
Reference sound velocity	→ 63
Temperature coefficient sound velocity	→ 63
Pressure compensation	→ 63
Pressure value	→ 63
External pressure	→ 63

Parameter overview with brief description

Parameter	Prerequisite	Description	Selection / User entry
Select medium	–	Use this function to select the type of medium: "Gas" or "Liquid". Select the "Other" option in exceptional cases in order to enter the properties of the medium manually (e.g. for highly compressive liquids such as sulfuric acid).	<ul style="list-style-type: none"> ▪ Liquid ▪ Gas
Select gas type	In the Medium selection submenu, the Gas option is selected.	Select measured gas type.	<ul style="list-style-type: none"> ▪ Air ▪ Ammonia NH₃ ▪ Argon Ar ▪ Sulfur hexafluoride SF₆ ▪ Oxygen O₂ ▪ Ozone O₃ ▪ Nitrogen oxide NO_x ▪ Nitrogen N₂ ▪ Nitrous oxide N₂O ▪ Methane CH₄ ▪ Hydrogen H₂ ▪ Helium He ▪ Hydrogen chloride HCl ▪ Hydrogen sulfide H₂S ▪ Ethylene C₂H₄ ▪ Carbon dioxide CO₂ ▪ Carbon monoxide CO ▪ Chlorine Cl₂ ▪ Butane C₄H₁₀ ▪ Propane C₃H₈ ▪ Propylene C₃H₆ ▪ Ethane C₂H₆ ▪ Others

Parameter	Prerequisite	Description	Selection / User entry
Reference sound velocity	In the Select gas type parameter, the Others option is selected.	Enter sound velocity of gas at 0 °C (32 °F).	1 to 99 999.9999 m/s
Temperature coefficient sound velocity	In the Select gas type parameter, the Others option is selected.	Enter temperature coefficient for the gas sound velocity.	Positive floating-point number
Pressure compensation	–	Select pressure compensation type.	<ul style="list-style-type: none"> ■ Off ■ Fixed value ■ External value
Pressure value	In the Pressure compensation parameter, the Fixed value option or the Current input 1...n option is selected.	Enter process pressure to be used for pressure correction.	Positive floating-point number
External pressure	In the Pressure compensation parameter, the External value option is selected.		

10.4.4 Configuring communication interface

The **Communication** submenu guides you systematically through all the parameters that have to be configured for selecting and setting the communication interface.

Navigation

"Setup" menu → Communication

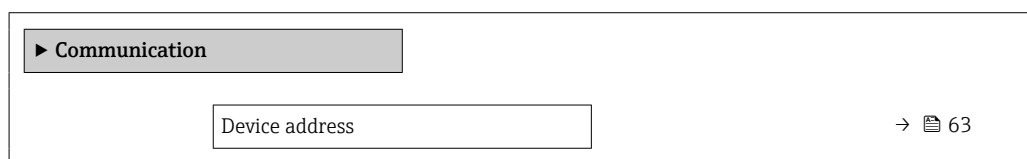

Parameter overview with brief description

Parameter	Description	User entry
Device address	Enter device address.	0 to 126

10.4.5 Configuration of the Analog Inputs

The **Analog inputs** submenu guides the user systematically to the individual **Analog input 1 to n** submenu. From here you get to the parameters of the individual analog input.

Navigation

"Setup" menu → Analog inputs

The screenshot shows a hierarchical menu structure for configuring analog inputs. At the top level, there is a button labeled "▶ Analog inputs". Below it, there is a button labeled "▶ Analog input 1 to n". Underneath this, there are four parameter settings, each consisting of a text input field and a right-pointing arrow followed by a document icon and the number 65, indicating a help or manual page reference.

Parameter	Reference
Channel	→ 65
PV filter time	→ 65
Fail safe type	→ 65
Fail safe value	→ 65

Parameter overview with brief description

Parameter	Prerequisite	Description	Selection / User entry
Channel	–	Select the process variable.	<ul style="list-style-type: none"> ■ Mass flow ■ Volume flow ■ Corrected volume flow ■ Target mass flow * ■ Carrier mass flow * ■ Density ■ Reference density ■ Concentration * ■ Dynamic viscosity * ■ Kinematic viscosity * ■ Temp. compensated dynamic viscosity * ■ Temp. compensated kinematic viscosity * ■ Temperature ■ Carrier pipe temperature * ■ Electronic temperature ■ Oscillation frequency 0 ■ Oscillation frequency 1 * ■ Oscillation amplitude 0 * ■ Oscillation amplitude 1 * ■ Frequency fluctuation 0 ■ Frequency fluctuation 1 * ■ Oscillation damping 0 ■ Oscillation damping 1 * ■ Tube damping fluctuation 0 ■ Tube damping fluctuation 1 * ■ Signal asymmetry ■ Exciter current 0 ■ Exciter current 1 * ■ Sensor integrity *
PV filter time	–	Specify the time to suppress signal peaks. During the specified time the Analog Input does not respond to an erratic increase in the process variable.	Positive floating-point number
Fail safe type	–	Select the failure mode.	<ul style="list-style-type: none"> ■ Fail safe value ■ Fallback value ■ Off
Fail safe value	In Fail safe type parameter, the Fail safe value option is selected.	Specify the values to be output when an error occurs.	Signed floating-point number

* Visibility depends on order options or device settings

10.4.6 Configuring the low flow cut off

The **Low flow cut off** submenu contains the parameters that must be set in order to configure the low flow cut off.

Navigation

"Setup" menu → Low flow cut off

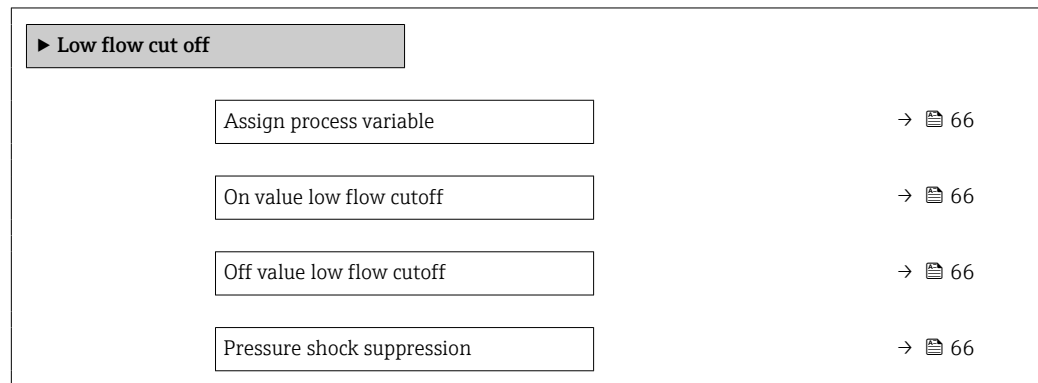

Parameter overview with brief description

Parameter	Prerequisite	Description	Selection / User entry	Factory setting
Assign process variable	–	Select process variable for low flow cut off.	<ul style="list-style-type: none"> ▪ Off ▪ Mass flow ▪ Volume flow ▪ Corrected volume flow 	–
On value low flow cutoff	A process variable is selected in the Assign process variable parameter (→ 66).	Enter on value for low flow cut off.	Positive floating-point number	Depends on country and nominal diameter
Off value low flow cutoff	A process variable is selected in the Assign process variable parameter (→ 66).	Enter off value for low flow cut off.	0 to 100.0 %	–
Pressure shock suppression	A process variable is selected in the Assign process variable parameter (→ 66).	Enter time frame for signal suppression (= active pressure shock suppression).	0 to 100 s	–

10.4.7 Configuring partially filled pipe detection

The **Partially filled pipe detection** submenu contains parameters that have to be set for configuring empty pipe detection.

Navigation

"Setup" menu → Partially filled pipe detection

▶ Partially filled pipe detection

Assign process variable	→ ⓘ 67
Low value partial filled pipe detection	→ ⓘ 67
High value partial filled pipe detection	→ ⓘ 67
Response time part. filled pipe detect.	→ ⓘ 67

Parameter overview with brief description

Parameter	Prerequisite	Description	Selection / User entry	Factory setting
Assign process variable	–	Select process variable for partially filled pipe detection.	<ul style="list-style-type: none"> ■ Off ■ Density ■ Reference density 	Density
Low value partial filled pipe detection	A process variable is selected in the Assign process variable parameter (→ ⓘ 67).	Enter lower limit value for deactivating partially filled pipe detection.	Signed floating-point number	Depends on country: <ul style="list-style-type: none"> ■ 200 kg/m³ ■ 12.5 lb/ft³
High value partial filled pipe detection	A process variable is selected in the Assign process variable parameter (→ ⓘ 67).	Enter upper limit value for deactivating partially filled pipe detection.	Signed floating-point number	Depends on country: <ul style="list-style-type: none"> ■ 6 000 kg/m³ ■ 374.6 lb/ft³
Response time part. filled pipe detect.	A process variable is selected in the Assign process variable parameter (→ ⓘ 67).	Use this function to enter the minimum time (hold time) the signal must be present before diagnostic message S962 "Pipe only partly filled" is triggered in the event of a partially filled or empty measuring pipe.	0 to 100 s	–

10.5 Advanced settings

The **Advanced setup** submenu with its submenus contains parameters for specific settings.

 The number of submenus can vary depending on the device version, e.g. viscosity is available only with the Promass I.

Navigation

"Setup" menu → Advanced setup

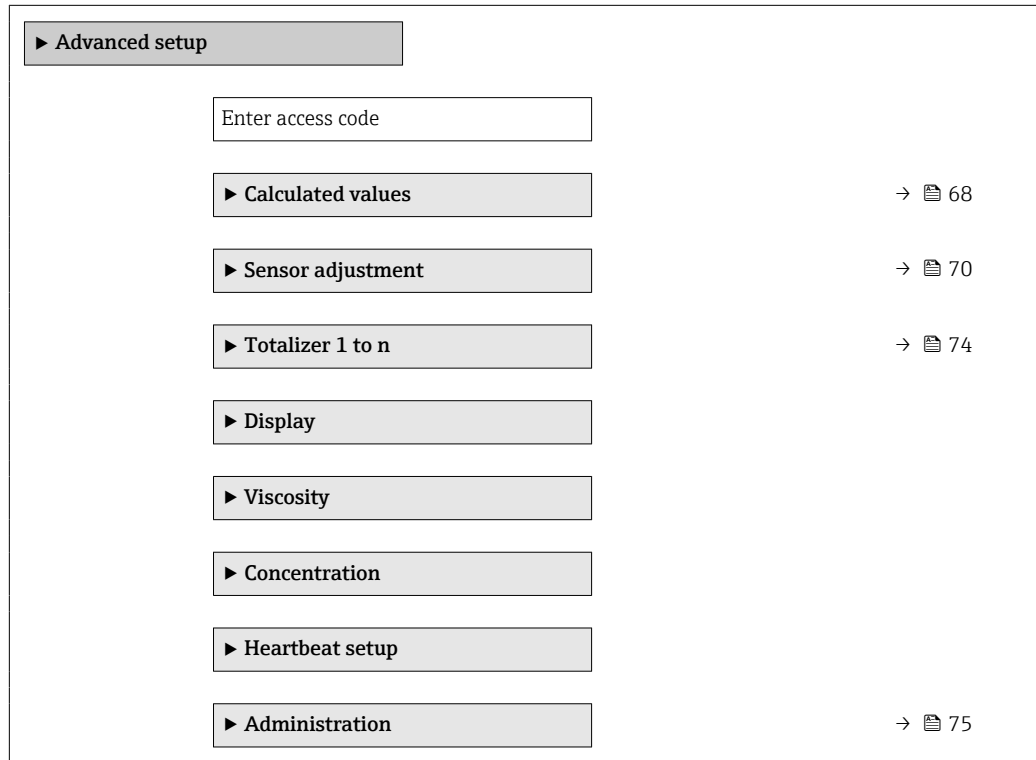

10.5.1 Using the parameter to enter the access code

Navigation

"Setup" menu → Advanced setup

Parameter overview with brief description

Parameter	Description	User entry
Enter access code	Enter access code to disable write protection of parameters.	Max. 16-digit character string comprising numbers, letters and special characters

10.5.2 Calculated process variables

The **Calculated values** submenu contains parameters for calculating the corrected volume flow.

Navigation

"Setup" menu → Advanced setup → Calculated values

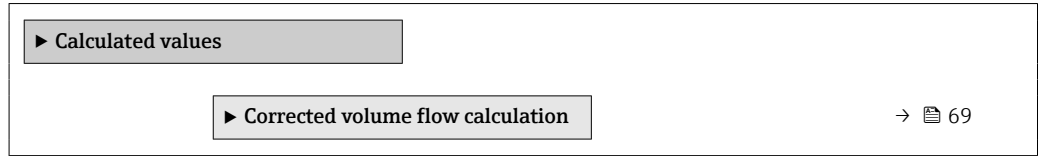

"Corrected volume flow calculation" submenu

Navigation

"Setup" menu → Advanced setup → Calculated values → Corrected volume flow calculation

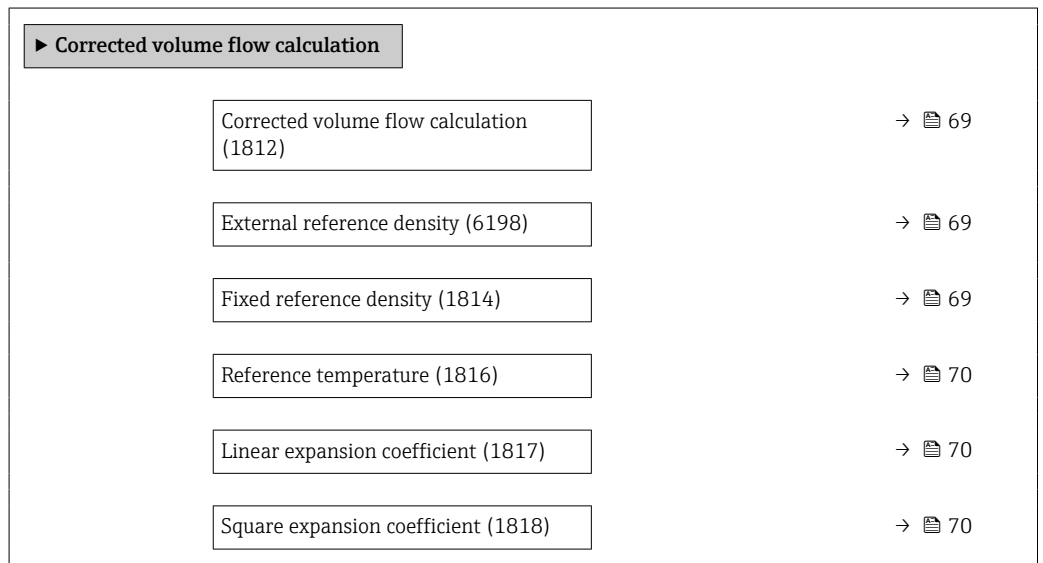

Parameter overview with brief description

Parameter	Prerequisite	Description	Selection / User interface / User entry	Factory setting
Corrected volume flow calculation	–	Select reference density for calculating the corrected volume flow.	<ul style="list-style-type: none"> ■ Fixed reference density ■ Calculated reference density ■ Reference density by API table 53 ■ External reference density 	–
External reference density	In the Corrected volume flow calculation parameter, the External reference density option is selected.	Shows external reference density.	Floating point number with sign	–
Fixed reference density	The Fixed reference density option is selected in the Corrected volume flow calculation parameter.	Enter fixed value for reference density.	Positive floating-point number	–

Parameter	Prerequisite	Description	Selection / User interface / User entry	Factory setting
Reference temperature	The Calculated reference density option is selected in the Corrected volume flow calculation parameter parameter.	Enter reference temperature for calculating the reference density.	-273.15 to 99 999 °C	Country-specific: <ul style="list-style-type: none"> ■ +20 °C ■ +68 °F
Linear expansion coefficient	The Calculated reference density option is selected in the Corrected volume flow calculation parameter parameter.	Enter linear, medium-specific expansion coefficient for calculating the reference density.	Signed floating-point number	-
Square expansion coefficient	The Calculated reference density option is selected in the Corrected volume flow calculation parameter parameter.	For media with a non-linear expansion pattern: enter the quadratic, medium-specific expansion coefficient for calculating the reference density.	Signed floating-point number	-

10.5.3 Carrying out a sensor adjustment

The **Sensor adjustment** submenu contains parameters that pertain to the functionality of the sensor.

Navigation

"Setup" menu → Advanced setup → Sensor adjustment

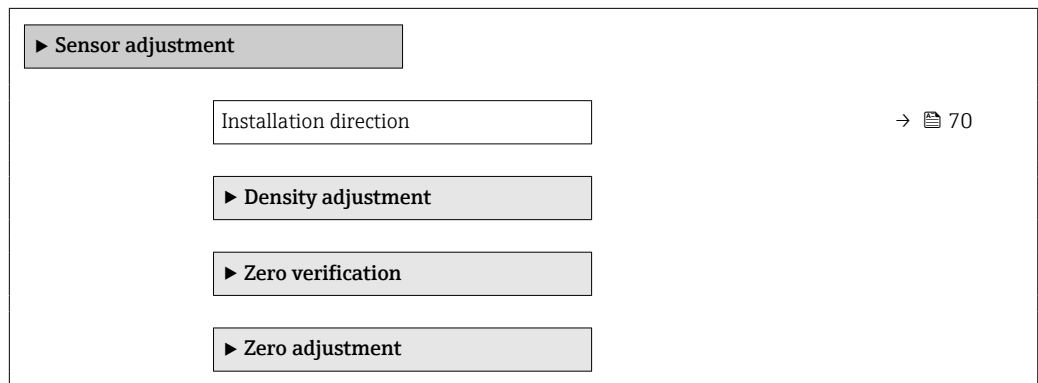

Parameter overview with brief description

Parameter	Description	Selection
Installation direction	Set sign of flow direction to match the direction of the arrow on the sensor.	<ul style="list-style-type: none"> ■ Flow in arrow direction ■ Flow against arrow direction

Density adjustment

i With density adjustment, a high level of accuracy is achieved only at the point of adjustment and at the relevant density and temperature. However, the accuracy of a density adjustment is only ever as good as the quality of the reference measuring data provided. Therefore it is not a substitute for special density calibration.

Performing density adjustment

Note the following before performing the adjustment:

- A density adjustment only makes sense if there is little variation in the operating conditions and the density adjustment is performed under the operating conditions.
- The density adjustment scales the internally computed density value with a user-specific slope and offset.
- A 1-point or 2-point density adjustment can be performed.
- For a 2-point density adjustment, there must be a difference of at least 0.2 kg/l between the two target density values.
- The reference media must be gas-free or pressurized so that any gas they contain is compressed.
- The reference density measurements must be performed at the same medium temperature that prevails in the process, as otherwise the density adjustment will not be accurate.
- The correction resulting from the density adjustment can be deleted with the **Restore original** option.

"1 point adjustment" option

1. In the **Density adjustment mode** parameter, select the **1 point adjustment** option and confirm.
2. In the **Density setpoint 1** parameter, enter the density value and confirm.
 - ↳ In the **Execute density adjustment** parameter the following options are now available:
 - Ok
 - Measure density 1 option**
 - Restore original
3. Select the **Measure density 1** option and confirm.
4. If 100% was reached in the **Progress** parameter on the display and the **Ok** option is displayed in the **Execute density adjustment** parameter, then confirm.
 - ↳ In the **Execute density adjustment** parameter the following options are now available:
 - Ok
 - Calculate
 - Cancel
5. Select the **Calculate** option and confirm.

If the adjustment was completed successfully, the **Density adjustment factor** parameter and the **Density adjustment offset** parameter and the values calculated for them are shown on the display.

"2 point adjustment" option

1. In the **Density adjustment mode** parameter, select the **2 point adjustment** option and confirm.
2. In the **Density setpoint 1** parameter, enter the density value and confirm.
3. In the **Density setpoint 2** parameter, enter the density value and confirm.
 - ↳ In the **Execute density adjustment** parameter the following options are now available:
 - Ok
 - Measure density 1
 - Restore original

4. Select the **Measure density 1** option and confirm.
 - ↳ In the **Execute density adjustment** parameter the following options are now available:
 - Ok
 - Measure density 2
 - Restore original
5. Select the **Measure density 2** option and confirm.
 - ↳ In the **Execute density adjustment** parameter the following options are now available:
 - Ok
 - Calculate
 - Cancel
6. Select the **Calculate** option and confirm.

If the **Density adjust failure** option is displayed in the **Execute density adjustment** parameter, call up the options and select the **Cancel** option. The density adjustment is canceled and can be repeated.

If the adjustment was completed successfully, the **Density adjustment factor** parameter and the **Density adjustment offset** parameter and the values calculated for them are shown on the display.

Navigation

"Expert" menu → Sensor → Sensor adjustment → Density adjustment

► Density adjustment	
Density adjustment mode	→ 72
Density setpoint 1	→ 72
Density setpoint 2	→ 73
Execute density adjustment	→ 73
Progress	→ 73
Density adjustment factor	→ 73
Density adjustment offset	→ 73

Parameter overview with brief description

Parameter	Prerequisite	Description	Selection / User entry / User interface	Factory setting
Density adjustment mode	-		<ul style="list-style-type: none"> ▪ 1 point adjustment ▪ 2 point adjustment 	-
Density setpoint 1	-		The entry depends on the unit selected in the Density unit parameter (0555).	-

Parameter	Prerequisite	Description	Selection / User entry / User interface	Factory setting
Density setpoint 2	In the Density adjustment mode parameter, the 2 point adjustment option is selected.		The entry depends on the unit selected in the Density unit parameter (0555).	–
Execute density adjustment	–		<ul style="list-style-type: none"> ■ Cancel ■ Busy ■ Ok ■ Density adjust failure ■ Measure density 1 ■ Measure density 2 ■ Calculate ■ Restore original 	–
Progress	–	Shows the progress of the process.	0 to 100 %	–
Density adjustment factor	–		Signed floating-point number	–
Density adjustment offset	–		Signed floating-point number	–

Zero verification and zero adjustment

All measuring instruments are calibrated in accordance with state-of-the-art technology. Calibration takes place under reference conditions →  137. Therefore, a zero adjustment in the field is generally not required.

Experience shows that zero adjustment is advisable only in special cases:

- To achieve maximum measurement accuracy even with low flow rates.
- Under extreme process or operating conditions (e.g. very high process temperatures or very high-viscosity fluids).
- For gas applications with low pressure



To achieve the highest possible measurement accuracy at low flow rates, the installation must protect the sensor from mechanical stresses during operation.

To get a representative zero point, ensure that:

- any flow in the device is prevented during the adjustment
- the process conditions (e.g. pressure, temperature) are stable and representative

Zero verification and zero adjustment cannot be performed if the following process conditions are present:

- Gas pockets
Ensure that the system has been sufficiently flushed with the medium. Repeat flushing can help to eliminate gas pockets
- Thermal circulation
In the event of temperature differences (e.g. between the measuring tube inlet and outlet section), induced flow can occur even if the valves are closed due to thermal circulation in the device
- Leaks at the valves
If the valves are not leak-tight, flow is not sufficiently prevented when determining the zero point

If these conditions cannot be avoided, it is advisable to keep the factory setting for the zero point.

Navigation

"Setup" menu → Advanced setup → Sensor adjustment → Zero point adjustment

▶ Zero point adjustment	
Zero point adjustment control	→ 74
Progress	→ 74

Parameter overview with brief description

Parameter	Description	Selection / User interface	Factory setting
Zero point adjustment control	Start zero point adjustment.	<ul style="list-style-type: none"> ■ Cancel ■ Busy ■ Zero point adjust failure ■ Start 	–
Progress	Shows the progress of the process.	0 to 100 %	–

10.5.4 Configuring the totalizer

In the "Totalizer 1 to n" submenu, you can configure the specific totalizer.

Navigation

"Setup" menu → Advanced setup → Totalizer 1 to n

▶ Totalizer 1 to n	
Assign process variable	→ 75
Unit totalizer	→ 75
Control Totalizer 1 to n	→ 75
Totalizer operation mode	→ 75
Failure mode	→ 75

Parameter overview with brief description

Parameter	Prerequisite	Description	Selection	Factory setting
Assign process variable	–	Select process variable for totalizer.	<ul style="list-style-type: none"> ■ Mass flow ■ Volume flow ■ Corrected volume flow ■ Target mass flow * ■ Carrier mass flow * 	–
Unit totalizer	One of the following options is selected in the Assign process variable parameter: <ul style="list-style-type: none"> ■ Mass flow ■ Volume flow ■ Corrected volume flow ■ Target mass flow * ■ Carrier mass flow * 	Select the unit for the process variable of the totalizer.	Unit choose list	Country-specific: <ul style="list-style-type: none"> ■ kg ■ lb
Control Totalizer 1 to n	One of the following options is selected in the Assign process variable parameter: <ul style="list-style-type: none"> ■ Mass flow ■ Volume flow ■ Corrected volume flow ■ Target mass flow * ■ Carrier mass flow * 	Control the totalizer value.	<ul style="list-style-type: none"> ■ Totalize ■ Reset + hold ■ Preset + hold 	–
Totalizer operation mode	In the Assign process variable parameter, one of the following options is selected: <ul style="list-style-type: none"> ■ Mass flow ■ Volume flow ■ Corrected volume flow ■ Target mass flow * ■ Carrier mass flow * 	Select totalizer calculation mode.	<ul style="list-style-type: none"> ■ Net flow total ■ Forward flow total ■ Reverse flow total ■ Last valid value 	–
Failure mode	In the Assign process variable parameter, one of the following options is selected: <ul style="list-style-type: none"> ■ Mass flow ■ Volume flow ■ Corrected volume flow ■ Target mass flow * ■ Carrier mass flow * 	Define the totalizer behavior in the event of a device alarm.	<ul style="list-style-type: none"> ■ Stop ■ Actual value ■ Last valid value 	–

* Visibility depends on order options or device settings

10.5.5 Using parameters for device administration

The **Administration** submenu systematically guides the user through all the parameters that can be used for device administration purposes.

Navigation

"Setup" menu → Advanced setup → Administration

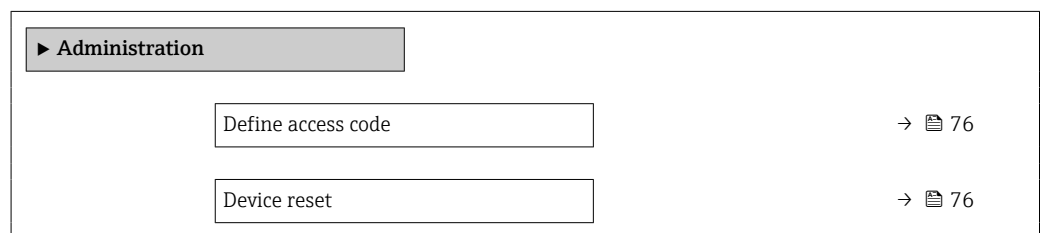

Parameter overview with brief description

Parameter	Description	User entry / Selection
Define access code	Define release code for write access to parameters.	0 to 9999
Device reset	Reset the device configuration - either entirely or in part - to a defined state.	<ul style="list-style-type: none"> ■ Cancel ■ To delivery settings ■ Restart device

10.6 Simulation

Via the **Simulation** submenu, it is possible to simulate various process variables in the process and the device alarm mode and verify downstream signal chains (switching valves or closed-control loops). The simulation can be performed without a real measurement (no flow of medium through the device).

Navigation

"Diagnostics" menu → Simulation

▶ Simulation	
Assign simulation process variable	→ 76
Value process variable	→ 76
Simulation device alarm	→ 76
Simulation diagnostic event	→ 77

Parameter overview with brief description



Parameter	Prerequisite	Description	Selection / User entry
Assign simulation process variable	–	Select a process variable for the simulation process that is activated.	<ul style="list-style-type: none"> ■ Off ■ Mass flow ■ Volume flow ■ Corrected volume flow ■ Density ■ Reference density ■ Temperature ■ Dynamic viscosity * ■ Kinematic viscosity * ■ Temp. compensated dynamic viscosity * ■ Temp. compensated kinematic viscosity * ■ Concentration * ■ Target mass flow * ■ Carrier mass flow *
Value process variable	A process variable is selected in the Assign simulation process variable parameter (→ 76).	Enter the simulation value for the selected process variable.	Depends on the process variable selected
Simulation device alarm	–	Switch the device alarm on and off.	<ul style="list-style-type: none"> ■ Off ■ On

Parameter	Prerequisite	Description	Selection / User entry
Diagnostic event category	–	Select a diagnostic event category.	<ul style="list-style-type: none"> ▪ Sensor ▪ Electronics ▪ Configuration ▪ Process
Simulation diagnostic event	–	Select a diagnostic event for the simulation process that is activated.	<ul style="list-style-type: none"> ▪ Off ▪ Diagnostic event picklist (depends on the category selected)

* Visibility depends on order options or device settings

10.7 Protecting settings from unauthorized access

The following options exist for protecting the configuration of the measuring device from unintentional modification after commissioning:

- Write protection via access code for Web browser →  77
- Write protection via write protection switch →  78

10.7.1 Write protection via access code

With the customer-specific access code, access to the measuring instrument via the Web browser is protected, as are the parameters for the measuring instrument configuration.

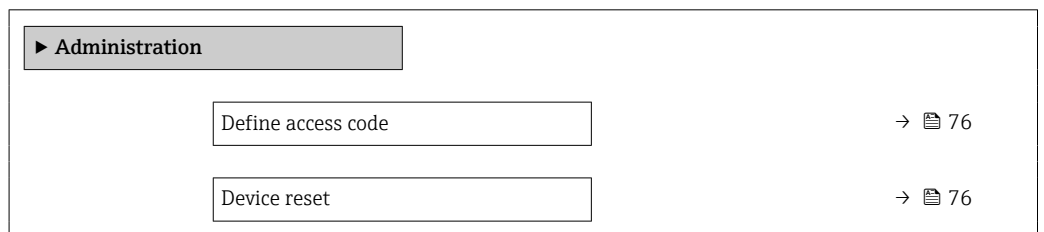

Navigation

"Setup" menu → Advanced setup → Administration → Define access code



Defining the access code via the web browser

1. Navigate to the **Define access code** parameter.
2. Define a 16-digit (max.) numeric code as the access code.
3. Enter the access code again in the to confirm.
 - ↳ The web browser switches to the login page.

- 
 - Disabling parameter write protection via access code .
 - If the access code is lost: Resetting the access code .
 - The **Access status tooling** parameter shows which user role the user is currently logged in with.
 - Navigation path: Operation → Access status tooling
 - User roles and their access rights →  39

If no action is performed for 10 minutes, the web browser automatically returns to the login page.

10.7.2 Write protection via write protection switch

The write protection switch makes it possible to block write access to the entire operating menu with the exception of the following parameters:

- External pressure
- External temperature
- Reference density
- All parameters for configuring the totalizer

The parameter values are now read only and cannot be edited any more:

- Via service interface (CDI-RJ45)
- Via PROFIBUS DP

1. Depending on the housing version, loosen the securing clamp or fixing screw of the housing cover.
2. Depending on the housing version, unscrew or open the housing cover and disconnect the local display from the main electronics module where necessary
→  148.

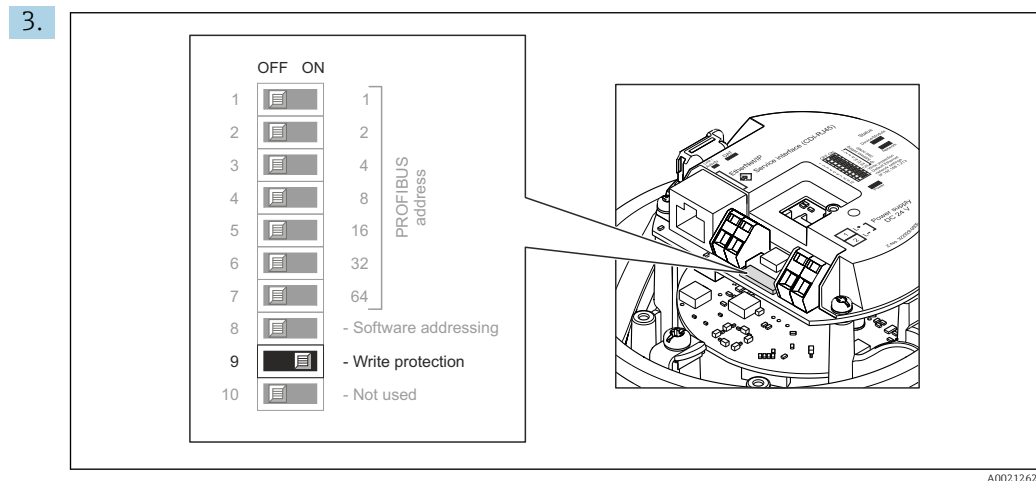

Setting the write protection switch on the main electronics module to the **On** position enables hardware write protection. Setting the write protection switch on the main electronics module to the **Off** position (factory setting) disables hardware write protection.

↳ If hardware write protection is enabled: the **Locking status** parameter displays the **Hardware locked** option ; if disabled, the **Locking status** parameter does not display any option .

4. Reverse the removal procedure to reassemble the transmitter.

11 Operation

11.1 Reading the device locking status

Device active write protection: **Locking status** parameter

Navigation



"Operation" menu → Locking status

Function scope of "Locking status" parameter

Options	Description
Hardware locked	The write protection switch (DIP switch) for hardware locking is activated on the I/O electronic module. This prevents write access to the parameters .
Temporarily locked	Write access to the parameters is temporarily locked on account of internal processes running in the device (e.g. data upload/download, reset etc.). Once the internal processing has been completed, the parameters can be changed once again.

11.2 Adjusting the operating language

 Detailed information:

- To configure the operating language →  58
- For information on the operating languages supported by the measuring device →  149

11.3 Configuring the display

Detailed information:



On the advanced settings for the local display

11.4 Reading off measured values

With the **Measured values** submenu, it is possible to read all the measured values.

Navigation

"Diagnostics" menu → Measured values

▶ Measured values	
▶ Process variables	→  79
▶ Totalizer 1 to n	→  82

11.4.1 "Measured variables" submenu











The **Process variables** submenu contains all the parameters needed to display the current measured values for each process variable.







Navigation

"Diagnostics" menu → Measured values → Measured variables

► Measured variables	
Mass flow	→ 81
Volume flow	→ 81
Corrected volume flow	→ 81
Density	→ 81
Reference density	→ 81
Temperature	→ 81
Pressure	→ 81
Dynamic viscosity	→ 81
Kinematic viscosity	→ 81
Temp. compensated dynamic viscosity	→ 81
Temp. compensated kinematic viscosity	→ 82
Concentration	→ 82
Target mass flow	→ 82
Carrier mass flow	→ 82
Target corrected volume flow	→ 82
Carrier corrected volume flow	→ 82
Target volume flow	→ 82
Carrier volume flow	→ 82

Parameter overview with brief description

Parameter	Prerequisite	Description	User interface
Mass flow	–	Displays the mass flow that is currently measured. <i>Dependency</i> The unit is taken from: Mass flow unit parameter (→  60)	Signed floating-point number
Volume flow	–	Displays the volume flow that is currently calculated. <i>Dependency</i> The unit is taken from the Volume flow unit parameter (→  60).	Signed floating-point number
Corrected volume flow	–	Displays the corrected volume flow that is currently calculated. <i>Dependency</i> The unit is taken from: Corrected volume flow unit parameter (→  60)	Signed floating-point number
Density	–	Shows the density currently measured. <i>Dependency</i> The unit is taken from the Density unit parameter (→  60).	Signed floating-point number
Reference density	–	Displays the reference density that is currently calculated. <i>Dependency</i> The unit is taken from: Reference density unit parameter (→  60)	Signed floating-point number
Temperature	–	Shows the medium temperature currently measured. <i>Dependency</i> The unit is taken from: Temperature unit parameter (→  61)	Signed floating-point number
Pressure value	–	Displays either a fixed or external pressure value. <i>Dependency</i> The unit is taken from the Pressure unit parameter (→  61).	Signed floating-point number
Dynamic viscosity	For the following order code: "Application package", option EG "Viscosity"  The software options currently enabled are displayed in the Software option overview parameter.	Displays the dynamic viscosity that is currently calculated. <i>Dependency</i> The unit is taken from: Dynamic viscosity unit parameter	Signed floating-point number
Kinematic viscosity	For the following order code: "Application package", option EG "Viscosity"  The software options currently enabled are displayed in the Software option overview parameter.	Displays the kinematic viscosity that is currently calculated. <i>Dependency</i> The unit is taken from: Kinematic viscosity unit parameter	Signed floating-point number
Temp. compensated dynamic viscosity	For the following order code: "Application package", option EG "Viscosity"  The software options currently enabled are displayed in the Software option overview parameter.	Displays the temperature compensation that is currently calculated for the viscosity. <i>Dependency</i> The unit is taken from: Dynamic viscosity unit parameter	Signed floating-point number

Parameter	Prerequisite	Description	User interface
Temp. compensated kinematic viscosity	For the following order code: "Application package", option EG "Viscosity"  The software options currently enabled are displayed in the Software option overview parameter.	Displays the temperature compensation that is currently calculated for the kinetic viscosity. <i>Dependency</i> The unit is taken from: Kinematic viscosity unit parameter (0578)	Signed floating-point number
Concentration	For the following order code: Order code for "Application package", option ED "Concentration"  The software options currently enabled are displayed in the Software option overview parameter.	Displays the concentration that is currently calculated. <i>Dependency</i> The unit is taken from the Concentration unit parameter.	Signed floating-point number
Target mass flow	With the following conditions: Order code for "Application package", option ED "Concentration"  The software options currently enabled are displayed in the Software option overview parameter.	Displays the mass flow that is currently measured for the target medium. <i>Dependency</i> The unit is taken from: Mass flow unit parameter (→  60)	Signed floating-point number
Carrier mass flow	With the following conditions: Order code for "Application package", option ED "Concentration"  The software options currently enabled are displayed in the Software option overview parameter.	Displays the mass flow of the carrier medium that is currently measured. <i>Dependency</i> The unit is taken from: Mass flow unit parameter (→  60)	Signed floating-point number
Target corrected volume flow	–		Signed floating-point number
Carrier corrected volume flow	–		Signed floating-point number
Target volume flow	–		Signed floating-point number
Carrier volume flow	–		Signed floating-point number

11.4.2 "Totalizer" submenu

The **Totalizer** submenu contains all the parameters needed to display the current measured values for every totalizer.

Navigation

"Diagnostics" menu → Measured values → Totalizer

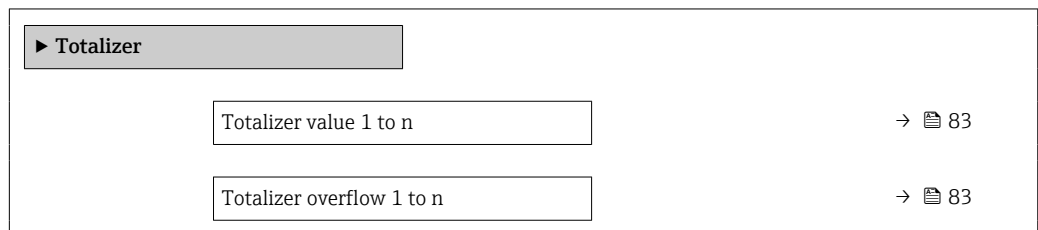

Parameter overview with brief description

Parameter	Prerequisite	Description	User interface
Totalizer value 1 to n	One of the following options is selected in the Assign process variable parameter of the Totalizer 1 to n submenu: <ul style="list-style-type: none"> ■ Volume flow ■ Mass flow ■ Corrected volume flow ■ Target mass flow * ■ Carrier mass flow * 	Displays the current totalizer counter value.	Signed floating-point number
Totalizer overflow 1 to n	One of the following options is selected in the Assign process variable parameter of the Totalizer 1 to n submenu: <ul style="list-style-type: none"> ■ Volume flow ■ Mass flow ■ Corrected volume flow ■ Target mass flow * ■ Carrier mass flow * 	Displays the current totalizer overflow.	Integer with sign

* Visibility depends on order options or device settings

11.5 Adapting the measuring device to the process conditions

The following are available for this purpose:

- Basic settings using the **Setup** menu (→ 58)
- Advanced settings using the **Advanced setup** submenu (→ 68)

11.6 Performing a totalizer reset

The totalizers are reset in the **Operation** submenu:

Control Totalizer 1 to n

Function range of "Control Totalizer " parameter

Options	Description
Totalize	The totalizer is started.
Reset + hold	The totaling process is stopped and the totalizer is reset to 0.
Preset + hold	The totaling process is stopped and the totalizer is set to its defined start value from the Preset value 1 to n parameter.
Stop totalizing option	Totalizing is stopped.



Navigation

"Operation" menu → Totalizer handling

▶ Totalizer handling

Control Totalizer 1 to n

→ 84

Preset value 1 to n	→  84
Reset all totalizers	→  84

Parameter overview with brief description

Parameter	Prerequisite	Description	Selection / User entry
Control Totalizer 1 to n	One of the following options is selected in the Assign process variable parameter: <ul style="list-style-type: none"> ■ Mass flow ■ Volume flow ■ Corrected volume flow ■ Target mass flow * ■ Carrier mass flow * 	Control the totalizer value.	<ul style="list-style-type: none"> ■ Totalize ■ Reset + hold ■ Preset + hold
Preset value 1 to n	–	Specify start value for totalizer.	Signed floating-point number
Reset all totalizers	–	Reset all totalizers to 0 and start.	<ul style="list-style-type: none"> ■ Cancel ■ Reset + totalize

* Visibility depends on order options or device settings

12 Diagnostics and troubleshooting

12.1 General troubleshooting

For local display

Error	Possible causes	Remedial action
Local display is dark, but signal output is within the valid range	The cable of the display module is not plugged in correctly.	Insert the plug correctly into the main electronics module and display module.
Local display dark and no output signals	Supply voltage does not match the voltage specified on the nameplate.	Apply the correct supply voltage → 29.
Local display dark and no output signals	Supply voltage has incorrect polarity.	Reverse polarity of supply voltage.
Local display dark and no output signals	No contact between connecting cables and terminals.	Ensure electrical contact between the cable and the terminal.
Local display dark and no output signals	<ul style="list-style-type: none"> ▪ Terminals are not plugged into the I/O electronics module correctly. ▪ 	Check terminals.
Local display dark and no output signals	<ul style="list-style-type: none"> ▪ I/O electronics module is defective. ▪ 	Order spare part → 126.
Local display cannot be read, but signal output is within the valid range	Display is set too bright or too dark.	<ul style="list-style-type: none"> ▪ Set the display brighter by simultaneously pressing \oplus + \boxplus. ▪ Set the display darker by simultaneously pressing \ominus + \boxplus.
Local display is dark, but signal output is within the valid range	Display module is defective.	Order spare part → 126.
Backlighting of local display is red	Diagnostic event with "Alarm" diagnostic behavior has occurred.	Take remedial measures → 93
Message on local display: "Communication Error" "Check Electronics"	Communication between the display module and the electronics is interrupted.	<ul style="list-style-type: none"> ▪ Check the cable and the connector between the main electronics module and display module. ▪ Order spare part → 126.

For output signals

Error	Possible causes	Remedial action
Green power LED on the main electronics module of the transmitter is dark	Supply voltage does not match the voltage specified on the nameplate.	Apply the correct supply voltage → 29.
Device measures incorrectly.	Configuration error or device is operated outside the application.	<ol style="list-style-type: none"> 1. Check and correct parameter configuration. 2. Observe limit values specified in the "Technical Data".

For access

Fault	Possible causes	Remedial action
Write access to parameters is not possible.	Hardware write protection is enabled.	Set the write protection switch on the main electronics module to the OFF position → 78.
Connection via PROFIBUS DP is not possible.	PROFIBUS DP bus cable is incorrectly connected.	Check the terminal assignment → 27.
Connection via PROFIBUS DP is not possible.	Device plug is incorrectly connected.	Check the pin assignment of the device plugs .
Connection via PROFIBUS DP is not possible.	PROFIBUS DP cable is incorrectly terminated.	Check the terminating resistor → 32.
Unable to connect to the web server.	Web server is disabled.	Using the "FieldCare" or "DeviceCare" operating tool, check whether the web server of the device is enabled, and enable it if necessary → 44.

Fault	Possible causes	Remedial action
	The Ethernet interface on the PC is incorrectly configured.	<ul style="list-style-type: none"> ▶ Check the properties of the Internet protocol (TCP/IP). ▶ Check the network settings with the IT manager.
Unable to connect to the web server.	The IP address on the PC is incorrectly configured.	Check the IP address: 192.168.1.212 → 41
Web browser frozen and operation no longer possible	Data transfer is active.	Wait until data transfer or current action is finished.
	Connection lost	<ul style="list-style-type: none"> ▶ Check cable connection and power supply. ▶ Refresh the web browser and restart if necessary.
Display of web browser content is difficult to read or incomplete.	Web browser version used is not optimal.	<ul style="list-style-type: none"> ▶ Use correct web browser version → 40. ▶ Empty the web browser cache. ▶ Restart the web browser.
	Unsuitable view settings.	Change the font size/display ratio of the Web browser.
Incomplete or no display of content in the web browser	<ul style="list-style-type: none"> ▪ JavaScript is not enabled. ▪ JavaScript cannot be enabled. 	<ul style="list-style-type: none"> ▶ Enable JavaScript. ▶ Enter http://XXX.XXX.X.XX/servlet/basic.html as the IP address.
Operation with FieldCare or DeviceCare via service interface CDI-RJ45 (port 8000) is not possible.	Firewall of the PC or network is blocking communication.	Depending on the settings of the firewall used on the PC or in the network, the firewall must be adapted or disabled to allow FieldCare/ DeviceCare access.
Flashing the firmware with FieldCare or DeviceCare via service interface CDI-RJ45 (port 8000 or TFTP ports) is not possible.	Firewall of the PC or network is blocking communication.	Depending on the settings of the firewall used on the PC or in the network, the firewall must be adapted or disabled to allow FieldCare/ DeviceCare access.

12.2 Diagnostic information via LEDs

12.2.1 Transmitter

Different LEDs in the transmitter provide information on the device status.

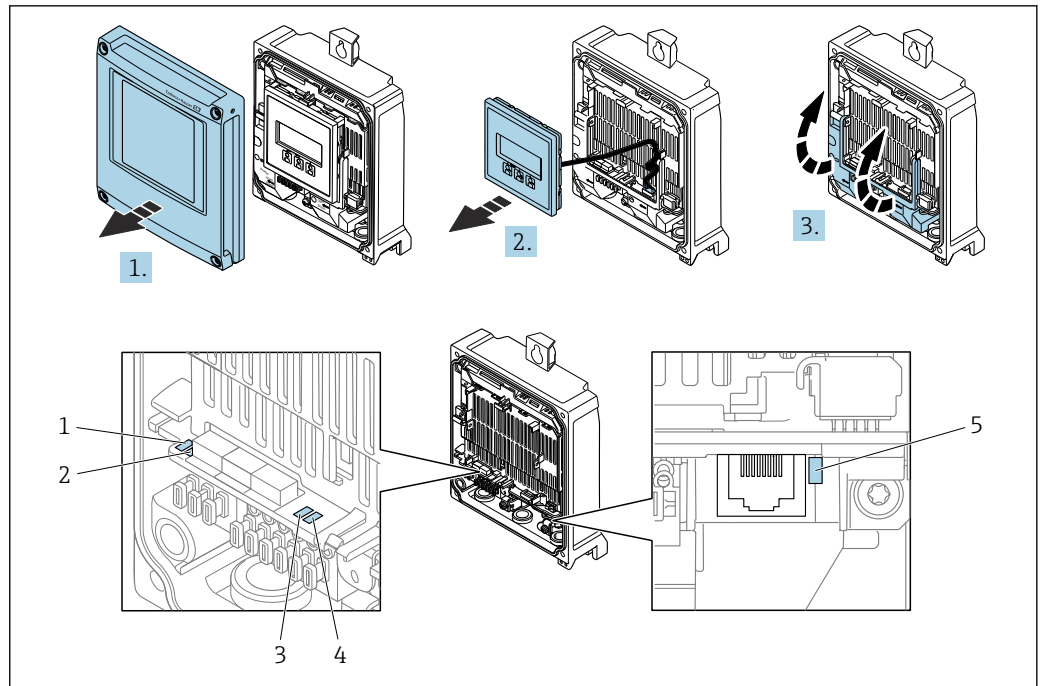

- 1 Supply voltage
- 2 Device status
- 3 Not used
- 4 Communication
- 5 Service interface (CDI) active, Ethernet Link/Activity

1. Open the housing cover.
2. Remove the display module.
3. Fold open the terminal cover.

LED	Color	Meaning
Supply voltage	Off	Supply voltage is off or too low
	Green	Supply voltage is ok
Alarm	Off	Device status is ok
	Flashing red	A device error of diagnostic behavior "Warning" has occurred
	Red	<ul style="list-style-type: none"> ▪ A device error of diagnostic behavior "Alarm" has occurred ▪ Boot loader is active
Communication	Flashing white	PROFIBUS DP communication is active

12.3 Diagnostic information in the web browser

12.3.1 Diagnostic options

Any faults detected by the measuring device are displayed in the Web browser on the home page once the user has logged on.

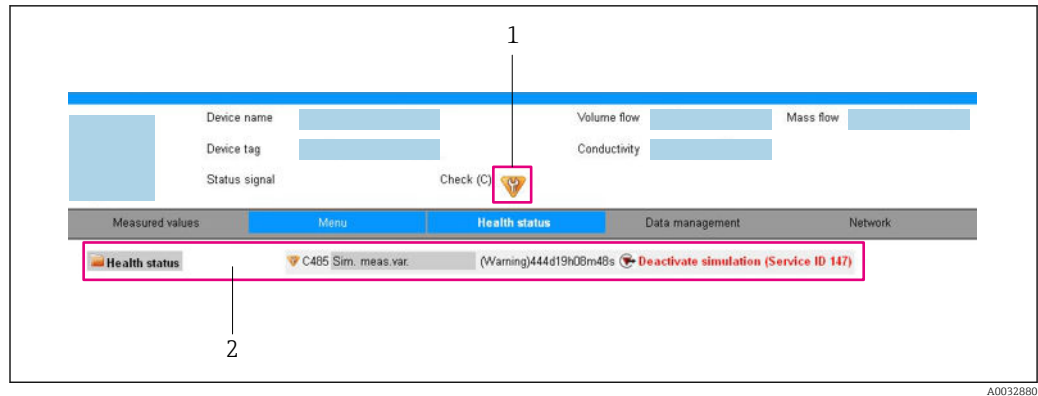

- 1 Status area with status signal
- 2 Diagnostics information → 88 and remedial measures with service ID

i In addition, diagnostic events which have occurred can be shown in the **Diagnostics** menu:

- Via parameter → 118
- Via submenu → 119

Status signals

The status signals provide information on the state and reliability of the device by categorizing the cause of the diagnostic information (diagnostic event).

Symbol	Meaning
	Failure A device error has occurred. The measured value is no longer valid.
	Function check The device is in service mode (e.g. during a simulation).
	Out of specification The device is being operated: Outside its technical specification limits (e.g. outside the process temperature range)
	Maintenance required Maintenance is required. The measured value remains valid.

i The status signals are categorized in accordance with VDI/VDE 2650 and NAMUR Recommendation NE 107.

Diagnostic information

The fault can be identified using the diagnostic information. The short text helps you by providing information about the fault.

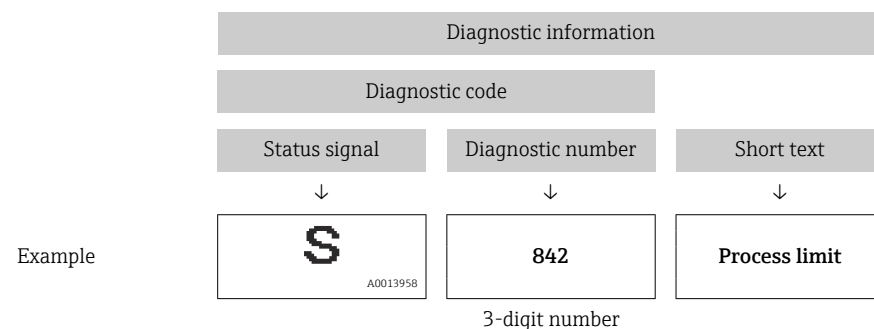

12.3.2 Calling up remedy information

Remedy information is provided for every diagnostic event to ensure that problems can be rectified quickly. These measures are displayed in red along with the diagnostic event and the related diagnostic information.

12.4 Diagnostic information in FieldCare or DeviceCare

12.4.1 Diagnostic options

Any faults detected by the measuring device are displayed on the home page of the operating tool once the connection has been established.

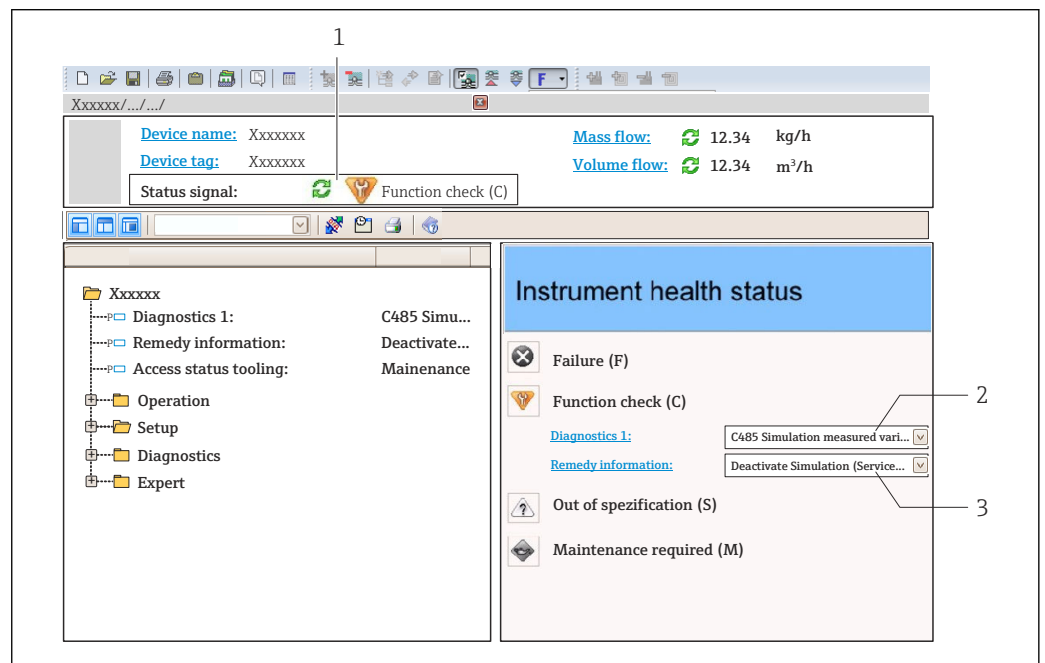

- 1 Status area with status signal
- 2 Diagnostic information → 88
- 3 Remedial measures with service ID

i In addition, diagnostic events which have occurred can be shown in the **Diagnostics** menu:

- Via parameter → 118
- Via submenu → 119

Diagnostic information

The fault can be identified using the diagnostic information. The short text helps you by providing information about the fault.

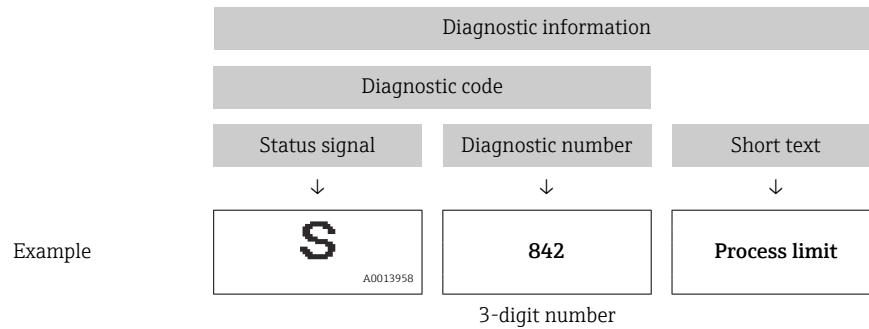

12.4.2 Calling up remedy information

Remedy information is provided for every diagnostic event to ensure that problems can be rectified quickly:

- On the home page
Remedy information is displayed in a separate field below the diagnostics information.
- In the **Diagnostics** menu
Remedy information can be called up in the working area of the user interface.

The user is in the **Diagnostics** menu.

1. Call up the desired parameter.
2. On the right in the working area, mouse over the parameter.
↳ A tool tip with remedy information for the diagnostic event appears.

12.5 Adapting the diagnostic information

12.5.1 Adapting the diagnostic behavior

Each item of diagnostic information is assigned a specific diagnostic behavior at the factory. The user can change this assignment for specific diagnostic information in the **Diagnostic behavior** submenu.

Expert → System → Diagnostic handling → Diagnostic behavior

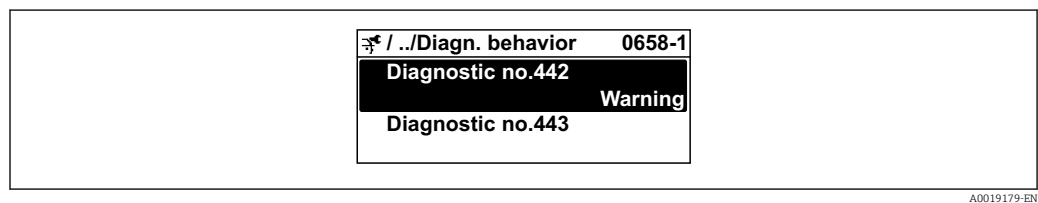

A0019179-EN

Available diagnostic behaviors

The following diagnostic behaviors can be assigned:

Diagnostic behavior	Description
Alarm	The device stops measurement. The totalizers assume the defined alarm condition. A diagnostic message is generated.
Warning	The device continues to measure. Measured value output via PROFIBUS and totalizers are not affected. A diagnostic message is generated.

Diagnostic behavior	Description
Logbook entry only	The device continues to measure. The diagnostic message is only displayed in the Event logbook submenu (Event list submenu) and is not displayed in alternating sequence with the operational display.
Off	The diagnostic event is ignored, and no diagnostic message is generated or entered.

Displaying the measured value status

If the Analog Input, Digital Input and Totalizer function blocks are configured for cyclic data transmission, the device status is coded as per PROFIBUS PA Profile 3.02 Specification and transmitted along with the measured value to the PROFIBUS Master (Class 1) via the coding byte (byte 5). The coding byte is split into three segments: Quality, Quality Substatus and Limits.

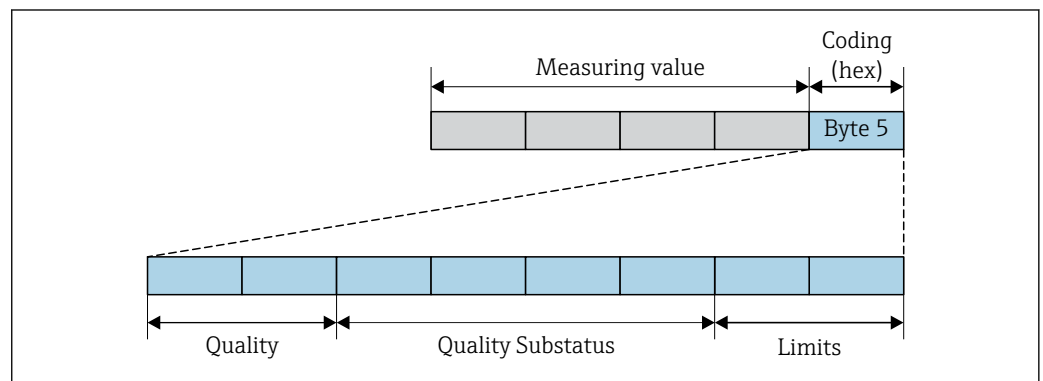

A0032228-EN

15 Structure of the coding byte

The content of the coding byte depends on the configured failure mode in the individual function block. Depending on which failure mode has been configured, status information in accordance with PROFINET PA Profile Specification 4 is transmitted to the PROFIBUS master (Class 1) via the coding byte status information.

Determining the measured value status and device status via the diagnostic behavior

When the diagnostic behavior is assigned, this also changes the measured value status and device status for the diagnostic information. The measured value status and device status depend on the choice of diagnostic behavior and on the group in which the diagnostic information is located.

The diagnostic information is grouped as follows:

- Diagnostic information pertaining to the sensor: diagnostic number 000 to 199
→ 92
- Diagnostic information pertaining to the electronics: diagnostic number 200 to 399
→ 92
- Diagnostic information pertaining to the configuration: diagnostic number 400 to 599
→ 92
- Diagnostic information pertaining to the process: diagnostic number 800 to 999
→ 93

Depending on the group in which the diagnostic information is located, the following measured value status and device status are firmly assigned to the particular diagnostic behavior:

Diagnostic information pertaining to the sensor: diagnostic number 000 to 199

Diagnostic behavior (configurable)	Measured value status (fixed assignment)				Device diagnosis (fixed assignment)
	Quality	Quality Substatus	Coding (hex)	Category (NE107)	
Alarm	BAD	Maintenance alarm	0x24 to 0x27	F (Failure)	Maintenance alarm
Warning	GOOD	Maintenance demanded	0xA8 to 0xAB	M (Maintenance)	Maintenance demanded
Logbook entry only	GOOD	ok	0x80 to 0x8E	-	-
Off					

*Diagnostic information pertaining to the electronics: diagnostic number 200 to 399**Diagnostic number 200 to 301, 303 to 399*

Diagnostic behavior (configurable)	Measured value status (fixed assignment)				Device diagnostics (fixed assignment)
	Quality	Quality Substatus	Coding (hex)	Category (NE107)	
Alarm	BAD	Maintenance alarm	0x24 to 0x27	F (Failure)	Maintenance alarm
Warning					
Logbook entry only	GOOD	ok	0x80 to 0x8E	-	-
Off					

Diagnostic information 302

Diagnostic behavior (configurable)	Measured value status (fixed assignment)				Device diagnostics (fixed assignment)
	Quality	Quality Substatus	Coding (hex)	Category (NE107)	
Alarm	BAD	Function check, local override	0x3C to 0x3F	C	Function check
Warning	GOOD	Function check	0xBC to 0xBF	-	-

Data logging continues when Heartbeat Verification is started. The signal outputs and totalizers are not affected.

- Signal status: Function check
- Choice of diagnostic behavior: alarm or warning (factory setting)

When the Heartbeat Verification is started, data logging is interrupted, the last valid measured value is output and the totalizer counter is stopped.



Diagnostic information pertaining to the configuration: diagnostic number 400 to 599

Diagnostic behavior (configurable)	Measured value status (fixed assignment)				Device diagnosis (fixed assignment)
	Quality	Quality Substatus	Coding (hex)	Category (NE107)	
Alarm	BAD	Function check	0x3C to 0x3F	C (Check)	Function check
Logbook entry only	GOOD	Function check	0xBC to 0xBF	-	Function check
Off					
Logbook entry only	GOOD	ok	0x80 to 0x8E	-	-
Off					

Diagnostic information pertaining to the process: diagnostic number 800 to 999

Diagnostic behavior (configurable)	Measured value status (fixed assignment)				Device diagnosis (fixed assignment)
	Quality	Quality Substatus	Coding (hex)	Category (NE107)	
Alarm	BAD	Process related	0x28 to 0x2B	F (Failure)	Invalid process condition
Warning	UNCERTAIN	Process related	0x78 to 0x7B	S (Out of specification)	Invalid process condition
Logbook entry only	GOOD	ok	0x80 to 0x8E	-	-
Off					

12.6 Overview of diagnostic information

-  The amount of diagnostic information and the number of measured variables affected increase if the measuring device has one or more application packages.
- All of the measured variables affected in the entire Promass instrument family are always listed under "Measured variables affected". The measured variables available for the device in question depend on the device version. When assigning the measured variables to the device functions, for example to the individual outputs, all of the measured variables available for the device version in question are available for selection.
-  In the case of some items of diagnostic information, the diagnostic behavior can be changed. Adapting the diagnostic information →  90

12.6.1 Diagnostic of sensor

No.	Diagnostic information		Remedy instructions	Influenced measured variables
	Status signal	Short text		
022	Sensor temperature		1. Change main electronic module 2. Change sensor	<ul style="list-style-type: none"> ▪ Carrier mass flow ▪ Concentration ▪ Density ▪ Dynamic viscosity ▪ Empty pipe detection option ▪ Kinematic viscosity ▪ Low flow cut off option ▪ Mass flow ▪ Sensor integrity ▪ Reference density ▪ Corrected volume flow ▪ Target mass flow ▪ Temp. compensated dynamic viscosity ▪ Temp. compensated kinematic viscosity ▪ Temperature ▪ Status ▪ Volume flow
	Status signal	F		
	Diagnostic behavior	Alarm		

Diagnostic information		Remedy instructions	Influenced measured variables	
No.	Short text			
046	Sensor limit exceeded	1. Inspect sensor 2. Check process condition	<ul style="list-style-type: none"> ▪ Carrier mass flow ▪ Concentration ▪ Density ▪ Dynamic viscosity ▪ Kinematic viscosity ▪ Mass flow ▪ Sensor integrity ▪ Reference density ▪ Corrected volume flow ▪ Target mass flow ▪ Temp. compensated dynamic viscosity ▪ Temp. compensated kinematic viscosity ▪ Volume flow 	
	Status signal			S
	Diagnostic behavior			Warning

Diagnostic information		Remedy instructions	Influenced measured variables	
No.	Short text			
062	Sensor connection	1. Change main electronic module 2. Change sensor	<ul style="list-style-type: none"> ▪ Carrier mass flow ▪ Concentration ▪ Density ▪ Dynamic viscosity ▪ Empty pipe detection option ▪ Kinematic viscosity ▪ Low flow cut off option ▪ Mass flow ▪ Sensor integrity ▪ Reference density ▪ Corrected volume flow ▪ Target mass flow ▪ Temp. compensated dynamic viscosity ▪ Temp. compensated kinematic viscosity ▪ Temperature ▪ Status ▪ Volume flow 	
	Status signal			F
	Diagnostic behavior			Alarm

Diagnostic information		Remedy instructions	Influenced measured variables	
No.	Short text			
082	Data storage	1. Check module connections 2. Contact service	<ul style="list-style-type: none"> ▪ Carrier mass flow ▪ Concentration ▪ Density ▪ Dynamic viscosity ▪ Empty pipe detection option ▪ Kinematic viscosity ▪ Low flow cut off option ▪ Mass flow ▪ Sensor integrity ▪ Reference density ▪ Corrected volume flow ▪ Target mass flow ▪ Temp. compensated dynamic viscosity ▪ Temp. compensated kinematic viscosity ▪ Temperature ▪ Volume flow 	
	Status signal			F
	Diagnostic behavior			Alarm

Diagnostic information		Remedy instructions	Influenced measured variables	
No.	Short text			
083	Memory content	1. Restart device 2. Contact service	<ul style="list-style-type: none"> ■ Carrier mass flow ■ Concentration ■ Density ■ Dynamic viscosity ■ Empty pipe detection option ■ Kinematic viscosity ■ Low flow cut off option ■ Mass flow ■ Sensor integrity ■ Reference density ■ Corrected volume flow ■ Target mass flow ■ Temp. compensated dynamic viscosity ■ Temp. compensated kinematic viscosity ■ Temperature ■ Status ■ Volume flow 	
	Status signal			F
	Diagnostic behavior			Alarm

Diagnostic information		Remedy instructions	Influenced measured variables	
No.	Short text			
140	Sensor signal	1. Check or change main electronics 2. Change sensor	<ul style="list-style-type: none"> ■ Carrier mass flow ■ Concentration ■ Density ■ Dynamic viscosity ■ Kinematic viscosity ■ Mass flow ■ Sensor integrity ■ Reference density ■ Corrected volume flow ■ Target mass flow ■ Temp. compensated dynamic viscosity ■ Temp. compensated kinematic viscosity ■ Temperature 	
	Status signal			S
	Diagnostic behavior			Alarm

Diagnostic information		Remedy instructions	Influenced measured variables	
No.	Short text			
144	Measuring error too high	1. Check or change sensor 2. Check process conditions	<ul style="list-style-type: none"> ■ Carrier mass flow ■ Concentration ■ Density ■ Dynamic viscosity ■ Kinematic viscosity ■ Mass flow ■ Sensor integrity ■ Reference density ■ Corrected volume flow ■ Target mass flow ■ Temp. compensated dynamic viscosity ■ Temp. compensated kinematic viscosity ■ Temperature 	
	Status signal			F
	Diagnostic behavior			Alarm

Diagnostic information		Remedy instructions	Influenced measured variables	
No.	Short text			
190	Special event 1	Contact service	<ul style="list-style-type: none"> ▪ Carrier mass flow ▪ Concentration ▪ Density ▪ Dynamic viscosity ▪ Empty pipe detection option ▪ Kinematic viscosity ▪ Low flow cut off option ▪ Mass flow ▪ Sensor integrity ▪ Reference density ▪ Corrected volume flow ▪ Target mass flow ▪ Temp. compensated dynamic viscosity ▪ Temp. compensated kinematic viscosity ▪ Temperature ▪ Status ▪ Volume flow 	
	Status signal			F
	Diagnostic behavior			Alarm

Diagnostic information		Remedy instructions	Influenced measured variables	
No.	Short text			
191	Special event 5	Contact service	<ul style="list-style-type: none"> ▪ Carrier mass flow ▪ Concentration ▪ Density ▪ Dynamic viscosity ▪ Empty pipe detection option ▪ Kinematic viscosity ▪ Low flow cut off option ▪ Mass flow ▪ Sensor integrity ▪ Reference density ▪ Corrected volume flow ▪ Target mass flow ▪ Temp. compensated dynamic viscosity ▪ Temp. compensated kinematic viscosity ▪ Temperature ▪ Status ▪ Volume flow 	
	Status signal			F
	Diagnostic behavior			Alarm

Diagnostic information		Remedy instructions	Influenced measured variables	
No.	Short text			
192	Special event 9	Contact service	<ul style="list-style-type: none"> ▪ Carrier mass flow ▪ Concentration ▪ Density ▪ Dynamic viscosity ▪ Kinematic viscosity ▪ Mass flow ▪ Sensor integrity ▪ Reference density ▪ Corrected volume flow ▪ Target mass flow ▪ Temp. compensated dynamic viscosity ▪ Temp. compensated kinematic viscosity ▪ Temperature ▪ Volume flow 	
	Status signal			F
	Diagnostic behavior			Alarm

12.6.2 Diagnostic of electronic

Diagnostic information		Remedy instructions	Influenced measured variables	
No.	Short text			
201	Device failure	1. Restart device 2. Contact service	<ul style="list-style-type: none"> ▪ Carrier mass flow ▪ Concentration ▪ Density ▪ Dynamic viscosity ▪ Empty pipe detection option ▪ Kinematic viscosity ▪ Low flow cut off option ▪ Mass flow ▪ Sensor integrity ▪ Reference density ▪ Corrected volume flow ▪ Target mass flow ▪ Temp. compensated dynamic viscosity ▪ Temp. compensated kinematic viscosity ▪ Temperature ▪ Status ▪ Volume flow 	
	Status signal			F
	Diagnostic behavior			Alarm

Diagnostic information		Remedy instructions	Influenced measured variables	
No.	Short text			
242	Software incompatible	1. Check software 2. Flash or change main electronics module	<ul style="list-style-type: none"> ▪ Carrier mass flow ▪ Concentration ▪ Density ▪ Dynamic viscosity ▪ Empty pipe detection option ▪ Kinematic viscosity ▪ Low flow cut off option ▪ Mass flow ▪ Sensor integrity ▪ Reference density ▪ Corrected volume flow ▪ Target mass flow ▪ Temp. compensated dynamic viscosity ▪ Temp. compensated kinematic viscosity ▪ Temperature ▪ Status ▪ Volume flow 	
	Status signal			F
	Diagnostic behavior			Alarm

Diagnostic information		Remedy instructions	Influenced measured variables	
No.	Short text			
252	Modules incompatible	1. Check electronic modules 2. Change electronic modules	<ul style="list-style-type: none"> ▪ Carrier mass flow ▪ Concentration ▪ Density ▪ Dynamic viscosity ▪ Empty pipe detection option ▪ Kinematic viscosity ▪ Low flow cut off option ▪ Mass flow ▪ Reference density ▪ Corrected volume flow ▪ Target mass flow ▪ Temp. compensated dynamic viscosity ▪ Temp. compensated kinematic viscosity ▪ Temperature ▪ Status ▪ Volume flow 	
	Status signal			F
	Diagnostic behavior			Alarm

Diagnostic information		Remedy instructions	Influenced measured variables	
No.	Short text			
262	Module connection	1. Check module connections 2. Change main electronics	<ul style="list-style-type: none"> ■ Carrier mass flow ■ Concentration ■ Density ■ Dynamic viscosity ■ Empty pipe detection option ■ Kinematic viscosity ■ Low flow cut off option ■ Mass flow ■ Sensor integrity ■ Reference density ■ Corrected volume flow ■ Target mass flow ■ Temp. compensated dynamic viscosity ■ Temp. compensated kinematic viscosity ■ Temperature ■ Status ■ Volume flow 	
	Status signal			F
	Diagnostic behavior			Alarm

Diagnostic information		Remedy instructions	Influenced measured variables	
No.	Short text			
270	Main electronic failure	Change main electronic module	<ul style="list-style-type: none"> ■ Carrier mass flow ■ Concentration ■ Density ■ Dynamic viscosity ■ Empty pipe detection option ■ Kinematic viscosity ■ Low flow cut off option ■ Mass flow ■ Sensor integrity ■ Reference density ■ Corrected volume flow ■ Target mass flow ■ Temp. compensated dynamic viscosity ■ Temp. compensated kinematic viscosity ■ Temperature ■ Status ■ Volume flow 	
	Status signal			F
	Diagnostic behavior			Alarm

Diagnostic information		Remedy instructions	Influenced measured variables	
No.	Short text			
271	Main electronic failure	1. Restart device 2. Change main electronic module	<ul style="list-style-type: none"> ▪ Carrier mass flow ▪ Concentration ▪ Density ▪ Dynamic viscosity ▪ Empty pipe detection option ▪ Kinematic viscosity ▪ Low flow cut off option ▪ Mass flow ▪ Sensor integrity ▪ Reference density ▪ Corrected volume flow ▪ Target mass flow ▪ Temp. compensated dynamic viscosity ▪ Temp. compensated kinematic viscosity ▪ Temperature ▪ Status ▪ Volume flow 	
	Status signal			F
	Diagnostic behavior			Alarm

Diagnostic information		Remedy instructions	Influenced measured variables	
No.	Short text			
272	Main electronic failure	1. Restart device 2. Contact service	<ul style="list-style-type: none"> ▪ Carrier mass flow ▪ Concentration ▪ Density ▪ Dynamic viscosity ▪ Empty pipe detection option ▪ Kinematic viscosity ▪ Low flow cut off option ▪ Mass flow ▪ Sensor integrity ▪ Reference density ▪ Corrected volume flow ▪ Target mass flow ▪ Temp. compensated dynamic viscosity ▪ Temp. compensated kinematic viscosity ▪ Temperature ▪ Status ▪ Volume flow 	
	Status signal			F
	Diagnostic behavior			Alarm

Diagnostic information		Remedy instructions	Influenced measured variables	
No.	Short text			
273	Main electronic failure	Change electronic	<ul style="list-style-type: none"> ▪ Carrier mass flow ▪ Concentration ▪ Density ▪ Dynamic viscosity ▪ Empty pipe detection option ▪ Kinematic viscosity ▪ Low flow cut off option ▪ Mass flow ▪ Sensor integrity ▪ Reference density ▪ Corrected volume flow ▪ Target mass flow ▪ Temp. compensated dynamic viscosity ▪ Temp. compensated kinematic viscosity ▪ Temperature ▪ Status ▪ Volume flow 	
	Status signal			F
	Diagnostic behavior			Alarm

Diagnostic information		Remedy instructions	Influenced measured variables	
No.	Short text			
274	Main electronic failure	Change electronic	<ul style="list-style-type: none"> ▪ Mass flow ▪ Sensor integrity ▪ Corrected volume flow ▪ Volume flow 	
	Status signal			S
	Diagnostic behavior			Warning

Diagnostic information		Remedy instructions	Influenced measured variables	
No.	Short text			
283	Memory content	1. Reset device 2. Contact service	<ul style="list-style-type: none"> ▪ Carrier mass flow ▪ Concentration ▪ Density ▪ Dynamic viscosity ▪ Empty pipe detection option ▪ Kinematic viscosity ▪ Low flow cut off option ▪ Mass flow ▪ Reference density ▪ Corrected volume flow ▪ Target mass flow ▪ Temp. compensated dynamic viscosity ▪ Temp. compensated kinematic viscosity ▪ Temperature ▪ Status ▪ Volume flow 	
	Status signal			F
	Diagnostic behavior			Alarm

Diagnostic information		Remedy instructions	Influenced measured variables	
No.	Short text			
311	Electronic failure	1. Reset device 2. Contact service	<ul style="list-style-type: none"> ▪ Carrier mass flow ▪ Concentration ▪ Density ▪ Dynamic viscosity ▪ Empty pipe detection option ▪ Kinematic viscosity ▪ Low flow cut off option ▪ Mass flow ▪ Sensor integrity ▪ Reference density ▪ Corrected volume flow ▪ Target mass flow ▪ Temp. compensated dynamic viscosity ▪ Temp. compensated kinematic viscosity ▪ Temperature ▪ Status ▪ Volume flow 	
	Status signal			F
	Diagnostic behavior			Alarm

Diagnostic information		Remedy instructions	Influenced measured variables	
No.	Short text			
311	Electronic failure	1. Do not reset device 2. Contact service	<ul style="list-style-type: none"> ▪ Carrier mass flow ▪ Concentration ▪ Density ▪ Dynamic viscosity ▪ Empty pipe detection option ▪ Kinematic viscosity ▪ Low flow cut off option ▪ Mass flow ▪ Sensor integrity ▪ Reference density ▪ Corrected volume flow ▪ Target mass flow ▪ Temp. compensated dynamic viscosity ▪ Temp. compensated kinematic viscosity ▪ Temperature ▪ Volume flow 	
	Status signal			M
	Diagnostic behavior			Warning

Diagnostic information		Remedy instructions	Influenced measured variables	
No.	Short text			
382	Data storage	1. Insert DAT module 2. Change DAT module	<ul style="list-style-type: none"> ▪ Carrier mass flow ▪ Concentration ▪ Density ▪ Dynamic viscosity ▪ Empty pipe detection option ▪ Kinematic viscosity ▪ Low flow cut off option ▪ Mass flow ▪ Reference density ▪ Corrected volume flow ▪ Target mass flow ▪ Temp. compensated dynamic viscosity ▪ Temp. compensated kinematic viscosity ▪ Temperature ▪ Status ▪ Volume flow 	
	Status signal			F
	Diagnostic behavior			Alarm

Diagnostic information		Remedy instructions	Influenced measured variables	
No.	Short text			
383	Memory content	1. Restart device 2. Check or change DAT module 3. Contact service	<ul style="list-style-type: none"> ▪ Carrier mass flow ▪ Concentration ▪ Density ▪ Dynamic viscosity ▪ Empty pipe detection option ▪ Kinematic viscosity ▪ Low flow cut off option ▪ Mass flow ▪ Reference density ▪ Corrected volume flow ▪ Target mass flow ▪ Temp. compensated dynamic viscosity ▪ Temp. compensated kinematic viscosity ▪ Temperature ▪ Status ▪ Volume flow 	
	Status signal			F
	Diagnostic behavior			Alarm

Diagnostic information		Remedy instructions	Influenced measured variables	
No.	Short text			
390	Special event 2	Contact service	<ul style="list-style-type: none"> ▪ Carrier mass flow ▪ Concentration ▪ Density ▪ Dynamic viscosity ▪ Empty pipe detection option ▪ Kinematic viscosity ▪ Low flow cut off option ▪ Mass flow ▪ Sensor integrity ▪ Reference density ▪ Corrected volume flow ▪ Target mass flow ▪ Temp. compensated dynamic viscosity ▪ Temp. compensated kinematic viscosity ▪ Temperature ▪ Status ▪ Volume flow 	
	Status signal			F
	Diagnostic behavior			Alarm

Diagnostic information		Remedy instructions	Influenced measured variables	
No.	Short text			
391	Special event 6	Contact service	<ul style="list-style-type: none"> ▪ Carrier mass flow ▪ Concentration ▪ Density ▪ Dynamic viscosity ▪ Empty pipe detection option ▪ Kinematic viscosity ▪ Low flow cut off option ▪ Mass flow ▪ Sensor integrity ▪ Reference density ▪ Corrected volume flow ▪ Target mass flow ▪ Temp. compensated dynamic viscosity ▪ Temp. compensated kinematic viscosity ▪ Temperature ▪ Status ▪ Volume flow 	
	Status signal			F
	Diagnostic behavior			Alarm

Diagnostic information		Remedy instructions	Influenced measured variables	
No.	Short text			
392	Special event 10	Contact service	<ul style="list-style-type: none"> ▪ Carrier mass flow ▪ Concentration ▪ Density ▪ Dynamic viscosity ▪ Kinematic viscosity ▪ Mass flow ▪ Sensor integrity ▪ Reference density ▪ Corrected volume flow ▪ Target mass flow ▪ Temp. compensated dynamic viscosity ▪ Temp. compensated kinematic viscosity ▪ Temperature ▪ Volume flow 	
	Status signal			F
	Diagnostic behavior			Alarm

12.6.3 Diagnostic of configuration

Diagnostic information		Remedy instructions	Influenced measured variables	
No.	Short text			
410	Data transfer	1. Check connection 2. Retry data transfer	<ul style="list-style-type: none"> ▪ Carrier mass flow ▪ Concentration ▪ Density ▪ Dynamic viscosity ▪ Empty pipe detection option ▪ Kinematic viscosity ▪ Low flow cut off option ▪ Mass flow ▪ Sensor integrity ▪ Reference density ▪ Corrected volume flow ▪ Target mass flow ▪ Temp. compensated dynamic viscosity ▪ Temp. compensated kinematic viscosity ▪ Temperature ▪ Volume flow 	
	Status signal			F
	Diagnostic behavior			Alarm

Diagnostic information		Remedy instructions	Influenced measured variables	
No.	Short text			
411	Up-/download active	Up-/download active, please wait	<ul style="list-style-type: none"> ▪ Carrier mass flow ▪ Concentration ▪ Density ▪ Dynamic viscosity ▪ Empty pipe detection option ▪ Kinematic viscosity ▪ Low flow cut off option ▪ Mass flow ▪ Sensor integrity ▪ Reference density ▪ Corrected volume flow ▪ Target mass flow ▪ Temp. compensated dynamic viscosity ▪ Temp. compensated kinematic viscosity ▪ Temperature ▪ Volume flow 	
	Status signal			C
	Diagnostic behavior			Warning

Diagnostic information		Remedy instructions	Influenced measured variables	
No.	Short text			
411	Up-/download active	Up-/download active, please wait	<ul style="list-style-type: none"> ▪ Carrier mass flow ▪ Concentration ▪ Density ▪ Dynamic viscosity ▪ Empty pipe detection option ▪ Kinematic viscosity ▪ Low flow cut off option ▪ Mass flow ▪ Sensor integrity ▪ Reference density ▪ Corrected volume flow ▪ Target mass flow ▪ Temp. compensated dynamic viscosity ▪ Temp. compensated kinematic viscosity ▪ Temperature ▪ Volume flow 	
	Status signal			C
	Diagnostic behavior			Warning

Diagnostic information		Remedy instructions	Influenced measured variables	
No.	Short text			
437	Configuration incompatible	1. Restart device 2. Contact service	<ul style="list-style-type: none"> ■ Carrier mass flow ■ Concentration ■ Density ■ Dynamic viscosity ■ Empty pipe detection option ■ Kinematic viscosity ■ Low flow cut off option ■ Mass flow ■ Reference density ■ Corrected volume flow ■ Target mass flow ■ Temp. compensated dynamic viscosity ■ Temp. compensated kinematic viscosity ■ Temperature ■ Status ■ Volume flow 	
	Status signal			F
	Diagnostic behavior			Alarm

Diagnostic information		Remedy instructions	Influenced measured variables	
No.	Short text			
438	Dataset	1. Check data set file 2. Check device configuration 3. Up- and download new configuration	<ul style="list-style-type: none"> ■ Carrier mass flow ■ Concentration ■ Density ■ Dynamic viscosity ■ Empty pipe detection option ■ Kinematic viscosity ■ Low flow cut off option ■ Mass flow ■ Sensor integrity ■ Reference density ■ Corrected volume flow ■ Target mass flow ■ Temp. compensated dynamic viscosity ■ Temp. compensated kinematic viscosity ■ Temperature ■ Volume flow 	
	Status signal			M
	Diagnostic behavior			Warning

Diagnostic information		Remedy instructions	Influenced measured variables	
No.	Short text			
453	Flow override	Deactivate flow override	<ul style="list-style-type: none"> ▪ Carrier mass flow ▪ Concentration ▪ Density ▪ Dynamic viscosity ▪ Empty pipe detection option ▪ Kinematic viscosity ▪ Low flow cut off option ▪ Mass flow ▪ Sensor integrity ▪ Reference density ▪ Corrected volume flow ▪ Target mass flow ▪ Temp. compensated dynamic viscosity ▪ Temp. compensated kinematic viscosity ▪ Temperature ▪ Volume flow 	
	Status signal			C
	Diagnostic behavior			Warning

Diagnostic information		Remedy instructions	Influenced measured variables	
No.	Short text			
482	FB not Auto/Cas	Set Block in AUTO mode	-	
	Status signal			F
	Diagnostic behavior			Alarm

Diagnostic information		Remedy instructions	Influenced measured variables	
No.	Short text			
484	Simulation failure mode	Deactivate simulation	<ul style="list-style-type: none"> ▪ Carrier mass flow ▪ Concentration ▪ Density ▪ Dynamic viscosity ▪ Empty pipe detection option ▪ Kinematic viscosity ▪ Low flow cut off option ▪ Mass flow ▪ Sensor integrity ▪ Reference density ▪ Corrected volume flow ▪ Target mass flow ▪ Temp. compensated dynamic viscosity ▪ Temp. compensated kinematic viscosity ▪ Temperature ▪ Volume flow 	
	Status signal			C
	Diagnostic behavior			Alarm

Diagnostic information		Remedy instructions	Influenced measured variables	
No.	Short text			
485	Simulation measured variable	Deactivate simulation	<ul style="list-style-type: none"> ■ Carrier mass flow ■ Concentration ■ Density ■ Dynamic viscosity ■ Empty pipe detection option ■ Kinematic viscosity ■ Low flow cut off option ■ Mass flow ■ Sensor integrity ■ Reference density ■ Corrected volume flow ■ Target mass flow ■ Temp. compensated dynamic viscosity ■ Temp. compensated kinematic viscosity ■ Temperature ■ Volume flow 	
	Status signal			C
	Diagnostic behavior			Warning

Diagnostic information		Remedy instructions	Influenced measured variables	
No.	Short text			
495	Simulation diagnostic event	Deactivate simulation	-	
	Status signal			C
	Diagnostic behavior			Warning

Diagnostic information		Remedy instructions	Influenced measured variables	
No.	Short text			
497	Simulation block output	Deactivate simulation	-	
	Status signal			C
	Diagnostic behavior			Warning

Diagnostic information		Remedy instructions	Influenced measured variables	
No.	Short text			
537	Configuration	1. Check IP addresses in network 2. Change IP address	-	
	Status signal			F
	Diagnostic behavior			Warning

Diagnostic information		Remedy instructions	Influenced measured variables	
No.	Short text			
590	Special event 3	Contact service	<ul style="list-style-type: none"> ▪ Carrier mass flow ▪ Concentration ▪ Density ▪ Dynamic viscosity ▪ Empty pipe detection option ▪ Kinematic viscosity ▪ Low flow cut off option ▪ Mass flow ▪ Sensor integrity ▪ Reference density ▪ Corrected volume flow ▪ Target mass flow ▪ Temp. compensated dynamic viscosity ▪ Temp. compensated kinematic viscosity ▪ Temperature ▪ Status ▪ Volume flow 	
	Status signal			F
	Diagnostic behavior			Alarm

Diagnostic information		Remedy instructions	Influenced measured variables	
No.	Short text			
591	Special event 7	Contact service	<ul style="list-style-type: none"> ▪ Carrier mass flow ▪ Concentration ▪ Density ▪ Dynamic viscosity ▪ Empty pipe detection option ▪ Kinematic viscosity ▪ Low flow cut off option ▪ Mass flow ▪ Sensor integrity ▪ Reference density ▪ Corrected volume flow ▪ Target mass flow ▪ Temp. compensated dynamic viscosity ▪ Temp. compensated kinematic viscosity ▪ Temperature ▪ Status ▪ Volume flow 	
	Status signal			F
	Diagnostic behavior			Alarm

Diagnostic information		Remedy instructions	Influenced measured variables	
No.	Short text			
592	Special event 11	Contact service	<ul style="list-style-type: none"> ▪ Carrier mass flow ▪ Concentration ▪ Density ▪ Dynamic viscosity ▪ Kinematic viscosity ▪ Mass flow ▪ Sensor integrity ▪ Reference density ▪ Corrected volume flow ▪ Target mass flow ▪ Temp. compensated dynamic viscosity ▪ Temp. compensated kinematic viscosity ▪ Temperature ▪ Volume flow 	
	Status signal			F
	Diagnostic behavior			Alarm

12.6.4 Diagnostic of process

Diagnostic information		Remedy instructions	Influenced measured variables	
No.	Short text			
825	Operating temperature	1. Check ambient temperature 2. Check process temperature	Volume flow	
	Status signal			S
	Diagnostic behavior			Warning

Diagnostic information		Remedy instructions	Influenced measured variables	
No.	Short text			
825	Operating temperature	1. Check ambient temperature 2. Check process temperature	<ul style="list-style-type: none"> ▪ Carrier mass flow ▪ Concentration ▪ Density ▪ Dynamic viscosity ▪ Empty pipe detection option ▪ Kinematic viscosity ▪ Low flow cut off option ▪ Mass flow ▪ Sensor integrity ▪ Reference density ▪ Corrected volume flow ▪ Target mass flow ▪ Temp. compensated dynamic viscosity ▪ Temp. compensated kinematic viscosity ▪ Temperature ▪ Status ▪ Volume flow 	
	Status signal			S
	Diagnostic behavior			Warning

Diagnostic information		Remedy instructions	Influenced measured variables	
No.	Short text			
825	Operating temperature	1. Check ambient temperature 2. Check process temperature	<ul style="list-style-type: none"> ▪ Carrier mass flow ▪ Concentration ▪ Density ▪ Dynamic viscosity ▪ Empty pipe detection option ▪ Kinematic viscosity ▪ Low flow cut off option ▪ Mass flow ▪ Reference density ▪ Corrected volume flow ▪ Target mass flow ▪ Temp. compensated dynamic viscosity ▪ Temp. compensated kinematic viscosity ▪ Temperature ▪ Status ▪ Volume flow 	
	Status signal			F
	Diagnostic behavior			Alarm

Diagnostic information		Remedy instructions	Influenced measured variables	
No.	Short text			
830	Sensor temperature too high	Reduce ambient temp. around the sensor housing	<ul style="list-style-type: none"> ▪ Carrier mass flow ▪ Concentration ▪ Density ▪ Dynamic viscosity ▪ Kinematic viscosity ▪ Mass flow ▪ Sensor integrity ▪ Reference density ▪ Corrected volume flow ▪ Target mass flow ▪ Temp. compensated dynamic viscosity ▪ Temp. compensated kinematic viscosity ▪ Temperature ▪ Volume flow 	
	Status signal			S
	Diagnostic behavior			Warning

Diagnostic information		Remedy instructions	Influenced measured variables	
No.	Short text			
831	Sensor temperature too low	Increase ambient temp. around the sensor housing	<ul style="list-style-type: none"> ▪ Carrier mass flow ▪ Concentration ▪ Density ▪ Dynamic viscosity ▪ Kinematic viscosity ▪ Mass flow ▪ Sensor integrity ▪ Reference density ▪ Corrected volume flow ▪ Target mass flow ▪ Temp. compensated dynamic viscosity ▪ Temp. compensated kinematic viscosity ▪ Temperature ▪ Volume flow 	
	Status signal			S
	Diagnostic behavior			Warning

Diagnostic information		Remedy instructions	Influenced measured variables	
No.	Short text			
832	Electronic temperature too high	Reduce ambient temperature	<ul style="list-style-type: none"> ▪ Carrier mass flow ▪ Concentration ▪ Density ▪ Empty pipe detection option ▪ Low flow cut off option ▪ Mass flow ▪ Sensor integrity ▪ Reference density ▪ Corrected volume flow ▪ Target mass flow ▪ Temperature ▪ Volume flow 	
	Status signal			S
	Diagnostic behavior			Warning

Diagnostic information		Remedy instructions	Influenced measured variables	
No.	Short text			
833	Electronic temperature too low	Increase ambient temperature	<ul style="list-style-type: none"> ▪ Carrier mass flow ▪ Concentration ▪ Density ▪ Dynamic viscosity ▪ Empty pipe detection option ▪ Kinematic viscosity ▪ Low flow cut off option ▪ Mass flow ▪ Sensor integrity ▪ Reference density ▪ Corrected volume flow ▪ Target mass flow ▪ Temp. compensated dynamic viscosity ▪ Temp. compensated kinematic viscosity ▪ Volume flow 	
	Status signal			S
	Diagnostic behavior			Warning

Diagnostic information		Remedy instructions	Influenced measured variables	
No.	Short text			
834	Process temperature too high	Reduce process temperature	<ul style="list-style-type: none"> ▪ Carrier mass flow ▪ Concentration ▪ Density ▪ Dynamic viscosity ▪ Kinematic viscosity ▪ Mass flow ▪ Sensor integrity ▪ Reference density ▪ Corrected volume flow ▪ Target mass flow ▪ Temp. compensated dynamic viscosity ▪ Temp. compensated kinematic viscosity ▪ Temperature ▪ Volume flow 	
	Status signal			S
	Diagnostic behavior			Warning

Diagnostic information		Remedy instructions	Influenced measured variables	
No.	Short text			
835	Process temperature too low	Increase process temperature	<ul style="list-style-type: none"> ▪ Carrier mass flow ▪ Concentration ▪ Density ▪ Dynamic viscosity ▪ Kinematic viscosity ▪ Mass flow ▪ Sensor integrity ▪ Reference density ▪ Corrected volume flow ▪ Target mass flow ▪ Temp. compensated dynamic viscosity ▪ Temp. compensated kinematic viscosity ▪ Temperature ▪ Volume flow 	
	Status signal			S
	Diagnostic behavior			Warning

Diagnostic information		Remedy instructions	Influenced measured variables	
No.	Short text			
842	Process limit	Low flow cut off active! 1. Check low flow cut off configuration	<ul style="list-style-type: none"> ▪ Carrier mass flow ▪ Concentration ▪ Density ▪ Dynamic viscosity ▪ Empty pipe detection option ▪ Kinematic viscosity ▪ Low flow cut off option ▪ Mass flow ▪ Reference density ▪ Corrected volume flow ▪ Target mass flow ▪ Temp. compensated dynamic viscosity ▪ Temp. compensated kinematic viscosity ▪ Temperature ▪ Volume flow 	
	Status signal			S
	Diagnostic behavior			Warning

Diagnostic information		Remedy instructions	Influenced measured variables	
No.	Short text			
843	Process limit	Check process conditions	<ul style="list-style-type: none"> ▪ Carrier mass flow ▪ Concentration ▪ Density ▪ Dynamic viscosity ▪ Empty pipe detection option ▪ Kinematic viscosity ▪ Low flow cut off option ▪ Mass flow ▪ Sensor integrity ▪ Reference density ▪ Corrected volume flow ▪ Target mass flow ▪ Temp. compensated dynamic viscosity ▪ Temp. compensated kinematic viscosity ▪ Temperature ▪ Volume flow 	
	Status signal			S
	Diagnostic behavior			Warning

Diagnostic information		Remedy instructions	Influenced measured variables
No.	Short text		
862	Partly filled pipe		<ul style="list-style-type: none"> ▪ Carrier mass flow ▪ Concentration ▪ Density ▪ Dynamic viscosity ▪ Kinematic viscosity ▪ Mass flow ▪ Sensor integrity ▪ Reference density ▪ Corrected volume flow ▪ Target mass flow ▪ Temp. compensated dynamic viscosity ▪ Temp. compensated kinematic viscosity ▪ Temperature ▪ Volume flow
	Status signal	S	
	Diagnostic behavior	Warning	

Diagnostic information		Remedy instructions	Influenced measured variables
No.	Short text		
882	Input signal		<ul style="list-style-type: none"> ▪ Density ▪ Mass flow ▪ Reference density ▪ Corrected volume flow ▪ Volume flow
	Status signal	F	
	Diagnostic behavior	Alarm	

Diagnostic information		Remedy instructions	Influenced measured variables
No.	Short text		
910	Tubes not oscillating		<ul style="list-style-type: none"> ▪ Carrier mass flow ▪ Concentration ▪ Density ▪ Empty pipe detection option ▪ Low flow cut off option ▪ Mass flow ▪ Sensor integrity ▪ Reference density ▪ Corrected volume flow ▪ Target mass flow ▪ Temperature ▪ Volume flow
	Status signal	F	
	Diagnostic behavior	Alarm	

Diagnostic information		Remedy instructions	Influenced measured variables	
No.	Short text			
912	Medium inhomogeneous	1. Check process cond. 2. Increase system pressure	<ul style="list-style-type: none"> ▪ Carrier mass flow ▪ Concentration ▪ Density ▪ Dynamic viscosity ▪ Empty pipe detection option ▪ Kinematic viscosity ▪ Low flow cut off option ▪ Mass flow ▪ Sensor integrity ▪ Reference density ▪ Corrected volume flow ▪ Target mass flow ▪ Temp. compensated dynamic viscosity ▪ Temp. compensated kinematic viscosity ▪ Temperature ▪ Volume flow 	
	Status signal			S
	Diagnostic behavior			Warning

Diagnostic information		Remedy instructions	Influenced measured variables	
No.	Short text			
912	Inhomogeneous	1. Check process cond. 2. Increase system pressure	<ul style="list-style-type: none"> ▪ Carrier mass flow ▪ Concentration ▪ Density ▪ Dynamic viscosity ▪ Empty pipe detection option ▪ Kinematic viscosity ▪ Low flow cut off option ▪ Mass flow ▪ Sensor integrity ▪ Reference density ▪ Corrected volume flow ▪ Target mass flow ▪ Temp. compensated dynamic viscosity ▪ Temp. compensated kinematic viscosity ▪ Temperature ▪ Volume flow 	
	Status signal			S
	Diagnostic behavior			Warning

Diagnostic information		Remedy instructions	Influenced measured variables	
No.	Short text			
913	Medium unsuitable	1. Check process conditions 2. Check electronic modules or sensor	<ul style="list-style-type: none"> ▪ Carrier mass flow ▪ Concentration ▪ Density ▪ Dynamic viscosity ▪ Kinematic viscosity ▪ Mass flow ▪ Sensor integrity ▪ Reference density ▪ Corrected volume flow ▪ Target mass flow ▪ Temp. compensated dynamic viscosity ▪ Temp. compensated kinematic viscosity ▪ Temperature ▪ Volume flow 	
	Status signal			S
	Diagnostic behavior			Warning

Diagnostic information		Remedy instructions	Influenced measured variables	
No.	Short text			
944	Monitoring failed	Check process conditions for Heartbeat Monitoring	<ul style="list-style-type: none"> ▪ Carrier mass flow ▪ Concentration ▪ Density ▪ Mass flow ▪ Sensor integrity ▪ Reference density ▪ Corrected volume flow ▪ Target mass flow ▪ Temperature 	
	Status signal			S
	Diagnostic behavior			Warning

Diagnostic information		Remedy instructions	Influenced measured variables	
No.	Short text			
948	Tube damping too high	Check process conditions	-	
	Status signal			S
	Diagnostic behavior			Warning

Diagnostic information		Remedy instructions	Influenced measured variables	
No.	Short text			
990	Special event 4	Contact service	<ul style="list-style-type: none"> ▪ Carrier mass flow ▪ Concentration ▪ Density ▪ Dynamic viscosity ▪ Empty pipe detection option ▪ Kinematic viscosity ▪ Low flow cut off option ▪ Mass flow ▪ Sensor integrity ▪ Reference density ▪ Corrected volume flow ▪ Target mass flow ▪ Temp. compensated dynamic viscosity ▪ Temp. compensated kinematic viscosity ▪ Temperature ▪ Status ▪ Volume flow 	
	Status signal			F
	Diagnostic behavior			Alarm



Diagnostic information		Remedy instructions	Influenced measured variables	
No.	Short text			
991	Special event 8	Contact service	<ul style="list-style-type: none"> ▪ Carrier mass flow ▪ Concentration ▪ Density ▪ Dynamic viscosity ▪ Empty pipe detection option ▪ Kinematic viscosity ▪ Low flow cut off option ▪ Mass flow ▪ Sensor integrity ▪ Reference density ▪ Corrected volume flow ▪ Target mass flow ▪ Temp. compensated dynamic viscosity ▪ Temp. compensated kinematic viscosity ▪ Temperature ▪ Status ▪ Volume flow 	
	Status signal			F
	Diagnostic behavior			Alarm



Diagnostic information		Remedy instructions	Influenced measured variables	
No.	Short text			
992	Special event 12	Contact service	<ul style="list-style-type: none"> ▪ Carrier mass flow ▪ Concentration ▪ Density ▪ Dynamic viscosity ▪ Kinematic viscosity ▪ Mass flow ▪ Sensor integrity ▪ Reference density ▪ Corrected volume flow ▪ Target mass flow ▪ Temp. compensated dynamic viscosity ▪ Temp. compensated kinematic viscosity ▪ Temperature ▪ Volume flow 	
	Status signal			F
	Diagnostic behavior			Alarm

12.7 Pending diagnostic events

The **Diagnostics** menu allows the user to view the current diagnostic event and the previous diagnostic event separately.

 To call up the measures to rectify a diagnostic event:

- Via web browser →  89
- Via "FieldCare" operating tool →  90
- Via "DeviceCare" operating tool →  90

 Other pending diagnostic events can be displayed in the **Diagnostic list** submenu →  119.

Navigation
 "Diagnostics" menu

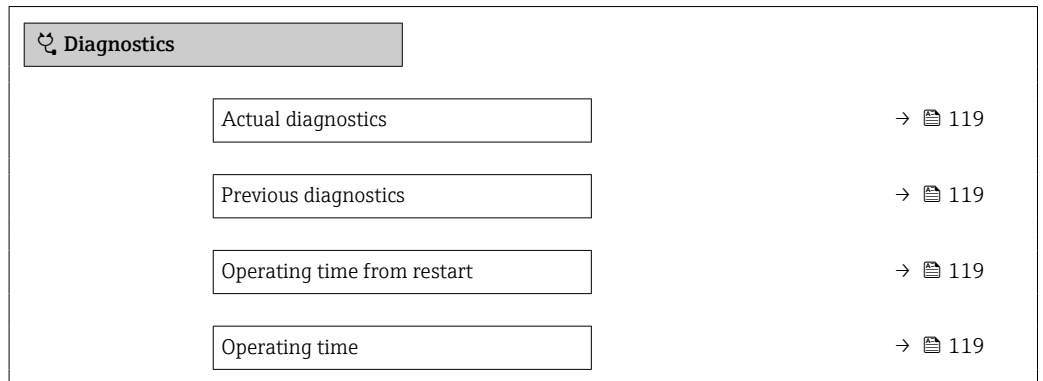

Parameter overview with brief description

Parameter	Prerequisite	Description	User interface
Actual diagnostics	A diagnostic event has occurred.	Shows the current occurred diagnostic event along with its diagnostic information. If two or more messages occur simultaneously, the message with the highest priority is shown on the display.	Symbol for diagnostic behavior, diagnostic code and short message.
Previous diagnostics	Two diagnostic events have already occurred.	Shows the diagnostic event that occurred prior to the current diagnostic event along with its diagnostic information.	Symbol for diagnostic behavior, diagnostic code and short message.
Operating time from restart	–	Shows the time the device has been in operation since the last device restart.	Days (d), hours (h), minutes (m) and seconds (s)
Operating time	–	Indicates how long the device has been in operation.	Days (d), hours (h), minutes (m) and seconds (s)

12.8 Diagnostics list

Up to 5 currently pending diagnostic events can be displayed in the **Diagnostic list** submenu along with the associated diagnostic information. If more than 5 diagnostic events are pending, the events with the highest priority are shown on the display.

Navigation path

Diagnostics → Diagnostic list

To call up the measures to rectify a diagnostic event:

- Via web browser → 89
- Via "FieldCare" operating tool → 90
- Via "DeviceCare" operating tool → 90

12.9 Event logbook



12.9.1 Reading out the event logbook

A chronological overview of the event messages that have occurred is provided in the **Events list** submenu.



Navigation path

Diagnostics menu → **Event logbook** submenu → Events list



The event history includes entries for:

- Diagnostic events →  93
- Information events →  120

In addition to the operating time when the event occurred, each event is also assigned a symbol that indicates whether the event has occurred or is finished:

- Diagnostics event
 - : Occurrence of the event
 - : End of the event
- Information event
 - : Occurrence of the event

 To call up the measures to rectify a diagnostic event:

- Via web browser →  89
- Via "FieldCare" operating tool →  90
- Via "DeviceCare" operating tool →  90

 For filtering the displayed event messages →  120

12.9.2 Filtering the event logbook

Using the **Filter options** parameter you can define which category of event message is displayed in the **Events list** submenu.

Navigation path

Diagnostics → Event logbook → Filter options

Filter categories

- All
- Failure (F)
- Function check (C)
- Out of specification (S)
- Maintenance required (M)
- Information (I)

12.9.3 Overview of information events

Unlike a diagnostic event, an information event is displayed in the event logbook only and not in the diagnostic list.

Info number	Info name
I1000	----- (Device ok)
I1089	Power on
I1090	Configuration reset
I1091	Configuration changed
I1110	Write protection switch changed
I1111	Density adjust failure
I1137	Electronic changed
I1151	History reset
I1155	Reset electronic temperature
I1157	Memory error event list
I1185	Display backup done
I1186	Restore via display done

Info number	Info name
I1187	Settings downloaded with display
I1188	Display data cleared
I1189	Backup compared
I1209	Density adjustment ok
I1221	Zero point adjust failure
I1222	Zero point adjustment ok
I1256	Display: access status changed
I1264	Safety sequence aborted
I1335	Firmware changed
I1361	Wrong web server login
I1397	Fieldbus: access status changed
I1398	CDI: access status changed
I1444	Device verification passed
I1445	Device verification failed
I1446	Device verification active
I1447	Record application reference data
I1448	Application reference data recorded
I1449	Recording application ref. data failed
I1450	Monitoring off
I1451	Monitoring on
I1457	Failed: Measured error verification
I1459	Failed: I/O module verification
I1460	Failed: Sensor integrity verification
I1461	Failed: Sensor verification
I1462	Failed: Sensor electronic module verific.

12.10 Resetting the measuring device

The entire device configuration or some of the configuration can be reset to a defined state with the **Device reset** parameter (→  76).

12.10.1 Function range of "Device reset" parameter

Options	Description
Cancel	No action is executed and the user exits the parameter.
To delivery settings	Every parameter for which a customer-specific default setting was ordered is reset to the customer-specific value. All other parameters are reset to the factory setting.  This option is not visible if no customer-specific settings have been ordered.
Restart device	The restart resets every parameter with data stored in volatile memory (RAM) to the factory setting (e.g. measured value data). The device configuration remains unchanged.

12.11 Device information

The **Device information** submenu contains all parameters that display different information for device identification.

Navigation





"Diagnostics" menu → Device information

▶ Device information

Device tag	→ ⓘ 122
Serial number	→ ⓘ 122
Firmware version	→ ⓘ 122
Device name	→ ⓘ 123
Order code	→ ⓘ 123
Extended order code 1	→ ⓘ 123
Extended order code 2	→ ⓘ 123
Extended order code 3	→ ⓘ 123
ENP version	→ ⓘ 123
PROFIBUS ident number	→ ⓘ 123
Status PROFIBUS Master Config	→ ⓘ 123
IP address	
Subnet mask	
Default gateway	



Parameter overview with brief description

Parameter	Description	User interface	Factory setting
Device tag	Shows name of measuring point.	Max. 32 characters, such as letters, numbers or special characters (e.g. @, %, /).	Promass 100 DP
Serial number	Shows the serial number of the measuring device.	Max. 11-digit character string comprising letters and numbers.	–
Firmware version	Shows the device firmware version installed.	Character string in the format xx.yy.zz	–

Parameter	Description	User interface	Factory setting
Order code	Shows the device order code.  The order code can be found on the nameplate of the sensor and transmitter in the "Order code" field.	Character string composed of letters, numbers and certain punctuation marks (e.g. /).	–
Device name	Shows the name of the transmitter.  The name can be found on the nameplate of the transmitter.	Max. 32 characters such as letters or numbers.	–
Extended order code 1	Shows the 1st part of the extended order code.  The extended order code can also be found on the nameplate of the sensor and transmitter in the "Ext. ord. cd." field.	Character string	–
Extended order code 2	Shows the 2nd part of the extended order code.  The extended order code can also be found on the nameplate of the sensor and transmitter in the "Ext. ord. cd." field.	Character string	–
Extended order code 3	Shows the 3rd part of the extended order code.  The extended order code can also be found on the nameplate of the sensor and transmitter in the "Ext. ord. cd." field.	Character string	–
ENP version	Shows the version of the electronic nameplate (ENP).	Character string	–
PROFIBUS ident number	Displays the PROFIBUS identification number.	0 to FFFF	0x1561
Status PROFIBUS Master Config	Displays the status of the PROFIBUS Master configuration.	<ul style="list-style-type: none"> ■ Active ■ Not active 	–

12.12 Firmware history

Release date	Firmware version	Order code for "Firmware version"	Firmware Changes	Documentation type	Documentation
09.2013	01.00.00	Option 78	Original firmware	Operating Instructions	BA01251D/06/EN/01.13
10.2014	01.01.zz	Option 69	<ul style="list-style-type: none"> ▪ Integration of optional local display ▪ New unit "Beer Barrel (BBL)" ▪ Simulation of diagnostic events 	Operating Instructions	BA01251D/06/EN/02.14

-  It is possible to flash the firmware to the current version or the previous version using the service interface.
-  For the compatibility of the firmware version with the previous version, the installed device description files and operating tools, observe the information about the device in the "Manufacturer's information" document.
-  The manufacturer's information is available:
 - In the Download Area of the Endress+Hauser web site: www.endress.com → Downloads
 - Specify the following details:
 - Product root, e.g. 8E1B
The product root is the first part of the order code: see the nameplate on the device.
 - Text search: Manufacturer's information
 - Media type: Documentation – Technical Documentation

13 Maintenance

13.1 Maintenance work

No special maintenance work is required.

13.1.1 Exterior cleaning

When cleaning the exterior of measuring devices, always use cleaning agents that do not attack the surface of the housing or the seals.

13.1.2 Internal cleaning

Observe the following points for CIP and SIP cleaning:

- Use only cleaning agents to which the process-wetted materials are adequately resistant.
- Observe the maximum permitted medium temperature for the measuring device .

Observe the following point for cleaning with pigs:

Observe the inside diameter of the measuring tube and process connection.

13.2 Measuring and test equipment

Endress+Hauser offers a variety of measuring and testing equipment, such as Netilion or device tests.

 Your Endress+Hauser Sales Center can provide detailed information on the services.

List of some of the measuring and testing equipment: →  129

13.3 Endress+Hauser services

Endress+Hauser offers a wide variety of services for maintenance such as recalibration, maintenance service or device tests.

 Your Endress+Hauser Sales Center can provide detailed information on the services.

14 Repair

14.1 General notes

14.1.1 Repair and conversion concept

The Endress+Hauser repair and conversion concept provides for the following:

- The measuring devices have a modular design.
- Spare parts are grouped into logical kits with the associated Installation Instructions.
- Repairs are carried out by Endress+Hauser Service or by appropriately trained customers.
- Certified devices can only be converted to other certified devices by Endress+Hauser Service or at the factory.

14.1.2 Notes for repair and conversion



For repair and conversion of a measuring device, observe the following notes:

- ▶ Use only original Endress+Hauser spare parts.
- ▶ Carry out the repair according to the Installation Instructions.
- ▶ Observe the applicable standards, federal/national regulations, Ex documentation (XA) and certificates.
- ▶ Document all repairs and conversions and enter the details in Netilion Analytics.

14.2 Spare parts

Device Viewer (www.endress.com/deviceviewer):

All the spare parts for the measuring device, along with the order code, are listed here and can be ordered. If available, users can also download the associated Installation Instructions.

-  Measuring device serial number:
 - Is located on the nameplate of the device.
 - Can be read out via the **Serial number** parameter (→  122) in the **Device information** submenu.

14.3 Endress+Hauser services

Endress+Hauser offers a wide range of services.

-  Your Endress+Hauser Sales Center can provide detailed information on the services.

14.4 Return

The requirements for safe device return can vary depending on the device type and national legislation.

1. Refer to the web page for information:
<https://www.endress.com/support/return-material>
 - ↳ Select the region.
2. If returning the device, pack the device in such a way that it is reliably protected against impact and external influences. The original packaging offers the best protection.

14.5 Disposal



If required by the Directive 2012/19/EU on waste electrical and electronic equipment (WEEE), the product is marked with the depicted symbol in order to minimize the disposal of WEEE as unsorted municipal waste. Do not dispose of products bearing this marking as unsorted municipal waste. Instead, return them to the manufacturer for disposal under the applicable conditions.

14.5.1 Removing the measuring device

1. Switch off the device.

WARNING

Danger to persons from process conditions!

- ▶ Beware of hazardous process conditions such as pressure in the measuring device, high temperatures or aggressive media.

2. Carry out the mounting and connection steps from the "Mounting the measuring device" and "Connecting the measuring device" sections in reverse order. Observe the safety instructions.

14.5.2 Disposing of the measuring device

WARNING

Danger to personnel and environment from fluids that are hazardous to health.

- ▶ Ensure that the measuring device and all cavities are free of fluid residues that are hazardous to health or the environment, e.g. substances that have permeated into crevices or diffused through plastic.

Observe the following notes during disposal:



- ▶ Observe valid federal/national regulations.
- ▶ Ensure proper separation and reuse of the device components.

15 Accessories



Various accessories, which can be ordered with the device or subsequently from Endress+Hauser, are available for the device. Detailed information on the order code in question is available from your local Endress+Hauser sales center or on the product page of the Endress+Hauser website: www.endress.com.







15.1 Device-specific accessories

15.1.1 For the sensor







Accessories	Description
Heating jacket	<p>Is used to stabilize the temperature of the fluids in the sensor. Water, water vapor and other non-corrosive liquids are permitted for use as fluids.</p> <p> If using oil as a heating medium, please consult with Endress+Hauser.</p> <ul style="list-style-type: none"> ▪ If ordered together with the measuring device: Order code for "Accessory enclosed" <ul style="list-style-type: none"> ▪ Option RB "Heating jacket, G 1/2" female thread" ▪ Option RC "Heating jacket, G 3/4" female thread" ▪ Option RD "Heating jacket, NPT 1/2" female thread" ▪ Option RE "Heating jacket, NPT 3/4" female thread" ▪ If ordered subsequently: Use the order code with the product root DK8003. <p> Special Documentation SD02158D</p>

15.2 Communication-specific accessories



Accessories	Description
Commubox FXA291	<p>Connects Endress+Hauser field devices with a CDI interface (= Endress+Hauser Common Data Interface) and the USB port of a computer or laptop.</p> <p> Technical Information TI00405C</p>
Fieldgate FXA42	<p>Transmission of the measured values of connected 4 to 20 mA analog measuring instruments, as well as digital measuring instruments</p> <p> <ul style="list-style-type: none"> ▪ Technical Information TI01297S ▪ Operating Instructions BA01778S ▪ Product page: www.endress.com/fxa42 </p>
Field Xpert SMT50	<p>The Field Xpert SMT50 tablet PC for device configuration enables mobile plant asset management in the non-hazardous areas. It is suitable for commissioning and maintenance staff to manage field instruments with a digital communication interface and to record progress.</p> <p>This tablet PC is designed as an all-in-one solution with a preinstalled driver library and is an easy-to-use, touch-sensitive tool which can be used to manage the field instruments throughout their entire life cycle.</p> <p> <ul style="list-style-type: none"> ▪ Technical Information TI01555S ▪ Operating Instructions BA02053S ▪ Product page: www.endress.com/smt50 </p>

Field Xpert SMT70	<p>The Field Xpert SMT70 tablet PC for device configuration enables mobile plant asset management in hazardous and non-hazardous areas. It is suitable for commissioning and maintenance staff to manage field instruments with a digital communication interface and to record progress.</p> <p>This tablet PC is designed as an all-in-one solution with a preinstalled driver library and is an easy-to-use, touch-sensitive tool which can be used to manage the field instruments throughout their entire life cycle.</p> <ul style="list-style-type: none">  Technical Information TI01342S  Operating Instructions BA01709S  Product page: www.endress.com/smt70
Field Xpert SMT77	<p>The Field Xpert SMT77 tablet PC for device configuration enables mobile plant asset management in areas categorized as Ex Zone 1.</p> <ul style="list-style-type: none">  Technical Information TI01418S  Operating Instructions BA01923S  Product page: www.endress.com/smt77

15.3 Service-specific accessories

Accessories	Description
Applicator	<p>Software for selecting and sizing Endress+Hauser measuring instruments:</p> <ul style="list-style-type: none">  Choice of measuring instruments for industrial requirements  Calculation of all the necessary data for identifying the optimum flowmeter: e.g. nominal diameter, pressure loss, flow velocity and measurement accuracy.  Graphic display of the calculation results  Determination of the partial order code, administration, documentation and access to all project-related data and parameters over the entire life cycle of a project. <p>Applicator is available: Via the Internet: https://portal.endress.com/webapp/applicator</p>
Netilion	<p>IloT ecosystem: Unlock knowledge</p> <p>With the Netilion IloT ecosystem, Endress+Hauser allows you to optimize your plant performance, digitize workflows, share knowledge, and enhance collaboration.</p> <p>Drawing upon decades of experience in process automation, Endress+Hauser offers the process industry an IloT ecosystem designed to effortlessly extract insights from data. These insights allow process optimization, leading to increased plant availability, efficiency, and reliability - ultimately resulting in a more profitable plant.</p> <p>www.netilion.endress.com</p>
FieldCare	<p>FDT-based plant asset management tool from Endress+Hauser. It can configure all intelligent field units in your system and helps you manage them. By using the status information, it is also a simple but effective way of checking their status and condition.</p> <ul style="list-style-type: none">  Operating Instructions BA00027S and BA00059S
DeviceCare	<p>Tool to connect and configure Endress+Hauser field devices.</p> <ul style="list-style-type: none">  Innovation brochure INO1047S

15.4 System components

Accessories	Description
Memograph M graphic data manager	<p>The Memograph M graphic data manager provides information on all the relevant measured variables. Measured values are recorded correctly, limit values are monitored and measuring points analyzed. The data are stored in the 256 MB internal memory and also on a SD card or USB stick.</p> <ul style="list-style-type: none">  ■ Technical Information TI00133R  ■ Operating Instructions BA00247R
iTEMP	<p>The temperature transmitters can be used in all applications and are suitable for the measurement of gases, steam and liquids. They can be used to read in the medium temperature.</p> <ul style="list-style-type: none">  "Fields of Activity" document FA00006T

16 Technical data

16.1 Application

The measuring device is intended only for the flow measurement of liquids and gases.

Depending on the version ordered, the measuring device can also measure potentially explosive, flammable, poisonous and oxidizing media.

To ensure that the device remains in proper operating condition for its service life, use the measuring device only for media against which the process-wetted materials are sufficiently resistant.

16.2 Function and system design

Measuring principle	Mass flow measurement based on the Coriolis measuring principle
Measuring system	<p>The device consists of a transmitter and a sensor.</p> <p>The device is available as a compact version: The transmitter and sensor form a mechanical unit.</p> <p>For information on the structure of the measuring instrument →  11</p>

16.3 Input

Measured variable

Direct measured variables

- Mass flow
- Density
- Temperature
- Viscosity

Calculated measured variables

- Volume flow
- Corrected volume flow
- Reference density

Measuring range

Measuring range for liquids

DN		Measuring range full scale values $\dot{m}_{\min(F)}$ to $\dot{m}_{\max(F)}$	
[mm]	[in]	[kg/h]	[lb/min]
8	$\frac{3}{8}$	0 to 2 000	0 to 73.50
15	$\frac{1}{2}$	0 to 6 500	0 to 238.9
15 FB	$\frac{1}{2}$ FB	0 to 18 000	0 to 661.5
25	1	0 to 18 000	0 to 661.5
25 FB	1 FB	0 to 45 000	0 to 1 654
40	$1\frac{1}{2}$	0 to 45 000	0 to 1 654
40 FB	$1\frac{1}{2}$ FB	0 to 70 000	0 to 2 573
50	2	0 to 70 000	0 to 2 573
50 FB	2 FB	0 to 180 000	0 to 6 615
80	3	0 to 180 000	0 to 6 615

FB = Full bore

Measuring range for gases

The full scale value depends on the density and the sound velocity of the gas used and can be calculated with the formula below:

The full scale value depends on the density and the sound velocity of the gas used. The full scale value can be calculated with the following formulas:

- $\dot{m}_{\max(G)} = \text{minimum} (\dot{m}_{\max(F)} \cdot \rho_G \cdot x)$
- $\dot{m}_{\max(G)} = \text{minimum} (\rho_G \cdot (c_G/2) \cdot d_i^2 \cdot (\pi/4) \cdot 3600 \cdot n)$

$\dot{m}_{\max(G)}$	Maximum full scale value for gas [kg/h]
$\dot{m}_{\max(F)}$	Maximum full scale value for liquid [kg/h]
$\dot{m}_{\max(G)} < \dot{m}_{\max(F)}$	$\dot{m}_{\max(G)}$ can never be greater than $\dot{m}_{\max(F)}$
ρ_G	Gas density in [kg/m ³] at operating conditions
x	Limitation constant for max. gas flow [kg/m ³]
c_G	Sound velocity (gas) [m/s]
d_i	Measuring tube internal diameter [m]
π	Pi
$n = 1$	Number of measuring tubes



DN		x
[mm]	[in]	[kg/m ³]
8	$\frac{3}{8}$	60
15	$\frac{1}{2}$	80
15 FB	$\frac{1}{2}$ FB	90
25	1	90
25 FB	1 FB	90
40	$1\frac{1}{2}$	90
40 FB	$1\frac{1}{2}$ FB	90
50	2	90
50 FB	2 FB	110
80	3	110

FB = Full bore

If calculating the full scale value using the two formulas:

1. Calculate the full scale value with both formulas.
2. The smaller value is the value that must be used.

Recommended measuring range

 Flow limit →  143

Operable flow range

Over 1000 : 1.

Flow rates above the preset full scale value do not override the electronics unit, with the result that the totalizer values are registered correctly.

Input signal

External measured values

To increase the measurement accuracy of certain measured variables or to calculate the corrected volume flow for gases, the automation system can continuously write different measured values to the measuring instrument:

- Operating pressure to increase measurement accuracy (Endress+Hauser recommends the use of a pressure measuring instrument for absolute pressure, e.g. Cerabar M or Cerabar S)
- Medium temperature to increase measurement accuracy (e.g. iTEMP)
- Reference density for calculating the corrected volume flow for gases

 Various pressure transmitters and temperature measuring instruments can be ordered from Endress+Hauser: see "Accessories" section →  130

It is recommended to read in external measured values to calculate the following measured variables:

- Mass flow
- Corrected volume flow

Digital communication

The measured values are written by the automation system via PROFIBUS DP.

16.4 Output

Output signal

PROFIBUS DP

Signal encoding	NRZ code
Data transfer	9.6 kBaud...12 MBaud

Signal on alarm

Depending on the interface, failure information is displayed as follows.

PROFIBUS DP

Status and alarm messages	Diagnostics in accordance with PROFIBUS PA Profile 3.02
---------------------------	---

Local display

Plain text display	With information on cause and remedial measures
Backlight	Red backlighting indicates a device error.

 Status signal as per NAMUR recommendation NE 107

Interface/protocol

- Via digital communication:
PROFIBUS DP
- Via service interface
CDI-RJ45 service interface

Plain text display	With information on cause and remedial measures
--------------------	---

Web browser

Plain text display	With information on cause and remedial measures
--------------------	---

Light emitting diodes (LED)

Status information	<p>Status indicated by various light emitting diodes</p> <p>The following information is displayed depending on the device version:</p> <ul style="list-style-type: none"> ▪ Supply voltage active ▪ Data transmission active ▪ Device alarm/error has occurred <p> Diagnostic information via light emitting diodes</p>
--------------------	--

Low flow cut off

The switch points for low flow cut off are user-selectable.

Galvanic isolation

The following connections are galvanically isolated from each other:

- Outputs
- Power supply

Protocol-specific data

protocol-specific data

Manufacturer ID	0x11
Ident number	0x1561
Profile version	3.02
Device description files (GSD, DTM, DD)	Information and files available at: <ul style="list-style-type: none"> ▪ https://www.endress.com/download On the device product page: PRODUCTS → Product Finder → Links ▪ https://www.profibus.com
Output values (from measuring instrument to automation system)	<p>Analog input 1 to 8</p> <ul style="list-style-type: none"> ▪ Mass flow ▪ Volume flow ▪ Corrected volume flow ▪ Target mass flow ▪ Carrier mass flow ▪ Density ▪ Reference density ▪ Concentration ▪ Dynamic viscosity ▪ Kinematic viscosity ▪ Temp. compensated dynamic viscosity ▪ Temp. compensated kinematic viscosity ▪ Temperature ▪ Carrier pipe temperature ▪ Electronics temperature ▪ Oscillation frequency ▪ Oscillation amplitude ▪ Frequency fluctuation ▪ Oscillation damping ▪ Tube damping fluctuation ▪ Signal asymmetry ▪ Exciter current <p>Digital input 1 to 2</p> <ul style="list-style-type: none"> ▪ Partially filled pipe detection ▪ Low flow cut off <p>Totalizer 1 to 3</p> <ul style="list-style-type: none"> ▪ Mass flow ▪ Volume flow ▪ Corrected volume flow
Input values (from automation system to measuring instrument)	<p>Analog output 1 to 3 (fixed assignment)</p> <ul style="list-style-type: none"> ▪ Pressure ▪ Temperature ▪ Reference density <p>Digital output 1 to 3 (fixed assignment)</p> <ul style="list-style-type: none"> ▪ Digital output 1: switch positive zero return on/off ▪ Digital output 2: perform zero adjustment ▪ Digital output 3: switch switch output on/off <p>Totalizer 1 to 3</p> <ul style="list-style-type: none"> ▪ Totalize ▪ Reset and hold ▪ Preset and hold ▪ Stop ▪ Operating mode configuration: <ul style="list-style-type: none"> ▪ Net flow total ▪ Forward flow total ▪ Reverse flow total

Supported functions	<ul style="list-style-type: none"> ▪ Identification & maintenance Straightforward device identification on the part of the control system and nameplate ▪ PROFIBUS upload/download Reading and writing parameters is up to ten times faster with PROFIBUS upload/download. ▪ Condensed status Straightforward and self-explanatory diagnostic information by categorizing diagnostic messages that occur
Configuration of the device address	<ul style="list-style-type: none"> ▪ DIP switches on the I/O electronics module ▪ Via operating tools (e.g. FieldCare)

16.5 Power supply

Terminal assignment ▪ →  27
▪

Supply voltage The power unit must be tested to ensure it meets safety requirements (e.g. PELV, SELV).

Transmitter
 DC 20 to 30 V

Power consumption **Transmitter**

Order code for "Output"	Maximum Power consumption
Option L: PROFIBUS DP	3.5 W

Current consumption **Transmitter**

Order code for "Output"	Maximum Current consumption	Maximum switch-on current
Option L: PROFIBUS DP	145 mA	18 A (< 0.125 ms)

Device fuse Fine-wire fuse (slow-blow) T2A

Power supply failure

- Totalizers stop at the last value measured.
- Depending on the device version, the configuration is retained in the device memory or in the pluggable data memory (HistoROM DAT).
- Error messages (incl. total operated hours) are stored.

Electrical connection →  28



Potential equalization →  30

Terminals **Transmitter**
 Spring terminals for wire cross-sections 0.5 to 2.5 mm² (20 to 14 AWG)

Cable entries	<ul style="list-style-type: none"> ■ Cable gland: M20 × 1.5 with cable Ø 6 to 12 mm (0.24 to 0.47 in) ■ Thread for cable entry: <ul style="list-style-type: none"> ■ M20 ■ G ½" ■ NPT ½"
---------------	--

Cable specification →  26

16.6 Performance characteristics

Reference operating conditions	<ul style="list-style-type: none"> ■ Error limits based on ISO 11631 ■ Water <ul style="list-style-type: none"> ■ +15 to +45 °C (+59 to +113 °F) ■ 2 to 6 bar (29 to 87 psi) ■ Data as indicated in the calibration protocol ■ Accuracy based on accredited calibration rigs according to ISO 17025 <p> To obtain measured errors, use the <i>Applicator</i> sizing tool →  129</p>
--------------------------------	--

Maximum measurement error o.r. = of reading; 1 g/cm³ = 1 kg/l; T = medium temperature

Base accuracy

 Design fundamentals →  140

Mass flow and volume flow (liquids)

±0.10 % o.r.

Mass flow (gases)

±0.50 % o.r.

Density (liquids)

Under reference conditions	Standard density calibration ¹⁾	Wide-range Density specification ^{2) 3)}
[g/cm ³]	[g/cm ³]	[g/cm ³]
±0.0005	±0.02	±0.004

- 1) Valid over the entire temperature and density range
- 2) Valid range for special density calibration: 0 to 2 g/cm³, +10 to +80 °C (+50 to +176 °F)
- 3) order code for "Application package", option EE "Special density"

Temperature

±0.5 °C ± 0.005 · T °C (±0.9 °F ± 0.003 · (T - 32) °F)

Zero point stability

DN		Zero point stability	
[mm]	[in]	[kg/h]	[lb/min]
8	3/8	0.150	0.0055
15	1/2	0.488	0.0179

DN		Zero point stability	
[mm]	[in]	[kg/h]	[lb/min]
15 FB	½ FB	1.350	0.0496
25	1	1.350	0.0496
25 FB	1 FB	3.375	0.124
40	1½	3.375	0.124
40 FB	1 ½ FB	5.25	0.193
50	2	5.25	0.193
50 FB	2 FB	13.5	0.496
80	3	13.5	0.496

FB = Full bore

Flow values

Flow values as turndown parameters depending on nominal diameter.

SI units

DN	1:1	1:10	1:20	1:50	1:100	1:500
[mm]	[kg/h]	[kg/h]	[kg/h]	[kg/h]	[kg/h]	[kg/h]
8	2 000	200	100	40	20	4
15	6 500	650	325	130	65	13
15 FB	18 000	1 800	900	360	180	36
25	18 000	1 800	900	360	180	36
25 FB	45 000	4 500	2 250	900	450	90
40	45 000	4 500	2 250	900	450	90
40 FB	70 000	7 000	3 500	1 400	700	140
50	70 000	7 000	3 500	1 400	700	140
50 FB	180 000	18 000	9 000	3 600	1 800	360
80	180 000	18 000	9 000	3 600	1 800	360

FB = Full bore

US units

DN	1:1	1:10	1:20	1:50	1:100	1:500
[inch]	[lb/min]	[lb/min]	[lb/min]	[lb/min]	[lb/min]	[lb/min]
⅜	73.50	7.350	3.675	1.470	0.735	0.147
½	238.9	23.89	11.95	4.778	2.389	0.478
½ FB	661.5	66.15	33.08	13.23	6.615	1.323
1	661.5	66.15	33.08	13.23	6.615	1.323
1 FB	1 654	165.4	82.70	33.08	16.54	3.308
1½	1 654	165.4	82.70	33.08	16.54	3.308
1½ FB	2 573	257.3	128.7	51.46	25.73	5.146
2	2 573	257.3	128.7	51.46	25.73	5.146
2 FB	6 615	661.5	330.8	132.3	66.15	13.23

DN	1:1	1:10	1:20	1:50	1:100	1:500
[inch]	[lb/min]	[lb/min]	[lb/min]	[lb/min]	[lb/min]	[lb/min]
3	6615	661.5	330.8	132.3	66.15	13.23
FB = Full bore						

Accuracy of outputs

 The output accuracy must be factored into the measurement error if analog outputs are used; but can be ignored for fieldbus outputs (e.g. Modbus RS485, EtherNet/IP).

The outputs have the following base accuracy specifications.

Repeatability o.r. = of reading; $1 \text{ g/cm}^3 = 1 \text{ kg/l}$; T = medium temperature

Base repeatability

 Design fundamentals →  140

Mass flow and volume flow (liquids)

$\pm 0.05 \%$ o.r.

Mass flow (gases)

$\pm 0.25 \%$ o.r.

Density (liquids)

$\pm 0.00025 \text{ g/cm}^3$

Temperature

$\pm 0.25 \text{ }^\circ\text{C} \pm 0.0025 \cdot T \text{ }^\circ\text{C}$ ($\pm 0.45 \text{ }^\circ\text{F} \pm 0.0015 \cdot (T-32) \text{ }^\circ\text{F}$)

Response time The response time depends on the configuration (damping).

Influence of medium temperature

Mass flow

o.f.s. = of full scale value

If there is a difference between the temperature during zero adjustment and the process temperature, the additional measurement error of the sensors is typically $\pm 0.0002 \%$ o.f.s./ $^\circ\text{C}$ ($\pm 0.0001 \%$ o. f.s./ $^\circ\text{F}$).

The influence is reduced when the zero adjustment is performed at process temperature.

Density

If there is a difference between the density calibration temperature and the process temperature, the measurement error of the sensors is typically $\pm 0.0001 \text{ g/cm}^3 / ^\circ\text{C}$ ($\pm 0.00005 \text{ g/cm}^3 / ^\circ\text{F}$). Field density adjustment is possible.

Wide-range density specification (special density calibration)

If the process temperature is outside the valid range (\rightarrow  137) the measurement error is $\pm 0.0001 \text{ g/cm}^3 / ^\circ\text{C}$ ($\pm 0.00005 \text{ g/cm}^3 / ^\circ\text{F}$)

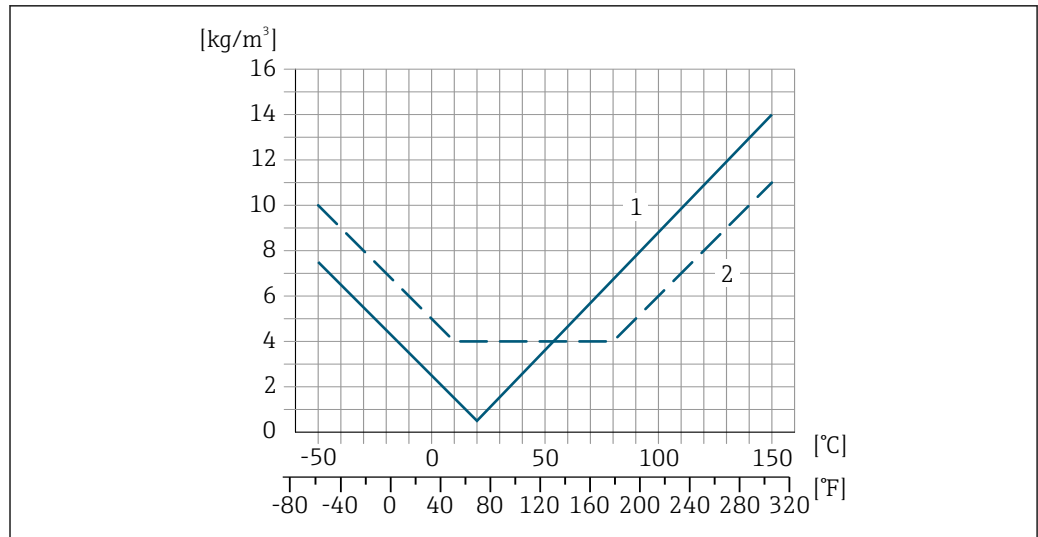

A0016614

- 1 Field density adjustment, for example at +20 °C (+68 °F)
- 2 Special density calibration

Temperature

$\pm 0.005 \cdot T \text{ } ^\circ\text{C}$ ($\pm 0.005 \cdot (T - 32) \text{ } ^\circ\text{F}$)

Influence of medium pressure

The following shows how the process pressure (gauge pressure) affects the accuracy of the mass flow.

o.r. = of reading



It is possible to compensate for the effect by:

- Reading in the current pressure measured value via the current input or a digital input.
- Specifying a fixed value for the pressure in the device parameters.



Operating Instructions .

DN		[% o.r./bar]	[% o.r./psi]
[mm]	[in]		
8	3/8	no influence	no influence
15	1/2	no influence	no influence
15 FB	1/2 FB	+0.003	+0.0002
25	1	+0.003	+0.0002
25 FB	1 FB	no influence	no influence
40	1 1/2	no influence	no influence
40 FB	1 1/2 FB	no influence	no influence
50	2	no influence	no influence
50 FB	2 FB	no influence	no influence
80	3	no influence	no influence
FB = Full bore			

Design fundamentals

o.r. = of reading, o.f.s. = of full scale value

BaseAccu = base accuracy in % o.r., BaseRepeat = base repeatability in % o.r.

MeasValue = measured value; ZeroPoint = zero point stability

Calculation of the maximum measured error as a function of the flow rate

Flow rate	Maximum measured error in % o.r.
$\geq \frac{\text{ZeroPoint}}{\text{BaseAccu}} \cdot 100$ <small>A0021332</small>	$\pm \text{BaseAccu}$ <small>A0021339</small>
$< \frac{\text{ZeroPoint}}{\text{BaseAccu}} \cdot 100$ <small>A0021333</small>	$\pm \frac{\text{ZeroPoint}}{\text{MeasValue}} \cdot 100$ <small>A0021334</small>

Calculation of the maximum repeatability as a function of the flow rate

Flow rate	Maximum repeatability in % o.r.
$\geq \frac{1/2 \cdot \text{ZeroPoint}}{\text{BaseRepeat}} \cdot 100$ <small>A0021335</small>	$\pm \text{BaseRepeat}$ <small>A0021340</small>
$< \frac{1/2 \cdot \text{ZeroPoint}}{\text{BaseRepeat}} \cdot 100$ <small>A0021336</small>	$\pm 1/2 \cdot \frac{\text{ZeroPoint}}{\text{MeasValue}} \cdot 100$ <small>A0021337</small>

Example of maximum measurement error

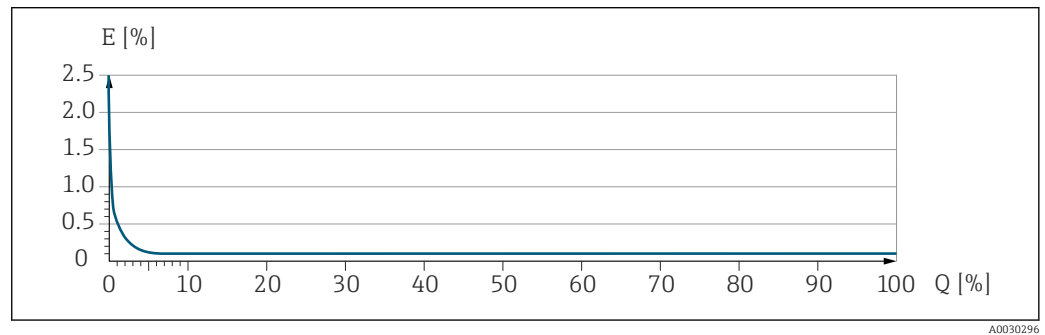

E Maximum measurement error in % o.r. (example)
Q Flow rate in % of maximum full scale value

16.7 Mounting

Mounting requirements → 18





16.8 Environment

Ambient temperature range → 20 → 20

Temperature tables

- Observe the interdependencies between the permitted ambient and fluid temperatures when operating the device in hazardous areas.
- For detailed information on the temperature tables, see the separate document entitled "Safety Instructions" (XA) for the device.

Storage temperature -40 to +80 °C (-40 to +176 °F), preferably at +20 °C (+68 °F) (standard version)
-50 to +80 °C (-58 to +176 °F) (Order code for "Test, certificate", option JM)

Climate class	DIN EN 60068-2-38 (test Z/AD)
Degree of protection	<p>Transmitter and sensor</p> <ul style="list-style-type: none"> ■ Standard: IP66/67, Type 4X enclosure, suitable for pollution degree 4 ■ With the order code for "Sensor options", option CM: IP69 can also be ordered ■ When the housing is open: IP20, Type 1 enclosure, suitable for pollution degree 2 ■ Display module: IP20, Type 1 enclosure, suitable for pollution degree 2
Shock and vibration resistance	<p>Vibration sinusoidal, in accordance with IEC 60068-2-6</p> <ul style="list-style-type: none"> ■ 2 to 8.4 Hz, 3.5 mm peak ■ 8.4 to 2 000 Hz, 1 g peak <p>Vibration broad-band random, according to IEC 60068-2-64</p> <ul style="list-style-type: none"> ■ 10 to 200 Hz, 0.003 g²/Hz ■ 200 to 2 000 Hz, 0.001 g²/Hz ■ Total: 1.54 g rms <p>Shock half-sine, according to IEC 60068-2-27</p> <p>6 ms 30 g</p> <p>Rough handling shocks according to IEC 60068-2-31</p>
Internal cleaning	<ul style="list-style-type: none"> ■ CIP cleaning ■ SIP cleaning ■ Cleaning with pigs <p>Options Oil- and grease-free version for wetted parts, without declaration Order code for "Service", option HA ³⁾</p>
Electromagnetic compatibility (EMC)	<ul style="list-style-type: none"> ■ As per IEC/EN 61326 and NAMUR Recommendation 21 (NE 21) ■ As per IEC/EN 61000-6-2 and IEC/EN 61000-6-4 ■ Complies with emission limits for industry as per EN 55011 (Class A) ■ Device version with PROFIBUS DP: Complies with emission limits for industry as per EN 50170 Volume 2, IEC 61784 <p> The following applies for PROFIBUS DP: If baud rates > 1.5 Mbaud, an EMC cable entry must be used and the cable shield must continue as far as the terminal wherever possible.</p> <p> Details are provided in the Declaration of Conformity.</p> <p> This unit is not intended for use in residential environments and cannot guarantee adequate protection of the radio reception in such environments.</p>
16.9 Process	
Medium temperature range	-50 to +150 °C (-58 to +302 °F)
Pressure-temperature ratings	 For an overview of the pressure-temperature ratings for the process connections, see the Technical Information

3) The cleaning refers to the measuring instrument only. Any accessories supplied are not cleaned.

Sensor housing

The sensor housing is filled with dry nitrogen gas and protects the electronics and mechanics inside.

 If a measuring tube fails (e.g. due to process characteristics like corrosive or abrasive fluids), the fluid will initially be contained by the sensor housing.

If the sensor is to be purged with gas (gas detection), it should be equipped with purge connections.

 Do not open the purge connections unless the containment can be filled immediately with a dry, inert gas. Use only low pressure to purge.

Maximum pressure: 5 bar (72.5 psi)

Burst pressure of the sensor housing

The following sensor housing burst pressures are only valid for standard devices and/or devices equipped with closed purge connections (not opened/as delivered).

If a device fitted with purge connections (order code for "Sensor option", option CH "Purge connection") is connected to the purge system, the maximum pressure is determined by the purge system itself or by the device, depending on which component has the lower pressure classification.

The sensor housing burst pressure refers to a typical internal pressure which is reached prior to mechanical failure of the sensor housing and which was determined during type testing. The corresponding type test declaration can be ordered with the device (order code for "Additional approval", option LN "Sensor housing burst pressure, type test").

DN		Sensor housing burst pressure	
[mm]	[in]	[bar]	[psi]
8	$\frac{3}{8}$	220	3 190
15	$\frac{1}{2}$	220	3 190
15 FB	$\frac{1}{2}$ FB	235	3 408
25	1	235	3 408
25 FB	1 FB	220	3 190
40	$1\frac{1}{2}$	220	3 190
40 FB	$1\frac{1}{2}$ FB	235	3 408
50	2	235	3 408
50 FB	2 FB	460	6 670
80	3	460	6 670



FB = Full bore

 For information on the dimensions: see the "Mechanical construction" section of the "Technical Information" document



Flow limit

Select the nominal diameter by optimizing between the required flow range and permissible pressure loss.

 For an overview of the full scale values for the measuring range, see the "Measuring range" section →  132

- The minimum recommended full scale value is approx. 1/20 of the maximum full scale value
 - In most applications, 20 to 50 % of the maximum full scale value can be considered ideal
 - A low full scale value must be selected for abrasive media (such as liquids with entrained solids): flow velocity < 1 m/s (< 3 ft/s).
 - For gas measurement the following rules apply:
 - The flow velocity in the measuring tubes should not exceed half the sound velocity (0.5 Mach).
 - The maximum mass flow depends on the density of the gas: formula →  132
-  To calculate the flow limit, use the *Applicator* sizing tool →  129

Pressure loss

 To calculate the pressure loss, use the *Applicator* sizing tool →  129

System pressure

→  20

16.10 Mechanical construction

Design, dimensions



For the dimensions and installation lengths of the device, see the "Technical Information" document, "Mechanical construction" section

Weight

All values (weight exclusive of packaging material) refer to devices with EN/DIN PN 40 flanges. Weight specifications including transmitter: order code for "Housing", option A "Compact, aluminum coated".

Weight in SI units

DN [mm]	Weight [kg]
8	11
15	13
15 FB	19
25	20
25 FB	39
40	40
40 FB	65
50	67
50 FB	118
80	122

FB = Full bore

Weight in US units

DN [in]	Weight [lbs]
3/8	24
1/2	29
1/2 FB	42
1	44
1 FB	86
1 1/2	88
1 1/2 FB	143
2	148
2 FB	260
3	269

FB = Full bore

Materials

Transmitter housing

- Order code for "Housing", option **A** "Compact, aluminum coated":
Aluminum, AlSi10Mg, coated
- Order code for "Housing", option **B** "Compact, hygienic, stainless":
Hygienic version, stainless steel 1.4301 (304)
- Order code for "Housing", option **C** "Ultra-compact, hygienic, stainless":
Hygienic version, stainless steel 1.4301 (304)
- Window material for optional local display (→ 148):
 - For order code for "Housing", option **A**: glass
 - For order code for "Housing", option **B** and **C**: plastic

Cable entries/cable glands

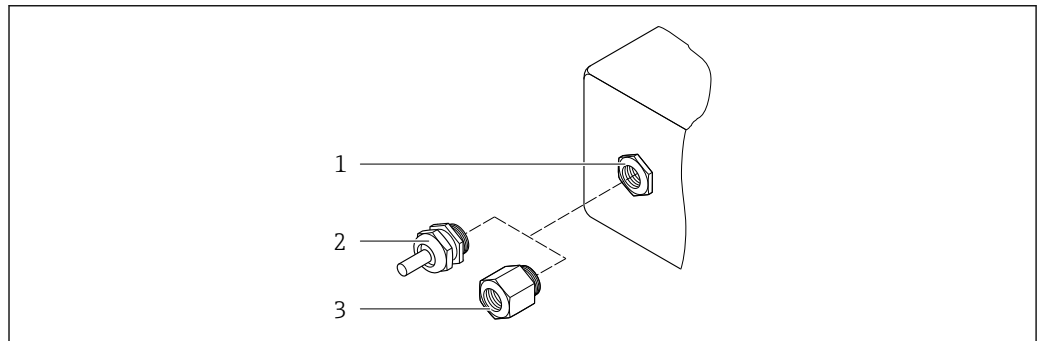

16 Possible cable entries/cable glands

- 1 Female thread M20 × 1.5
- 2 Cable gland M20 × 1.5
- 3 Adapter for cable entry with female thread G ½" or NPT ½"

Order code for "Housing", option A "Compact, aluminum, coated"

The various cable entries are suitable for hazardous and non-hazardous areas.

Cable entry/cable gland	Material
Cable gland M20 × 1.5	Nickel-plated brass
Adapter for cable entry with internal thread G ½"	
Adapter for cable entry with internal thread NPT ½"	

Order code for "Housing", option B "Compact, hygienic, stainless"

The various cable entries are suitable for hazardous and non-hazardous areas.

Cable entry/cable gland	Material
Cable gland M20 × 1.5	Stainless steel, 1.4404 (316L)
Adapter for cable entry with internal thread G ½"	
Adapter for cable entry with internal thread NPT ½"	

Device plug

Electrical connection	Material
Plug M12x1	<ul style="list-style-type: none"> ■ Socket: Stainless steel, 1.4404 (316L) ■ Contact housing: Polyamide ■ Contacts: Gold-plated brass

Sensor housing

- Acid and alkali-resistant outer surface
- Stainless steel 1.4301 (304)

Measuring tubes

Grade 9 titanium

Process connections

- Flanges according to EN 1092-1 (DIN 2501) / according to ASME B16.5/ according to JIS:
 - Stainless steel 1.4301 (304)
 - Wetted parts: Grade 2 titanium
- All other process connections:
 - Grade 2 titanium



Available process connections → 147

Seals

Welded process connections without internal seals

Accessories

Protective cover

Stainless steel, 1.4404 (316L)

Safety Barrier Promass 100

Housing: Polyamide

Process connections

- Fixed flange connections:
 - EN 1092-1 (DIN 2501) flange
 - EN 1092-1 (DIN 2512N) flange
 - ASME B16.5 flange
 - JIS B2220 flange
 - DIN 11864-2 Form A flange, DIN 11866 series A, flange with notch
- Clamp connections:
 - Tri-Clamp (OD tubes), DIN 11866 series C
- Eccentric clamp connections:
 - Eccen. Tri-Clamp, DIN 11866 series C
- Thread:
 - DIN 11851 thread, DIN 11866 series A
 - SMS 1145 thread
 - ISO 2853 thread, ISO 2037
 - DIN 11864-1 Form A thread, DIN 11866 series A



Process connection materials

Surface roughness

All data refer to parts in contact with the medium.

The following surface roughness categories can be ordered:

Category	Method	Option(s) order code "Measuring tube mat., wetted surface"
Not polished	–	CA
$Ra \leq 0.76 \mu\text{m}$ (30 μin) ¹⁾	Mechanically polished ²⁾	CB
$Ra \leq 0.38 \mu\text{m}$ (15 μin) ¹⁾	Mechanically polished ²⁾	CD

- 1) Ra according to ISO 21920
- 2) Except for inaccessible welds between pipe and manifold

16.11 Operability

Local display

The local display is only available with the following device order code:
Order code for "Display; operation", option **B**: 4-line; illuminated, via communication

Display element

- 4-line liquid crystal display with 16 characters per line.
- White background lighting; switches to red in event of device errors.
- Format for displaying measured variables and status variables can be individually configured.
- Permitted ambient temperature for the display: -20 to $+60$ °C (-4 to $+140$ °F). The readability of the display may be impaired at temperatures outside the temperature range.

Disconnecting the local display from the main electronics module

 In the case of the "Compact, aluminum coated" housing version, the local display must only be disconnected manually from the main electronics module. In the case of the "Compact, hygienic, stainless" and "Ultra-compact, hygienic, stainless" housing versions, the local display is integrated in the housing cover and is disconnected from the main electronics module when the housing cover is opened.

"Compact, aluminum coated" housing version

The local display is plugged onto the main electronics module. The electronic connection between the local display and main electronics module is established via a connecting cable.

For some work performed on the measuring device (e.g. electrical connection), it is advisable to disconnect the local display from the main electronics module:

1. Press in the side latches of the local display.
2. Remove the local display from the main electronics module. Pay attention to the length of the connecting cable when doing so.

Once the work is completed, plug the local display back on.

Remote operation

Via PROFIBUS DP network

This communication interface is available in device versions with PROFIBUS DP.

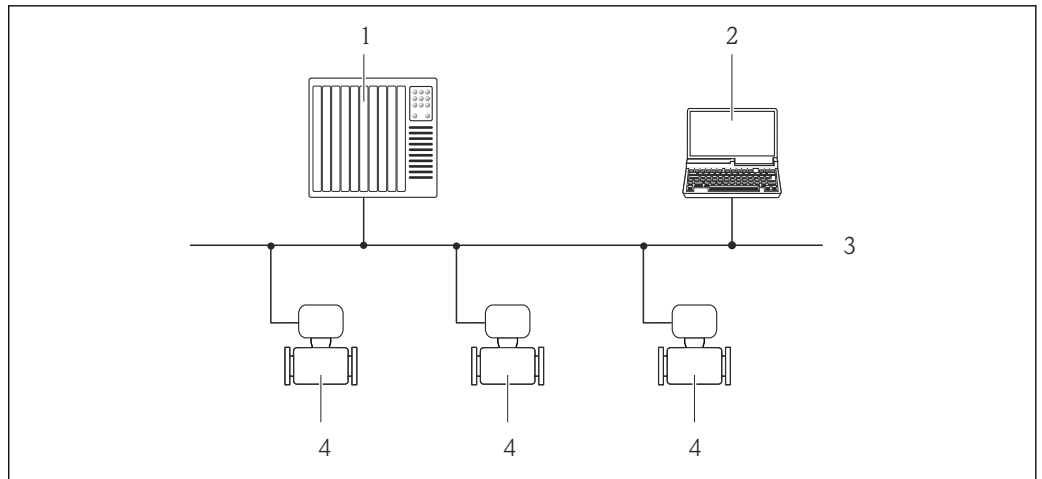

A0020903

17 Options for remote operation via PROFIBUS DP network

- 1 Automation system
- 2 Computer with PROFIBUS network card
- 3 PROFIBUS DP network
- 4 Measuring device

Service interface

Via service interface (CDI-RJ45)

PROFIBUS DP

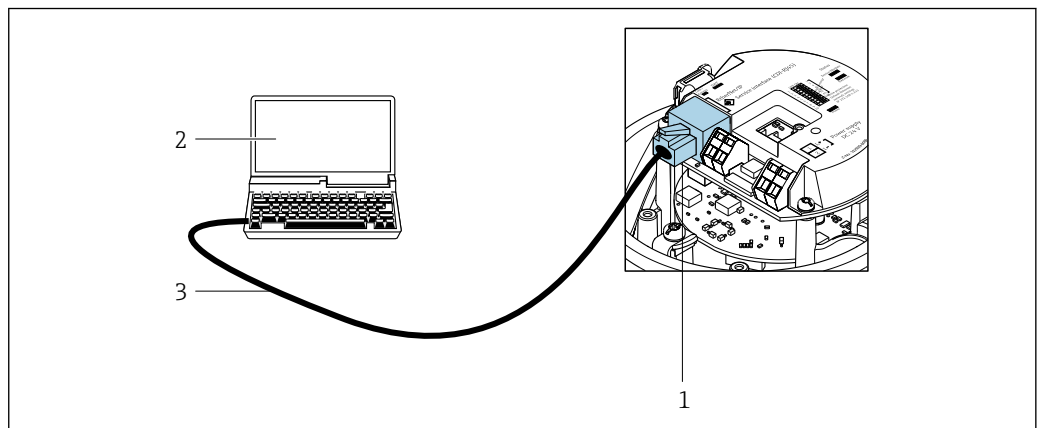

A0021270

18 Connection for order code for "Output", option L: PROFIBUS DP

- 1 Service interface (CDI-RJ45) of the measuring device with access to the integrated web server
- 2 Computer with web browser (e.g. Internet Explorer) for accessing the integrated web server or with "FieldCare" operating tool with COM DTM "CDI Communication TCP/IP"
- 3 Standard Ethernet connecting cable with RJ45 plug

Languages

Can be operated in the following languages:

- Via "FieldCare" operating tool: English, German, French, Spanish, Italian, Chinese, Japanese
- Via Web browser
English, German, French, Spanish, Italian, Dutch, Portuguese, Polish, Russian, Turkish, Chinese, Japanese, Bahasa (Indonesian), Vietnamese, Czech, Swedish, Korean

16.12 Certificates and approvals

Current certificates and approvals for the product are available at www.endress.com on the relevant product page:

1. Select the product using the filters and search field.
2. Open the product page.
3. Select **Downloads**.

CE mark The device meets the legal requirements of the applicable EU Directives. These are listed in the corresponding EU Declaration of Conformity along with the standards applied.
Endress+Hauser confirms successful testing of the device by affixing to it the CE mark.

UKCA marking The device meets the legal requirements of the applicable UK regulations (Statutory Instruments). These are listed in the UKCA Declaration of Conformity along with the designated standards. By selecting the order option for UKCA marking, Endress+Hauser confirms a successful evaluation and testing of the device by affixing the UKCA mark.

Contact address Endress+Hauser UK:
Endress+Hauser Ltd.
Floats Road
Manchester M23 9NF
United Kingdom
www.uk.endress.com

RCM marking The measuring system meets the EMC requirements of the "Australian Communications and Media Authority (ACMA)".

Ex-approval The devices are certified for use in hazardous areas and the relevant safety instructions are provided in the separate "Safety Instructions" (XA) document. Reference is made to this document on the nameplate.

Hygienic compatibility

- **3-A approval**
 - Only measuring instruments with the order code for "Additional approval", option LP "3A" have 3-A approval.
 - The 3-A approval refers to the measuring instrument.
 - When installing the measuring instrument, ensure that no liquid can accumulate on the outside of the measuring instrument.
A remote display module must be installed in accordance with the 3-A Standard.
 - Accessories (e.g. heating jacket, weather protection cover, wall holder unit) must be installed in accordance with the 3-A Standard.
Each accessory can be cleaned. Disassembly may be necessary under certain circumstances.
- **EHEDG-tested**
Only devices with the order code for "Additional approval", option LT "EHEDG" have been tested and meet the requirements of the EHEDG.
To meet the requirements for EHEDG certification, the device must be used with process connections in accordance with the EHEDG position paper entitled "Easy cleanable Pipe couplings and Process connections" (www.ehedg.org).
To meet the requirements for EHEDG certification, the device must be installed in a position that ensures drainability.

 Observe the special installation instructions



Pharmaceutical compatibility	<ul style="list-style-type: none"> ■ FDA 21 CFR 177 ■ USP <87> ■ USP <88> Class VI 121 °C ■ TSE/BSE Certificate of Suitability
Certification PROFIBUS	<p>PROFIBUS interface</p> <p>The measuring device is certified and registered by the PNO (PROFIBUS Nutzerorganisation e.V./PROFIBUS User Organization). The measuring system meets all the requirements of the following specifications:</p> <ul style="list-style-type: none"> ■ Certified according to PA Profile 3.02 ■ The device can also be operated with certified devices of other manufacturers (interoperability)
Pressure Equipment Directive	<ul style="list-style-type: none"> ■ With the marking <ul style="list-style-type: none"> a) PED/G1/x (x = category) or b) PESR/G1/x (x = category) on the sensor nameplate, Endress+Hauser confirms compliance with the "Essential Safety Requirements" <ul style="list-style-type: none"> a) specified in Annex I of the Pressure Equipment Directive 2014/68/EU or b) Schedule 2 of Statutory Instruments 2016 No. 1105. ■ Devices not bearing this marking (without PED or PESR) are designed and manufactured according to sound engineering practice. They meet the requirements of <ul style="list-style-type: none"> a) Art. 4 Para. 3 of the Pressure Equipment Directive 2014/68/EU or b) Part 1, Para. 8 of Statutory Instruments 2016 No. 1105. The scope of application is indicated <ul style="list-style-type: none"> a) in diagrams 6 to 9 in Annex II of the Pressure Equipment Directive 2014/68/EU or b) Schedule 3, Para. 2 of Statutory Instruments 2016 No. 1105.
External standards and guidelines	<ul style="list-style-type: none"> ■ EN 60529 Degrees of protection provided by enclosures (IP code) ■ IEC/EN 60068-2-6 Environmental influences: Test procedure - Test Fc: vibrate (sinusoidal). ■ IEC/EN 60068-2-31 Environmental influences: Test procedure - Test Ec: shocks due to rough handling, primarily for devices. ■ EN 61010-1 Safety requirements for electrical equipment for measurement, control and laboratory use - general requirements ■ EN 61326-1/-2-3 EMC requirements for electrical equipment for measurement, control and laboratory use ■ NAMUR NE 21 Electromagnetic compatibility (EMC) of industrial process and laboratory control equipment ■ NAMUR NE 32 Data retention in the event of a power failure in field and control instruments with microprocessors ■ NAMUR NE 43 Standardization of the signal level for the breakdown information of digital transmitters with analog output signal. ■ NAMUR NE 53 Software of field devices and signal-processing devices with digital electronics ■ NAMUR NE 80 The application of the pressure equipment directive to process control devices ■ NAMUR NE 105 Specifications for integrating fieldbus devices in engineering tools for field devices

- NAMUR NE 107
Self-monitoring and diagnosis of field devices
- NAMUR NE 131
Requirements for field devices for standard applications
- NAMUR NE 132
Coriolis mass meter
- ETSI EN 300 328
Guidelines for 2.4 GHz radio components.
- EN 301489
Electromagnetic compatibility and radio spectrum matters (ERM).

16.13 Application packages

Many different application packages are available to enhance the functionality of the device. Such packages might be needed to address safety aspects or specific application requirements.

The application packages can be ordered with the device or subsequently from Endress+Hauser. Detailed information on the order code in question is available from your local Endress+Hauser sales center or on the product page of the Endress+Hauser website: www.endress.com.

 Detailed information on the application packages:
Special Documentation →  154

Heartbeat Technology

Order code for "Application package", option EB "Heartbeat Verification + Monitoring"

Heartbeat Verification

Meets the requirement for traceable verification to DIN ISO 9001:2008 Chapter 7.6 a) "Control of monitoring and measuring equipment".

- Functional testing in the installed state without interrupting the process.
- Traceable verification results on request, including a report.
- Simple testing process via local operation or other operating interfaces.
- Clear measuring point assessment (pass/fail) with high test coverage within the framework of manufacturer specifications.
- Extension of calibration intervals according to operator's risk assessment.

Heartbeat Monitoring

Continuously supplies data, which are characteristic of the measuring principle, to an external condition monitoring system for the purpose of preventive maintenance or process analysis. These data enable the operator to:

- Draw conclusions - using these data and other information - about the impact process influences (e.g. corrosion, abrasion, buildup etc.) have on the measuring performance over time.
- Schedule servicing in time.
- Monitor the process or product quality, e.g. gas pockets .

 For detailed information, see the Special Documentation for the device.

Concentration measurement

Order code for "Application package", option ED "Concentration"

Calculation and outputting of fluid concentrations.

The measured density is converted to the concentration of a substance of a binary mixture using the "Concentration" application package:

- Choice of predefined fluids (e.g. various sugar solutions, acids, alkalis, salts, ethanol etc.).
- Common or user-defined units (°Brix, °Plato, % mass, % volume, mol/l etc.) for standard applications.
- Concentration calculation from user-defined tables.

The measured values are output via the digital and analog outputs of the device.



For detailed information, see the Special Documentation for the device.

Viscosity

Order code for "Application package", option EG "Viscosity"

In-line and real-time viscosity measurement

Promass I with the "Viscosity" application package also measures the real-time viscosity of the fluid directly in the process, in addition to measuring the mass flow/volume flow/temperature and density.

The following viscosity measurements are performed on liquids:

- Dynamic viscosity
- Kinematic viscosity
- Temperature-compensated viscosity (kinematic and dynamic) in relation to the reference temperature

Viscosity measurement can be used for Newtonian and non-Newtonian applications and supplies accurate measured data irrespective of the flow, even under difficult conditions.



For detailed information, see the Special Documentation for the device.

Special density

Order code for "Application package", option EE "Special density"

Many applications use density as a key measured value for monitoring quality or controlling processes. The measuring instrument measures the density of the fluid as standard and makes this value available to the control system.

The "Special Density" application package offers high-precision density measurement over a wide density and temperature range particularly for applications subject to varying process conditions.



For detailed information, see the Operating Instructions for the device.

16.14 Accessories



Overview of accessories available to order → 128

16.15 Supplementary documentation



For an overview of the scope of the associated Technical Documentation, refer to the following:

- *Device Viewer* (www.endress.com/deviceviewer): Enter the serial number from the nameplate
- *Endress+Hauser Operations app*: Enter serial number from nameplate or scan matrix code on nameplate.

Standard documentation

Brief Operating instructions

Brief Operating Instructions for the sensor

Measuring instrument	Documentation code
Proline Promass I	KA01284D

Transmitter Brief Operating Instructions

Measuring device	Documentation code
Proline Promass 100	KA01333D

Technical Information

Measuring device	Documentation code
Proline Promass I 100	TI01035D

Description of Device Parameters

Measuring device	Documentation code
Proline Promass 100	GP01034D

Supplementary device-dependent documentation



Safety Instructions

Content	Documentation code
ATEX/IECEX Ex i	XA00159D
ATEX/IECEX Ex nA	XA01029D
cCSAus IS	XA00160D
INMETRO Ex i	XA01219D
INMETRO Ex nA	XA01220D
NEPSI Ex i	XA01249D
NEPSI Ex nA	XA01262D

Special Documentation

Content	Documentation code
Information on the Pressure Equipment Directive	SD00142D
Concentration measurement	SD01152D
Viscosity Measurement	SD01151D
Heartbeat Technology	SD01153D
Web server	SD01821D

Installation instructions

Contents	Note
Installation instructions for spare part sets and accessories	<ul style="list-style-type: none"> ▪ Access the overview of all the available spare part sets via <i>Device Viewer</i> →  126 ▪ Accessories available for order with Installation Instructions →  128

Index

0 ... 9

3-A approval 150

A

Access authorization to parameters

Read access 39

Write access 39

Access code 39

Incorrect input 39

Adapting the diagnostic behavior 90

Ambient conditions

Shock and vibration resistance 142

Storage temperature 141

Analog Input module 53

Analog Output module 56

Application 131

Application packages 152

Applicator 132

Approvals 150

C

Cable entries

Technical data 137

Cable entry

Degree of protection 33

CE mark 10, 150

Certificates 150

Certification PROFIBUS 151

cGMP 151

Checklist

Post-connection check 33

Post-installation check 25

CIP cleaning 142

Cleaning

CIP cleaning 125

Exterior cleaning 125

Internal cleaning 125

SIP cleaning 125

Climate class 142

Commissioning 58

Advanced settings 68

Configuring the measuring instrument 58

Compatibility with previous model 48

Connecting cable 26

Connecting the measuring instrument 28

Connection

see Electrical connection

Connection preparations 28

Connection tools 26

Current consumption 136

Cyclic data transmission 52

D

Date of manufacture 13, 14

Declaration of Conformity 10

Defining the access code 77

Degree of protection 33, 142

Density adjustment 70

Design

Measuring device 11

Operating menu 36

Design fundamentals

Measurement error 140

Repeatability 140

Device components 11

Device description files 48

Device fuse 136

Device locking, status 79

Device master file

GSD 48

Device name

Sensor 14

Transmitter 13

Device repair 126

Device revision 48

Device type ID 48

Device Viewer 126

DeviceCare 47

Device description file 48

Diagnostic information

Design, description 88, 89

DeviceCare 89

FieldCare 89

LEDs 86

Overview 93

Remedial measures 93

Web browser 87

Diagnostics list 119

DIP switch

see Write protection switch

Disabling write protection 77

Discrete Input module 56

Discrete Output module 57

Display area

For operational display 38

Display values

For locking status 79

Disposal 127

Document

Function 6

Symbols 6

Document function 6

Down pipe 18

E

EHEDG-tested 150

Electrical connection

Degree of protection 33

Measuring instrument 26

Operating tools

Via PROFIBUS DP network 45, 148

Via service interface (CDI-RJ45) 45, 149

Web server 45, 149
 Electromagnetic compatibility 142
 EMPTY_MODULE module 57
 Enabling write protection 77
 Endress+Hauser services
 Maintenance 125
 Repair 126
 Error messages
 see Diagnostic messages
 Event logbook 119
 Events list 119
 Ex-approval 150
 Extended order code
 Sensor 14
 Transmitter 13
 Exterior cleaning 125
F
 FDA 150, 151
 Field of application
 Residual risks 10
 FieldCare 46
 Device description file 48
 Establishing a connection 46
 Function 46
 User interface 47
 Filtering the event logbook 120
 Firmware
 Release date 48
 Version 48
 Firmware history 124
 Flow direction 19, 24
 Flow limit 143
 Food Contact Materials Regulation 150
 FOUNDATION Fieldbus block structure 50
 Functions
 see Parameters
G
 Galvanic isolation 134
H
 Hardware write protection 78
 Hygienic compatibility 150
I
 I/O electronics module 11, 29
 Identifying the measuring instrument 12
 Incoming acceptance 12
 Indication
 Current diagnostic event 118
 Previous diagnostic event 118
 Influence
 Medium pressure 140
 Medium temperature 139
 Information about this document 6
 Inlet runs 19
 Input variables 132
 Inspection
 Connection 33

Installation 25
 Received goods 12
 Installation 18
 Installation dimensions 20
 Installation point 18
 Intended use 9
 Internal cleaning 125, 142
L
 Languages, operation options 149
 Local display
 see Operational display
 Low flow cut off 134
M
 Main electronics module 11
 Maintenance work 125
 Manufacturer ID 48
 Materials 146
 Maximum measurement error 137
 Measured variables
 see Process variables
 Measurement accuracy 137
 Measuring and test equipment 125
 Measuring device
 Conversion 126
 Design 11
 Disposal 127
 Mounting the sensor 24
 Preparing for electrical connection 28
 Removing 127
 Repairs 126
 Measuring instrument
 Configuring 58
 Preparing for mounting 23
 Measuring principle 131
 Measuring range
 For gases 132
 For liquids 132
 Measuring range, recommended 143
 Measuring system 131
 Medium pressure
 Influence 140
 Medium temperature
 Influence 139
 Menu
 Diagnostics 118
 Operation 79
 Setup 59
 Menus
 For measuring instrument configuration 58
 For specific settings 68
 Module
 Analog Input 53
 Analog output 56
 Discrete Input 56
 Discrete Output 57
 EMPTY_MODULE 57

- Totalizer
 - SETTOT_MODETOT_TOTAL 55
 - SETTOT_TOTAL 54
 - TOTAL 54
- Mounting dimensions
 - see Installation dimensions
- Mounting preparations 23
- Mounting requirements
 - Down pipe 18
 - Inlet and outlet runs 19
 - Installation dimensions 20
 - Installation point 18
 - Orientation 19
 - Sensor heating 21
 - Static pressure 20
 - Thermal insulation 20
 - Vibrations 21
- Mounting tools 23
- N**
- Nameplate
 - Sensor 14
 - Transmitter 13
- Netilion 125
- O**
- Operable flow range 133
- Operating menu
 - Design 36
 - Menus, submenus 36
 - Submenus and user roles 37
- Operating philosophy 37
- Operation 79
- Operation options 35
- Operational display 38
- Operational safety 10
- Order code 13, 14
- Orientation (vertical, horizontal) 19
- Outlet runs 19
- Output signal 134
- Output variables 134
- P**
- Packaging disposal 17
- Parameter settings
 - Administration (Submenu) 75
 - Advanced setup (Submenu) 68
 - Analog inputs (Submenu) 64
 - Communication (Submenu) 63
 - Corrected volume flow calculation (Submenu) 69
 - Density adjustment (Wizard) 71
 - Device information (Submenu) 122
 - Diagnostics (Menu) 118
 - Low flow cut off (Wizard) 66
 - Measured variables (Submenu) 79
 - Medium selection (Submenu) 62
 - Partially filled pipe detection (Wizard) 67
 - Sensor adjustment (Submenu) 70
 - Setup (Menu) 59
 - Simulation (Submenu) 76
 - System units (Submenu) 59
 - Totalizer (Submenu) 82
 - Totalizer 1 to n (Submenu) 74
 - Totalizer handling (Submenu) 83
 - Web server (Submenu) 44
 - Zero point adjustment (Submenu) 73
- Performance characteristics 137
- Performing density adjustment 71
- Pharmaceutical compatibility 151
- Post-connection check 58
- Post-connection check (checklist) 33
- Post-installation check 58
- Post-installation check (checklist) 25
- Potential equalization 30
- Power consumption 136
- Power supply failure 136
- Pressure Equipment Directive 151
- Pressure loss 144
- Pressure-temperature ratings 142
- Process connections 147
- Process variables
 - Calculated 132
 - Measured 132
- Product safety 10
- Protecting parameter settings 77
- R**
- RCM marking 150
- Read access 39
- Reading off measured values 79
- Recalibration 125
- Reference operating conditions 137
- Registered trademarks 8
- Remote operation 148
- Repair 126
 - Notes 126
- Repair of a device 126
- Repeatability 139
- Replacement
 - Device components 126
- Requirements for personnel 9
- Response time 139
- Return 126
- S**
- Safety 9
- Sensor
 - Installing 24
- Sensor heating 21
- Sensor housing 143
- Serial number 13, 14
- Setting the operating language 58
- Settings
 - Adapting the measuring device to the process conditions 83
 - Administration 75
 - Analog Input 64
 - Communication interface 63

- Low flow cut off 66
- Medium 62
- Operating language 58
- Partially filled pipe detection 67
- Resetting the device 121
- Resetting the totalizer 83
- Sensor adjustment 70
- Simulation 76
- System units 59
- Tag name 59
- Totalizer 74
- Totalizer reset 83
- SETTOT_MODETOT_TOTAL module 55
- SETTOT_TOTAL module 54
- Shock and vibration resistance 142
- Signal on alarm 134
- SIP cleaning 142
- Software release 48
- Spare part 126
- Spare parts 126
- Special connection instructions 31
- Special mounting instructions
 - Hygienic compatibility 22
- Standards and guidelines 151
- Static pressure 20
- Status area
 - For operational display 38
- Status signals 88
- Storage conditions 16
- Storage temperature 16
- Storage temperature range 141
- Submenu
 - Administration 75
 - Advanced setup 68
 - Analog inputs 64
 - Calculated values 68
 - Communication 63
 - Corrected volume flow calculation 69
 - Device information 122
 - Events list 119
 - Measured values 79
 - Measured variables 79
 - Medium selection 62
 - Overview 37
 - Process variables 68
 - Sensor adjustment 70
 - Simulation 76
 - System units 59
 - Totalizer 82
 - Totalizer 1 to n 74
 - Totalizer handling 83
 - Web server 44
 - Zero point adjustment 73
- Supply voltage 136
- Surface roughness 148
- Symbols
 - For communication 38
 - For diagnostic behavior 38
 - For locking 38
- For measured variable 38
- For measurement channel number 38
- For status signal 38
- In the status area of the local display 38
- System design
 - Measuring system 131
 - see Measuring device design
- System integration 48
- T**
- Technical data, overview 131
- Temperature range
 - Medium temperature 142
 - Storage temperature 16
- Terminal assignment 27, 29
- Terminals 136
- Thermal insulation 20
- Tool
 - Transport 16
- Tools
 - Electrical connection 26
 - For mounting 23
- TOTAL module 54
- Totalizer
 - Configuring 74
 - Operating 83
 - Reset 83
- Transmitter
 - Connecting the signal cables 29
 - Turning the display module 24
- Transporting the measuring device 16
- Troubleshooting
 - General 85
- TSE/BSE Certificate of Suitability 151
- Turning the display module 24
- U**
- UKCA marking 150
- Use of measuring device
 - Borderline cases 9
 - Incorrect use 9
- Use of measuring instrument
 - see Intended use
- User roles 37
- USP Class VI 151
- V**
- Version data for the device 48
- Vibrations 21
- W**
- W@M Device Viewer 12
- Weight
 - SI units 145
 - Transport (notes) 16
 - US units 145
- Wizard
 - Define access code 77
 - Density adjustment 71
 - Low flow cut off 66

Partially filled pipe detection	67
Workplace safety	10
Write access	39
Write protection	
Via access code	77
Via write protection switch	78
Write protection switch	78



71674472

www.addresses.endress.com
