

# Operating Instructions

## Proline Promass O 300

Coriolis flowmeter  
Modbus RS485

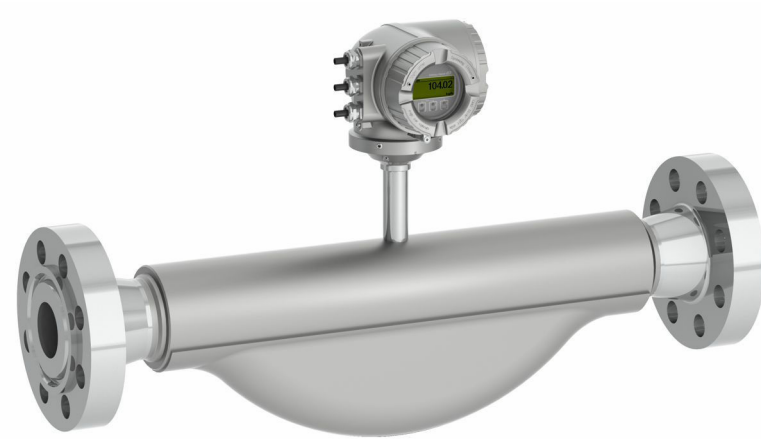

- Make sure the document is stored in a safe place such that it is always available when working on or with the device.
- To avoid danger to individuals or the facility, read the "Basic safety instructions" section carefully, as well as all other safety instructions in the document that are specific to working procedures.
- The manufacturer reserves the right to modify technical data without prior notice. Your Endress+Hauser sales organization will supply you with current information and updates to this manual.

## Table of contents

|          |  |           |  |  |
|----------|--|-----------|--|--|
| <b>1</b> | <b>About this document</b> . . . . .                                   | <b>6</b>  |  |  |
| 1.1      | Document function . . . . .  | 6         |  |  |
| 1.2      | Symbols . . . . .  | 6         |  |  |
| 1.2.1    | Safety symbols . . . . .   | 6         |  |  |
| 1.2.2    | Electrical symbols . . . . .   | 6         |  |  |
| 1.2.3    | Communication-specific symbols . . . . .                               | 6         |  |  |
| 1.2.4    | Tool symbols . . . . .   | 7         |  |  |
| 1.2.5    | Symbols for<br>certain types of information . . . . .                  | 7         |  |  |
| 1.2.6    | Symbols in graphics . . . . .  | 7         |  |  |
| 1.3      | Documentation . . . . .  | 8         |  |  |
| 1.4      | Registered trademarks . . . . .  | 8         |  |  |
| <b>2</b> | <b>Safety instructions</b> . . . . .                                   | <b>9</b>  |  |  |
| 2.1      | Requirements for the personnel . . . . .                               | 9         |  |  |
| 2.2      | Intended use . . . . .   | 9         |  |  |
| 2.3      | Workplace safety . . . . .   | 10        |  |  |
| 2.4      | Operational safety . . . . .   | 10        |  |  |
| 2.5      | Product safety . . . . .   | 10        |  |  |
| 2.6      | IT security . . . . .  | 11        |  |  |
| 2.7      | Device-specific IT security . . . . .                                  | 11        |  |  |
| 2.7.1    | Protecting access via hardware write<br>protection . . . . .           | 11        |  |  |
| 2.7.2    | Protecting access via a password . . . . .                             | 11        |  |  |
| 2.7.3    | Access via web server . . . . .  | 12        |  |  |
| 2.7.4    | Access via service interface (CDI-<br>RJ45) . . . . .                  | 12        |  |  |
| <b>3</b> | <b>Product description</b> . . . . .                                   | <b>14</b> |  |  |
| 3.1      | Product design . . . . .   | 14        |  |  |
| <b>4</b> | <b>Incoming acceptance and product<br/>identification</b> . . . . .    | <b>15</b> |  |  |
| 4.1      | Incoming acceptance . . . . .  | 15        |  |  |
| 4.2      | Product identification . . . . .                                       | 15        |  |  |
| 4.2.1    | Transmitter nameplate . . . . .  | 16        |  |  |
| 4.2.2    | Sensor nameplate . . . . .   | 17        |  |  |
| 4.2.3    | Symbols on the device . . . . .  | 18        |  |  |
| <b>5</b> | <b>Storage and transport</b> . . . . .                                 | <b>19</b> |  |  |
| 5.1      | Storage conditions . . . . .   | 19        |  |  |
| 5.2      | Transporting the product . . . . .                                     | 19        |  |  |
| 5.2.1    | Measuring devices without lifting<br>lugs . . . . .                    | 19        |  |  |
| 5.2.2    | Measuring devices with lifting lugs . . . . .                          | 20        |  |  |
| 5.2.3    | Transporting with a fork lift . . . . .                                | 20        |  |  |
| 5.3      | Packaging disposal . . . . .   | 20        |  |  |
| <b>6</b> | <b>Mounting</b> . . . . .  | <b>21</b> |  |  |
| 6.1      | Mounting requirements . . . . .  | 21        |  |  |
| 6.1.1    | Installation position . . . . .  | 21        |  |  |
| 6.1.2    | Environmental and process<br>requirements . . . . .                    | 23        |  |  |
| 6.1.3    | Special mounting instructions . . . . .                                | 25        |  |  |
| 6.2      | Mounting the measuring instrument . . . . .                            | 27        |  |  |
| 6.2.1    | Required tools . . . . .   | 27        |  |  |
| 6.2.2    | Preparing the measuring instrument . . . . .                           | 28        |  |  |
| 6.2.3    | Mounting the measuring device . . . . .                                | 28        |  |  |
| 6.2.4    | Turning the transmitter housing . . . . .                              | 28        |  |  |
| 6.2.5    | Turning the display module . . . . .                                   | 29        |  |  |
| 6.3      | Post-installation check . . . . .                                      | 30        |  |  |
| <b>7</b> | <b>Electrical connection</b> . . . . .                                 | <b>31</b> |  |  |
| 7.1      | Electrical safety . . . . .  | 31        |  |  |
| 7.2      | Connecting requirements . . . . .                                      | 31        |  |  |
| 7.2.1    | Required tools . . . . .   | 31        |  |  |
| 7.2.2    | Requirements for connection cable . . . . .                            | 31        |  |  |
| 7.2.3    | Terminal assignment . . . . .  | 34        |  |  |
| 7.2.4    | Shielding and grounding . . . . .                                      | 34        |  |  |
| 7.2.5    | Preparing the measuring device . . . . .                               | 34        |  |  |
| 7.3      | Connecting the measuring instrument . . . . .                          | 35        |  |  |
| 7.3.1    | Connecting the transmitter . . . . .                                   | 35        |  |  |
| 7.3.2    | Connecting the remote display and<br>operating module DKX001 . . . . . | 38        |  |  |
| 7.4      | Potential equalization . . . . .                                       | 38        |  |  |
| 7.4.1    | Requirements . . . . .   | 38        |  |  |
| 7.5      | Special connection instructions . . . . .                              | 39        |  |  |
| 7.5.1    | Connection examples . . . . .  | 39        |  |  |
| 7.6      | Hardware settings . . . . .  | 42        |  |  |
| 7.6.1    | Setting the device address . . . . .                                   | 42        |  |  |
| 7.6.2    | Activating the terminating resistor . . . . .                          | 43        |  |  |
| 7.7      | Ensuring the degree of protection . . . . .                            | 43        |  |  |
| 7.8      | Post-connection check . . . . .  | 43        |  |  |
| <b>8</b> | <b>Operation options</b> . . . . .                                     | <b>45</b> |  |  |
| 8.1      | Overview of operation options . . . . .                                | 45        |  |  |
| 8.2      | Structure and function of the operating<br>menu . . . . .              | 46        |  |  |
| 8.2.1    | Structure of the operating menu . . . . .                              | 46        |  |  |
| 8.2.2    | Operating philosophy . . . . .   | 47        |  |  |
| 8.3      | Access to operating menu via local display . . . . .                   | 48        |  |  |
| 8.3.1    | Operational display . . . . .  | 48        |  |  |
| 8.3.2    | Navigation view . . . . .  | 51        |  |  |
| 8.3.3    | Editing view . . . . .   | 53        |  |  |
| 8.3.4    | Operating elements . . . . .   | 55        |  |  |
| 8.3.5    | Opening the context menu . . . . .                                     | 55        |  |  |
| 8.3.6    | Navigating and selecting from list . . . . .                           | 57        |  |  |
| 8.3.7    | Calling the parameter directly . . . . .                               | 57        |  |  |
| 8.3.8    | Calling up help text . . . . .   | 58        |  |  |
| 8.3.9    | Changing the parameters . . . . .                                      | 58        |  |  |
| 8.3.10   | User roles and related access<br>authorization . . . . .               | 59        |  |  |
| 8.3.11   | Disabling write protection via access<br>code . . . . .                | 59        |  |  |

|           |   |           |           |   |            |
|-----------|---|-----------|-----------|---|------------|
| 8.3.12    | Enabling and disabling the keypad lock .....              | 60        | 10.5.5    | Carrying out additional display configurations .....          | 125        |
| 8.4       | Access to operating menu via web browser ...              | 60        | 10.5.6    | WLAN configuration .....                                      | 131        |
| 8.4.1     | Function range .....                                      | 60        | 10.5.7    | Configuration management .....                                | 133        |
| 8.4.2     | Requirements .....  | 61        | 10.5.8    | Using parameters for device administration .....              | 134        |
| 8.4.3     | Connecting the device .....                               | 62        | 10.6      | Simulation .....  | 136        |
| 8.4.4     | Logging on .....  | 64        | 10.7      | Protecting settings from unauthorized access                  | 139        |
| 8.4.5     | User interface .....                                      | 65        | 10.7.1    | Write protection via access code ...                          | 139        |
| 8.4.6     | Disabling the Web server .....                            | 66        | 10.7.2    | Write protection via write protection switch .....            | 140        |
| 8.4.7     | Logging out .....   | 66        |           |   |            |
| 8.5       | Access to the operating menu via the operating tool ..... | 67        | <b>11</b> | <b>Operation .....</b>  | <b>142</b> |
| 8.5.1     | Connecting the operating tool .....                       | 67        | 11.1      | Reading off the device locking status .....                   | 142        |
| 8.5.2     | FieldCare .....   | 69        | 11.2      | Adjusting the operating language .....                        | 142        |
| 8.5.3     | DeviceCare .....  | 71        | 11.3      | Configuring the display .....                                 | 142        |
| <b>9</b>  | <b>System integration .....</b>                           | <b>72</b> | 11.4      | Reading off measured values .....                             | 142        |
| 9.1       | Overview of device description files .....                | 72        | 11.4.1    | "Measured variables" submenu .....                            | 143        |
| 9.1.1     | Current version data for the device ...                   | 72        | 11.4.2    | "Totalizer" submenu .....                                     | 153        |
| 9.1.2     | Operating tools .....                                     | 72        | 11.4.3    | "Input values" submenu .....                                  | 154        |
| 9.2       | Compatibility with previous model .....                   | 72        | 11.4.4    | Output values .....   | 155        |
| 9.3       | Modbus RS485 information .....                            | 73        | 11.5      | Adapting the measuring device to the process conditions ..... | 157        |
| 9.3.1     | Function codes .....                                      | 73        | 11.6      | Performing a totalizer reset .....                            | 157        |
| 9.3.2     | Register information .....                                | 74        | 11.6.1    | Function scope of "Control Totalizer" parameter .....         | 159        |
| 9.3.3     | Response time .....                                       | 74        | 11.6.2    | Function range of "Reset all totalizers" parameter .....      | 159        |
| 9.3.4     | Data types .....  | 74        | 11.7      | Displaying the measured value history .....                   | 159        |
| 9.3.5     | Byte transmission sequence .....                          | 75        | 11.8      | Gas Fraction Handler .....                                    | 163        |
| 9.3.6     | Modbus data map .....                                     | 75        | 11.8.1    | "Measurement mode" submenu .....                              | 163        |
| <b>10</b> | <b>Commissioning .....</b>                                | <b>78</b> | 11.8.2    | "Medium index" submenu .....                                  | 164        |
| 10.1      | Post-mounting and post-connection check ...               | 78        | <b>12</b> | <b>Diagnostics and troubleshooting ..</b>                     | <b>165</b> |
| 10.2      | Switching on the measuring device .....                   | 78        | 12.1      | General troubleshooting .....                                 | 165        |
| 10.3      | Setting the operating language .....                      | 78        | 12.2      | Diagnostic information via light emitting diodes .....        | 167        |
| 10.4      | Configuring the measuring instrument .....                | 78        | 12.2.1    | Transmitter .....   | 167        |
| 10.4.1    | Defining the tag name .....                               | 80        | 12.3      | Diagnostic information on local display .....                 | 168        |
| 10.4.2    | Setting the system units .....                            | 80        | 12.3.1    | Diagnostic message .....                                      | 168        |
| 10.4.3    | Configuring the communication interface .....             | 82        | 12.3.2    | Calling up remedial measures .....                            | 170        |
| 10.4.4    | Selecting and setting the medium ...                      | 84        | 12.4      | Diagnostic information in the web browser ..                  | 170        |
| 10.4.5    | Displaying the I/O configuration ...                      | 86        | 12.4.1    | Diagnostic options .....                                      | 170        |
| 10.4.6    | Configuring the current input .....                       | 87        | 12.4.2    | Calling up remedy information .....                           | 171        |
| 10.4.7    | Configuring the status input .....                        | 88        | 12.5      | Diagnostic information in FieldCare or DeviceCare .....       | 171        |
| 10.4.8    | Configuring the current output .....                      | 89        | 12.5.1    | Diagnostic options .....                                      | 171        |
| 10.4.9    | Configuring the pulse/frequency/switch output .....       | 94        | 12.5.2    | Calling up remedy information .....                           | 172        |
| 10.4.10   | Configuring the relay output .....                        | 103       | 12.6      | Diagnostic information via communication interface .....      | 173        |
| 10.4.11   | Configuring the double pulse output                       | 106       | 12.6.1    | Reading out diagnostic information                            | 173        |
| 10.4.12   | Configuring the local display .....                       | 107       | 12.6.2    | Configuring error response mode ...                           | 173        |
| 10.4.13   | Configuring the low flow cut off ...                      | 112       | 12.7      | Adapting the diagnostic information .....                     | 173        |
| 10.4.14   | Configuring partially filled pipe detection .....         | 113       | 12.7.1    | Adapting the diagnostic behavior ...                          | 173        |
| 10.5      | Advanced settings .....                                   | 114       | 12.8      | Overview of diagnostic information .....                      | 174        |
| 10.5.1    | Using the parameter to enter the access code .....        | 115       | 12.9      | Pending diagnostic events .....                               | 179        |
| 10.5.2    | Calculated process variables .....                        | 115       | 12.10     | Diagnostics list .....  | 179        |
| 10.5.3    | Carrying out a sensor adjustment ...                      | 116       |           |   |            |
| 10.5.4    | Configuring the totalizer .....                           | 122       |           |   |            |

|                        |   |            |
|------------------------|---|------------|
| 12.11                  | Event logbook . . . . .                                 | 180        |
| 12.11.1                | Reading out the event logbook . . . . .                 | 180        |
| 12.11.2                | Filtering the event logbook . . . . .                   | 181        |
| 12.11.3                | Overview of information events . . . . .                | 181        |
| 12.12                  | Resetting the measuring device . . . . .                | 182        |
| 12.12.1                | Function range of "Device reset"<br>parameter . . . . . | 183        |
| 12.13                  | Device information . . . . .                            | 183        |
| 12.14                  | Firmware history . . . . .                              | 185        |
| 12.15                  | Device history and compatibility . . . . .              | 187        |
| <b>13</b>              | <b>Maintenance . . . . .</b>                            | <b>188</b> |
| 13.1                   | Maintenance work . . . . .                              | 188        |
| 13.1.1                 | Exterior cleaning . . . . .                             | 188        |
| 13.2                   | Measuring and test equipment . . . . .                  | 188        |
| 13.3                   | Endress+Hauser services . . . . .                       | 188        |
| <b>14</b>              | <b>Repair . . . . .</b>                                 | <b>189</b> |
| 14.1                   | General notes . . . . .                                 | 189        |
| 14.1.1                 | Repair and conversion concept . . . . .                 | 189        |
| 14.1.2                 | Notes for repair and conversion . . . . .               | 189        |
| 14.2                   | Spare parts . . . . .                                   | 189        |
| 14.3                   | Endress+Hauser services . . . . .                       | 189        |
| 14.4                   | Return . . . . .  | 189        |
| 14.5                   | Disposal . . . . .                                      | 190        |
| 14.5.1                 | Removing the measuring device . . . . .                 | 190        |
| 14.5.2                 | Disposing of the measuring device . . . . .             | 190        |
| <b>15</b>              | <b>Accessories . . . . .</b>                            | <b>191</b> |
| 15.1                   | Device-specific accessories . . . . .                   | 191        |
| 15.1.1                 | For the transmitter . . . . .                           | 191        |
| 15.1.2                 | For the sensor . . . . .                                | 192        |
| 15.2                   | Service-specific accessories . . . . .                  | 192        |
| 15.3                   | System components . . . . .                             | 192        |
| <b>16</b>              | <b>Technical data . . . . .</b>                         | <b>194</b> |
| 16.1                   | Application . . . . .                                   | 194        |
| 16.2                   | Function and system design . . . . .                    | 194        |
| 16.3                   | Input . . . . .   | 195        |
| 16.4                   | Output . . . . .  | 197        |
| 16.5                   | Power supply . . . . .                                  | 202        |
| 16.6                   | Performance characteristics . . . . .                   | 203        |
| 16.7                   | Mounting . . . . .                                      | 207        |
| 16.8                   | Environment . . . . .                                   | 207        |
| 16.9                   | Process . . . . .                                       | 209        |
| 16.10                  | Custody transfer . . . . .                              | 211        |
| 16.11                  | Mechanical construction . . . . .                       | 211        |
| 16.12                  | Operability . . . . .                                   | 214        |
| 16.13                  | Certificates and approvals . . . . .                    | 218        |
| 16.14                  | Application packages . . . . .                          | 221        |
| 16.15                  | Accessories . . . . .                                   | 223        |
| 16.16                  | Supplementary documentation . . . . .                   | 223        |
| <b>Index . . . . .</b> |   | <b>226</b> |

# 1 About this document

## 1.1 Document function

These Operating Instructions contain all the information required in the various life cycle phases of the device: from product identification, incoming acceptance and storage, to installation, connection, operation and commissioning, through to troubleshooting, maintenance and disposal.

## 1.2 Symbols

### 1.2.1 Safety symbols

#### DANGER

This symbol alerts you to a dangerous situation. Failure to avoid this situation will result in serious or fatal injury.

#### WARNING

This symbol alerts you to a potentially dangerous situation. Failure to avoid this situation can result in serious or fatal injury.





#### CAUTION

This symbol alerts you to a potentially dangerous situation. Failure to avoid this situation can result in minor or medium injury.

#### NOTICE

This symbol alerts you to a potentially harmful situation. Failure to avoid this situation can result in damage to the product or something in its vicinity.

### 1.2.2 Electrical symbols

| Symbol  | Meaning  |
|---|--|
|  | Direct current   |
|  | Alternating current  |
|  | Direct current and alternating current   |
|  | <b>Ground connection</b><br>A grounded terminal which, as far as the operator is concerned, is grounded via a grounding system.  |
|  | <b>Potential equalization connection (PE: protective earth)</b><br>Ground terminals that must be connected to ground prior to establishing any other connections.<br><br>The ground terminals are located on the interior and exterior of the device: <ul style="list-style-type: none"> <li>▪ Interior ground terminal: potential equalization is connected to the supply network.</li> <li>▪ Exterior ground terminal: device is connected to the plant grounding system.</li> </ul> |

### 1.2.3 Communication-specific symbols

| Symbol  | Meaning   |
|---|---|
|  | <b>Wireless Local Area Network (WLAN)</b><br>Communication via a wireless, local network. |

### 1.2.4 Tool symbols

| Symbol  | Meaning                |
|---|------------------------|
|  | Flat-blade screwdriver |
|  | Allen key              |
|  | Open-ended wrench      |

### 1.2.5 Symbols for certain types of information

| Symbol  | Meaning  |
|---|--|
|    | <b>Permitted</b><br>Procedures, processes or actions that are permitted. |
|    | <b>Preferred</b><br>Procedures, processes or actions that are preferred. |
|    | <b>Forbidden</b><br>Procedures, processes or actions that are forbidden. |
|    | <b>Tip</b><br>Indicates additional information.                          |
|   | Reference to documentation   |
|  | Reference to page  |
|  | Reference to graphic   |
|  | Notice or individual step to be observed                                 |
|  | Series of steps  |
|  | Result of a step   |
|  | Help in the event of a problem   |
|  | Visual inspection  |

### 1.2.6 Symbols in graphics

| Symbol  | Meaning                        |
|---|--------------------------------|
|  | Item numbers                   |
|  | Series of steps                |
|  | Views                          |
|  | Sections                       |
|  | Hazardous area                 |
|  | Safe area (non-hazardous area) |
|  | Flow direction                 |

## 1.3 Documentation

 For an overview of the scope of the associated Technical Documentation, refer to the following:

- *Device Viewer* ([www.endress.com/deviceviewer](http://www.endress.com/deviceviewer)): Enter the serial number from the nameplate
- *Endress+Hauser Operations app*: Enter serial number from nameplate or scan matrix code on nameplate.

The following documentation may be available depending on the device version ordered:

| Document type  | Purpose and content of the document   |
|--|---|
| Technical Information (TI)                           | <b>Planning aid for your device</b><br>The document contains all the technical data on the device and provides an overview of the accessories and other products that can be ordered for the device.  |
| Brief Operating Instructions (KA)                    | <b>Guide that takes you quickly to the 1st measured value</b><br>The Brief Operating Instructions contain all the essential information from incoming acceptance to initial commissioning.  |
| Operating Instructions (BA)                          | <b>Your reference document</b><br>These Operating Instructions contain all the information that is required in the various life cycle phases of the device: from product identification, incoming acceptance and storage, to mounting, connection, operation and commissioning, through to troubleshooting, maintenance and disposal.   |
| Description of Device Parameters (GP)                | <b>Reference for your parameters</b><br>The document provides a detailed explanation of each individual parameter. The description is aimed at those who work with the device over the entire life cycle and perform specific configurations.   |
| Safety Instructions (XA)                             | Depending on the approval, safety instructions for electrical equipment in hazardous areas are also supplied with the device. The Safety Instructions are a constituent part of the Operating Instructions.<br><br> Information on the Safety Instructions (XA) that are relevant for the device is provided on the nameplate. |
| Supplementary device-dependent documentation (SD/FY) | Always comply strictly with the instructions in the relevant supplementary documentation. The supplementary documentation is a constituent part of the device documentation.  |

## 1.4 Registered trademarks

### Modbus®

Registered trademark of SCHNEIDER AUTOMATION, INC.

### TRI-CLAMP®

Registered trademark of Ladish & Co., Inc., Kenosha, USA



## 2 Safety instructions

### 2.1 Requirements for the personnel

The personnel for installation, commissioning, diagnostics and maintenance must fulfill the following requirements:

- ▶ Trained, qualified specialists must have a relevant qualification for this specific function and task.
- ▶ Are authorized by the plant owner/operator.
- ▶ Are familiar with federal/national regulations.
- ▶ Before starting work, read and understand the instructions in the manual and supplementary documentation as well as the certificates (depending on the application).
- ▶ Follow instructions and comply with basic conditions.

The operating personnel must fulfill the following requirements:

- ▶ Are instructed and authorized according to the requirements of the task by the facility's owner-operator.
- ▶ Follow the instructions in this manual.

### 2.2 Intended use

#### Application and media

The measuring instrument described in this manual is intended only for the flow measurement of liquids and gases.

Depending on the version ordered, the measuring instrument can also be used to measure potentially explosive <sup>1)</sup>, flammable, toxid and oxidizing media.

Measuring instruments for use in hazardous areas, in hygienic applications, or where there is an increased risk due to pressure, are specially labeled on the nameplate.

To ensure that the measuring instrument is in perfect condition during operation:

- ▶ Only use the measuring instrument in full compliance with the data on the nameplate and the general conditions listed in the Operating Instructions and supplementary documentation.
- ▶ Using the nameplate, check whether the ordered device is permitted for the intended use in the hazardous area (e.g. explosion protection, pressure vessel safety).
- ▶ Use the measuring instrument only for media to which the process-wetted materials are sufficiently resistant.
- ▶ Keep within the specified pressure and temperature range.
- ▶ Keep within the specified ambient temperature range.
- ▶ Protect the measuring instrument permanently against corrosion from environmental influences.

#### Incorrect use

Non-designated use can compromise safety. The manufacturer is not liable for damage caused by improper or non-designated use.

#### **WARNING**

#### **Danger of breakage due to corrosive or abrasive fluids and ambient conditions!**

- ▶ Verify the compatibility of the process fluid with the sensor material.
- ▶ Ensure the resistance of all fluid-wetted materials in the process.
- ▶ Keep within the specified pressure and temperature range.

1) Not applicable for IO-Link measuring instruments

**NOTICE****Verification for borderline cases:**

- ▶ For special fluids and fluids for cleaning, Endress+Hauser is glad to provide assistance in verifying the corrosion resistance of fluid-wetted materials, but does not accept any warranty or liability as minute changes in the temperature, concentration or level of contamination in the process can alter the corrosion resistance properties.

**Residual risks****⚠ CAUTION****Risk of hot or cold burns! The use of media and electronics with high or low temperatures can produce hot or cold surfaces on the device.**

- ▶ Mount suitable touch protection.

**⚠ WARNING****Danger of housing breaking due to measuring tube breakage!**

If a measuring tube ruptures, the pressure inside the sensor housing will rise according to the operating process pressure.

- ▶ Use a rupture disk.

**⚠ WARNING****Danger from medium escaping!**

For device versions with a rupture disk: medium escaping under pressure can cause injury or material damage.

- ▶ Take precautions to prevent injury and material damage if the rupture disk is actuated.

## 2.3 Workplace safety

When working on and with the device:

- ▶ Wear the required personal protective equipment as per national regulations.

## 2.4 Operational safety

Damage to the device!

- ▶ Operate the device in proper technical condition and fail-safe condition only.
- ▶ The operator is responsible for the interference-free operation of the device.

**Modifications to the device**

Unauthorized modifications to the device are not permitted and can lead to unforeseeable dangers!

- ▶ If modifications are nevertheless required, consult with the manufacturer.

**Repair**

To ensure continued operational safety and reliability:

- ▶ Carry out repairs on the device only if they are expressly permitted.
- ▶ Observe federal/national regulations pertaining to the repair of an electrical device.
- ▶ Use only original spare parts and accessories.

## 2.5 Product safety

This measuring device is designed in accordance with good engineering practice to meet state-of-the-art safety requirements, has been tested, and left the factory in a condition in which it is safe to operate.

It meets general safety standards and legal requirements. It also complies with the EU directives listed in the device-specific EU Declaration of Conformity. The manufacturer confirms this by affixing the CE mark to the device..





## 2.6 IT security

Our warranty is valid only if the product is installed and used as described in the Operating Instructions. The product is equipped with security mechanisms to protect it against any inadvertent changes to the settings.

IT security measures, which provide additional protection for the product and associated data transfer, must be implemented by the operators themselves in line with their security standards.

## 2.7 Device-specific IT security

The device offers a range of specific functions to support protective measures on the operator's side. These functions can be configured by the user and guarantee greater in-operation safety if used correctly. The following list provides an overview of the most important functions:

| Function/interface  | Factory setting    | Recommendation  |
|---|--------------------|---|
| Write protection via hardware write protection switch →  11                  | Not enabled        | On an individual basis following risk assessment          |
| Access code (also applies to web server login or FieldCare connection) →  12 | Not enabled (0000) | Assign a customized access code during commissioning      |
| WLAN (order option in display module)   | Enabled            | On an individual basis following risk assessment          |
| WLAN security mode  | Enabled (WPA2-PSK) | Do not change   |
| WLAN passphrase (Password) →  12   | Serial number      | Assign an individual WLAN passphrase during commissioning |
| WLAN mode   | Access point       | On an individual basis following risk assessment          |
| Web server →  12   | Enabled            | On an individual basis following risk assessment          |
| Service interface CDI-RJ45 →  12   | –                  | On an individual basis following risk assessment          |

### 2.7.1 Protecting access via hardware write protection

Write access to the parameters of the device via the local display, web browser or operating tool (e.g. FieldCare, DeviceCare) can be disabled via a write protection switch (DIP switch on the main electronics module). When hardware write protection is enabled, only read access to the parameters is possible.

Hardware write protection is disabled when the device is delivered →  140.

### 2.7.2 Protecting access via a password

Different passwords are available to protect write access to the device parameters or access to the device via the WLAN interface.

- **User-specific access code**  
Protect write access to the device parameters via the local display, web browser or operating tool (e.g. FieldCare, DeviceCare). Access authorization is clearly regulated through the use of a user-specific access code.
- **WLAN passphrase**  
The network key protects a connection between an operating unit (e.g. notebook or tablet) and the device via the WLAN interface which can be ordered as an option.
- **Infrastructure mode**  
When the device is operated in infrastructure mode, the WLAN passphrase corresponds to the WLAN passphrase configured on the operator side.

### User-specific access code

Write access to the device parameters via the local display, web browser or operating tool (e.g. FieldCare, DeviceCare) can be protected by the modifiable, user-specific access code (→  139).

When the device is delivered, the device does not have an access code and is equivalent to 0000 (open).

### WLAN passphrase: Operation as WLAN access point

A connection between an operating unit (e.g. notebook or tablet) and the device via the WLAN interface (→  68), which can be ordered as an optional extra, is protected by the network key. The WLAN authentication of the network key complies with the IEEE 802.11 standard.

When the device is delivered, the network key is pre-defined depending on the device. It can be changed via the **WLAN settings** submenu in the **WLAN passphrase** parameter (→  132).

### Infrastructure mode

A connection between the device and WLAN access point is protected by means of an SSID and passphrase on the system side. Please contact the relevant system administrator for access.

### General notes on the use of passwords

- The access code and network key supplied with the device should be changed during commissioning for safety reasons.
- Follow the general rules for generating a secure password when defining and managing the access code and network key.
- The user is responsible for the management and careful handling of the access code and network key.
- For information on configuring the access code or on what to do if you lose the password, for example, see "Write protection via access code" →  139.

## 2.7.3 Access via web server

The integrated web server can be used to operate and configure the device via a web browser →  60. The connection is established via the service interface (CDI-RJ45) or the WLAN interface.

The web server is enabled when the device is delivered. The web server can be disabled via the **Web server functionality** parameter if necessary (e.g., after commissioning).

The device and status information can be hidden on the login page. This prevents unauthorized access to the information.



Detailed information on the device parameters:  
"Description of device parameters" document .

## 2.7.4 Access via service interface (CDI-RJ45)

The device can be connected to a network via the service interface (CDI-RJ45). Device-specific functions guarantee the secure operation of the device in a network.

The use of relevant industrial standards and guidelines that have been defined by national and international safety committees, such as IEC/ISA62443 or the IEEE, is recommended.

This includes organizational security measures such as the assignment of access authorization as well as technical measures such as network segmentation.



Transmitters with an Ex de approval may not be connected via the service interface (CDI-RJ45)!

Order code for "Approval transmitter + sensor", options (Ex de): BA, BB, C1, C2, GA, GB, MA, MB, NA, NB BB, C2, GB, MB, NB

### 3 Product description

The device consists of a transmitter and a sensor.

The device is available as a compact version:

The transmitter and sensor form a mechanical unit.

#### 3.1 Product design

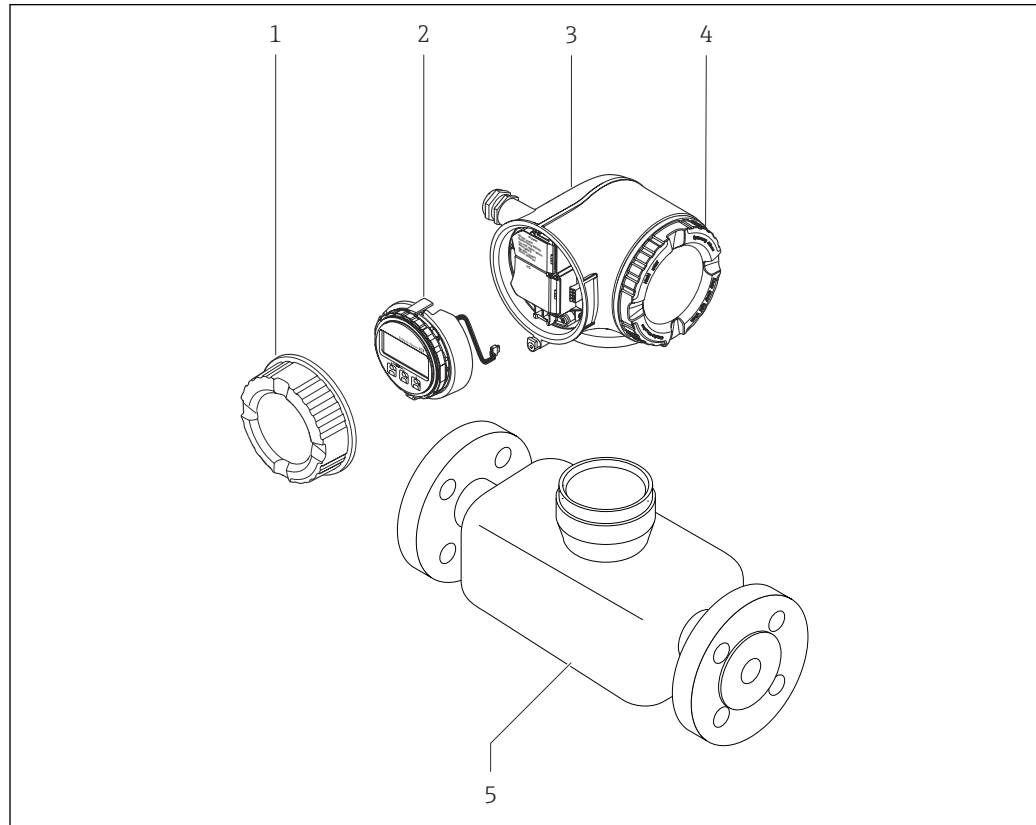

A0029586

1 Important components of a measuring device

- 1 Connection compartment cover
- 2 Display module
- 3 Transmitter housing
- 4 Electronics compartment cover
- 5 Sensor

## 4 Incoming acceptance and product identification

### 4.1 Incoming acceptance

On receipt of the delivery:

1. Check the packaging for damage.
  - ↳ Report all damage immediately to the manufacturer.  
Do not install damaged components.
2. Check the scope of delivery using the delivery note.
3. Compare the data on the nameplate with the order specifications on the delivery note.
4. Check the technical documentation and all other necessary documents, e.g. certificates, to ensure they are complete.

 If one of the conditions is not satisfied, contact the manufacturer.

### 4.2 Product identification

The device can be identified in the following ways:

- Nameplate
- Order code with details of the device features on the delivery note
- Enter the serial numbers from the nameplates in the *Device Viewer* ([www.endress.com/deviceviewer](http://www.endress.com/deviceviewer)): all the information about the device is displayed.
- Enter the serial numbers from the nameplates into the *Endress+Hauser Operations app* or scan the DataMatrix code on the nameplate with the *Endress+Hauser Operations app*: all the information about the device is displayed.

For an overview of the scope of the associated Technical Documentation, refer to the following:

- The "Additional standard device documentation" and "Supplementary device-dependent documentation" sections
- The *Device Viewer*: Enter the serial number from the nameplate ([www.endress.com/deviceviewer](http://www.endress.com/deviceviewer))
- The *Endress+Hauser Operations app*: Enter the serial number from the nameplate or scan the DataMatrix code on the nameplate.

### 4.2.1 Transmitter nameplate

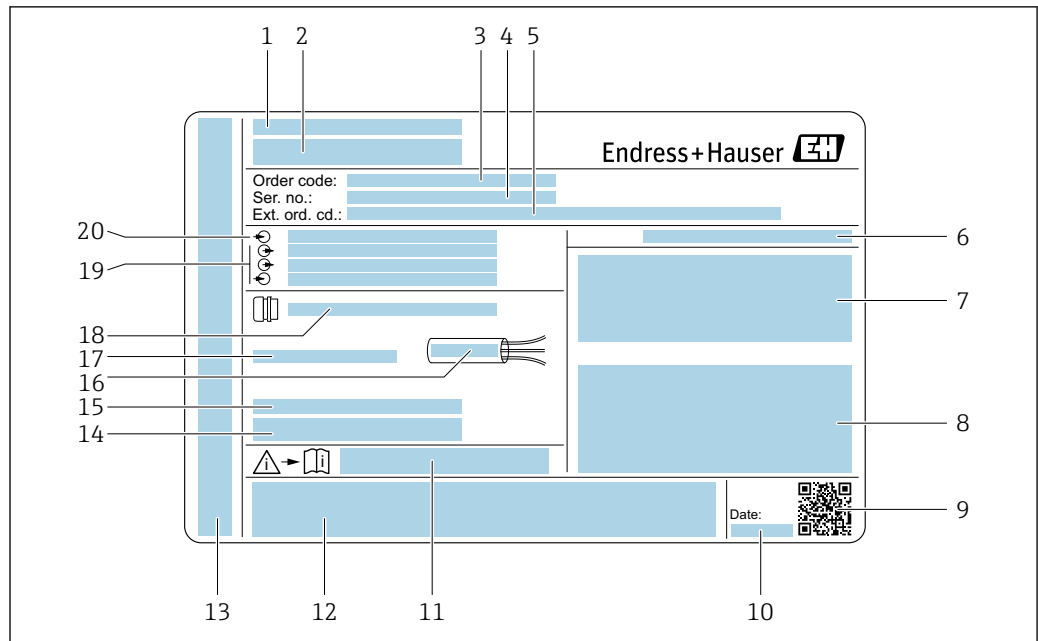

A0029192

 2 Example of a transmitter nameplate

- 1 Manufacturer address/certificate holder
- 2 Name of the transmitter
- 3 Order code
- 4 Serial number
- 5 Extended order code
- 6 Degree of protection
- 7 Space for approvals: use in hazardous areas
- 8 Electrical connection data: available inputs and outputs
- 9 2-D matrix code
- 10 Date of manufacture: year-month
- 11 Document number of safety-related supplementary documentation
- 12 Space for approvals and certificates: e.g. CE mark, RCM tick
- 13 Space for degree of protection of connection and electronics compartment when used in hazardous areas
- 14 Firmware version (FW) and device revision (Dev. rev.) from the factory
- 15 Space for additional information in the case of special products
- 16 Permitted temperature range for cable
- 17 Permitted ambient temperature ( $T_a$ )
- 18 Information on cable gland
- 19 Available inputs and outputs, supply voltage
- 20 Electrical connection data: supply voltage



## 4.2.2 Sensor nameplate

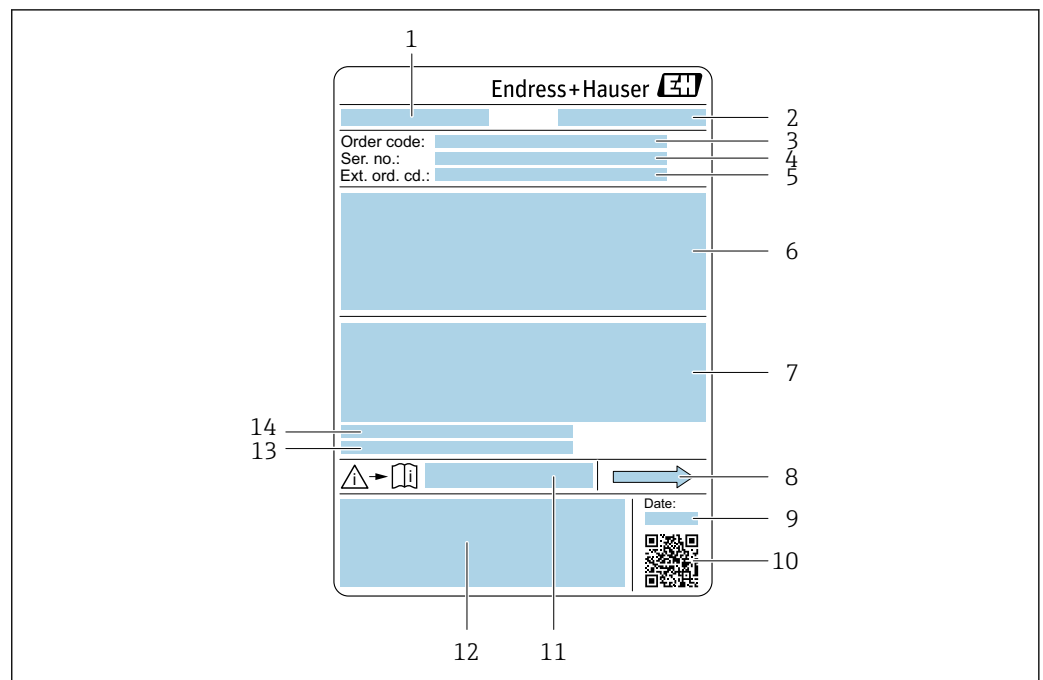

A0029199

3 Example of a sensor nameplate

- 1 Name of the sensor
- 2 Manufacturer address/certificate holder
- 3 Order code
- 4 Serial number (Ser. no.)
- 5 Extended order code (Ext. ord. cd.)
- 6 Nominal diameter of the sensor; flange nominal diameter/nominal pressure; sensor test pressure; medium temperature range; material of measuring tube and manifold; sensor-specific information: e.g. pressure range of sensor housing, wide-range density specification (special density calibration)
- 7 Approval information for explosion protection, Pressure Equipment Directive and degree of protection
- 8 Flow direction
- 9 Date of manufacture: year-month
- 10 2-D matrix code
- 11 Document number of safety-related supplementary documentation
- 12 CE mark, RCM-Tick mark
- 13 Surface roughness
- 14 Allowable ambient temperature ( $T_a$ )



### Order code

The measuring device is reordered using the order code.

#### Extended order code

- The device type (product root) and basic specifications (mandatory features) are always listed.
- Of the optional specifications (optional features), only the safety and approval-related specifications are listed (e.g. LA). If other optional specifications are also ordered, these are indicated collectively using the # placeholder symbol (e.g. #LA#).
- If the ordered optional specifications do not include any safety and approval-related specifications, they are indicated by the + placeholder symbol (e.g. XXXXXX-ABCDE+).

### 4.2.3 Symbols on the device

| Symbol  | Meaning   |
|---|---|
|  | <b>WARNING!</b><br>This symbol alerts you to a dangerous situation. Failure to avoid this situation can result in serious or fatal injury. Please consult the documentation for the measuring instrument to discover the type of potential danger and measures to avoid it. |
|  | <b>Reference to documentation</b><br>Refers to the corresponding device documentation.  |
|  | <b>Protective ground connection</b><br>A terminal that must be connected to the ground prior to establishing any other connections.   |

## 5 Storage and transport

### 5.1 Storage conditions

Observe the following notes for storage:

- ▶ Store in the original packaging to ensure protection from shock.
- ▶ Do not remove protective covers or protective caps installed on process connections. They prevent mechanical damage to the sealing surfaces and contamination in the measuring tube.
- ▶ Protect from direct sunlight. Avoid unacceptably high surface temperatures.
- ▶ Store in a dry and dust-free place.
- ▶ Do not store outdoors.

Storage temperature →  207

### 5.2 Transporting the product

Transport the measuring device to the measuring point in the original packaging.



A0029252

-  Do not remove protective covers or caps installed on process connections. They prevent mechanical damage to the sealing surfaces and contamination in the measuring tube.

#### 5.2.1 Measuring devices without lifting lugs

##### WARNING

**Center of gravity of the measuring device is higher than the suspension points of the webbing slings.**

Risk of injury if the measuring device slips.

- ▶ Secure the measuring device against slipping or turning.
- ▶ Observe the weight specified on the packaging (stick-on label).



A0029214

## 5.2.2 Measuring devices with lifting lugs

### CAUTION

#### Special transportation instructions for devices with lifting lugs

- ▶ Only use the lifting lugs fitted on the device or flanges to transport the device.
- ▶ The device must always be secured at two lifting lugs at least.

## 5.2.3 Transporting with a fork lift

If transporting in wood crates, the floor structure enables the crates to be lifted lengthwise or at both sides using a forklift.

## 5.3 Packaging disposal

All packaging materials are environmentally friendly and 100% recyclable:

- Outer packaging of device
  - Stretch wrap made of polymer in accordance with EU Directive 2002/95/EC (RoHS)
- Packaging
  - Wood crate treated in accordance with ISPM 15 standard, confirmed by IPPC logo
  - Cardboard box in accordance with European packaging guideline 94/62/EC, recyclability confirmed by Resy symbol
- Transport material and fastening fixtures
  - Disposable plastic pallet
  - Plastic straps
  - Plastic adhesive strips
- Filler material
  - Paper pads

## 6 Mounting

### 6.1 Mounting requirements

#### 6.1.1 Installation position

##### Installation point

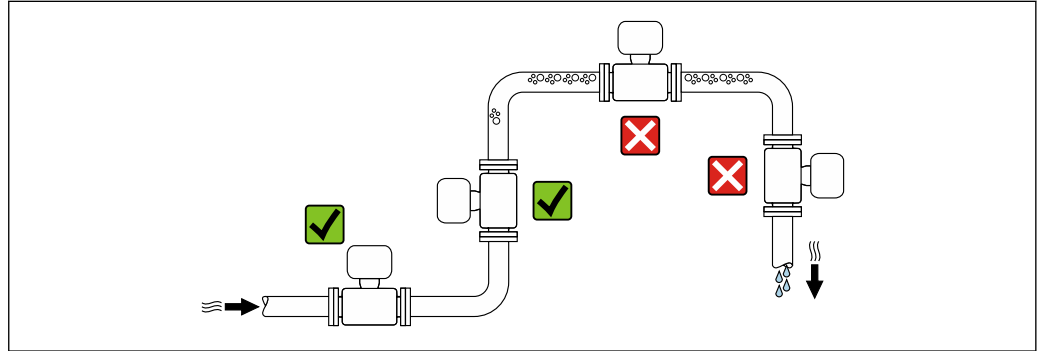

A0028772

To prevent measuring errors arising from accumulation of gas bubbles in the measuring pipe, avoid the following mounting locations in the piping:

- Highest point of a pipeline.
- Directly upstream of a free pipe outlet in a down pipe.

##### Installation in down pipes

However, the following installation suggestion allows for installation in an open vertical pipeline. Pipe restrictions or the use of an orifice with a smaller cross-section than the nominal diameter prevent the sensor running empty while measurement is in progress.

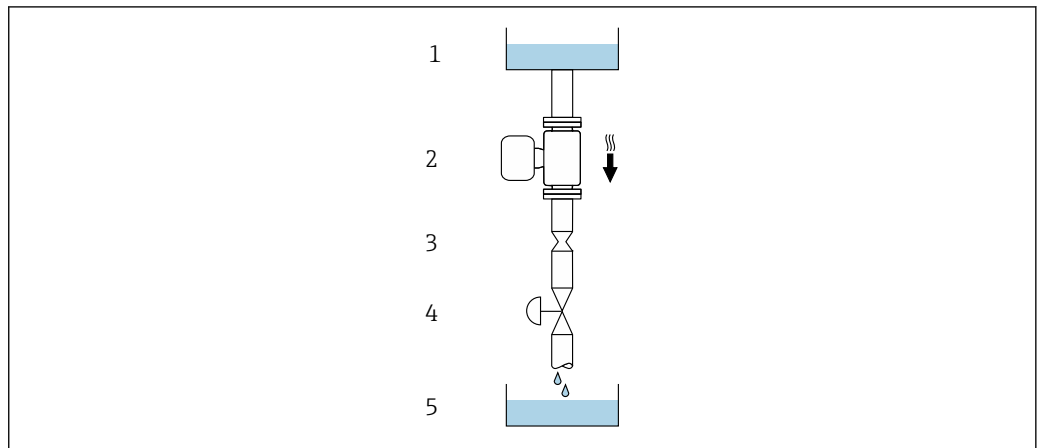

A0028773



4 Installation in a down pipe (e.g. for batching applications)

- 1 Supply tank
- 2 Sensor
- 3 Orifice plate, pipe restriction
- 4 Valve
- 5 Filling vessel

| DN   |      | Ø orifice plate, pipe restriction |      |
|------|------|-----------------------------------|------|
| [mm] | [in] | [mm]                              | [in] |
| 80   | 3    | 50                                | 1.97 |
| 100  | 4    | 65                                | 2.60 |
| 150  | 6    | 90                                | 3.54 |
| 250  | 10   | 150                               | 5.91 |

**Orientation**

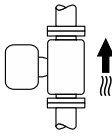
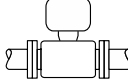
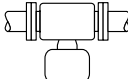
The direction of the arrow on the sensor nameplate helps you to install the sensor according to the flow direction (direction of medium flow through the piping).

| Orientation |   |   | Recommendation                                |
|-------------|---|---|---|
| <b>A</b>    | Vertical orientation                          | <br><small>A0015591</small>   | ✓✓ <sup>1)</sup>                              |
| <b>B</b>    | Horizontal orientation, transmitter at top    | <br><small>A0015589</small>   | ✓✓ <sup>2)</sup><br>Exception:<br>→ ☒ 5, ☒ 22 |
| <b>C</b>    | Horizontal orientation, transmitter at bottom | <br><small>A0015590</small> | ✓✓ <sup>3)</sup><br>Exception:<br>→ ☒ 5, ☒ 22 |
| <b>D</b>    | Horizontal orientation, transmitter at side   | <br><small>A0015592</small> | ✗   |

- 1) This orientation is recommended to ensure self-draining.
- 2) Applications with low process temperatures may reduce the ambient temperature. To maintain the minimum ambient temperature for the transmitter, this orientation is recommended.
- 3) Applications with high process temperatures may increase the ambient temperature. To maintain the maximum ambient temperature for the transmitter, this orientation is recommended.

If a sensor is installed horizontally with a curved measuring tube, match the position of the sensor to the fluid properties.

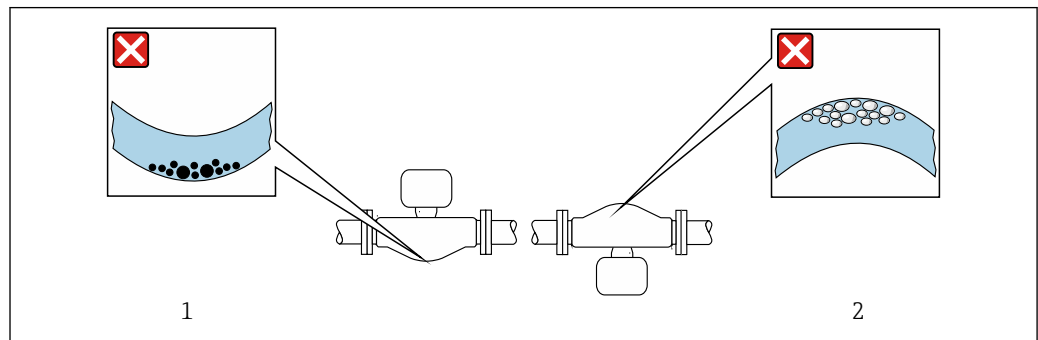

☒ 5 Orientation of sensor with curved measuring tube

- 1 Avoid this orientation for fluids with entrained solids: Risk of solids accumulating
- 2 Avoid this orientation for outgassing fluids: Risk of gas accumulating

### Inlet and outlet runs

No special precautions need to be taken for fittings that create turbulence, such as valves, elbows or T-pieces, as long as no cavitation occurs → 23.



### Installation dimensions



For the dimensions and installation lengths of the device, see the "Technical Information" document, "Mechanical construction" section

## 6.1.2 Environmental and process requirements

### Ambient temperature range

|                                  |   |
|----------------------------------|---|
| Measuring device                 | <ul style="list-style-type: none"> <li>▪ -40 to +60 °C (-40 to +140 °F)</li> <li>▪ Order code for "Test, certificate", option JP:<br/>-50 to +60 °C (-58 to +140 °F)</li> </ul> |
| Readability of the local display | <p>-20 to +60 °C (-4 to +140 °F)</p> <p>The readability of the display may be impaired at temperatures outside the temperature range.</p>                                       |



Dependency of ambient temperature on medium temperature → 209

- ▶ If operating outdoors:  
Avoid direct sunlight, particularly in warm climatic regions.

### Static pressure

It is important that cavitation does not occur, or that gases entrained in the liquids do not outgas.

Cavitation is caused if the pressure drops below the vapor pressure:

- In liquids that have a low boiling point (e.g. hydrocarbons, solvents, liquefied gases)
  - In suction lines
- ▶ Ensure the static pressure is sufficiently high to prevent cavitation and outgassing.

For this reason, the following mounting locations are recommended:

- At the lowest point in a vertical pipe
- Downstream from pumps (no danger of vacuum)

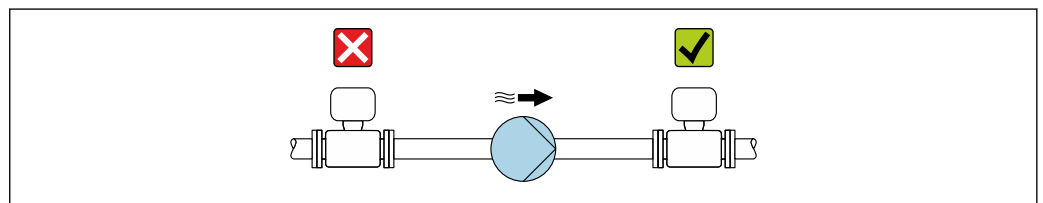

A0028777

### Thermal insulation

In the case of some fluids, it is important to keep the heat radiated from the sensor to the transmitter to a low level. A wide range of materials can be used for the required insulation.

The following device versions are recommended for versions with thermal insulation:  
Version with extended neck:

Order code for "Measuring tube material", option FA with an extended neck length of 105 mm (4.13 in).

#### NOTICE

#### Electronics overheating on account of thermal insulation!

- ▶ Recommended orientation: horizontal orientation, transmitter housing pointing downwards.
- ▶ Do not insulate the transmitter housing .
- ▶ Maximum permissible temperature at the lower end of the transmitter housing: 80 °C (176 °F)
- ▶ Regarding thermal insulation with an exposed extended neck: We advise against insulating the extended neck to ensure optimal heat dissipation.

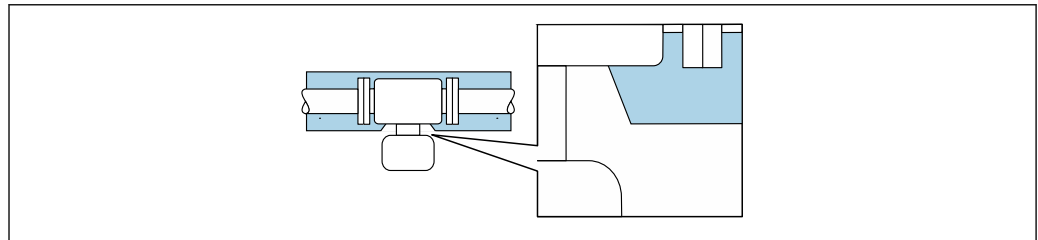

A0034391

6 Thermal insulation with exposed extended neck

### Heating

#### NOTICE

#### Electronics can overheat due to elevated ambient temperature!

- ▶ Observe maximum permitted ambient temperature for the transmitter.
- ▶ Depending on the medium temperature, take the device orientation requirements into account.

#### NOTICE

#### Danger of overheating when heating

- ▶ Ensure that the temperature at the lower end of the transmitter housing does not exceed 80 °C (176 °F).
- ▶ Ensure that sufficient convection takes place at the transmitter neck.
- ▶ Ensure that a sufficiently large area of the transmitter neck remains exposed. The uncovered part serves as a radiator and protects the electronics from overheating and excessive cooling.
- ▶ When using in potentially explosive atmospheres, observe the information in the device-specific Ex documentation. For detailed information on the temperature tables, see the separate document entitled "Safety Instructions" (XA) for the device.
- ▶ Consider the "830 ambient temperature too high" and "832 electronics temperature too high" process diagnostics if overheating cannot be ruled out based on a suitable system design.



### Heating options

If a fluid requires that no heat loss should occur at the sensor, users can avail of the following heating options:

- Electrical heating, e.g. with electric band heaters<sup>2)</sup>
- Via pipes carrying hot water or steam
- Via heating jackets

### Vibrations

The high oscillation frequency of the measuring tubes ensures that the correct operation of the measuring system is not influenced by plant vibrations.

## 6.1.3 Special mounting instructions

### Drainability

When installed vertically, the measuring tubes can be drained completely and protected against buildup.

### Hygienic compatibility

-  ■ When installing in hygienic applications, please refer to the information in the "Certificates and approvals/hygienic compatibility" section
- In the case of measuring devices with the order code for "Housing", option B "Stainless, hygienic", to seal the connection compartment cover, screw it closed finger-tight and tighten it by another 45° (corresponds to 15 Nm).

### Rupture disk

Process-related information: →  210.

#### **WARNING**

#### **Danger from medium escaping!**

Medium escaping under pressure can cause injury or material damage.

- ▶ Take precautions to prevent danger to persons and damage if the rupture disk is actuated.
- ▶ Observe the information on the rupture disk sticker.
- ▶ Make sure that the function and operation of the rupture disk is not impeded through the installation of the device.
- ▶ Do not use a heating jacket.
- ▶ Do not remove or damage the rupture disk.

The position of the rupture disk is indicated by a sticker affixed beside it.

The transportation guard must be removed.

The existing connecting nozzles are not intended for the purpose of rinsing or pressure monitoring, but instead serve as the mounting location for the rupture disk.

In the event of a failure of the rupture disk, a drain device can be screwed onto the internal thread of the rupture disk in order to drain off any escaping medium.

---

2) The use of parallel electric band heaters is generally recommended (bidirectional electricity flow). Particular considerations must be made if a single-wire heating cable is to be used. For additional information, refer to EA01339D "Installation Instructions for Electrical Trace Heating Systems".

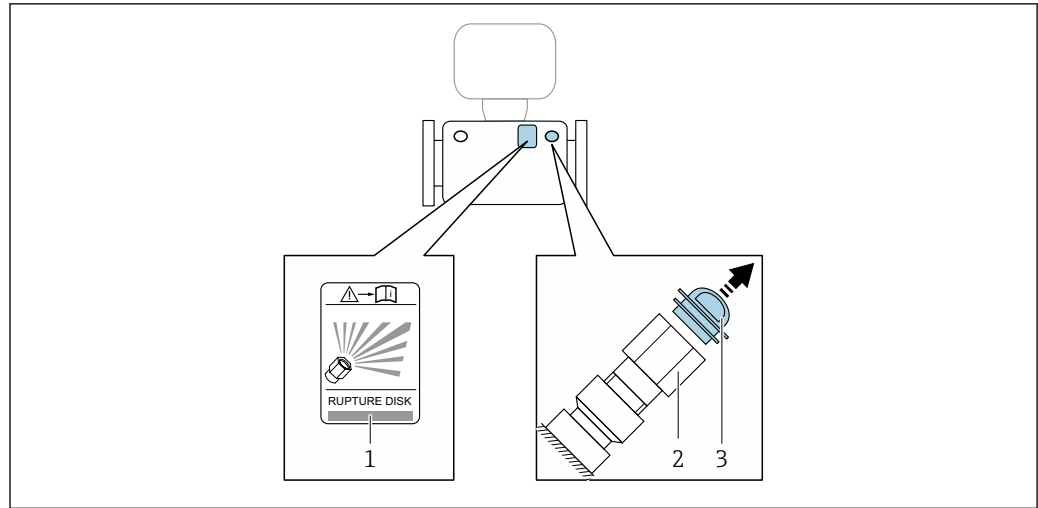

A0030346

- 1 Rupture disk label
- 2 Rupture disk with 1/2" NPT internal thread and 1" width across flats
- 3 Transportation guard



For information on the dimensions, see the "Technical Information" document, "Mechanical construction" section (accessories).

### Zero verification and zero adjustment

All measuring instruments are calibrated in accordance with state-of-the-art technology. Calibration takes place under reference conditions → 203. Therefore, a zero adjustment in the field is generally not required.

Experience shows that zero adjustment is advisable only in special cases:

- To achieve maximum measurement accuracy even with low flow rates.
- Under extreme process or operating conditions (e.g. very high process temperatures or very high-viscosity fluids).
- For gas applications with low pressure



To achieve the highest possible measurement accuracy at low flow rates, the installation must protect the sensor from mechanical stresses during operation.

To get a representative zero point, ensure that:

- any flow in the device is prevented during the adjustment
- the process conditions (e.g. pressure, temperature) are stable and representative

Verification and adjustment cannot be carried out if the following process conditions are present:

- Gas pockets  
Ensure that the system has been sufficiently flushed with the medium. Repeat flushing can help to eliminate gas pockets
- Thermal circulation  
In the event of temperature differences (e.g. between the measuring tube inlet and outlet section), induced flow can occur even if the valves are closed due to thermal circulation in the device
- Leaks at the valves  
If the valves are not leak-tight, flow is not sufficiently prevented when determining the zero point

If these conditions cannot be avoided, it is advisable to keep the factory setting for the zero point.

### Weather protection cover

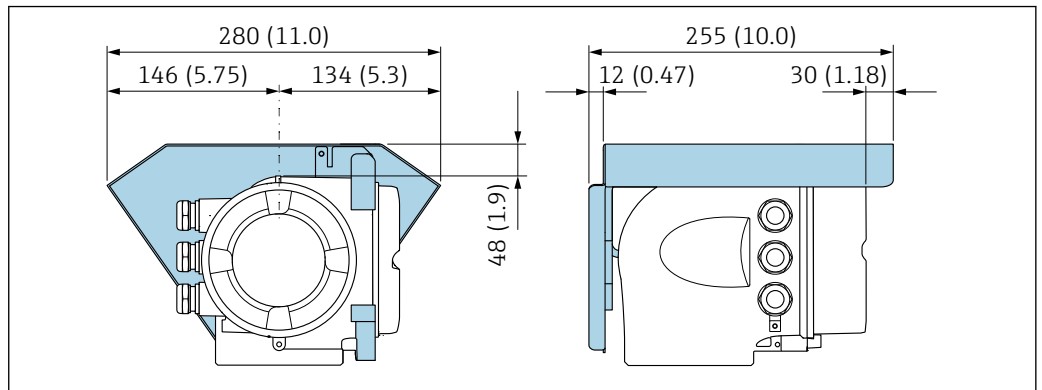

A0029553

7 Engineering unit mm (in)

### Cover lock

#### NOTICE

**Order code "Housing", option L "Cast, stainless": The covers of the transmitter housing are provided with a borehole to lock the cover.**

The cover can be locked using screws and a chain or cable provided by the customer on site.

- ▶ The use of stainless steel chains or cables is recommended.
- ▶ If a protective coating is applied, it is recommended to use a heat shrink tube to protect the housing paint.

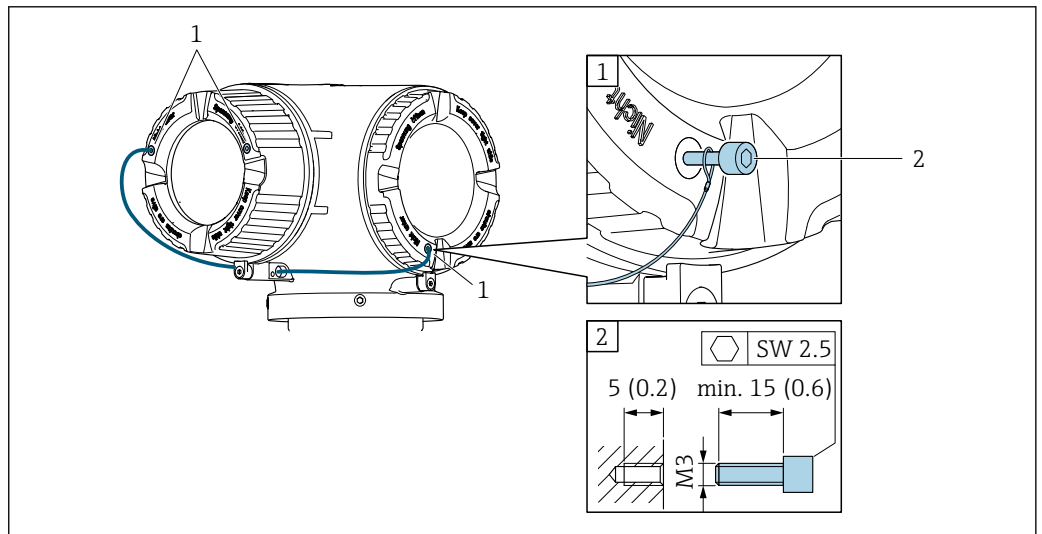

A0029800

- 1 Cover borehole for the securing screw
- 2 Securing screw to lock the cover

## 6.2 Mounting the measuring instrument

### 6.2.1 Required tools

#### For sensor

For flanges and other process connections: Use a suitable mounting tool.

## 6.2.2 Preparing the measuring instrument

1. Remove all remaining transport packaging.
2. Remove any protective covers or protective caps present from the sensor.
3. Remove stick-on label on the electronics compartment cover.

## 6.2.3 Mounting the measuring device

### **⚠ WARNING**

#### **Danger due to improper process sealing!**

- ▶ Ensure that the inside diameters of the gaskets are greater than or equal to that of the process connections and piping.
  - ▶ Ensure that the seals are clean and undamaged.
  - ▶ Secure the seals correctly.
1. Ensure that the direction of the arrow on the nameplate of the sensor matches the flow direction of the medium.
  2. Install the measuring device or turn the transmitter housing so that the cable entries do not point upwards.

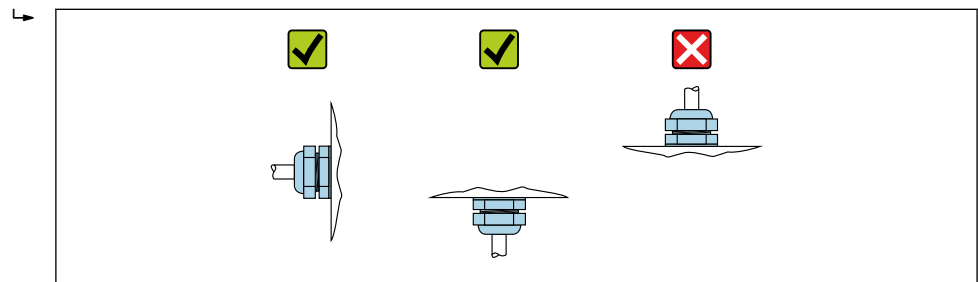

A0029263

## 6.2.4 Turning the transmitter housing

To provide easier access to the connection compartment or display module, the transmitter housing can be turned.

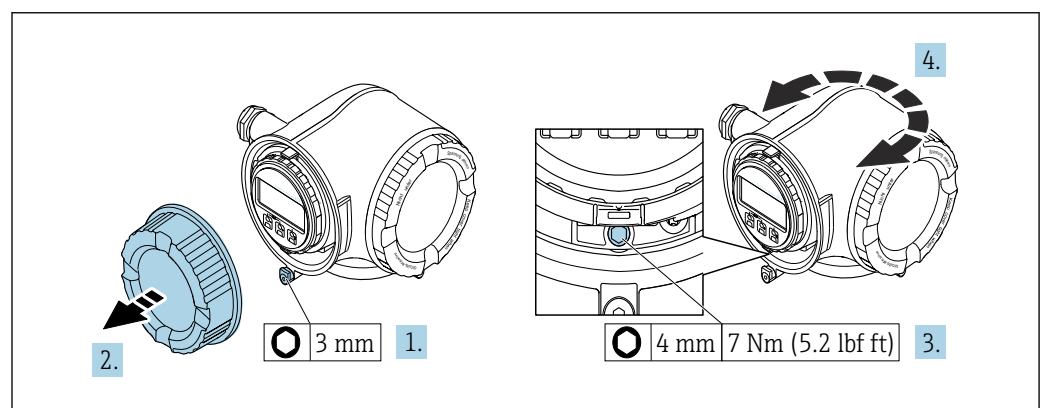

A0029993

8 Housing in non-Ex version

1. Depending on the device version: Loosen the securing clamp of the connection compartment cover.
2. Unscrew the connection compartment cover.
3. Loosen the fixing screw.
4. Turn the housing to the desired position.
5. Tighten the securing screw.

6. Screw on the connection compartment cover.
7. Depending on the device version: Attach the securing clamp of the connection compartment cover.

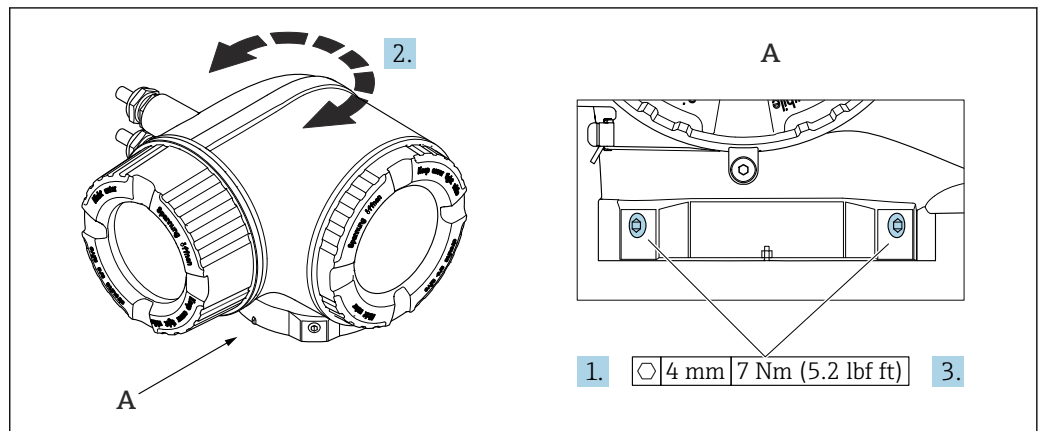

9 Ex housing

1. Loosen the fixing screws.
2. Turn the housing to the desired position.
3. Tighten the securing screws.

### 6.2.5 Turning the display module

The display module can be turned to optimize display readability and operability.

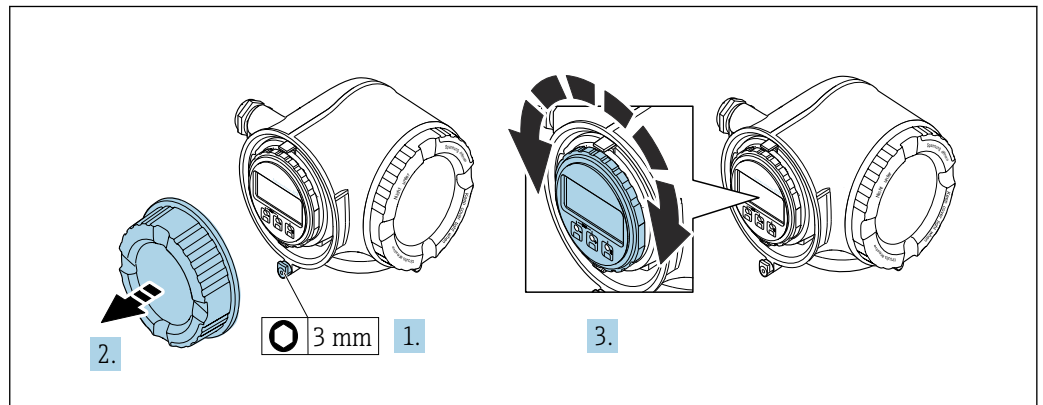

1. Depending on the device version: Loosen the securing clamp of the connection compartment cover.
2. Unscrew the connection compartment cover.
3. Turn the display module to the desired position: max.  $8 \times 45^\circ$  in each direction.
4. Screw on the connection compartment cover.
5. Depending on the device version: Attach the securing clamp of the connection compartment cover.

### 6.3 Post-installation check

|   |                          |
|---|--------------------------|
| Is the device undamaged (visual inspection)?  | <input type="checkbox"/> |
| Does the measuring instrument correspond to the measuring point specifications?<br>For example:<br><ul style="list-style-type: none"> <li>▪ Process temperature → 209</li> <li>▪ Pressure (refer to the "Pressure-temperature ratings" section of the "Technical Information" document).</li> <li>▪ Ambient temperature</li> <li>▪ Measuring range</li> </ul> | <input type="checkbox"/> |
| Has the correct orientation for the sensor been selected → 22?<br><ul style="list-style-type: none"> <li>▪ According to sensor type</li> <li>▪ According to medium temperature</li> <li>▪ According to medium properties (outgassing, with entrained solids)</li> </ul>   | <input type="checkbox"/> |
| Does the arrow on the sensor match the direction of flow of the medium? → 22?   | <input type="checkbox"/> |
| Is the tag name and labeling correct (visual inspection)?   | <input type="checkbox"/> |
| Is the device sufficiently protected from precipitation and direct sunlight?  | <input type="checkbox"/> |
| Are the securing screw and securing clamp tightened securely?   | <input type="checkbox"/> |

## 7 Electrical connection

### WARNING

**Live parts! Incorrect work performed on the electrical connections can result in an electric shock.**

- ▶ Set up a disconnecting device (switch or power-circuit breaker) to easily disconnect the device from the supply voltage.
- ▶ In addition to the device fuse, include an overcurrent protection unit with max. 10 A in the plant installation.

### 7.1 Electrical safety

In accordance with applicable national regulations.

### 7.2 Connecting requirements

#### 7.2.1 Required tools

- For cable entries: Use corresponding tools
- For securing clamp: Allen key 3 mm
- Wire stripper
- When using stranded cables: Crimper for wire end ferrule
- For removing cables from terminal: Flat blade screwdriver  $\leq 3$  mm (0.12 in)

#### 7.2.2 Requirements for connection cable

The connecting cables provided by the customer must fulfill the following requirements.

##### **Protective grounding cable for the outer ground terminal**

Conductor cross-section  $< 2.1$  mm<sup>2</sup> (14 AWG)

The use of a cable lug enables the connection of larger cross-sections.

The grounding impedance must be less than 2  $\Omega$ .

##### **Permitted temperature range**

- The installation guidelines that apply in the country of installation must be observed.
- The cables must be suitable for the minimum and maximum temperatures to be expected.

##### **Power supply cable (incl. conductor for the inner ground terminal)**

Standard installation cable is sufficient.

##### **Signal cable**

-  For custody transfer, all signal lines must be shielded cables (tinned copper braiding, optical coverage  $\geq 85$  %). The cable shield must be connected on both sides.

##### *Ethernet-APL*

Shielded twisted-pair cable. Cable type A is recommended.

-  See <https://www.profibus.com> Ethernet-APL White Paper "

*Modbus RS485*

Shielded twisted-pair cable.



See <https://modbus.org> "MODBUS over Serial Line Specification and Implementation Guide".

*Current output 0 /4 to 20 mA (excluding HART)*

Standard installation cable is sufficient.

*Pulse /frequency /switch output*

Standard installation cable is sufficient.

*Relay output*

Standard installation cable is sufficient.

*Current input 4 to 20 mA*

Standard installation cable is sufficient.

*Status input*

Standard installation cable is sufficient.

**Cable diameter**

- Cable glands supplied:  
M20 × 1.5 with cable Ø 6 to 12 mm (0.24 to 0.47 in)
- Spring-loaded terminals: Suitable for strands and strands with ferrules.  
Conductor cross-section 0.2 to 2.5 mm<sup>2</sup> (24 to 12 AWG).

**Requirements for connecting cable – remote display and operating module DKX001***Optionally available connecting cable*

A cable is supplied depending on the order option

- Order code for measuring device: order code **030** for "Display; operation", option **O** or
- Order code for measuring device: order code **030** for "Display; operation", option **M** and
- Order code for DKX001: order code **040** for "Cable", option **A, B, D, E**

|                                 |  |
|---------------------------------|--|
| <b>Standard cable</b>           | 2 × 2 × 0.34 mm <sup>2</sup> (22 AWG) PVC cable with common shield (2 pairs, pair-stranded)                                    |
| <b>Flame resistance</b>         | According to DIN EN 60332-1-2  |
| <b>Oil resistance</b>           | According to DIN EN 60811-2-1  |
| <b>Shield</b>                   | Tin-plated copper braid, optical cover ≥ 85 %  |
| <b>Capacitance: core/shield</b> | ≤ 200 pF/m   |
| <b>L/R</b>                      | ≤ 24 µH/Ω  |
| <b>Available cable length</b>   | 5 m (15 ft)/10 m (35 ft)/20 m (65 ft)/30 m (100 ft)  |
| <b>Operating temperature</b>    | When mounted in a fixed position: -50 to +105 °C (-58 to +221 °F); when cable can move freely: -25 to +105 °C (-13 to +221 °F) |

*Standard cable - customer-specific cable*

With the following order option, no cable is supplied with the device and must be provided by the customer:

Order code for DKX001: Order code **040** for "Cable", option **1** "None, provided by customer, max 300 m"



A standard cable with the following minimum requirements can be used as the connecting cable, even in the hazardous area (Zone 2, Class I, Division 2 and Zone 1, Class I, Division 1):



|                                 |   |
|---------------------------------|---|
| <b>Standard cable</b>           | 4 wires (2 pairs); pair-stranded with common shield, minimum wire cross-section 0.34 mm <sup>2</sup> (22 AWG) |
| <b>Shield</b>                   | Tin-plated copper braid, optical cover ≥ 85 %   |
| <b>Cable impedance (pair)</b>   | Minimum 80 Ω  |
| <b>Cable length</b>             | Maximum 300 m (1000 ft), maximum loop impedance 20 Ω  |
| <b>Capacitance: core/shield</b> | Maximum 1000 nF for Zone 1, Class I, Division 1   |
| <b>L/R</b>                      | Maximum 24 μH/Ω for Zone 1, Class I, Division 1   |

### 7.2.3 Terminal assignment

#### Transmitter: supply voltage, input/outputs

The terminal assignment of the inputs and outputs depends on the individual order version of the device. The device-specific terminal assignment is documented on an adhesive label in the terminal cover.

| Supply voltage   |       | Input/output 1 |        | Input/output 2 |        | Input/output 3 |        |
|--|-------|----------------|--------|----------------|--------|----------------|--------|
| 1 (+)  | 2 (-) | 26 (B)         | 27 (A) | 24 (+)         | 25 (-) | 22 (+)         | 23 (-) |
| Device-specific terminal assignment: adhesive label in terminal cover. |       |                |        |                |        |                |        |

 Terminal assignment of the remote display and operating module →  38.

### 7.2.4 Shielding and grounding

#### Shielding and grounding concept

1. Maintain electromagnetic compatibility (EMC).
2. Take explosion protection into consideration.
3. Pay attention to the protection of persons.
4. Comply with national installation regulations and guidelines.
5. Observe cable specifications .
6. Keep the stripped and twisted lengths of cable shield to the ground terminal as short as possible.
7. Shield cables fully.

#### Grounding of the cable shield

##### NOTICE

**In systems without potential matching, the multiple grounding of the cable shield causes mains frequency equalizing currents!**

Damage to the bus cable shield.

- ▶ Only ground the bus cable shield to either the local ground or the protective ground at one end.
- ▶ Insulate the shield that is not connected.

To comply with EMC requirements:

1. Ensure the cable shield is grounded to the potential matching line at multiple points.
2. Connect every local ground terminal to the potential matching line.

### 7.2.5 Preparing the measuring device

##### NOTICE

**Insufficient sealing of the housing!**

Operational reliability of the measuring device could be compromised.

- ▶ Use suitable cable glands corresponding to the degree of protection.

1. Remove dummy plug if present.
2. If the measuring device is supplied without cable glands:  
Provide suitable cable gland for corresponding connecting cable.
3. If the measuring device is supplied with cable glands:  
Observe requirements for connecting cables →  31.

## 7.3 Connecting the measuring instrument

### NOTICE

#### An incorrect connection compromises electrical safety!

- ▶ Only properly trained specialist staff may perform electrical connection work.
- ▶ Observe applicable federal/national installation codes and regulations.
- ▶ Comply with local workplace safety regulations.
- ▶ Always connect the protective ground cable  $\ominus$  before connecting additional cables.
- ▶ When using in potentially explosive atmospheres, observe the information in the device-specific Ex documentation.

### 7.3.1 Connecting the transmitter

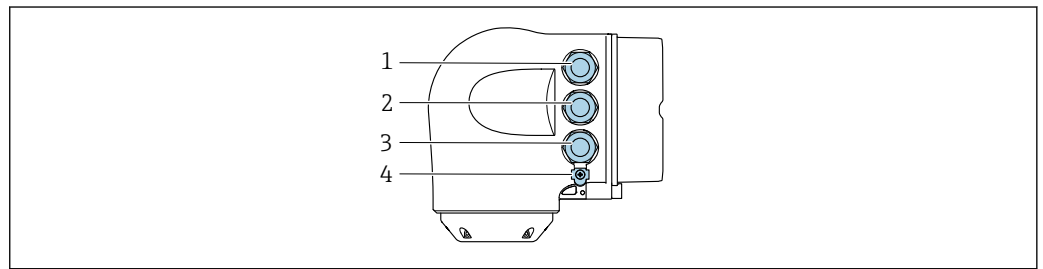

A0026781

- 1 Terminal connection for supply voltage
- 2 Terminal connection for signal transmission, input/output
- 3 Terminal connection for signal transmission, input/output or terminal connection for network connection via service interface (CDI-RJ45); optional: connection for external WLAN antenna or remote display and operating module DKX001
- 4 Protective earth (PE)

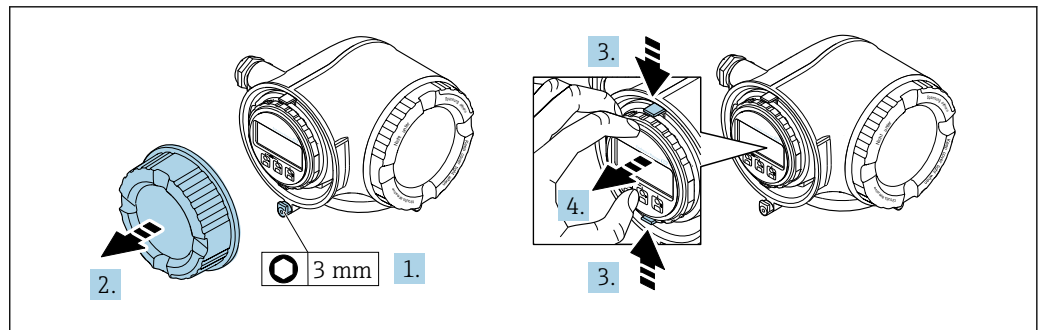

A0029813

1. Loosen the securing clamp of the connection compartment cover.
2. Unscrew the connection compartment cover.
3. Squeeze the tabs of the display module holder together.
4. Remove the display module holder.

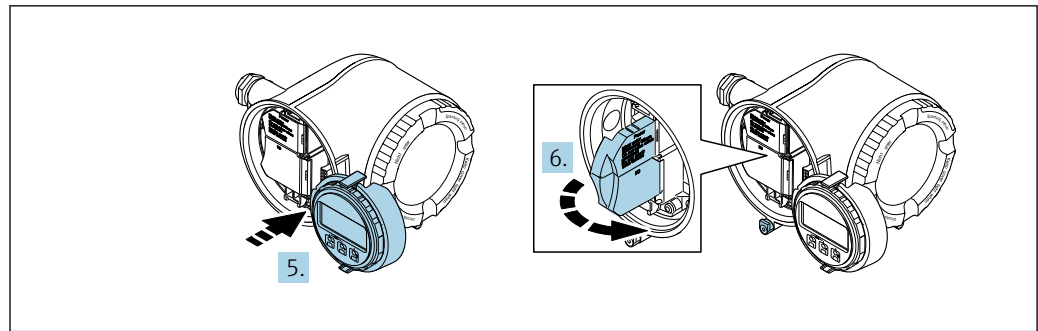

A0029814

5. Attach the holder to the edge of the electronics compartment.
6. Open the terminal cover.

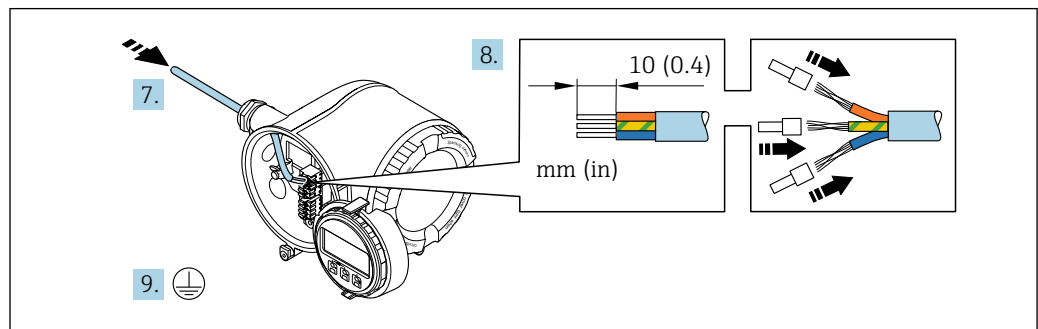

A0029815

7. Push the cable through the cable entry. To ensure tight sealing, do not remove the sealing ring from the cable entry.
8. Strip the cable and cable ends. In the case of stranded cables, also fit ferrules.
9. Connect the protective ground.

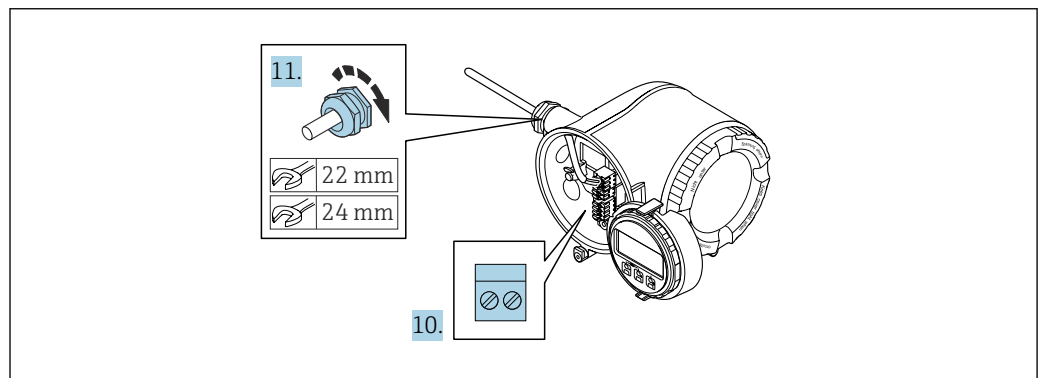

A0029816

10. Connect the cable according to the terminal assignment.
  - ↳ **Signal cable terminal assignment:** The device-specific terminal assignment is documented on an adhesive label in the terminal cover.
  - Supply voltage connection terminal assignment:** Adhesive label in the terminal cover or → 34.
11. Firmly tighten the cable glands.
  - ↳ This concludes the cable connection process.
12. Close the terminal cover.
13. Fit the display module holder in the electronics compartment.
14. Screw on the connection compartment cover.
15. Secure the securing clamp of the connection compartment cover.

### Removing a cable

To remove a cable from the terminal:

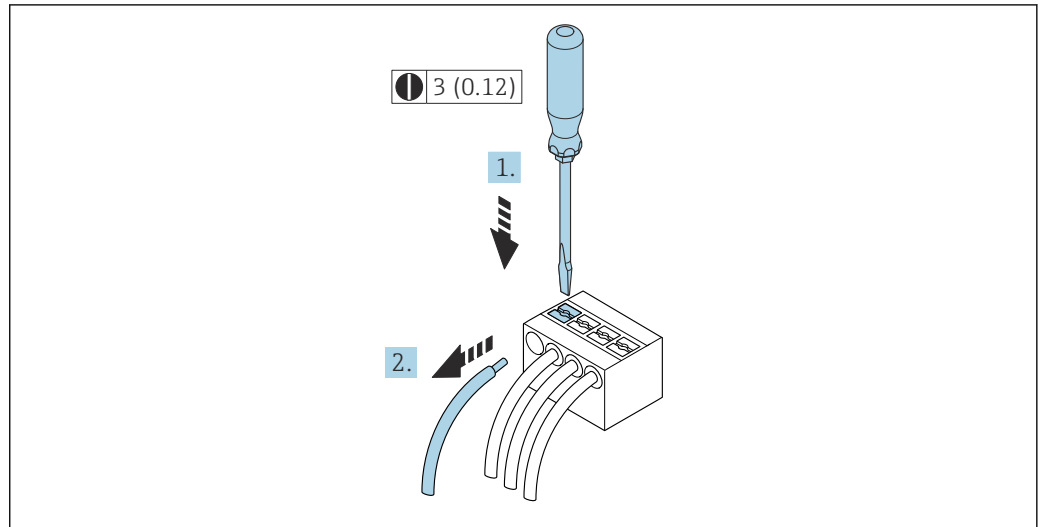

 10 Engineering unit mm (in)

1. Use a flat-blade screwdriver to press down on the slot between the two terminal holes.
2. Remove the cable end from the terminal.

### 7.3.2 Connecting the remote display and operating module DKX001

**i** The remote display and operating module DKX001 is available as an optional extra → 191..

- The measuring instrument is always supplied with a dummy cover when the remote display and operating module DKX001 is ordered directly with the measuring instrument. Display or operation at the transmitter is not possible in this case.
- If ordered subsequently, the remote display and operating module DKX001 may not be connected at the same time as the existing measuring instrument display module. Only one display or operation unit may be connected to the transmitter at any one time.

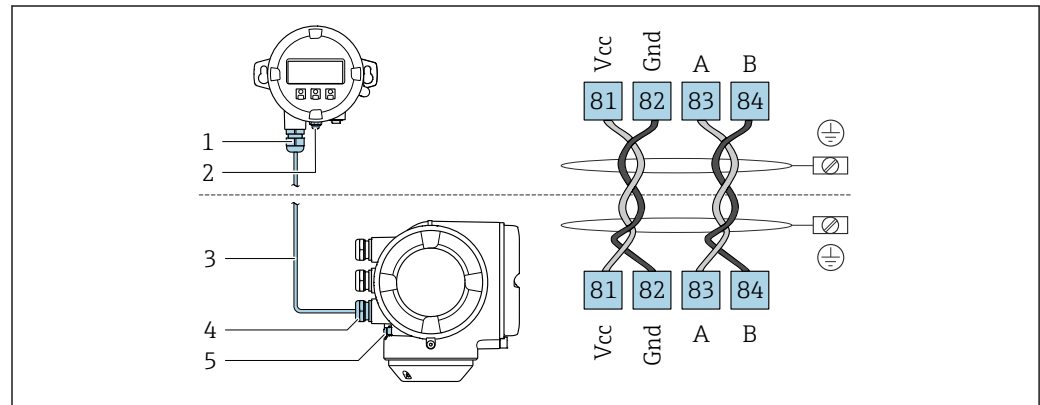

- 1 Remote display and operating module DKX001
- 2 Terminal connection for potential equalization (PE)
- 3 Connecting cable
- 4 Measuring instrument
- 5 Terminal connection for potential equalization (PE)

## 7.4 Potential equalization

### 7.4.1 Requirements

For potential equalization:

- Pay attention to in-house grounding concepts
- Take account of operating conditions, such as the pipe material and grounding
- Connect the medium, sensor and transmitter to the same electric potential
- Use a ground cable with a minimum cross-section of 6 mm<sup>2</sup> (10 AWG) and a cable lug for potential equalization connections

## 7.5 Special connection instructions

### 7.5.1 Connection examples

#### Modbus RS485

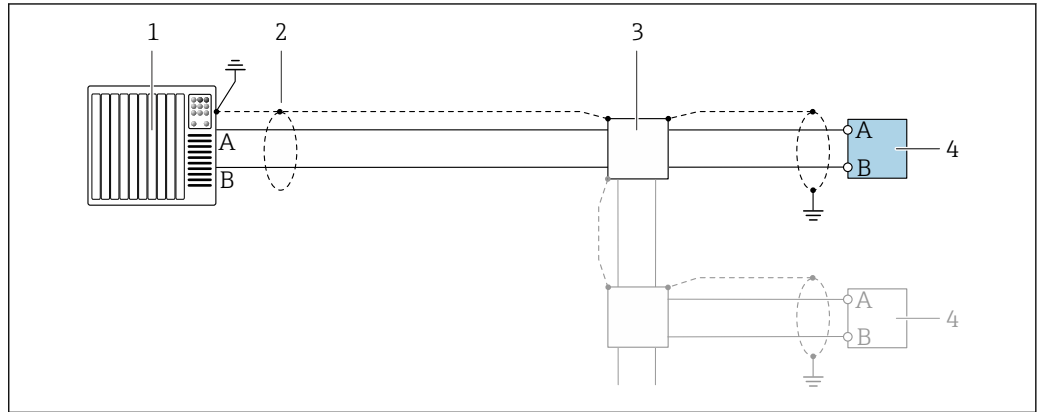

A0028765

11 Connection example for Modbus RS485, non-hazardous area and Zone 2; Class I, Division 2

- 1 Control system (e.g. PLC)
- 2 Cable shield provided at one end. The cable shield must be grounded at both ends to comply with EMC requirements; observe cable specifications
- 3 Distribution box
- 4 Transmitter

#### Current output 4-20 mA

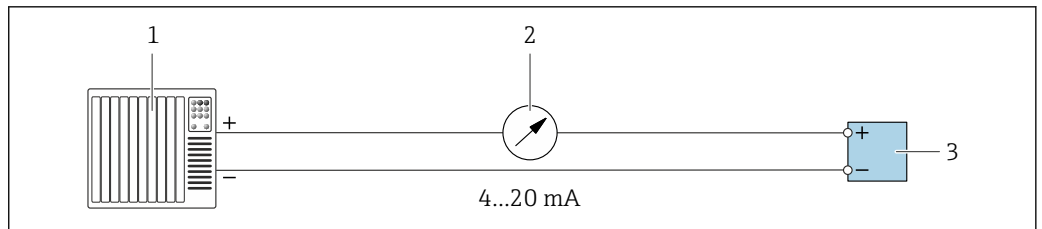

A0028758

12 Connection example for 4-20 mA current output (active)

- 1 Automation system with current input (e.g. PLC)
- 2 Analog display unit: observe maximum load
- 3 Transmitter

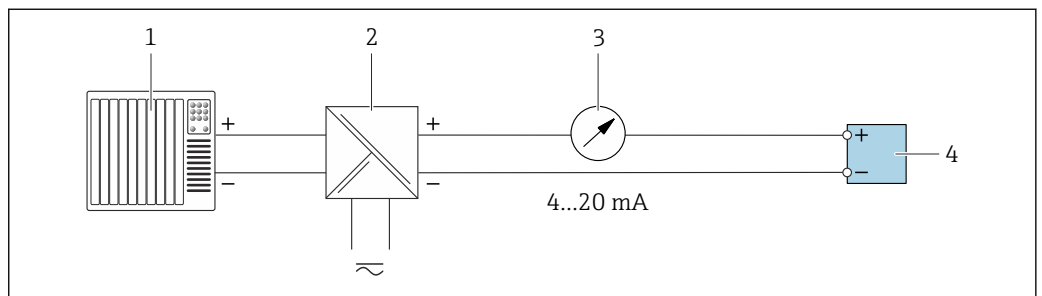

A0028759

13 Connection example for 4-20 mA current output (passive)

- 1 Automation system with current input (e.g. PLC)
- 2 Active barrier for power supply (e.g. RN221N)
- 3 Analog display unit: observe maximum load
- 4 Transmitter

### Pulse/frequency output

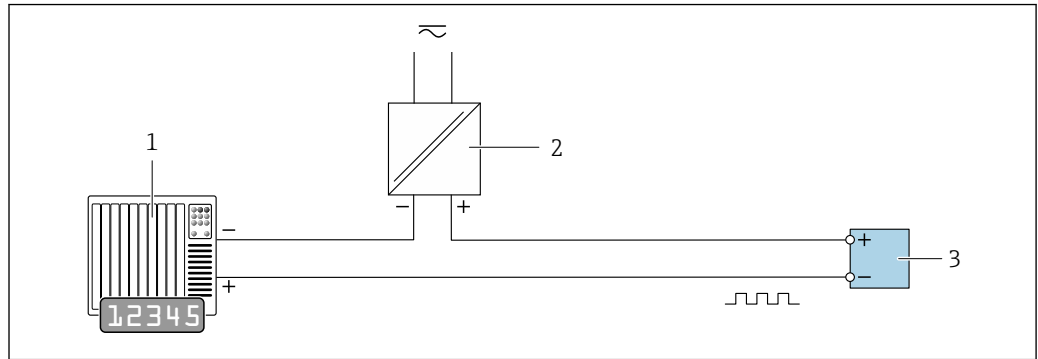

A0028761

14 Connection example for pulse/frequency output (passive)

- 1 Automation system with pulse/frequency input (e.g. PLC with 10 kΩ pull-up or pull-down resistor)
- 2 Power supply
- 3 Transmitter: observe input values → 197

### Switch output

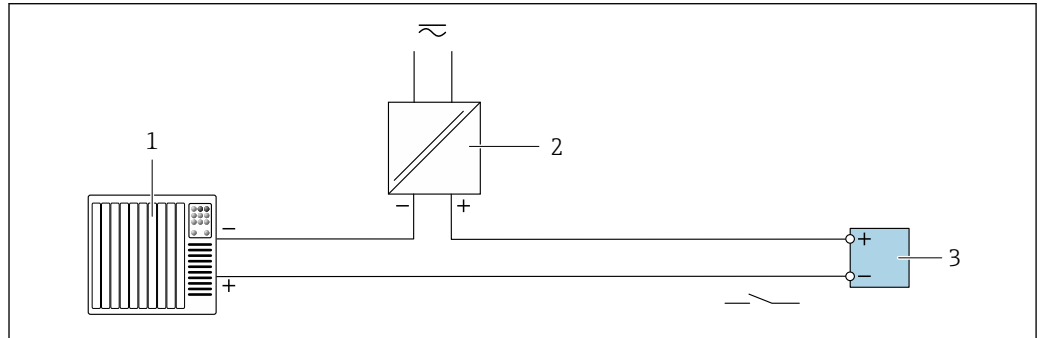

A0028760

15 Connection example for switch output (passive)

- 1 Automation system with switch input (e.g. PLC with a 10 kΩ pull-up or pull-down resistor)
- 2 Power supply
- 3 Transmitter: observe input values → 197

### Double pulse output

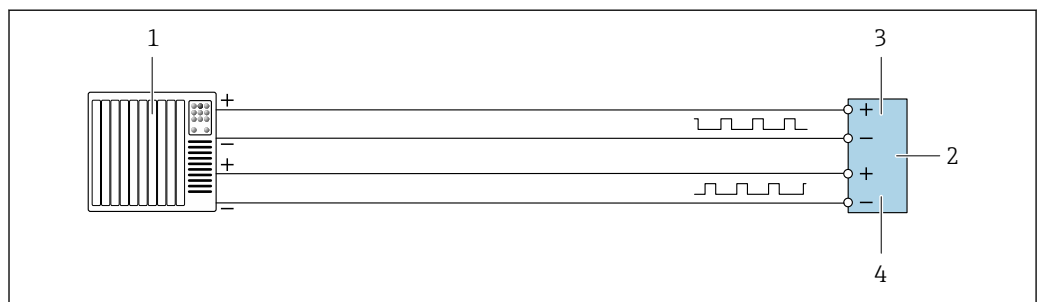

A0029280

16 Connection example for double pulse output (active)

- 1 Automation system with double pulse input (e.g. PLC)
- 2 Transmitter: observe input values → 199
- 3 Double pulse output
- 4 Double pulse output (slave), phase-shifted



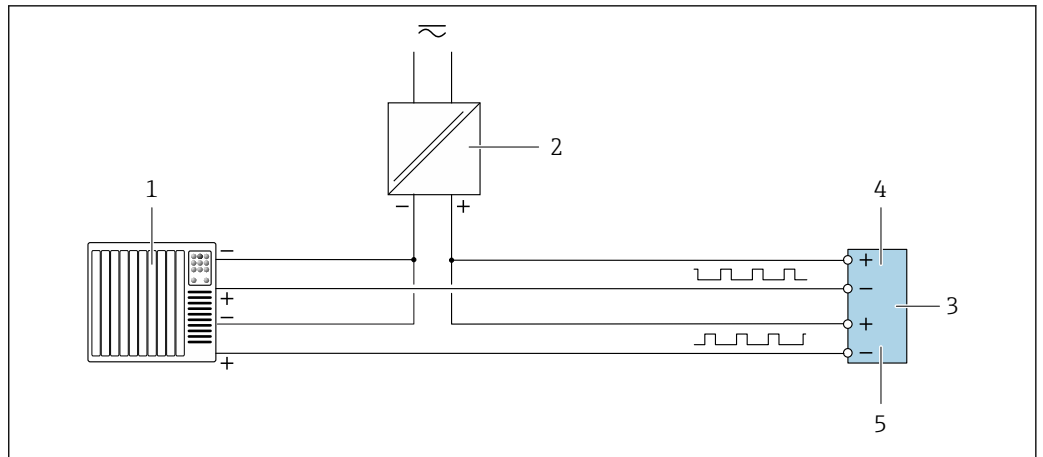

A0029279

17 Connection example for double pulse output (passive)

- 1 Automation system with double pulse input (e.g. PLC with a 10 kΩ pull-up or pull-down resistor)
- 2 Power supply
- 3 Transmitter: observe input values → 199
- 4 Double pulse output
- 5 Double pulse output (slave), phase-shifted

### Relay output

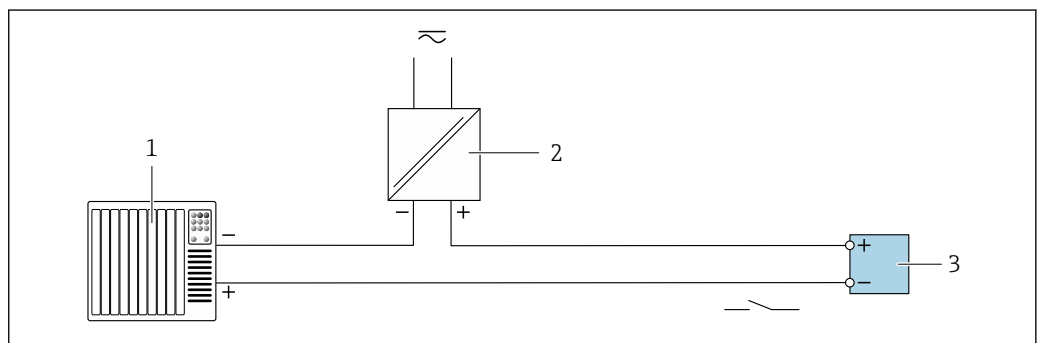

A0028760

18 Connection example for relay output (passive)

- 1 Automation system with relay input (e.g. PLC)
- 2 Power supply
- 3 Transmitter: observe input values → 199

### Current input

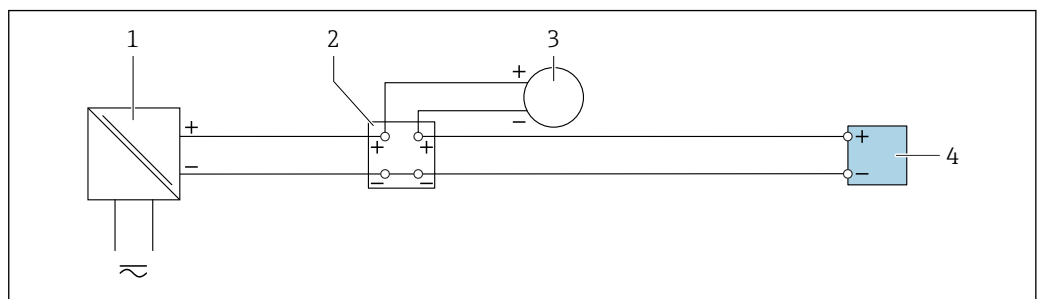

A0028915

19 Connection example for 4 to 20 mA current input

- 1 Power supply
- 2 Terminal box
- 3 External measuring device (to read in pressure or temperature, for instance)
- 4 Transmitter

### Status input

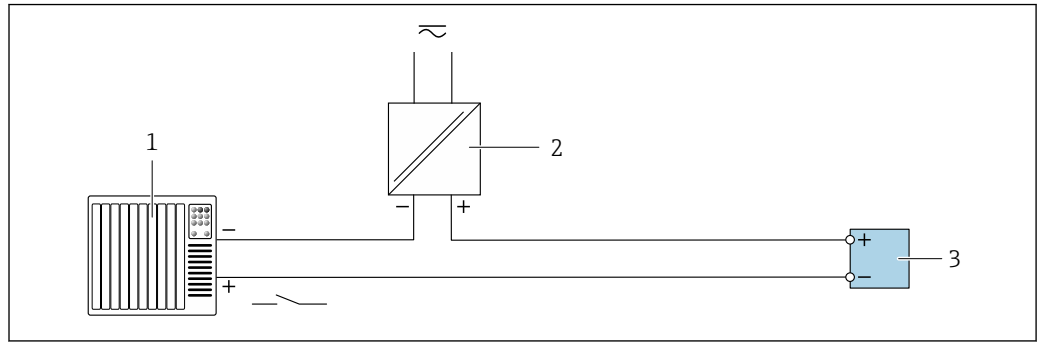

A0028764

20 Connection example for status input

- 1 Automation system with status output (e.g. PLC)
- 2 Power supply
- 3 Transmitter

## 7.6 Hardware settings

### 7.6.1 Setting the device address

The device address must always be configured for a Modbus slave. The valid device addresses are in the range from 1 to 247. Each address may only be assigned once in a Modbus RS485 network. If an address is not configured correctly, the measuring device is not recognized by the Modbus master. All measuring devices are delivered from the factory with the device address 247 and with the "software addressing" address mode.

#### Hardware addressing

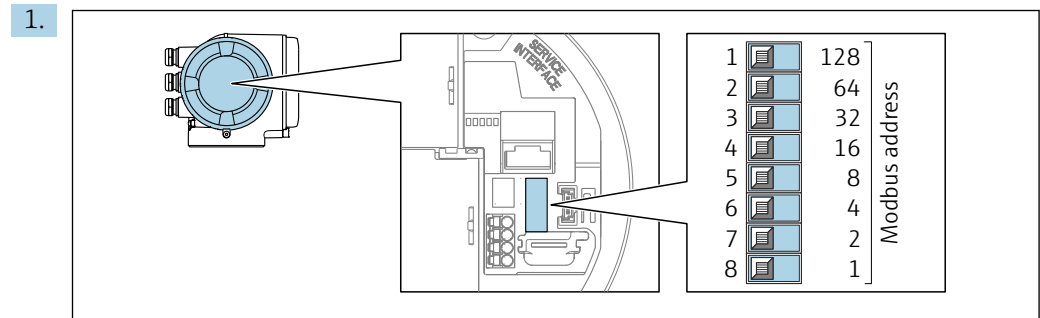

A0029634

Set the desired device address using the DIP switches in the connection compartment.

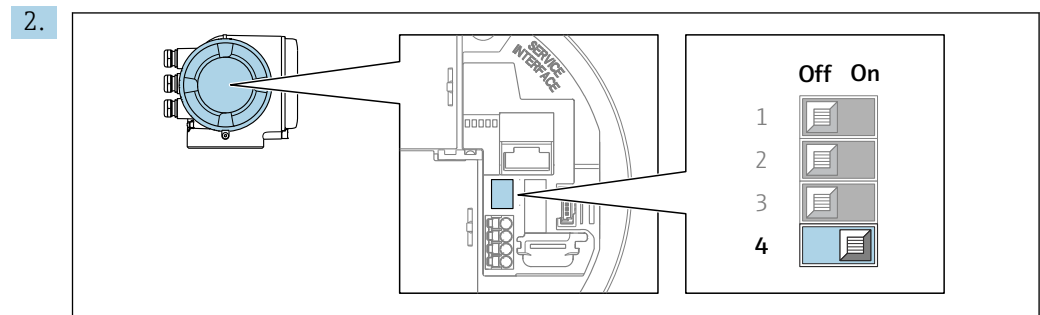

A0029633

To switch addressing from software addressing to hardware addressing: set the DIP switch to **On**.

↳ The change of device address takes effect after 10 seconds.

### Software addressing

- ▶ To switch addressing from hardware addressing to software addressing: set the DIP switch to **Off**.
  - ↳ The device address configured in the **Device address** parameter takes effect after 10 seconds.

### 7.6.2 Activating the terminating resistor

To avoid incorrect communication transmission caused by impedance mismatch, terminate the Modbus RS485 cable correctly at the start and end of the bus segment.

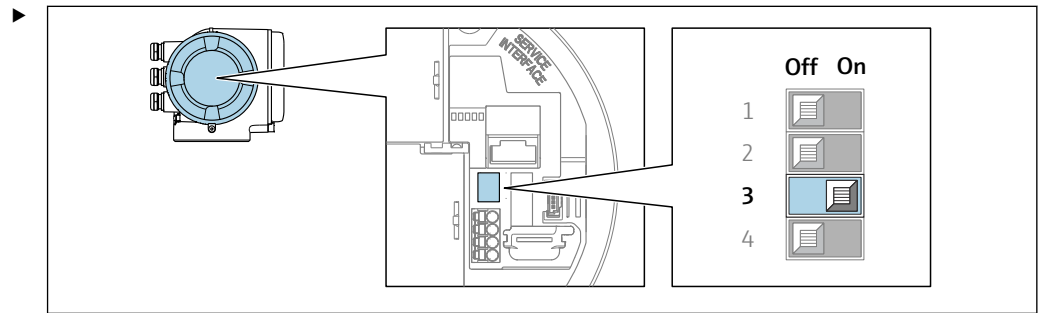

Switch DIP switch no. 3 to **On**.

## 7.7 Ensuring the degree of protection

The measuring instrument fulfills all the requirements for the degree of protection IP66/67, Type 4X enclosure.

To guarantee the degree of protection IP66/67, Type 4X enclosure, carry out the following steps after the electrical connection:

1. Check that the housing seals are clean and fitted correctly.
2. Dry, clean or replace the seals if necessary.
3. Tighten all housing screws and screw covers.
4. Firmly tighten the cable glands.
5. To ensure that moisture does not enter the cable entry:

Route the cable so that it loops down before the cable entry ("water trap").

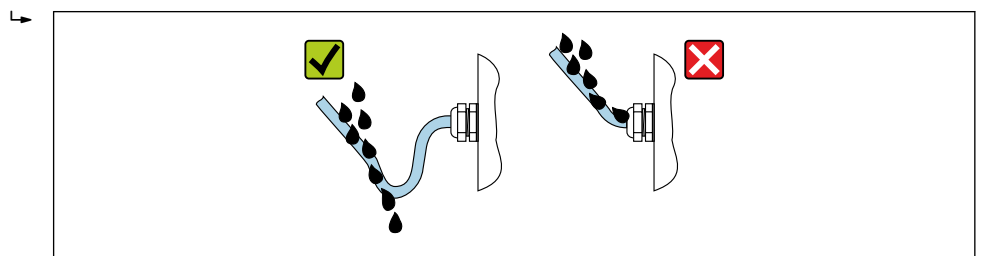

6. The cable glands supplied do not ensure housing protection when not in use. They must therefore be replaced by dummy plugs corresponding to the housing protection.

## 7.8 Post-connection check

|   |                          |
|---|--------------------------|
| Are the device and cable undamaged (visual inspection)? | <input type="checkbox"/> |
| Is the protective earthing established correctly?       | <input type="checkbox"/> |

|  |                          |
|--|--------------------------|
| Do the cables used comply with the requirements ?  | <input type="checkbox"/> |
| Are the installed cables strain-relieved and securely routed?  | <input type="checkbox"/> |
| Are all cable glands installed, securely tightened and leak-tight? Cable run with "water trap"<br>→ 43?        | <input type="checkbox"/> |
| Is the terminal assignment correct ?   | <input type="checkbox"/> |
| If supply voltage is present:<br>Does an indication appear on the display module?                              | <input type="checkbox"/> |
| Are dummy plugs inserted in unused cable entries and have transportation plugs been replaced with dummy plugs? | <input type="checkbox"/> |

## 8 Operation options

### 8.1 Overview of operation options

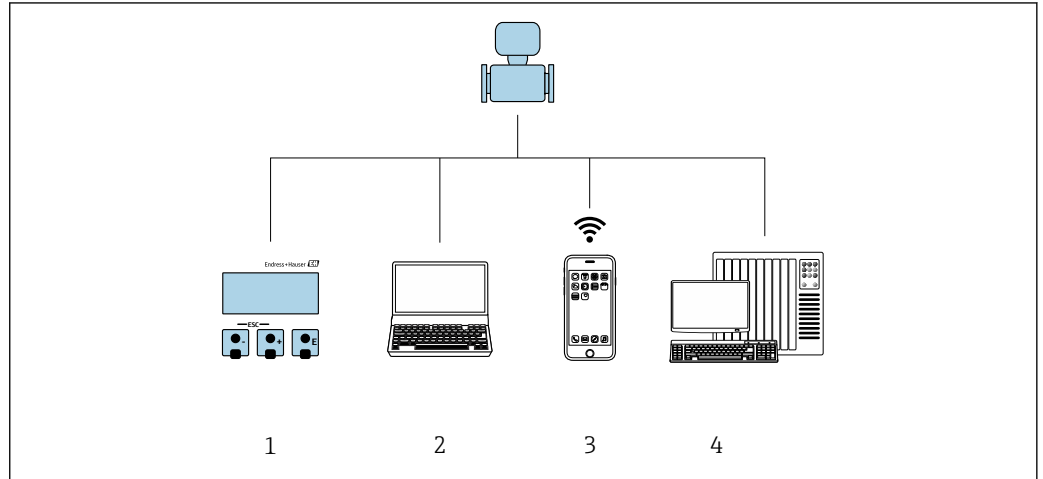

A0030213

- 1 Local operation via display module
- 2 Computer with web browser or operating tool (e.g. FieldCare, DeviceCare, AMS Device Manager, SIMATIC PDM)
- 3 Mobile handheld terminal with SmartBlue app
- 4 Automation system (e.g. PLC)

## 8.2 Structure and function of the operating menu

### 8.2.1 Structure of the operating menu



For an overview of the operating menu for experts: see the "Description of Device Parameters" document supplied with the device

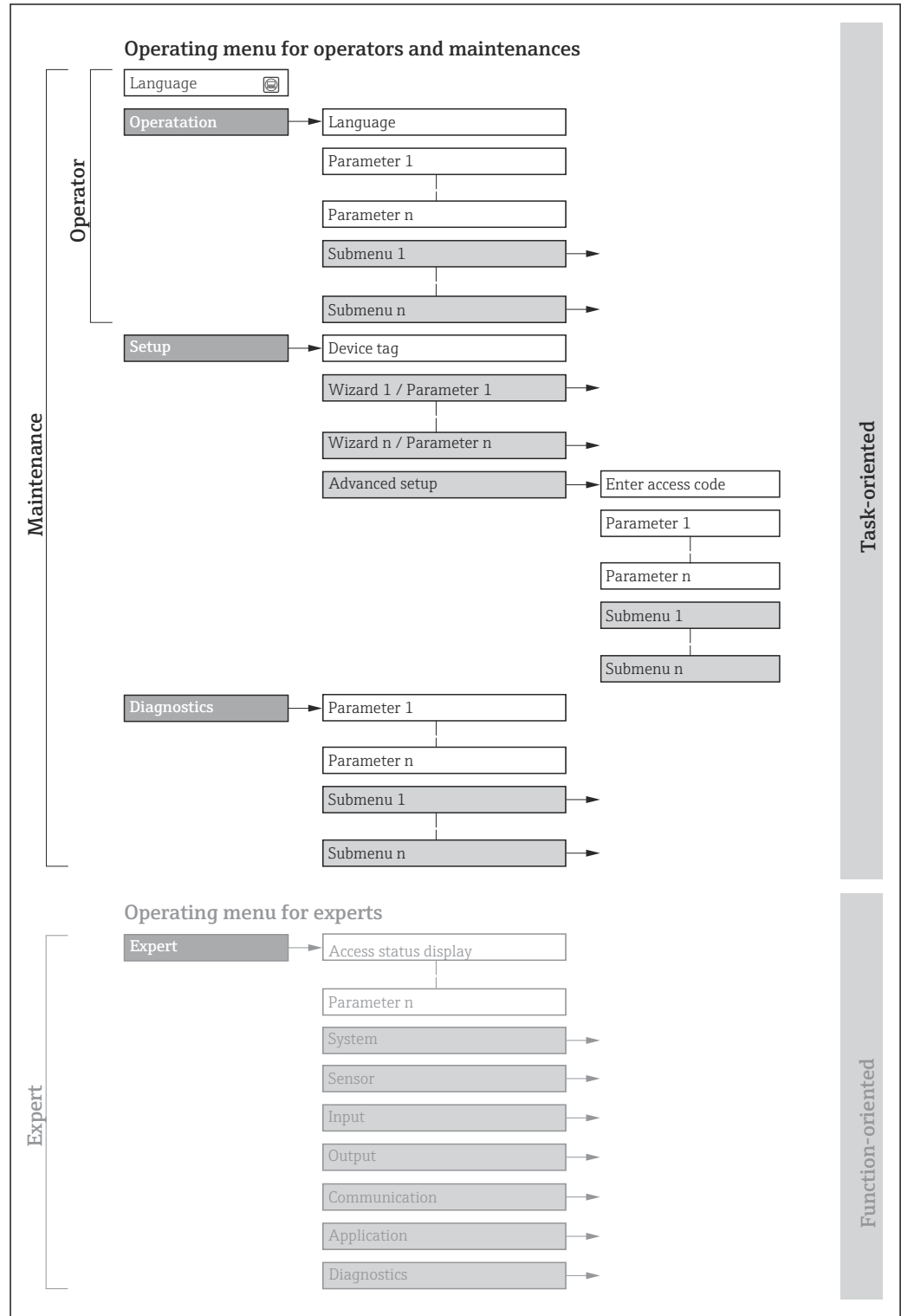

21 Schematic structure of the operating menu

A0018237-EN

### 8.2.2 Operating philosophy

The individual parts of the operating menu are assigned to certain user roles (e.g. operator, maintenance etc.). Each user role contains typical tasks within the device life cycle.

 For custody transfer, once the device has been put into circulation or sealed, its operation is restricted.

| Menu/parameter |   | User role and tasks   | Content/meaning  |
|----------------|---|---|--|
| Language       | Task-oriented   | <b>Role "Operator", "Maintenance"</b><br>Tasks during operation: <ul style="list-style-type: none"> <li>▪ Configuration of the operational display</li> <li>▪ Reading measured values</li> </ul>  | <ul style="list-style-type: none"> <li>▪ Defining the operating language</li> <li>▪ Defining the Web server operating language</li> <li>▪ Resetting and controlling totalizers</li> </ul>  |
| Operation      |   |   | <ul style="list-style-type: none"> <li>▪ Configuration of the operational display (e.g. display format, display contrast)</li> <li>▪ Resetting and controlling totalizers</li> </ul>   |
| Setup          |   | <b>"Maintenance" role</b><br>Commissioning: <ul style="list-style-type: none"> <li>▪ Configuration of the measurement</li> <li>▪ Configuration of the inputs and outputs</li> <li>▪ Configuration of the communication interface</li> </ul>   | Wizards for fast commissioning: <ul style="list-style-type: none"> <li>▪ Configuring the system units</li> <li>▪ Configuration of the communication interface</li> <li>▪ Definition of the medium</li> <li>▪ Displaying the I/O configuration</li> <li>▪ Configuring the inputs</li> <li>▪ Configuring the outputs</li> <li>▪ Configuration of the operational display</li> <li>▪ Configuring the low flow cut off</li> <li>▪ Configuring partial and empty pipe detection</li> </ul> Advanced setup <ul style="list-style-type: none"> <li>▪ For more customized configuration of the measurement (adaptation to special measuring conditions)</li> <li>▪ Configuration of totalizers</li> <li>▪ Configuration of WLAN settings</li> <li>▪ Administration (define access code, reset measuring device)</li> </ul> |
| Diagnostics    | <b>"Maintenance" role</b><br>Troubleshooting: <ul style="list-style-type: none"> <li>▪ Diagnostics and elimination of process and device errors</li> <li>▪ Measured value simulation</li> </ul> | Contains all parameters for error detection and analyzing process and device errors: <ul style="list-style-type: none"> <li>▪ Diagnostic list<br/>Contains up to 5 currently pending diagnostic messages.</li> <li>▪ Event logbook<br/>Contains event messages that have occurred.</li> <li>▪ Device information<br/>Contains information for identifying the device</li> <li>▪ Measured values<br/>Contains all current measured values.</li> <li>▪ <b>Data logging</b> submenu with the "Extended HistoROM" order option<br/>Storage and visualization of measured values</li> <li>▪ Heartbeat Technology<br/>Verification of device functionality on request and documentation of verification results</li> <li>▪ Simulation<br/>Used to simulate measured values or output values.</li> </ul> |  |

| Menu/parameter | User role and tasks | Content/meaning   |
|----------------|---------------------|---|
| Expert         | Function-oriented   | <p>Tasks that require detailed knowledge of the function of the device:</p> <ul style="list-style-type: none"> <li>▪ Commissioning measurements under difficult conditions</li> <li>▪ Optimal adaptation of the measurement to difficult conditions</li> <li>▪ Detailed configuration of the communication interface</li> <li>▪ Error diagnostics in difficult cases</li> </ul> <p>Contains all of the device parameters and allows direct access to these by means of an access code. The structure of this menu is based on the function blocks of the device:</p> <ul style="list-style-type: none"> <li>▪ System<br/>Contains all higher-level device parameters that do not affect measurement or measured value communication</li> <li>▪ Sensor<br/>Configuration of the measurement.</li> <li>▪ Input<br/>Configuration of the status input</li> <li>▪ Output<br/>Configuration of the analog current outputs as well as the pulse/frequency and switch output</li> <li>▪ Communication<br/>Configuration of the digital communication interface and the Web server</li> <li>▪ Application<br/>Configuration of the functions that go beyond the actual measurement (e.g. totalizer)</li> <li>▪ Diagnostics<br/>Error detection and analysis of process and device errors and for device simulation and Heartbeat Technology.</li> </ul> |

### 8.3 Access to operating menu via local display

#### 8.3.1 Operational display

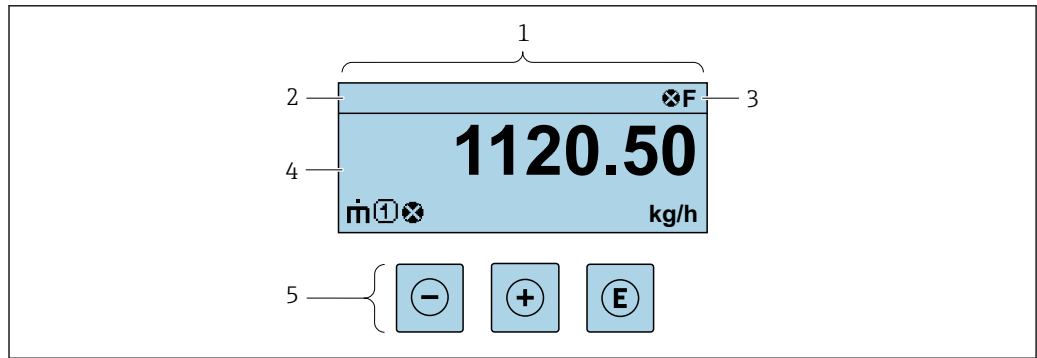

A0029348

- 1 Operational display
- 2 Device tag
- 3 Status area
- 4 Display range for measured values (up to 4 lines)
- 5 Operating elements → 55

#### Status area

The following symbols appear in the status area of the operational display at the top right:

- Status signals → 168
  - F: Failure
  - C: Function check
  - S: Out of specification
  - M: Maintenance required
- Diagnostic behavior → 169
  - ⊗: Alarm
  - ⚠: Warning
  - 🔒: Locking (the device is locked via the hardware )
  - ↔: Communication (communication via remote operation is active)



### Display area

In the display area, each measured value is prefaced by certain symbol types for further description:

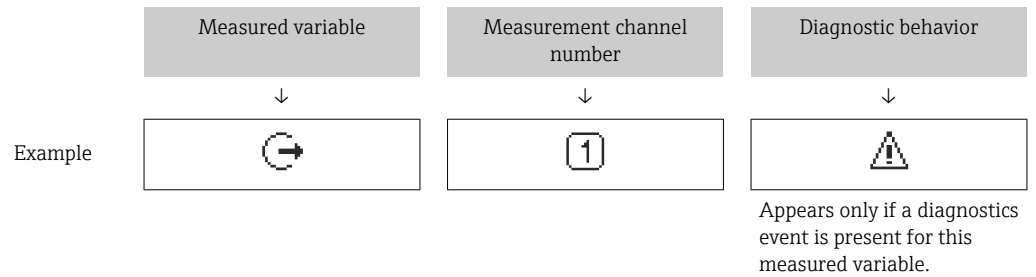

### Measured variables

| Symbol | Meaning  |
|--------|--|
|        | Mass flow  |
|        | <ul style="list-style-type: none"> <li>▪ Volume flow</li> <li>▪ Corrected volume flow</li> </ul> |
|        | <ul style="list-style-type: none"> <li>▪ Density</li> <li>▪ Reference density</li> </ul>         |
|        | Temperature  |

The number and display format of the measured variables can be configured via the **Format display** parameter (→ 109).

### Totalizer

| Symbol | Meaning   |
|--------|---|
|        | Totalizer<br>The measurement channel number indicates which of the three totalizers is displayed. |

### Output

| Symbol | Meaning   |
|--------|---|
|        | Output<br>The measurement channel number indicates which of the outputs is displayed. |



### Input

| Symbol | Meaning      |
|--------|--------------|
|        | Status input |

### Measurement channel numbers

| Symbol | Meaning   |
|--------|---|
|        | Measurement channel 1 to 4<br>The measurement channel number is displayed only if more than one channel is present for the same measured variable type (e.g. totalizer 1 to 3). |

*Diagnostic behavior*

| Symbol  | Meaning   |
|---|---|
|  | <b>Alarm</b> <ul style="list-style-type: none"><li>▪ Measurement is interrupted.</li><li>▪ Signal outputs and totalizers assume the defined alarm condition.</li><li>▪ A diagnostic message is generated.</li></ul> |
|  | <b>Warning</b> <ul style="list-style-type: none"><li>▪ Measurement is resumed.</li><li>▪ The signal outputs and totalizers are not affected.</li><li>▪ A diagnostic message is generated.</li></ul>                 |

 The diagnostic behavior pertains to a diagnostic event that is relevant to the displayed measured variable.

### 8.3.2 Navigation view

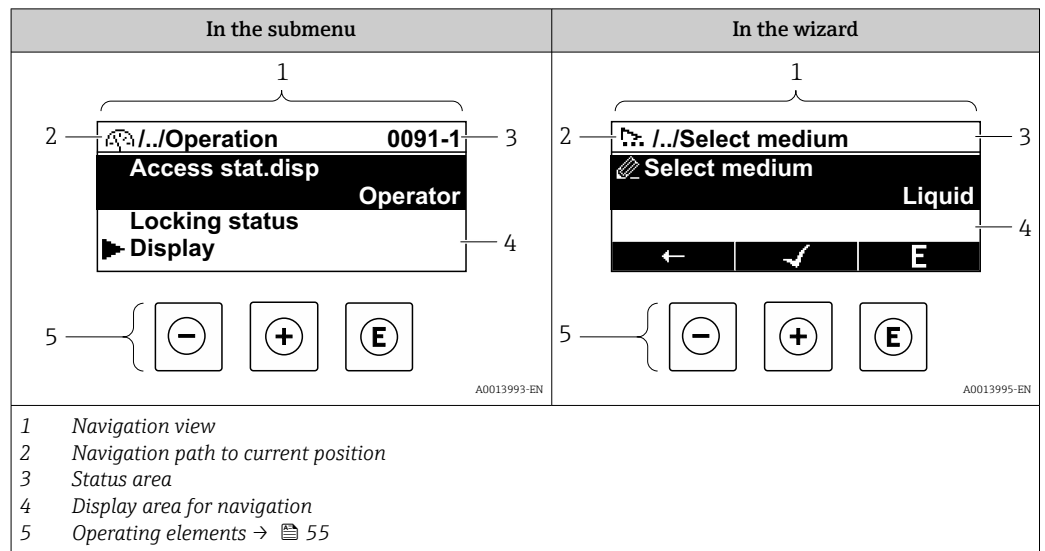

#### Navigation path

The navigation path to the current position is displayed at the top left in the navigation view and consists of the following elements:

- The display symbol for the menu/submenu (▶) or the wizard (⚙).
- An omission symbol (/ ../) for operating menu levels in between.
- Name of the current submenu, wizard or parameter

|         | Display symbol | Omission symbol | Parameter  |
|---------|----------------|-----------------|------------|
|         | ↓              | ↓               | ↓          |
| Example | ▶              | / ../           | Indication |

**i** For more information about the icons in the menu, refer to the "Display area" section → 51

#### Status area

The following appears in the status area of the navigation view in the top right corner:



- In the submenu
  - The direct access code to the parameter (e.g., 0022-1)
  - If a diagnostic event is present, the diagnostic behavior and status signal
- In the wizard
  - If a diagnostic event is present, the diagnostic behavior and status signal

**i** For information on the diagnostic behavior and status signal → 168  
 For information on the function and entry of the direct access code → 57





#### Display area

##### Menus

| Symbol | Meaning  |
|--------|--|
|        | <b>Operation</b><br>Is displayed: <ul style="list-style-type: none"> <li>▪ In the menu next to the "Operation" selection</li> <li>▪ At the left in the navigation path in the <b>Operation</b> menu</li> </ul> |

|   |  |
|---|--|
|  | <p><b>Setup</b><br/>Is displayed:</p> <ul style="list-style-type: none"> <li>▪ In the menu next to the "Setup" selection</li> <li>▪ At the left in the navigation path in the <b>Setup</b> menu</li> </ul>                 |
|  | <p><b>Diagnosis</b><br/>Is displayed:</p> <ul style="list-style-type: none"> <li>▪ In the menu next to the "Diagnostics" selection</li> <li>▪ At the left in the navigation path in the <b>Diagnostics</b> menu</li> </ul> |
|  | <p><b>Expert</b><br/>Is displayed:</p> <ul style="list-style-type: none"> <li>▪ In the menu next to the "Expert" selection</li> <li>▪ At the left in the navigation path in the <b>Expert</b> menu</li> </ul>              |



*Submenus, wizards, parameters*

| Symbol  | Meaning  |
|---|--|
|  | Submenu  |
|  | Wizards  |
|  | Parameters within a wizard<br> No display symbol exists for parameters in submenus. |

*Locking procedure*

| Symbol  | Meaning   |
|---|---|
|  | <p><b>Parameter locked</b><br/>When displayed in front of a parameter name, indicates that the parameter is locked.</p> <ul style="list-style-type: none"> <li>▪ By a user-specific access code</li> <li>▪ By the hardware write protection switch</li> </ul> |

*Wizards*

| Symbol  | Meaning  |
|---|--|
|  | Switches to the previous parameter.                              |
|  | Confirms the parameter value and switches to the next parameter. |
|  | Opens the editing view of the parameter.                         |

### 8.3.3 Editing view

#### Numeric editor

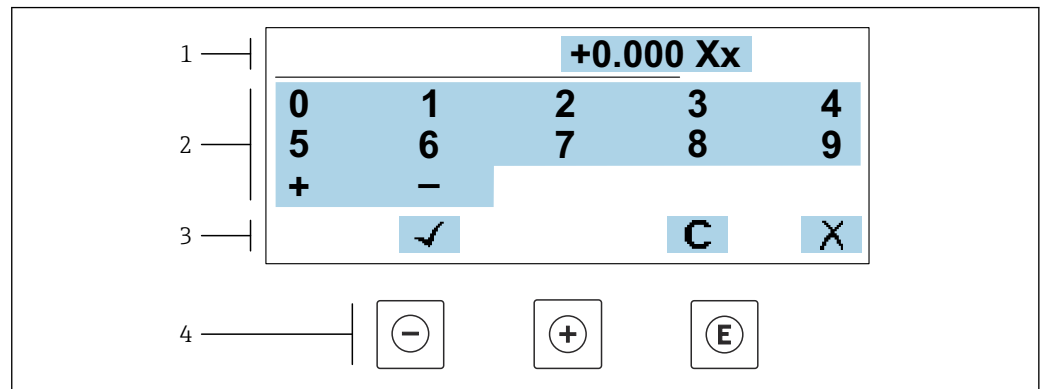

A0034250

22 For entering values in parameters (e.g. limit values)

- 1 Entry display area
- 2 Input screen
- 3 Confirm, delete or reject entry
- 4 Operating elements

#### Text editor

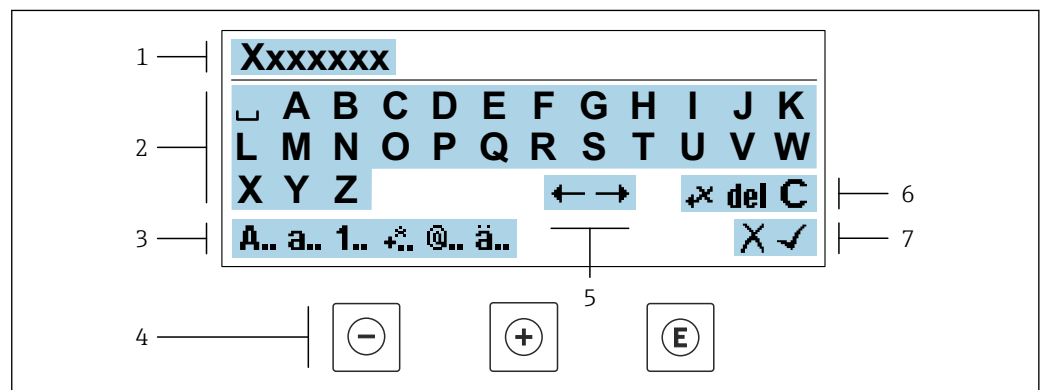



A0034114

23 For entering text in parameters (e.g. device tag)



- 1 Entry display area
- 2 Current input screen
- 3 Change input screen
- 4 Operating elements
- 5 Move entry position
- 6 Delete entry
- 7 Reject or confirm entry

#### Using the operating elements in the editing view





| Operating key | Meaning  |
|---------------|--|
| ⊖             | <b>Minus key</b><br>Move the entry position to the left. |
| ⊕             | <b>Plus key</b><br>Move the entry position to the right. |

| Operating key   | Meaning   |
|---|---|
|  | <b>Enter key</b> <ul style="list-style-type: none"> <li>▪ Pressing the key briefly confirms your selection.</li> <li>▪ Pressing the key for 2 s confirms your entry.</li> </ul> |
|  | <b>Escape key combination (press keys simultaneously)</b><br>Close the editing view without accepting a change.   |





*Input screens*

| Symbol  | Meaning   |
|---|---|
| <b>A..</b>  | Upper case  |
| <b>a..</b>  | Lower case  |
| <b>1..</b>  | Numbers   |
|  | Punctuation marks and special characters: = + - * / <sup>2</sup> <sup>3</sup> ¼ ½ ¾ ( ) [ ] < > { } |
|  | Punctuation marks and special characters: " ` ^ . , ; : ? ! % μ ° € \$ £ ¥ \$ @ # / \   ~ & _       |
| <b>ä..</b>  | Umlauts and accents   |

*Controlling data entries*

| Symbol  | Meaning   |
|---|---|
|  | Move entry position   |
|  | Reject entry  |
|  | Confirm entry   |
|  | Delete character immediately to the left of the entry position  |
| <b>del</b>  | Delete character immediately to the right of the entry position |
| <b>C</b>  | Clear all the characters entered                                |

### 8.3.4 Operating elements

| Operating key   | Meaning  |
|---|--|
|    | <p><b>Minus key</b></p> <p><i>In menu, submenu</i><br/>Moves the selection bar upwards in a picklist</p> <p><i>In wizards</i><br/>Goes to previous parameter</p> <p><i>In the text and numeric editor</i><br/>Move the entry position to the left.</p>   |
|    | <p><b>Plus key</b></p> <p><i>In menu, submenu</i><br/>Moves the selection bar downwards in a picklist</p> <p><i>In wizards</i><br/>Goes to the next parameter</p> <p><i>In the text and numeric editor</i><br/>Move the entry position to the right.</p>   |
|   | <p><b>Enter key</b></p> <p><i>In the operational display</i><br/>Pressing the key briefly opens the operating menu.</p> <p><i>In menu, submenu</i></p> <ul style="list-style-type: none"> <li>▪ Pressing the key briefly: <ul style="list-style-type: none"> <li>▪ Opens the selected menu, submenu or parameter.</li> <li>▪ Starts the wizard.</li> <li>▪ If help text is open, closes the help text of the parameter.</li> </ul> </li> <li>▪ Pressing the key for 2 s in a parameter: <ul style="list-style-type: none"> <li>▪ If present, opens the help text for the function of the parameter.</li> </ul> </li> </ul> <p><i>In wizards</i><br/>Opens the editing view of the parameter and confirms the parameter value</p> <p><i>In the text and numeric editor</i></p> <ul style="list-style-type: none"> <li>▪ Pressing the key briefly confirms your selection.</li> <li>▪ Pressing the key for 2 s confirms your entry.</li> </ul> |
|  | <p><b>Escape key combination (press keys simultaneously)</b></p> <p><i>In menu, submenu</i></p> <ul style="list-style-type: none"> <li>▪ Pressing the key briefly: <ul style="list-style-type: none"> <li>▪ Exits the current menu level and takes you to the next higher level.</li> <li>▪ If help text is open, closes the help text of the parameter.</li> </ul> </li> <li>▪ Pressing the key for 2 s returns you to the operational display ("home position").</li> </ul> <p><i>In wizards</i><br/>Exits the wizard and takes you to the next higher level</p> <p><i>In the text and numeric editor</i><br/>Exits the Editing view without applying the changes.</p>   |
|  | <p><b>Minus/Enter key combination (press and hold down the keys simultaneously)</b></p> <ul style="list-style-type: none"> <li>▪ If keypad lock is active: <ul style="list-style-type: none"> <li>▪ Pressing the key for 3 s deactivates the keypad lock.</li> </ul> </li> <li>▪ If keypad lock is not active: <ul style="list-style-type: none"> <li>▪ Pressing the key for 3 s opens the context menu including the option for activating the keypad lock.</li> </ul> </li> </ul>  |

### 8.3.5 Opening the context menu

Using the context menu, the user can call up the following menus quickly and directly from the operational display:

- Setup
- Data backup
- Simulation

### Calling up and closing the context menu

The user is in the operational display.

1. Press the  $\square$  and  $\boxplus$  keys for longer than 3 seconds.  
↳ The context menu opens.

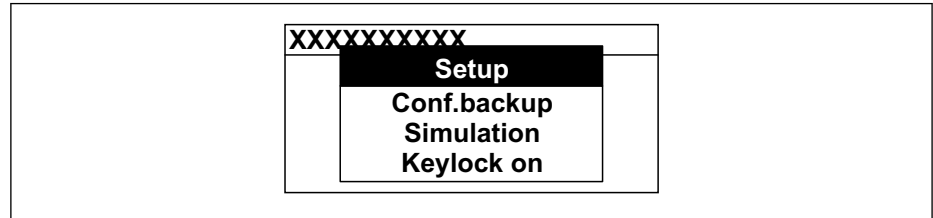

A0034608-EN

2. Press  $\square$  +  $\boxplus$  simultaneously.  
↳ The context menu is closed and the operational display appears.

### Calling up the menu via the context menu

1. Open the context menu.
2. Press  $\boxplus$  to navigate to the desired menu.
3. Press  $\square$  to confirm the selection.  
↳ The selected menu opens.



### 8.3.6 Navigating and selecting from list

Different operating elements are used to navigate through the operating menu. The navigation path is displayed on the left in the header. Icons are displayed in front of the individual menus. These icons are also shown in the header during navigation.

**i** For an explanation of the navigation view with symbols and operating elements → 51

**Example: Setting the number of displayed measured values to "2 values"**

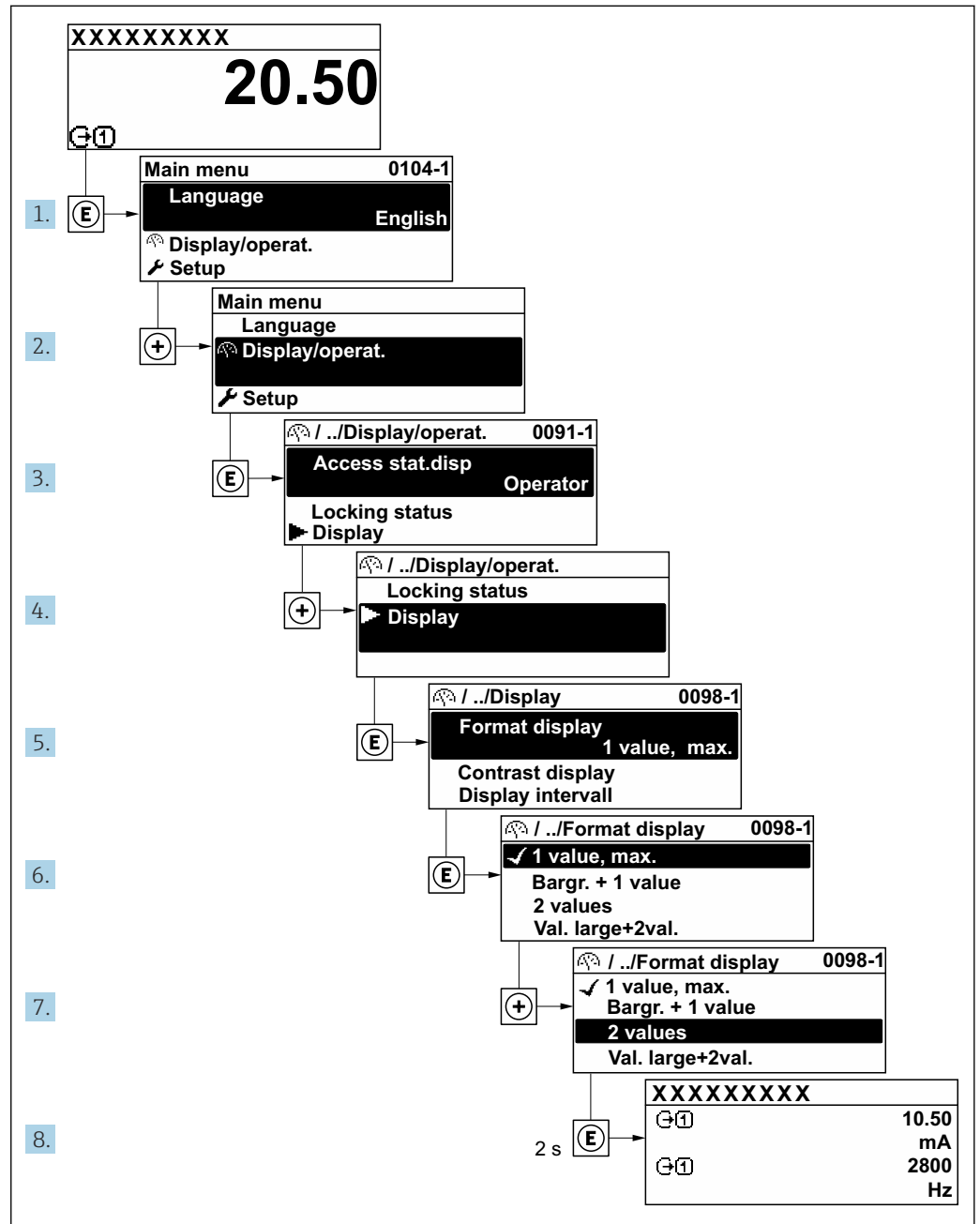

A0029562-EN

### 8.3.7 Calling the parameter directly

A parameter number is assigned to every parameter to be able to access a parameter directly via the onsite display. Entering this access code in the **Direct access** parameter calls up the desired parameter directly.

#### Navigation path

Expert → Direct access

The direct access code consists of a 5-digit number (at maximum) and the channel number, which identifies the channel of a process variable: e.g. 00914-2. In the navigation view, this appears on the right-hand side in the header of the selected parameter.

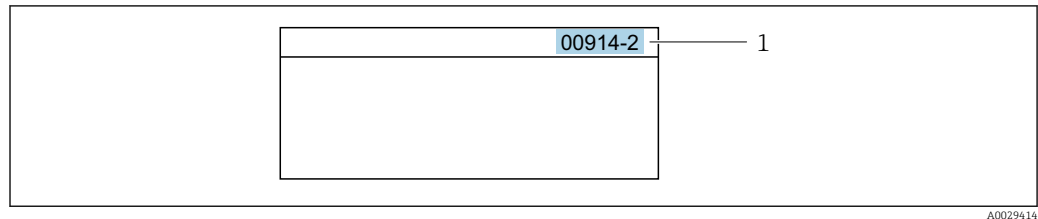

1 Direct access code

Note the following when entering the direct access code:

- The leading zeros in the direct access code do not have to be entered.  
Example: Enter "914" instead of "00914"
- If no channel number is entered, channel 1 is opened automatically.  
Example: Enter 00914 → **Assign process variable** parameter
- If a different channel is opened: Enter the direct access code with the corresponding channel number.  
Example: Enter 00914-2 → **Assign process variable** parameter

 For the direct access codes of the individual parameters, see the "Description of Device Parameters" document for the device

### 8.3.8 Calling up help text

Help text is available for some parameters and can be called up from the navigation view. The help text provides a brief explanation of the parameter function and thereby supports swift and safe commissioning.



#### Calling up and closing the help text

The user is in the navigation view and the selection bar is on a parameter.

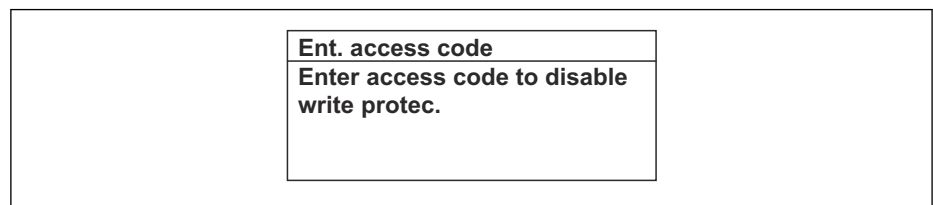
1. Press  for 2 s.  
↳ The help text for the selected parameter opens.



 24 Example: Help text for parameter "Enter access code"

2. Press  +  simultaneously.  
↳ The help text is closed.

### 8.3.9 Changing the parameters

Parameters can be changed via the numeric editor or text editor.

- Numeric editor: Change values in a parameter, e.g. specifications for limit values.
- Text editor: Enter text in a parameter, e.g. tag name.

A message is displayed if the value entered is outside the permitted value range.

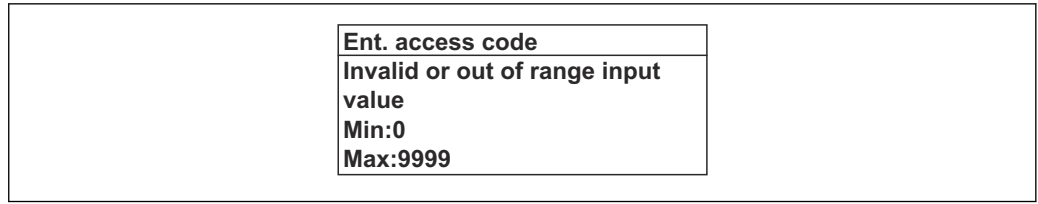

A0014049-EN

For a description of the editing view - consisting of the text editor and numeric editor - with symbols → 53, for a description of the operating elements → 55

### 8.3.10 User roles and related access authorization

The two user roles "Operator" and "Maintenance" have different write access to the parameters if the customer defines a user-specific access code. This protects the device configuration via the local display from unauthorized access → 139.

#### Defining access authorization for user roles

An access code is not yet defined when the device is delivered from the factory. Access authorization (read and write access) to the device is not restricted and corresponds to the "Maintenance" user role.

- ▶ Define the access code.
  - ↳ The "Operator" user role is redefined in addition to the "Maintenance" user role. Access authorization differs for the two user roles.

*Access authorization to parameters: "Maintenance" user role*

| Access code status   | Read access | Write access    |
|--|-------------|-----------------|
| An access code has not yet been defined (factory setting). | ✓           | ✓               |
| After an access code has been defined.                     | ✓           | ✓ <sup>1)</sup> |

1) The user only has write access after entering the access code.

*Access authorization to parameters: "Operator" user role*

| Access code status                     | Read access | Write access    |
|--|-------------|-----------------|
| After an access code has been defined. | ✓           | _ <sup>1)</sup> |

1) Despite the defined access code, certain parameters can always be modified and thus are excluded from the write protection as they do not affect the measurement: write protection via access code → 139

The user role with which the user is currently logged on is indicated by the **Access status** parameter. Navigation path: Operation → Access status

### 8.3.11 Disabling write protection via access code

If the -symbol appears on the local display in front of a parameter, the parameter is write-protected by a user-specific access code and its value cannot be changed at the moment using local operation → 139.

Parameter write protection via local operation can be disabled by entering the user-specific access code in the **Enter access code** parameter (→ 115) via the respective access option.

1. After you press , the input prompt for the access code appears.

2. Enter the access code.
  - ↳ The -symbol in front of the parameters disappears; all previously write-protected parameters are now re-enabled.

### 8.3.12 Enabling and disabling the keypad lock



The keypad lock makes it possible to block access to the entire operating menu via local operation. As a result, it is no longer possible to navigate through the operating menu or change the values of individual parameters. Users can only read the measured values on the operational display.

The keypad lock is switched on and off via the context menu.

#### Switching on the keypad lock



-  The keypad lock is switched on automatically:
- If the device has not been operated via the display for > 1 minute.
  - Each time the device is restarted.

#### To activate the keylock manually:

1. The device is in the measured value display.  
Press the  and  keys for 3 seconds.
  - ↳ A context menu appears.
2. In the context menu select the **Keylock on** option.
  - ↳ The keypad lock is switched on.

-  If the user attempts to access the operating menu while the keypad lock is active, the **Keylock on** message appears.

#### Switching off the keypad lock



- ▶ The keypad lock is switched on.  
Press the  and  keys for 3 seconds.
  - ↳ The keypad lock is switched off.

## 8.4 Access to operating menu via web browser

### 8.4.1 Function range

With the integrated web server, the device can be operated and configured via a web browser service interface (CDI-RJ45) or WLAN interface. The structure of the operating menu is the same as for the local display. In addition to the measured values, status information on the device is displayed and can be used to monitor device health. Furthermore the device data can be managed and the network parameters can be configured.

A device that has a WLAN interface (can be ordered as an option) is required for the WLAN connection: order code for "Display; operation", option G "4-line, illuminated; touch control + WLAN". The device acts as an Access Point and enables communication by computer or a mobile handheld terminal.

-  For additional information on the web server, see the Special Documentation for the device. →  224

## 8.4.2 Requirements

### Computer hardware



| Hardware   | Interface  |  |
|------------|--|--|
|            | CDI-RJ45   | WLAN   |
| Interface  | The computer must have a RJ45 interface. <sup>1)</sup>     | The operating unit must have a WLAN interface. |
| Connection | Standard Ethernet cable                                    | Connection via Wireless LAN.                   |
| Screen     | Recommended size: ≥ 12" (depends on the screen resolution) |  |

1) Recommended cable: CAT5e, CAT6 or CAT7, with shielded plug (e.g. YAMAICHI product; part no. Y-ConProfixPlug63/Prod. ID: 82-006660)

### Computer software

| Software                      | Interface  |      |
|-------------------------------|--|------|
|                               | CDI-RJ45   | WLAN |
| Recommended operating systems | <ul style="list-style-type: none"> <li>▪ Microsoft Windows 8 or higher.</li> <li>▪ Mobile operating systems:                             <ul style="list-style-type: none"> <li>▪ iOS</li> <li>▪ Android</li> </ul> </li> </ul>  Microsoft Windows XP and Windows 7 is supported. |      |
| Web browsers supported        | <ul style="list-style-type: none"> <li>▪ Microsoft Internet Explorer 8 or higher</li> <li>▪ Microsoft Edge</li> <li>▪ Mozilla Firefox</li> <li>▪ Google Chrome</li> <li>▪ Safari</li> </ul>  |      |

### Computer settings

| Settings                                 | Interface  |  |
|--|--|--|
|  | CDI-RJ45   | WLAN   |
| User rights                              | Appropriate user rights (e.g. administrator rights) for TCP/IP and proxy server settings are necessary (e.g. for adjusting the IP address, subnet mask etc.).  |  |
| Proxy server settings of the web browser | The web browser setting <i>Use a proxy server for your LAN</i> must be <b>disabled</b> .   |  |
| JavaScript                               | JavaScript must be enabled.<br> If JavaScript cannot be enabled:<br>Enter <code>http://192.168.1.212/servlet/basic.html</code> in the address bar of the web browser. A fully functional but simplified version of the operating menu structure starts in the web browser.<br><br> When installing a new firmware version:<br>To enable correct data display, clear the temporary memory (cache) under <b>Internet options</b> in the web browser. | JavaScript must be enabled.<br> The WLAN display requires JavaScript support. |
| Network connections                      | Only use the active network connections to the measuring device.   |  |
|  | Switch off all other network connections such as WLAN for example.   | Switch off all other network connections.  |

 In the event of connection problems: →  166

*Measuring device: Via CDI-RJ45 service interface*

| Device           | CDI-RJ45 service interface   |
|------------------|--|
| Measuring device | The measuring device has an RJ45 interface.  |
| Web server       | Web server must be enabled; factory setting: ON<br> For information on enabling the Web server → 66 |

*Measuring device: via WLAN interface*

| Device           | WLAN interface  |
|------------------|---|
| Measuring device | The measuring device has a WLAN antenna: <ul style="list-style-type: none"> <li>▪ Transmitter with integrated WLAN antenna</li> <li>▪ Transmitter with external WLAN antenna</li> </ul>       |
| Web server       | Web server and WLAN must be enabled; factory setting: ON<br> For information on enabling the Web server → 66 |

### 8.4.3 Connecting the device

#### Via service interface (CDI-RJ45)

*Preparing the measuring device*

1. Depending on the housing version:  
Loosen the securing clamp or fixing screw of the housing cover.
2. Depending on the housing version:  
Unscrew or open the housing cover.
3. Connect the computer to the RJ45 plug via the standard Ethernet connecting cable..

*Configuring the Internet protocol of the computer*

The following information refers to the default Ethernet settings of the device.

IP address of the device: 192.168.1.212 (factory setting)

1. Switch on the measuring device.
2. Connect the computer to the RJ45 plug via the standard Ethernet cable → 67.
3. If a 2nd network card is not used, close all the applications on the notebook.
  - ↳ Applications requiring Internet or a network, such as e-mail, SAP applications, Internet or Windows Explorer.
4. Close any open Internet browsers.
5. Configure the properties of the Internet protocol (TCP/IP) as defined in the table:

|                 |  |
|-----------------|--|
| IP address      | 192.168.1.XXX; for XXX all numerical sequences except: 0, 212 and 255 → e.g. 192.168.1.213 |
| Subnet mask     | 255.255.255.0  |
| Default gateway | 192.168.1.212 or leave cells empty   |

#### Via WLAN interface

*Configuring the Internet protocol of the mobile terminal*

**NOTICE**

**If the WLAN connection is lost during the configuration, settings made may be lost.**

- ▶ Make sure that the WLAN connection is not disconnected while configuring the device.

**NOTICE****Note the following to avoid a network conflict:**

- ▶ Avoid accessing the measuring device simultaneously from the same mobile terminal via the service interface (CDI-RJ45) and the WLAN interface.
- ▶ Only activate one service interface (CDI-RJ45 or WLAN interface).
- ▶ If simultaneous communication is necessary: configure different IP address ranges, e.g. 192.168.0.1 (WLAN interface) and 192.168.1.212 (CDI-RJ45 service interface).

*Preparing the mobile terminal*

- ▶ Enable WLAN on the mobile terminal.

*Establishing a WLAN connection from the mobile terminal to the measuring device*

1. In the WLAN settings of the mobile terminal:  
Select the measuring device using the SSID (e.g. EH\_Promass\_300\_A802000).
2. If necessary, select the WPA2 encryption method.
3. Enter the password:  
Serial number of the measuring device ex-works (e.g. L100A802000).
  - ↳ The LED on the display module flashes. It is now possible to operate the measuring device with the web browser, FieldCare or DeviceCare.



The serial number can be found on the nameplate.



To ensure the safe and swift assignment of the WLAN network to the measuring point, it is advisable to change the SSID name. It should be possible to clearly assign the new SSID name to the measuring point (e.g. tag name) because it is displayed as the WLAN network.

*Terminating the WLAN connection*

- ▶ After configuring the device:  
Terminate the WLAN connection between the mobile terminal and measuring device.

**Starting the web browser**

1. Start the web browser on the computer.

2. Enter the IP address of the web server in the address line of the web browser:  
192.168.1.212  
↳ The login page appears.

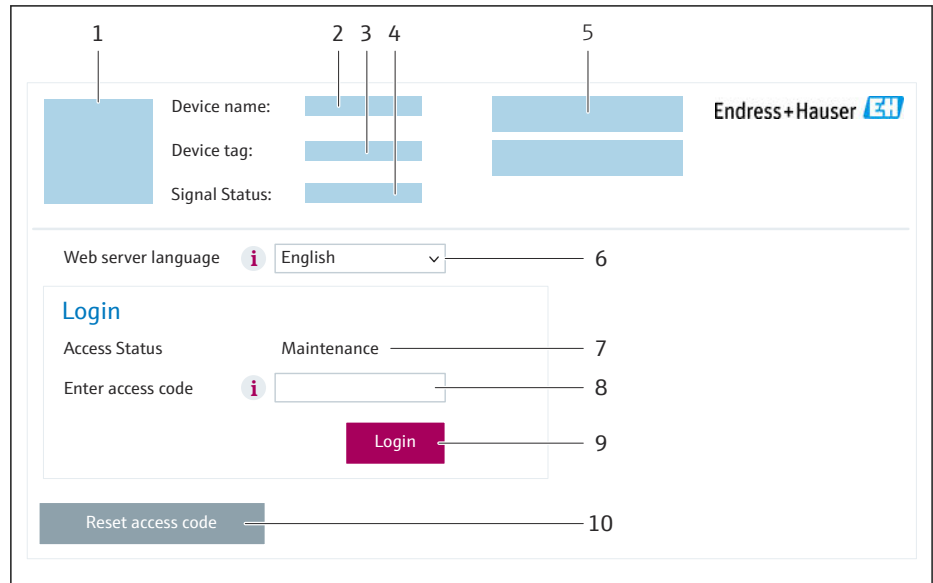

- 1 Picture of device
- 2 Device name
- 3 Device tag
- 4 Status signal
- 5 Current measured values
- 6 Operating language
- 7 User role
- 8 Access code
- 9 Login
- 10 Reset access code (→ 135)

**i** If a login page does not appear, or if the page is incomplete → 166

### 8.4.4 Logging on

1. Select the preferred operating language for the Web browser.
2. Enter the user-specific access code.
3. Press **OK** to confirm your entry.

|                    |  |
|--------------------|--|
| <b>Access code</b> | 0000 (factory setting); can be changed by customer |
|--------------------|--|

**i** If no action is performed for 10 minutes, the Web browser automatically returns to the login page.



### 8.4.5 User interface



A0029418

- 1 Function row
- 2 Local display language
- 3 Navigation area

#### Header

The following information appears in the header:

- Device name
- Device tag
- Device status with status signal → 📄 171
- Current measured values

#### Function row

| Functions       | Meaning   |
|-----------------|---|
| Measured values | Displays the measured values of the device  |
| Menu            | <ul style="list-style-type: none"> <li>■ Access to the operating menu from the measuring device</li> <li>■ The structure of the operating menu is the same as for the local display</li> </ul>  Detailed information on the operating menu structure: Description of Device Parameters   |
| Device status   | Displays the diagnostic messages currently pending, listed in order of priority   |
| Data management | Data exchange between computer and measuring device: <ul style="list-style-type: none"> <li>■ Device configuration:                             <ul style="list-style-type: none"> <li>■ Load settings from the device (XML format, save configuration)</li> <li>■ Save settings to the device (XML format, restore configuration)</li> </ul> </li> <li>■ Logbook - Export Event logbook (.csv file)</li> <li>■ Documents - Export documents:                             <ul style="list-style-type: none"> <li>■ Export backup data record (.csv file, create documentation of the measuring point configuration)</li> <li>■ Verification report (PDF file, only available with the "Heartbeat Verification" application package)</li> </ul> </li> <li>■ Firmware update - Flashing a firmware version</li> </ul> |
| Network         | Configuration and checking of all the parameters required for establishing the connection to the measuring device: <ul style="list-style-type: none"> <li>■ Network settings (e.g. IP address, MAC address)</li> <li>■ Device information (e.g. serial number, firmware version)</li> </ul>   |
| Logout          | End the operation and call up the login page  |

#### Navigation area

The menus, the associated submenus and parameters can be selected in the navigation area.

**Working area**

Depending on the selected function and the related submenus, various actions can be performed in this area:

- Configuring parameters
- Reading measured values
- Calling up help text
- Starting an upload/download

**8.4.6 Disabling the Web server**

The Web server of the measuring device can be switched on and off as required using the **Web server functionality** parameter.

**Navigation**

"Expert" menu → Communication → Web server

**Parameter overview with brief description**

| Parameter                | Description                       | Selection   | Factory setting |
|--------------------------|-----------------------------------|---|-----------------|
| Web server functionality | Switch the Web server on and off. | <ul style="list-style-type: none"> <li>▪ Off</li> <li>▪ HTML Off</li> <li>▪ On</li> </ul> | On              |

**Function scope of the "Web server functionality" parameter**

| Option   | Description   |
|----------|---|
| Off      | <ul style="list-style-type: none"> <li>▪ The Web server is completely disabled.</li> <li>▪ Port 80 is locked.</li> </ul>  |
| HTML Off | The HTML version of the Web server is not available.  |
| On       | <ul style="list-style-type: none"> <li>▪ The complete Web server functionality is available.</li> <li>▪ JavaScript is used.</li> <li>▪ The password is transferred in an encrypted state.</li> <li>▪ Any change to the password is also transferred in an encrypted state.</li> </ul> |

**Enabling the Web server**

If the Web server is disabled it can only be re-enabled with the **Web server functionality** parameter via the following operating options:

- Via local display
- Via Bedientool "FieldCare"
- Via "DeviceCare" operating tool

**8.4.7 Logging out**

 Before logging out, perform a data backup via the **Data management** function (upload configuration from device) if necessary.

1. Select the **Logout** entry in the function row.
  - ↳ The home page with the Login box appears.
2. Close the Web browser.
3. If no longer needed:
  - Reset the modified properties of the Internet protocol (TCP/IP) →  62.

## 8.5 Access to the operating menu via the operating tool

The structure of the operating menu in the operating tools is the same as for operation via the local display.

### 8.5.1 Connecting the operating tool

#### Via Modbus RS485 protocol

This communication interface is available in device versions with a Modbus RS485 output.

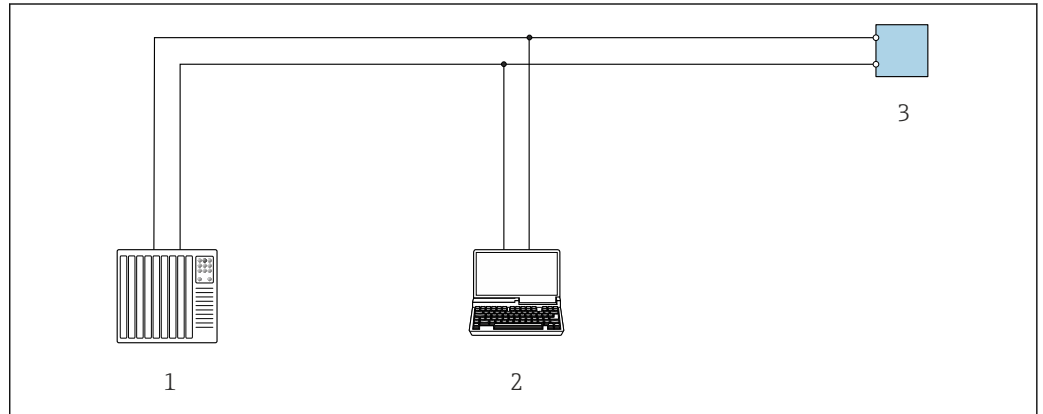

25 Options for remote operation via Modbus RS485 protocol (active)

- 1 Control system (e.g. PLC)
- 2 Computer with web browser (e.g. Microsoft Edge) to access the integrated device web server or with operating tool (e.g. FieldCare, DeviceCare) with COM DTM "CDI Communication TCP/IP" or Modbus DTM
- 3 Transmitter

#### Service interface

##### Via service interface (CDI-RJ45)

A point-to-point connection can be established to configure the device onsite. With the housing open, the connection is established directly via the service interface (CDI-RJ45) of the device.

**i** An adapter for the RJ45 to the M12 plug is optionally available for the non-hazardous area:

Order code for "Accessories", option **NB**: "Adapter RJ45 M12 (service interface)"

The adapter connects the service interface (CDI-RJ45) to an M12 plug mounted in the cable entry. The connection to the service interface can be established via an M12 plug without opening the device.

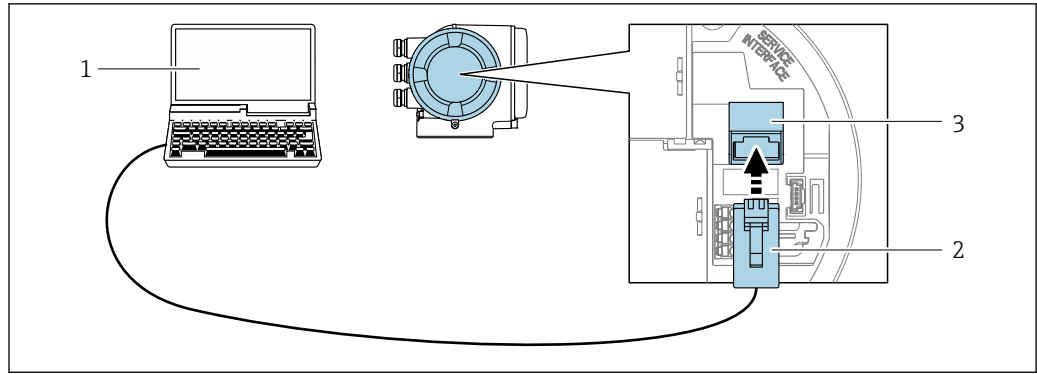

A0027563

26 Connection via service interface (CDI-RJ45)

- 1 Computer with web browser (e.g. Microsoft Internet Explorer, Microsoft Edge) for accessing the integrated web server or with "FieldCare" operating tool, "DeviceCare" with COM DTM "CDI Communication TCP/IP" or Modbus DTM
- 2 Standard Ethernet connecting cable with RJ45 plug
- 3 Service interface (CDI-RJ45) of the measuring device with access to the integrated Web server

Via WLAN interface

The optional WLAN interface is available on the following device version:

Order code for "Display; operation", option G "4-line, illuminated; touch control + WLAN"

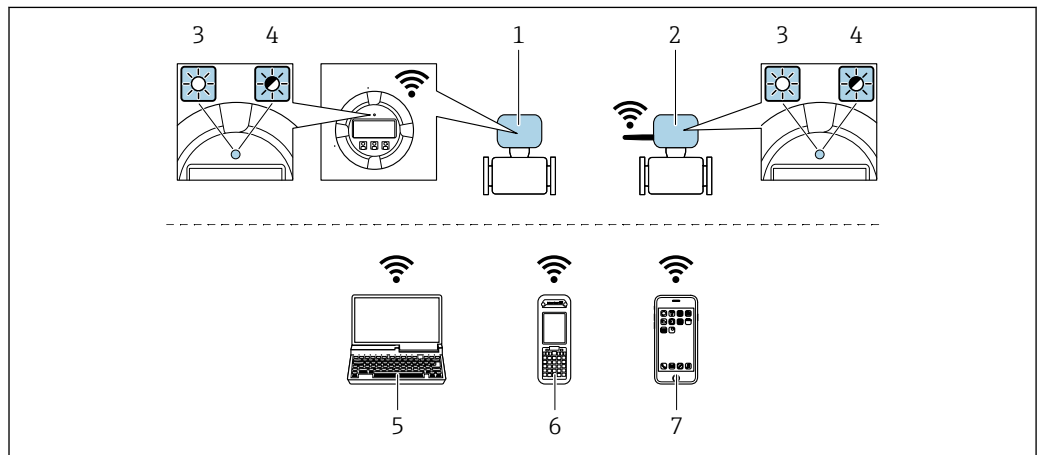

A0034570

- 1 Transmitter with integrated WLAN antenna
- 2 Transmitter with external WLAN antenna
- 3 LED lit constantly: WLAN reception is enabled on measuring device
- 4 LED flashing: WLAN connection established between operating unit and measuring device
- 5 Computer with WLAN interface and web browser (e.g. Microsoft Internet Explorer, Microsoft Edge) for accessing the integrated device web server or with operating tool (e.g. FieldCare, DeviceCare)
- 6 Mobile handheld terminal with WLAN interface and web browser (e.g. Microsoft Internet Explorer, Microsoft Edge) for accessing the integrated device web server or operating tool (e.g. FieldCare, DeviceCare)
- 7 Smart phone or tablet (e.g. Field Xpert SMT70)

|                            |   |
|----------------------------|---|
| Function                   | WLAN: IEEE 802.11 b/g (2.4 GHz)   |
| Encryption                 | WPA2-PSK AES-128 (in accordance with IEEE 802.11i)  |
| Configurable WLAN channels | 1 to 11   |
| Degree of protection       | IP67  |
| Available antennas         | <ul style="list-style-type: none"> <li>▪ Internal antenna</li> <li>▪ External antenna (optional)</li> </ul> In the event of poor transmission/reception conditions at the place of installation.<br>ⓘ Only 1 antenna is active at any one time! |

|                              |   |
|------------------------------|---|
| Range                        | <ul style="list-style-type: none"> <li>▪ Internal antenna: typically 10 m (32 ft)</li> <li>▪ External antenna: typically 50 m (164 ft)</li> </ul>   |
| Materials (external antenna) | <ul style="list-style-type: none"> <li>▪ Antenna: ASA plastic (acrylonitrile styrene acrylate) and nickel-plated brass</li> <li>▪ Adapter: Stainless steel and nickel-plated brass</li> <li>▪ Cable: Polyethylene</li> <li>▪ Plug: Nickel-plated brass</li> <li>▪ Angle bracket: Stainless steel</li> </ul> |

### *Configuring the Internet protocol of the mobile terminal*

#### **NOTICE**

**If the WLAN connection is lost during the configuration, settings made may be lost.**

- ▶ Make sure that the WLAN connection is not disconnected while configuring the device.

#### **NOTICE**

**Note the following to avoid a network conflict:**

- ▶ Avoid accessing the measuring device simultaneously from the same mobile terminal via the service interface (CDI-RJ45) and the WLAN interface.
- ▶ Only activate one service interface (CDI-RJ45 or WLAN interface).
- ▶ If simultaneous communication is necessary: configure different IP address ranges, e.g. 192.168.0.1 (WLAN interface) and 192.168.1.212 (CDI-RJ45 service interface).

### *Preparing the mobile terminal*

- ▶ Enable WLAN on the mobile terminal.

### *Establishing a WLAN connection from the mobile terminal to the measuring device*

1. In the WLAN settings of the mobile terminal:  
Select the measuring device using the SSID (e.g. EH\_Promass\_300\_A802000).
2. If necessary, select the WPA2 encryption method.
3. Enter the password:  
Serial number of the measuring device ex-works (e.g. L100A802000).  
↳ The LED on the display module flashes. It is now possible to operate the measuring device with the web browser, FieldCare or DeviceCare.

 The serial number can be found on the nameplate.

 To ensure the safe and swift assignment of the WLAN network to the measuring point, it is advisable to change the SSID name. It should be possible to clearly assign the new SSID name to the measuring point (e.g. tag name) because it is displayed as the WLAN network.

### *Terminating the WLAN connection*



- ▶ After configuring the device:  
Terminate the WLAN connection between the mobile terminal and measuring device.

## 8.5.2 FieldCare

### **Function range**

FDT-based (Field Device Technology) plant asset management tool from Endress+Hauser. It can configure all smart field units in a system and helps you manage them. By using the status information, it is also a simple but effective way of checking their status and condition.



Access is via:

- CDI-RJ45 service interface →  67
- WLAN interface →  68

Typical functions:

- Transmitter parameter configuration
- Loading and saving of device data (upload/download)
- Documentation of the measuring point
- Visualization of the measured value memory (line recorder) and event logbook

-  ■ Operating Instructions BA00027S
- Operating Instructions BA00059S

-  Source for device description files →  72

### Establishing a connection

-  ■ Operating Instructions BA00027S
- Operating Instructions BA00059S

### User interface

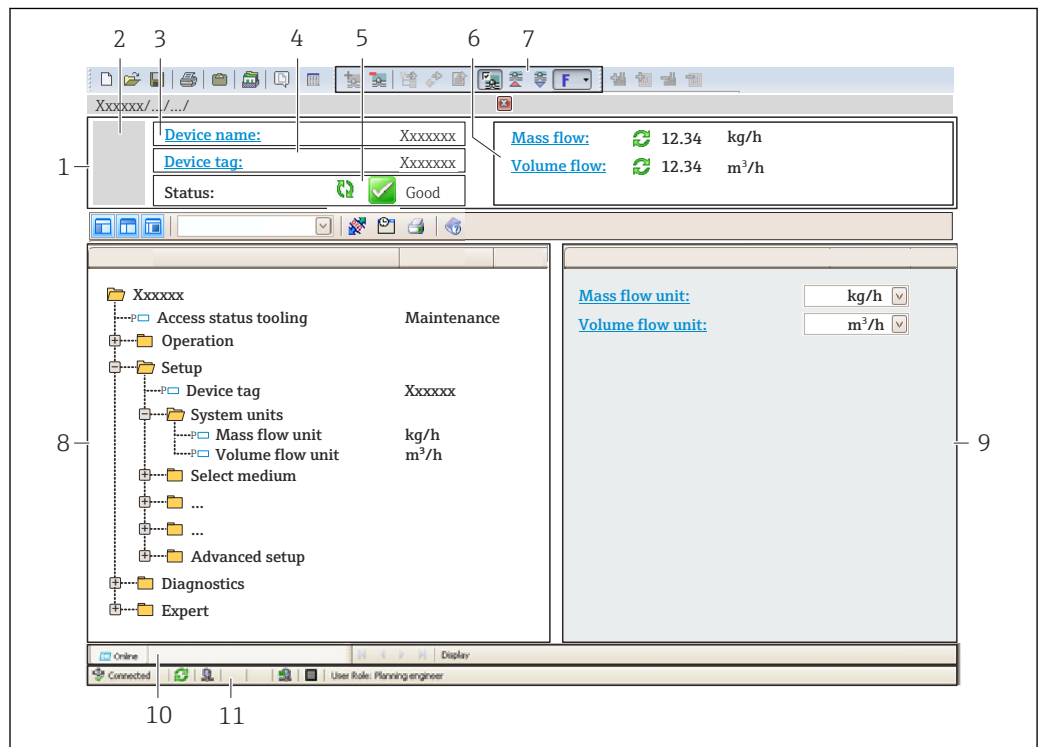

A0021051-EN

- 1 Header
- 2 Picture of device
- 3 Device name
- 4 Device tag
- 5 Status area with status signal →  171
- 6 Display area for current measured values
- 7 Editing toolbar with additional functions such as save/load, event list and create documentation
- 8 Navigation area with operating menu structure
- 9 Work area
- 10 Action area
- 11 Status area

### 8.5.3 DeviceCare

#### Function range

Tool for connecting and configuring Endress+Hauser field devices.

The fastest way to configure Endress+Hauser field devices is with the dedicated "DeviceCare" tool. Together with the device type managers (DTMs) it presents a convenient, comprehensive solution.



Innovation brochure IN01047S





Source for device description files →  72

## 9 System integration

### 9.1 Overview of device description files

#### 9.1.1 Current version data for the device

|                                  |          |   |
|----------------------------------|----------|---|
| Firmware version                 | 01.06.zz | <ul style="list-style-type: none"> <li>▪ On the title page of the manual</li> <li>▪ On the transmitter nameplate</li> <li>▪ Firmware version<br/>Diagnostics → Device information → Firmware version</li> </ul> |
| Release date of firmware version | 08.2022  | ---   |

 For an overview of the various firmware versions for the device →  185

#### 9.1.2 Operating tools

The suitable device description file for the individual operating tools is listed in the table below, along with information on where the file can be acquired.

| Operating tool via service interface (CDI) or Modbus interface | Sources for obtaining device descriptions   |
|--|---|
| FieldCare  | <ul style="list-style-type: none"> <li>▪ <a href="http://www.endress.com">www.endress.com</a> → Downloads area</li> <li>▪ USB stick (contact Endress+Hauser)</li> <li>▪ DVD (contact Endress+Hauser)</li> </ul> |
| DeviceCare   | <ul style="list-style-type: none"> <li>▪ <a href="http://www.endress.com">www.endress.com</a> → Downloads area</li> <li>▪ CD-ROM (contact Endress+Hauser)</li> <li>▪ DVD (contact Endress+Hauser)</li> </ul>    |

## 9.2 Compatibility with previous model

If the device is replaced, the measuring device Promass 300 supports the compatibility of the Modbus registers for the process variables and the diagnostic information with the previous model Promass 83. It is not necessary to change the engineering parameters in the automation system.



*Compatible Modbus registers: process variables*

| Process variable      | Compatible Modbus registers |
|-----------------------|-----------------------------|
| Mass flow             | 2007                        |
| Volume flow           | 2009                        |
| Corrected volume flow | 2011                        |
| Density               | 2013                        |
| Reference density     | 2015                        |
| Temperature           | 2017                        |
| Totalizer 1           | 2610                        |
| Totalizer 2           | 2810                        |
| Totalizer 3           | 3010                        |



*Compatible Modbus registers: diagnostic information*



| Diagnostic information                           | Compatible Modbus registers |
|--|-----------------------------|
| Diagnostic code (data type: String), e.g. F270   | 6821                        |
| Diagnostic number (data type: Integer), e.g. 270 | 6859                        |



 The Modbus registers are compatible but the diagnostic numbers are not. Overview of the new diagnostic numbers →  174.

## 9.3 Modbus RS485 information

### 9.3.1 Function codes



Function codes are used to define which read or write action is carried out via the Modbus protocol. The measuring device supports the following function codes:

| Code | Name                   | Description   | Application   |
|------|------------------------|---|---|
| 03   | Read holding register  | <p>Master reads one or more Modbus registers from the device. A maximum of 125 consecutive registers can be read with 1 telegram: 1 register = 2 bytes</p> <p> The measuring device does not make a distinction between function codes 03 and 04; these codes therefore yield the same result.</p>  | <p>Read device parameters with read and write access</p> <p>Example:<br/>Read mass flow</p> |
| 04   | Read input register    | <p>Master reads one or more Modbus registers from the device. A maximum of 125 consecutive registers can be read with 1 telegram: 1 register = 2 bytes</p> <p> The measuring device does not make a distinction between function codes 03 and 04; these codes therefore yield the same result.</p> | <p>Read device parameters with read access</p> <p>Example:<br/>Read totalizer value</p>     |
| 06   | Write single registers | <p>Master writes a new value to <b>one</b> Modbus register of the measuring device.</p> <p> Use function code 16 to write multiple registers with just 1 telegram.</p>   | <p>Write only 1 device parameter</p> <p>Example: reset totalizer</p>                        |
| 08   | Diagnostics            | <p>Master checks the communication connection to the measuring device. The following "Diagnostics codes" are supported:</p> <ul style="list-style-type: none"> <li>▪ Sub-function 00 = Return query data (loopback test)</li> <li>▪ Sub-function 02 = Return diagnostics register</li> </ul>  |   |

| Code | Name                          | Description  | Application  |
|------|-------------------------------|--|--|
| 16   | Write multiple registers      | <p>Master writes a new value to multiple Modbus registers of the device.<br/>A maximum of 120 consecutive registers can be written with 1 telegram.</p> <p> If the required device parameters are not available as a group, yet must nevertheless be addressed with a single telegram, use Modbus data map →  75</p> | <p>Write multiple device parameters</p> <p>Example:</p> <ul style="list-style-type: none"> <li>▪ Mass flow unit</li> <li>▪ Mass unit</li> </ul>                |
| 23   | Read/Write multiple registers | <p>Master reads and writes a maximum of 118 Modbus registers of the measuring device simultaneously with 1 telegram.<br/>Write access is executed <b>before</b> read access.</p>   | <p>Write and read multiple device parameters</p> <p>Example:</p> <ul style="list-style-type: none"> <li>▪ Read mass flow</li> <li>▪ Reset totalizer</li> </ul> |

 Broadcast messages are only allowed with function codes 06, 16 and 23.

### 9.3.2 Register information

 For an overview of device parameters with their respective Modbus register information, please refer to the "Modbus RS485 register information" section in the "Description of device parameters" documentation →  223.

### 9.3.3 Response time

Response time of the measuring device to the request telegram of the Modbus master: typically 3 to 5 ms

### 9.3.4 Data types

The measuring device supports the following data types:

|  |          |          |          |
|--|----------|----------|----------|
| <b>FLOAT</b> (floating point number IEEE 754)<br>Data length = 4 bytes (2 registers) |          |          |          |
| Byte 3   | Byte 2   | Byte 1   | Byte 0   |
| SEEEEEEE   | EMMMMMMM | MMMMMMMM | MMMMMMMM |
| S = sign, E = exponent, M = mantissa   |          |          |          |

|  |                              |
|--|------------------------------|
| <b>INTEGER</b><br>Data length = 2 bytes (1 register) |                              |
| Byte 1   | Byte 0                       |
| Most significant byte (MSB)                          | Least significant byte (LSB) |

|   |         |     |        |                              |
|---|---------|-----|--------|------------------------------|
| <b>STRING</b><br>Data length = depends on the device parameter, e.g. presentation of a device parameter with a data length = 18 bytes (9 registers) |         |     |        |                              |
| Byte 17   | Byte 16 | ... | Byte 1 | Byte 0                       |
| Most significant byte (MSB)   |         | ... |        | Least significant byte (LSB) |

### 9.3.5 Byte transmission sequence

Byte addressing, i.e. the transmission sequence of the bytes, is not specified in the Modbus specification. For this reason, it is important to coordinate or match the addressing method between the master and slave during commissioning. This can be configured in the measuring device using the **Byte order** parameter.

The bytes are transmitted depending on the selection in the **Byte order** parameter:

| FLOAT           |                      |                      |                      |                      |
|-----------------|----------------------|----------------------|----------------------|----------------------|
|                 | Sequence             |                      |                      |                      |
| Options         | 1.                   | 2.                   | 3.                   | 4.                   |
| 1 - 0 - 3 - 2 * | Byte 1<br>(MMMMMMMM) | Byte 0<br>(MMMMMMMM) | Byte 3<br>(SEEEEEEE) | Byte 2<br>(EMMMMMMM) |
| 0 - 1 - 2 - 3   | Byte 0<br>(MMMMMMMM) | Byte 1<br>(MMMMMMMM) | Byte 2<br>(EMMMMMMM) | Byte 3<br>(SEEEEEEE) |
| 2 - 3 - 0 - 1   | Byte 2<br>(EMMMMMMM) | Byte 3<br>(SEEEEEEE) | Byte 0<br>(MMMMMMMM) | Byte 1<br>(MMMMMMMM) |
| 3 - 2 - 1 - 0   | Byte 3<br>(SEEEEEEE) | Byte 2<br>(EMMMMMMM) | Byte 1<br>(MMMMMMMM) | Byte 0<br>(MMMMMMMM) |

\* = factory setting, S = sign, E = exponent, M = mantissa

| INTEGER                          |                 |                 |
|----------------------------------|-----------------|-----------------|
|                                  | Sequence        |                 |
| Options                          | 1.              | 2.              |
| 1 - 0 - 3 - 2 *<br>3 - 2 - 1 - 0 | Byte 1<br>(MSB) | Byte 0<br>(LSB) |
| 0 - 1 - 2 - 3<br>2 - 3 - 0 - 1   | Byte 0<br>(LSB) | Byte 1<br>(MSB) |

\* = factory setting, MSB = most significant byte, LSB = least significant byte

| STRING  |                  |                  |     |                 |                 |
|---|------------------|------------------|-----|-----------------|-----------------|
| Presentation taking the example of a device parameter with a data length of 18 bytes. |                  |                  |     |                 |                 |
|   | Sequence         |                  |     |                 |                 |
| Options   | 1.               | 2.               | ... | 17.             | 18.             |
| 1 - 0 - 3 - 2 *<br>3 - 2 - 1 - 0  | Byte 17<br>(MSB) | Byte 16          | ... | Byte 1          | Byte 0<br>(LSB) |
| 0 - 1 - 2 - 3<br>2 - 3 - 0 - 1  | Byte 16          | Byte 17<br>(MSB) | ... | Byte 0<br>(LSB) | Byte 1          |

\* = factory setting, MSB = most significant byte, LSB = least significant byte

### 9.3.6 Modbus data map

#### Function of the Modbus data map

The measuring instrument offers a special memory area, the Modbus data map (for a maximum of 16 device parameters), to allow users to call up multiple device parameters via Modbus RS485 and not only individual device parameters or a group of consecutive device parameters.

Grouping of device parameters is flexible and the Modbus master can read or write to the entire data block simultaneously with a single request telegram.

### Structure of the Modbus data map

The Modbus data map consists of two data sets:

- **Scan list: Configuration area**  
The device parameters to be grouped are defined in a list by entering their Modbus RS485 register addresses in the list.
- **Data area**  
The measuring instrument reads out the register addresses entered in the scan list cyclically and writes the associated device data (values) to the data area.



For an overview of device parameters with their respective Modbus register information, please refer to the "Modbus RS485 register information" section in the "Description of device parameters" documentation → 223.

### Scan list configuration

For configuration, the Modbus RS485 register addresses of the device parameters to be grouped must be entered in the scan list. Please note the following basic requirements of the scan list:

|                                    |  |
|------------------------------------|--|
| <b>Max. entries</b>                | 16 device parameters   |
| <b>Supported device parameters</b> | Only parameters with the following characteristics are supported: <ul style="list-style-type: none"> <li>■ Access type: read or write access</li> <li>■ Data type: float or integer</li> </ul> |

#### *Configuration of the scan list via FieldCare or DeviceCare*

Carried out using the operating menu of the measuring instrument:  
Expert → Communication → Modbus data map → Scan list register 0 to 15

| Scan list |                        |
|-----------|------------------------|
| No.       | Configuration register |
| 0         | Scan list register 0   |
| ...       | ...                    |
| 15        | Scan list register 15  |

#### *Configuration of the scan list via Modbus RS485*

Carried out using register addresses 5001 - 5016

| Scan list |                       |           |                        |
|-----------|-----------------------|-----------|------------------------|
| No.       | Modbus RS485 register | Data type | Configuration register |
| 0         | 5001                  | Integer   | Scan list register 0   |
| ...       | ...                   | Integer   | ...                    |
| 15        | 5016                  | Integer   | Scan list register 15  |

### Reading out data via Modbus RS485

The Modbus master accesses the data area of the Modbus data map to read out the current values of the device parameters defined in the scan list.

|                                   |                                  |
|-----------------------------------|----------------------------------|
| <b>Master access to data area</b> | Via register addresses 5051-5081 |
|-----------------------------------|----------------------------------|

| Data area                       |                       |                              |               |            |
|---------------------------------|-----------------------|------------------------------|---------------|------------|
| Device parameter value          | Modbus RS485 register |                              | Data type*    | Access**   |
|                                 | Start register        | End register<br>(Float only) |               |            |
| Value of scan list register 0   | 5051                  | 5052                         | Integer/float | read/write |
| Value of scan list register 1   | 5053                  | 5054                         | Integer/float | read/write |
| Value of scan list register ... | ...                   | ...                          | ...           | ...        |
| Value of scan list register 15  | 5081                  | 5082                         | Integer/float | read/write |

\* Data type depends on the device parameters entered in the scan list.  
\*\* Data access depends on the device parameters entered in the scan list. If the device parameter entered supports read and write access, the parameter can also be accessed via the data area.

## 10 Commissioning

### 10.1 Post-mounting and post-connection check

Before commissioning the device:

- ▶ Make sure that the post-installation and post-connection checks have been performed successfully.
- Checklist for "Post-installation" check → 30
- Checklist for "Post-connection" check → 43

### 10.2 Switching on the measuring device

- ▶ Switch on the device upon successful completion of the post-mounting and post-connection check.
  - ↳ After a successful startup, the local display switches automatically from the startup display to the operational display.

If nothing appears on the local display or if a diagnostic message is displayed, refer to the section on "Diagnostics and troubleshooting" → 165.

### 10.3 Setting the operating language

Factory setting: English or ordered local language

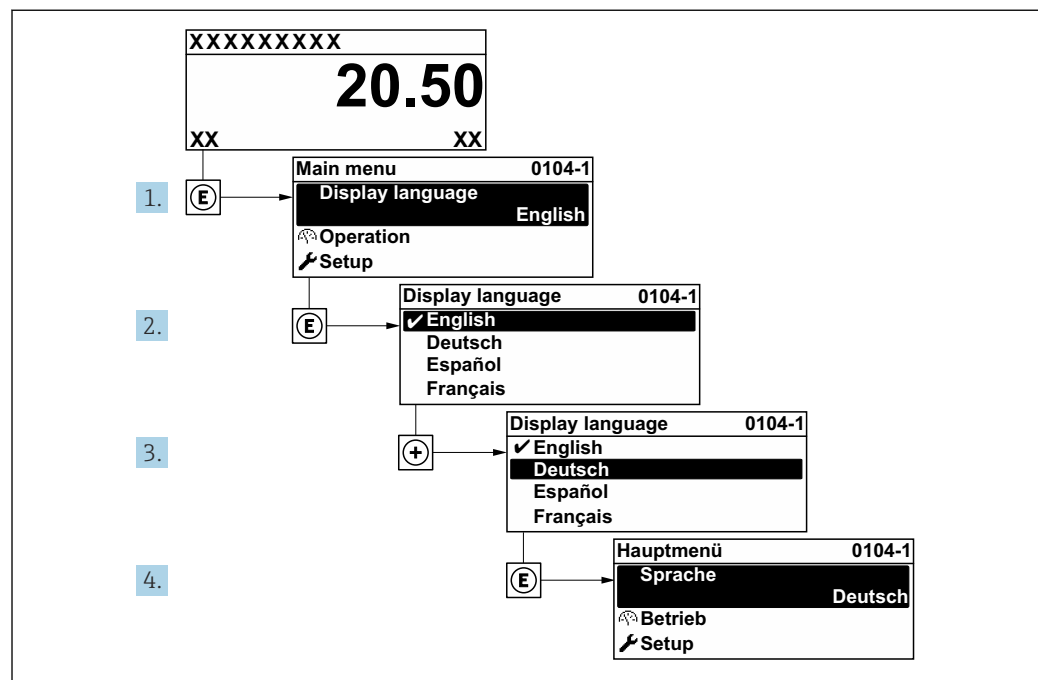

27 Taking the example of the local display

### 10.4 Configuring the measuring instrument

The **Setup** menu with its guided wizards contains all the parameters needed for standard operation.

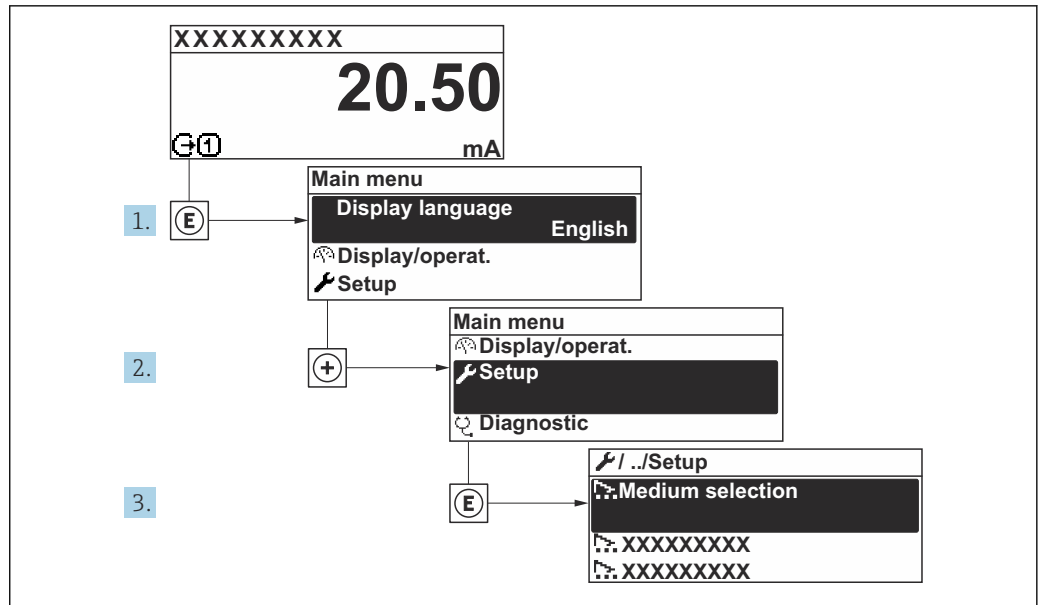

A003222-EN

28 Navigation to "Setup" menu using the example of the local display

**i** The number of submenus and parameters can vary depending on the device version. Certain submenus and parameters in these submenus are not described in the Operating Instructions. Instead a description is provided in the Special Documentation for the device ("Supplementary documentation").

| 🔧 Setup                                |       |
|--|-------|
| Device tag                             |       |
| ▶ System units                         | → 80  |
| ▶ Communication                        | → 82  |
| ▶ Medium selection                     | → 84  |
| ▶ I/O configuration                    | → 86  |
| ▶ Current input 1 to n                 | → 87  |
| ▶ Status input 1 to n                  | → 88  |
| ▶ Current output 1 to n                | → 89  |
| ▶ Pulse/frequency/switch output 1 to n | → 94  |
| ▶ Relay output 1 to n                  | → 103 |
| ▶ Double pulse output                  | → 106 |
| ▶ Display                              | → 107 |

|                                   |       |
|-----------------------------------|-------|
| ▶ Low flow cut off                | → 112 |
| ▶ Partially filled pipe detection | → 113 |
| ▶ Advanced setup                  | → 114 |

### 10.4.1 Defining the tag name

To enable fast identification of the measuring point within the system, you can enter a unique designation using the **Device tag** parameter and thus change the factory setting.

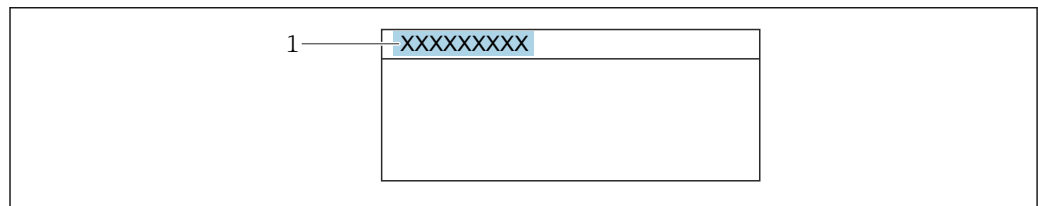

29 Header of the operational display with tag name

1 Tag name

**i** Enter the tag name in the "FieldCare" operating tool → 70

#### Navigation

"Setup" menu → Device tag

#### Parameter overview with brief description

| Parameter  | Description                             | User entry   | Factory setting |
|------------|---|--|-----------------|
| Device tag | Enter the name for the measuring point. | Max. 32 characters, such as letters, numbers or special characters (e.g. @, %, /). | Promag          |

### 10.4.2 Setting the system units

In the **System units** submenu the units of all the measured values can be set.









**i** The number of submenus and parameters can vary depending on the device version. Certain submenus and parameters in these submenus are not described in the Operating Instructions. Instead a description is provided in the Special Documentation for the device ("Supplementary documentation").

#### Navigation

"Setup" menu → System units

|                  |      |
|------------------|------|
| ▶ System units   |      |
| Mass flow unit   | → 81 |
| Mass unit        | → 81 |
| Volume flow unit | → 81 |



|                            |  |
|----------------------------|--|
| Volume unit                | →  81 |
| Corrected volume flow unit | →  81 |
| Corrected volume unit      | →  81 |
| Density unit               | →  81 |
| Reference density unit     | →  82 |
| Density 2 unit             | →  82 |
| Temperature unit           | →  82 |
| Pressure unit              | →  82 |

**Parameter overview with brief description**

| Parameter                  | Description  | Selection        | Factory setting  |
|----------------------------|--|------------------|--|
| Mass flow unit             | Select mass flow unit.<br><i>Effect</i><br>The selected unit applies to:<br><ul style="list-style-type: none"> <li>▪ Output</li> <li>▪ Low flow cut off</li> <li>▪ Simulation process variable</li> </ul>                      | Unit choose list | Country-specific:<br><ul style="list-style-type: none"> <li>▪ kg/h</li> <li>▪ lb/min</li> </ul>  |
| Mass unit                  | Select mass unit.  | Unit choose list | Country-specific:<br><ul style="list-style-type: none"> <li>▪ kg</li> <li>▪ lb</li> </ul>  |
| Volume flow unit           | Select volume flow unit.<br><i>Effect</i><br>The selected unit applies to:<br><ul style="list-style-type: none"> <li>▪ Output</li> <li>▪ Low flow cut off</li> <li>▪ Simulation process variable</li> </ul>                    | Unit choose list | Country-specific:<br><ul style="list-style-type: none"> <li>▪ l/h</li> <li>▪ gal/min (us)</li> </ul>   |
| Volume unit                | Select volume unit.  | Unit choose list | Country-specific:<br><ul style="list-style-type: none"> <li>▪ l (DN &gt; 150 (6"): <b>m<sup>3</sup></b> option)</li> <li>▪ gal (us)</li> </ul> |
| Corrected volume flow unit | Select corrected volume flow unit.<br><i>Effect</i><br>The selected unit applies to:<br><b>Corrected volume flow</b> parameter<br>(→  145)  | Unit choose list | Country-specific:<br><ul style="list-style-type: none"> <li>▪ NI/h</li> <li>▪ Sft<sup>3</sup>/min</li> </ul>                                   |
| Corrected volume unit      | Select corrected volume unit.  | Unit choose list | Country-specific:<br><ul style="list-style-type: none"> <li>▪ NI</li> <li>▪ Sft<sup>3</sup></li> </ul>   |
| Density unit               | Select density unit.<br><i>Effect</i><br>The selected unit applies to:<br><ul style="list-style-type: none"> <li>▪ Output</li> <li>▪ Simulation process variable</li> <li>▪ Density adjustment (<b>Expert</b> menu)</li> </ul> | Unit choose list | Country-specific:<br><ul style="list-style-type: none"> <li>▪ kg/l</li> <li>▪ lb/ft<sup>3</sup></li> </ul>                                     |

| Parameter              | Description  | Selection        | Factory setting   |
|------------------------|--|------------------|---|
| Reference density unit | Select reference density unit.   | Unit choose list | Country-specific: <ul style="list-style-type: none"> <li>kg/Nl</li> <li>lb/Sft<sup>3</sup></li> </ul> |
| Density 2 unit         | Select second density unit.  | Unit choose list | Country-specific: <ul style="list-style-type: none"> <li>kg/l</li> <li>lb/ft<sup>3</sup></li> </ul>   |
| Temperature unit       | Select temperature unit.<br><i>Effect</i><br>The selected unit applies to: <ul style="list-style-type: none"> <li><b>Electronic temperature</b> parameter (6053)</li> <li><b>Maximum value</b> parameter (6051)</li> <li><b>Minimum value</b> parameter (6052)</li> <li><b>External temperature</b> parameter (6080)</li> <li><b>Maximum value</b> parameter (6108)</li> <li><b>Minimum value</b> parameter (6109)</li> <li><b>Carrier pipe temperature</b> parameter (6027)</li> <li><b>Maximum value</b> parameter (6029)</li> <li><b>Minimum value</b> parameter (6030)</li> <li><b>Reference temperature</b> parameter (1816)</li> <li><b>Temperature</b> parameter</li> </ul> | Unit choose list | Country-specific: <ul style="list-style-type: none"> <li>°C</li> <li>°F</li> </ul>                    |
| Pressure unit          | Select process pressure unit.<br><i>Effect</i><br>The unit is taken from: <ul style="list-style-type: none"> <li><b>Pressure value</b> parameter (→ ⓘ 86)</li> <li><b>External pressure</b> parameter (→ ⓘ 86)</li> <li>Pressure value</li> </ul>  | Unit choose list | Country-specific: <ul style="list-style-type: none"> <li>bar a</li> <li>psi a</li> </ul>              |

### 10.4.3 Configuring the communication interface

The **Communication** submenu guides you systematically through all the parameters that have to be configured for selecting and setting the communication interface.

#### Navigation

"Setup" menu → Communication

► **Communication**

|                    |        |
|--------------------|--------|
| Bus address        | → ⓘ 83 |
| Baudrate           | → ⓘ 83 |
| Data transfer mode | → ⓘ 83 |
| Parity             | → ⓘ 83 |
| Byte order         | → ⓘ 83 |
| Failure mode       | → ⓘ 83 |

## Parameter overview with brief description

| Parameter          | Description   | User entry / Selection   | Factory setting |
|--------------------|---|--|-----------------|
| Bus address        | Enter device address.   | 1 to 247   | 247             |
| Baudrate           | Define data transfer speed.   | <ul style="list-style-type: none"> <li>■ 1200 BAUD</li> <li>■ 2400 BAUD</li> <li>■ 4800 BAUD</li> <li>■ 9600 BAUD</li> <li>■ 19200 BAUD</li> <li>■ 38400 BAUD</li> <li>■ 57600 BAUD</li> <li>■ 115200 BAUD</li> <li>■ 230400 BAUD</li> </ul>   | 19200 BAUD      |
| Data transfer mode | Select data transfer mode.  | <ul style="list-style-type: none"> <li>■ ASCII</li> <li>■ RTU</li> </ul>   | RTU             |
| Parity             | Select parity bits.   | Picklist <b>ASCII</b> option: <ul style="list-style-type: none"> <li>■ 0 = <b>Even</b> option</li> <li>■ 1 = <b>Odd</b> option</li> </ul> Picklist <b>RTU</b> option: <ul style="list-style-type: none"> <li>■ 0 = <b>Even</b> option</li> <li>■ 1 = <b>Odd</b> option</li> <li>■ 2 = <b>None / 1 stop bit</b> option</li> <li>■ 3 = <b>None / 2 stop bits</b> option</li> </ul> | Even            |
| Byte order         | Select byte transmission sequence.  | <ul style="list-style-type: none"> <li>■ 0-1-2-3</li> <li>■ 3-2-1-0</li> <li>■ 1-0-3-2</li> <li>■ 2-3-0-1</li> </ul>   | 1-0-3-2         |
| Failure mode       | Select measured value output behavior when a diagnostic message occurs via Modbus communication.<br>NaN <sup>1)</sup> | <ul style="list-style-type: none"> <li>■ NaN value</li> <li>■ Last valid value</li> </ul>  | NaN value       |

1) Not a Number

### 10.4.4 Selecting and setting the medium

The **Select medium** wizard submenu contains parameters that must be configured in order to select and set the medium.

#### Navigation

"Setup" menu → Medium selection

| ► Medium selection                     |        |
|--|--------|
| MFT (Multi-Frequency Technology)       |        |
| Select medium type                     | → ⓘ 85 |
| Select gas type                        | → ⓘ 85 |
| Reference sound velocity               | → ⓘ 85 |
| Reference sound velocity               | → ⓘ 85 |
| Temperature coefficient sound velocity | → ⓘ 85 |
| Temperature coefficient sound velocity | → ⓘ 85 |
| Pressure compensation                  | → ⓘ 85 |
| Pressure value                         | → ⓘ 86 |
| External pressure                      | → ⓘ 86 |

## Parameter overview with brief description

| Parameter                              | Prerequisite   | Description  | Selection / User entry   | Factory setting |
|--|--|--|--|-----------------|
| Select medium type                     | –  | Use this function to select the type of medium: "Gas" or "Liquid". Select the "Other" option in exceptional cases in order to enter the properties of the medium manually (e.g. for highly compressive liquids such as sulfuric acid). | <ul style="list-style-type: none"> <li>■ Liquid</li> <li>■ Gas</li> <li>■ Other</li> </ul>   | Liquid          |
| Select gas type                        | In the <b>Medium selection</b> submenu, the <b>Gas</b> option is selected.       | Select measured gas type.  | <ul style="list-style-type: none"> <li>■ Air</li> <li>■ Ammonia NH3</li> <li>■ Argon Ar</li> <li>■ Sulfur hexafluoride SF6</li> <li>■ Oxygen O2</li> <li>■ Ozone O3</li> <li>■ Nitrogen oxide NOx</li> <li>■ Nitrogen N2</li> <li>■ Nitrous oxide N2O</li> <li>■ Methane CH4</li> <li>■ Methane CH4 + 10% Hydrogen H2</li> <li>■ Methane CH4 + 20% Hydrogen H2</li> <li>■ Methane CH4 + 30% Hydrogen H2</li> <li>■ Hydrogen H2</li> <li>■ Helium He</li> <li>■ Hydrogen chloride HCl</li> <li>■ Hydrogen sulfide H2S</li> <li>■ Ethylene C2H4</li> <li>■ Carbon dioxide CO2</li> <li>■ Carbon monoxide CO</li> <li>■ Chlorine Cl2</li> <li>■ Butane C4H10</li> <li>■ Propane C3H8</li> <li>■ Propylene C3H6</li> <li>■ Ethane C2H6</li> <li>■ Other</li> </ul> | Methane CH4     |
| Reference sound velocity               | In the <b>Select gas type</b> parameter, the <b>Other</b> option is selected.    | Enter sound velocity of the gas at 0 °C (32 °F).   | 1 to 99 999.9999 m/s   | 415.0 m/s       |
| Reference sound velocity               | In the <b>Select medium type</b> parameter, the <b>Other</b> option is selected. | Enter sound velocity of the medium at 0 °C (32 °F).  | Signed floating-point number   | 1 456 m/s       |
| Temperature coefficient sound velocity | In the <b>Select gas type</b> parameter, the <b>Other</b> option is selected.    | Enter the temperature coefficient for the gas sound velocity.  | Positive floating point number   | 0.87 (m/s)/K    |
| Temperature coefficient sound velocity | In the <b>Select medium type</b> parameter, the <b>Other</b> option is selected. | Enter temperature coefficient for the medium sound velocity.   | Signed floating-point number   | 1.3 (m/s)/K     |
| Pressure compensation                  | –  | Select pressure compensation type.   | <ul style="list-style-type: none"> <li>■ Off</li> <li>■ Fixed value</li> <li>■ External value</li> <li>■ Current input 1 *</li> <li>■ Current input 2 *</li> </ul>   | Off             |

| Parameter         | Prerequisite  | Description  | Selection / User entry         | Factory setting |
|-------------------|---|--|--------------------------------|-----------------|
| Pressure value    | In the <b>Pressure compensation</b> parameter, the <b>Fixed value</b> option is selected.   | Enter process pressure to be used for pressure correction. | Positive floating-point number | 1.01325 bar     |
| External pressure | In the <b>Pressure compensation</b> parameter, the <b>External value</b> option or the <b>Current input 1...n</b> option is selected. | Shows the process pressure read from the external device.  |                                | –               |

\* Visibility depends on order options or device settings

### 10.4.5 Displaying the I/O configuration

The **I/O configuration** submenu guides the user systematically through all the parameters in which the configuration of the I/O modules is displayed.

#### Navigation

"Setup" menu → I/O configuration

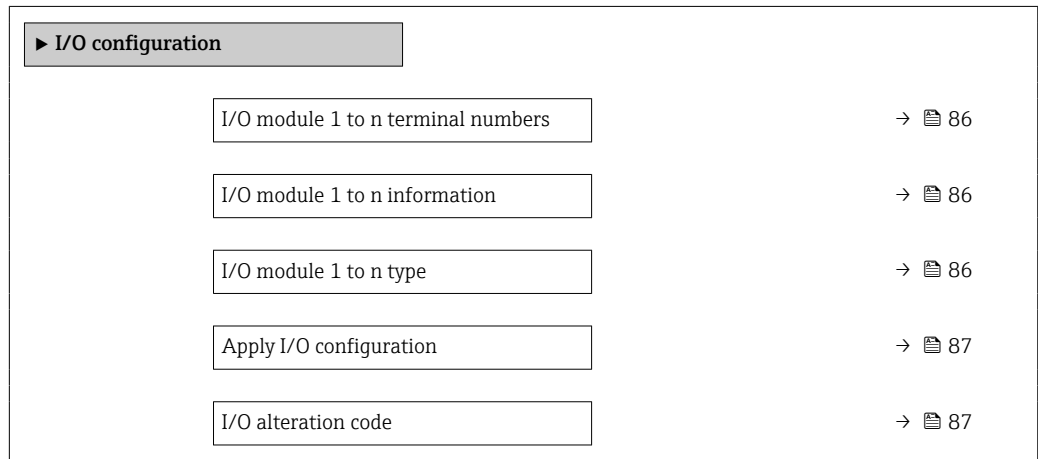

#### Parameter overview with brief description

| Parameter                          | Description  | User interface / Selection / User entry  | Factory setting |
|------------------------------------|--|--|-----------------|
| I/O module 1 to n terminal numbers | Shows the terminal numbers used by the I/O module. | <ul style="list-style-type: none"> <li>Not used</li> <li>26-27 (I/O 1)</li> <li>24-25 (I/O 2)</li> <li>22-23 (I/O 3)</li> </ul>  | –               |
| I/O module 1 to n information      | Shows information of the plugged I/O module.       | <ul style="list-style-type: none"> <li>Not plugged</li> <li>Invalid</li> <li>Not configurable</li> <li>Configurable</li> <li>MODBUS</li> </ul>   | –               |
| I/O module 1 to n type             | Shows the I/O module type.                         | <ul style="list-style-type: none"> <li>Off</li> <li>Current output *</li> <li>Current input *</li> <li>Status input *</li> <li>Pulse/frequency/switch output *</li> <li>Double pulse output *</li> <li>Relay output *</li> </ul> | Off             |

| Parameter               | Description   | User interface / Selection / User entry                               | Factory setting |
|-------------------------|---|---|-----------------|
| Apply I/O configuration | Apply parameterization of the freely configurable I/O module. | <ul style="list-style-type: none"> <li>■ No</li> <li>■ Yes</li> </ul> | No              |
| I/O alteration code     | Enter the code in order to change the I/O configuration.      | Positive integer  | 0               |

\* Visibility depends on order options or device settings

### 10.4.6 Configuring the current input

The "Current input" wizard guides the user systematically through all the parameters that have to be set for configuring the current input.

#### Navigation

"Setup" menu → Current input

▶ **Current input 1 to n**

|                 |        |
|-----------------|--------|
| Terminal number | → ⓘ 87 |
| Signal mode     | → ⓘ 87 |
| 0/4 mA value    | → ⓘ 87 |
| 20 mA value     | → ⓘ 87 |
| Current span    | → ⓘ 88 |
| Failure mode    | → ⓘ 88 |
| Failure value   | → ⓘ 88 |

#### Parameter overview with brief description

| Parameter       | Prerequisite  | Description  | User interface / Selection / User entry  | Factory setting                         |
|-----------------|---|--|--|---|
| Terminal number | –   | Shows the terminal numbers used by the current input module. | <ul style="list-style-type: none"> <li>■ Not used</li> <li>■ 24-25 (I/O 2)</li> <li>■ 22-23 (I/O 3)</li> </ul> | –                                       |
| Signal mode     | The measuring device is <b>not</b> approved for use in the hazardous area with type of protection Ex-i. | Select the signal mode for the current input.                | <ul style="list-style-type: none"> <li>■ Passive*</li> <li>■ Active*</li> </ul>                                | Active                                  |
| 0/4 mA value    | –   | Enter 4 mA value.  | Signed floating-point number   | 0                                       |
| 20 mA value     | –   | Enter 20 mA value.   | Signed floating-point number   | Depends on country and nominal diameter |

| Parameter     | Prerequisite   | Description   | User interface / Selection / User entry  | Factory setting  |
|---------------|--|---|--|--|
| Current span  | –  | Select current range for process value output and upper/lower level for alarm signal. | <ul style="list-style-type: none"> <li>▪ 4...20 mA (4...20.5 mA)</li> <li>▪ 4...20 mA NE (3.8...20.5 mA)</li> <li>▪ 4...20 mA US (3.9...20.8 mA)</li> <li>▪ 0...20 mA (0...20.5 mA)</li> </ul> | Country-specific: <ul style="list-style-type: none"> <li>▪ 4...20 mA NE (3.8...20.5 mA)</li> <li>▪ 4...20 mA US (3.9...20.8 mA)</li> </ul> |
| Failure mode  | –  | Define input behavior in alarm condition.   | <ul style="list-style-type: none"> <li>▪ Alarm</li> <li>▪ Last valid value</li> <li>▪ Defined value</li> </ul>   | Alarm  |
| Failure value | In the <b>Failure mode</b> parameter, the <b>Defined value</b> option is selected. | Enter value to be used by the device if input value from external device is missing.  | Signed floating-point number   | 0  |

\* Visibility depends on order options or device settings

### 10.4.7 Configuring the status input

The **Status input** submenu guides the user systematically through all the parameters that have to be set for configuring the status input.

#### Navigation

"Setup" menu → Status input 1 to n

▶ Status input 1 to n

|                            |       |
|----------------------------|-------|
| Assign status input        | →  89 |
| Terminal number            | →  89 |
| Active level               | →  89 |
| Terminal number            | →  89 |
| Response time status input | →  89 |
| Terminal number            | →  89 |



**Parameter overview with brief description**

| Parameter                  | Description   | Selection / User interface / User entry  | Factory setting |
|----------------------------|---|--|-----------------|
| Assign status input        | Select function for the status input.   | <ul style="list-style-type: none"> <li>■ Off</li> <li>■ Reset totalizer 1</li> <li>■ Reset totalizer 2</li> <li>■ Reset totalizer 3</li> <li>■ Reset all totalizers</li> <li>■ Flow override</li> <li>■ Zero adjustment</li> <li>■ Reset weighted averages *</li> <li>■ Reset weighted averages + totalizer 3 *</li> </ul> | Off             |
| Terminal number            | Shows the terminal numbers used by the status input module.   | <ul style="list-style-type: none"> <li>■ Not used</li> <li>■ 24-25 (I/O 2)</li> <li>■ 22-23 (I/O 3)</li> </ul>   | -               |
| Active level               | Define input signal level at which the assigned function is triggered.  | <ul style="list-style-type: none"> <li>■ High</li> <li>■ Low</li> </ul>  | High            |
| Response time status input | Define the minimum amount of time the input signal level must be present before the selected function is triggered. | 5 to 200 ms  | 50 ms           |

\* Visibility depends on order options or device settings

**10.4.8 Configuring the current output**

The **Current output** wizard guides you systematically through all the parameters that have to be set for configuring the current output.

**Navigation**

"Setup" menu → Current output





▶ **Current output 1 to n**

|                                 |        |
|---------------------------------|--------|
| Terminal number                 | → ⓘ 90 |
| Signal mode                     | → ⓘ 90 |
| Process variable current output | → ⓘ 91 |
| Current range output            | → ⓘ 92 |
| Lower range value output        | → ⓘ 92 |
| Upper range value output        | → ⓘ 92 |
| Fixed current                   | → ⓘ 92 |
| Damping current output          | → ⓘ 92 |
| Failure behavior current output | → ⓘ 93 |
| Failure current                 | → ⓘ 93 |

### Parameter overview with brief description

| Parameter       | Prerequisite | Description   | User interface / Selection / User entry  | Factory setting |
|-----------------|--------------|---|--|-----------------|
| Terminal number | –            | Shows the terminal numbers used by the current output module. | <ul style="list-style-type: none"> <li>▪ Not used</li> <li>▪ 24-25 (I/O 2)</li> <li>▪ 22-23 (I/O 3)</li> </ul> | –               |
| Signal mode     | –            | Select the signal mode for the current output.                | <ul style="list-style-type: none"> <li>▪ Active *</li> <li>▪ Passive *</li> </ul>                              | Active          |

| Parameter                       | Prerequisite | Description   | User interface / Selection / User entry   | Factory setting |
|---------------------------------|--------------|---|---|-----------------|
| Process variable current output | -            | Select the process variable for the current output. | <ul style="list-style-type: none"> <li>■ Off*</li> <li>■ Mass flow</li> <li>■ Volume flow</li> <li>■ Corrected volume flow*</li> <li>■ Density</li> <li>■ Reference density*</li> <li>■ Temperature</li> <li>■ Target mass flow*</li> <li>■ Carrier mass flow*</li> <li>■ Target volume flow*</li> <li>■ Carrier volume flow*</li> <li>■ Target corrected volume flow*</li> <li>■ Carrier corrected volume flow*</li> <li>■ Reference density alternative*</li> <li>■ GSV flow*</li> <li>■ GSV flow alternative*</li> <li>■ NSV flow*</li> <li>■ NSV flow alternative*</li> <li>■ S&amp;W volume flow*</li> <li>■ Water cut*</li> <li>■ Oil density*</li> <li>■ Water density*</li> <li>■ Oil mass flow*</li> <li>■ Water mass flow*</li> <li>■ Oil volume flow*</li> <li>■ Water volume flow*</li> <li>■ Oil corrected volume flow*</li> <li>■ Water corrected volume flow*</li> <li>■ Concentration*</li> <li>■ Application specific output 0*</li> <li>■ Application specific output 1*</li> <li>■ Inhomogeneous medium index</li> <li>■ Suspended bubbles index*</li> <li>■ Raw value mass flow</li> <li>■ Exciter current 0</li> <li>■ Oscillation damping 0</li> <li>■ Oscillation damping fluctuation 0*</li> <li>■ Oscillation frequency 0</li> <li>■ Frequency fluctuation 0*</li> <li>■ Signal asymmetry</li> <li>■ Torsion signal asymmetry*</li> <li>■ Carrier pipe temperature*</li> <li>■ Frequency fluctuation 0*</li> </ul> | Mass flow       |

| Parameter                | Prerequisite   | Description  | User interface / Selection / User entry  | Factory setting  |
|--------------------------|--|--|--|--|
|                          |  |  | <ul style="list-style-type: none"> <li>▪ Oscillation amplitude 0 *</li> <li>▪ Oscillation damping fluctuation 0 *</li> <li>▪ HBSI *</li> <li>▪ Pressure *</li> <li>▪ Electronics temperature</li> <li>▪ Sensor index coil asymmetry</li> <li>▪ Test point 0</li> <li>▪ Test point 1</li> </ul> |  |
| Current range output     | –  | Select current range for process value output and upper/lower level for alarm signal.  | <ul style="list-style-type: none"> <li>▪ 4...20 mA NE (3.8...20.5 mA)</li> <li>▪ 4...20 mA US (3.9...20.8 mA)</li> <li>▪ 4...20 mA (4...20.5 mA)</li> <li>▪ 0...20 mA (0...20.5 mA)</li> <li>▪ Fixed value</li> </ul>  | Depends on country: <ul style="list-style-type: none"> <li>▪ 4...20 mA NE (3.8...20.5 mA)</li> <li>▪ 4...20 mA US (3.9...20.8 mA)</li> </ul> |
| Lower range value output | In <b>Current span</b> parameter (→  92), one of the following options is selected: <ul style="list-style-type: none"> <li>▪ 4...20 mA NE (3.8...20.5 mA)</li> <li>▪ 4...20 mA US (3.9...20.8 mA)</li> <li>▪ 4...20 mA (4...20.5 mA)</li> <li>▪ 0...20 mA (0...20.5 mA)</li> </ul>  | Enter lower range value for the measured value range.  | Signed floating-point number   | Depends on country: <ul style="list-style-type: none"> <li>▪ 0 kg/h</li> <li>▪ 0 lb/min</li> </ul>   |
| Upper range value output | In <b>Current span</b> parameter (→  92), one of the following options is selected: <ul style="list-style-type: none"> <li>▪ 4...20 mA NE (3.8...20.5 mA)</li> <li>▪ 4...20 mA US (3.9...20.8 mA)</li> <li>▪ 4...20 mA (4...20.5 mA)</li> <li>▪ 0...20 mA (0...20.5 mA)</li> </ul>  | Enter upper range value for the measured value range.  | Signed floating-point number   | Depends on country and nominal diameter  |
| Fixed current            | The <b>Fixed current</b> option is selected in the <b>Current span</b> parameter (→  92).   | Defines the fixed output current.  | 0 to 22.5 mA   | 22.5 mA  |
| Damping current output   | A process variable is selected in the <b>Assign current output</b> parameter (→  91) and one of the following options is selected in the <b>Current span</b> parameter (→  92): <ul style="list-style-type: none"> <li>▪ 4...20 mA NE (3.8...20.5 mA)</li> <li>▪ 4...20 mA US (3.9...20.8 mA)</li> <li>▪ 4...20 mA (4...20.5 mA)</li> <li>▪ 0...20 mA (0...20.5 mA)</li> </ul> | Enter time constant for output damping (PT1 element). Damping reduces the effect of fluctuations in the measured value on the output signal. | 0.0 to 999.9 s   | 1.0 s  |

| Parameter                       | Prerequisite   | Description  | User interface / Selection / User entry   | Factory setting |
|---------------------------------|--|--|---|-----------------|
| Failure behavior current output | A process variable is selected in the <b>Assign current output</b> parameter (→ 91) and one of the following options is selected in the <b>Current span</b> parameter (→ 92): <ul style="list-style-type: none"> <li>▪ 4...20 mA NE (3.8...20.5 mA)</li> <li>▪ 4...20 mA US (3.9...20.8 mA)</li> <li>▪ 4...20 mA (4...20.5 mA)</li> <li>▪ 0...20 mA (0...20.5 mA)</li> </ul> | Select output behavior in the event of a device alarm. | <ul style="list-style-type: none"> <li>▪ Min.</li> <li>▪ Max.</li> <li>▪ Last valid value</li> <li>▪ Actual value</li> <li>▪ Fixed value</li> </ul> | Max.            |
| Failure current                 | The <b>Defined value</b> option is selected in the <b>Failure mode</b> parameter.  | Enter current output value in alarm condition.         | 0 to 22.5 mA  | 22.5 mA         |

\* Visibility depends on order options or device settings

### 10.4.9 Configuring the pulse/frequency/switch output

The **Pulse/frequency/switch output** wizard guides you systematically through all the parameters that can be set for configuring the selected output type.

#### Navigation

"Setup" menu → Advanced setup → Pulse/frequency/switch output

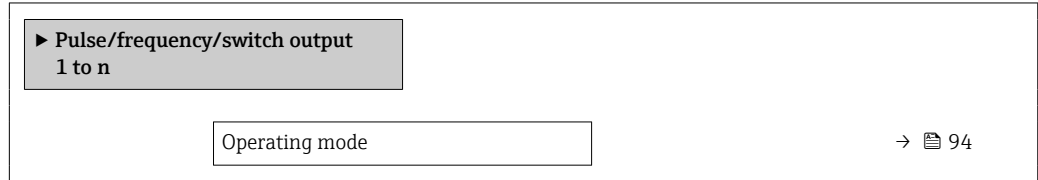

#### Parameter overview with brief description

| Parameter      | Description   | Selection  | Factory setting |
|----------------|---|--|-----------------|
| Operating mode | Define the output as a pulse, frequency or switch output. | <ul style="list-style-type: none"> <li>■ Pulse</li> <li>■ Frequency</li> <li>■ Switch</li> </ul> | Pulse           |

#### Configuring the pulse output

#### Navigation

"Setup" menu → Pulse/frequency/switch output

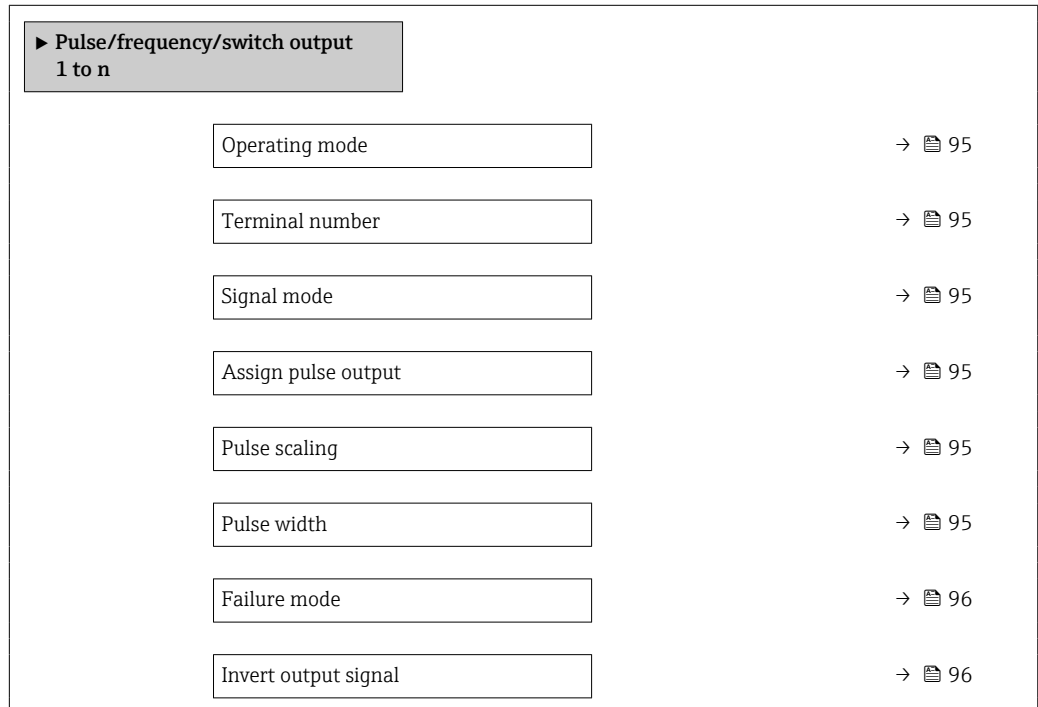

## Parameter overview with brief description

| Parameter           | Prerequisite   | Description   | Selection / User interface / User entry  | Factory setting                         |
|---------------------|--|---|--|---|
| Operating mode      | –  | Define the output as a pulse, frequency or switch output.     | <ul style="list-style-type: none"> <li>■ Pulse</li> <li>■ Frequency</li> <li>■ Switch</li> </ul>   | Pulse                                   |
| Terminal number     | –  | Shows the terminal numbers used by the PFS output module.     | <ul style="list-style-type: none"> <li>■ Not used</li> <li>■ 24-25 (I/O 2)</li> <li>■ 22-23 (I/O 3)</li> </ul>   | –                                       |
| Signal mode         | –  | Select the signal mode for the PFS output.                    | <ul style="list-style-type: none"> <li>■ Passive</li> <li>■ Active *</li> <li>■ Passive NE</li> </ul>  | Passive                                 |
| Assign pulse output | The <b>Pulse</b> option is selected in <b>Operating mode</b> parameter.  | Select process variable for pulse output.                     | <ul style="list-style-type: none"> <li>■ Off</li> <li>■ Mass flow</li> <li>■ Volume flow</li> <li>■ Corrected volume flow *</li> <li>■ Target mass flow *</li> <li>■ Carrier mass flow *</li> <li>■ Target volume flow *</li> <li>■ Carrier volume flow *</li> <li>■ Target corrected volume flow *</li> <li>■ Carrier corrected volume flow *</li> <li>■ GSV flow *</li> <li>■ GSV flow alternative *</li> <li>■ NSV flow *</li> <li>■ NSV flow alternative *</li> <li>■ S&amp;W volume flow *</li> <li>■ Oil mass flow *</li> <li>■ Water mass flow *</li> <li>■ Oil volume flow *</li> <li>■ Water volume flow *</li> <li>■ Oil corrected volume flow *</li> <li>■ Water corrected volume flow *</li> </ul> | Off                                     |
| Pulse scaling       | The <b>Pulse</b> option is selected in the <b>Operating mode</b> parameter (→ 94) and a process variable is selected in the <b>Assign pulse output</b> parameter (→ 95). | Enter quantity for measured value at which a pulse is output. | Positive floating point number   | Depends on country and nominal diameter |
| Pulse width         | The <b>Pulse</b> option is selected in the <b>Operating mode</b> parameter (→ 94) and a process variable is selected in the <b>Assign pulse output</b> parameter (→ 95). | Define time width of the output pulse.                        | 0.05 to 2000 ms  | 100 ms                                  |

| Parameter            | Prerequisite   | Description  | Selection / User interface / User entry   | Factory setting |
|----------------------|--|--|---|-----------------|
| Failure mode         | The <b>Pulse</b> option is selected in the <b>Operating mode</b> parameter (→ 94) and a process variable is selected in the <b>Assign pulse output</b> parameter (→ 95). | Select output behavior in the event of a device alarm. | <ul style="list-style-type: none"> <li>▪ Actual value</li> <li>▪ No pulses</li> </ul> | No pulses       |
| Invert output signal | –  | Invert the output signal.                              | <ul style="list-style-type: none"> <li>▪ No</li> <li>▪ Yes</li> </ul>                 | No              |

\* Visibility depends on order options or device settings

## Configuring the frequency output

### Navigation

"Setup" menu → Pulse/frequency/switch output

| ► Pulse/frequency/switch output<br>1 to n |      |
|---|------|
| Operating mode                            | → 97 |
| Terminal number                           | → 97 |
| Signal mode                               | → 97 |
| Assign frequency output                   | → 98 |
| Minimum frequency value                   | → 99 |
| Maximum frequency value                   | → 99 |
| Measuring value at minimum frequency      | → 99 |
| Measuring value at maximum frequency      | → 99 |
| Failure mode                              | → 99 |
| Failure frequency                         | → 99 |
| Invert output signal                      | → 99 |



### Parameter overview with brief description

| Parameter       | Prerequisite | Description   | Selection / User interface / User entry  | Factory setting |
|-----------------|--------------|---|--|-----------------|
| Operating mode  | –            | Define the output as a pulse, frequency or switch output. | <ul style="list-style-type: none"> <li>■ Pulse</li> <li>■ Frequency</li> <li>■ Switch</li> </ul>               | Pulse           |
| Terminal number | –            | Shows the terminal numbers used by the PFS output module. | <ul style="list-style-type: none"> <li>■ Not used</li> <li>■ 24-25 (I/O 2)</li> <li>■ 22-23 (I/O 3)</li> </ul> | –               |
| Signal mode     | –            | Select the signal mode for the PFS output.                | <ul style="list-style-type: none"> <li>■ Passive</li> <li>■ Active *</li> <li>■ Passive NE</li> </ul>          | Passive         |

| Parameter               | Prerequisite   | Description                                   | Selection / User interface / User entry  | Factory setting |
|-------------------------|--|---|--|-----------------|
| Assign frequency output | The <b>Frequency</b> option is selected in <b>Operating mode</b> parameter (→ 94). | Select process variable for frequency output. | <ul style="list-style-type: none"> <li>▪ Off</li> <li>▪ Mass flow</li> <li>▪ Volume flow</li> <li>▪ Corrected volume flow *</li> <li>▪ Density</li> <li>▪ Reference density *</li> <li>▪ Time period signal frequency (TPS) *</li> <li>▪ Temperature</li> <li>▪ Pressure</li> <li>▪ GSV flow *</li> <li>▪ GSV flow alternative *</li> <li>▪ NSV flow *</li> <li>▪ NSV flow alternative *</li> <li>▪ S&amp;W volume flow *</li> <li>▪ Reference density alternative *</li> <li>▪ Water cut *</li> <li>▪ Oil density *</li> <li>▪ Water density *</li> <li>▪ Oil mass flow *</li> <li>▪ Water mass flow *</li> <li>▪ Oil volume flow *</li> <li>▪ Water volume flow *</li> <li>▪ Oil corrected volume flow *</li> <li>▪ Water corrected volume flow *</li> <li>▪ Concentration *</li> <li>▪ Target mass flow *</li> <li>▪ Carrier mass flow *</li> <li>▪ Target volume flow *</li> <li>▪ Carrier volume flow *</li> <li>▪ Target corrected volume flow *</li> <li>▪ Carrier corrected volume flow *</li> <li>▪ Application specific output 0 *</li> <li>▪ Application specific output 1 *</li> <li>▪ Inhomogeneous medium index</li> <li>▪ Suspended bubbles index *</li> <li>▪ HBSI *</li> <li>▪ Raw value mass flow</li> <li>▪ Exciter current 0</li> <li>▪ Oscillation damping 0</li> <li>▪ Oscillation damping fluctuation 0 *</li> <li>▪ Oscillation frequency 0</li> <li>▪ Frequency fluctuation 0 *</li> <li>▪ Oscillation amplitude 0 *</li> <li>▪ Signal asymmetry</li> </ul> | Off             |

| Parameter                            | Prerequisite  | Description  | Selection / User interface / User entry  | Factory setting                         |
|--------------------------------------|---|--|--|---|
|                                      |   |  | <ul style="list-style-type: none"> <li>■ Torsion signal asymmetry *</li> <li>■ Carrier pipe temperature *</li> <li>■ Electronics temperature</li> <li>■ Sensor index coil asymmetry</li> <li>■ Test point 0</li> <li>■ Test point 1</li> </ul> |   |
| Minimum frequency value              | The <b>Frequency</b> option is selected in the <b>Operating mode</b> parameter (→ 94) and a process variable is selected in the <b>Assign frequency output</b> parameter (→ 98).  | Enter minimum frequency.                               | 0.0 to 10000.0 Hz  | 0.0 Hz                                  |
| Maximum frequency value              | The <b>Frequency</b> option is selected in the <b>Operating mode</b> parameter (→ 94) and a process variable is selected in the <b>Assign frequency output</b> parameter (→ 98).  | Enter maximum frequency.                               | 0.0 to 10000.0 Hz  | 10000.0 Hz                              |
| Measuring value at minimum frequency | The <b>Frequency</b> option is selected in the <b>Operating mode</b> parameter (→ 94) and a process variable is selected in the <b>Assign frequency output</b> parameter (→ 98).  | Enter measured value for minimum frequency.            | Signed floating-point number   | Depends on country and nominal diameter |
| Measuring value at maximum frequency | The <b>Frequency</b> option is selected in the <b>Operating mode</b> parameter (→ 94) and a process variable is selected in the <b>Assign frequency output</b> parameter (→ 98).  | Enter measured value for maximum frequency.            | Signed floating-point number   | Depends on country and nominal diameter |
| Failure mode                         | The <b>Frequency</b> option is selected in the <b>Operating mode</b> parameter (→ 94) and a process variable is selected in the <b>Assign frequency output</b> parameter (→ 98).  | Select output behavior in the event of a device alarm. | <ul style="list-style-type: none"> <li>■ Actual value</li> <li>■ Defined value</li> <li>■ 0 Hz</li> </ul>  | 0 Hz                                    |
| Failure frequency                    | In the <b>Operating mode</b> parameter (→ 94), the <b>Frequency</b> option is selected, in the <b>Assign frequency output</b> parameter (→ 98) a process variable is selected, and in the <b>Failure mode</b> parameter, the <b>Defined value</b> option is selected. | Enter frequency output value in alarm condition.       | 0.0 to 12500.0 Hz  | 0.0 Hz                                  |
| Invert output signal                 | –   | Invert the output signal.                              | <ul style="list-style-type: none"> <li>■ No</li> <li>■ Yes</li> </ul>  | No                                      |

\* Visibility depends on order options or device settings

## Configuring the switch output

### Navigation

"Setup" menu → Pulse/frequency/switch output

| ► Pulse/frequency/switch output<br>1 to n |       |
|---|-------|
| Operating mode                            | → 100 |
| Terminal number                           | → 100 |
| Signal mode                               | → 100 |
| Switch output function                    | → 101 |
| Assign diagnostic behavior                | → 101 |
| Assign limit                              | → 102 |
| Assign flow direction check               | → 102 |
| Assign status                             | → 103 |
| Switch-on value                           | → 103 |
| Switch-off value                          | → 103 |
| Switch-on delay                           | → 103 |
| Switch-off delay                          | → 103 |
| Failure mode                              | → 103 |
| Invert output signal                      | → 103 |

### Parameter overview with brief description

| Parameter       | Prerequisite | Description   | Selection / User interface / User entry  | Factory setting |
|-----------------|--------------|---|--|-----------------|
| Operating mode  | –            | Define the output as a pulse, frequency or switch output. | <ul style="list-style-type: none"> <li>▪ Pulse</li> <li>▪ Frequency</li> <li>▪ Switch</li> </ul>               | Pulse           |
| Terminal number | –            | Shows the terminal numbers used by the PFS output module. | <ul style="list-style-type: none"> <li>▪ Not used</li> <li>▪ 24-25 (I/O 2)</li> <li>▪ 22-23 (I/O 3)</li> </ul> | –               |
| Signal mode     | –            | Select the signal mode for the PFS output.                | <ul style="list-style-type: none"> <li>▪ Passive*</li> <li>▪ Active*</li> <li>▪ Passive NE</li> </ul>          | Passive         |

| Parameter                  | Prerequisite  | Description   | Selection / User interface / User entry   | Factory setting |
|----------------------------|---|---|---|-----------------|
| Switch output function     | The <b>Switch</b> option is selected in the <b>Operating mode</b> parameter.  | Select function for switch output.  | <ul style="list-style-type: none"> <li>▪ Off</li> <li>▪ On</li> <li>▪ Diagnostic behavior</li> <li>▪ Limit</li> <li>▪ Flow direction check</li> <li>▪ Status</li> </ul> | Off             |
| Assign diagnostic behavior | <ul style="list-style-type: none"> <li>▪ In the <b>Operating mode</b> parameter, the <b>Switch</b> option is selected.</li> <li>▪ In the <b>Switch output function</b> parameter, the <b>Diagnostic behavior</b> option is selected.</li> </ul> | The output is switched on (closed, conductive), if there is a pending diagnostic event of the assigned behavioral category. | <ul style="list-style-type: none"> <li>▪ Alarm</li> <li>▪ Alarm or warning</li> <li>▪ Warning</li> </ul>  | Alarm           |

| Parameter                   | Prerequisite   | Description   | Selection / User interface / User entry  | Factory setting |
|-----------------------------|--|---|--|-----------------|
| Assign limit                | <ul style="list-style-type: none"> <li>■ The <b>Switch</b> option is selected in <b>Operating mode</b> parameter.</li> <li>■ The <b>Limit</b> option is selected in <b>Switch output function</b> parameter.</li> </ul>                        | Select the variable to monitor in case the specified limit value is exceeded. If a limit value is exceeded, the output is switched on (conductive). | <ul style="list-style-type: none"> <li>■ Mass flow</li> <li>■ Volume flow</li> <li>■ Corrected volume flow *</li> <li>■ Target mass flow *</li> <li>■ Carrier mass flow *</li> <li>■ Target volume flow *</li> <li>■ Carrier volume flow *</li> <li>■ Target corrected volume flow *</li> <li>■ Carrier corrected volume flow *</li> <li>■ Density</li> <li>■ Reference density *</li> <li>■ Reference density alternative *</li> <li>■ GSV flow *</li> <li>■ GSV flow alternative *</li> <li>■ NSV flow *</li> <li>■ NSV flow alternative *</li> <li>■ S&amp;W volume flow *</li> <li>■ Water cut *</li> <li>■ Oil density *</li> <li>■ Water density *</li> <li>■ Oil mass flow *</li> <li>■ Water mass flow *</li> <li>■ Oil volume flow *</li> <li>■ Water volume flow *</li> <li>■ Oil corrected volume flow *</li> <li>■ Water corrected volume flow *</li> <li>■ Concentration *</li> <li>■ Temperature</li> <li>■ Totalizer 1</li> <li>■ Totalizer 2</li> <li>■ Totalizer 3</li> <li>■ Oscillation damping</li> <li>■ Pressure</li> <li>■ Application specific output 0 *</li> <li>■ Application specific output 1 *</li> <li>■ Inhomogeneous medium index</li> <li>■ Suspended bubbles index *</li> </ul> | Volume flow     |
| Assign flow direction check | <ul style="list-style-type: none"> <li>■ The <b>Switch</b> option is selected in the <b>Operating mode</b> parameter.</li> <li>■ The <b>Flow direction check</b> option is selected in the <b>Switch output function</b> parameter.</li> </ul> | Select process variable for flow direction monitoring.  |  | Mass flow       |

| Parameter            | Prerequisite  | Description  | Selection / User interface / User entry   | Factory setting  |
|----------------------|---|--|---|--|
| Assign status        | <ul style="list-style-type: none"> <li>The <b>Switch</b> option is selected in <b>Operating mode</b> parameter.</li> <li>The <b>Status</b> option is selected in <b>Switch output function</b> parameter.</li> </ul>        | Select the device function for which to display the status. If the switch on point is reached, the output is switched on (closed, conductive). | <ul style="list-style-type: none"> <li>Partially filled pipe detection</li> <li>Low flow cut off</li> </ul> | Partially filled pipe detection  |
| Switch-on value      | <ul style="list-style-type: none"> <li>The <b>Switch</b> option is selected in the <b>Operating mode</b> parameter.</li> <li>The <b>Limit</b> option is selected in the <b>Switch output function</b> parameter.</li> </ul> | Enter limit value for switch-on point (process variable > switch-on value = closed, conductive).   | Signed floating-point number  | Depends on country: <ul style="list-style-type: none"> <li>0 kg/h</li> <li>0 lb/min</li> </ul> |
| Switch-off value     | <ul style="list-style-type: none"> <li>The <b>Switch</b> option is selected in the <b>Operating mode</b> parameter.</li> <li>The <b>Limit</b> option is selected in the <b>Switch output function</b> parameter.</li> </ul> | Enter limit value for switch-off point (process variable < switch-off value = open, nonconductive).  | Signed floating-point number  | Depends on country: <ul style="list-style-type: none"> <li>0 kg/h</li> <li>0 lb/min</li> </ul> |
| Switch-on delay      | <ul style="list-style-type: none"> <li>The <b>Switch</b> option is selected in the <b>Operating mode</b> parameter.</li> <li>The <b>Limit</b> option is selected in the <b>Switch output function</b> parameter.</li> </ul> | Enter a delay before the output is switched on.  | 0.0 to 100.0 s  | 0.0 s  |
| Switch-off delay     | <ul style="list-style-type: none"> <li>The <b>Switch</b> option is selected in the <b>Operating mode</b> parameter.</li> <li>The <b>Limit</b> option is selected in the <b>Switch output function</b> parameter.</li> </ul> | Enter a delay before the output is switched off.   | 0.0 to 100.0 s  | 0.0 s  |
| Failure mode         | –   | Select output behavior in the event of a device alarm.   | <ul style="list-style-type: none"> <li>Actual status</li> <li>Open</li> <li>Closed</li> </ul>               | Open   |
| Invert output signal | –   | Invert the output signal.  | <ul style="list-style-type: none"> <li>No</li> <li>Yes</li> </ul>   | No   |

\* Visibility depends on order options or device settings

### 10.4.10 Configuring the relay output









The **Relay output** wizard guides the user systematically through all the parameters that have to be set for configuring the relay output.

#### Navigation

"Setup" menu → Relay output 1 to n

▶ **Relay output 1 to n**

|                             |         |
|-----------------------------|---------|
| Terminal number             | → ⓘ 104 |
| Relay output function       | → ⓘ 104 |
| Assign flow direction check | → ⓘ 104 |
| Assign limit                | → ⓘ 105 |

|                            |   |
|----------------------------|---|
| Assign diagnostic behavior | →  105 |
| Assign status              | →  105 |
| Switch-off value           | →  106 |
| Switch-off delay           | →  106 |
| Switch-on value            | →  106 |
| Switch-on delay            | →  106 |
| Failure mode               | →  106 |
| Switch state               | →  106 |
| Powerless relay status     | →  106 |

### Parameter overview with brief description

| Parameter                   | Prerequisite  | Description   | User interface / Selection / User entry  | Factory setting |
|-----------------------------|---|---|--|-----------------|
| Terminal number             | –   | Shows the terminal numbers used by the relay output module. | <ul style="list-style-type: none"> <li>▪ Not used</li> <li>▪ 24-25 (I/O 2)</li> <li>▪ 22-23 (I/O 3)</li> </ul>   | –               |
| Relay output function       | –   | Select the function for the relay output.                   | <ul style="list-style-type: none"> <li>▪ Closed</li> <li>▪ Open</li> <li>▪ Diagnostic behavior</li> <li>▪ Limit</li> <li>▪ Flow direction check</li> <li>▪ Status</li> </ul> | Closed          |
| Assign flow direction check | The <b>Flow direction check</b> option is selected in the <b>Relay output function</b> parameter. | Select process variable for flow direction monitoring.      |  | Mass flow       |



| Parameter                  | Prerequisite  | Description   | User interface / Selection / User entry  | Factory setting                 |
|----------------------------|---|---|--|---------------------------------|
| Assign limit               | The <b>Limit</b> option is selected in <b>Relay output function</b> parameter.                    | Select the variable to monitor in case the specified limit value is exceeded. If a limit value is exceeded, the output is switched on (conductive). | <ul style="list-style-type: none"> <li>■ Mass flow</li> <li>■ Volume flow</li> <li>■ Corrected volume flow<sup>*</sup></li> <li>■ Target mass flow<sup>*</sup></li> <li>■ Carrier mass flow<sup>*</sup></li> <li>■ Target volume flow<sup>*</sup></li> <li>■ Carrier volume flow<sup>*</sup></li> <li>■ Target corrected volume flow<sup>*</sup></li> <li>■ Carrier corrected volume flow<sup>*</sup></li> <li>■ Density</li> <li>■ Reference density<sup>*</sup></li> <li>■ Reference density alternative<sup>*</sup></li> <li>■ GSV flow<sup>*</sup></li> <li>■ GSV flow alternative<sup>*</sup></li> <li>■ NSV flow<sup>*</sup></li> <li>■ NSV flow alternative<sup>*</sup></li> <li>■ S&amp;W volume flow<sup>*</sup></li> <li>■ Water cut<sup>*</sup></li> <li>■ Oil density<sup>*</sup></li> <li>■ Water density<sup>*</sup></li> <li>■ Oil mass flow<sup>*</sup></li> <li>■ Water mass flow<sup>*</sup></li> <li>■ Oil volume flow<sup>*</sup></li> <li>■ Water volume flow<sup>*</sup></li> <li>■ Oil corrected volume flow<sup>*</sup></li> <li>■ Water corrected volume flow<sup>*</sup></li> <li>■ Concentration<sup>*</sup></li> <li>■ Temperature</li> <li>■ Totalizer 1</li> <li>■ Totalizer 2</li> <li>■ Totalizer 3</li> <li>■ Oscillation damping</li> <li>■ Pressure</li> <li>■ Application specific output 0<sup>*</sup></li> <li>■ Application specific output 1<sup>*</sup></li> <li>■ Inhomogeneous medium index</li> <li>■ Suspended bubbles index<sup>*</sup></li> </ul> | Mass flow                       |
| Assign diagnostic behavior | In the <b>Relay output function</b> parameter, the <b>Diagnostic behavior</b> option is selected. | The output is switched on (closed, conductive), if there is a pending diagnostic event of the assigned behavioral category.                         | <ul style="list-style-type: none"> <li>■ Alarm</li> <li>■ Alarm or warning</li> <li>■ Warning</li> </ul>   | Alarm                           |
| Assign status              | In the <b>Relay output function</b> parameter, the <b>Digital Output</b> option is selected.      | Select the device function for which to display the status. If the switch on point is reached, the output is switched on (closed, conductive).      | <ul style="list-style-type: none"> <li>■ Partially filled pipe detection</li> <li>■ Low flow cut off</li> </ul>  | Partially filled pipe detection |

| Parameter              | Prerequisite  | Description   | User interface / Selection / User entry   | Factory setting   |
|------------------------|---|---|---|---|
| Switch-off value       | The <b>Limit</b> option is selected in the <b>Relay output function</b> parameter.  | Enter limit value for switch-off point (process variable < switch-off value = open, nonconductive). | Signed floating-point number  | Depends on country:<br><ul style="list-style-type: none"> <li>■ 0 kg/h</li> <li>■ 0 lb/min</li> </ul> |
| Switch-off delay       | In the <b>Relay output function</b> parameter, the <b>Limit</b> option is selected. | Enter a delay before the output is switched off.  | 0.0 to 100.0 s  | 0.0 s   |
| Switch-on value        | The <b>Limit</b> option is selected in the <b>Relay output function</b> parameter.  | Enter measured value for the switch-on point.   | Signed floating-point number  | Depends on country:<br><ul style="list-style-type: none"> <li>■ 0 kg/h</li> <li>■ 0 lb/min</li> </ul> |
| Switch-on delay        | In the <b>Relay output function</b> parameter, the <b>Limit</b> option is selected. | Enter a delay before the output is switched on.   | 0.0 to 100.0 s  | 0.0 s   |
| Failure mode           | –   | Select output behavior in the event of a device alarm.  | <ul style="list-style-type: none"> <li>■ Actual status</li> <li>■ Open</li> <li>■ Closed</li> </ul> | Open  |
| Switch state           | –   | Indicates the current switch state of the output.   | <ul style="list-style-type: none"> <li>■ Open</li> <li>■ Closed</li> </ul>                          | –   |
| Powerless relay status | –   | Select quiescent state for relay.   | <ul style="list-style-type: none"> <li>■ Open</li> <li>■ Closed</li> </ul>                          | Open  |

\* Visibility depends on order options or device settings

### 10.4.11 Configuring the double pulse output

The **Double pulse output** submenu guides the user systematically through all the parameters that have to be set for configuring the double pulse output.

#### Navigation

"Setup" menu → Double pulse output

|                        |       |
|------------------------|-------|
| ▶ Double pulse output  |       |
| Signal mode            | → 107 |
| Master terminal number | → 107 |
| Assign pulse output    | → 107 |
| Measuring mode         | → 107 |
| Value per pulse        | → 107 |
| Pulse width            | → 107 |
| Failure mode           | → 107 |
| Invert output signal   | → 107 |

**Parameter overview with brief description**

| Parameter              | Description  | Selection / User interface / User entry  | Factory setting                         |
|------------------------|--|--|---|
| Signal mode            | Select the signal mode for the double pulse output.                              | <ul style="list-style-type: none"> <li>■ Passive</li> <li>■ Active *</li> <li>■ Passive NE</li> </ul>  | Passive                                 |
| Master terminal number | Shows the terminal numbers used by the master of the double pulse output module. | <ul style="list-style-type: none"> <li>■ Not used</li> <li>■ 24-25 (I/O 2)</li> <li>■ 22-23 (I/O 3)</li> </ul>   | –                                       |
| Assign pulse output    | Select process variable for pulse output.  | <ul style="list-style-type: none"> <li>■ Off</li> <li>■ Mass flow</li> <li>■ Volume flow</li> <li>■ Corrected volume flow *</li> <li>■ Target mass flow *</li> <li>■ Carrier mass flow *</li> <li>■ Target volume flow *</li> <li>■ Carrier volume flow *</li> <li>■ Target corrected volume flow *</li> <li>■ Carrier corrected volume flow *</li> <li>■ GSV flow *</li> <li>■ GSV flow alternative *</li> <li>■ NSV flow *</li> <li>■ NSV flow alternative *</li> <li>■ S&amp;W volume flow *</li> <li>■ Oil mass flow *</li> <li>■ Water mass flow *</li> <li>■ Oil volume flow *</li> <li>■ Water volume flow *</li> <li>■ Oil corrected volume flow *</li> <li>■ Water corrected volume flow *</li> </ul> | Off                                     |
| Measuring mode         | Select measuring mode for pulse output.  | <ul style="list-style-type: none"> <li>■ Forward flow</li> <li>■ Forward/Reverse flow</li> <li>■ Reverse flow</li> <li>■ Reverse flow compensation</li> </ul>  | Forward flow                            |
| Value per pulse        | Enter measured value at which a pulse is output.                                 | Signed floating-point number   | Depends on country and nominal diameter |
| Pulse width            | Define time width of the output pulse.   | 0.5 to 2 000 ms  | 0.5 ms                                  |
| Failure mode           | Select output behavior in the event of a device alarm.                           | <ul style="list-style-type: none"> <li>■ Actual value</li> <li>■ No pulses</li> </ul>  | No pulses                               |
| Invert output signal   | Invert the output signal.  | <ul style="list-style-type: none"> <li>■ No</li> <li>■ Yes</li> </ul>  | No                                      |

\* Visibility depends on order options or device settings









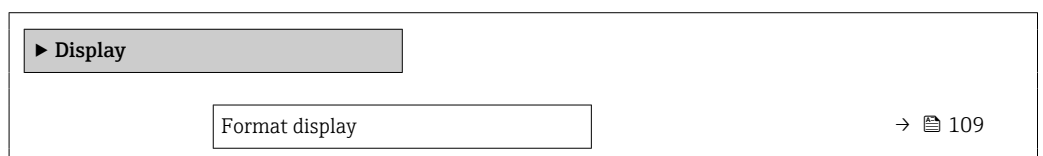



**10.4.12 Configuring the local display**

The **Display** wizard guides you systematically through all the parameters that can be configured for configuring the local display.

**Navigation**

"Setup" menu → Display



|                       |   |
|-----------------------|---|
| Value 1 display       | →  110   |
| 0% bargraph value 1   | →  111   |
| 100% bargraph value 1 | →  111   |
| Value 2 display       | →  111   |
| Value 3 display       | →  111   |
| 0% bargraph value 3   | →  111   |
| 100% bargraph value 3 | →  111   |
| Value 4 display       | →  111   |
| Value 5 display       | →  111   |
| Value 6 display       | →  111   |
| Value 7 display       | →  111 |
| Value 8 display       | →  111 |

**Parameter overview with brief description**

| Parameter      | Prerequisite                 | Description  | Selection / User entry   | Factory setting    |
|----------------|------------------------------|--|--|--------------------|
| Format display | A local display is provided. | Select how measured values are shown on the display. | <ul style="list-style-type: none"><li>■ 1 value, max. size</li><li>■ 1 bargraph + 1 value</li><li>■ 2 values</li><li>■ 1 value large + 2 values</li><li>■ 4 values</li></ul> | 1 value, max. size |

| Parameter       | Prerequisite                 | Description   | Selection / User entry   | Factory setting |
|-----------------|------------------------------|---|--|-----------------|
| Value 1 display | A local display is provided. | Select the measured value that is shown on the local display. | <ul style="list-style-type: none"> <li>▪ Mass flow</li> <li>▪ Volume flow</li> <li>▪ Corrected volume flow *</li> <li>▪ Density</li> <li>▪ Reference density *</li> <li>▪ Temperature</li> <li>▪ Pressure</li> <li>▪ Totalizer 1</li> <li>▪ Totalizer 2</li> <li>▪ Totalizer 3</li> <li>▪ GSV flow *</li> <li>▪ GSV flow alternative *</li> <li>▪ NSV flow *</li> <li>▪ NSV flow alternative *</li> <li>▪ S&amp;W volume flow *</li> <li>▪ Reference density alternative *</li> <li>▪ Weighted density average *</li> <li>▪ Weighted temperature average *</li> <li>▪ Water cut *</li> <li>▪ Oil density *</li> <li>▪ Water density *</li> <li>▪ Oil mass flow *</li> <li>▪ Water mass flow *</li> <li>▪ Oil volume flow *</li> <li>▪ Water volume flow *</li> <li>▪ Oil corrected volume flow *</li> <li>▪ Water corrected volume flow *</li> <li>▪ Concentration *</li> <li>▪ Target mass flow *</li> <li>▪ Carrier mass flow *</li> <li>▪ Target volume flow *</li> <li>▪ Carrier volume flow *</li> <li>▪ Target corrected volume flow *</li> <li>▪ Carrier corrected volume flow *</li> <li>▪ Application specific output 0 *</li> <li>▪ Application specific output 1 *</li> <li>▪ Inhomogeneous medium index</li> <li>▪ Suspended bubbles index *</li> <li>▪ HBSI *</li> <li>▪ Raw value mass flow</li> <li>▪ Exciter current 0</li> <li>▪ Oscillation damping 0</li> <li>▪ Oscillation damping fluctuation 0 *</li> <li>▪ Oscillation frequency 0</li> </ul> | Mass flow       |

| Parameter             | Prerequisite  | Description   | Selection / User entry   | Factory setting  |
|-----------------------|---|---|--|--|
|                       |   |   | <ul style="list-style-type: none"> <li>■ Frequency fluctuation 0 *</li> <li>■ Oscillation amplitude 0 *</li> <li>■ Signal asymmetry</li> <li>■ Torsion signal asymmetry *</li> <li>■ Carrier pipe temperature *</li> <li>■ Electronics temperature</li> <li>■ Sensor index coil asymmetry</li> <li>■ Test point 0</li> <li>■ Test point 1</li> <li>■ Current output 1</li> <li>■ Current output 2 *</li> <li>■ Current output 3 *</li> </ul> |  |
| 0% bargraph value 1   | A local display is provided.                                  | Enter 0% value for bar graph display.                         | Signed floating-point number   | Country-specific: <ul style="list-style-type: none"> <li>■ 0 kg/h</li> <li>■ 0 lb/min</li> </ul> |
| 100% bargraph value 1 | A local display is provided.                                  | Enter 100% value for bar graph display.                       | Signed floating-point number   | Depends on country and nominal diameter  |
| Value 2 display       | A local display is provided.                                  | Select the measured value that is shown on the local display. | For the picklist, see <b>Value 1 display</b> parameter (→ 110)   | None   |
| Value 3 display       | A local display is provided.                                  | Select the measured value that is shown on the local display. | For the picklist, see <b>Value 1 display</b> parameter (→ 110)   | None   |
| 0% bargraph value 3   | A selection was made in the <b>Value 3 display</b> parameter. | Enter 0% value for bar graph display.                         | Signed floating-point number   | Country-specific: <ul style="list-style-type: none"> <li>■ 0 kg/h</li> <li>■ 0 lb/min</li> </ul> |
| 100% bargraph value 3 | A selection was made in the <b>Value 3 display</b> parameter. | Enter 100% value for bar graph display.                       | Signed floating-point number   | 0  |
| Value 4 display       | A local display is provided.                                  | Select the measured value that is shown on the local display. | For the picklist, see <b>Value 1 display</b> parameter (→ 110)   | None   |
| Value 5 display       | A local display is provided.                                  | Select the measured value that is shown on the local display. | For the picklist, see <b>Value 1 display</b> parameter (→ 110)   | None   |
| Value 6 display       | A local display is provided.                                  | Select the measured value that is shown on the local display. | For the picklist, see <b>Value 1 display</b> parameter (→ 110)   | None   |
| Value 7 display       | A local display is provided.                                  | Select the measured value that is shown on the local display. | For the picklist, see <b>Value 1 display</b> parameter (→ 110)   | None   |
| Value 8 display       | A local display is provided.                                  | Select the measured value that is shown on the local display. | For the picklist, see <b>Value 1 display</b> parameter (→ 110)   | None   |

\* Visibility depends on order options or device settings

### 10.4.13 Configuring the low flow cut off

The **Low flow cut off** wizard systematically guides the user through all the parameters that must be set to configure low flow cut off.

#### Navigation

"Setup" menu → Low flow cut off

| ► Low flow cut off         |         |
|----------------------------|---------|
| Assign process variable    | → ⓘ 112 |
| On value low flow cutoff   | → ⓘ 112 |
| Off value low flow cutoff  | → ⓘ 112 |
| Pressure shock suppression | → ⓘ 112 |

#### Parameter overview with brief description

| Parameter                  | Prerequisite  | Description  | Selection / User entry   | Factory setting                         |
|----------------------------|---|--|--|---|
| Assign process variable    | –   | Select process variable for low flow cut off.                                  | <ul style="list-style-type: none"> <li>■ Off</li> <li>■ Mass flow</li> <li>■ Volume flow</li> <li>■ Corrected volume flow<sup>*</sup></li> </ul> | Mass flow                               |
| On value low flow cutoff   | A process variable is selected in the <b>Assign process variable</b> parameter (→ ⓘ 112). | Enter on value for low flow cut off.   | Positive floating-point number   | Depends on country and nominal diameter |
| Off value low flow cutoff  | A process variable is selected in the <b>Assign process variable</b> parameter (→ ⓘ 112). | Enter off value for low flow cut off.  | 0 to 100.0 %   | 50 %                                    |
| Pressure shock suppression | A process variable is selected in the <b>Assign process variable</b> parameter (→ ⓘ 112). | Enter time frame for signal suppression (= active pressure shock suppression). | 0 to 100 s   | 0 s                                     |

\* Visibility depends on order options or device settings



### 10.4.14 Configuring partially filled pipe detection

The **Partial filled pipe detection** wizard guides you systematically through all parameters that have to be set for configuring the monitoring of the pipe filling.

#### Navigation

"Setup" menu → Partially filled pipe detection

| ► Partially filled pipe detection        |         |
|--|---------|
| Assign process variable                  | → ⓘ 113 |
| Low value partial filled pipe detection  | → ⓘ 113 |
| High value partial filled pipe detection | → ⓘ 113 |
| Response time part. filled pipe detect.  | → ⓘ 113 |

#### Parameter overview with brief description

| Parameter                                | Prerequisite  | Description  | Selection / User entry   | Factory setting   |
|--|---|--|--|---|
| Assign process variable                  | –   | Select process variable for partially filled pipe detection.   | <ul style="list-style-type: none"> <li>■ Off</li> <li>■ Density</li> <li>■ Calculated reference density</li> </ul> | Density   |
| Low value partial filled pipe detection  | A process variable is selected in the <b>Assign process variable</b> parameter (→ ⓘ 113). | Enter lower limit value for deactivating partialy filled pipe detection.   | Signed floating-point number   | Depends on country: <ul style="list-style-type: none"> <li>■ 200 kg/m<sup>3</sup></li> <li>■ 12.5 lb/ft<sup>3</sup></li> </ul>    |
| High value partial filled pipe detection | A process variable is selected in the <b>Assign process variable</b> parameter (→ ⓘ 113). | Enter upper limit value for deactivating partialy filled pipe detection.   | Signed floating-point number   | Depends on country: <ul style="list-style-type: none"> <li>■ 6 000 kg/m<sup>3</sup></li> <li>■ 374.6 lb/ft<sup>3</sup></li> </ul> |
| Response time part. filled pipe detect.  | A process variable is selected in the <b>Assign process variable</b> parameter (→ ⓘ 113). | Use this function to enter the minimum time (hold time) the signal must be present before diagnostic message S962 "Pipe only partly filled" is triggered in the event of a partially filled or empty measuring pipe. | 0 to 100 s   | 1 s   |

## 10.5 Advanced settings

The **Advanced setup** submenu with its submenus contains parameters for specific settings.

*Navigation to the "Advanced setup" submenu*

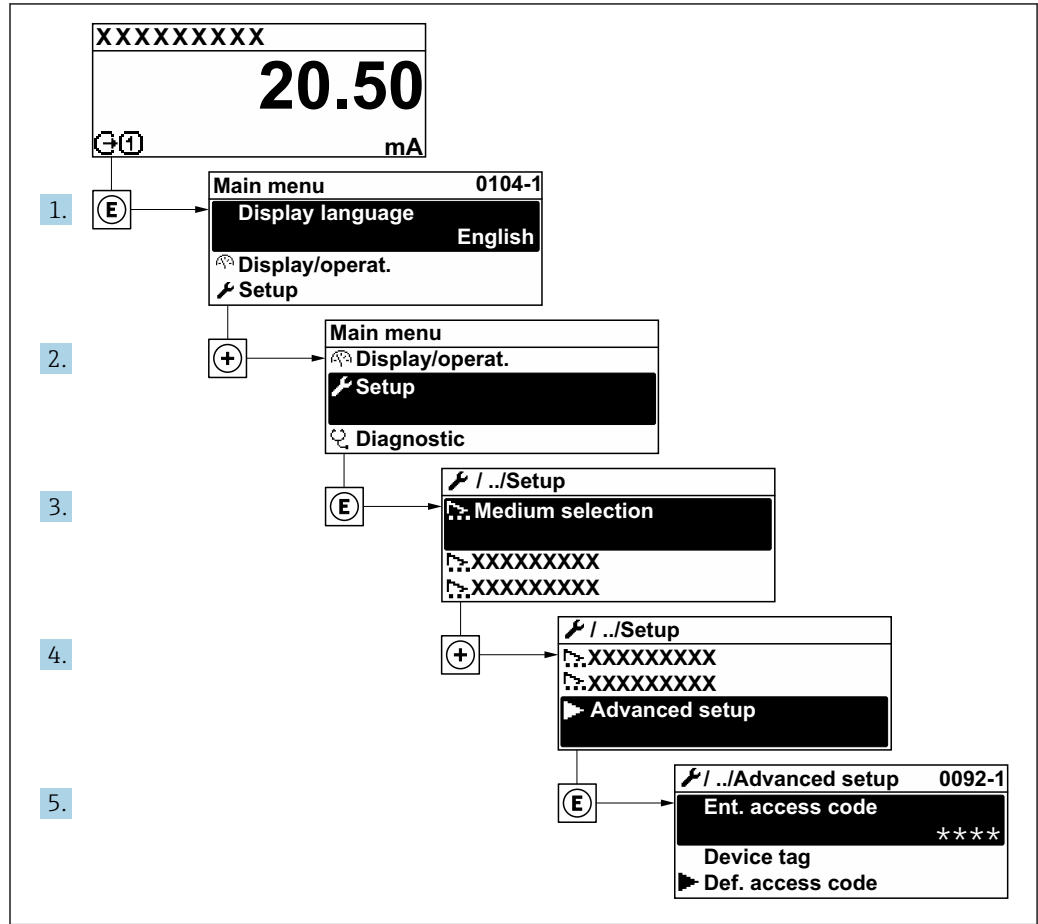

A0032223-EN

**i** The number of submenus and parameters can vary depending on the device version and the available application packages. These submenus and their parameters are explained in the Special Documentation for the device and not in Operating Instructions.

For detailed information on the parameter descriptions for application packages or for operation in custody transfer mode: Special Documentation for the device → 224

### Navigation

"Setup" menu → Advanced setup

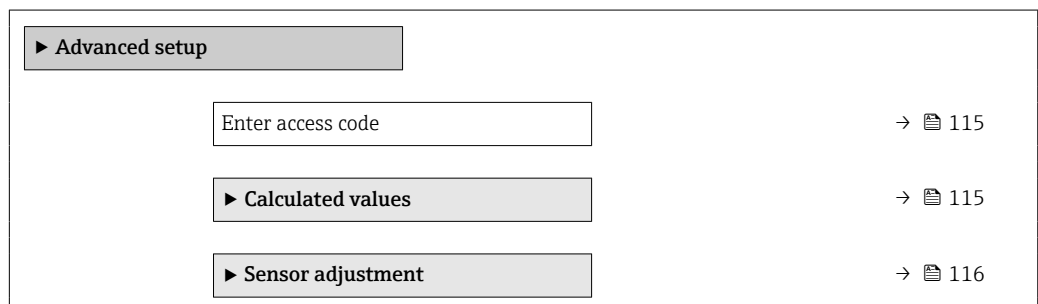

|                        |       |
|------------------------|-------|
| ▶ Totalizer 1 to n     | → 122 |
| ▶ Display              | → 125 |
| ▶ WLAN settings        | → 131 |
| ▶ Configuration backup | → 133 |
| ▶ Administration       | → 134 |

### 10.5.1 Using the parameter to enter the access code

#### Navigation

"Setup" menu → Advanced setup

#### Parameter overview with brief description

| Parameter         | Description  | User entry  |
|-------------------|--|---|
| Enter access code | Enter access code to disable write protection of parameters. | Max. 16-digit character string comprising numbers, letters and special characters |

### 10.5.2 Calculated process variables

The **Calculated values** submenu contains parameters for calculating the corrected volume flow.

**i** The **Calculated values** submenu is **not** available if one of the following options was selected in the **Petroleum mode** parameter in the "Application package", option **EJ "Petroleum": API referenced correction** option, **Net oil & water cut** option or **ASTM D4311** option

#### Navigation

"Setup" menu → Advanced setup → Calculated values





|                                     |       |
|-------------------------------------|-------|
| ▶ Calculated values                 |       |
| ▶ Corrected volume flow calculation | → 115 |

#### "Corrected volume flow calculation" submenu

#### Navigation

"Setup" menu → Advanced setup → Calculated values → Corrected volume flow calculation

|                                     |       |
|-------------------------------------|-------|
| ▶ Corrected volume flow calculation |       |
| Select reference density (1812)     | → 116 |
| External reference density (6198)   | → 116 |

|                                     |   |
|-------------------------------------|---|
| Fixed reference density (1814)      | →  116 |
| Reference temperature (1816)        | →  116 |
| Linear expansion coefficient (1817) | →  116 |
| Square expansion coefficient (1818) | →  116 |

### Parameter overview with brief description

| Parameter                    | Prerequisite  | Description  | Selection / User interface / User entry   | Factory setting  |
|------------------------------|---|--|---|--|
| Select reference density     | –   | Select reference density for calculating the corrected volume flow.  | <ul style="list-style-type: none"> <li>■ Fixed reference density</li> <li>■ Calculated reference density</li> <li>■ Current input 1<sup>*</sup></li> <li>■ Current input 2<sup>*</sup></li> </ul> | Calculated reference density   |
| External reference density   | In the <b>Corrected volume flow calculation</b> parameter, the <b>External reference density</b> option is selected.            | Shows external reference density.  | Floating point number with sign   | –  |
| Fixed reference density      | The <b>Fixed reference density</b> option is selected in the <b>Corrected volume flow calculation</b> parameter parameter.      | Enter fixed value for reference density.   | Positive floating-point number  | 1 kg/Nl  |
| Reference temperature        | The <b>Calculated reference density</b> option is selected in the <b>Corrected volume flow calculation</b> parameter parameter. | Enter reference temperature for calculating the reference density.   | –273.15 to 99 999 °C  | Country-specific: <ul style="list-style-type: none"> <li>■ +20 °C</li> <li>■ +68 °F</li> </ul> |
| Linear expansion coefficient | The <b>Calculated reference density</b> option is selected in the <b>Corrected volume flow calculation</b> parameter parameter. | Enter linear, medium-specific expansion coefficient for calculating the reference density.   | Signed floating-point number  | 0.0 1/K  |
| Square expansion coefficient | The <b>Calculated reference density</b> option is selected in the <b>Corrected volume flow calculation</b> parameter parameter. | For media with a non-linear expansion pattern: enter the quadratic, medium-specific expansion coefficient for calculating the reference density. | Signed floating-point number  | 0.0 1/K <sup>2</sup>   |

\* Visibility depends on order options or device settings

### 10.5.3 Carrying out a sensor adjustment

The **Sensor adjustment** submenu contains parameters that pertain to the functionality of the sensor.

**Navigation**

"Setup" menu → Advanced setup → Sensor adjustment

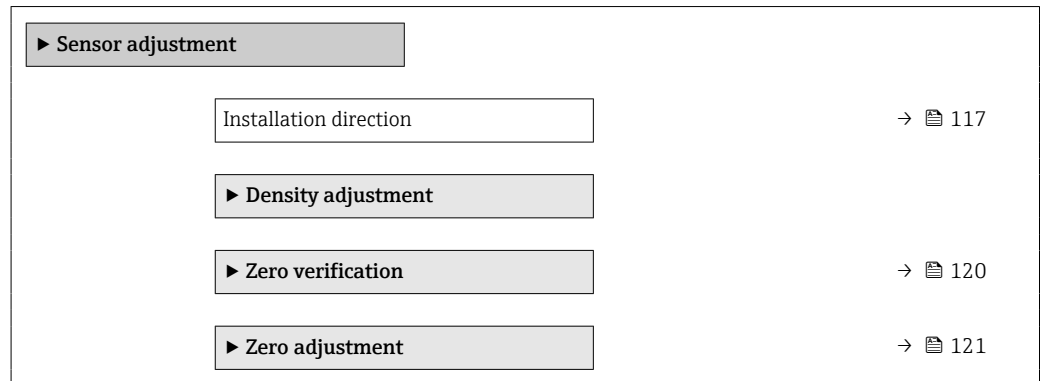

**Parameter overview with brief description**

| Parameter              | Description                    | Selection  | Factory setting |
|------------------------|--------------------------------|--|-----------------|
| Installation direction | Select sign of flow direction. | <ul style="list-style-type: none"> <li>■ Forward flow</li> <li>■ Reverse flow</li> </ul> | Forward flow    |

**Density adjustment**

 With density adjustment, a high level of accuracy is achieved only at the point of adjustment and at the relevant density and temperature. However, the accuracy of a density adjustment is only ever as good as the quality of the reference measuring data provided. Therefore it is not a substitute for special density calibration.

*Performing density adjustment*

-  Note the following before performing the adjustment:
- A density adjustment only makes sense if there is little variation in the operating conditions and the density adjustment is performed under the operating conditions.
  - The density adjustment scales the internally computed density value with a user-specific slope and offset.
  - A 1-point or 2-point density adjustment can be performed.
  - For a 2-point density adjustment, there must be a difference of at least 0.2 kg/l between the two target density values.
  - The reference media must be gas-free or pressurized so that any gas they contain is compressed.
  - The reference density measurements must be performed at the same medium temperature that prevails in the process, as otherwise the density adjustment will not be accurate.
  - The correction resulting from the density adjustment can be deleted with the **Restore original** option.

**"1 point adjustment" option**

1. In the **Density adjustment mode** parameter, select the **1 point adjustment** option and confirm.
2. In the **Density setpoint 1** parameter, enter the density value and confirm.
  - ↳ In the **Execute density adjustment** parameter the following options are now available:
    - Ok
    - Measure density 1 option**
    - Restore original

3. Select the **Measure density 1** option and confirm.
4. If 100% was reached in the **Progress** parameter on the display and the **Ok** option is displayed in the **Execute density adjustment** parameter, then confirm.
  - ↳ In the **Execute density adjustment** parameter the following options are now available:
    - Ok
    - Calculate
    - Cancel
5. Select the **Calculate** option and confirm.

If the adjustment was completed successfully, the **Density adjustment factor** parameter and the **Density adjustment offset** parameter and the values calculated for them are shown on the display.

### "2 point adjustment" option

1. In the **Density adjustment mode** parameter, select the **2 point adjustment** option and confirm.
2. In the **Density setpoint 1** parameter, enter the density value and confirm.
3. In the **Density setpoint 2** parameter, enter the density value and confirm.
  - ↳ In the **Execute density adjustment** parameter the following options are now available:
    - Ok
    - Measure density 1
    - Restore original
4. Select the **Measure density 1** option and confirm.
  - ↳ In the **Execute density adjustment** parameter the following options are now available:
    - Ok
    - Measure density 2
    - Restore original
5. Select the **Measure density 2** option and confirm.
  - ↳ In the **Execute density adjustment** parameter the following options are now available:
    - Ok
    - Calculate
    - Cancel
6. Select the **Calculate** option and confirm.

If the **Density adjust failure** option is displayed in the **Execute density adjustment** parameter, call up the options and select the **Cancel** option. The density adjustment is canceled and can be repeated.

If the adjustment was completed successfully, the **Density adjustment factor** parameter and the **Density adjustment offset** parameter and the values calculated for them are shown on the display.

### Navigation

"Expert" menu → Sensor → Sensor adjustment → Density adjustment

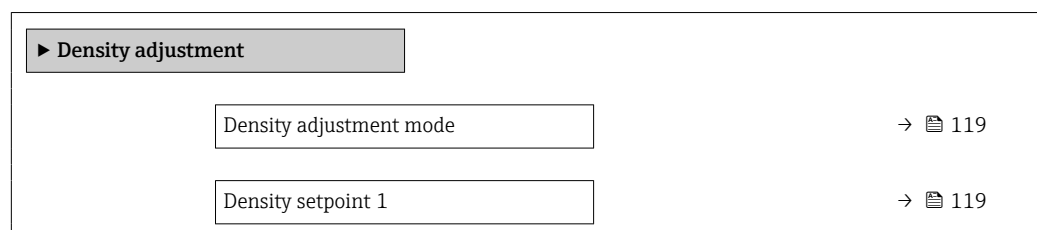

|                            |         |
|----------------------------|---------|
| Density setpoint 2         | → ⓘ 119 |
| Execute density adjustment | → ⓘ 119 |
| Progress                   | → ⓘ 119 |
| Density adjustment factor  | → ⓘ 119 |
| Density adjustment offset  | → ⓘ 119 |

**Parameter overview with brief description**

| Parameter                  | Prerequisite   | Description  | Selection / User entry / User interface   | Factory setting         |
|----------------------------|--|--|---|-------------------------|
| Density adjustment mode    | –  | Select the method for field density adjustment to correct the factory setting. | <ul style="list-style-type: none"> <li>■ 1 point adjustment</li> <li>■ 2 point adjustment</li> </ul>  | 1 point adjustment      |
| Density setpoint 1         | –  | Enter density for the first reference media.                                   | The entry depends on the unit selected in the <b>Density unit</b> parameter (0555).   | 1 000 kg/m <sup>3</sup> |
| Density setpoint 2         | In the <b>Density adjustment mode</b> parameter, the <b>2 point adjustment</b> option is selected. | Enter density for the second reference media.                                  | The entry depends on the unit selected in the <b>Density unit</b> parameter (0555).   | 1 000 kg/m <sup>3</sup> |
| Execute density adjustment | –  | Select the next step to be performed for the density adjustment.               | <ul style="list-style-type: none"> <li>■ Cancel<sup>*</sup></li> <li>■ Busy<sup>*</sup></li> <li>■ Ok</li> <li>■ Density adjust failure<sup>*</sup></li> <li>■ Measure density 1<sup>*</sup></li> <li>■ Measure density 2<sup>*</sup></li> <li>■ Calculate<sup>*</sup></li> <li>■ Restore original<sup>*</sup></li> </ul> | Ok                      |
| Progress                   | –  | Shows the progress of the process.   | 0 to 100 %  | –                       |
| Density adjustment factor  | –  | Shows the calculated correction factor for the density.                        | Signed floating-point number  | 1                       |
| Density adjustment offset  | –  | Shows the calculated correction offset for the density.                        | Signed floating-point number  | 0                       |

\* Visibility depends on order options or device settings

**Zero verification and zero adjustment**

All measuring instruments are calibrated in accordance with state-of-the-art technology. Calibration takes place under reference conditions → ⓘ 203. Therefore, a zero adjustment in the field is generally not required.

Experience shows that zero adjustment is advisable only in special cases:

- To achieve maximum measurement accuracy even with low flow rates.
- Under extreme process or operating conditions (e.g. very high process temperatures or very high-viscosity fluids).
- For gas applications with low pressure

 To achieve the highest possible measurement accuracy at low flow rates, the installation must protect the sensor from mechanical stresses during operation.

To get a representative zero point, ensure that:

- any flow in the device is prevented during the adjustment
- the process conditions (e.g. pressure, temperature) are stable and representative

Zero verification and zero adjustment cannot be performed if the following process conditions are present:

- Gas pockets  
Ensure that the system has been sufficiently flushed with the medium. Repeat flushing can help to eliminate gas pockets
- Thermal circulation  
In the event of temperature differences (e.g. between the measuring tube inlet and outlet section), induced flow can occur even if the valves are closed due to thermal circulation in the device
- Leaks at the valves  
If the valves are not leak-tight, flow is not sufficiently prevented when determining the zero point

If these conditions cannot be avoided, it is advisable to keep the factory setting for the zero point.

#### *Zero point verification*

The zero point can be verified with the **Zero verification** wizard.

#### **Navigation**

"Setup" menu → Advanced setup → Sensor adjustment → Zero verification

| ► Zero verification           |         |
|-------------------------------|---------|
| Process conditions            | → ⓘ 121 |
| Progress                      | → ⓘ 121 |
| Status                        | → ⓘ 121 |
| Additional information        | → ⓘ 121 |
| Recommendation:               | → ⓘ 121 |
| Root cause                    | → ⓘ 121 |
| Abort cause                   | → ⓘ 121 |
| Zero point measured           | → ⓘ 121 |
| Zero point standard deviation | → ⓘ 121 |



**Parameter overview with brief description**

| Parameter                     | Description   | Selection / User interface   | Factory setting |
|-------------------------------|---|--|-----------------|
| Process conditions            | Ensure process conditions as follows.   | <ul style="list-style-type: none"> <li>▪ Tubes are completely filled</li> <li>▪ Process operational pressure applied</li> <li>▪ No-flow conditions (closed valves)</li> <li>▪ Process and ambient temperatures stable</li> </ul> | –               |
| Progress                      | Shows the progress of the process.  | 0 to 100 %   | –               |
| Status                        | Shows the status of the process.  | <ul style="list-style-type: none"> <li>▪ Busy</li> <li>▪ Failed</li> <li>▪ Done</li> </ul>   | –               |
| Additional information        | Indicate whether to display additional information.   | <ul style="list-style-type: none"> <li>▪ Hide</li> <li>▪ Show</li> </ul>   | Hide            |
| Recommendation:               | Indicates whether an adjustment is recommended. Only recommended if the measured zero point deviates significantly from the current zero point. | <ul style="list-style-type: none"> <li>▪ Do not adjust zero point</li> <li>▪ Adjust zero point</li> </ul>  | –               |
| Abort cause                   | Indicates why the wizard was aborted.   | <ul style="list-style-type: none"> <li>▪ Check process conditions!</li> <li>▪ A technical issue has occurred</li> </ul>  | –               |
| Root cause                    | Shows the diagnostic and remedy.  | <ul style="list-style-type: none"> <li>▪ Zero point too high. Ensure no-flow.</li> <li>▪ Zero point is unstable. Ensure no-flow.</li> <li>▪ Fluctuation high. Avoid 2-phase medium.</li> </ul>                                   | –               |
| Zero point measured           | Shows the zero point measured for the adjustment.   | Signed floating-point number   | –               |
| Zero point standard deviation | Shows the standard deviation of the zero point measured.  | Positive floating-point number   | –               |

*Zero adjust*





The zero point can be adjusted with the **Zero adjustment** wizard.







-  ▪ A zero point verification should be performed before a zero adjustment.
- The zero point can also be adjusted manually: Expert → Sensor → Calibration

**Navigation**

"Setup" menu → Advanced setup → Sensor adjustment → Zero adjustment

▶ Zero adjustment

|                    |   |
|--------------------|---|
| Process conditions | →  122 |
| Progress           | →  122 |
| Status             | →  122 |
| Root cause         | →  122 |
| Abort cause        | →  122 |

|                                    |   |
|------------------------------------|---|
| Root cause                         | →  122 |
| Reliability of measured zero point | →  122 |
| Additional information             | →  122 |
| Reliability of measured zero point | →  122 |
| Zero point measured                | →  122 |
| Zero point standard deviation      | →  122 |
| Select action                      | →  122 |

### Parameter overview with brief description

| Parameter                          | Description  | Selection / User interface   | Factory setting         |
|------------------------------------|--|--|-------------------------|
| Process conditions                 | Ensure process conditions as follows.                    | <ul style="list-style-type: none"> <li>▪ Tubes are completely filled</li> <li>▪ Process operational pressure applied</li> <li>▪ No-flow conditions (closed valves)</li> <li>▪ Process and ambient temperatures stable</li> </ul> | –                       |
| Progress                           | Shows the progress of the process.                       | 0 to 100 %   | –                       |
| Status                             | Shows the status of the process.                         | <ul style="list-style-type: none"> <li>▪ Busy</li> <li>▪ Failed</li> <li>▪ Done</li> </ul>   | –                       |
| Abort cause                        | Indicates why the wizard was aborted.                    | <ul style="list-style-type: none"> <li>▪ Check process conditions!</li> <li>▪ A technical issue has occurred</li> </ul>  | –                       |
| Root cause                         | Shows the diagnostic and remedy.                         | <ul style="list-style-type: none"> <li>▪ Zero point too high. Ensure no-flow.</li> <li>▪ Zero point is unstable. Ensure no-flow.</li> <li>▪ Fluctuation high. Avoid 2-phase medium.</li> </ul>                                   | –                       |
| Reliability of measured zero point | Indicates the reliability of the zero point measured.    | <ul style="list-style-type: none"> <li>▪ Not done</li> <li>▪ Good</li> <li>▪ Uncertain</li> </ul>  | –                       |
| Additional information             | Indicate whether to display additional information.      | <ul style="list-style-type: none"> <li>▪ Hide</li> <li>▪ Show</li> </ul>   | Hide                    |
| Zero point measured                | Shows the zero point measured for the adjustment.        | Signed floating-point number   | –                       |
| Zero point standard deviation      | Shows the standard deviation of the zero point measured. | Positive floating-point number   | –                       |
| Select action                      | Select the zero point value to apply.                    | <ul style="list-style-type: none"> <li>▪ Keep current zero point</li> <li>▪ Apply zero point measured</li> <li>▪ Apply factory zero point *</li> </ul>   | Keep current zero point |

\* Visibility depends on order options or device settings

## 10.5.4 Configuring the totalizer

In the "Totalizer 1 to n" submenu, you can configure the specific totalizer.



**Navigation**

"Setup" menu → Advanced setup → Totalizer 1 to n

|   |         |
|---|---------|
| <div style="background-color: #cccccc; padding: 2px; margin-bottom: 10px;">▶ Totalizer 1 to n</div> |         |
| Assign process variable 1 to n  | → ⓘ 123 |
| Process variable unit 1 to n  | → ⓘ 123 |
| Totalizer 1 to n operation mode   | → ⓘ 124 |
| Totalizer 1 to n failure behavior   | → ⓘ 124 |

**Parameter overview with brief description**

| Parameter                      | Prerequisite   | Description  | Selection   | Factory setting  |
|--------------------------------|--|--|---|--|
| Assign process variable 1 to n | –  | Select process variable for totalizer.                     | <ul style="list-style-type: none"> <li>■ Off</li> <li>■ Mass flow</li> <li>■ Volume flow</li> <li>■ Corrected volume flow<sup>*</sup></li> <li>■ Target mass flow<sup>*</sup></li> <li>■ Carrier mass flow<sup>*</sup></li> <li>■ Target volume flow<sup>*</sup></li> <li>■ Carrier volume flow<sup>*</sup></li> <li>■ Target corrected volume flow<sup>*</sup></li> <li>■ Carrier corrected volume flow<sup>*</sup></li> <li>■ GSV flow<sup>*</sup></li> <li>■ GSV flow alternative<sup>*</sup></li> <li>■ NSV flow<sup>*</sup></li> <li>■ NSV flow alternative<sup>*</sup></li> <li>■ S&amp;W volume flow<sup>*</sup></li> <li>■ Oil mass flow<sup>*</sup></li> <li>■ Water mass flow<sup>*</sup></li> <li>■ Oil volume flow<sup>*</sup></li> <li>■ Water volume flow<sup>*</sup></li> <li>■ Oil corrected volume flow<sup>*</sup></li> <li>■ Water corrected volume flow<sup>*</sup></li> <li>■ Raw value mass flow</li> </ul> | Mass flow  |
| Process variable unit 1 to n   | A process variable is selected in the <b>Assign process variable</b> parameter (→ ⓘ 123) of the <b>Totalizer 1 to n</b> submenu. | Select the unit for the process variable of the totalizer. | Unit choose list  | Depends on country: <ul style="list-style-type: none"> <li>■ kg</li> <li>■ lb</li> </ul> |

| Parameter                         | Prerequisite   | Description   | Selection   | Factory setting |
|-----------------------------------|--|---|---|-----------------|
| Totalizer 1 to n operation mode   | A process variable is selected in the <b>Assign process variable</b> parameter (→  123) of the <b>Totalizer 1 to n</b> submenu. | Select totalizer operation mode, e.g. only totalize forward flow or only totalize reverse flow. | <ul style="list-style-type: none"> <li>▪ Net</li> <li>▪ Forward</li> <li>▪ Reverse</li> </ul>                       | Net             |
| Totalizer 1 to n failure behavior | A process variable is selected in the <b>Assign process variable</b> parameter (→  123) of the <b>Totalizer 1 to n</b> submenu. | Select totalizer behavior in the event of a device alarm.                                       | <ul style="list-style-type: none"> <li>▪ Hold</li> <li>▪ Continue</li> <li>▪ Last valid value + continue</li> </ul> | Hold            |

\* Visibility depends on order options or device settings













### 10.5.5 Carrying out additional display configurations

In the **Display** submenu you can set all the parameters associated with the configuration of the local display.

#### Navigation

"Setup" menu → Advanced setup → Display

| ► Display             |       |
|-----------------------|-------|
| Format display        | → 127 |
| Value 1 display       | → 128 |
| 0% bargraph value 1   | → 129 |
| 100% bargraph value 1 | → 129 |
| Decimal places 1      | → 129 |
| Value 2 display       | → 129 |
| Decimal places 2      | → 129 |
| Value 3 display       | → 129 |
| 0% bargraph value 3   | → 129 |
| 100% bargraph value 3 | → 129 |
| Decimal places 3      | → 129 |
| Value 4 display       | → 129 |
| Decimal places 4      | → 130 |
| Value 5 display       | → 130 |
| 0% bargraph value 5   | → 130 |
| 100% bargraph value 5 | → 130 |
| Decimal places 5      | → 130 |
| Value 6 display       | → 130 |
| Decimal places 6      | → 130 |
| Value 7 display       | → 130 |

|                       |   |
|-----------------------|---|
| 0% bargraph value 7   | →  130   |
| 100% bargraph value 7 | →  130   |
| Decimal places 7      | →  130   |
| Value 8 display       | →  130   |
| Decimal places 8      | →  131   |
| Display language      | →  131   |
| Display interval      | →  131   |
| Display damping       | →  131   |
| Header                | →  131   |
| Header text           | →  131   |
| Separator             | →  131 |
| Backlight             | →  131 |





**Parameter overview with brief description**

| Parameter      | Prerequisite                 | Description  | Selection / User entry   | Factory setting    |
|----------------|------------------------------|--|--|--------------------|
| Format display | A local display is provided. | Select how measured values are shown on the display. | <ul style="list-style-type: none"><li>■ 1 value, max. size</li><li>■ 1 bargraph + 1 value</li><li>■ 2 values</li><li>■ 1 value large + 2 values</li><li>■ 4 values</li></ul> | 1 value, max. size |

| Parameter       | Prerequisite                 | Description   | Selection / User entry   | Factory setting |
|-----------------|------------------------------|---|--|-----------------|
| Value 1 display | A local display is provided. | Select the measured value that is shown on the local display. | <ul style="list-style-type: none"> <li>■ Mass flow</li> <li>■ Volume flow</li> <li>■ Corrected volume flow *</li> <li>■ Density</li> <li>■ Reference density *</li> <li>■ Temperature</li> <li>■ Pressure</li> <li>■ Totalizer 1</li> <li>■ Totalizer 2</li> <li>■ Totalizer 3</li> <li>■ GSV flow *</li> <li>■ GSV flow alternative *</li> <li>■ NSV flow *</li> <li>■ NSV flow alternative *</li> <li>■ S&amp;W volume flow *</li> <li>■ Reference density alternative *</li> <li>■ Weighted density average *</li> <li>■ Weighted temperature average *</li> <li>■ Water cut *</li> <li>■ Oil density *</li> <li>■ Water density *</li> <li>■ Oil mass flow *</li> <li>■ Water mass flow *</li> <li>■ Oil volume flow *</li> <li>■ Water volume flow *</li> <li>■ Oil corrected volume flow *</li> <li>■ Water corrected volume flow *</li> <li>■ Concentration *</li> <li>■ Target mass flow *</li> <li>■ Carrier mass flow *</li> <li>■ Target volume flow *</li> <li>■ Carrier volume flow *</li> <li>■ Target corrected volume flow *</li> <li>■ Carrier corrected volume flow *</li> <li>■ Application specific output 0 *</li> <li>■ Application specific output 1 *</li> <li>■ Inhomogeneous medium index</li> <li>■ Suspended bubbles index *</li> <li>■ HBSI *</li> <li>■ Raw value mass flow</li> <li>■ Exciter current 0</li> <li>■ Oscillation damping 0</li> <li>■ Oscillation damping fluctuation 0 *</li> <li>■ Oscillation frequency 0</li> </ul> | Mass flow       |



| Parameter             | Prerequisite   | Description   | Selection / User entry   | Factory setting  |
|-----------------------|--|---|--|--|
|                       |  |   | <ul style="list-style-type: none"> <li>▪ Frequency fluctuation 0 *</li> <li>▪ Oscillation amplitude 0 *</li> <li>▪ Signal asymmetry</li> <li>▪ Torsion signal asymmetry *</li> <li>▪ Carrier pipe temperature *</li> <li>▪ Electronics temperature</li> <li>▪ Sensor index coil asymmetry</li> <li>▪ Test point 0</li> <li>▪ Test point 1</li> <li>▪ Current output 1</li> <li>▪ Current output 2 *</li> <li>▪ Current output 3 *</li> </ul> |  |
| 0% bargraph value 1   | A local display is provided.   | Enter 0% value for bar graph display.                         | Signed floating-point number   | Country-specific: <ul style="list-style-type: none"> <li>▪ 0 kg/h</li> <li>▪ 0 lb/min</li> </ul> |
| 100% bargraph value 1 | A local display is provided.   | Enter 100% value for bar graph display.                       | Signed floating-point number   | Depends on country and nominal diameter  |
| Decimal places 1      | A measured value is specified in the <b>Value 1 display</b> parameter. | Select the number of decimal places for the display value.    | <ul style="list-style-type: none"> <li>▪ x</li> <li>▪ x.x</li> <li>▪ x.xx</li> <li>▪ x.xxx</li> <li>▪ x.xxxx</li> <li>▪ x.xxxxx</li> <li>▪ x.xxxxxx</li> </ul>   | x.xx   |
| Value 2 display       | A local display is provided.   | Select the measured value that is shown on the local display. | For the picklist, see <b>Value 1 display</b> parameter (→  110)   | None   |
| Decimal places 2      | A measured value is specified in the <b>Value 2 display</b> parameter. | Select the number of decimal places for the display value.    | <ul style="list-style-type: none"> <li>▪ x</li> <li>▪ x.x</li> <li>▪ x.xx</li> <li>▪ x.xxx</li> <li>▪ x.xxxx</li> <li>▪ x.xxxxx</li> <li>▪ x.xxxxxx</li> </ul>   | x.xx   |
| Value 3 display       | A local display is provided.   | Select the measured value that is shown on the local display. | For the picklist, see <b>Value 1 display</b> parameter (→  110)   | None   |
| 0% bargraph value 3   | A selection was made in the <b>Value 3 display</b> parameter.          | Enter 0% value for bar graph display.                         | Signed floating-point number   | Country-specific: <ul style="list-style-type: none"> <li>▪ 0 kg/h</li> <li>▪ 0 lb/min</li> </ul> |
| 100% bargraph value 3 | A selection was made in the <b>Value 3 display</b> parameter.          | Enter 100% value for bar graph display.                       | Signed floating-point number   | 0  |
| Decimal places 3      | A measured value is specified in the <b>Value 3 display</b> parameter. | Select the number of decimal places for the display value.    | <ul style="list-style-type: none"> <li>▪ x</li> <li>▪ x.x</li> <li>▪ x.xx</li> <li>▪ x.xxx</li> <li>▪ x.xxxx</li> <li>▪ x.xxxxx</li> <li>▪ x.xxxxxx</li> </ul>   | x.xx   |
| Value 4 display       | A local display is provided.   | Select the measured value that is shown on the local display. | For the picklist, see <b>Value 1 display</b> parameter (→  110)   | None   |

| Parameter             | Prerequisite   | Description   | Selection / User entry   | Factory setting  |
|-----------------------|--|---|--|--|
| Decimal places 4      | A measured value is specified in the <b>Value 4 display</b> parameter. | Select the number of decimal places for the display value.    | <ul style="list-style-type: none"> <li>■ x</li> <li>■ x.x</li> <li>■ x.xx</li> <li>■ x.xxx</li> <li>■ x.xxxx</li> <li>■ x.xxxxx</li> <li>■ x.xxxxxx</li> </ul> | x.xx   |
| Value 5 display       | A local display is provided.   | Select the measured value that is shown on the local display. | For the picklist, see <b>Value 1 display</b> parameter (→  110)               | None   |
| 0% bargraph value 5   | An option was selected in the <b>Value 5 display</b> parameter.        | Enter 0% value for bar graph display.                         | Signed floating-point number   | Depends on country: <ul style="list-style-type: none"> <li>■ 0 kg/h</li> <li>■ 0 lb/min</li> </ul> |
| 100% bargraph value 5 | An option was selected in the <b>Value 5 display</b> parameter.        | Enter 100% value for bar graph display.                       | Signed floating-point number   | 0  |
| Decimal places 5      | A measured value is specified in the <b>Value 5 display</b> parameter. | Select the number of decimal places for the display value.    | <ul style="list-style-type: none"> <li>■ x</li> <li>■ x.x</li> <li>■ x.xx</li> <li>■ x.xxx</li> <li>■ x.xxxx</li> <li>■ x.xxxxx</li> <li>■ x.xxxxxx</li> </ul> | x.xx   |
| Value 6 display       | A local display is provided.   | Select the measured value that is shown on the local display. | For the picklist, see <b>Value 1 display</b> parameter (→  110)               | None   |
| Decimal places 6      | A measured value is specified in the <b>Value 6 display</b> parameter. | Select the number of decimal places for the display value.    | <ul style="list-style-type: none"> <li>■ x</li> <li>■ x.x</li> <li>■ x.xx</li> <li>■ x.xxx</li> <li>■ x.xxxx</li> <li>■ x.xxxxx</li> <li>■ x.xxxxxx</li> </ul> | x.xx   |
| Value 7 display       | A local display is provided.   | Select the measured value that is shown on the local display. | For the picklist, see <b>Value 1 display</b> parameter (→  110)               | None   |
| 0% bargraph value 7   | An option was selected in the <b>Value 7 display</b> parameter.        | Enter 0% value for bar graph display.                         | Signed floating-point number   | Depends on country: <ul style="list-style-type: none"> <li>■ 0 kg/h</li> <li>■ 0 lb/min</li> </ul> |
| 100% bargraph value 7 | An option was selected in the <b>Value 7 display</b> parameter.        | Enter 100% value for bar graph display.                       | Signed floating-point number   | 0  |
| Decimal places 7      | A measured value is specified in the <b>Value 7 display</b> parameter. | Select the number of decimal places for the display value.    | <ul style="list-style-type: none"> <li>■ x</li> <li>■ x.x</li> <li>■ x.xx</li> <li>■ x.xxx</li> <li>■ x.xxxx</li> <li>■ x.xxxxx</li> <li>■ x.xxxxxx</li> </ul> | x.xx   |
| Value 8 display       | A local display is provided.   | Select the measured value that is shown on the local display. | For the picklist, see <b>Value 1 display</b> parameter (→  110)               | None   |

| Parameter        | Prerequisite  | Description   | Selection / User entry   | Factory setting   |
|------------------|---|---|--|---|
| Decimal places 8 | A measured value is specified in the <b>Value 8 display</b> parameter.  | Select the number of decimal places for the display value.                          | <ul style="list-style-type: none"> <li>▪ x</li> <li>▪ x.x</li> <li>▪ x.xx</li> <li>▪ x.xxx</li> <li>▪ x.xxxx</li> <li>▪ x.xxxxx</li> <li>▪ x.xxxxxx</li> </ul>   | x.xx  |
| Display language | A local display is provided.  | Set display language.   | <ul style="list-style-type: none"> <li>▪ English</li> <li>▪ Deutsch</li> <li>▪ Français</li> <li>▪ Español</li> <li>▪ Italiano</li> <li>▪ Nederlands</li> <li>▪ Portuguesa</li> <li>▪ Polski</li> <li>▪ русский язык (Russian)</li> <li>▪ Svenska</li> <li>▪ Türkçe</li> <li>▪ 中文 (Chinese)</li> <li>▪ 日本語 (Japanese)</li> <li>▪ 한국어 (Korean)</li> <li>▪ tiếng Việt (Vietnamese)</li> <li>▪ čeština (Czech)</li> </ul> | English (alternatively, the ordered language is preset in the device) |
| Display interval | A local display is provided.  | Set time measured values are shown on display if display alternates between values. | 1 to 10 s  | 5 s   |
| Display damping  | A local display is provided.  | Set display reaction time to fluctuations in the measured value.                    | 0.0 to 999.9 s   | 0.0 s   |
| Header           | A local display is provided.  | Select header contents on local display.  | <ul style="list-style-type: none"> <li>▪ Device tag</li> <li>▪ Free text</li> </ul>  | Device tag  |
| Header text      | The <b>Free text</b> option is selected in the <b>Header</b> parameter.   | Enter display header text.  | Max. 12 characters, such as letters, numbers or special characters (e.g. @, %, /)  | -----   |
| Separator        | A local display is provided.  | Select decimal separator for displaying numerical values.                           | <ul style="list-style-type: none"> <li>▪ . (point)</li> <li>▪ , (comma)</li> </ul>   | . (point)   |
| Backlight        | One of the following conditions is met: <ul style="list-style-type: none"> <li>▪ Order code for "Display; operation", option <b>F</b> "4-line, illum.; touch control"</li> <li>▪ Order code for "Display; operation", option <b>G</b> "4-line, illum.; touch control +WLAN"</li> <li>▪ Order code for "Display; operation", option <b>O</b> "Remote display 4-line illuminated; 10m/30ft cable; touch control"</li> </ul> | Switch the local display backlight on and off.                                      | <ul style="list-style-type: none"> <li>▪ Disable</li> <li>▪ Enable</li> </ul>  | Enable  |

\* Visibility depends on order options or device settings

### 10.5.6 WLAN configuration

The **WLAN Settings** submenu guides the user systematically through all the parameters that have to be set for the WLAN configuration.

**Navigation**

"Setup" menu → Advanced setup → WLAN settings

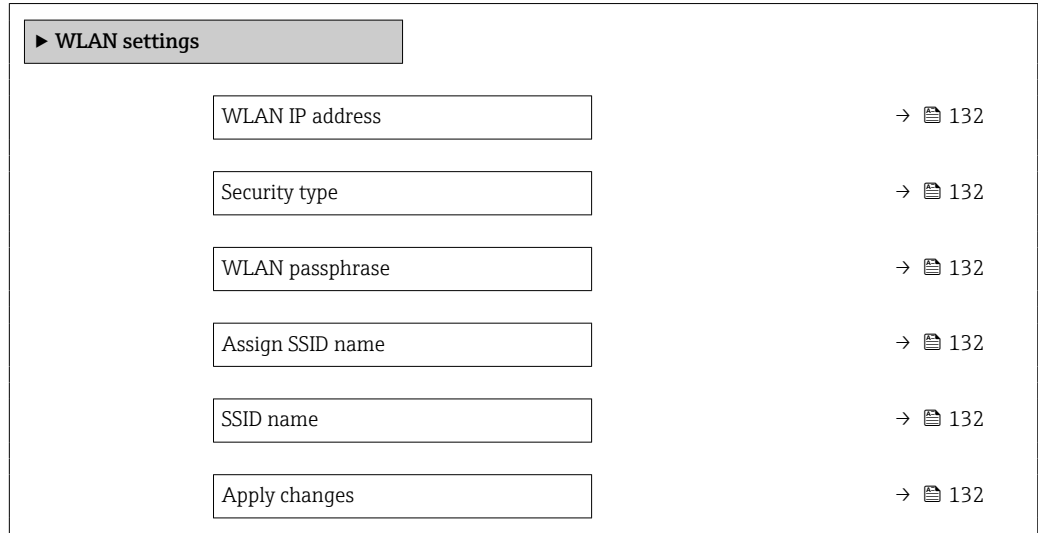

**Parameter overview with brief description**

| Parameter        | Prerequisite   | Description  | User entry / Selection  | Factory setting   |
|------------------|--|--|---|---|
| WLAN IP address  | –  | Enter IP address of the WLAN interface of the device.  | 4 octet: 0 to 255 (in the particular octet)   | 192.168.1.212   |
| Network security | –  | Select the security type of the WLAN network.  | <ul style="list-style-type: none"> <li>Unsecured</li> <li>WPA2-PSK</li> <li>EAP-PEAP with MSCHAPv2*</li> <li>EAP-PEAP MSCHAPv2 no server authentic.*</li> <li>EAP-TLS*</li> </ul> | WPA2-PSK  |
| WLAN passphrase  | The <b>WPA2-PSK</b> option is selected in the <b>Security type</b> parameter.  | Enter the network key (8 to 32 characters).<br>The network key supplied with the device should be changed during commissioning for security reasons.   | 8 to 32-digit character string comprising numbers, letters and special characters (without spaces)  | Serial number of the measuring device (e.g. L100A802000)                                |
| Assign SSID name | –  | Select which name will be used for SSID: device tag or user-defined name.  | <ul style="list-style-type: none"> <li>Device tag</li> <li>User-defined</li> </ul>  | User-defined  |
| SSID name        | <ul style="list-style-type: none"> <li>The <b>User-defined</b> option is selected in the <b>Assign SSID name</b> parameter.</li> <li>The <b>WLAN access point</b> option is selected in the <b>WLAN mode</b> parameter.</li> </ul> | Enter the user-defined SSID name (max. 32 characters).<br>The user-defined SSID name may only be assigned once. If the SSID name is assigned more than once, the devices can interfere with one another. | Max. 32-digit character string comprising numbers, letters and special characters   | EH_device designation_last 7 digits of the serial number (e.g. EH_Promass_300_A 802000) |
| Apply changes    | –  | Use changed WLAN settings.   | <ul style="list-style-type: none"> <li>Cancel</li> <li>Ok</li> </ul>  | Cancel  |

\* Visibility depends on order options or device settings

### 10.5.7 Configuration management

After commissioning, you can save the current device configuration or restore the previous device configuration. The device configuration is managed via the **Configuration management** parameter.

#### Navigation

"Setup" menu → Advanced setup → Configuration backup

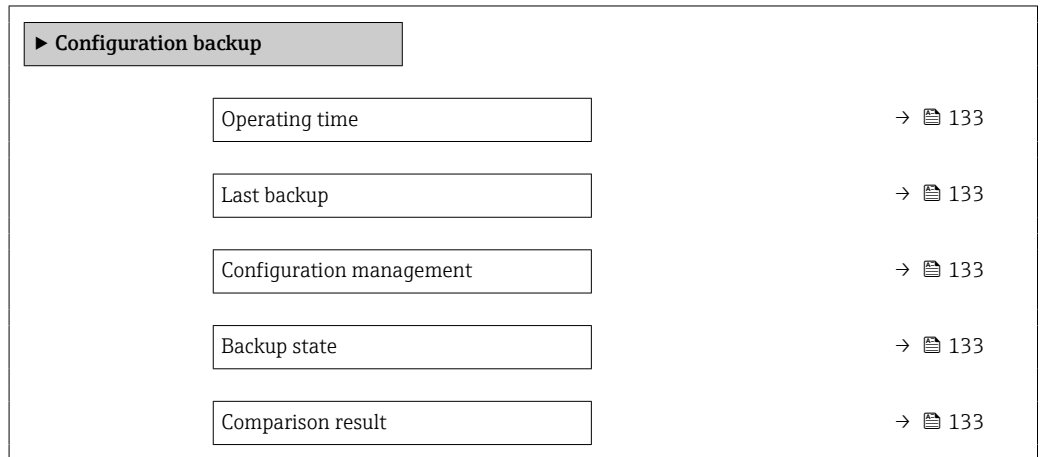

#### Parameter overview with brief description

| Parameter                | Description  | User interface / Selection  | Factory setting |
|--------------------------|--|---|-----------------|
| Operating time           | Indicates how long the device has been in operation.               | Days (d), hours (h), minutes (m) and seconds (s)  | –               |
| Last backup              | Shows when the last data backup was saved to HistoROM backup.      | Days (d), hours (h), minutes (m) and seconds (s)  | –               |
| Configuration management | Select action for managing the device data in the HistoROM backup. | <ul style="list-style-type: none"> <li>■ Cancel</li> <li>■ Execute backup</li> <li>■ Restore *</li> <li>■ Compare *</li> <li>■ Clear backup data</li> </ul>   | Cancel          |
| Backup state             | Shows the current status of data saving or restoring.              | <ul style="list-style-type: none"> <li>■ None</li> <li>■ Backup in progress</li> <li>■ Restoring in progress</li> <li>■ Delete in progress</li> <li>■ Compare in progress</li> <li>■ Restoring failed</li> <li>■ Backup failed</li> </ul> | None            |
| Comparison result        | Comparison of current device data with HistoROM backup.            | <ul style="list-style-type: none"> <li>■ Settings identical</li> <li>■ Settings not identical</li> <li>■ No backup available</li> <li>■ Backup settings corrupt</li> <li>■ Check not done</li> <li>■ Dataset incompatible</li> </ul>      | Check not done  |

\* Visibility depends on order options or device settings

### Function scope of the "Configuration management" parameter

| Options           | Description   |
|-------------------|---|
| Cancel            | No action is executed and the user exits the parameter.   |
| Execute backup    | A backup copy of the current device configuration is saved from the HistoROM backup to the memory of the device. The backup copy includes the transmitter data of the device.     |
| Restore           | The last backup copy of the device configuration is restored from the device memory to the device's HistoROM backup. The backup copy includes the transmitter data of the device. |
| Compare           | The device configuration saved in the device memory is compared with the current device configuration of the HistoROM backup.   |
| Clear backup data | The backup copy of the device configuration is deleted from the memory of the device.   |

#### *HistoROM backup*

A HistoROM is a "non-volatile" device memory in the form of an EEPROM.



 While this action is in progress, the configuration cannot be edited via the local display and a message on the processing status appears on the display.

### 10.5.8 Using parameters for device administration

The **Administration** submenu systematically guides the user through all the parameters that can be used for device administration purposes.

#### Navigation

"Setup" menu → Advanced setup → Administration



|                      |   |
|----------------------|---|
| ▶ Administration     |   |
| ▶ Define access code | →  134 |
| ▶ Reset access code  | →  135 |
| Device reset         | →  135 |

#### Using the parameter to define the access code

Complete this wizard to specify an access code for the Maintenance role.

#### Navigation

"Setup" menu → Advanced setup → Administration → Define access code

|                      |   |
|----------------------|---|
| ▶ Define access code |   |
| Define access code   | →  135 |
| Confirm access code  | →  135 |

**Parameter overview with brief description**

| Parameter           | Description   | User entry  |
|---------------------|---|---|
| Define access code  | Specify an access code that is required to obtain the access rights for the Maintenance role. | Max. 16-digit character string comprising numbers, letters and special characters |
| Confirm access code | Confirm the access code entered for the Maintenance role.                                     | Max. 16-digit character string comprising numbers, letters and special characters |

**Using the parameter to reset the access code**

**Navigation**

"Setup" menu → Advanced setup → Administration → Reset access code

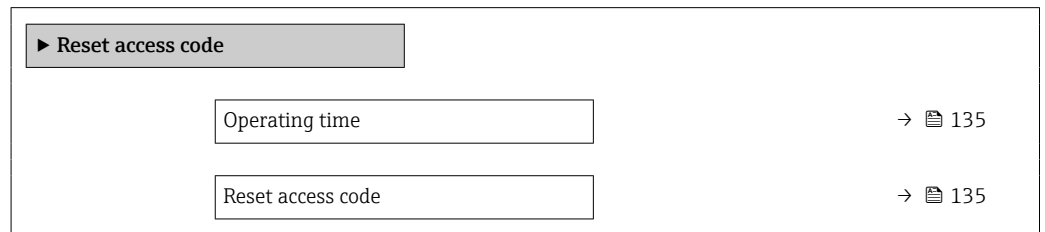

**Parameter overview with brief description**

| Parameter         | Description   | User interface / User entry   | Factory setting |
|-------------------|---|---|-----------------|
| Operating time    | Indicates how long the device has been in operation.  | Days (d), hours (h), minutes (m) and seconds (s)                    | –               |
| Reset access code | <p>Enter the code provided by Endress+Hauser Technical Support to reset the Maintenance code.</p> <p> For a reset code, contact your Endress+Hauser service organization.</p> <p>The reset code can only be entered via:</p> <ul style="list-style-type: none"> <li>▪ Web browser</li> <li>▪ DeviceCare, FieldCare (via CDI-RJ45 service interface)</li> <li>▪ Fieldbus</li> </ul> | Character string comprising numbers, letters and special characters | 0x00            |

**Using the parameter to reset the device**

**Navigation**

"Setup" menu → Advanced setup → Administration

**Parameter overview with brief description**

| Parameter    | Description   | Selection  | Factory setting |
|--------------|---|--|-----------------|
| Device reset | Reset the device configuration - either entirely or in part - to a defined state. | <ul style="list-style-type: none"> <li>▪ Cancel</li> <li>▪ To delivery settings</li> <li>▪ Restart device</li> <li>▪ Restore S-DAT backup *</li> </ul> | Cancel          |

\* Visibility depends on order options or device settings

## 10.6 Simulation



Via the **Simulation** submenu, it is possible to simulate various process variables in the process and the device alarm mode and verify downstream signal chains (switching valves or closed-control loops). The simulation can be performed without a real measurement (no flow of medium through the device).

### Navigation

"Diagnostics" menu → Simulation



| ► Simulation                       |       |
|------------------------------------|-------|
| Assign simulation process variable | → 137 |
| Process variable value             | → 137 |
| Current input 1 to n simulation    | → 138 |
| Value current input 1 to n         | → 138 |
| Status input 1 to n simulation     | → 138 |
| Input signal level 1 to n          | → 138 |
| Current output 1 to n simulation   | → 137 |
| Current output value               | → 137 |
| Frequency output 1 to n simulation | → 137 |
| Frequency output 1 to n value      | → 138 |
| Pulse output simulation 1 to n     | → 138 |
| Pulse value 1 to n                 | → 138 |
| Switch output simulation 1 to n    | → 138 |
| Switch state 1 to n                | → 138 |
| Relay output 1 to n simulation     | → 138 |
| Switch state 1 to n                | → 138 |
| Pulse output simulation            | → 138 |
| Pulse value                        | → 138 |
| Device alarm simulation            | → 138 |



|                             |   |
|-----------------------------|---|
| Diagnostic event category   | →  138 |
| Diagnostic event simulation | →  138 |

**Parameter overview with brief description**



| Parameter                          | Prerequisite   | Description   | Selection / User entry   | Factory setting |
|------------------------------------|--|---|--|-----------------|
| Assign simulation process variable | –  | Select a process variable for the simulation process that is activated. | <ul style="list-style-type: none"> <li>■ Off</li> <li>■ Mass flow</li> <li>■ Volume flow</li> <li>■ Corrected volume flow<sup>*</sup></li> <li>■ Target mass flow<sup>*</sup></li> <li>■ Carrier mass flow<sup>*</sup></li> <li>■ Target volume flow<sup>*</sup></li> <li>■ Carrier volume flow<sup>*</sup></li> <li>■ Target corrected volume flow<sup>*</sup></li> <li>■ Carrier corrected volume flow<sup>*</sup></li> <li>■ Density</li> <li>■ Reference density<sup>*</sup></li> <li>■ Reference density alternative<sup>*</sup></li> <li>■ GSV flow<sup>*</sup></li> <li>■ GSV flow alternative<sup>*</sup></li> <li>■ NSV flow<sup>*</sup></li> <li>■ NSV flow alternative<sup>*</sup></li> <li>■ S&amp;W volume flow<sup>*</sup></li> <li>■ Water cut<sup>*</sup></li> <li>■ Oil density<sup>*</sup></li> <li>■ Water density<sup>*</sup></li> <li>■ Oil mass flow<sup>*</sup></li> <li>■ Water mass flow<sup>*</sup></li> <li>■ Oil volume flow<sup>*</sup></li> <li>■ Water volume flow<sup>*</sup></li> <li>■ Oil corrected volume flow<sup>*</sup></li> <li>■ Water corrected volume flow<sup>*</sup></li> <li>■ Temperature<sup>*</sup></li> <li>■ Concentration<sup>*</sup></li> <li>■ Time period signal frequency (TPS)<sup>*</sup></li> </ul> | Off             |
| Process variable value             | A process variable is selected in the <b>Assign simulation process variable</b> parameter (→  137). | Enter the simulation value for the selected process variable.           | Depends on the process variable selected   | 0               |
| Current output 1 to n simulation   | –  | Switch the simulation of the current output on and off.                 | <ul style="list-style-type: none"> <li>■ Off</li> <li>■ On</li> </ul>  | Off             |
| Current output value               | In the <b>Current output 1 to n simulation</b> parameter, the <b>On</b> option is selected.  | Enter the current value for simulation.                                 | 3.59 to 22.5 mA  | 3.59 mA         |
| Frequency output 1 to n simulation | In the <b>Operating mode</b> parameter, the <b>Frequency</b> option is selected.   | Switch the simulation of the frequency output on and off.               | <ul style="list-style-type: none"> <li>■ Off</li> <li>■ On</li> </ul>  | Off             |

| Parameter                       | Prerequisite   | Description  | Selection / User entry  | Factory setting |
|---------------------------------|--|--|---|-----------------|
| Frequency output 1 to n value   | In the <b>Frequency simulation 1 to n</b> parameter, the <b>On</b> option is selected.                     | Enter the frequency value for the simulation.  | 0.0 to 12 500.0 Hz  | 0.0 Hz          |
| Pulse output simulation 1 to n  | In the <b>Operating mode</b> parameter, the <b>Pulse</b> option is selected.                               | Set and switch off the pulse output simulation.<br> For <b>Fixed value</b> option: <b>Pulse width</b> parameter (->  95) defines the pulse width of the pulses output. | <ul style="list-style-type: none"> <li>▪ Off</li> <li>▪ Fixed value</li> <li>▪ Down-counting value</li> </ul>                   | Off             |
| Pulse value 1 to n              | In the <b>Pulse output simulation 1 to n</b> parameter, the <b>Down-counting value</b> option is selected. | Enter the number of pulses for simulation.   | 0 to 65 535   | 0               |
| Switch output simulation 1 to n | In the <b>Operating mode</b> parameter, the <b>Switch</b> option is selected.                              | Switch the simulation of the switch output on and off.   | <ul style="list-style-type: none"> <li>▪ Off</li> <li>▪ On</li> </ul>   | Off             |
| Switch state 1 to n             | –  | Select the status of the status output for the simulation.   | <ul style="list-style-type: none"> <li>▪ Open</li> <li>▪ Closed</li> </ul>  | Open            |
| Relay output 1 to n simulation  | –  | Switch simulation of the relay output on and off.  | <ul style="list-style-type: none"> <li>▪ Off</li> <li>▪ On</li> </ul>   | Off             |
| Switch state 1 to n             | The <b>On</b> option is selected in the <b>Switch output simulation 1 to n</b> parameter parameter.        | Select status of the relay output for the simulation.  | <ul style="list-style-type: none"> <li>▪ Open</li> <li>▪ Closed</li> </ul>  | Open            |
| Pulse output simulation         | –  | Set and switch off the pulse output simulation.<br> For <b>Fixed value</b> option: <b>Pulse width</b> parameter defines the pulse width of the pulses output.   | <ul style="list-style-type: none"> <li>▪ Off</li> <li>▪ Fixed value</li> <li>▪ Down-counting value</li> </ul>                   | Off             |
| Pulse value                     | In the <b>Pulse output simulation</b> parameter, the <b>Down-counting value</b> option is selected.        | Set and switch off the pulse output simulation.  | 0 to 65 535   | 0               |
| Device alarm simulation         | –  | Switch the device alarm on and off.  | <ul style="list-style-type: none"> <li>▪ Off</li> <li>▪ On</li> </ul>   | Off             |
| Diagnostic event category       | –  | Select a diagnostic event category.  | <ul style="list-style-type: none"> <li>▪ Sensor</li> <li>▪ Electronics</li> <li>▪ Configuration</li> <li>▪ Process</li> </ul>   | Process         |
| Diagnostic event simulation     | –  | Select a diagnostic event to simulate this event.  | <ul style="list-style-type: none"> <li>▪ Off</li> <li>▪ Diagnostic event picklist (depends on the category selected)</li> </ul> | Off             |
| Current input 1 to n simulation | –  | Switch simulation of the current input on and off.   | <ul style="list-style-type: none"> <li>▪ Off</li> <li>▪ On</li> </ul>   | Off             |
| Value current input 1 to n      | In the <b>Current input 1 to n simulation</b> parameter, the <b>On</b> option is selected.                 | Enter the current value for simulation.  | 0 to 22.5 mA  | 0 mA            |
| Status input 1 to n simulation  | –  | Switch simulation of the status input on and off.  | <ul style="list-style-type: none"> <li>▪ Off</li> <li>▪ On</li> </ul>   | Off             |
| Input signal level 1 to n       | In the <b>Status input simulation</b> parameter, the <b>On</b> option is selected.                         | Select the signal level for the simulation of the status input.  | <ul style="list-style-type: none"> <li>▪ High</li> <li>▪ Low</li> </ul>   | High            |

\* Visibility depends on order options or device settings

## 10.7 Protecting settings from unauthorized access

The following write protection options exist in order to protect the configuration of the measuring device from unintentional modification:



- Protect access to parameters via access code →  139
- Protect access to local operation via key locking →  60
- Protect access to measuring device via write protection switch →  140

### 10.7.1 Write protection via access code





The effects of the user-specific access code are as follows:

- Via local operation, the parameters for the measuring device configuration are write-protected and their values can no longer be changed.
- Device access is protected via the Web browser, as are the parameters for the measuring device configuration.
- Device access is protected via FieldCare or DeviceCare (via CDI-RJ45 service interface), as are the parameters for the measuring device configuration.

#### Defining the access code via the local display

1. Navigate to the **Define access code** parameter (→  135).
2. Maximum of 16-digit character string comprising numbers, letters and special characters as the access code.
3. Enter the access code again in the **Confirm access code** parameter (→  135) to confirm.

↳ The  symbol appears in front of all write-protected parameters.

-  ▪ Disabling parameter write protection via access code →  59.
- If the access code is lost: Resetting the access code →  140.
- The user role with which the user is currently logged in is displayed in **Access status** parameter.
  - Navigation path: Operation → Access status
  - User roles and their access rights →  59
- The device automatically locks the write-protected parameters again if a key is not pressed for 10 minutes in the navigation and editing view.
- The device locks the write-protected parameters automatically after 60 s if the user skips back to the operational display mode from the navigation and editing view.



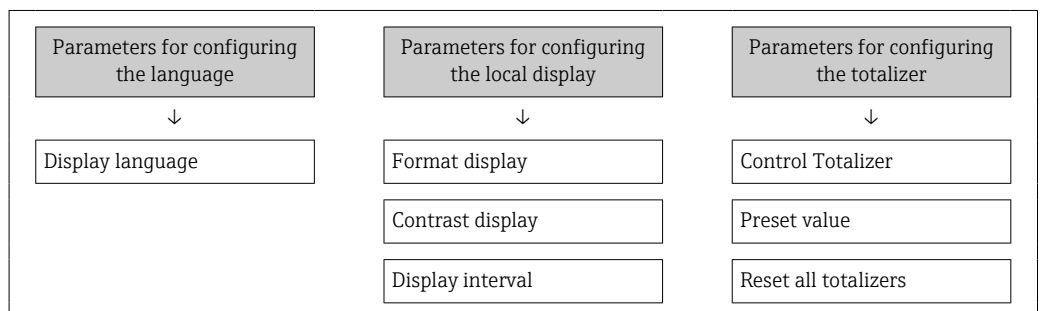

#### Parameters which can always be modified via the local display

Certain parameters that do not affect the measurement are excepted from parameter write protection via the local display. Despite the user-specific access code, they can always be modified, even if the other parameters are locked.



#### Defining the access code via the web browser

1. Navigate to the **Define access code** parameter (→  135).





2. Define a 16-digit (max.) numeric code as the access code.
  3. Enter the access code again in the **Confirm access code** parameter (→  135) to confirm.
    - ↳ The web browser switches to the login page.
-  ■ Disabling parameter write protection via access code →  59.
- If the access code is lost: Resetting the access code →  140.
- The **Access status** parameter shows which user role the user is currently logged in with.
- Navigation path: Operation → Access status
  - User roles and their access rights →  59

If no action is performed for 10 minutes, the web browser automatically returns to the login page.

### Resetting the access code

If you misplace the user-specific access code, it is possible to reset the code to the factory setting. A reset code must be entered for this purpose. The user-specific access code can then be defined again afterwards.

*Via Web browser, FieldCare, DeviceCare (via CDI-RJ45 service interface), fieldbus*

-  You can only obtain a reset code from your local Endress+Hauser service organization. The code must be calculated explicitly for every device.
1. Note down the serial number of the device.
  2. Read off the **Operating time** parameter.
  3. Contact the local Endress+Hauser service organization and tell them the serial number and the operating time.
    - ↳ Get the calculated reset code.
  4. Enter the reset code in the **Reset access code** parameter (→  135).
    - ↳ The access code has been reset to the factory setting **0000**. It can be redefined →  139.
-  For IT security reasons, the calculated reset code is only valid for 96 hours from the specified operating time and for the specific serial number. If you cannot return to the device within 96 hours, you should either increase the operating time you read out by a few days or switch off the device.

### 10.7.2 Write protection via write protection switch

Unlike parameter write protection via a user-specific access code, this allows the user to lock write access to the entire operating menu - apart from the **"Contrast display" parameter**.

The parameter values are now read only and cannot be edited any more (exception **"Contrast display" parameter**):

- Via local display
- Via MODBUS RS485 protocol

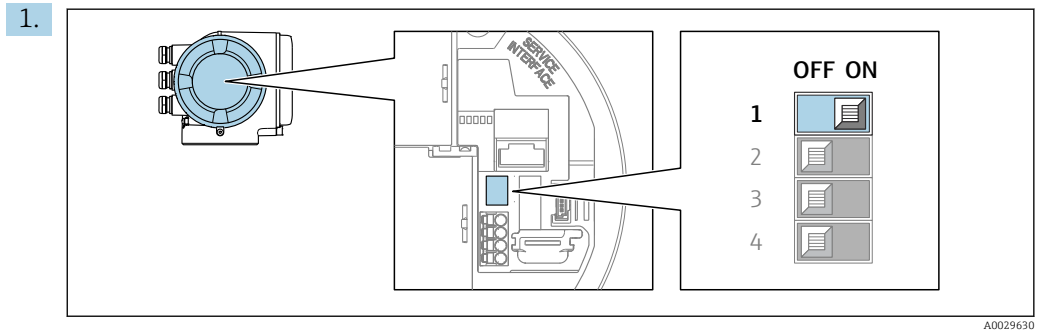

Setting the write protection (WP) switch on the main electronics module to the **ON** position enables hardware write protection.

- ↳ In the **Locking status** parameter, the **Hardware locked** option is displayed → 142. In addition, on the local display the  symbol appears in front of the parameters in the header of the operational display and in the navigation view.

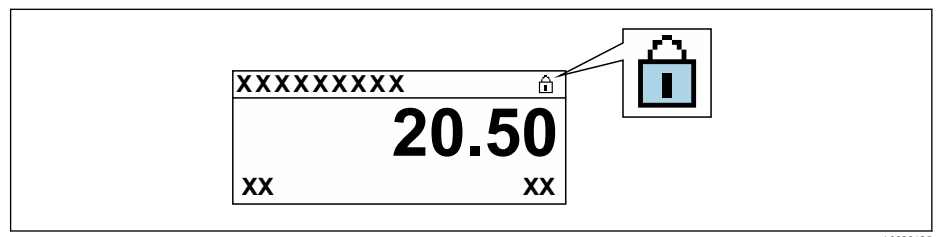

2. Setting the write protection (WP) switch on the main electronics module to the **OFF** position (factory setting) disables hardware write protection.

- ↳ No option is displayed in the **Locking status** parameter → 142. On the local display, the  symbol disappears from in front of the parameters in the header of the operational display and in the navigation view.





## 11 Operation

### 11.1 Reading off the device locking status

Device active write protection: **Locking status** parameter



Operation → Locking status

*Function scope of the "Locking status" parameter*

| Options                        | Description   |
|--------------------------------|---|
| None                           | The access authorization displayed in the <b>Access status</b> parameter applies →  59. Only appears on local display.   |
| Hardware locked                | The DIP switch for hardware locking is activated on the PCB board. This locks write access to the parameters (e.g. via local display or operating tool) →  140.  |
| CT active - all parameters     | The DIP switch for custody transfer mode is activated on the PCB board. Locks the parameters that are relevant for custody transfer and also parameters that are predefined by Endress+Hauser and are not relevant for custody transfer (e.g. on local display or operating tool).<br> For detailed information on custody transfer mode, see the Special Documentation for the device |
| CT active - defined parameters | The DIP switch for the custody transfer mode is activated on the PCB board. Only locks the parameters that are relevant for custody transfer (e.g. on the local display or operating tool).<br> For detailed information on custody transfer mode, see the Special Documentation for the device   |
| Temporarily locked             | Write access to the parameters is temporarily locked on account of internal processes running in the device (e.g. data upload/download, reset, etc.). Once the internal processing has been completed, the parameters can be changed once again.  |



### 11.2 Adjusting the operating language

 Detailed information:

- To configure the operating language →  78
- For information on the operating languages supported by the measuring device →  214

### 11.3 Configuring the display

Detailed information:

- On the basic settings for the local display →  107
- On the advanced settings for the local display →  125

### 11.4 Reading off measured values

With the **Measured values** submenu, it is possible to read all the measured values.

**Navigation**

"Diagnostics" menu → Measured values

|                      |       |
|----------------------|-------|
| ▶ Measured values    |       |
| ▶ Measured variables | → 143 |
| ▶ Input values       | → 154 |
| ▶ Output values      | → 155 |
| ▶ Totalizer          | → 153 |

**11.4.1 "Measured variables" submenu**

The **Measured variables** submenu contains all the parameters needed to display the current measured values for each process variable.







**Navigation**

"Diagnostics" menu → Measured values → Measured variables





|                               |       |
|-------------------------------|-------|
| ▶ Measured variables          |       |
| Mass flow                     | → 145 |
| Volume flow                   | → 145 |
| Corrected volume flow         | → 145 |
| Density                       | → 145 |
| Reference density             | → 145 |
| Temperature                   | → 145 |
| Pressure                      | → 146 |
| Concentration                 | → 146 |
| Target mass flow              | → 146 |
| Carrier mass flow             | → 146 |
| Target corrected volume flow  | → 146 |
| Carrier corrected volume flow | → 146 |
| Target volume flow            | → 147 |











|                               |       |
|-------------------------------|-------|
| Carrier volume flow           | → 147 |
| CTL                           | → 147 |
| CPL                           | → 147 |
| CTPL                          | → 148 |
| S&W volume flow               | → 148 |
| S&W correction value          | → 148 |
| Reference density alternative | → 148 |
| GSV flow                      | → 148 |
| GSV flow alternative          | → 149 |
| NSV flow                      | → 149 |
| NSV flow alternative          | → 149 |
| Oil CTL                       | → 149 |
| Oil CPL                       | → 149 |
| Oil CTPL                      | → 150 |
| Water CTL                     | → 150 |
| CTL alternative               | → 150 |
| CPL alternative               | → 150 |
| CTPL alternative              | → 150 |
| Oil reference density         | → 151 |
| Water reference density       | → 151 |
| Oil density                   | → 151 |
| Water density                 | → 151 |
| Water cut                     | → 151 |
| Oil volume flow               | → 152 |
| Oil corrected volume flow     | → 152 |









|                              |   |
|------------------------------|---|
| Oil mass flow                | →  152 |
| Water volume flow            | →  152 |
| Water corrected volume flow  | →  152 |
| Water mass flow              | →  153 |
| Weighted density average     | →  153 |
| Weighted temperature average | →  153 |





**Parameter overview with brief description**





| Parameter             | Prerequisite | Description   | User interface               | Factory setting |
|-----------------------|--------------|---|------------------------------|-----------------|
| Mass flow             | –            | Displays the mass flow that is currently measured.<br><i>Dependency</i><br>The unit is taken from: <b>Mass flow unit</b> parameter (→  81)                             | Signed floating-point number | –               |
| Volume flow           | –            | Displays the volume flow that is currently calculated.<br><i>Dependency</i><br>The unit is taken from the <b>Volume flow unit</b> parameter (→  81).                 | Signed floating-point number | –               |
| Corrected volume flow | –            | Displays the corrected volume flow that is currently calculated.<br><i>Dependency</i><br>The unit is taken from: <b>Corrected volume flow unit</b> parameter (→  81) | Signed floating-point number | –               |
| Density               | –            | Shows the density currently measured.<br><i>Dependency</i><br>The unit is taken from the <b>Density unit</b> parameter (→  81).                                      | Signed floating-point number | –               |
| Reference density     | –            | Displays the reference density that is currently calculated.<br><i>Dependency</i><br>The unit is taken from: <b>Reference density unit</b> parameter (→  82)         | Signed floating-point number | –               |
| Temperature           | –            | Shows the medium temperature currently measured.<br><i>Dependency</i><br>The unit is taken from: <b>Temperature unit</b> parameter (→  82)                           | Signed floating-point number | –               |





| Parameter                     | Prerequisite   | Description  | User interface               | Factory setting |
|-------------------------------|--|--|------------------------------|-----------------|
| Pressure                      | –  | Displays either a fixed or external pressure value.<br><br><i>Dependency</i><br>The unit is taken from the <b>Pressure unit</b> parameter (→  82).                                      | Signed floating-point number | –               |
| Concentration                 | For the following order code: Order code for "Application package", option <b>ED</b> "Concentration"<br><br> The software options currently enabled are displayed in the <b>Software option overview</b> parameter.   | Displays the concentration that is currently calculated.<br><br><i>Dependency</i><br>The unit is taken from the <b>Concentration unit</b> parameter.   | Signed floating-point number | –               |
| Target mass flow              | With the following conditions: Order code for "Application package", option <b>ED</b> "Concentration"<br><br> The software options currently enabled are displayed in the <b>Software option overview</b> parameter.  | Displays the mass flow that is currently measured for the target medium.<br><br><i>Dependency</i><br>The unit is taken from: <b>Mass flow unit</b> parameter (→  81)                    | Signed floating-point number | –               |
| Carrier mass flow             | With the following conditions: Order code for "Application package", option <b>ED</b> "Concentration"<br><br> The software options currently enabled are displayed in the <b>Software option overview</b> parameter.  | Displays the mass flow of the carrier medium that is currently measured.<br><br><i>Dependency</i><br>The unit is taken from: <b>Mass flow unit</b> parameter (→  81)                  | Signed floating-point number | –               |
| Target corrected volume flow  | With the following conditions:<br><ul style="list-style-type: none"> <li>▪ Order code for "Application package", option <b>ED</b> "Concentration"</li> <li>▪ The <b>Ethanol in water</b> option or <b>%mass / %volume</b> option is selected in the <b>Liquid type</b> parameter.</li> </ul>  The software options currently enabled are displayed in the <b>Software option overview</b> parameter.  | Displays the corrected volume flow that is currently measured for the target fluid.<br><br><i>Dependency</i><br>The unit is taken from the <b>Volume flow unit</b> parameter (→  81). | Signed floating-point number | –               |
| Carrier corrected volume flow | With the following conditions:<br><ul style="list-style-type: none"> <li>▪ Order code for "Application package", option <b>ED</b> "Concentration"</li> <li>▪ In the <b>Liquid type</b> parameter, the <b>Ethanol in water</b> option or <b>%mass / %volume</b> option is selected.</li> </ul>  The software options currently enabled are displayed in the <b>Software option overview</b> parameter. | Displays the corrected volume flow currently measured for the carrier fluid.<br><br><i>Dependency</i><br>The unit is taken from the <b>Volume flow unit</b> parameter (→  81).        | Signed floating-point number | –               |





| Parameter           | Prerequisite   | Description  | User interface                 | Factory setting |
|---------------------|--|--|--------------------------------|-----------------|
| Target volume flow  | <p>With the following conditions:</p> <ul style="list-style-type: none"> <li>▪ Order code for "Application package", option <b>ED</b> "Concentration"</li> <li>▪ The <b>Ethanol in water</b> option or <b>%mass / %volume</b> option is selected in the <b>Liquid type</b> parameter.</li> <li>▪ The <b>%vol</b> option is selected in the <b>Concentration unit</b> parameter.</li> </ul> <p> The software options currently enabled are displayed in the <b>Software option overview</b> parameter.</p>   | <p>Displays the volume flow currently measured for the target medium.</p> <p><i>Dependency</i><br/>The unit is taken from the <b>Volume flow unit</b> parameter (→  81).</p>  | Signed floating-point number   | –               |
| Carrier volume flow | <p>With the following conditions:</p> <ul style="list-style-type: none"> <li>▪ Order code for "Application package", option <b>ED</b> "Concentration"</li> <li>▪ The <b>Ethanol in water</b> option or <b>%mass / %volume</b> option is selected in the <b>Liquid type</b> parameter.</li> <li>▪ The <b>%vol</b> option is selected in the <b>Concentration unit</b> parameter.</li> </ul> <p> The software options currently enabled are displayed in the <b>Software option overview</b> parameter.</p> | <p>Displays the volume flow currently measured for the carrier medium.</p> <p><i>Dependency</i><br/>The unit is taken from the <b>Volume flow unit</b> parameter (→  81).</p> | Signed floating-point number   | –               |
| CTL                 | <p>For the following order code:</p> <ul style="list-style-type: none"> <li>▪ "Application package", option EJ "Petroleum"</li> <li>▪ The <b>API referenced correction</b> option is selected in <b>Petroleum mode</b> parameter.</li> </ul> <p> The software options currently enabled are displayed in the <b>Software option overview</b> parameter.</p>   | <p>Displays the calibration factor which represents the effect of temperature on the fluid. This is used to convert the measured volume flow and the measured density to values at reference temperature.</p>  | Positive floating-point number | –               |
| CPL                 | <p>For the following order code:</p> <ul style="list-style-type: none"> <li>▪ "Application package", option EJ "Petroleum"</li> <li>▪ The <b>API referenced correction</b> option is selected in <b>Petroleum mode</b> parameter.</li> </ul> <p> The software options currently enabled are displayed in the <b>Software option overview</b> parameter.</p>   | <p>Displays the calibration factor which represents the effect of pressure on the fluid. This is used to convert the measured volume flow and the measured density to values at reference pressure.</p>  | Positive floating-point number | –               |

| Parameter                     | Prerequisite   | Description  | User interface                 | Factory setting |
|-------------------------------|--|--|--------------------------------|-----------------|
| CTPL                          | <p>For the following order code:</p> <ul style="list-style-type: none"> <li>▪ "Application package", option EJ "Petroleum"</li> <li>▪ The <b>API referenced correction</b> option is selected in <b>Petroleum mode</b> parameter.</li> </ul> <p> The software options currently enabled are displayed in the <b>Software option overview</b> parameter.</p>                                     | <p>Displays the combined calibration factor which represents the effect of temperature and pressure on the fluid. This is used to convert the measured volume flow and the measured density to values at reference temperature and reference pressure.</p> | Positive floating-point number | -               |
| S&W volume flow               | <p>For the following order code:</p> <ul style="list-style-type: none"> <li>▪ "Application package", option EJ "Petroleum"</li> <li>▪ The <b>API referenced correction</b> option is selected in <b>Petroleum mode</b> parameter.</li> </ul> <p> The software options currently enabled are displayed in the <b>Software option overview</b> parameter.</p>                                     | <p>Displays the S&amp;W volume flow which is calculated from the measured total volume flow minus the net volume flow.</p> <p><i>Dependency</i><br/>The unit is taken from: <b>Volume flow unit</b> parameter</p>  | Signed floating-point number   | -               |
| S&W correction value          | <p>For the following order code:</p> <ul style="list-style-type: none"> <li>▪ "Application package", option EJ "Petroleum"</li> <li>▪ The <b>External value</b> option or <b>Current input 1...n</b> option is selected in the <b>S&amp;W input mode</b> parameter.</li> </ul> <p> The software options currently enabled are displayed in the <b>Software option overview</b> parameter.</p> | Shows the correction value for sediment and water.   | Positive floating-point number | -               |
| Reference density alternative | <p>For the following order code:</p> <ul style="list-style-type: none"> <li>▪ "Application package", option EJ "Petroleum"</li> <li>▪ In the <b>Petroleum mode</b> parameter, the <b>API referenced correction</b> option is selected.</li> </ul> <p> The software options currently enabled are displayed in the <b>Software option overview</b> parameter.</p>                              | <p>Displays the fluid density at the alternative reference temperature.</p> <p><i>Dependency</i><br/>The unit is taken from: <b>Reference density unit</b> parameter</p>   | Signed floating-point number   | -               |
| GSV flow                      | <p>For the following order code:</p> <ul style="list-style-type: none"> <li>▪ "Application package", option EJ "Petroleum"</li> <li>▪ The <b>API referenced correction</b> option is selected in <b>Petroleum mode</b> parameter.</li> </ul> <p> The software options currently enabled are displayed in the <b>Software option overview</b> parameter.</p>                                   | <p>Displays the measured total volume flow, corrected to the reference temperature and the reference pressure.</p> <p><i>Dependency</i><br/>The unit is taken from: <b>Corrected volume flow unit</b> parameter</p>  | Signed floating-point number   | -               |



| Parameter            | Prerequisite  | Description   | User interface                 | Factory setting |
|----------------------|---|---|--------------------------------|-----------------|
| GSV flow alternative | <p>For the following order code:</p> <ul style="list-style-type: none"> <li>▪ "Application package", option EJ "Petroleum"</li> <li>▪ In the <b>Petroleum mode</b> parameter, the <b>API referenced correction</b> option is selected.</li> </ul> <p> The software options currently enabled are displayed in the <b>Software option overview</b> parameter.</p>   | <p>Displays the measured total volume flow, corrected to the alternative reference temperature and the alternative reference pressure.</p> <p><i>Dependency</i><br/>The unit is taken from: <b>Corrected volume flow unit</b> parameter</p>                           | Signed floating-point number   | –               |
| NSV flow             | <p>For the following order code:</p> <ul style="list-style-type: none"> <li>▪ "Application package", option EJ "Petroleum"</li> <li>▪ The <b>API referenced correction</b> option is selected in <b>Petroleum mode</b> parameter.</li> </ul> <p> The software options currently enabled are displayed in the <b>Software option overview</b> parameter.</p>        | <p>Displays the net volume flow which is calculated from the measured total volume flow minus the value for sediment &amp; water and minus the shrinkage.</p> <p><i>Dependency</i><br/>The unit is taken from: <b>Corrected volume flow unit</b> parameter</p>        | Signed floating-point number   | –               |
| NSV flow alternative | <p>For the following order code:</p> <ul style="list-style-type: none"> <li>▪ "Application package", option EJ "Petroleum"</li> <li>▪ In the <b>Petroleum mode</b> parameter, the <b>API referenced correction</b> option is selected.</li> </ul> <p> The software options currently enabled are displayed in the <b>Software option overview</b> parameter.</p> | <p>Displays the net volume flow which is calculated from the measured alternative total volume minus the value for sediment &amp; water and minus the shrinkage.</p> <p><i>Dependency</i><br/>The unit is taken from: <b>Corrected volume flow unit</b> parameter</p> | Signed floating-point number   | –               |
| Oil CTL              | <p>For the following order code:</p> <ul style="list-style-type: none"> <li>▪ "Application package", option EJ "Petroleum"</li> <li>▪ In the <b>Petroleum mode</b> parameter, the <b>Net oil &amp; water cut</b> option is selected.</li> </ul> <p> The software options currently enabled are displayed in the <b>Software option overview</b> parameter.</p>   | <p>Displays the correction factor which represents the effect of temperature on the oil. This is used to convert the measured oil volume flow and the measured oil density to values at reference temperature.</p>  | Positive floating-point number | –               |
| Oil CPL              | <p>For the following order code:</p> <ul style="list-style-type: none"> <li>▪ "Application package", option EJ "Petroleum"</li> <li>▪ In the <b>Petroleum mode</b> parameter, the <b>Net oil &amp; water cut</b> option is selected.</li> </ul> <p> The software options currently enabled are displayed in the <b>Software option overview</b> parameter.</p>   | <p>Displays the correction factor which represents the effect of pressure on the oil. This is used to convert the measured oil volume flow and the measured oil density to values at reference pressure.</p>  | Positive floating-point number | –               |

| Parameter        | Prerequisite   | Description   | User interface                 | Factory setting |
|------------------|--|---|--------------------------------|-----------------|
| Oil CTPL         | <p>For the following order code:</p> <ul style="list-style-type: none"> <li>▪ "Application package", option <b>EJ</b> "Petroleum"</li> <li>▪ In the <b>Petroleum mode</b> parameter, the <b>Net oil &amp; water cut</b> option is selected.</li> </ul> <p> The software options currently enabled are displayed in the <b>Software option overview</b> parameter.</p>     | <p>Displays the combined correction factor which represents the effect of temperature and pressure on the oil. This is used to convert the measured oil volume flow and the measured oil density to values at reference temperature and reference pressure.</p>                           | Positive floating-point number | -               |
| Water CTL        | <p>For the following order code:</p> <ul style="list-style-type: none"> <li>▪ "Application package", option <b>EJ</b> "Petroleum"</li> <li>▪ In the <b>Petroleum mode</b> parameter, the <b>Net oil &amp; water cut</b> option is selected.</li> </ul> <p> The software options currently enabled are displayed in the <b>Software option overview</b> parameter.</p>     | <p>Displays the correction factor which represents the effect of temperature on the water. This is used to convert the measured water volume flow and the measured water density to values at reference temperature.</p>  | Positive floating-point number | -               |
| CTL alternative  | <p>For the following order code:</p> <ul style="list-style-type: none"> <li>▪ "Application package", option <b>EJ</b> "Petroleum"</li> <li>▪ In the <b>Petroleum mode</b> parameter, the <b>API referenced correction</b> option is selected.</li> </ul> <p> The software options currently enabled are displayed in the <b>Software option overview</b> parameter.</p> | <p>Displays the correction factor which represents the effect of temperature on the fluid. This is used to convert the measured volume flow and the measured density to values at the alternative reference temperature.</p>  | Positive floating-point number | -               |
| CPL alternative  | <p>For the following order code:</p> <ul style="list-style-type: none"> <li>▪ "Application package", option <b>EJ</b> "Petroleum"</li> <li>▪ In the <b>Petroleum mode</b> parameter, the <b>API referenced correction</b> option is selected.</li> </ul> <p> The software options currently enabled are displayed in the <b>Software option overview</b> parameter.</p> | <p>Displays the correction factor which represents the effect of pressure on the fluid. This is used to convert the measured volume flow and the measured density to values at the alternative reference pressure.</p>  | Positive floating-point number | -               |
| CTPL alternative | <p>For the following order code:</p> <ul style="list-style-type: none"> <li>▪ "Application package", option <b>EJ</b> "Petroleum"</li> <li>▪ In the <b>Petroleum mode</b> parameter, the <b>API referenced correction</b> option is selected.</li> </ul> <p> The software options currently enabled are displayed in the <b>Software option overview</b> parameter.</p> | <p>Displays the combined correction factor which represents the effect of temperature and pressure on the fluid. This is used to convert the measured volume flow and the measured density to values at the alternative reference temperature and the alternative reference pressure.</p> | Positive floating-point number | 1               |

| Parameter               | Prerequisite  | Description  | User interface               | Factory setting |
|-------------------------|---|--|------------------------------|-----------------|
| Oil reference density   | <p>For the following order code:</p> <ul style="list-style-type: none"> <li>▪ "Application package", option EJ "Petroleum"</li> <li>▪ In the <b>Petroleum mode</b> parameter, the <b>Net oil &amp; water cut</b> option is selected.</li> </ul> <p> The software options currently enabled are displayed in the <b>Software option overview</b> parameter.</p>     | Shows the oil density at the reference temperature.  | Signed floating-point number | –               |
| Water reference density | <p>For the following order code:</p> <ul style="list-style-type: none"> <li>▪ "Application package", option EJ "Petroleum"</li> <li>▪ In the <b>Petroleum mode</b> parameter, the <b>Net oil &amp; water cut</b> option is selected.</li> </ul> <p> The software options currently enabled are displayed in the <b>Software option overview</b> parameter.</p>     | Shows the water density at the reference temperature.  | Signed floating-point number | –               |
| Oil density             | <p>For the following order code:</p> <ul style="list-style-type: none"> <li>▪ "Application package", option EJ "Petroleum"</li> <li>▪ In the <b>Petroleum mode</b> parameter, the <b>Net oil &amp; water cut</b> option is selected.</li> </ul> <p> The software options currently enabled are displayed in the <b>Software option overview</b> parameter.</p>   | Displays the density of the oil currently measured.  | Signed floating-point number | –               |
| Water density           | <p>For the following order code:</p> <ul style="list-style-type: none"> <li>▪ "Application package", option EJ "Petroleum"</li> <li>▪ In the <b>Petroleum mode</b> parameter, the <b>Net oil &amp; water cut</b> option is selected.</li> </ul> <p> The software options currently enabled are displayed in the <b>Software option overview</b> parameter.</p>   | Displays the density of the water currently measured.  | Signed floating-point number | –               |
| Water cut               | <p>For the following order code:</p> <ul style="list-style-type: none"> <li>▪ "Application package", option EJ "Petroleum"</li> <li>▪ In the <b>Petroleum mode</b> parameter, the <b>API referenced correction</b> option is selected.</li> </ul> <p> The software options currently enabled are displayed in the <b>Software option overview</b> parameter.</p> | Displays the percentage water volume flow in relation to the total volume flow of the fluid. | 0 to 100 %                   | –               |

| Parameter                   | Prerequisite  | Description   | User interface               | Factory setting |
|-----------------------------|---|---|------------------------------|-----------------|
| Oil volume flow             | <p>For the following order code:</p> <ul style="list-style-type: none"> <li>▪ "Application package", option EJ "Petroleum"</li> <li>▪ In the <b>Petroleum mode</b> parameter, the <b>Net oil &amp; water cut</b> option is selected.</li> </ul> <p> The software options currently enabled are displayed in the <b>Software option overview</b> parameter.</p>   | <p>Displays the currently calculated volume flow of the oil.</p> <p>Dependency:</p> <ul style="list-style-type: none"> <li>▪ Based on the value displayed in the <b>Water cut</b> parameter</li> <li>▪ The unit is taken from: <b>Volume flow unit</b> parameter</li> </ul>   | Signed floating-point number | -               |
| Oil corrected volume flow   | <p>For the following order code:</p> <ul style="list-style-type: none"> <li>▪ "Application package", option EJ "Petroleum"</li> <li>▪ In the <b>Petroleum mode</b> parameter, the <b>Net oil &amp; water cut</b> option is selected.</li> </ul> <p> The software options currently enabled are displayed in the <b>Software option overview</b> parameter.</p>   | <p>Displays the currently calculated volume flow of the oil, calculated to values at reference temperature and reference pressure.</p> <p>Dependency:</p> <ul style="list-style-type: none"> <li>▪ Based on the value displayed in the <b>Water cut</b> parameter</li> <li>▪ The unit is taken from: <b>Corrected volume flow unit</b> parameter</li> </ul>   | Signed floating-point number | -               |
| Oil mass flow               | <p>For the following order code:</p> <ul style="list-style-type: none"> <li>▪ "Application package", option EJ "Petroleum"</li> <li>▪ In the <b>Petroleum mode</b> parameter, the <b>Net oil &amp; water cut</b> option is selected.</li> </ul> <p> The software options currently enabled are displayed in the <b>Software option overview</b> parameter.</p> | <p>Displays the currently calculated mass flow of the oil.</p> <p>Dependency:</p> <ul style="list-style-type: none"> <li>▪ Based on the value displayed in the <b>Water cut</b> parameter</li> <li>▪ The unit is taken from: <b>Mass flow unit</b> parameter</li> </ul>   | Signed floating-point number | -               |
| Water volume flow           | <p>For the following order code:</p> <ul style="list-style-type: none"> <li>▪ "Application package", option EJ "Petroleum"</li> <li>▪ In the <b>Petroleum mode</b> parameter, the <b>Net oil &amp; water cut</b> option is selected.</li> </ul> <p> The software options currently enabled are displayed in the <b>Software option overview</b> parameter.</p> | <p>Displays the currently calculated volume flow of the water.</p> <p>Dependency:</p> <ul style="list-style-type: none"> <li>▪ Based on the value displayed in the <b>Water cut</b> parameter</li> <li>▪ The unit is taken from: <b>Volume flow unit</b> parameter</li> </ul>   | Signed floating-point number | -               |
| Water corrected volume flow | <p>For the following order code:</p> <ul style="list-style-type: none"> <li>▪ "Application package", option EJ "Petroleum"</li> <li>▪ In the <b>Petroleum mode</b> parameter, the <b>Net oil &amp; water cut</b> option is selected.</li> </ul> <p> The software options currently enabled are displayed in the <b>Software option overview</b> parameter.</p> | <p>Displays the currently calculated volume flow of the water, calculated to values at reference temperature and reference pressure.</p> <p>Dependency:</p> <ul style="list-style-type: none"> <li>▪ Based on the value displayed in the <b>Water cut</b> parameter</li> <li>▪ The unit is taken from: <b>Corrected volume flow unit</b> parameter</li> </ul> | Signed floating-point number | -               |



| Parameter                    | Prerequisite   | Description   | User interface               | Factory setting |
|------------------------------|--|---|------------------------------|-----------------|
| Water mass flow              | <p>For the following order code:</p> <ul style="list-style-type: none"> <li>▪ "Application package", option <b>EJ</b> "Petroleum"</li> <li>▪ In the <b>Petroleum mode</b> parameter, the <b>Net oil &amp; water cut</b> option is selected.</li> </ul> <p> The software options currently enabled are displayed in the <b>Software option overview</b> parameter.</p> | <p>Displays the currently calculated mass flow of the water.</p> <p>Dependency:</p> <ul style="list-style-type: none"> <li>▪ Based on the value displayed in the <b>Water cut</b> parameter</li> <li>▪ The unit is taken from: <b>Mass flow unit</b> parameter</li> </ul>   | Signed floating-point number | -               |
| Weighted density average     | <p>For the following order code:</p> <ul style="list-style-type: none"> <li>▪ "Application package", option <b>EJ</b> "Petroleum"</li> <li>▪ "Application package", option <b>EM</b> "Petroleum + Locking function"</li> </ul> <p> The software options currently enabled are displayed in the <b>Software option overview</b> parameter.</p>                         | <p>Displays the weighted average for the density since the last time the density averages were reset.</p> <p>Dependency:</p> <ul style="list-style-type: none"> <li>▪ The unit is taken from: <b>Density unit</b> parameter</li> <li>▪ The value is reset to NaN (Not a Number) via the <b>Reset weighted averages</b> parameter</li> </ul>             | Signed floating-point number | -               |
| Weighted temperature average | <p>For the following order code:</p> <ul style="list-style-type: none"> <li>▪ "Application package", option <b>EJ</b> "Petroleum"</li> <li>▪ "Application package", option <b>EM</b> "Petroleum + Locking function"</li> </ul> <p> The software options currently enabled are displayed in the <b>Software option overview</b> parameter.</p>                       | <p>Displays the weighted average for the temperature since the last time the temperature averages were reset.</p> <p>Dependency:</p> <ul style="list-style-type: none"> <li>▪ The unit is taken from: <b>Temperature unit</b> parameter</li> <li>▪ The value is reset to NaN (Not a Number) via the <b>Reset weighted averages</b> parameter</li> </ul> | Signed floating-point number | -               |

### 11.4.2 "Totalizer" submenu

The **Totalizer** submenu contains all the parameters needed to display the current measured values for every totalizer.

#### Navigation

"Diagnostics" menu → Measured values → Totalizer

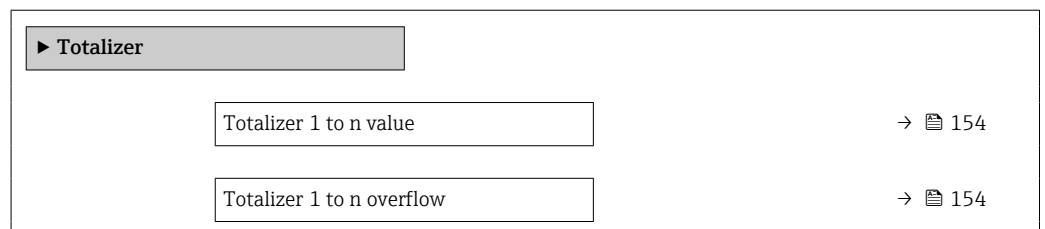

**Parameter overview with brief description**

| Parameter                 | Prerequisite   | Description                                   | User interface               |
|---------------------------|--|---|------------------------------|
| Totalizer 1 to n value    | A process variable is selected in the <b>Assign process variable</b> parameter (→ 123) of the <b>Totalizer 1 to n</b> submenu. | Displays the current totalizer counter value. | Signed floating-point number |
| Totalizer 1 to n overflow | A process variable is selected in the <b>Assign process variable</b> parameter (→ 123) of the <b>Totalizer 1 to n</b> submenu. | Displays the current totalizer overflow.      | Integer with sign            |

**11.4.3 "Input values" submenu**

The **Input values** submenu guides you systematically to the individual input values.

**Navigation**

"Diagnostics" menu → Measured values → Input values

|                               |       |
|-------------------------------|-------|
| ▶ <b>Input values</b>         |       |
| ▶ <b>Current input 1 to n</b> | → 154 |
| ▶ <b>Status input 1 to n</b>  | → 154 |

**Input values of current input**

The **Current input 1 to n** submenu contains all the parameters needed to display the current measured values for every current input.

**Navigation**

"Diagnostics" menu → Measured values → Input values → Current input 1 to n

|                               |       |
|-------------------------------|-------|
| ▶ <b>Current input 1 to n</b> |       |
| Measured values 1 to n        | → 154 |
| Measured current 1 to n       | → 154 |

**Parameter overview with brief description**

| Parameter               | Description                                      | User interface               |
|-------------------------|--|------------------------------|
| Measured values 1 to n  | Displays the current input value.                | Signed floating-point number |
| Measured current 1 to n | Displays the current value of the current input. | 0 to 22.5 mA                 |

**Input values of status input**

The **Status input 1 to n** submenu contains all the parameters needed to display the current measured values for every status input.

**Navigation**

"Diagnostics" menu → Measured values → Input values → Status input 1 to n

▶ Status input 1 to n

Value status input

→ ⓘ 155

**Parameter overview with brief description**

| Parameter          | Description                           | User interface  |
|--------------------|---------------------------------------|---|
| Value status input | Shows the current input signal level. | <ul style="list-style-type: none"> <li>▪ High</li> <li>▪ Low</li> </ul> |

**11.4.4 Output values**

The **Output values** submenu contains all the parameters needed to display the current measured values for every output.

**Navigation**

"Diagnostics" menu → Measured values → Output values

▶ Output values

▶ Current output 1 to n

→ ⓘ 155

▶ Pulse/frequency/switch output 1 to n

→ ⓘ 156

▶ Relay output 1 to n

→ ⓘ 156

▶ Double pulse output

→ ⓘ 157

**Output values of current output**

The **Value current output** submenu contains all the parameters needed to display the current measured values for every current output.

**Navigation**

"Diagnostics" menu → Measured values → Output values → Value current output 1 to n

▶ Current output 1 to n

Output current

→ ⓘ 156

Measured current

→ ⓘ 156

**Parameter overview with brief description**

| Parameter        | Description   | User interface  |
|------------------|---|-----------------|
| Output current   | Displays the current value currently calculated for the current output. | 3.59 to 22.5 mA |
| Measured current | Displays the current value currently measured for the current output.   | 0 to 30 mA      |

**Output values for pulse/frequency/switch output**

The **Pulse/frequency/switch output 1 to n** submenu contains all the parameters needed to display the current measured values for every pulse/frequency/switch output.

**Navigation**

"Diagnostics" menu → Measured values → Output values → Pulse/frequency/switch output 1 to n

| ► Pulse/frequency/switch output 1 to n |  |       |
|--|--|-------|
| Output frequency                       |  | → 156 |
| Pulse output                           |  | → 156 |
| Switch state                           |  | → 156 |

**Parameter overview with brief description**

| Parameter        | Prerequisite  | Description   | User interface   |
|------------------|---|---|--|
| Output frequency | In the <b>Operating mode</b> parameter, the <b>Frequency</b> option is selected.      | Displays the value currently measured for the frequency output. | 0.0 to 12 500.0 Hz   |
| Pulse output     | The <b>Pulse</b> option is selected in the <b>Operating mode</b> parameter parameter. | Displays the pulse frequency currently output.                  | Positive floating-point number   |
| Switch state     | The <b>Switch</b> option is selected in the <b>Operating mode</b> parameter.          | Displays the current switch output status.                      | <ul style="list-style-type: none"> <li>▪ Open</li> <li>▪ Closed</li> </ul> |

**Output values for relay output**

The **Relay output 1 to n** submenu contains all the parameters needed to display the current measured values for every relay output.

**Navigation**

"Diagnostics" menu → Measured values → Output values → Relay output 1 to n

| ► Relay output 1 to n     |  |       |
|---------------------------|--|-------|
| Switch state              |  | → 157 |
| Switch cycles             |  | → 157 |
| Max. switch cycles number |  | → 157 |

**Parameter overview with brief description**

| Parameter                 | Description   | User interface   |
|---------------------------|---|--|
| Switch state              | Indicates the current switch state of the output.     | <ul style="list-style-type: none"> <li>■ Open</li> <li>■ Closed</li> </ul> |
| Switch cycles             | Shows number of all performed switch cycles.          | Positive integer   |
| Max. switch cycles number | Shows the maximal number of guaranteed switch cycles. | Positive integer   |

**Output values for double pulse output**

The **Double pulse output** submenu contains all the parameters needed to display the current measured values for every double pulse output.

**Navigation**

"Diagnostics" menu → Measured values → Output values → Double pulse output

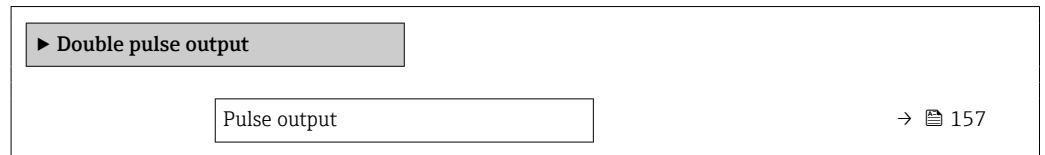

**Parameter overview with brief description**

| Parameter    | Description                                 | User interface                 |
|--------------|---|--------------------------------|
| Pulse output | Shows the currently output pulse frequency. | Positive floating-point number |

## 11.5 Adapting the measuring device to the process conditions

The following are available for this purpose:

- Basic settings using the **Setup** menu (→ 📄 78)
- Advanced settings using the **Advanced setup** submenu (→ 📄 114)

## 11.6 Performing a totalizer reset





The totalizers are reset in the **Operation** submenu:

- Control Totalizer
- Reset all totalizers

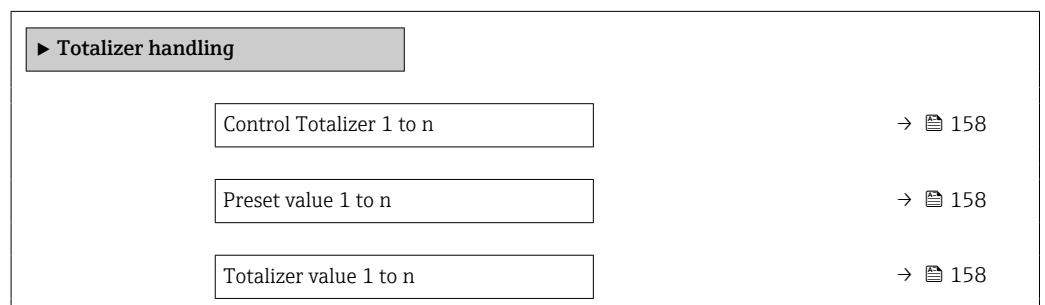





**Navigation**

"Operation" menu → Totalizer handling



|                              |   |
|------------------------------|---|
| Weighted density average     | →  158 |
| Weighted temperature average | →  158 |
| Reset weighted averages      | →  159 |
| Reset all totalizers         | →  159 |

**Parameter overview with brief description**

| Parameter                    | Prerequisite   | Description  | Selection / User entry / User interface  | Factory setting  |
|------------------------------|--|--|--|--|
| Control Totalizer 1 to n     | A process variable is selected in the <b>Assign process variable</b> parameter (→  123) of the <b>Totalizer 1 to n</b> submenu.   | Control totalizer value.   | <ul style="list-style-type: none"> <li>▪ Totalize</li> <li>▪ Reset + hold *</li> <li>▪ Preset + hold *</li> <li>▪ Reset + totalize</li> <li>▪ Preset + totalize *</li> <li>▪ Hold *</li> </ul> | Totalize   |
| Preset value 1 to n          | A process variable is selected in the <b>Assign process variable</b> parameter (→  123) of the <b>Totalizer 1 to n</b> submenu.   | Specify start value for totalizer.<br><i>Dependency</i><br> The unit of the selected process variable is defined in the <b>Unit totalizer</b> parameter (→  123) for the totalizer. | Signed floating-point number   | Depends on country: <ul style="list-style-type: none"> <li>▪ 0 kg</li> <li>▪ 0 lb</li> </ul> |
| Totalizer 1 to n value       | A process variable is selected in the <b>Assign process variable</b> parameter (→  123) of the <b>Totalizer 1 to n</b> submenu.   | Displays the current totalizer counter value.  | Signed floating-point number   | -  |
| Weighted density average     | For the following order code: <ul style="list-style-type: none"> <li>▪ "Application package", option <b>EJ</b> "Petroleum"</li> <li>▪ "Application package", option <b>EM</b> "Petroleum + Locking function"</li> </ul>  The software options currently enabled are displayed in the <b>Software option overview</b> parameter. | Displays the weighted average for the density since the last time the density averages were reset.<br><i>Dependency:</i> <ul style="list-style-type: none"> <li>▪ The unit is taken from: <b>Density unit</b> parameter</li> <li>▪ The value is reset to NaN (Not a Number) via the <b>Reset weighted averages</b> parameter</li> </ul>                  | Signed floating-point number   | -  |
| Weighted temperature average | For the following order code: <ul style="list-style-type: none"> <li>▪ "Application package", option <b>EJ</b> "Petroleum"</li> <li>▪ "Application package", option <b>EM</b> "Petroleum + Locking function"</li> </ul>  The software options currently enabled are displayed in the <b>Software option overview</b> parameter. | Displays the weighted average for the temperature since the last time the temperature averages were reset.<br><i>Dependency:</i> <ul style="list-style-type: none"> <li>▪ The unit is taken from: <b>Temperature unit</b> parameter</li> <li>▪ The value is reset to NaN (Not a Number) via the <b>Reset weighted averages</b> parameter</li> </ul>      | Signed floating-point number   | -  |

| Parameter               | Prerequisite   | Description   | Selection / User entry / User interface  | Factory setting |
|-------------------------|--|---|--|-----------------|
| Reset weighted averages | The values can only be reset at zero flow.<br>For the following order code: "Application package", option EJ "Petroleum"<br> The software options currently enabled are displayed in the <b>Software option overview</b> parameter. | Resets the weighted averages for density and temperature to NaN (Not a Number) and then starts determining the weighted averages. | <ul style="list-style-type: none"> <li>■ Totalize</li> <li>■ Reset weighted averages</li> <li>■ Reset weighted averages + totalizer 3</li> </ul> | Totalize        |
| Reset all totalizers    | –  | Reset all totalizers to 0 and start.  | <ul style="list-style-type: none"> <li>■ Cancel</li> <li>■ Reset + totalize</li> </ul>   | Cancel          |

\* Visibility depends on order options or device settings

### 11.6.1 Function scope of "Control Totalizer" parameter

| Options                         | Description   |
|---------------------------------|---|
| Totalize                        | The totalizer is started or continues running.  |
| Reset + hold                    | The totaling process is stopped and the totalizer is reset to 0.  |
| Preset + hold <sup>1)</sup>     | The totaling process is stopped and the totalizer is set to its defined start value from the <b>Preset value</b> parameter. |
| Reset + totalize                | The totalizer is reset to 0 and the totaling process is restarted.  |
| Preset + totalize <sup>1)</sup> | The totalizer is set to the defined start value in the <b>Preset value</b> parameter and the totaling process is restarted. |
| Hold                            | Totalizing is stopped.  |

1) Visible depending on the order options or device settings

### 11.6.2 Function range of "Reset all totalizers" parameter

| Options          | Description   |
|------------------|---|
| Cancel           | No action is executed and the user exits the parameter.   |
| Reset + totalize | Resets all totalizers to 0 and restarts the totaling process. This deletes all the previously aggregated flow values. |

## 11.7 Displaying the measured value history

The **Extended HistorOM** application package must be enabled in the device (order option) for the **Data logging** submenu to appear. This contains all the parameters for the measured value history.



Data logging is also available via:

- Plant Asset Management Tool FieldCare →  69.
- Web browser

#### Function range

- A total of 1000 measured values can be stored
- 4 logging channels
- Adjustable logging interval for data logging
- Measured value trend for each logging channel displayed in the form of a chart

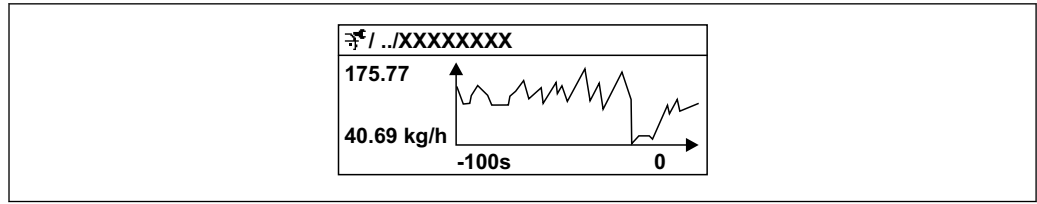

30 Chart of a measured value trend

- x-axis: depending on the number of channels selected displays 250 to 1000 measured values of a process variable.
- y-axis: displays the approximate measured value span and constantly adapts this to the ongoing measurement.

**i** If the length of the logging interval or the assignment of the process variables to the channels is changed, the content of the data logging is deleted.

**Navigation**

"Diagnostics" menu → Data logging







▶ Data logging

|                         |       |
|-------------------------|-------|
| Assign channel 1        | → 161 |
| Assign channel 2        | → 162 |
| Assign channel 3        | → 162 |
| Assign channel 4        | → 162 |
| Logging interval        | → 162 |
| Clear logging data      | → 162 |
| Data logging            | → 162 |
| Logging delay           | → 162 |
| Data logging control    | → 162 |
| Data logging status     | → 163 |
| Entire logging duration | → 163 |
| ▶ Display channel 1     |       |
| ▶ Display channel 2     |       |
| ▶ Display channel 3     |       |
| ▶ Display channel 4     |       |



Parameter overview with brief description

| Parameter        | Prerequisite   | Description                                 | Selection / User entry / User interface  | Factory setting |
|------------------|--|---|--|-----------------|
| Assign channel 1 | The <b>Extended HistoROM</b> application package is available. | Assign process variable to logging channel. | <ul style="list-style-type: none"> <li>■ Off</li> <li>■ Mass flow</li> <li>■ Volume flow</li> <li>■ Corrected volume flow *</li> <li>■ Density</li> <li>■ Reference density *</li> <li>■ Temperature</li> <li>■ Pressure</li> <li>■ GSV flow *</li> <li>■ GSV flow alternative *</li> <li>■ NSV flow *</li> <li>■ NSV flow alternative *</li> <li>■ S&amp;W volume flow *</li> <li>■ Reference density alternative *</li> <li>■ Water cut *</li> <li>■ Oil density *</li> <li>■ Water density *</li> <li>■ Oil mass flow *</li> <li>■ Water mass flow *</li> <li>■ Oil volume flow *</li> <li>■ Water volume flow *</li> <li>■ Oil corrected volume flow *</li> <li>■ Water corrected volume flow *</li> <li>■ Concentration *</li> <li>■ Target mass flow *</li> <li>■ Carrier mass flow *</li> <li>■ Target volume flow *</li> <li>■ Carrier volume flow *</li> <li>■ Target corrected volume flow *</li> <li>■ Carrier corrected volume flow *</li> <li>■ Application specific output 0 *</li> <li>■ Application specific output 1 *</li> <li>■ Inhomogeneous medium index</li> <li>■ Suspended bubbles index *</li> <li>■ HBSI *</li> <li>■ Raw value mass flow</li> <li>■ Exciter current 0</li> <li>■ Oscillation damping 0</li> <li>■ Oscillation damping fluctuation 0 *</li> <li>■ Oscillation frequency 0</li> <li>■ Frequency fluctuation 0 *</li> <li>■ Oscillation amplitude *</li> </ul> | Off             |

| Parameter            | Prerequisite  | Description  | Selection / User entry / User interface   | Factory setting |
|----------------------|---|--|---|-----------------|
|                      |   |  | <ul style="list-style-type: none"> <li>▪ Oscillation amplitude 1 *</li> <li>▪ Signal asymmetry</li> <li>▪ Torsion signal asymmetry *</li> <li>▪ Carrier pipe temperature *</li> <li>▪ Electronics temperature</li> <li>▪ Sensor index coil asymmetry</li> <li>▪ Test point 0</li> <li>▪ Test point 1</li> <li>▪ Current output 1 *</li> <li>▪ Current output 2 *</li> <li>▪ Current output 3 *</li> </ul> |                 |
| Assign channel 2     | <p>The <b>Extended HistorOM</b> application package is available.</p> <p> The software options currently enabled are displayed in the <b>Software option overview</b> parameter.</p>   | Assign a process variable to logging channel.  | For the picklist, see <b>Assign channel 1</b> parameter (→  161)   | Off             |
| Assign channel 3     | <p>The <b>Extended HistorOM</b> application package is available.</p> <p> The software options currently enabled are displayed in the <b>Software option overview</b> parameter.</p> | Assign a process variable to logging channel.  | For the picklist, see <b>Assign channel 1</b> parameter (→  161)   | Off             |
| Assign channel 4     | <p>The <b>Extended HistorOM</b> application package is available.</p> <p> The software options currently enabled are displayed in the <b>Software option overview</b> parameter.</p> | Assign a process variable to logging channel.  | For the picklist, see <b>Assign channel 1</b> parameter (→  161)   | Off             |
| Logging interval     | The <b>Extended HistorOM</b> application package is available.  | Define the logging interval for data logging. This value defines the time interval between the individual data points in the memory. | 0.1 to 3 600.0 s  | 1.0 s           |
| Clear logging data   | The <b>Extended HistorOM</b> application package is available.  | Clear the entire logging data.   | <ul style="list-style-type: none"> <li>▪ Cancel</li> <li>▪ Clear data</li> </ul>  | Cancel          |
| Data logging         | –   | Select the type of data logging.   | <ul style="list-style-type: none"> <li>▪ Overwriting</li> <li>▪ Not overwriting</li> </ul>  | Overwriting     |
| Logging delay        | In the <b>Data logging</b> parameter, the <b>Not overwriting</b> option is selected.  | Enter the time delay for measured value logging.   | 0 to 999 h  | 0 h             |
| Data logging control | In the <b>Data logging</b> parameter, the <b>Not overwriting</b> option is selected.  | Start and stop measured value logging.   | <ul style="list-style-type: none"> <li>▪ None</li> <li>▪ Delete + start</li> <li>▪ Stop</li> </ul>  | None            |

| Parameter               | Prerequisite   | Description                                 | Selection / User entry / User interface   | Factory setting |
|-------------------------|--|---|---|-----------------|
| Data logging status     | In the <b>Data logging</b> parameter, the <b>Not overwriting</b> option is selected. | Displays the measured value logging status. | <ul style="list-style-type: none"> <li>■ Done</li> <li>■ Delay active</li> <li>■ Active</li> <li>■ Stopped</li> </ul> | Done            |
| Entire logging duration | In the <b>Data logging</b> parameter, the <b>Not overwriting</b> option is selected. | Displays the total logging duration.        | Positive floating-point number  | 0 s             |

\* Visibility depends on order options or device settings

## 11.8 Gas Fraction Handler

The Gas Fraction Handler improves measurement stability and repeatability in the event of two-phase media and provides valuable diagnostic information for the process.

The function continuously checks for the presence of gas bubbles in liquids or droplets in gases, as this second phase influences the output values for flow and density.

In the case of two-phase media, the Gas Fraction Handler stabilizes the output values and enables better readability for operators and easier interpretation by the distributed control system. The level of smoothing is adjusted according to the severity of the disturbances introduced by the second phase. In the case of single-phase media, the Gas Fraction Handler does not have any influence on the output values.

Possible options in the Gas Fraction Handler parameter:

- Off: Disables the Gas Fraction Handler. When a second phase is present, large fluctuations in the values output for flow and density will occur.
- Moderate: Use for applications with low levels or intermittent levels of second phase.
- Powerful: Use for applications with very significant levels of second phase.

The Gas Fraction Handler is cumulative to any fixed damping constants applied to flow and density that are set elsewhere in the instrument parameterization.



For detailed information on the parameter descriptions of the Gas Fraction Handler, see the Special Documentation for the device → 224

### 11.8.1 "Measurement mode" submenu

#### Navigation

"Expert" menu → Sensor → Measurement mode

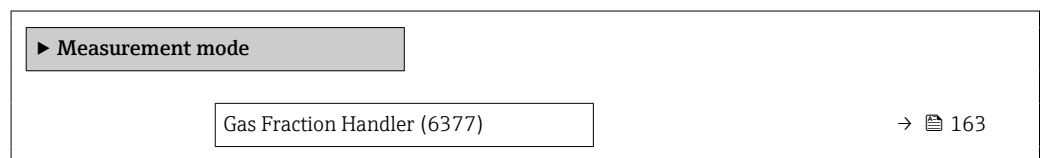

#### Parameter overview with brief description

| Parameter            | Description  | Selection   | Factory setting |
|----------------------|--|---|-----------------|
| Gas Fraction Handler | Activates the Gas Fraction Handler function for two phase media. | <ul style="list-style-type: none"> <li>■ Off</li> <li>■ Moderate</li> <li>■ Powerful</li> </ul> | Moderate        |

## 11.8.2 "Medium index" submenu

### Navigation

"Expert" menu → Application → Medium index

|                                      |       |
|--------------------------------------|-------|
| ▶ Medium index                       |       |
| Inhomogeneous medium index (6368)    | → 164 |
| Cut off inhomogeneous wet gas (6375) | → 164 |
| Cut off inhomogeneous liquid (6374)  | → 164 |
| Suspended bubbles index (6376)       | → 164 |
| Cut off suspended bubbles (6370)     | → 164 |

### Parameter overview with brief description

| Parameter                     | Prerequisite  | Description  | User interface / User entry    | Factory setting |
|-------------------------------|---|--|--------------------------------|-----------------|
| Inhomogeneous medium index    | –   | Shows the degree of inhomogeneity of the medium.   | Signed floating-point number   | –               |
| Cut off inhomogeneous wet gas | –   | Enter cut off value for wet gas applications. Below this value the 'Inhomogeneous medium index' is set to 0.   | Positive floating-point number | 0.25            |
| Cut off inhomogeneous liquid  | –   | Enter cut off value for liquid applications. Below this value the 'Inhomogeneous medium index' is set to 0.    | Positive floating-point number | 0.05            |
| Suspended bubbles index       | The diagnostic index is only available for Promass Q. | Shows the relative amount of suspended bubbles in the medium.  | Signed floating-point number   | –               |
| Cut off suspended bubbles     | The parameter is only available for Promass Q.        | Enter the cut off value for suspended bubbles. Below this value the 'Index for suspended bubbles' is set to 0. | Positive floating-point number | 0.05            |

## 12 Diagnostics and troubleshooting

### 12.1 General troubleshooting

*For local display*

| Error   | Possible causes   | Remedial action  |
|---|---|--|
| Local display is dark, but signal output is within the valid range        | The cable of the display module is not plugged in correctly.  | Insert the plug correctly into the main electronics module and display module.   |
| Local display dark and no output signals                                  | Supply voltage does not match the voltage specified on the nameplate.   | Apply the correct supply voltage → 35.   |
| Local display dark and no output signals                                  | Supply voltage has incorrect polarity.  | Reverse polarity of supply voltage.  |
| Local display dark and no output signals                                  | No contact between connecting cables and terminals.   | Ensure electrical contact between the cable and the terminal.  |
| Local display dark and no output signals                                  | <ul style="list-style-type: none"> <li>▪ Terminals are not plugged into the I/O electronics module correctly.</li> <li>▪ Terminals are not plugged into the main electronics module correctly.</li> </ul> | Check terminals.   |
| Local display dark and no output signals                                  | <ul style="list-style-type: none"> <li>▪ I/O electronics module is defective.</li> <li>▪ Main electronics module is defective.</li> </ul>   | Order spare part → 189.  |
| Local display cannot be read, but signal output is within the valid range | Display is set too bright or too dark.  | <ul style="list-style-type: none"> <li>▪ Set the display brighter by simultaneously pressing <math>\square + \square</math>.</li> <li>▪ Set the display darker by simultaneously pressing <math>\square + \square</math>.</li> </ul>                       |
| Local display is dark, but signal output is within the valid range        | Display module is defective.  | Order spare part → 189.  |
| Backlighting of local display is red                                      | Diagnostic event with "Alarm" diagnostic behavior has occurred.   | Take remedial measures → 174   |
| Text on local display appears in a language that cannot be understood.    | The selected operating language cannot be understood.   | <ol style="list-style-type: none"> <li>1. Press <math>\square + \square</math> for 2 s ("home position").</li> <li>2. Press <math>\square</math>.</li> <li>3. Configure the required language in the <b>Display language</b> parameter (→ 131).</li> </ol> |
| Message on local display:<br>"Communication Error"<br>"Check Electronics" | Communication between the display module and the electronics is interrupted.  | <ul style="list-style-type: none"> <li>▪ Check the cable and the connector between the main electronics module and display module.</li> <li>▪ Order spare part → 189.</li> </ul>   |

*For output signals*

| Error   | Possible causes  | Remedial action   |
|---|--|---|
| Signal output outside the valid range   | Main electronics module is defective.                              | Order spare part → 189.   |
| Device shows correct value on local display, but signal output is incorrect, though in the valid range. | Parameter configuration error                                      | Check and adjust parameter configuration.   |
| Device measures incorrectly.  | Configuration error or device is operated outside the application. | <ol style="list-style-type: none"> <li>1. Check and correct parameter configuration.</li> <li>2. Observe limit values specified in the "Technical Data".</li> </ol> |

## For access

| Fault  | Possible causes   | Remedial action  |
|--|---|--|
| Write access to parameters is not possible.                        | Hardware write protection is enabled.   | Set the write protection switch on the main electronics module to the <b>OFF</b> position<br>→ ☰ 140.  |
| Write access to parameters is not possible.                        | Current user role has limited access authorization.   | 1. Check user role → ☰ 59.<br>2. Enter correct customer-specific access code<br>→ ☰ 59.  |
| Connection via Modbus RS485 is not possible.                       | Modbus RS485 bus cable is connected incorrectly.  | Check the terminal assignment → ☰ 34.  |
| Connection via Modbus RS485 is not possible.                       | Modbus RS485 cable is incorrectly terminated.   | Check the terminating resistor → ☰ 43.   |
| Connection via Modbus RS485 is not possible.                       | Settings for the communication interface are incorrect.   | Check the Modbus RS485 configuration<br>→ ☰ 82.  |
| Unable to connect to the web server.                               | Web server is disabled.   | Using the "FieldCare" or "DeviceCare" operating tool, check whether the web server of the device is enabled, and enable it if necessary → ☰ 66.  |
|  | The Ethernet interface on the PC is incorrectly configured.   | <ul style="list-style-type: none"> <li>▶ Check the properties of the Internet protocol (TCP/IP) → ☰ 62.</li> <li>▶ Check the network settings with the IT manager.</li> </ul>  |
| Unable to connect to the web server.                               | The IP address on the PC is incorrectly configured.   | Check the IP address: 192.168.1.212 → ☰ 62   |
| Unable to connect to the web server.                               | WLAN access data are incorrect.   | <ul style="list-style-type: none"> <li>▪ Check WLAN network status.</li> <li>▪ Log on to the device again using WLAN access data.</li> <li>▪ Check that WLAN is enabled on the measuring instrument and operating unit<br/>→ ☰ 62.</li> </ul>            |
|  | WLAN communication is disabled.   | –  |
| Unable to connect to web server, FieldCare or DeviceCare.          | WLAN network is not available.  | <ul style="list-style-type: none"> <li>▪ Check if WLAN reception is present: LED on display module is lit blue.</li> <li>▪ Check if WLAN connection is enabled: LED on display module flashes blue.</li> <li>▪ Switch on instrument function.</li> </ul> |
| Network connection not present or unstable                         | WLAN network is weak.   | <ul style="list-style-type: none"> <li>▪ Operating unit outside reception range: Check network status on operating unit.</li> <li>▪ To improve network performance, use an external WLAN antenna.</li> </ul>   |
|  | Parallel WLAN and Ethernet communication  | <ul style="list-style-type: none"> <li>▪ Check network settings.</li> <li>▪ Temporarily enable only the WLAN as an interface.</li> </ul>   |
| Web browser frozen and operation no longer possible                | Data transfer is active.  | Wait until data transfer or current action is finished.  |
|  | Connection lost   | <ul style="list-style-type: none"> <li>▶ Check cable connection and power supply.</li> <li>▶ Refresh the web browser and restart if necessary.</li> </ul>  |
| Display of web browser content is difficult to read or incomplete. | Web browser version used is not optimal.  | <ul style="list-style-type: none"> <li>▶ Use correct web browser version → ☰ 61.</li> <li>▶ Empty the web browser cache.</li> <li>▶ Restart the web browser.</li> </ul>  |
|  | Unsuitable view settings.   | Change the font size/display ratio of the Web browser.   |
| Incomplete or no display of content in the web browser             | <ul style="list-style-type: none"> <li>▪ JavaScript is not enabled.</li> <li>▪ JavaScript cannot be enabled.</li> </ul> | <ul style="list-style-type: none"> <li>▶ Enable JavaScript.</li> <li>▶ Enter http://XXX.XXX.X.XX/servlet/basic.html as the IP address.</li> </ul>  |

| Fault  | Possible causes  | Remedial action   |
|--|--|---|
| Operation with FieldCare or DeviceCare via service interface CDI-RJ45 (port 8000) is not possible.                           | Firewall of the PC or network is blocking communication. | Depending on the settings of the firewall used on the PC or in the network, the firewall must be adapted or disabled to allow FieldCare/ DeviceCare access. |
| Flashing the firmware with FieldCare or DeviceCare via service interface CDI-RJ45 (port 8000 or TFTP ports) is not possible. | Firewall of the PC or network is blocking communication. | Depending on the settings of the firewall used on the PC or in the network, the firewall must be adapted or disabled to allow FieldCare/ DeviceCare access. |

## 12.2 Diagnostic information via light emitting diodes

### 12.2.1 Transmitter

Different LEDs in the transmitter provide information on the device status.

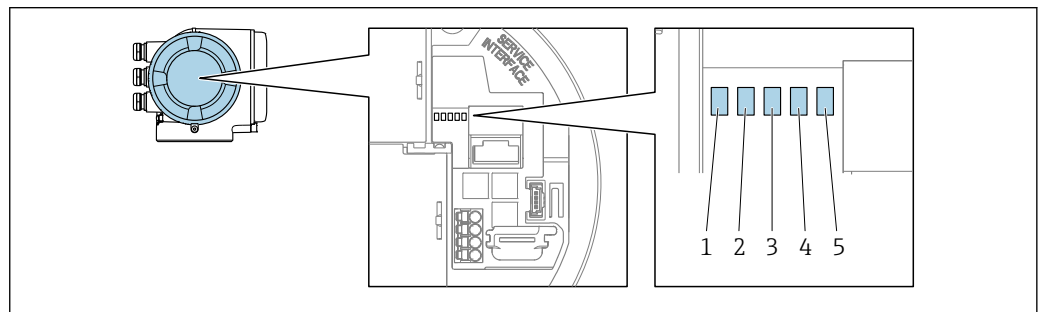

A0029629

- 1 Supply voltage
- 2 Device status
- 3 Not used
- 4 Communication
- 5 Service interface (CDI) active

| LED                                | Color               | Meaning   |
|------------------------------------|---------------------|---|
| 1 Supply voltage                   | Off                 | Supply voltage is off or too low.                                   |
|                                    | Green               | Supply voltage is OK.   |
| 2 Device status (normal operation) | Off                 | Firmware error  |
|                                    | Green               | Device status is OK.  |
|                                    | Flashing green      | Device is not configured.   |
|                                    | Red                 | A diagnostic event with "Alarm" diagnostic behavior has occurred.   |
|                                    | Flashing red        | A diagnostic event with "Warning" diagnostic behavior has occurred. |
| 2 Device status (during start-up)  | Flashes red slowly  | If > 30 seconds: problem with the boot loader.                      |
|                                    | Flashes red quickly | If > 30 seconds: compatibility problem when reading the firmware.   |
| 3 Not used                         | –                   | –   |
| 4 Communication                    | Off                 | Communication not active.   |
|                                    | White               | Communication active.   |
| 5 Service interface (CDI)          | Off                 | Not connected or no connection established.                         |
|                                    | Yellow              | Connected and connection established.                               |
|                                    | Flashing yellow     | Service interface active.   |

## 12.3 Diagnostic information on local display

### 12.3.1 Diagnostic message

Faults detected by the self-monitoring system of the measuring device are displayed as a diagnostic message in alternation with the operational display.

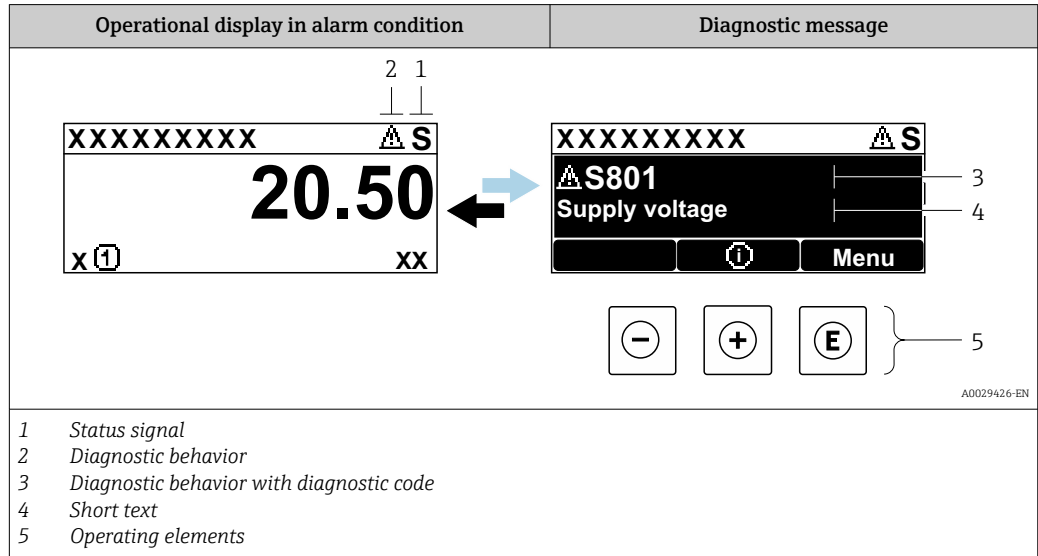

If two or more diagnostic events are pending simultaneously, only the message of the diagnostic event with the highest priority is shown.

- i** Other diagnostic events that have occurred can be displayed in the **Diagnostics** menu:
  - Via parameter → 179
  - Via submenus → 179

#### Status signals



The status signals provide information on the state and reliability of the device by categorizing the cause of the diagnostic information (diagnostic event).

- i** The status signals are categorized according to VDI/VDE 2650 and NAMUR Recommendation NE 107: F = Failure, C = Function Check, S = Out of Specification, M = Maintenance Required

| Symbol   | Meaning   |
|----------|---|
| <b>F</b> | <b>Failure</b><br>A device error has occurred. The measured value is no longer valid.   |
| <b>C</b> | <b>Function check</b><br>The device is in service mode (e.g. during a simulation).  |
| <b>S</b> | <b>Out of specification</b><br>The device is being operated:<br>Outside its technical specification limits (e.g. outside the process temperature range) |
| <b>M</b> | <b>Maintenance required</b><br>Maintenance is required. The measured value remains valid.   |



### Diagnostic behavior



| Symbol  | Meaning   |
|---|---|
|  | <b>Alarm</b> <ul style="list-style-type: none"> <li>Measurement is interrupted.</li> <li>Signal outputs and totalizers assume the defined alarm condition.</li> <li>A diagnostic message is generated.</li> </ul> |
|  | <b>Warning</b> <ul style="list-style-type: none"> <li>Measurement is resumed.</li> <li>The signal outputs and totalizers are not affected.</li> <li>A diagnostic message is generated.</li> </ul>                 |

### Diagnostic information

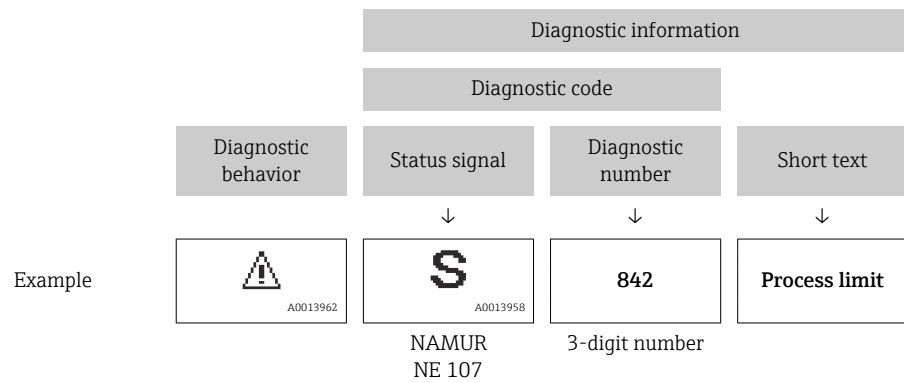
The fault can be identified using the diagnostic information. The short text helps you by providing information about the fault. In addition, the corresponding symbol for the diagnostic behavior is displayed in front of the diagnostic information on the local display.



### Operating elements

| Operating key   | Meaning  |
|---|--|
|  | <b>Plus key</b><br><i>In menu, submenu</i><br>Opens the message about the remedial measures. |
|  | <b>Enter key</b><br><i>In menu, submenu</i><br>Opens the operating menu.                     |

### 12.3.2 Calling up remedial measures

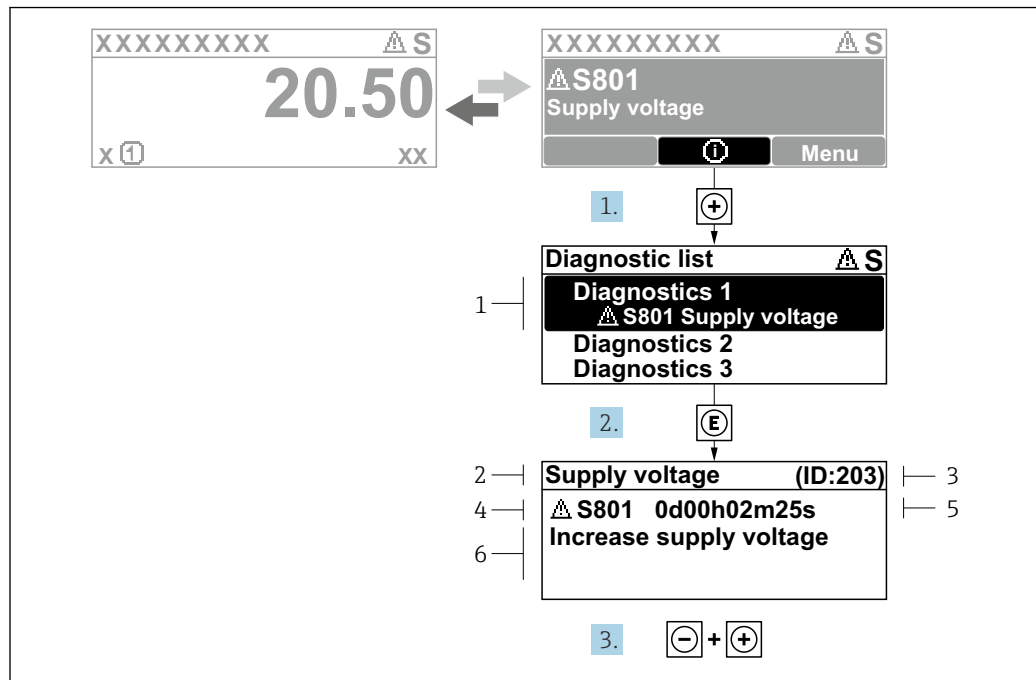

31 Message for remedial measures

- 1 Diagnostic information
- 2 Short text
- 3 Service ID
- 4 Diagnostic behavior with diagnostic code
- 5 Operation time when error occurred
- 6 Remedial measures

1. The user is in the diagnostic message.  
Press **+** (ⓘ symbol).  
↳ The **Diagnostic list** submenu opens.
2. Select the desired diagnostic event with **+** or **-** and press **E**.  
↳ The message about the remedial measures opens.
3. Press **- +** simultaneously.  
↳ The message about the remedial measures closes.

The user is in the **Diagnostics** menu at an entry for a diagnostics event, e.g. in the **Diagnostic list** submenu or **Previous diagnostics** parameter.

1. Press **E**.  
↳ The message for the remedial measures for the selected diagnostic event opens.
2. Press **- +** simultaneously.  
↳ The message for the remedial measures closes.

## 12.4 Diagnostic information in the web browser

### 12.4.1 Diagnostic options

Any faults detected by the measuring device are displayed in the Web browser on the home page once the user has logged on.



- 1 Status area with status signal
- 2 Diagnostic information
- 3 Remedial measures with service ID

**i** In addition, diagnostic events which have occurred can be shown in the **Diagnostics** menu:

- Via parameter → 179
- Via submenu → 179

### Status signals

The status signals provide information on the state and reliability of the device by categorizing the cause of the diagnostic information (diagnostic event).

| Symbol | Meaning   |
|--------|---|
|        | <b>Failure</b><br>A device error has occurred. The measured value is no longer valid.   |
|        | <b>Function check</b><br>The device is in service mode (e.g. during a simulation).  |
|        | <b>Out of specification</b><br>The device is being operated:<br>Outside its technical specification limits (e.g. outside the process temperature range) |
|        | <b>Maintenance required</b><br>Maintenance is required. The measured value remains valid.   |

**i** The status signals are categorized in accordance with VDI/VDE 2650 and NAMUR Recommendation NE 107.

### 12.4.2 Calling up remedy information

Remedy information is provided for every diagnostic event to ensure that problems can be rectified quickly. These measures are displayed in red along with the diagnostic event and the related diagnostic information.

## 12.5 Diagnostic information in FieldCare or DeviceCare

### 12.5.1 Diagnostic options

Any faults detected by the measuring device are displayed on the home page of the operating tool once the connection has been established.

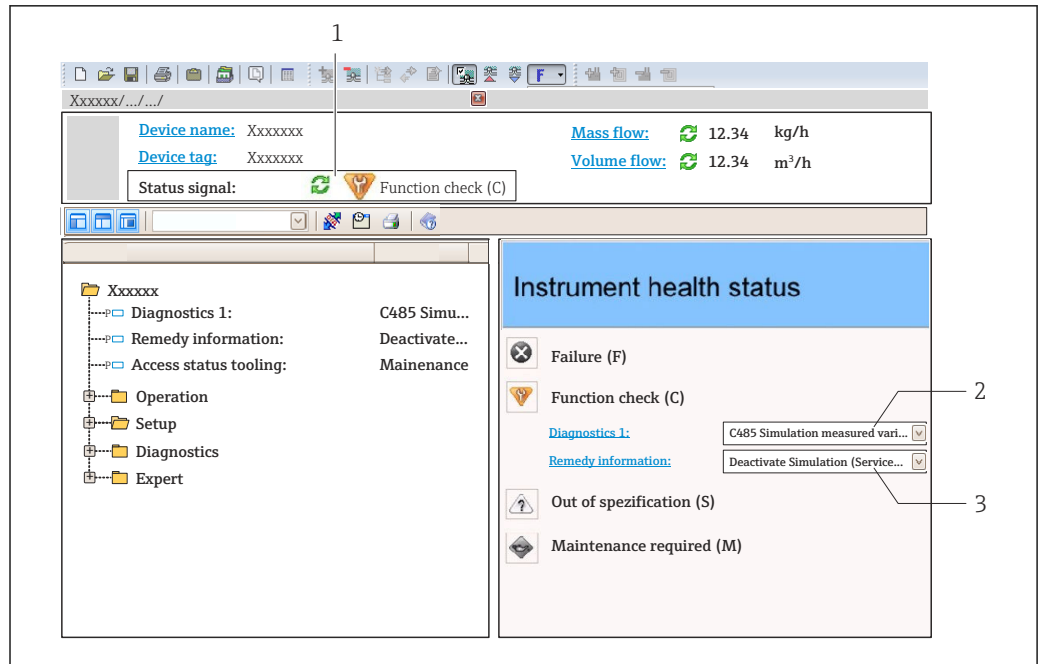

A0021799-EN

- 1 Status area with status signal → 168
- 2 Diagnostic information → 169
- 3 Remedial measures with service ID

**i** In addition, diagnostic events which have occurred can be shown in the **Diagnostics** menu:

- Via parameter → 179
- Via submenu → 179

### Diagnostic information

The fault can be identified using the diagnostic information. The short text helps you by providing information about the fault. In addition, the corresponding symbol for the diagnostic behavior is displayed in front of the diagnostic information on the local display.

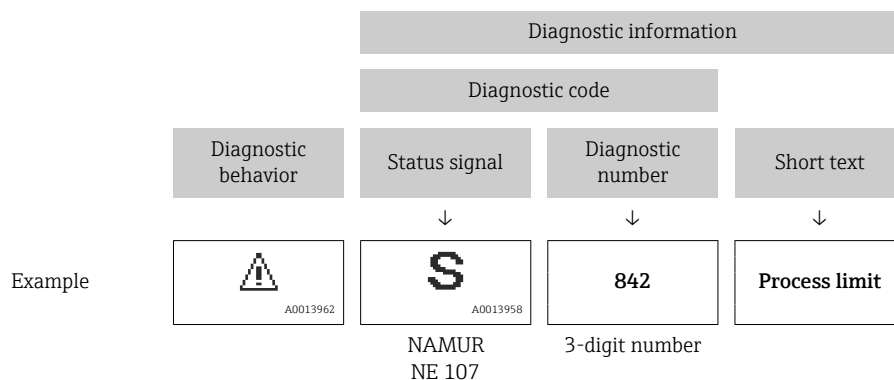

### 12.5.2 Calling up remedy information

Remedy information is provided for every diagnostic event to ensure that problems can be rectified quickly:

- On the home page  
Remedy information is displayed in a separate field below the diagnostics information.
- In the **Diagnostics** menu  
Remedy information can be called up in the working area of the user interface.

The user is in the **Diagnostics** menu.

1. Call up the desired parameter.
2. On the right in the working area, mouse over the parameter.
  - ↳ A tool tip with remedy information for the diagnostic event appears.

## 12.6 Diagnostic information via communication interface

### 12.6.1 Reading out diagnostic information

Diagnostic information can be read out via Modbus RS485 register addresses.

- Via register address **6821** (data type = string): diagnosis code, e.g. F270
- Via register address **6859** (data type = integer): diagnosis number, e.g. 270

 For an overview of diagnostic events with diagnosis number and diagnosis code  
 →  174



### 12.6.2 Configuring error response mode

The error response mode for Modbus RS485 communication can be configured in the **Communication** submenu using 2 parameters.

#### Navigation path

Setup → Communication

*Parameter overview with brief description*

| Parameter    | Description   | Options  | Factory setting |
|--------------|---|--|-----------------|
| Failure mode | Select measured value output behavior when a diagnostic message occurs via Modbus communication.<br><br> The effect of this parameter depends on the option selected in the <b>Assign diagnostic behavior</b> parameter. | <ul style="list-style-type: none"> <li>▪ NaN value</li> <li>▪ Last valid value</li> </ul>  NaN ≙ not a number | NaN value       |

## 12.7 Adapting the diagnostic information

### 12.7.1 Adapting the diagnostic behavior

Each item of diagnostic information is assigned a specific diagnostic behavior at the factory. The user can change this assignment for specific diagnostic information in the **Diagnostic behavior** submenu.

Expert → System → Diagnostic handling → Diagnostic behavior



You can assign the following options to the diagnostic number as the diagnostic behavior:

| Options | Description  |
|---------|--|
| Alarm   | The device stops measurement. The measured value output via Modbus RS485 and the totalizers assume the defined alarm condition. A diagnostic message is generated. The background lighting changes to red. |
| Warning | The device continues to measure. The measured value output via Modbus RS485 and the totalizers are not affected. A diagnostic message is generated.  |

| Options            | Description   |
|--------------------|---|
| Logbook entry only | The device continues to measure. The diagnostic message is only displayed in the <b>Event logbook</b> submenu ( <b>Event list</b> submenu) and is not displayed in alternating sequence with the operational display. |
| Off                | The diagnostic event is ignored, and no diagnostic message is generated or entered.   |

## 12.8 Overview of diagnostic information

 The amount of diagnostic information and the number of measured variables affected increase if the measuring device has one or more application packages.

 In the case of some items of diagnostic information, the diagnostic behavior can be changed. Adapting the diagnostic information →  173

| Diagnostic number           | Short text                           | Remedy instructions  | Status signal [from the factory] | Diagnostic behavior [from the factory] |
|-----------------------------|--------------------------------------|--|----------------------------------|--|
| <b>Diagnostic of sensor</b> |                                      |  |                                  |  |
| 002                         | Sensor unknown                       | 1. Check if the correct sensor is mounted<br>2. Check if the 2-D matrix code on the sensor is undamaged  | F                                | Alarm                                  |
| 022                         | Temperature sensor defective         | 1. If available: Check connection cable between sensor and transmitter<br>2. Check or replace sensor electronic module (ISEM)<br>3. Replace sensor | F                                | Alarm                                  |
| 046                         | Sensor limit exceeded                | 1. Check process conditions<br>2. Check sensor   | S                                | Warning <sup>1)</sup>                  |
| 062                         | Sensor connection faulty             | 1. If available: Check connection cable between sensor and transmitter<br>2. Check or replace sensor electronic module (ISEM)<br>3. Replace sensor | F                                | Alarm                                  |
| 063                         | Exciter current faulty               | 1. If available: Check connection cable between sensor and transmitter<br>2. Check or replace sensor electronic module (ISEM)<br>3. Replace sensor | F                                | Alarm                                  |
| 082                         | Data storage inconsistent            | Check module connections   | F                                | Alarm                                  |
| 083                         | Memory content inconsistent          | 1. Restart device<br>2. Restore S-DAT data<br>3. Replace S-DAT   | F                                | Alarm                                  |
| 119                         | Sensor initialization active         | Sensor initialization in progress, please wait   | C                                | Warning                                |
| 140                         | Sensor signal asymmetrical           | 1. If available: Check connection cable between sensor and transmitter<br>2. Check or replace sensor electronic module (ISEM)<br>3. Replace sensor | S                                | Alarm <sup>1)</sup>                    |
| 141                         | Zero adjustment failed               | 1. Check process conditions<br>2. Repeat commissioning procedure<br>3. Check sensor  | F                                | Alarm                                  |
| 142                         | Sensor index coil asymmetry too high | Check sensor   | S                                | Warning <sup>1)</sup>                  |

| Diagnostic number               | Short text                        | Remedy instructions   | Status signal [from the factory] | Diagnostic behavior [from the factory] |
|---------------------------------|-----------------------------------|---|----------------------------------|--|
| 144                             | Measurement error too high        | 1. Check process conditions<br>2. Check or change sensor  | F                                | Alarm <sup>1)</sup>                    |
| <b>Diagnostic of electronic</b> |                                   |   |                                  |  |
| 201                             | Electronics faulty                | 1. Restart device<br>2. Replace electronics   | F                                | Alarm                                  |
| 242                             | Firmware incompatible             | 1. Check firmware version<br>2. Flash or replace electronic module  | F                                | Alarm                                  |
| 252                             | Module incompatible               | 1. Check electronic modules<br>2. Check if correct modules are available (e.g. NEx, Ex)<br>3. Replace electronic modules                          | F                                | Alarm                                  |
| 262                             | Module connection interrupted     | 1. Check or replace connection cable between sensor electronic module (ISEM) and main electronics<br>2. Check or replace ISEM or main electronics | F                                | Alarm                                  |
| 270                             | Main electronics defective        | 1. Restart device<br>2. Replace main electronic module  | F                                | Alarm                                  |
| 271                             | Main electronics faulty           | 1. Restart device<br>2. Replace main electronic module  | F                                | Alarm                                  |
| 272                             | Main electronics faulty           | Restart device  | F                                | Alarm                                  |
| 273                             | Main electronics defective        | 1. Pay attention to display emergency operation<br>2. Replace main electronics  | F                                | Alarm                                  |
| 275                             | I/O module defective              | Change I/O module   | F                                | Alarm                                  |
| 276                             | I/O module faulty                 | 1. Restart device<br>2. Change I/O module   | F                                | Alarm                                  |
| 283                             | Memory content inconsistent       | Restart device  | F                                | Alarm                                  |
| 302                             | Device verification active        | Device verification active, please wait.  | C                                | Warning <sup>1)</sup>                  |
| 303                             | I/O 1 to n configuration changed  | 1. Apply I/O module configuration (parameter 'Apply I/O configuration')<br>2. Afterwards reload device description and check wiring               | M                                | Warning                                |
| 304                             | Device verification failed        | 1. Check verification report<br>2. Repeat commissioning procedure<br>3. Check sensor  | F                                | Alarm <sup>1)</sup>                    |
| 311                             | Sensor electronics (ISEM) faulty  | Maintenance required!<br>Do not reset device  | M                                | Warning                                |
| 330                             | Flash file invalid                | 1. Update firmware of device<br>2. Restart device   | M                                | Warning                                |
| 331                             | Firmware update failed            | 1. Update firmware of device<br>2. Restart device   | F                                | Warning                                |
| 332                             | Writing in HistoROM backup failed | 1. Replace user interface board<br>2. Ex d/XP: replace transmitter  | F                                | Alarm                                  |
| 361                             | I/O module 1 to n faulty          | 1. Restart device<br>2. Check electronic modules<br>3. Change I/O module or main electronics  | F                                | Alarm                                  |
| 369                             | Matrix code scanner defective     | Replace matrix code scanner   | F                                | Alarm                                  |

| Diagnostic number                  | Short text                             | Remedy instructions   | Status signal [from the factory] | Diagnostic behavior [from the factory] |
|------------------------------------|--|---|----------------------------------|--|
| 371                                | Temperature sensor defective           | Contact service   | M                                | Warning                                |
| 372                                | Sensor electronics (ISEM) faulty       | 1. Restart device<br>2. Check if failure recurs<br>3. Replace sensor electronic module (ISEM)   | F                                | Alarm                                  |
| 373                                | Sensor electronics (ISEM) faulty       | Transfer data or reset device   | F                                | Alarm                                  |
| 374                                | Sensor electronics (ISEM) faulty       | 1. Restart device<br>2. Check if failure recurs<br>3. Replace sensor electronic module (ISEM)   | S                                | Warning <sup>1)</sup>                  |
| 375                                | I/O- 1 to n communication failed       | 1. Restart device<br>2. Check if failure recurs<br>3. Replace module rack inclusive electronic modules  | F                                | Alarm                                  |
| 378                                | Supply voltage ISEM faulty             | 1. If available: Check connection cable between sensor and transmitter<br>2. Replace main electronic module<br>3. Replace sensor electronic module (ISEM) | F                                | Alarm                                  |
| 382                                | Data storage                           | 1. Insert T-DAT<br>2. Replace T-DAT   | F                                | Alarm                                  |
| 383                                | Memory content                         | Reset device  | F                                | Alarm                                  |
| 387                                | HistoROM data faulty                   | Contact service organization  | F                                | Alarm                                  |
| <b>Diagnostic of configuration</b> |  |   |                                  |  |
| 410                                | Data transfer failed                   | 1. Retry data transfer<br>2. Check connection   | F                                | Alarm                                  |
| 412                                | Processing download                    | Download active, please wait  | C                                | Warning                                |
| 431                                | Trim 1 to n required                   | Carry out trim  | M                                | Warning                                |
| 437                                | Configuration incompatible             | 1. Update firmware<br>2. Execute factory reset  | F                                | Alarm                                  |
| 438                                | Dataset different                      | 1. Check dataset file<br>2. Check device parameterization<br>3. Download new device parameterization  | M                                | Warning                                |
| 441                                | Current output 1 to n saturated        | 1. Check current output settings<br>2. Check process  | S                                | Warning <sup>1)</sup>                  |
| 442                                | Frequency output 1 to n saturated      | 1. Check frequency output settings<br>2. Check process  | S                                | Warning <sup>1)</sup>                  |
| 443                                | Pulse output 1 to n saturated          | 1. Check pulse output settings<br>2. Check process  | S                                | Warning <sup>1)</sup>                  |
| 444                                | Current input 1 to n saturated         | 1. Check current input settings<br>2. Check connected device<br>3. Check process  | S                                | Warning <sup>1)</sup>                  |
| 453                                | Flow override active                   | Deactivate flow override  | C                                | Warning                                |
| 484                                | Failure mode simulation active         | Deactivate simulation   | C                                | Alarm                                  |
| 485                                | Process variable simulation active     | Deactivate simulation   | C                                | Warning                                |
| 486                                | Current input 1 to n simulation active | Deactivate simulation   | C                                | Warning                                |



| Diagnostic number            | Short text                                | Remedy instructions   | Status signal [from the factory] | Diagnostic behavior [from the factory] |
|------------------------------|---|---|----------------------------------|--|
| 491                          | Current output 1 to n simulation active   | Deactivate simulation   | C                                | Warning                                |
| 492                          | Frequency output 1 to n simulation active | Deactivate simulation frequency output  | C                                | Warning                                |
| 493                          | Pulse output simulation active            | Deactivate simulation pulse output  | C                                | Warning                                |
| 494                          | Switch output 1 to n simulation active    | Deactivate simulation switch output   | C                                | Warning                                |
| 495                          | Diagnostic event simulation active        | Deactivate simulation   | C                                | Warning                                |
| 496                          | Status input 1 to n simulation active     | Deactivate simulation status input  | C                                | Warning                                |
| 502                          | CT activation/deactivation failed         | Follow the sequence of the custody transfer activation/deactivation: First authorized user login, then set the DIP switch on the main electronic module   | C                                | Warning                                |
| 520                          | I/O 1 to n hardware configuration invalid | 1. Check I/O hardware configuration<br>2. Replace wrong I/O module<br>3. Plug the module of double pulse output on correct slot                           | F                                | Alarm                                  |
| 528                          | Concentration calculation not possible    | Out of valid range of the selected calculation algorithm<br>1. Check concentration settings<br>2. Check measured values, e.g. density or temperature      | S                                | Alarm                                  |
| 529                          | Concentration calculation not accurate    | Out of valid range of the selected calculation algorithm<br>1. Check concentration settings<br>2. Check measured values, e.g. density or temperature      | S                                | Warning                                |
| 537                          | Configuration                             | 1. Check IP addresses in network<br>2. Change IP address  | F                                | Warning                                |
| 540                          | Custody transfer mode failed              | 1. Power off device and toggle DIP switch<br>2. Deactivate custody transfer mode<br>3. Reactivate custody transfer mode<br>4. Check electronic components | F                                | Alarm                                  |
| 543                          | Double pulse output                       | 1. Check process<br>2. Check pulse output settings  | S                                | Warning <sup>1)</sup>                  |
| 593                          | Double pulse output 1 simulation          | Deactivate simulation pulse output  | C                                | Warning                                |
| 594                          | Relay output 1 to n simulation active     | Deactivate simulation switch output   | C                                | Warning                                |
| 599                          | Custody transfer logbook full             | 1. Deactivate custody transfer mode<br>2. Clear custody transfer logbook (all 30 entries)<br>3. Activate custody transfer mode                            | F                                | Warning <sup>1)</sup>                  |
| <b>Diagnostic of process</b> |   |   |                                  |  |
| 803                          | Loop current 1 faulty                     | 1. Check wiring<br>2. Change I/O module   | F                                | Alarm                                  |
| 830                          | Ambient temperature too high              | Reduce ambient temp. around the sensor housing  | S                                | Warning <sup>1)</sup>                  |
| 831                          | Ambient temperature too low               | Increase ambient temp. around the sensor housing  | S                                | Warning <sup>1)</sup>                  |





| Diagnostic number | Short text                              | Remedy instructions  | Status signal [from the factory] | Diagnostic behavior [from the factory] |
|-------------------|---|--|----------------------------------|--|
| 832               | Electronics temperature too high        | Reduce ambient temperature   | S                                | Warning <sup>1)</sup>                  |
| 833               | Electronics temperature too low         | Increase ambient temperature   | S                                | Warning <sup>1)</sup>                  |
| 834               | Process temperature too high            | Reduce process temperature   | S                                | Warning <sup>1)</sup>                  |
| 835               | Process temperature too low             | Increase process temperature   | S                                | Warning <sup>1)</sup>                  |
| 842               | Process value below limit               | Low flow cut off active!<br>Check low flow cut off configuration   | S                                | Warning <sup>1)</sup>                  |
| 862               | Partly filled pipe                      | 1. Check for gas in process<br>2. Adjust detection limits  | S                                | Warning <sup>1)</sup>                  |
| 882               | Input signal faulty                     | 1. Check input signal parameterization<br>2. Check external device<br>3. Check process conditions  | F                                | Alarm                                  |
| 910               | Tubes not oscillating                   | 1. If available: Check connection cable between sensor and transmitter<br>2. Check or replace sensor electronic module (ISEM)<br>3. Check sensor | F                                | Alarm                                  |
| 912               | Medium inhomogeneous                    | 1. Check process cond.<br>2. Increase system pressure  | S                                | Warning <sup>1)</sup>                  |
| 913               | Medium unsuitable                       | 1. Check process conditions<br>2. Check electronic modules or sensor   | S                                | Warning <sup>1)</sup>                  |
| 915               | Viscosity out of specification          | 1. Avoid 2-phase flow<br>2. Increase system pressure<br>3. Verify viscosity and density are within range<br>4. Check process conditions          | S                                | Warning <sup>1)</sup>                  |
| 941               | API/ASTM temperature out of specificat. | 1. Check process temperature with selected API/ASTM commodity group<br>2. Check API/ASTM-related parameters                                      | S                                | Warning <sup>1)</sup>                  |
| 942               | API/ASTM density out of specification   | 1. Check process density with selected API/ASTM commodity group<br>2. Check API/ASTM-related parameters  | S                                | Warning <sup>1)</sup>                  |
| 943               | API pressure out of specification       | 1. Check process pressure with selected API commodity group<br>2. Check API related parameters   | S                                | Warning <sup>1)</sup>                  |
| 944               | Monitoring failed                       | Check process conditions for Heartbeat Monitoring  | S                                | Warning <sup>1)</sup>                  |
| 948               | Oscillation damping too high            | Check process conditions   | S                                | Warning <sup>1)</sup>                  |
| 984               | Condensation risk                       | 1. Decrease ambient temperature<br>2. Increase medium temperature  | S                                | Warning <sup>1)</sup>                  |



1) Diagnostic behavior can be changed.

## 12.9 Pending diagnostic events

The **Diagnostics** menu allows the user to view the current diagnostic event and the previous diagnostic event separately.

 To call up the measures to rectify a diagnostic event:

- Via local display →  170
- Via web browser →  171
- Via "FieldCare" operating tool →  172
- Via "DeviceCare" operating tool →  172

 Other pending diagnostic events can be displayed in the **Diagnostic list** submenu →  179.

### Navigation

"Diagnostics" menu

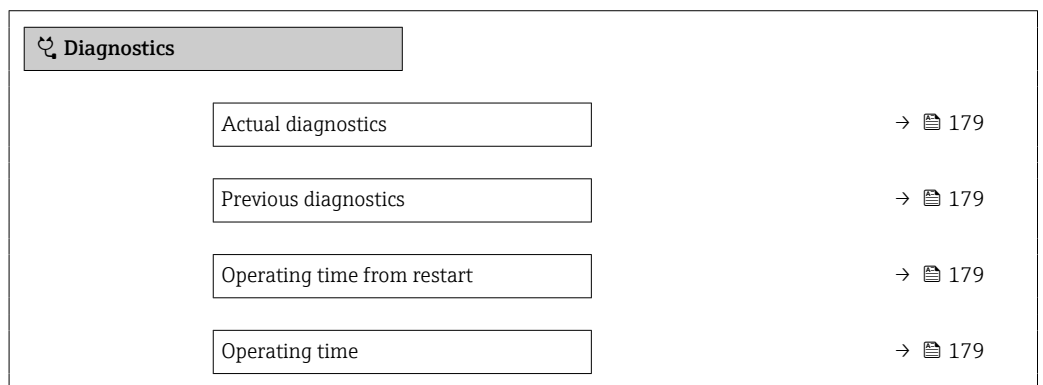

### Parameter overview with brief description

| Parameter                   | Prerequisite                                 | Description  | User interface   |
|-----------------------------|--|--|--|
| Actual diagnostics          | A diagnostic event has occurred.             | Shows the current occurred diagnostic event along with its diagnostic information.<br> If two or more messages occur simultaneously, the message with the highest priority is shown on the display. | Symbol for diagnostic behavior, diagnostic code and short message. |
| Previous diagnostics        | Two diagnostic events have already occurred. | Shows the diagnostic event that occurred prior to the current diagnostic event along with its diagnostic information.  | Symbol for diagnostic behavior, diagnostic code and short message. |
| Operating time from restart | –  | Shows the time the device has been in operation since the last device restart.   | Days (d), hours (h), minutes (m) and seconds (s)                   |
| Operating time              | –  | Indicates how long the device has been in operation.   | Days (d), hours (h), minutes (m) and seconds (s)                   |

## 12.10 Diagnostics list

Up to 5 currently pending diagnostic events can be displayed in the **Diagnostic list** submenu along with the associated diagnostic information. If more than 5 diagnostic events are pending, the events with the highest priority are shown on the display.

### Navigation path

Diagnostics → Diagnostic list

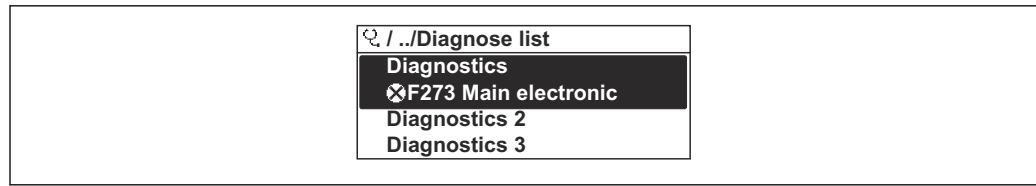

A0014006-EN

32 Using the example of the local display

**i** To call up the measures to rectify a diagnostic event:

- Via local display → 170
- Via web browser → 171
- Via "FieldCare" operating tool → 172
- Via "DeviceCare" operating tool → 172

## 12.11 Event logbook

### 12.11.1 Reading out the event logbook

A chronological overview of the event messages that have occurred is provided in the **Events list** submenu.

#### Navigation path

**Diagnostics** menu → **Event logbook** submenu → Events list

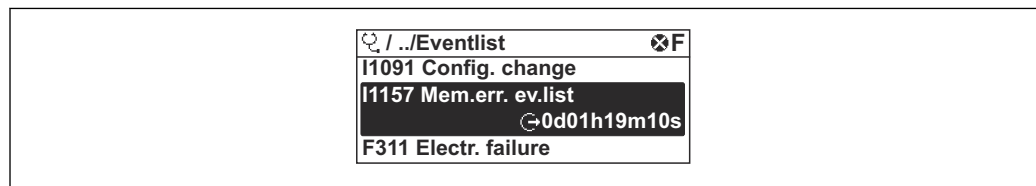

A0014008-EN

33 Using the example of the local display

- A maximum of 20 event messages can be displayed in chronological order.
- If the **Extended HistoROM** application package (order option) is enabled in the device, the event list can contain up to 100 entries.

The event history includes entries for:

- Diagnostic events → 174
- Information events → 181

In addition to the operating time when the event occurred, each event is also assigned a symbol that indicates whether the event has occurred or is finished:

- Diagnostics event
  - ☹: Occurrence of the event
  - ☺: End of the event
- Information event
  - ☹: Occurrence of the event

**i** To call up the measures to rectify a diagnostic event:

- Via local display → 170
- Via web browser → 171
- Via "FieldCare" operating tool → 172
- Via "DeviceCare" operating tool → 172

**i** For filtering the displayed event messages → 181

### 12.11.2 Filtering the event logbook

Using the **Filter options** parameter you can define which category of event message is displayed in the **Events list** submenu.

#### Navigation path

Diagnostics → Event logbook → Filter options

#### Filter categories

- All
- Failure (F)
- Function check (C)
- Out of specification (S)
- Maintenance required (M)
- Information (I)

### 12.11.3 Overview of information events

Unlike a diagnostic event, an information event is displayed in the event logbook only and not in the diagnostic list.

| Info number | Info name                                |
|-------------|--|
| I1000       | ----- (Device ok)                        |
| I1079       | Sensor changed                           |
| I1089       | Power on                                 |
| I1090       | Configuration reset                      |
| I1091       | Configuration changed                    |
| I1092       | HistoROM backup deleted                  |
| I1111       | Density adjust failure                   |
| I11280      | ZeroPT verified and adjustm. recommended |
| I11281      | ZeroPT verif. and adjust. not recommend. |
| I1137       | Electronics changed                      |
| I1151       | History reset                            |
| I1155       | Reset electronics temperature            |
| I1156       | Memory error trend                       |
| I1157       | Memory error event list                  |
| I1209       | Density adjustment ok                    |
| I1221       | Zero point adjust failure                |
| I1222       | Zero point adjustment ok                 |
| I1256       | Display: access status changed           |
| I1278       | I/O module restarted                     |
| I1335       | Firmware changed                         |
| I1361       | Web server: login failed                 |
| I1397       | Fieldbus: access status changed          |
| I1398       | CDI: access status changed               |
| I1444       | Device verification passed               |
| I1445       | Device verification failed               |
| I1447       | Record application reference data        |
| I1448       | Application reference data recorded      |
| I1449       | Recording application ref. data failed   |

| Info number | Info name                                |
|-------------|--|
| I1450       | Monitoring off                           |
| I1451       | Monitoring on                            |
| I1457       | Measurement error verification failed    |
| I1459       | I/O module verification failed           |
| I1460       | HBSI verification failed                 |
| I1461       | Sensor verification failed               |
| I1462       | Sensor electronic module verific. failed |
| I1512       | Download started                         |
| I1513       | Download finished                        |
| I1514       | Upload started                           |
| I1515       | Upload finished                          |
| I1517       | Custody transfer active                  |
| I1518       | Custody transfer inactive                |
| I1618       | I/O module 2 replaced                    |
| I1619       | I/O module 3 replaced                    |
| I1621       | I/O module 4 replaced                    |
| I1622       | Calibration changed                      |
| I1624       | All totalizers reset                     |
| I1625       | Write protection activated               |
| I1626       | Write protection deactivated             |
| I1627       | Web server: login successful             |
| I1628       | Display: login successful                |
| I1629       | CDI: login successful                    |
| I1631       | Web server access changed                |
| I1632       | Display: login failed                    |
| I1633       | CDI: login failed                        |
| I1634       | Reset to factory settings                |
| I1635       | Reset to delivery settings               |
| I1639       | Max. switch cycles number reached        |
| I1643       | Custody transfer logbook cleared         |
| I1649       | Hardware write protection activated      |
| I1650       | Hardware write protection deactivated    |
| I1651       | Custody transfer parameter changed       |
| I1712       | New flash file received                  |
| I1725       | Sensor electronic module (ISEM) changed  |
| I1726       | Configuration backup failed              |

## 12.12 Resetting the measuring device

The entire device configuration or some of the configuration can be reset to a defined state with the **Device reset** parameter (→  135).

### 12.12.1 Function range of "Device reset" parameter

| Options              | Description   |
|----------------------|---|
| Cancel               | No action is executed and the user exits the parameter.   |
| To delivery settings | Every parameter for which a customer-specific default setting was ordered is reset to the customer-specific value. All other parameters are reset to the factory setting.   |
| Restart device       | The restart resets every parameter with data stored in volatile memory (RAM) to the factory setting (e.g. measured value data). The device configuration remains unchanged.   |
| Restore S-DAT backup | Restores the data that is saved on the S-DAT. Additional information: This function can be used to resolve the memory issue "083 Memory content inconsistent" or to restore the S-DAT data when a new S-DAT has been installed.<br> This option is displayed only in an alarm condition. |

### 12.13 Device information





The **Device information** submenu contains all parameters that display different information for device identification.

#### Navigation

"Diagnostics" menu → Device information

| ► Device information  |         |
|-----------------------|---------|
| Device tag            | → ⓘ 184 |
| Serial number         | → ⓘ 184 |
| Firmware version      | → ⓘ 184 |
| Device name           | → ⓘ 184 |
| Manufacturer          |         |
| Order code            | → ⓘ 184 |
| Extended order code 1 | → ⓘ 184 |
| Extended order code 2 | → ⓘ 184 |
| Extended order code 3 | → ⓘ 184 |
| ENP version           | → ⓘ 184 |

## Parameter overview with brief description



| Parameter             | Description  | User interface  | Factory setting |
|-----------------------|--|---|-----------------|
| Device tag            | Shows name of measuring point.   | Max. 32 characters, such as letters, numbers or special characters (e.g. @, %, /).    | Promass         |
| Serial number         | Shows the serial number of the measuring device.   | Max. 11-digit character string comprising letters and numbers.                        | –               |
| Firmware version      | Shows the device firmware version installed.   | Character string in the format xx.yy.zz   | –               |
| Device name           | Shows the name of the transmitter.<br> The name can be found on the nameplate of the transmitter.   | Promass 300/500   | –               |
| Order code            | Shows the device order code.<br> The order code can be found on the nameplate of the sensor and transmitter in the "Order code" field.                                      | Character string composed of letters, numbers and certain punctuation marks (e.g. /). | –               |
| Extended order code 1 | Shows the 1st part of the extended order code.<br> The extended order code can also be found on the nameplate of the sensor and transmitter in the "Ext. ord. cd." field.   | Character string  | –               |
| Extended order code 2 | Shows the 2nd part of the extended order code.<br> The extended order code can also be found on the nameplate of the sensor and transmitter in the "Ext. ord. cd." field. | Character string  | –               |
| Extended order code 3 | Shows the 3rd part of the extended order code.<br> The extended order code can also be found on the nameplate of the sensor and transmitter in the "Ext. ord. cd." field. | Character string  | –               |
| ENP version           | Shows the version of the electronic nameplate (ENP).   | Character string  | 2.02.00         |



## 12.14 Firmware history

| Release date | Firmware version | Order code for "Firmware version" | Firmware Changes   | Documentation type     | Documentation        |
|--------------|------------------|-----------------------------------|--|------------------------|----------------------|
| 08.2022      | 01.06.zz         | Option 58                         | <ul style="list-style-type: none"> <li>▪ New gas type: methane with hydrogen</li> <li>▪ Eight display values on local display</li> <li>▪ Zero point verification and zero adjustment wizard</li> <li>▪ New density unit: °API</li> <li>▪ New diagnostic parameters</li> <li>▪ Additional languages for Heartbeat Technology Reports</li> </ul> | Operating Instructions | BA01499D/06/EN/06.22 |
| 09.2019      | 01.05.zz         | Option 64                         | <ul style="list-style-type: none"> <li>▪ Gas fraction handler Adaptive filter, gas entrainment index</li> <li>▪ Application-specific input module</li> <li>▪ Upgrading of the petroleum application package</li> </ul>   | Operating Instructions | BA01499D/06/EN/04.19 |
| 10.2018      | 01.02.zz         | Option 65                         | <ul style="list-style-type: none"> <li>▪ Integration of "StdBarrelOil" and "MillionStdCubicFeetPerDay" units</li> <li>▪ Modification of the functionality in the "Weighted Averages" Flow Block: <ul style="list-style-type: none"> <li>▪ Weighted density average</li> <li>▪ Weighted temperature average</li> </ul> </li> </ul>              | Operating Instructions | BA01499D/06/EN/03.18 |

| Release date | Firmware version | Order code for "Firmware version" | Firmware Changes  | Documentation type     | Documentation        |
|--------------|------------------|-----------------------------------|---|------------------------|----------------------|
| 10.2017      | 01.01.zz         | Option <b>70</b>                  | <ul style="list-style-type: none"> <li>▪ Petroleum new</li> <li>▪ Concentration update</li> <li>▪ Local display - enhanced performance and data entry via text editor</li> <li>▪ Optimized keypad lock for local display</li> <li>▪ Improvements and enhancements with regard to custody transfer measurement</li> <li>▪ Web server feature update <ul style="list-style-type: none"> <li>▪ Support for trend data function</li> <li>▪ Heartbeat function enhanced to include detailed results (page 3/4 of the report)</li> </ul> </li> <li>▪ Device configuration as PDF (parameter log, similar to FDT print)</li> <li>▪ Network capability of Ethernet (service) interface</li> <li>▪ Comprehensive Heartbeat feature update</li> <li>▪ Local display - support for WLAN infrastructure mode</li> <li>▪ Implementation of reset code</li> </ul> | Operating Instructions | BA01499D/06/EN/02.17 |
| 08.2016      | 01.00.zz         | Option <b>76</b>                  | Original firmware   | Operating Instructions | BA01499D/06/EN/01.16 |

 It is possible to flash the firmware to the current version or the previous version using the service interface. For the compatibility of the firmware version, see the "Device history and compatibility" section →  187

 For the compatibility of the firmware version with the previous version, the installed device description files and operating tools, observe the information about the device in the "Manufacturer's information" document.



The manufacturer's information is available:

- In the Download Area of the Endress+Hauser web site: [www.endress.com](http://www.endress.com) → Downloads
- Specify the following details:
  - Product root: e.g. 803B  
The product root is the first part of the order code: see the nameplate on the device.
  - Text search: Manufacturer's information
  - Media type: Documentation – Technical Documentation

## 12.15 Device history and compatibility

The device model is documented in the order code on the nameplate of the device (e.g. 8F3BXX-XXX...XXA1-XXXXXX).

| Device model | Release | Change compared with earlier model  | Compatibility with earlier model |
|--------------|---------|---|----------------------------------|
| A2           | 09.2019 | I/O module with enhanced performance and functionality: see device firmware 01.05.zz →  185 | No                               |
| A1           | 08.2016 | -   | -                                |

## 13 Maintenance

### 13.1 Maintenance work

No special maintenance work is required.

#### 13.1.1 Exterior cleaning

When cleaning the exterior of measuring devices, always use cleaning agents that do not attack the surface of the housing or the seals.

### 13.2 Measuring and test equipment

Endress+Hauser offers a variety of measuring and testing equipment, such as Netilion or device tests.

 Your Endress+Hauser Sales Center can provide detailed information on the services.

List of some of the measuring and testing equipment: →  192

### 13.3 Endress+Hauser services

Endress+Hauser offers a wide variety of services for maintenance such as recalibration, maintenance service or device tests.

 Your Endress+Hauser Sales Center can provide detailed information on the services.

## 14 Repair

### 14.1 General notes

#### 14.1.1 Repair and conversion concept

The Endress+Hauser repair and conversion concept provides for the following:

- The measuring devices have a modular design.
- Spare parts are grouped into logical kits with the associated Installation Instructions.
- Repairs are carried out by Endress+Hauser Service or by appropriately trained customers.
- Certified devices can only be converted to other certified devices by Endress+Hauser Service or at the factory.

#### 14.1.2 Notes for repair and conversion

For repair and conversion of a measuring device, observe the following notes:

- ▶ Use only original Endress+Hauser spare parts.
- ▶ Carry out the repair according to the Installation Instructions.
- ▶ Observe the applicable standards, federal/national regulations, Ex documentation (XA) and certificates.
- ▶ Document all repairs and conversions and enter the details in Netilion Analytics.

### 14.2 Spare parts

*Device Viewer* ([www.endress.com/deviceviewer](http://www.endress.com/deviceviewer)):

All the spare parts for the measuring device, along with the order code, are listed here and can be ordered. If available, users can also download the associated Installation Instructions.



Measuring device serial number:

- Is located on the nameplate of the device.
- Can be read out via the **Serial number** parameter (→ 184) in the **Device information** submenu.

### 14.3 Endress+Hauser services

Endress+Hauser offers a wide range of services.



Your Endress+Hauser Sales Center can provide detailed information on the services.

### 14.4 Return

The requirements for safe device return can vary depending on the device type and national legislation.

1. Refer to the web page for information:  
<https://www.endress.com/support/return-material>  
↳ Select the region.
2. If returning the device, pack the device in such a way that it is reliably protected against impact and external influences. The original packaging offers the best protection.

## 14.5 Disposal

 If required by the Directive 2012/19/EU on waste electrical and electronic equipment (WEEE), the product is marked with the depicted symbol in order to minimize the disposal of WEEE as unsorted municipal waste. Do not dispose of products bearing this marking as unsorted municipal waste. Instead, return them to the manufacturer for disposal under the applicable conditions.

### 14.5.1 Removing the measuring device

1. Switch off the device.

#### WARNING

##### **Danger to persons from process conditions!**

- ▶ Beware of hazardous process conditions such as pressure in the measuring device, high temperatures or aggressive media.

2. Carry out the mounting and connection steps from the "Mounting the measuring device" and "Connecting the measuring device" sections in reverse order. Observe the safety instructions.

### 14.5.2 Disposing of the measuring device

#### WARNING

##### **Danger to personnel and environment from fluids that are hazardous to health.**

- ▶ Ensure that the measuring device and all cavities are free of fluid residues that are hazardous to health or the environment, e.g. substances that have permeated into crevices or diffused through plastic.

Observe the following notes during disposal:











- ▶ Observe valid federal/national regulations.
- ▶ Ensure proper separation and reuse of the device components.

## 15 Accessories



Various accessories, which can be ordered with the device or subsequently from Endress+Hauser, are available for the device. Detailed information on the order code in question is available from your local Endress+Hauser sales center or on the product page of the Endress+Hauser website: [www.endress.com](http://www.endress.com).

### 15.1 Device-specific accessories



#### 15.1.1 For the transmitter

| Accessories                                | Description  |
|--|--|
| Proline 300 transmitter                    | <p>Transmitter for replacement or storage. Use the order code to define the following specifications:</p> <ul style="list-style-type: none"> <li>▪ Approvals</li> <li>▪ Output</li> <li>▪ Input</li> <li>▪ Display/operation</li> <li>▪ Housing</li> <li>▪ Software</li> </ul> <p> Order code: 8X3BXX</p> <p> Installation Instructions EA01200D</p>   |
| Remote display and operating module DKX001 | <ul style="list-style-type: none"> <li>▪ If ordered directly with the measuring device:<br/>Order code for "Display; operation", option O "Remote display 4-line, illuminated; 10 m (30 ft) cable; touch control"</li> <li>▪ If ordered separately: <ul style="list-style-type: none"> <li>▪ Measuring device: order code for "Display; operation", option M "W/o, prepared for remote display"</li> <li>▪ DKX001: Via the separate product structure DKX001</li> </ul> </li> <li>▪ If ordered subsequently:<br/>DKX001: Via the separate product structure DKX001</li> </ul> <p><b>Mounting bracket for DKX001</b></p> <ul style="list-style-type: none"> <li>▪ If ordered directly: order code for "Accessory enclosed", option RA "Mounting bracket, pipe 1/2"</li> <li>▪ If ordered subsequently: order number: 71340960</li> </ul> <p><b>Connecting cable (replacement cable)</b><br/>Via the separate product structure: DKX002</p> <p> Further information on display and operating module DKX001 →  214.</p> <p> Special Documentation SD01763D</p> |
| External WLAN antenna                      | <p>External WLAN antenna with 1.5 m (59.1 in) connecting cable and two angle brackets. Order code for "Accessory enclosed", option P8 "Wireless antenna wide area".</p> <p> <ul style="list-style-type: none"> <li>▪ The external WLAN antenna is not suitable for use in hygienic applications.</li> <li>▪ Additional information regarding the WLAN interface →  68.</li> </ul></p> <p> Order number: 71351317</p> <p> Installation Instructions EA01238D</p>  |
| Weather protection cover                   | <p>Is used to protect the measuring device from the effects of the weather: e.g. rainwater, excess heating from direct sunlight.</p> <p> Order number: 71343505</p> <p> Installation Instructions EA01160D</p>   |



### 15.1.2 For the sensor

| Accessories    | Description   |
|----------------|---|
| Heating jacket | <p>Is used to stabilize the temperature of the fluids in the sensor. Water, water vapor and other non-corrosive liquids are permitted for use as fluids.</p> <p> If using oil as a heating medium, please consult with Endress+Hauser.</p> <p> Special Documentation SD02159D</p> |



## 15.2 Service-specific accessories

| Accessories | Description   |
|-------------|---|
| Applicator  | <p>Software for selecting and sizing Endress+Hauser measuring instruments:</p> <ul style="list-style-type: none"> <li>▪ Choice of measuring instruments for industrial requirements</li> <li>▪ Calculation of all the necessary data for identifying the optimum flowmeter: e.g. nominal diameter, pressure loss, flow velocity and measurement accuracy.</li> <li>▪ Graphic display of the calculation results</li> <li>▪ Determination of the partial order code, administration, documentation and access to all project-related data and parameters over the entire life cycle of a project.</li> </ul> <p>Applicator is available:<br/>Via the Internet: <a href="https://portal.endress.com/webapp/applicator">https://portal.endress.com/webapp/applicator</a></p> |
| Netilion    | <p>IIoT ecosystem: Unlock knowledge</p> <p>With the Netilion IIoT ecosystem, Endress+Hauser allows you to optimize your plant performance, digitize workflows, share knowledge, and enhance collaboration.</p> <p>Drawing upon decades of experience in process automation, Endress+Hauser offers the process industry an IIoT ecosystem designed to effortlessly extract insights from data. These insights allow process optimization, leading to increased plant availability, efficiency, and reliability - ultimately resulting in a more profitable plant.</p> <p><a href="http://www.netilion.endress.com">www.netilion.endress.com</a></p>  |
| FieldCare   | <p>FDT-based plant asset management tool from Endress+Hauser. It can configure all intelligent field units in your system and helps you manage them. By using the status information, it is also a simple but effective way of checking their status and condition.</p> <p> Operating Instructions BA00027S and BA00059S</p>   |
| DeviceCare  | <p>Tool to connect and configure Endress+Hauser field devices.</p> <p> Innovation brochure IN01047S</p>  |

## 15.3 System components

| Accessories                      | Description  |
|----------------------------------|--|
| Memograph M graphic data manager | <p>The Memograph M graphic data manager provides information on all the relevant measured variables. Measured values are recorded correctly, limit values are monitored and measuring points analyzed. The data are stored in the 256 MB internal memory and also on a SD card or USB stick.</p> <p> <ul style="list-style-type: none"> <li>▪ Technical Information TI00133R</li> <li>▪ Operating Instructions BA00247R</li> </ul> </p> |
| Cerabar M                        | <p>The pressure transmitter for measuring the absolute and gauge pressure of gases, steam and liquids. It can be used to read in the operating pressure value.</p> <p> <ul style="list-style-type: none"> <li>▪ Technical Information TI00426P and TI00436P</li> <li>▪ Operating Instructions BA00200P and BA00382P</li> </ul> </p>   |



| Accessories | Description  |
|-------------|--|
| Cerabar S   | <p>The pressure transmitter for measuring the absolute and gauge pressure of gases, steam and liquids. It can be used to read in the operating pressure value.</p> <p> <ul style="list-style-type: none"><li>▪ Technical Information TI00383P</li><li>▪ Operating Instructions BA00271P</li></ul></p> |
| iTEMP       | <p>The temperature transmitters can be used in all applications and are suitable for the measurement of gases, steam and liquids. They can be used to read in the medium temperature.</p> <p> "Fields of Activity" document FA00006T</p>  |

## 16 Technical data

### 16.1 Application

The measuring device is intended only for the flow measurement of liquids and gases.

Depending on the version ordered, the measuring device can also measure potentially explosive, flammable, poisonous and oxidizing media.

To ensure that the device remains in proper operating condition for its service life, use the measuring device only for media against which the process-wetted materials are sufficiently resistant.

### 16.2 Function and system design

---

|                     |  |
|---------------------|--|
| Measuring principle | Mass flow measurement based on the Coriolis measuring principle  |
| Measuring system    | <p>The device consists of a transmitter and a sensor.</p> <p>The device is available as a compact version:<br/>The transmitter and sensor form a mechanical unit.</p> <p>For information on the structure of the measuring instrument →  14</p> |

---

## 16.3 Input

Measured variable

### Direct measured variables

- Mass flow
- Density
- Temperature

### Calculated measured variables

- Volume flow
- Corrected volume flow
- Reference density

Measuring range

### Measuring range for liquids

| DN   |      | Measuring range full scale values $\dot{m}_{\min(F)}$ to $\dot{m}_{\max(F)}$ |             |
|------|------|--|-------------|
| [mm] | [in] | [kg/h]   | [lb/min]    |
| 80   | 3    | 0 to 180 000   | 0 to 6 615  |
| 100  | 4    | 0 to 350 000   | 0 to 12 860 |
| 150  | 6    | 0 to 800 000   | 0 to 29 400 |
| 250  | 10   | 0 to 2 200 000   | 0 to 80 850 |



### Measuring range for gases

The full scale value depends on the density and the sound velocity of the gas used. The full scale value can be calculated with the following formulas:

$$\dot{m}_{\max(G)} = (\rho_G \cdot (c_G/m) \cdot d_i^2 \cdot (\pi/4) \cdot 3600 \cdot n)$$

|                     |   |
|---------------------|---|
| $\dot{m}_{\max(G)}$ | Maximum full scale value for gas [kg/h]                     |
| $\rho_G$            | Gas density in [kg/m <sup>3</sup> ] at operating conditions |
| $c_G$               | Sound velocity (gas) [m/s]                                  |
| $d_i$               | Measuring tube internal diameter [m]                        |
| $\pi$               | Pi  |
| $n = 2$             | Number of measuring tubes                                   |
| $m = 2$             | For all gases except pure H <sub>2</sub> and He gas         |
| $m = 3$             | For pure H <sub>2</sub> and He gas                          |

### Recommended measuring range

 Flow limit →  210

Operable flow range

Over 1000 : 1.



Flow rates above the preset full scale value do not override the electronics unit, with the result that the totalizer values are registered correctly.

Input signal

**External measured values**

To increase the measurement accuracy of certain measured variables or to calculate the corrected volume flow for gases, the automation system can continuously write different measured values to the measuring instrument:

- Operating pressure to increase measurement accuracy (Endress+Hauser recommends the use of a pressure measuring device for absolute pressure, e.g. Cerabar M or Cerabar S)
- Medium temperature to increase measurement accuracy (e.g. iTEMP)
- Reference density for calculating the corrected volume flow for gases

 Various pressure and temperature measuring devices can be ordered from Endress +Hauser: see "Accessories" section →  192

It is recommended to read in external measured values to calculate the corrected volume flow.

*Current input*

The measured values are written from the automation system to the measuring device via the current input →  196.

*Digital communication*

The measured values are written by the automation system via Modbus RS485.

**Current input 0/4 to 20 mA**

|                                 |   |
|---------------------------------|---|
| <b>Current input</b>            | 0/4 to 20 mA (active/passive)   |
| <b>Current span</b>             | <ul style="list-style-type: none"> <li>▪ 4 to 20 mA (active)</li> <li>▪ 0/4 to 20 mA (passive)</li> </ul> |
| <b>Resolution</b>               | 1 µA  |
| <b>Voltage drop</b>             | Typically: 0.6 to 2 V for 3.6 to 22 mA (passive)  |
| <b>Maximum input voltage</b>    | ≤ 30 V (passive)  |
| <b>Open-circuit voltage</b>     | ≤ 28.8 V (active)   |
| <b>Possible input variables</b> | <ul style="list-style-type: none"> <li>▪ Pressure</li> <li>▪ Temperature</li> <li>▪ Density</li> </ul>    |

**Status input**

|                             |  |
|-----------------------------|--|
| <b>Maximum input values</b> | <ul style="list-style-type: none"> <li>▪ DC -3 to 30 V</li> <li>▪ If status input is active (ON): <math>R_i &gt; 3 \text{ k}\Omega</math></li> </ul>                   |
| <b>Response time</b>        | Configurable: 5 to 200 ms  |
| <b>Input signal level</b>   | <ul style="list-style-type: none"> <li>▪ Low signal: DC -3 to +5 V</li> <li>▪ High signal: DC 12 to 30 V</li> </ul>  |
| <b>Assignable functions</b> | <ul style="list-style-type: none"> <li>▪ Off</li> <li>▪ Reset the individual totalizers separately</li> <li>▪ Reset all totalizers</li> <li>▪ Flow override</li> </ul> |

## 16.4 Output

Output signal

### Modbus RS485



|                      |   |
|----------------------|---|
| Physical interface   | RS485 in accordance with EIA/TIA-485 standard |
| Terminating resistor | Integrated, can be activated via DIP switches |

### Current output 4 to 20 mA

|                               |  |
|-------------------------------|--|
| Signal mode                   | Can be set to: <ul style="list-style-type: none"> <li>▪ Active</li> <li>▪ Passive</li> </ul>   |
| Current range                 | Can be set to: <ul style="list-style-type: none"> <li>▪ 4 to 20 mA NAMUR</li> <li>▪ 4 to 20 mA US</li> <li>▪ 4 to 20 mA</li> <li>▪ 0 to 20 mA (only if the signal mode is active)</li> <li>▪ Fixed current</li> </ul>  |
| Maximum output values         | 22.5 mA  |
| Open-circuit voltage          | DC 28.8 V (active)   |
| Maximum input voltage         | DC 30 V (passive)  |
| Load                          | 0 to 700 $\Omega$  |
| Resolution                    | 0.38 $\mu$ A   |
| Damping                       | Configurable: 0 to 999.9 s   |
| Assignable measured variables | <ul style="list-style-type: none"> <li>▪ Mass flow</li> <li>▪ Volume flow</li> <li>▪ Corrected volume flow</li> <li>▪ Density</li> <li>▪ Reference density</li> <li>▪ Temperature</li> <li>▪ Electronics temperature</li> <li>▪ Oscillation frequency 0</li> <li>▪ Oscillation damping 0</li> <li>▪ Signal asymmetry</li> <li>▪ Exciter current 0</li> </ul> <p> The range of options increases if the measuring device has one or more application packages.</p> |

### Pulse/frequency/switch output

|                      |  |
|----------------------|--|
| Function             | Can be configured as pulse, frequency or switch output   |
| Version              | Open collector<br>Can be set to: <ul style="list-style-type: none"> <li>▪ Active</li> <li>▪ Passive</li> <li>▪ Passive NAMUR</li> </ul> <p> Ex-i, passive</p> |
| Maximum input values | DC 30 V, 250 mA (passive)  |
| Open-circuit voltage | DC 28.8 V (active)   |
| Voltage drop         | For 22.5 mA: $\leq$ DC 2 V   |
| <b>Pulse output</b>  |  |
| Maximum input values | DC 30 V, 250 mA (passive)  |

|                                      |  |
|--------------------------------------|--|
| <b>Maximum output current</b>        | 22.5 mA (active)   |
| <b>Open-circuit voltage</b>          | DC 28.8 V (active)   |
| <b>Pulse width</b>                   | Configurable: 0.05 to 2 000 ms   |
| <b>Maximum pulse rate</b>            | 10 000 Impulse/s   |
| <b>Pulse value</b>                   | Configurable   |
| <b>Assignable measured variables</b> | <ul style="list-style-type: none"> <li>▪ Mass flow</li> <li>▪ Volume flow</li> <li>▪ Corrected volume flow</li> </ul> <p> The range of options increases if the measuring device has one or more application packages.</p>  |
| <b>Frequency output</b>              |  |
| <b>Maximum input values</b>          | DC 30 V, 250 mA (passive)  |
| <b>Maximum output current</b>        | 22.5 mA (active)   |
| <b>Open-circuit voltage</b>          | DC 28.8 V (active)   |
| <b>Output frequency</b>              | Configurable: end value frequency 2 to 10 000 Hz ( $f_{max} = 12\,500$ Hz)   |
| <b>Damping</b>                       | Configurable: 0 to 999.9 s   |
| <b>Pulse/pause ratio</b>             | 1:1  |
| <b>Assignable measured variables</b> | <ul style="list-style-type: none"> <li>▪ Mass flow</li> <li>▪ Volume flow</li> <li>▪ Corrected volume flow</li> <li>▪ Density</li> <li>▪ Reference density</li> <li>▪ Temperature</li> <li>▪ Electronics temperature</li> <li>▪ Oscillation frequency 0</li> <li>▪ Oscillation damping 0</li> <li>▪ Signal asymmetry</li> <li>▪ Exciter current 0</li> </ul> <p> The range of options increases if the measuring device has one or more application packages.</p>   |
| <b>Switch output</b>                 |  |
| <b>Maximum input values</b>          | DC 30 V, 250 mA (passive)  |
| <b>Open-circuit voltage</b>          | DC 28.8 V (active)   |
| <b>Switching behavior</b>            | Binary, conductive or non-conductive   |
| <b>Switching delay</b>               | Configurable: 0 to 100 s   |
| <b>Number of switching cycles</b>    | Unlimited  |
| <b>Assignable functions</b>          | <ul style="list-style-type: none"> <li>▪ Disable</li> <li>▪ On</li> <li>▪ Diagnostic behavior</li> <li>▪ Limit                             <ul style="list-style-type: none"> <li>▪ Mass flow</li> <li>▪ Volume flow</li> <li>▪ Corrected volume flow</li> <li>▪ Density</li> <li>▪ Reference density</li> <li>▪ Temperature</li> <li>▪ Totalizer 1-3</li> </ul> </li> <li>▪ Flow direction monitoring</li> <li>▪ Status                             <ul style="list-style-type: none"> <li>▪ Partially filled pipe detection</li> <li>▪ Low flow cut off</li> </ul> </li> </ul> <p> The range of options increases if the measuring device has one or more application packages.</p> |

### Double pulse output

|                                      |  |
|--------------------------------------|--|
| <b>Function</b>                      | Double pulse   |
| <b>Version</b>                       | Open collector<br>Can be set to: <ul style="list-style-type: none"> <li>▪ Active</li> <li>▪ Passive</li> <li>▪ Passive NAMUR</li> </ul>  |
| <b>Maximum input values</b>          | DC 30 V, 250 mA (passive)  |
| <b>Open-circuit voltage</b>          | DC 28.8 V (active)   |
| <b>Voltage drop</b>                  | For 22.5 mA: ≤ DC 2 V  |
| <b>Output frequency</b>              | Configurable: 0 to 1000 Hz   |
| <b>Damping</b>                       | Configurable: 0 to 999 s   |
| <b>Pulse/pause ratio</b>             | 1:1  |
| <b>Assignable measured variables</b> | <ul style="list-style-type: none"> <li>▪ Mass flow</li> <li>▪ Volume flow</li> <li>▪ Corrected volume flow</li> <li>▪ Density</li> <li>▪ Reference density</li> <li>▪ Temperature</li> </ul> <p> The range of options increases if the measuring device has one or more application packages.</p> |

### Relay output

|   |  |
|---|--|
| <b>Function</b>                             | Switch output  |
| <b>Version</b>                              | Relay output, galvanically isolated  |
| <b>Switching behavior</b>                   | Can be set to: <ul style="list-style-type: none"> <li>▪ NO (normally open), factory setting</li> <li>▪ NC (normally closed)</li> </ul>   |
| <b>Maximum switching capacity (passive)</b> | <ul style="list-style-type: none"> <li>▪ DC 30 V, 0.1 A</li> <li>▪ AC 30 V, 0.5 A</li> </ul>   |
| <b>Assignable functions</b>                 | <ul style="list-style-type: none"> <li>▪ Disable</li> <li>▪ On</li> <li>▪ Diagnostic behavior</li> <li>▪ Limit <ul style="list-style-type: none"> <li>▪ Mass flow</li> <li>▪ Volume flow</li> <li>▪ Corrected volume flow</li> <li>▪ Density</li> <li>▪ Reference density</li> <li>▪ Temperature</li> <li>▪ Totalizer 1-3</li> </ul> </li> <li>▪ Flow direction monitoring</li> <li>▪ Status <ul style="list-style-type: none"> <li>▪ Partially filled pipe detection</li> <li>▪ Low flow cut off</li> </ul> </li> </ul> <p> The range of options increases if the measuring device has one or more application packages.</p> |

### User-configurable input/output

**One** specific input or output is assigned to a user-configurable input/output (configurable I/O) during device commissioning.

The following inputs and outputs are available for assignment:

- Choice of current output: 4 to 20 mA (active), 0/4 to 20 mA (passive)
- Pulse/frequency/switch output
- Choice of current input: 4 to 20 mA (active), 0/4 to 20 mA (passive)
- Status input

Signal on alarm

Depending on the interface, failure information is displayed as follows:

**Modbus RS485**

|                     |   |
|---------------------|---|
| <b>Failure mode</b> | Choose from: <ul style="list-style-type: none"> <li>■ NaN value instead of current value</li> <li>■ Last valid value</li> </ul> |
|---------------------|---|

**Current output 0/4 to 20 mA**

*4 to 20 mA*

|                     |   |
|---------------------|---|
| <b>Failure mode</b> | Choose from: <ul style="list-style-type: none"> <li>■ 4 to 20 mA in accordance with NAMUR recommendation NE 43</li> <li>■ 4 to 20 mA in accordance with US</li> <li>■ Min. value: 3.59 mA</li> <li>■ Max. value: 22.5 mA</li> <li>■ Definable value between: 3.59 to 22.5 mA</li> <li>■ Actual value</li> <li>■ Last valid value</li> </ul> |
|---------------------|---|

*0 to 20 mA*

|                     |  |
|---------------------|--|
| <b>Failure mode</b> | Choose from: <ul style="list-style-type: none"> <li>■ Maximum alarm: 22 mA</li> <li>■ Definable value between: 0 to 20.5 mA</li> </ul> |
|---------------------|--|

**Pulse/frequency/switch output**

|                         |  |
|-------------------------|--|
| <b>Pulse output</b>     |  |
| <b>Fault mode</b>       | Choose from: <ul style="list-style-type: none"> <li>■ Actual value</li> <li>■ No pulses</li> </ul>   |
| <b>Frequency output</b> |  |
| <b>Fault mode</b>       | Choose from: <ul style="list-style-type: none"> <li>■ Actual value</li> <li>■ 0 Hz</li> <li>■ Definable value between: 2 to 12 500 Hz</li> </ul> |
| <b>Switch output</b>    |  |
| <b>Fault mode</b>       | Choose from: <ul style="list-style-type: none"> <li>■ Current status</li> <li>■ Open</li> <li>■ Closed</li> </ul>                                |

**Relay output**

|                     |   |
|---------------------|---|
| <b>Failure mode</b> | Choose from: <ul style="list-style-type: none"> <li>■ Current status</li> <li>■ Open</li> <li>■ Closed</li> </ul> |
|---------------------|---|



**Local display**

|                           |   |
|---------------------------|---|
| <b>Plain text display</b> | With information on cause and remedial measures |
| <b>Backlight</b>          | Red lighting indicates a device error.          |

 Status signal as per NAMUR recommendation NE 107

**Interface/protocol**



- Via digital communication:  
Modbus RS485
- Via service interface
  - CDI-RJ45 service interface
  - WLAN interface

|                           |   |
|---------------------------|---|
| <b>Plain text display</b> | With information on cause and remedial measures |
|---------------------------|---|

**Web browser**

|                           |   |
|---------------------------|---|
| <b>Plain text display</b> | With information on cause and remedial measures |
|---------------------------|---|

**Light emitting diodes (LED)**

|                           |  |
|---------------------------|--|
| <b>Status information</b> | Status indicated by various light emitting diodes<br><br>The following information is displayed depending on the device version: <ul style="list-style-type: none"> <li>■ Supply voltage active</li> <li>■ Data transmission active</li> <li>■ Device alarm/error has occurred</li> </ul>  Diagnostic information via light emitting diodes →  167 |
|---------------------------|--|



Low flow cut off                      The switch points for low flow cut off are user-selectable.

Galvanic isolation                    The outputs are galvanically isolated:

- from the power supply
- from one another
- from the potential equalization (PE) terminal

Protocol-specific data

|                                |  |
|--------------------------------|--|
| <b>Protocol</b>                | Modbus Applications Protocol Specification V1.1  |
| <b>Response times</b>          | <ul style="list-style-type: none"> <li>■ Direct data access: typically 25 to 50 ms</li> <li>■ Auto-scan buffer (data range): typically 3 to 5 ms</li> </ul>  |
| <b>Device type</b>             | Slave  |
| <b>Slave address range</b>     | 1 to 247   |
| <b>Broadcast address range</b> | 0  |
| <b>Function codes</b>          | <ul style="list-style-type: none"> <li>■ 03: Read holding register</li> <li>■ 04: Read input register</li> <li>■ 06: Write single registers</li> <li>■ 08: Diagnostics</li> <li>■ 16: Write multiple registers</li> <li>■ 23: Read/write multiple registers</li> </ul> |

|   |   |
|---|---|
| <b>Broadcast messages</b>               | Supported by the following function codes: <ul style="list-style-type: none"> <li>▪ 06: Write single registers</li> <li>▪ 16: Write multiple registers</li> <li>▪ 23: Read/write multiple registers</li> </ul>  |
| <b>Supported baud rate</b>              | <ul style="list-style-type: none"> <li>▪ 1 200 BAUD</li> <li>▪ 2 400 BAUD</li> <li>▪ 4 800 BAUD</li> <li>▪ 9 600 BAUD</li> <li>▪ 19 200 BAUD</li> <li>▪ 38 400 BAUD</li> <li>▪ 57 600 BAUD</li> <li>▪ 115 200 BAUD</li> </ul>   |
| <b>Data transmission mode</b>           | <ul style="list-style-type: none"> <li>▪ ASCII</li> <li>▪ RTU</li> </ul>  |
| <b>Data access</b>                      | Each device parameter can be accessed via Modbus RS485.<br> For Modbus register information  |
| <b>Compatibility with earlier model</b> | If the device is replaced, the measuring device Promass 300 supports the compatibility of the Modbus registers for the process variables and the diagnostic information with the previous model Promass 83. It is not necessary to change the engineering parameters in the automation system.                                |
| <b>System integration</b>               | Information regarding system integration →  73. <ul style="list-style-type: none"> <li>▪ Modbus RS485 information</li> <li>▪ Function codes</li> <li>▪ Register information</li> <li>▪ Response time</li> <li>▪ Modbus data map</li> </ul> |

## 16.5 Power supply

Terminal assignment →  34

| Supply voltage | Order code "Power supply" |            | Terminal voltage | Frequency range |
|----------------|---------------------------|------------|------------------|-----------------|
|                | Option D                  | DC 24 V    | ±20%             | –               |
| Option E       | AC 100 to 240 V           | –15...+10% | 50/60 Hz         |                 |
| Option I       | DC 24 V                   | ±20%       | –                |                 |
|                | AC 100 to 240 V           | –15...+10% | 50/60 Hz         |                 |

Power consumption **Transmitter**  
 Max. 10 W (active power)

|                          |   |
|--------------------------|---|
| <b>switch-on current</b> | Max. 36 A (<5 ms) as per NAMUR Recommendation NE 21 |
|--------------------------|---|

Current consumption **Transmitter**

- Max. 400 mA (24 V)
- Max. 200 mA (110 V, 50/60 Hz; 230 V, 50/60 Hz)

Power supply failure

- Totalizers stop at the last value measured.
- Depending on the device version, the configuration is retained in the device memory or in the pluggable data memory (HistoROM DAT).
- Error messages (incl. total operated hours) are stored.

Overcurrent protection element The device must be operated with a dedicated circuit breaker, as it does not have an ON/OFF switch of its own.

- The circuit breaker must be easy to reach and labeled accordingly.
- Permitted nominal current of the circuit breaker: 2 A up to maximum 10 A.

Electrical connection →  35

Potential equalization →  38

Terminals Spring-loaded terminals: Suitable for strands and strands with ferrules. Conductor cross-section 0.2 to 2.5 mm<sup>2</sup> (24 to 12 AWG).

Cable entries

- Cable gland: M20 × 1.5 with cable Ø 6 to 12 mm (0.24 to 0.47 in)
- Thread for cable entry:
  - NPT ½"
  - G ½"
  - M20



Cable specification →  31

|                        |  |  |
|------------------------|--|--|
| Overvoltage protection | <b>Mains voltage fluctuations</b>        | →  202 |
|                        | <b>Overvoltage category</b>              | Overvoltage category II  |
|                        | <b>Short-term, temporary overvoltage</b> | Between cable and ground up to 1200 V, for max. 5 s  |
|                        | <b>Long-term, temporary overvoltage</b>  | Between cable and ground up to 500 V   |

## 16.6 Performance characteristics

Reference operating conditions

- Error limits based on ISO 11631
- Water
  - +15 to +45 °C (+59 to +113 °F)
  - 2 to 6 bar (29 to 87 psi)
- Data as indicated in the calibration protocol
- Accuracy based on accredited calibration rigs according to ISO 17025

 To obtain measured errors, use the *Applicator* sizing tool →  192

Maximum measurement error o.r. = of reading; 1 g/cm<sup>3</sup> = 1 kg/l; T = medium temperature

### Base accuracy

 Design fundamentals →  206

#### *Mass flow and volume flow (liquids)*

- ±0.05 % o.r. (optional for mass flow: PremiumCal; order code for "Calibration flow", option D)
- ±0.10 % o.r. (standard)

#### *Mass flow (gases)*

±0.35 % o.r.

*Density (liquids)*

| Under reference conditions | Standard density calibration | Wide-range Density specification <sup>1) 2)</sup> | Extended density calibration <sup>3) 4)</sup> |
|----------------------------|------------------------------|---|---|
| [g/cm <sup>3</sup> ]       | [g/cm <sup>3</sup> ]         | [g/cm <sup>3</sup> ]                              | [g/cm <sup>3</sup> ]                          |
| ±0.0005                    | ±0.0005                      | ±0.001  | ±0.0005                                       |

- 1) Valid range for special density calibration: 0 to 2 g/cm<sup>3</sup>, +5 to +80 °C (+41 to +176 °F)
- 2) order code for "Application package", option EE "Special density" (for nominal diameter ≤ 100 DN)
- 3) Valid range for extended density calibration: 0 to 2 g/cm<sup>3</sup>, +20 to +60 °C (+68 to +140 °F)
- 4) order code for "Application package", option E1 "Extended density"

*Temperature*

$$\pm 0.5 \text{ °C} \pm 0.005 \cdot T \text{ °C} (\pm 0.9 \text{ °F} \pm 0.003 \cdot (T - 32) \text{ °F})$$

**Zero point stability**

| DN   |      | Zero point stability |          |
|------|------|----------------------|----------|
| [mm] | [in] | [kg/h]               | [lb/min] |
| 80   | 3    | 9                    | 0.330    |
| 100  | 4    | 14                   | 0.514    |
| 150  | 6    | 32                   | 1.17     |
| 250  | 10   | 88                   | 3.23     |

**Flow values**

Flow values as turndown parameters depending on nominal diameter.

*SI units*

| DN   | 1:1     | 1:10   | 1:20   | 1:50   | 1:100  | 1:500  |
|------|---------|--------|--------|--------|--------|--------|
| [mm] | [kg/h]  | [kg/h] | [kg/h] | [kg/h] | [kg/h] | [kg/h] |
| 80   | 180000  | 18000  | 9000   | 3600   | 1800   | 360    |
| 100  | 350000  | 35000  | 17500  | 7000   | 3500   | 700    |
| 150  | 800000  | 80000  | 40000  | 16000  | 8000   | 1600   |
| 250  | 2200000 | 220000 | 110000 | 44000  | 22000  | 4400   |

*US units*

| DN     | 1:1      | 1:10     | 1:20     | 1:50     | 1:100    | 1:500    |
|--------|----------|----------|----------|----------|----------|----------|
| [inch] | [lb/min] | [lb/min] | [lb/min] | [lb/min] | [lb/min] | [lb/min] |
| 3      | 6615     | 661.5    | 330.8    | 132.3    | 66.15    | 13.23    |
| 4      | 12860    | 1286     | 643.0    | 257.2    | 128.6    | 25.72    |
| 6      | 29400    | 2940     | 1470     | 588      | 294      | 58.80    |
| 10     | 80850    | 8085     | 4043     | 1617     | 808.5    | 161.7    |

**Accuracy of outputs**

The outputs have the following base accuracy specifications.

*Current output*

|                 |       |
|-----------------|-------|
| <b>Accuracy</b> | ±5 µA |
|-----------------|-------|

*Pulse/frequency output*

o.r. = of reading

|                 |   |
|-----------------|---|
| <b>Accuracy</b> | Max. ±50 ppm o.r. (over the entire ambient temperature range) |
|-----------------|---|

## Repeatability

o.r. = of reading; 1 g/cm<sup>3</sup> = 1 kg/l; T = medium temperature**Base repeatability**
 Design fundamentals →  206
*Mass flow and volume flow (liquids)*

±0.025 % o.r. (PremiumCal, for mass flow)

±0.05 % o.r.

*Mass flow (gases)*

±0.25 % o.r.

*Density (liquids)*±0.00025 g/cm<sup>3</sup>*Temperature*

±0.25 °C ± 0.0025 · T °C (±0.45 °F ± 0.0015 · (T-32) °F)

## Response time

The response time depends on the configuration (damping).

## Influence of ambient temperature

**Current output**

|                                |              |
|--------------------------------|--------------|
| <b>Temperature coefficient</b> | Max. 1 µA/°C |
|--------------------------------|--------------|

**Pulse/frequency output**

|                                |   |
|--------------------------------|---|
| <b>Temperature coefficient</b> | No additional effect. Included in accuracy. |
|--------------------------------|---|

## Influence of medium temperature

**Mass flow**

o.f.s. = of full scale value

If there is a difference between the temperature during zero adjustment and the process temperature, the additional measurement error of the sensors is typically ±0.0002 %o.f.s./°C (±0.0001 % o. f.s./°F).

The influence is reduced when the zero adjustment is performed at process temperature.

**Density**

If there is a difference between the density calibration temperature and the process temperature, the measurement error of the sensors is typically ±0.00005 g/cm<sup>3</sup>/°C (±0.000025 g/cm<sup>3</sup>/°F). Field density adjustment is possible.

**Wide-range density specification (special density calibration)**

If the process temperature is outside the valid range (→ ⓘ 203) the measurement error is  $\pm 0.00005 \text{ g/cm}^3 / ^\circ\text{C}$  ( $\pm 0.000025 \text{ g/cm}^3 / ^\circ\text{F}$ )

**Extended density specification**

If the process temperature is outside the valid range (→ ⓘ 203) the measurement error is  $\pm 0.000025 \text{ g/cm}^3 / ^\circ\text{C}$  ( $\pm 0.0000125 \text{ g/cm}^3 / ^\circ\text{F}$ )

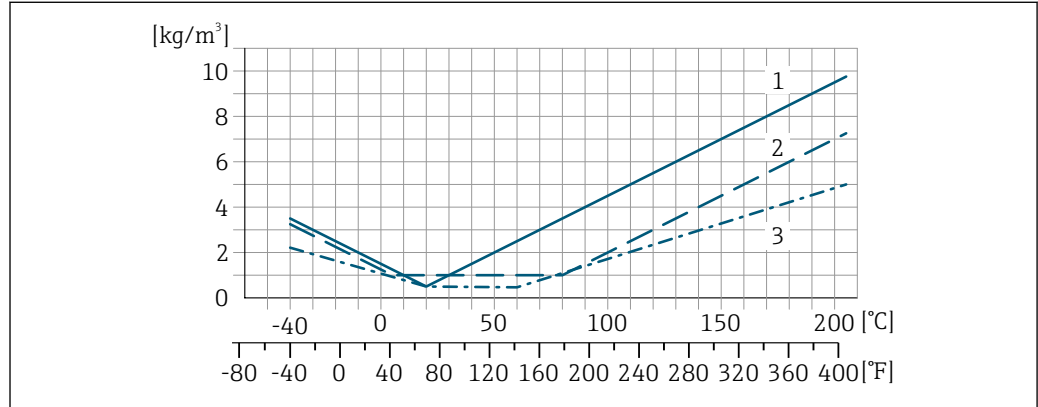

A0016612

- 1 Field density adjustment, for example at +20 °C (+68 °F)
- 2 Special density calibration
- 3 Extended density calibration

**Temperature**

$\pm 0.005 \cdot T \text{ } ^\circ\text{C}$  ( $\pm 0.005 \cdot (T - 32) \text{ } ^\circ\text{F}$ )

**Influence of medium pressure**

The following shows how the process pressure (gauge pressure) affects the accuracy of the mass flow.

o.r. = of reading



It is possible to compensate for the effect by:

- Reading in the current pressure measured value via the current input or a digital input.
- Specifying a fixed value for the pressure in the device parameters.



Operating Instructions .

| DN   |      | [% o.r./bar] | [% o.r./psi] |
|------|------|--------------|--------------|
| [mm] | [in] |              |              |
| 80   | 3    | -0.0056      | -0.0004      |
| 100  | 4    | -0.0037      | -0.0002      |
| 150  | 6    | -0.002       | -0.0001      |
| 250  | 10   | -0.0067      | -0.0005      |

**Design fundamentals**

o.r. = of reading, o.f.s. = of full scale value

BaseAccu = base accuracy in % o.r., BaseRepeat = base repeatability in % o.r.

MeasValue = measured value; ZeroPoint = zero point stability

Calculation of the maximum measured error as a function of the flow rate

| Flow rate  | Maximum measured error in % o.r.   |
|--|--|
| $\geq \frac{\text{ZeroPoint}}{\text{BaseAccu}} \cdot 100$<br><small>A0021332</small> | $\pm \text{BaseAccu}$<br><small>A0021339</small>                                     |
| $< \frac{\text{ZeroPoint}}{\text{BaseAccu}} \cdot 100$<br><small>A0021333</small>    | $\pm \frac{\text{ZeroPoint}}{\text{MeasValue}} \cdot 100$<br><small>A0021334</small> |

Calculation of the maximum repeatability as a function of the flow rate

| Flow rate  | Maximum repeatability in % o.r.  |
|--|--|
| $\geq \frac{1/2 \cdot \text{ZeroPoint}}{\text{BaseRepeat}} \cdot 100$<br><small>A0021335</small> | $\pm \text{BaseRepeat}$<br><small>A0021340</small>   |
| $< \frac{1/2 \cdot \text{ZeroPoint}}{\text{BaseRepeat}} \cdot 100$<br><small>A0021336</small>    | $\pm 1/2 \cdot \frac{\text{ZeroPoint}}{\text{MeasValue}} \cdot 100$<br><small>A0021337</small> |

Example of maximum measurement error

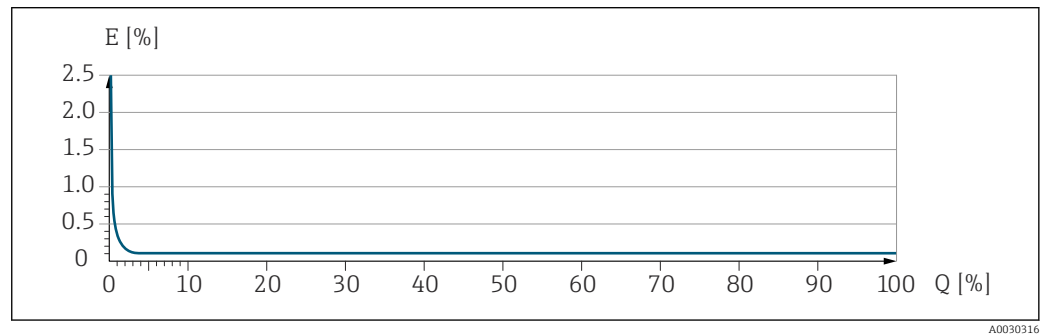

E Maximum measurement error in % o.r. (example)  
 Q Flow rate in % of maximum full scale value

## 16.7 Mounting

Mounting requirements → 21

## 16.8 Environment

Ambient temperature range → 23

### Temperature tables

- Observe the interdependencies between the permitted ambient and fluid temperatures when operating the device in hazardous areas.
- For detailed information on the temperature tables, see the separate document entitled "Safety Instructions" (XA) for the device.

Storage temperature

|                                |  |
|--------------------------------|--|
| Climate class                  | DIN EN 60068-2-38 (test Z/AD)  |
| Relative humidity              | The device is suitable for use outdoors and indoors with a relative humidity of 4 to 95 %.   |
| Operating height               | According to EN 61010-1 <ul style="list-style-type: none"> <li>■ ≤ 2 000 m (6 562 ft)</li> <li>■ &gt; 2 000 m (6 562 ft) with additional overvoltage protection (e.g. Endress+Hauser HAW Series)</li> </ul>  |
| Degree of protection           | <p><b>Transmitter</b></p> <ul style="list-style-type: none"> <li>■ IP66/67, Type 4X enclosure, suitable for pollution degree 4</li> <li>■ When the housing is open: IP20, Type 1 enclosure, suitable for pollution degree 2</li> <li>■ Display module: IP20, Type 1 enclosure, suitable for pollution degree 2</li> </ul> <p><b>Optional</b></p> <p>Order code for "Sensor options", option CM "IP69"</p> <p><b>External WLAN antenna</b></p> <p>IP67</p>  |
| Shock and vibration resistance | <p><b>Vibration sinusoidal, in accordance with IEC 60068-2-6</b></p> <ul style="list-style-type: none"> <li>■ 2 to 8.4 Hz, 3.5 mm peak</li> <li>■ 8.4 to 2 000 Hz, 1 g peak</li> </ul> <p><b>Vibration broad-band random, according to IEC 60068-2-64</b></p> <ul style="list-style-type: none"> <li>■ 10 to 200 Hz, 0.003 g<sup>2</sup>/Hz</li> <li>■ 200 to 2 000 Hz, 0.001 g<sup>2</sup>/Hz</li> <li>■ Total: 1.54 g rms</li> </ul> <p><b>Shock half-sine, according to IEC 60068-2-27</b></p> <p>6 ms 30 g</p> <p><b>Rough handling shocks according to IEC 60068-2-31</b></p> |
| Internal cleaning              | <ul style="list-style-type: none"> <li>■ CIP cleaning</li> <li>■ SIP cleaning</li> </ul> <p><b>Options</b></p> <ul style="list-style-type: none"> <li>■ Oil- and grease-free version for wetted parts, without declaration<br/>Order code for "Service", option HA <sup>3)</sup></li> <li>■ Oil- and grease-free version for wetted parts as per IEC/TR 60877-2.0 and BOC 50000810-4, with declaration<br/>Order code for "Service", option HB <sup>3)</sup></li> </ul>  |
| Mechanical load                | <p>Transmitter housing:</p> <ul style="list-style-type: none"> <li>■ Protect against mechanical effects, such as shock or impact</li> <li>■ Do not use as a ladder or climbing aid</li> </ul>  |

3) The cleaning refers to the measuring instrument only. Any accessories supplied are not cleaned.



Electromagnetic compatibility (EMC)

- As per IEC/EN 61326 and NAMUR Recommendation 21 (NE 21)
- As per IEC/EN 61000-6-2 and IEC/EN 61000-6-4



Details are provided in the Declaration of Conformity.



This unit is not intended for use in residential environments and cannot guarantee adequate protection of the radio reception in such environments.

## 16.9 Process

Medium temperature range -40 to +205 °C (-40 to +401 °F)

Pressure-temperature ratings



For an overview of the pressure-temperature ratings for the process connections, see the Technical Information

Sensor housing

The sensor housing is filled with dry nitrogen gas and protects the electronics and mechanics inside.



If a measuring tube fails (e.g. due to process characteristics like corrosive or abrasive fluids), the fluid will initially be contained by the sensor housing.

In the event of a tube failure, the pressure level inside the sensor housing will rise according to the operating process pressure. If the user judges that the sensor housing burst pressure does not provide an adequate safety margin, the device can be fitted with a rupture disk. This prevents excessively high pressure from forming inside the sensor housing. Therefore, the use of a rupture disk is strongly recommended in applications involving high gas pressures, and particularly in applications in which the process pressure is greater than 2/3 of the sensor housing burst pressure.

If there is a need to drain the leaking medium into a discharge device, the sensor should be fitted with a rupture disk. Connect the discharge to the additional threaded connection .

If the sensor is to be purged with gas (gas detection), it should be equipped with purge connections.



Do not open the purge connections unless the containment can be filled immediately with a dry, inert gas. Use only low pressure to purge.

Maximum pressure:

- DN 80 to 150 (3 to 6"): 5 bar (72.5 psi)
- DN 250 (10"): 3 bar (43.5 psi)

### Burst pressure of the sensor housing

The following sensor housing burst pressures are only valid for standard devices and/or devices equipped with closed purge connections (not opened/as delivered).

If a device fitted with purge connections (order code for "Sensor option", option CH "Purge connection") is connected to the purge system, the maximum pressure is determined by the purge system itself or by the device, depending on which component has the lower pressure classification.

If the device is fitted with a rupture disk (order code for "Sensor option", option CA "Rupture disk"), the rupture disk trigger pressure is decisive .

The sensor housing burst pressure refers to a typical internal pressure which is reached prior to mechanical failure of the sensor housing and which was determined during type

testing. The corresponding type test declaration can be ordered with the device (order code for "Additional approval", option LN "Sensor housing burst pressure, type test").

| DN   |      | Sensor housing burst pressure |       |
|------|------|-------------------------------|-------|
| [mm] | [in] | [bar]                         | [psi] |
| 80   | 3    | 120                           | 1740  |
| 100  | 4    | 95                            | 1370  |
| 150  | 6    | 75                            | 1080  |
| 250  | 10   | 50                            | 720   |

 For information on the dimensions: see the "Mechanical construction" section of the "Technical Information" document

Rupture disk

To increase the level of safety, a device version with a rupture disk with a trigger pressure of 10 to 15 bar (145 to 217.5 psi) can be used (order code for "Sensor option", option CA "rupture disk").



 For information on the dimensions of the rupture disk: see the "Mechanical construction" section of the "Technical Information" document

Flow limit



Select the nominal diameter by optimizing between the required flow range and permissible pressure loss.

 For an overview of the full scale values for the measuring range, see the "Measuring range" section →  195

- The minimum recommended full scale value is approx. 1/20 of the maximum full scale value
- In most applications, 20 to 50 % of the maximum full scale value can be considered ideal
- A low full scale value must be selected for abrasive media (such as liquids with entrained solids): flow velocity < 1 m/s (< 3 ft/s).
- For gas measurement the following rules apply:
  - The flow velocity in the measuring tubes should not exceed half the sound velocity (0.5 Mach).
  - The maximum mass flow depends on the density of the gas: formula

 To calculate the flow limit, use the *Applicator* sizing tool →  192

Pressure loss

 To calculate the pressure loss, use the *Applicator* sizing tool →  192

System pressure

→  23

## 16.10 Custody transfer

The measuring device is optionally tested in accordance with OIML R117 and has an EU type evaluation certificate which authorizes the use in EU type-examination certificates according to Measuring Instruments Directive 2014/32/EU for service subject to legal metrological control ("custody transfer") for liquids other than water (Annex VII).

The measuring device is optionally tested according to OIML R137 and has an EU type-examination certificate according to Measuring Instruments Directive 2014/32/EU for service subject to legal metrological control ("custody transfer") as a gas meter (Annex IV).

The device is used with a legally controlled totalizer display on the local display and optionally with outputs subject to legal metrological control.

Measuring devices subject to legal metrological control totalize in both directions, i.e. all the outputs consider flow components in the positive (forward) and negative (reverse) flow direction.

Generally a measuring device subject to legal metrological control is secured against tampering by seals on the transmitter or sensor. These seals may normally only be opened by a representative of the competent authority for legal metrology controls.

After putting the device into circulation or after sealing the device, operation is only possible to a limited extent.

Detailed ordering information is available from your local Endress+Hauser sales center for national approvals, which are based on the OIML certificates, for applications with liquids other than water or gases.

 More information is provided in the supplementary documentation.

## 16.11 Mechanical construction

Design, dimensions



For the dimensions and installation lengths of the device, see the "Technical Information" document, "Mechanical construction" section

Weight

All values (weight exclusive of packaging material) refer to devices with ASME B16.5 Class 900 flanges. Weight specifications including transmitter as per order code for "Housing", option A "Aluminum, coated".

Different values due to different transmitter versions:

- Transmitter version for the hazardous area  
(Order code for "Housing", option A "Aluminum, coated"; Ex d): +2 kg (+4.4 lbs)
- Cast transmitter version, stainless  
(Order code for "Housing", option L "Cast, stainless"): +6 kg (+13 lbs)

### Weight in SI units

| DN [mm] | Weight [kg] |
|---------|-------------|
| 80      | 75          |
| 100     | 141         |
| 150     | 246         |
| 250     | 572         |

**Weight in US units**

| DN [in] | Weight [lbs] |
|---------|--------------|
| 3       | 165          |
| 4       | 311          |
| 6       | 542          |
| 10      | 1261         |

**Materials**

**Transmitter housing**

Order code for "Housing":

- Option **A** "Aluminum, coated": aluminum, AlSi10Mg, coated
- Option **L** "Cast, stainless": cast, stainless steel, 1.4409 (CF3M) similar to 316L

*Window material*

Order code for "Housing":

- Option **A** "Aluminum, coated": glass
- Option **L** "Cast, stainless": glass

**Cable entries/cable glands**

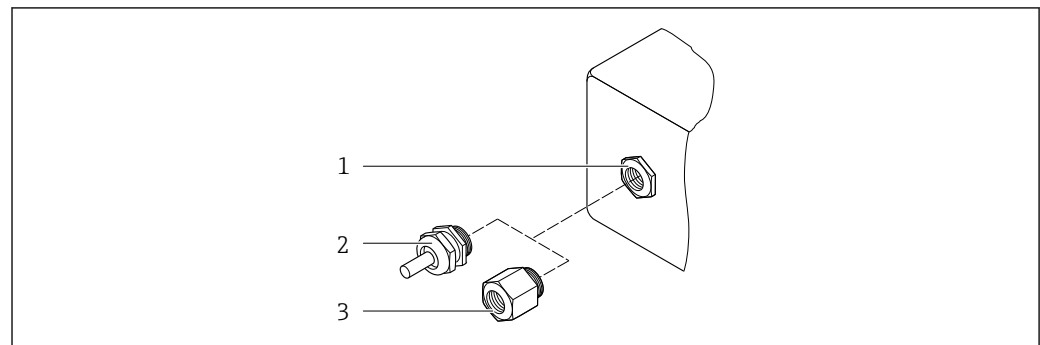

A0020640

34 Possible cable entries/cable glands

- 1 Female thread M20 × 1.5
- 2 Cable gland M20 × 1.5
- 3 Adapter for cable entry with female thread G ½" or NPT ½"

Order code for "Housing", option A "Aluminum, coated"

The various cable entries are suitable for hazardous and non-hazardous areas.

| Cable entry/cable gland                           | Material                            |
|---|-------------------------------------|
| Compression fitting M20 × 1.5                     | Non-Ex: plastic                     |
|   | Z2, D2, Ex d/de: brass with plastic |
| Adapter for cable entry with female thread G ½"   | Nickel-plated brass                 |
| Adapter for cable entry with female thread NPT ½" |                                     |

*Order code for "Housing", option L "Cast, stainless"*

The various cable entries are suitable for hazardous and non-hazardous areas.

| Cable entry/cable gland                           | Material                       |
|---|--------------------------------|
| Cable gland M20 × 1.5                             | Stainless steel, 1.4404 (316L) |
| Adapter for cable entry with female thread G ½"   |                                |
| Adapter for cable entry with female thread NPT ½" |                                |

### Sensor housing

- Acid and alkali-resistant outer surface
- Stainless steel, 1.4404 (316L)

### Measuring tubes

Stainless steel, 1.4410/UNS S32750 25Cr Duplex (Super Duplex)

### Process connections

Stainless steel, 1.4410/F53 25Cr Duplex (Super Duplex)

### Seals

Welded process connections without internal seals

### Accessories

*Protective cover*

Stainless steel, 1.4404 (316L)

*External WLAN antenna*

- Antenna: ASA plastic (acrylonitrile styrene acrylate) and nickel-plated brass
- Adapter: Stainless steel and nickel-plated brass
- Cable: Polyethylene
- Plug: Nickel-plated brass
- Angle bracket: Stainless steel

---

#### Process connections

Fixed flange connections:

- EN 1092-1 (DIN 2512N) flange
- ASME B16.5 flange
- JIS B2220 flange

 Process connection materials →  213

---

#### Surface roughness

All data refer to parts in contact with the medium.

The following surface roughness categories can be ordered:  
Not polished

## 16.12 Operability

### Languages

Can be operated in the following languages:

- Via local operation  
English, German, French, Spanish, Italian, Dutch, Portuguese, Polish, Russian, Turkish, Chinese, Japanese, Korean, Vietnamese, Czech, Swedish
- Via web browser  
English, German, French, Spanish, Italian, Dutch, Portuguese, Polish, Russian, Turkish, Chinese, Japanese, Vietnamese, Czech, Swedish
- Via "FieldCare", "DeviceCare" operating tool: English, German, French, Spanish, Italian, Chinese, Japanese

### Onsite operation

#### Via display module

Features:

- Order code for "Display; operation", option F "4-line, illuminated, graphic display; touch control"
- Order code for "Display; operation", option G "4-line, illuminated, graphic display; touch control + WLAN"

 Information about WLAN interface →  68

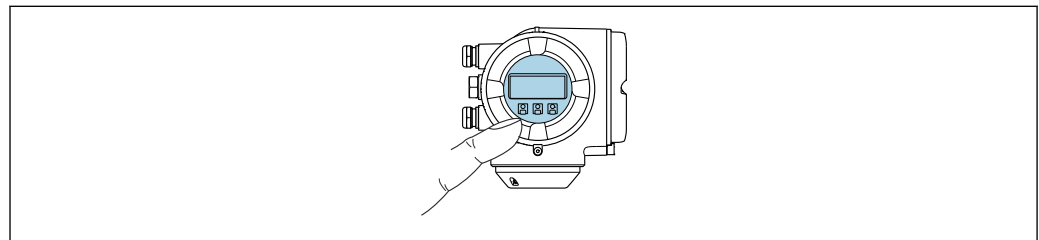



A0026785

 35 *Operation with touch control*



#### Display elements

- 4-line, illuminated, graphic display
- White background lighting; switches to red in event of device errors
- Format for displaying measured variables and status variables can be individually configured

#### Operating elements

- External operation via touch control (3 optical keys) without opening the housing: , , 
- Operating elements also accessible in the various zones of the hazardous area

#### Via remote display and operating module DKX001

 The remote display and operating module DKX001 is available as an optional extra →  191..

- The measuring instrument is always supplied with a dummy cover when the remote display and operating module DKX001 is ordered directly with the measuring instrument. Display or operation at the transmitter is not possible in this case.
- If ordered subsequently, the remote display and operating module DKX001 may not be connected at the same time as the existing measuring instrument display module. Only one display or operation unit may be connected to the transmitter at any one time.

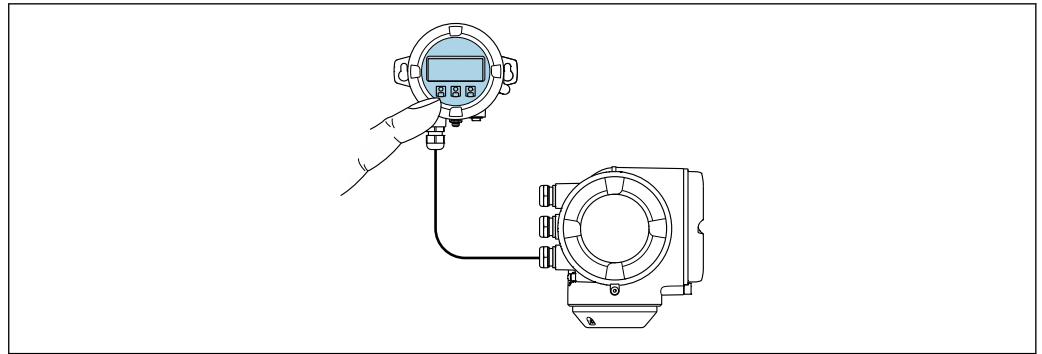

A0026786

36 Operation via remote display and operating module DKX001

*Display and operating elements*

The display and operating elements correspond to those of the display module → 214.

*Housing material*

The housing material of the display and operating module DKX001 depends on the choice of transmitter housing material.

| Transmitter housing         |   | Remote display and operating module |
|-----------------------------|---|-------------------------------------|
| Order code for "Housing"    | Material  | Material                            |
| Option A "Aluminum, coated" | AlSi10Mg, coated                                    | AlSi10Mg, coated                    |
| Option L "Cast, stainless"  | Cast stainless steel, 1.4409 (CF3M) similar to 316L | 1.4409 (CF3M)                       |

*Cable entry*

Corresponds to the choice of transmitter housing, order code for "Electrical connection".

*Connecting cable*

→ 32

*Dimensions*



Information on the dimensions:

"Mechanical construction" section of the "Technical Information" document.

---





Remote operation → 67

---

Service interface → 67

---

Supported operating tools Different operating tools can be used for local or remote access to the measuring device. Depending on the operating tool used, access is possible with different operating units and via a variety of interfaces.

| Supported operating tools | Operating unit                                       | Interface   | Additional information   |
|---------------------------|--|---|--|
| Web browser               | Notebook, PC or tablet with Web browser              | <ul style="list-style-type: none"> <li>■ CDI-RJ45 service interface</li> <li>■ WLAN interface</li> </ul>  | Special Documentation for device →  224 |
| DeviceCare SFE100         | Notebook, PC or tablet with Microsoft Windows system | <ul style="list-style-type: none"> <li>■ CDI-RJ45 service interface</li> <li>■ WLAN interface</li> <li>■ Fieldbus protocol</li> </ul>                           | →  192                                  |
| FieldCare SFE500          | Notebook, PC or tablet with Microsoft Windows system | <ul style="list-style-type: none"> <li>■ CDI-RJ45 service interface</li> <li>■ WLAN interface</li> <li>■ Fieldbus protocol</li> </ul>                           | →  192                                  |
| Field Xpert               | SMT70/77/50  | <ul style="list-style-type: none"> <li>■ All fieldbus protocols</li> <li>■ WLAN interface</li> <li>■ Bluetooth</li> <li>■ CDI-RJ45 service interface</li> </ul> | Operating Instructions BA01202S<br><br>Device description files:<br>Use update function of handheld terminal               |
| SmartBlue app             | Smartphone or tablet with iOS or Android             | WLAN  | →  192                                  |

 Other operating tools based on FDT technology with a device driver such as DTM/iDTM or DD/EDD can be used for device operation. These operating tools are available from the individual manufacturers. Integration into the following operating tools, among others, is supported:

- Field Device Manager (FDM) from Honeywell → [www.process.honeywell.com](http://www.process.honeywell.com)
- FieldMate from Yokogawa → [www.yokogawa.com](http://www.yokogawa.com)
- PACTWare → [www.pactware.com](http://www.pactware.com)

The related device description files are available: [www.endress.com](http://www.endress.com) → Download Area



### Web server

With the integrated web server, the device can be operated and configured via a web browser service interface (CDI-RJ45) or WLAN interface. The structure of the operating menu is the same as for the local display. In addition to the measured values, status information on the device is displayed and can be used to monitor device health. Furthermore the device data can be managed and the network parameters can be configured.

A device that has a WLAN interface (can be ordered as an option) is required for the WLAN connection: order code for "Display; operation", option G "4-line, illuminated; touch control + WLAN". The device acts as an Access Point and enables communication by computer or a mobile handheld terminal.

#### Supported functions

Data exchange between the operating unit (such as a notebook, for example,) and measuring instrument:

- Upload the configuration from the measuring instrument (XML format, configuration backup)
- Save the configuration to the measuring instrument (XML format, restore configuration)
- Export event list (.csv file)
- Export parameter settings (.csv file or PDF file, document the measuring point configuration)
- Export the Heartbeat Technology verification report (PDF file, only available with the **Heartbeat Verification** →  221 application package)
- Flash firmware version for device firmware upgrade, for example
- Download driver for system integration
- Visualize up to 1000 saved measured values (only available with the **Extended HistoROM** application package →  221)



**HistoROM data management** The measuring device features HistoROM data management. HistoROM data management comprises both the storage and import/export of key device and process data, making operation and servicing far more reliable, secure and efficient.

 When the device is delivered, the factory settings of the configuration data are stored as a backup in the device memory. This memory can be overwritten with an updated data record, for example after commissioning.

**Additional information on the data storage concept**

There are different types of data storage units in which device data are stored and used by the device:

|                         | HistoROM backup  | T-DAT  | S-DAT   |
|-------------------------|--|--|---|
| <b>Available data</b>   | <ul style="list-style-type: none"> <li>▪ Event logbook, e.g. diagnostic events</li> <li>▪ Parameter data record backup</li> <li>▪ Device firmware package</li> </ul> | <ul style="list-style-type: none"> <li>▪ Measured value logging ("Extended HistoROM" order option)</li> <li>▪ Current parameter data record (used by firmware at run time)</li> <li>▪ Indicator (minimum/maximum values)</li> <li>▪ Totalizer value</li> </ul> | <ul style="list-style-type: none"> <li>▪ Sensor data: e.g. nominal diameter</li> <li>▪ Serial number</li> <li>▪ Calibration data</li> <li>▪ Device configuration (e.g. SW options, fixed I/O or multi I/O)</li> </ul> |
| <b>Storage location</b> | Fixed on the user interface PC board in the connection compartment   | Can be plugged into the user interface PC board in the connection compartment  | In the sensor plug in the transmitter neck part   |

**Data backup**

**Automatic**

- The most important device data (sensor and transmitter) are automatically saved in the DAT modules
- If the transmitter or measuring device is replaced: once the T-DAT containing the previous device data has been exchanged, the new measuring device is ready for operation again immediately without any errors
- If exchanging the electronics module (e.g. I/O electronics module): Once the electronics module has been replaced, the software of the module is compared against the current device firmware. The module software is upgraded or downgraded where necessary. The electronics module is available for use immediately afterwards and no compatibility problems occur.

**Manual**

Additional parameter data record (complete parameter settings) in the integrated device memory HistoROM backup for:

- Data backup function  
Backup and subsequent restoration of a device configuration in the device memory HistoROM backup
- Data comparison function  
Comparison of the current device configuration with the device configuration saved in the device memory HistoROM backup

**Data transmission**

**Manual**

Transfer of a device configuration to another device using the export function of the specific operating tool, e.g. with FieldCare, DeviceCare or Web server: to duplicate the configuration or to store in an archive (e.g. for backup purposes)

## Event list

### Automatic

- Chronological display of up to 20 event messages in the events list
- If the **Extended HistoROM** application package (order option) is enabled: up to 100 event messages are displayed in the events list along with a time stamp, plain text description and remedial measures
- The events list can be exported and displayed via a variety of interfaces and operating tools e.g. DeviceCare, FieldCare or Web server

## Data logging

### Manual

If the **Extended HistoROM** application package (order option) is enabled:

- Recording of 1 to 4 channels of up to 1 000 measured values (up to 250 measured values per channel)
- User configurable recording interval
- Export the measured value log via a variety of interfaces and operating tools e.g. FieldCare, DeviceCare or web server

## 16.13 Certificates and approvals

Current certificates and approvals for the product are available at [www.endress.com](http://www.endress.com) on the relevant product page:

1. Select the product using the filters and search field.
2. Open the product page.
3. Select **Downloads**.

---

### CE mark

The device meets the legal requirements of the applicable EU Directives. These are listed in the corresponding EU Declaration of Conformity along with the standards applied.

Endress+Hauser confirms successful testing of the device by affixing to it the CE mark.

---

### UKCA marking

The device meets the legal requirements of the applicable UK regulations (Statutory Instruments). These are listed in the UKCA Declaration of Conformity along with the designated standards. By selecting the order option for UKCA marking, Endress+Hauser confirms a successful evaluation and testing of the device by affixing the UKCA mark.



Contact address Endress+Hauser UK:

Endress+Hauser Ltd.  
Floats Road  
Manchester M23 9NF  
United Kingdom  
[www.uk.endress.com](http://www.uk.endress.com)

---

### RCM marking

The measuring system meets the EMC requirements of the "Australian Communications and Media Authority (ACMA)".

|                               |  |
|-------------------------------|--|
| Pressure Equipment Directive  | <ul style="list-style-type: none"> <li>■ With the marking           <ul style="list-style-type: none"> <li>a) PED/G1/x (x = category) or</li> <li>b) PESR/G1/x (x = category)</li> </ul>           on the sensor nameplate, Endress+Hauser confirms compliance with the "Essential Safety Requirements"           <ul style="list-style-type: none"> <li>a) specified in Annex I of the Pressure Equipment Directive 2014/68/EU or</li> <li>b) Schedule 2 of Statutory Instruments 2016 No. 1105.</li> </ul> </li> <li>■ Devices not bearing this marking (without PED or PESR) are designed and manufactured according to sound engineering practice. They meet the requirements of           <ul style="list-style-type: none"> <li>a) Art. 4 Para. 3 of the Pressure Equipment Directive 2014/68/EU or</li> <li>b) Part 1, Para. 8 of Statutory Instruments 2016 No. 1105.</li> </ul>           The scope of application is indicated           <ul style="list-style-type: none"> <li>a) in diagrams 6 to 9 in Annex II of the Pressure Equipment Directive 2014/68/EU or</li> <li>b) Schedule 3, Para. 2 of Statutory Instruments 2016 No. 1105.</li> </ul> </li> </ul>   |
| Radio approval                | <p>The measuring device has radio approval.</p> <p> For detailed information on the radio approval, see the Special Documentation →  224</p>   |
| Measuring instrument approval | <p>The measuring device is (optionally) approved as a gas meter (MI-002) or component in measuring systems (MI-005) in service subject to legal metrological control in accordance with the European Measuring Instruments Directive 2014/32/EU (MID).</p> <p>The measuring device is qualified to OIML R117 or OIML R137 OIML R117 and has an OIML Certificate of Conformity (optional).</p>  |
| Additional certification      | <p><b>CRN approval</b></p> <p>Some device versions have CRN approval. A CRN-approved process connection with a CSA approval must be ordered for a CRN-approved device.</p> <p><b>Tests and certificates</b></p> <ul style="list-style-type: none"> <li>■ ISO 23277 ZG2x (PT)+ISO 10675-1 ZG1 (RT) measuring pipe (PT) + process connection (RT) weld seam, Heartbeat Technology verification report</li> <li>■ Penetrant + radiographic testing ASME B31.3 NFS(RT) measuring pipe (PT) + process connection (RT) weld seam, Heartbeat Technology verification report</li> <li>■ Penetrant + radiographic testing ASME VIII Div.1(RT) measuring pipe (PT) + process connection (RT) weld seam, Heartbeat Technology verification report</li> <li>■ Visual+penetrant+radiographic testing NORSOK M-601 (RT) measuring pipe (VT+PT) +process connection (VT+RT) weld seam, Heartbeat Technology verification report</li> <li>■ ISO 23277 ZG2x (PT)+ISO 10675-1 ZG1 (DR) measuring pipe (PT) + process connection (DR) weld seam, Heartbeat Technology verification report</li> <li>■ Penetrant + radiographic testing ASME B31.3 NFS(DR) measuring pipe (PT) + process connection (DR) weld seam, Heartbeat Technology verification report</li> <li>■ Penetrant +radiographic testing ASME VIII Div.1(DR) measuring pipe (PT) + process connection (DR) weld seam, Heartbeat Technology verification report</li> <li>■ Visual +penetrant+radiographic testing NORSOK M-601 (DR) measuring pipe (VT+PT) +process connection (VT+DR) weld seam, Heartbeat Technology verification report</li> </ul> |

*Testing of welded connections*

| Option   | Test standard                                   |                      |                                 |                 | Component      |                    |
|--|---|----------------------|---------------------------------|-----------------|----------------|--------------------|
|  | ISO 23277 AL2x (PT)<br>ISO 10675-1 AL1 (RT, DR) | ASME<br>B31.3<br>NFS | ASME<br>VIII Div.1<br>Appx. 4+8 | NORSOK<br>M-601 | Measuring pipe | Process connection |
| KF   | x   |                      |                                 |                 | PT             | RT                 |
| KK   |   | x                    |                                 |                 | PT             | RT                 |
| KP   |   |                      | x                               |                 | PT             | RT                 |
| KR   |   |                      |                                 | x               | VT, PT         | VT, RT             |
| K1   | x   |                      |                                 |                 | PT             | DR                 |
| K2   |   | x                    |                                 |                 | PT             | DR                 |
| K3   |   |                      | x                               |                 | PT             | DR                 |
| K4   |   |                      |                                 | x               | VT, PT         | VT, DR             |
| PT = penetrant testing, RT = radiographic testing, VT = visual testing, DR = digital radiography<br>All options with test report |   |                      |                                 |                 |                |                    |

External standards and guidelines



- EN 60529  
Degrees of protection provided by enclosures (IP code)
- IEC/EN 60068-2-6  
Environmental influences: Test procedure - Test Fc: vibrate (sinusoidal).
- IEC/EN 60068-2-31  
Environmental influences: Test procedure - Test Ec: shocks due to rough handling, primarily for devices.
- EN 61010-1  
Safety requirements for electrical equipment for measurement, control and laboratory use - general requirements
- EN 61326-1/-2-3  
EMC requirements for electrical equipment for measurement, control and laboratory use
- NAMUR NE 21  
Electromagnetic compatibility (EMC) of industrial process and laboratory control equipment
- NAMUR NE 32  
Data retention in the event of a power failure in field and control instruments with microprocessors
- NAMUR NE 43  
Standardization of the signal level for the breakdown information of digital transmitters with analog output signal.
- NAMUR NE 53  
Software of field devices and signal-processing devices with digital electronics
- NAMUR NE 80  
The application of the pressure equipment directive to process control devices
- NAMUR NE 105  
Specifications for integrating fieldbus devices in engineering tools for field devices
- NAMUR NE 107  
Self-monitoring and diagnosis of field devices
- NAMUR NE 131  
Requirements for field devices for standard applications
- NAMUR NE 132  
Coriolis mass meter
- NACE MR0103  
Materials resistant to sulfide stress cracking in corrosive petroleum refining environments.

- NACE MR0175/ISO 15156-1  
Materials for use in H<sub>2</sub>S-containing Environments in Oil and Gas Production.
- ETSI EN 300 328  
Guidelines for 2.4 GHz radio components.
- EN 301489  
Electromagnetic compatibility and radio spectrum matters (ERM).

## 16.14 Application packages

Many different application packages are available to enhance the functionality of the device. Such packages might be needed to address safety aspects or specific application requirements.

The application packages can be ordered with the device or subsequently from Endress+Hauser. Detailed information on the order code in question is available from your local Endress+Hauser sales center or on the product page of the Endress+Hauser website: [www.endress.com](http://www.endress.com).

 Detailed information on the application packages:  
Special Documentation →  224

---

|                          |  |
|--------------------------|--|
| Diagnostic functionality | <p>Order code for "Application package", option EA "Extended HistoROM"</p> <p>Comprises extended functions concerning the event log and the activation of the measured value memory.</p> <p>Event log:<br/>Memory volume is extended from 20 message entries (standard version) to up to 100 entries.</p> <p>Data logging (line recorder):</p> <ul style="list-style-type: none"> <li>▪ Memory capacity for up to 1000 measured values is activated.</li> <li>▪ 250 measured values can be output via each of the 4 memory channels. The recording interval can be defined and configured by the user.</li> <li>▪ Measured value logs can be accessed via the local display or operating tool e.g. FieldCare, DeviceCare or Web server.</li> </ul> <p> For detailed information, see the Operating Instructions for the device.</p> |
|--------------------------|--|

---

|                      |  |
|----------------------|--|
| Heartbeat Technology | <p>Order code for "Application package", option EB "Heartbeat Verification + Monitoring"</p> <p><b>Heartbeat Verification</b><br/>Meets the requirement for traceable verification to DIN ISO 9001:2008 Chapter 7.6 a) "Control of monitoring and measuring equipment".</p> <ul style="list-style-type: none"> <li>▪ Functional testing in the installed state without interrupting the process.</li> <li>▪ Traceable verification results on request, including a report.</li> <li>▪ Simple testing process via local operation or other operating interfaces.</li> <li>▪ Clear measuring point assessment (pass/fail) with high test coverage within the framework of manufacturer specifications.</li> <li>▪ Extension of calibration intervals according to operator's risk assessment.</li> </ul> |
|----------------------|--|

**Heartbeat Monitoring**

Continuously supplies data, which are characteristic of the measuring principle, to an external condition monitoring system for the purpose of preventive maintenance or process analysis. These data enable the operator to:

- Draw conclusions - using these data and other information - about the impact process influences (e.g. corrosion, abrasion, buildup etc.) have on the measuring performance over time.
- Schedule servicing in time.
- Monitor the process or product quality, e.g. gas pockets .

 For detailed information, see the Special Documentation for the device.

Concentration measurement

Order code for "Application package", option ED "Concentration"

Calculation and outputting of fluid concentrations.

The measured density is converted to the concentration of a substance of a binary mixture using the "Concentration" application package:

- Choice of predefined fluids (e.g. various sugar solutions, acids, alkalis, salts, ethanol etc.).
- Common or user-defined units (°Brix, °Plato, % mass, % volume, mol/l etc.) for standard applications.
- Concentration calculation from user-defined tables.

 For detailed information, see the Special Documentation for the device.

Special density

Order code for "Application package", option EE "Special density"

Many applications use density as a key measured value for monitoring quality or controlling processes. The measuring instrument measures the density of the fluid as standard and makes this value available to the control system.

The "Special Density" application package offers high-precision density measurement over a wide density and temperature range particularly for applications subject to varying process conditions.

The calibration certificate supplied contains the following information:

- Density performance in air
- Density performance in liquids with different density
- Density performance in water with different temperatures

 For detailed information, see the Operating Instructions for the device.

Extended density

Order code for "Application package", option E1 "Extended density"

For volume-based applications, the device can calculate and output a volume flow rate by dividing the mass flow rate by the measured density.

This application package is the standard calibration for custody transfer applications according to national and international standards (e.g. OIML, MID). It is recommended for volume-based fiscal dosing applications over a wide temperature range.

The calibration certificate supplied describes the density performance in air and water at various temperatures in detail.

 For detailed information, see the Operating Instructions for the device.

Petroleum

Order code for "Application package", option EJ "Petroleum"

The most important parameters for the Oil & Gas Industry can be calculated and displayed with this application package.

- Corrected volume flow and calculated reference density in accordance with the "API Manual of Petroleum Measurement Standards, Chapter 11.1"
- Water content, based on density measurement
- Weighted mean of the density and temperature



For detailed information, see the Special Documentation for the device.

Petroleum & locking function

Order code for "Application package", option EM "Petroleum & locking function"

The most important parameters for the Oil & Gas Industry can be calculated and displayed with this application package. It is also possible to lock the settings.

- Corrected volume flow and calculated reference density in accordance with the "API Manual of Petroleum Measurement Standards, Chapter 11.1"
- Water content, based on density measurement
- Weighted mean of the density and temperature



For detailed information, see the Special Documentation for the device.

## 16.15 Accessories



Overview of accessories available to order →  191

## 16.16 Supplementary documentation



For an overview of the scope of the associated Technical Documentation, refer to the following:

- *Device Viewer* ([www.endress.com/deviceviewer](http://www.endress.com/deviceviewer)): Enter the serial number from the nameplate
- *Endress+Hauser Operations app*: Enter serial number from nameplate or scan matrix code on nameplate.

Standard documentation

### Brief Operating Instructions

*Brief Operating Instructions for the sensor*

| Measuring instrument | Documentation code |
|----------------------|--------------------|
| Proline Promass O    | KA01285D           |

*Brief Operating Instructions for transmitter*

| Measuring device | Documentation code |
|------------------|--------------------|
| Proline 300      | KA01311D           |

### Technical Information

| Measuring device | Documentation code |
|------------------|--------------------|
| Promass O 300    | TI01275D           |

### Description of Device Parameters

| Measuring device | Documentation code |                     |             |             |              |             |          | PROFINET with Ethernet-APL |
|------------------|--------------------|---------------------|-------------|-------------|--------------|-------------|----------|----------------------------|
|                  | HART               | FOUNDATION Fieldbus | PROFIBUS PA | PROFIBUS DP | Modbus RS485 | EtherNet/IP | PROFINET |                            |
| Promass 300      | GP01057D           | GP01094D            | GP01058D    | GP01134D    | GP01059D     | GP01114D    | GP01115D | GP01168D                   |

Supplementary device-dependent documentation

#### Safety instructions

Safety instructions for electrical equipment for hazardous areas.

| Contents              | Documentation code |
|-----------------------|--------------------|
| ATEX/IECEX Ex d/Ex de | XA01405D           |
| ATEX/IECEX Ex ec      | XA01439D           |
| cCSAus XP             | XA01373D           |
| cCSAus Ex d/ Ex de    | XA01372D           |
| cCSAus Ex nA          | XA01507D           |
| INMETRO Ex d/Ex de    | XA01468D           |
| INMETRO Ex ec         | XA01470D           |
| NEPSI Ex d/Ex de      | XA01469D           |
| NEPSI Ex nA           | XA01471D           |
| EAC Ex d/Ex de        | XA01656D           |
| EAC Ex nA             | XA01657D           |
| JPN Ex d              | XA01778D           |

#### Remote display and operating module DKX001

| Contents         | Documentation code |
|------------------|--------------------|
| ATEX/IECEX Ex i  | XA01494D           |
| ATEX/IECEX Ex ec | XA01498D           |
| cCSAus IS        | XA01499D           |
| cCSAus Ex nA     | XA01513D           |
| INMETRO Ex i     | XA01500D           |
| INMETRO Ex ec    | XA01501D           |
| NEPSI Ex i       | XA01502D           |
| NEPSI Ex nA      | XA01503D           |



#### Special documentation

| Contents  | Documentation code |
|---|--------------------|
| Information on the Pressure Equipment Directive                 | SD01614D           |
| Remote display and operating module DKX001                      | SD01763D           |
| Radio approvals for WLAN interface for A309/A310 display module | SD01793D           |
| Web server  | SD01663D           |
| Heartbeat Technology  | SD01697D           |
| Concentration measurement                                       | SD01707D           |



| Contents   | Documentation code |
|--|--------------------|
| Petroleum  | SD02098D           |
| Custody transfer (counter for liquids other than water)  | SD01689D           |
| Custody transfer (counter for gas)   | SD02463D           |
| Custody transfer (counter for gas, in accordance with the German Measurement and Calibration Ordinance (Mess- und Eichverordnung)) | SD02581D           |

### Installation instructions

| Contents  | Note  |
|---|---|
| Installation instructions for spare part sets and accessories | <ul style="list-style-type: none"> <li>▪ Access the overview of all the available spare part sets via <i>Device Viewer</i> →  189</li> <li>▪ Accessories available for order with Installation Instructions →  191</li> </ul> |

# Index

## A

|                                    |     |
|------------------------------------|-----|
| Access authorization to parameters |     |
| Read access                        | 59  |
| Write access                       | 59  |
| Access code                        | 59  |
| Incorrect input                    | 59  |
| Adapting the diagnostic behavior   | 173 |
| Additional certification           | 219 |
| Ambient conditions                 |     |
| Mechanical load                    | 208 |
| Operating height                   | 208 |
| Relative humidity                  | 208 |
| Shock and vibration resistance     | 208 |
| Storage temperature                | 207 |
| Ambient temperature                |     |
| Influence                          | 205 |
| Ambient temperature range          | 208 |
| Application                        | 194 |
| Application packages               | 221 |
| Applicator                         | 195 |
| Approvals                          | 218 |
| Auto scan buffer                   |     |
| see Modbus RS485 Modbus data map   |     |

## C

|   |         |
|---|---------|
| Cable entries                                 |         |
| Technical data                                | 203     |
| Cable entry                                   |         |
| Degree of protection                          | 43      |
| CE mark                                       | 10, 218 |
| Certificates                                  | 218     |
| Checklist                                     |         |
| Post-connection check                         | 43      |
| Post-installation check                       | 30      |
| CIP cleaning                                  | 208     |
| Cleaning                                      |         |
| Exterior cleaning                             | 188     |
| Climate class                                 | 208     |
| Commissioning                                 | 78      |
| Advanced settings                             | 114     |
| Configuring the measuring instrument          | 78      |
| Compatibility                                 | 187     |
| Configuring error response mode, Modbus RS485 | 173     |
| Connecting cable                              | 32      |
| Connecting the measuring instrument           | 35      |
| Connecting the signal cables                  | 35      |
| Connecting the supply voltage cables          | 35      |
| Connection                                    |         |
| see Electrical connection                     |         |
| Connection cable                              | 31      |
| Connection preparations                       | 34      |
| Connection tools                              | 31      |
| Context menu                                  |         |
| Calling up                                    | 55      |
| Closing                                       | 55      |
| Explanation                                   | 55      |

|                     |     |
|---------------------|-----|
| Current consumption | 202 |
| Custody transfer    | 211 |

## D

|                                     |          |
|-------------------------------------|----------|
| Date of manufacture                 | 16, 17   |
| Declaration of Conformity           | 10       |
| Defining the access code            | 139      |
| Degree of protection                | 43, 208  |
| Density adjustment                  | 117      |
| Design                              |          |
| Operating menu                      | 46       |
| Design fundamentals                 |          |
| Measurement error                   | 206      |
| Repeatability                       | 206      |
| Device components                   | 14       |
| Device description files            | 72       |
| Device history                      | 187      |
| Device locking, status              | 142      |
| Device name                         |          |
| Sensor                              | 17       |
| Transmitter                         | 16       |
| Device repair                       | 189      |
| Device revision                     | 72       |
| Device type ID                      | 72       |
| Device Viewer                       | 189      |
| DeviceCare                          | 71       |
| Device description file             | 72       |
| Diagnosis                           |          |
| Symbols                             | 168      |
| Diagnostic behavior                 |          |
| Explanation                         | 169      |
| Symbols                             | 169      |
| Diagnostic information              |          |
| Communication interface             | 173      |
| Design, description                 | 169, 172 |
| DeviceCare                          | 171      |
| FieldCare                           | 171      |
| Light emitting diodes               | 167      |
| Local display                       | 168      |
| Overview                            | 174      |
| Remedial measures                   | 174      |
| Web browser                         | 170      |
| Diagnostic message                  | 168      |
| Diagnostics list                    | 179      |
| DIP switch                          |          |
| see Write protection switch         |          |
| Direct access                       | 57       |
| Disabling write protection          | 139      |
| Display                             |          |
| see Local display                   |          |
| Display and operating module DKX001 | 214      |
| Display area                        |          |
| For operational display             | 49       |
| In the navigation view              | 51       |
| Display values                      |          |
| For locking status                  | 142      |

- Displaying the measured value history . . . . . 159
- Disposal . . . . . 190
- Document
  - Function . . . . . 6
  - Symbols . . . . . 6
- Document function . . . . . 6
- Down pipe . . . . . 21
- E**
- Editing view . . . . . 53
  - Input screen . . . . . 54
  - Using operating elements . . . . . 53, 54
- Electrical connection
  - Computer with web browser (e.g. Microsoft Edge) . . . . . 67
  - Degree of protection . . . . . 43
  - Measuring instrument . . . . . 31
  - Operating tool (e.g. FieldCare, DeviceCare, AMS Device Manager, SIMATIC PDM) . . . . . 67
  - Operating tools
    - Via Modbus RS485 protocol . . . . . 67
    - Via service interface (CDI-RJ45) . . . . . 67
    - Via WLAN interface . . . . . 68
  - Web server . . . . . 67
  - WLAN interface . . . . . 68
- Electromagnetic compatibility . . . . . 209
- Electronics module . . . . . 14
- Enabling write protection . . . . . 139
- Enabling/disabling the keypad lock . . . . . 60
- Endress+Hauser services
  - Maintenance . . . . . 188
  - Repair . . . . . 189
- Error messages
  - see Diagnostic messages
- Event logbook . . . . . 180
- Events list . . . . . 180
- Extended order code
  - Sensor . . . . . 17
  - Transmitter . . . . . 16
- Exterior cleaning . . . . . 188
- F**
- Field of application
  - Residual risks . . . . . 10
- FieldCare . . . . . 69
  - Device description file . . . . . 72
  - Establishing a connection . . . . . 70
  - Function . . . . . 69
  - User interface . . . . . 70
- Filtering the event logbook . . . . . 181
- Firmware
  - Release date . . . . . 72
  - Version . . . . . 72
- Firmware history . . . . . 185
- Flow direction . . . . . 22, 28
- Flow limit . . . . . 210
- Function codes . . . . . 73
- Functions
  - see Parameters
- G**
- Galvanic isolation . . . . . 201
- Gas Fraction Handler . . . . . 163
- H**
- Hardware write protection . . . . . 140
- Help text
  - Calling up . . . . . 58
  - Closing . . . . . 58
  - Explanation . . . . . 58
- HistoROM . . . . . 133
- I**
- Identifying the measuring instrument . . . . . 15
- Incoming acceptance . . . . . 15
- Indication
  - Current diagnostic event . . . . . 179
  - Previous diagnostic event . . . . . 179
- Influence
  - Ambient temperature . . . . . 205
  - Medium pressure . . . . . 206
  - Medium temperature . . . . . 205
- Information about this document . . . . . 6
- Inlet runs . . . . . 23
- Input variables . . . . . 195
- Inspection
  - Connection . . . . . 43
  - Installation . . . . . 30
  - Received goods . . . . . 15
- Installation dimensions . . . . . 23
- Installation point . . . . . 21
- Intended use . . . . . 9
- Internal cleaning . . . . . 208
- L**
- Languages, operation options . . . . . 214
- Line recorder . . . . . 159
- Local display . . . . . 214
  - Navigation view . . . . . 51
  - see Diagnostic message
  - see In alarm condition
  - see Operational display
  - Text editor . . . . . 53
- Low flow cut off . . . . . 201
- M**
- Main electronics module . . . . . 14
- Maintenance work . . . . . 188
- Managing the device configuration . . . . . 133
- Manufacturer ID . . . . . 72
- Materials . . . . . 212
- Maximum measurement error . . . . . 203
- Measured variables
  - see Process variables
- Measurement accuracy . . . . . 203
- Measuring and test equipment . . . . . 188
- Measuring device
  - Conversion . . . . . 189
  - Disposal . . . . . 190

- Mounting the sensor . . . . . 28
- Preparing for electrical connection . . . . . 34
- Removing . . . . . 190
- Repairs . . . . . 189
- Structure . . . . . 14
- Switching on . . . . . 78
- Measuring instrument
  - Configuring . . . . . 78
  - Preparing for mounting . . . . . 28
- Measuring instrument approval . . . . . 219
- Measuring principle . . . . . 194
- Measuring range
  - For gases . . . . . 195
  - For liquids . . . . . 195
- Measuring range, recommended . . . . . 210
- Measuring system . . . . . 194
- Mechanical load . . . . . 208
- Medium pressure
  - Influence . . . . . 206
- Medium temperature
  - Influence . . . . . 205
- Menu
  - Diagnostics . . . . . 179
  - Setup . . . . . 80
- Menus
  - For measuring instrument configuration . . . . . 78
  - For specific settings . . . . . 114
- Modbus RS485
  - Configuring error response mode . . . . . 173
  - Diagnostic information . . . . . 173
  - Function codes . . . . . 73
  - Modbus data map . . . . . 75
  - Read access . . . . . 73
  - Reading out data . . . . . 76
  - Register addresses . . . . . 74
  - Register information . . . . . 74
  - Response time . . . . . 74
  - Scan list . . . . . 76
  - Write access . . . . . 73
- Mounting . . . . . 21
- Mounting dimensions
  - see Installation dimensions
- Mounting preparations . . . . . 28
- Mounting requirements
  - Down pipe . . . . . 21
  - Inlet and outlet runs . . . . . 23
  - Installation dimensions . . . . . 23
  - Installation point . . . . . 21
  - Orientation . . . . . 22
  - Rupture disk . . . . . 25
  - Sensor heating . . . . . 24
  - Static pressure . . . . . 23
  - Thermal insulation . . . . . 24
  - Vibrations . . . . . 25
- Mounting tool . . . . . 27
- N**
- Nameplate
  - Sensor . . . . . 17
- Transmitter . . . . . 16
- Navigation path (navigation view) . . . . . 51
- Navigation view
  - In the submenu . . . . . 51
  - In the wizard . . . . . 51
- Netilion . . . . . 188
- Numeric editor . . . . . 53
- O**
- Onsite display
  - Numeric editor . . . . . 53
- Operable flow range . . . . . 195
- Operating elements . . . . . 55, 169
- Operating height . . . . . 208
- Operating keys
  - see Operating elements
- Operating menu
  - Design . . . . . 46
  - Menus, submenus . . . . . 46
  - Submenus and user roles . . . . . 47
- Operating philosophy . . . . . 47
- Operation . . . . . 142
- Operation options . . . . . 45
- Operational display . . . . . 48
- Operational safety . . . . . 10
- Order code . . . . . 16, 17
- Orientation (vertical, horizontal) . . . . . 22
- Outlet runs . . . . . 23
- Output signal . . . . . 197
- Output variables . . . . . 197
- P**
- Packaging disposal . . . . . 20
- Parameter
  - Changing . . . . . 58
  - Entering values or text . . . . . 58
- Parameter settings
  - Administration (Submenu) . . . . . 135
  - Advanced setup (Submenu) . . . . . 115
  - Communication (Submenu) . . . . . 82
  - Configuration backup (Submenu) . . . . . 133
  - Corrected volume flow calculation (Submenu) . . . . . 115
  - Current input . . . . . 87
  - Current input (Wizard) . . . . . 87
  - Current input 1 to n (Submenu) . . . . . 154
  - Current output . . . . . 89
  - Current output (Wizard) . . . . . 89
  - Data logging (Submenu) . . . . . 159
  - Define access code (Wizard) . . . . . 134
  - Density adjustment (Wizard) . . . . . 117
  - Device information (Submenu) . . . . . 183
  - Diagnostics (Menu) . . . . . 179
  - Display (Submenu) . . . . . 125
  - Display (Wizard) . . . . . 107
  - Double pulse output . . . . . 106
  - Double pulse output (Submenu) . . . . . 157
  - Double pulse output (Wizard) . . . . . 106
  - I/O configuration . . . . . 86
  - I/O configuration (Submenu) . . . . . 86

- Low flow cut off (Wizard) . . . . . 112
  - Measured variables (Submenu) . . . . . 143
  - Measurement mode (Submenu) . . . . . 163
  - Medium index (Submenu) . . . . . 164
  - Medium selection (Wizard) . . . . . 84
  - Partially filled pipe detection (Wizard) . . . . . 113
  - Pulse/frequency/switch output . . . . . 94
  - Pulse/frequency/switch output (Wizard) 94, 96, 100
  - Pulse/frequency/switch output 1 to n (Submenu) 156
  - Relay output . . . . . 103
  - Relay output 1 to n (Submenu) . . . . . 156
  - Relay output 1 to n (Wizard) . . . . . 103
  - Reset access code (Submenu) . . . . . 135
  - Sensor adjustment (Submenu) . . . . . 116
  - Setup (Menu) . . . . . 80
  - Simulation (Submenu) . . . . . 136
  - Status input . . . . . 88
  - Status input 1 to n (Submenu) . . . . . 154
  - Status input 1 to n (Wizard) . . . . . 88
  - System units (Submenu) . . . . . 80
  - Totalizer (Submenu) . . . . . 153
  - Totalizer 1 to n (Submenu) . . . . . 122
  - Totalizer handling (Submenu) . . . . . 157
  - Value current output 1 to n (Submenu) . . . . . 155
  - Web server (Submenu) . . . . . 66
  - WLAN settings (Wizard) . . . . . 131
  - Zero adjustment (Wizard) . . . . . 121
  - Zero verification (Wizard) . . . . . 120
  - Performance characteristics . . . . . 203
  - Performing density adjustment . . . . . 117
  - Post-connection check . . . . . 78
  - Post-connection check (checklist) . . . . . 43
  - Post-installation check . . . . . 78
  - Post-installation check (checklist) . . . . . 30
  - Potential equalization . . . . . 38
  - Power consumption . . . . . 202
  - Power supply failure . . . . . 202
  - Pressure Equipment Directive . . . . . 219
  - Pressure loss . . . . . 210
  - Pressure-temperature ratings . . . . . 209
  - Process connections . . . . . 213
  - Process variables
    - Calculated . . . . . 195
    - Measured . . . . . 195
  - Product safety . . . . . 10
  - Protecting parameter settings . . . . . 139
- R**
- Radio approval . . . . . 219
  - RCM marking . . . . . 218
  - Read access . . . . . 59
  - Reading off measured values . . . . . 142
  - Reading out diagnostic information, Modbus RS485 173
  - Recalibration . . . . . 188
  - Reference operating conditions . . . . . 203
  - Registered trademarks . . . . . 8
  - Remedial measures
    - Calling up . . . . . 170
    - Closing . . . . . 170
  - Remote operation . . . . . 215
  - Repair . . . . . 189
    - Notes . . . . . 189
  - Repair of a device . . . . . 189
  - Repeatability . . . . . 205
  - Replacement
    - Device components . . . . . 189
    - Requirements for personnel . . . . . 9
  - Response time . . . . . 205
  - Return . . . . . 189
  - Rupture disk
    - Safety instructions . . . . . 25
    - Triggering pressure . . . . . 210
- S**
- Safety . . . . . 9
  - Sensor
    - Installing . . . . . 28
  - Sensor heating . . . . . 24
  - Sensor housing . . . . . 209
  - Serial number . . . . . 16, 17
  - Setting the operating language . . . . . 78
  - Settings
    - Adapting the measuring device to the process conditions . . . . . 157
    - Administration . . . . . 134
    - Advanced display configurations . . . . . 125
    - Communication interface . . . . . 82
    - Current input . . . . . 87
    - Current output . . . . . 89
    - Double pulse output . . . . . 106
    - I/O configuration . . . . . 86
    - Local display . . . . . 107
    - Low flow cut off . . . . . 112
    - Managing the device configuration . . . . . 133
    - Medium . . . . . 84
    - Operating language . . . . . 78
    - Partially filled pipe detection . . . . . 113
    - Pulse output . . . . . 94
    - Pulse/frequency/switch output . . . . . 94, 96
    - Relay output . . . . . 103
    - Resetting the device . . . . . 182
    - Resetting the totalizer . . . . . 157
    - Sensor adjustment . . . . . 116
    - Simulation . . . . . 136
    - Status input . . . . . 88
    - Switch output . . . . . 100
    - System units . . . . . 80
    - Tag name . . . . . 80
    - Totalizer . . . . . 122
    - Totalizer reset . . . . . 157
    - WLAN . . . . . 131
  - Shock and vibration resistance . . . . . 208
  - Signal on alarm . . . . . 200
  - SIP cleaning . . . . . 208
  - Software release . . . . . 72
  - Spare part . . . . . 189
  - Spare parts . . . . . 189
  - Special connection instructions . . . . . 39

- Special mounting instructions
  - Hygienic compatibility . . . . . 25
- Standards and guidelines . . . . . 220
- Static pressure . . . . . 23
- Status area
  - For operational display . . . . . 48
  - In the navigation view . . . . . 51
- Status signals . . . . . 168, 171
- Storage concept . . . . . 217
- Storage conditions . . . . . 19
- Storage temperature . . . . . 19
- Storage temperature range . . . . . 207
- Structure
  - Measuring device . . . . . 14
- Submenu
  - Administration . . . . . 134, 135
  - Advanced setup . . . . . 114, 115
  - Calculated values . . . . . 115
  - Communication . . . . . 82
  - Configuration backup . . . . . 133
  - Corrected volume flow calculation . . . . . 115
  - Current input 1 to n . . . . . 154
  - Data logging . . . . . 159
  - Device information . . . . . 183
  - Display . . . . . 125
  - Double pulse output . . . . . 157
  - Events list . . . . . 180
  - I/O configuration . . . . . 86
  - Input values . . . . . 154
  - Measured values . . . . . 142
  - Measured variables . . . . . 143
  - Measurement mode . . . . . 163
  - Medium index . . . . . 164
  - Output values . . . . . 155
  - Overview . . . . . 47
  - Process variables . . . . . 115
  - Pulse/frequency/switch output 1 to n . . . . . 156
  - Relay output 1 to n . . . . . 156
  - Reset access code . . . . . 135
  - Sensor adjustment . . . . . 116
  - Simulation . . . . . 136
  - Status input 1 to n . . . . . 154
  - System units . . . . . 80
  - Totalizer . . . . . 153
  - Totalizer 1 to n . . . . . 122
  - Totalizer handling . . . . . 157
  - Value current output 1 to n . . . . . 155
  - Web server . . . . . 66
- Supply voltage . . . . . 202
- Surface roughness . . . . . 213
- Switch output . . . . . 199
- Symbols
  - Controlling data entries . . . . . 54
  - For communication . . . . . 48
  - For diagnostic behavior . . . . . 48
  - For locking . . . . . 48
  - For measured variable . . . . . 49
  - For measurement channel number . . . . . 49
  - For menus . . . . . 51
  - For parameters . . . . . 51
  - For status signal . . . . . 48
  - For submenu . . . . . 51
  - For wizards . . . . . 51
  - In the status area of the local display . . . . . 48
  - Input screen . . . . . 54
  - Operating elements . . . . . 53
- System design
  - Measuring system . . . . . 194
  - see Measuring device design
- System integration . . . . . 72
- T**
  - Technical data, overview . . . . . 194
  - Temperature range
    - Ambient temperature range for display . . . . . 214
    - Medium temperature . . . . . 209
    - Storage temperature . . . . . 19
  - Terminal assignment . . . . . 34
  - Terminals . . . . . 203
  - Tests and certificates . . . . . 219
  - Text editor . . . . . 53
  - Thermal insulation . . . . . 24
  - Tool
    - For mounting . . . . . 27
    - Transport . . . . . 19
  - Tool tip
    - see Help text
  - Tools
    - Electrical connection . . . . . 31
  - Totalizer
    - Configuring . . . . . 122
  - Transmitter
    - Turning the display module . . . . . 29
    - Turning the housing . . . . . 28
  - Transporting the measuring device . . . . . 19
  - Troubleshooting
    - General . . . . . 165
  - Turning the display module . . . . . 29
  - Turning the electronics housing
    - see Turning the transmitter housing
  - Turning the transmitter housing . . . . . 28
- U**
  - UKCA marking . . . . . 218
  - Use of measuring device
    - Borderline cases . . . . . 9
    - Incorrect use . . . . . 9
  - Use of measuring instrument
    - see Intended use
  - User roles . . . . . 47
- V**
  - Version data for the device . . . . . 72
  - Vibrations . . . . . 25
- W**
  - W@M Device Viewer . . . . . 15
  - Weight
    - SI units . . . . . 211

---

|   |             |
|---|-------------|
| Transport (notes) . . . . .               | 19          |
| US units . . . . .                        | 212         |
| Wizard                                    |             |
| Current input . . . . .                   | 87          |
| Current output . . . . .                  | 89          |
| Define access code . . . . .              | 134         |
| Density adjustment . . . . .              | 117         |
| Display . . . . .                         | 107         |
| Double pulse output . . . . .             | 106         |
| Low flow cut off . . . . .                | 112         |
| Medium selection . . . . .                | 84          |
| Partially filled pipe detection . . . . . | 113         |
| Pulse/frequency/switch output . . . . .   | 94, 96, 100 |
| Relay output 1 to n . . . . .             | 103         |
| Status input 1 to n . . . . .             | 88          |
| WLAN settings . . . . .                   | 131         |
| Zero adjustment . . . . .                 | 121         |
| Zero verification . . . . .               | 120         |
| WLAN settings . . . . .                   | 131         |
| Workplace safety . . . . .                | 10          |
| Write access . . . . .                    | 59          |
| Write protection                          |             |
| Via access code . . . . .                 | 139         |
| Via write protection switch . . . . .     | 140         |
| Write protection switch . . . . .         | 140         |



71674567

[www.addresses.endress.com](http://www.addresses.endress.com)

---