

Operating Instructions

Proline Promass A 500

FOUNDATION Fieldbus

Coriolis flowmeter

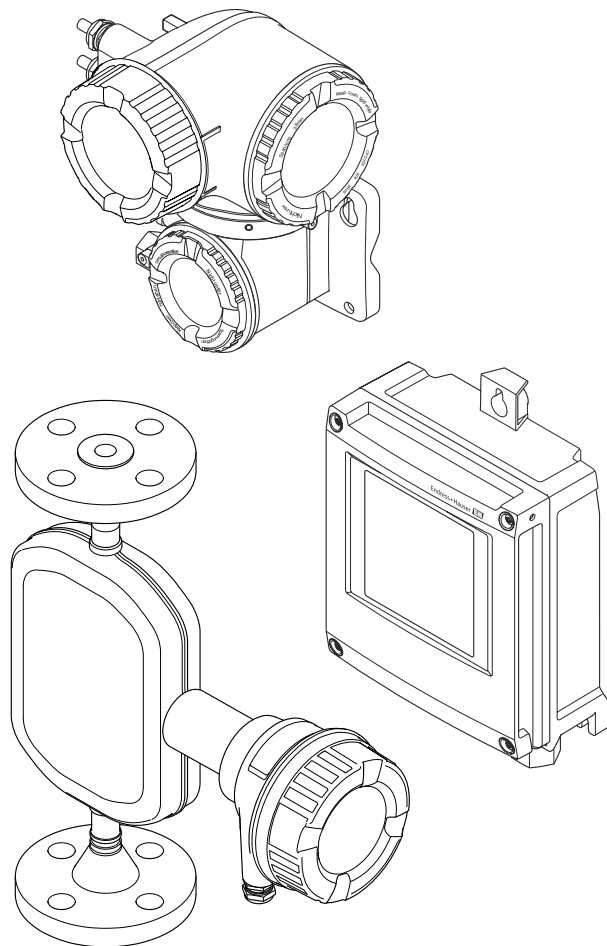

- Make sure the document is stored in a safe place such that it is always available when working on or with the device.
- To avoid danger to individuals or the facility, read the "Basic safety instructions" section carefully, as well as all other safety instructions in the document that are specific to working procedures.
- The manufacturer reserves the right to modify technical data without prior notice. Your Endress+Hauser sales organization will supply you with current information and updates to this manual.

Table of contents

| | | | | |
|----------|---|-----------|--|--|
| 1 | About this document | 6 | | |
| 1.1 | Document function | 6 | | |
| 1.2 | Symbols | 6 | | |
| 1.2.1 | Safety symbols | 6 | | |
| 1.2.2 | Electrical symbols | 6 | | |
| 1.2.3 | Communication-specific symbols | 6 | | |
| 1.2.4 | Tool symbols | 7 | | |
| 1.2.5 | Symbols for certain types of information | 7 | | |
| 1.2.6 | Symbols in graphics | 7 | | |
| 1.3 | Documentation | 8 | | |
| 1.4 | Registered trademarks | 8 | | |
| 2 | Safety instructions | 9 | | |
| 2.1 | Requirements for the personnel | 9 | | |
| 2.2 | Intended use | 9 | | |
| 2.3 | Workplace safety | 10 | | |
| 2.4 | Operational safety | 10 | | |
| 2.5 | Product safety | 10 | | |
| 2.6 | IT security | 11 | | |
| 2.7 | Device-specific IT security | 11 | | |
| 2.7.1 | Protecting access via hardware write protection | 11 | | |
| 2.7.2 | Protecting access via a password | 11 | | |
| 2.7.3 | Access via web server | 12 | | |
| 3 | Product description | 13 | | |
| 3.1 | Product design | 13 | | |
| 3.1.1 | Proline 500 – digital | 13 | | |
| 3.1.2 | Proline 500 | 14 | | |
| 4 | Incoming acceptance and product identification | 15 | | |
| 4.1 | Incoming acceptance | 15 | | |
| 4.2 | Product identification | 15 | | |
| 4.2.1 | Transmitter nameplate | 16 | | |
| 4.2.2 | Sensor nameplate | 18 | | |
| 4.2.3 | Symbols on the device | 19 | | |
| 5 | Storage and transport | 20 | | |
| 5.1 | Storage conditions | 20 | | |
| 5.2 | Transporting the product | 20 | | |
| 5.2.1 | Measuring devices without lifting lugs | 20 | | |
| 5.2.2 | Measuring devices with lifting lugs | 21 | | |
| 5.2.3 | Transporting with a fork lift | 21 | | |
| 5.3 | Packaging disposal | 21 | | |
| 6 | Installation | 21 | | |
| 6.1 | Mounting requirements | 21 | | |
| 6.1.1 | Installation position | 21 | | |
| 6.1.2 | Environmental and process requirements | 23 | | |
| 6.1.3 | Special installation instructions | 25 | | |
| 6.2 | Installing the measuring instrument | 29 | | |
| 6.2.1 | Required tools | 29 | | |
| 6.2.2 | Preparing the measuring instrument | 29 | | |
| 6.2.3 | Mounting the measuring device | 29 | | |
| 6.2.4 | Mounting the transmitter housing: Proline 500 – digital | 30 | | |
| 6.2.5 | Mounting the transmitter housing: Proline 500 | 32 | | |
| 6.2.6 | Turning the transmitter housing: Proline 500 | 33 | | |
| 6.2.7 | Turning the display module: Proline 500 | 33 | | |
| 6.3 | Post-installation check | 34 | | |
| 7 | Electrical connection | 35 | | |
| 7.1 | Electrical safety | 35 | | |
| 7.2 | Connecting requirements | 35 | | |
| 7.2.1 | Required tools | 35 | | |
| 7.2.2 | Requirements for connection cable | 35 | | |
| 7.2.3 | Terminal assignment | 40 | | |
| 7.2.4 | Available device plugs | 40 | | |
| 7.2.5 | device plug pin assignment | 41 | | |
| 7.2.6 | Shielding and grounding | 41 | | |
| 7.2.7 | Preparing the measuring device | 42 | | |
| 7.3 | Connecting the measuring instrument: Proline 500 - digital | 43 | | |
| 7.3.1 | Connecting the connecting cable | 43 | | |
| 7.3.2 | Connecting the signal cable and the supply voltage cable | 48 | | |
| 7.4 | Connecting the measuring instrument: Proline 500 | 50 | | |
| 7.4.1 | Fitting the connecting cable | 50 | | |
| 7.4.2 | Connecting the signal cable and the supply voltage cable | 54 | | |
| 7.5 | Potential equalization | 56 | | |
| 7.5.1 | Requirements | 56 | | |
| 7.6 | Special connection instructions | 57 | | |
| 7.6.1 | Connection examples | 57 | | |
| 7.7 | Ensuring the degree of protection | 60 | | |
| 7.8 | Post-connection check | 60 | | |
| 8 | Operation options | 61 | | |
| 8.1 | Overview of operation options | 61 | | |
| 8.2 | Structure and function of the operating menu | 62 | | |
| 8.2.1 | Structure of the operating menu | 62 | | |
| 8.2.2 | Operating philosophy | 63 | | |
| 8.3 | Access to operating menu via local display | 64 | | |
| 8.3.1 | Operational display | 64 | | |
| 8.3.2 | Navigation view | 67 | | |
| 8.3.3 | Editing view | 69 | | |

| | | | | | |
|-----------|--|------------|--|--|--|
| 8.3.4 | Operating elements | 71 | | | |
| 8.3.5 | Opening the context menu | 71 | | | |
| 8.3.6 | Navigating and selecting from list . . . | 73 | | | |
| 8.3.7 | Calling the parameter directly | 73 | | | |
| 8.3.8 | Calling up help text | 74 | | | |
| 8.3.9 | Changing the parameters | 74 | | | |
| 8.3.10 | User roles and related access authorization | 75 | | | |
| 8.3.11 | Disabling write protection via access code | 75 | | | |
| 8.3.12 | Enabling and disabling the keypad lock | 76 | | | |
| 8.4 | Access to operating menu via web browser . . . | 76 | | | |
| 8.4.1 | Function range | 76 | | | |
| 8.4.2 | Requirements | 77 | | | |
| 8.4.3 | Connecting the device | 78 | | | |
| 8.4.4 | Logging on | 80 | | | |
| 8.4.5 | User interface | 81 | | | |
| 8.4.6 | Disabling the Web server | 82 | | | |
| 8.4.7 | Logging out | 82 | | | |
| 8.5 | Access to the operating menu via the operating tool | 83 | | | |
| 8.5.1 | Connecting the operating tool | 83 | | | |
| 8.5.2 | Field Xpert SFX350, SFX370 | 86 | | | |
| 8.5.3 | FieldCare | 86 | | | |
| 8.5.4 | DeviceCare | 88 | | | |
| 8.5.5 | AMS Device Manager | 88 | | | |
| 8.5.6 | Field Communicator 475 | 88 | | | |
| 9 | System integration | 89 | | | |
| 9.1 | Overview of device description files | 89 | | | |
| 9.1.1 | Current version data for the device . . . | 89 | | | |
| 9.1.2 | Operating tools | 89 | | | |
| 9.2 | Cyclic data transmission | 89 | | | |
| 9.2.1 | Block model | 89 | | | |
| 9.2.2 | Description of the modules | 90 | | | |
| 9.2.3 | Execution times | 93 | | | |
| 9.2.4 | Methods | 94 | | | |
| 10 | Commissioning | 95 | | | |
| 10.1 | Post-mounting and post-connection check . . . | 95 | | | |
| 10.2 | Switching on the measuring device | 95 | | | |
| 10.3 | Connecting via FieldCare | 95 | | | |
| 10.4 | Setting the operating language | 95 | | | |
| 10.5 | Configuring the measuring instrument | 96 | | | |
| 10.5.1 | Defining the device tag | 97 | | | |
| 10.5.2 | Setting the system units | 97 | | | |
| 10.5.3 | Selecting and setting the medium . . | 100 | | | |
| 10.5.4 | Configuring the analog inputs | 102 | | | |
| 10.5.5 | Displaying the I/O configuration . . . | 102 | | | |
| 10.5.6 | Configuring the current input | 103 | | | |
| 10.5.7 | Configuring the status input | 104 | | | |
| 10.5.8 | Configuring the current output | 105 | | | |
| 10.5.9 | Configuring the pulse/frequency/ switch output | 108 | | | |
| 10.5.10 | Configuring the relay output | 115 | | | |
| 10.5.11 | Configuring the local display | 117 | | | |
| 10.5.12 | Configuring the low flow cut off | 120 | | | |
| 10.5.13 | Configuring partially filled pipe detection | 121 | | | |
| 10.6 | Advanced settings | 122 | | | |
| 10.6.1 | Using the parameter to enter the access code | 123 | | | |
| 10.6.2 | Calculated process variables | 123 | | | |
| 10.6.3 | Carrying out a sensor adjustment . . . | 124 | | | |
| 10.6.4 | Configuring the totalizer | 130 | | | |
| 10.6.5 | Carrying out additional display configurations | 132 | | | |
| 10.6.6 | WLAN configuration | 135 | | | |
| 10.6.7 | Configuration management | 136 | | | |
| 10.6.8 | Using parameters for device administration | 137 | | | |
| 10.7 | Simulation | 139 | | | |
| 10.8 | Protecting settings from unauthorized access | 142 | | | |
| 10.8.1 | Write protection via access code . . . | 142 | | | |
| 10.8.2 | Write protection via write protection switch | 144 | | | |
| 10.8.3 | Write protection via block operation | 146 | | | |
| 11 | Operation | 147 | | | |
| 11.1 | Reading off the device locking status | 147 | | | |
| 11.2 | Adjusting the operating language | 147 | | | |
| 11.3 | Configuring the display | 147 | | | |
| 11.4 | Reading off measured values | 147 | | | |
| 11.4.1 | "Measured variables" submenu | 148 | | | |
| 11.4.2 | "Totalizer" submenu | 150 | | | |
| 11.4.3 | "Input values" submenu | 151 | | | |
| 11.4.4 | Output values | 152 | | | |
| 11.5 | Adapting the measuring device to the process conditions | 154 | | | |
| 11.6 | Performing a totalizer reset | 154 | | | |
| 11.6.1 | Function scope of "Control Totalizer" parameter | 155 | | | |
| 11.6.2 | Function range of "Reset all totalizers" parameter | 155 | | | |
| 11.7 | Displaying the measured value history | 156 | | | |
| 12 | Diagnostics and troubleshooting . . | 159 | | | |
| 12.1 | General troubleshooting | 159 | | | |
| 12.2 | Diagnostic information via light emitting diodes | 161 | | | |
| 12.2.1 | Transmitter | 161 | | | |
| 12.2.2 | Sensor connection housing | 162 | | | |
| 12.3 | Diagnostic information on local display | 164 | | | |
| 12.3.1 | Diagnostic message | 164 | | | |
| 12.3.2 | Calling up remedial measures | 166 | | | |
| 12.4 | Diagnostic information in the web browser . . | 166 | | | |
| 12.4.1 | Diagnostic options | 166 | | | |
| 12.4.2 | Calling up remedy information | 167 | | | |
| 12.5 | Diagnostic information in FieldCare or DeviceCare | 167 | | | |
| 12.5.1 | Diagnostic options | 167 | | | |
| 12.5.2 | Calling up remedy information | 168 | | | |
| 12.6 | Adapting the diagnostic information | 169 | | | |
| 12.6.1 | Adapting the diagnostic behavior . . . | 169 | | | |
| 12.6.2 | Adapting the status signal | 169 | | | |

| | | | | | |
|-----------|---|------------|------------------------|--------------------------------------|-----|
| 12.7 | Overview of diagnostic information | 173 | 16.9 | Process | 225 |
| 12.7.1 | Diagnostic of sensor | 174 | 16.10 | Mechanical construction | 226 |
| 12.7.2 | Diagnostic of electronic | 176 | 16.11 | User interface | 230 |
| 12.7.3 | Diagnostic of configuration | 182 | 16.12 | Certificates and approvals | 234 |
| 12.7.4 | Diagnostic of process | 189 | 16.13 | Application packages | 237 |
| 12.8 | Pending diagnostic events | 194 | 16.14 | Accessories | 238 |
| 12.9 | Diagnostic messages in the DIAGNOSTIC Transducer Block | 195 | 16.15 | Supplemental documentation | 238 |
| 12.10 | Diagnostics list | 195 | Index | 240 | |
| 12.11 | Event logbook | 196 | | | |
| 12.11.1 | Reading out the event logbook | 196 | | | |
| 12.11.2 | Filtering the event logbook | 197 | | | |
| 12.11.3 | Overview of information events | 197 | | | |
| 12.12 | Resetting the measuring instrument | 198 | | | |
| 12.12.1 | Function range of "Restart" parameter | 198 | | | |
| 12.12.2 | Function range of "Service reset" parameter | 199 | | | |
| 12.13 | Device information | 199 | | | |
| 12.14 | Firmware history | 201 | | | |
| 13 | Maintenance | 202 | | | |
| 13.1 | Maintenance work | 202 | | | |
| 13.1.1 | Exterior cleaning | 202 | | | |
| 13.1.2 | Internal cleaning | 202 | | | |
| 13.2 | Measuring and test equipment | 202 | | | |
| 13.3 | Endress+Hauser services | 202 | | | |
| 14 | Repair | 203 | | | |
| 14.1 | General notes | 203 | | | |
| 14.1.1 | Repair and conversion concept | 203 | | | |
| 14.1.2 | Notes for repair and conversion | 203 | | | |
| 14.2 | Spare parts | 203 | | | |
| 14.3 | Endress+Hauser services | 203 | | | |
| 14.4 | Return | 203 | | | |
| 14.5 | Disposal | 204 | | | |
| 14.5.1 | Removing the measuring device | 204 | | | |
| 14.5.2 | Disposing of the measuring device | 204 | | | |
| 15 | Accessories | 205 | | | |
| 15.1 | Device-specific accessories | 205 | | | |
| 15.1.1 | For the transmitter | 205 | | | |
| 15.1.2 | For the sensor | 206 | | | |
| 15.2 | Communication-specific accessories | 206 | | | |
| 15.3 | Service-specific accessories | 207 | | | |
| 15.4 | System components | 208 | | | |
| 16 | Technical data | 209 | | | |
| 16.1 | Application | 209 | | | |
| 16.2 | Function and system design | 209 | | | |
| 16.3 | Input | 210 | | | |
| 16.4 | Output | 212 | | | |
| 16.5 | Power supply | 218 | | | |
| 16.6 | Performance characteristics | 219 | | | |
| 16.7 | Mounting | 223 | | | |
| 16.8 | Environment | 223 | | | |

1 About this document

1.1 Document function

These Operating Instructions contain all the information required in the various life cycle phases of the device: from product identification, incoming acceptance and storage, to installation, connection, operation and commissioning, through to troubleshooting, maintenance and disposal.

1.2 Symbols

1.2.1 Safety symbols

DANGER

This symbol alerts you to a dangerous situation. Failure to avoid this situation will result in serious or fatal injury.

WARNING

This symbol alerts you to a potentially dangerous situation. Failure to avoid this situation can result in serious or fatal injury.





CAUTION

This symbol alerts you to a potentially dangerous situation. Failure to avoid this situation can result in minor or medium injury.

NOTICE

This symbol alerts you to a potentially harmful situation. Failure to avoid this situation can result in damage to the product or something in its vicinity.



1.2.2 Electrical symbols

| Symbol | Meaning |
|---|--|
|  | Direct current |
|  | Alternating current |
|  | Direct current and alternating current |
|  | Ground connection A grounded terminal which, as far as the operator is concerned, is grounded via a grounding system. |
|  | Potential equalization connection (PE: protective earth) Ground terminals that must be connected to ground prior to establishing any other connections. The ground terminals are located on the interior and exterior of the device: <ul style="list-style-type: none"> ▪ Interior ground terminal: potential equalization is connected to the supply network. ▪ Exterior ground terminal: device is connected to the plant grounding system. |













1.2.3 Communication-specific symbols

| Symbol | Meaning |
|---|---|
|  | Wireless Local Area Network (WLAN) Communication via a wireless, local network. |



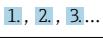

1.2.4 Tool symbols

| Symbol | Meaning |
|---|---------------------------|
|  | Torx screwdriver |
|  | Phillips head screwdriver |
|  | Open-ended wrench |

1.2.5 Symbols for certain types of information

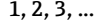
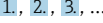
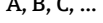
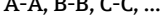
| Symbol | Meaning |
|---|--|
|  | Permitted Procedures, processes or actions that are permitted. |
|  | Preferred Procedures, processes or actions that are preferred. |
|  | Forbidden Procedures, processes or actions that are forbidden. |
|  | Tip Indicates additional information. |
|  | Reference to documentation |
|  | Reference to page |
|  | Reference to graphic |
|  | Notice or individual step to be observed |
|  | Series of steps |
|  | Result of a step |
|  | Help in the event of a problem |
|  | Visual inspection |

1.2.6 Symbols in graphics

| Symbol | Meaning |
|---|--------------------------------|
|  | Item numbers |
|  | Series of steps |
|  | Views |
|  | Sections |
|  | Hazardous area |
|  | Safe area (non-hazardous area) |
|  | Flow direction |

1.3 Documentation

 For an overview of the scope of the associated Technical Documentation, refer to the following:

- *Device Viewer* (www.endress.com/deviceviewer): Enter the serial number from the nameplate
- *Endress+Hauser Operations app*: Enter serial number from nameplate or scan matrix code on nameplate.

The following documentation may be available depending on the device version ordered:

| Document type | Purpose and content of the document |
|--|---|
| Technical Information (TI) | Planning aid for your device The document contains all the technical data on the device and provides an overview of the accessories and other products that can be ordered for the device. |
| Brief Operating Instructions (KA) | Guide that takes you quickly to the 1st measured value The Brief Operating Instructions contain all the essential information from incoming acceptance to initial commissioning. |
| Operating Instructions (BA) | Your reference document These Operating Instructions contain all the information that is required in the various life cycle phases of the device: from product identification, incoming acceptance and storage, to mounting, connection, operation and commissioning, through to troubleshooting, maintenance and disposal. |
| Description of Device Parameters (GP) | Reference for your parameters The document provides a detailed explanation of each individual parameter. The description is aimed at those who work with the device over the entire life cycle and perform specific configurations. |
| Safety Instructions (XA) | Depending on the approval, safety instructions for electrical equipment in hazardous areas are also supplied with the device. The Safety Instructions are a constituent part of the Operating Instructions.  Information on the Safety Instructions (XA) that are relevant for the device is provided on the nameplate. |
| Supplementary device-dependent documentation (SD/FY) | Always comply strictly with the instructions in the relevant supplementary documentation. The supplementary documentation is a constituent part of the device documentation. |

1.4 Registered trademarks

FOUNDATION™ Fieldbus

Registration-pending trademark of the FieldComm Group, Austin, Texas, USA

TRI-CLAMP®

Registered trademark of Ladish & Co., Inc., Kenosha, USA

2 Safety instructions

2.1 Requirements for the personnel

The personnel for installation, commissioning, diagnostics and maintenance must fulfill the following requirements:

- ▶ Trained, qualified specialists must have a relevant qualification for this specific function and task.
- ▶ Are authorized by the plant owner/operator.
- ▶ Are familiar with federal/national regulations.
- ▶ Before starting work, read and understand the instructions in the manual and supplementary documentation as well as the certificates (depending on the application).
- ▶ Follow instructions and comply with basic conditions.

The operating personnel must fulfill the following requirements:

- ▶ Are instructed and authorized according to the requirements of the task by the facility's owner-operator.
- ▶ Follow the instructions in this manual.

2.2 Intended use

Application and media

The measuring instrument described in this manual is intended only for the flow measurement of liquids and gases.

Depending on the version ordered, the measuring instrument can also be used to measure potentially explosive ¹⁾, flammable, toxid and oxidizing media.

Measuring instruments for use in hazardous areas, in hygienic applications, or where there is an increased risk due to pressure, are specially labeled on the nameplate.

To ensure that the measuring instrument is in perfect condition during operation:

- ▶ Only use the measuring instrument in full compliance with the data on the nameplate and the general conditions listed in the Operating Instructions and supplementary documentation.
- ▶ Using the nameplate, check whether the ordered device is permitted for the intended use in the hazardous area (e.g. explosion protection, pressure vessel safety).
- ▶ Use the measuring instrument only for media to which the process-wetted materials are sufficiently resistant.
- ▶ Keep within the specified pressure and temperature range.
- ▶ Keep within the specified ambient temperature range.
- ▶ Protect the measuring instrument permanently against corrosion from environmental influences.

Incorrect use

Non-designated use can compromise safety. The manufacturer is not liable for damage caused by improper or non-designated use.

WARNING

Danger of breakage due to corrosive or abrasive fluids and ambient conditions!

- ▶ Verify the compatibility of the process fluid with the sensor material.
- ▶ Ensure the resistance of all fluid-wetted materials in the process.
- ▶ Keep within the specified pressure and temperature range.

1) Not applicable for IO-Link measuring instruments

NOTICE**Verification for borderline cases:**

- ▶ For special fluids and fluids for cleaning, Endress+Hauser is glad to provide assistance in verifying the corrosion resistance of fluid-wetted materials, but does not accept any warranty or liability as minute changes in the temperature, concentration or level of contamination in the process can alter the corrosion resistance properties.

Residual risks**⚠ CAUTION**

Risk of hot or cold burns! The use of media and electronics with high or low temperatures can produce hot or cold surfaces on the device.

- ▶ Mount suitable touch protection.

⚠ WARNING

Danger of housing breaking due to measuring tube breakage!

If a measuring tube ruptures, the pressure inside the sensor housing will rise according to the operating process pressure.

- ▶ Use a rupture disk.

⚠ WARNING

Danger from medium escaping!

For device versions with a rupture disk: medium escaping under pressure can cause injury or material damage.

- ▶ Take precautions to prevent injury and material damage if the rupture disk is actuated.

2.3 Workplace safety

When working on and with the device:

- ▶ Wear the required personal protective equipment as per national regulations.

2.4 Operational safety

Damage to the device!

- ▶ Operate the device in proper technical condition and fail-safe condition only.
- ▶ The operator is responsible for the interference-free operation of the device.

Modifications to the device

Unauthorized modifications to the device are not permitted and can lead to unforeseeable dangers!

- ▶ If modifications are nevertheless required, consult with the manufacturer.

Repair

To ensure continued operational safety and reliability:

- ▶ Carry out repairs on the device only if they are expressly permitted.
- ▶ Observe federal/national regulations pertaining to the repair of an electrical device.
- ▶ Use only original spare parts and accessories.

2.5 Product safety

This measuring device is designed in accordance with good engineering practice to meet state-of-the-art safety requirements, has been tested, and left the factory in a condition in which it is safe to operate.

It meets general safety standards and legal requirements. It also complies with the EU directives listed in the device-specific EU Declaration of Conformity. The manufacturer confirms this by affixing the CE mark to the device..





2.6 IT security

The manufacturer warranty is valid only if the product is installed and used as described in the Operating Instructions. The product is equipped with security mechanisms to protect it against any inadvertent changes to the settings.

IT security measures, which provide additional protection for the product and associated data transfer, must be implemented by the operators themselves in line with their security standards.

2.7 Device-specific IT security

The device offers a range of specific functions to support protective measures on the operator's side. These functions can be configured by the user and guarantee greater in-operation safety if used correctly. The following list provides an overview of the most important functions:

| Function/interface | Factory setting | Recommendation |
|---|--------------------|---|
| Write protection via hardware write protection switch →  11 | Not enabled | On an individual basis following risk assessment |
| Access code (also applies to web server login or FieldCare connection) →  12 | Not enabled (0000) | Assign a customized access code during commissioning |
| WLAN (order option in display module) | Enabled | On an individual basis following risk assessment |
| WLAN security mode | Enabled (WPA2-PSK) | Do not change |
| WLAN passphrase (Password) →  12 | Serial number | Assign an individual WLAN passphrase during commissioning |
| WLAN mode | Access point | On an individual basis following risk assessment |
| Web server →  12 | Enabled | On an individual basis following risk assessment |
| Service interface CDI-RJ45 | – | On an individual basis following risk assessment |

2.7.1 Protecting access via hardware write protection

Write access to the parameters of the device via the local display, web browser or operating tool (e.g. FieldCare, DeviceCare) can be disabled via a write protection switch (DIP switch on the main electronics module). When hardware write protection is enabled, only read access to the parameters is possible.

Hardware write protection is disabled when the device is delivered →  144.

2.7.2 Protecting access via a password

Different passwords are available to protect write access to the device parameters or access to the device via the WLAN interface.

- **User-specific access code**
Protect write access to the device parameters via the local display, web browser or operating tool (e.g. FieldCare, DeviceCare). Access authorization is clearly regulated through the use of a user-specific access code.
- **WLAN passphrase**
The network key protects a connection between an operating unit (e.g. notebook or tablet) and the device via the WLAN interface which can be ordered as an option.
- **Infrastructure mode**
When the device is operated in infrastructure mode, the WLAN passphrase corresponds to the WLAN passphrase configured on the operator side.

User-specific access code

Write access to the device parameters via the local display, web browser or operating tool (e.g. FieldCare, DeviceCare) can be protected by the modifiable, user-specific access code (→  142).

When the device is delivered, the device does not have an access code and is equivalent to 0000 (open).

WLAN passphrase: Operation as WLAN access point

A connection between an operating unit (e.g. notebook or tablet) and the device via the WLAN interface (→  84), which can be ordered as an optional extra, is protected by the network key. The WLAN authentication of the network key complies with the IEEE 802.11 standard.

When the device is delivered, the network key is pre-defined depending on the device. It can be changed via the **WLAN settings** submenu in the **WLAN passphrase** parameter (→  135).

Infrastructure mode

A connection between the device and WLAN access point is protected by means of an SSID and passphrase on the system side. Please contact the relevant system administrator for access.

General notes on the use of passwords

- The access code and network key supplied with the device should be changed during commissioning for safety reasons.
- Follow the general rules for generating a secure password when defining and managing the access code and network key.
- The user is responsible for the management and careful handling of the access code and network key.
- For information on configuring the access code or on what to do if you lose the password, for example, see "Write protection via access code" →  142.

2.7.3 Access via web server

The integrated web server can be used to operate and configure the device via a web browser →  76. The connection is established via the service interface (CDI-RJ45) or the WLAN interface.

The web server is enabled when the device is delivered. The web server can be disabled via the **Web server functionality** parameter if necessary (e.g., after commissioning).

The device and status information can be hidden on the login page. This prevents unauthorized access to the information.



Detailed information on the device parameters:
"Description of device parameters" document .

3 Product description

The measuring system consists of a transmitter and a sensor. The transmitter and sensor are mounted in physically separate locations. They are interconnected by connecting cables.

3.1 Product design

Two versions of the transmitter are available.

3.1.1 Proline 500 – digital

Signal transmission: digital

Order code for "Integrated ISEM electronics", option **A** "Sensor"

For use in applications not required to meet special requirements due to ambient or operating conditions.

As the electronics are located in the sensor, the device is ideal:
For simple transmitter replacement.

- A standard cable can be used as the connecting cable.
- Not sensitive to external EMC interference.

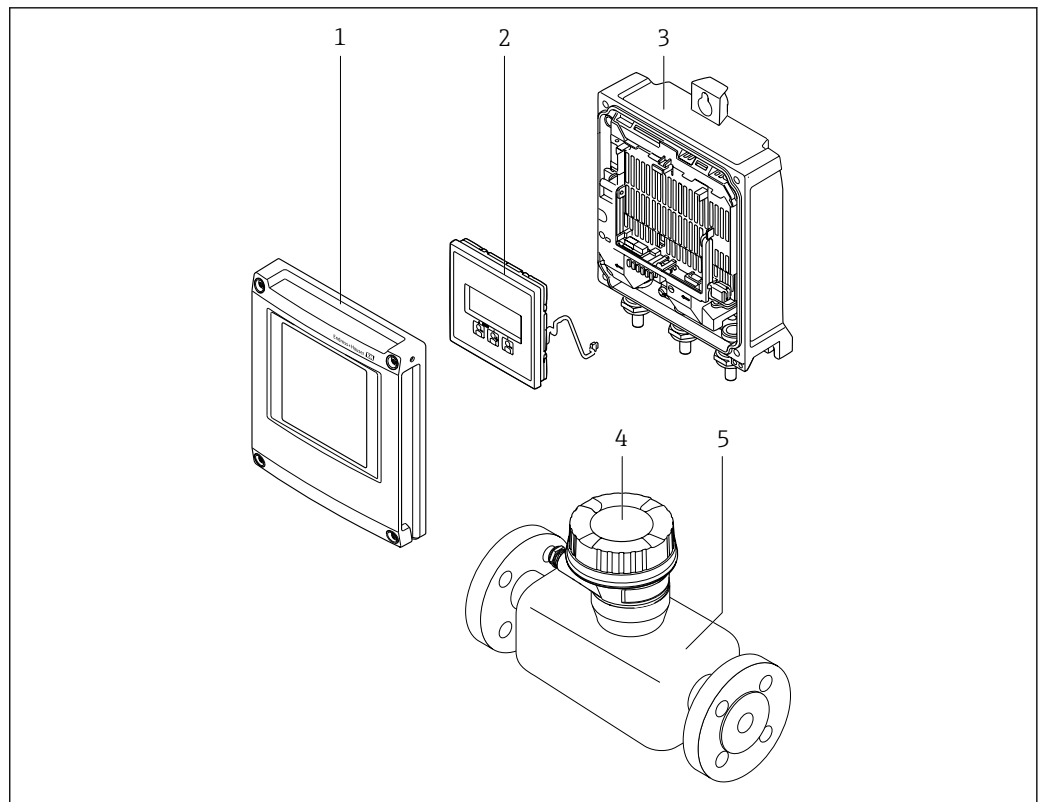

A0029593

1 Important components of a measuring device

- 1 Electronics compartment cover
- 2 Display module
- 3 Transmitter housing
- 4 Sensor connection housing with integrated ISEM electronics: connecting cable connection
- 5 Sensor

3.1.2 Proline 500

Signal transmission: analog

Order code for "Integrated ISEM electronics", option **B** "Transmitter"

For use in applications required to meet special requirements due to ambient or operating conditions.

As the electronics are located in the transmitter, the device is ideal in the event of:

- Strong vibrations at the sensor.
- Sensor operation in underground installations.
- Permanent sensor immersion in water.

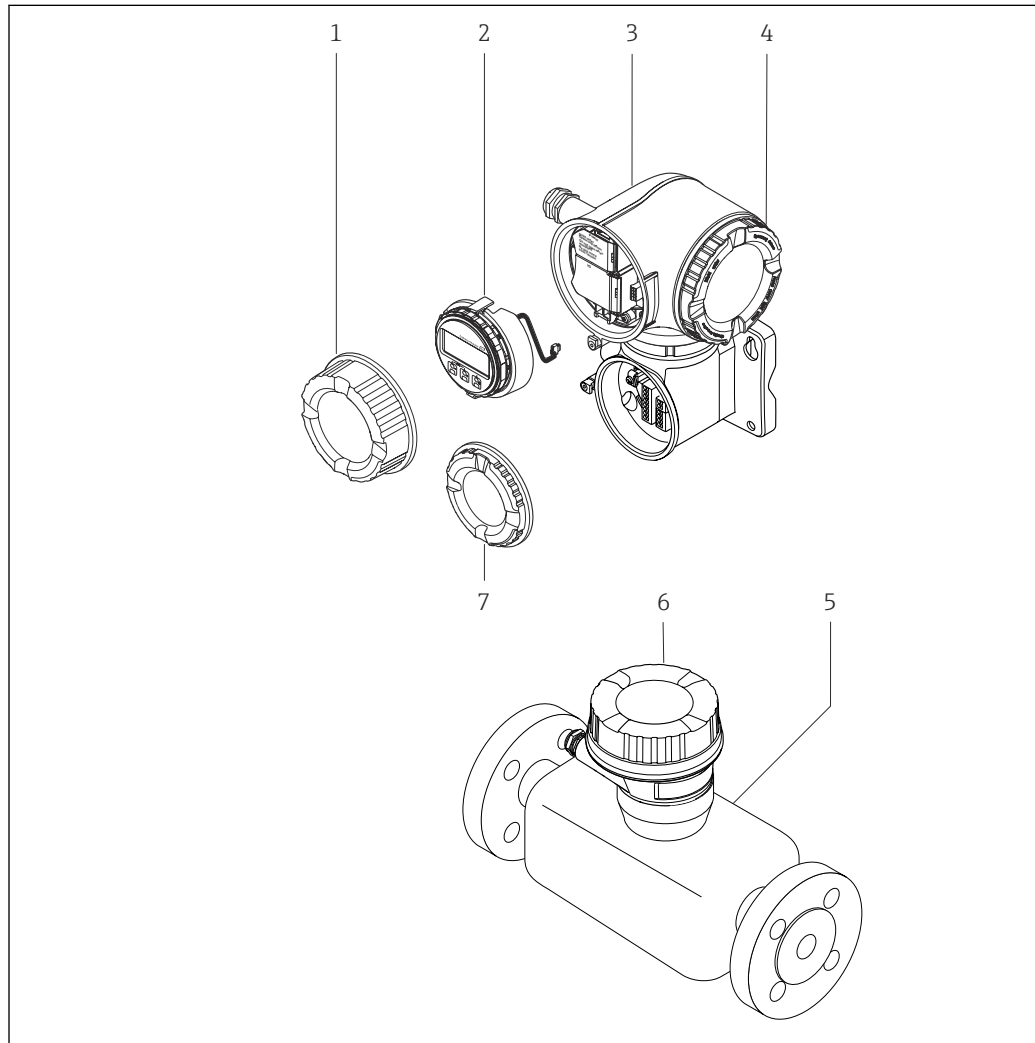

A0029589

2 Important components of a measuring device

- 1 Connection compartment cover
- 2 Display module
- 3 Transmitter housing with integrated ISEM electronics
- 4 Electronics compartment cover
- 5 Sensor
- 6 Sensor connection housing: connecting cable connection
- 7 Connection compartment cover: connecting cable connection

4 Incoming acceptance and product identification

4.1 Incoming acceptance

On receipt of the delivery:

1. Check the packaging for damage.
 - ↳ Report all damage immediately to the manufacturer.
Do not install damaged components.
2. Check the scope of delivery using the delivery note.
3. Compare the data on the nameplate with the order specifications on the delivery note.
4. Check the technical documentation and all other necessary documents, e.g. certificates, to ensure they are complete.

 If one of the conditions is not satisfied, contact the manufacturer.

4.2 Product identification

The device can be identified in the following ways:

- Nameplate
- Order code with details of the device features on the delivery note
- Enter the serial numbers from the nameplates in the *Device Viewer* (www.endress.com/deviceviewer): all the information about the device is displayed.
- Enter the serial numbers from the nameplates into the *Endress+Hauser Operations app* or scan the DataMatrix code on the nameplate with the *Endress+Hauser Operations app*: all the information about the device is displayed.

For an overview of the scope of the associated Technical Documentation, refer to the following:

- The "Additional standard device documentation" and "Supplementary device-dependent documentation" sections
- The *Device Viewer*: Enter the serial number from the nameplate (www.endress.com/deviceviewer)
- The *Endress+Hauser Operations app*: Enter the serial number from the nameplate or scan the DataMatrix code on the nameplate.

4.2.1 Transmitter nameplate

Proline 500 – digital

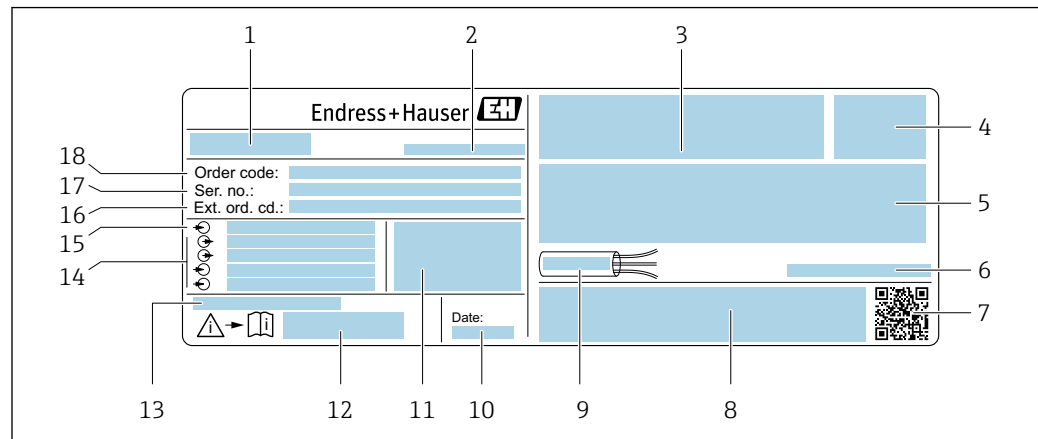

A0029194

3 Example of a transmitter nameplate

- 1 Name of the transmitter
- 2 Manufacturer address/certificate holder
- 3 Space for approvals: Use in hazardous areas
- 4 Degree of protection
- 5 Electrical connection data: available inputs and outputs
- 6 Allowable ambient temperature (T_a)
- 7 2-D matrix code
- 8 Space for approvals and certificates: e.g. CE mark, RCM tick
- 9 Permitted temperature range for cable
- 10 Date of manufacture: year-month
- 11 Firmware version (FW) and device revision (Dev. rev.) from the factory
- 12 Document number of safety-related supplementary documentation
- 13 Space for additional information in the case of special products
- 14 Available inputs and outputs, supply voltage
- 15 Electrical connection data: supply voltage
- 16 Extended order code (Ext. ord. cd.)
- 17 Serial number (Ser. no.)
- 18 Order code

Proline 500

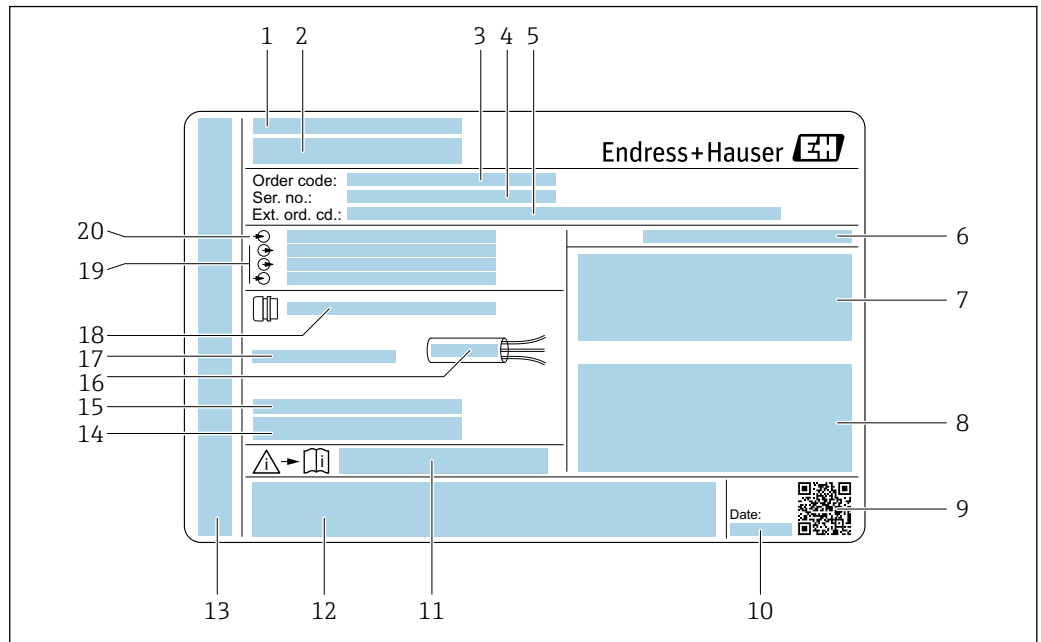

A0029192

4 Example of a transmitter nameplate

- 1 Manufacturer address/certificate holder
- 2 Name of the transmitter
- 3 Order code
- 4 Serial number (Ser. no.)
- 5 Extended order code (Ext. ord. cd.)
- 6 Degree of protection
- 7 Space for approvals: use in hazardous areas
- 8 Electrical connection data: available inputs and outputs
- 9 2-D matrix code
- 10 Date of manufacture: year-month
- 11 Document number of safety-related supplementary documentation
- 12 Space for approvals and certificates: e.g. CE mark, RCM tick
- 13 Space for degree of protection of connection and electronics compartment when used in hazardous areas
- 14 Firmware version (FW) and device revision (Dev. rev.) from the factory
- 15 Space for additional information in the case of special products
- 16 Permitted temperature range for cable
- 17 Allowable ambient temperature (T_a)
- 18 Information on cable gland
- 19 Available inputs and outputs, supply voltage
- 20 Electrical connection data: supply voltage

4.2.2 Sensor nameplate

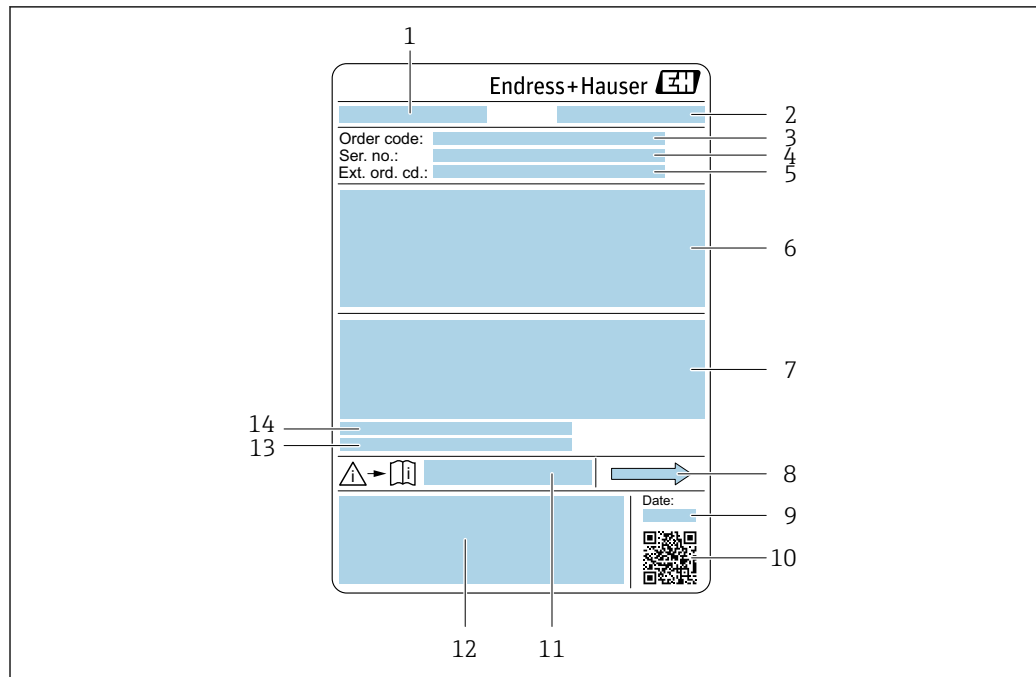

A0029199

5 Example of a sensor nameplate

- 1 Name of the sensor
- 2 Manufacturer address/certificate holder
- 3 Order code
- 4 Serial number (Ser. no.)
- 5 Extended order code (Ext. ord. cd.)
- 6 Nominal diameter of the sensor; flange nominal diameter/nominal pressure; sensor test pressure; medium temperature range; material of measuring tube and manifold; sensor-specific information: e.g. pressure range of sensor housing, wide-range density specification (special density calibration)
- 7 Approval information for explosion protection, Pressure Equipment Directive and degree of protection
- 8 Flow direction
- 9 Date of manufacture: year-month
- 10 2-D matrix code
- 11 Document number of safety-related supplementary documentation
- 12 CE mark, RCM-Tick mark
- 13 Surface roughness
- 14 Allowable ambient temperature (T_a)





Order code

The measuring device is reordered using the order code.

Extended order code

- The device type (product root) and basic specifications (mandatory features) are always listed.
- Of the optional specifications (optional features), only the safety and approval-related specifications are listed (e.g. LA). If other optional specifications are also ordered, these are indicated collectively using the # placeholder symbol (e.g. #LA#).
- If the ordered optional specifications do not include any safety and approval-related specifications, they are indicated by the + placeholder symbol (e.g. XXXXXX-ABCDE +).

4.2.3 Symbols on the device

| Symbol | Meaning |
|---|---|
|  | WARNING! This symbol alerts you to a dangerous situation. Failure to avoid this situation can result in serious or fatal injury. Please consult the documentation for the measuring instrument to discover the type of potential danger and measures to avoid it. |
|  | Reference to documentation Refers to the corresponding device documentation. |
|  | Protective ground connection A terminal that must be connected to the ground prior to establishing any other connections. |

5 Storage and transport

5.1 Storage conditions

Observe the following notes for storage:

- ▶ Store in the original packaging to ensure protection from shock.
- ▶ Do not remove protective covers or protective caps installed on process connections. They prevent mechanical damage to the sealing surfaces and contamination in the measuring tube.
- ▶ Protect from direct sunlight. Avoid unacceptably high surface temperatures.
- ▶ Store in a dry and dust-free place.
- ▶ Do not store outdoors.

Storage temperature → 📄 223

5.2 Transporting the product

Transport the measuring device to the measuring point in the original packaging.

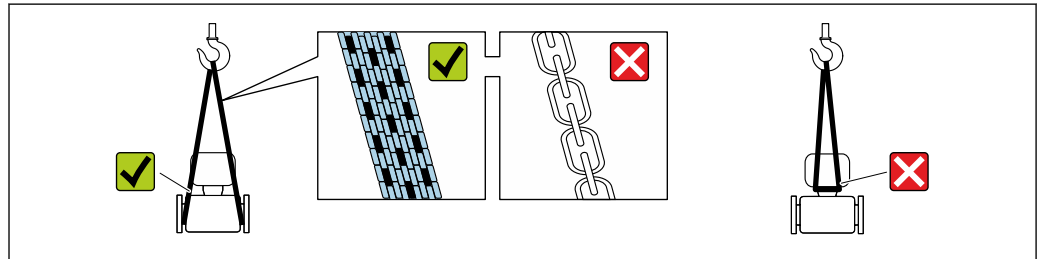

A0029252

i Do not remove protective covers or caps installed on process connections. They prevent mechanical damage to the sealing surfaces and contamination in the measuring tube.

5.2.1 Measuring devices without lifting lugs

⚠ WARNING

Center of gravity of the measuring device is higher than the suspension points of the webbing slings.

Risk of injury if the measuring device slips.

- ▶ Secure the measuring device against slipping or turning.
- ▶ Observe the weight specified on the packaging (stick-on label).

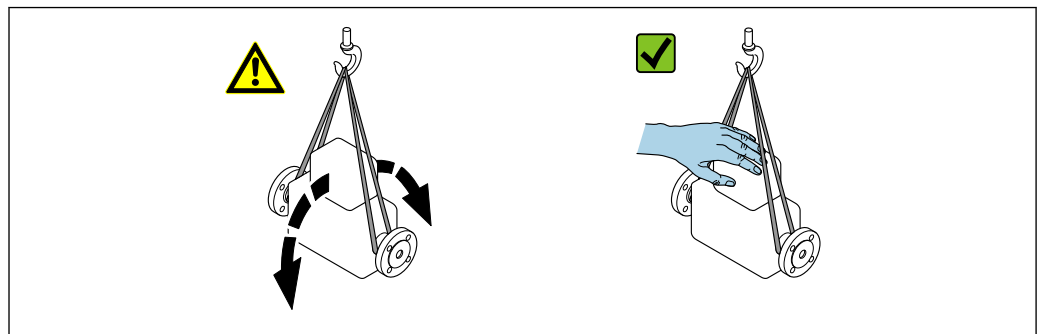

A0029214

5.2.2 Measuring devices with lifting lugs

⚠ CAUTION

Special transportation instructions for devices with lifting lugs

- ▶ Only use the lifting lugs fitted on the device or flanges to transport the device.
- ▶ The device must always be secured at two lifting lugs at least.

5.2.3 Transporting with a fork lift

If transporting in wood crates, the floor structure enables the crates to be lifted lengthwise or at both sides using a forklift.

5.3 Packaging disposal

All packaging materials are environmentally friendly and 100% recyclable:

- Outer packaging of device
 - Stretch wrap made of polymer in accordance with EU Directive 2002/95/EC (RoHS)
- Packaging
 - Wood crate treated in accordance with ISPM 15 standard, confirmed by IPPC logo
 - Cardboard box in accordance with European packaging guideline 94/62/EC, recyclability confirmed by Resy symbol
- Transport material and fastening fixtures
 - Disposable plastic pallet
 - Plastic straps
 - Plastic adhesive strips
- Filler material
 - Paper pads

6 Installation

6.1 Mounting requirements

6.1.1 Installation position

Installation point

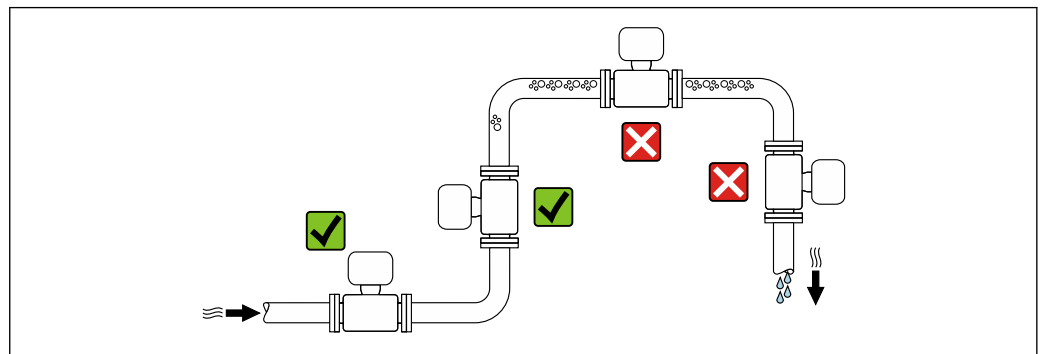

A0028772

To prevent measuring errors arising from accumulation of gas bubbles in the measuring pipe, avoid the following mounting locations in the piping:

- Highest point of a pipeline.
- Directly upstream of a free pipe outlet in a down pipe.

Installation in down pipes

However, the following installation suggestion allows for installation in an open vertical pipeline. Pipe restrictions or the use of an orifice with a smaller cross-section than the nominal diameter prevent the sensor running empty while measurement is in progress.

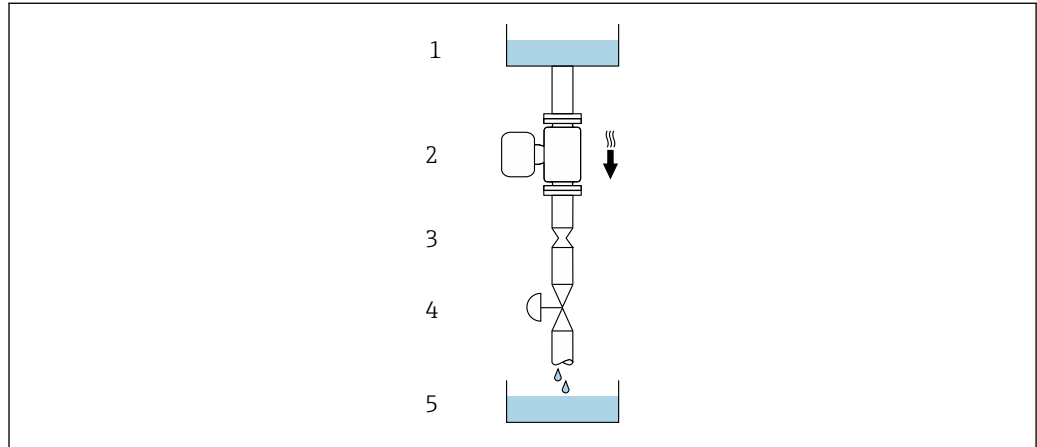

6 Installation in a down pipe (e.g. for batching applications)

- 1 Supply tank
- 2 Sensor
- 3 Orifice plate, pipe restriction
- 4 Valve
- 5 Filling vessel

| DN | | Ø orifice plate, pipe restriction | |
|------|------|-----------------------------------|------|
| [mm] | [in] | [mm] | [in] |
| 1 | 1/24 | 0.8 | 0.03 |
| 2 | 1/12 | 1.5 | 0.06 |
| 4 | 1/8 | 3.0 | 0.12 |

Orientation

The direction of the arrow on the sensor nameplate helps you to install the sensor according to the flow direction (direction of medium flow through the piping).

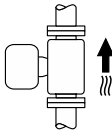
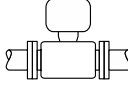
| Orientation | | Recommendation |
|-------------|--|--|
| A | Vertical orientation |  <input checked="" type="checkbox"/> <input checked="" type="checkbox"/> ¹⁾ |
| B | Horizontal orientation, transmitter at top |  <input checked="" type="checkbox"/> ²⁾ |

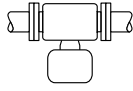
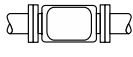
| Orientation | | Recommendation |
|-------------|--|---|
| C | Horizontal orientation, transmitter at bottom  | <input checked="" type="checkbox"/> ³⁾ |
| D | Horizontal orientation, transmitter at side  | <input checked="" type="checkbox"/> |

- 1) This orientation is recommended to ensure self-draining.
- 2) Applications with low process temperatures may reduce the ambient temperature. To maintain the minimum ambient temperature for the transmitter, this orientation is recommended.
- 3) Applications with high process temperatures may increase the ambient temperature. To maintain the maximum ambient temperature for the transmitter, this orientation is recommended.

If a sensor is installed horizontally with a curved measuring tube, match the position of the sensor to the fluid properties.

Inlet and outlet runs

No special precautions need to be taken for fittings that create turbulence, such as valves, elbows or T-pieces, as long as no cavitation occurs → 23.

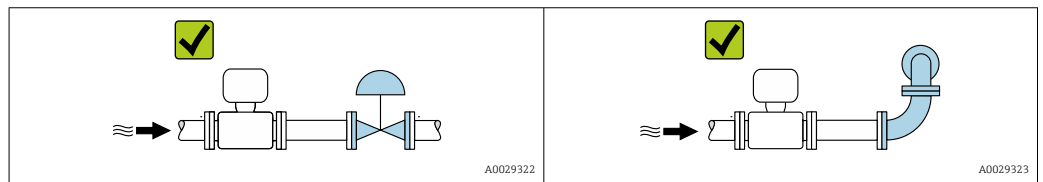

Installation dimensions

 For the dimensions and installation lengths of the device, see the "Technical Information" document, "Mechanical construction" section

6.1.2 Environmental and process requirements

Ambient temperature range

| | |
|----------------------------------|---|
| Measuring device | <ul style="list-style-type: none"> ■ -40 to +60 °C (-40 to +140 °F) ■ Order code for "Test, certificate", option JP: -50 to +60 °C (-58 to +140 °F) |
| Readability of the local display | -20 to +60 °C (-4 to +140 °F) The readability of the display may be impaired at temperatures outside the temperature range. |

 Dependency of ambient temperature on medium temperature → 225

- ▶ If operating outdoors:
Avoid direct sunlight, particularly in warm climatic regions.

Static pressure

It is important that cavitation does not occur, or that gases entrained in the liquids do not outgas.

Cavitation is caused if the pressure drops below the vapor pressure:

- In liquids that have a low boiling point (e.g. hydrocarbons, solvents, liquefied gases)
 - In suction lines
- ▶ Ensure the static pressure is sufficiently high to prevent cavitation and outgassing.

For this reason, the following mounting locations are recommended:

- At the lowest point in a vertical pipe
- Downstream from pumps (no danger of vacuum)

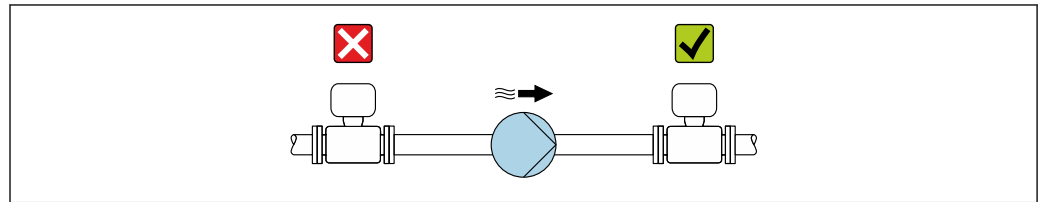

A0028777

Thermal insulation

In the case of some fluids, it is important to keep the heat radiated from the sensor to the transmitter to a low level. A wide range of materials can be used for the required insulation.

NOTICE

Electronics overheating on account of thermal insulation!

- ▶ Recommended orientation: horizontal orientation, sensor connection housing pointing downwards.
- ▶ Do not insulate the sensor connection housing.
- ▶ Maximum permissible temperature at the lower end of the sensor connection housing: 80 °C (176 °F)
- ▶ Regarding thermal insulation with an exposed extended neck: We advise against insulating the extended neck to ensure optimal heat dissipation.

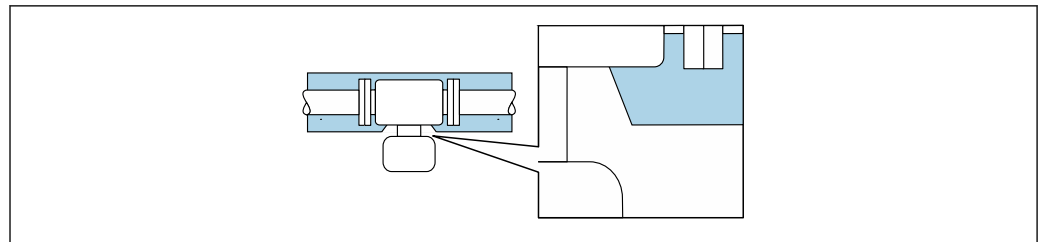

A0034391

7 Thermal insulation with exposed extended neck

Heating

NOTICE

Electronics can overheat due to elevated ambient temperature!

- ▶ Observe maximum permitted ambient temperature for the transmitter.
- ▶ Depending on the medium temperature, take the device orientation requirements into account.

NOTICE**Danger of overheating when heating**

- ▶ Ensure that the temperature at the lower end of the transmitter housing does not exceed 80 °C (176 °F).
- ▶ Ensure that sufficient convection takes place at the transmitter neck.
- ▶ Ensure that a sufficiently large area of the transmitter neck remains exposed. The uncovered part serves as a radiator and protects the electronics from overheating and excessive cooling.
- ▶ When using in potentially explosive atmospheres, observe the information in the device-specific Ex documentation. For detailed information on the temperature tables, see the separate document entitled "Safety Instructions" (XA) for the device.
- ▶ Consider the "830 ambient temperature too high" and "832 electronics temperature too high" process diagnostics if overheating cannot be ruled out based on a suitable system design.

Heating options

If a fluid requires that no heat loss should occur at the sensor, users can avail of the following heating options:

- Electrical heating, e.g. with electric band heaters ²⁾
- Via pipes carrying hot water or steam
- Via heating jackets



Vibrations

The high oscillation frequency of the measuring tubes ensures that the correct operation of the measuring system is not influenced by plant vibrations.

6.1.3 Special installation instructions**Drainability**

When the device is installed in a vertical position, the measuring tube can be drained completely and protected against deposit buildup if the properties of the measured liquid allow this. Furthermore, as only one measuring tube is used the flow is not impeded and the risk of product being retained in the measuring device is reduced to a minimum. The larger internal diameter of the measuring tube ³⁾ also reduces the risk of particles getting trapped in the measuring system. Due to the larger cross-section of the individual measuring tube, the tube is also generally less susceptible to clogging.

Hygienic compatibility

 When installing in hygienic applications, please refer to the information in the "Certificates and approvals/hygienic compatibility" section →  235

Rupture disk

Process-related information: →  225.

2) The use of parallel electric band heaters is generally recommended (bidirectional electricity flow). Particular considerations must be made if a single-wire heating cable is to be used. For additional information, refer to EA01339D "Installation Instructions for Electrical Trace Heating Systems".

3) Compared with the double-tube design with a similar flow capacity and measuring tubes with a smaller internal diameter

⚠ WARNING**Danger from medium escaping!**

Medium escaping under pressure can cause injury or material damage.

- ▶ Take precautions to prevent danger to persons and damage if the rupture disk is actuated.
- ▶ Observe the information on the rupture disk sticker.
- ▶ Make sure that the function and operation of the rupture disk is not impeded through the installation of the device.
- ▶ Do not remove or damage the rupture disk, drain connection and warning signs.

The position of the rupture disk is indicated by an affixed sticker. In versions without a drain connection (order option CU), the sticker is destroyed if the rupture disk is triggered. The disk can therefore be visually monitored.

To allow any escaping medium to drain in a controlled manner, a drain connection is available for the rupture disk integrated in the sensor: order code for "Sensor option", option CU "Drain connection for rupture disk". This connection is intended for a pipe connection with a 1/4" NPT thread and sealed with a grip plug for protection. To guarantee the function of the rupture disk with a drain connection, the drain connection must be connected to the drain system in a hermetically tight manner.

- i** The drain connection is firmly mounted in place by the manufacturer and may not be removed.
- i** It is not possible to use the holder with a measuring device with a drain connection for a rupture disk: order code for "Sensor option", option CU "Drain connection for rupture disk"
- i** It is not possible to use a heating jacket if the drain connection is used: order code for "Sensor option", option CU "Drain connection for rupture disk"

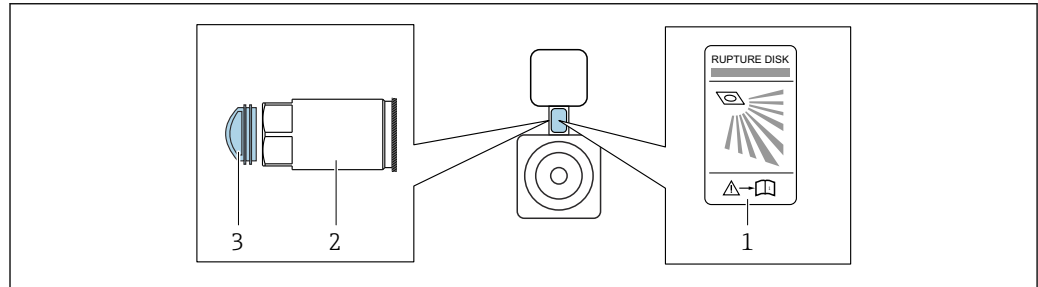

A0042344

- 1 Rupture disk label
- 2 Drain connection for rupture disk with 1/4" NPT internal thread and 17mm width across flats (AF): order code for "Sensor option", option CU, drain connection for rupture disk
- 3 Transportation guard

- i** For information on the dimensions, see the "Technical Information" document, "Mechanical construction" section (accessories).

Zero verification and zero adjustment

All measuring instruments are calibrated in accordance with state-of-the-art technology. Calibration takes place under reference conditions → 219. Therefore, a zero adjustment in the field is generally not required.

Experience shows that zero adjustment is advisable only in special cases:

- To achieve maximum measurement accuracy even with low flow rates.
- Under extreme process or operating conditions (e.g. very high process temperatures or very high-viscosity fluids).
- For gas applications with low pressure

- i** To achieve the highest possible measurement accuracy at low flow rates, the installation must protect the sensor from mechanical stresses during operation.

To get a representative zero point, ensure that:

- any flow in the device is prevented during the adjustment
- the process conditions (e.g. pressure, temperature) are stable and representative

Verification and adjustment cannot be carried out if the following process conditions are present:

- Gas pockets

Ensure that the system has been sufficiently flushed with the medium. Repeat flushing can help to eliminate gas pockets

- Thermal circulation

In the event of temperature differences (e.g. between the measuring tube inlet and outlet section), induced flow can occur even if the valves are closed due to thermal circulation in the device

- Leaks at the valves

If the valves are not leak-tight, flow is not sufficiently prevented when determining the zero point

If these conditions cannot be avoided, it is advisable to keep the factory setting for the zero point.

Sensor holder

The sensor holder is used to secure the device to a wall, tabletop or pipe (order code for "Accessory enclosed", option PR).

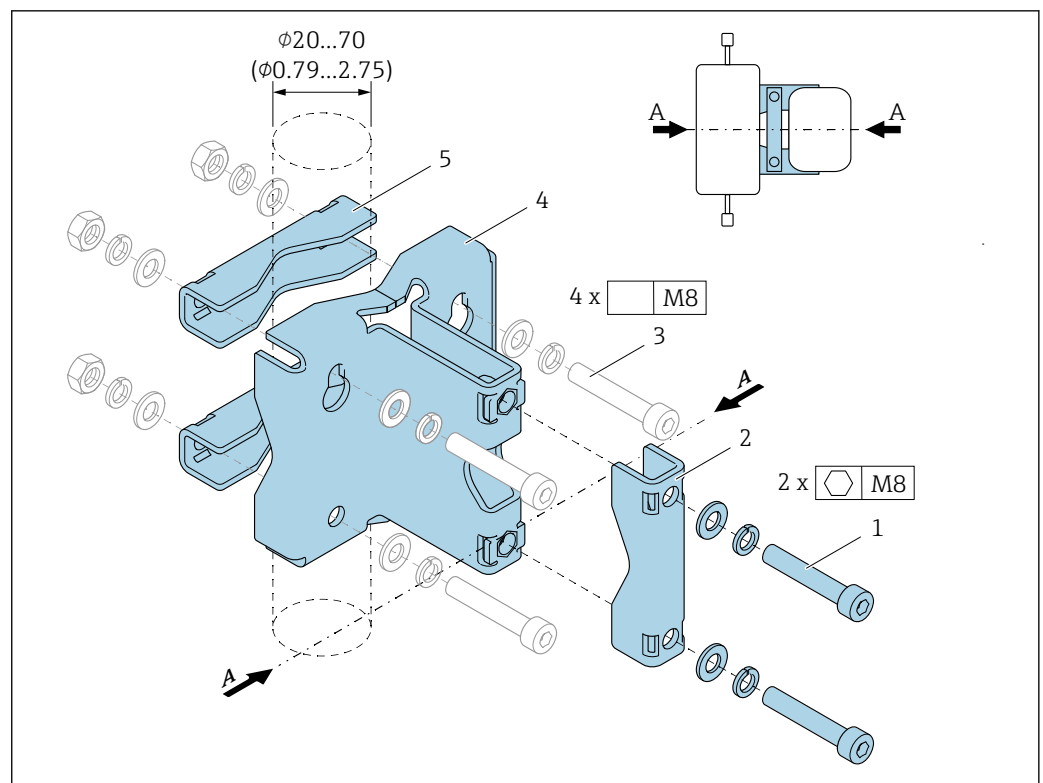

- 1 2 x Allen screw M8 x 50, washer and spring washer A4
 2 1 x clamp (measuring instrument neck)
 3 4 x securing screw for wall, tabletop or pipe mounting (not supplied)
 4 1 x base profile
 5 2 x clamp (pipe mounting)
 A Measuring instrument central line

If the holder is used with a measuring instrument fitted with a rupture disk, it is important to ensure that the rupture disk in the neck is not covered over and that the cover of the rupture disk is not damaged.

⚠ WARNING**Strain on pipes!**

Excessive strain on an unsupported pipe can cause the pipe to break.

- ▶ Install the sensor in a sufficiently supported pipe. In addition to the use of the sensor holder, for maximum mechanical stability the sensor can also be supported on the inlet and outlet sides onsite at the installation location with the use of pipe clamps, for example.

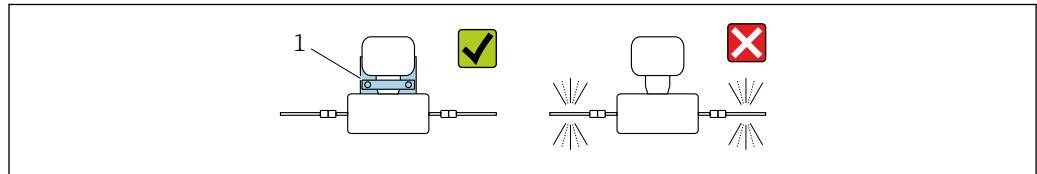

A0036492

1 Sensor holder (Order code for "Accessories enclosed", option PR)

The following mounting versions are recommended for the installation:

- i** Lubricate all threaded joints prior to mounting. The screws for wall, tabletop or pipe mounting are not supplied with the device and must be chosen to suit the individual installation position.

Wall mounting

Screw the sensor holder to the wall with four screws. Two of the four holes to secure the holder are designed to hook into the screws.

Mounting on a table

Screw the sensor holder onto the tabletop with four screws.

Pipe mounting

Secure the sensor holder to the pipe with two clamps.

⚠ WARNING**Failure to comply with the specifications for vibration and shock resistance can damage the measuring instrument!**

- ▶ During operation, transportation and storage, ensure compliance with the specifications for maximum vibration and shock resistance → 224.

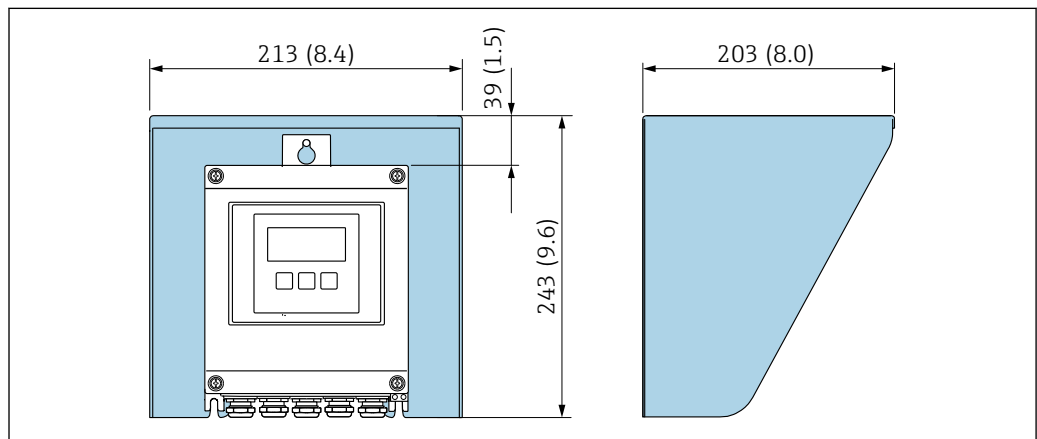
Weather protection cover

A0029552

8 Weather protection cover for Proline 500 – digital; engineering unit mm (in)

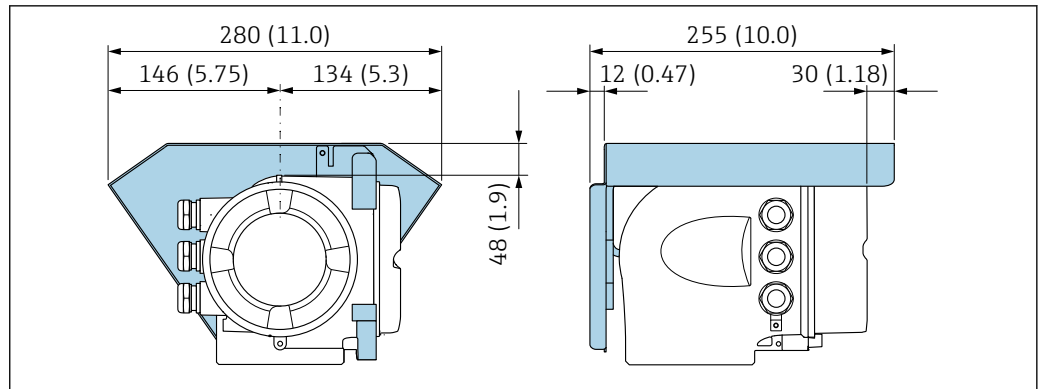

A0029553

9 Weather protection cover for Proline 500; engineering unit mm (in)

6.2 Installing the measuring instrument

6.2.1 Required tools

For transmitter

For mounting on a post:

- Proline 500 – digital transmitter
 - Open-ended wrench AF 10
 - Torx screwdriver TX 25
- Proline 500 transmitter
 - Open-ended wrench AF 13

For wall mounting:

Drill with drill bit \varnothing 6.0 mm

For sensor

For flanges and other process connections: Use a suitable mounting tool.

6.2.2 Preparing the measuring instrument

1. Remove all remaining transport packaging.
2. Remove any protective covers or protective caps present from the sensor.
3. Remove stick-on label on the electronics compartment cover.

6.2.3 Mounting the measuring device

⚠ WARNING

Danger due to improper process sealing!

- ▶ Ensure that the inside diameters of the gaskets are greater than or equal to that of the process connections and piping.
 - ▶ Ensure that the seals are clean and undamaged.
 - ▶ Secure the seals correctly.
1. Ensure that the direction of the arrow on the nameplate of the sensor matches the flow direction of the medium.

2. Install the measuring device or turn the transmitter housing so that the cable entries do not point upwards.

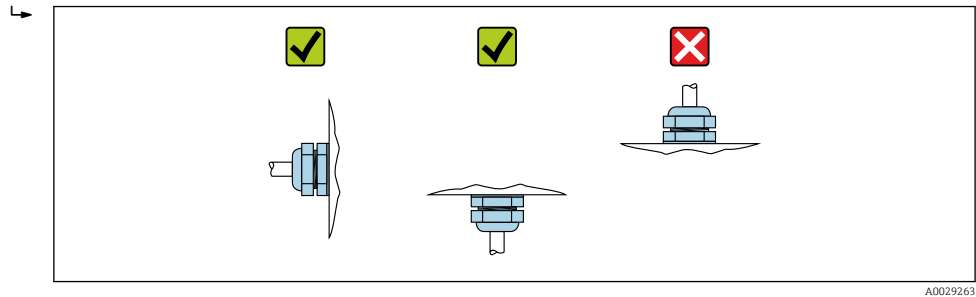

A0029263

6.2.4 Mounting the transmitter housing: Proline 500 – digital

CAUTION

Ambient temperature too high!

Danger of electronics overheating and housing deformation.

- ▶ Do not exceed the permitted maximum ambient temperature.
- ▶ If operating outdoors: Avoid direct sunlight and exposure to weathering, particularly in warm climatic regions.

CAUTION

Excessive force can damage the housing!

- ▶ Avoid excessive mechanical stress.

The transmitter can be mounted in the following ways:

- Post mounting
- Wall mounting

Pipe mounting

Required tools:

- Open-ended wrench AF 10
- Torx screwdriver TX 25

NOTICE

Excessive tightening torque applied to the fixing screws!

Risk of damaging the plastic transmitter.

- ▶ Tighten the fixing screws as per the tightening torque: 2.5 Nm (1.8 lbf ft)

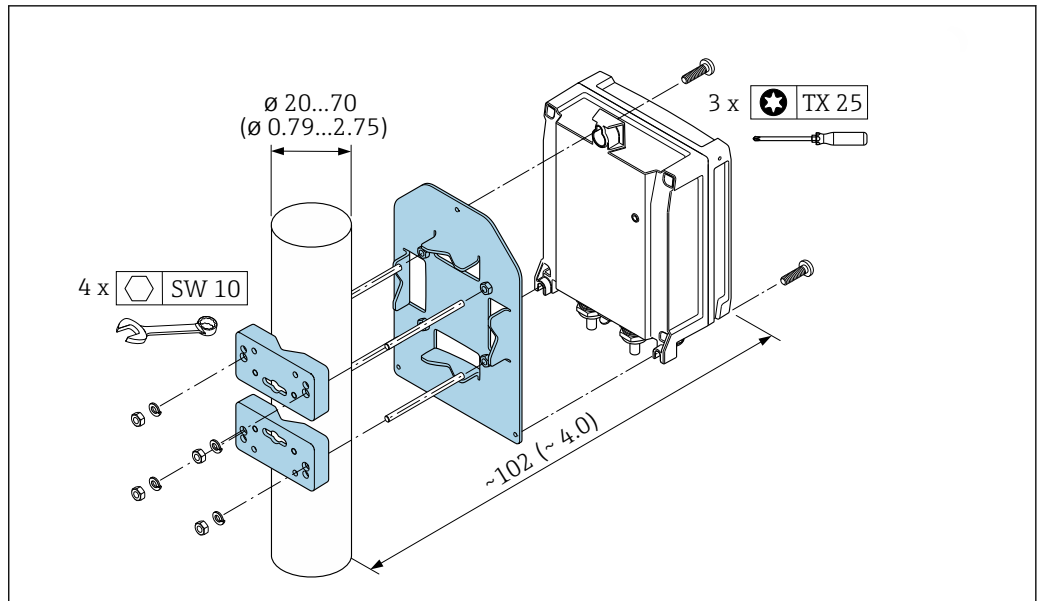

A0029051

10 Unit mm (in)

Wall mounting

Required tools:

Drill with drill bit $\varnothing 6.0$ mm

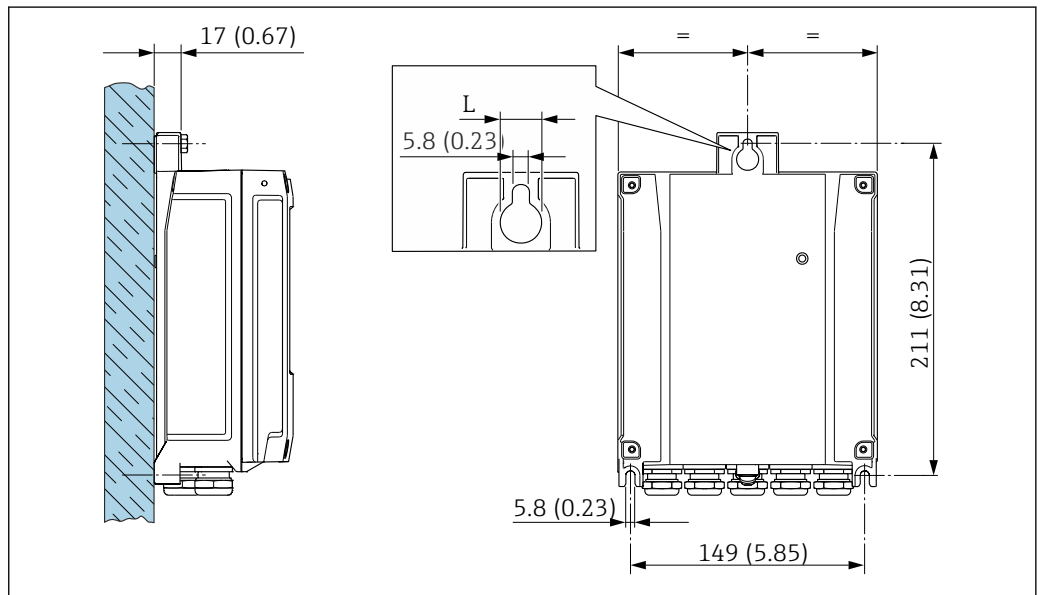

A0029054

11 Engineering unit mm (in)

L Depends on order code for "Transmitter housing"

Order code for "Transmitter housing"

- Option A, aluminum, coated: L = 14 mm (0.55 in)
- Option D, polycarbonate: L = 13 mm (0.51 in)

1. Drill the holes.
2. Insert wall plugs into the drilled holes.
3. Screw in the fixing screws slightly.
4. Fit the transmitter housing over the fixing screws and mount in place.

5. Tighten the fixing screws.

6.2.5 Mounting the transmitter housing: Proline 500

⚠ CAUTION

Ambient temperature too high!

Danger of electronics overheating and housing deformation.

- ▶ Do not exceed the permitted maximum ambient temperature.
- ▶ If operating outdoors: Avoid direct sunlight and exposure to weathering, particularly in warm climatic regions.

⚠ CAUTION

Excessive force can damage the housing!

- ▶ Avoid excessive mechanical stress.

The transmitter can be mounted in the following ways:

- Post mounting
- Wall mounting

Wall mounting

Required tools

Drill with drill bit \varnothing 6.0 mm

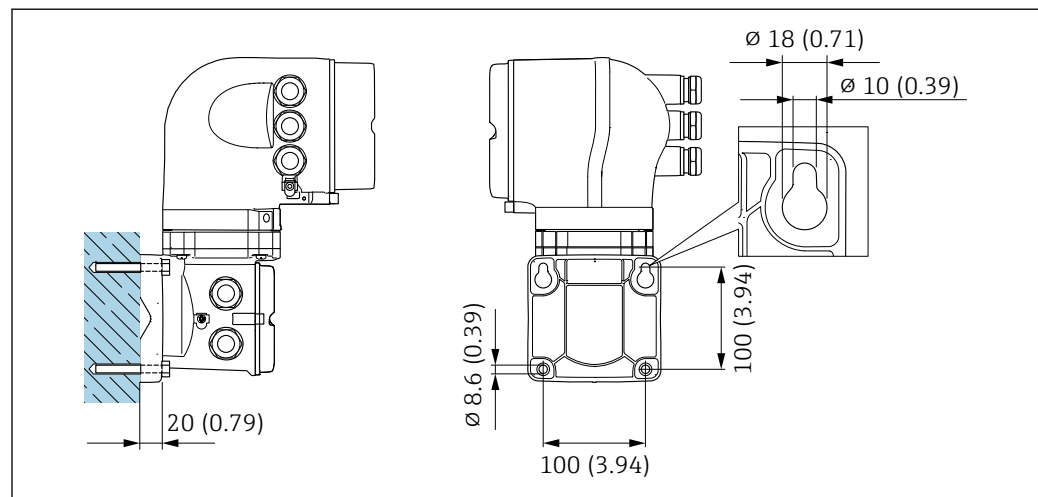

12 Engineering unit mm (in)

1. Drill the holes.
2. Insert wall plugs into the drilled holes.
3. Screw in the fixing screws slightly.
4. Fit the transmitter housing over the fixing screws and mount in place.
5. Tighten the fixing screws.

Pipe mounting

Required tools

Open-ended wrench AF 13

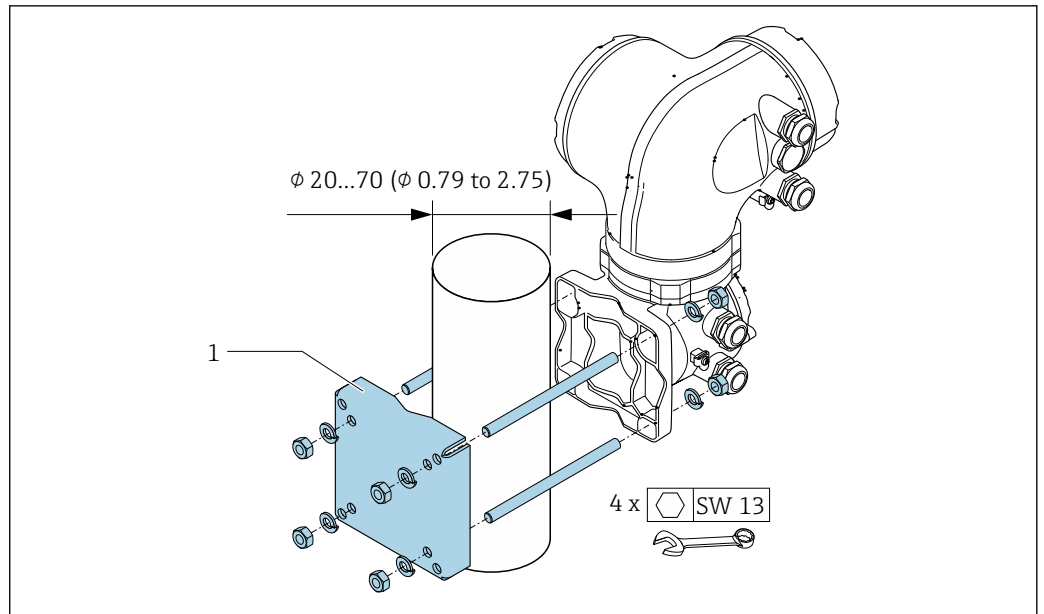

13 Engineering unit mm (in)

6.2.6 Turning the transmitter housing: Proline 500

To provide easier access to the connection compartment or display module, the transmitter housing can be turned.

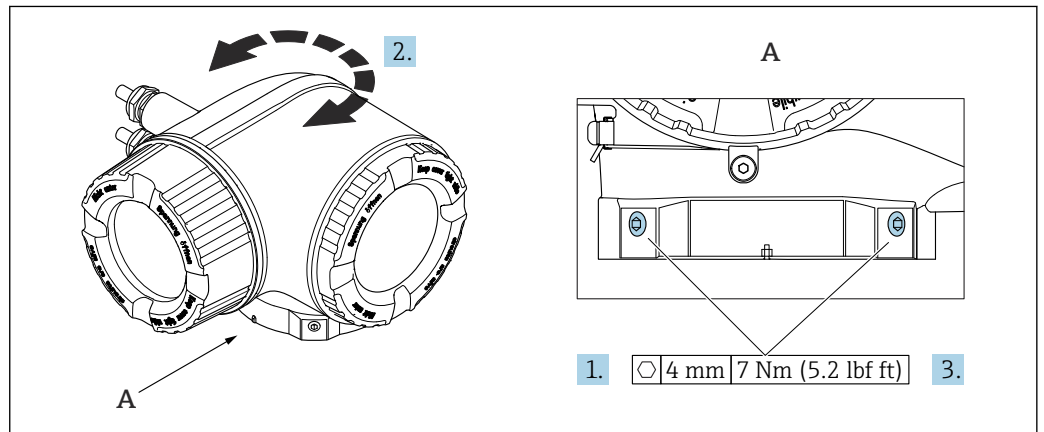

14 Ex housing

1. Loosen the fixing screws.
2. Turn the housing to the desired position.
3. Tighten the securing screws.

6.2.7 Turning the display module: Proline 500

The display module can be turned to optimize display readability and operability.

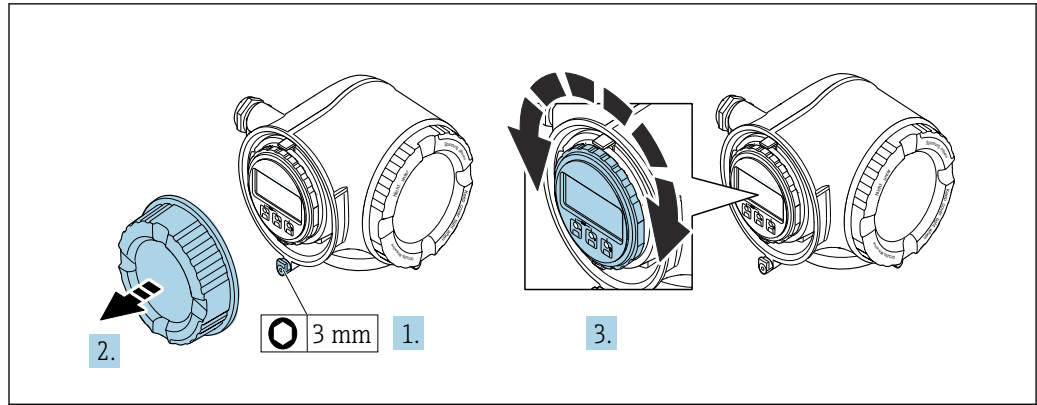

1. Depending on the device version: Loosen the securing clamp of the connection compartment cover.
2. Unscrew the connection compartment cover.
3. Turn the display module to the desired position: max. $8 \times 45^\circ$ in each direction.
4. Screw on the connection compartment cover.
5. Depending on the device version: Attach the securing clamp of the connection compartment cover.

6.3 Post-installation check

| | |
|--|--------------------------|
| Is the device undamaged (visual inspection)? | <input type="checkbox"/> |
| Does the measuring instrument correspond to the measuring point specifications? For example: <ul style="list-style-type: none"> ▪ Process temperature → 225 ▪ Pressure (refer to the "Pressure-temperature ratings" section of the "Technical Information" document). ▪ Ambient temperature ▪ Measuring range | <input type="checkbox"/> |
| Has the correct orientation for the sensor been selected → 22? <ul style="list-style-type: none"> ▪ According to sensor type ▪ According to medium temperature ▪ According to medium properties (outgassing, with entrained solids) | <input type="checkbox"/> |
| Does the arrow on the sensor match the direction of flow of the medium? → 22? | <input type="checkbox"/> |
| Is the tag name and labeling correct (visual inspection)? | <input type="checkbox"/> |
| Is the device sufficiently protected from precipitation and direct sunlight? | <input type="checkbox"/> |
| Are the securing screw and securing clamp tightened securely? | <input type="checkbox"/> |

7 Electrical connection

WARNING

Live parts! Incorrect work performed on the electrical connections can result in an electric shock.

- ▶ Set up a disconnecting device (switch or power-circuit breaker) to easily disconnect the device from the supply voltage.
- ▶ In addition to the device fuse, include an overcurrent protection unit with max. 10 A in the plant installation.

7.1 Electrical safety

In accordance with applicable national regulations.

7.2 Connecting requirements

7.2.1 Required tools

- For cable entries: use appropriate tool
- For securing clamp: Allen key 3 mm
- Wire stripper
- When using stranded cables: crimper for wire end ferrule
- For removing cables from terminal: flat blade screwdriver ≤ 3 mm (0.12 in)

7.2.2 Requirements for connection cable

The connecting cables provided by the customer must fulfill the following requirements.

Protective grounding cable for the outer ground terminal

Conductor cross-section $< 2.1 \text{ mm}^2$ (14 AWG)

The use of a cable lug enables the connection of larger cross-sections.

The grounding impedance must be less than 2Ω .

Permitted temperature range

- The installation guidelines that apply in the country of installation must be observed.
- The cables must be suitable for the minimum and maximum temperatures to be expected.

Power supply cable (incl. conductor for the inner ground terminal)

Standard installation cable is sufficient.

Signal cable

-  For custody transfer, all signal lines must be shielded cables (tinned copper braiding, optical coverage $\geq 85 \%$). The cable shield must be connected on both sides.

Ethernet-APL

Shielded twisted-pair cable. Cable type A is recommended.

-  See <https://www.profibus.com> Ethernet-APL White Paper "

FOUNDATION Fieldbus

Twisted, shielded two-wire cable.



For further information on planning and installing FOUNDATION Fieldbus networks see:

- Operating Instructions for "FOUNDATION Fieldbus Overview" (BA00013S)
- FOUNDATION Fieldbus Guideline
- IEC 61158-2 (MBP)

Current output 0 /4 to 20 mA (excluding HART)

Standard installation cable is sufficient.

Pulse /frequency /switch output

Standard installation cable is sufficient.

Relay output

Standard installation cable is sufficient.

Current input 4 to 20 mA

Standard installation cable is sufficient.

Status input

Standard installation cable is sufficient.

Cable diameter

- Cable glands supplied:
 - M20 × 1.5 with cable \varnothing 6 to 12 mm (0.24 to 0.47 in)
- Spring-loaded terminals: Suitable for strands and strands with ferrules.
 - Conductor cross-section 0.2 to 2.5 mm² (24 to 12 AWG).

Choice of connecting cable between the transmitter and sensor

Depends on the type of transmitter and the installation zones

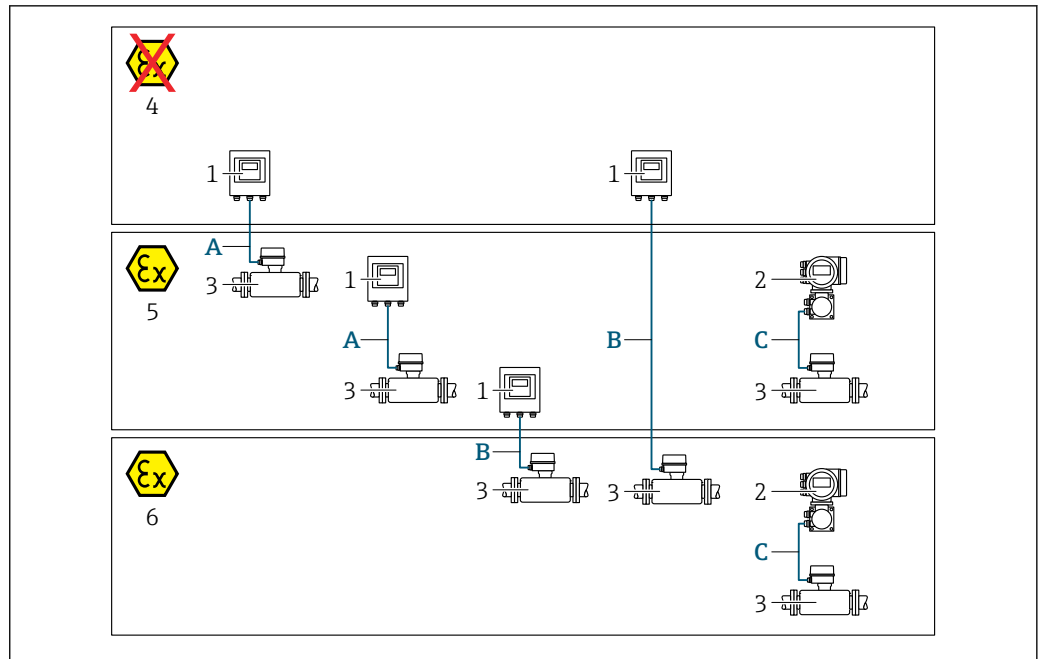

A0032476

- 1 Proline 500 digital transmitter
- 2 Proline 500 transmitter
- 3 Sensor Promass
- 4 Non-hazardous area
- 5 Hazardous area: Zone 2; Class I, Division 2
- 6 Hazardous area: Zone 1; Class I, Division 1
- A Standard cable to 500 digital transmitter → 37
Transmitter installed in the non-hazardous area or hazardous area: Zone 2; Class I, Division 2/sensor installed in the hazardous area: Zone 2; Class I, Division 2
- B Standard cable to 500 digital transmitter → 38
Transmitter installed in the hazardous area: Zone 2; Class I, Division 2/sensor installed in the hazardous area: Zone 1; Class I, Division 1
- C Signal cable to 500 transmitter → 40
Transmitter and sensor installed in the hazardous area: Zone 2; Class I, Division 2 or Zone 1; Class I, Division 1

A: Connecting cable between sensor and transmitter: Proline 500 – digital Standard cable

A standard cable with the following specifications can be used as the connecting cable.

| | |
|----------------------------|--|
| Design | 4 cores (2 pairs); uninsulated stranded CU wires; pair-stranded with common shield |
| Shield | Tin-plated copper braid, optical cover ≥ 85 % |
| Loop resistance | Power supply line (+, -): maximum 10 Ω |
| Cable length | Maximum 300 m (900 ft), see the following table. |
| Device plug, side 1 | M12 socket, 5-pin, A-coded. |
| Device plug, side 2 | M12 plug, 5-pin, A-coded. |
| Pins 1+2 | Connected cores as twisted pair. |
| Pins 3+4 | Connected cores as twisted pair. |

| Cross-section | Cable length [max.] |
|-------------------------------|---------------------|
| 0.34 mm ² (AWG 22) | 80 m (240 ft) |
| 0.50 mm ² (AWG 20) | 120 m (360 ft) |
| 0.75 mm ² (AWG 18) | 180 m (540 ft) |

| Cross-section | Cable length [max.] |
|-------------------------------|---------------------|
| 1.00 mm ² (AWG 17) | 240 m (720 ft) |
| 1.50 mm ² (AWG 15) | 300 m (900 ft) |

Optionally available connecting cable

| | |
|---|--|
| Design | 2 × 2 × 0.34 mm ² (AWG 22) PVC cable ¹⁾ with common shield (2 pairs, uninsulated stranded CU wires; pair-stranded) |
| Flame resistance | According to DIN EN 60332-1-2 |
| Oil resistance | According to DIN EN 60811-2-1 |
| Shield | Tin-plated copper braid, optical cover ≥ 85 % |
| Continuous operating temperature | When mounted in a fixed position: -50 to +105 °C (-58 to +221 °F); when cable can move freely: -25 to +105 °C (-13 to +221 °F) |
| Available cable length | Fixed: 20 m (60 ft); variable: up to maximum 50 m (150 ft) |

1) UV radiation can impair the cable outer sheath. Protect the cable from direct sunshine where possible.

B: Connecting cable between sensor and transmitter: Proline 500 - digital

Standard cable

A standard cable with the following specifications can be used as the connecting cable.

| | |
|--|--|
| Design | 4, 6, 8 cores (2, 3, 4 pairs); uninsulated stranded CU wires; pair-stranded with common shield |
| Shielding | Tin-plated copper braid, optical cover ≥ 85 % |
| Capacitance C | Maximum 760 nF IIC, maximum 4.2 μF IIB |
| Inductance L | Maximum 26 μH IIC, maximum 104 μH IIB |
| Inductance/resistance ratio (L/R) | Maximum 8.9 μH/Ω IIC, maximum 35.6 μH/Ω IIB (e.g. according to IEC 60079-25) |
| Loop resistance | Power supply line (+, -): maximum 5 Ω |
| Cable length | Maximum 150 m (450 ft), see the following table. |

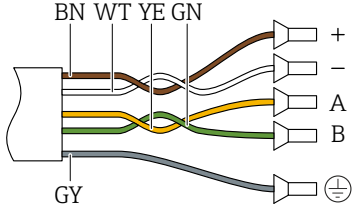
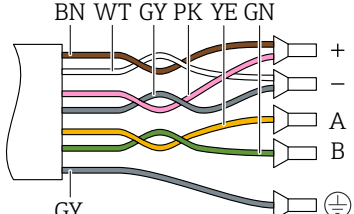
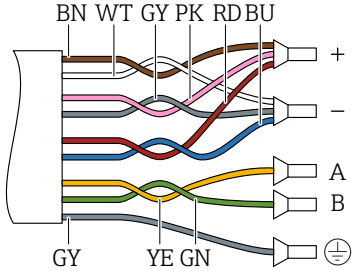
| Cross-section | Cable length [max.] | Termination |
|--|---------------------|---|
| 2 x 2 x 0.50 mm ² (AWG 20) | 50 m (150 ft) | 2 x 2 x 0.50 mm ² (AWG 20)  <ul style="list-style-type: none"> ▪ +, - = 0.5 mm² ▪ A, B = 0.5 mm² |
| 3 x 2 x 0.50 mm ² (AWG 20) | 100 m (300 ft) | 3 x 2 x 0.50 mm ² (AWG 20)  <ul style="list-style-type: none"> ▪ +, - = 1.0 mm² ▪ A, B = 0.5 mm² |
| 4 x 2 x 0.50 mm ² (AWG 20) | 150 m (450 ft) | 4 x 2 x 0.50 mm ² (AWG 20)  <ul style="list-style-type: none"> ▪ +, - = 1.5 mm² ▪ A, B = 0.5 mm² |

Optionally available connecting cable

| | |
|-------------------------------|--|
| Connecting cable for | Zone 1; Class I, Division 1 |
| Standard cable | 2 × 2 × 0.5 mm ² (AWG 20) PVC cable ¹⁾ with common shield (2 pairs, pair-stranded) |
| Flame resistance | According to DIN EN 60332-1-2 |
| Oil-resistance | According to DIN EN 60811-2-1 |
| Shielding | Tin-plated copper braid, optical cover ≥ 85 % |
| Operating temperature | When mounted in a fixed position: -50 to +105 °C (-58 to +221 °F); when cable can move freely: -25 to +105 °C (-13 to +221 °F) |
| Available cable length | Fixed: 20 m (60 ft); variable: up to maximum 50 m (150 ft) |

1) UV radiation can impair the cable outer sheath. Protect the cable from direct sunshine where possible.

C: Connecting cable between sensor and transmitter: Proline 500

| | |
|--|--|
| Design | 6 × 0.38 mm ² PVC cable ¹⁾ with individual shielded cores and common copper shield |
| Conductor resistance | ≤ 50 Ω/km (0.015 Ω/ft) |
| Capacitance: core/shield | ≤ 420 pF/m (128 pF/ft) |
| Cable length (max.) | 20 m (60 ft) |
| Cable lengths (available for order) | 5 m (15 ft), 10 m (30 ft), 20 m (60 ft) |
| Cable diameter | 11 mm (0.43 in) ± 0.5 mm (0.02 in) |
| Continuous operating temperature | Max. 105 °C (221 °F) |

1) UV radiation can impair the cable outer sheath. Protect the cable from direct sunshine where possible.

7.2.3 Terminal assignment

Transmitter: supply voltage, input/outputs



The terminal assignment of the inputs and outputs depends on the individual order version of the device. The device-specific terminal assignment is documented on an adhesive label in the terminal cover.

| Supply voltage | | Input/output 1 | | Input/output 2 | | Input/output 3 | | Input/output 4 | |
|--|-------|----------------|--------|----------------|--------|----------------|--------|----------------|--------|
| 1 (+) | 2 (-) | 26 (A) | 27 (B) | 24 (+) | 25 (-) | 22 (+) | 23 (-) | 20 (+) | 21 (-) |
| Device-specific terminal assignment: adhesive label in terminal cover. | | | | | | | | | |

Transmitter and sensor connection housing: connecting cable

The sensor and transmitter, which are mounted in separate locations, are interconnected by a connecting cable. The cable is connected via the sensor connection housing and the transmitter housing.

Terminal assignment and connection of the connecting cable:

- Proline 500 – digital →  43
- Proline 500 →  50

7.2.4 Available device plugs

 Device plugs may not be used in hazardous areas!

Order code for "Input; output 1", option SA "FOUNDATION Fieldbus"

| Order code for "Electrical connection" | Cable entry/connection | |
|---|------------------------|---|
| | 2 | 3 |
| M, 3, 4, 5 | 7/8" connector | - |

7.2.5 device plug pin assignment

| Pin | Assignment | | Coding | Plug/socket |
|-----|------------|--------------|--------|-------------|
| | | | | |
| 1 | + | Signal + | A | Plug |
| 2 | - | Signal - | | |
| 3 | | Grounding | | |
| 4 | | Not assigned | | |

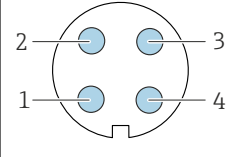

7.2.6 Shielding and grounding

Optimal electromagnetic compatibility (EMC) of the fieldbus system can be guaranteed only if the system components and, in particular, the lines are shielded and the shield forms as complete a cover as possible. A shield coverage of 90 % is ideal.

1. To ensure optimal EMC protection, connect the shield to the reference ground as often as possible.
2. For reasons concerning explosion protection, it is recommended that grounding be dispensed with.

To comply with both requirements, there are basically three different types of shielding in the fieldbus system:

- Shielding at both ends
- Shielding at one end on the feed side with capacitance termination at the field device
- Shielding at one end on the feed side

Experience shows that the best results with regard to EMC are achieved in most cases in installations with one-sided shielding on the feed side (without capacitance termination at the field device). Appropriate measures with regard to input wiring must be taken to allow unrestricted operation when EMC interference is present. These measures have been taken into account for this device. Operation in the event of disturbance variables as per NAMUR NE21 is thus guaranteed.

1. Observe national installation requirements and guidelines during installation.
2. Where there are large differences in potential between the individual grounding points, connect only one point of the shielding directly to the reference ground.
3. In systems without potential equalization, the cable shielding of fieldbus systems should be grounded on one side only, for example at the fieldbus supply unit or at safety barriers.

NOTICE

In systems without potential matching, the multiple grounding of the cable shield causes mains frequency equalizing currents!

Damage to the bus cable shield.

- ▶ Only ground the bus cable shield to either the local ground or the protective ground at one end.
- ▶ Insulate the shield that is not connected.

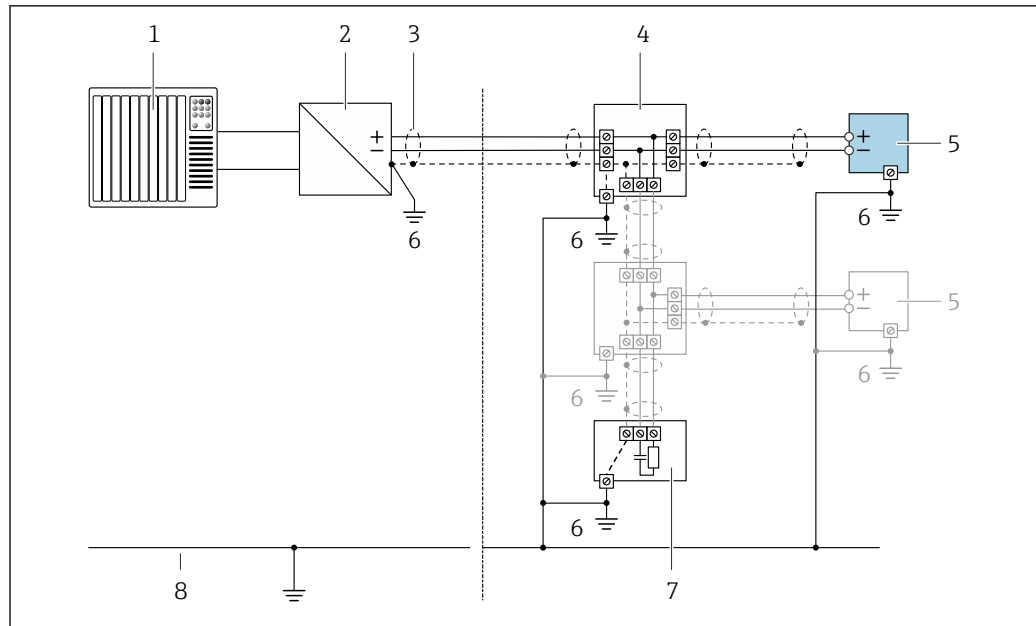

15 Connection example for FOUNDATION Fieldbus

- 1 Control system (e.g. PLC)
- 2 Power conditioner (FOUNDATION Fieldbus)
- 3 Cable shield: the cable shield must be grounded at both ends to comply with EMC requirements; observe cable specifications
- 4 T-box
- 5 Measuring device
- 6 Local grounding
- 7 Bus terminator
- 8 Potential equalization conductor

7.2.7 Preparing the measuring device

Carry out the steps in the following order:

1. Mount the sensor and transmitter.
2. Sensor connection housing: Connect connecting cable.
3. Transmitter: Connect connecting cable.
4. Transmitter: Connect signal cable and cable for supply voltage.

NOTICE

Insufficient sealing of the housing!

Operational reliability of the measuring device could be compromised.

- Use suitable cable glands corresponding to the degree of protection.

1. Remove dummy plug if present.
2. If the measuring device is supplied without cable glands:
Provide suitable cable gland for corresponding connecting cable.
3. If the measuring device is supplied with cable glands:
Observe requirements for connecting cables → 35.

7.3 Connecting the measuring instrument: Proline 500 - digital

NOTICE

An incorrect connection compromises electrical safety!

- ▶ Only properly trained specialist staff may perform electrical connection work.
- ▶ Observe applicable federal/national installation codes and regulations.
- ▶ Comply with local workplace safety regulations.
- ▶ Always connect the protective ground cable ⊕ before connecting additional cables.
- ▶ When using in potentially explosive atmospheres, observe the information in the device-specific Ex documentation.

7.3.1 Connecting the connecting cable

⚠ WARNING

Risk of damaging electronic components!

- ▶ Connect the sensor and transmitter to the same potential equalization.
- ▶ Only connect the sensor to a transmitter with the same serial number.

Connecting cable terminal assignment

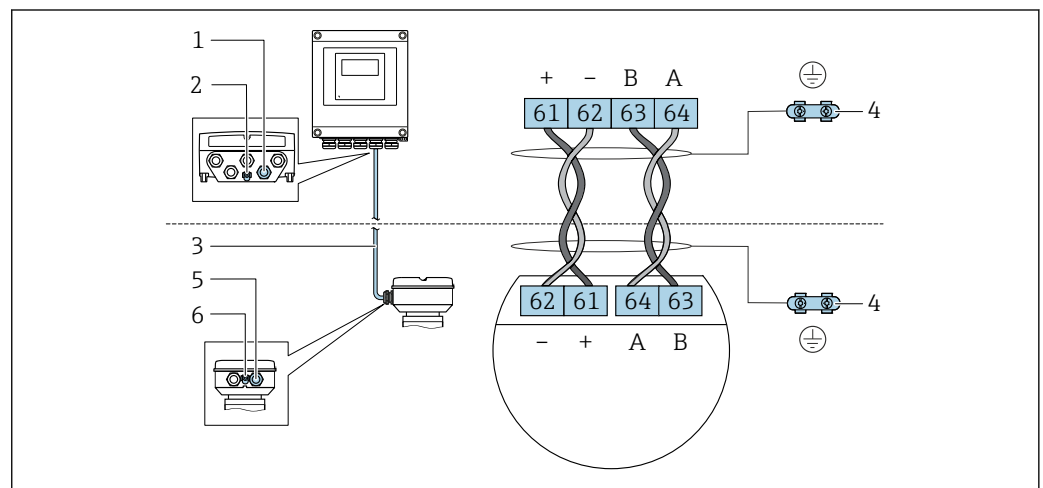

A0028198

- 1 Cable entry for cable on transmitter housing
- 2 Protective earth (PE)
- 3 Connecting cable ISEM communication
- 4 Grounding via ground connection; in the version with a device plug, grounding is ensured through the plug itself
- 5 Cable entry for cable or connection of device plug on sensor connection housing
- 6 Protective earth (PE)

Connecting the connecting cable to the sensor connection housing

- Connection via terminals with order code for "Sensor connection housing":
 - Option **A** "Aluminum, coated" → 44
 - Option **B** "Stainless" → 45
 - Option **L** "Cast, stainless" → 44
- Connection via connectors with order code for "Sensor connection housing":
 - Option **C** "Ultra-compact hygienic, stainless" → 46

Connecting the connecting cable to the transmitter

The cable is connected to the transmitter via terminals → 47.

Connecting the sensor connection housing via terminals

For the device version with the order code for "Sensor connection housing":

- Option A "Aluminum coated"
- Option L "Cast, stainless"

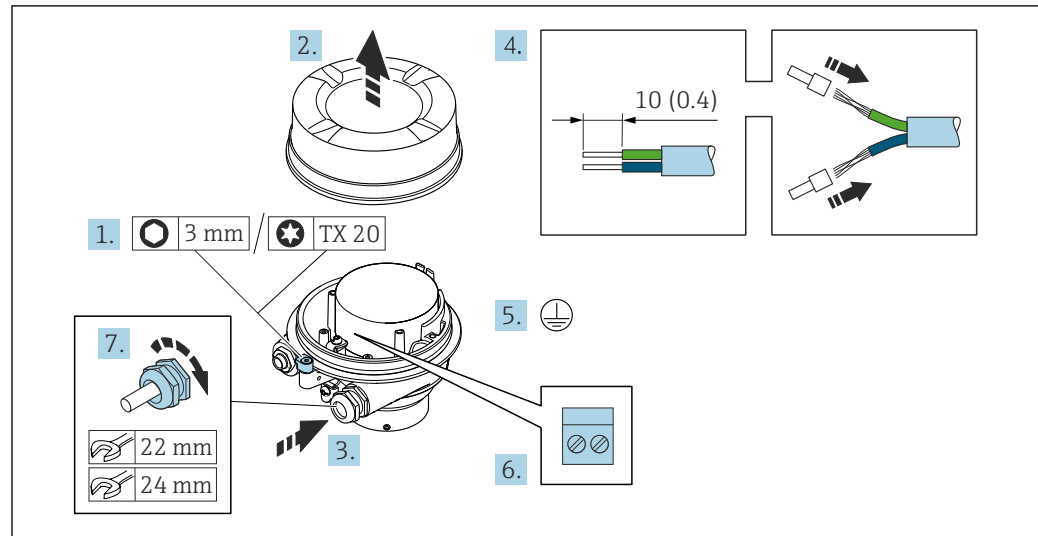

A0029616

1. Loosen the securing clamp of the housing cover.
2. Unscrew the housing cover.
3. Push the cable through the cable entry. To ensure tight sealing, do not remove the sealing ring from the cable entry.
4. Strip the cable and cable ends. In the case of stranded cables, fit ferrules.
5. Connect the protective ground.
6. Connect the cable in accordance with the connecting cable terminal assignment.
7. Firmly tighten the cable glands.
 - ↳ This concludes the process for connecting the connecting cable.

⚠ WARNING

Housing degree of protection voided due to insufficient sealing of the housing.

- ▶ Screw in the thread on the cover without using any lubricant. The thread on the cover is coated with a dry lubricant.
8. Screw on the housing cover.
 9. Tighten the securing clamp of the housing cover.

Connecting the sensor connection housing via terminals

For the device version with the order code for "Sensor connection housing":
Option B "Stainless"

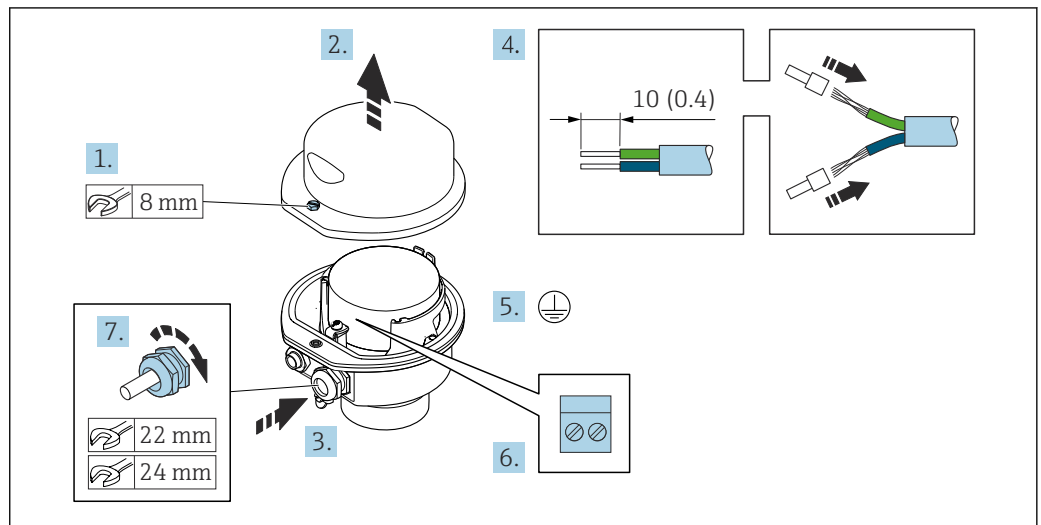

A0029613

1. Release the securing screw of the housing cover.
2. Open the housing cover.
3. Push the cable through the cable entry . To ensure tight sealing, do not remove the sealing ring from the cable entry.
4. Strip the cable and cable ends. In the case of stranded cables, fit ferrules.
5. Connect the protective ground.
6. Connect the cable in accordance with the connecting cable terminal assignment.
7. Firmly tighten the cable glands.
 - ↳ This concludes the process for connecting the connecting cable.
8. Close the housing cover.
9. Tighten the securing screw of the housing cover.

Connecting the sensor connection housing via the connector

For the device version with the order code for "Sensor connection housing":
Option **C** "Ultra-compact hygienic, stainless"

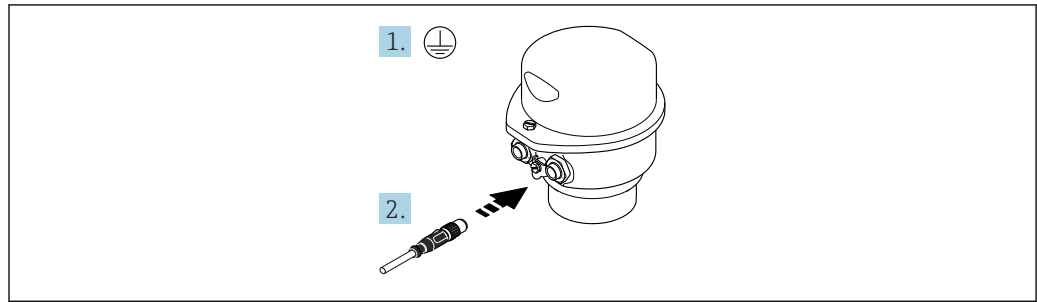

A0029615

1. Connect the protective ground.
2. Connect the connector.

Connecting the connecting cable to the transmitter

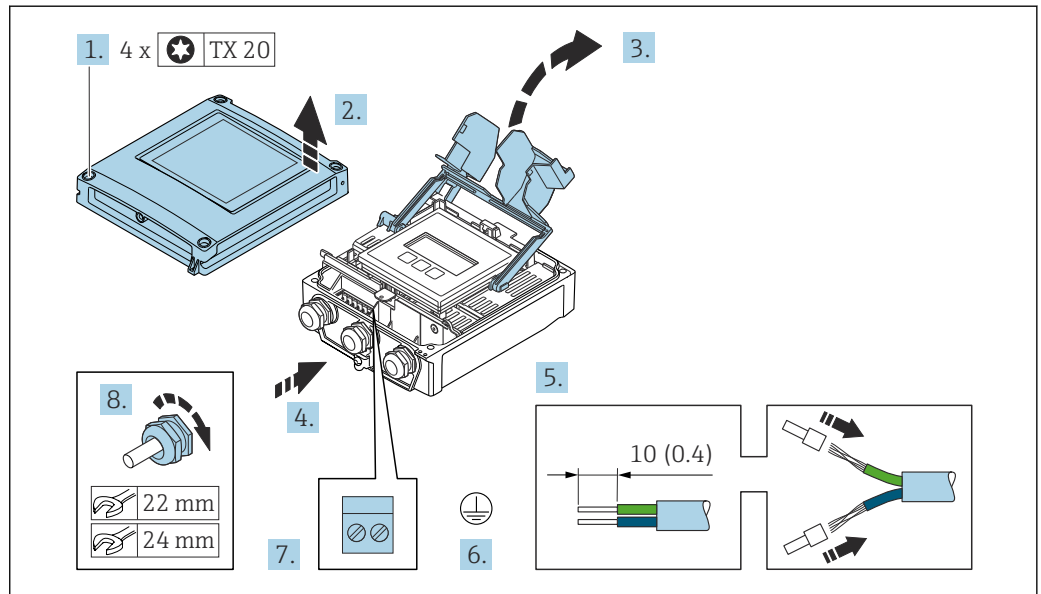

1. Loosen the 4 fixing screws on the housing cover.
2. Open the housing cover.
3. Fold open the terminal cover.
4. Push the cable through the cable entry. To ensure tight sealing, do not remove the sealing ring from the cable entry.
5. Strip the cable and cable ends. In the case of stranded cables, fit ferrules.
6. Connect the protective ground.
7. Connect the cable according to the terminal assignment for the connecting cable → 43.
8. Firmly tighten the cable glands.
 - ↳ The process for connecting the connecting cable is now complete.
9. Close the housing cover.
10. Tighten the securing screw of the housing cover.
11. After connecting the connecting cable:
 - Connect the signal cable and the supply voltage cable → 48.

7.3.2 Connecting the signal cable and the supply voltage cable

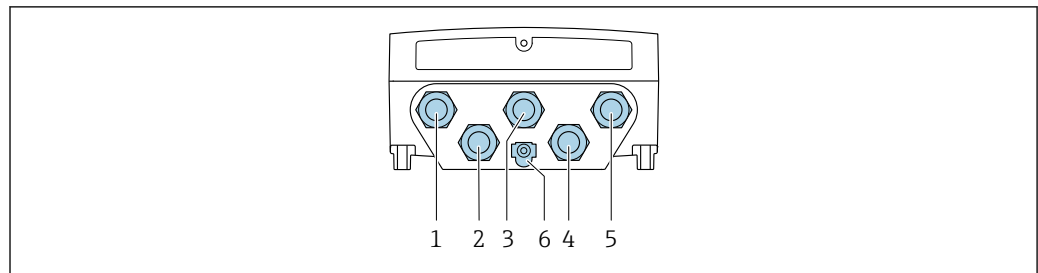

A0028200

- 1 Terminal connection for supply voltage
- 2 Terminal connection for signal transmission, input/output
- 3 Terminal connection for signal transmission, input/output
- 4 Terminal connection for connecting cable between sensor and transmitter
- 5 Terminal connection for signal transmission, input/output; optional: connection for external WLAN antenna
- 6 Protective earth (PE)

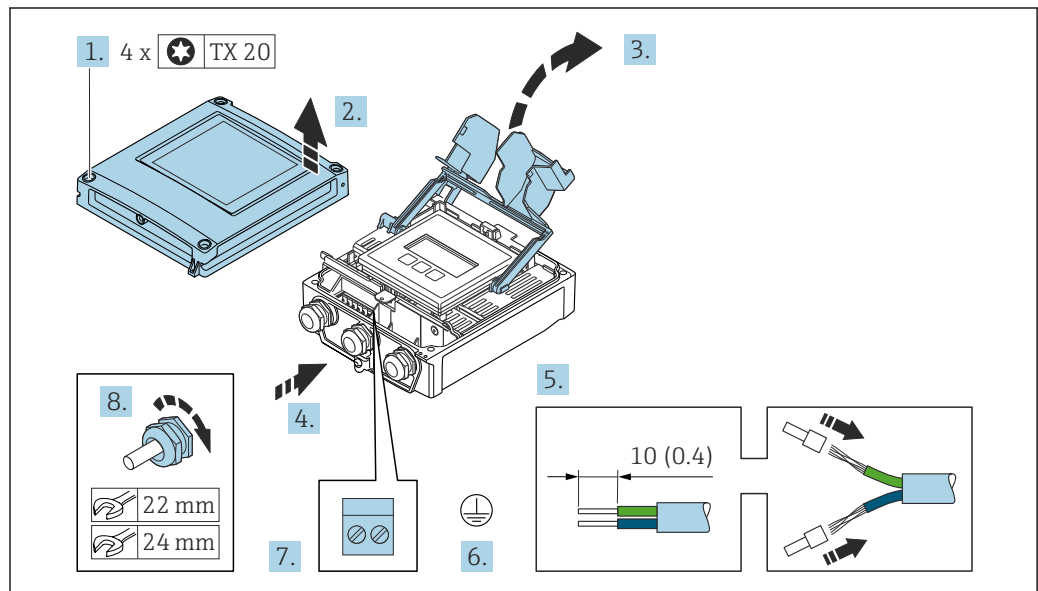

A0029597

1. Loosen the 4 fixing screws on the housing cover.
2. Open the housing cover.
3. Fold open the terminal cover.
4. Push the cable through the cable entry. To ensure tight sealing, do not remove the sealing ring from the cable entry.
5. Strip the cable and cable ends. In the case of stranded cables, fit ferrules.
6. Connect the protective ground.
7. Connect the cable according to the terminal assignment.
 - ↳ **Signal cable terminal assignment:** The device-specific terminal assignment is documented on an adhesive label in the terminal cover.
 - Supply voltage terminal assignment:** Adhesive label in the terminal cover or → 40.
8. Firmly tighten the cable glands.
 - ↳ This concludes the cable connection process.
9. Close the terminal cover.
10. Close the housing cover.

⚠ WARNING

Housing degree of protection may be voided due to insufficient sealing of the housing.

- ▶ Screw in the screw without using any lubricant.

NOTICE

Excessive tightening torque applied to the fixing screws!

Risk of damaging the plastic transmitter.

- ▶ Tighten the fixing screws as per the tightening torque: 2.5 Nm (1.8 lbf ft)

11. Tighten the 4 fixing screws on the housing cover.

Removing a cable

To remove a cable from the terminal:

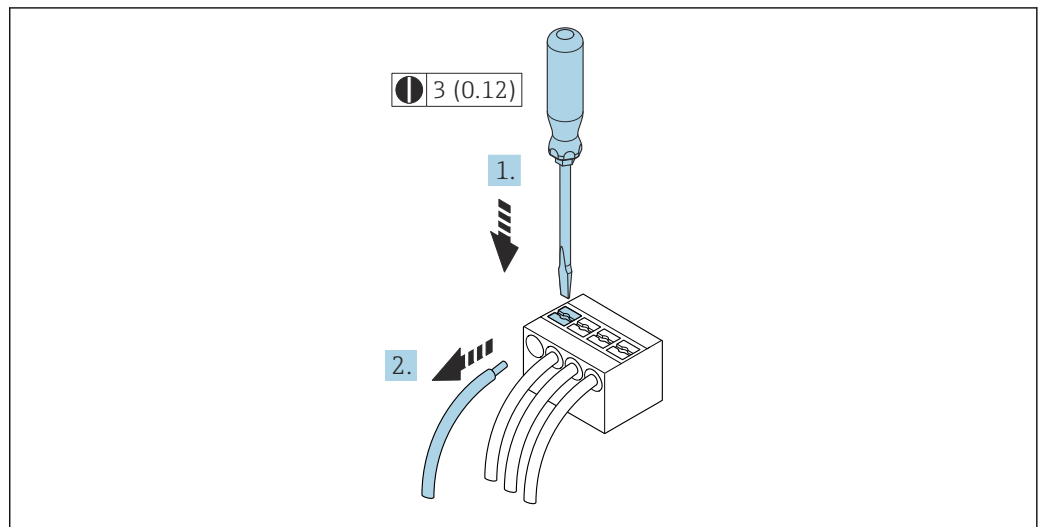

A0029598

16 Engineering unit mm (in)

1. Use a flat-blade screwdriver to press down on the slot between the two terminal holes.
2. Remove the cable end from the terminal.

7.4 Connecting the measuring instrument: Proline 500

NOTICE

An incorrect connection compromises electrical safety!

- ▶ Only properly trained specialist staff may perform electrical connection work.
- ▶ Observe applicable federal/national installation codes and regulations.
- ▶ Comply with local workplace safety regulations.
- ▶ Always connect the protective ground cable ⊕ before connecting additional cables.
- ▶ When using in potentially explosive atmospheres, observe the information in the device-specific Ex documentation.

7.4.1 Fitting the connecting cable

⚠ WARNING

Risk of damaging electronic components!

- ▶ Connect the sensor and transmitter to the same potential equalization.
- ▶ Only connect the sensor to a transmitter with the same serial number.

⚠ CAUTION

Measurement error due to shortening of the connecting cable

- ▶ The connecting cable is ready for installation and must be used in the length supplied. Shortening the connecting cable can affect the sensor's measurement accuracy.

Connecting cable terminal assignment

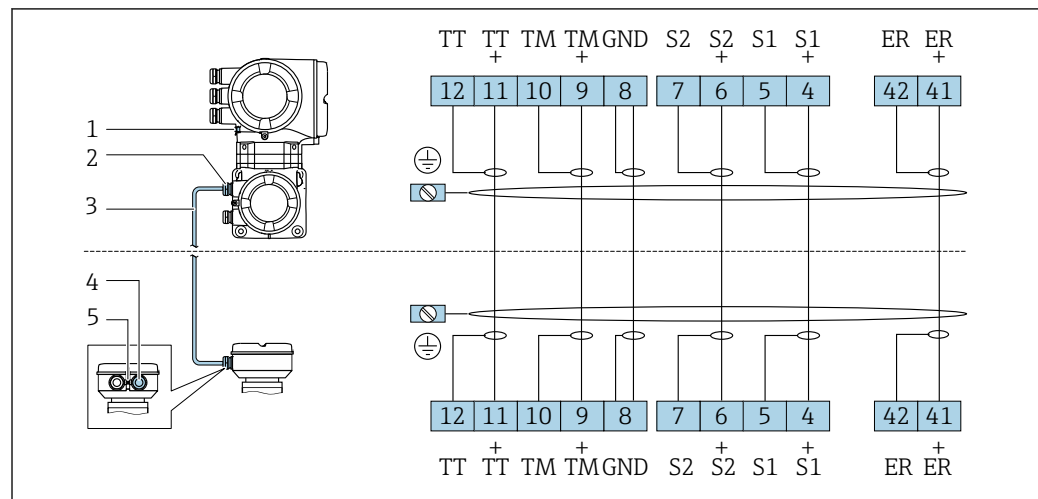

- 1 Protective earth (PE)
- 2 Cable entry for connecting cable on transmitter connection housing
- 3 Connecting cable
- 4 Cable entry for connecting cable on sensor connection housing
- 5 Protective earth (PE)

Connecting the connecting cable to the sensor connection housing

Connection via terminals with order code for "Housing":

- Option A "Aluminum coated" → 51
- Option B "Stainless" → 52

Connecting the sensor connection housing via terminals

For the device version with the order code for "Housing":
Option **A** "Aluminum coated"

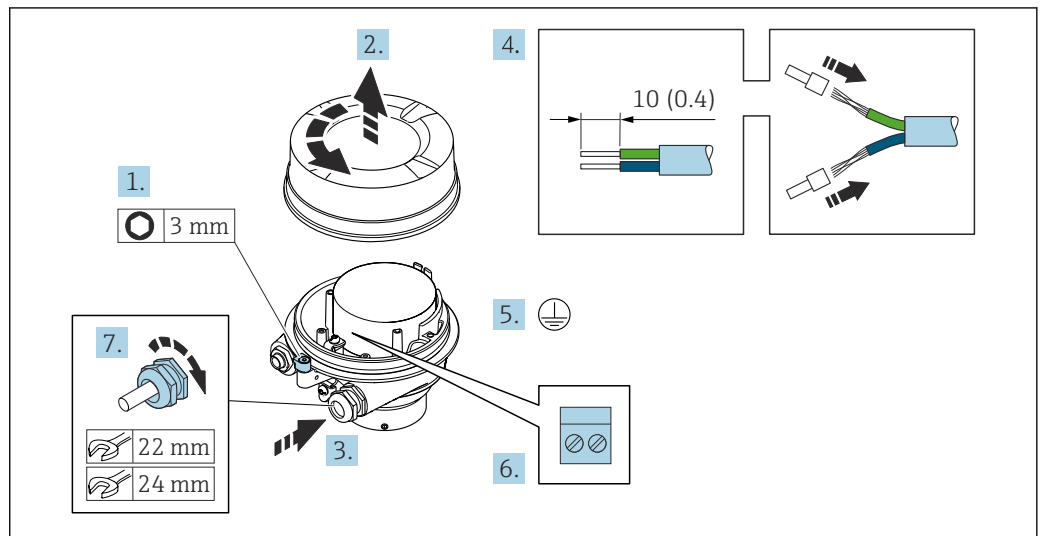

A0029612

1. Loosen the securing clamp of the housing cover.
2. Unscrew the housing cover.
3. Push the cable through the cable entry . To ensure tight sealing, do not remove the sealing ring from the cable entry.
4. Strip the cable and cable ends. In the case of stranded cables, fit ferrules.
5. Connect the protective ground.
6. Connect the cable in accordance with the connecting cable terminal assignment.
7. Firmly tighten the cable glands.
 - ↳ The process for connecting the connecting cable is now complete.

⚠ WARNING

Housing degree of protection voided due to insufficient sealing of the housing.

- ▶ Screw in the thread on the cover without using any lubricant. The thread on the cover is coated with a dry lubricant.
8. Screw on the housing cover.
 9. Tighten the securing clamp of the housing cover.

Connecting the sensor connection housing via terminals

For the device version with the order code for "Housing":
Option B "Stainless"

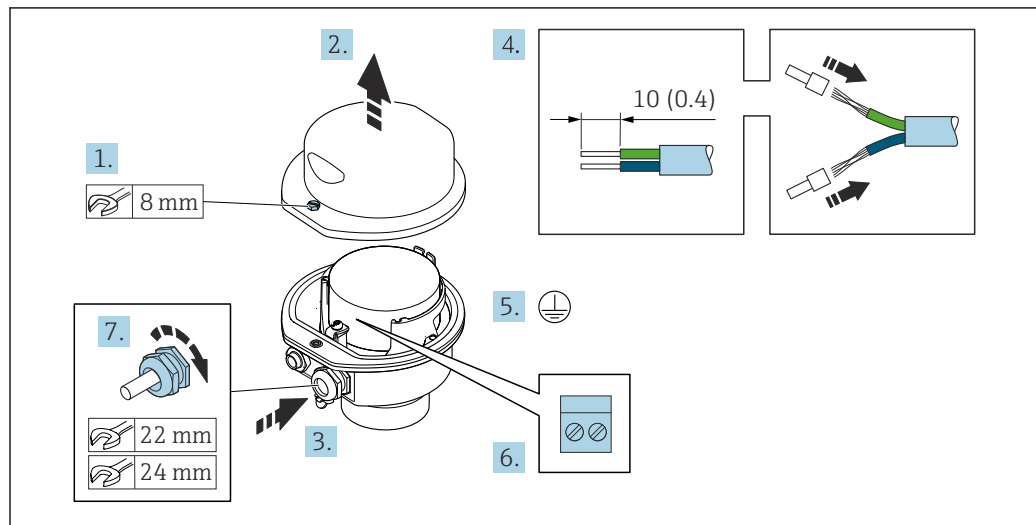

A0029613

1. Release the securing screw of the housing cover.
2. Open the housing cover.
3. Push the cable through the cable entry . To ensure tight sealing, do not remove the sealing ring from the cable entry.
4. Strip the cable and cable ends. In the case of stranded cables, fit ferrules.
5. Connect the protective ground.
6. Connect the cable in accordance with the connecting cable terminal assignment.
7. Firmly tighten the cable glands.
 - ↳ This concludes the process for connecting the connecting cable.
8. Close the housing cover.
9. Tighten the securing screw of the housing cover.

Attaching the connecting cable to the transmitter

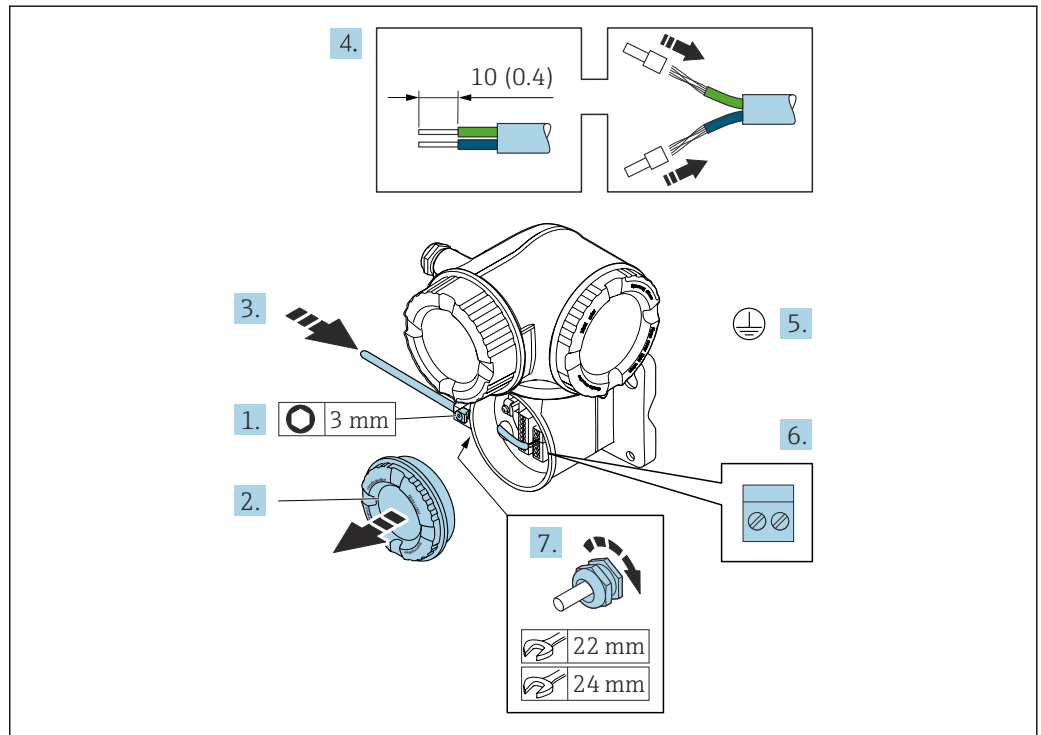

A0029592

1. Loosen the securing clamp of the connection compartment cover.
2. Unscrew the connection compartment cover.
3. Push the cable through the cable entry. To ensure tight sealing, do not remove the sealing ring from the cable entry.
4. Strip the cable and cable ends. In the case of stranded cables, also fit ferrules.
5. Connect the protective ground.
6. Connect the cable in accordance with the connecting cable terminal assignment → 50.
7. Firmly tighten the cable glands.
 - ↳ This concludes the process for attaching the connecting cable.
8. Screw on the connection compartment cover.
9. Tighten the securing clamp of the connection compartment cover.
10. After connecting the connecting cable:
 - Connect the signal cable and the supply voltage cable → 54.

7.4.2 Connecting the signal cable and the supply voltage cable

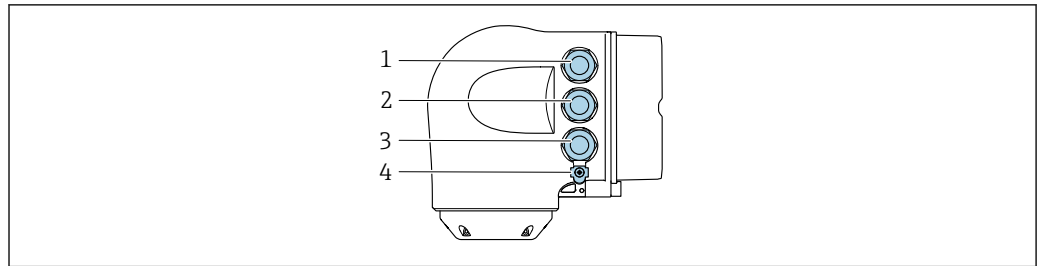

A0026781

- 1 Terminal connection for supply voltage
- 2 Terminal connection for signal transmission, input/output
- 3 Terminal connection for signal transmission, input/output or terminal connection for network connection via service interface (CDI-RJ45)
- 4 Protective earth (PE)

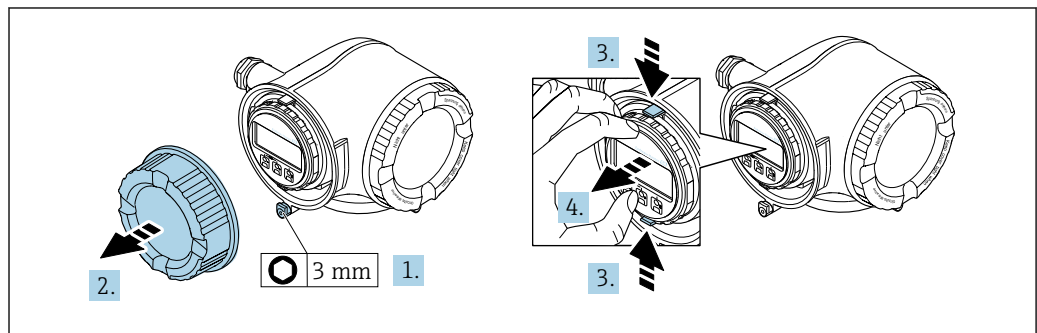

A0029813

1. Loosen the securing clamp of the connection compartment cover.
2. Unscrew the connection compartment cover.
3. Squeeze the tabs of the display module holder together.
4. Remove the display module holder.

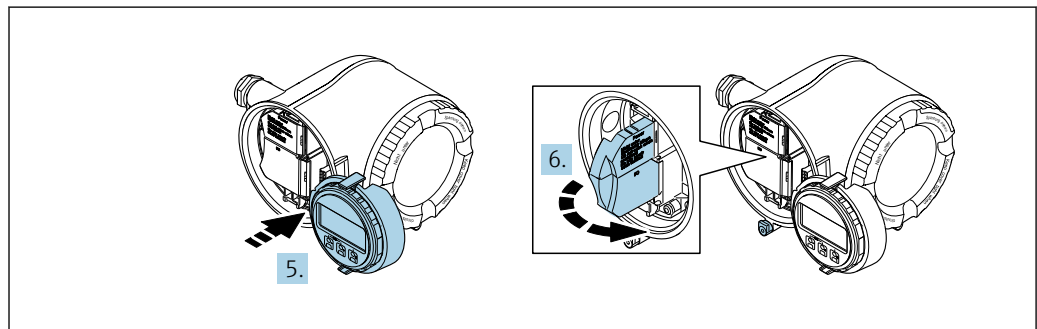

A0029814

5. Attach the holder to the edge of the electronics compartment.
6. Open the terminal cover.

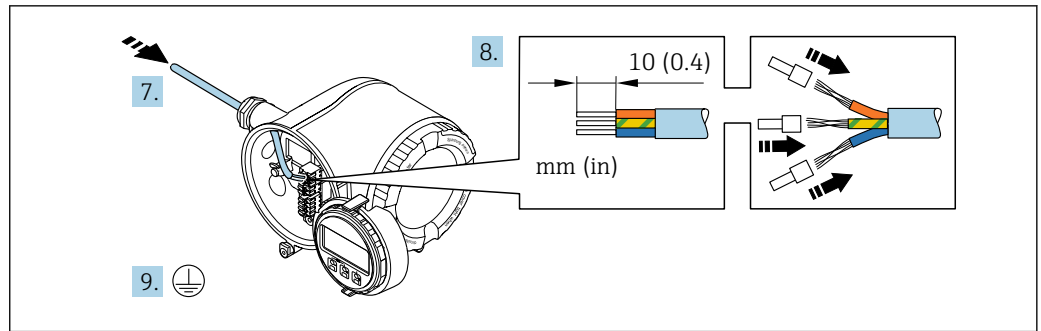

A0029815

7. Push the cable through the cable entry. To ensure tight sealing, do not remove the sealing ring from the cable entry.
8. Strip the cable and cable ends. In the case of stranded cables, also fit ferrules.
9. Connect the protective ground.

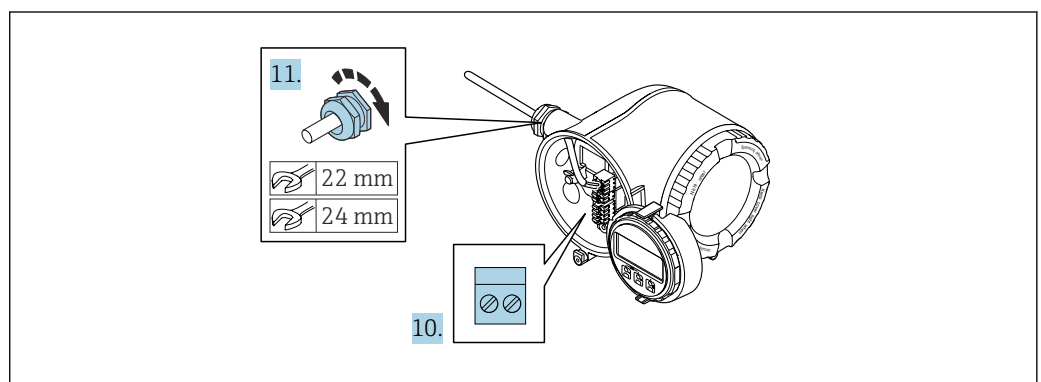

A0029816

10. Connect the cable according to the terminal assignment.
 - ↳ **Signal cable terminal assignment:** The device-specific terminal assignment is documented on an adhesive label in the terminal cover.
 - Supply voltage connection terminal assignment:** Adhesive label in the terminal cover or → 40.
11. Firmly tighten the cable glands.
 - ↳ This concludes the cable connection process.
12. Close the terminal cover.
13. Fit the display module holder in the electronics compartment.
14. Screw on the connection compartment cover.
15. Secure the securing clamp of the connection compartment cover.

Removing a cable

To remove a cable from the terminal:

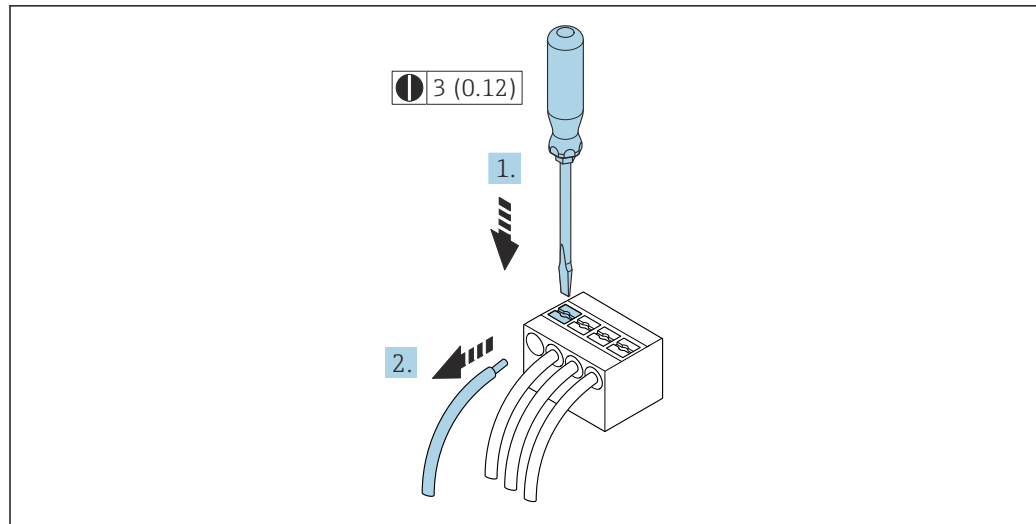

A0029598

17 Engineering unit mm (in)

1. Use a flat-blade screwdriver to press down on the slot between the two terminal holes.
2. Remove the cable end from the terminal.

7.5 Potential equalization

7.5.1 Requirements

For potential equalization:

- Pay attention to in-house grounding concepts
- Take account of operating conditions, such as the pipe material and grounding
- Connect the medium, sensor and transmitter to the same electric potential
- Use a ground cable with a minimum cross-section of 6 mm^2 (10 AWG) and a cable lug for potential equalization connections

7.6 Special connection instructions

7.6.1 Connection examples

FOUNDATION Fieldbus

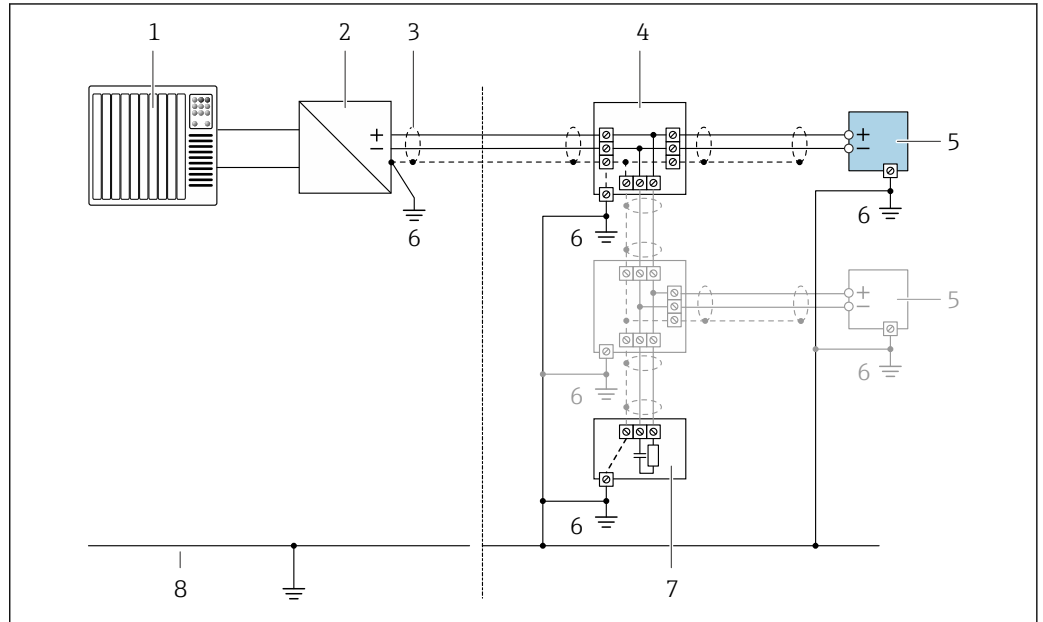

18 Connection example for FOUNDATION Fieldbus

- 1 Control system (e.g. PLC)
- 2 Power Conditioner (FOUNDATION Fieldbus)
- 3 Cable shield provided at one end. The cable shield must be grounded at both ends to comply with EMC requirements; observe cable specifications
- 4 T-box
- 5 Measuring device
- 6 Local grounding
- 7 Bus terminator
- 8 Potential matching line

Current output 4-20 mA

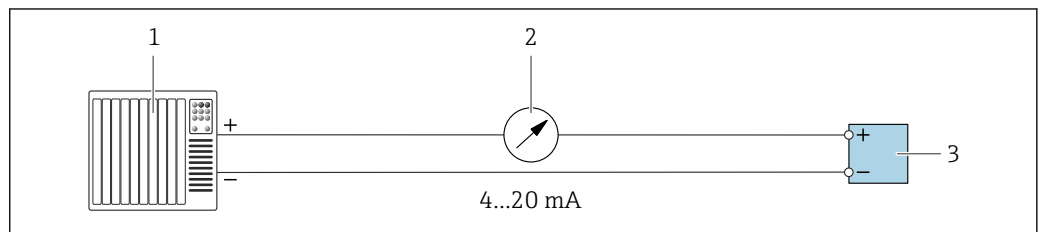

19 Connection example for 4-20 mA current output (active)

- 1 Automation system with current input (e.g. PLC)
- 2 Analog display unit: observe maximum load
- 3 Transmitter

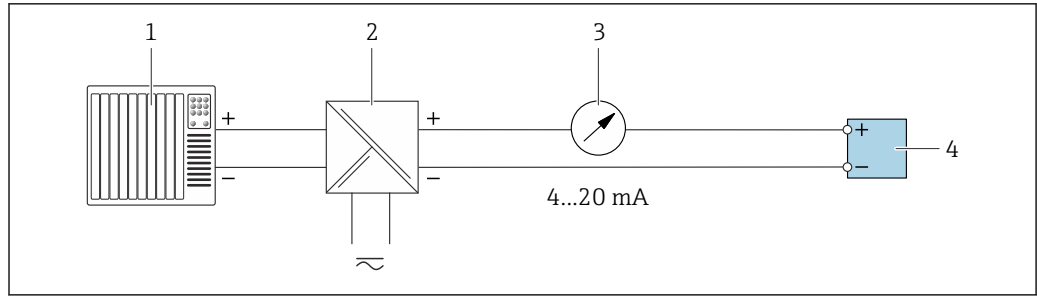

A0028759

20 Connection example for 4-20 mA current output (passive)

- 1 Automation system with current input (e.g. PLC)
- 2 Active barrier for power supply (e.g. RN221N)
- 3 Analog display unit: observe maximum load
- 4 Transmitter

Pulse/frequency output

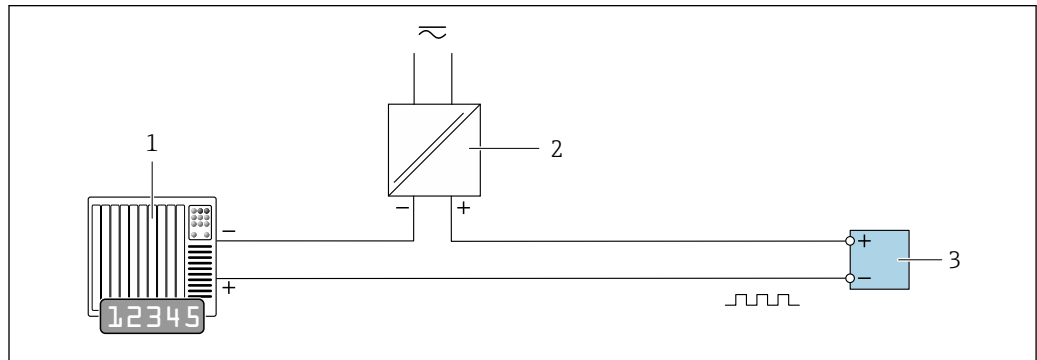

A0028761

21 Connection example for pulse/frequency output (passive)

- 1 Automation system with pulse/frequency input (e.g. PLC with 10 kΩ pull-up or pull-down resistor)
- 2 Power supply
- 3 Transmitter: observe input values → 213

Switch output

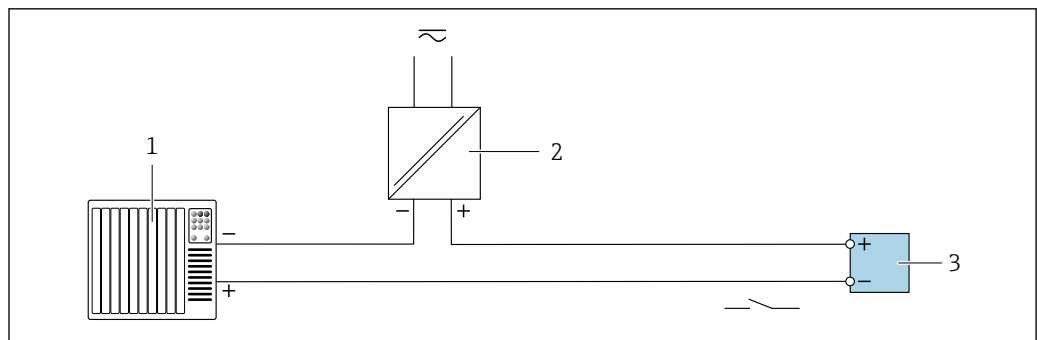

A0028760

22 Connection example for switch output (passive)

- 1 Automation system with switch input (e.g. PLC with a 10 kΩ pull-up or pull-down resistor)
- 2 Power supply
- 3 Transmitter: observe input values → 213

Relay output

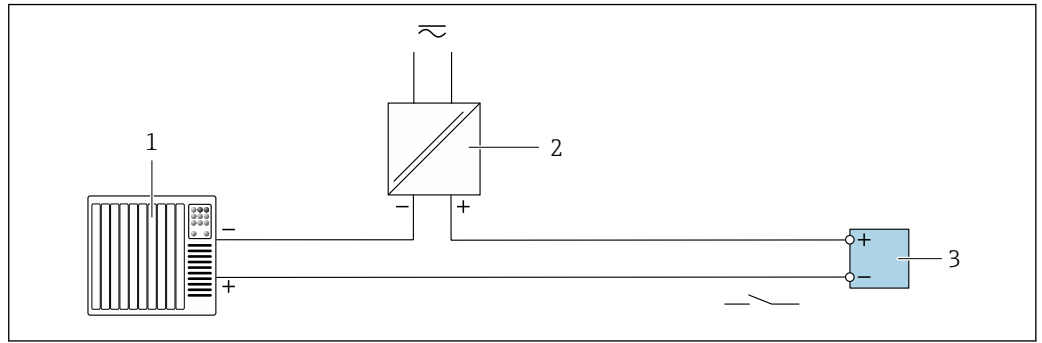

A0028760

23 Connection example for relay output (passive)

- 1 Automation system with relay input (e.g. PLC)
- 2 Power supply
- 3 Transmitter: observe input values → 214

Current input

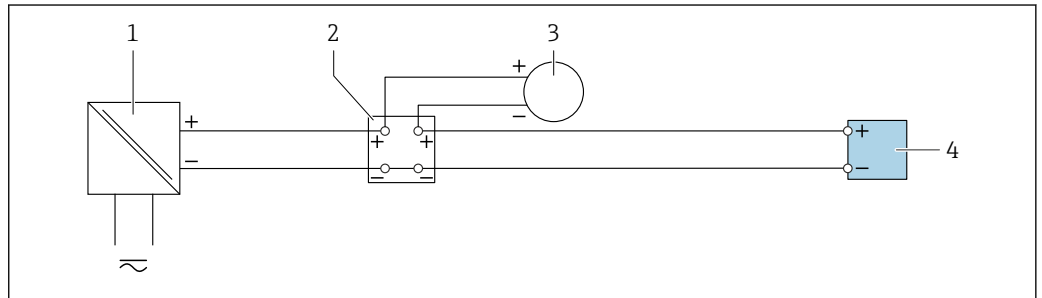

A0028915

24 Connection example for 4 to 20 mA current input

- 1 Power supply
- 2 Terminal box
- 3 External measuring device (to read in pressure or temperature, for instance)
- 4 Transmitter

Status input

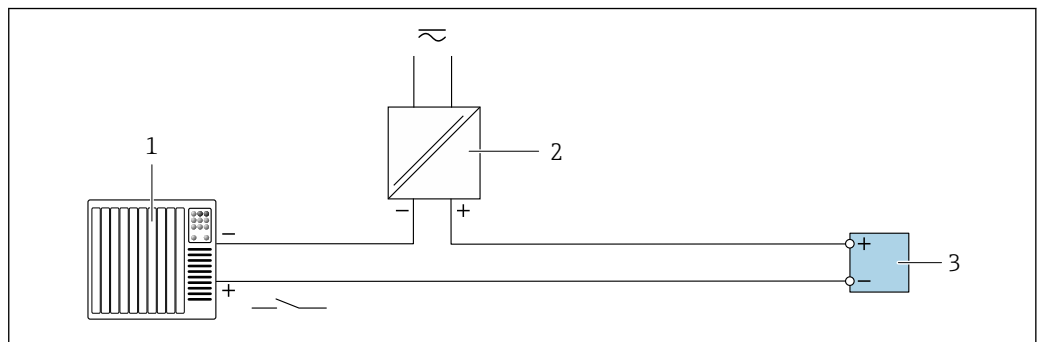

A0028764

25 Connection example for status input

- 1 Automation system with status output (e.g. PLC)
- 2 Power supply
- 3 Transmitter

7.7 Ensuring the degree of protection

The measuring instrument fulfills all the requirements for the degree of protection IP66/67, Type 4X enclosure.

To guarantee the degree of protection IP66/67, Type 4X enclosure, carry out the following steps after the electrical connection:

1. Check that the housing seals are clean and fitted correctly.
2. Dry, clean or replace the seals if necessary.
3. Tighten all housing screws and screw covers.
4. Firmly tighten the cable glands.
5. To ensure that moisture does not enter the cable entry:
Route the cable so that it loops down before the cable entry ("water trap").

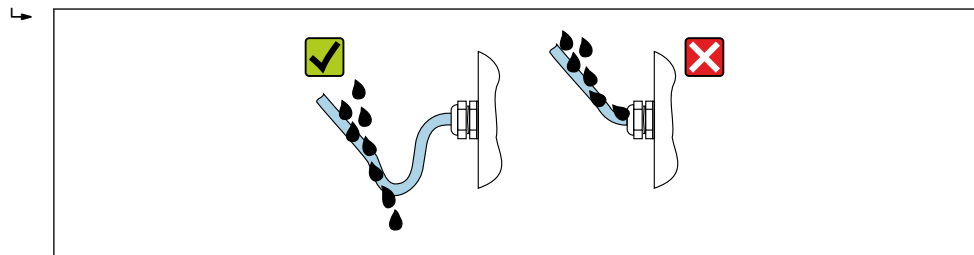

A0029278

6. The cable glands supplied do not ensure housing protection when not in use. They must therefore be replaced by dummy plugs corresponding to the housing protection.

7.8 Post-connection check

| | |
|--|--------------------------|
| Are the device and cable undamaged (visual inspection)? | <input type="checkbox"/> |
| Is the protective earthing established correctly? | <input type="checkbox"/> |
| Do the cables used comply with the requirements ? | <input type="checkbox"/> |
| Are the installed cables strain-relieved and securely routed? | <input type="checkbox"/> |
| Are all cable glands installed, securely tightened and leak-tight? Cable run with "water trap" → 60? | <input type="checkbox"/> |
| Is the terminal assignment correct ? | <input type="checkbox"/> |
| Are dummy plugs inserted in unused cable entries and have transportation plugs been replaced with dummy plugs? | <input type="checkbox"/> |

8 Operation options

8.1 Overview of operation options

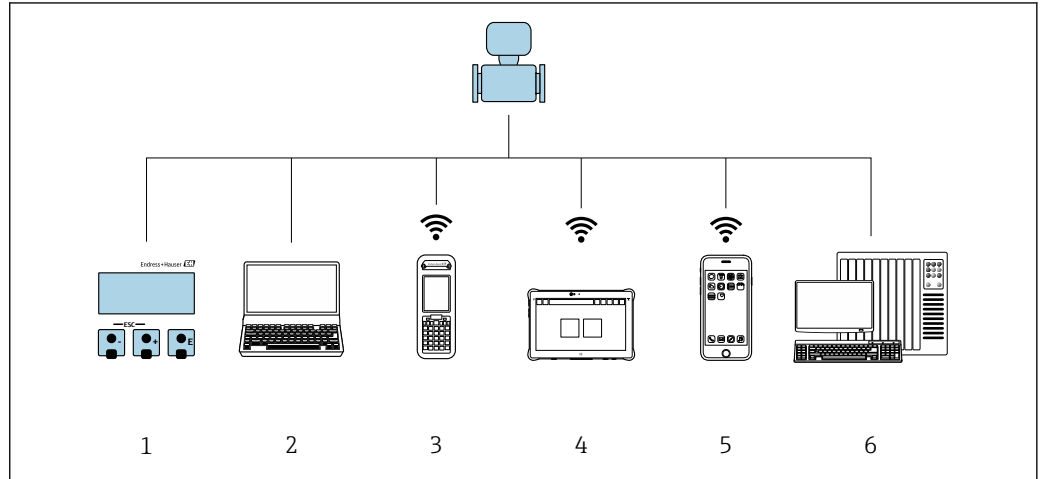



A0034513

- 1 Local operation via display module
- 2 Computer with web browser or operating tool (e.g. FieldCare, DeviceCare, AMS Device Manager, SIMATIC PDM)
- 3 Field Xpert SFX350 or SFX370
- 4 Field Xpert SMT70
- 5 Mobile handheld terminal
- 6 Automation system (e.g. PLC)

8.2 Structure and function of the operating menu

8.2.1 Structure of the operating menu

 For an overview of the operating menu for experts: see the "Description of Device Parameters" document supplied with the device →  239

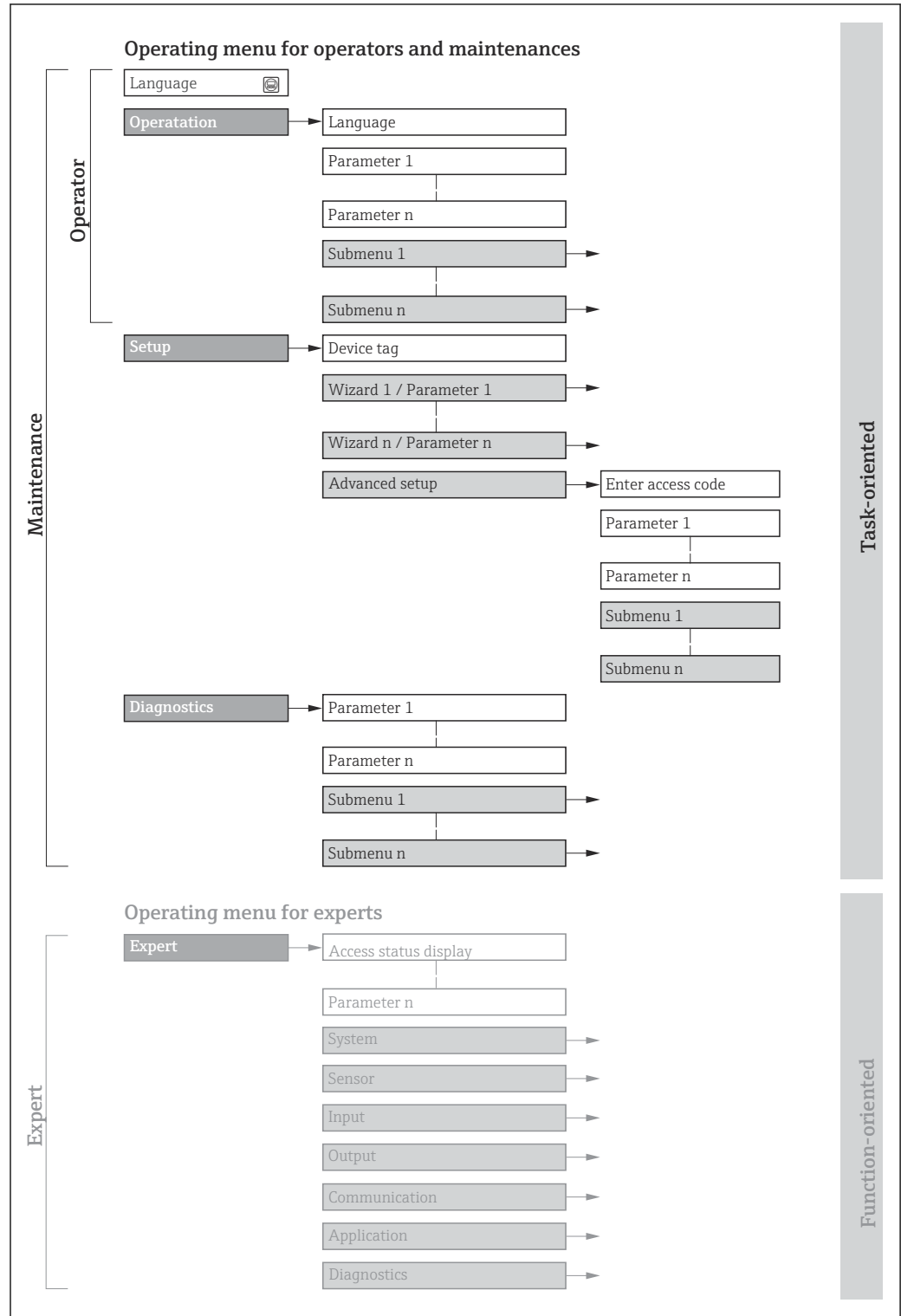

 26 Schematic structure of the operating menu

A0018237-EN

8.2.2 Operating philosophy

The individual parts of the operating menu are assigned to certain user roles (e.g. operator, maintenance etc.). Each user role contains typical tasks within the device life cycle.

| Menu/parameter | | User role and tasks | Content/meaning |
|----------------|---------------|---|--|
| Language | Task-oriented | Role "Operator", "Maintenance" Tasks during operation: <ul style="list-style-type: none"> ▪ Configuration of the operational display ▪ Reading measured values | <ul style="list-style-type: none"> ▪ Defining the operating language ▪ Defining the Web server operating language ▪ Resetting and controlling totalizers |
| Operation | | | <ul style="list-style-type: none"> ▪ Configuration of the operational display (e.g. display format, display contrast) ▪ Resetting and controlling totalizers |
| Setup | | "Maintenance" role Commissioning: <ul style="list-style-type: none"> ▪ Configuration of the measurement ▪ Configuration of the inputs and outputs ▪ Configuration of the communication interface | Wizards for fast commissioning: <ul style="list-style-type: none"> ▪ Configuring the system units ▪ Configuration of the communication interface ▪ Definition of the medium ▪ Displaying the I/O configuration ▪ Configuring the inputs ▪ Configuring the outputs ▪ Configuration of the operational display ▪ Configuring the low flow cut off ▪ Configuring partial and empty pipe detection Advanced setup <ul style="list-style-type: none"> ▪ For more customized configuration of the measurement (adaptation to special measuring conditions) ▪ Configuration of totalizers ▪ Configuration of WLAN settings ▪ Administration (define access code, reset measuring device) |
| Diagnostics | | "Maintenance" role Troubleshooting: <ul style="list-style-type: none"> ▪ Diagnostics and elimination of process and device errors ▪ Measured value simulation | Contains all parameters for error detection and analyzing process and device errors: <ul style="list-style-type: none"> ▪ Diagnostic list Contains up to 5 currently pending diagnostic messages. ▪ Event logbook Contains event messages that have occurred. ▪ Device information Contains information for identifying the device ▪ Measured values Contains all current measured values. ▪ Data logging submenu with the "Extended HistoROM" order option Storage and visualization of measured values ▪ Heartbeat Technology Verification of device functionality on request and documentation of verification results ▪ Simulation Used to simulate measured values or output values. |

| Menu/parameter | User role and tasks | Content/meaning |
|----------------|---------------------|--|
| Expert | Function-oriented | <p>Tasks that require detailed knowledge of the function of the device:</p> <ul style="list-style-type: none"> ▪ Commissioning measurements under difficult conditions ▪ Optimal adaptation of the measurement to difficult conditions ▪ Detailed configuration of the communication interface ▪ Error diagnostics in difficult cases <p>Contains all of the device parameters and allows direct access to these by means of an access code. The structure of this menu is based on the function blocks of the device:</p> <ul style="list-style-type: none"> ▪ System Contains all higher-level device parameters that do not affect measurement or measured value communication ▪ Sensor Configuration of the measurement. ▪ Output Configuration of the pulse/frequency/switch output ▪ Input Configuration of the status input ▪ Output Configuration of the analog current outputs as well as the pulse/frequency and switch output ▪ Communication Configuration of the digital communication interface and the Web server ▪ Submenus for function blocks (e.g. "Analog Inputs") Configuration of function blocks ▪ Application Configuration of the functions that go beyond the actual measurement (e.g. totalizer) ▪ Diagnostics Error detection and analysis of process and device errors and for device simulation and Heartbeat Technology. |

8.3 Access to operating menu via local display

8.3.1 Operational display

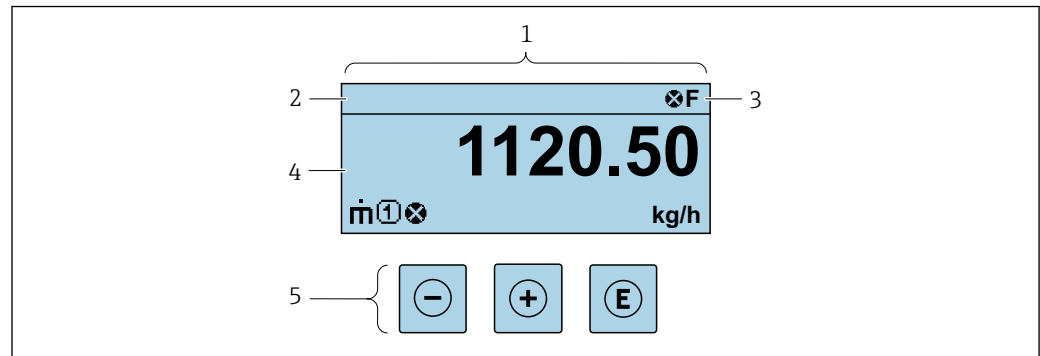







A0029348

- 1 Operational display
- 2 Device tag
- 3 Status area
- 4 Display range for measured values (up to 4 lines)
- 5 Operating elements → 71

Status area





The following symbols appear in the status area of the operational display at the top right:



- Status signals →  164
 - **F**: Failure
 - **C**: Function check
 - **S**: Out of specification
 - **M**: Maintenance required
- Diagnostic behavior →  165
 - : Alarm
 - : Warning
- : Locking (the device is locked via the hardware)
- : Communication (communication via remote operation is active)

Display area



In the display area, each measured value is prefaced by certain symbol types for further description:

Measured variables

| Symbol | Meaning |
|---|--|
|  | Mass flow |
|  | <ul style="list-style-type: none"> ▪ Volume flow ▪ Corrected volume flow |
|  | <ul style="list-style-type: none"> ▪ Density ▪ Reference density |
|  | Temperature |

 The number and display format of the measured variables can be configured via the **Format display** parameter (→  118).



Totalizer

| Symbol | Meaning |
|---|---|
|  | Totalizer  The measurement channel number indicates which of the three totalizers is displayed. |



Input

| Symbol | Meaning |
|---|--------------|
|  | Status input |

Measurement channel numbers

| Symbol | Meaning |
|---|---|
|  | Measurement channel 1 to 4  The measurement channel number is displayed only if more than one channel is present for the same measured variable type (e.g. totalizer 1 to 3). |

Diagnostic behavior

| Symbol | Meaning |
|---|---|
|  | Alarm <ul style="list-style-type: none">▪ Measurement is interrupted.▪ Signal outputs and totalizers assume the defined alarm condition.▪ A diagnostic message is generated. |
|  | Warning <ul style="list-style-type: none">▪ Measurement is resumed.▪ The signal outputs and totalizers are not affected.▪ A diagnostic message is generated. |

 The diagnostic behavior pertains to a diagnostic event that is relevant to the displayed measured variable.

8.3.2 Navigation view

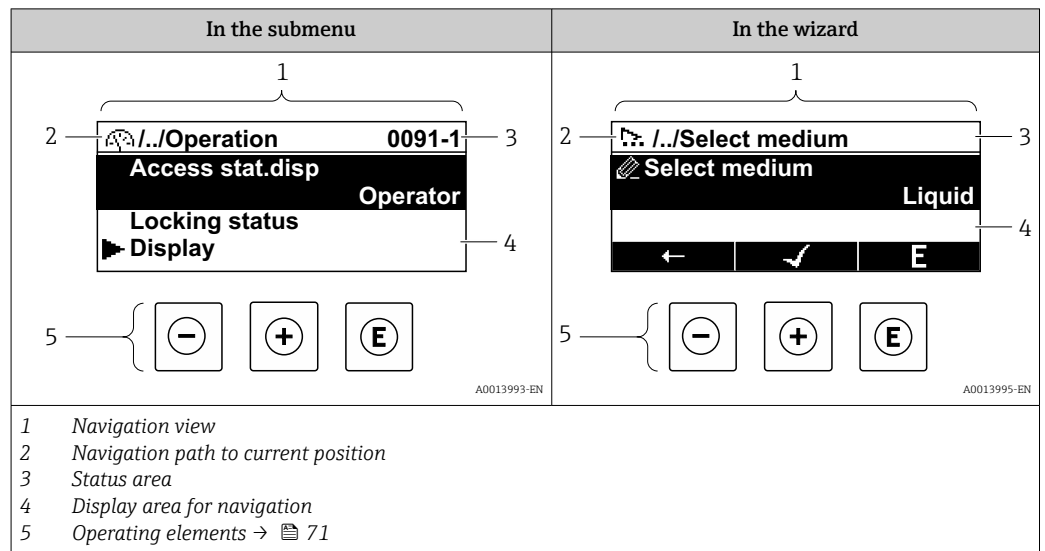

Navigation path

The navigation path to the current position is displayed at the top left in the navigation view and consists of the following elements:

- The display symbol for the menu/submenu (▶) or the wizard (⚙).
- An omission symbol (/ ../) for operating menu levels in between.
- Name of the current submenu, wizard or parameter

| | Display symbol | Omission symbol | Parameter |
|---------|----------------|-----------------|------------|
| | ↓ | ↓ | ↓ |
| Example | ▶ | / ../ | Indication |

For more information about the icons in the menu, refer to the "Display area" section → 67

Status area

The following appears in the status area of the navigation view in the top right corner:



- In the submenu
 - The direct access code to the parameter (e.g., 0022-1)
 - If a diagnostic event is present, the diagnostic behavior and status signal
- In the wizard
 - If a diagnostic event is present, the diagnostic behavior and status signal

- For information on the diagnostic behavior and status signal → 164
- For information on the function and entry of the direct access code → 73





Display area

Menus

| Symbol | Meaning |
|---|---|
|  | <p>Operation Is displayed:</p> <ul style="list-style-type: none"> ▪ In the menu next to the "Operation" selection ▪ At the left in the navigation path in the Operation menu |

| | |
|---|--|
|  | <p>Setup Is displayed:</p> <ul style="list-style-type: none"> ▪ In the menu next to the "Setup" selection ▪ At the left in the navigation path in the Setup menu |
|  | <p>Diagnosis Is displayed:</p> <ul style="list-style-type: none"> ▪ In the menu next to the "Diagnostics" selection ▪ At the left in the navigation path in the Diagnostics menu |
|  | <p>Expert Is displayed:</p> <ul style="list-style-type: none"> ▪ In the menu next to the "Expert" selection ▪ At the left in the navigation path in the Expert menu |



Submenus, wizards, parameters

| Symbol | Meaning |
|---|--|
|  | Submenu |
|  | Wizards |
|  | Parameters within a wizard  No display symbol exists for parameters in submenus. |

Locking procedure

| Symbol | Meaning |
|---|---|
|  | <p>Parameter locked When displayed in front of a parameter name, indicates that the parameter is locked.</p> <ul style="list-style-type: none"> ▪ By a user-specific access code ▪ By the hardware write protection switch |

Wizards

| Symbol | Meaning |
|---|--|
|  | Switches to the previous parameter. |
|  | Confirms the parameter value and switches to the next parameter. |
|  | Opens the editing view of the parameter. |

8.3.3 Editing view

Numeric editor

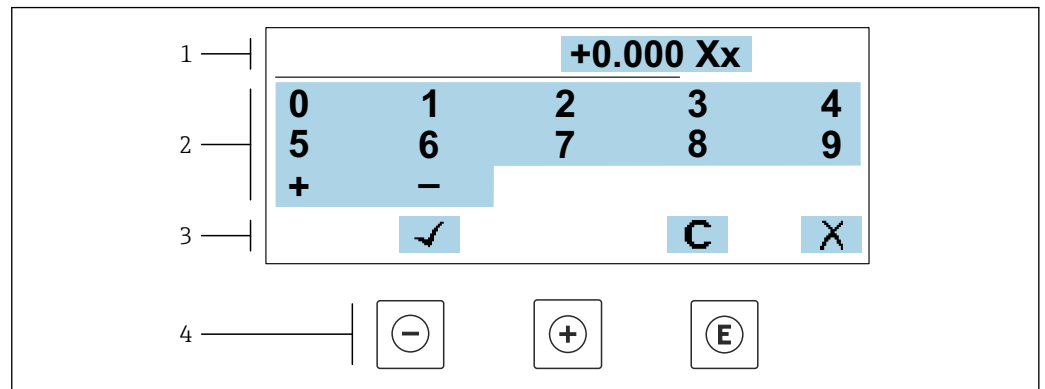

A0034250

27 For entering values in parameters (e.g. limit values)

- 1 Entry display area
- 2 Input screen
- 3 Confirm, delete or reject entry
- 4 Operating elements

Text editor

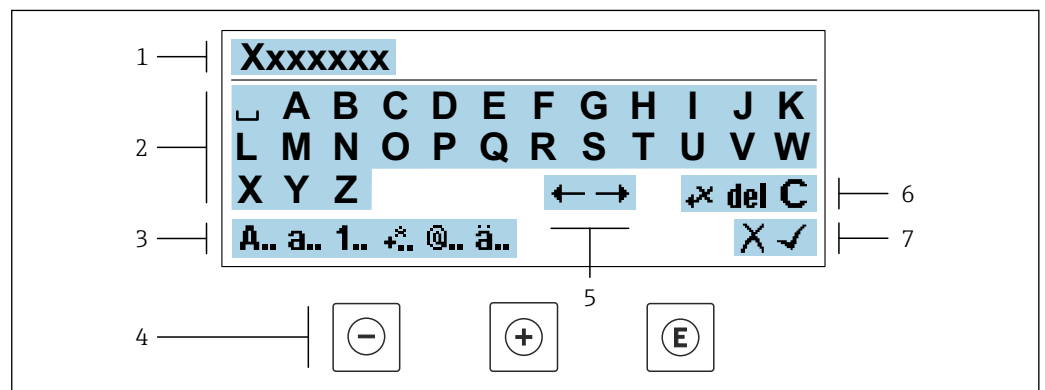



A0034114

28 For entering text in parameters (e.g. device tag)



- 1 Entry display area
- 2 Current input screen
- 3 Change input screen
- 4 Operating elements
- 5 Move entry position
- 6 Delete entry
- 7 Reject or confirm entry

Using the operating elements in the editing view





| Operating key | Meaning |
|---------------|--|
| ⊖ | Minus key Move the entry position to the left. |
| ⊕ | Plus key Move the entry position to the right. |

| Operating key | Meaning |
|---|---|
|  | Enter key <ul style="list-style-type: none"> ▪ Pressing the key briefly confirms your selection. ▪ Pressing the key for 2 s confirms your entry. |
|  | Escape key combination (press keys simultaneously) Close the editing view without accepting a change. |





Input screens

| Symbol | Meaning |
|---|---|
| A.. | Upper case |
| a.. | Lower case |
| 1.. | Numbers |
|  | Punctuation marks and special characters: = + - * / ² ³ ¼ ½ ¾ () [] < > { } |
|  | Punctuation marks and special characters: " ` ^ . , ; : ? ! % ° € \$ £ ¥ \$ @ # / \ ~ & _ |
| ä.. | Umlauts and accents |

Controlling data entries

| Symbol | Meaning |
|---|---|
|  | Move entry position |
|  | Reject entry |
|  | Confirm entry |
|  | Delete character immediately to the left of the entry position |
| del | Delete character immediately to the right of the entry position |
| C | Clear all the characters entered |

8.3.4 Operating elements

| Operating key | Meaning |
|---|--|
|  | <p>Minus key</p> <p><i>In menu, submenu</i> Moves the selection bar upwards in a picklist</p> <p><i>In wizards</i> Goes to previous parameter</p> <p><i>In the text and numeric editor</i> Move the entry position to the left.</p> |
|  | <p>Plus key</p> <p><i>In menu, submenu</i> Moves the selection bar downwards in a picklist</p> <p><i>In wizards</i> Goes to the next parameter</p> <p><i>In the text and numeric editor</i> Move the entry position to the right.</p> |
|  | <p>Enter key</p> <p><i>In the operational display</i> Pressing the key briefly opens the operating menu.</p> <p><i>In menu, submenu</i></p> <ul style="list-style-type: none"> ▪ Pressing the key briefly: <ul style="list-style-type: none"> ▪ Opens the selected menu, submenu or parameter. ▪ Starts the wizard. ▪ If help text is open, closes the help text of the parameter. ▪ Pressing the key for 2 s in a parameter: <ul style="list-style-type: none"> ▪ If present, opens the help text for the function of the parameter. <p><i>In wizards</i> Opens the editing view of the parameter and confirms the parameter value</p> <p><i>In the text and numeric editor</i></p> <ul style="list-style-type: none"> ▪ Pressing the key briefly confirms your selection. ▪ Pressing the key for 2 s confirms your entry. |
|  | <p>Escape key combination (press keys simultaneously)</p> <p><i>In menu, submenu</i></p> <ul style="list-style-type: none"> ▪ Pressing the key briefly: <ul style="list-style-type: none"> ▪ Exits the current menu level and takes you to the next higher level. ▪ If help text is open, closes the help text of the parameter. ▪ Pressing the key for 2 s returns you to the operational display ("home position"). <p><i>In wizards</i> Exits the wizard and takes you to the next higher level</p> <p><i>In the text and numeric editor</i> Exits the Editing view without applying the changes.</p> |
|  | <p>Minus/Enter key combination (press and hold down the keys simultaneously)</p> <ul style="list-style-type: none"> ▪ If keypad lock is active: <ul style="list-style-type: none"> ▪ Pressing the key for 3 s deactivates the keypad lock. ▪ If keypad lock is not active: <ul style="list-style-type: none"> ▪ Pressing the key for 3 s opens the context menu including the option for activating the keypad lock. |

8.3.5 Opening the context menu

Using the context menu, the user can call up the following menus quickly and directly from the operational display:

- Setup
- Data backup
- Simulation

Calling up and closing the context menu

The user is in the operational display.

1. Press the \square and \boxplus keys for longer than 3 seconds.
↳ The context menu opens.

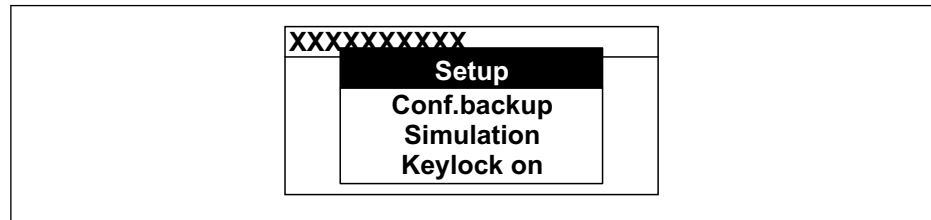

A0034608-EN

2. Press \square + \boxplus simultaneously.
↳ The context menu is closed and the operational display appears.

Calling up the menu via the context menu

1. Open the context menu.
2. Press \boxplus to navigate to the desired menu.
3. Press \boxtimes to confirm the selection.
↳ The selected menu opens.

8.3.6 Navigating and selecting from list

Different operating elements are used to navigate through the operating menu. The navigation path is displayed on the left in the header. Icons are displayed in front of the individual menus. These icons are also shown in the header during navigation.

i For an explanation of the navigation view with symbols and operating elements → 67

Example: Setting the number of displayed measured values to "2 values"

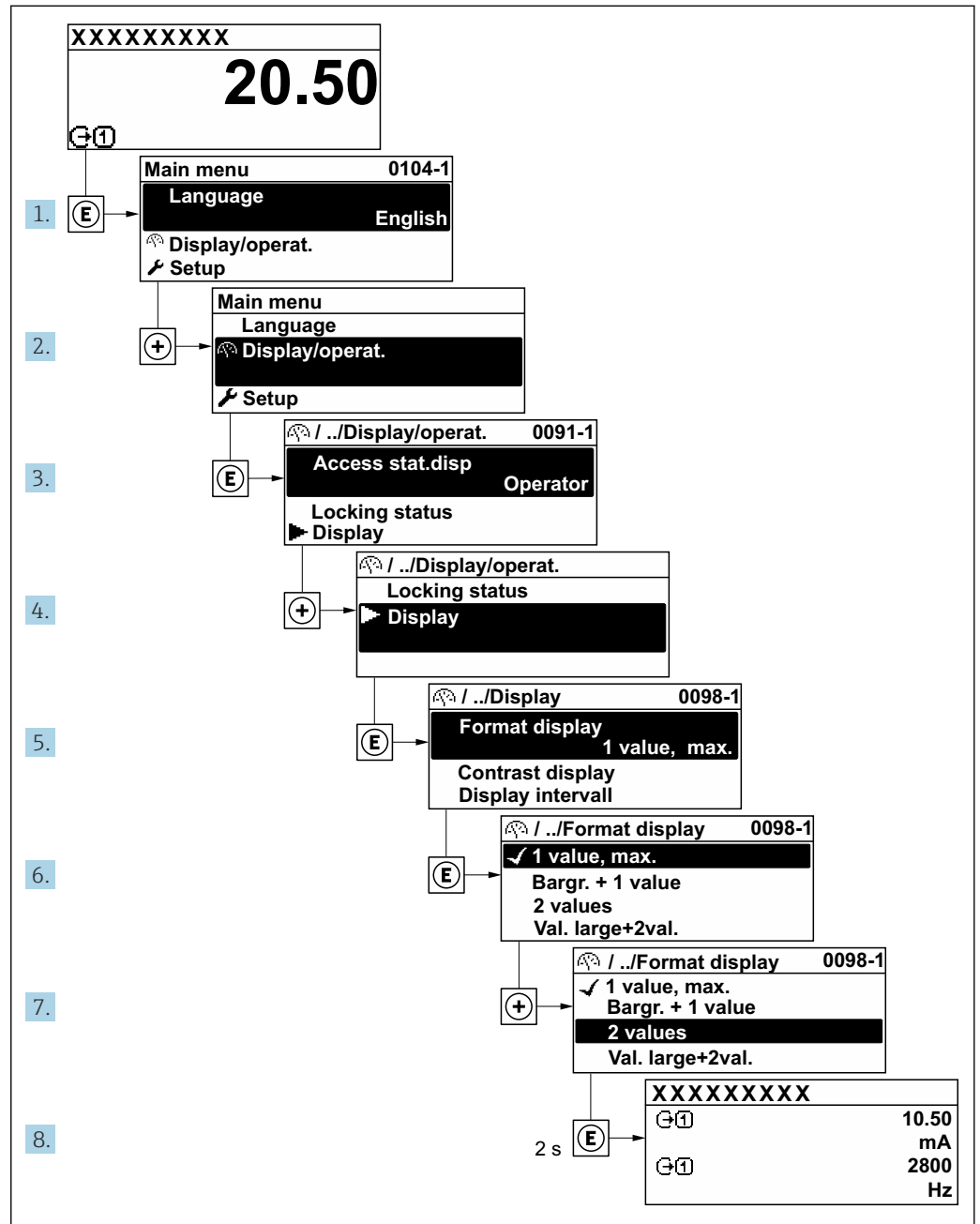

A0029562-EN

8.3.7 Calling the parameter directly

A parameter number is assigned to every parameter to be able to access a parameter directly via the onsite display. Entering this access code in the **Direct access** parameter calls up the desired parameter directly.

Navigation path

Expert → Direct access

The direct access code consists of a 5-digit number (at maximum) and the channel number, which identifies the channel of a process variable: e.g. 00914-2. In the navigation view, this appears on the right-hand side in the header of the selected parameter.

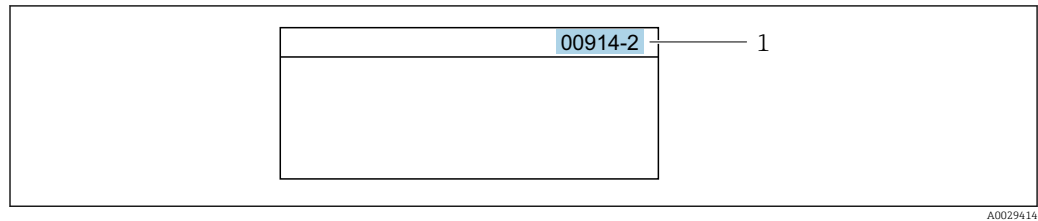

1 Direct access code

Note the following when entering the direct access code:

- The leading zeros in the direct access code do not have to be entered.
Example: Enter "914" instead of "00914"
- If no channel number is entered, channel 1 is opened automatically.
Example: Enter 00914 → **Assign process variable** parameter
- If a different channel is opened: Enter the direct access code with the corresponding channel number.
Example: Enter 00914-2 → **Assign process variable** parameter



For the direct access codes of the individual parameters, see the "Description of Device Parameters" document for the device

8.3.8 Calling up help text

Help text is available for some parameters and can be called up from the navigation view. The help text provides a brief explanation of the parameter function and thereby supports swift and safe commissioning.

Calling up and closing the help text

The user is in the navigation view and the selection bar is on a parameter.

1. Press \square for 2 s.
↳ The help text for the selected parameter opens.

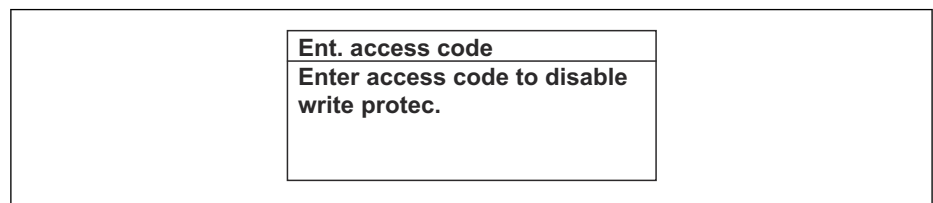

29 Example: Help text for parameter "Enter access code"

2. Press \square + \oplus simultaneously.
↳ The help text is closed.

8.3.9 Changing the parameters

Parameters can be changed via the numeric editor or text editor.

- Numeric editor: Change values in a parameter, e.g. specifications for limit values.
- Text editor: Enter text in a parameter, e.g. tag name.

A message is displayed if the value entered is outside the permitted value range.

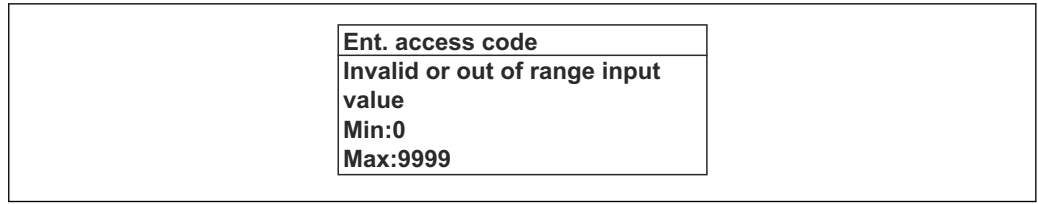

A0014049-EN

For a description of the editing view - consisting of the text editor and numeric editor - with symbols → 69, for a description of the operating elements → 71

8.3.10 User roles and related access authorization

The two user roles "Operator" and "Maintenance" have different write access to the parameters if the customer defines a user-specific access code. This protects the device configuration via the local display from unauthorized access → 142.

Defining access authorization for user roles

An access code is not yet defined when the device is delivered from the factory. Access authorization (read and write access) to the device is not restricted and corresponds to the "Maintenance" user role.

- ▶ Define the access code.
 - ↳ The "Operator" user role is redefined in addition to the "Maintenance" user role. Access authorization differs for the two user roles.

Access authorization to parameters: "Maintenance" user role

| Access code status | Read access | Write access |
|--|-------------|-----------------|
| An access code has not yet been defined (factory setting). | ✓ | ✓ |
| After an access code has been defined. | ✓ | ✓ ¹⁾ |

1) The user only has write access after entering the access code.

Access authorization to parameters: "Operator" user role

| Access code status | Read access | Write access |
|--|-------------|-----------------|
| After an access code has been defined. | ✓ | _ ¹⁾ |

1) Despite the defined access code, certain parameters can always be modified and thus are excluded from the write protection as they do not affect the measurement: write protection via access code → 142

The user role with which the user is currently logged on is indicated by the **Access status** parameter. Navigation path: Operation → Access status

8.3.11 Disabling write protection via access code

If the -symbol appears on the local display in front of a parameter, the parameter is write-protected by a user-specific access code and its value cannot be changed at the moment using local operation → 142.

Parameter write protection via local operation can be disabled by entering the user-specific access code in the **Enter access code** parameter (→ 123) via the respective access option.

1. After you press , the input prompt for the access code appears.

2. Enter the access code.
 - ↳ The -symbol in front of the parameters disappears; all previously write-protected parameters are now re-enabled.

8.3.12 Enabling and disabling the keypad lock



The keypad lock makes it possible to block access to the entire operating menu via local operation. As a result, it is no longer possible to navigate through the operating menu or change the values of individual parameters. Users can only read the measured values on the operational display.

The keypad lock is switched on and off via the context menu.

Switching on the keypad lock



-  The keypad lock is switched on automatically:
- If the device has not been operated via the display for > 1 minute.
 - Each time the device is restarted.

To activate the keylock manually:

1. The device is in the measured value display.
Press the  and  keys for 3 seconds.
 - ↳ A context menu appears.
2. In the context menu select the **Keylock on** option.
 - ↳ The keypad lock is switched on.

-  If the user attempts to access the operating menu while the keypad lock is active, the **Keylock on** message appears.

Switching off the keypad lock

- ▶ The keypad lock is switched on.
Press the  and  keys for 3 seconds.
 - ↳ The keypad lock is switched off.

8.4 Access to operating menu via web browser

8.4.1 Function range

With the integrated web server, the device can be operated and configured via a web browser service interface (CDI-RJ45) or WLAN interface. The structure of the operating menu is the same as for the local display. In addition to the measured values, status information on the device is displayed and can be used to monitor device health. Furthermore the device data can be managed and the network parameters can be configured.

A device that has a WLAN interface (can be ordered as an option) is required for the WLAN connection: order code for "Display; operation", option G "4-line, illuminated; touch control + WLAN". The device acts as an Access Point and enables communication by computer or a mobile handheld terminal.

-  For additional information on the web server, see the Special Documentation for the device. →  239

8.4.2 Requirements

Computer hardware



| Hardware | Interface | |
|------------|--|--|
| | CDI-RJ45 | WLAN |
| Interface | The computer must have a RJ45 interface. ¹⁾ | The operating unit must have a WLAN interface. |
| Connection | | Connection via Wireless LAN. |
| Screen | Recommended size: ≥ 12" (depends on the screen resolution) | |

1) Recommended cable: CAT5e, CAT6 or CAT7, with shielded plug (e.g. YAMAICHI product; part no. Y-ConProfixPlug63/Prod. ID: 82-006660)

Computer software



| Software | Interface | |
|-------------------------------|--|------|
| | CDI-RJ45 | WLAN |
| Recommended operating systems | <ul style="list-style-type: none"> ▪ Microsoft Windows 8 or higher. ▪ Mobile operating systems: <ul style="list-style-type: none"> ▪ iOS ▪ Android  Microsoft Windows XP and Windows 7 is supported. | |
| Web browsers supported | <ul style="list-style-type: none"> ▪ Microsoft Internet Explorer 8 or higher ▪ Microsoft Edge ▪ Mozilla Firefox ▪ Google Chrome ▪ Safari | |

Computer settings



| Settings | Interface | |
|--|--|--|
| | CDI-RJ45 | WLAN |
| User rights | Appropriate user rights (e.g. administrator rights) for TCP/IP and proxy server settings are necessary (e.g. for adjusting the IP address, subnet mask etc.). | |
| Proxy server settings of the web browser | The web browser setting <i>Use a proxy server for your LAN</i> must be disabled . | |
| JavaScript | JavaScript must be enabled.  If JavaScript cannot be enabled: Enter <code>http://192.168.1.212/servlet/basic.html</code> in the address bar of the web browser. A fully functional but simplified version of the operating menu structure starts in the web browser.  When installing a new firmware version: To enable correct data display, clear the temporary memory (cache) under Internet options in the web browser. | JavaScript must be enabled.  The WLAN display requires JavaScript support. |
| Network connections | Only use the active network connections to the measuring device. | |
| | Switch off all other network connections such as WLAN for example. | Switch off all other network connections. |

 In the event of connection problems: →  160

Measuring device: Via CDI-RJ45 service interface

| Device | CDI-RJ45 service interface |
|------------------|--|
| Measuring device | The measuring device has an RJ45 interface. |
| Web server | Web server must be enabled; factory setting: ON  For information on enabling the Web server →  82 |

Measuring device: via WLAN interface

| Device | WLAN interface |
|------------------|---|
| Measuring device | The measuring device has a WLAN antenna: <ul style="list-style-type: none"> ▪ Transmitter with integrated WLAN antenna ▪ Transmitter with external WLAN antenna |
| Web server | Web server and WLAN must be enabled; factory setting: ON  For information on enabling the Web server →  82 |

8.4.3 Connecting the device

Via service interface (CDI-RJ45)

Preparing the measuring device

Proline 500 – digital

1. Loosen the 4 fixing screws on the housing cover.
2. Open the housing cover.
3. The location of the connection socket depends on the measuring device and the communication protocol.
Connect the computer to the RJ45 plug via the standard Ethernet cable .

Proline 500

1. Depending on the housing version:
Loosen the securing clamp or fixing screw of the housing cover.
2. Depending on the housing version:
Unscrew or open the housing cover.
3. Connect the computer to the RJ45 plug via the standard Ethernet connecting cable..

Configuring the Internet protocol of the computer

The following information refers to the default Ethernet settings of the device.

IP address of the device: 192.168.1.212 (factory setting)

1. Switch on the measuring device.
2. Connect the computer to the RJ45 plug via the standard Ethernet cable →  83.
3. If a 2nd network card is not used, close all the applications on the notebook.
 ↳ Applications requiring Internet or a network, such as e-mail, SAP applications, Internet or Windows Explorer.
4. Close any open Internet browsers.
5. Configure the properties of the Internet protocol (TCP/IP) as defined in the table:

| | |
|------------------------|--|
| IP address | 192.168.1.XXX; for XXX all numerical sequences except: 0, 212 and 255 → e.g. 192.168.1.213 |
| Subnet mask | 255.255.255.0 |
| Default gateway | 192.168.1.212 or leave cells empty |

Via WLAN interface

Configuring the Internet protocol of the mobile terminal

NOTICE

If the WLAN connection is lost during the configuration, settings made may be lost.

- ▶ Make sure that the WLAN connection is not disconnected while configuring the device.

NOTICE

Note the following to avoid a network conflict:

- ▶ Avoid accessing the measuring device simultaneously from the same mobile terminal via the service interface (CDI-RJ45) and the WLAN interface.
- ▶ Only activate one service interface (CDI-RJ45 or WLAN interface).
- ▶ If simultaneous communication is necessary: configure different IP address ranges, e.g. 192.168.0.1 (WLAN interface) and 192.168.1.212 (CDI-RJ45 service interface).

Preparing the mobile terminal

- ▶ Enable WLAN on the mobile terminal.

Establishing a WLAN connection from the mobile terminal to the measuring device

1. In the WLAN settings of the mobile terminal:
Select the measuring device using the SSID (e.g. EH_Promass_500_A802000).
2. If necessary, select the WPA2 encryption method.
3. Enter the password:
Serial number of the measuring device ex-works (e.g. L100A802000).
↳ The LED on the display module flashes. It is now possible to operate the measuring device with the web browser, FieldCare or DeviceCare.



The serial number can be found on the nameplate.



To ensure the safe and swift assignment of the WLAN network to the measuring point, it is advisable to change the SSID name. It should be possible to clearly assign the new SSID name to the measuring point (e.g. tag name) because it is displayed as the WLAN network.

Terminating the WLAN connection

- ▶ After configuring the device:
Terminate the WLAN connection between the mobile terminal and measuring device.

Starting the web browser

1. Start the web browser on the computer.

2. Enter the IP address of the web server in the address line of the web browser:
192.168.1.212
↳ The login page appears.

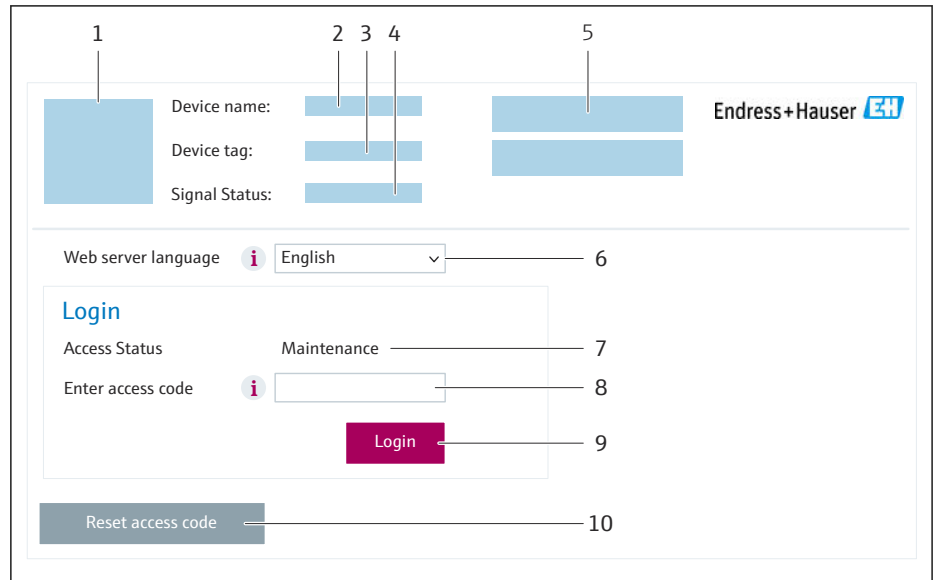

A0053670

- 1 Picture of device
- 2 Device name
- 3 Device tag
- 4 Status signal
- 5 Current measured values
- 6 Operating language
- 7 User role
- 8 Access code
- 9 Login
- 10 Reset access code (→ 138)

i If a login page does not appear, or if the page is incomplete → 160

8.4.4 Logging on

1. Select the preferred operating language for the Web browser.
2. Enter the user-specific access code.
3. Press **OK** to confirm your entry.

| | |
|-------------|--|
| Access code | 0000 (factory setting); can be changed by customer |
|-------------|--|

i If no action is performed for 10 minutes, the Web browser automatically returns to the login page.

8.4.5 User interface

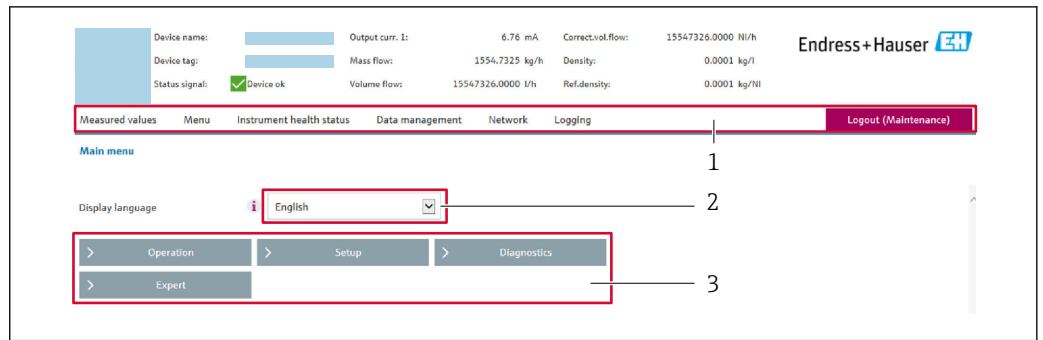

A0029418

- 1 Function row
- 2 Local display language
- 3 Navigation area

Header

The following information appears in the header:

- Device name
- Device tag
- Device status with status signal → 167
- Current measured values

Function row

| Functions | Meaning |
|-----------------|---|
| Measured values | Displays the measured values of the device |
| Menu | <ul style="list-style-type: none"> ■ Access to the operating menu from the measuring device ■ The structure of the operating menu is the same as for the local display |
| Device status | Displays the diagnostic messages currently pending, listed in order of priority |
| Data management | <p>Data exchange between computer and measuring device:</p> <ul style="list-style-type: none"> ■ Device configuration: <ul style="list-style-type: none"> ■ Load settings from the device (XML format, save configuration) ■ Save settings to the device (XML format, restore configuration) ■ Logbook - Export Event logbook (.csv file) ■ Documents - Export documents: <ul style="list-style-type: none"> ■ Export backup data record (.csv file, create documentation of the measuring point configuration) ■ Verification report (PDF file, only available with the "Heartbeat Verification" application package) ■ File for system integration - If using fieldbuses, upload device drivers for system integration from the measuring device: FOUNDATION Fieldbus: DD file ■ Firmware update - Flashing a firmware version |
| Network | <p>Configuration and checking of all the parameters required for establishing the connection to the measuring device:</p> <ul style="list-style-type: none"> ■ Network settings (e.g. IP address, MAC address) ■ Device information (e.g. serial number, firmware version) |
| Logout | End the operation and call up the login page |

Navigation area

The menus, the associated submenus and parameters can be selected in the navigation area.

Working area

Depending on the selected function and the related submenus, various actions can be performed in this area:

- Configuring parameters
- Reading measured values
- Calling up help text
- Starting an upload/download

8.4.6 Disabling the Web server

The Web server of the measuring device can be switched on and off as required using the **Web server functionality** parameter.

Navigation

"Expert" menu → Communication → Web server

Parameter overview with brief description

| Parameter | Description | Selection |
|--------------------------|-----------------------------------|---|
| Web server functionality | Switch the Web server on and off. | <ul style="list-style-type: none"> ▪ Off ▪ HTML Off ▪ On |

Function scope of the "Web server functionality" parameter

| Option | Description |
|----------|---|
| Off | <ul style="list-style-type: none"> ▪ The Web server is completely disabled. ▪ Port 80 is locked. |
| HTML Off | The HTML version of the Web server is not available. |
| On | <ul style="list-style-type: none"> ▪ The complete Web server functionality is available. ▪ JavaScript is used. ▪ The password is transferred in an encrypted state. ▪ Any change to the password is also transferred in an encrypted state. |

Enabling the Web server

If the Web server is disabled it can only be re-enabled with the **Web server functionality** parameter via the following operating options:

- Via local display
- Via Bedientool "FieldCare"
- Via "DeviceCare" operating tool

8.4.7 Logging out

 Before logging out, perform a data backup via the **Data management** function (upload configuration from device) if necessary.

1. Select the **Logout** entry in the function row.
↳ The home page with the Login box appears.
2. Close the Web browser.

3. If no longer needed:
Reset the modified properties of the Internet protocol (TCP/IP) → 78.

8.5 Access to the operating menu via the operating tool

The structure of the operating menu in the operating tools is the same as for operation via the local display.

8.5.1 Connecting the operating tool

Via FOUNDATION Fieldbus network

This communication interface is available in device versions with FOUNDATION Fieldbus.

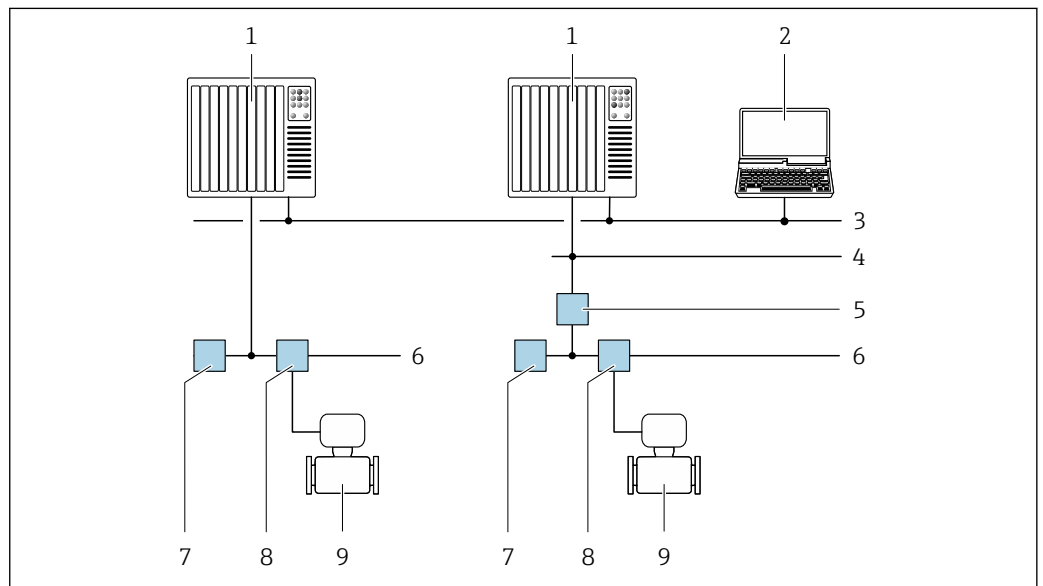

30 Options for remote operation via FOUNDATION Fieldbus network

- 1 Automation system
- 2 Computer with FOUNDATION Fieldbus network card
- 3 Industry network
- 4 High Speed Ethernet FF-HSE network
- 5 Segment coupler FF-HSE/FF-H1
- 6 FOUNDATION Fieldbus FF-H1 network
- 7 Power supply FF-H1 network
- 8 T-box
- 9 Measuring device

Service interface

Via service interface (CDI-RJ45)

A point-to-point connection can be established to configure the device onsite. With the housing open, the connection is established directly via the service interface (CDI-RJ45) of the device.

-  An adapter for the RJ45 to the M12 plug is optionally available for the non-hazardous area:

Order code for "Accessories", option **NB**: "Adapter RJ45 M12 (service interface)"

The adapter connects the service interface (CDI-RJ45) to an M12 plug mounted in the cable entry. The connection to the service interface can be established via an M12 plug without opening the device.

Proline 500 – digital transmitter

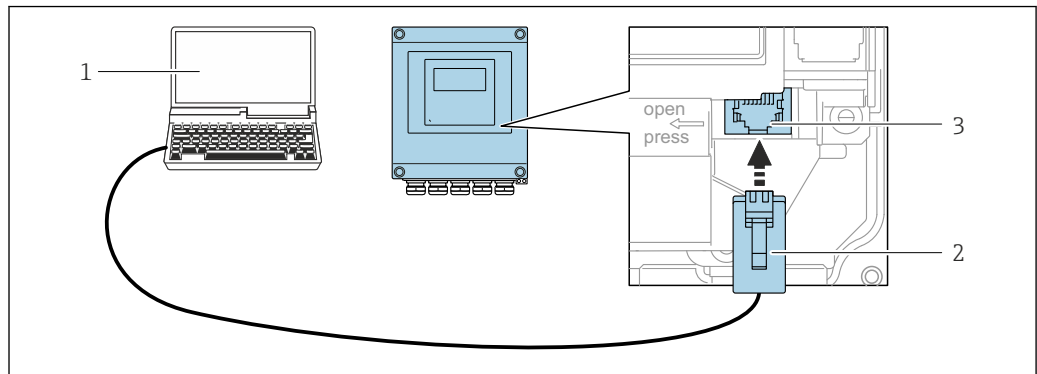

A0029163

31 Connection via service interface (CDI-RJ45)

- 1 Computer with web browser (e.g. Microsoft Internet Explorer, Microsoft Edge) for accessing the integrated web server or with "FieldCare" operating tool, "DeviceCare" with COM DTM "CDI Communication TCP/IP"
- 2 Standard Ethernet connecting cable with RJ45 plug
- 3 Service interface (CDI-RJ45) of the measuring device with access to the integrated Web server

Proline 500 transmitter

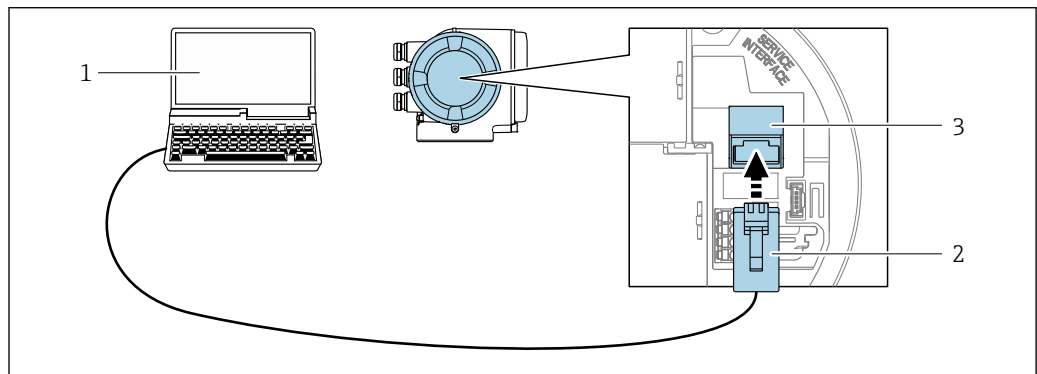

A0027563

32 Connection via service interface (CDI-RJ45)

- 1 Computer with web browser (e.g. Microsoft Internet Explorer, Microsoft Edge) for accessing the integrated web server or with "FieldCare" operating tool, "DeviceCare" with COM DTM "CDI Communication TCP/IP"
- 2 Standard Ethernet connecting cable with RJ45 plug
- 3 Service interface (CDI-RJ45) of the measuring device with access to the integrated Web server

Via WLAN interface

The optional WLAN interface is available on the following device version:

Order code for "Display; operation", option G "4-line, illuminated; touch control + WLAN"

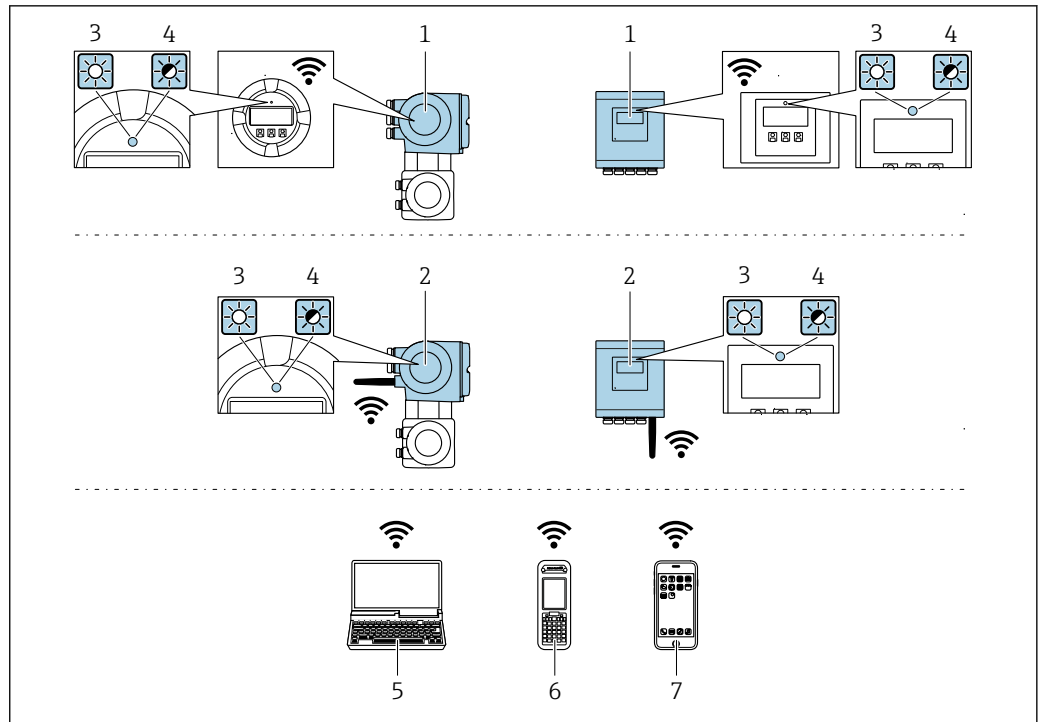

A0034569

- 1 Transmitter with integrated WLAN antenna
- 2 Transmitter with external WLAN antenna
- 3 LED lit constantly: WLAN reception is enabled on measuring device
- 4 LED flashing: WLAN connection established between operating unit and measuring device
- 5 Computer with WLAN interface and web browser (e.g. Microsoft Internet Explorer, Microsoft Edge) for accessing the integrated device web server or with operating tool (e.g. FieldCare, DeviceCare)
- 6 Mobile handheld terminal with WLAN interface and web browser (e.g. Microsoft Internet Explorer, Microsoft Edge) for accessing the integrated device web server or operating tool (e.g. FieldCare, DeviceCare)
- 7 Smart phone or tablet (e.g. Field Xpert SMT70)

| | |
|------------------------------|---|
| Function | WLAN: IEEE 802.11 b/g (2.4 GHz) |
| Encryption | WPA2-PSK AES-128 (in accordance with IEEE 802.11i) |
| Configurable WLAN channels | 1 to 11 |
| Degree of protection | IP67 |
| Available antennas | <ul style="list-style-type: none"> ▪ Internal antenna ▪ External antenna (optional) <p>In the event of poor transmission/reception conditions at the place of installation.</p> <p>i Only 1 antenna is active at any one time!</p> |
| Range | <ul style="list-style-type: none"> ▪ Internal antenna: typically 10 m (32 ft) ▪ External antenna: typically 50 m (164 ft) |
| Materials (external antenna) | <ul style="list-style-type: none"> ▪ Antenna: ASA plastic (acrylonitrile styrene acrylate) and nickel-plated brass ▪ Adapter: Stainless steel and nickel-plated brass ▪ Cable: Polyethylene ▪ Plug: Nickel-plated brass ▪ Angle bracket: Stainless steel |

Configuring the Internet protocol of the mobile terminal

NOTICE

If the WLAN connection is lost during the configuration, settings made may be lost.

- ▶ Make sure that the WLAN connection is not disconnected while configuring the device.

NOTICE**Note the following to avoid a network conflict:**

- ▶ Avoid accessing the measuring device simultaneously from the same mobile terminal via the service interface (CDI-RJ45) and the WLAN interface.
- ▶ Only activate one service interface (CDI-RJ45 or WLAN interface).
- ▶ If simultaneous communication is necessary: configure different IP address ranges, e.g. 192.168.0.1 (WLAN interface) and 192.168.1.212 (CDI-RJ45 service interface).

Preparing the mobile terminal

- ▶ Enable WLAN on the mobile terminal.

Establishing a WLAN connection from the mobile terminal to the measuring device

1. In the WLAN settings of the mobile terminal:
Select the measuring device using the SSID (e.g. EH_Promass_500_A802000).
2. If necessary, select the WPA2 encryption method.
3. Enter the password:
Serial number of the measuring device ex-works (e.g. L100A802000).
↳ The LED on the display module flashes. It is now possible to operate the measuring device with the web browser, FieldCare or DeviceCare.



The serial number can be found on the nameplate.



To ensure the safe and swift assignment of the WLAN network to the measuring point, it is advisable to change the SSID name. It should be possible to clearly assign the new SSID name to the measuring point (e.g. tag name) because it is displayed as the WLAN network.

Terminating the WLAN connection

- ▶ After configuring the device:
Terminate the WLAN connection between the mobile terminal and measuring device.

8.5.2 Field Xpert SFX350, SFX370**Function scope**

Field Xpert SFX350 and Field Xpert SFX370 are mobile computers for commissioning and maintenance. They enable efficient device configuration and diagnostics for HART and FOUNDATION Fieldbus devices in the **non-hazardous area** (SFX350, SFX370) and **hazardous area** (SFX370).



For details, see Operating Instructions BA01202S



Source for device description files

See information → 89

8.5.3 FieldCare**Function range**

FDT-based (Field Device Technology) plant asset management tool from Endress+Hauser. It can configure all smart field units in a system and helps you manage them. By using the status information, it is also a simple but effective way of checking their status and condition.



Access is via:

- CDI-RJ45 service interface →  83
- WLAN interface →  84

Typical functions:

- Transmitter parameter configuration
- Loading and saving of device data (upload/download)
- Documentation of the measuring point
- Visualization of the measured value memory (line recorder) and event logbook

-  ■ Operating Instructions BA00027S
- Operating Instructions BA00059S

-  Source for device description files →  89

Establishing a connection

-  ■ Operating Instructions BA00027S
- Operating Instructions BA00059S

User interface

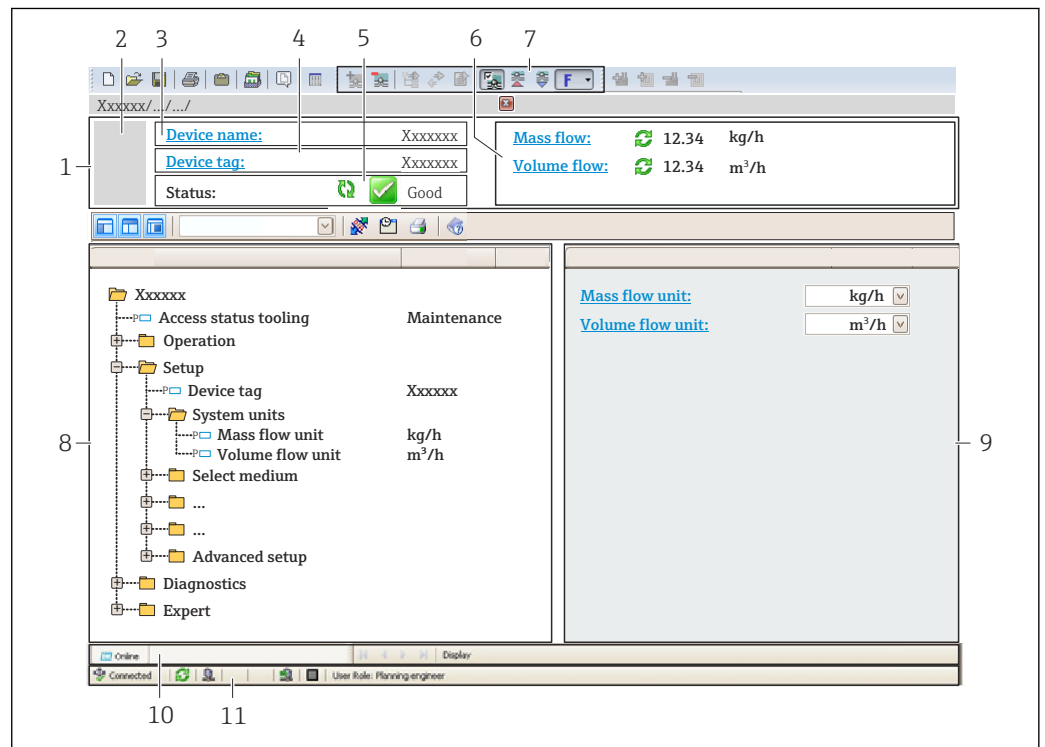

A0021051-EN

- 1 Header
- 2 Picture of device
- 3 Device name
- 4 Device tag
- 5 Status area with status signal →  167
- 6 Display area for current measured values
- 7 Editing toolbar with additional functions such as save/load, event list and create documentation
- 8 Navigation area with operating menu structure
- 9 Work area
- 10 Action area
- 11 Status area

8.5.4 DeviceCare

Function range

Tool for connecting and configuring Endress+Hauser field devices.

The fastest way to configure Endress+Hauser field devices is with the dedicated "DeviceCare" tool. Together with the device type managers (DTMs) it presents a convenient, comprehensive solution.



Innovation brochure IN01047S



Source for device description files →  89

8.5.5 AMS Device Manager

Function range

Program from Emerson Process Management for operating and configuring measuring devices via FOUNDATION Fieldbus H1 protocol.



Source for device description files →  89

8.5.6 Field Communicator 475

Function scope

Industrial handheld terminal from Emerson Process Management for remote configuration and measured value display via FOUNDATION Fieldbus H1 protocol.

Source for device description files

See information →  89

9 System integration

9.1 Overview of device description files

9.1.1 Current version data for the device

| | | |
|----------------------------------|---|---|
| Firmware Version | 01.00.zz | <ul style="list-style-type: none"> ▪ On the title page of the manual ▪ On the transmitter nameplate ▪ Firmware version Diagnostics → Device information → Firmware version |
| Release date of firmware version | 02.2017 | --- |
| Manufacturer ID | 0x452B48 (hex) | Manufacturer ID Diagnostics → Device information → Manufacturer ID |
| Device type code | 0x103B (hex) | Device type Diagnostics → Device information → Device type |
| Device revision | 1 | <ul style="list-style-type: none"> ▪ On the transmitter nameplate ▪ Device revision Diagnostics → Device information → Device revision |
| DD revision | Information and files available at: <ul style="list-style-type: none"> ▪ www.endress.com ▪ www.fieldbus.org | |
| CFF revision | | |



For an overview of the various firmware versions for the device → 201

9.1.2 Operating tools

The suitable device description file for the individual operating tools is listed in the table below, along with information on where the file can be acquired.

| Operating tool via FOUNDATION Fieldbus | Sources for obtaining device descriptions |
|--|---|
| FieldCare | <ul style="list-style-type: none"> ▪ www.endress.com → Downloads area ▪ USB stick (contact Endress+Hauser) ▪ DVD (contact Endress+Hauser) |
| DeviceCare | <ul style="list-style-type: none"> ▪ www.endress.com → Downloads area ▪ CD-ROM (contact Endress+Hauser) ▪ DVD (contact Endress+Hauser) |
| <ul style="list-style-type: none"> ▪ Field Xpert SMT70 ▪ Field Xpert SMT77 | Use update function of handheld terminal |
| AMS Device Manager (Emerson Process Management) | www.endress.com → Downloads area |
| Field Communicator 475 (Emerson Process Management) | Use update function of handheld terminal |

9.2 Cyclic data transmission

Cyclic data transmission when using the device master file (GSD).

9.2.1 Block model

The block model shows which input and output data the measuring device makes available for cyclic data exchange. Cyclic data exchange takes place with a FOUNDATION Fieldbus master (Class 1), e.g. a control system etc.

| Display text (xxxx... = serial number) | Base index | Description |
|--|------------|---|
| RESOURCE_ xxxxxxxxxxxx | 400 | Resource block |
| SETUP_ xxxxxxxxxxxx | 600 | "Setup" Transducer block |
| TRDDISP_ xxxxxxxxxxxx | 800 | "Display" Transducer block |
| TRDHROM_ xxxxxxxxxxxx | 1000 | "HistoROM" Transducer block |
| TRDDIAG_ xxxxxxxxxxxx | 1200 | "Diagnostic" Transducer block |
| EXPERT_CONFIG_ xxxxxxxxxxxx | 1400 | "Expert configuration" Transducer block |
| SERVICE_SENSOR_ xxxxxxxxxxxx | 1600 | "Service sensor" Transducer block |
| TRDTIC_ xxxxxxxxxxxx | 1800 | "Totalizer" Transducer block |
| TRDHBT_ xxxxxxxxxxxx | 2000 | "Heartbeat results" Transducer block |
| ANALOG_INPUT_1_ xxxxxxxxxxxx | 3400 | Analog Input function block 1 (AI) |
| ANALOG_INPUT_2_ xxxxxxxxxxxx | 3600 | Analog Input function block 2 (AI) |
| ANALOG_INPUT_3_ xxxxxxxxxxxx | 3800 | Analog Input function block 3 (AI) |
| ANALOG_INPUT_4_ xxxxxxxxxxxx | 4000 | Analog Input function block 4 (AI) |
| ANALOG_INPUT_5_ xxxxxxxxxxxx | 4200 | Analog Input function block 5 (AI) |
| ANALOG_INPUT_6_ xxxxxxxxxxxx | 4400 | Analog Input function block 6 (AI) |
| ANALOG_INPUT_7_ xxxxxxxxxxxx | 4600 | Analog Input function block 7 (AI) |
| ANALOG_INPUT_8_ xxxxxxxxxxxx | 4800 | Analog Input function block 8 (AI) |
| MAO_ xxxxxxxxxxxx | 5000 | Multiple Analog Output block (MAO) |
| DIGITAL_INPUT_1_ xxxxxxxxxxxx | 5200 | Digital Input function block 1 (DI) |
| DIGITAL_INPUT_2_ xxxxxxxxxxxx | 5400 | Digital Input function block 2 (DI) |
| MDO_ xxxxxxxxxxxx | 5600 | Multiple Digital Output block (MDO) |
| PID_ xxxxxxxxxxxx | 5800 | PID function block (PID) |
| INTEGRATOR_ xxxxxxxxxxxx | 6000 | Integrator function block (INTG) |

9.2.2 Description of the modules

The input value of a module/function block is defined via the CHANNEL parameter.

AI module (Analog Input)

Eight Analog Input blocks are available.

| CHANNEL | Measured variable |
|---------|-------------------------------------|
| 0 | Uninitialized (factory setting) |
| 7 | Temperature |
| 9 | Volume flow |
| 10 | Concentration ¹⁾ |
| 11 | Mass flow |
| 13 | Corrected volume flow |
| 14 | Density |
| 15 | Reference density |
| 16 | Totalizer 1 |
| 17 | Totalizer 2 |
| 18 | Totalizer 3 |
| 33 | Oscillation frequency ¹⁾ |

| CHANNEL | Measured variable |
|---------|--|
| 43 | Frequency fluctuation ¹⁾ |
| 51 | Carrier pipe temperature ¹⁾ |
| 57 | Carrier mass flow ¹⁾ |
| 58 | Target mass flow ¹⁾ |
| 63 | Oscillation damping ¹⁾ |
| 65 | Electronic temperature |
| 66 | Tube damping fluctuation ¹⁾ |
| 68 | Exciter current ¹⁾ |
| 81 | HBSI ¹⁾ |
| 99 | Current input 1 ¹⁾ |

1) Visible depending on the order options or device settings

MAO module (Multiple Analog Output)

| Channel | Description |
|---------|-------------|
| 121 | Channel_0 |

Structure

| Channel_0 | | | | | | | |
|-----------|---------|---------|---------|---------|---------|---------|---------|
| Value 1 | Value 2 | Value 3 | Value 4 | Value 5 | Value 6 | Value 7 | Value 8 |

| Values | Measured variable |
|---------|--|
| Value 1 | External pressure ¹⁾ |
| Value 2 | External temperature ¹⁾ |
| Value 3 | External reference density ¹⁾ |
| Value 4 | Not assigned |
| Value 5 | Not assigned |
| Value 6 | Not assigned |
| Value 7 | Not assigned |
| Value 8 | Not assigned |

1) The external measured values must be transmitted to the device in the SI basic unit

 The selection is made via: Expert → Sensor → External compensation

DI module (Discrete Input)

Two Discrete Input blocks are available.

| CHANNEL | Device function | Status |
|---------|---------------------------------|---------------------|
| 0 | Uninitialized (factory setting) | - |
| 101 | Switch output state | 0 = off, 1 = active |
| 103 | Low flow cut off | 0 = off, 1 = active |

| CHANNEL | Device function | Status |
|---------|-----------------------------------|--|
| 104 | Empty pipe detection | 0 = off, 1 = active |
| 105 | Verification status ¹⁾ | <p>Overall result of verification</p> <p>Verification:</p> <ul style="list-style-type: none"> ▪ 16 = Failed ▪ 32 = Passed ▪ 64 = Not performed <p>Verification status</p> <p>Verification:</p> <ul style="list-style-type: none"> ▪ 1 = Not performed ▪ 2 = Failed ▪ 4 = Being performed ▪ 8 = Finished <p>Status; result</p> <ul style="list-style-type: none"> ▪ 17 = Status: not performed; Result: failed ▪ 18 = Status: failed; Result: failed ▪ 20 = Status: being performed; Result: failed ▪ 24 = Status: finished; Result: failed ▪ 33 = Status: not performed; Result: passed ▪ 34 = Status: failed; Result: passed ▪ 36 = Status: being performed; Result: passed ▪ 40 = Status: finished; Result: passed ▪ 65 = Status: not performed; Result: not performed ▪ 66 = Status: failed; Result: not performed ▪ 68 = Status: being performed; Result: not performed ▪ 72 = Status: finished; Result: not performed |

1) Only available with the Heartbeat Verification application package

MDO module (Multiple Discrete Output)

| Channel | Description |
|---------|-------------|
| 122 | Channel_DO |

Structure

| Channel_DO | | | | | | | |
|------------|---------|---------|---------|---------|---------|---------|---------|
| Value 1 | Value 2 | Value 3 | Value 4 | Value 5 | Value 6 | Value 7 | Value 8 |

| Value | Device function | Status |
|---------|--|----------------------|
| Value 1 | Reset totalizer 1 | 0 = off, 1 = execute |
| Value 2 | Reset totalizer 2 | 0 = off, 1 = execute |
| Value 3 | Reset totalizer 3 | 0 = off, 1 = execute |
| Value 4 | Flow override | 0 = off, 1 = active |
| Value 5 | Start Heartbeat Verification ¹⁾ | 0 = off, 1 = start |
| Value 6 | Status output | 0 = off, 1 = active |



| Value | Device function | Status |
|---------|-----------------|-----------------|
| Value 7 | Zero adjustment | 0 = off, 1 = on |
| Value 8 | Not used | – |

1) Only available with the Heartbeat Verification application package

9.2.3 Execution times

| Function block | Execution time (ms) |
|-------------------------------------|---------------------|
| Analog Input function block (AI) | 6 |
| Digital Input function block (DI) | 4 |
| PID function block (PID) | 5 |
| Multiple Analog Output block (MAO) | 4 |
| Multiple Digital Output block (MDO) | 4 |
| Integrator function block (INTG) | 5 |

9.2.4 Methods

| Method | Block | Navigation | Description |
|---|-----------------------------|--|--|
| Set to "AUTO" mode | Resource block | Via menu: Expert → Communication → Resource block → Target mode | This method sets the Resource Block and all the Transducer Blocks to the AUTO (Automatic) mode. |
| Set to "OOS" mode | Resource block | Via menu: Expert → Communication → Resource block → Target mode | This method sets the Resource Block and all the Transducer Blocks to the OOS (Out of service) mode. |
| Restart | Resource block | Via menu: Expert → Communication → Resource block → Restart | This method is used to select the configuration for the Restart parameter in the Resource Block. This resets device parameters to a specific value. The following options are supported: <ul style="list-style-type: none"> ▪ Uninitialized ▪ Run ▪ Resource ▪ Defaults ▪ Processor ▪ To delivery settings |
| ENP parameter | Resource block | Via menu: Actions → Methods → Calibrate → ENP parameter | This method is used to display and configure the parameters of the electronic nameplate (ENP). |
| Overview diagnostics - Remedy information | Diagnostic Transducer Block | Via link: Namur symbol | This method is used to display the diagnostic event with the highest priority that is currently active and the corresponding remedial measures. |
| Actual diagnostics - Remedy information | Diagnostic Transducer Block | Via menu: <ul style="list-style-type: none"> ▪ Configure/Setup → Diagnostics → Actual diagnostics ▪ Device/Diagnostics → Diagnostics | This method is used to display remedial measures for the diagnostic event with the highest priority that is currently active.  This method is available only if an appropriate diagnostic event has occurred. |
| Previous diagnostics - Remedy information | Diagnostic Transducer Block | Via menu: <ul style="list-style-type: none"> ▪ Configure/Setup → Diagnostics → Previous diagnostics ▪ Device/Diagnostics → Diagnostics | This method is used to display remedial measures for the previous diagnostic event.  This method is available only if an appropriate diagnostic event has occurred. |

10 Commissioning

10.1 Post-mounting and post-connection check

Before commissioning the device:

- ▶ Make sure that the post-installation and post-connection checks have been performed successfully.
- Checklist for "Post-installation" check → 34
- Checklist for "Post-connection" check → 60

10.2 Switching on the measuring device

- ▶ Switch on the device upon successful completion of the post-mounting and post-connection check.
 - ↳ After a successful startup, the local display switches automatically from the startup display to the operational display.

If nothing appears on the local display or if a diagnostic message is displayed, refer to the section on "Diagnostics and troubleshooting" → 159.

10.3 Connecting via FieldCare

- For connecting FieldCare → 83
- For connecting via FieldCare → 87
- For user interface of FieldCare → 87

10.4 Setting the operating language

Factory setting: English or ordered local language

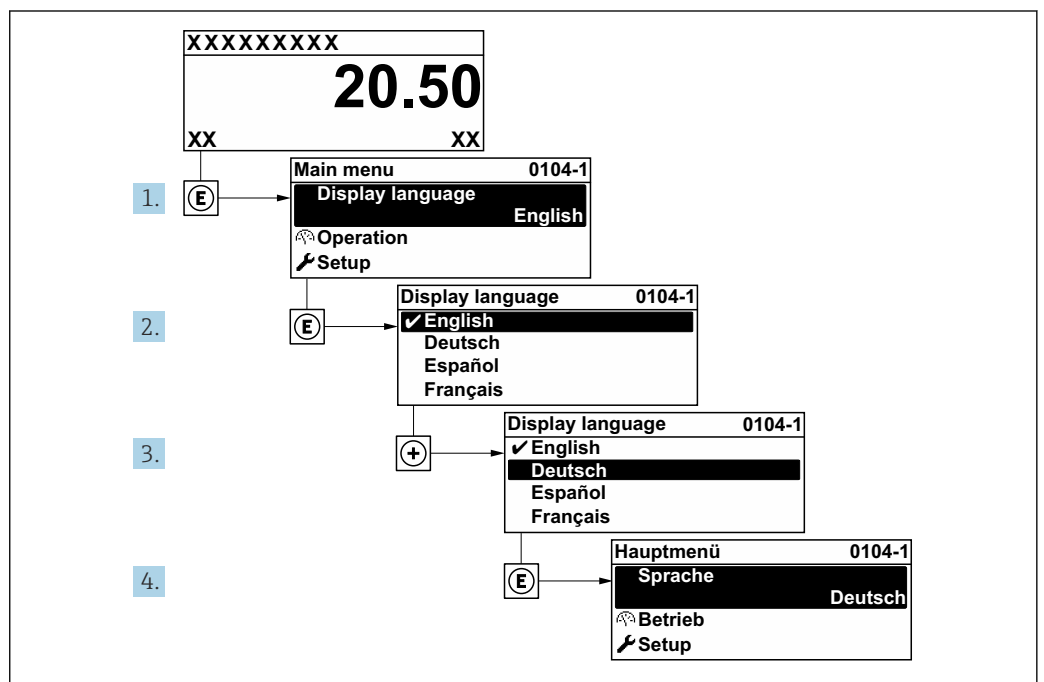

33 Taking the example of the local display

A0029420

10.5 Configuring the measuring instrument

The **Setup** menu with its guided wizards contains all the parameters needed for standard operation.

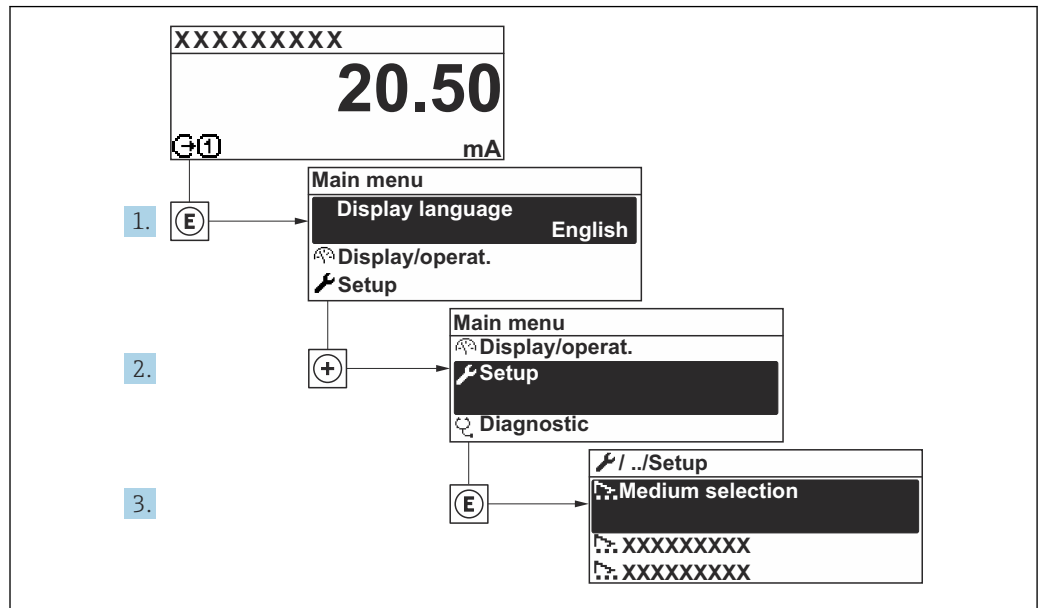

34 Navigation to "Setup" menu using the example of the local display

i The number of submenus and parameters can vary depending on the device version. Certain submenus and parameters in these submenus are not described in the Operating Instructions. Instead a description is provided in the Special Documentation for the device ("Supplementary documentation").

| 🔧 Setup | |
|-----------------------------------|-------|
| Device tag | → 97 |
| ▶ System units | → 97 |
| ▶ Medium selection | → 100 |
| ▶ Analog inputs | → 102 |
| ▶ I/O configuration | → 102 |
| ▶ Current input 1 | → 103 |
| ▶ Status input 1 | → 104 |
| ▶ Current output 1 | → 105 |
| ▶ Pulse/frequency/switch output 1 | → 108 |
| ▶ Relay output 1 | → 115 |

| | |
|-----------------------------------|---------|
| ▶ Display | → 📄 117 |
| ▶ Low flow cut off | → 📄 120 |
| ▶ Partially filled pipe detection | → 📄 121 |
| ▶ Advanced setup | → 📄 122 |

10.5.1 Defining the device tag

To enable fast identification of the measuring point within the system, you can enter a unique designation using the **Device tag** parameter and thus change the factory setting.

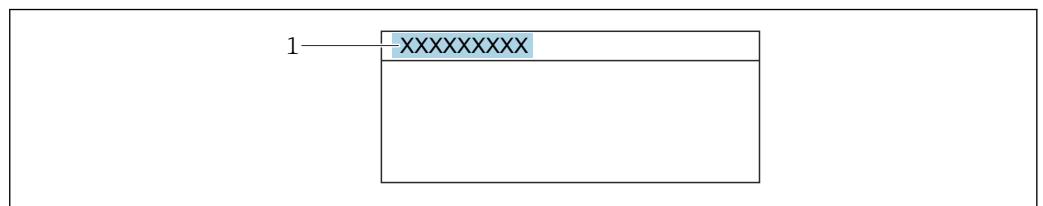

A0029422

35 Header of the operational display with tag name

1 Tag name

i Enter the tag name in the "FieldCare" operating tool → 📄 87

Navigation

"Setup" menu → Device tag

Parameter overview with brief description

| Parameter | Description | User entry |
|------------|---|---|
| Device tag | Enter the name for the measuring point. | Max. 32 characters, such as letters, numbers or special characters (e.g. @, %, /) |

10.5.2 Setting the system units









In the **System units** submenu the units of all the measured values can be set.

i The number of submenus and parameters can vary depending on the device version. Certain submenus and parameters in these submenus are not described in the Operating Instructions. Instead a description is provided in the Special Documentation for the device ("Supplementary documentation").

Navigation

"Setup" menu → System units

| | |
|----------------|--------|
| ▶ System units | |
| Mass flow unit | → 📄 98 |
| Mass unit | → 📄 98 |

| | |
|----------------------------|--|
| Volume flow unit | →  98 |
| Volume unit | →  98 |
| Corrected volume flow unit | →  98 |
| Corrected volume unit | →  98 |
| Density unit | →  98 |
| Reference density unit | →  99 |
| Temperature unit | →  99 |
| Pressure unit | →  99 |

Parameter overview with brief description

| Parameter | Description | Selection | Factory setting |
|----------------------------|--|------------------|--|
| Mass flow unit | Select mass flow unit. <i>Effect</i> The selected unit applies to: <ul style="list-style-type: none"> ▪ Output ▪ Low flow cut off ▪ Simulation process variable | Unit choose list | Country-specific: <ul style="list-style-type: none"> ▪ kg/h ▪ lb/min |
| Mass unit | Select mass unit. | Unit choose list | Country-specific: <ul style="list-style-type: none"> ▪ kg ▪ lb |
| Volume flow unit | Select volume flow unit. <i>Effect</i> The selected unit applies to: <ul style="list-style-type: none"> ▪ Output ▪ Low flow cut off ▪ Simulation process variable | Unit choose list | Country-specific: <ul style="list-style-type: none"> ▪ l/h ▪ gal/min (us) |
| Volume unit | Select volume unit. | Unit choose list | Country-specific: <ul style="list-style-type: none"> ▪ l ▪ gal (us) |
| Corrected volume flow unit | Select corrected volume flow unit. <i>Effect</i> The selected unit applies to: Corrected volume flow parameter (→  149) | Unit choose list | Country-specific: <ul style="list-style-type: none"> ▪ NI/h ▪ Sft³/min |
| Corrected volume unit | Select corrected volume unit. | Unit choose list | Country-specific: <ul style="list-style-type: none"> ▪ NI ▪ Sft³ |
| Density unit | Select density unit. <i>Effect</i> The selected unit applies to: <ul style="list-style-type: none"> ▪ Output ▪ Simulation process variable ▪ Density adjustment (Expert menu) | Unit choose list | Country-specific: <ul style="list-style-type: none"> ▪ kg/l ▪ lb/ft³ |

| Parameter | Description | Selection | Factory setting |
|------------------------|---|------------------|---|
| Reference density unit | Select reference density unit. | Unit choose list | Country-specific <ul style="list-style-type: none"> ■ kg/Nl ■ lb/Sft³ |
| Density 2 unit | Select second density unit. | Unit choose list | Country-specific: <ul style="list-style-type: none"> ■ kg/l ■ lb/ft³ |
| Temperature unit | Select temperature unit. <i>Effect</i> The selected unit applies to: <ul style="list-style-type: none"> ■ Electronic temperature parameter (6053) ■ Maximum value parameter (6051) ■ Minimum value parameter (6052) ■ Maximum value parameter (6108) ■ Minimum value parameter (6109) ■ Maximum value parameter (6029) ■ Minimum value parameter (6030) ■ Reference temperature parameter (1816) ■ Temperature parameter | Unit choose list | Country-specific: <ul style="list-style-type: none"> ■ °C ■ °F |
| Pressure unit | Select process pressure unit. <i>Effect</i> The unit is taken from: <ul style="list-style-type: none"> ■ Pressure value parameter (→ ⓘ 101) ■ External pressure parameter (→ ⓘ 101) ■ Pressure value | Unit choose list | Country-specific: <ul style="list-style-type: none"> ■ bar a ■ psi a |

10.5.3 Selecting and setting the medium

The **Select medium** wizard submenu contains parameters that must be configured in order to select and set the medium.

Navigation

"Setup" menu → Medium selection

| ► Medium selection | |
|--|---------|
| Select medium | → ⓘ 100 |
| Select gas type | → ⓘ 100 |
| Reference sound velocity | → ⓘ 101 |
| Temperature coefficient sound velocity | → ⓘ 101 |
| Pressure compensation | → ⓘ 101 |
| Pressure value | → ⓘ 101 |
| External pressure | → ⓘ 101 |

Parameter overview with brief description

| Parameter | Prerequisite | Description | Selection / User entry / User interface |
|-----------------|--|--|--|
| Select medium | – | Use this function to select the type of medium: "Gas" or "Liquid". Select the "Other" option in exceptional cases in order to enter the properties of the medium manually (e.g. for highly compressive liquids such as sulfuric acid). | <ul style="list-style-type: none"> ▪ Liquid ▪ Gas |
| Select gas type | In the Medium selection submenu, the Gas option is selected. | Select measured gas type. | <ul style="list-style-type: none"> ▪ Air ▪ Ammonia NH₃ ▪ Argon Ar ▪ Sulfur hexafluoride SF₆ ▪ Oxygen O₂ ▪ Ozone O₃ ▪ Nitrogen oxide NO_x ▪ Nitrogen N₂ ▪ Nitrous oxide N₂O ▪ Methane CH₄ ▪ Hydrogen H₂ ▪ Helium He ▪ Hydrogen chloride HCl ▪ Hydrogen sulfide H₂S ▪ Ethylene C₂H₄ ▪ Carbon dioxide CO₂ ▪ Carbon monoxide CO ▪ Chlorine Cl₂ ▪ Butane C₄H₁₀ ▪ Propane C₃H₈ ▪ Propylene C₃H₆ ▪ Ethane C₂H₆ ▪ Others |

| Parameter | Prerequisite | Description | Selection / User entry / User interface |
|--|---|--|---|
| Reference sound velocity | In the Select gas type parameter, the Others option is selected. | Enter sound velocity of gas at 0 °C (32 °F). | 1 to 99999.9999 m/s |
| Reference sound velocity | In the Select medium type parameter, the Others option is selected. | Enter sound velocity of gas at 0 °C (32 °F). | Signed floating-point number |
| Temperature coefficient sound velocity | In the Select gas type parameter, the Others option is selected. | Enter temperature coefficient for the gas sound velocity. | Positive floating point number |
| Temperature coefficient sound velocity | In the Select medium type parameter, the Others option is selected. | Enter temperature coefficient for the gas sound velocity. | Signed floating-point number |
| Pressure compensation | – | Select pressure compensation type. | <ul style="list-style-type: none"> ■ Off ■ Fixed value ■ External value ■ Current input 1 * |
| Pressure value | In the Pressure compensation parameter, the Fixed value option is selected. | Enter process pressure to be used for pressure correction. | Positive floating-point number |
| External pressure | In the Pressure compensation parameter, the External value option or the Current input 1...n option is selected. | Shows the external process pressure value. | |

* Visibility depends on order options or device settings

10.5.4 Configuring the analog inputs

The **Analog inputs** submenu guides the user systematically to the individual **Analog input 1 to n** submenu. From here you get to the parameters of the individual analog input.

Navigation

"Setup" menu → Analog inputs

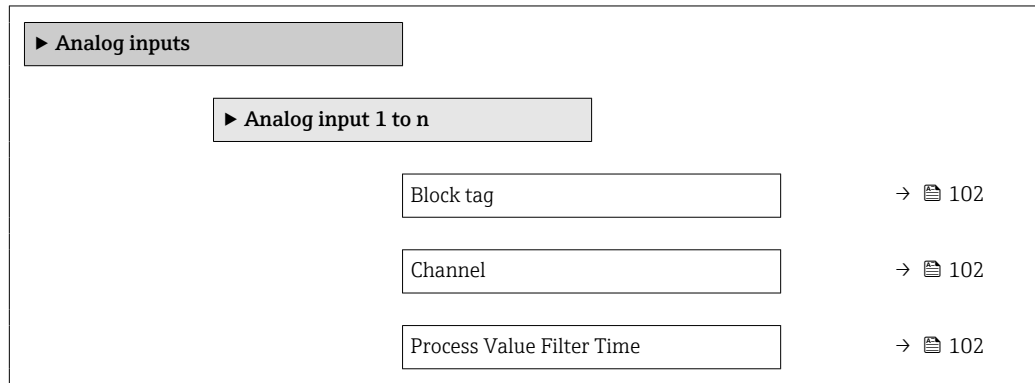

Parameter overview with brief description

| Parameter | Description | User entry / Selection | Factory setting |
|---------------------------|--|---|------------------------------------|
| Block tag | Unique name of the measuring device. | Max. 32 characters such as letters, numbers or special characters (e. g. @, %, /). | ANALOG_INPUT_1 ... 4_Serial number |
| Channel | Use this function to select the process variable. | <ul style="list-style-type: none"> ▪ Mass flow ▪ Volume flow ▪ Corrected volume flow ▪ Target mass flow * ▪ Carrier mass flow * ▪ Density ▪ Reference density ▪ Concentration * ▪ Temperature ▪ Carrier pipe temperature * ▪ Electronic temperature ▪ Oscillation frequency 0 ▪ Oscillation amplitude 0 ▪ Frequency fluctuation 0 ▪ Oscillation damping 0 ▪ Oscillation damping fluctuation 0 ▪ Signal asymmetry ▪ Exciter current 0 ▪ HBSI * ▪ Totalizer 1 ▪ Totalizer 2 ▪ Totalizer 3 ▪ Current input 1 * ▪ Uninitialized | – |
| Process Value Filter Time | Enter the filter time specification for the filtering of the unconverted input value (PV). | Positive floating-point number | – |

* Visibility depends on order options or device settings

10.5.5 Displaying the I/O configuration

The **I/O configuration** submenu guides the user systematically through all the parameters in which the configuration of the I/O modules is displayed.

Navigation

"Setup" menu → I/O configuration

| | | |
|------------------------------------|---|-------|
| ▶ I/O configuration | | |
| I/O module 1 to n terminal numbers | → | 📄 103 |
| I/O module 1 to n information | → | 📄 103 |
| I/O module 1 to n type | → | 📄 103 |
| Apply I/O configuration | → | 📄 103 |
| Conversion code | → | 📄 103 |

Parameter overview with brief description

| Parameter | Description | User interface / Selection / User entry |
|-----------------------------|---|--|
| I/O module terminal numbers | Shows the terminal numbers used by the I/O module. | <ul style="list-style-type: none"> ▪ Not used ▪ 26-27 (I/O 1) ▪ 24-25 (I/O 2) |
| I/O module information | Shows information of the plugged I/O module. | <ul style="list-style-type: none"> ▪ Not plugged ▪ Invalid ▪ Not configurable ▪ Configurable ▪ Fieldbus |
| I/O module type | Shows the I/O module type. | <ul style="list-style-type: none"> ▪ Off ▪ Current output ▪ Current input ▪ Status input ▪ Pulse/frequency/switch output ▪ Double pulse output ▪ Relay output |
| Apply I/O configuration | Apply parameterization of the freely configurable I/O module. | <ul style="list-style-type: none"> ▪ No ▪ Yes |
| Conversion code | Enter the code in order to change the I/O configuration. | Positive integer |

10.5.6 Configuring the current input

The "Current input" wizard guides the user systematically through all the parameters that have to be set for configuring the current input.

Navigation

"Setup" menu → Current input

| | | |
|-------------------|---|-------|
| ▶ Current input 1 | | |
| Terminal number | → | 📄 104 |
| Signal mode | → | 📄 104 |

| | |
|---------------|---------|
| 0/4 mA value | → ⓘ 104 |
| 20 mA value | → ⓘ 104 |
| Current span | → ⓘ 104 |
| Failure mode | → ⓘ 104 |
| Failure value | → ⓘ 104 |

Parameter overview with brief description

| Parameter | Prerequisite | Description | User interface / Selection / User entry | Factory setting |
|-----------------|---|---|---|---|
| Terminal number | - | Shows the terminal numbers used by the current input module. | <ul style="list-style-type: none"> ▪ Not used ▪ 24-25 (I/O 2) ▪ 20-21 (I/O 4) * | - |
| Signal mode | The measuring device is not approved for use in the hazardous area with type of protection Ex-i. | Select the signal mode for the current input. | <ul style="list-style-type: none"> ▪ Passive ▪ Active | Active |
| 0/4 mA value | - | Enter 4 mA value. | Signed floating-point number | - |
| 20 mA value | - | Enter 20 mA value. | Signed floating-point number | Depends on country and nominal diameter |
| Current span | - | Select current range for process value output and upper/lower level for alarm signal. | <ul style="list-style-type: none"> ▪ 4...20 mA ▪ 4...20 mA NAMUR ▪ 4...20 mA US ▪ 0...20 mA | Country-specific: <ul style="list-style-type: none"> ▪ 4...20 mA NAMUR ▪ 4...20 mA US |
| Failure mode | - | Define input behavior in alarm condition. | <ul style="list-style-type: none"> ▪ Alarm ▪ Last valid value ▪ Defined value | - |
| Failure value | In the Failure mode parameter, the Defined value option is selected. | Enter value to be used by the device if input value from external device is missing. | Signed floating-point number | - |

* Visibility depends on order options or device settings

10.5.7 Configuring the status input

The **Status input** submenu guides the user systematically through all the parameters that have to be set for configuring the status input.

Navigation

"Setup" menu → Status input 1 to n

| | |
|-----------------------|---------|
| ▶ Status input 1 to n | |
| Assign status input | → ⓘ 105 |
| Terminal number | → ⓘ 105 |

| | |
|----------------------------|-------|
| Active level | → 105 |
| Terminal number | → 105 |
| Response time status input | → 105 |
| Terminal number | → 105 |

Parameter overview with brief description

| Parameter | Description | Selection / User interface / User entry |
|----------------------------|---|---|
| Assign status input | Select function for the status input. | <ul style="list-style-type: none"> ■ Off ■ Reset totalizer 1 ■ Reset totalizer 2 ■ Reset totalizer 3 ■ Reset all totalizers ■ Flow override |
| Terminal number | Shows the terminal numbers used by the status input module. | <ul style="list-style-type: none"> ■ Not used ■ 24-25 (I/O 2) ■ 20-21 (I/O 4)* |
| Active level | Define input signal level at which the assigned function is triggered. | <ul style="list-style-type: none"> ■ High ■ Low |
| Response time status input | Define the minimum amount of time the input signal level must be present before the selected function is triggered. | 5 to 200 ms |

* Visibility depends on order options or device settings



10.5.8 Configuring the current output

The **Current output** wizard guides you systematically through all the parameters that have to be set for configuring the current output.



Navigation





"Setup" menu → Current output

| | |
|---------------------------|-------|
| ► Current output 1 | |
| Terminal number | → 106 |
| Signal mode | → 106 |
| Assign current output 1 | → 106 |
| Current span | → 106 |
| 0/4 mA value | → 106 |
| 20 mA value | → 106 |
| Fixed current | → 107 |

| | |
|-----------------|---|
| Failure mode | →  107 |
| Failure current | →  107 |

Parameter overview with brief description

| Parameter | Prerequisite | Description | User interface / Selection / User entry | Factory setting |
|-----------------------|---|---|---|---|
| Terminal number | – | Shows the terminal numbers used by the current output module. | <ul style="list-style-type: none"> ▪ Not used ▪ 24-25 (I/O 2) ▪ 20-21 (I/O 4) * | – |
| Signal mode | – | Select the signal mode for the current output. | <ul style="list-style-type: none"> ▪ Passive ▪ Active | Active |
| Assign current output | – | Select process variable for current output. | <ul style="list-style-type: none"> ▪ Off ▪ Mass flow ▪ Volume flow ▪ Corrected volume flow ▪ Target mass flow * ▪ Carrier mass flow * ▪ Density ▪ Reference density ▪ Concentration * ▪ Temperature ▪ Carrier pipe temperature * ▪ Electronic temperature ▪ Oscillation frequency 0 ▪ Oscillation amplitude 0 * ▪ Frequency fluctuation 0 ▪ Oscillation damping 0 ▪ Oscillation damping fluctuation 0 ▪ Signal asymmetry ▪ Exciter current 0 ▪ HBSI * | – |
| Current span | – | Select current range for process value output and upper/lower level for alarm signal. | <ul style="list-style-type: none"> ▪ 4...20 mA NAMUR ▪ 4...20 mA US ▪ 4...20 mA ▪ 0...20 mA ▪ Fixed current | Depends on country: <ul style="list-style-type: none"> ▪ 4...20 mA NAMUR ▪ 4...20 mA US |
| 0/4 mA value | In Current span parameter (→  106), one of the following options is selected: <ul style="list-style-type: none"> ▪ 4...20 mA NAMUR ▪ 4...20 mA US ▪ 4...20 mA ▪ 0...20 mA | Enter 4 mA value. | Signed floating-point number | Depends on country: <ul style="list-style-type: none"> ▪ 0 kg/h ▪ 0 lb/min |
| 20 mA value | In Current span parameter (→  106), one of the following options is selected: <ul style="list-style-type: none"> ▪ 4...20 mA NAMUR ▪ 4...20 mA US ▪ 4...20 mA ▪ 0...20 mA | Enter 20 mA value. | Signed floating-point number | Depends on country and nominal diameter |

| Parameter | Prerequisite | Description | User interface / Selection / User entry | Factory setting |
|-----------------|---|--|---|-----------------|
| Fixed current | The Fixed current option is selected in the Current span parameter (→  106). | Defines the fixed output current. | 0 to 22.5 mA | 22.5 mA |
| Damping output | A process variable is selected in the Assign current output parameter (→  106) and one of the following options is selected in the Current span parameter (→  106): <ul style="list-style-type: none"> ▪ 4...20 mA NAMUR ▪ 4...20 mA US ▪ 4...20 mA ▪ 0...20 mA | Set reaction time for output signal to fluctuations in the measured value. | 0.0 to 999.9 s | – |
| Failure mode | A process variable is selected in the Assign current output parameter (→  106) and one of the following options is selected in the Current span parameter (→  106): <ul style="list-style-type: none"> ▪ 4...20 mA NAMUR ▪ 4...20 mA US ▪ 4...20 mA ▪ 0...20 mA | Define output behavior in alarm condition. | <ul style="list-style-type: none"> ▪ Min. ▪ Max. ▪ Last valid value ▪ Actual value ▪ Defined value | – |
| Failure current | The Defined value option is selected in the Failure mode parameter. | Enter current output value in alarm condition. | 0 to 22.5 mA | 22.5 mA |

* Visibility depends on order options or device settings

10.5.9 Configuring the pulse/frequency/switch output

The **Pulse/frequency/switch output** wizard guides you systematically through all the parameters that can be set for configuring the selected output type.

Navigation

"Setup" menu → Advanced setup → Pulse/frequency/switch output

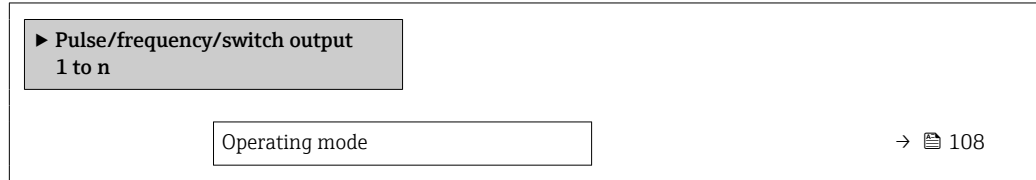

Parameter overview with brief description

| Parameter | Description | Selection |
|----------------|---|--|
| Operating mode | Define the output as a pulse, frequency or switch output. | <ul style="list-style-type: none"> ■ Pulse ■ Frequency ■ Switch |

Configuring the pulse output

Navigation

"Setup" menu → Pulse/frequency/switch output

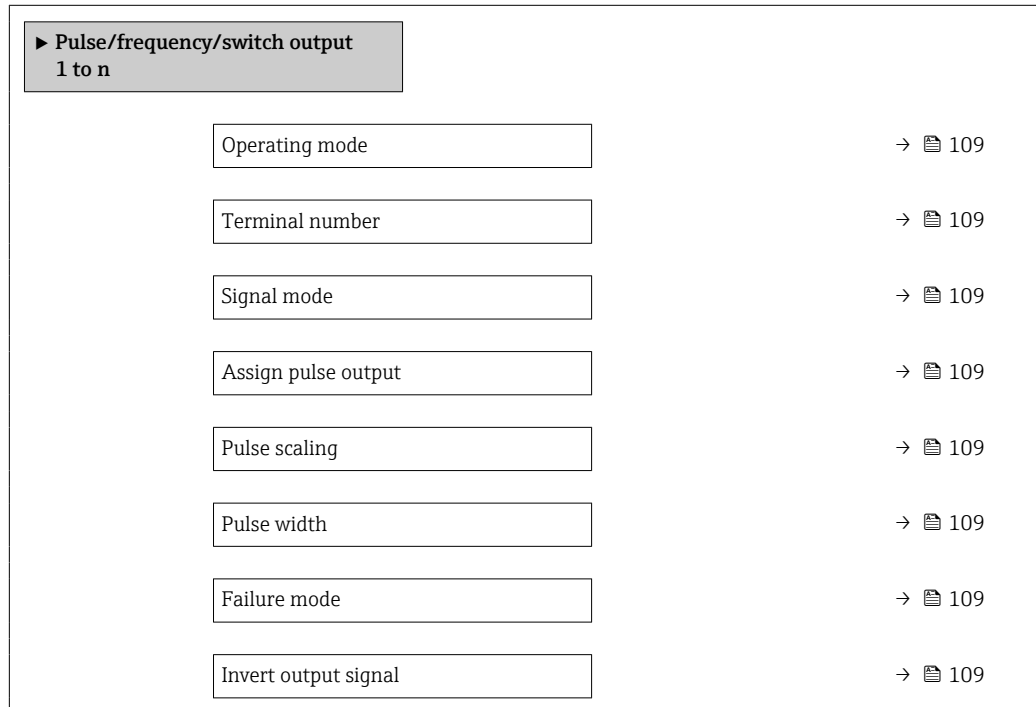

Parameter overview with brief description

| Parameter | Prerequisite | Description | Selection / User interface / User entry | Factory setting |
|----------------------------|--|---|---|---|
| Operating mode | – | Define the output as a pulse, frequency or switch output. | <ul style="list-style-type: none"> ■ Pulse ■ Frequency ■ Switch | – |
| Terminal number | – | Shows the terminal numbers used by the PFS output module. | <ul style="list-style-type: none"> ■ Not used ■ 24-25 (I/O 2) ■ 20-21 (I/O 4) * | – |
| Signal mode | – | Select the signal mode for the PFS output. | <ul style="list-style-type: none"> ■ Passive ■ Active | – |
| Assign pulse output 1 to n | The Pulse option is selected in Operating mode parameter. | Select process variable for pulse output. | <ul style="list-style-type: none"> ■ Off ■ Mass flow ■ Volume flow ■ Corrected volume flow ■ Target mass flow * ■ Carrier mass flow * | – |
| Value per pulse | The Pulse option is selected in the Operating mode parameter (→ 108) and a process variable is selected in the Assign pulse output parameter (→ 109). | Enter measured value at which a pulse is output. | Positive floating point number | Depends on country and nominal diameter |
| Pulse width | The Pulse option is selected in the Operating mode parameter (→ 108) and a process variable is selected in the Assign pulse output parameter (→ 109). | Define time width of the output pulse. | 0.05 to 2 000 ms | – |
| Failure mode | The Pulse option is selected in the Operating mode parameter (→ 108) and a process variable is selected in the Assign pulse output parameter (→ 109). | Define output behavior in alarm condition. | <ul style="list-style-type: none"> ■ Actual value ■ No pulses | – |
| Invert output signal | – | Invert the output signal. | <ul style="list-style-type: none"> ■ No ■ Yes | – |

* Visibility depends on order options or device settings









Configuring the frequency output

Navigation

"Setup" menu → Pulse/frequency/switch output

▶ **Pulse/frequency/switch output 1 to n**

| | |
|-----------------|-------|
| Operating mode | → 110 |
| Terminal number | → 110 |
| Signal mode | → 110 |

| | |
|--------------------------------------|---|
| Assign frequency output | →  111 |
| Minimum frequency value | →  111 |
| Maximum frequency value | →  111 |
| Measuring value at minimum frequency | →  111 |
| Measuring value at maximum frequency | →  111 |
| Failure mode | →  111 |
| Failure frequency | →  112 |
| Invert output signal | →  112 |

Parameter overview with brief description

| Parameter | Prerequisite | Description | Selection / User interface / User entry | Factory setting |
|-----------------|--------------|---|--|-----------------|
| Operating mode | – | Define the output as a pulse, frequency or switch output. | <ul style="list-style-type: none"> ▪ Pulse ▪ Frequency ▪ Switch | – |
| Terminal number | – | Shows the terminal numbers used by the PFS output module. | <ul style="list-style-type: none"> ▪ Not used ▪ 24-25 (I/O 2) ▪ 20-21 (I/O 4) * | – |
| Signal mode | – | Select the signal mode for the PFS output. | <ul style="list-style-type: none"> ▪ Passive ▪ Active | – |

| Parameter | Prerequisite | Description | Selection / User interface / User entry | Factory setting |
|--------------------------------------|--|---|---|---|
| Assign frequency output | The Frequency option is selected in Operating mode parameter (→ 108). | Select process variable for frequency output. | <ul style="list-style-type: none"> ■ Off ■ Mass flow ■ Volume flow ■ Corrected volume flow * ■ Density ■ Reference density * ■ Temperature ■ Concentration * ■ Target mass flow * ■ Carrier mass flow * ■ HBSI * ■ Exciter current 0 ■ Oscillation damping 0 ■ Oscillation damping fluctuation 0 * ■ Oscillation frequency 0 ■ Frequency fluctuation 0 * ■ Oscillation amplitude 0 * ■ Signal asymmetry ■ Carrier pipe temperature * ■ Electronic temperature | – |
| Minimum frequency value | The Frequency option is selected in the Operating mode parameter (→ 108) and a process variable is selected in the Assign frequency output parameter (→ 111). | Enter minimum frequency. | 0.0 to 10000.0 Hz | – |
| Maximum frequency value | The Frequency option is selected in the Operating mode parameter (→ 108) and a process variable is selected in the Assign frequency output parameter (→ 111). | Enter maximum frequency. | 0.0 to 10000.0 Hz | – |
| Measuring value at minimum frequency | The Frequency option is selected in the Operating mode parameter (→ 108) and a process variable is selected in the Assign frequency output parameter (→ 111). | Enter measured value for minimum frequency. | Signed floating-point number | Depends on country and nominal diameter |
| Measuring value at maximum frequency | The Frequency option is selected in the Operating mode parameter (→ 108) and a process variable is selected in the Assign frequency output parameter (→ 111). | Enter measured value for maximum frequency. | Signed floating-point number | Depends on country and nominal diameter |
| Failure mode | The Frequency option is selected in the Operating mode parameter (→ 108) and a process variable is selected in the Assign frequency output parameter (→ 111). | Define output behavior in alarm condition. | <ul style="list-style-type: none"> ■ Actual value ■ Defined value ■ 0 Hz | – |

| Parameter | Prerequisite | Description | Selection / User interface / User entry | Factory setting |
|----------------------|---|--|---|-----------------|
| Failure frequency | In the Operating mode parameter (→ 108), the Frequency option is selected, in the Assign frequency output parameter (→ 111) a process variable is selected, and in the Failure mode parameter, the Defined value option is selected. | Enter frequency output value in alarm condition. | 0.0 to 12 500.0 Hz | – |
| Invert output signal | – | Invert the output signal. | <ul style="list-style-type: none"> ▪ No ▪ Yes | – |

* Visibility depends on order options or device settings

Configuring the switch output

Navigation

"Setup" menu → Pulse/frequency/switch output

| ► Pulse/frequency/switch output 1 to n | |
|---|-------|
| Operating mode | → 113 |
| Terminal number | → 113 |
| Signal mode | → 113 |
| Switch output function | → 114 |
| Assign diagnostic behavior | → 114 |
| Assign limit | → 114 |
| Assign flow direction check | → 114 |
| Assign status | → 114 |
| Switch-on value | → 114 |
| Switch-off value | → 114 |
| Switch-on delay | → 114 |
| Switch-off delay | → 115 |
| Failure mode | → 115 |
| Invert output signal | → 115 |

Parameter overview with brief description

| Parameter | Prerequisite | Description | Selection / User interface / User entry | Factory setting |
|-----------------|--------------|---|---|-----------------|
| Operating mode | - | Define the output as a pulse, frequency or switch output. | <ul style="list-style-type: none"> ■ Pulse ■ Frequency ■ Switch | - |
| Terminal number | - | Shows the terminal numbers used by the PFS output module. | <ul style="list-style-type: none"> ■ Not used ■ 24-25 (I/O 2) ■ 20-21 (I/O 4)* | - |
| Signal mode | - | Select the signal mode for the PFS output. | <ul style="list-style-type: none"> ■ Passive ■ Active | - |

| Parameter | Prerequisite | Description | Selection / User interface / User entry | Factory setting |
|-----------------------------|---|--|--|--|
| Switch output function | The Switch option is selected in the Operating mode parameter. | Select function for switch output. | <ul style="list-style-type: none"> ▪ Off ▪ On ▪ Diagnostic behavior ▪ Limit ▪ Flow direction check ▪ Status | – |
| Assign diagnostic behavior | <ul style="list-style-type: none"> ▪ In the Operating mode parameter, the Switch option is selected. ▪ In the Switch output function parameter, the Diagnostic behavior option is selected. | Select diagnostic behavior for switch output. | <ul style="list-style-type: none"> ▪ Alarm ▪ Alarm or warning ▪ Warning | – |
| Assign limit | <ul style="list-style-type: none"> ▪ The Switch option is selected in Operating mode parameter. ▪ The Limit option is selected in Switch output function parameter. | Select process variable for limit function. | <ul style="list-style-type: none"> ▪ Mass flow ▪ Volume flow ▪ Corrected volume flow ▪ Target mass flow * ▪ Carrier mass flow * ▪ Density ▪ Reference density ▪ Concentration * ▪ Temperature ▪ Totalizer 1 ▪ Totalizer 2 ▪ Totalizer 3 ▪ Oscillation damping | – |
| Assign flow direction check | <ul style="list-style-type: none"> ▪ The Switch option is selected in the Operating mode parameter. ▪ The Flow direction check option is selected in the Switch output function parameter. | Select process variable for flow direction monitoring. | | – |
| Assign status | <ul style="list-style-type: none"> ▪ The Switch option is selected in Operating mode parameter. ▪ The Status option is selected in Switch output function parameter. | Select device status for switch output. | <ul style="list-style-type: none"> ▪ Partially filled pipe detection ▪ Low flow cut off ▪ Digital output 6 | – |
| Switch-on value | <ul style="list-style-type: none"> ▪ The Switch option is selected in the Operating mode parameter. ▪ The Limit option is selected in the Switch output function parameter. | Enter measured value for the switch-on point. | Signed floating-point number | Depends on country: <ul style="list-style-type: none"> ▪ 0 kg/h ▪ 0 lb/min |
| Switch-off value | <ul style="list-style-type: none"> ▪ The Switch option is selected in the Operating mode parameter. ▪ The Limit option is selected in the Switch output function parameter. | Enter measured value for the switch-off point. | Signed floating-point number | Depends on country: <ul style="list-style-type: none"> ▪ 0 kg/h ▪ 0 lb/min |
| Switch-on delay | <ul style="list-style-type: none"> ▪ The Switch option is selected in the Operating mode parameter. ▪ The Limit option is selected in the Switch output function parameter. | Define delay for the switch-on of status output. | 0.0 to 100.0 s | – |

| Parameter | Prerequisite | Description | Selection / User interface / User entry | Factory setting |
|----------------------|---|---|---|-----------------|
| Switch-off delay | <ul style="list-style-type: none"> ▪ The Switch option is selected in the Operating mode parameter. ▪ The Limit option is selected in the Switch output function parameter. | Define delay for the switch-off of status output. | 0.0 to 100.0 s | – |
| Failure mode | – | Define output behavior in alarm condition. | <ul style="list-style-type: none"> ▪ Actual status ▪ Open ▪ Closed | – |
| Invert output signal | – | Invert the output signal. | <ul style="list-style-type: none"> ▪ No ▪ Yes | – |

* Visibility depends on order options or device settings

10.5.10 Configuring the relay output

The **Relay output** wizard guides the user systematically through all the parameters that have to be set for configuring the relay output.

Navigation

"Setup" menu → Relay output 1 to n

| ► Relay output 1 to n | |
|-----------------------------|---------|
| Terminal number | → ⓘ 116 |
| Relay output function | → ⓘ 116 |
| Assign flow direction check | → ⓘ 116 |
| Assign limit | → ⓘ 116 |
| Assign diagnostic behavior | → ⓘ 116 |
| Assign status | → ⓘ 116 |
| Switch-off value | → ⓘ 116 |
| Switch-off delay | → ⓘ 116 |
| Switch-on value | → ⓘ 116 |
| Switch-on delay | → ⓘ 116 |
| Failure mode | → ⓘ 116 |
| Switch status | → ⓘ 116 |
| Powerless relay status | → ⓘ 116 |

Parameter overview with brief description

| Parameter | Prerequisite | Description | User interface / Selection / User entry | Factory setting |
|-----------------------------|---|---|--|--|
| Terminal number | – | Shows the terminal numbers used by the relay output module. | <ul style="list-style-type: none"> ▪ Not used ▪ 24-25 (I/O 2) | – |
| Relay output function | – | Select the function for the relay output. | <ul style="list-style-type: none"> ▪ Closed ▪ Open ▪ Diagnostic behavior ▪ Limit ▪ Flow direction check ▪ Digital Output | – |
| Assign flow direction check | The Flow direction check option is selected in the Relay output function parameter. | Select process variable for flow direction monitoring. | | – |
| Assign limit | The Limit option is selected in the Relay output function parameter. | Select process variable for limit function. | <ul style="list-style-type: none"> ▪ Mass flow ▪ Volume flow ▪ Corrected volume flow ▪ Target mass flow[*] ▪ Carrier mass flow[*] ▪ Density ▪ Reference density[*] ▪ Concentration[*] ▪ Temperature ▪ Totalizer 1 ▪ Totalizer 2 ▪ Totalizer 3 ▪ Oscillation damping | – |
| Assign diagnostic behavior | In the Relay output function parameter, the Diagnostic behavior option is selected. | Select diagnostic behavior for switch output. | <ul style="list-style-type: none"> ▪ Alarm ▪ Alarm or warning ▪ Warning | – |
| Assign status | In the Relay output function parameter, the Digital Output option is selected. | Select device status for switch output. | <ul style="list-style-type: none"> ▪ Partially filled pipe detection ▪ Low flow cut off ▪ Digital output 6 | – |
| Switch-off value | The Limit option is selected in the Relay output function parameter. | Enter measured value for the switch-off point. | Signed floating-point number | Depends on country: <ul style="list-style-type: none"> ▪ 0 kg/h ▪ 0 lb/min |
| Switch-off delay | In the Relay output function parameter, the Limit option is selected. | Define delay for the switch-off of status output. | 0.0 to 100.0 s | – |
| Switch-on value | The Limit option is selected in the Relay output function parameter. | Enter measured value for the switch-on point. | Signed floating-point number | Depends on country: <ul style="list-style-type: none"> ▪ 0 kg/h ▪ 0 lb/min |
| Switch-on delay | In the Relay output function parameter, the Limit option is selected. | Define delay for the switch-on of status output. | 0.0 to 100.0 s | – |
| Failure mode | – | Define output behavior in alarm condition. | <ul style="list-style-type: none"> ▪ Actual status ▪ Open ▪ Closed | – |
| Switch status | – | Shows the current relay switch status. | <ul style="list-style-type: none"> ▪ Open ▪ Closed | – |
| Powerless relay status | – | | <ul style="list-style-type: none"> ▪ Open ▪ Closed | – |

* Visibility depends on order options or device settings

10.5.11 Configuring the local display

The **Display** wizard guides you systematically through all the parameters that can be configured for configuring the local display.

Navigation

"Setup" menu → Display

| ► Display | |
|-----------------------|-------|
| Format display | → 118 |
| Value 1 display | → 118 |
| 0% bargraph value 1 | → 118 |
| 100% bargraph value 1 | → 118 |
| Value 2 display | → 118 |
| Value 3 display | → 118 |
| 0% bargraph value 3 | → 118 |
| 100% bargraph value 3 | → 118 |
| Value 4 display | → 119 |

Parameter overview with brief description

| Parameter | Prerequisite | Description | Selection / User entry | Factory setting |
|-----------------------|---|---|---|--|
| Format display | A local display is provided. | Select how measured values are shown on the display. | <ul style="list-style-type: none"> ▪ 1 value, max. size ▪ 1 bargraph + 1 value ▪ 2 values ▪ 1 value large + 2 values ▪ 4 values | – |
| Value 1 display | A local display is provided. | Select the measured value that is shown on the local display. | <ul style="list-style-type: none"> ▪ Mass flow ▪ Volume flow ▪ Corrected volume flow * ▪ Density ▪ Reference density * ▪ Temperature ▪ Totalizer 1 ▪ Totalizer 2 ▪ Totalizer 3 ▪ Concentration * ▪ Target mass flow * ▪ Carrier mass flow * ▪ HBSI * ▪ Exciter current 0 ▪ Oscillation damping 0 ▪ Oscillation damping fluctuation 0 * ▪ Oscillation frequency 0 ▪ Frequency fluctuation 0 * ▪ Oscillation amplitude 0 * ▪ Signal asymmetry ▪ Carrier pipe temperature * ▪ Electronic temperature ▪ Current output 1 ▪ Current output 2 * ▪ Current output 3 * ▪ Current output 4 * | – |
| 0% bargraph value 1 | A local display is provided. | Enter 0% value for bar graph display. | Signed floating-point number | Country-specific: <ul style="list-style-type: none"> ▪ 0 kg/h ▪ 0 lb/min |
| 100% bargraph value 1 | A local display is provided. | Enter 100% value for bar graph display. | Signed floating-point number | Depends on country and nominal diameter |
| Value 2 display | A local display is provided. | Select the measured value that is shown on the local display. | For the picklist, see Value 1 display parameter (→ 118) | – |
| Value 3 display | A local display is provided. | Select the measured value that is shown on the local display. | For the picklist, see Value 1 display parameter (→ 118) | – |
| 0% bargraph value 3 | A selection was made in the Value 3 display parameter. | Enter 0% value for bar graph display. | Signed floating-point number | Country-specific: <ul style="list-style-type: none"> ▪ 0 kg/h ▪ 0 lb/min |
| 100% bargraph value 3 | A selection was made in the Value 3 display parameter. | Enter 100% value for bar graph display. | Signed floating-point number | – |

| Parameter | Prerequisite | Description | Selection / User entry | Factory setting |
|-----------------|------------------------------|---|--|-----------------|
| Value 4 display | A local display is provided. | Select the measured value that is shown on the local display. | For the picklist, see Value 1 display parameter (→ 118) | – |
| Value 5 display | A local display is provided. | Select the measured value that is shown on the local display. | For the picklist, see Value 1 display parameter (→ 118) | – |
| Value 6 display | A local display is provided. | Select the measured value that is shown on the local display. | For the picklist, see Value 1 display parameter (→ 118) | – |
| Value 7 display | A local display is provided. | Select the measured value that is shown on the local display. | For the picklist, see Value 1 display parameter (→ 118) | – |
| Value 8 display | A local display is provided. | Select the measured value that is shown on the local display. | For the picklist, see Value 1 display parameter (→ 118) | – |





* Visibility depends on order options or device settings

10.5.12 Configuring the low flow cut off



The **Low flow cut off** wizard systematically guides the user through all the parameters that must be set to configure low flow cut off.

Navigation

"Setup" menu → Low flow cut off

| ► Low flow cut off | |
|----------------------------|---|
| Assign process variable | →  120 |
| On value low flow cutoff | →  120 |
| Off value low flow cutoff | →  120 |
| Pressure shock suppression | →  120 |

Parameter overview with brief description

| Parameter | Prerequisite | Description | Selection / User entry | Factory setting |
|----------------------------|---|--|--|---|
| Assign process variable | – | Select process variable for low flow cut off. | <ul style="list-style-type: none"> ■ Off ■ Mass flow ■ Volume flow ■ Corrected volume flow | – |
| On value low flow cutoff | A process variable is selected in the Assign process variable parameter (→  120). | Enter on value for low flow cut off. | Positive floating-point number | Depends on country and nominal diameter |
| Off value low flow cutoff | A process variable is selected in the Assign process variable parameter (→  120). | Enter off value for low flow cut off. | 0 to 100.0 % | – |
| Pressure shock suppression | A process variable is selected in the Assign process variable parameter (→  120). | Enter time frame for signal suppression (= active pressure shock suppression). | 0 to 100 s | – |

10.5.13 Configuring partially filled pipe detection

The **Partial filled pipe detection** wizard guides you systematically through all parameters that have to be set for configuring the monitoring of the pipe filling.

Navigation

"Setup" menu → Partially filled pipe detection

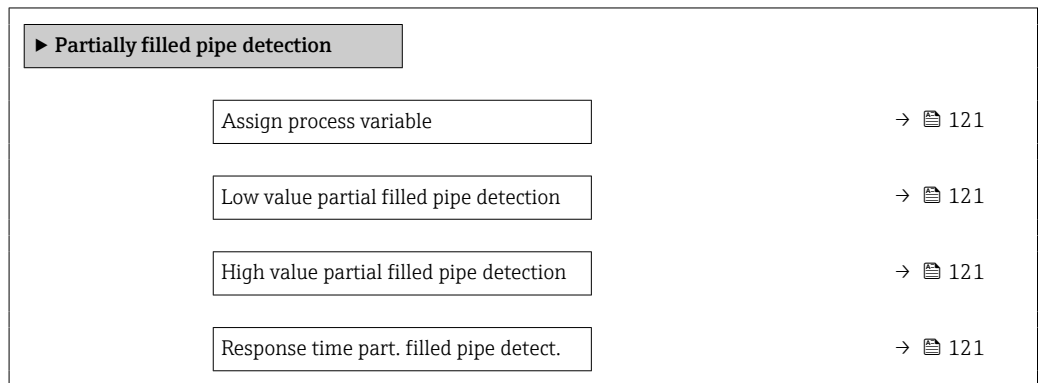

Parameter overview with brief description

| Parameter | Prerequisite | Description | Selection / User entry | Factory setting |
|--|---|--|---|---|
| Assign process variable | – | Select process variable for partially filled pipe detection. | <ul style="list-style-type: none"> ■ Off ■ Density ■ Reference density | Density |
| Low value partial filled pipe detection | A process variable is selected in the Assign process variable parameter (→ 121). | Enter lower limit value for deactivating partially filled pipe detection. | Signed floating-point number | Depends on country: <ul style="list-style-type: none"> ■ 200 kg/m³ ■ 12.5 lb/ft³ |
| High value partial filled pipe detection | A process variable is selected in the Assign process variable parameter (→ 121). | Enter upper limit value for deactivating partially filled pipe detection. | Signed floating-point number | Depends on country: <ul style="list-style-type: none"> ■ 6 000 kg/m³ ■ 374.6 lb/ft³ |
| Response time part. filled pipe detect. | A process variable is selected in the Assign process variable parameter (→ 121). | Use this function to enter the minimum time (hold time) the signal must be present before diagnostic message S962 "Pipe only partly filled" is triggered in the event of a partially filled or empty measuring pipe. | 0 to 100 s | – |

10.6 Advanced settings

The **Advanced setup** submenu with its submenus contains parameters for specific settings.

Navigation to the "Advanced setup" submenu

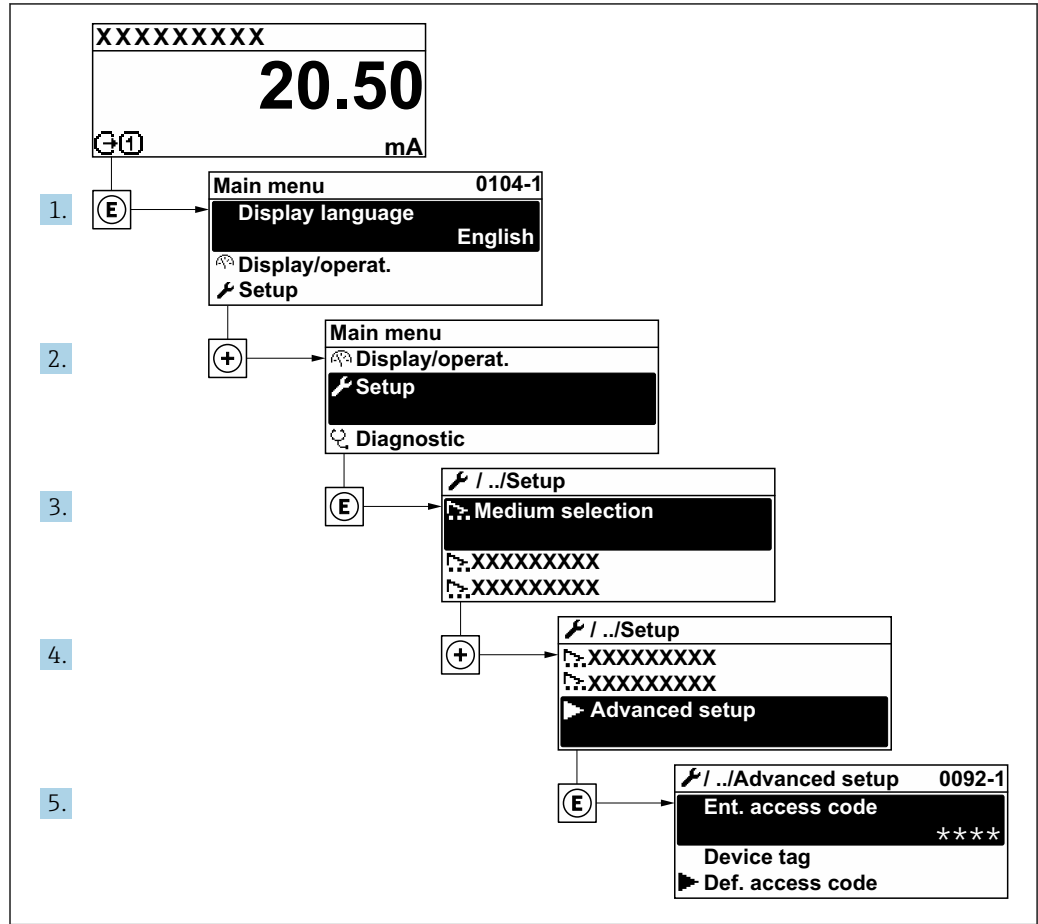

A0032223-EN

i The number of submenus and parameters can vary depending on the device version and the available application packages. These submenus and their parameters are explained in the Special Documentation for the device and not in Operating Instructions.

For detailed information on the parameter descriptions for application packages:
Special Documentation for the device → 239

Navigation

"Setup" menu → Advanced setup

| | |
|---------------------|--------|
| ▶ Advanced setup | |
| Enter access code | → 123 |
| ▶ Calculated values | → 123 |
| ▶ Sensor adjustment | → 124 |

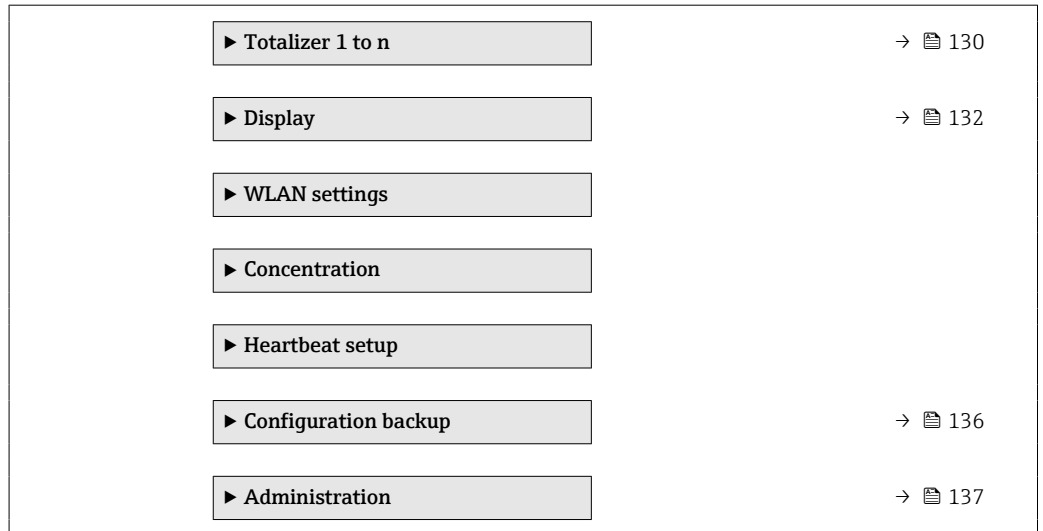

10.6.1 Using the parameter to enter the access code

Navigation

"Setup" menu → Advanced setup

Parameter overview with brief description

| Parameter | Description | User entry |
|-------------------|--|---|
| Enter access code | Enter access code to disable write protection of parameters. | Max. 16-digit character string comprising numbers, letters and special characters |

10.6.2 Calculated process variables

The **Calculated values** submenu contains parameters for calculating the corrected volume flow.

Navigation

"Setup" menu → Advanced setup → Calculated values

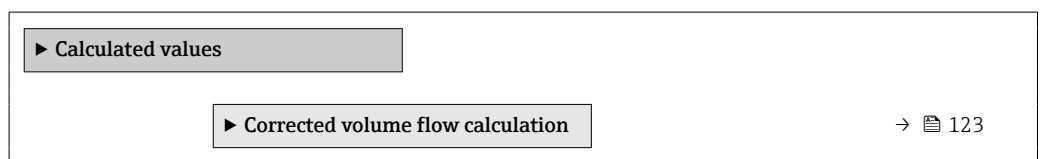



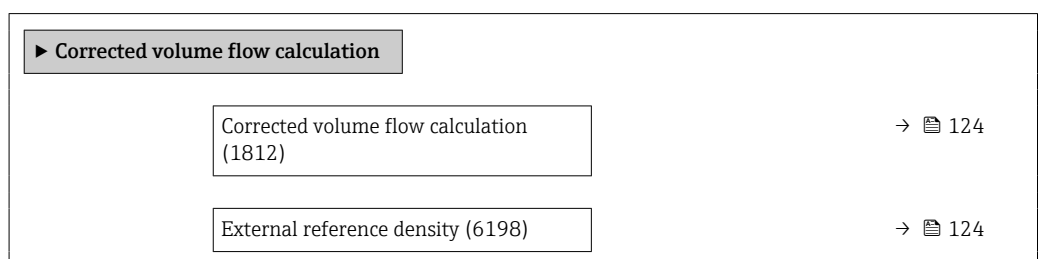

"Corrected volume flow calculation" submenu

Navigation

"Setup" menu → Advanced setup → Calculated values → Corrected volume flow calculation



| | |
|-------------------------------------|---|
| Fixed reference density (1814) | →  124 |
| Reference temperature (1816) | →  124 |
| Linear expansion coefficient (1817) | →  124 |
| Square expansion coefficient (1818) | →  124 |

Parameter overview with brief description

| Parameter | Prerequisite | Description | Selection / User interface / User entry | Factory setting |
|-----------------------------------|---|--|---|--|
| Corrected volume flow calculation | – | Select reference density for calculating the corrected volume flow. | <ul style="list-style-type: none"> ■ Fixed reference density ■ Calculated reference density ■ Reference density by API table 53 ■ External reference density ■ Current input 1 * | – |
| External reference density | – | Shows external reference density. | Floating point number with sign | – |
| Fixed reference density | The Fixed reference density option is selected in the Corrected volume flow calculation parameter parameter. | Enter fixed value for reference density. | Positive floating-point number | – |
| Reference temperature | The Calculated reference density option is selected in the Corrected volume flow calculation parameter parameter. | Enter reference temperature for calculating the reference density. | –273.15 to 99 999 °C | Country-specific: <ul style="list-style-type: none"> ■ +20 °C ■ +68 °F |
| Linear expansion coefficient | The Calculated reference density option is selected in the Corrected volume flow calculation parameter parameter. | Enter linear, medium-specific expansion coefficient for calculating the reference density. | Signed floating-point number | – |
| Square expansion coefficient | The Calculated reference density option is selected in the Corrected volume flow calculation parameter parameter. | For media with a non-linear expansion pattern: enter the quadratic, medium-specific expansion coefficient for calculating the reference density. | Signed floating-point number | – |

* Visibility depends on order options or device settings

10.6.3 Carrying out a sensor adjustment

The **Sensor adjustment** submenu contains parameters that pertain to the functionality of the sensor.

Navigation

"Setup" menu → Advanced setup → Sensor adjustment

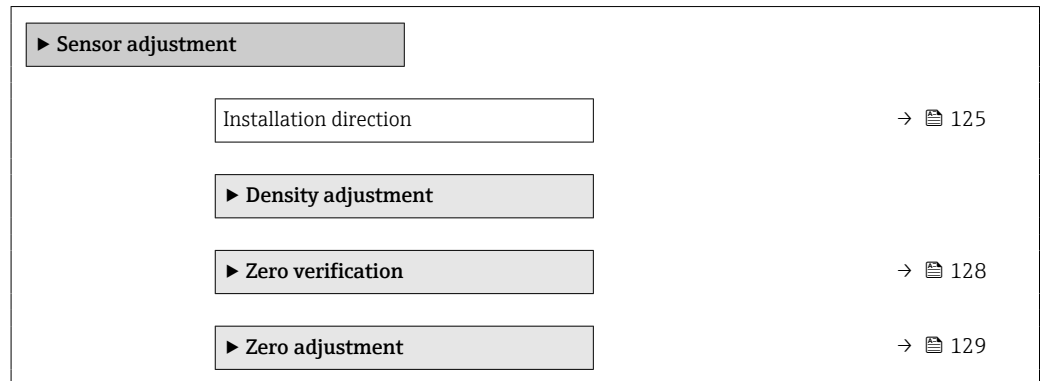

Parameter overview with brief description

| Parameter | Description | Selection |
|------------------------|---|---|
| Installation direction | Set sign of flow direction to match the direction of the arrow on the sensor. | <ul style="list-style-type: none"> ■ Flow in arrow direction ■ Flow against arrow direction |

Density adjustment

 With density adjustment, a high level of accuracy is achieved only at the point of adjustment and at the relevant density and temperature. However, the accuracy of a density adjustment is only ever as good as the quality of the reference measuring data provided. Therefore it is not a substitute for special density calibration.

Performing density adjustment

-  Note the following before performing the adjustment:
- A density adjustment only makes sense if there is little variation in the operating conditions and the density adjustment is performed under the operating conditions.
 - The density adjustment scales the internally computed density value with a user-specific slope and offset.
 - A 1-point or 2-point density adjustment can be performed.
 - For a 2-point density adjustment, there must be a difference of at least 0.2 kg/l between the two target density values.
 - The reference media must be gas-free or pressurized so that any gas they contain is compressed.
 - The reference density measurements must be performed at the same medium temperature that prevails in the process, as otherwise the density adjustment will not be accurate.
 - The correction resulting from the density adjustment can be deleted with the **Restore original** option.

"1 point adjustment" option

1. In the **Density adjustment mode** parameter, select the **1 point adjustment** option and confirm.
2. In the **Density setpoint 1** parameter, enter the density value and confirm.
 - ↳ In the **Execute density adjustment** parameter the following options are now available:
 - Ok
 - Measure density 1 option**
 - Restore original

3. Select the **Measure density 1** option and confirm.
4. If 100% was reached in the **Progress** parameter on the display and the **Ok** option is displayed in the **Execute density adjustment** parameter, then confirm.
 - ↳ In the **Execute density adjustment** parameter the following options are now available:
 - Ok
 - Calculate
 - Cancel
5. Select the **Calculate** option and confirm.

If the adjustment was completed successfully, the **Density adjustment factor** parameter and the **Density adjustment offset** parameter and the values calculated for them are shown on the display.

"2 point adjustment" option

1. In the **Density adjustment mode** parameter, select the **2 point adjustment** option and confirm.
2. In the **Density setpoint 1** parameter, enter the density value and confirm.
3. In the **Density setpoint 2** parameter, enter the density value and confirm.
 - ↳ In the **Execute density adjustment** parameter the following options are now available:
 - Ok
 - Measure density 1
 - Restore original
4. Select the **Measure density 1** option and confirm.
 - ↳ In the **Execute density adjustment** parameter the following options are now available:
 - Ok
 - Measure density 2
 - Restore original
5. Select the **Measure density 2** option and confirm.
 - ↳ In the **Execute density adjustment** parameter the following options are now available:
 - Ok
 - Calculate
 - Cancel
6. Select the **Calculate** option and confirm.





If the **Density adjust failure** option is displayed in the **Execute density adjustment** parameter, call up the options and select the **Cancel** option. The density adjustment is canceled and can be repeated.

If the adjustment was completed successfully, the **Density adjustment factor** parameter and the **Density adjustment offset** parameter and the values calculated for them are shown on the display.

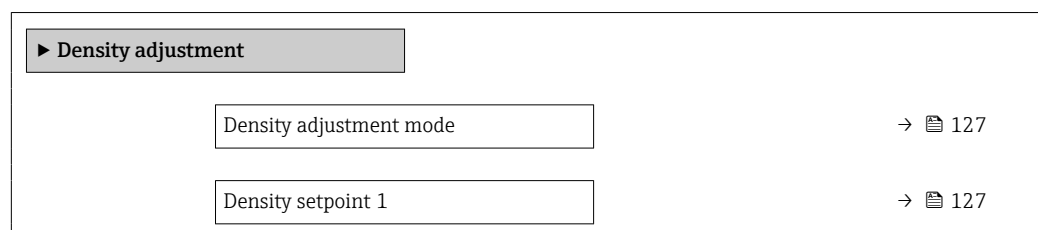
Navigation

"Expert" menu → Sensor → Sensor adjustment → Density adjustment



| | |
|----------------------------|---|
| Density setpoint 2 | →  127 |
| Execute density adjustment | →  127 |
| Progress | →  127 |
| Density adjustment factor | →  127 |
| Density adjustment offset | →  127 |

Parameter overview with brief description

| Parameter | Prerequisite | Description | Selection / User entry / User interface | Factory setting |
|----------------------------|--|------------------------------------|---|-----------------|
| Density adjustment mode | – | | <ul style="list-style-type: none"> ■ 1 point adjustment ■ 2 point adjustment | – |
| Density setpoint 1 | – | | The entry depends on the unit selected in the Density unit parameter (0555). | – |
| Density setpoint 2 | In the Density adjustment mode parameter, the 2 point adjustment option is selected. | | The entry depends on the unit selected in the Density unit parameter (0555). | – |
| Execute density adjustment | – | | <ul style="list-style-type: none"> ■ Cancel ■ Busy ■ Ok ■ Density adjust failure ■ Measure density 1 ■ Measure density 2 ■ Calculate ■ Restore original | – |
| Progress | – | Shows the progress of the process. | 0 to 100 % | – |
| Density adjustment factor | – | | Signed floating-point number | – |
| Density adjustment offset | – | | Signed floating-point number | – |

Zero verification and zero adjustment

All measuring instruments are calibrated in accordance with state-of-the-art technology. Calibration takes place under reference conditions →  219. Therefore, a zero adjustment in the field is generally not required.

Experience shows that zero adjustment is advisable only in special cases:

- To achieve maximum measurement accuracy even with low flow rates.
- Under extreme process or operating conditions (e.g. very high process temperatures or very high-viscosity fluids).
- For gas applications with low pressure

 To achieve the highest possible measurement accuracy at low flow rates, the installation must protect the sensor from mechanical stresses during operation.

To get a representative zero point, ensure that:

- any flow in the device is prevented during the adjustment
- the process conditions (e.g. pressure, temperature) are stable and representative

Zero verification and zero adjustment cannot be performed if the following process conditions are present:

- Gas pockets
Ensure that the system has been sufficiently flushed with the medium. Repeat flushing can help to eliminate gas pockets
- Thermal circulation
In the event of temperature differences (e.g. between the measuring tube inlet and outlet section), induced flow can occur even if the valves are closed due to thermal circulation in the device
- Leaks at the valves
If the valves are not leak-tight, flow is not sufficiently prevented when determining the zero point

If these conditions cannot be avoided, it is advisable to keep the factory setting for the zero point.

Zero point verification

The zero point can be verified with the **Zero verification** wizard.

Navigation

"Setup" menu → Advanced setup → Sensor adjustment → Zero verification

| ► Zero verification | |
|-------------------------------|---------|
| Process conditions | → ⓘ 129 |
| Progress | → ⓘ 129 |
| Status | → ⓘ 129 |
| Additional information | → ⓘ 129 |
| Recommendation: | → ⓘ 129 |
| Root cause | → ⓘ 129 |
| Abort cause | → ⓘ 129 |
| Zero point measured | → ⓘ 129 |
| Zero point standard deviation | → ⓘ 129 |

Parameter overview with brief description

| Parameter | Description | Selection / User interface | Factory setting |
|-------------------------------|---|--|-----------------|
| Process conditions | Ensure process conditions as follows. | <ul style="list-style-type: none"> ▪ Tubes are completely filled ▪ Process operational pressure applied ▪ No-flow conditions (closed valves) ▪ Process and ambient temperatures stable | – |
| Progress | Shows the progress of the process. | 0 to 100 % | – |
| Zero point adjustment status | | <ul style="list-style-type: none"> ▪ Busy ▪ Alarm ▪ Ok | – |
| Additional information | Indicate whether to display additional information. | <ul style="list-style-type: none"> ▪ Hide ▪ Show | – |
| Recommendation: | Indicates whether an adjustment is recommended. Only recommended if the measured zero point deviates significantly from the current zero point. | <ul style="list-style-type: none"> ▪ Do not adjust zero point ▪ Adjust zero point | – |
| Abort cause | Indicates why the wizard was aborted. | <ul style="list-style-type: none"> ▪ Check process conditions! ▪ A technical issue has occurred | – |
| Root cause | Shows the diagnostic and remedy. | <ul style="list-style-type: none"> ▪ Zero point too high. Ensure no-flow. ▪ Zero point is unstable. Ensure no-flow. ▪ Fluctuation high. Avoid 2-phase medium. | – |
| Zero point measured | Shows the zero point measured for the adjustment. | Signed floating-point number | – |
| Zero point standard deviation | Shows the standard deviation of the zero point measured. | Positive floating-point number | – |

Zero adjust

The zero point can be adjusted with the **Zero adjustment** wizard.

-  A zero point verification should be performed before a zero adjustment.
- The zero point can also be adjusted manually: Expert → Sensor → Calibration

Navigation

"Setup" menu → Advanced setup → Sensor adjustment → Zero adjustment

▶ **Zero adjustment**

- Process conditions → ⓘ 130
- Progress → ⓘ 130
- Status → ⓘ 130
- Root cause → ⓘ 130
- Abort cause → ⓘ 130

| | |
|------------------------------------|---------|
| Root cause | → ⓘ 130 |
| Reliability of measured zero point | → ⓘ 130 |
| Additional information | → ⓘ 130 |
| Reliability of measured zero point | → ⓘ 130 |
| Zero point measured | → ⓘ 130 |
| Zero point standard deviation | → ⓘ 130 |
| Select action | → ⓘ 130 |

Parameter overview with brief description

| Parameter | Description | Selection / User interface | Factory setting |
|------------------------------------|--|--|-----------------|
| Process conditions | Ensure process conditions as follows. | <ul style="list-style-type: none"> ▪ Tubes are completely filled ▪ Process operational pressure applied ▪ No-flow conditions (closed valves) ▪ Process and ambient temperatures stable | – |
| Progress | Shows the progress of the process. | 0 to 100 % | – |
| Zero point adjustment status | | <ul style="list-style-type: none"> ▪ Busy ▪ Alarm ▪ Ok | – |
| Abort cause | Indicates why the wizard was aborted. | <ul style="list-style-type: none"> ▪ Check process conditions! ▪ A technical issue has occurred | – |
| Root cause | Shows the diagnostic and remedy. | <ul style="list-style-type: none"> ▪ Zero point too high. Ensure no-flow. ▪ Zero point is unstable. Ensure no-flow. ▪ Fluctuation high. Avoid 2-phase medium. | – |
| Reliability of measured zero point | Indicates the reliability of the zero point measured. | <ul style="list-style-type: none"> ▪ Not done ▪ Good ▪ Uncertain | – |
| Additional information | Indicate whether to display additional information. | <ul style="list-style-type: none"> ▪ Hide ▪ Show | – |
| Zero point measured | Shows the zero point measured for the adjustment. | Signed floating-point number | – |
| Zero point standard deviation | Shows the standard deviation of the zero point measured. | Positive floating-point number | – |
| Select action | Select the zero point value to apply. | <ul style="list-style-type: none"> ▪ Keep current zero point ▪ Apply zero point measured ▪ Apply factory zero point * | – |

* Visibility depends on order options or device settings

10.6.4 Configuring the totalizer

In the "Totalizer 1 to n" submenu, you can configure the specific totalizer.

Navigation

"Setup" menu → Advanced setup → Totalizer 1 to n

| | |
|--------------------------|---------|
| ▶ Totalizer 1 to n | |
| Assign process variable | → ⓘ 131 |
| Unit totalizer 1 to n | → ⓘ 131 |
| Totalizer operation mode | → ⓘ 131 |
| Failure mode | → ⓘ 131 |

Parameter overview with brief description

| Parameter | Prerequisite | Description | Selection | Factory setting |
|--------------------------|--|---|---|--|
| Assign process variable | – | Select process variable for totalizer. | <ul style="list-style-type: none"> ▪ Off ▪ Mass flow ▪ Volume flow ▪ Corrected volume flow[*] ▪ Target mass flow[*] ▪ Carrier mass flow[*] | – |
| Unit totalizer 1 to n | A process variable is selected in the Assign process variable parameter (→ ⓘ 131) of the Totalizer 1 to n submenu. | Select process variable totalizer unit. | Unit choose list | Depends on country: <ul style="list-style-type: none"> ▪ kg ▪ lb |
| Totalizer operation mode | A process variable is selected in the Assign process variable parameter (→ ⓘ 131) of the Totalizer 1 to n submenu. | Select totalizer calculation mode. | <ul style="list-style-type: none"> ▪ Net flow total ▪ Forward flow total ▪ Reverse flow total | – |
| Failure mode | A process variable is selected in the Assign process variable parameter (→ ⓘ 131) of the Totalizer 1 to n submenu. | Define totalizer behavior in alarm condition. | <ul style="list-style-type: none"> ▪ Stop ▪ Actual value ▪ Last valid value | – |

* Visibility depends on order options or device settings

10.6.5 Carrying out additional display configurations

In the **Display** submenu you can set all the parameters associated with the configuration of the local display.

Navigation

"Setup" menu → Advanced setup → Display

| ► Display | |
|-----------------------|-------|
| Format display | → 133 |
| Value 1 display | → 133 |
| 0% bargraph value 1 | → 133 |
| 100% bargraph value 1 | → 133 |
| Decimal places 1 | → 133 |
| Value 2 display | → 133 |
| Decimal places 2 | → 133 |
| Value 3 display | → 134 |
| 0% bargraph value 3 | → 134 |
| 100% bargraph value 3 | → 134 |
| Decimal places 3 | → 134 |
| Value 4 display | → 134 |
| Decimal places 4 | → 134 |
| Display language | → 134 |
| Display interval | → 134 |
| Display damping | → 134 |
| Header | → 134 |
| Header text | → 134 |
| Separator | → 135 |
| Backlight | → 135 |

Parameter overview with brief description

| Parameter | Prerequisite | Description | Selection / User entry | Factory setting |
|-----------------------|--|---|---|--|
| Format display | A local display is provided. | Select how measured values are shown on the display. | <ul style="list-style-type: none"> ■ 1 value, max. size ■ 1 bargraph + 1 value ■ 2 values ■ 1 value large + 2 values ■ 4 values | – |
| Value 1 display | A local display is provided. | Select the measured value that is shown on the local display. | <ul style="list-style-type: none"> ■ Mass flow ■ Volume flow ■ Corrected volume flow * ■ Density ■ Reference density * ■ Temperature ■ Totalizer 1 ■ Totalizer 2 ■ Totalizer 3 ■ Concentration * ■ Target mass flow * ■ Carrier mass flow * ■ HBSI * ■ Exciter current 0 ■ Oscillation damping 0 ■ Oscillation damping fluctuation 0 * ■ Oscillation frequency 0 ■ Frequency fluctuation 0 * ■ Oscillation amplitude 0 * ■ Signal asymmetry ■ Carrier pipe temperature * ■ Electronic temperature ■ Current output 1 ■ Current output 2 * ■ Current output 3 * ■ Current output 4 * | – |
| 0% bargraph value 1 | A local display is provided. | Enter 0% value for bar graph display. | Signed floating-point number | Country-specific: <ul style="list-style-type: none"> ■ 0 kg/h ■ 0 lb/min |
| 100% bargraph value 1 | A local display is provided. | Enter 100% value for bar graph display. | Signed floating-point number | Depends on country and nominal diameter |
| Decimal places 1 | A measured value is specified in the Value 1 display parameter. | Select the number of decimal places for the display value. | <ul style="list-style-type: none"> ■ x ■ x.x ■ x.xx ■ x.xxx ■ x.xxxx | – |
| Value 2 display | A local display is provided. | Select the measured value that is shown on the local display. | For the picklist, see Value 1 display parameter (→ 118) | – |
| Decimal places 2 | A measured value is specified in the Value 2 display parameter. | Select the number of decimal places for the display value. | <ul style="list-style-type: none"> ■ x ■ x.x ■ x.xx ■ x.xxx ■ x.xxxx | – |

| Parameter | Prerequisite | Description | Selection / User entry | Factory setting |
|-----------------------|---|---|--|---|
| Value 3 display | A local display is provided. | Select the measured value that is shown on the local display. | For the picklist, see Value 1 display parameter (→ 118) | – |
| 0% bargraph value 3 | A selection was made in the Value 3 display parameter. | Enter 0% value for bar graph display. | Signed floating-point number | Country-specific: ■ 0 kg/h ■ 0 lb/min |
| 100% bargraph value 3 | A selection was made in the Value 3 display parameter. | Enter 100% value for bar graph display. | Signed floating-point number | – |
| Decimal places 3 | A measured value is specified in the Value 3 display parameter. | Select the number of decimal places for the display value. | <ul style="list-style-type: none"> ■ x ■ x.x ■ x.xx ■ x.xxx ■ x.xxxx | – |
| Value 4 display | A local display is provided. | Select the measured value that is shown on the local display. | For the picklist, see Value 1 display parameter (→ 118) | – |
| Decimal places 4 | A measured value is specified in the Value 4 display parameter. | Select the number of decimal places for the display value. | <ul style="list-style-type: none"> ■ x ■ x.x ■ x.xx ■ x.xxx ■ x.xxxx | – |
| Display language | A local display is provided. | Set display language. | <ul style="list-style-type: none"> ■ English ■ Deutsch * ■ Français * ■ Español * ■ Italiano * ■ Nederlands * ■ Portuguesa * ■ Polski * ■ русский язык (Russian) * ■ Svenska * ■ Türkçe * ■ 中文 (Chinese) * ■ 日本語 (Japanese) * ■ 한국어 (Korean) * ■ tiếng Việt (Vietnamese) * ■ čeština (Czech) * | English (alternatively, the ordered language is preset in the device) |
| Display interval | A local display is provided. | Set time measured values are shown on display if display alternates between values. | 1 to 10 s | – |
| Display damping | A local display is provided. | Set display reaction time to fluctuations in the measured value. | 0.0 to 999.9 s | – |
| Header | A local display is provided. | Select header contents on local display. | <ul style="list-style-type: none"> ■ Device tag ■ Free text | – |
| Header text | The Free text option is selected in the Header parameter. | Enter display header text. | Max. 12 characters, such as letters, numbers or special characters (e.g. @, %, /) | – |

| Parameter | Prerequisite | Description | Selection / User entry | Factory setting |
|-----------|--|---|--|-----------------|
| Separator | A local display is provided. | Select decimal separator for displaying numerical values. | <ul style="list-style-type: none"> ▪ . (point) ▪ , (comma) | . (point) |
| Backlight | One of the following conditions is met: <ul style="list-style-type: none"> ▪ Order code for "Display; operation", option F"4-line, illum.; touch control" ▪ Order code for "Display; operation", option G"4-line, illum.; touch control +WLAN" | Switch the local display backlight on and off. | <ul style="list-style-type: none"> ▪ Disable ▪ Enable | – |

* Visibility depends on order options or device settings

10.6.6 WLAN configuration

The **WLAN Settings** submenu guides the user systematically through all the parameters that have to be set for the WLAN configuration.

Navigation

"Setup" menu → Advanced setup → WLAN settings

▶ WLAN settings

| | |
|------------------|---------|
| WLAN IP address | → ⓘ 135 |
| Security type | → ⓘ 135 |
| WLAN passphrase | → ⓘ 135 |
| Assign SSID name | → ⓘ 136 |
| SSID name | → ⓘ 136 |
| Apply changes | → ⓘ 136 |

Parameter overview with brief description

| Parameter | Prerequisite | Description | User entry / Selection | Factory setting |
|-----------------|---|--|--|--|
| WLAN IP address | – | Enter IP address of the device WLAN interface. | 4 octet: 0 to 255 (in the particular octet) | – |
| Security type | – | Select the security type of the WLAN interface. | <ul style="list-style-type: none"> ▪ Unsecured ▪ WPA2-PSK | – |
| WLAN passphrase | The WPA2-PSK option is selected in the Security type parameter. | Enter the network key (8 to 32 characters). The network key supplied with the device should be changed during commissioning for security reasons. | 8 to 32-digit character string comprising numbers, letters and special characters (without spaces) | Serial number of the measuring device (e.g. L100A802000) |

| Parameter | Prerequisite | Description | User entry / Selection | Factory setting |
|------------------|--|--|--|---|
| Assign SSID name | – | Select which name will be used for SSID: device tag or user-defined name. | <ul style="list-style-type: none"> ▪ Device tag ▪ User-defined | – |
| SSID name | <ul style="list-style-type: none"> ▪ The User-defined option is selected in the Assign SSID name parameter. ▪ The WLAN access point option is selected in the WLAN mode parameter. | Enter the user-defined SSID name (max. 32 characters).  The user-defined SSID name may only be assigned once. If the SSID name is assigned more than once, the devices can interfere with one another. | Max. 32-digit character string comprising numbers, letters and special characters | EH_device designation_last 7 digits of the serial number (e.g. EH_Promass_500_A 802000) |
| Apply changes | – | Use changed WLAN settings. | <ul style="list-style-type: none"> ▪ Cancel ▪ Ok | – |

10.6.7 Configuration management

After commissioning, you can save the current device configuration or restore the previous device configuration. The device configuration is managed via the **Configuration management** parameter.

Navigation

"Setup" menu → Advanced setup → Configuration backup

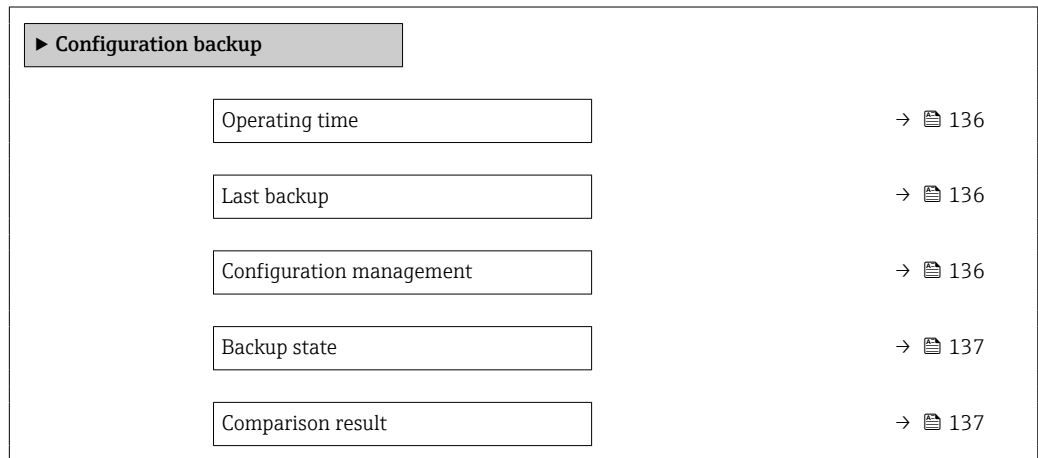

Parameter overview with brief description

| Parameter | Description | User interface / Selection |
|--------------------------|--|---|
| Operating time | Indicates how long the device has been in operation. | Days (d), hours (h), minutes (m) and seconds (s) |
| Last backup | Shows when the last data backup was saved to embedded HistoROM. | Days (d), hours (h), minutes (m) and seconds (s) |
| Configuration management | Select action for managing the device data in the embedded HistoROM. | <ul style="list-style-type: none"> ▪ Cancel ▪ Execute backup ▪ Restore ▪ Compare ▪ Clear backup data |

| Parameter | Description | User interface / Selection |
|-------------------|---|---|
| Backup state | Shows the current status of data saving or restoring. | <ul style="list-style-type: none"> ■ None ■ Backup in progress ■ Restoring in progress ■ Delete in progress ■ Compare in progress ■ Restoring failed ■ Backup failed |
| Comparison result | Comparison of current device data with embedded HistoROM. | <ul style="list-style-type: none"> ■ Settings identical ■ Settings not identical ■ No backup available ■ Backup settings corrupt ■ Check not done ■ Dataset incompatible |

Function scope of the "Configuration management" parameter

| Options | Description |
|-------------------|---|
| Cancel | No action is executed and the user exits the parameter. |
| Execute backup | A backup copy of the current device configuration is saved from the HistoROM backup to the memory of the device. The backup copy includes the transmitter data of the device. |
| Restore | The last backup copy of the device configuration is restored from the device memory to the device's HistoROM backup. The backup copy includes the transmitter data of the device. |
| Compare | The device configuration saved in the device memory is compared with the current device configuration of the HistoROM backup. |
| Clear backup data | The backup copy of the device configuration is deleted from the memory of the device. |

 *HistoROM backup*

A HistoROM is a "non-volatile" device memory in the form of an EEPROM.



While this action is in progress, the configuration cannot be edited via the local display and a message on the processing status appears on the display.

10.6.8 Using parameters for device administration

The **Administration** submenu systematically guides the user through all the parameters that can be used for device administration purposes.

Navigation

"Setup" menu → Advanced setup → Administration

| | | |
|----------------------|--|---------|
| ▶ Administration | | |
| ▶ Define access code | | → ⓘ 138 |
| ▶ Reset access code | | → ⓘ 138 |
| Device reset | | → ⓘ 139 |

Using the parameter to define the access code

Navigation

"Setup" menu → Advanced setup → Administration → Define access code

▶ Define access code

Define access code

→ 138

Confirm access code

→ 138

Parameter overview with brief description

| Parameter | Description | User entry |
|---------------------|---|---|
| Define access code | Restrict write-access to parameters to protect the configuration of the device against unintentional changes. | Max. 16-digit character string comprising numbers, letters and special characters |
| Confirm access code | Confirm the entered access code. | Max. 16-digit character string comprising numbers, letters and special characters |

Using the parameter to reset the access code

Navigation

"Setup" menu → Advanced setup → Administration → Reset access code

▶ Reset access code

Operating time

→ 138

Reset access code

→ 138

Parameter overview with brief description

| Parameter | Description | User interface / User entry |
|-------------------|--|---|
| Operating time | Indicates how long the device has been in operation. | Days (d), hours (h), minutes (m) and seconds (s) |
| Reset access code | Reset access code to factory settings. For a reset code, contact your Endress+Hauser service organization. The reset code can only be entered via: <ul style="list-style-type: none"> ▪ Web browser ▪ DeviceCare, FieldCare (via CDI-RJ45 service interface) ▪ Fieldbus | Character string comprising numbers, letters and special characters |

Using the parameter to reset the device

Navigation

"Setup" menu → Advanced setup → Administration

Parameter overview with brief description

| Parameter | Description | Selection |
|--------------|---|---|
| Device reset | Reset the device configuration - either entirely or in part - to a defined state. | <ul style="list-style-type: none"> ■ Cancel ■ To delivery settings ■ Restart device ■ Restore S-DAT backup ■ ENP restart |

10.7 Simulation

Via the **Simulation** submenu, it is possible to simulate various process variables in the process and the device alarm mode and verify downstream signal chains (switching valves or closed-control loops). The simulation can be performed without a real measurement (no flow of medium through the device).

Activating and deactivating simulation mode via DIP switch

The following hardware settings can be made for the FOUNDATION Fieldbus via DIP switch 4 on the main electronics module:

- Enable/block simulation mode in the function blocks (e.g. **Analog Input** or **Discrete Output** function block)
- Simulation mode enabled (factory setting) = simulation in the **Analog Input** or **Discrete Output** function block possible
- Simulation mode blocked = simulation in the **Analog Input** or **Discrete Output** function block not possible

Proline 500 – digital

NOTICE

Excessive tightening torque applied to the fixing screws!

Risk of damaging the plastic transmitter.

- ▶ Tighten the fixing screws as per the tightening torque: 2.5 Nm (1.8 lbf ft)

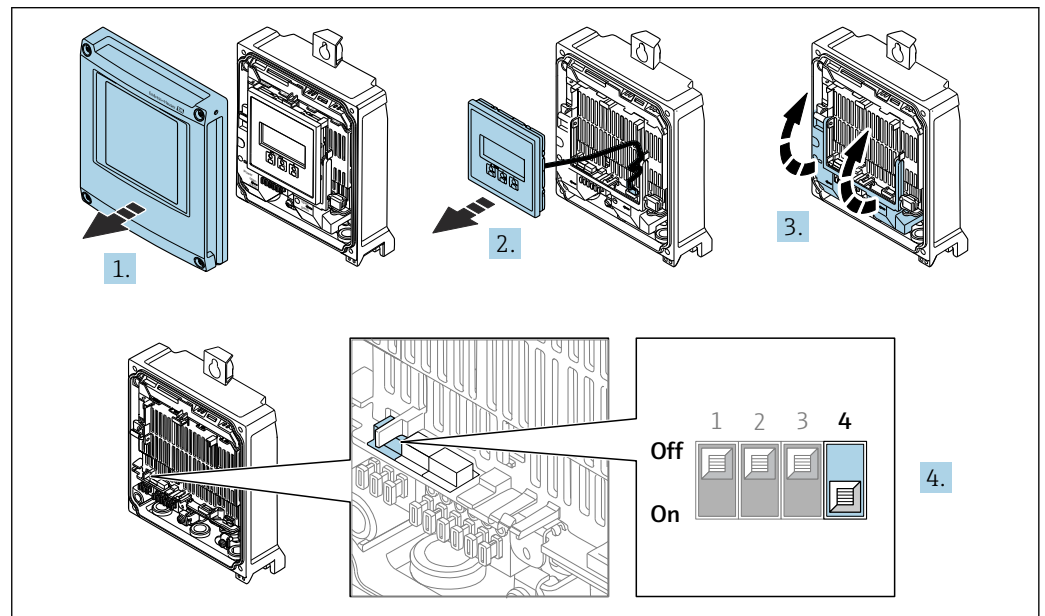

A0046504

1. Open the housing cover.
2. Remove the display module.
3. Fold open the terminal cover.

4. Set the write protection switch (SIM) on the main electronics module to the **ON** position (factory setting):
 - ↳ Simulation mode enabled.
5. Set the write protection switch (SIM) on the main electronics module to the **OFF** position:
 - ↳ Simulation mode disabled.

Proline 500

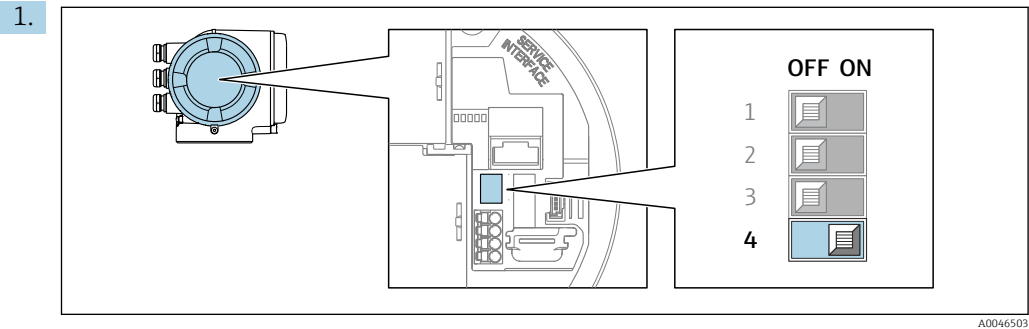









1. Set the write protection switch (SIM) on the main electronics module to the **ON** position (factory setting):
 - ↳ Simulation mode enabled.
2. Set the write protection switch (SIM) on the main electronics module to the **OFF** position:
 - ↳ Simulation mode disabled.

Navigation



"Diagnostics" menu → Simulation

▶ **Simulation**

| | |
|------------------------------------|---------|
| Assign simulation process variable | → ⓘ 141 |
| Process variable value | → ⓘ 141 |
| Status input simulation | → ⓘ 142 |
| Input signal level | → ⓘ 142 |
| Current input 1 to n simulation | → ⓘ 142 |
| Value current input 1 to n | → ⓘ 142 |
| Current output 1 to n simulation | → ⓘ 141 |
| Value current output 1 to n | → ⓘ 141 |
| Frequency output simulation 1 to n | → ⓘ 141 |
| Frequency value 1 to n | → ⓘ 141 |

| | |
|---------------------------------|---|
| Pulse output simulation 1 to n | →  141 |
| Pulse value 1 to n | →  141 |
| Switch output simulation 1 to n | →  142 |
| Switch status 1 to n | →  142 |
| Relay output 1 to n simulation | →  142 |
| Switch status 1 to n | →  142 |
| Device alarm simulation | →  142 |
| Diagnostic event category | →  142 |
| Diagnostic event simulation | →  142 |

Parameter overview with brief description





| Parameter | Prerequisite | Description | Selection / User entry |
|------------------------------------|--|--|---|
| Assign simulation process variable | – | Select a process variable for the simulation process that is activated. | <ul style="list-style-type: none"> ▪ Off ▪ Mass flow ▪ Volume flow ▪ Corrected volume flow ▪ Density ▪ Reference density ▪ Temperature ▪ Target mass flow * ▪ Carrier mass flow * ▪ Concentration * |
| Process variable value | A process variable is selected in the Assign simulation process variable parameter (→  141). | Enter the simulation value for the selected process variable. | Depends on the process variable selected |
| Current output simulation | – | Switch the simulation of the current output on and off. | <ul style="list-style-type: none"> ▪ Off ▪ On |
| Value current output | In the Current output 1 to n simulation parameter, the On option is selected. | Enter the current value for simulation. | 3.59 to 22.5 mA |
| Frequency output simulation | In the Operating mode parameter, the Frequency option is selected. | Switch the simulation of the frequency output on and off. | <ul style="list-style-type: none"> ▪ Off ▪ On |
| Frequency value | In the Frequency output simulation 1 to n parameter, the On option is selected. | Enter the frequency value for the simulation. | 0.0 to 12 500.0 Hz |
| Pulse output simulation | In the Operating mode parameter, the Pulse option is selected. | Set and switch off the pulse output simulation.  For Fixed value option: Pulse width parameter (→  109) defines the pulse width of the pulses output. | <ul style="list-style-type: none"> ▪ Off ▪ Fixed value ▪ Down-counting value |
| Pulse value | In the Pulse output simulation 1 to n parameter, the Down-counting value option is selected. | Enter the number of pulses for simulation. | 0 to 65 535 |

| Parameter | Prerequisite | Description | Selection / User entry |
|-----------------------------|---|---|---|
| Switch output simulation | In the Operating mode parameter, the Switch option is selected. | Switch the simulation of the switch output on and off. | <ul style="list-style-type: none"> ■ Off ■ On |
| Switch status | – | Select the status of the status output for the simulation. | <ul style="list-style-type: none"> ■ Open ■ Closed |
| Relay output simulation | – | Switch simulation of the relay output on and off. | <ul style="list-style-type: none"> ■ Off ■ On |
| Switch status | The On option is selected in the Switch output simulation 1 to n parameter parameter. | Select status of the relay output for the simulation. | <ul style="list-style-type: none"> ■ Open ■ Closed |
| Device alarm simulation | – | Switch the device alarm on and off. | <ul style="list-style-type: none"> ■ Off ■ On |
| Diagnostic event category | – | Select a diagnostic event category. | <ul style="list-style-type: none"> ■ Sensor ■ Electronics ■ Configuration ■ Process |
| Diagnostic event simulation | – | Select a diagnostic event to simulate this event. | <ul style="list-style-type: none"> ■ Off ■ Diagnostic event picklist (depends on the category selected) |
| Current input simulation | – | Switch simulation of the current input on and off. | <ul style="list-style-type: none"> ■ Off ■ On |
| Value current input | In the Current input 1 to n simulation parameter, the On option is selected. | Enter the current value for simulation. | 0 to 22.5 mA |
| Status input simulation | – | Switch simulation of the status input on and off. | <ul style="list-style-type: none"> ■ Off ■ On |
| Input signal level | In the Status input simulation parameter, the On option is selected. | Select the signal level for the simulation of the status input. | <ul style="list-style-type: none"> ■ High ■ Low |

* Visibility depends on order options or device settings

10.8 Protecting settings from unauthorized access

The following write protection options exist in order to protect the configuration of the measuring device from unintentional modification:

- Protect access to parameters via access code →  142
- Protect access to local operation via key locking →  76
- Protect access to measuring device via write protection switch →  144
- Protect access to parameters via block operation →  146







10.8.1 Write protection via access code

The effects of the user-specific access code are as follows:

- Via local operation, the parameters for the measuring device configuration are write-protected and their values can no longer be changed.
- Device access is protected via the Web browser, as are the parameters for the measuring device configuration.
- Device access is protected via FieldCare or DeviceCare (via CDI-RJ45 service interface), as are the parameters for the measuring device configuration.

Defining the access code via the local display

1. Navigate to the **Define access code** parameter (→  138).
2. Maximum of 16-digit character string comprising numbers, letters and special characters as the access code.





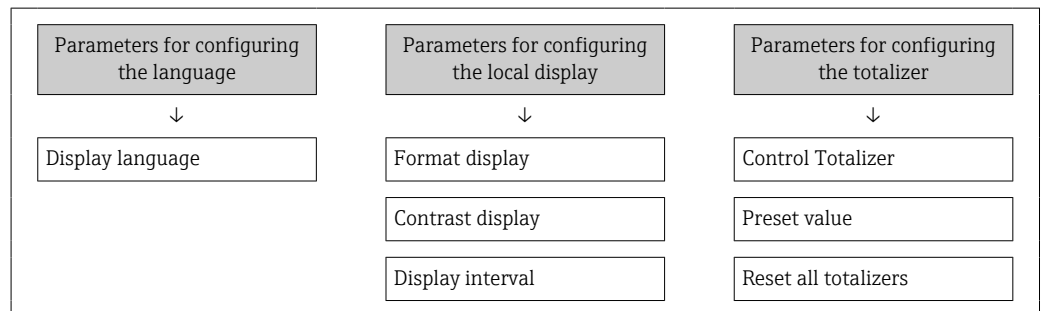

3. Enter the access code again in the **Confirm access code** parameter (→  138) to confirm.
 - ↳ The  symbol appears in front of all write-protected parameters.
- 
 - Disabling parameter write protection via access code →  75.
 - If the access code is lost: Resetting the access code →  143.
 - The user role with which the user is currently logged in is displayed in **Access status** parameter.
 - Navigation path: Operation → Access status
 - User roles and their access rights →  75
 - The device automatically locks the write-protected parameters again if a key is not pressed for 10 minutes in the navigation and editing view.
 - The device locks the write-protected parameters automatically after 60 s if the user skips back to the operational display mode from the navigation and editing view.

Parameters which can always be modified via the local display

Certain parameters that do not affect the measurement are excepted from parameter write protection via the local display. Despite the user-specific access code, they can always be modified, even if the other parameters are locked.



Defining the access code via the web browser

1. Navigate to the **Define access code** parameter (→  138).
 2. Define a 16-digit (max.) numeric code as the access code.
 3. Enter the access code again in the **Confirm access code** parameter (→  138) to confirm.
 - ↳ The web browser switches to the login page.
- 
 - Disabling parameter write protection via access code →  75.
 - If the access code is lost: Resetting the access code →  143.
 - The **Access status** parameter shows which user role the user is currently logged in with.
 - Navigation path: Operation → Access status
 - User roles and their access rights →  75



If no action is performed for 10 minutes, the web browser automatically returns to the login page.

Resetting the access code

If you misplace the user-specific access code, it is possible to reset the code to the factory setting. A reset code must be entered for this purpose. The user-specific access code can then be defined again afterwards.

Via Web browser, FieldCare, DeviceCare (via CDI-RJ45 service interface), fieldbus

i You can only obtain a reset code from your local Endress+Hauser service organization. The code must be calculated explicitly for every device.

1. Note down the serial number of the device.
2. Read off the **Operating time** parameter.
3. Contact the local Endress+Hauser service organization and tell them the serial number and the operating time.
 - ↳ Get the calculated reset code.
4. Enter the reset code in the **Reset access code** parameter (→  138).
 - ↳ The access code has been reset to the factory setting **0000**. It can be redefined →  142.

i For IT security reasons, the calculated reset code is only valid for 96 hours from the specified operating time and for the specific serial number. If you cannot return to the device within 96 hours, you should either increase the operating time you read out by a few days or switch off the device.

10.8.2 Write protection via write protection switch

Unlike parameter write protection via a user-specific access code, this allows the user to lock write access to the entire operating menu - apart from the **"Contrast display" parameter**.

The parameter values are now read only and cannot be edited any more (exception **"Contrast display" parameter**):

- Via local display
- Via FOUNDATION Fieldbus

Proline 500 – digital

Enable/disable write protection

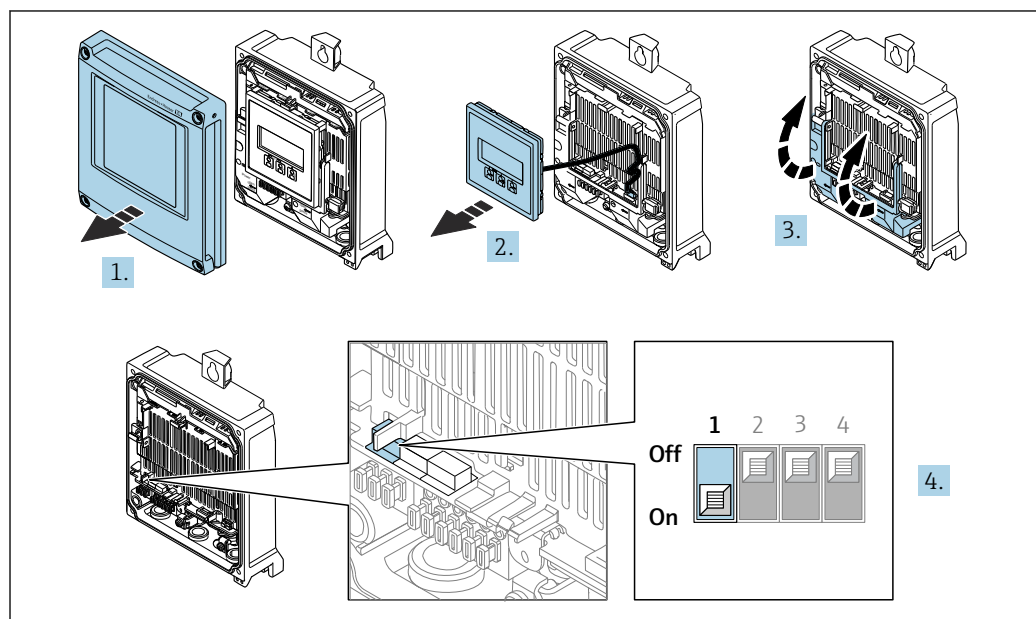

1. Open the housing cover.
2. Remove the display module.
3. Fold open the terminal cover.

A0029673

4. Enable or disable write protection:

Setting the write protection (WP) switch on the main electronics module to the **ON** position enables hardware write protection/setting to **OFF** (factory setting) disables hardware write protection.

- ↳ In the **Locking status** parameter, the **Hardware locked** option is displayed → 147. When hardware write protection is enabled, the  symbol appears in the header of the measured value display and in the navigation view in front of the parameters.

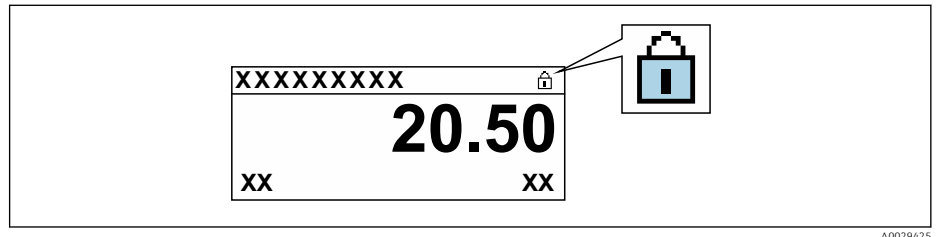

A0029425

5. Insert the display module.

6. Close the housing cover.

7. NOTICE

Excessive tightening torque applied to the fixing screws!

Risk of damaging the plastic transmitter.

- ▶ Tighten the fixing screws as per the tightening torque: 2.5 Nm (1.8 lbf ft)

Tighten the fixing screws.

Proline 500

1.

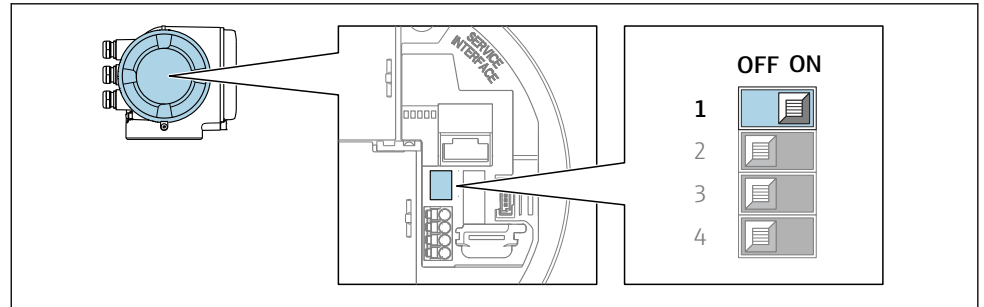

A0029630

Setting the write protection (WP) switch on the main electronics module to the **ON** position enables hardware write protection.

- ↳ In the **Locking status** parameter, the **Hardware locked** option is displayed → 147. In addition, on the local display the  symbol appears in front of the parameters in the header of the operational display and in the navigation view.

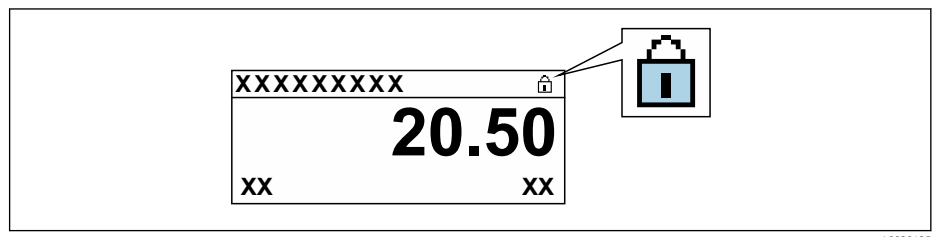

A0029425

2. Setting the write protection (WP) switch on the main electronics module to the **OFF** position (factory setting) disables hardware write protection.

- ↳ No option is displayed in the **Locking status** parameter → 147. On the local display, the  symbol disappears from in front of the parameters in the header of the operational display and in the navigation view.

10.8.3 Write protection via block operation

Locking via block operation:

- Block: **DISPLAY (TRDDISP)**; parameter: **Define access code**
- Block: **EXPERT_CONFIG (TRDEXP)**; parameter: **Enter access code**



11 Operation

11.1 Reading off the device locking status

Device active write protection: **Locking status** parameter



Operation → Locking status

Function scope of the "Locking status" parameter

| Options | Description |
|--------------------|--|
| None | The access authorization displayed in the Access status parameter applies →  75. Only appears on local display. |
| Hardware locked | The DIP switch for hardware locking is activated on the PCB board. This locks write access to the parameters (e.g. via local display or operating tool) →  144. |
| Temporarily locked | Write access to the parameters is temporarily locked on account of internal processes running in the device (e.g. data upload/download, reset, etc.). Once the internal processing has been completed, the parameters can be changed once again. |



11.2 Adjusting the operating language

 Detailed information:

- To configure the operating language →  95
- For information on the operating languages supported by the measuring device →  230

11.3 Configuring the display

Detailed information:





- On the basic settings for the local display →  117
- On the advanced settings for the local display →  132

11.4 Reading off measured values

With the **Measured values** submenu, it is possible to read all the measured values.

Navigation

"Diagnostics" menu → Measured values

| | |
|----------------------|---|
| ▶ Measured values | |
| ▶ Measured variables | →  148 |
| ▶ Input values | →  151 |
| ▶ Output values | →  152 |
| ▶ Totalizer | →  150 |

11.4.1 "Measured variables" submenu

The **Measured variables** submenu contains all the parameters needed to display the current measured values for each process variable.





Navigation







"Diagnostics" menu → Measured values → Measured variables

| ► Measured variables | |
|-------------------------------|---------|
| Mass flow | → ⓘ 148 |
| Volume flow | → ⓘ 148 |
| Corrected volume flow | → ⓘ 149 |
| Density | → ⓘ 149 |
| Reference density | → ⓘ 149 |
| Temperature | → ⓘ 149 |
| Pressure | → ⓘ 149 |
| Concentration | → ⓘ 149 |
| Target mass flow | → ⓘ 149 |
| Carrier mass flow | → ⓘ 149 |
| Target corrected volume flow | → ⓘ 149 |
| Carrier corrected volume flow | → ⓘ 150 |
| Target volume flow | → ⓘ 150 |
| Carrier volume flow | → ⓘ 150 |

Parameter overview with brief description

| Parameter | Prerequisite | Description | User interface |
|-------------|--------------|---|------------------------------|
| Mass flow | – | Displays the mass flow that is currently measured. <i>Dependency</i> The unit is taken from: Mass flow unit parameter (→ ⓘ 98) | Signed floating-point number |
| Volume flow | – | Displays the volume flow that is currently calculated. <i>Dependency</i> The unit is taken from the Volume flow unit parameter (→ ⓘ 98). | Signed floating-point number |

| Parameter | Prerequisite | Description | User interface |
|------------------------------|--|--|------------------------------|
| Corrected volume flow | – | Displays the corrected volume flow that is currently calculated. <i>Dependency</i> The unit is taken from: Corrected volume flow unit parameter (→ 98) | Signed floating-point number |
| Density | – | Shows the density currently measured. <i>Dependency</i> The unit is taken from the Density unit parameter (→ 98). | Signed floating-point number |
| Reference density | – | Displays the reference density that is currently calculated. <i>Dependency</i> The unit is taken from: Reference density unit parameter (→ 99) | Signed floating-point number |
| Temperature | – | Shows the medium temperature currently measured. <i>Dependency</i> The unit is taken from: Temperature unit parameter (→ 99) | Signed floating-point number |
| Pressure value | – | Displays either a fixed or external pressure value. <i>Dependency</i> The unit is taken from the Pressure unit parameter (→ 99). | Signed floating-point number |
| Concentration | For the following order code: Order code for "Application package", option ED "Concentration"  The software options currently enabled are displayed in the Software option overview parameter. | Displays the concentration that is currently calculated. <i>Dependency</i> The unit is taken from the Concentration unit parameter. | Signed floating-point number |
| Target mass flow | With the following conditions: Order code for "Application package", option ED "Concentration"  The software options currently enabled are displayed in the Software option overview parameter. | Displays the mass flow that is currently measured for the target medium. <i>Dependency</i> The unit is taken from: Mass flow unit parameter (→ 98) | Signed floating-point number |
| Carrier mass flow | With the following conditions: Order code for "Application package", option ED "Concentration"  The software options currently enabled are displayed in the Software option overview parameter. | Displays the mass flow of the carrier medium that is currently measured. <i>Dependency</i> The unit is taken from: Mass flow unit parameter (→ 98) | Signed floating-point number |
| Target corrected volume flow | With the following conditions: ▪ Order code for "Application package", option ED "Concentration" ▪ The Ethanol in water option or %mass / %volume option is selected in the Liquid type parameter.  The software options currently enabled are displayed in the Software option overview parameter. | Displays the corrected volume flow that is currently measured for the target fluid. <i>Dependency</i> The unit is taken from the Volume flow unit parameter (→ 98). | Signed floating-point number |

| Parameter | Prerequisite | Description | User interface |
|-------------------------------|--|---|------------------------------|
| Carrier corrected volume flow | <p>With the following conditions:</p> <ul style="list-style-type: none"> Order code for "Application package", option ED "Concentration" In the Liquid type parameter, the Ethanol in water option or %mass / %volume option is selected. <p> The software options currently enabled are displayed in the Software option overview parameter.</p> | <p>Displays the corrected volume flow currently measured for the carrier fluid.</p> <p><i>Dependency</i> The unit is taken from the Volume flow unit parameter (→  98).</p> | Signed floating-point number |
| Target volume flow | <p>With the following conditions:</p> <ul style="list-style-type: none"> Order code for "Application package", option ED "Concentration" The Ethanol in water option or %mass / %volume option is selected in the Liquid type parameter. The %vol option is selected in the Concentration unit parameter. <p> The software options currently enabled are displayed in the Software option overview parameter.</p> | <p>Displays the volume flow currently measured for the target medium.</p> <p><i>Dependency</i> The unit is taken from the Volume flow unit parameter (→  98).</p> | Signed floating-point number |
| Carrier volume flow | <p>With the following conditions:</p> <ul style="list-style-type: none"> Order code for "Application package", option ED "Concentration" The Ethanol in water option or %mass / %volume option is selected in the Liquid type parameter. The %vol option is selected in the Concentration unit parameter. <p> The software options currently enabled are displayed in the Software option overview parameter.</p> | <p>Displays the volume flow currently measured for the carrier medium.</p> <p><i>Dependency</i> The unit is taken from the Volume flow unit parameter (→  98).</p> | Signed floating-point number |

11.4.2 "Totalizer" submenu

The **Totalizer** submenu contains all the parameters needed to display the current measured values for every totalizer.

Navigation

"Diagnostics" menu → Measured values → Totalizer

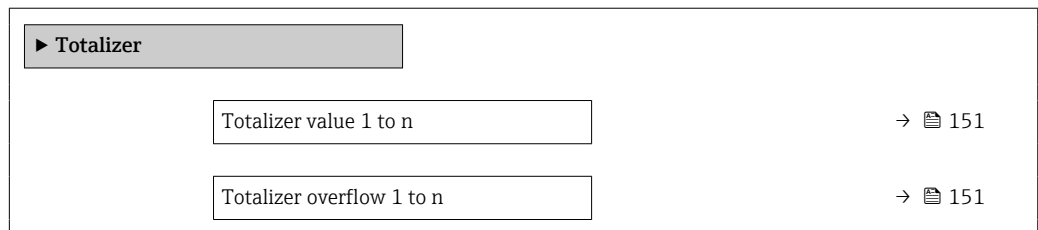

Parameter overview with brief description

| Parameter | Prerequisite | Description | User interface |
|---------------------------|--|---|------------------------------|
| Totalizer value 1 to n | A process variable is selected in the Assign process variable parameter (→ 131) of the Totalizer 1 to n submenu. | Displays the current totalizer counter value. | Signed floating-point number |
| Totalizer overflow 1 to n | A process variable is selected in the Assign process variable parameter (→ 131) of the Totalizer 1 to n submenu. | Displays the current totalizer overflow. | Integer with sign |

11.4.3 "Input values" submenu

The **Input values** submenu guides you systematically to the individual input values.

Navigation

"Diagnostics" menu → Measured values → Input values

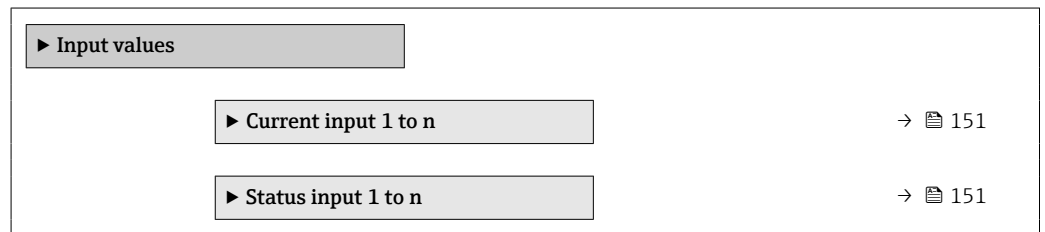

Input values of current input

The **Current input 1 to n** submenu contains all the parameters needed to display the current measured values for every current input.

Navigation

"Diagnostics" menu → Measured values → Input values → Current input 1 to n

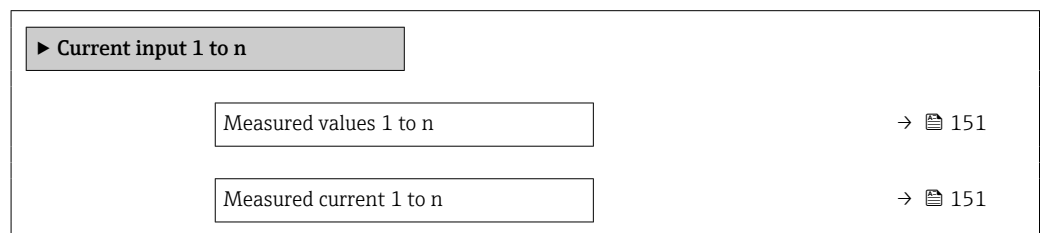

Parameter overview with brief description

| Parameter | Description | User interface |
|------------------|--|------------------------------|
| Measured values | Displays the current input value. | Signed floating-point number |
| Measured current | Displays the current value of the current input. | 0 to 22.5 mA |

Input values of status input

The **Status input 1 to n** submenu contains all the parameters needed to display the current measured values for every status input.

Navigation

"Diagnostics" menu → Measured values → Input values → Status input 1 to n

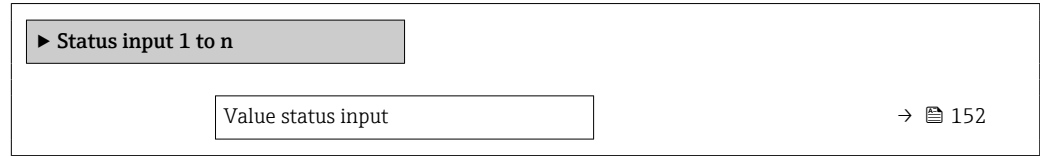

Parameter overview with brief description

| Parameter | Description | User interface |
|--------------------|---------------------------------------|---|
| Value status input | Shows the current input signal level. | <ul style="list-style-type: none"> ▪ High ▪ Low |

11.4.4 Output values

The **Output values** submenu contains all the parameters needed to display the current measured values for every output.

Navigation

"Diagnostics" menu → Measured values → Output values

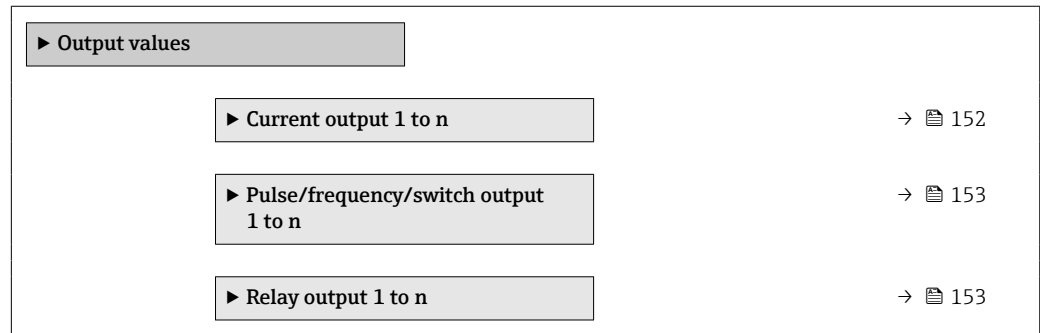

Output values of current output

The **Value current output** submenu contains all the parameters needed to display the current measured values for every current output.

Navigation

"Diagnostics" menu → Measured values → Output values → Value current output 1 to n

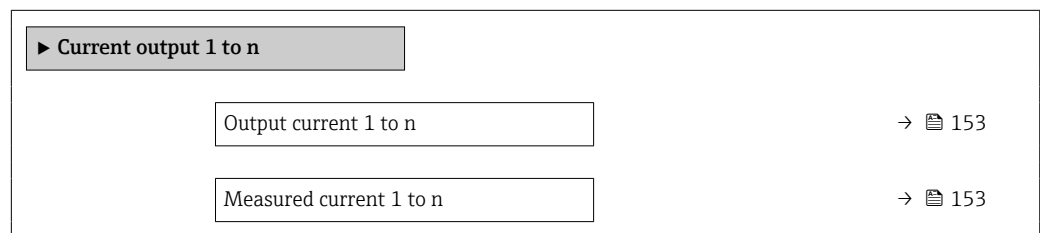

Parameter overview with brief description

| Parameter | Description | User interface |
|------------------|---|-----------------|
| Output current 1 | Displays the current value currently calculated for the current output. | 3.59 to 22.5 mA |
| Measured current | Displays the current value currently measured for the current output. | 0 to 30 mA |

Output values for pulse/frequency/switch output

The **Pulse/frequency/switch output 1 to n** submenu contains all the parameters needed to display the current measured values for every pulse/frequency/switch output.

Navigation

"Diagnostics" menu → Measured values → Output values → Pulse/frequency/switch output 1 to n

▶ **Pulse/frequency/switch output 1 to n**

| | |
|-------------------------|---------|
| Output frequency 1 to n | → ⓘ 153 |
| Pulse output 1 to n | → ⓘ 153 |
| Switch status 1 to n | → ⓘ 153 |

Parameter overview with brief description

| Parameter | Prerequisite | Description | User interface |
|------------------|---|---|--|
| Output frequency | In the Operating mode parameter, the Frequency option is selected. | Displays the value currently measured for the frequency output. | 0.0 to 12 500.0 Hz |
| Pulse output | The Pulse option is selected in the Operating mode parameter parameter. | Displays the pulse frequency currently output. | Positive floating-point number |
| Switch status | The Switch option is selected in the Operating mode parameter. | Displays the current switch output status. | <ul style="list-style-type: none"> ▪ Open ▪ Closed |

Output values for relay output

The **Relay output 1 to n** submenu contains all the parameters needed to display the current measured values for every relay output.

Navigation

"Diagnostics" menu → Measured values → Output values → Relay output 1 to n

▶ **Relay output 1 to n**



| | |
|---------------------------|---------|
| Switch status | → ⓘ 154 |
| Switch cycles | → ⓘ 154 |
| Max. switch cycles number | → ⓘ 154 |

Parameter overview with brief description

| Parameter | Description | User interface |
|---------------------------|---|--|
| Switch status | Shows the current relay switch status. | <ul style="list-style-type: none"> ▪ Open ▪ Closed |
| Switch cycles | Shows number of all performed switch cycles. | Positive integer |
| Max. switch cycles number | Shows the maximal number of guaranteed switch cycles. | Positive integer |

11.5 Adapting the measuring device to the process conditions

The following are available for this purpose:

- Basic settings using the **Setup** menu (→  96)
- Advanced settings using the **Advanced setup** submenu (→  122)





11.6 Performing a totalizer reset

The totalizers are reset in the **Operation** submenu:

- Control Totalizer
- Reset all totalizers

Navigation

"Operation" menu → Totalizer handling

| ► Totalizer handling | |
|--------------------------|---|
| Control Totalizer 1 to n | →  155 |
| Preset value 1 to n | →  155 |
| Totalizer value 1 to n | →  155 |
| Reset all totalizers | →  155 |

Parameter overview with brief description

| Parameter | Prerequisite | Description | Selection / User entry / User interface | Factory setting |
|--------------------------|--|---|--|--|
| Control Totalizer 1 to n | A process variable is selected in the Assign process variable parameter (→ 131) of the Totalizer 1 to n submenu. | Control totalizer value. | <ul style="list-style-type: none"> ■ Totalize ■ Reset + hold ■ Preset + hold ■ Reset + totalize ■ Preset + totalize ■ Hold | – |
| Preset value 1 to n | A process variable is selected in the Assign process variable parameter (→ 131) of the Totalizer 1 to n submenu. | Specify start value for totalizer. <i>Dependency</i>  The unit of the selected process variable is defined in the Unit totalizer parameter (→ 131) for the totalizer. | Signed floating-point number | Depends on country: <ul style="list-style-type: none"> ■ 0 kg ■ 0 lb |
| Totalizer value | A process variable is selected in the Assign process variable parameter (→ 131) of the Totalizer 1 to n submenu. | Displays the current totalizer counter value. | Signed floating-point number | – |
| Reset all totalizers | – | Reset all totalizers to 0 and start. | <ul style="list-style-type: none"> ■ Cancel ■ Reset + totalize | – |

11.6.1 Function scope of "Control Totalizer" parameter

| Options | Description |
|---------------------------------|---|
| Totalize | The totalizer is started or continues running. |
| Reset + hold | The totaling process is stopped and the totalizer is reset to 0. |
| Preset + hold ¹⁾ | The totaling process is stopped and the totalizer is set to its defined start value from the Preset value parameter. |
| Reset + totalize | The totalizer is reset to 0 and the totaling process is restarted. |
| Preset + totalize ¹⁾ | The totalizer is set to the defined start value in the Preset value parameter and the totaling process is restarted. |
| Hold | Totalizing is stopped. |



1) Visible depending on the order options or device settings

11.6.2 Function range of "Reset all totalizers" parameter

| Options | Description |
|------------------|---|
| Cancel | No action is executed and the user exits the parameter. |
| Reset + totalize | Resets all totalizers to 0 and restarts the totaling process. This deletes all the previously aggregated flow values. |

11.7 Displaying the measured value history

The **Extended HistoROM** application package must be enabled in the device (order option) for the **Data logging** submenu to appear. This contains all the parameters for the measured value history.

-  Data logging is also available via:
 - Plant Asset Management Tool FieldCare →  86.
 - Web browser

Function range

- A total of 1000 measured values can be stored
- 4 logging channels
- Adjustable logging interval for data logging
- Measured value trend for each logging channel displayed in the form of a chart

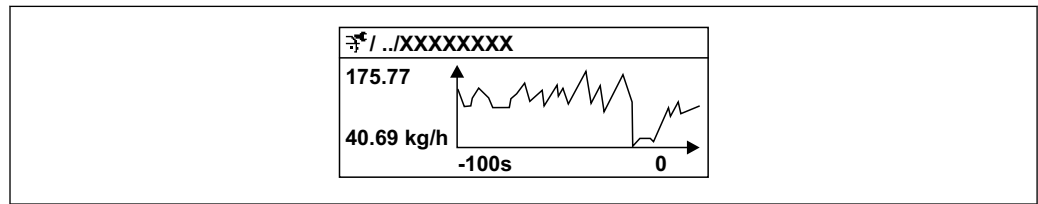

A0016357





 36 Chart of a measured value trend



- x-axis: depending on the number of channels selected displays 250 to 1000 measured values of a process variable.
 - y-axis: displays the approximate measured value span and constantly adapts this to the ongoing measurement.
-  If the length of the logging interval or the assignment of the process variables to the channels is changed, the content of the data logging is deleted.

Navigation





"Diagnostics" menu → Data logging



▶ Data logging

| | |
|----------------------|---|
| Assign channel 1 | →  157 |
| Assign channel 2 | →  157 |
| Assign channel 3 | →  157 |
| Assign channel 4 | →  158 |
| Logging interval | →  158 |
| Clear logging data | →  158 |
| Data logging | →  158 |
| Logging delay | →  158 |
| Data logging control | →  158 |

| | |
|-------------------------|---|
| Data logging status | →  158 |
| Entire logging duration | →  158 |
| ▶ Display channel 1 | |
| ▶ Display channel 2 | |
| ▶ Display channel 3 | |
| ▶ Display channel 4 | |

Parameter overview with brief description

| Parameter | Prerequisite | Description | Selection / User entry / User interface |
|------------------|--|---|---|
| Assign channel 1 | The Extended HistoROM application package is available. | Assign process variable to logging channel. | <ul style="list-style-type: none"> ■ Off ■ Mass flow ■ Volume flow ■ Corrected volume flow * ■ Density ■ Reference density * ■ Temperature ■ Concentration * ■ Target mass flow * ■ Carrier mass flow * ■ Oscillation amplitude ■ Current output 1 ■ Current output 2 * ■ Current output 3 * ■ Current output 4 * ■ HBSI * ■ Exciter current 0 ■ Oscillation damping ■ Oscillation damping fluctuation 0 * ■ Oscillation frequency 0 ■ Frequency fluctuation 0 * ■ Oscillation amplitude ■ Oscillation amplitude 1 * ■ Signal asymmetry ■ Carrier pipe temperature * ■ Electronic temperature |
| Assign channel 2 | The Extended HistoROM application package is available.  The software options currently enabled are displayed in the Software option overview parameter. | Assign a process variable to logging channel. | For the picklist, see Assign channel 1 parameter (→  157) |
| Assign channel 3 | The Extended HistoROM application package is available.  The software options currently enabled are displayed in the Software option overview parameter. | Assign a process variable to logging channel. | For the picklist, see Assign channel 1 parameter (→  157) |















| Parameter | Prerequisite | Description | Selection / User entry / User interface |
|-------------------------|--|--|---|
| Assign channel 4 | The Extended HistoROM application package is available.  The software options currently enabled are displayed in the Software option overview parameter. | Assign a process variable to logging channel. | For the picklist, see Assign channel 1 parameter (→  157) |
| Logging interval | The Extended HistoROM application package is available. | Define the logging interval for data logging. This value defines the time interval between the individual data points in the memory. | 0.1 to 999.0 s |
| Clear logging data | The Extended HistoROM application package is available. | Clear the entire logging data. | <ul style="list-style-type: none"> ▪ Cancel ▪ Clear data |
| Data logging | – | Select the type of data logging. | <ul style="list-style-type: none"> ▪ Overwriting ▪ Not overwriting |
| Logging delay | In the Data logging parameter, the Not overwriting option is selected. | Enter the time delay for measured value logging. | 0 to 999 h |
| Data logging control | In the Data logging parameter, the Not overwriting option is selected. | Start and stop measured value logging. | <ul style="list-style-type: none"> ▪ None ▪ Delete + start ▪ Stop |
| Data logging status | In the Data logging parameter, the Not overwriting option is selected. | Displays the measured value logging status. | <ul style="list-style-type: none"> ▪ Done ▪ Delay active ▪ Active ▪ Stopped |
| Entire logging duration | In the Data logging parameter, the Not overwriting option is selected. | Displays the total logging duration. | Positive floating-point number |

* Visibility depends on order options or device settings

12 Diagnostics and troubleshooting

12.1 General troubleshooting

For local display

| Error | Possible causes | Remedial action |
|---|---|--|
| Local display is dark, but signal output is within the valid range | The cable of the display module is not plugged in correctly. | Insert the plug correctly into the main electronics module and display module. |
| Local display dark and no output signals | Supply voltage does not match the voltage specified on the nameplate. | Apply the correct supply voltage →  54 →  48. |
| Local display dark and no output signals | Supply voltage has incorrect polarity. | Reverse polarity of supply voltage. |
| Local display dark and no output signals | No contact between connecting cables and terminals. | Ensure electrical contact between the cable and the terminal. |
| Local display dark and no output signals | <ul style="list-style-type: none"> ▪ Terminals are not plugged into the I/O electronics module correctly. ▪ Terminals are not plugged into the main electronics module correctly. | Check terminals. |
| Local display dark and no output signals | <ul style="list-style-type: none"> ▪ I/O electronics module is defective. ▪ Main electronics module is defective. | Order spare part →  203. |
| Local display dark and no output signals | The connector between the main electronics module and display module is not plugged in correctly. | Check the connection and correct if necessary. |
| Local display cannot be read, but signal output is within the valid range | Display is set too bright or too dark. | <ul style="list-style-type: none"> ▪ Set the display brighter by simultaneously pressing  + . ▪ Set the display darker by simultaneously pressing  + . |
| Local display is dark, but signal output is within the valid range | Display module is defective. | Order spare part →  203. |
| Backlighting of local display is red | Diagnostic event with "Alarm" diagnostic behavior has occurred. | Take remedial measures →  173 |
| Text on local display appears in a language that cannot be understood. | The selected operating language cannot be understood. | <ol style="list-style-type: none"> 1. Press  +  for 2 s ("home position"). 2. Press . 3. Configure the required language in the Display language parameter (→  134). |
| Message on local display: "Communication Error" "Check Electronics" | Communication between the display module and the electronics is interrupted. | <ul style="list-style-type: none"> ▪ Check the cable and the connector between the main electronics module and display module. ▪ Order spare part →  203. |

For output signals

| Error | Possible causes | Remedial action |
|---|--|---|
| Signal output outside the valid range | Main electronics module is defective. | Order spare part →  203. |
| Device shows correct value on local display, but signal output is incorrect, though in the valid range. | Parameter configuration error | Check and adjust parameter configuration. |
| Device measures incorrectly. | Configuration error or device is operated outside the application. | <ol style="list-style-type: none"> 1. Check and correct parameter configuration. 2. Observe limit values specified in the "Technical Data". |

For access

| Fault | Possible causes | Remedial action |
|--|---|--|
| Write access to parameters is not possible. | Hardware write protection is enabled. | Set the write protection switch on the main electronics module to the OFF position → ☰ 144. |
| Write access to parameters is not possible. | Current user role has limited access authorization. | 1. Check user role → ☰ 75. 2. Enter correct customer-specific access code → ☰ 75. |
| Connection via FOUNDATION Fieldbus is not possible. | Device plug is incorrectly connected. | Check the pin assignment of the device plugs . |
| Unable to connect to the web server. | Web server is disabled. | Using the "FieldCare" or "DeviceCare" operating tool, check whether the web server of the device is enabled, and enable it if necessary → ☰ 82. |
| | The Ethernet interface on the PC is incorrectly configured. | <ul style="list-style-type: none"> ▶ Check the properties of the Internet protocol (TCP/IP) → ☰ 78. ▶ Check the network settings with the IT manager. |
| Unable to connect to the web server. | The IP address on the PC is incorrectly configured. | Check the IP address: 192.168.1.212 → ☰ 78 |
| Unable to connect to the web server. | WLAN access data are incorrect. | <ul style="list-style-type: none"> ▪ Check WLAN network status. ▪ Log on to the device again using WLAN access data. ▪ Check that WLAN is enabled on the measuring instrument and operating unit → ☰ 78. |
| | WLAN communication is disabled. | – |
| Unable to connect to web server, FieldCare or DeviceCare. | WLAN network is not available. | <ul style="list-style-type: none"> ▪ Check if WLAN reception is present: LED on display module is lit blue. ▪ Check if WLAN connection is enabled: LED on display module flashes blue. ▪ Switch on instrument function. |
| Network connection not present or unstable | WLAN network is weak. | <ul style="list-style-type: none"> ▪ Operating unit outside reception range: Check network status on operating unit. ▪ To improve network performance, use an external WLAN antenna. |
| | Parallel WLAN and Ethernet communication | <ul style="list-style-type: none"> ▪ Check network settings. ▪ Temporarily enable only the WLAN as an interface. |
| Web browser frozen and operation no longer possible | Data transfer is active. | Wait until data transfer or current action is finished. |
| | Connection lost | <ul style="list-style-type: none"> ▶ Check cable connection and power supply. ▶ Refresh the web browser and restart if necessary. |
| Display of web browser content is difficult to read or incomplete. | Web browser version used is not optimal. | <ul style="list-style-type: none"> ▶ Use correct web browser version → ☰ 77. ▶ Empty the web browser cache. ▶ Restart the web browser. |
| | Unsuitable view settings. | Change the font size/display ratio of the Web browser. |
| Incomplete or no display of content in the web browser | <ul style="list-style-type: none"> ▪ JavaScript is not enabled. ▪ JavaScript cannot be enabled. | <ul style="list-style-type: none"> ▶ Enable JavaScript. ▶ Enter http://XXX.XXX.X.XX/servlet/basic.html as the IP address. |

| Fault | Possible causes | Remedial action |
|--|--|---|
| Operation with FieldCare or DeviceCare via service interface CDI-RJ45 (port 8000) is not possible. | Firewall of the PC or network is blocking communication. | Depending on the settings of the firewall used on the PC or in the network, the firewall must be adapted or disabled to allow FieldCare/ DeviceCare access. |
| Flashing the firmware with FieldCare or DeviceCare via service interface CDI-RJ45 (port 8000 or TFTP ports) is not possible. | Firewall of the PC or network is blocking communication. | Depending on the settings of the firewall used on the PC or in the network, the firewall must be adapted or disabled to allow FieldCare/ DeviceCare access. |

12.2 Diagnostic information via light emitting diodes

12.2.1 Transmitter

Proline 500 – digital

Different LEDs in the transmitter provide information on the device status.

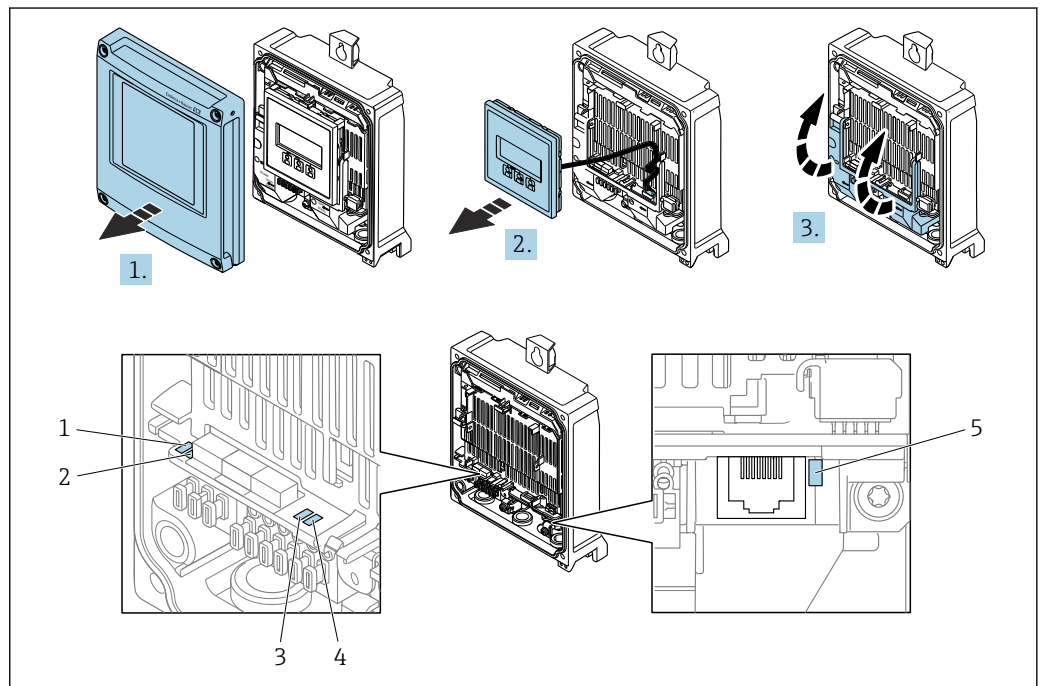

- 1 Supply voltage
- 2 Device status
- 3 Not used
- 4 Communication
- 5 Service interface (CDI) active

1. Open the housing cover.
2. Remove the display module.
3. Fold open the terminal cover.

| LED | Color | Meaning |
|------------------------------------|--------------|-----------------------------------|
| 1 Supply voltage | Green | Supply voltage is OK. |
| | Off | Supply voltage is off or too low. |
| 2 Device status (normal operation) | Red | Error |
| | Flashing red | Warning |

| LED | Color | Meaning |
|-----------------------------------|---------------------|---|
| 2 Device status (during start-up) | Flashes red slowly | If > 30 seconds: problem with the boot loader. |
| | Flashes red quickly | If > 30 seconds: compatibility problem when reading the firmware. |
| 3 Not used | – | – |
| 4 Communication | White | Communication active. |
| 5 Service interface (CDI) | Yellow | Connection established. |
| | Flashing yellow | Communication active. |
| | Off | No connection. |

Proline 500

Different LEDs in the transmitter provide information on the device status.

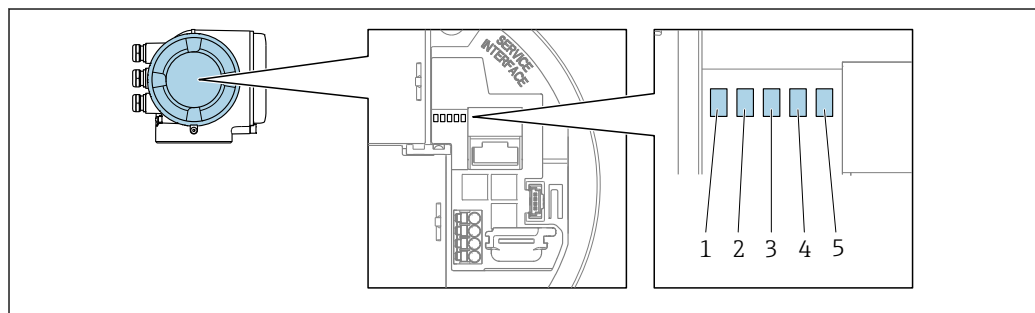

A0029629

- 1 Supply voltage
- 2 Device status
- 3 Not used
- 4 Communication
- 5 Service interface (CDI) active

| LED | Color | Meaning |
|------------------------------------|---------------------|---|
| 1 Supply voltage | Green | Supply voltage is OK. |
| | Off | Supply voltage is off or too low. |
| 2 Device status (normal operation) | Red | Error |
| | Flashing red | Warning |
| 2 Device status (during start-up) | Flashes red slowly | If > 30 seconds: problem with the boot loader. |
| | Flashes red quickly | If > 30 seconds: compatibility problem when reading the firmware. |
| 3 Not used | – | – |
| 4 Communication | White | Communication active. |
| 5 Service interface (CDI) | Yellow | Connection established. |
| | Flashing yellow | Communication active. |
| | Off | No connection. |

12.2.2 Sensor connection housing

Proline 500 – digital

Various light emitting diodes (LED) on the ISEM electronics unit (intelligent sensor electronics module) in the sensor connection housing provide information about the device status.

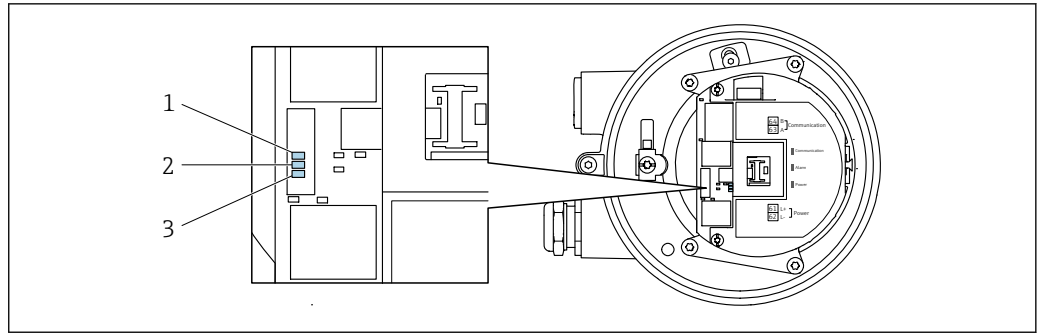

A0029699

- 1 *Communication*
- 2 *Device status*
- 3 *Supply voltage*

| LED | Color | Meaning |
|------------------------------------|---------------------|---|
| 1 Communication | White | Communication active. |
| 2 Device status (normal operation) | Red | Error |
| | Flashing red | Warning |
| 2 Device status (during start-up) | Flashes red slowly | If > 30 seconds: problem with the boot loader. |
| | Flashes red quickly | If > 30 seconds: compatibility problem when reading the firmware. |
| 3 Supply voltage | Green | Supply voltage is ok. |
| | Off | Supply voltage is off or too low. |

12.3 Diagnostic information on local display

12.3.1 Diagnostic message

Faults detected by the self-monitoring system of the measuring device are displayed as a diagnostic message in alternation with the operational display.

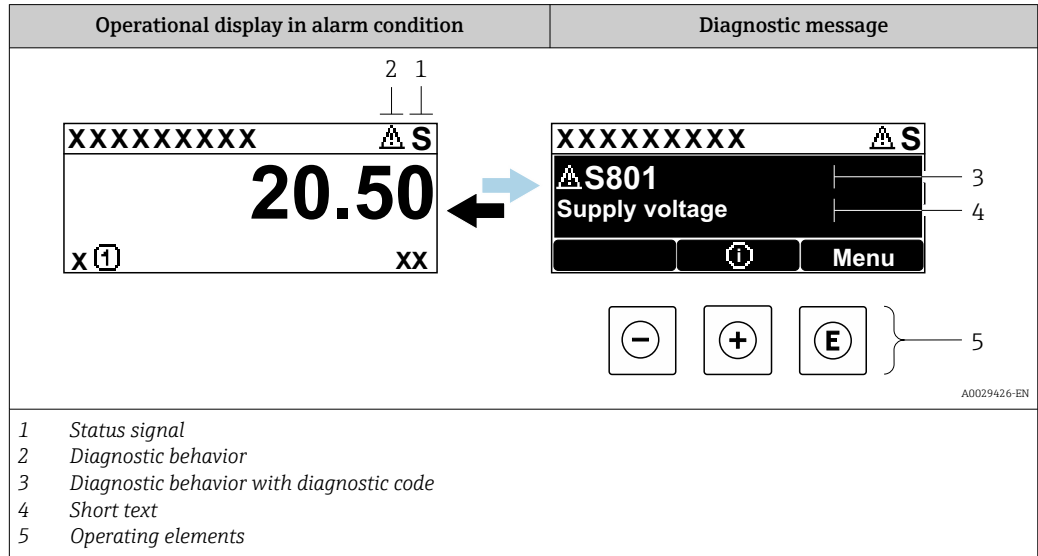

If two or more diagnostic events are pending simultaneously, only the message of the diagnostic event with the highest priority is shown.

- i** Other diagnostic events that have occurred can be displayed in the **Diagnostics** menu:
 - Via parameter → 194
 - Via submenus → 195



Status signals

The status signals provide information on the state and reliability of the device by categorizing the cause of the diagnostic information (diagnostic event).

- i** The status signals are categorized according to VDI/VDE 2650 and NAMUR Recommendation NE 107: F = Failure, C = Function Check, S = Out of Specification, M = Maintenance Required

| Symbol | Meaning |
|----------|---|
| F | Failure A device error has occurred. The measured value is no longer valid. |
| C | Function check The device is in service mode (e.g. during a simulation). |
| S | Out of specification The device is being operated: Outside its technical specification limits (e.g. outside the process temperature range) |
| M | Maintenance required Maintenance is required. The measured value remains valid. |

Diagnostic behavior



| Symbol | Meaning |
|---|---|
|  | Alarm <ul style="list-style-type: none"> Measurement is interrupted. Signal outputs and totalizers assume the defined alarm condition. A diagnostic message is generated. |
|  | Warning <ul style="list-style-type: none"> Measurement is resumed. The signal outputs and totalizers are not affected. A diagnostic message is generated. |

Diagnostic information

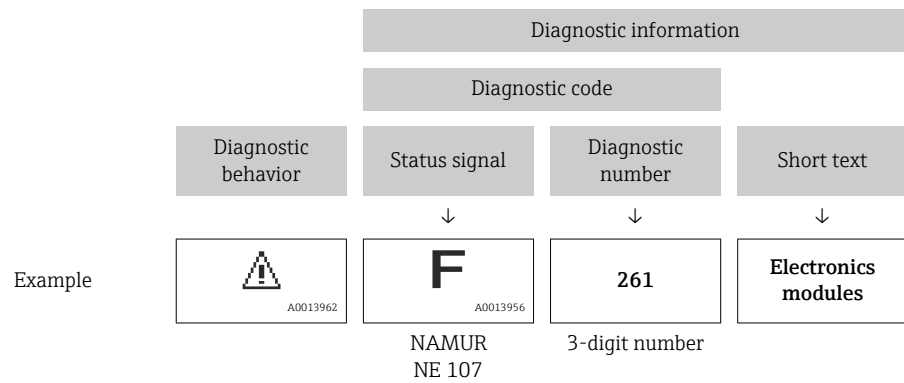
The fault can be identified using the diagnostic information. The short text helps you by providing information about the fault. In addition, the corresponding symbol for the diagnostic behavior is displayed in front of the diagnostic information on the local display.



Operating elements

| Operating key | Meaning |
|---|--|
|  | Plus key <i>In menu, submenu</i> Opens the message about the remedial measures. |
|  | Enter key <i>In menu, submenu</i> Opens the operating menu. |

12.3.2 Calling up remedial measures

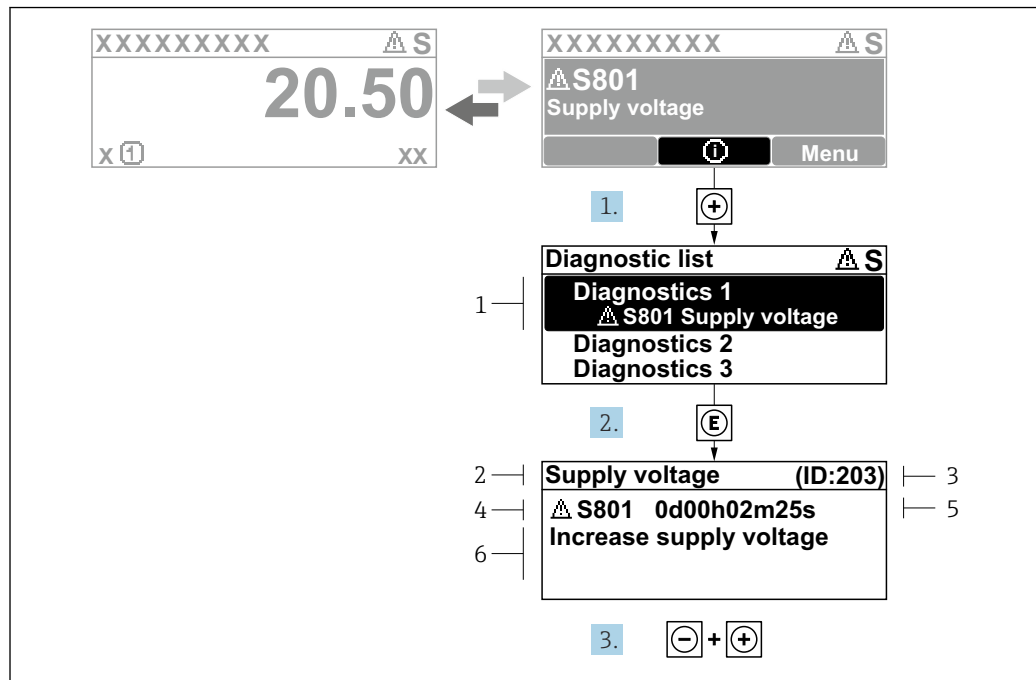

37 Message for remedial measures

- 1 Diagnostic information
- 2 Short text
- 3 Service ID
- 4 Diagnostic behavior with diagnostic code
- 5 Operation time when error occurred
- 6 Remedial measures

1. The user is in the diagnostic message.
Press \oplus (ⓘ symbol).
↳ The **Diagnostic list** submenu opens.
2. Select the desired diagnostic event with \oplus or \ominus and press \boxplus .
↳ The message about the remedial measures opens.
3. Press $\ominus + \oplus$ simultaneously.
↳ The message about the remedial measures closes.

The user is in the **Diagnostics** menu at an entry for a diagnostics event, e.g. in the **Diagnostic list** submenu or **Previous diagnostics** parameter.

1. Press \boxplus .
↳ The message for the remedial measures for the selected diagnostic event opens.
2. Press $\ominus + \oplus$ simultaneously.
↳ The message for the remedial measures closes.

12.4 Diagnostic information in the web browser

12.4.1 Diagnostic options

Any faults detected by the measuring device are displayed in the Web browser on the home page once the user has logged on.

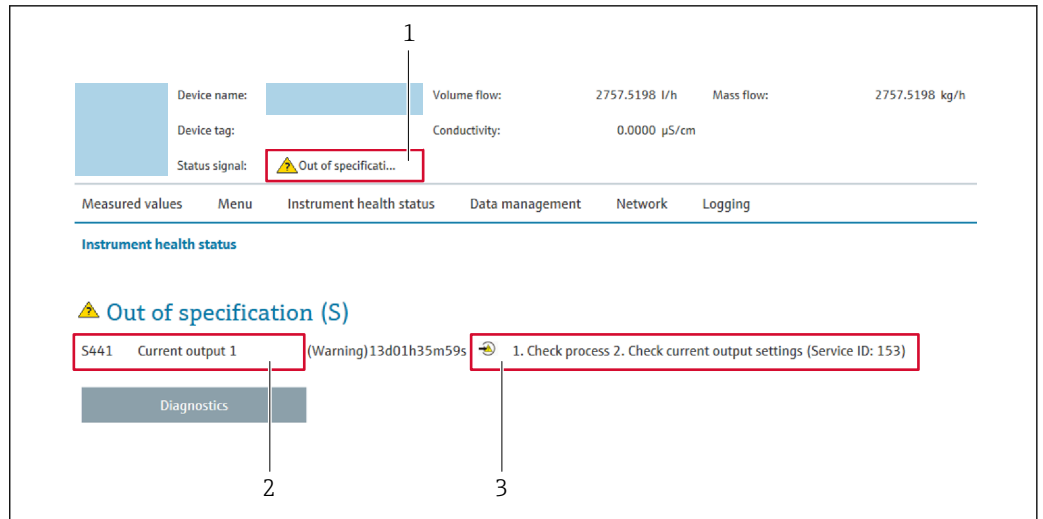

- 1 Status area with status signal
- 2 Diagnostic information
- 3 Remedial measures with service ID

i In addition, diagnostic events which have occurred can be shown in the **Diagnostics** menu:

- Via parameter → 194
- Via submenu → 195

Status signals

The status signals provide information on the state and reliability of the device by categorizing the cause of the diagnostic information (diagnostic event).

| Symbol | Meaning |
|--------|---|
| | Failure A device error has occurred. The measured value is no longer valid. |
| | Function check The device is in service mode (e.g. during a simulation). |
| | Out of specification The device is being operated: Outside its technical specification limits (e.g. outside the process temperature range) |
| | Maintenance required Maintenance is required. The measured value remains valid. |

i The status signals are categorized in accordance with VDI/VDE 2650 and NAMUR Recommendation NE 107.

12.4.2 Calling up remedy information

Remedy information is provided for every diagnostic event to ensure that problems can be rectified quickly. These measures are displayed in red along with the diagnostic event and the related diagnostic information.

12.5 Diagnostic information in FieldCare or DeviceCare

12.5.1 Diagnostic options

Any faults detected by the measuring device are displayed on the home page of the operating tool once the connection has been established.

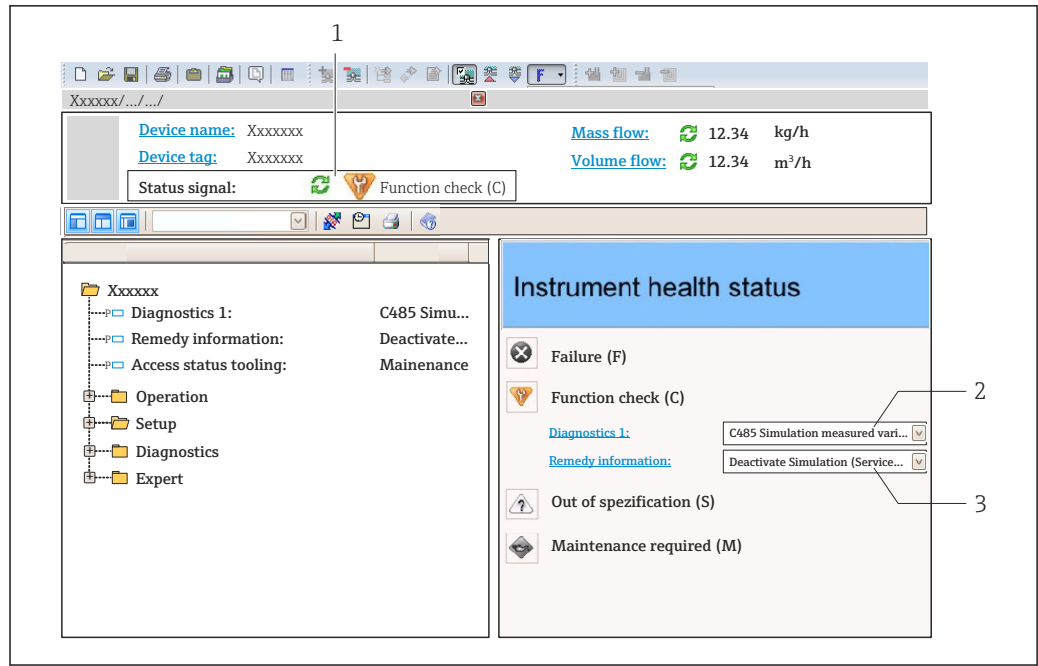

A0021799-EN

- 1 Status area with status signal → 164
- 2 Diagnostic information → 165
- 3 Remedial measures with service ID

i In addition, diagnostic events which have occurred can be shown in the **Diagnostics** menu:

- Via parameter → 194
- Via submenu → 195

Diagnostic information

The fault can be identified using the diagnostic information. The short text helps you by providing information about the fault. In addition, the corresponding symbol for the diagnostic behavior is displayed in front of the diagnostic information on the local display.

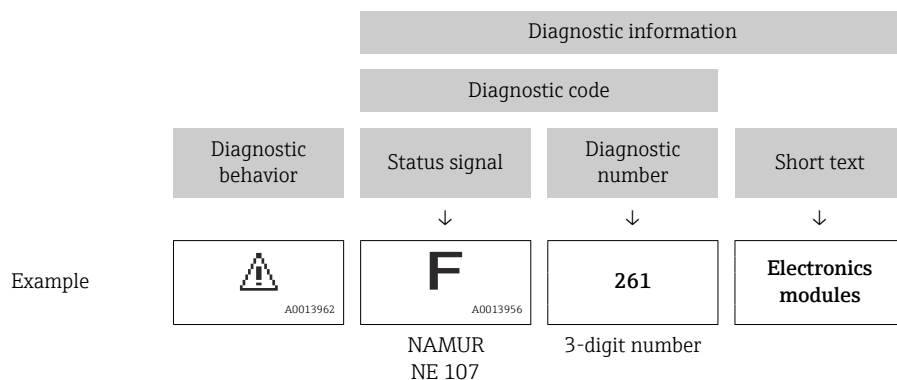

12.5.2 Calling up remedy information

Remedy information is provided for every diagnostic event to ensure that problems can be rectified quickly:

- On the home page
Remedy information is displayed in a separate field below the diagnostics information.
- In the **Diagnostics** menu
Remedy information can be called up in the working area of the user interface.

The user is in the **Diagnostics** menu.

1. Call up the desired parameter.
2. On the right in the working area, mouse over the parameter.
 - ↳ A tool tip with remedy information for the diagnostic event appears.

12.6 Adapting the diagnostic information

12.6.1 Adapting the diagnostic behavior

Each item of diagnostic information is assigned a specific diagnostic behavior at the factory. The user can change this assignment for specific diagnostic information in the **Diagnostic behavior** submenu.

Expert → System → Diagnostic handling → Diagnostic behavior

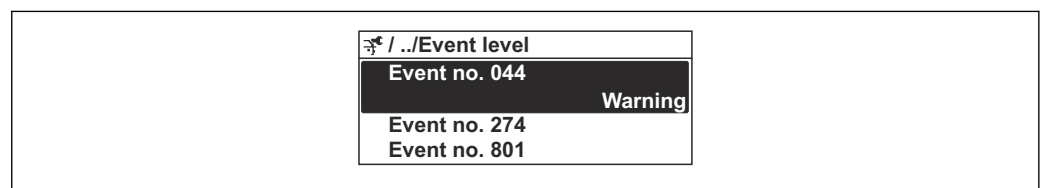

38 Using the example of the local display

You can assign the following options to the diagnostic number as the diagnostic behavior:

| Options | Description |
|--------------------|---|
| Alarm | The device stops measurement. The signal outputs and totalizers assume the defined alarm condition. A diagnostic message is generated. The background lighting changes to red. |
| Warning | The device continues to measure. The signal outputs and totalizers are not affected. A diagnostic message is generated. |
| Logbook entry only | The device continues to measure. The diagnostic message is only displayed in the Event logbook submenu (Event list submenu) and is not displayed in alternating sequence with the operational display. |
| Off | The diagnostic event is ignored, and no diagnostic message is generated or entered. |

12.6.2 Adapting the status signal

Each item of diagnostic information is assigned a specific status signal at the factory. The user can change this assignment for specific diagnostic information in the **Diagnostic event category** submenu.

Expert → Communication → Diagnostic event category

Available status signals

Configuration as per FOUNDATION Fieldbus Specification (FF912), in accordance with NAMUR NE107.

| Symbol | Meaning |
|-------------------------------------|---|
| F <small>A0013956</small> | Failure A device error has occurred. The measured value is no longer valid. |
| C <small>A0013959</small> | Function check The device is in service mode (e.g. during a simulation). |

| Symbol | Meaning |
|-------------------------------------|---|
| S <small>A0013958</small> | Out of specification The device is being operated: Outside its technical specification limits (e.g. outside the process temperature range) |
| M <small>A0013957</small> | Maintenance required Maintenance is required. The measured value remains valid. |

Enabling the configuration of the diagnostic information according to FF912

For compatibility reasons, the configuration of the diagnostic information according to FOUNDATION Fieldbus Specification FF912 is not enabled when the device is delivered from the factory.

Enabling the configuration of the diagnostic information according to FOUNDATION Fieldbus Specification FF912

1. Open the Resource block.
2. In **Feature Selection** parameter, select **Multi-bit Alarm (Bit-Alarm) Support** option.
 - ↳ The diagnostic information can be configured according to FOUNDATION Fieldbus Specification FF912.

Grouping the diagnostic information

Diagnostic information is assigned to different groups. The groups differ depending on the weighting (severity) of the diagnostic event:

- Highest weighting
- High weighting
- Low weighting

Assignment of the diagnostic information (factory setting)

The assignment of the diagnostic information ex-works is indicated in the following tables.

The individual ranges of the diagnostic information can be assigned to another status signal → [📄 171](#).

Some diagnostic information can be assigned individually, irrespective of their range → [📄 172](#).

 Overview and description of all diagnostic information → [📄 173](#)

| Weighting | Status signal (factory setting) | Allocation | Diagnostic information range |
|-----------|---------------------------------|---------------|------------------------------|
| Highest | Failure (F) | Sensor | F000 to 199 |
| | | Electronics | F200 to 399 |
| | | Configuration | F400 to 700 |
| | | Process | F800 to 999 |



| Weighting | Status signal (factory setting) | Allocation | Diagnostic information range |
|-----------|---------------------------------|---------------|------------------------------|
| High | Function check (C) | Sensor | C000 to 199 |
| | | Electronics | C200 to 399 |
| | | Configuration | C400 to 700 |
| | | Process | C800 to 999 |

| Weighting | Status signal (factory setting) | Allocation | Diagnostic information range |
|-----------|---------------------------------|---------------|------------------------------|
| Low | Out of specification (S) | Sensor | S000 to 199 |
| | | Electronics | S200 to 399 |
| | | Configuration | S400 to 700 |
| | | Process | S800 to 999 |

| Weighting | Status signal (factory setting) | Allocation | Diagnostic information range |
|-----------|---------------------------------|---------------|------------------------------|
| Low | Maintenance required (M) | Sensor | M000 to 199 |
| | | Electronics | M200 to 399 |
| | | Configuration | M400 to 700 |
| | | Process | M800 to 999 |

Changing the assignment of the diagnostic information

The individual ranges of the diagnostic information can be assigned to another status signal. This is done by changing the bit in the associated parameter. The bit change always applies for the entire range of the diagnostic information.

 Some diagnostic information can be assigned individually, irrespective of their range
 →  172

Each status signal has a parameter in the Resource Block in which it is possible to define the diagnostic event for which the status signal is transmitted:

- Failure (F): **FD_FAIL_MAP** parameter
- Function check (C): **FD_CHECK_MAP** parameter
- Out of specification (S): **FD_OFFSPEC_MAP** parameter
- Maintenance required (M): **FD_MAINT_MAP** parameter

Structure and assignment of the parameters for the status signals (factory setting)

| Weighting | Allocation | Bit | FD_FAIL_MAP | FD_CHECK_MAP | FD_OFFSPEC_MAP | FD_MAINT_MAP |
|-----------|---------------|-----|-------------|--------------|----------------|--------------|
| Highest | Sensor | 31 | 1 | 0 | 0 | 0 |
| | Electronics | 30 | 1 | 0 | 0 | 0 |
| | Configuration | 29 | 1 | 0 | 0 | 0 |
| | Process | 28 | 1 | 0 | 0 | 0 |
| High | Sensor | 27 | 0 | 1 | 0 | 0 |
| | Electronics | 26 | 0 | 1 | 0 | 0 |
| | Configuration | 25 | 0 | 1 | 0 | 0 |
| | Process | 24 | 0 | 1 | 0 | 0 |
| Low | Sensor | 23 | 0 | 0 | 1 | 0 |
| | Electronics | 22 | 0 | 0 | 1 | 0 |
| | Configuration | 21 | 0 | 0 | 1 | 0 |
| | Process | 20 | 0 | 0 | 1 | 0 |
| Low | Sensor | 19 | 0 | 0 | 0 | 1 |
| | Electronics | 18 | 0 | 0 | 0 | 1 |
| | Configuration | 17 | 0 | 0 | 0 | 1 |
| | Process | 16 | 0 | 0 | 0 | 1 |

| Weighting | Allocation | Bit | FD_FAIL_MAP | FD_CHECK_MAP | FD_OFFSPEC_MAP | FD_MAINT_MAP |
|--------------------------------|------------|---------|-------------|--------------|----------------|--------------|
| Configurable range → 172 | | 15 to 1 | 0 | 0 | 0 | 0 |
| Reserved (Fieldbus Foundation) | | 0 | 0 | 0 | 0 | 0 |

Changing the status signal for a range of diagnostic information

Example: The status signal for the diagnostic information for electronics with the "Highest" weighting is to be changed from failure (F) to function check (C).

1. Set the Resource Block to the **OOS** block mode.
2. Open the **FD_FAIL_MAP** parameter in the Resource Block.
3. Change **Bit 30** to **0** in the parameter.
4. Open the **FD_CHECK_MAP** parameter in the Resource Block.
5. Change **Bit 26** to **1** in the parameter.
 - ↳ If a diagnostic event occurs for electronics with the "Highest weighting", the diagnostic information to this effect is displayed with the function check (C) status signal.
6. Set the Resource Block to the **AUTO** block mode.

NOTICE

No status signal is assigned to an area of diagnostic information.

If a diagnostic event occurs in this area, no status signal is transmitted to the control system.

- ▶ If you are changing the parameters, make sure that a status signal is assigned to all areas.

 If FieldCare is used, the status signal is enabled and disabled using the check box of the particular parameter.

Assigning diagnostic information individually to a status signal

Some diagnostic information can be individually assigned to a status signal, irrespective of their original range.

Assigning diagnostic information individually to a status signal via FieldCare.

1. In the FieldCare navigation window: **Expert** → **Communication** → **Field diagnostics** → **Alarm detection enable**
2. Select the desired diagnostic information from one of the fields **Configurable Area Bits 1** to **Configurable Area Bits 15**.
3. Press Enter to confirm.
4. When selecting the desired status signal (e.g. Offspec Map), also select the **Configurable Area Bit 1** to **Configurable Area Bit 15** that was assigned previously to the diagnostic information (step 2).
5. Press Enter to confirm.
 - ↳ The diagnostic event of the selected diagnostic information is recorded.
6. In the FieldCare navigation window: **Expert** → **Communication** → **Field diagnostics** → **Alarm broadcast enable**
7. Select the desired diagnostic information from one of the fields **Configurable Area Bits 1** to **Configurable Area Bits 15**.
8. Press Enter to confirm.

9. When selecting the desired status signal (e.g. Offspec Map), also select the **Configurable Area Bit 1** to **Configurable Area Bit 15** that was assigned previously to the diagnostic information (step 7).
 10. Press Enter to confirm.
 - ↳ The selected diagnostic information is transmitted over the bus when a diagnostic event to this effect occurs.
-  A change in the status signal does not affect diagnostic information that already exists. The new status signal is only assigned if this error occurs again after the status signal has changed.

Transmitting the diagnostic information over the bus

Prioritizing diagnostic information for transmission over the bus

Diagnostic information is only transmitted over the bus if its priority is between 2 and 15. Priority 1-events are displayed but are not transmitted over the bus. Diagnostic information with priority 0 (factory setting) is ignored.



It is possible to change the priority individually for the different status signals. The following parameters of the Resource Block are used for this purpose:

- FD_FAIL_PRI
- FD_CHECK_PRI
- FD_OFFSPEC_PRI
- FD_MAINT_PRI

Suppressing certain diagnostic information

It is possible to suppress certain events during transmission over the bus using a mask. While these events are displayed they are not transmitted over the bus. This mask is in FieldCare **Expert** → **Communication** → **Field diagnostics** → **Alarm broadcast enable**. The mask is a negative selection mask, i.e. if a field is selected the associated diagnostic information is not transmitted over the bus.

12.7 Overview of diagnostic information

-  The amount of diagnostic information and the number of measured variables affected increase if the measuring device has one or more application packages.
 - All of the measured variables affected in the entire Promass instrument family are always listed under "Measured variables affected". The measured variables available for the device in question depend on the device version. When assigning the measured variables to the device functions, for example to the individual outputs, all of the measured variables available for the device version in question are available for selection.
-  In the case of some items of diagnostic information, the status signal and the diagnostic behavior can be changed. Change the diagnostic information →  169

12.7.1 Diagnostic of sensor

| Diagnostic information | | Remedy instructions | Influenced measured variables | |
|------------------------|--|--|--|----------------|
| No. | Short text | | | |
| 022 | Temperature sensor defective | <ol style="list-style-type: none"> 1. Check or replace sensor electronic module (ISEM) 2. If available: Check connection cable between sensor and transmitter 3. Replace sensor | <ul style="list-style-type: none"> ▪ Empty pipe detection option ▪ Low flow cut off option ▪ Switch output status option ▪ Pressure option | |
| | Measured variable status | | | |
| | Quality | | | Bad |
| | Quality substatus | | | Sensor failure |
| | | | | |
| | Status signal [from the factory] ¹⁾ | | | F |
| Diagnostic behavior | Alarm | | | |

1) Status signal can be changed.

| Diagnostic information | | Remedy instructions | Influenced measured variables | |
|--|--|---|--|--------------|
| No. | Short text | | | |
| 046 | Sensor limit exceeded | <ol style="list-style-type: none"> 1. Inspect sensor 2. Check process condition | <ul style="list-style-type: none"> ▪ Empty pipe detection option ▪ Low flow cut off option ▪ Switch output status option ▪ Pressure option | |
| | Measured variable status [from the factory] ¹⁾ | | | |
| | Quality | | | Good |
| | Quality substatus | | | Non specific |
| | | | | |
| | Status signal [from the factory] ²⁾ | | | S |
| Diagnostic behavior [from the factory] ³⁾ | Warning | | | |

1) Quality can be changed. This causes the overall status of the measured variable to change.

2) Status signal can be changed.

3) Diagnostic behavior can be changed.

| Diagnostic information | | Remedy instructions | Influenced measured variables | |
|------------------------|--|--|--|----------------|
| No. | Short text | | | |
| 062 | Sensor connection faulty | <ol style="list-style-type: none"> 1. Check or replace sensor electronic module (ISEM) 2. If available: Check connection cable between sensor and transmitter 3. Replace sensor | <ul style="list-style-type: none"> ▪ Empty pipe detection option ▪ Low flow cut off option ▪ Switch output status option ▪ Pressure option | |
| | Measured variable status | | | |
| | Quality | | | Bad |
| | Quality substatus | | | Sensor failure |
| | | | | |
| | Status signal [from the factory] ¹⁾ | | | F |
| Diagnostic behavior | Alarm | | | |

1) Status signal can be changed.

| Diagnostic information | | Remedy instructions | Influenced measured variables | | |
|------------------------|--|--|--|----------------|--|
| No. | Short text | | | | |
| 063 | Exciter current faulty | 1. Check or replace sensor electronic module (ISEM) 2. If available: Check connection cable between sensor and transmitter 3. Replace sensor | <ul style="list-style-type: none"> ▪ Empty pipe detection option ▪ Low flow cut off option | | |
| | Measured variable status | | | | |
| | Quality | | | Bad | |
| | Quality substatus | | | Sensor failure | |
| | Status signal [from the factory] ¹⁾ | | | S | |
| | Diagnostic behavior | | | Alarm | |

1) Status signal can be changed.

| Diagnostic information | | Remedy instructions | Influenced measured variables | | |
|------------------------|--|---|--|----------------|--|
| No. | Short text | | | | |
| 082 | Data storage | 1. Check module connections 2. Contact service | <ul style="list-style-type: none"> ▪ Empty pipe detection option ▪ Low flow cut off option ▪ Switch output status option ▪ Pressure option | | |
| | Measured variable status | | | | |
| | Quality | | | Bad | |
| | Quality substatus | | | Sensor failure | |
| | Status signal [from the factory] ¹⁾ | | | F | |
| | Diagnostic behavior | | | Alarm | |

1) Status signal can be changed.

| Diagnostic information | | Remedy instructions | Influenced measured variables | | |
|------------------------|--|---|--|----------------|--|
| No. | Short text | | | | |
| 083 | Memory content | 1. Restart device 2. Restore HistoROM S-DAT backup ('Device reset' parameter) 3. Replace HistoROM S-DAT | <ul style="list-style-type: none"> ▪ Empty pipe detection option ▪ Low flow cut off option ▪ Switch output status option ▪ Pressure option | | |
| | Measured variable status | | | | |
| | Quality | | | Bad | |
| | Quality substatus | | | Sensor failure | |
| | Status signal [from the factory] ¹⁾ | | | F | |
| | Diagnostic behavior | | | Alarm | |

1) Status signal can be changed.

| Diagnostic information | | Remedy instructions | Influenced measured variables | | |
|------------------------|--|--|--|--------------|--|
| No. | Short text | | | | |
| 140 | Sensor signal asymmetrical | 1. Check or replace sensor electronic module (ISEM) 2. If available: Check connection cable between sensor and transmitter 3. Replace sensor | <ul style="list-style-type: none"> ▪ Empty pipe detection option ▪ Low flow cut off option ▪ Switch output status option ▪ Pressure option | | |
| | Measured variable status [from the factory] ¹⁾ | | | | |
| | Quality | | | Good | |
| | Quality substatus | | | Non specific | |
| | Status signal [from the factory] ²⁾ | | | S | |
| | Diagnostic behavior [from the factory] ³⁾ | | | Alarm | |

1) Quality can be changed. This causes the overall status of the measured variable to change.

2) Status signal can be changed.

3) Diagnostic behavior can be changed.

| Diagnostic information | | Remedy instructions | Influenced measured variables | |
|--|--|--|--|--------------|
| No. | Short text | | | |
| 144 | Measuring error too high | 1. Check or change sensor 2. Check process conditions | <ul style="list-style-type: none"> ▪ Empty pipe detection option ▪ Low flow cut off option ▪ Switch output status option ▪ Pressure option | |
| | Measured variable status [from the factory] ¹⁾ | | | |
| | Quality | | | Good |
| | Quality substatus | | | Non specific |
| | | | | |
| | Status signal [from the factory] ²⁾ | | | F |
| Diagnostic behavior [from the factory] ³⁾ | Alarm | | | |

1) Quality can be changed. This causes the overall status of the measured variable to change.

2) Status signal can be changed.

3) Diagnostic behavior can be changed.

12.7.2 Diagnostic of electronic

| Diagnostic information | | Remedy instructions | Influenced measured variables | |
|------------------------|--|---|--|----------------|
| No. | Short text | | | |
| 201 | Device failure | 1. Restart device 2. Contact service | <ul style="list-style-type: none"> ▪ Empty pipe detection option ▪ Low flow cut off option ▪ Switch output status option ▪ Pressure option | |
| | Measured variable status | | | |
| | Quality | | | Bad |
| | Quality substatus | | | Device failure |
| | | | | |
| | Status signal [from the factory] ¹⁾ | | | F |
| Diagnostic behavior | Alarm | | | |

1) Status signal can be changed.

| Diagnostic information | | Remedy instructions | Influenced measured variables | |
|------------------------|--|---|--|----------------|
| No. | Short text | | | |
| 242 | Software incompatible | 1. Check software 2. Flash or change main electronics module | <ul style="list-style-type: none"> ▪ Empty pipe detection option ▪ Low flow cut off option ▪ Switch output status option ▪ Pressure option | |
| | Measured variable status | | | |
| | Quality | | | Bad |
| | Quality substatus | | | Device failure |
| | | | | |
| | Status signal [from the factory] ¹⁾ | | | F |
| Diagnostic behavior | Alarm | | | |

1) Status signal can be changed.

| Diagnostic information | | Remedy instructions | Influenced measured variables | |
|------------------------|--|---|--|----------------|
| No. | Short text | | | |
| 252 | Modules incompatible | 1. Check electronic modules 2. Change electronic modules | <ul style="list-style-type: none"> ▪ Empty pipe detection option ▪ Low flow cut off option ▪ Switch output status option ▪ Pressure option | |
| | Measured variable status | | | |
| | Quality | | | Bad |
| | Quality substatus | | | Device failure |
| | Status signal [from the factory] ¹⁾ F | | | |
| | Diagnostic behavior | | | Alarm |

1) Status signal can be changed.

| Diagnostic information | | Remedy instructions | Influenced measured variables | |
|------------------------|--|---|--|----------------|
| No. | Short text | | | |
| 262 | Sensor electronic connection faulty | 1. Check or replace connection cable between sensor electronic module (ISEM) and main electronics 2. Check or replace ISEM or main electronics | <ul style="list-style-type: none"> ▪ Empty pipe detection option ▪ Low flow cut off option ▪ Pressure option | |
| | Measured variable status | | | |
| | Quality | | | Bad |
| | Quality substatus | | | Device failure |
| | Status signal [from the factory] ¹⁾ F | | | |
| | Diagnostic behavior | | | Alarm |

1) Status signal can be changed.

| Diagnostic information | | Remedy instructions | Influenced measured variables | |
|------------------------|--|-------------------------------|--|----------------|
| No. | Short text | | | |
| 270 | Main electronic failure | Change main electronic module | <ul style="list-style-type: none"> ▪ Empty pipe detection option ▪ Low flow cut off option ▪ Switch output status option ▪ Pressure option | |
| | Measured variable status | | | |
| | Quality | | | Bad |
| | Quality substatus | | | Device failure |
| | Status signal [from the factory] ¹⁾ F | | | |
| | Diagnostic behavior | | | Alarm |

1) Status signal can be changed.

| Diagnostic information | | Remedy instructions | Influenced measured variables | |
|------------------------|--|---|--|----------------|
| No. | Short text | | | |
| 271 | Main electronic failure | 1. Restart device 2. Change main electronic module | <ul style="list-style-type: none"> ▪ Empty pipe detection option ▪ Low flow cut off option ▪ Switch output status option ▪ Pressure option | |
| | Measured variable status | | | |
| | Quality | | | Bad |
| | Quality substatus | | | Device failure |
| | Status signal [from the factory] ¹⁾ F | | | |
| | Diagnostic behavior | | | Alarm |

1) Status signal can be changed.

| Diagnostic information | | Remedy instructions | Influenced measured variables | |
|------------------------|--|---|--|----------------|
| No. | Short text | | | |
| 272 | Main electronic failure | 1. Restart device 2. Contact service | <ul style="list-style-type: none"> ▪ Empty pipe detection option ▪ Low flow cut off option ▪ Switch output status option ▪ Pressure option | |
| | Measured variable status | | | |
| | Quality | | | Bad |
| | Quality substatus | | | Device failure |
| | | | | |
| | Status signal [from the factory] ¹⁾ | | | F |
| Diagnostic behavior | Alarm | | | |

1) Status signal can be changed.

| Diagnostic information | | Remedy instructions | Influenced measured variables | |
|------------------------|--|---------------------|--|----------------|
| No. | Short text | | | |
| 273 | Main electronic failure | Change electronic | <ul style="list-style-type: none"> ▪ Empty pipe detection option ▪ Low flow cut off option ▪ Switch output status option ▪ Pressure option | |
| | Measured variable status | | | |
| | Quality | | | Bad |
| | Quality substatus | | | Device failure |
| | | | | |
| | Status signal [from the factory] ¹⁾ | | | F |
| Diagnostic behavior | Alarm | | | |

1) Status signal can be changed.

| Diagnostic information | | Remedy instructions | Influenced measured variables | |
|------------------------|--|---------------------|--|----------------|
| No. | Short text | | | |
| 275 | I/O module 1 to n defective | Change I/O module | <ul style="list-style-type: none"> ▪ Empty pipe detection option ▪ Low flow cut off option ▪ Switch output status option ▪ Pressure option | |
| | Measured variable status | | | |
| | Quality | | | Bad |
| | Quality substatus | | | Device failure |
| | | | | |
| | Status signal [from the factory] ¹⁾ | | | F |
| Diagnostic behavior | Alarm | | | |

1) Status signal can be changed.

| Diagnostic information | | Remedy instructions | Influenced measured variables | |
|------------------------|--|---|--|--------------|
| No. | Short text | | | |
| 276 | I/O module 1 to n faulty | 1. Restart device 2. Change I/O module | <ul style="list-style-type: none"> ▪ Empty pipe detection option ▪ Low flow cut off option ▪ Switch output status option ▪ Pressure option | |
| | Measured variable status | | | |
| | Quality | | | Uncertain |
| | Quality substatus | | | Non specific |
| | | | | |
| | Status signal [from the factory] ¹⁾ | | | F |
| Diagnostic behavior | Alarm | | | |

1) Status signal can be changed.

| Diagnostic information | | Remedy instructions | Influenced measured variables | |
|------------------------|--|---|--|----------------|
| No. | Short text | | | |
| 276 | I/O module 1 to n faulty | 1. Restart device 2. Change I/O module | <ul style="list-style-type: none"> ▪ Empty pipe detection option ▪ Low flow cut off option ▪ Switch output status option ▪ Pressure option | |
| | Measured variable status | | | |
| | Quality | | | Bad |
| | Quality substatus | | | Device failure |
| | Status signal [from the factory] ¹⁾ | | | |
| | Diagnostic behavior | | | Alarm |

1) Status signal can be changed.

| Diagnostic information | | Remedy instructions | Influenced measured variables | |
|------------------------|--|---------------------------------------|--|----------------|
| No. | Short text | | | |
| 283 | Memory content | 1. Reset device 2. Contact service | <ul style="list-style-type: none"> ▪ Empty pipe detection option ▪ Low flow cut off option ▪ Switch output status option ▪ Pressure option | |
| | Measured variable status | | | |
| | Quality | | | Bad |
| | Quality substatus | | | Device failure |
| | Status signal [from the factory] ¹⁾ | | | |
| | Diagnostic behavior | | | Alarm |

1) Status signal can be changed.

| Diagnostic information | | Remedy instructions | Influenced measured variables | |
|------------------------|--|--|--|----------------|
| No. | Short text | | | |
| 302 | Device verification active | Device verification active, please wait. | <ul style="list-style-type: none"> ▪ Empty pipe detection option ▪ Low flow cut off option ▪ Switch output status option ▪ Pressure option | |
| | Measured variable status | | | |
| | Quality | | | Bad |
| | Quality substatus | | | Device failure |
| | Status signal [from the factory] ¹⁾ | | | |
| | Diagnostic behavior | | | Warning |

1) Status signal can be changed.

| Diagnostic information | | Remedy instructions | Influenced measured variables | |
|------------------------|--|--|--|----------------|
| No. | Short text | | | |
| 311 | Electronic failure | 1. Do not reset device 2. Contact service | <ul style="list-style-type: none"> ▪ Empty pipe detection option ▪ Low flow cut off option ▪ Switch output status option ▪ Pressure option | |
| | Measured variable status | | | |
| | Quality | | | Bad |
| | Quality substatus | | | Device failure |
| | Status signal [from the factory] ¹⁾ | | | |
| | Diagnostic behavior | | | Warning |

1) Status signal can be changed.

| Diagnostic information | | Remedy instructions | Influenced measured variables | |
|------------------------|--|--|--|----------------|
| No. | Short text | | | |
| 332 | Writing in embedded HistoROM failed | Replace user interface board Ex d/XP: replace transmitter | <ul style="list-style-type: none"> ▪ Empty pipe detection option ▪ Low flow cut off option ▪ Switch output status option ▪ Pressure option | |
| | Measured variable status | | | |
| | Quality | | | Bad |
| | Quality substatus | | | Device failure |
| | | | | |
| | Status signal [from the factory] ¹⁾ | | | F |
| Diagnostic behavior | Alarm | | | |

1) Status signal can be changed.

| Diagnostic information | | Remedy instructions | Influenced measured variables | |
|------------------------|--|---|--|----------------|
| No. | Short text | | | |
| 361 | I/O module 1 to n faulty | <ol style="list-style-type: none"> 1. Restart device 2. Check electronic modules 3. Change I/O Modul or main electronics | <ul style="list-style-type: none"> ▪ Empty pipe detection option ▪ Low flow cut off option ▪ Switch output status option ▪ Pressure option | |
| | Measured variable status | | | |
| | Quality | | | Bad |
| | Quality substatus | | | Device failure |
| | | | | |
| | Status signal [from the factory] ¹⁾ | | | F |
| Diagnostic behavior | Alarm | | | |

1) Status signal can be changed.

| Diagnostic information | | Remedy instructions | Influenced measured variables | |
|------------------------|--|---|--|----------------|
| No. | Short text | | | |
| 372 | Sensor electronic (ISEM) faulty | <ol style="list-style-type: none"> 1. Restart device 2. Check if failure recurs 3. Replace sensor electronic module (ISEM) | <ul style="list-style-type: none"> ▪ Empty pipe detection option ▪ Low flow cut off option ▪ Switch output status option ▪ Pressure option | |
| | Measured variable status | | | |
| | Quality | | | Bad |
| | Quality substatus | | | Device failure |
| | | | | |
| | Status signal [from the factory] ¹⁾ | | | F |
| Diagnostic behavior | Alarm | | | |

1) Status signal can be changed.

| Diagnostic information | | Remedy instructions | Influenced measured variables | |
|------------------------|--|--|--|----------------|
| No. | Short text | | | |
| 373 | Sensor electronic (ISEM) faulty | <ol style="list-style-type: none"> 1. Transfer data or reset device 2. Contact service | <ul style="list-style-type: none"> ▪ Empty pipe detection option ▪ Low flow cut off option ▪ Switch output status option ▪ Pressure option | |
| | Measured variable status | | | |
| | Quality | | | Bad |
| | Quality substatus | | | Device failure |
| | | | | |
| | Status signal [from the factory] ¹⁾ | | | F |
| Diagnostic behavior | Alarm | | | |

1) Status signal can be changed.

| Diagnostic information | | Remedy instructions | Influenced measured variables | |
|--|--|---|--|--------------|
| No. | Short text | | | |
| 374 | Sensor electronic (ISEM) faulty | 1. Restart device 2. Check if failure recurs 3. Replace sensor electronic module (ISEM) | <ul style="list-style-type: none"> ▪ Empty pipe detection option ▪ Low flow cut off option ▪ Switch output status option ▪ Pressure option | |
| | Measured variable status [from the factory] ¹⁾ | | | |
| | Quality | | | Good |
| | Quality substatus | | | Non specific |
| | Status signal [from the factory] ²⁾ | | | S |
| Diagnostic behavior [from the factory] ³⁾ | Warning | | | |

- 1) Quality can be changed. This causes the overall status of the measured variable to change.
- 2) Status signal can be changed.
- 3) Diagnostic behavior can be changed.

| Diagnostic information | | Remedy instructions | Influenced measured variables | |
|------------------------|--|--|--|----------------|
| No. | Short text | | | |
| 375 | I/O- 1 to n communication failed | 1. Restart device 2. Check if failure recurs 3. Replace module rack inclusive electronic modules | <ul style="list-style-type: none"> ▪ Empty pipe detection option ▪ Low flow cut off option ▪ Switch output status option ▪ Pressure option | |
| | Measured variable status | | | |
| | Quality | | | Bad |
| | Quality substatus | | | Device failure |
| | Status signal [from the factory] ¹⁾ | | | F |
| Diagnostic behavior | Alarm | | | |

- 1) Status signal can be changed.

| Diagnostic information | | Remedy instructions | Influenced measured variables | |
|------------------------|--|-------------------------------------|---|----------------|
| No. | Short text | | | |
| 382 | Data storage | 1. Insert T-DAT 2. Replace T-DAT | <ul style="list-style-type: none"> ▪ Empty pipe detection option ▪ Low flow cut off option ▪ Pressure option | |
| | Measured variable status | | | |
| | Quality | | | Bad |
| | Quality substatus | | | Device failure |
| | Status signal [from the factory] ¹⁾ | | | F |
| Diagnostic behavior | Alarm | | | |

- 1) Status signal can be changed.

| Diagnostic information | | Remedy instructions | Influenced measured variables | |
|------------------------|--|---|--|----------------|
| No. | Short text | | | |
| 383 | Memory content | 1. Restart device 2. Delete T-DAT via 'Reset device' parameter 3. Replace T-DAT | <ul style="list-style-type: none"> ▪ Empty pipe detection option ▪ Low flow cut off option ▪ Switch output status option ▪ Pressure option | |
| | Measured variable status | | | |
| | Quality | | | Bad |
| | Quality substatus | | | Device failure |
| | Status signal [from the factory] ¹⁾ | | | F |
| Diagnostic behavior | Alarm | | | |

- 1) Status signal can be changed.

| Diagnostic information | | Remedy instructions | Influenced measured variables | |
|------------------------|--|------------------------------|--|----------------|
| No. | Short text | | | |
| 387 | Embedded HistoROM failed | Contact service organization | <ul style="list-style-type: none"> ▪ Empty pipe detection option ▪ Low flow cut off option ▪ Switch output status option ▪ Pressure option | |
| | Measured variable status | | | |
| | Quality | | | Bad |
| | Quality substatus | | | Device failure |
| | | | | |
| | Status signal [from the factory] ¹⁾ | | | F |
| Diagnostic behavior | Alarm | | | |

1) Status signal can be changed.

12.7.3 Diagnostic of configuration

| Diagnostic information | | Remedy instructions | Influenced measured variables | |
|------------------------|--|---|-------------------------------|--------------|
| No. | Short text | | | |
| 303 | I/O 1 to n configuration changed | <ol style="list-style-type: none"> 1. Apply I/O module configuration (parameter 'Apply I/O configuration') 2. Afterwards reload device description and check wiring | - | |
| | Measured variable status | | | |
| | Quality | | | Good |
| | Quality substatus | | | Non specific |
| | | | | |
| | Status signal [from the factory] ¹⁾ | | | M |
| Diagnostic behavior | Warning | | | |

1) Status signal can be changed.

| Diagnostic information | | Remedy instructions | Influenced measured variables | |
|------------------------|--|---|--|---------------------|
| No. | Short text | | | |
| 330 | Flash file invalid | <ol style="list-style-type: none"> 1. Update firmware of device 2. Restart device | <ul style="list-style-type: none"> ▪ Empty pipe detection option ▪ Low flow cut off option ▪ Switch output status option ▪ Pressure option | |
| | Measured variable status | | | |
| | Quality | | | Bad |
| | Quality substatus | | | Configuration error |
| | | | | |
| | Status signal [from the factory] ¹⁾ | | | M |
| Diagnostic behavior | Warning | | | |

1) Status signal can be changed.

| Diagnostic information | | Remedy instructions | Influenced measured variables | |
|------------------------|--|---|--|---------------------|
| No. | Short text | | | |
| 331 | Firmware update failed | <ol style="list-style-type: none"> 1. Update firmware of device 2. Restart device | <ul style="list-style-type: none"> ▪ Empty pipe detection option ▪ Low flow cut off option ▪ Switch output status option ▪ Pressure option | |
| | Measured variable status | | | |
| | Quality | | | Bad |
| | Quality substatus | | | Configuration error |
| | | | | |
| | Status signal [from the factory] ¹⁾ | | | F |
| Diagnostic behavior | Warning | | | |

1) Status signal can be changed.

| Diagnostic information | | Remedy instructions | Influenced measured variables | | |
|------------------------|--|---|--|---------------------|--|
| No. | Short text | | | | |
| 410 | Data transfer | 1. Check connection 2. Retry data transfer | <ul style="list-style-type: none"> ▪ Empty pipe detection option ▪ Low flow cut off option ▪ Switch output status option ▪ Pressure option | | |
| | Measured variable status | | | | |
| | Quality | | | Bad | |
| | Quality substatus | | | Configuration error | |
| | Status signal [from the factory] ¹⁾ | | | F | |
| | Diagnostic behavior | | | Alarm | |

1) Status signal can be changed.

| Diagnostic information | | Remedy instructions | Influenced measured variables | | |
|------------------------|--|------------------------------|--|--------------|--|
| No. | Short text | | | | |
| 412 | Processing download | Download active, please wait | <ul style="list-style-type: none"> ▪ Empty pipe detection option ▪ Low flow cut off option ▪ Switch output status option ▪ Pressure option | | |
| | Measured variable status | | | | |
| | Quality | | | Uncertain | |
| | Quality substatus | | | Non specific | |
| | Status signal [from the factory] ¹⁾ | | | C | |
| | Diagnostic behavior | | | Warning | |

1) Status signal can be changed.

| Diagnostic information | | Remedy instructions | Influenced measured variables | | |
|------------------------|--|---------------------|-------------------------------|--------------|--|
| No. | Short text | | | | |
| 431 | Trim 1 to n | Carry out trim | - | | |
| | Measured variable status | | | | |
| | Quality | | | Good | |
| | Quality substatus | | | Non specific | |
| | Status signal [from the factory] ¹⁾ | | | C | |
| | Diagnostic behavior | | | Warning | |

1) Status signal can be changed.

| Diagnostic information | | Remedy instructions | Influenced measured variables | | |
|------------------------|--|---|--|---------------------|--|
| No. | Short text | | | | |
| 437 | Configuration incompatible | 1. Restart device 2. Contact service | <ul style="list-style-type: none"> ▪ Empty pipe detection option ▪ Low flow cut off option ▪ Switch output status option ▪ Pressure option | | |
| | Measured variable status | | | | |
| | Quality | | | Bad | |
| | Quality substatus | | | Configuration error | |
| | Status signal [from the factory] ¹⁾ | | | F | |
| | Diagnostic behavior | | | Alarm | |

1) Status signal can be changed.

| Diagnostic information | | Remedy instructions | Influenced measured variables | |
|------------------------|--|--|--|--------------|
| No. | Short text | | | |
| 438 | Dataset | 1. Check data set file 2. Check device configuration 3. Up- and download new configuration | <ul style="list-style-type: none"> ■ Empty pipe detection option ■ Low flow cut off option ■ Switch output status option ■ Pressure option | |
| | Measured variable status | | | |
| | Quality | | | Uncertain |
| | Quality substatus | | | Non specific |
| | | | | |
| | Status signal [from the factory] ¹⁾ | | | M |
| Diagnostic behavior | Warning | | | |

1) Status signal can be changed.

| Diagnostic information | | Remedy instructions | Influenced measured variables | |
|--|--|--|-------------------------------|--------------|
| No. | Short text | | | |
| 441 | Current output 1 to n | 1. Check process 2. Check current output settings | - | |
| | Measured variable status | | | |
| | Quality | | | Good |
| | Quality substatus | | | Non specific |
| | | | | |
| | Status signal [from the factory] ¹⁾ | | | S |
| Diagnostic behavior [from the factory] ²⁾ | Warning | | | |

1) Status signal can be changed.

2) Diagnostic behavior can be changed.

| Diagnostic information | | Remedy instructions | Influenced measured variables | |
|--|--|--|-------------------------------|--------------|
| No. | Short text | | | |
| 442 | Frequency output 1 to n | 1. Check process 2. Check frequency output settings | - | |
| | Measured variable status | | | |
| | Quality | | | Good |
| | Quality substatus | | | Non specific |
| | | | | |
| | Status signal [from the factory] ¹⁾ | | | S |
| Diagnostic behavior [from the factory] ²⁾ | Warning | | | |

1) Status signal can be changed.

2) Diagnostic behavior can be changed.

| Diagnostic information | | Remedy instructions | Influenced measured variables | |
|--|--|--|-------------------------------|--------------|
| No. | Short text | | | |
| 443 | Pulse output 1 to n | 1. Check process 2. Check pulse output settings | - | |
| | Measured variable status | | | |
| | Quality | | | Good |
| | Quality substatus | | | Non specific |
| | Status signal [from the factory] ¹⁾ | | | S |
| Diagnostic behavior [from the factory] ²⁾ | Warning | | | |

- 1) Status signal can be changed.
- 2) Diagnostic behavior can be changed.

| Diagnostic information | | Remedy instructions | Influenced measured variables | |
|--|--|---|-------------------------------|--------------|
| No. | Short text | | | |
| 444 | Current input 1 to n | 1. Check process 2. Check current input settings | - | |
| | Measured variable status | | | |
| | Quality | | | Good |
| | Quality substatus | | | Non specific |
| | Status signal [from the factory] ¹⁾ | | | S |
| Diagnostic behavior [from the factory] ²⁾ | Warning | | | |

- 1) Status signal can be changed.
- 2) Diagnostic behavior can be changed.

| Diagnostic information | | Remedy instructions | Influenced measured variables | |
|------------------------|--|--------------------------|--|--------------|
| No. | Short text | | | |
| 453 | Flow override | Deactivate flow override | <ul style="list-style-type: none"> ▪ Empty pipe detection option ▪ Low flow cut off option ▪ Switch output status option ▪ Pressure option | |
| | Measured variable status | | | |
| | Quality | | | Good |
| | Quality substatus | | | Non specific |
| | Status signal [from the factory] ¹⁾ | | | C |
| Diagnostic behavior | Warning | | | |

- 1) Status signal can be changed.

| Diagnostic information | | Remedy instructions | Influenced measured variables | |
|------------------------|--|--|--|---------------------|
| No. | Short text | | | |
| 463 | Analog input 1 to n selection invalid | 1. Check module/channel configuration 2. Check I/O module configuration | <ul style="list-style-type: none"> ▪ Empty pipe detection option ▪ Low flow cut off option ▪ Switch output status option ▪ Pressure option | |
| | Measured variable status | | | |
| | Quality | | | Bad |
| | Quality substatus | | | Configuration error |
| | | | | |
| | Status signal [from the factory] ¹⁾ | | | F |
| Diagnostic behavior | Alarm | | | |

1) Status signal can be changed.

| Diagnostic information | | Remedy instructions | Influenced measured variables | |
|------------------------|--|-----------------------|--|---------------------|
| No. | Short text | | | |
| 484 | Failure mode simulation | Deactivate simulation | <ul style="list-style-type: none"> ▪ Empty pipe detection option ▪ Low flow cut off option ▪ Switch output status option ▪ Pressure option | |
| | Measured variable status | | | |
| | Quality | | | Bad |
| | Quality substatus | | | Configuration error |
| | | | | |
| | Status signal [from the factory] ¹⁾ | | | C |
| Diagnostic behavior | Alarm | | | |

1) Status signal can be changed.

| Diagnostic information | | Remedy instructions | Influenced measured variables | |
|------------------------|--|-----------------------|--|--------------|
| No. | Short text | | | |
| 485 | Measured variable simulation | Deactivate simulation | <ul style="list-style-type: none"> ▪ Empty pipe detection option ▪ Low flow cut off option ▪ Switch output status option ▪ Pressure option | |
| | Measured variable status | | | |
| | Quality | | | Good |
| | Quality substatus | | | Non specific |
| | | | | |
| | Status signal [from the factory] ¹⁾ | | | C |
| Diagnostic behavior | Warning | | | |

1) Status signal can be changed.

| Diagnostic information | | Remedy instructions | Influenced measured variables | |
|------------------------|--|-----------------------|-------------------------------|--------------|
| No. | Short text | | | |
| 486 | Current input 1 to n simulation | Deactivate simulation | - | |
| | Measured variable status | | | |
| | Quality | | | Good |
| | Quality substatus | | | Non specific |
| | | | | |
| | Status signal [from the factory] ¹⁾ | | | C |
| Diagnostic behavior | Warning | | | |

1) Status signal can be changed.

| Diagnostic information | | Remedy instructions | Influenced measured variables | |
|------------------------|--|-----------------------|-------------------------------|--------------|
| No. | Short text | | | |
| 491 | Current output 1 to n simulation | Deactivate simulation | - | |
| | Measured variable status | | | |
| | Quality | | | Good |
| | Quality substatus | | | Non specific |
| | | | | |
| | Status signal [from the factory] ¹⁾ | | | C |
| Diagnostic behavior | Warning | | | |

1) Status signal can be changed.

| Diagnostic information | | Remedy instructions | Influenced measured variables | |
|------------------------|--|--|-------------------------------|--------------|
| No. | Short text | | | |
| 492 | Simulation frequency output 1 to n | Deactivate simulation frequency output | - | |
| | Measured variable status | | | |
| | Quality | | | Good |
| | Quality substatus | | | Non specific |
| | | | | |
| | Status signal [from the factory] ¹⁾ | | | C |
| Diagnostic behavior | Warning | | | |

1) Status signal can be changed.

| Diagnostic information | | Remedy instructions | Influenced measured variables | |
|------------------------|--|------------------------------------|-------------------------------|--------------|
| No. | Short text | | | |
| 493 | Simulation pulse output 1 to n | Deactivate simulation pulse output | - | |
| | Measured variable status | | | |
| | Quality | | | Good |
| | Quality substatus | | | Non specific |
| | | | | |
| | Status signal [from the factory] ¹⁾ | | | C |
| Diagnostic behavior | Warning | | | |

1) Status signal can be changed.

| Diagnostic information | | Remedy instructions | Influenced measured variables | |
|------------------------|--|-------------------------------------|-------------------------------|--------------|
| No. | Short text | | | |
| 494 | Switch output simulation 1 to n | Deactivate simulation switch output | - | |
| | Measured variable status | | | |
| | Quality | | | Good |
| | Quality substatus | | | Non specific |
| | | | | |
| | Status signal [from the factory] ¹⁾ | | | C |
| Diagnostic behavior | Warning | | | |

1) Status signal can be changed.

| Diagnostic information | | Remedy instructions | Influenced measured variables | |
|------------------------|--|-----------------------|-------------------------------|--------------|
| No. | Short text | | | |
| 495 | Diagnostic event simulation | Deactivate simulation | – | |
| | Measured variable status | | | |
| | Quality | | | Good |
| | Quality substatus | | | Non specific |
| | | | | |
| | Status signal [from the factory] ¹⁾ | | | C |
| Diagnostic behavior | Warning | | | |

1) Status signal can be changed.

| Diagnostic information | | Remedy instructions | Influenced measured variables | |
|------------------------|--|------------------------------------|-------------------------------|--------------|
| No. | Short text | | | |
| 496 | Status input simulation | Deactivate simulation status input | – | |
| | Measured variable status | | | |
| | Quality | | | Good |
| | Quality substatus | | | Non specific |
| | | | | |
| | Status signal [from the factory] ¹⁾ | | | C |
| Diagnostic behavior | Warning | | | |

1) Status signal can be changed.

| Diagnostic information | | Remedy instructions | Influenced measured variables | |
|------------------------|--|-----------------------|-------------------------------|--------------|
| No. | Short text | | | |
| 497 | Simulation block output | Deactivate simulation | – | |
| | Measured variable status | | | |
| | Quality | | | Good |
| | Quality substatus | | | Non specific |
| | | | | |
| | Status signal [from the factory] ¹⁾ | | | C |
| Diagnostic behavior | Warning | | | |

1) Status signal can be changed.

| Diagnostic information | | Remedy instructions | Influenced measured variables | |
|------------------------|--|---|-------------------------------|--------------|
| No. | Short text | | | |
| 520 | I/O 1 to n hardware configuration invalid | <ol style="list-style-type: none"> 1. Check I/O hardware configuration 2. Replace wrong I/O module 3. Plug the module of double pulse output on correct slot | – | |
| | Measured variable status | | | |
| | Quality | | | Good |
| | Quality substatus | | | Non specific |
| | | | | |
| | Status signal [from the factory] ¹⁾ | | | F |
| Diagnostic behavior | Alarm | | | |

1) Status signal can be changed.

| Diagnostic information | | Remedy instructions | Influenced measured variables | |
|------------------------|--|--|-------------------------------|--------------|
| No. | Short text | | | |
| 537 | Configuration | 1. Check IP addresses in network 2. Change IP address | - | |
| | Measured variable status | | | |
| | Quality | | | Good |
| | Quality substatus | | | Non specific |
| | Status signal [from the factory] ¹⁾ F | | | |
| | Diagnostic behavior | | | Warning |

1) Status signal can be changed.

| Diagnostic information | | Remedy instructions | Influenced measured variables | |
|------------------------|--|-------------------------------------|-------------------------------|--------------|
| No. | Short text | | | |
| 594 | Relay output simulation | Deactivate simulation switch output | - | |
| | Measured variable status | | | |
| | Quality | | | Good |
| | Quality substatus | | | Non specific |
| | Status signal [from the factory] ¹⁾ C | | | |
| | Diagnostic behavior | | | Warning |

1) Status signal can be changed.

12.7.4 Diagnostic of process

| Diagnostic information | | Remedy instructions | Influenced measured variables | |
|------------------------|--|---|-------------------------------|--------------|
| No. | Short text | | | |
| 803 | Current loop 1 to n | 1. Check wiring 2. Change I/O module | - | |
| | Measured variable status | | | |
| | Quality | | | Good |
| | Quality substatus | | | Non specific |
| | Status signal [from the factory] ¹⁾ F | | | |
| | Diagnostic behavior | | | Alarm |

1) Status signal can be changed.

| Diagnostic information | | Remedy instructions | Influenced measured variables | |
|--|--|--|--|--------------|
| No. | Short text | | | |
| 830 | Sensor temperature too high | Reduce ambient temp. around the sensor housing | <ul style="list-style-type: none"> ▪ Empty pipe detection option ▪ Low flow cut off option ▪ Switch output status option ▪ Pressure option | |
| | Measured variable status [from the factory] ¹⁾ | | | |
| | Quality | | | Good |
| | Quality substatus | | | Non specific |
| | | | | |
| | Status signal [from the factory] ²⁾ | | | S |
| Diagnostic behavior [from the factory] ³⁾ | Warning | | | |

- 1) Quality can be changed. This causes the overall status of the measured variable to change.
 2) Status signal can be changed.
 3) Diagnostic behavior can be changed.

| Diagnostic information | | Remedy instructions | Influenced measured variables | |
|--|--|--|--|--------------|
| No. | Short text | | | |
| 831 | Sensor temperature too low | Increase ambient temp. around the sensor housing | <ul style="list-style-type: none"> ▪ Empty pipe detection option ▪ Low flow cut off option ▪ Switch output status option ▪ Pressure option | |
| | Measured variable status [from the factory] ¹⁾ | | | |
| | Quality | | | Good |
| | Quality substatus | | | Non specific |
| | | | | |
| | Status signal [from the factory] ²⁾ | | | S |
| Diagnostic behavior [from the factory] ³⁾ | Warning | | | |

- 1) Quality can be changed. This causes the overall status of the measured variable to change.
 2) Status signal can be changed.
 3) Diagnostic behavior can be changed.

| Diagnostic information | | Remedy instructions | Influenced measured variables | |
|--|--|----------------------------|--|--------------|
| No. | Short text | | | |
| 832 | Electronic temperature too high | Reduce ambient temperature | <ul style="list-style-type: none"> ▪ Empty pipe detection option ▪ Low flow cut off option ▪ Switch output status option ▪ Pressure option | |
| | Measured variable status [from the factory] ¹⁾ | | | |
| | Quality | | | Good |
| | Quality substatus | | | Non specific |
| | | | | |
| | Status signal [from the factory] ²⁾ | | | S |
| Diagnostic behavior [from the factory] ³⁾ | Warning | | | |

- 1) Quality can be changed. This causes the overall status of the measured variable to change.
 2) Status signal can be changed.
 3) Diagnostic behavior can be changed.

| Diagnostic information | | Remedy instructions | Influenced measured variables | |
|--|--|------------------------------|--|--------------|
| No. | Short text | | | |
| 833 | Electronic temperature too low | Increase ambient temperature | <ul style="list-style-type: none"> ▪ Empty pipe detection option ▪ Low flow cut off option ▪ Switch output status option ▪ Pressure option | |
| | Measured variable status [from the factory] ¹⁾ | | | |
| | Quality | | | Good |
| | Quality substatus | | | Non specific |
| | | | | |
| | Status signal [from the factory] ²⁾ | | | S |
| Diagnostic behavior [from the factory] ³⁾ | Warning | | | |

- 1) Quality can be changed. This causes the overall status of the measured variable to change.
- 2) Status signal can be changed.
- 3) Diagnostic behavior can be changed.

| Diagnostic information | | Remedy instructions | Influenced measured variables | |
|--|--|----------------------------|--|--------------|
| No. | Short text | | | |
| 834 | Process temperature too high | Reduce process temperature | <ul style="list-style-type: none"> ▪ Empty pipe detection option ▪ Low flow cut off option ▪ Switch output status option ▪ Pressure option | |
| | Measured variable status [from the factory] ¹⁾ | | | |
| | Quality | | | Good |
| | Quality substatus | | | Non specific |
| | | | | |
| | Status signal [from the factory] ²⁾ | | | S |
| Diagnostic behavior [from the factory] ³⁾ | Warning | | | |

- 1) Quality can be changed. This causes the overall status of the measured variable to change.
- 2) Status signal can be changed.
- 3) Diagnostic behavior can be changed.

| Diagnostic information | | Remedy instructions | Influenced measured variables | |
|--|--|------------------------------|--|--------------|
| No. | Short text | | | |
| 835 | Process temperature too low | Increase process temperature | <ul style="list-style-type: none"> ▪ Empty pipe detection option ▪ Low flow cut off option ▪ Switch output status option ▪ Pressure option | |
| | Measured variable status [from the factory] ¹⁾ | | | |
| | Quality | | | Good |
| | Quality substatus | | | Non specific |
| | | | | |
| | Status signal [from the factory] ²⁾ | | | S |
| Diagnostic behavior [from the factory] ³⁾ | Warning | | | |

- 1) Quality can be changed. This causes the overall status of the measured variable to change.
- 2) Status signal can be changed.
- 3) Diagnostic behavior can be changed.

| Diagnostic information | | Remedy instructions | Influenced measured variables | |
|------------------------|--|---|--|--------------|
| No. | Short text | | | |
| 842 | Process limit | Low flow cut off active! 1. Check low flow cut off configuration | <ul style="list-style-type: none"> ▪ Empty pipe detection option ▪ Low flow cut off option ▪ Switch output status option ▪ Pressure option | |
| | Measured variable status | | | |
| | Quality | | | Good |
| | Quality substatus | | | Non specific |
| | | | | |
| | Status signal [from the factory] ¹⁾ | | | S |
| Diagnostic behavior | Warning | | | |

1) Status signal can be changed.

| Diagnostic information | | Remedy instructions | Influenced measured variables | |
|------------------------|--|--------------------------|--|--------------|
| No. | Short text | | | |
| 843 | Process limit | Check process conditions | <ul style="list-style-type: none"> ▪ Empty pipe detection option ▪ Low flow cut off option ▪ Switch output status option ▪ Pressure option | |
| | Measured variable status | | | |
| | Quality | | | Good |
| | Quality substatus | | | Non specific |
| | | | | |
| | Status signal [from the factory] ¹⁾ | | | S |
| Diagnostic behavior | Alarm | | | |

1) Status signal can be changed.

| Diagnostic information | | Remedy instructions | Influenced measured variables | |
|--|--|---|-------------------------------|--------------|
| No. | Short text | | | |
| 862 | Partly filled pipe | 1. Check for gas in process 2. Adjust detection limits | - | |
| | Measured variable status [from the factory] ¹⁾ | | | |
| | Quality | | | Good |
| | Quality substatus | | | Non specific |
| | | | | |
| | Status signal [from the factory] ²⁾ | | | S |
| Diagnostic behavior [from the factory] ³⁾ | Warning | | | |

1) Quality can be changed. This causes the overall status of the measured variable to change.

2) Status signal can be changed.

3) Diagnostic behavior can be changed.

| Diagnostic information | | Remedy instructions | Influenced measured variables | |
|------------------------|--|--|-------------------------------|--------------|
| No. | Short text | | | |
| 882 | Input signal | 1. Check input configuration 2. Check external device or process conditions | - | |
| | Measured variable status | | | |
| | Quality | | | Bad |
| | Quality substatus | | | Non specific |
| | | | | |
| | Status signal [from the factory] ¹⁾ | | | F |
| Diagnostic behavior | Alarm | | | |

1) Status signal can be changed.

| Diagnostic information | | Remedy instructions | Influenced measured variables | |
|------------------------|--|--|--|--------------|
| No. | Short text | | | |
| 910 | Tubes not oscillating | 1. Check electronic 2. Inspect sensor | <ul style="list-style-type: none"> ▪ Empty pipe detection option ▪ Low flow cut off option ▪ Switch output status option ▪ Pressure option | |
| | Measured variable status | | | |
| | Quality | | | Bad |
| | Quality substatus | | | Non specific |
| | Status signal [from the factory] ¹⁾ | | | F |
| | Diagnostic behavior | | | Alarm |

1) Status signal can be changed.

| Diagnostic information | | Remedy instructions | Influenced measured variables | |
|------------------------|--|---|--|--------------|
| No. | Short text | | | |
| 912 | Medium inhomogeneous | 1. Check process cond. 2. Increase system pressure | <ul style="list-style-type: none"> ▪ Empty pipe detection option ▪ Low flow cut off option ▪ Switch output status option ▪ Pressure option | |
| | Measured variable status [from the factory] ¹⁾ | | | |
| | Quality | | | Good |
| | Quality substatus | | | Non specific |
| | Status signal [from the factory] ²⁾ | | | S |
| | Diagnostic behavior [from the factory] ³⁾ | | | Warning |

1) Quality can be changed. This causes the overall status of the measured variable to change.

2) Status signal can be changed.

3) Diagnostic behavior can be changed.

| Diagnostic information | | Remedy instructions | Influenced measured variables | |
|------------------------|--|--|--|--------------|
| No. | Short text | | | |
| 913 | Medium unsuitable | 1. Check process conditions 2. Check electronic modules or sensor | <ul style="list-style-type: none"> ▪ Empty pipe detection option ▪ Low flow cut off option ▪ Switch output status option ▪ Pressure option | |
| | Measured variable status [from the factory] ¹⁾ | | | |
| | Quality | | | Good |
| | Quality substatus | | | Non specific |
| | Status signal [from the factory] ²⁾ | | | S |
| | Diagnostic behavior [from the factory] ³⁾ | | | Warning |

1) Quality can be changed. This causes the overall status of the measured variable to change.

2) Status signal can be changed.

3) Diagnostic behavior can be changed.

| Diagnostic information | | Remedy instructions | Influenced measured variables | |
|--|--|---|--|--------------|
| No. | Short text | | | |
| 944 | Monitoring failed | Check process conditions for Heartbeat Monitoring | <ul style="list-style-type: none"> ▪ Empty pipe detection option ▪ Low flow cut off option ▪ Switch output status option ▪ Pressure option | |
| | Measured variable status [from the factory] ¹⁾ | | | |
| | Quality | | | Good |
| | Quality substatus | | | Non specific |
| | | | | |
| | Status signal [from the factory] ²⁾ | | | S |
| Diagnostic behavior [from the factory] ³⁾ | Warning | | | |





- 1) Quality can be changed. This causes the overall status of the measured variable to change.
- 2) Status signal can be changed.
- 3) Diagnostic behavior can be changed.



| Diagnostic information | | Remedy instructions | Influenced measured variables | |
|--|--|--------------------------|--|--------------|
| No. | Short text | | | |
| 948 | Oscillation damping too high | Check process conditions | <ul style="list-style-type: none"> ▪ Empty pipe detection option ▪ Low flow cut off option ▪ Switch output status option ▪ Pressure option | |
| | Measured variable status [from the factory] ¹⁾ | | | |
| | Quality | | | Good |
| | Quality substatus | | | Non specific |
| | | | | |
| | Status signal [from the factory] ²⁾ | | | S |
| Diagnostic behavior [from the factory] ³⁾ | Warning | | | |

- 1) Quality can be changed. This causes the overall status of the measured variable to change.
- 2) Status signal can be changed.
- 3) Diagnostic behavior can be changed.

12.8 Pending diagnostic events



The **Diagnostics** menu allows the user to view the current diagnostic event and the previous diagnostic event separately.



-  To call up the measures to rectify a diagnostic event:
 - Via local display →  166
 - Via web browser →  167
 - Via "FieldCare" operating tool →  168
 - Via "DeviceCare" operating tool →  168

-  Other pending diagnostic events can be displayed in the **Diagnostic list** submenu →  195.

Navigation

"Diagnostics" menu

| | |
|--|---|
|  Diagnostics | |
| Actual diagnostics | →  195 |
| Previous diagnostics | →  195 |

| | |
|-----------------------------|---|
| Operating time from restart | →  195 |
| Operating time | →  195 |

Parameter overview with brief description

| Parameter | Prerequisite | Description | User interface |
|-----------------------------|--|--|--|
| Actual diagnostics | A diagnostic event has occurred. | Shows the current occurred diagnostic event along with its diagnostic information.  If two or more messages occur simultaneously, the message with the highest priority is shown on the display. | Symbol for diagnostic behavior, diagnostic code and short message. |
| Previous diagnostics | Two diagnostic events have already occurred. | Shows the diagnostic event that occurred prior to the current diagnostic event along with its diagnostic information. | Symbol for diagnostic behavior, diagnostic code and short message. |
| Operating time from restart | – | Shows the time the device has been in operation since the last device restart. | Days (d), hours (h), minutes (m) and seconds (s) |
| Operating time | – | Indicates how long the device has been in operation. | Days (d), hours (h), minutes (m) and seconds (s) |

12.9 Diagnostic messages in the DIAGNOSTIC Transducer Block

- The **Actual diagnostics** parameter (**actual diagnostics**) displays the message with the highest priority.
- A list of the active alarms can be viewed via the **Diagnostics 1** parameter (**diagnostics_1**) to Diagnostics 5 (**diagnostics 5**). If more than 5 messages are pending, the messages with the highest priority are shown on the display.
- You can view the last alarm that is no longer active via the **Previous diagnostics** parameter (**previous_diagnostics**).

12.10 Diagnostics list

Up to 5 currently pending diagnostic events can be displayed in the **Diagnostic list** submenu along with the associated diagnostic information. If more than 5 diagnostic events are pending, the events with the highest priority are shown on the display.

Navigation path

Diagnostics → Diagnostic list

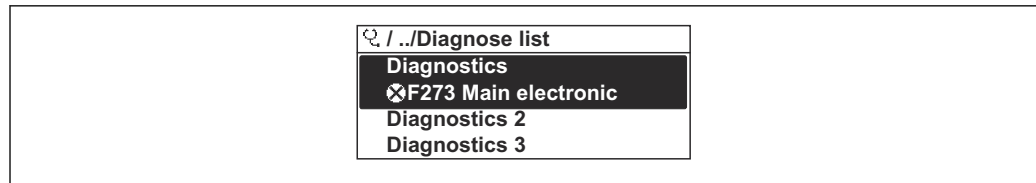

A0014006-EN

39 Using the example of the local display

To call up the measures to rectify a diagnostic event:

- Via local display → 166
- Via web browser → 167
- Via "FieldCare" operating tool → 168
- Via "DeviceCare" operating tool → 168

12.11 Event logbook

12.11.1 Reading out the event logbook

A chronological overview of the event messages that have occurred is provided in the **Events list** submenu.

Navigation path

Diagnostics menu → **Event logbook** submenu → Events list

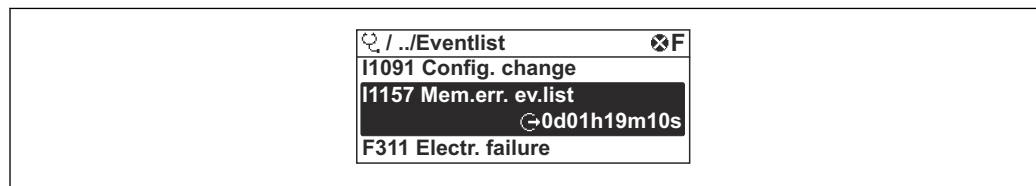

A0014006-EN

40 Using the example of the local display

- A maximum of 20 event messages can be displayed in chronological order.
- If the **Extended HistoROM** application package (order option) is enabled in the device, the event list can contain up to 100 entries.

The event history includes entries for:

- Diagnostic events → 173
- Information events → 197

In addition to the operating time when the event occurred, each event is also assigned a symbol that indicates whether the event has occurred or is finished:

- Diagnostics event
 - ⌚: Occurrence of the event
 - ⌚: End of the event
- Information event
 - ⌚: Occurrence of the event

To call up the measures to rectify a diagnostic event:

- Via local display → 166
- Via web browser → 167
- Via "FieldCare" operating tool → 168
- Via "DeviceCare" operating tool → 168

For filtering the displayed event messages → 197

12.11.2 Filtering the event logbook

Using the **Filter options** parameter you can define which category of event message is displayed in the **Events list** submenu.

Navigation path

Diagnostics → Event logbook → Filter options

Filter categories

- All
- Failure (F)
- Function check (C)
- Out of specification (S)
- Maintenance required (M)
- Information (I)

12.11.3 Overview of information events

Unlike a diagnostic event, an information event is displayed in the event logbook only and not in the diagnostic list.

| Info number | Info name |
|-------------|--|
| I1000 | ----- (Device ok) |
| I1079 | Sensor changed |
| I1089 | Power on |
| I1090 | Configuration reset |
| I1091 | Configuration changed |
| I1092 | Embedded HistoROM deleted |
| I1111 | Density adjust failure |
| I1137 | Electronic changed |
| I1151 | History reset |
| I1155 | Reset electronic temperature |
| I1156 | Memory error trend |
| I1157 | Memory error event list |
| I1184 | Display connected |
| I1209 | Density adjustment ok |
| I1221 | Zero point adjust failure |
| I1222 | Zero point adjustment ok |
| I1256 | Display: access status changed |
| I1278 | I/O module reset detected |
| I1335 | Firmware changed |
| I1361 | Web server login failed |
| I1397 | Fieldbus: access status changed |
| I1398 | CDI: access status changed |
| I1444 | Device verification passed |
| I1445 | Device verification failed |
| I1447 | Record application reference data |
| I1448 | Application reference data recorded |
| I1449 | Recording application ref. data failed |
| I1450 | Monitoring off |

| Info number | Info name |
|-------------|--|
| I1451 | Monitoring on |
| I1457 | Measured error verification failed |
| I1459 | I/O module verification failed |
| I1460 | HBSI verification failed |
| I1461 | Sensor verification failed |
| I1462 | Sensor electronic module verific. failed |
| I1512 | Download started |
| I1513 | Download finished |
| I1514 | Upload started |
| I1515 | Upload finished |
| I1618 | I/O module replaced |
| I1619 | I/O module replaced |
| I1621 | I/O module replaced |
| I1622 | Calibration changed |
| I1624 | Reset all totalizers |
| I1625 | Write protection activated |
| I1626 | Write protection deactivated |
| I1627 | Web server login successful |
| I1628 | Display login successful |
| I1629 | CDI login successful |
| I1631 | Web server access changed |
| I1632 | Display login failed |
| I1633 | CDI login failed |
| I1634 | Parameter factory reset |
| I1635 | Parameter delivery reset |
| I1637 | FOUNDATION Fieldbus specific reset done |
| I1639 | Max. switch cycles number reached |
| I1649 | Hardware write protection activated |
| I1650 | Hardware write protection deactivated |
| I1712 | New flash file received |
| I1725 | Sensor electronic module (ISEM) changed |
| I1726 | Configuration backup failed |

12.12 Resetting the measuring instrument

The entire device configuration or some of the configuration can be reset to a defined state with the **Restart** parameter.

12.12.1 Function range of "Restart" parameter

| Options | Description |
|---------------|--|
| Uninitialized | The selection has no effect on the device. |
| Run | The selection has no effect on the device. |
| Resource | The selection has no effect on the device. |

| Options | Description |
|----------------------|---|
| Defaults | All FOUNDATION Fieldbus blocks are reset to their factory settings. Example: Analog Input Channel to the Uninitialized option. |
| Processor | The device is restarted. |
| To delivery settings | Advanced FOUNDATION Fieldbus parameters (FOUNDATION Fieldbus blocks, schedule information) and device parameters for which a customer-specific default setting was ordered are reset to this customer-specific value. |

12.12.2 Function range of "Service reset" parameter

| Options | Description |
|----------------------------|---|
| Uninitialized | The selection has no effect on the device. |
| To delivery settings + MIB | Advanced FOUNDATION Fieldbus parameters (FOUNDATION Fieldbus blocks, schedule information, device tag and device address) and the device parameters for which a customer-specific default setting was ordered, are reset to this customer-specific value. |
| ENP restart | The parameters of the electronic name plate are reset. The device is restarted. |

12.13 Device information





The **Device information** submenu contains all parameters that display different information for device identification.

Navigation

"Diagnostics" menu → Device information



| ► Device information | |
|-----------------------|---------|
| Device tag | → ⓘ 200 |
| Serial number | → ⓘ 200 |
| Device name | → ⓘ 200 |
| Firmware version | → ⓘ 200 |
| Order code | → ⓘ 200 |
| Extended order code 1 | → ⓘ 200 |
| Extended order code 2 | → ⓘ 200 |
| ENP version | → ⓘ 200 |

Parameter overview with brief description

| Parameter | Description | User entry / User interface | Factory setting |
|-----------------------|--|---|-----------------|
| Device tag | Enter the name for the measuring point. | Max. 32 characters, such as letters, numbers or special characters (e.g. @, %, /) | – |
| Serial number | Displays the serial number of the measuring device. | Max. 11-digit character string comprising letters and numbers. | – |
| Device name | Shows the name of the transmitter.  The name can be found on the nameplate of the transmitter. | Promass 300/500 | – |
| Firmware version | Shows the device firmware version installed. | Character string with the following format: xx.yy.zz | – |
| Order code | Shows the device order code.  The order code can be found on the nameplate of the sensor and transmitter in the "Order code" field. | Character string composed of letters, numbers and certain punctuation marks | – |
| Extended order code 1 | Shows the 1st part of the extended order code.  The extended order code can also be found on the nameplate of the sensor and transmitter in the "Ext. ord. cd." field. | Character string | – |
| Extended order code 2 | Shows the 2nd part of the extended order code.  The extended order code can also be found on the nameplate of the sensor and transmitter in the "Ext. ord. cd." field. | Character string | – |
| ENP version | Shows the version of the electronic nameplate (ENP). | Character string in the format xx.yy.zz | – |

12.14 Firmware history

| Release date | Firmware version | Order code for "Firmware version" | Firmware Changes | Documentation type | Documentation |
|--------------|------------------|-----------------------------------|-------------------|------------------------|----------------------|
| 02.2017 | 01.00.zz | Option 74 | Original firmware | Operating Instructions | BA01883D/06/EN/01.18 |

-  It is possible to flash the firmware to the current version or the previous version using the service interface.
-  For the compatibility of the firmware version with the previous version, the installed device description files and operating tools, observe the information about the device in the "Manufacturer's information" document.
-  The manufacturer's information is available:
 - In the Download Area of the Endress+Hauser web site: www.endress.com → Downloads
 - Specify the following details:
 - Product root: e.g. 8A5B
The product root is the first part of the order code: see the nameplate on the device.
 - Text search: Manufacturer's information
 - Media type: Documentation – Technical Documentation

13 Maintenance

13.1 Maintenance work

No special maintenance work is required.

13.1.1 Exterior cleaning

When cleaning the exterior of measuring devices, always use cleaning agents that do not attack the surface of the housing or the seals.

13.1.2 Internal cleaning

Observe the following points for CIP and SIP cleaning:

- Use only cleaning agents to which the process-wetted materials are adequately resistant.
- Observe the maximum permitted medium temperature for the measuring device .

13.2 Measuring and test equipment

Endress+Hauser offers a variety of measuring and testing equipment, such as Netilion or device tests.

 Your Endress+Hauser Sales Center can provide detailed information on the services.

List of some of the measuring and testing equipment: →  207

13.3 Endress+Hauser services

Endress+Hauser offers a wide variety of services for maintenance such as recalibration, maintenance service or device tests.

 Your Endress+Hauser Sales Center can provide detailed information on the services.

14 Repair

14.1 General notes

14.1.1 Repair and conversion concept

The Endress+Hauser repair and conversion concept provides for the following:

- The measuring devices have a modular design.
- Spare parts are grouped into logical kits with the associated Installation Instructions.
- Repairs are carried out by Endress+Hauser Service or by appropriately trained customers.
- Certified devices can only be converted to other certified devices by Endress+Hauser Service or at the factory.

14.1.2 Notes for repair and conversion

For repair and conversion of a measuring device, observe the following notes:

- ▶ Use only original Endress+Hauser spare parts.
- ▶ Carry out the repair according to the Installation Instructions.
- ▶ Observe the applicable standards, federal/national regulations, Ex documentation (XA) and certificates.
- ▶ Document all repairs and conversions and enter the details in Netilion Analytics.

14.2 Spare parts

Device Viewer (www.endress.com/deviceviewer):

All the spare parts for the measuring device, along with the order code, are listed here and can be ordered. If available, users can also download the associated Installation Instructions.

-  Measuring device serial number:
 - Is located on the nameplate of the device.
 - Can be read out via the **Serial number** parameter in the **Device information** submenu.

14.3 Endress+Hauser services

Endress+Hauser offers a wide range of services.

-  Your Endress+Hauser Sales Center can provide detailed information on the services.

14.4 Return

The requirements for safe device return can vary depending on the device type and national legislation.

1. Refer to the web page for information:
<https://www.endress.com/support/return-material>
↳ Select the region.
2. If returning the device, pack the device in such a way that it is reliably protected against impact and external influences. The original packaging offers the best protection.

14.5 Disposal



If required by the Directive 2012/19/EU on waste electrical and electronic equipment (WEEE), the product is marked with the depicted symbol in order to minimize the disposal of WEEE as unsorted municipal waste. Do not dispose of products bearing this marking as unsorted municipal waste. Instead, return them to the manufacturer for disposal under the applicable conditions.

14.5.1 Removing the measuring device

1. Switch off the device.

WARNING

Danger to persons from process conditions!

- ▶ Beware of hazardous process conditions such as pressure in the measuring device, high temperatures or aggressive media.

2. Carry out the mounting and connection steps from the "Mounting the measuring device" and "Connecting the measuring device" sections in reverse order. Observe the safety instructions.

14.5.2 Disposing of the measuring device

WARNING

Danger to personnel and environment from fluids that are hazardous to health.

- ▶ Ensure that the measuring device and all cavities are free of fluid residues that are hazardous to health or the environment, e.g. substances that have permeated into crevices or diffused through plastic.

Observe the following notes during disposal:













- ▶ Observe valid federal/national regulations.
- ▶ Ensure proper separation and reuse of the device components.





15 Accessories

Various accessories, which can be ordered with the device or subsequently from Endress+Hauser, are available for the device. Detailed information on the order code in question is available from your local Endress+Hauser sales center or on the product page of the Endress+Hauser website: www.endress.com.



15.1 Device-specific accessories

15.1.1 For the transmitter

| Accessories | Description |
|--|--|
| Transmitter <ul style="list-style-type: none"> ▪ Proline 500 – digital ▪ Proline 500 | Transmitter for replacement or storage. Use the order code to define the following specifications: <ul style="list-style-type: none"> ▪ Approvals ▪ Output ▪ Input ▪ Display/operation ▪ Housing ▪ Software <ul style="list-style-type: none">  ▪ Proline 500 – digital transmitter: Order number: 8X5BXX-*****A ▪ Proline 500 transmitter: Order number: 8X5BXX-*****B <ul style="list-style-type: none">  Proline 500 transmitter for replacement: It is essential to specify the serial number of the current transmitter when ordering. On the basis of the serial number, the device-specific data (e.g. calibration factors) of the replaced device can be used for the new transmitter. <ul style="list-style-type: none">  ▪ Proline 500 – digital transmitter: Installation Instructions EA01151D ▪ Proline 500 transmitter: Installation Instructions EA01152D |
| External WLAN antenna | External WLAN antenna with 1.5 m (59.1 in) connecting cable and two angle brackets. Order code for "Accessory enclosed", option P8 "Wireless antenna wide area". <ul style="list-style-type: none">  ▪ The external WLAN antenna is not suitable for use in hygienic applications. ▪ Additional information regarding the WLAN interface →  84. <ul style="list-style-type: none">  Order number: 71351317 <ul style="list-style-type: none">  Installation Instructions EA01238D |
| Pipe mounting set | Pipe mounting set for transmitter. <ul style="list-style-type: none">  Proline 500 – digital transmitter Order number: 71346427 <ul style="list-style-type: none">  Installation Instructions EA01195D <ul style="list-style-type: none">  Proline 500 transmitter Order number: 71346428 |
| Weather protection cover Transmitter <ul style="list-style-type: none"> ▪ Proline 500 – digital ▪ Proline 500 | Is used to protect the measuring device from the effects of the weather: e.g. rainwater, excess heating from direct sunlight. <ul style="list-style-type: none">  ▪ Proline 500 – digital transmitter Order number: 71343504 ▪ Proline 500 transmitter Order number: 71343505 <ul style="list-style-type: none">  Installation Instructions EA01191D |









| | |
|--|--|
| Display guard Proline 500 – digital | Is used to protect the display against impact or scoring, for example from sand in desert areas.  Order number: 71228792  Installation Instructions EA01093D |
| Connecting cable Proline 500 – digital Sensor – Transmitter | The connecting cable can be ordered directly with the measuring device (order code for "Cable, sensor connection) or as an accessory (order number DK8012). The following cable lengths are available: order code for "Cable, sensor connection" <ul style="list-style-type: none"> ▪ Option B: 20 m (65 ft) ▪ Option E: User-configurable up to max. 50 m ▪ Option F: User-configurable up to max. 165 ft  Maximum possible cable length for a Proline 500 – digital connecting cable: 300 m (1 000 ft) |
| Connecting cables Proline 500 Sensor – Transmitter | The connecting cable can be ordered directly with the measuring device (order code for "Cable, sensor connection") or as an accessory (order number DK8012). The following cable lengths are available: order code for "Cable, sensor connection" <ul style="list-style-type: none"> ▪ Option 1: 5 m (16 ft) ▪ Option 2: 10 m (32 ft) ▪ Option 3: 20 m (65 ft)  Possible cable length for a Proline 500 connecting cable: max. 20 m (65 ft) |

15.1.2 For the sensor







| Accessories | Description |
|----------------|--|
| Heating jacket | Is used to stabilize the temperature of the fluids in the sensor. Water, water vapor and other non-corrosive liquids are permitted for use as fluids.  If using oil as a heating medium, please consult with Endress+Hauser. <ul style="list-style-type: none"> ▪ If ordered together with the measuring device: Order code for "Accessory enclosed" <ul style="list-style-type: none"> ▪ Option RB "Heating jacket, G 1/2" female thread" ▪ Option RD "Heating jacket, NPT 1/2" female thread" ▪ If ordered subsequently: Use the order code with the product root DK8003.  Special Documentation SD02173D |
| Sensor holder | For wall, tabletop and pipe mounting.  Order number: 71392563 |

15.2 Communication-specific accessories







| Accessories | Description |
|-----------------|---|
| Fieldgate FXA42 | Transmission of the measured values of connected 4 to 20 mA analog measuring instruments, as well as digital measuring instruments  <ul style="list-style-type: none"> ▪ Technical Information TI01297S ▪ Operating Instructions BA01778S ▪ Product page: www.endress.com/fxa42 |

| | |
|-------------------|--|
| Field Xpert SMT50 | <p>The Field Xpert SMT50 tablet PC for device configuration enables mobile plant asset management in the non-hazardous areas. It is suitable for commissioning and maintenance staff to manage field instruments with a digital communication interface and to record progress.</p> <p>This tablet PC is designed as an all-in-one solution with a preinstalled driver library and is an easy-to-use, touch-sensitive tool which can be used to manage field instruments throughout their entire life cycle.</p> <ul style="list-style-type: none">  Technical Information TI01555S  Operating Instructions BA02053S  Product page: www.endress.com/smt50 |
| Field Xpert SMT70 | <p>The Field Xpert SMT70 tablet PC for device configuration enables mobile plant asset management in hazardous and non-hazardous areas. It is suitable for commissioning and maintenance staff to manage field instruments with a digital communication interface and to record progress.</p> <p>This tablet PC is designed as an all-in-one solution with a preinstalled driver library and is an easy-to-use, touch-sensitive tool which can be used to manage the field instruments throughout their entire life cycle.</p> <ul style="list-style-type: none">  Technical Information TI01342S  Operating Instructions BA01709S  Product page: www.endress.com/smt70 |
| Field Xpert SMT77 | <p>The Field Xpert SMT77 tablet PC for device configuration enables mobile plant asset management in areas categorized as Ex Zone 1.</p> <ul style="list-style-type: none">  Technical Information TI01418S  Operating Instructions BA01923S  Product page: www.endress.com/smt77 |

15.3 Service-specific accessories

| Accessories | Description |
|-------------|---|
| Applicator | <p>Software for selecting and sizing Endress+Hauser measuring instruments:</p> <ul style="list-style-type: none">  Choice of measuring instruments for industrial requirements  Calculation of all the necessary data for identifying the optimum flowmeter: e.g. nominal diameter, pressure loss, flow velocity and measurement accuracy.  Graphic display of the calculation results  Determination of the partial order code, administration, documentation and access to all project-related data and parameters over the entire life cycle of a project. <p>Applicator is available: Via the Internet: https://portal.endress.com/webapp/applicator</p> |
| Netilion | <p>IloT ecosystem: Unlock knowledge</p> <p>With the Netilion IloT ecosystem, Endress+Hauser allows you to optimize your plant performance, digitize workflows, share knowledge, and enhance collaboration.</p> <p>Drawing upon decades of experience in process automation, Endress+Hauser offers the process industry an IloT ecosystem designed to effortlessly extract insights from data. These insights allow process optimization, leading to increased plant availability, efficiency, and reliability - ultimately resulting in a more profitable plant.</p> <p>www.netilion.endress.com</p> |
| FieldCare | <p>FDT-based plant asset management tool from Endress+Hauser.</p> <p>It can configure all intelligent field units in your system and helps you manage them. By using the status information, it is also a simple but effective way of checking their status and condition.</p> <ul style="list-style-type: none">  Operating Instructions BA00027S and BA00059S |
| DeviceCare | <p>Tool to connect and configure Endress+Hauser field devices.</p> <ul style="list-style-type: none">  Innovation brochure IN01047S |

15.4 System components

| Accessories | Description |
|----------------------------------|--|
| Memograph M graphic data manager | <p>The Memograph M graphic data manager provides information on all the relevant measured variables. Measured values are recorded correctly, limit values are monitored and measuring points analyzed. The data are stored in the 256 MB internal memory and also on a SD card or USB stick.</p> <ul style="list-style-type: none">  ■ Technical Information TI00133R  ■ Operating Instructions BA00247R |
| Cerabar M | <p>The pressure transmitter for measuring the absolute and gauge pressure of gases, steam and liquids. It can be used to read in the operating pressure value.</p> <ul style="list-style-type: none">  ■ Technical Information TI00426P and TI00436P  ■ Operating Instructions BA00200P and BA00382P |
| Cerabar S | <p>The pressure transmitter for measuring the absolute and gauge pressure of gases, steam and liquids. It can be used to read in the operating pressure value.</p> <ul style="list-style-type: none">  ■ Technical Information TI00383P  ■ Operating Instructions BA00271P |
| iTEMP | <p>The temperature transmitters can be used in all applications and are suitable for the measurement of gases, steam and liquids. They can be used to read in the medium temperature.</p> <ul style="list-style-type: none">  "Fields of Activity" document FA00006T |

16 Technical data

16.1 Application

The measuring device is intended only for the flow measurement of liquids and gases.

Depending on the version ordered, the measuring device can also measure potentially explosive, flammable, poisonous and oxidizing media.

To ensure that the device remains in proper operating condition for its service life, use the measuring device only for media against which the process-wetted materials are sufficiently resistant.

16.2 Function and system design

Measuring principle

Mass flow measurement based on the Coriolis measuring principle

Measuring system

The measuring system consists of a transmitter and a sensor. The transmitter and sensor are mounted in physically separate locations. They are interconnected by connecting cables.

For information on the structure of the measuring instrument →  13

16.3 Input

Measured variable

Direct measured variables

- Mass flow
- Density
- Temperature

Calculated measured variables

- Volume flow
- Corrected volume flow
- Reference density

Measuring range

Measuring range for liquids

| DN | | Measuring range full scale values $\dot{m}_{\min(F)}$ to $\dot{m}_{\max(F)}$ | |
|------|----------------|--|------------|
| [mm] | [in] | [kg/h] | [lb/min] |
| 1 | $\frac{1}{24}$ | 0 to 20 | 0 to 0.735 |
| 2 | $\frac{1}{12}$ | 0 to 100 | 0 to 3.675 |
| 4 | $\frac{1}{6}$ | 0 to 450 | 0 to 16.54 |



Measuring range for gases

The full scale value depends on the density and the sound velocity of the gas used. The full scale value can be calculated with the following formulas:

$$\dot{m}_{\max(G)} = (\rho_G \cdot (c_G/m) \cdot d_i^2 \cdot (\pi/4) \cdot 3600 \cdot n)$$

| | |
|---------------------|---|
| $\dot{m}_{\max(G)}$ | Maximum full scale value for gas [kg/h] |
| ρ_G | Gas density in [kg/m ³] at operating conditions |
| c_G | Sound velocity (gas) [m/s] |
| d_i | Measuring tube internal diameter [m] |
| π | Pi |
| $n = 1$ | Number of measuring tubes |
| $m = 2$ | For all gases except pure H ₂ and He gas |
| $m = 3$ | For pure H ₂ and He gas |

Recommended measuring range

 Flow limit →  226

Operable flow range

Over 1000 : 1.



Flow rates above the preset full scale value do not override the electronics unit, with the result that the totalizer values are registered correctly.

Input signal

External measured values

To increase the measurement accuracy of certain measured variables or to calculate the corrected volume flow for gases, the automation system can continuously write different measured values to the measuring instrument:

- Operating pressure to increase measurement accuracy (Endress+Hauser recommends the use of a pressure measuring device for absolute pressure, e.g. Cerabar M or Cerabar S)
- Medium temperature to increase measurement accuracy (e.g. iTEMP)
- Reference density for calculating the corrected volume flow for gases

 Various pressure and temperature measuring devices can be ordered from Endress +Hauser: see "Accessories" section →  208

It is recommended to read in external measured values to calculate the corrected volume flow.

Current input

The measured values are written from the automation system to the measuring device via the current input →  211.

Digital communication

The measured values are written by the automation system via FOUNDATION fieldbus.

Current input 0/4 to 20 mA

| | |
|---------------------------------|---|
| Current input | 0/4 to 20 mA (active/passive) |
| Current span | <ul style="list-style-type: none"> ■ 4 to 20 mA (active) ■ 0/4 to 20 mA (passive) |
| Resolution | 1 µA |
| Voltage drop | Typically: 0.6 to 2 V for 3.6 to 22 mA (passive) |
| Maximum input voltage | ≤ 30 V (passive) |
| Open-circuit voltage | ≤ 28.8 V (active) |
| Possible input variables | <ul style="list-style-type: none"> ■ Pressure ■ Temperature ■ Density |

Status input

| | |
|-----------------------------|--|
| Maximum input values | <ul style="list-style-type: none"> ■ DC -3 to 30 V ■ If status input is active (ON): $R_i > 3 \text{ k}\Omega$ |
| Response time | Configurable: 5 to 200 ms |
| Input signal level | <ul style="list-style-type: none"> ■ Low signal: DC -3 to +5 V ■ High signal: DC 12 to 30 V |
| Assignable functions | <ul style="list-style-type: none"> ■ Off ■ Reset the individual totalizers separately ■ Reset all totalizers ■ Flow override |

16.4 Output

Output signal

FOUNDATION Fieldbus

| | |
|--------------------------|---|
| FOUNDATION Fieldbus | H1, IEC 61158-2, galvanically isolated |
| Data transfer | 31.25 kbit/s |
| Current consumption | 10 mA |
| Permitted supply voltage | 9 to 32 V |
| Bus connection | With integrated reverse polarity protection |

Current output 4 to 20 mA



| | |
|-------------------------------|--|
| Signal mode | Can be set to: <ul style="list-style-type: none"> ■ Active ■ Passive |
| Current range | Can be set to: <ul style="list-style-type: none"> ■ 4 to 20 mA NAMUR ■ 4 to 20 mA US ■ 4 to 20 mA ■ 0 to 20 mA (only if the signal mode is active) ■ Fixed current |
| Maximum output values | 22.5 mA |
| Open-circuit voltage | DC 28.8 V (active) |
| Maximum input voltage | DC 30 V (passive) |
| Load | 0 to 700 Ω |
| Resolution | 0.38 μA |
| Damping | Configurable: 0 to 999.9 s |
| Assignable measured variables | <ul style="list-style-type: none"> ■ Mass flow ■ Volume flow ■ Corrected volume flow ■ Density ■ Reference density ■ Temperature ■ Electronics temperature ■ Oscillation frequency 0 ■ Oscillation damping 0 ■ Signal asymmetry ■ Exciter current 0 <p> The range of options increases if the measuring device has one or more application packages.</p> |



Current output 4 to 20 mA Ex i passive

| | |
|-----------------------|---|
| Order code | "Output; input 2" (21), "Output; input 3" (022): Option C: current output 4 to 20 mA Ex i passive |
| Signal mode | Passive |
| Current range | Can be set to: <ul style="list-style-type: none"> ■ 4 to 20 mA NAMUR ■ 4 to 20 mA US ■ 4 to 20 mA ■ Fixed current |
| Maximum output values | 22.5 mA |
| Maximum input voltage | DC 30 V |

| | |
|--------------------------------------|--|
| Load | 0 to 700 Ω |
| Resolution | 0.38 μ A |
| Damping | Configurable: 0 to 999 s |
| Assignable measured variables | <ul style="list-style-type: none"> ▪ Mass flow ▪ Volume flow ▪ Corrected volume flow ▪ Density ▪ Reference density ▪ Temperature ▪ Electronics temperature ▪ Oscillation frequency 0 ▪ Oscillation damping 0 ▪ Signal asymmetry ▪ Exciter current 0 <p> The range of options increases if the measuring device has one or more application packages.</p> |

Pulse/frequency/switch output

| | |
|--------------------------------------|---|
| Function | Can be configured as pulse, frequency or switch output |
| Version | Open collector Can be set to: <ul style="list-style-type: none"> ▪ Active ▪ Passive ▪ Passive NAMUR <p> Ex-i, passive</p> |
| Maximum input values | DC 30 V, 250 mA (passive) |
| Open-circuit voltage | DC 28.8 V (active) |
| Voltage drop | For 22.5 mA: \leq DC 2 V |
| Pulse output | |
| Maximum input values | DC 30 V, 250 mA (passive) |
| Maximum output current | 22.5 mA (active) |
| Open-circuit voltage | DC 28.8 V (active) |
| Pulse width | Configurable: 0.05 to 2 000 ms |
| Maximum pulse rate | 10 000 Impulse/s |
| Pulse value | Configurable |
| Assignable measured variables | <ul style="list-style-type: none"> ▪ Mass flow ▪ Volume flow ▪ Corrected volume flow <p> The range of options increases if the measuring device has one or more application packages.</p> |
| Frequency output | |
| Maximum input values | DC 30 V, 250 mA (passive) |
| Maximum output current | 22.5 mA (active) |
| Open-circuit voltage | DC 28.8 V (active) |
| Output frequency | Configurable: end value frequency 2 to 10 000 Hz ($f_{\max} = 12\,500$ Hz) |
| Damping | Configurable: 0 to 999.9 s |
| Pulse/pause ratio | 1:1 |

| | |
|--------------------------------------|--|
| Assignable measured variables | <ul style="list-style-type: none"> ■ Mass flow ■ Volume flow ■ Corrected volume flow ■ Density ■ Reference density ■ Temperature ■ Electronics temperature ■ Oscillation frequency 0 ■ Oscillation damping 0 ■ Signal asymmetry ■ Exciter current 0 <p> The range of options increases if the measuring device has one or more application packages.</p> |
| Switch output | |
| Maximum input values | DC 30 V, 250 mA (passive) |
| Open-circuit voltage | DC 28.8 V (active) |
| Switching behavior | Binary, conductive or non-conductive |
| Switching delay | Configurable: 0 to 100 s |
| Number of switching cycles | Unlimited |
| Assignable functions | <ul style="list-style-type: none"> ■ Disable ■ On ■ Diagnostic behavior ■ Limit <ul style="list-style-type: none"> ■ Mass flow ■ Volume flow ■ Corrected volume flow ■ Density ■ Reference density ■ Temperature ■ Totalizer 1-3 ■ Flow direction monitoring ■ Status <ul style="list-style-type: none"> ■ Partially filled pipe detection ■ Low flow cut off <p> The range of options increases if the measuring device has one or more application packages.</p> |

Relay output

| | |
|---------------------------|--|
| Function | Switch output |
| Version | Relay output, galvanically isolated |
| Switching behavior | Can be set to: <ul style="list-style-type: none"> ■ NO (normally open), factory setting ■ NC (normally closed) |

| | |
|---|--|
| Maximum switching capacity (passive) | <ul style="list-style-type: none"> ▪ DC 30 V, 0.1 A ▪ AC 30 V, 0.5 A |
| Assignable functions | <ul style="list-style-type: none"> ▪ Disable ▪ On ▪ Diagnostic behavior ▪ Limit <ul style="list-style-type: none"> ▪ Mass flow ▪ Volume flow ▪ Corrected volume flow ▪ Density ▪ Reference density ▪ Temperature ▪ Totalizer 1-3 ▪ Flow direction monitoring ▪ Status <ul style="list-style-type: none"> ▪ Partially filled pipe detection ▪ Low flow cut off <p> The range of options increases if the measuring device has one or more application packages.</p> |

User-configurable input/output

One specific input or output is assigned to a user-configurable input/output (configurable I/O) during device commissioning.

The following inputs and outputs are available for assignment:

- Choice of current output: 4 to 20 mA (active), 0/4 to 20 mA (passive)
- Pulse/frequency/switch output
- Choice of current input: 4 to 20 mA (active), 0/4 to 20 mA (passive)
- Status input

Signal on alarm

Depending on the interface, failure information is displayed as follows:

FOUNDATION Fieldbus

| | |
|---|---------------------------------------|
| Status and alarm messages | Diagnostics in accordance with FF-891 |
| Failure current FDE (Fault Disconnection Electronic) | 0 mA |

Current output 0/4 to 20 mA

4 to 20 mA

| | |
|---------------------|---|
| Failure mode | Choose from: <ul style="list-style-type: none"> ▪ 4 to 20 mA in accordance with NAMUR recommendation NE 43 ▪ 4 to 20 mA in accordance with US ▪ Min. value: 3.59 mA ▪ Max. value: 22.5 mA ▪ Definable value between: 3.59 to 22.5 mA ▪ Actual value ▪ Last valid value |
|---------------------|---|

0 to 20 mA

| | |
|---------------------|--|
| Failure mode | Choose from: <ul style="list-style-type: none"> ▪ Maximum alarm: 22 mA ▪ Definable value between: 0 to 20.5 mA |
|---------------------|--|

Pulse/frequency/switch output

| Pulse output | |
|------------------|--|
| Fault mode | Choose from: <ul style="list-style-type: none"> ▪ Actual value ▪ No pulses |
| Frequency output | |
| Fault mode | Choose from: <ul style="list-style-type: none"> ▪ Actual value ▪ 0 Hz ▪ Definable value between: 2 to 12 500 Hz |
| Switch output | |
| Fault mode | Choose from: <ul style="list-style-type: none"> ▪ Current status ▪ Open ▪ Closed |

Relay output

| | |
|--------------|---|
| Failure mode | Choose from: <ul style="list-style-type: none"> ▪ Current status ▪ Open ▪ Closed |
|--------------|---|

Local display

| | |
|--------------------|---|
| Plain text display | With information on cause and remedial measures |
| Backlight | Red lighting indicates a device error. |

 Status signal as per NAMUR recommendation NE 107

Interface/protocol



- Via digital communication:
 - FOUNDATION Fieldbus
- Via service interface
 - CDI-RJ45 service interface
 - WLAN interface

| | |
|--------------------|---|
| Plain text display | With information on cause and remedial measures |
|--------------------|---|

Web browser

| | |
|--------------------|---|
| Plain text display | With information on cause and remedial measures |
|--------------------|---|

Light emitting diodes (LED)

| | |
|--------------------|--|
| Status information | <p>Status indicated by various light emitting diodes</p> <p>The following information is displayed depending on the device version:</p> <ul style="list-style-type: none"> ▪ Supply voltage active ▪ Data transmission active ▪ Device alarm/error has occurred <p> Diagnostic information via light emitting diodes →  161</p> |
|--------------------|--|

Low flow cut off The switch points for low flow cut off are user-selectable.

Galvanic isolation The outputs are galvanically isolated:

- from the power supply
- from one another
- from the potential equalization (PE) terminal

protocol-specific data

| | |
|---|---|
| Manufacturer ID | 0x452B48 (hex) |
| Ident number | 0x103B (hex) |
| Device revision | 1 |
| DD revision | Information and files under: |
| CFF revision | <ul style="list-style-type: none"> ▪ www.endress.com ▪ www.fieldcommgroup.org |
| Interoperability Test Kit (ITK) | Version 6.2.0 |
| ITK Test Campaign Number | Information: <ul style="list-style-type: none"> ▪ www.endress.com ▪ www.fieldcommgroup.org |
| Link Master capability (LAS) | Yes |
| Choice of "Link Master" and "Basic Device" | Yes Factory setting: Basic Device |
| Node address | Factory setting: 247 (0xF7) |
| Supported functions | The following methods are supported: <ul style="list-style-type: none"> ▪ Restart ▪ ENP Restart ▪ Diagnostic ▪ Set to OOS ▪ Set to AUTO ▪ Read trend data ▪ Read event logbook |
| Virtual Communication Relationships (VCRs) | |
| Number of VCRs | 44 |
| Number of link objects in VFD | 50 |
| Permanent entries | 1 |
| Client VCRs | 0 |
| Server VCRs | 10 |
| Source VCRs | 43 |
| Sink VCRs | 0 |
| Subscriber VCRs | 43 |
| Publisher VCRs | 43 |
| Device Link Capabilities | |
| Slot time | 4 |
| Min. delay between PDU | 8 |
| Max. response delay | 16 |
| System integration | Information regarding system integration →  89. <ul style="list-style-type: none"> ▪ Cyclic data transmission ▪ Description of the modules ▪ Execution times ▪ Methods |

16.5 Power supply

Terminal assignment →  40

Available device plugs →  40

Available device plugs →  41

Supply voltage

| Order code "Power supply" | Terminal voltage | | Frequency range |
|------------------------------|------------------|------------|-----------------|
| Option D | DC 24 V | ±20% | – |
| Option E | AC 100 to 240 V | –15...+10% | 50/60 Hz |
| Option I | DC 24 V | ±20% | – |
| | AC 100 to 240 V | –15...+10% | 50/60 Hz |

Power consumption

Transmitter

Max. 10 W (active power)

| | |
|-------------------|---|
| switch-on current | Max. 36 A (<5 ms) as per NAMUR Recommendation NE 21 |
|-------------------|---|

Current consumption

Transmitter

- Max. 400 mA (24 V)
- Max. 200 mA (110 V, 50/60 Hz; 230 V, 50/60 Hz)

Power supply failure



- Totalizers stop at the last value measured.
- Depending on the device version, the configuration is retained in the device memory or in the pluggable data memory (HistoROM DAT).
- Error messages (incl. total operated hours) are stored.

Overcurrent protection element

The device must be operated with a dedicated circuit breaker, as it does not have an ON/OFF switch of its own.

- The circuit breaker must be easy to reach and labeled accordingly.
- Permitted nominal current of the circuit breaker: 2 A up to maximum 10 A.

Electrical connection

- →  43
- →  50

Potential equalization

→  56

Terminals



Spring-loaded terminals: Suitable for strands and strands with ferrules.
Conductor cross-section 0.2 to 2.5 mm² (24 to 12 AWG).

- Cable entries
- Cable gland: M20 × 1.5 with cable Ø 6 to 12 mm (0.24 to 0.47 in)
 - Thread for cable entry:
 - NPT ½"
 - G ½"
 - M20
 - Device plug for digital communication: M12

Cable specification →  35

| | | |
|------------------------|--|---|
| Overvoltage protection | Mains voltage fluctuations | →  218 |
| | Overvoltage category | Overvoltage category II |
| | Short-term, temporary overvoltage | Between cable and ground up to 1200 V, for max. 5 s |
| | Long-term, temporary overvoltage | Between cable and ground up to 500 V |

16.6 Performance characteristics

- Reference operating conditions
- Error limits based on ISO 11631
 - Water
 - +15 to +45 °C (+59 to +113 °F)
 - 2 to 6 bar (29 to 87 psi)
 - Data as indicated in the calibration protocol
 - Accuracy based on accredited calibration rigs according to ISO 17025
-  To obtain measured errors, use the *Applicator* sizing tool →  207

Maximum measurement error o.r. = of reading; 1 g/cm³ = 1 kg/l; T = medium temperature

Base accuracy

 Design fundamentals →  222

Mass flow and volume flow (liquids)

±0.10 % o.r.

Mass flow (gases)

±0.35 % o.r.

Density (liquids)

| Under reference conditions | Standard density calibration ¹⁾ | Wide-range Density specification ^{2) 3)} |
|----------------------------|--|---|
| [g/cm ³] | [g/cm ³] | [g/cm ³] |
| ±0.0005 | ±0.001 | ±0.002 |

- 1) For devices with the order code "Measuring tube material, wetted surface", option HB "Alloy C22, high pressure, not polished", the standard density calibration ±0.002 g/cm³
- 2) Valid range for special density calibration: 0 to 2 g/cm³, +5 to +80 °C (+41 to +176 °F)
- 3) order code for "Application package", option EE "Special density"

Temperature

±0.5 °C ± 0.005 · T °C (±0.9 °F ± 0.003 · (T - 32) °F)

Zero point stability

Standard version: order code for "Measuring tube mat., wetted surface", option BB, BF, HA, SA

| DN | | Zero point stability | |
|------|------|----------------------|----------|
| [mm] | [in] | [kg/h] | [lb/min] |
| 1 | 1/24 | 0.0005 | 0.000018 |
| 2 | 1/12 | 0.0025 | 0.00009 |
| 4 | 1/8 | 0.0100 | 0.00036 |

High-pressure version: order code for "Measuring tube mat., wetted surface", option HB

| DN | | Zero point stability | |
|------|------|----------------------|-----------|
| [mm] | [in] | [kg/h] | [lb/min] |
| 1 | 1/24 | 0.0008 | 0.0000288 |
| 2 | 1/12 | 0.0040 | 0.000144 |
| 4 | 1/8 | 0.0160 | 0.000576 |

Flow values

Flow values as turndown parameters depending on nominal diameter.

SI units

| DN [mm] | 1:1 | 1:10 | 1:20 | 1:50 | 1:100 | 1:500 |
|------------|--------|--------|--------|--------|--------|--------|
| | [kg/h] | [kg/h] | [kg/h] | [kg/h] | [kg/h] | [kg/h] |
| 1 | 20 | 2 | 1 | 0.4 | 0.2 | 0.04 |
| 2 | 100 | 10 | 5 | 2 | 1 | 0.2 |
| 4 | 450 | 45 | 22.5 | 9 | 4.5 | 0.9 |

US units

| DN [inch] | 1:1 | 1:10 | 1:20 | 1:50 | 1:100 | 1:500 |
|--------------|----------|----------|----------|----------|----------|----------|
| | [lb/min] | [lb/min] | [lb/min] | [lb/min] | [lb/min] | [lb/min] |
| 1/24 | 0.735 | 0.074 | 0.037 | 0.015 | 0.007 | 0.001 |
| 1/12 | 3.675 | 0.368 | 0.184 | 0.074 | 0.037 | 0.007 |
| 1/8 | 16.54 | 1.654 | 0.827 | 0.331 | 0.165 | 0.033 |

Accuracy of outputs

The outputs have the following base accuracy specifications.

Current output

| | |
|----------|-------|
| Accuracy | ±5 µA |
|----------|-------|



Pulse/frequency output

o.r. = of reading

| | |
|-----------------|--|
| Accuracy | Max. ± 50 ppm o.r. (over the entire ambient temperature range) |
|-----------------|--|

Repeatability o.r. = of reading; $1 \text{ g/cm}^3 = 1 \text{ kg/l}$; T = medium temperature

Base repeatability

 Design fundamentals →  222

Mass flow and volume flow (liquids)

± 0.05 % o.r.

Mass flow (gases)

± 0.15 % o.r.

Density (liquids)

$\pm 0.00025 \text{ g/cm}^3$

Temperature

$\pm 0.25 \text{ }^\circ\text{C} \pm 0.0025 \cdot T \text{ }^\circ\text{C}$ ($\pm 0.45 \text{ }^\circ\text{F} \pm 0.0015 \cdot (T-32) \text{ }^\circ\text{F}$)

Response time The response time depends on the configuration (damping).

Influence of ambient temperature

Current output

| | |
|--------------------------------|--|
| Temperature coefficient | Max. $1 \text{ } \mu\text{A}/^\circ\text{C}$ |
|--------------------------------|--|

Pulse/frequency output

| | |
|--------------------------------|---|
| Temperature coefficient | No additional effect. Included in accuracy. |
|--------------------------------|---|

Influence of medium temperature

Mass flow

o.f.s. = of full scale value

If there is a difference between the temperature during zero adjustment and the process temperature, the additional measurement error of the sensors is typically $\pm 0.0002 \text{ \%o.f.s.}/^\circ\text{C}$ ($\pm 0.0001 \text{ \% o. f.s.}/^\circ\text{F}$).

The influence is reduced when the zero adjustment is performed at process temperature.

Density

If there is a difference between the density calibration temperature and the process temperature, the measurement error of the sensors is typically $\pm 0.00005 \text{ g/cm}^3/^\circ\text{C}$ ($\pm 0.000025 \text{ g/cm}^3/^\circ\text{F}$). Field density adjustment is possible.

Wide-range density specification (special density calibration)

If the process temperature is outside the valid range (\rightarrow  219) the measurement error is $\pm 0.00005 \text{ g/cm}^3 /^\circ\text{C}$ ($\pm 0.000025 \text{ g/cm}^3 /^\circ\text{F}$)

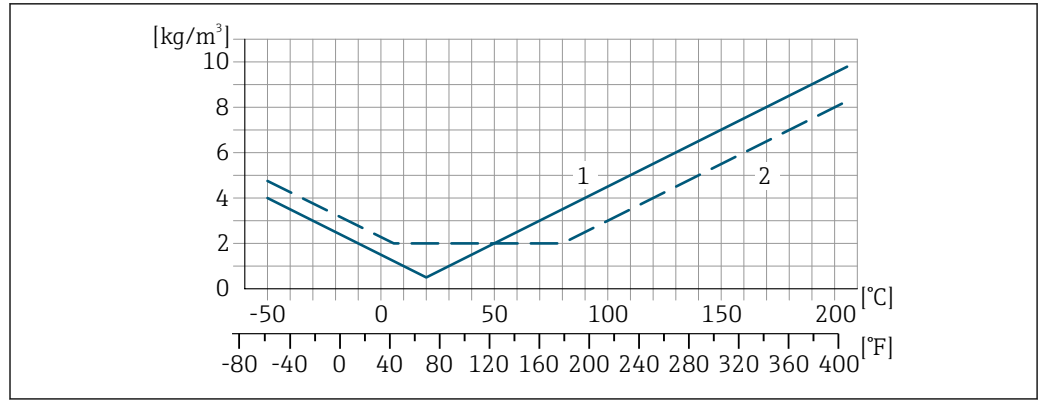

A0016616

- 1 Field density adjustment, for example at +20 °C (+68 °F)
- 2 Special density calibration

Influence of medium pressure A difference between the calibration pressure and process pressure does not affect accuracy.

Influence of process density If there is a difference in density between the calibration density and the process density, the measurement error for the measured density is typically:

- ±0.6% for nominal diameter DN 4 (1/2 in)
- ±1.4% for nominal diameter DN 2 (1/2 in)
- ±2.0% for nominal diameter DN 1 (1/2 in) and for devices with order code for "Measuring tube material, wetted surface.", option HB "Alloy C22, high pressure, not polished"

 A field density adjustment is possible.

Design fundamentals o.r. = of reading, o.f.s. = of full scale value
 BaseAccu = base accuracy in % o.r., BaseRepeat = base repeatability in % o.r.
 MeasValue = measured value; ZeroPoint = zero point stability

Calculation of the maximum measured error as a function of the flow rate

| Flow rate | Maximum measured error in % o.r. |
|--|--|
| $\geq \frac{\text{ZeroPoint}}{\text{BaseAccu}} \cdot 100$ <small>A0021332</small> | $\pm \text{BaseAccu}$ <small>A0021339</small> |
| $< \frac{\text{ZeroPoint}}{\text{BaseAccu}} \cdot 100$ <small>A0021333</small> | $\pm \frac{\text{ZeroPoint}}{\text{MeasValue}} \cdot 100$ <small>A0021334</small> |

Calculation of the maximum repeatability as a function of the flow rate

| Flow rate | Maximum repeatability in % o.r. |
|--|--|
| $\geq \frac{1/2 \cdot \text{ZeroPoint}}{\text{BaseRepeat}} \cdot 100$ <small>A0021335</small> | $\pm \text{BaseRepeat}$ <small>A0021340</small> |
| $< \frac{1/2 \cdot \text{ZeroPoint}}{\text{BaseRepeat}} \cdot 100$ <small>A0021336</small> | $\pm 1/2 \cdot \frac{\text{ZeroPoint}}{\text{MeasValue}} \cdot 100$ <small>A0021337</small> |

Example of maximum measurement error

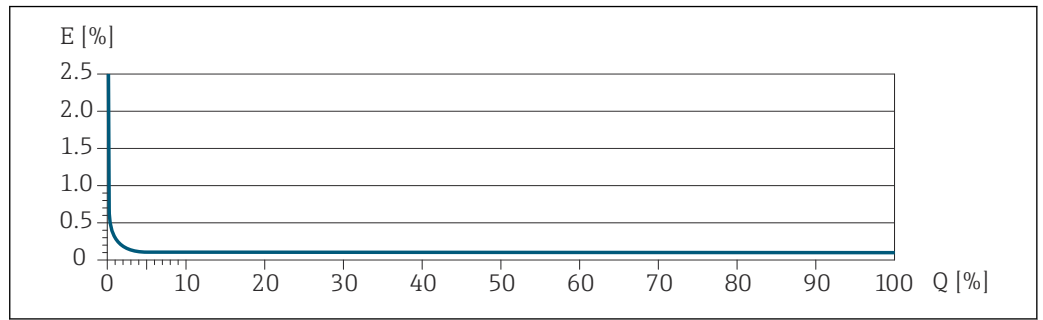

E Maximum measurement error in % o.r. (example)
 Q Flow rate in % of maximum full scale value



16.7 Mounting

Mounting requirements → 21

16.8 Environment

Ambient temperature range → 23

Temperature tables

-  Observe the interdependencies between the permitted ambient and fluid temperatures when operating the device in hazardous areas.
-  For detailed information on the temperature tables, see the separate document entitled "Safety Instructions" (XA) for the device.

Storage temperature

Climate class DIN EN 60068-2-38 (test Z/AD)

Relative humidity The device is suitable for use outdoors and indoors with a relative humidity of 4 to 95 %.

Operating height According to EN 61010-1
 ■ ≤ 2 000 m (6 562 ft)
 ■ > 2 000 m (6 562 ft) with additional overvoltage protection (e.g. Endress+Hauser HAW Series)

Degree of protection **Transmitter**

- IP66/67, Type 4X enclosure, suitable for pollution degree 4
- When the housing is open: IP20, Type 1 enclosure, suitable for pollution degree 2
- Display module: IP20, Type 1 enclosure, suitable for pollution degree 2

Sensor

- IP66/67, Type 4X enclosure, suitable for pollution degree 4
- When the housing is open: IP20, Type 1 enclosure, suitable for pollution degree 2

Optional

Order code for "Sensor options", option CM "IP69

External WLAN antenna

IP67

Shock and vibration resistance

Vibration sinusoidal, in accordance with IEC 60068-2-6

Sensor

- 2 to 8.4 Hz, 3.5 mm peak
- 8.4 to 2 000 Hz, 1 g peak

Transmitter

- 2 to 8.4 Hz, 7.5 mm peak
- 8.4 to 2 000 Hz, 2 g peak

Vibration broad-band random, according to IEC 60068-2-64

Sensor

- 10 to 200 Hz, 0.003 g²/Hz
- 200 to 2 000 Hz, 0.001 g²/Hz
- Total: 1.54 g rms

Transmitter

- 10 to 200 Hz, 0.01 g²/Hz
- 200 to 2 000 Hz, 0.003 g²/Hz
- Total: 2.70 g rms

Shock half-sine, according to IEC 60068-2-27

- Sensor
 - 6 ms 30 g
- Transmitter
 - 6 ms 50 g

Rough handling shocks according to IEC 60068-2-31

Internal cleaning

- CIP cleaning
- SIP cleaning

Options

Oil- and grease-free version for wetted parts, without declaration
 Order code for "Service", option HA ⁴⁾

Mechanical load

Transmitter housing and sensor connection housing:

- Protect against mechanical effects, such as shock or impact
- Do not use as a ladder or climbing aid

Electromagnetic compatibility (EMC)



Details are provided in the Declaration of Conformity.



This unit is not intended for use in residential environments and cannot guarantee adequate protection of the radio reception in such environments.

4) The cleaning refers to the measuring instrument only. Any accessories supplied are not cleaned.

16.9 Process

Medium temperature range -50 to +205 °C (-58 to +401 °F)

Pressure-temperature ratings



For an overview of the pressure-temperature ratings for the process connections, see the Technical Information

Sensor housing

The sensor housing is filled with dry nitrogen gas and protects the electronics and mechanics inside.



If a measuring tube fails (e.g. due to process characteristics like corrosive or abrasive fluids), the fluid will initially be contained by the sensor housing.

In the event of a tube failure, the pressure level inside the sensor housing will rise according to the operating process pressure. If the user judges that the sensor housing burst pressure does not provide an adequate safety margin, the device can be fitted with a rupture disk. This prevents excessively high pressure from forming inside the sensor housing. Therefore, the use of a rupture disk is strongly recommended in applications involving high gas pressures, and particularly in applications in which the process pressure is greater than 2/3 of the sensor housing burst pressure.



High-pressure devices are always fitted with a rupture disk: order code for "Measuring tube mat., wetted surface", option HB

Burst pressure of the sensor housing

If the device is fitted with a rupture disk (order code for "Sensor option", option CA "Rupture disk"), the rupture disk trigger pressure is decisive .

The sensor housing burst pressure refers to a typical internal pressure which is reached prior to mechanical failure of the sensor housing and which was determined during type testing. The corresponding type test declaration can be ordered with the device (order code for "Additional approval", option LN "Sensor housing burst pressure, type test").

| DN | | Sensor housing burst pressure | |
|------|------|-------------------------------|-------|
| [mm] | [in] | [bar] | [psi] |
| 1 | 1/24 | 220 | 3 190 |
| 2 | 1/12 | 140 | 2 030 |
| 4 | 1/8 | 105 | 1 520 |



For information on the dimensions: see the "Mechanical construction" section of the "Technical Information" document

Rupture disk

To increase the level of safety, a device version with a rupture disk with a trigger pressure of 10 to 15 bar (145 to 217.5 psi) can be used (order code for "Sensor option", option CA "rupture disk").

Drain connection for rupture disk

To allow any escaping medium to drain in a controlled manner in the event of an error, an optional drain connection can be ordered in addition to the rupture disk.





The function of the rupture disk is not compromised in any way.

Flow limit



Select the nominal diameter by optimizing between the required flow range and permissible pressure loss.

 For an overview of the full scale values for the measuring range, see the "Measuring range" section →  210

- The minimum recommended full scale value is approx. 1/20 of the maximum full scale value
- In most applications, 20 to 50 % of the maximum full scale value can be considered ideal
- A low full scale value must be selected for abrasive media (such as liquids with entrained solids): flow velocity < 1 m/s (< 3 ft/s).
- For gas measurement the following rules apply:
 - The flow velocity in the measuring tubes should not exceed half the sound velocity (0.5 Mach).
 - The maximum mass flow depends on the density of the gas: formula

 To calculate the flow limit, use the *Applicator* sizing tool →  207

Pressure loss

 To calculate the pressure loss, use the *Applicator* sizing tool →  207

System pressure

→  23

16.10 Mechanical construction

Design, dimensions

 For the dimensions and installation lengths of the device, see the "Technical Information" document, "Mechanical construction" section

Weight

All values (weight exclusive of packaging material) refer to devices with VCO couplings.

Transmitter

- Proline 500 – digital polycarbonate: 1.4 kg (3.1 lbs)
- Proline 500 – digital aluminum: 2.4 kg (5.3 lbs)
- Proline 500 aluminum: 6.5 kg (14.3 lbs)
- Proline 500 cast, stainless: 15.6 kg (34.4 lbs)

Sensor

Sensor with aluminum connection housing version:

Weight in SI units

| DN [mm] | Weight [kg] |
|---------|-------------|
| 1 | 2.75 |
| 2 | 4.3 |
| 4 | 6.15 |

Weight in US units

| DN [in] | Weight [lbs] |
|---------|--------------|
| 1/24 | 6 |
| 1/12 | 9 |
| 1/8 | 14 |

Materials

Transmitter housing

Housing of Proline 500 – digital transmitter

Order code for "Transmitter housing":

- Option **A** "Aluminum coated": aluminum, AlSi10Mg, coated
- Option **D** "Polycarbonate": polycarbonate

Housing of Proline 500 transmitter

Order code for "Transmitter housing":

- Option **A** "Aluminum coated": aluminum, AlSi10Mg, coated
- Option **L** "Cast, stainless": cast, stainless steel, 1.4409 (CF3M) similar to 316L

Window material

Order code for "Transmitter housing":

- Option **A** "Aluminum, coated": glass
- Option **D** "Polycarbonate": plastic
- Option **L** "Cast, stainless": glass

Fastening components for mounting on a post



- Screws, threaded bolts, washers, nuts: stainless A2 (chrome-nickel steel)
- Metal plates: stainless steel, 1.4301 (304)

Sensor connection housing

Order code for "Sensor connection housing":

- Option **A** "Aluminum coated": aluminum, AlSi10Mg, coated
- Option **B** "Stainless":
Stainless steel 1.4301 (304)
- Option **C** "Ultra-compact, stainless":
Stainless steel 1.4301 (304)
- Option **L** "Cast, stainless": 1.4409 (CF3M) similar to 316L

Cable entries/cable glands

| Cable entries and adapters | Material |
|---|--------------------------------|
| Cable gland M20 × 1.5 | Plastic |
| <ul style="list-style-type: none"> ■ Adapter for cable entry with female thread G ½" ■ Adapter for cable entry with female thread NPT ½" <p> Only available for certain device versions:</p> <ul style="list-style-type: none"> ■ Order code for "Transmitter housing": <ul style="list-style-type: none"> ■ Option A "Aluminum, coated" ■ Option D "Polycarbonate" ■ Order code for "Sensor connection housing": <ul style="list-style-type: none"> ■ Proline 500 – digital: Option A "Aluminum coated" Option B "Stainless" ■ Proline 500: Option B "Stainless" | Nickel-plated brass |
| <p>Adapter for device plug</p> <p> Device plug for digital communication: Only available for certain device versions .</p> <ul style="list-style-type: none"> ■ Device plug for connecting cable: A device plug is always used for the device version, order code for "Sensor connection housing", option C (ultra-compact, hygienic, stainless). | Stainless steel, 1.4404 (316L) |

Device plug

| Electrical connection | Material |
|-----------------------|---|
| Plug M12x1 | <ul style="list-style-type: none"> ■ Socket: Stainless steel, 1.4404 (316L) ■ Contact housing: Polyamide ■ Contacts: Gold-plated brass |

Connecting cables

 UV rays can impair the cable outer sheath. Protect the cable from exposure to sun as much as possible.

Connecting cable for sensor - Proline 500 – digital transmitter

PVC cable with copper shield

Connecting cable for sensor - Proline 500 transmitter

PVC cable with copper shield

Sensor housing

- Acid and alkali-resistant outer surface
- Stainless steel, 1.4404 (316L)

Measuring tubes

Order code for "Measuring tube mat., wetted surface", option BB, BF, SA

Stainless steel, 1.4435 (316/316L)

Order code for "Measuring tube mat., wetted surface", option HA, HB, HC, HD

Alloy C22, 2.4602 (UNS N06022)

Process connections

Order code for "Measuring tube mat., wetted surface", option SA

| | |
|--|------------------------------------|
| VCO coupling | Stainless steel, 1.4404 (316/316L) |
| G ¹ / ₄ ", G ¹ / ₂ " female thread | Stainless steel, 1.4404 (316/316L) |
| NPT ¹ / ₄ ", NPT ¹ / ₂ " female thread | Stainless steel, 1.4404 (316/316L) |
| Tri-Clamp ¹ / ₂ " | Stainless steel, 1.4435 (316L) |
| Fixed flange EN 1092-1, ASME B16.5, JIS B2220 | Stainless steel, 1.4404 (316/316L) |

Order code for "Measuring tube mat., wetted surface", option BB, BF

| | |
|---|------------------------------------|
| VCO coupling | Stainless steel, 1.4404 (316/316L) |
| Tri-Clamp ¹ / ₂ " | Stainless steel, 1.4435 (316L) |

Order code for "Measuring tube mat., wetted surface", option HC, HD



| | |
|---|--------------------------------|
| VCO coupling | Alloy C22, 2.4602 (UNS N06022) |
| Tri-Clamp ¹ / ₂ " | Alloy C22, 2.4602 (UNS N06022) |

Order code for "Measuring tube mat., wetted surface", option HA

| | |
|---|---|
| VCO coupling | Alloy C22, 2.4602 (UNS N06022) |
| G$\frac{1}{4}$", G$\frac{1}{2}$" female thread | Alloy C22, 2.4602 (UNS N06022) |
| NPT$\frac{1}{4}$", NPT$\frac{1}{2}$" female thread | Alloy C22, 2.4602 (UNS N06022) |
| Fixed flange EN 1092-1, ASME B16.5, JIS B2220 | Alloy C22, 2.4602 (UNS N06022) |
| Lap joint flange EN 1092-1, ASME B16.5, JIS B2220 | Stainless steel, 1.4301 (F304), wetted parts Alloy C22, 2.4602 (UNS N06022) |

Order code for "Measuring tube mat., wetted surface", option HB (high-pressure option)

| | |
|---|--|
| VCO coupling | Alloy C22, 2.4602 (UNS N06022) |
| G$\frac{1}{4}$", G$\frac{1}{2}$" female thread | Alloy C22, 2.4602 (UNS N06022) |
| NPT$\frac{1}{4}$", NPT$\frac{1}{2}$" female thread | Alloy C22, 2.4602 (UNS N06022) |
| Fixed flange EN 1092-1, ASME B16.5, JIS B2220 | Stainless steel, 1.4404 (316/316L); Alloy C22, 2.4602 (UNS N06022) |

 Available process connections →  230

Seals

Welded process connections without internal seals

Accessories

Sensor holder

Stainless steel, 1.4404 (316L)

Heating jacket

- Heating jacket housing: stainless steel, 1.4571 (316Ti)
- NPT adapter $\frac{1}{2}$ " : stainless steel, 1.4404 (316)
- G $\frac{1}{2}$ " adapter: stainless steel, 1.4404

Protective cover



Stainless steel, 1.4404 (316L)

External WLAN antenna

- Antenna: ASA plastic (acrylonitrile styrene acrylate) and nickel-plated brass
- Adapter: Stainless steel and nickel-plated brass
- Cable: Polyethylene
- Plug: Nickel-plated brass
- Angle bracket: Stainless steel

Process connections

- Fixed flange connections:
 - EN 1092-1 (DIN 2501) flange
 - EN 1092-1 (DIN 2512N) flange
 - ASME B16.5 flange
 - JIS B2220 flange
- Clamp connections:
 - Tri-Clamp (OD tubes), DIN 11866 series C
- VCO connections:
 - 4-VCO-4
- Internal thread:
 - Cylindrical internal thread BSPP (G) in accordance with ISO 228-1
 - NPT

 Process connection materials →  228

Surface roughness

All data refer to parts in contact with the medium.

The following surface roughness categories can be ordered:

| Category | Method | Option(s) order code "Measuring tube mat., wetted surface" |
|---|-------------------------------------|---|
| Not polished | – | HA, HB, SA |
| $Ra \leq 0.76 \mu\text{m}$ (30 μin) ¹⁾ | Mechanically polished ²⁾ | BB, HC |
| $Ra \leq 0.38 \mu\text{m}$ (15 μin) ¹⁾ | Mechanically polished ²⁾ | BF, HD |

1) Ra according to ISO 21920
 2) Except for inaccessible welds between pipe and manifold

16.11 User interface

Languages

Can be operated in the following languages:

- Via local operation
 - English, German, French, Spanish, Italian, Dutch, Portuguese, Polish, Russian, Turkish, Chinese, Japanese, Korean, Vietnamese, Czech, Swedish
- Via web browser
 - English, German, French, Spanish, Italian, Dutch, Portuguese, Polish, Russian, Turkish, Chinese, Japanese, Vietnamese, Czech, Swedish
- Via "FieldCare", "DeviceCare" operating tool: English, German, French, Spanish, Italian, Chinese, Japanese

Onsite operation

Via display module

Features:

- Order code for "Display; operation", option F "4-line, illuminated, graphic display; touch control"
- Order code for "Display; operation", option G "4-line, illuminated, graphic display; touch control + WLAN"

 Information about WLAN interface →  84

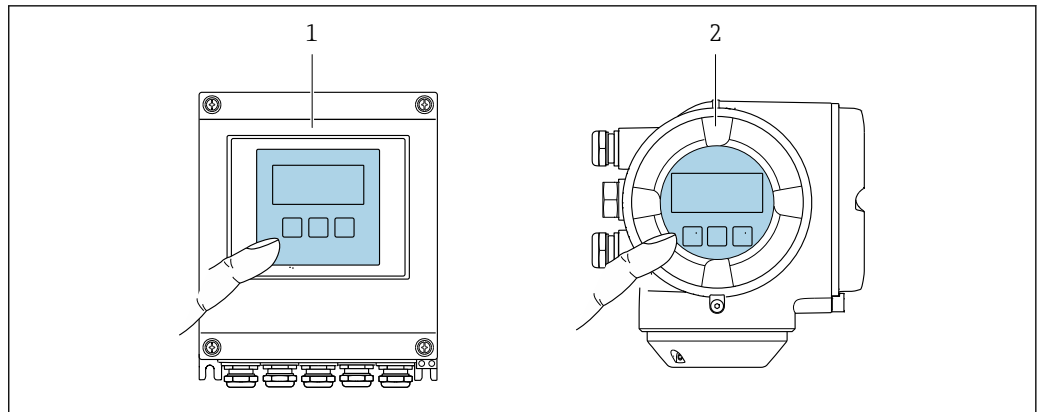

A0028232



41 Operation with touch control

- 1 Proline 500 – digital
- 2 Proline 500

Display elements

- 4-line, illuminated, graphic display
- White background lighting; switches to red in event of device errors
- Format for displaying measured variables and status variables can be individually configured



Operating elements

- External operation via touch control (3 optical keys) without opening the housing: , , 
- Operating elements also accessible in the various zones of the hazardous area

Remote operation →  83

Service interface →  83

Supported operating tools Different operating tools can be used for local or remote access to the measuring device. Depending on the operating tool used, access is possible with different operating units and via a variety of interfaces.

| Supported operating tools | Operating unit | Interface | Additional information |
|---------------------------|--|---|--|
| Web browser | Notebook, PC or tablet with Web browser | <ul style="list-style-type: none"> ■ CDI-RJ45 service interface ■ WLAN interface | Special Documentation for device →  239 |
| DeviceCare SFE100 | Notebook, PC or tablet with Microsoft Windows system | <ul style="list-style-type: none"> ■ CDI-RJ45 service interface ■ WLAN interface ■ Fieldbus protocol | →  207 |
| FieldCare SFE500 | Notebook, PC or tablet with Microsoft Windows system | <ul style="list-style-type: none"> ■ CDI-RJ45 service interface ■ WLAN interface ■ Fieldbus protocol | →  207 |

| Supported operating tools | Operating unit | Interface | Additional information |
|---------------------------|--|---|--|
| Field Xpert | SMT70/77/50 | <ul style="list-style-type: none"> ▪ All fieldbus protocols ▪ WLAN interface ▪ Bluetooth ▪ CDI-RJ45 service interface | Operating Instructions BA01202S Device description files: Use update function of handheld terminal |
| SmartBlue app | Smartphone or tablet with iOS or Android | WLAN | →  207 |

 Other operating tools based on FDT technology with a device driver such as DTM/iDTM or DD/EDD can be used for device operation. These operating tools are available from the individual manufacturers. Integration into the following operating tools, among others, is supported:

- FactoryTalk AssetCentre (FTAC) from Rockwell Automation → www.rockwellautomation.com
- Asset Management Solutions (AMS) from Emerson → www.emersonprocess.com
- FieldCommunicator 375/475 from Emerson → www.emersonprocess.com
- Field Device Manager (FDM) from Honeywell → www.process.honeywell.com
- FieldMate from Yokogawa → www.yokogawa.com
- PACTWare → www.pactware.com

The related device description files are available: www.endress.com → Download Area



Web server

With the integrated web server, the device can be operated and configured via a web browser service interface (CDI-RJ45) or WLAN interface. The structure of the operating menu is the same as for the local display. In addition to the measured values, status information on the device is displayed and can be used to monitor device health. Furthermore the device data can be managed and the network parameters can be configured.

A device that has a WLAN interface (can be ordered as an option) is required for the WLAN connection: order code for "Display; operation", option G "4-line, illuminated; touch control + WLAN". The device acts as an Access Point and enables communication by computer or a mobile handheld terminal.

Supported functions

Data exchange between the operating unit (such as a notebook, for example,) and measuring instrument:

- Upload the configuration from the measuring instrument (XML format, configuration backup)
- Save the configuration to the measuring instrument (XML format, restore configuration)
- Export event list (.csv file)
- Export parameter settings (.csv file or PDF file, document the measuring point configuration)
- Export the Heartbeat Technology verification report (PDF file, only available with the **Heartbeat Verification** →  237 application package)
- Flash firmware version for device firmware upgrade, for example
- Download driver for system integration
- Visualize up to 1000 saved measured values (only available with the **Extended HistoROM** application package →  237)

HistoROM data management The measuring device features HistoROM data management. HistoROM data management comprises both the storage and import/export of key device and process data, making operation and servicing far more reliable, secure and efficient.



When the device is delivered, the factory settings of the configuration data are stored as a backup in the device memory. This memory can be overwritten with an updated data record, for example after commissioning.

Additional information on the data storage concept

There are different types of data storage units in which device data are stored and used by the device:

| | HistoROM backup | T-DAT | S-DAT |
|-------------------------|--|--|---|
| Available data | <ul style="list-style-type: none"> ■ Event logbook, e.g. diagnostic events ■ Parameter data record backup ■ Device firmware package ■ Driver for system integration for exporting via web server, e.g.: DD for FOUNDATION Fieldbus | <ul style="list-style-type: none"> ■ Measured value logging ("Extended HistoROM" order option) ■ Current parameter data record (used by firmware at run time) ■ Indicator (minimum/maximum values) ■ Totalizer value | <ul style="list-style-type: none"> ■ Sensor data: e.g. nominal diameter ■ Serial number ■ Calibration data ■ Device configuration (e.g. SW options, fixed I/O or multi I/O) |
| Storage location | Fixed on the user interface PC board in the connection compartment | Can be plugged into the user interface PC board in the connection compartment | In the sensor plug in the transmitter neck part |

Data backup

Automatic

- The most important device data (sensor and transmitter) are automatically saved in the DAT modules
- If the transmitter or measuring device is replaced: once the T-DAT containing the previous device data has been exchanged, the new measuring device is ready for operation again immediately without any errors
- If the sensor is replaced: once the sensor has been replaced, new sensor data are transferred from the S-DAT in the measuring device and the measuring device is ready for operation again immediately without any errors
- If exchanging the electronics module (e.g. I/O electronics module): Once the electronics module has been replaced, the software of the module is compared against the current device firmware. The module software is upgraded or downgraded where necessary. The electronics module is available for use immediately afterwards and no compatibility problems occur.

Manual

Additional parameter data record (complete parameter settings) in the integrated device memory HistoROM backup for:

- Data backup function
Backup and subsequent restoration of a device configuration in the device memory HistoROM backup
- Data comparison function
Comparison of the current device configuration with the device configuration saved in the device memory HistoROM backup

Data transmission

Manual

- Transfer of a device configuration to another device using the export function of the specific operating tool, e.g. with FieldCare, DeviceCare or Web server: to duplicate the configuration or to store in an archive (e.g. for backup purposes)
- Transmission of the drivers for system integration via Web server, e.g.: DD for FOUNDATION Fieldbus

Event list

Automatic

- Chronological display of up to 20 event messages in the events list
- If the **Extended HistoROM** application package (order option) is enabled: up to 100 event messages are displayed in the events list along with a time stamp, plain text description and remedial measures
- The events list can be exported and displayed via a variety of interfaces and operating tools e.g. DeviceCare, FieldCare or Web server

Data logging

Manual

If the **Extended HistoROM** application package (order option) is enabled:

- Recording of 1 to 4 channels of up to 1 000 measured values (up to 250 measured values per channel)
- User configurable recording interval
- Export the measured value log via a variety of interfaces and operating tools e.g. FieldCare, DeviceCare or web server

16.12 Certificates and approvals

Current certificates and approvals for the product are available at www.endress.com on the relevant product page:

1. Select the product using the filters and search field.
2. Open the product page.
3. Select **Downloads**.

CE mark

The device meets the legal requirements of the applicable EU Directives. These are listed in the corresponding EU Declaration of Conformity along with the standards applied.

Endress+Hauser confirms successful testing of the device by affixing to it the CE mark.

UKCA marking



The device meets the legal requirements of the applicable UK regulations (Statutory Instruments). These are listed in the UKCA Declaration of Conformity along with the designated standards. By selecting the order option for UKCA marking, Endress+Hauser confirms a successful evaluation and testing of the device by affixing the UKCA mark.

Contact address Endress+Hauser UK:

Endress+Hauser Ltd.
Floats Road
Manchester M23 9NF
United Kingdom
www.uk.endress.com

RCM marking

The measuring system meets the EMC requirements of the "Australian Communications and Media Authority (ACMA)".

| | |
|-----------------------------------|--|
| Hygienic compatibility | <ul style="list-style-type: none"> ■ 3-A approval <ul style="list-style-type: none"> ■ Only measuring instruments with the order code for "Additional approval", option LP "3A" have 3-A approval. ■ The 3-A approval refers to the measuring instrument. ■ When installing the measuring instrument, ensure that no liquid can accumulate on the outside of the measuring instrument. A remote display module must be installed in accordance with the 3-A Standard. ■ Accessories (e.g. heating jacket, weather protection cover, wall holder unit) must be installed in accordance with the 3-A Standard. Each accessory can be cleaned. Disassembly may be necessary under certain circumstances. ■ FDA ■ Food Contact Materials Regulation (EC) 1935/2004 <p> Observe the special installation instructions</p> |
| FOUNDATION Fieldbus certification | <p>FOUNDATION Fieldbus interface</p> <p>The measuring device is certified and registered by the FieldComm Group. The measuring system meets all the requirements of the following specifications:</p> <ul style="list-style-type: none"> ■ Certified in accordance with FOUNDATION Fieldbus H1 ■ Interoperability Test Kit (ITK), revision version 6.2.0 (certificate available on request) ■ Physical Layer Conformance Test ■ The device can also be operated with certified devices of other manufacturers (interoperability) |
| Radio approval | <p>The measuring device has radio approval.</p> <p> For detailed information on the radio approval, see the Special Documentation →  239</p> |
| Additional certification | <p>CRN approval</p> <p>Some device versions have CRN approval. A CRN-approved process connection with a CSA approval must be ordered for a CRN-approved device.</p> <p>Tests and certificates</p> <ul style="list-style-type: none"> ■ Radiographic testing ISO 10675-1 ZG1 (RT), process connection, weld seam, Heartbeat Technology verification report ■ Radiographic testing ASME B31.3 NFS (RT), process connection, weld seam, Heartbeat Technology verification report ■ Radiographic testing ASME VIII Div.1 (RT), process connection, weld seam, Heartbeat Technology verification report ■ Radiographic testing NORSOK M-601 (RT), process connection, weld seam, Heartbeat Technology verification report ■ Radiographic testing ISO 10675-1 ZG1 (DR), process connection, weld seam, Heartbeat Technology verification report ■ Radiographic testing ASME B31.3 NFS (DR), process connection, weld seam, Heartbeat Technology verification report ■ Radiographic testing ASME VIII Div.1 (DR), process connection, weld seam, Heartbeat Technology verification report ■ Radiographic testing NORSOK M-601 (DR), process connection, weld seam, Heartbeat Technology verification report |

Testing of welded connections

| Option | Test standard | | | | Process connection |
|---|-----------------|----------------|-----------------|--------------|--------------------|
| | ISO 10675-1 AL1 | ASME B31.3 NFS | ASME VIII Div.1 | NORSOK M-601 | |
| KE | x | | | | RT |
| KI | | x | | | RT |
| KN | | | x | | RT |
| KS | | | | x | RT |
| K5 | x | | | | DR |
| K6 | | x | | | DR |
| K7 | | | x | | DR |
| K8 | | | | x | DR |
| RT = Radiographic testing, DR = Digital radiography All options with test report | | | | | |



External standards and guidelines



- EN 60529
Degrees of protection provided by enclosures (IP code)
- IEC/EN 60068-2-6
Environmental influences: Test procedure - Test Fc: vibrate (sinusoidal).
- IEC/EN 60068-2-31
Environmental influences: Test procedure - Test Ec: shocks due to rough handling, primarily for devices.
- EN 61010-1
Safety requirements for electrical equipment for measurement, control and laboratory use - general requirements
- EN 61326-1/-2-3
EMC requirements for electrical equipment for measurement, control and laboratory use
- NAMUR NE 21
Electromagnetic compatibility (EMC) of industrial process and laboratory control equipment
- NAMUR NE 32
Data retention in the event of a power failure in field and control instruments with microprocessors
- NAMUR NE 43
Standardization of the signal level for the breakdown information of digital transmitters with analog output signal.
- NAMUR NE 53
Software of field devices and signal-processing devices with digital electronics
- NAMUR NE 105
Specifications for integrating fieldbus devices in engineering tools for field devices
- NAMUR NE 107
Self-monitoring and diagnosis of field devices
- NAMUR NE 131
Requirements for field devices for standard applications
- NAMUR NE 132
Coriolis mass meter
- ETSI EN 300 328
Guidelines for 2.4 GHz radio components.
- EN 301489
Electromagnetic compatibility and radio spectrum matters (ERM).

16.13 Application packages

Many different application packages are available to enhance the functionality of the device. Such packages might be needed to address safety aspects or specific application requirements.

The application packages can be ordered with the device or subsequently from Endress+Hauser. Detailed information on the order code in question is available from your local Endress+Hauser sales center or on the product page of the Endress+Hauser website: www.endress.com.

 Detailed information on the application packages:
Special Documentation →  239

| | |
|---------------------------|---|
| Diagnostic functionality | <p>Order code for "Application package", option EA "Extended HistoROM"</p> <p>Comprises extended functions concerning the event log and the activation of the measured value memory.</p> <p>Event log: Memory volume is extended from 20 message entries (standard version) to up to 100 entries.</p> <p>Data logging (line recorder):</p> <ul style="list-style-type: none"> ■ Memory capacity for up to 1000 measured values is activated. ■ 250 measured values can be output via each of the 4 memory channels. The recording interval can be defined and configured by the user. ■ Measured value logs can be accessed via the local display or operating tool e.g. FieldCare, DeviceCare or Web server. <p> For detailed information, see the Operating Instructions for the device.</p> |
| Heartbeat Technology | <p>Order code for "Application package", option EB "Heartbeat Verification + Monitoring"</p> <p>Heartbeat Verification Meets the requirement for traceable verification to DIN ISO 9001:2008 Chapter 7.6 a) "Control of monitoring and measuring equipment".</p> <ul style="list-style-type: none"> ■ Functional testing in the installed state without interrupting the process. ■ Traceable verification results on request, including a report. ■ Simple testing process via local operation or other operating interfaces. ■ Clear measuring point assessment (pass/fail) with high test coverage within the framework of manufacturer specifications. ■ Extension of calibration intervals according to operator's risk assessment. <p>Heartbeat Monitoring Continuously supplies data, which are characteristic of the measuring principle, to an external condition monitoring system for the purpose of preventive maintenance or process analysis. These data enable the operator to:</p> <ul style="list-style-type: none"> ■ Draw conclusions - using these data and other information - about the impact process influences (e.g. corrosion, abrasion, buildup etc.) have on the measuring performance over time. ■ Schedule servicing in time. ■ Monitor the process or product quality, e.g. gas pockets . <p> For detailed information, see the Special Documentation for the device.</p> |
| Concentration measurement | <p>Order code for "Application package", option ED "Concentration"</p> <p>Calculation and outputting of fluid concentrations.</p> |

The measured density is converted to the concentration of a substance of a binary mixture using the "Concentration" application package:

- Choice of predefined fluids (e.g. various sugar solutions, acids, alkalis, salts, ethanol etc.).
- Common or user-defined units ("Brix", "Plato", % mass, % volume, mol/l etc.) for standard applications.
- Concentration calculation from user-defined tables.

 For detailed information, see the Special Documentation for the device.

Special density



Order code for "Application package", option EE "Special density"

Many applications use density as a key measured value for monitoring quality or controlling processes. The measuring instrument measures the density of the fluid as standard and makes this value available to the control system.

The "Special Density" application package offers high-precision density measurement over a wide density and temperature range particularly for applications subject to varying process conditions.

 For detailed information, see the Operating Instructions for the device.

16.14 Accessories

 Overview of accessories available to order →  205

16.15 Supplemental documentation

 For an overview of the scope of the associated Technical Documentation, refer to the following:

- *Device Viewer* (www.endress.com/deviceviewer): Enter the serial number from the nameplate
- *Endress+Hauser Operations app*: Enter serial number from nameplate or scan matrix code on nameplate.

Standard documentation **Brief operating instructions**

Brief Operating Instructions for the sensor

| Measuring instrument | Documentation code |
|----------------------|--------------------|
| Proline Promass A | KA01282D |

Brief Operating Instructions for the transmitter

| Measuring device | Documentation code |
|-----------------------|--------------------|
| Proline 500 – digital | KA01233D |
| Proline 500 | KA01291D |

Technical information

| Measuring device | Documentation code |
|------------------|--------------------|
| Promass A 500 | TI01375D |

Description of device parameters

| Measuring instrument | Documentation code |
|----------------------|--------------------|
| Promass 500 | GP01096D |

Supplementary device-
dependent documentation



Safety instructions

Safety instructions for electrical equipment for hazardous areas.

Special documentation

| Contents | Documentation code |
|---|--------------------|
| Information on the Pressure Equipment Directive | SD01614D |
| Radio approvals for WLAN interface for A309/A310 display module | SD01793D |
| Web server | SD01669D |
| Heartbeat Technology | SD01703D |
| Concentration measurement | SD01709D |

Installation instructions

| Contents | Note |
|---|---|
| Installation instructions for spare part sets and accessories | <ul style="list-style-type: none"> ▪ Access the overview of all the available spare part sets via <i>Device Viewer</i> →  203 ▪ Accessories available for order with Installation Instructions →  205 |

Index

- 0 ... 9**
- 3-A approval 235
- A**
- Access authorization to parameters
 - Read access 75
 - Write access 75
 - Access code 75
 - Incorrect input 75
 - Adapting the diagnostic behavior 169
 - Adapting the status signal 169
 - Additional certification 235
 - Ambient conditions
 - Mechanical load 224
 - Operating height 223
 - Relative humidity 223
 - Shock and vibration resistance 224
 - Storage temperature 223
 - Ambient temperature
 - Influence 221
 - Ambient temperature range 223
 - AMS Device Manager 88
 - Function 88
 - Application 209
 - Application packages 237
 - Applicator 210
 - Approvals 234
 - Attaching the connecting cable
 - Proline 500 transmitter 53
- C**
- Cable entries
 - Technical data 219
 - Cable entry
 - Degree of protection 60
 - CE mark 10, 234
 - Certificates 234
 - Checklist
 - Post-connection check 60
 - Post-installation check 34
 - CIP cleaning 224
 - Cleaning
 - CIP cleaning 202
 - Exterior cleaning 202
 - Internal cleaning 202
 - SIP cleaning 202
 - Climate class 223
 - Commissioning 95
 - Advanced settings 122
 - Configuring the measuring instrument 96
 - Connecting the connecting cable
 - Proline 500 – digital transmitter 47
 - Sensor connection housing, Proline 500 - digital 43
 - Terminal assignment of Proline 500 - digital 43
 - Connecting the measuring instrument
 - Proline 500 50
 - Proline 500 – digital 43
 - Connecting the signal cable/supply voltage cable
 - Proline 500 – digital transmitter 48
 - Proline 500 transmitter 54
 - Connection
 - see Electrical connection
 - Connection cable 35
 - Connection preparations 42
 - Connection tool 35
 - Context menu
 - Calling up 71
 - Closing 71
 - Explanation 71
 - Current consumption 218
 - Cyclic data transmission 89
- D**
- Date of manufacture 16, 18
 - Declaration of Conformity 10
 - Defining the access code 142, 143
 - Degree of protection 60, 223
 - Density adjustment 125
 - Design
 - Measuring device 13
 - Operating menu 62
 - Design fundamentals
 - Measurement error 222
 - Repeatability 222
 - Device components 13
 - Device description files 89
 - Device locking, status 147
 - Device name
 - Sensor 18
 - Transmitter 16
 - Device repair 203
 - Device revision 89
 - Device type code 89
 - Device Viewer 203
 - DeviceCare 88
 - Device description file 89
 - Diagnosis
 - Symbols 164
 - Diagnostic behavior
 - Explanation 165
 - Symbols 165
 - Diagnostic information
 - Design, description 165, 168
 - DeviceCare 167
 - FieldCare 167
 - Light emitting diodes 161
 - Local display 164
 - Overview 173
 - Remedial measures 173
 - Web browser 166
 - Diagnostic message 164
 - DIAGNOSTIC Transducer Block 195

- Diagnostics list 195
 - DIP switch
 - see Write protection switch
 - Direct access 73
 - Disabling write protection 142
 - Display
 - see Local display
 - Display area
 - For operational display 65
 - In the navigation view 67
 - Display values
 - For locking status 147
 - Displaying the measured value history 156
 - Disposal 204
 - Document
 - Function 6
 - Symbols 6
 - Document function 6
 - Down pipe 22
- E**
- Editing view 69
 - Input screen 70
 - Using operating elements 69, 70
 - EHEDG-tested 235
 - Electrical connection
 - Degree of protection 60
 - Measuring instrument 35
 - Operating tools
 - Via FOUNDATION Fieldbus network 83
 - Via service interface (CDI-RJ45) 83
 - Via WLAN interface 84
 - Web server 83
 - WLAN interface 84
 - Electromagnetic compatibility 224
 - Electronics module 13
 - Enabling write protection 142
 - Enabling/disabling the keypad lock 76
 - Endress+Hauser services
 - Maintenance 202
 - Repair 203
 - Error messages
 - see Diagnostic messages
 - Event logbook 196
 - Events list 196
 - Extended order code
 - Sensor 18
 - Transmitter 16
 - Exterior cleaning 202
- F**
- FDA 235
 - Field Communicator
 - Function 88
 - Field Communicator 475 88
 - Field of application
 - Residual risks 10
 - Field Xpert
 - Function 86
 - Field Xpert SFX350 86
 - FieldCare 86
 - Device description file 89
 - Establishing a connection 87
 - Function 86
 - User interface 87
 - Filtering the event logbook 197
 - Firmware
 - Release date 89
 - Version 89
 - Firmware history 201
 - Fitting the connecting cable
 - Proline 500 terminal assignment 50
 - Sensor connection housing, Proline 500 50
 - Flow direction 22, 29
 - Flow limit 226
 - Food Contact Materials Regulation 235
 - FOUNDATION Fieldbus certification 235
 - Function range
 - AMS Device Manager 88
 - Function scope
 - Field Communicator 88
 - Field Communicator 475 88
 - Field Xpert 86
 - Functions
 - see Parameters
- G**
- Galvanic isolation 217
- H**
- Hardware write protection 144
 - Help text
 - Calling up 74
 - Closing 74
 - Explanation 74
 - HistoROM 136
 - Hygienic compatibility 235
- I**
- Identifying the measuring instrument 15
 - Incoming acceptance 15
 - Indication
 - Current diagnostic event 194
 - Previous diagnostic event 194
 - Influence
 - Ambient temperature 221
 - Medium pressure 222
 - Medium temperature 221
 - Process density 222
 - Information about this document 6
 - Inlet runs 23
 - Input variables 210
 - Inspection
 - Connection 60
 - Installation 34
 - Received goods 15
 - Installation 21
 - Installation dimensions 23

- Installation point 21
- Intended use 9
- Internal cleaning 202, 224
- L**
- Languages, operation options 230
- Line recorder 156
- Local display 230
 - Navigation view 67
 - see Diagnostic message
 - see In alarm condition
 - see Operational display
 - Text editor 69
- Low flow cut off 217
- M**
- Main electronics module 13
- Maintenance work 202
- Managing the device configuration 136
- Manufacturer ID 89
- Materials 227
- Maximum measurement error 219
- Measured variables
 - see Process variables
- Measurement accuracy 219
- Measuring and test equipment 202
- Measuring device
 - Conversion 203
 - Design 13
 - Disposal 204
 - Mounting the sensor 29
 - Preparing for electrical connection 42
 - Removing 204
 - Repairs 203
 - Switching on 95
- Measuring instrument
 - Configuring 96
 - Preparing for mounting 29
- Measuring principle 209
- Measuring range
 - For gases 210
 - For liquids 210
- Measuring range, recommended 226
- Measuring system 209
- Mechanical load 224
- Medium pressure
 - Influence 222
- Medium temperature
 - Influence 221
- Menu
 - Diagnostics 194
 - Setup 97
- Menus
 - For measuring instrument configuration 96
 - For specific settings 122
- Mounting dimensions
 - see Installation dimensions
- Mounting preparations 29
- Mounting requirements
 - Down pipe 22
 - Inlet and outlet runs 23
 - Installation dimensions 23
 - Installation point 21
 - Orientation 22
 - Rupture disk 25
 - Sensor heating 24
 - Static pressure 23
 - Thermal insulation 24
 - Vibrations 25
- Mounting tool 29
- N**
- Nameplate
 - Sensor 18
 - Transmitter 16
- Navigation path (navigation view) 67
- Navigation view
 - In the submenu 67
 - In the wizard 67
- Netilion 202
- Numeric editor 69
- O**
- Onsite display
 - Numeric editor 69
- Operable flow range 210
- Operating elements 71, 165
- Operating height 223
- Operating keys
 - see Operating elements
- Operating menu
 - Design 62
 - Menus, submenus 62
 - Submenus and user roles 63
- Operating philosophy 63
- Operation 147
- Operation options 61
- Operational display 64
- Operational safety 10
- Order code 16, 18
- Orientation (vertical, horizontal) 22
- Outlet runs 23
- Output signal 212
- Output variables 212
- P**
- Packaging disposal 21
- Parameter
 - Changing 74
 - Entering values or text 74
- Parameter settings
 - Administration (Submenu) 138
 - Advanced setup (Submenu) 123
 - Analog inputs (Submenu) 102
 - Configuration backup (Submenu) 136
 - Corrected volume flow calculation (Submenu) 123
 - Current input 103

- Current input (Wizard) 103
- Current input 1 to n (Submenu) 151
- Current output 105
- Current output (Wizard) 105
- Data logging (Submenu) 156
- Define access code (Wizard) 138
- Density adjustment (Wizard) 125
- Device information (Submenu) 199
- Diagnostics (Menu) 194
- Display (Submenu) 132
- Display (Wizard) 117
- I/O configuration 102
- I/O configuration (Submenu) 102
- Low flow cut off (Wizard) 120
- Measured variables (Submenu) 148
- Medium selection (Wizard) 100
- Partially filled pipe detection (Wizard) 121
- Pulse/frequency/switch output 108
- Pulse/frequency/switch output (Wizard) 108, 109, 113
- Pulse/frequency/switch output 1 to n (Submenu) 153
- Relay output 115
- Relay output 1 to n (Submenu) 153
- Relay output 1 to n (Wizard) 115
- Reset access code (Submenu) 138
- Sensor adjustment (Submenu) 124
- Setup (Menu) 97
- Simulation (Submenu) 139
- Status input 104
- Status input 1 to n (Submenu) 151
- Status input 1 to n (Wizard) 104
- System units (Submenu) 97
- Totalizer (Submenu) 150
- Totalizer 1 to n (Submenu) 130
- Totalizer handling (Submenu) 154
- Value current output 1 to n (Submenu) 152
- Web server (Submenu) 82
- WLAN settings (Wizard) 135
- Zero adjustment (Wizard) 129
- Zero verification (Wizard) 128
- Performance characteristics 219
- Performing density adjustment 125
- Post-connection check 95
- Post-connection check (checklist) 60
- Post-installation check 95
- Post-installation check (checklist) 34
- Potential equalization 56
- Power consumption 218
- Power supply failure 218
- Pressure loss 226
- Pressure-temperature ratings 225
- Process connections 230
- Process density
 - Influence 222
- Process variables
 - Calculated 210
 - Measured 210
- Product safety 10
- Proline 500 – digital transmitter
 - Connecting the signal cable/supply voltage cable 48
- Proline 500 connecting cable terminal assignment
 - Sensor connection housing 50
- Proline 500 transmitter
 - Connecting the signal cable/supply voltage cable 54
- Protecting parameter settings 142
- R**
 - Radio approval 235
 - RCM marking 234
 - Read access 75
 - Reading off measured values 147
 - Recalibration 202
 - Reference operating conditions 219
 - Registered trademarks 8
 - Remedial measures
 - Calling up 166
 - Closing 166
 - Remote operation 231
 - Repair 203
 - Notes 203
 - Repair of a device 203
 - Repeatability 221
 - Replacement
 - Device components 203
 - Requirements for personnel 9
 - Response time 221
 - Return 203
 - Rupture disk
 - Safety instructions 25
 - Triggering pressure 225
- S**
 - Safety 9
 - Sensor
 - Installing 29
 - Sensor heating 24
 - Sensor housing 225
 - Serial number 16, 18
 - Setting the operating language 95
 - Settings
 - Adapting the measuring device to the process conditions 154
 - Administration 137
 - Advanced display configurations 132
 - Analog input 102
 - Current input 103
 - Current output 105
 - Device tag 97
 - I/O configuration 102
 - Local display 117
 - Low flow cut off 120
 - Managing the device configuration 136
 - Medium 100
 - Operating language 95
 - Partially filled pipe detection 121
 - Pulse output 108
 - Pulse/frequency/switch output 108, 109

- Relay output 115
- Resetting the device 198
- Resetting the totalizer 154
- Restarting the device 198
- Sensor adjustment 124
- Simulation 139
- Status input 104
- Switch output 113
- System units 97
- Totalizer 130
- Totalizer reset 154
- WLAN 135
- Shock and vibration resistance 224
- Signal on alarm 215
- SIP cleaning 224
- Software release 89
- Spare part 203
- Spare parts 203
- Special connection instructions 57
- Special mounting instructions
 - Hygienic compatibility 25
- Standards and guidelines 236
- Static pressure 23
- Status area
 - For operational display 65
 - In the navigation view 67
- Status signals 164, 167
- Storage concept 233
- Storage conditions 20
- Storage temperature 20
- Storage temperature range 223
- Submenu
 - Administration 137, 138
 - Advanced setup 122, 123
 - Analog inputs 102
 - Calculated values 123
 - Configuration backup 136
 - Corrected volume flow calculation 123
 - Current input 1 to n 151
 - Data logging 156
 - Device information 199
 - Display 132
 - Events list 196
 - I/O configuration 102
 - Input values 151
 - Measured values 147
 - Measured variables 148
 - Output values 152
 - Overview 63
 - Process variables 123
 - Pulse/frequency/switch output 1 to n 153
 - Relay output 1 to n 153
 - Reset access code 138
 - Sensor adjustment 124
 - Simulation 139
 - Status input 1 to n 151
 - System units 97
 - Totalizer 150
 - Totalizer 1 to n 130
 - Totalizer handling 154
 - Value current output 1 to n 152
 - Web server 82
- Supply voltage 218
- Surface roughness 230
- Switch output 214
- Symbols
 - Controlling data entries 70
 - For communication 65
 - For diagnostic behavior 65
 - For locking 65
 - For measured variable 65
 - For measurement channel number 65
 - For menus 67
 - For parameters 67
 - For status signal 65
 - For submenu 67
 - For wizards 67
 - In the status area of the local display 65
 - Input screen 70
 - Operating elements 69
- System design
 - Measuring system 209
 - see Measuring device design
- System integration 89
- T**
 - Technical data, overview 209
 - Temperature range
 - Ambient temperature range for display 230
 - Medium temperature 225
 - Storage temperature 20
 - Terminal assignment 40
 - Terminal assignment of connecting cable for Proline
 - 500- digital
 - Sensor connection housing 43
 - Terminals 218
 - Tests and certificates 235
 - Text editor 69
 - Thermal insulation 24
 - Tool
 - For electrical connection 35
 - For mounting 29
 - Transport 20
 - Tool tip
 - see Help text
 - Totalizer
 - Configuring 130
 - Transmitter
 - Turning the display module 33
 - Turning the housing 33
 - Transporting the measuring device 20
 - Troubleshooting
 - General 159
 - Turning the display module 33
 - Turning the electronics housing
 - see Turning the transmitter housing
 - Turning the transmitter housing 33

U

| | |
|-----------------------------|-----|
| UKCA marking | 234 |
| Use of measuring device | |
| Borderline cases | 9 |
| Incorrect use | 9 |
| Use of measuring instrument | |
| see Intended use | |
| User roles | 63 |

V

| | |
|---------------------------------------|----|
| Version data for the device | 89 |
| Vibrations | 25 |

W

| | |
|---|---------------|
| W@M Device Viewer | 15 |
| Weight | |
| SI units | 226 |
| Transport (notes) | 20 |
| US units | 226 |
| Wizard | |
| Current input | 103 |
| Current output | 105 |
| Define access code | 138 |
| Density adjustment | 125 |
| Display | 117 |
| Low flow cut off | 120 |
| Medium selection | 100 |
| Partially filled pipe detection | 121 |
| Pulse/frequency/switch output | 108, 109, 113 |
| Relay output 1 to n | 115 |
| Status input 1 to n | 104 |
| WLAN settings | 135 |
| Zero adjustment | 129 |
| Zero verification | 128 |
| WLAN settings | 135 |
| Workplace safety | 10 |
| Write access | 75 |
| Write protection | |
| Via access code | 142 |
| Via block operation | 146 |
| Via write protection switch | 144 |
| Write protection switch | 144 |



71675065

www.addresses.endress.com
