

Operating Instructions

Proline Promass X 300

FOUNDATION Fieldbus

Coriolis flowmeter

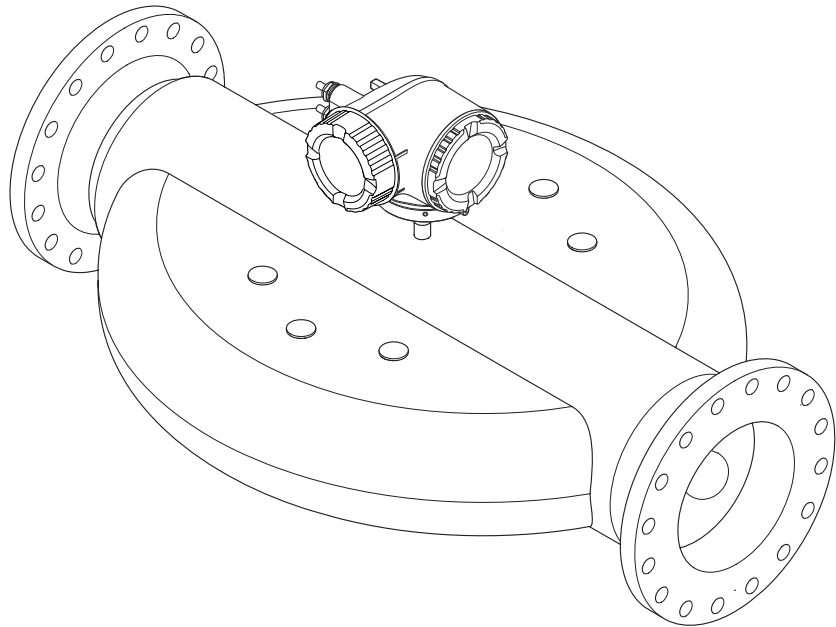

- Make sure the document is stored in a safe place such that it is always available when working on or with the device.
- To avoid danger to individuals or the facility, read the "Basic safety instructions" section carefully, as well as all other safety instructions in the document that are specific to working procedures.
- The manufacturer reserves the right to modify technical data without prior notice. Your Endress+Hauser sales organization will supply you with current information and updates to this manual.

Table of contents

1	About this document	6			
1.1	Document function	6			
1.2	Symbols	6			
1.2.1	Safety symbols	6			
1.2.2	Electrical symbols	6			
1.2.3	Communication-specific symbols	6			
1.2.4	Tool symbols	7			
1.2.5	Symbols for certain types of information	7			
1.2.6	Symbols in graphics	7			
1.3	Documentation	8			
1.4	Registered trademarks	8			
2	Safety instructions	9			
2.1	Requirements for the personnel	9			
2.2	Intended use	9			
2.3	Workplace safety	10			
2.4	Operational safety	10			
2.5	Product safety	10			
2.6	IT security	11			
2.7	Device-specific IT security	11			
2.7.1	Protecting access via hardware write protection	11			
2.7.2	Protecting access via a password	11			
2.7.3	Access via web server	12			
3	Product description	13			
3.1	Product design	13			
4	Incoming acceptance and product identification	14			
4.1	Incoming acceptance	14			
4.2	Product identification	14			
4.2.1	Transmitter nameplate	15			
4.2.2	Sensor nameplate	16			
4.2.3	Symbols on the device	17			
5	Storage and transport	18			
5.1	Storage conditions	18			
5.2	Transporting the product	18			
5.2.1	Measuring devices without lifting lugs	18			
5.2.2	Measuring devices with lifting lugs	19			
5.2.3	Transporting with a fork lift	19			
5.3	Packaging disposal	19			
6	Mounting	20			
6.1	Mounting requirements	20			
6.1.1	Installation position	20			
6.1.2	Environmental and process requirements	22			
			6.1.3	Special mounting instructions	24
			6.2	Mounting the measuring instrument	26
			6.2.1	Required tools	26
			6.2.2	Preparing the measuring instrument	27
			6.2.3	Mounting the measuring device	27
			6.2.4	Turning the transmitter housing	27
			6.2.5	Turning the display module	28
			6.3	Post-installation check	29
			7	Electrical connection	30
			7.1	Electrical safety	30
			7.2	Connecting requirements	30
			7.2.1	Required tools	30
			7.2.2	Requirements for connection cable	30
			7.2.3	Terminal assignment	33
			7.2.4	Available device plugs	33
			7.2.5	device plug pin assignment	33
			7.2.6	Shielding and grounding	33
			7.2.7	Preparing the measuring device	34
			7.3	Connecting the measuring instrument	35
			7.3.1	Connecting the transmitter	35
			7.3.2	Connecting the remote display and operating module DKX001	38
			7.4	Potential equalization	38
			7.4.1	Requirements	38
			7.5	Special connection instructions	39
			7.5.1	Connection examples	39
			7.6	Ensuring the degree of protection	42
			7.7	Post-connection check	42
			8	Operation options	43
			8.1	Overview of operation options	43
			8.2	Structure and function of the operating menu	44
			8.2.1	Structure of the operating menu	44
			8.2.2	Operating philosophy	45
			8.3	Access to operating menu via local display	46
			8.3.1	Operational display	46
			8.3.2	Navigation view	49
			8.3.3	Editing view	51
			8.3.4	Operating elements	53
			8.3.5	Opening the context menu	53
			8.3.6	Navigating and selecting from list	55
			8.3.7	Calling the parameter directly	55
			8.3.8	Calling up help text	56
			8.3.9	Changing the parameters	56
			8.3.10	User roles and related access authorization	57
			8.3.11	Disabling write protection via access code	57
			8.3.12	Enabling and disabling the keypad lock	58
			8.4	Access to operating menu via web browser	58
			8.4.1	Function range	58

8.4.2	Requirements	59	10.7	Simulation	122
8.4.3	Connecting the device	60	10.8	Protecting settings from unauthorized access	125
8.4.4	Logging on	62	10.8.1	Write protection via access code ...	125
8.4.5	User interface	63	10.8.2	Write protection via write protection switch	126
8.4.6	Disabling the Web server	64	10.8.3	Write protection via block operation	127
8.4.7	Logging out	64			
8.5	Access to the operating menu via the operating tool	65	11	Operation	128
8.5.1	Connecting the operating tool	65	11.1	Reading off the device locking status	128
8.5.2	Field Xpert SFX350, SFX370	67	11.2	Adjusting the operating language	128
8.5.3	FieldCare	68	11.3	Configuring the display	128
8.5.4	DeviceCare	69	11.4	Reading off measured values	128
8.5.5	AMS Device Manager	69	11.4.1	"Measured variables" submenu	129
8.5.6	Field Communicator 475	70	11.4.2	"Totalizer" submenu	139
			11.4.3	"Input values" submenu	139
9	System integration	71	11.4.4	Output values	141
9.1	Overview of device description files	71	11.5	Adapting the measuring device to the process conditions	143
9.1.1	Current version data for the device ...	71	11.6	Performing a totalizer reset	143
9.1.2	Operating tools	71	11.6.1	Function scope of "Control Totalizer" parameter	144
9.2	Cyclic data transmission	71	11.6.2	Function range of "Reset all totalizers" parameter	145
9.2.1	Block model	71	11.7	Displaying the measured value history	145
9.2.2	Description of the modules	72			
9.2.3	Execution times	75	12	Diagnostics and troubleshooting ..	148
9.2.4	Methods	76	12.1	General troubleshooting	148
10	Commissioning	77	12.2	Diagnostic information via light emitting diodes	150
10.1	Post-mounting and post-connection check ...	77	12.2.1	Transmitter	150
10.2	Switching on the measuring device	77	12.3	Diagnostic information on local display	151
10.3	Connecting via FieldCare	77	12.3.1	Diagnostic message	151
10.4	Setting the operating language	77	12.3.2	Calling up remedial measures	153
10.5	Configuring the measuring instrument	78	12.4	Diagnostic information in the web browser ..	153
10.5.1	Defining the device tag	79	12.4.1	Diagnostic options	153
10.5.2	Setting the system units	79	12.4.2	Calling up remedy information	154
10.5.3	Selecting and setting the medium ...	82	12.5	Diagnostic information in FieldCare or DeviceCare	154
10.5.4	Configuring the analog inputs	84	12.5.1	Diagnostic options	154
10.5.5	Displaying the I/O configuration ...	84	12.5.2	Calling up remedy information	155
10.5.6	Configuring the current input	85	12.6	Adapting the diagnostic information	156
10.5.7	Configuring the status input	86	12.6.1	Adapting the diagnostic behavior ...	156
10.5.8	Configuring the current output	87	12.6.2	Adapting the status signal	156
10.5.9	Configuring the pulse/frequency/switch output	90	12.7	Overview of diagnostic information	160
10.5.10	Configuring the relay output	97	12.7.1	Diagnostic of sensor	161
10.5.11	Configuring the local display	99	12.7.2	Diagnostic of electronic	163
10.5.12	Configuring the low flow cut off ...	102	12.7.3	Diagnostic of configuration	169
10.5.13	Configuring partially filled pipe detection	103	12.7.4	Diagnostic of process	176
10.6	Advanced settings	104	12.8	Pending diagnostic events	181
10.6.1	Using the parameter to enter the access code	105	12.9	Diagnostic messages in the DIAGNOSTIC Transducer Block	182
10.6.2	Calculated process variables	105	12.10	Diagnostics list	182
10.6.3	Carrying out a sensor adjustment ...	107	12.11	Event logbook	183
10.6.4	Configuring the totalizer	113	12.11.1	Reading out the event logbook	183
10.6.5	Carrying out additional display configurations	115	12.11.2	Filtering the event logbook	184
10.6.6	WLAN configuration	118	12.11.3	Overview of information events	184
10.6.7	Configuration management	119			
10.6.8	Using parameters for device administration	120			

12.12	Resetting the measuring instrument	185
12.12.1	Function range of "Restart" parameter	185
12.12.2	Function range of "Service reset" parameter	186
12.13	Device information	186
12.14	Firmware history	188
13	Maintenance	189
13.1	Maintenance work	189
13.1.1	Exterior cleaning	189
13.2	Measuring and test equipment	189
13.3	Endress+Hauser services	189
14	Repair	190
14.1	General notes	190
14.1.1	Repair and conversion concept	190
14.1.2	Notes for repair and conversion	190
14.2	Spare parts	190
14.3	Endress+Hauser services	190
14.4	Return	190
14.5	Disposal	191
14.5.1	Removing the measuring device	191
14.5.2	Disposing of the measuring device	191
15	Accessories	192
15.1	Device-specific accessories	192
15.1.1	For the transmitter	192
15.2	Communication-specific accessories	193
15.3	Service-specific accessories	193
15.4	System components	194
16	Technical data	195
16.1	Application	195
16.2	Function and system design	195
16.3	Input	196
16.4	Output	199
16.5	Power supply	205
16.6	Performance characteristics	206
16.7	Mounting	210
16.8	Environment	210
16.9	Process	211
16.10	Mechanical construction	212
16.11	Operability	215
16.12	Certificates and approvals	219
16.13	Application packages	221
16.14	Accessories	223
16.15	Supplementary documentation	224
Index	226

1 About this document

1.1 Document function

These Operating Instructions contain all the information required in the various life cycle phases of the device: from product identification, incoming acceptance and storage, to installation, connection, operation and commissioning, through to troubleshooting, maintenance and disposal.

1.2 Symbols

1.2.1 Safety symbols

DANGER

This symbol alerts you to a dangerous situation. Failure to avoid this situation will result in serious or fatal injury.

WARNING

This symbol alerts you to a potentially dangerous situation. Failure to avoid this situation can result in serious or fatal injury.





CAUTION

This symbol alerts you to a potentially dangerous situation. Failure to avoid this situation can result in minor or medium injury.

NOTICE

This symbol alerts you to a potentially harmful situation. Failure to avoid this situation can result in damage to the product or something in its vicinity.

1.2.2 Electrical symbols

Symbol	Meaning
	Direct current
	Alternating current
	Direct current and alternating current
	Ground connection A grounded terminal which, as far as the operator is concerned, is grounded via a grounding system.
	Potential equalization connection (PE: protective earth) Ground terminals that must be connected to ground prior to establishing any other connections. The ground terminals are located on the interior and exterior of the device: <ul style="list-style-type: none"> ▪ Interior ground terminal: potential equalization is connected to the supply network. ▪ Exterior ground terminal: device is connected to the plant grounding system.

1.2.3 Communication-specific symbols

Symbol	Meaning
	Wireless Local Area Network (WLAN) Communication via a wireless, local network.





1.2.4 Tool symbols

Symbol	Meaning
	Flat-blade screwdriver
	Allen key
	Open-ended wrench

1.2.5 Symbols for certain types of information

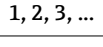
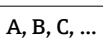
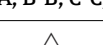
Symbol	Meaning
	Permitted Procedures, processes or actions that are permitted.
	Preferred Procedures, processes or actions that are preferred.
	Forbidden Procedures, processes or actions that are forbidden.
	Tip Indicates additional information.
	Reference to documentation
	Reference to page
	Reference to graphic
	Notice or individual step to be observed
	Series of steps
	Result of a step
	Help in the event of a problem
	Visual inspection

1.2.6 Symbols in graphics

Symbol	Meaning
	Item numbers
	Series of steps
	Views
	Sections
	Hazardous area
	Safe area (non-hazardous area)
	Flow direction

1.3 Documentation

 For an overview of the scope of the associated Technical Documentation, refer to the following:

- *Device Viewer* (www.endress.com/deviceviewer): Enter the serial number from the nameplate
- *Endress+Hauser Operations app*: Enter serial number from nameplate or scan matrix code on nameplate.

The following documentation may be available depending on the device version ordered:

Document type	Purpose and content of the document
Technical Information (TI)	Planning aid for your device The document contains all the technical data on the device and provides an overview of the accessories and other products that can be ordered for the device.
Brief Operating Instructions (KA)	Guide that takes you quickly to the 1st measured value The Brief Operating Instructions contain all the essential information from incoming acceptance to initial commissioning.
Operating Instructions (BA)	Your reference document These Operating Instructions contain all the information that is required in the various life cycle phases of the device: from product identification, incoming acceptance and storage, to mounting, connection, operation and commissioning, through to troubleshooting, maintenance and disposal.
Description of Device Parameters (GP)	Reference for your parameters The document provides a detailed explanation of each individual parameter. The description is aimed at those who work with the device over the entire life cycle and perform specific configurations.
Safety Instructions (XA)	Depending on the approval, safety instructions for electrical equipment in hazardous areas are also supplied with the device. The Safety Instructions are a constituent part of the Operating Instructions.  Information on the Safety Instructions (XA) that are relevant for the device is provided on the nameplate.
Supplementary device-dependent documentation (SD/FY)	Always comply strictly with the instructions in the relevant supplementary documentation. The supplementary documentation is a constituent part of the device documentation.

1.4 Registered trademarks

FOUNDATION™ Fieldbus

Registration-pending trademark of the FieldComm Group, Austin, Texas, USA

2 Safety instructions

2.1 Requirements for the personnel

The personnel for installation, commissioning, diagnostics and maintenance must fulfill the following requirements:

- ▶ Trained, qualified specialists must have a relevant qualification for this specific function and task.
- ▶ Are authorized by the plant owner/operator.
- ▶ Are familiar with federal/national regulations.
- ▶ Before starting work, read and understand the instructions in the manual and supplementary documentation as well as the certificates (depending on the application).
- ▶ Follow instructions and comply with basic conditions.

The operating personnel must fulfill the following requirements:

- ▶ Are instructed and authorized according to the requirements of the task by the facility's owner-operator.
- ▶ Follow the instructions in this manual.

2.2 Intended use

Application and media

The measuring instrument described in this manual is intended only for the flow measurement of liquids and gases.

Depending on the version ordered, the measuring instrument can also be used to measure potentially explosive ¹⁾, flammable, toxid and oxidizing media.

Measuring instruments for use in hazardous areas, in hygienic applications, or where there is an increased risk due to pressure, are specially labeled on the nameplate.

To ensure that the measuring instrument is in perfect condition during operation:

- ▶ Only use the measuring instrument in full compliance with the data on the nameplate and the general conditions listed in the Operating Instructions and supplementary documentation.
- ▶ Using the nameplate, check whether the ordered device is permitted for the intended use in the hazardous area (e.g. explosion protection, pressure vessel safety).
- ▶ Use the measuring instrument only for media to which the process-wetted materials are sufficiently resistant.
- ▶ Keep within the specified pressure and temperature range.
- ▶ Keep within the specified ambient temperature range.
- ▶ Protect the measuring instrument permanently against corrosion from environmental influences.

Incorrect use

Non-designated use can compromise safety. The manufacturer is not liable for damage caused by improper or non-designated use.

WARNING

Danger of breakage due to corrosive or abrasive fluids and ambient conditions!

- ▶ Verify the compatibility of the process fluid with the sensor material.
- ▶ Ensure the resistance of all fluid-wetted materials in the process.
- ▶ Keep within the specified pressure and temperature range.

1) Not applicable for IO-Link measuring instruments

NOTICE**Verification for borderline cases:**

- ▶ For special fluids and fluids for cleaning, Endress+Hauser is glad to provide assistance in verifying the corrosion resistance of fluid-wetted materials, but does not accept any warranty or liability as minute changes in the temperature, concentration or level of contamination in the process can alter the corrosion resistance properties.

Residual risks**⚠ CAUTION**

Risk of hot or cold burns! The use of media and electronics with high or low temperatures can produce hot or cold surfaces on the device.

- ▶ Mount suitable touch protection.

⚠ WARNING

Danger of housing breaking due to measuring tube breakage!

If a measuring tube ruptures, the pressure inside the sensor housing will rise according to the operating process pressure.

- ▶ Use a rupture disk.

⚠ WARNING

Danger from medium escaping!

For device versions with a rupture disk: medium escaping under pressure can cause injury or material damage.

- ▶ Take precautions to prevent injury and material damage if the rupture disk is actuated.

2.3 Workplace safety

When working on and with the device:

- ▶ Wear the required personal protective equipment as per national regulations.

2.4 Operational safety

Damage to the device!

- ▶ Operate the device in proper technical condition and fail-safe condition only.
- ▶ The operator is responsible for the interference-free operation of the device.

Modifications to the device

Unauthorized modifications to the device are not permitted and can lead to unforeseeable dangers!

- ▶ If modifications are nevertheless required, consult with the manufacturer.

Repair

To ensure continued operational safety and reliability:

- ▶ Carry out repairs on the device only if they are expressly permitted.
- ▶ Observe federal/national regulations pertaining to the repair of an electrical device.
- ▶ Use only original spare parts and accessories.

2.5 Product safety

This measuring device is designed in accordance with good engineering practice to meet state-of-the-art safety requirements, has been tested, and left the factory in a condition in which it is safe to operate.

It meets general safety standards and legal requirements. It also complies with the EU directives listed in the device-specific EU Declaration of Conformity. The manufacturer confirms this by affixing the CE mark to the device..





2.6 IT security

Our warranty is valid only if the product is installed and used as described in the Operating Instructions. The product is equipped with security mechanisms to protect it against any inadvertent changes to the settings.

IT security measures, which provide additional protection for the product and associated data transfer, must be implemented by the operators themselves in line with their security standards.

2.7 Device-specific IT security

The device offers a range of specific functions to support protective measures on the operator's side. These functions can be configured by the user and guarantee greater in-operation safety if used correctly. The following list provides an overview of the most important functions:

Function/interface	Factory setting	Recommendation
Write protection via hardware write protection switch →  11	Not enabled	On an individual basis following risk assessment
Access code (also applies to web server login or FieldCare connection) →  12	Not enabled (0000)	Assign a customized access code during commissioning
WLAN (order option in display module)	Enabled	On an individual basis following risk assessment
WLAN security mode	Enabled (WPA2-PSK)	Do not change
WLAN passphrase (Password) →  12	Serial number	Assign an individual WLAN passphrase during commissioning
WLAN mode	Access point	On an individual basis following risk assessment
Web server →  12	Enabled	On an individual basis following risk assessment
Service interface CDI-RJ45	–	On an individual basis following risk assessment

2.7.1 Protecting access via hardware write protection

Write access to the parameters of the device via the local display, web browser or operating tool (e.g. FieldCare, DeviceCare) can be disabled via a write protection switch (DIP switch on the main electronics module). When hardware write protection is enabled, only read access to the parameters is possible.

Hardware write protection is disabled when the device is delivered →  126.

2.7.2 Protecting access via a password

Different passwords are available to protect write access to the device parameters or access to the device via the WLAN interface.

- **User-specific access code**
Protect write access to the device parameters via the local display, web browser or operating tool (e.g. FieldCare, DeviceCare). Access authorization is clearly regulated through the use of a user-specific access code.
- **WLAN passphrase**
The network key protects a connection between an operating unit (e.g. notebook or tablet) and the device via the WLAN interface which can be ordered as an option.
- **Infrastructure mode**
When the device is operated in infrastructure mode, the WLAN passphrase corresponds to the WLAN passphrase configured on the operator side.

User-specific access code

Write access to the device parameters via the local display, web browser or operating tool (e.g. FieldCare, DeviceCare) can be protected by the modifiable, user-specific access code (→  125).

When the device is delivered, the device does not have an access code and is equivalent to 0000 (open).

WLAN passphrase: Operation as WLAN access point

A connection between an operating unit (e.g. notebook or tablet) and the device via the WLAN interface (→  66), which can be ordered as an optional extra, is protected by the network key. The WLAN authentication of the network key complies with the IEEE 802.11 standard.

When the device is delivered, the network key is pre-defined depending on the device. It can be changed via the **WLAN settings** submenu in the **WLAN passphrase** parameter (→  119).

Infrastructure mode

A connection between the device and WLAN access point is protected by means of an SSID and passphrase on the system side. Please contact the relevant system administrator for access.

General notes on the use of passwords

- The access code and network key supplied with the device should be changed during commissioning for safety reasons.
- Follow the general rules for generating a secure password when defining and managing the access code and network key.
- The user is responsible for the management and careful handling of the access code and network key.
- For information on configuring the access code or on what to do if you lose the password, for example, see "Write protection via access code" →  125.

2.7.3 Access via web server

The integrated web server can be used to operate and configure the device via a web browser →  58. The connection is established via the service interface (CDI-RJ45) or the WLAN interface.

The web server is enabled when the device is delivered. The web server can be disabled via the **Web server functionality** parameter if necessary (e.g., after commissioning).

The device and status information can be hidden on the login page. This prevents unauthorized access to the information.



Detailed information on the device parameters:
"Description of device parameters" document .

3 Product description

The device consists of a transmitter and a sensor.

The device is available as a compact version:

The transmitter and sensor form a mechanical unit.

3.1 Product design

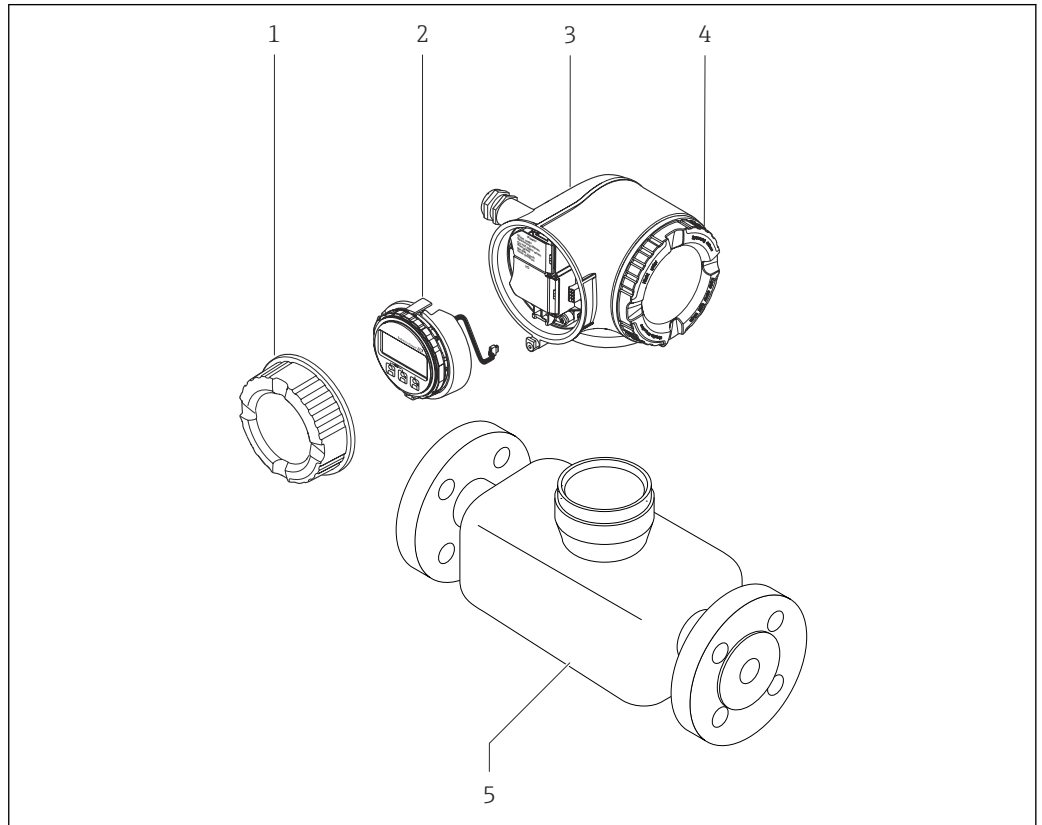

1 Important components of a measuring device

- 1 Connection compartment cover
- 2 Display module
- 3 Transmitter housing
- 4 Electronics compartment cover
- 5 Sensor

A0029586

4 Incoming acceptance and product identification

4.1 Incoming acceptance

On receipt of the delivery:

1. Check the packaging for damage.
 - ↳ Report all damage immediately to the manufacturer.
Do not install damaged components.
2. Check the scope of delivery using the delivery note.
3. Compare the data on the nameplate with the order specifications on the delivery note.
4. Check the technical documentation and all other necessary documents, e.g. certificates, to ensure they are complete.



If one of the conditions is not satisfied, contact the manufacturer.

4.2 Product identification

The device can be identified in the following ways:

- Nameplate
- Order code with details of the device features on the delivery note
- Enter the serial numbers from the nameplates in the *Device Viewer* (www.endress.com/deviceviewer): all the information about the device is displayed.
- Enter the serial numbers from the nameplates into the *Endress+Hauser Operations app* or scan the DataMatrix code on the nameplate with the *Endress+Hauser Operations app*: all the information about the device is displayed.

For an overview of the scope of the associated Technical Documentation, refer to the following:

- The "Additional standard device documentation" and "Supplementary device-dependent documentation" sections
- The *Device Viewer*: Enter the serial number from the nameplate (www.endress.com/deviceviewer)
- The *Endress+Hauser Operations app*: Enter the serial number from the nameplate or scan the DataMatrix code on the nameplate.

4.2.1 Transmitter nameplate

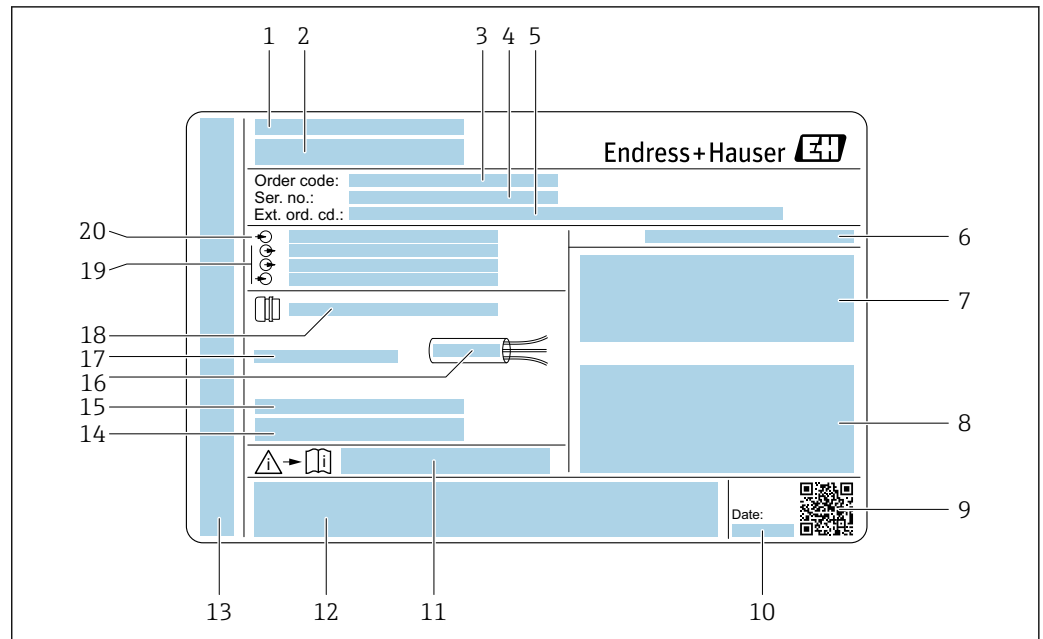

A0029192

 2 Example of a transmitter nameplate

- 1 Manufacturer address/certificate holder
- 2 Name of the transmitter
- 3 Order code
- 4 Serial number
- 5 Extended order code
- 6 Degree of protection
- 7 Space for approvals: use in hazardous areas
- 8 Electrical connection data: available inputs and outputs
- 9 2-D matrix code
- 10 Date of manufacture: year-month
- 11 Document number of safety-related supplementary documentation
- 12 Space for approvals and certificates: e.g. CE mark, RCM tick
- 13 Space for degree of protection of connection and electronics compartment when used in hazardous areas
- 14 Firmware version (FW) and device revision (Dev. rev.) from the factory
- 15 Space for additional information in the case of special products
- 16 Permitted temperature range for cable
- 17 Permitted ambient temperature (T_a)
- 18 Information on cable gland
- 19 Available inputs and outputs, supply voltage
- 20 Electrical connection data: supply voltage

4.2.2 Sensor nameplate

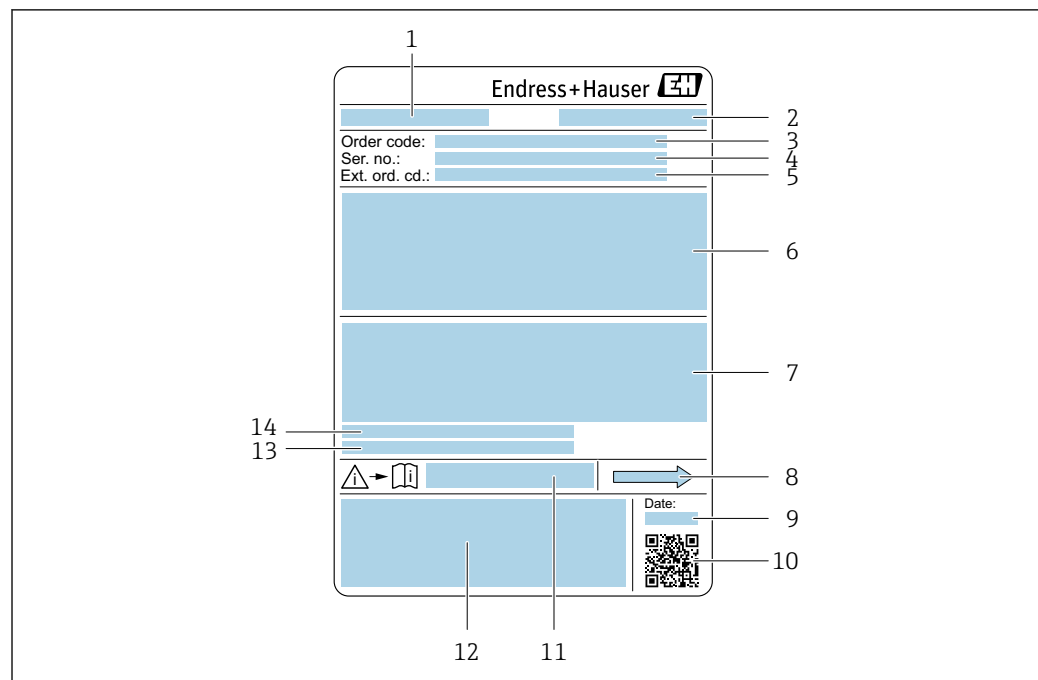

A0029199

 3 Example of a sensor nameplate

- 1 Name of the sensor
- 2 Manufacturer address/certificate holder
- 3 Order code
- 4 Serial number (Ser. no.)
- 5 Extended order code (Ext. ord. cd.)
- 6 Nominal diameter of the sensor; flange nominal diameter/nominal pressure; sensor test pressure; medium temperature range; material of measuring tube and manifold; sensor-specific information: e.g. pressure range of sensor housing, wide-range density specification (special density calibration)
- 7 Approval information for explosion protection, Pressure Equipment Directive and degree of protection
- 8 Flow direction
- 9 Date of manufacture: year-month
- 10 2-D matrix code
- 11 Document number of safety-related supplementary documentation
- 12 CE mark, RCM-Tick mark
- 13 Surface roughness
- 14 Allowable ambient temperature (T_a)



Order code

The measuring device is reordered using the order code.

Extended order code

- The device type (product root) and basic specifications (mandatory features) are always listed.
- Of the optional specifications (optional features), only the safety and approval-related specifications are listed (e.g. LA). If other optional specifications are also ordered, these are indicated collectively using the # placeholder symbol (e.g. #LA#).
- If the ordered optional specifications do not include any safety and approval-related specifications, they are indicated by the + placeholder symbol (e.g. XXXXXX-ABCDE+).

4.2.3 Symbols on the device

Symbol	Meaning
	WARNING! This symbol alerts you to a dangerous situation. Failure to avoid this situation can result in serious or fatal injury. Please consult the documentation for the measuring instrument to discover the type of potential danger and measures to avoid it.
	Reference to documentation Refers to the corresponding device documentation.
	Protective ground connection A terminal that must be connected to the ground prior to establishing any other connections.

5 Storage and transport

5.1 Storage conditions

Observe the following notes for storage:

- ▶ Store in the original packaging to ensure protection from shock.
- ▶ Do not remove protective covers or protective caps installed on process connections. They prevent mechanical damage to the sealing surfaces and contamination in the measuring tube.
- ▶ Protect from direct sunlight. Avoid unacceptably high surface temperatures.
- ▶ Store in a dry and dust-free place.
- ▶ Do not store outdoors.

Storage temperature → 📄 210

5.2 Transporting the product

Transport the measuring device to the measuring point in the original packaging.

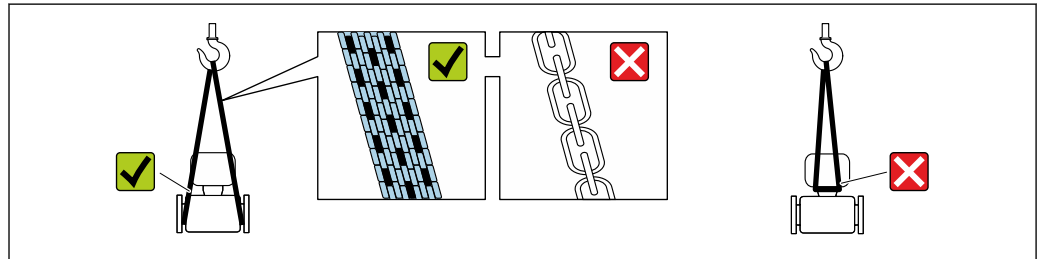

A0029252

- i** Do not remove protective covers or caps installed on process connections. They prevent mechanical damage to the sealing surfaces and contamination in the measuring tube.

5.2.1 Measuring devices without lifting lugs

⚠ WARNING

Center of gravity of the measuring device is higher than the suspension points of the webbing slings.

Risk of injury if the measuring device slips.

- ▶ Secure the measuring device against slipping or turning.
- ▶ Observe the weight specified on the packaging (stick-on label).

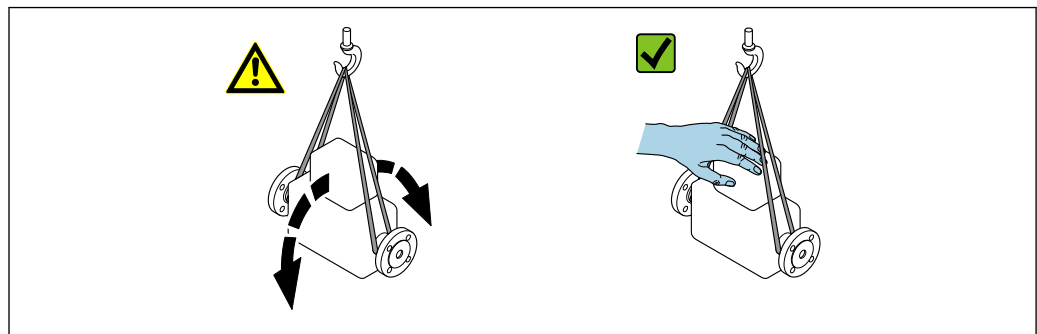

A0029214

5.2.2 Measuring devices with lifting lugs

⚠ CAUTION

Special transportation instructions for devices with lifting lugs

- ▶ Only use the lifting lugs fitted on the device or flanges to transport the device.
- ▶ The device must always be secured at two lifting lugs at least.

5.2.3 Transporting with a fork lift

If transporting in wood crates, the floor structure enables the crates to be lifted lengthwise or at both sides using a forklift.

5.3 Packaging disposal

All packaging materials are environmentally friendly and 100% recyclable:

- Outer packaging of device
 - Stretch wrap made of polymer in accordance with EU Directive 2002/95/EC (RoHS)
- Packaging
 - Wood crate treated in accordance with ISPM 15 standard, confirmed by IPPC logo
 - Cardboard box in accordance with European packaging guideline 94/62/EC, recyclability confirmed by Resy symbol
- Transport material and fastening fixtures
 - Disposable plastic pallet
 - Plastic straps
 - Plastic adhesive strips
- Filler material
 - Paper pads

6 Mounting

6.1 Mounting requirements

6.1.1 Installation position

Installation point

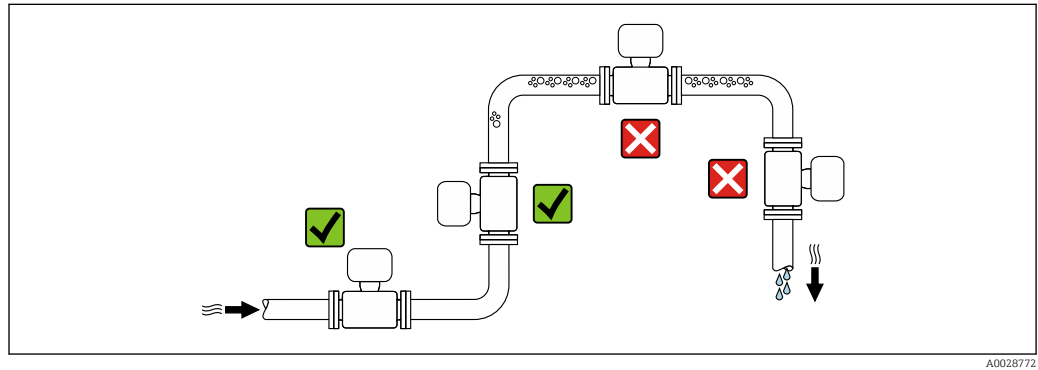

To prevent measuring errors arising from accumulation of gas bubbles in the measuring pipe, avoid the following mounting locations in the piping:

- Highest point of a pipeline.
- Directly upstream of a free pipe outlet in a down pipe.

Installation in down pipes

However, the following installation suggestion allows for installation in an open vertical pipeline. Pipe restrictions or the use of an orifice with a smaller cross-section than the nominal diameter prevent the sensor running empty while measurement is in progress.

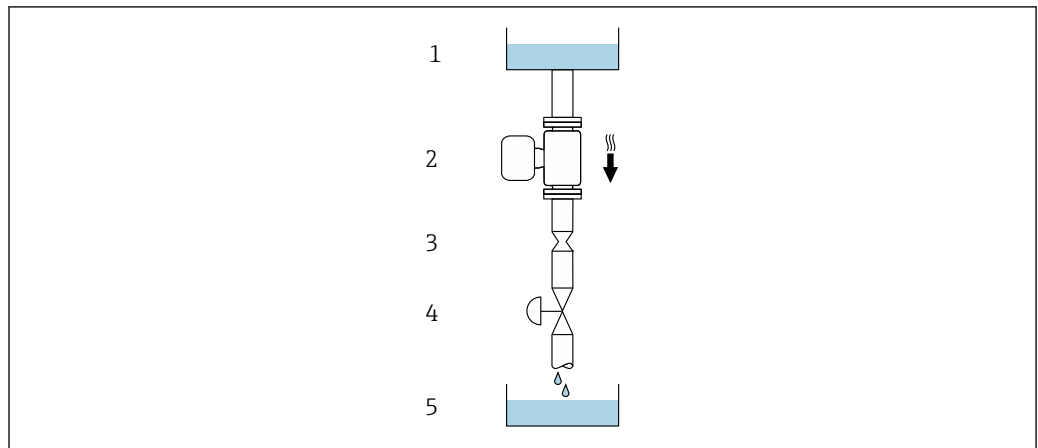



4 Installation in a down pipe (e.g. for batching applications)

- 1 Supply tank
- 2 Sensor
- 3 Orifice plate, pipe restriction
- 4 Valve
- 5 Filling vessel

DN		Ø orifice plate, pipe restriction	
[mm]	[in]	[mm]	[in]
300	12	210	8.27
350	14	210	8.27
400	16	210	8.27

Orientation

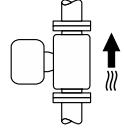
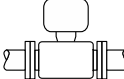
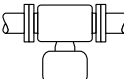
The direction of the arrow on the sensor nameplate helps you to install the sensor according to the flow direction (direction of medium flow through the piping).

Orientation		Recommendation
A	Vertical orientation  A0015591	☑☑ ¹⁾
B	Horizontal orientation, transmitter at top  A0015589	☑☑ ²⁾ → ☑ 5, ☑ 21
C	Horizontal orientation, transmitter at bottom  A0015590	☑☑ ³⁾ → ☑ 5, ☑ 21
D	Horizontal orientation, transmitter at side  A0015592	☑ → ☑ 5, ☑ 21

- 1) This orientation is recommended to ensure self-draining.
- 2) Applications with low process temperatures may reduce the ambient temperature. To maintain the minimum ambient temperature for the transmitter, this orientation is recommended.
- 3) Applications with high process temperatures may increase the ambient temperature. To maintain the maximum ambient temperature for the transmitter, this orientation is recommended.

If a sensor is installed horizontally with a curved measuring tube, match the position of the sensor to the fluid properties.

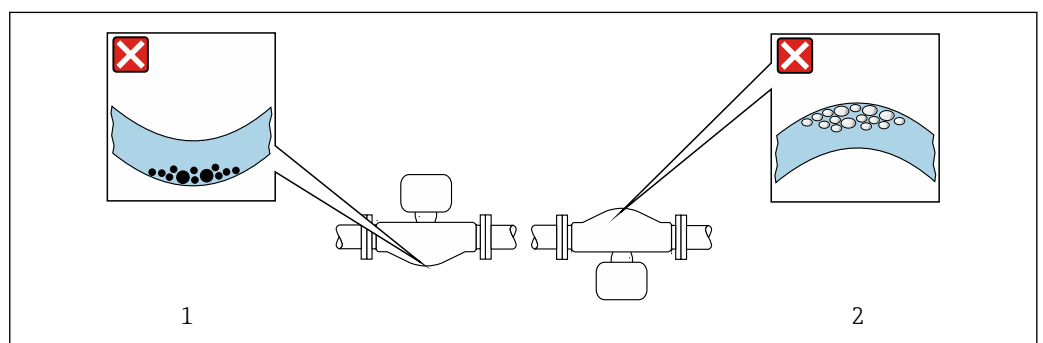

☑ 5 Orientation of sensor with curved measuring tube

- 1 Avoid this orientation for fluids with entrained solids: Risk of solids accumulating
- 2 Avoid this orientation for outgassing fluids: Risk of gas accumulating

Inlet and outlet runs

No special precautions need to be taken for fittings that create turbulence, such as valves, elbows or T-pieces, as long as no cavitation occurs → 22.

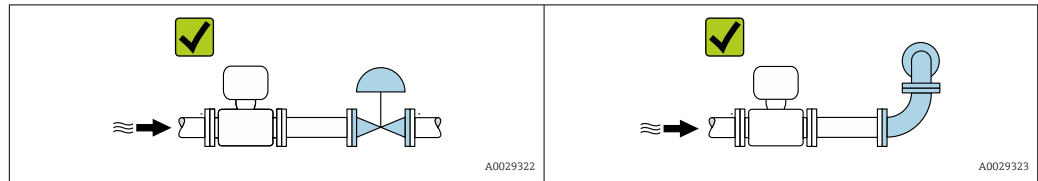

Installation dimensions

For the dimensions and installation lengths of the device, see the "Technical Information" document, "Mechanical construction" section

6.1.2 Environmental and process requirements

Ambient temperature range

Measuring device	<ul style="list-style-type: none"> ▪ -40 to +60 °C (-40 to +140 °F) ▪ Order code for "Test, certificate", option JP: -50 to +60 °C (-58 to +140 °F)
Readability of the local display	<p>-20 to +60 °C (-4 to +140 °F) The readability of the display may be impaired at temperatures outside the temperature range.</p>

Dependency of ambient temperature on medium temperature → 211

- ▶ If operating outdoors:
Avoid direct sunlight, particularly in warm climatic regions.

Static pressure

It is important that cavitation does not occur, or that gases entrained in the liquids do not outgas.

Cavitation is caused if the pressure drops below the vapor pressure:

- In liquids that have a low boiling point (e.g. hydrocarbons, solvents, liquefied gases)
- In suction lines

- ▶ Ensure the static pressure is sufficiently high to prevent cavitation and outgassing.

For this reason, the following mounting locations are recommended:

- At the lowest point in a vertical pipe
- Downstream from pumps (no danger of vacuum)

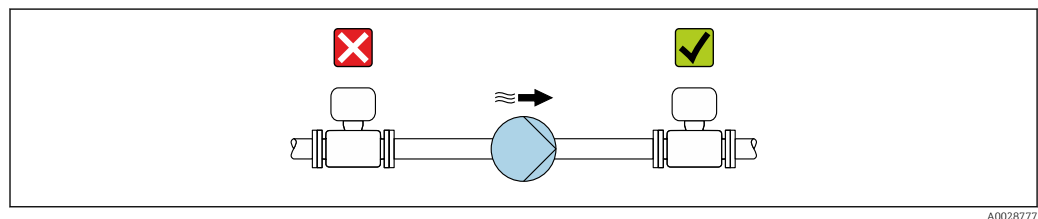

Thermal insulation

In the case of some fluids, it is important to keep the heat radiated from the sensor to the transmitter to a low level. A wide range of materials can be used for the required insulation.

The following device versions are recommended for versions with thermal insulation:
Version with extended neck:

Order code for "Measuring tube material", option SA with an extended neck length of 105 mm (4.13 in).

NOTICE

Electronics overheating on account of thermal insulation!

- ▶ Recommended orientation: horizontal orientation, transmitter housing pointing downwards.
- ▶ Do not insulate the transmitter housing .
- ▶ Maximum permissible temperature at the lower end of the transmitter housing: 80 °C (176 °F)
- ▶ Regarding thermal insulation with an exposed extended neck: We advise against insulating the extended neck to ensure optimal heat dissipation.

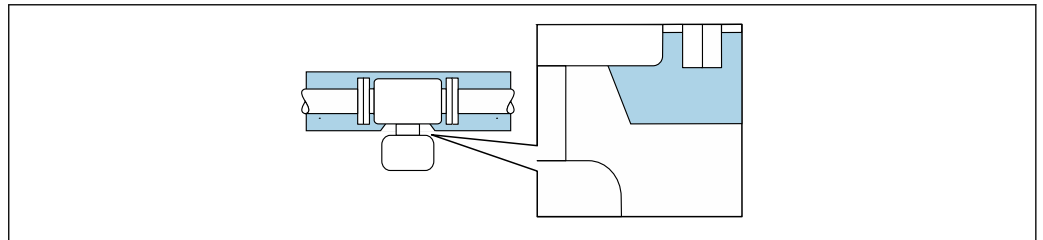

6 Thermal insulation with exposed extended neck

Heating

NOTICE

Electronics can overheat due to elevated ambient temperature!

- ▶ Observe maximum permitted ambient temperature for the transmitter.
- ▶ Depending on the medium temperature, take the device orientation requirements into account.

i Under critical climatic conditions, in particular, it is important to ensure that the temperature difference between the ambient temperature and the fluid temperature is not >100 K. Suitable measures must be taken, such as heating or insulation.

NOTICE

Danger of overheating when heating

- ▶ Ensure that the temperature at the lower end of the transmitter housing does not exceed 80 °C (176 °F).
- ▶ Ensure that sufficient convection takes place at the transmitter neck.
- ▶ Ensure that a sufficiently large area of the transmitter neck remains exposed. The uncovered part serves as a radiator and protects the electronics from overheating and excessive cooling.
- ▶ When using in potentially explosive atmospheres, observe the information in the device-specific Ex documentation. For detailed information on the temperature tables, see the separate document entitled "Safety Instructions" (XA) for the device.

Heating options

If a fluid requires that no heat loss should occur at the sensor, users can avail of the following heating options:

- Electrical heating, e.g. with electric band heaters ²⁾
- Via pipes carrying hot water or steam
- Via heating jackets

Vibrations

The high oscillation frequency of the measuring tubes ensures that the correct operation of the measuring system is not influenced by plant vibrations.

6.1.3 Special mounting instructions

Drainability

When installed vertically, the measuring tubes can be drained completely and protected against buildup.

Hygienic compatibility

-  ▪ When installing in hygienic applications, please refer to the information in the "Certificates and approvals/hygienic compatibility" section
- In the case of measuring devices with the order code for "Housing", option B "Stainless, hygienic", to seal the connection compartment cover, screw it closed finger-tight and tighten it by another 45° (corresponds to 15 Nm).

Rupture disk

Process-related information: →  212.

WARNING

Danger from medium escaping!

Medium escaping under pressure can cause injury or material damage.

- ▶ Take precautions to prevent danger to persons and damage if the rupture disk is actuated.
- ▶ Observe the information on the rupture disk sticker.
- ▶ Make sure that the function and operation of the rupture disk is not impeded through the installation of the device.
- ▶ Do not use a heating jacket.
- ▶ Do not remove or damage the rupture disk.

The position of the rupture disk is indicated by a sticker affixed beside it.

The transportation guard must be removed.

The existing connecting nozzles are not intended for the purpose of rinsing or pressure monitoring, but instead serve as the mounting location for the rupture disk.

In the event of a failure of the rupture disk, a drain device can be screwed onto the internal thread of the rupture disk in order to drain off any escaping medium.

2) The use of parallel electric band heaters is generally recommended (bidirectional electricity flow). Particular considerations must be made if a single-wire heating cable is to be used. For additional information, refer to EA01339D "Installation Instructions for Electrical Trace Heating Systems".

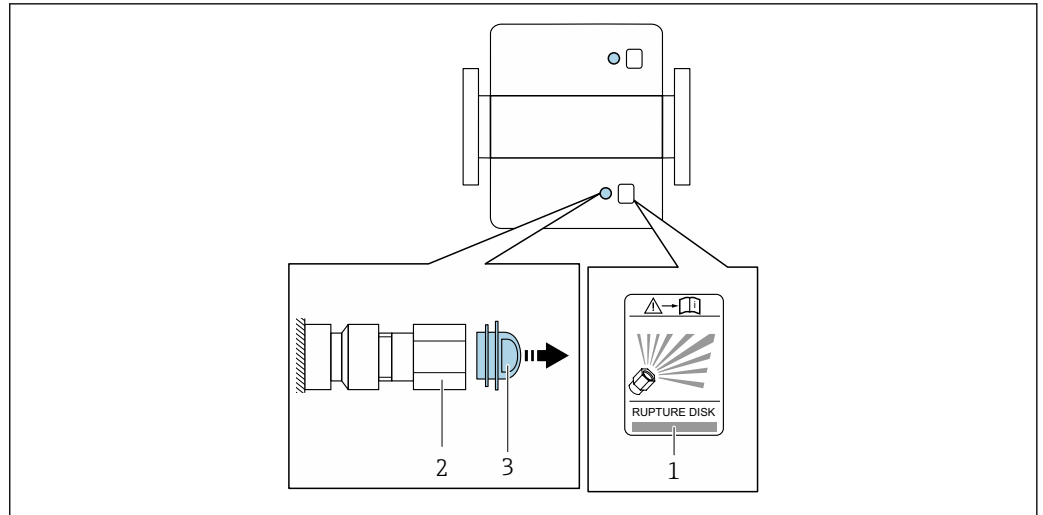

A0029944

- 1 Rupture disk label
- 2 Rupture disk with 1/2" NPT internal thread and 1" width across flats
- 3 Transportation guard



For information on the dimensions, see the "Technical Information" document, "Mechanical construction" section (accessories).

Zero verification and zero adjustment

All measuring instruments are calibrated in accordance with state-of-the-art technology. Calibration takes place under reference conditions → 206. Therefore, a zero adjustment in the field is generally not required.

Experience shows that zero adjustment is advisable only in special cases:

- To achieve maximum measurement accuracy even with low flow rates.
- Under extreme process or operating conditions (e.g. very high process temperatures or very high-viscosity fluids).
- For gas applications with low pressure



To achieve the highest possible measurement accuracy at low flow rates, the installation must protect the sensor from mechanical stresses during operation.

To get a representative zero point, ensure that:

- any flow in the device is prevented during the adjustment
- the process conditions (e.g. pressure, temperature) are stable and representative

Verification and adjustment cannot be carried out if the following process conditions are present:

- Gas pockets

Ensure that the system has been sufficiently flushed with the medium. Repeat flushing can help to eliminate gas pockets

- Thermal circulation

In the event of temperature differences (e.g. between the measuring tube inlet and outlet section), induced flow can occur even if the valves are closed due to thermal circulation in the device

- Leaks at the valves

If the valves are not leak-tight, flow is not sufficiently prevented when determining the zero point

If these conditions cannot be avoided, it is advisable to keep the factory setting for the zero point.

Weather protection cover

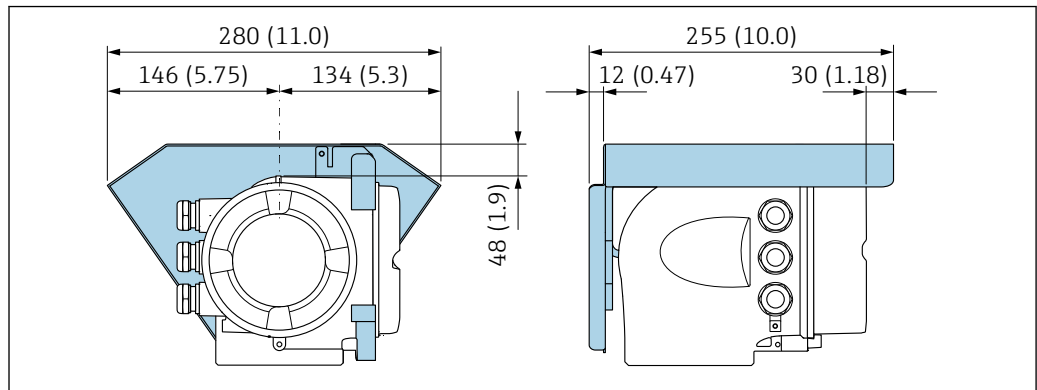

A0029553

7 Engineering unit mm (in)

Cover lock

NOTICE

Order code "Housing", option L "Cast, stainless": The covers of the transmitter housing are provided with a borehole to lock the cover.

The cover can be locked using screws and a chain or cable provided by the customer on site.

- ▶ The use of stainless steel chains or cables is recommended.
- ▶ If a protective coating is applied, it is recommended to use a heat shrink tube to protect the housing paint.

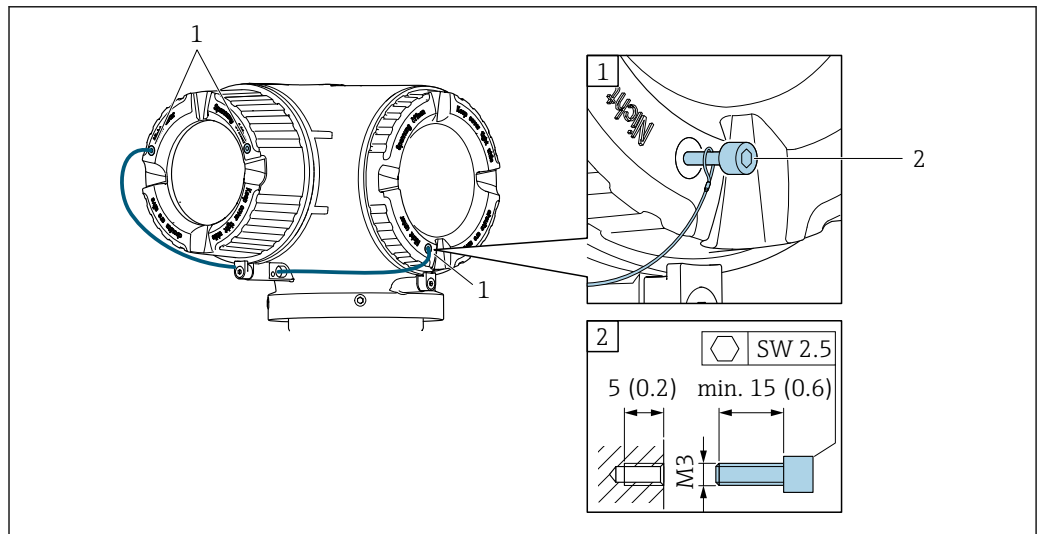

A0029800

- 1 Cover borehole for the securing screw
- 2 Securing screw to lock the cover

6.2 Mounting the measuring instrument

6.2.1 Required tools

For sensor

For flanges and other process connections: Use a suitable mounting tool.

6.2.2 Preparing the measuring instrument

1. Remove all remaining transport packaging.
2. Remove any protective covers or protective caps present from the sensor.
3. Remove stick-on label on the electronics compartment cover.

6.2.3 Mounting the measuring device

⚠ WARNING

Danger due to improper process sealing!

- ▶ Ensure that the inside diameters of the gaskets are greater than or equal to that of the process connections and piping.
 - ▶ Ensure that the seals are clean and undamaged.
 - ▶ Secure the seals correctly.
1. Ensure that the direction of the arrow on the nameplate of the sensor matches the flow direction of the medium.
 2. Install the measuring device or turn the transmitter housing so that the cable entries do not point upwards.

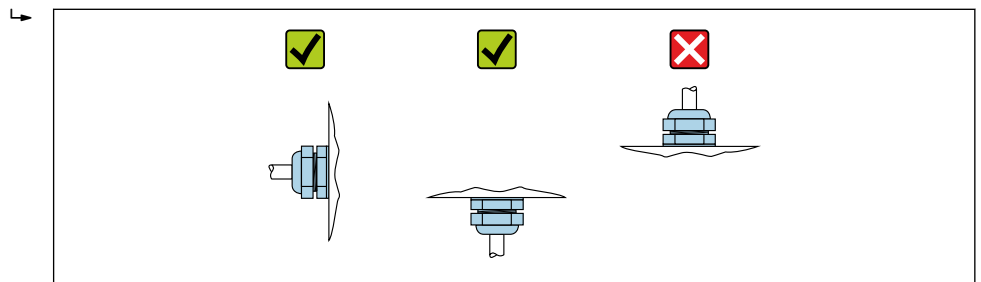

A0029263

6.2.4 Turning the transmitter housing

To provide easier access to the connection compartment or display module, the transmitter housing can be turned.

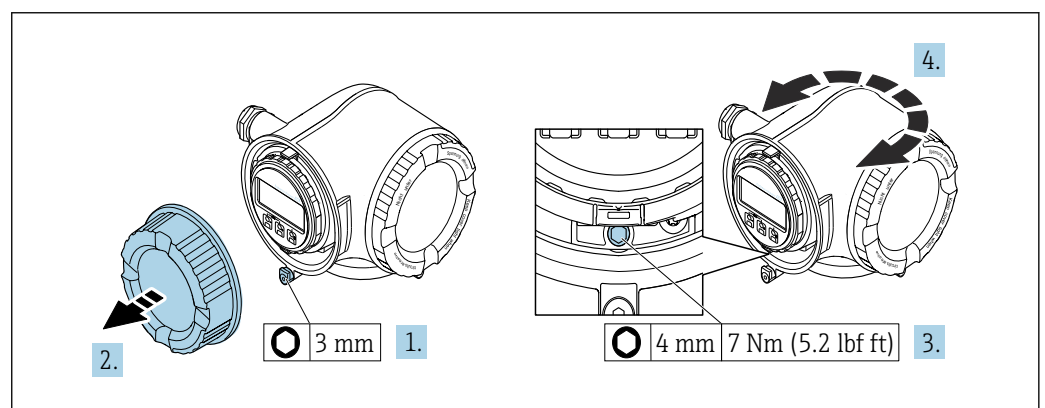

A0029993

8 Housing in non-Ex version

1. Depending on the device version: Loosen the securing clamp of the connection compartment cover.
2. Unscrew the connection compartment cover.
3. Loosen the fixing screw.
4. Turn the housing to the desired position.
5. Tighten the securing screw.

6. Screw on the connection compartment cover.
7. Depending on the device version: Attach the securing clamp of the connection compartment cover.

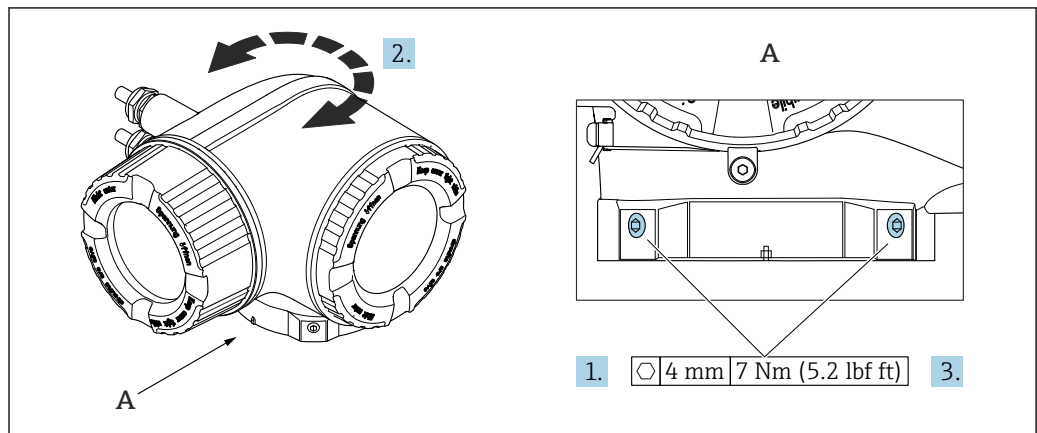

A0043150

9 Ex housing

1. Loosen the fixing screws.
2. Turn the housing to the desired position.
3. Tighten the securing screws.

6.2.5 Turning the display module

The display module can be turned to optimize display readability and operability.

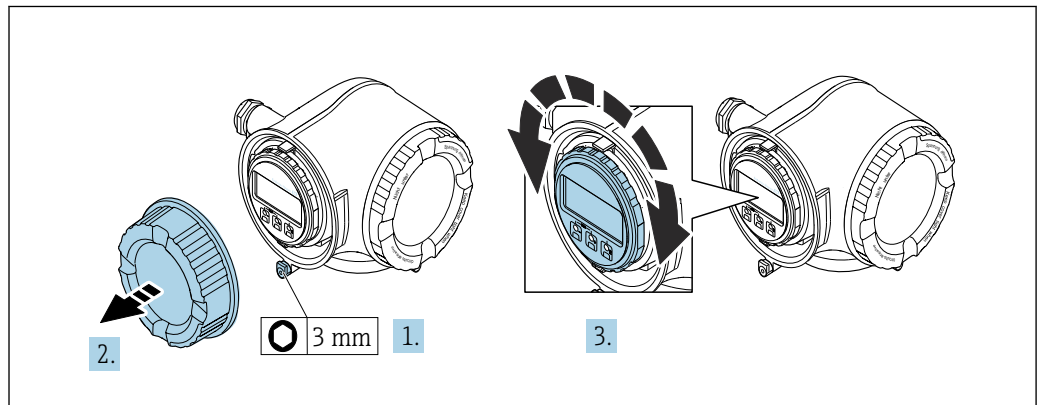

A0030035

1. Depending on the device version: Loosen the securing clamp of the connection compartment cover.
2. Unscrew the connection compartment cover.
3. Turn the display module to the desired position: max. $8 \times 45^\circ$ in each direction.
4. Screw on the connection compartment cover.
5. Depending on the device version: Attach the securing clamp of the connection compartment cover.

6.3 Post-installation check

Is the device undamaged (visual inspection)?	<input type="checkbox"/>
Does the measuring instrument correspond to the measuring point specifications? For example: <ul style="list-style-type: none"> ▪ Process temperature → 211 ▪ Pressure (refer to the "Pressure-temperature ratings" section of the "Technical Information" document). ▪ Ambient temperature ▪ Measuring range 	<input type="checkbox"/>
Has the correct orientation for the sensor been selected → 21? <ul style="list-style-type: none"> ▪ According to sensor type ▪ According to medium temperature ▪ According to medium properties (outgassing, with entrained solids) 	<input type="checkbox"/>
Does the arrow on the sensor match the direction of flow of the medium? → 21?	<input type="checkbox"/>
Is the tag name and labeling correct (visual inspection)?	<input type="checkbox"/>
Is the device sufficiently protected from precipitation and direct sunlight?	<input type="checkbox"/>
Are the securing screw and securing clamp tightened securely?	<input type="checkbox"/>

7 Electrical connection

WARNING

Live parts! Incorrect work performed on the electrical connections can result in an electric shock.

- ▶ Set up a disconnecting device (switch or power-circuit breaker) to easily disconnect the device from the supply voltage.
- ▶ In addition to the device fuse, include an overcurrent protection unit with max. 10 A in the plant installation.

7.1 Electrical safety

In accordance with applicable national regulations.

7.2 Connecting requirements

7.2.1 Required tools

- For cable entries: Use corresponding tools
- For securing clamp: Allen key 3 mm
- Wire stripper
- When using stranded cables: Crimper for wire end ferrule
- For removing cables from terminal: Flat blade screwdriver ≤ 3 mm (0.12 in)

7.2.2 Requirements for connection cable

The connecting cables provided by the customer must fulfill the following requirements.

Protective grounding cable for the outer ground terminal

Conductor cross-section < 2.1 mm² (14 AWG)

The use of a cable lug enables the connection of larger cross-sections.

The grounding impedance must be less than 2 Ω .

Permitted temperature range

- The installation guidelines that apply in the country of installation must be observed.
- The cables must be suitable for the minimum and maximum temperatures to be expected.

Power supply cable (incl. conductor for the inner ground terminal)

Standard installation cable is sufficient.

Signal cable

-  For custody transfer, all signal lines must be shielded cables (tinned copper braiding, optical coverage ≥ 85 %). The cable shield must be connected on both sides.

Ethernet-APL

Shielded twisted-pair cable. Cable type A is recommended.

-  See <https://www.profibus.com> Ethernet-APL White Paper "

FOUNDATION Fieldbus

Twisted, shielded two-wire cable.



For further information on planning and installing FOUNDATION Fieldbus networks see:

- Operating Instructions for "FOUNDATION Fieldbus Overview" (BA00013S)
- FOUNDATION Fieldbus Guideline
- IEC 61158-2 (MBP)

Current output 0 /4 to 20 mA (excluding HART)

Standard installation cable is sufficient.

Pulse /frequency /switch output

Standard installation cable is sufficient.

Relay output

Standard installation cable is sufficient.

Current input 4 to 20 mA

Standard installation cable is sufficient.

Status input

Standard installation cable is sufficient.

Cable diameter

- Cable glands supplied:
M20 × 1.5 with cable Ø 6 to 12 mm (0.24 to 0.47 in)
- Spring-loaded terminals: Suitable for strands and strands with ferrules.
Conductor cross-section 0.2 to 2.5 mm² (24 to 12 AWG).

Requirements for connecting cable – remote display and operating module DKX001*Optionally available connecting cable*

A cable is supplied depending on the order option

- Order code for measuring device: order code **030** for "Display; operation", option **O**
or
- Order code for measuring device: order code **030** for "Display; operation", option **M**
and
- Order code for DKX001: order code **040** for "Cable", option **A, B, D, E**

Standard cable	2 × 2 × 0.34 mm ² (22 AWG) PVC cable with common shield (2 pairs, pair-stranded)
Flame resistance	According to DIN EN 60332-1-2
Oil resistance	According to DIN EN 60811-2-1
Shield	Tin-plated copper braid, optical cover ≥ 85 %
Capacitance: core/shield	≤ 200 pF/m
L/R	≤ 24 μH/Ω
Available cable length	5 m (15 ft)/10 m (35 ft)/20 m (65 ft)/30 m (100 ft)
Operating temperature	When mounted in a fixed position: -50 to +105 °C (-58 to +221 °F); when cable can move freely: -25 to +105 °C (-13 to +221 °F)

Standard cable - customer-specific cable

With the following order option, no cable is supplied with the device and must be provided by the customer:

Order code for DKX001: Order code **040** for "Cable", option **1** "None, provided by customer, max 300 m"

A standard cable with the following minimum requirements can be used as the connecting cable, even in the hazardous area (Zone 2, Class I, Division 2 and Zone 1, Class I, Division 1):



Standard cable	4 wires (2 pairs); pair-stranded with common shield, minimum wire cross-section 0.34 mm ² (22 AWG)
Shield	Tin-plated copper braid, optical cover ≥ 85 %
Cable impedance (pair)	Minimum 80 Ω
Cable length	Maximum 300 m (1000 ft), maximum loop impedance 20 Ω
Capacitance: core/shield	Maximum 1 000 nF for Zone 1, Class I, Division 1
L/R	Maximum 24 μH/Ω for Zone 1, Class I, Division 1

7.2.3 Terminal assignment

Transmitter: supply voltage, input/outputs

The terminal assignment of the inputs and outputs depends on the individual order version of the device. The device-specific terminal assignment is documented on an adhesive label in the terminal cover.

Supply voltage		Input/output 1		Input/output 2		Input/output 3	
1 (+)	2 (-)	26 (A)	27 (B)	24 (+)	25 (-)	22 (+)	23 (-)
Device-specific terminal assignment: adhesive label in terminal cover.							

 Terminal assignment of the remote display and operating module →  38.

7.2.4 Available device plugs

 Device plugs may not be used in hazardous areas!

Order code for "Input; output 1", option SA "FOUNDATION Fieldbus"

Order code for "Electrical connection"	Cable entry/connection	
	2	3
M, 3, 4, 5	7/8" connector	-

7.2.5 device plug pin assignment

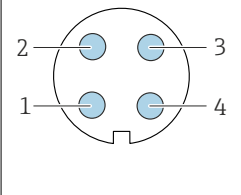
	Pin	Assignment	Coding A	Plug/socket Plug	
	1	+			Signal +
	2	-			Signal -
	3				Grounding
	4				Not assigned

7.2.6 Shielding and grounding

Optimal electromagnetic compatibility (EMC) of the fieldbus system can be guaranteed only if the system components and, in particular, the lines are shielded and the shield forms as complete a cover as possible. A shield coverage of 90 % is ideal.

1. To ensure optimal EMC protection, connect the shield to the reference ground as often as possible.
2. For reasons concerning explosion protection, it is recommended that grounding be dispensed with.

To comply with both requirements, there are basically three different types of shielding in the fieldbus system:

- Shielding at both ends
- Shielding at one end on the feed side with capacitance termination at the field device
- Shielding at one end on the feed side

Experience shows that the best results with regard to EMC are achieved in most cases in installations with one-sided shielding on the feed side (without capacitance termination at the field device). Appropriate measures with regard to input wiring must be taken to allow

unrestricted operation when EMC interference is present. These measures have been taken into account for this device. Operation in the event of disturbance variables as per NAMUR NE21 is thus guaranteed.

1. Observe national installation requirements and guidelines during installation.
2. Where there are large differences in potential between the individual grounding points, connect only one point of the shielding directly to the reference ground.
3. In systems without potential equalization, the cable shielding of fieldbus systems should be grounded on one side only, for example at the fieldbus supply unit or at safety barriers.

NOTICE

In systems without potential matching, the multiple grounding of the cable shield causes mains frequency equalizing currents!

Damage to the bus cable shield.

- ▶ Only ground the bus cable shield to either the local ground or the protective ground at one end.
- ▶ Insulate the shield that is not connected.

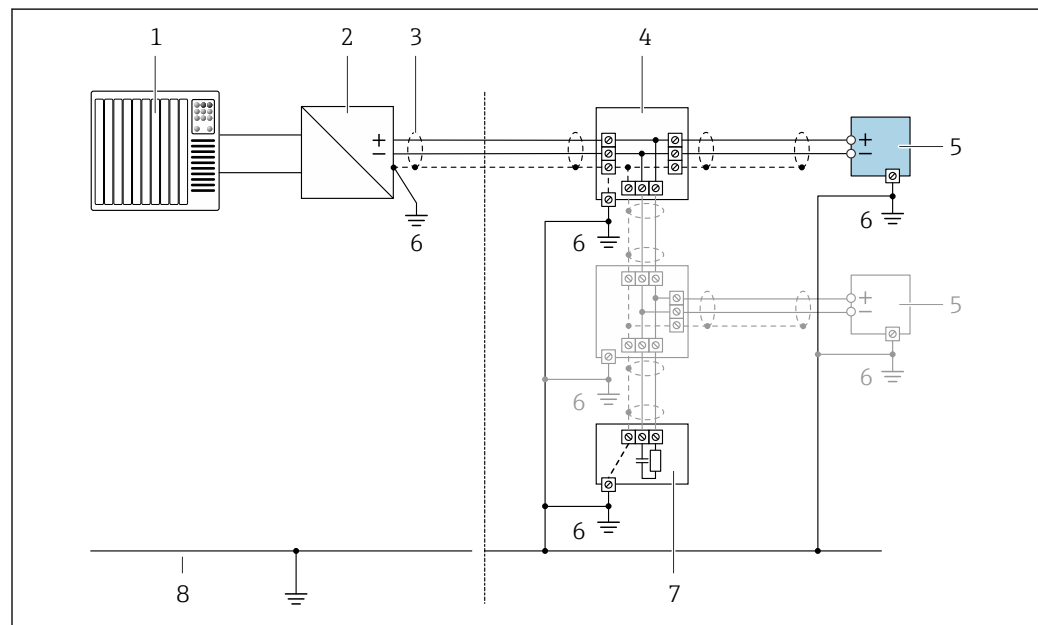

10 Connection example for FOUNDATION Fieldbus

- 1 Control system (e.g. PLC)
- 2 Power conditioner (FOUNDATION Fieldbus)
- 3 Cable shield: the cable shield must be grounded at both ends to comply with EMC requirements; observe cable specifications
- 4 T-box
- 5 Measuring device
- 6 Local grounding
- 7 Bus terminator
- 8 Potential equalization conductor

7.2.7 Preparing the measuring device

NOTICE

Insufficient sealing of the housing!

Operational reliability of the measuring device could be compromised.

- ▶ Use suitable cable glands corresponding to the degree of protection.

1. Remove dummy plug if present.

2. If the measuring device is supplied without cable glands:
Provide suitable cable gland for corresponding connecting cable.
3. If the measuring device is supplied with cable glands:
Observe requirements for connecting cables → 30.

7.3 Connecting the measuring instrument

NOTICE

An incorrect connection compromises electrical safety!

- ▶ Only properly trained specialist staff may perform electrical connection work.
- ▶ Observe applicable federal/national installation codes and regulations.
- ▶ Comply with local workplace safety regulations.
- ▶ Always connect the protective ground cable ⊕ before connecting additional cables.
- ▶ When using in potentially explosive atmospheres, observe the information in the device-specific Ex documentation.

7.3.1 Connecting the transmitter

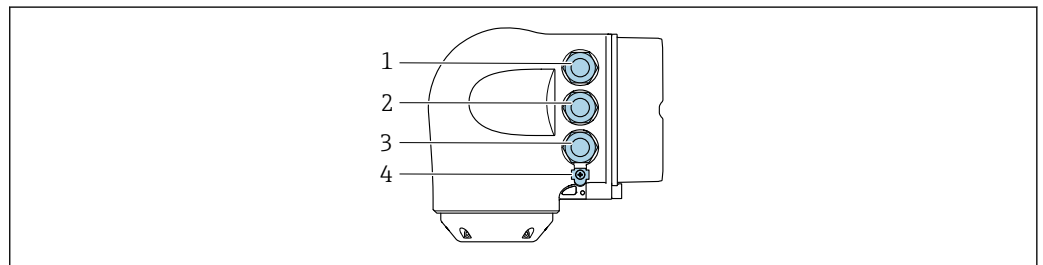

A0026781

- 1 Terminal connection for supply voltage
- 2 Terminal connection for signal transmission, input/output
- 3 Terminal connection for signal transmission, input/output or terminal connection for network connection via service interface (CDI-RJ45); optional: connection for external WLAN antenna or remote display and operating module DKX001
- 4 Protective earth (PE)

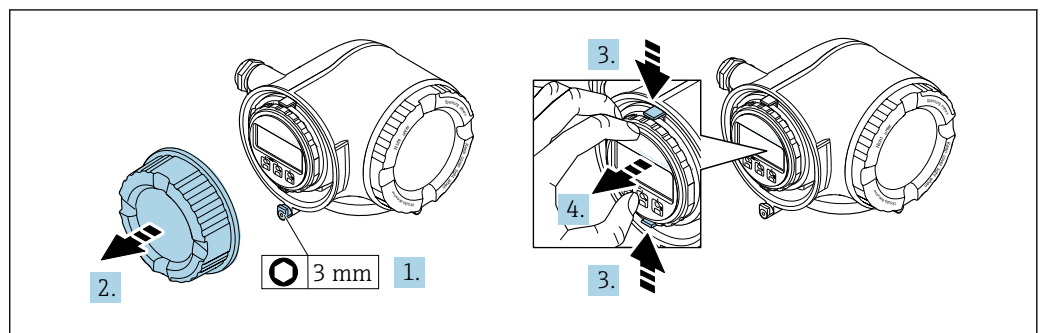

A0029813

1. Loosen the securing clamp of the connection compartment cover.
2. Unscrew the connection compartment cover.
3. Squeeze the tabs of the display module holder together.
4. Remove the display module holder.

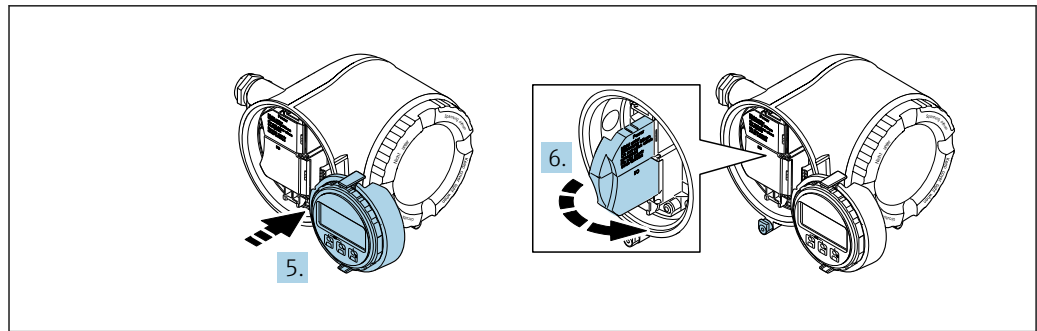

A0029814

5. Attach the holder to the edge of the electronics compartment.
6. Open the terminal cover.

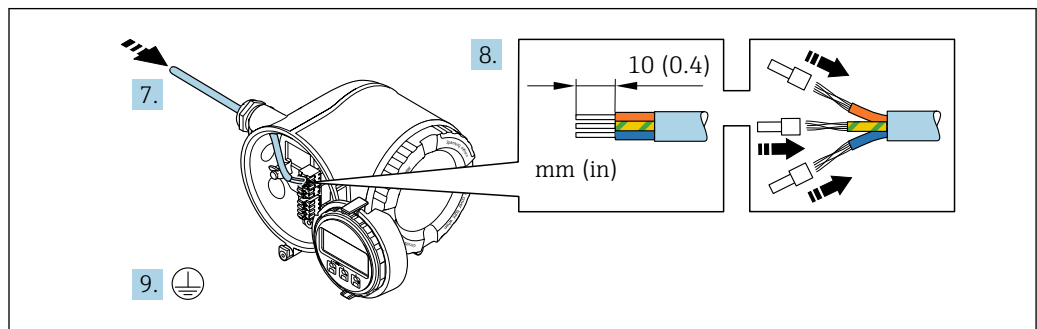

A0029815

7. Push the cable through the cable entry. To ensure tight sealing, do not remove the sealing ring from the cable entry.
8. Strip the cable and cable ends. In the case of stranded cables, also fit ferrules.
9. Connect the protective ground.

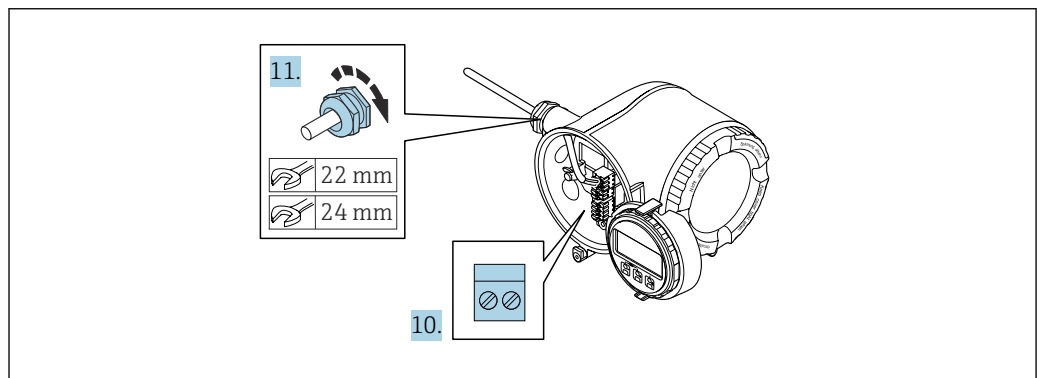

A0029816

10. Connect the cable according to the terminal assignment.
 - ↳ **Signal cable terminal assignment:** The device-specific terminal assignment is documented on an adhesive label in the terminal cover.
 - Supply voltage connection terminal assignment:** Adhesive label in the terminal cover or → 33.
11. Firmly tighten the cable glands.
 - ↳ This concludes the cable connection process.
12. Close the terminal cover.
13. Fit the display module holder in the electronics compartment.
14. Screw on the connection compartment cover.
15. Secure the securing clamp of the connection compartment cover.

Removing a cable

To remove a cable from the terminal:

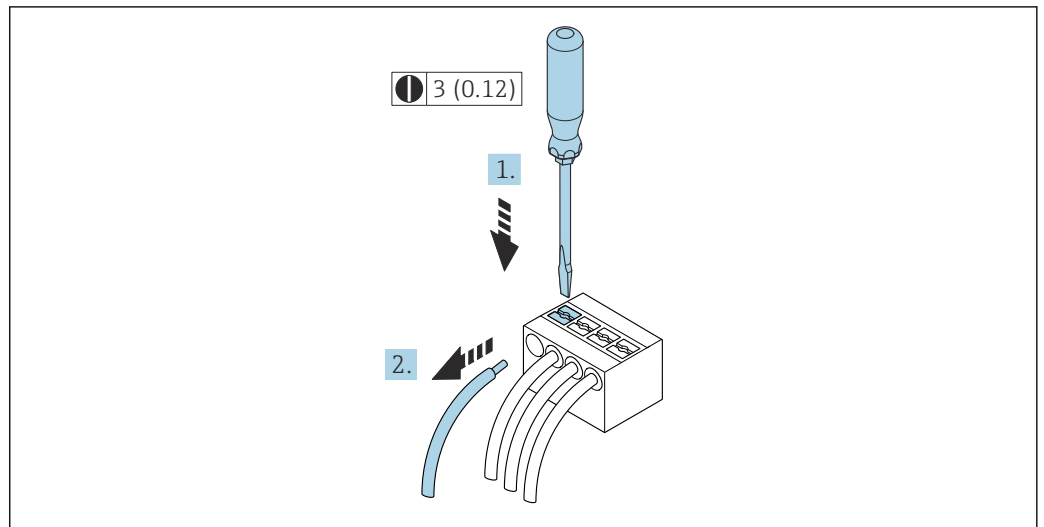

11 Engineering unit mm (in)

1. Use a flat-blade screwdriver to press down on the slot between the two terminal holes.
2. Remove the cable end from the terminal.

7.3.2 Connecting the remote display and operating module DKX001

i The remote display and operating module DKX001 is available as an optional extra → 192..

- The measuring instrument is always supplied with a dummy cover when the remote display and operating module DKX001 is ordered directly with the measuring instrument. Display or operation at the transmitter is not possible in this case.
- If ordered subsequently, the remote display and operating module DKX001 may not be connected at the same time as the existing measuring instrument display module. Only one display or operation unit may be connected to the transmitter at any one time.

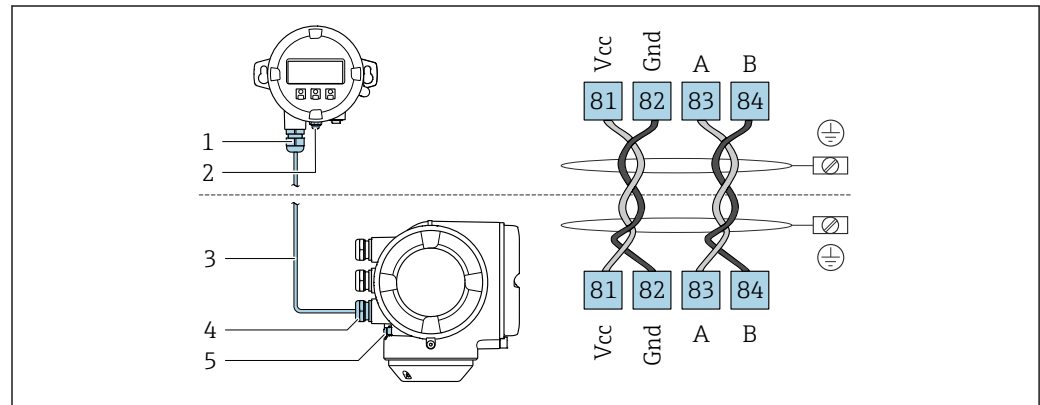

- 1 Remote display and operating module DKX001
- 2 Terminal connection for potential equalization (PE)
- 3 Connecting cable
- 4 Measuring instrument
- 5 Terminal connection for potential equalization (PE)

7.4 Potential equalization

7.4.1 Requirements

For potential equalization:

- Pay attention to in-house grounding concepts
- Take account of operating conditions, such as the pipe material and grounding
- Connect the medium, sensor and transmitter to the same electric potential
- Use a ground cable with a minimum cross-section of 6 mm² (10 AWG) and a cable lug for potential equalization connections

7.5 Special connection instructions

7.5.1 Connection examples

FOUNDATION Fieldbus

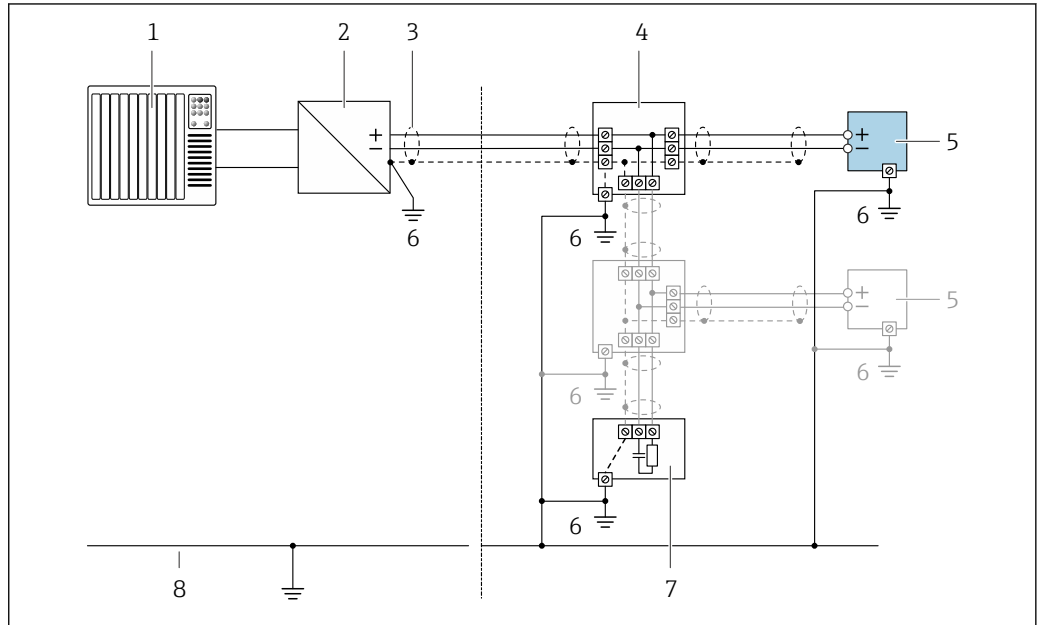

A0028768

12 Connection example for FOUNDATION Fieldbus

- 1 Control system (e.g. PLC)
- 2 Power Conditioner (FOUNDATION Fieldbus)
- 3 Cable shield provided at one end. The cable shield must be grounded at both ends to comply with EMC requirements; observe cable specifications
- 4 T-box
- 5 Measuring device
- 6 Local grounding
- 7 Bus terminator
- 8 Potential matching line

Current output 4-20 mA

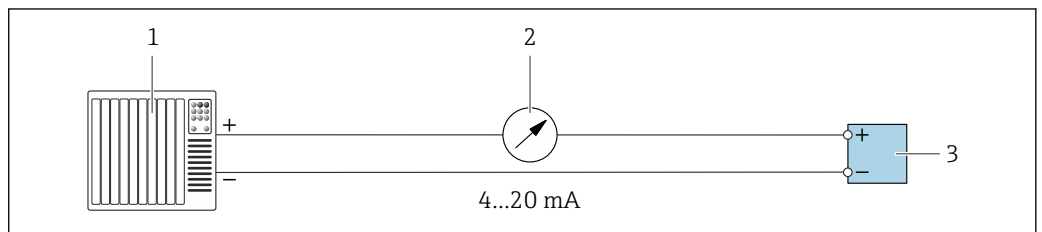

A0028758

13 Connection example for 4-20 mA current output (active)

- 1 Automation system with current input (e.g. PLC)
- 2 Analog display unit: observe maximum load
- 3 Transmitter

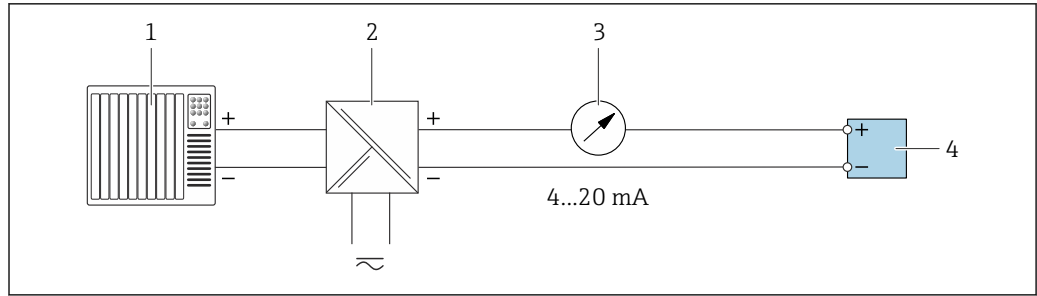

A0028759

14 Connection example for 4-20 mA current output (passive)

- 1 Automation system with current input (e.g. PLC)
- 2 Active barrier for power supply (e.g. RN221N)
- 3 Analog display unit: observe maximum load
- 4 Transmitter

Pulse/frequency output

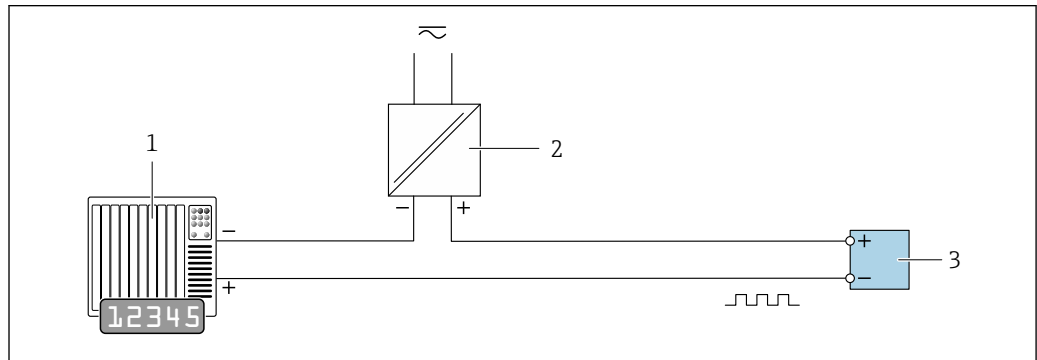

A0028761

15 Connection example for pulse/frequency output (passive)

- 1 Automation system with pulse/frequency input (e.g. PLC with 10 kΩ pull-up or pull-down resistor)
- 2 Power supply
- 3 Transmitter: observe input values → 200

Switch output

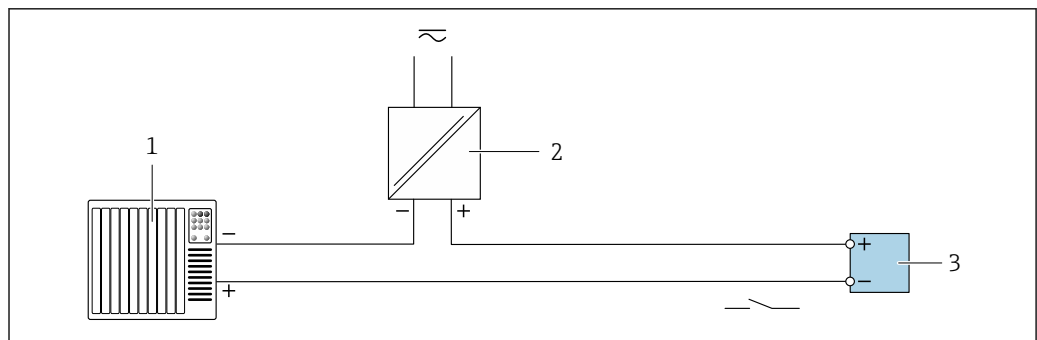

A0028760

16 Connection example for switch output (passive)

- 1 Automation system with switch input (e.g. PLC with a 10 kΩ pull-up or pull-down resistor)
- 2 Power supply
- 3 Transmitter: observe input values → 200

Relay output

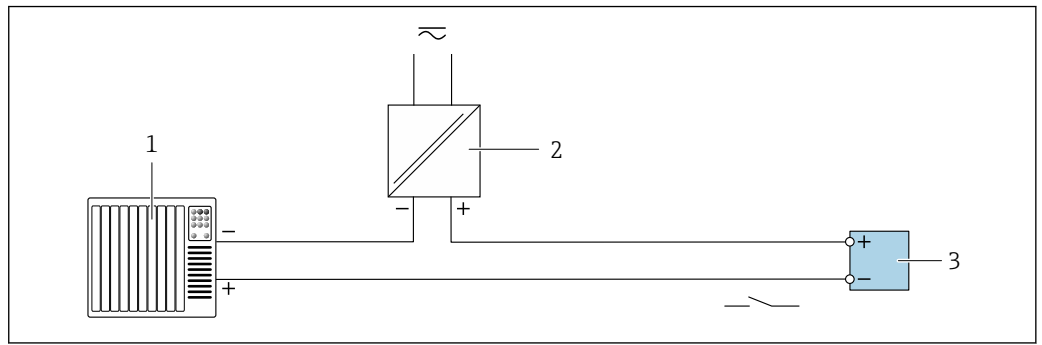

A0028760

17 Connection example for relay output (passive)

- 1 Automation system with relay input (e.g. PLC)
- 2 Power supply
- 3 Transmitter: observe input values → 201

Current input

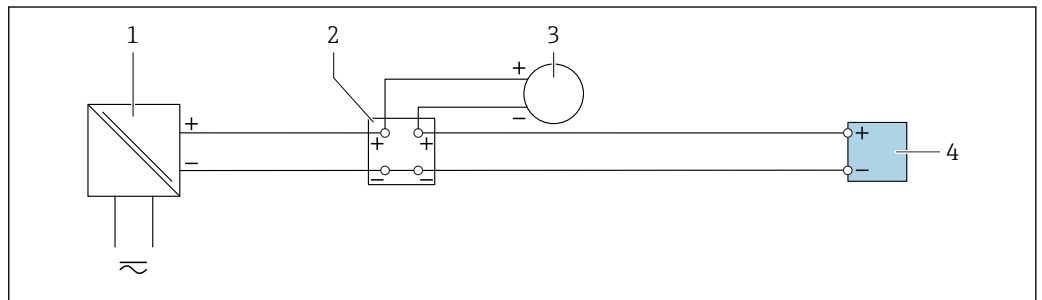

A0028915

18 Connection example for 4 to 20 mA current input

- 1 Power supply
- 2 Terminal box
- 3 External measuring device (to read in pressure or temperature, for instance)
- 4 Transmitter

Status input

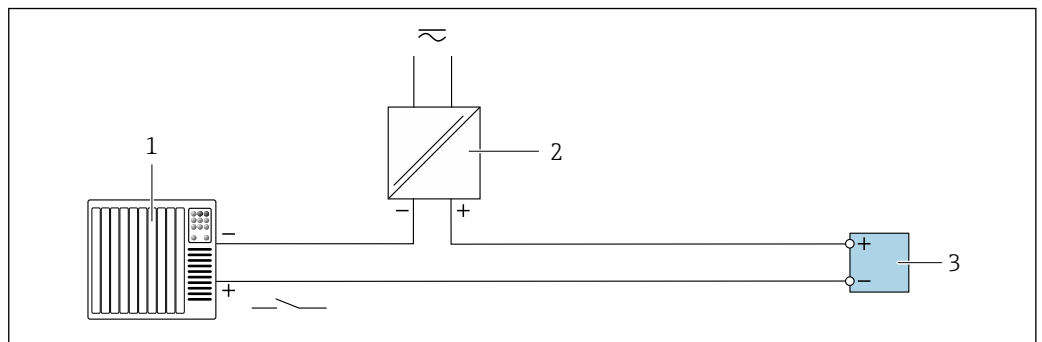

A0028764

19 Connection example for status input

- 1 Automation system with status output (e.g. PLC)
- 2 Power supply
- 3 Transmitter

7.6 Ensuring the degree of protection

The measuring instrument fulfills all the requirements for the degree of protection IP66/67, Type 4X enclosure.

To guarantee the degree of protection IP66/67, Type 4X enclosure, carry out the following steps after the electrical connection:

1. Check that the housing seals are clean and fitted correctly.
2. Dry, clean or replace the seals if necessary.
3. Tighten all housing screws and screw covers.
4. Firmly tighten the cable glands.
5. To ensure that moisture does not enter the cable entry:
Route the cable so that it loops down before the cable entry ("water trap").

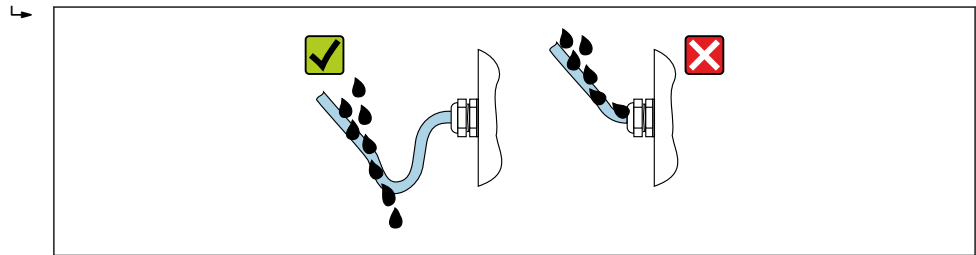

A0029278

6. The cable glands supplied do not ensure housing protection when not in use. They must therefore be replaced by dummy plugs corresponding to the housing protection.

7.7 Post-connection check

Are the device and cable undamaged (visual inspection)?	<input type="checkbox"/>
Is the protective earthing established correctly?	<input type="checkbox"/>
Do the cables used comply with the requirements ?	<input type="checkbox"/>
Are the installed cables strain-relieved and securely routed?	<input type="checkbox"/>
Are all cable glands installed, securely tightened and leak-tight? Cable run with "water trap" → 42?	<input type="checkbox"/>
Is the terminal assignment correct ?	<input type="checkbox"/>
If supply voltage is present: Does an indication appear on the display module?	<input type="checkbox"/>
Are dummy plugs inserted in unused cable entries and have transportation plugs been replaced with dummy plugs?	<input type="checkbox"/>

8 Operation options

8.1 Overview of operation options

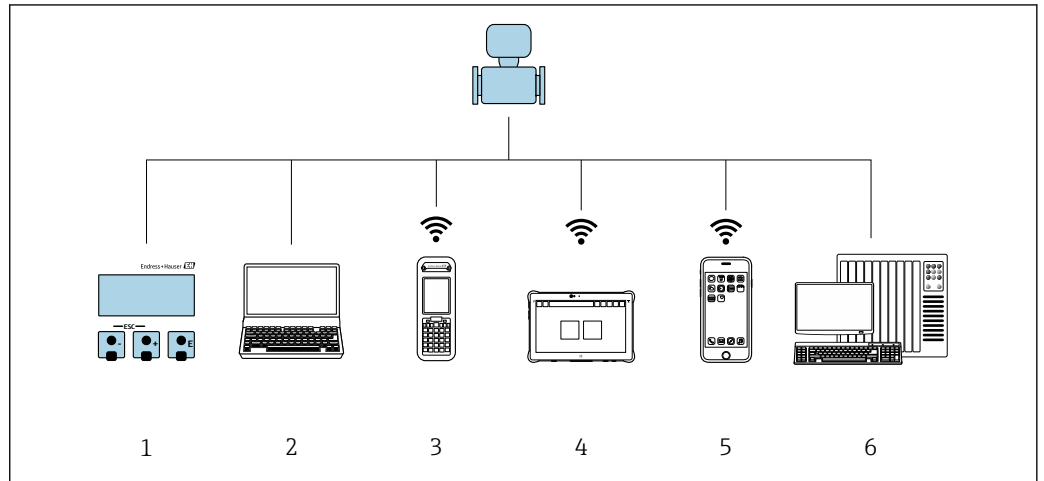

A0034513

- 1 Local operation via display module
- 2 Computer with web browser or operating tool (e.g. FieldCare, DeviceCare, AMS Device Manager, SIMATIC PDM)
- 3 Field Xpert SFX350 or SFX370
- 4 Field Xpert SMT70
- 5 Mobile handheld terminal
- 6 Automation system (e.g. PLC)

8.2 Structure and function of the operating menu

8.2.1 Structure of the operating menu

 For an overview of the operating menu for experts: see the "Description of Device Parameters" document supplied with the device



 20 Schematic structure of the operating menu

A0018237-EN

8.2.2 Operating philosophy

The individual parts of the operating menu are assigned to certain user roles (e.g. operator, maintenance etc.). Each user role contains typical tasks within the device life cycle.

 For custody transfer, once the device has been put into circulation or sealed, its operation is restricted.

Menu/parameter		User role and tasks	Content/meaning
Language	Task-oriented	Role "Operator", "Maintenance" Tasks during operation: <ul style="list-style-type: none"> ▪ Configuration of the operational display ▪ Reading measured values 	<ul style="list-style-type: none"> ▪ Defining the operating language ▪ Defining the Web server operating language ▪ Resetting and controlling totalizers
Operation			<ul style="list-style-type: none"> ▪ Configuration of the operational display (e.g. display format, display contrast) ▪ Resetting and controlling totalizers
Setup		"Maintenance" role Commissioning: <ul style="list-style-type: none"> ▪ Configuration of the measurement ▪ Configuration of the inputs and outputs ▪ Configuration of the communication interface 	Wizards for fast commissioning: <ul style="list-style-type: none"> ▪ Configuring the system units ▪ Configuration of the communication interface ▪ Definition of the medium ▪ Displaying the I/O configuration ▪ Configuring the inputs ▪ Configuring the outputs ▪ Configuration of the operational display ▪ Configuring the low flow cut off ▪ Configuring partial and empty pipe detection Advanced setup <ul style="list-style-type: none"> ▪ For more customized configuration of the measurement (adaptation to special measuring conditions) ▪ Configuration of totalizers ▪ Configuration of WLAN settings ▪ Administration (define access code, reset measuring device)
Diagnostics		"Maintenance" role Troubleshooting: <ul style="list-style-type: none"> ▪ Diagnostics and elimination of process and device errors ▪ Measured value simulation 	Contains all parameters for error detection and analyzing process and device errors: <ul style="list-style-type: none"> ▪ Diagnostic list Contains up to 5 currently pending diagnostic messages. ▪ Event logbook Contains event messages that have occurred. ▪ Device information Contains information for identifying the device ▪ Measured values Contains all current measured values. ▪ Data logging submenu with the "Extended HistoROM" order option Storage and visualization of measured values ▪ Heartbeat Technology Verification of device functionality on request and documentation of verification results ▪ Simulation Used to simulate measured values or output values.

Menu/parameter	User role and tasks	Content/meaning
Expert	Function-oriented	<p>Tasks that require detailed knowledge of the function of the device:</p> <ul style="list-style-type: none"> ▪ Commissioning measurements under difficult conditions ▪ Optimal adaptation of the measurement to difficult conditions ▪ Detailed configuration of the communication interface ▪ Error diagnostics in difficult cases <p>Contains all of the device parameters and allows direct access to these by means of an access code. The structure of this menu is based on the function blocks of the device:</p> <ul style="list-style-type: none"> ▪ System Contains all higher-level device parameters that do not affect measurement or measured value communication ▪ Sensor Configuration of the measurement. ▪ Output Configuration of the pulse/frequency/switch output ▪ Input Configuration of the status input ▪ Output Configuration of the analog current outputs as well as the pulse/frequency and switch output ▪ Communication Configuration of the digital communication interface and the Web server ▪ Submenus for function blocks (e.g. "Analog Inputs") Configuration of function blocks ▪ Application Configuration of the functions that go beyond the actual measurement (e.g. totalizer) ▪ Diagnostics Error detection and analysis of process and device errors and for device simulation and Heartbeat Technology.

8.3 Access to operating menu via local display

8.3.1 Operational display

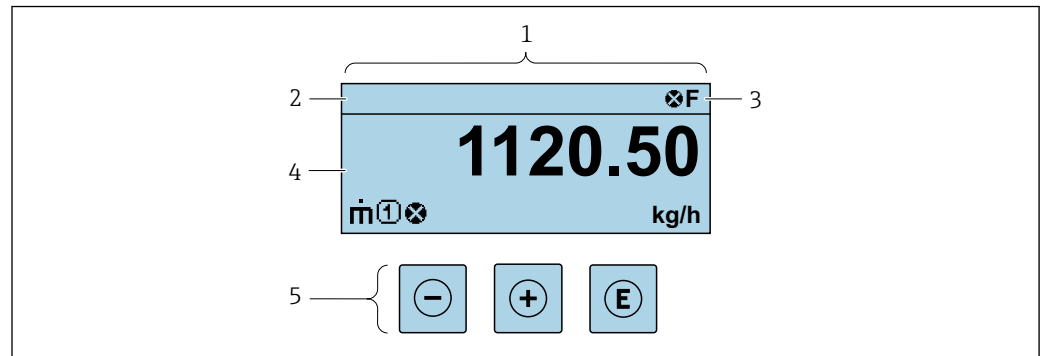







A0029348

- 1 Operational display
- 2 Device tag
- 3 Status area
- 4 Display range for measured values (up to 4 lines)
- 5 Operating elements → 53

Status area





The following symbols appear in the status area of the operational display at the top right:



- Status signals →  151
 - **F**: Failure
 - **C**: Function check
 - **S**: Out of specification
 - **M**: Maintenance required
- Diagnostic behavior →  152
 - : Alarm
 - : Warning
- : Locking (the device is locked via the hardware)
- : Communication (communication via remote operation is active)

Display area



In the display area, each measured value is prefaced by certain symbol types for further description:

Measured variables

Symbol	Meaning
	Mass flow
	<ul style="list-style-type: none"> ▪ Volume flow ▪ Corrected volume flow
	<ul style="list-style-type: none"> ▪ Density ▪ Reference density
	Temperature

 The number and display format of the measured variables can be configured via the **Format display** parameter (→  100).



Totalizer

Symbol	Meaning
	Totalizer  The measurement channel number indicates which of the three totalizers is displayed.



Input

Symbol	Meaning
	Status input

Measurement channel numbers

Symbol	Meaning
	Measurement channel 1 to 4  The measurement channel number is displayed only if more than one channel is present for the same measured variable type (e.g. totalizer 1 to 3).

Diagnostic behavior

Symbol	Meaning
	Alarm <ul style="list-style-type: none">▪ Measurement is interrupted.▪ Signal outputs and totalizers assume the defined alarm condition.▪ A diagnostic message is generated.
	Warning <ul style="list-style-type: none">▪ Measurement is resumed.▪ The signal outputs and totalizers are not affected.▪ A diagnostic message is generated.

 The diagnostic behavior pertains to a diagnostic event that is relevant to the displayed measured variable.

8.3.2 Navigation view

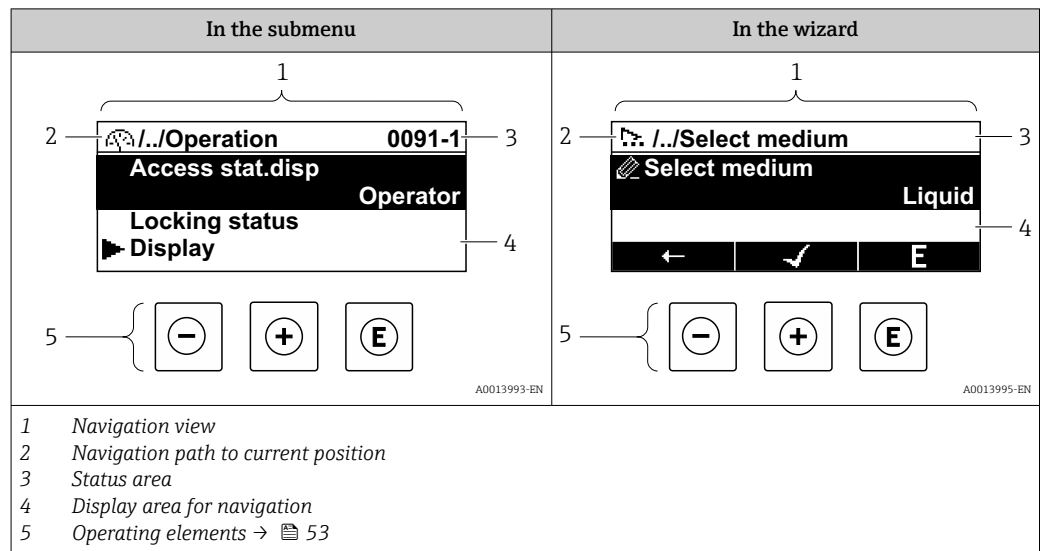

Navigation path

The navigation path to the current position is displayed at the top left in the navigation view and consists of the following elements:

- The display symbol for the menu/submenu (▶) or the wizard (⚙).
- An omission symbol (/ ../) for operating menu levels in between.
- Name of the current submenu, wizard or parameter

	Display symbol	Omission symbol	Parameter
	↓	↓	↓
Example	▶	/ ../	Indication

i For more information about the icons in the menu, refer to the "Display area" section → 49

Status area

The following appears in the status area of the navigation view in the top right corner:



- In the submenu
 - The direct access code to the parameter (e.g., 0022-1)
 - If a diagnostic event is present, the diagnostic behavior and status signal
- In the wizard
 - If a diagnostic event is present, the diagnostic behavior and status signal

i For information on the diagnostic behavior and status signal → 151
 For information on the function and entry of the direct access code → 55





Display area

Menus

Symbol	Meaning
	Operation Is displayed: <ul style="list-style-type: none"> ▪ In the menu next to the "Operation" selection ▪ At the left in the navigation path in the Operation menu

	<p>Setup Is displayed:</p> <ul style="list-style-type: none"> ▪ In the menu next to the "Setup" selection ▪ At the left in the navigation path in the Setup menu
	<p>Diagnosis Is displayed:</p> <ul style="list-style-type: none"> ▪ In the menu next to the "Diagnostics" selection ▪ At the left in the navigation path in the Diagnostics menu
	<p>Expert Is displayed:</p> <ul style="list-style-type: none"> ▪ In the menu next to the "Expert" selection ▪ At the left in the navigation path in the Expert menu



Submenus, wizards, parameters

Symbol	Meaning
	Submenu
	Wizards
	Parameters within a wizard  No display symbol exists for parameters in submenus.

Locking procedure

Symbol	Meaning
	<p>Parameter locked When displayed in front of a parameter name, indicates that the parameter is locked.</p> <ul style="list-style-type: none"> ▪ By a user-specific access code ▪ By the hardware write protection switch

Wizards

Symbol	Meaning
	Switches to the previous parameter.
	Confirms the parameter value and switches to the next parameter.
	Opens the editing view of the parameter.

8.3.3 Editing view

Numeric editor

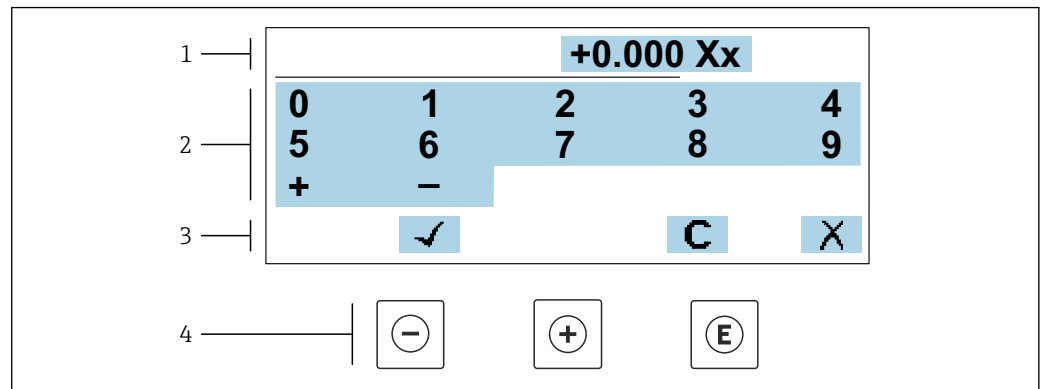

A0034250

21 For entering values in parameters (e.g. limit values)

- 1 Entry display area
- 2 Input screen
- 3 Confirm, delete or reject entry
- 4 Operating elements

Text editor

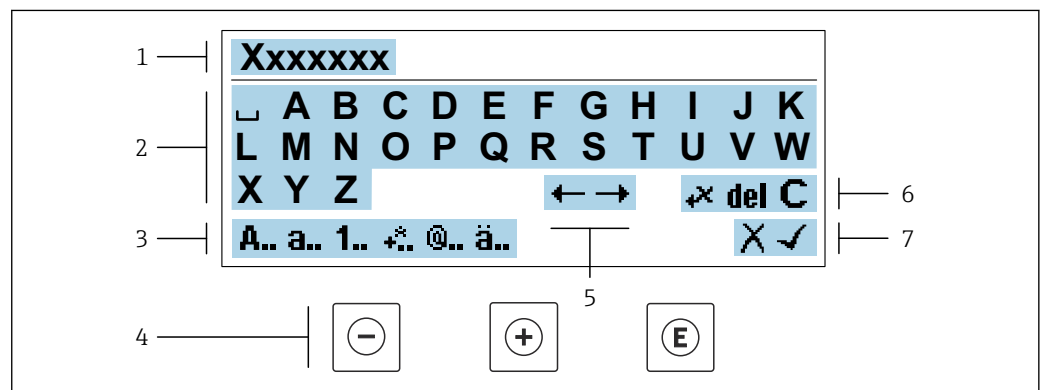



A0034114

22 For entering text in parameters (e.g. device tag)



- 1 Entry display area
- 2 Current input screen
- 3 Change input screen
- 4 Operating elements
- 5 Move entry position
- 6 Delete entry
- 7 Reject or confirm entry

Using the operating elements in the editing view





Operating key	Meaning
	Minus key Move the entry position to the left.
	Plus key Move the entry position to the right.

Operating key	Meaning
	Enter key <ul style="list-style-type: none"> ▪ Pressing the key briefly confirms your selection. ▪ Pressing the key for 2 s confirms your entry.
	Escape key combination (press keys simultaneously) Close the editing view without accepting a change.





Input screens

Symbol	Meaning
A..	Upper case
a..	Lower case
1..	Numbers
	Punctuation marks and special characters: = + - * / ² ³ ¼ ½ ¾ () [] < > { }
	Punctuation marks and special characters: " ` ^ . , ; : ? ! % μ ° € \$ £ ¥ \$ @ # / \ ~ & _
ä..	Umlauts and accents

Controlling data entries

Symbol	Meaning
	Move entry position
	Reject entry
	Confirm entry
	Delete character immediately to the left of the entry position
del	Delete character immediately to the right of the entry position
C	Clear all the characters entered

8.3.4 Operating elements

Operating key	Meaning
	<p>Minus key</p> <p><i>In menu, submenu</i> Moves the selection bar upwards in a picklist</p> <p><i>In wizards</i> Goes to previous parameter</p> <p><i>In the text and numeric editor</i> Move the entry position to the left.</p>
	<p>Plus key</p> <p><i>In menu, submenu</i> Moves the selection bar downwards in a picklist</p> <p><i>In wizards</i> Goes to the next parameter</p> <p><i>In the text and numeric editor</i> Move the entry position to the right.</p>
	<p>Enter key</p> <p><i>In the operational display</i> Pressing the key briefly opens the operating menu.</p> <p><i>In menu, submenu</i></p> <ul style="list-style-type: none"> ▪ Pressing the key briefly: <ul style="list-style-type: none"> ▪ Opens the selected menu, submenu or parameter. ▪ Starts the wizard. ▪ If help text is open, closes the help text of the parameter. ▪ Pressing the key for 2 s in a parameter: <ul style="list-style-type: none"> ▪ If present, opens the help text for the function of the parameter. <p><i>In wizards</i> Opens the editing view of the parameter and confirms the parameter value</p> <p><i>In the text and numeric editor</i></p> <ul style="list-style-type: none"> ▪ Pressing the key briefly confirms your selection. ▪ Pressing the key for 2 s confirms your entry.
	<p>Escape key combination (press keys simultaneously)</p> <p><i>In menu, submenu</i></p> <ul style="list-style-type: none"> ▪ Pressing the key briefly: <ul style="list-style-type: none"> ▪ Exits the current menu level and takes you to the next higher level. ▪ If help text is open, closes the help text of the parameter. ▪ Pressing the key for 2 s returns you to the operational display ("home position"). <p><i>In wizards</i> Exits the wizard and takes you to the next higher level</p> <p><i>In the text and numeric editor</i> Exits the Editing view without applying the changes.</p>
	<p>Minus/Enter key combination (press and hold down the keys simultaneously)</p> <ul style="list-style-type: none"> ▪ If keypad lock is active: <ul style="list-style-type: none"> ▪ Pressing the key for 3 s deactivates the keypad lock. ▪ If keypad lock is not active: <ul style="list-style-type: none"> ▪ Pressing the key for 3 s opens the context menu including the option for activating the keypad lock.

8.3.5 Opening the context menu

Using the context menu, the user can call up the following menus quickly and directly from the operational display:

- Setup
- Data backup
- Simulation

Calling up and closing the context menu

The user is in the operational display.

1. Press the \square and \boxplus keys for longer than 3 seconds.
↳ The context menu opens.

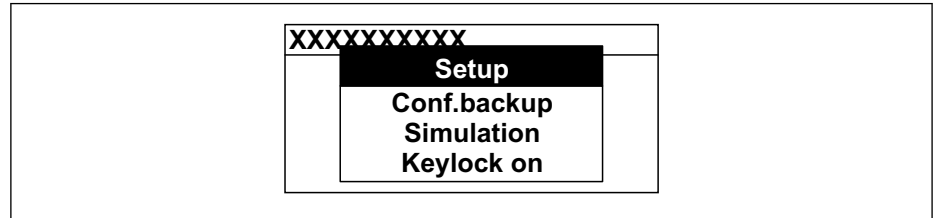

A0034608-EN

2. Press \square + \boxplus simultaneously.
↳ The context menu is closed and the operational display appears.

Calling up the menu via the context menu

1. Open the context menu.
2. Press \boxplus to navigate to the desired menu.
3. Press \square to confirm the selection.
↳ The selected menu opens.

8.3.6 Navigating and selecting from list

Different operating elements are used to navigate through the operating menu. The navigation path is displayed on the left in the header. Icons are displayed in front of the individual menus. These icons are also shown in the header during navigation.

i For an explanation of the navigation view with symbols and operating elements → 49

Example: Setting the number of displayed measured values to "2 values"

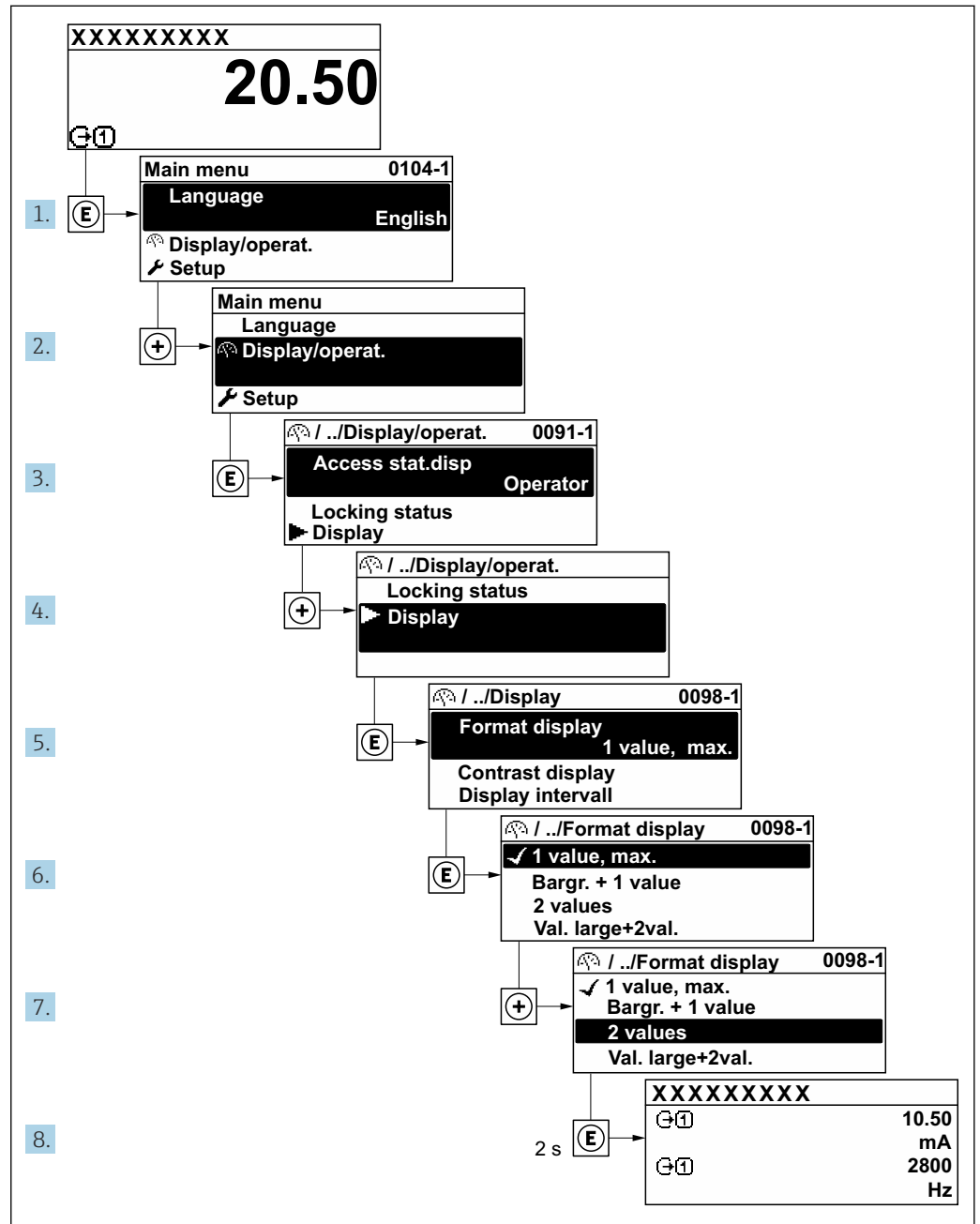

A0029562-EN

8.3.7 Calling the parameter directly

A parameter number is assigned to every parameter to be able to access a parameter directly via the onsite display. Entering this access code in the **Direct access** parameter calls up the desired parameter directly.

Navigation path

Expert → Direct access

The direct access code consists of a 5-digit number (at maximum) and the channel number, which identifies the channel of a process variable: e.g. 00914-2. In the navigation view, this appears on the right-hand side in the header of the selected parameter.

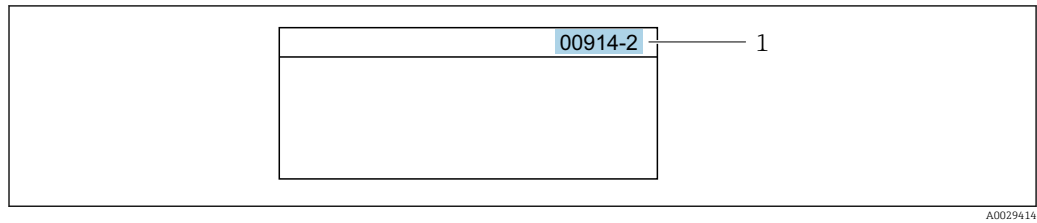

1 Direct access code

Note the following when entering the direct access code:

- The leading zeros in the direct access code do not have to be entered.
Example: Enter "914" instead of "00914"
- If no channel number is entered, channel 1 is opened automatically.
Example: Enter 00914 → **Assign process variable** parameter
- If a different channel is opened: Enter the direct access code with the corresponding channel number.
Example: Enter 00914-2 → **Assign process variable** parameter



For the direct access codes of the individual parameters, see the "Description of Device Parameters" document for the device

8.3.8 Calling up help text

Help text is available for some parameters and can be called up from the navigation view. The help text provides a brief explanation of the parameter function and thereby supports swift and safe commissioning.

Calling up and closing the help text

The user is in the navigation view and the selection bar is on a parameter.

1. Press \square for 2 s.
↳ The help text for the selected parameter opens.

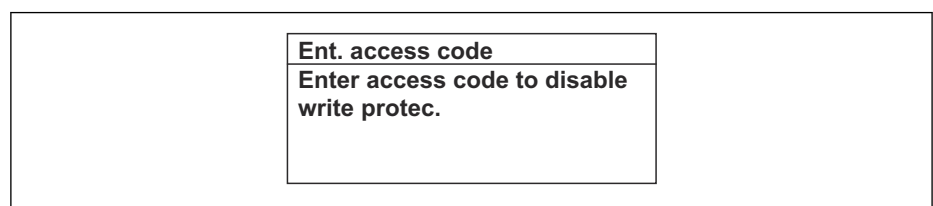

23 Example: Help text for parameter "Enter access code"

2. Press \square + \oplus simultaneously.
↳ The help text is closed.

8.3.9 Changing the parameters

Parameters can be changed via the numeric editor or text editor.

- Numeric editor: Change values in a parameter, e.g. specifications for limit values.
- Text editor: Enter text in a parameter, e.g. tag name.

A message is displayed if the value entered is outside the permitted value range.

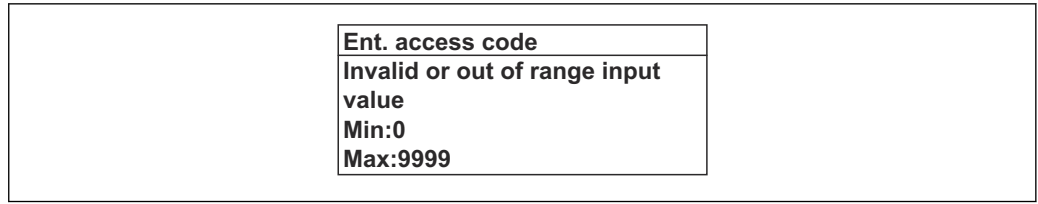

A0014049-EN

For a description of the editing view - consisting of the text editor and numeric editor - with symbols → 51, for a description of the operating elements → 53

8.3.10 User roles and related access authorization

The two user roles "Operator" and "Maintenance" have different write access to the parameters if the customer defines a user-specific access code. This protects the device configuration via the local display from unauthorized access → 125.

Defining access authorization for user roles

An access code is not yet defined when the device is delivered from the factory. Access authorization (read and write access) to the device is not restricted and corresponds to the "Maintenance" user role.

- ▶ Define the access code.
 - ↳ The "Operator" user role is redefined in addition to the "Maintenance" user role. Access authorization differs for the two user roles.

Access authorization to parameters: "Maintenance" user role

Access code status	Read access	Write access
An access code has not yet been defined (factory setting).	✓	✓
After an access code has been defined.	✓	✓ ¹⁾

1) The user only has write access after entering the access code.

Access authorization to parameters: "Operator" user role

Access code status	Read access	Write access
After an access code has been defined.	✓	_ ¹⁾

1) Despite the defined access code, certain parameters can always be modified and thus are excluded from the write protection as they do not affect the measurement: write protection via access code → 125

The user role with which the user is currently logged on is indicated by the **Access status** parameter. Navigation path: Operation → Access status

8.3.11 Disabling write protection via access code

If the -symbol appears on the local display in front of a parameter, the parameter is write-protected by a user-specific access code and its value cannot be changed at the moment using local operation → 125.

Parameter write protection via local operation can be disabled by entering the user-specific access code in the **Enter access code** parameter (→ 105) via the respective access option.

1. After you press , the input prompt for the access code appears.

2. Enter the access code.
 - ↳ The -symbol in front of the parameters disappears; all previously write-protected parameters are now re-enabled.

8.3.12 Enabling and disabling the keypad lock



The keypad lock makes it possible to block access to the entire operating menu via local operation. As a result, it is no longer possible to navigate through the operating menu or change the values of individual parameters. Users can only read the measured values on the operational display.

The keypad lock is switched on and off via the context menu.

Switching on the keypad lock



-  The keypad lock is switched on automatically:
- If the device has not been operated via the display for > 1 minute.
 - Each time the device is restarted.

To activate the keylock manually:

1. The device is in the measured value display.
Press the  and  keys for 3 seconds.
 - ↳ A context menu appears.
2. In the context menu select the **Keylock on** option.
 - ↳ The keypad lock is switched on.

-  If the user attempts to access the operating menu while the keypad lock is active, the **Keylock on** message appears.

Switching off the keypad lock



- ▶ The keypad lock is switched on.
Press the  and  keys for 3 seconds.
 - ↳ The keypad lock is switched off.

8.4 Access to operating menu via web browser

8.4.1 Function range

With the integrated web server, the device can be operated and configured via a web browser service interface (CDI-RJ45) or WLAN interface. The structure of the operating menu is the same as for the local display. In addition to the measured values, status information on the device is displayed and can be used to monitor device health. Furthermore the device data can be managed and the network parameters can be configured.

A device that has a WLAN interface (can be ordered as an option) is required for the WLAN connection: order code for "Display; operation", option G "4-line, illuminated; touch control + WLAN". The device acts as an Access Point and enables communication by computer or a mobile handheld terminal.

-  For additional information on the web server, see the Special Documentation for the device. →  225

8.4.2 Requirements

Computer hardware



Hardware	Interface	
	CDI-RJ45	WLAN
Interface	The computer must have a RJ45 interface. ¹⁾	The operating unit must have a WLAN interface.
Connection		Connection via Wireless LAN.
Screen	Recommended size: ≥ 12" (depends on the screen resolution)	

1) Recommended cable: CAT5e, CAT6 or CAT7, with shielded plug (e.g. YAMAICHI product; part no. Y-ConProfixPlug63/Prod. ID: 82-006660)

Computer software

Software	Interface	
	CDI-RJ45	WLAN
Recommended operating systems	<ul style="list-style-type: none"> ▪ Microsoft Windows 8 or higher. ▪ Mobile operating systems: <ul style="list-style-type: none"> ▪ iOS ▪ Android  Microsoft Windows XP and Windows 7 is supported.	
Web browsers supported	<ul style="list-style-type: none"> ▪ Microsoft Internet Explorer 8 or higher ▪ Microsoft Edge ▪ Mozilla Firefox ▪ Google Chrome ▪ Safari 	

Computer settings

Settings	Interface	
	CDI-RJ45	WLAN
User rights	Appropriate user rights (e.g. administrator rights) for TCP/IP and proxy server settings are necessary (e.g. for adjusting the IP address, subnet mask etc.).	
Proxy server settings of the web browser	The web browser setting <i>Use a proxy server for your LAN</i> must be disabled .	
JavaScript	JavaScript must be enabled.  If JavaScript cannot be enabled: Enter <code>http://192.168.1.212/servlet/basic.html</code> in the address bar of the web browser. A fully functional but simplified version of the operating menu structure starts in the web browser.  When installing a new firmware version: To enable correct data display, clear the temporary memory (cache) under Internet options in the web browser.	JavaScript must be enabled.  The WLAN display requires JavaScript support.
Network connections	Only use the active network connections to the measuring device.	
	Switch off all other network connections such as WLAN for example.	Switch off all other network connections.

 In the event of connection problems: →  149

Measuring device: Via CDI-RJ45 service interface

Device	CDI-RJ45 service interface
Measuring device	The measuring device has an RJ45 interface.
Web server	Web server must be enabled; factory setting: ON  For information on enabling the Web server → 64

Measuring device: via WLAN interface

Device	WLAN interface
Measuring device	The measuring device has a WLAN antenna: <ul style="list-style-type: none"> ▪ Transmitter with integrated WLAN antenna ▪ Transmitter with external WLAN antenna
Web server	Web server and WLAN must be enabled; factory setting: ON  For information on enabling the Web server → 64

8.4.3 Connecting the device

Via service interface (CDI-RJ45)

Preparing the measuring device

1. Depending on the housing version:
Loosen the securing clamp or fixing screw of the housing cover.
2. Depending on the housing version:
Unscrew or open the housing cover.
3. Connect the computer to the RJ45 plug via the standard Ethernet connecting cable..

Configuring the Internet protocol of the computer

The following information refers to the default Ethernet settings of the device.

IP address of the device: 192.168.1.212 (factory setting)

1. Switch on the measuring device.
2. Connect the computer to the RJ45 plug via the standard Ethernet cable → 65.
3. If a 2nd network card is not used, close all the applications on the notebook.
 - ↳ Applications requiring Internet or a network, such as e-mail, SAP applications, Internet or Windows Explorer.
4. Close any open Internet browsers.
5. Configure the properties of the Internet protocol (TCP/IP) as defined in the table:

IP address	192.168.1.XXX; for XXX all numerical sequences except: 0, 212 and 255 → e.g. 192.168.1.213
Subnet mask	255.255.255.0
Default gateway	192.168.1.212 or leave cells empty

Via WLAN interface

Configuring the Internet protocol of the mobile terminal

NOTICE

If the WLAN connection is lost during the configuration, settings made may be lost.

- ▶ Make sure that the WLAN connection is not disconnected while configuring the device.

NOTICE**Note the following to avoid a network conflict:**

- ▶ Avoid accessing the measuring device simultaneously from the same mobile terminal via the service interface (CDI-RJ45) and the WLAN interface.
- ▶ Only activate one service interface (CDI-RJ45 or WLAN interface).
- ▶ If simultaneous communication is necessary: configure different IP address ranges, e.g. 192.168.0.1 (WLAN interface) and 192.168.1.212 (CDI-RJ45 service interface).

Preparing the mobile terminal

- ▶ Enable WLAN on the mobile terminal.

Establishing a WLAN connection from the mobile terminal to the measuring device

1. In the WLAN settings of the mobile terminal:
Select the measuring device using the SSID (e.g. EH_Promass_300_A802000).
2. If necessary, select the WPA2 encryption method.
3. Enter the password:
Serial number of the measuring device ex-works (e.g. L100A802000).
 - ↳ The LED on the display module flashes. It is now possible to operate the measuring device with the web browser, FieldCare or DeviceCare.



The serial number can be found on the nameplate.



To ensure the safe and swift assignment of the WLAN network to the measuring point, it is advisable to change the SSID name. It should be possible to clearly assign the new SSID name to the measuring point (e.g. tag name) because it is displayed as the WLAN network.

Terminating the WLAN connection

- ▶ After configuring the device:
Terminate the WLAN connection between the mobile terminal and measuring device.

Starting the web browser

1. Start the web browser on the computer.

2. Enter the IP address of the web server in the address line of the web browser:
192.168.1.212
↳ The login page appears.

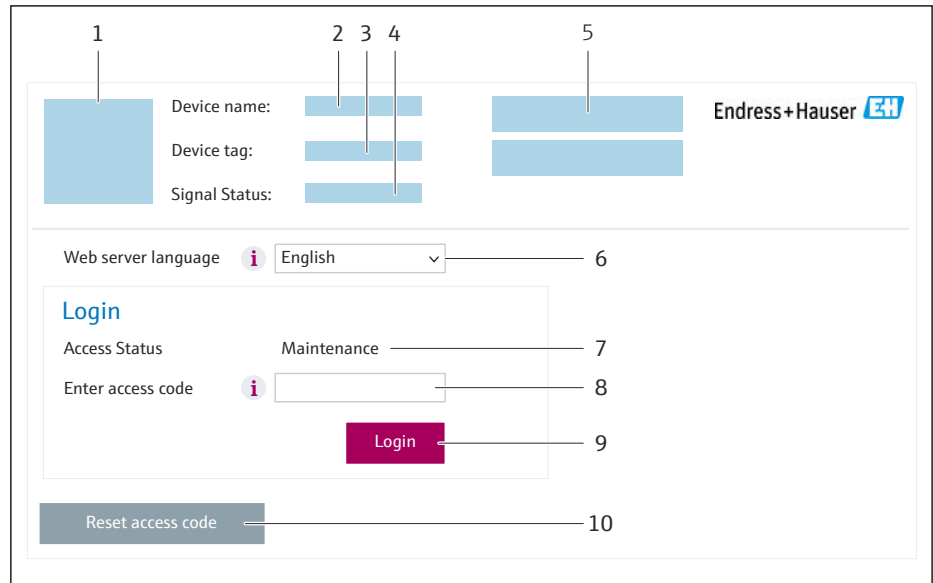

- 1 Picture of device
- 2 Device name
- 3 Device tag
- 4 Status signal
- 5 Current measured values
- 6 Operating language
- 7 User role
- 8 Access code
- 9 Login
- 10 Reset access code (→ 121)

i If a login page does not appear, or if the page is incomplete → 149

8.4.4 Logging on

1. Select the preferred operating language for the Web browser.
2. Enter the user-specific access code.
3. Press **OK** to confirm your entry.

Access code	0000 (factory setting); can be changed by customer
-------------	--

i If no action is performed for 10 minutes, the Web browser automatically returns to the login page.

8.4.5 User interface

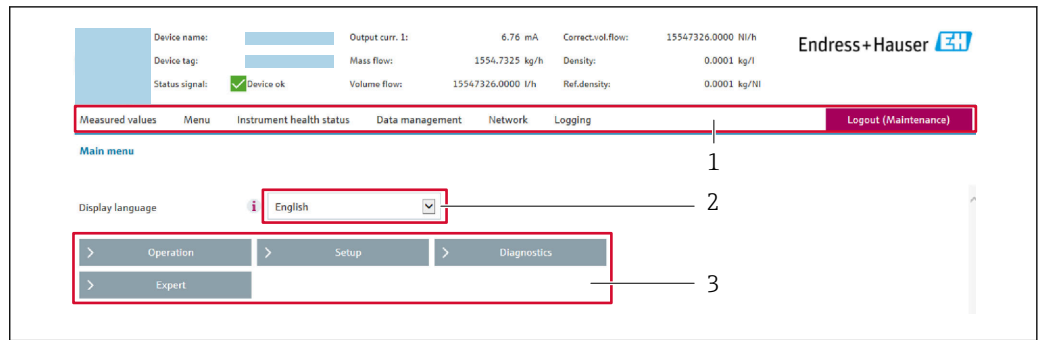

A0029418

- 1 Function row
- 2 Local display language
- 3 Navigation area

Header

The following information appears in the header:

- Device name
- Device tag
- Device status with status signal → 📄 154
- Current measured values

Function row

Functions	Meaning
Measured values	Displays the measured values of the device
Menu	<ul style="list-style-type: none"> ■ Access to the operating menu from the measuring device ■ The structure of the operating menu is the same as for the local display 📄 Detailed information on the operating menu structure: Description of Device Parameters
Device status	Displays the diagnostic messages currently pending, listed in order of priority
Data management	<p>Data exchange between computer and measuring device:</p> <ul style="list-style-type: none"> ■ Device configuration: <ul style="list-style-type: none"> ■ Load settings from the device (XML format, save configuration) ■ Save settings to the device (XML format, restore configuration) ■ Logbook - Export Event logbook (.csv file) ■ Documents - Export documents: <ul style="list-style-type: none"> ■ Export backup data record (.csv file, create documentation of the measuring point configuration) ■ Verification report (PDF file, only available with the "Heartbeat Verification" application package) ■ File for system integration - If using fieldbuses, upload device drivers for system integration from the measuring device: FOUNDATION Fieldbus: DD file ■ Firmware update - Flashing a firmware version
Network	<p>Configuration and checking of all the parameters required for establishing the connection to the measuring device:</p> <ul style="list-style-type: none"> ■ Network settings (e.g. IP address, MAC address) ■ Device information (e.g. serial number, firmware version)
Logout	End the operation and call up the login page

Navigation area

The menus, the associated submenus and parameters can be selected in the navigation area.

Working area

Depending on the selected function and the related submenus, various actions can be performed in this area:

- Configuring parameters
- Reading measured values
- Calling up help text
- Starting an upload/download

8.4.6 Disabling the Web server

The Web server of the measuring device can be switched on and off as required using the **Web server functionality** parameter.

Navigation

"Expert" menu → Communication → Web server

Parameter overview with brief description

Parameter	Description	Selection
Web server functionality	Switch the Web server on and off.	<ul style="list-style-type: none"> ▪ Off ▪ HTML Off ▪ On

Function scope of the "Web server functionality" parameter

Option	Description
Off	<ul style="list-style-type: none"> ▪ The Web server is completely disabled. ▪ Port 80 is locked.
HTML Off	The HTML version of the Web server is not available.
On	<ul style="list-style-type: none"> ▪ The complete Web server functionality is available. ▪ JavaScript is used. ▪ The password is transferred in an encrypted state. ▪ Any change to the password is also transferred in an encrypted state.

Enabling the Web server

If the Web server is disabled it can only be re-enabled with the **Web server functionality** parameter via the following operating options:

- Via local display
- Via Bedientool "FieldCare"
- Via "DeviceCare" operating tool

8.4.7 Logging out

 Before logging out, perform a data backup via the **Data management** function (upload configuration from device) if necessary.

1. Select the **Logout** entry in the function row.
↳ The home page with the Login box appears.
2. Close the Web browser.

3. If no longer needed:
Reset the modified properties of the Internet protocol (TCP/IP) → 60.

8.5 Access to the operating menu via the operating tool

The structure of the operating menu in the operating tools is the same as for operation via the local display.

8.5.1 Connecting the operating tool

Via FOUNDATION Fieldbus network

This communication interface is available in device versions with FOUNDATION Fieldbus.

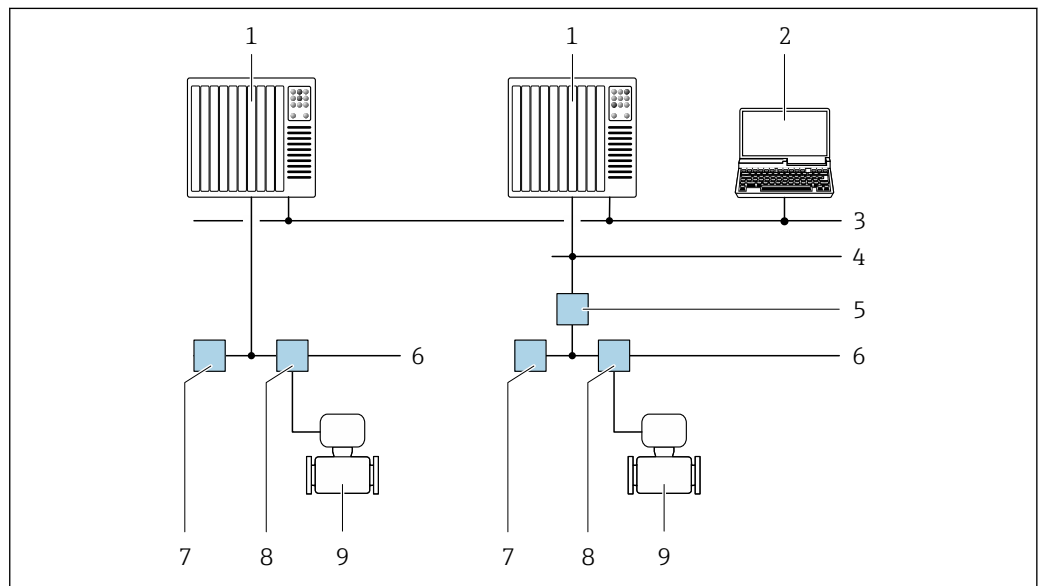

24 Options for remote operation via FOUNDATION Fieldbus network

- 1 Automation system
- 2 Computer with FOUNDATION Fieldbus network card
- 3 Industry network
- 4 High Speed Ethernet FF-HSE network
- 5 Segment coupler FF-HSE/FF-H1
- 6 FOUNDATION Fieldbus FF-H1 network
- 7 Power supply FF-H1 network
- 8 T-box
- 9 Measuring device

Service interface

Via service interface (CDI-RJ45)

A point-to-point connection can be established to configure the device onsite. With the housing open, the connection is established directly via the service interface (CDI-RJ45) of the device.

-  An adapter for the RJ45 to the M12 plug is optionally available for the non-hazardous area:

Order code for "Accessories", option **NB**: "Adapter RJ45 M12 (service interface)"

The adapter connects the service interface (CDI-RJ45) to an M12 plug mounted in the cable entry. The connection to the service interface can be established via an M12 plug without opening the device.

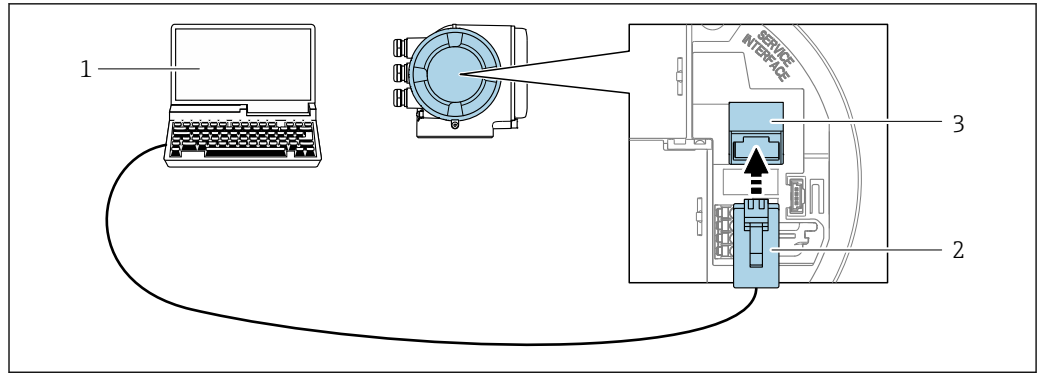

A0027563

25 Connection via service interface (CDI-RJ45)

- 1 Computer with web browser (e.g. Microsoft Internet Explorer, Microsoft Edge) for accessing the integrated web server or with "FieldCare" operating tool, "DeviceCare" with COM DTM "CDI Communication TCP/IP"
- 2 Standard Ethernet connecting cable with RJ45 plug
- 3 Service interface (CDI-RJ45) of the measuring device with access to the integrated Web server

Via WLAN interface

The optional WLAN interface is available on the following device version:

Order code for "Display; operation", option G "4-line, illuminated; touch control + WLAN"

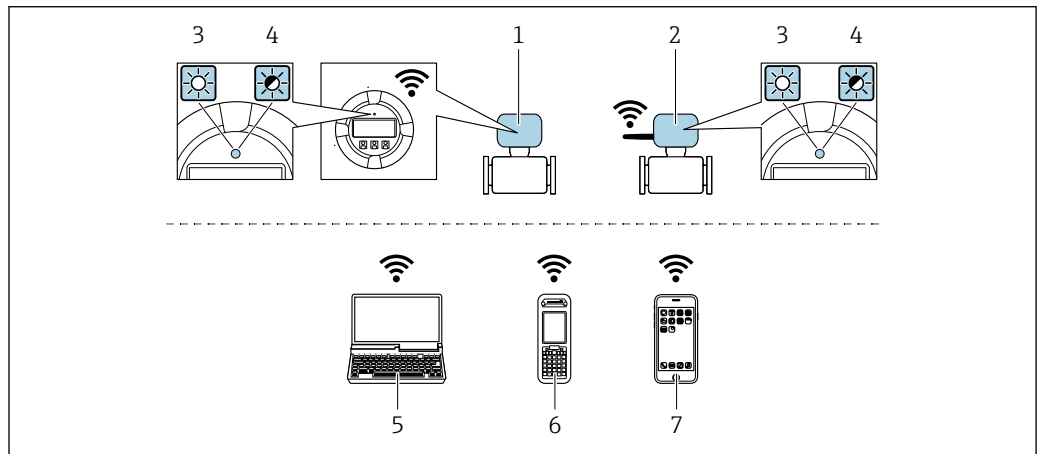

A0034570

- 1 Transmitter with integrated WLAN antenna
- 2 Transmitter with external WLAN antenna
- 3 LED lit constantly: WLAN reception is enabled on measuring device
- 4 LED flashing: WLAN connection established between operating unit and measuring device
- 5 Computer with WLAN interface and web browser (e.g. Microsoft Internet Explorer, Microsoft Edge) for accessing the integrated device web server or with operating tool (e.g. FieldCare, DeviceCare)
- 6 Mobile handheld terminal with WLAN interface and web browser (e.g. Microsoft Internet Explorer, Microsoft Edge) for accessing the integrated device web server or operating tool (e.g. FieldCare, DeviceCare)
- 7 Smart phone or tablet (e.g. Field Xpert SMT70)

Function	WLAN: IEEE 802.11 b/g (2.4 GHz)
Encryption	WPA2-PSK AES-128 (in accordance with IEEE 802.11i)
Configurable WLAN channels	1 to 11
Degree of protection	IP67
Available antennas	<ul style="list-style-type: none"> ▪ Internal antenna ▪ External antenna (optional) In the event of poor transmission/reception conditions at the place of installation. <p>i Only 1 antenna is active at any one time!</p>

Range	<ul style="list-style-type: none"> ▪ Internal antenna: typically 10 m (32 ft) ▪ External antenna: typically 50 m (164 ft)
Materials (external antenna)	<ul style="list-style-type: none"> ▪ Antenna: ASA plastic (acrylonitrile styrene acrylate) and nickel-plated brass ▪ Adapter: Stainless steel and nickel-plated brass ▪ Cable: Polyethylene ▪ Plug: Nickel-plated brass ▪ Angle bracket: Stainless steel

Configuring the Internet protocol of the mobile terminal

NOTICE

If the WLAN connection is lost during the configuration, settings made may be lost.

- ▶ Make sure that the WLAN connection is not disconnected while configuring the device.

NOTICE

Note the following to avoid a network conflict:

- ▶ Avoid accessing the measuring device simultaneously from the same mobile terminal via the service interface (CDI-RJ45) and the WLAN interface.
- ▶ Only activate one service interface (CDI-RJ45 or WLAN interface).
- ▶ If simultaneous communication is necessary: configure different IP address ranges, e.g. 192.168.0.1 (WLAN interface) and 192.168.1.212 (CDI-RJ45 service interface).

Preparing the mobile terminal

- ▶ Enable WLAN on the mobile terminal.

Establishing a WLAN connection from the mobile terminal to the measuring device

1. In the WLAN settings of the mobile terminal:
Select the measuring device using the SSID (e.g. EH_Promass_300_A802000).
2. If necessary, select the WPA2 encryption method.
3. Enter the password:
Serial number of the measuring device ex-works (e.g. L100A802000).
↳ The LED on the display module flashes. It is now possible to operate the measuring device with the web browser, FieldCare or DeviceCare.

 The serial number can be found on the nameplate.

 To ensure the safe and swift assignment of the WLAN network to the measuring point, it is advisable to change the SSID name. It should be possible to clearly assign the new SSID name to the measuring point (e.g. tag name) because it is displayed as the WLAN network.

Terminating the WLAN connection

- ▶ After configuring the device:
Terminate the WLAN connection between the mobile terminal and measuring device.

8.5.2 Field Xpert SFX350, SFX370

Function scope

Field Xpert SFX350 and Field Xpert SFX370 are mobile computers for commissioning and maintenance. They enable efficient device configuration and diagnostics for HART and FOUNDATION Fieldbus devices in the **non-hazardous area** (SFX350, SFX370) and **hazardous area** (SFX370).

 For details, see Operating Instructions BA01202S

Source for device description files



See information →  71

8.5.3 FieldCare

Function range

FDT-based (Field Device Technology) plant asset management tool from Endress+Hauser. It can configure all smart field units in a system and helps you manage them. By using the status information, it is also a simple but effective way of checking their status and condition.

Access is via:

- CDI-RJ45 service interface →  65
- WLAN interface →  66

Typical functions:

- Transmitter parameter configuration
- Loading and saving of device data (upload/download)
- Documentation of the measuring point
- Visualization of the measured value memory (line recorder) and event logbook



- Operating Instructions BA00027S
- Operating Instructions BA00059S



Source for device description files →  71

Establishing a connection



- Operating Instructions BA00027S
- Operating Instructions BA00059S

User interface

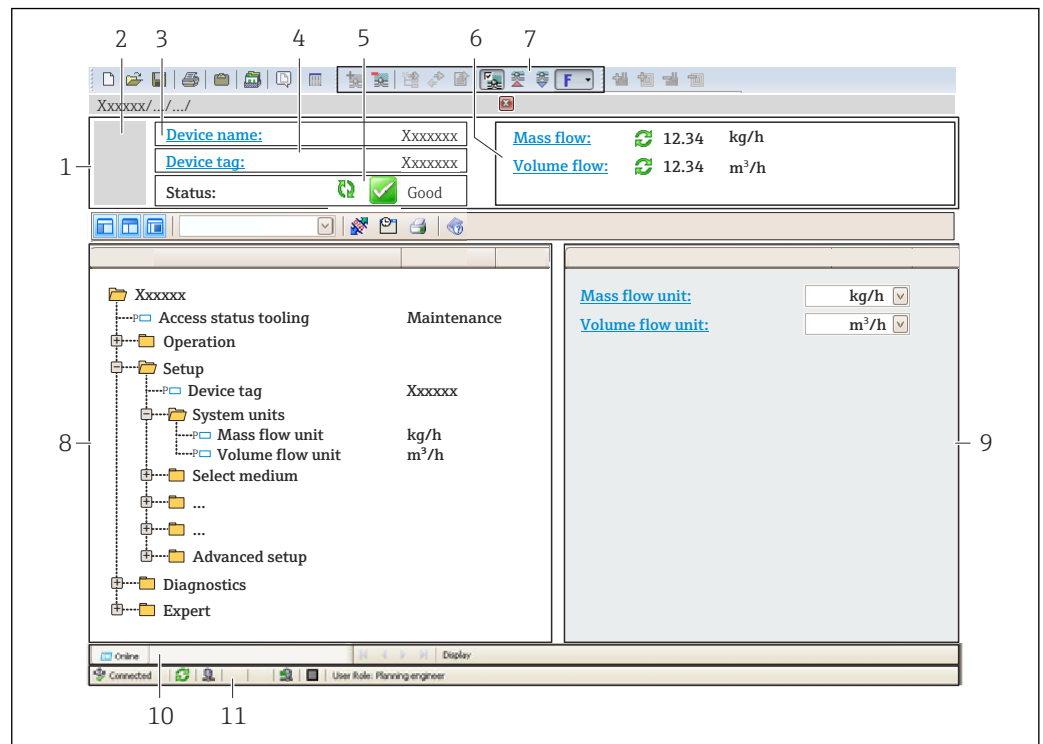

A0021051-EN

- 1 Header
- 2 Picture of device
- 3 Device name
- 4 Device tag
- 5 Status area with status signal → 154
- 6 Display area for current measured values
- 7 Editing toolbar with additional functions such as save/load, event list and create documentation
- 8 Navigation area with operating menu structure
- 9 Work area
- 10 Action area
- 11 Status area

8.5.4 DeviceCare

Function range

Tool for connecting and configuring Endress+Hauser field devices.

The fastest way to configure Endress+Hauser field devices is with the dedicated "DeviceCare" tool. Together with the device type managers (DTMs) it presents a convenient, comprehensive solution.

 Innovation brochure IN01047S

 Source for device description files → 71

8.5.5 AMS Device Manager

Function range

Program from Emerson Process Management for operating and configuring measuring devices via FOUNDATION Fieldbus H1 protocol.

 Source for device description files → 71

8.5.6 Field Communicator 475

Function scope

Industrial handheld terminal from Emerson Process Management for remote configuration and measured value display via FOUNDATION Fieldbus H1 protocol.

Source for device description files

See information →  71

9 System integration

9.1 Overview of device description files

9.1.1 Current version data for the device

Firmware Version	01.00.zz	<ul style="list-style-type: none"> ▪ On the title page of the manual ▪ On the transmitter nameplate ▪ Firmware version Diagnostics → Device information → Firmware version
Release date of firmware version	02.2017	---
Manufacturer ID	0x452B48 (hex)	Manufacturer ID Diagnostics → Device information → Manufacturer ID
Device type code	0x103B (hex)	Device type Diagnostics → Device information → Device type
Device revision	1	<ul style="list-style-type: none"> ▪ On the transmitter nameplate ▪ Device revision Diagnostics → Device information → Device revision
DD revision	Information and files available at: <ul style="list-style-type: none"> ▪ www.endress.com ▪ www.fieldbus.org 	
CFF revision		



For an overview of the various firmware versions for the device → 188

9.1.2 Operating tools

The suitable device description file for the individual operating tools is listed in the table below, along with information on where the file can be acquired.

Operating tool via FOUNDATION Fieldbus	Sources for obtaining device descriptions
FieldCare	<ul style="list-style-type: none"> ▪ www.endress.com → Downloads area ▪ USB stick (contact Endress+Hauser) ▪ DVD (contact Endress+Hauser)
DeviceCare	<ul style="list-style-type: none"> ▪ www.endress.com → Downloads area ▪ CD-ROM (contact Endress+Hauser) ▪ DVD (contact Endress+Hauser)
<ul style="list-style-type: none"> ▪ Field Xpert SMT70 ▪ Field Xpert SMT77 	Use update function of handheld terminal
AMS Device Manager (Emerson Process Management)	www.endress.com → Downloads area
Field Communicator 475 (Emerson Process Management)	Use update function of handheld terminal

9.2 Cyclic data transmission

Cyclic data transmission when using the device master file (GSD).

9.2.1 Block model

The block model shows which input and output data the measuring device makes available for cyclic data exchange. Cyclic data exchange takes place with a FOUNDATION Fieldbus master (Class 1), e.g. a control system etc.

Display text (xxxx... = serial number)	Base index	Description
RESOURCE_ xxxxxxxxxxxx	400	Resource block
SETUP_ xxxxxxxxxxxx	600	"Setup" Transducer block
TRDDISP_ xxxxxxxxxxxx	800	"Display" Transducer block
TRDHROM_ xxxxxxxxxxxx	1000	"HistoROM" Transducer block
TRDDIAG_ xxxxxxxxxxxx	1200	"Diagnostic" Transducer block
EXPERT_CONFIG_ xxxxxxxxxxxx	1400	"Expert configuration" Transducer block
SERVICE_SENSOR_ xxxxxxxxxxxx	1600	"Service sensor" Transducer block
TRDTIC_ xxxxxxxxxxxx	1800	"Totalizer" Transducer block
TRDHBT_ xxxxxxxxxxxx	2000	"Heartbeat results" Transducer block
ANALOG_INPUT_1_ xxxxxxxxxxxx	3400	Analog Input function block 1 (AI)
ANALOG_INPUT_2_ xxxxxxxxxxxx	3600	Analog Input function block 2 (AI)
ANALOG_INPUT_3_ xxxxxxxxxxxx	3800	Analog Input function block 3 (AI)
ANALOG_INPUT_4_ xxxxxxxxxxxx	4000	Analog Input function block 4 (AI)
ANALOG_INPUT_5_ xxxxxxxxxxxx	4200	Analog Input function block 5 (AI)
ANALOG_INPUT_6_ xxxxxxxxxxxx	4400	Analog Input function block 6 (AI)
ANALOG_INPUT_7_ xxxxxxxxxxxx	4600	Analog Input function block 7 (AI)
ANALOG_INPUT_8_ xxxxxxxxxxxx	4800	Analog Input function block 8 (AI)
MAO_ xxxxxxxxxxxx	5000	Multiple Analog Output block (MAO)
DIGITAL_INPUT_1_ xxxxxxxxxxxx	5200	Digital Input function block 1 (DI)
DIGITAL_INPUT_2_ xxxxxxxxxxxx	5400	Digital Input function block 2 (DI)
MDO_ xxxxxxxxxxxx	5600	Multiple Digital Output block (MDO)
PID_ xxxxxxxxxxxx	5800	PID function block (PID)
INTEGRATOR_ xxxxxxxxxxxx	6000	Integrator function block (INTG)

9.2.2 Description of the modules

The input value of a module/function block is defined via the CHANNEL parameter.

AI module (Analog Input)

Eight Analog Input blocks are available.

CHANNEL	Measured variable
0	Uninitialized (factory setting)
7	Temperature
9	Volume flow
10	Concentration ¹⁾
11	Mass flow
13	Corrected volume flow
14	Density
15	Reference density
16	Totalizer 1
17	Totalizer 2
18	Totalizer 3
33	Oscillation frequency ¹⁾

CHANNEL	Measured variable
43	Frequency fluctuation ¹⁾
51	Carrier pipe temperature ¹⁾
57	Carrier mass flow ¹⁾
58	Target mass flow ¹⁾
63	Oscillation damping ¹⁾
65	Electronic temperature
66	Tube damping fluctuation ¹⁾
68	Exciter current ¹⁾
81	HBSI ¹⁾
99	Current input 1 ¹⁾

1) Visible depending on the order options or device settings

MAO module (Multiple Analog Output)

Channel	Description
121	Channel_0

Structure

Channel_0							
Value 1	Value 2	Value 3	Value 4	Value 5	Value 6	Value 7	Value 8

Values	Measured variable
Value 1	External pressure ¹⁾
Value 2	External temperature ¹⁾
Value 3	External reference density ¹⁾
Value 4	Not assigned
Value 5	Not assigned
Value 6	Not assigned
Value 7	Not assigned
Value 8	Not assigned

1) The external measured values must be transmitted to the device in the SI basic unit

 The selection is made via: Expert → Sensor → External compensation

DI module (Discrete Input)

Two Discrete Input blocks are available.

CHANNEL	Device function	Status
0	Uninitialized (factory setting)	-
101	Switch output state	0 = off, 1 = active
103	Low flow cut off	0 = off, 1 = active

CHANNEL	Device function	Status
104	Empty pipe detection	0 = off, 1 = active
105	Verification status ¹⁾	<p>Overall result of verification</p> <p>Verification:</p> <ul style="list-style-type: none"> ■ 16 = Failed ■ 32 = Passed ■ 64 = Not performed <p>Verification status</p> <p>Verification:</p> <ul style="list-style-type: none"> ■ 1 = Not performed ■ 2 = Failed ■ 4 = Being performed ■ 8 = Finished <p>Status; result</p> <ul style="list-style-type: none"> ■ 17 = Status: not performed; Result: failed ■ 18 = Status: failed; Result: failed ■ 20 = Status: being performed; Result: failed ■ 24 = Status: finished; Result: failed ■ 33 = Status: not performed; Result: passed ■ 34 = Status: failed; Result: passed ■ 36 = Status: being performed; Result: passed ■ 40 = Status: finished; Result: passed ■ 65 = Status: not performed; Result: not performed ■ 66 = Status: failed; Result: not performed ■ 68 = Status: being performed; Result: not performed ■ 72 = Status: finished; Result: not performed

1) Only available with the Heartbeat Verification application package

MDO module (Multiple Discrete Output)

Channel	Description
122	Channel_DO

Structure

Channel_DO							
Value 1	Value 2	Value 3	Value 4	Value 5	Value 6	Value 7	Value 8

Value	Device function	Status
Value 1	Reset totalizer 1	0 = off, 1 = execute
Value 2	Reset totalizer 2	0 = off, 1 = execute
Value 3	Reset totalizer 3	0 = off, 1 = execute
Value 4	Flow override	0 = off, 1 = active
Value 5	Start Heartbeat Verification ¹⁾	0 = off, 1 = start
Value 6	Status output	0 = off, 1 = active



Value	Device function	Status
Value 7	Zero adjustment	0 = off, 1 = on
Value 8	Not used	–

1) Only available with the Heartbeat Verification application package

9.2.3 Execution times

Function block	Execution time (ms)
Analog Input function block (AI)	6
Digital Input function block (DI)	4
PID function block (PID)	5
Multiple Analog Output block (MAO)	4
Multiple Digital Output block (MDO)	4
Integrator function block (INTG)	5



9.2.4 Methods

Method	Block	Navigation	Description
Set to "AUTO" mode	Resource block	Via menu: Expert → Communication → Resource block → Target mode	This method sets the Resource Block and all the Transducer Blocks to the AUTO (Automatic) mode.
Set to "OOS" mode	Resource block	Via menu: Expert → Communication → Resource block → Target mode	This method sets the Resource Block and all the Transducer Blocks to the OOS (Out of service) mode.
Restart	Resource block	Via menu: Expert → Communication → Resource block → Restart	This method is used to select the configuration for the Restart parameter in the Resource Block. This resets device parameters to a specific value. The following options are supported: <ul style="list-style-type: none"> ▪ Uninitialized ▪ Run ▪ Resource ▪ Defaults ▪ Processor ▪ To delivery settings
ENP parameter	Resource block	Via menu: Actions → Methods → Calibrate → ENP parameter	This method is used to display and configure the parameters of the electronic nameplate (ENP).
Overview diagnostics - Remedy information	Diagnostic Transducer Block	Via link: Namur symbol	This method is used to display the diagnostic event with the highest priority that is currently active and the corresponding remedial measures.
Actual diagnostics - Remedy information	Diagnostic Transducer Block	Via menu: <ul style="list-style-type: none"> ▪ Configure/Setup → Diagnostics → Actual diagnostics ▪ Device/Diagnostics → Diagnostics 	This method is used to display remedial measures for the diagnostic event with the highest priority that is currently active.  This method is available only if an appropriate diagnostic event has occurred.
Previous diagnostics - Remedy information	Diagnostic Transducer Block	Via menu: <ul style="list-style-type: none"> ▪ Configure/Setup → Diagnostics → Previous diagnostics ▪ Device/Diagnostics → Diagnostics 	This method is used to display remedial measures for the previous diagnostic event.  This method is available only if an appropriate diagnostic event has occurred.

10 Commissioning



10.1 Post-mounting and post-connection check

Before commissioning the device:



- ▶ Make sure that the post-installation and post-connection checks have been performed successfully.
- Checklist for "Post-installation" check →  29
- Checklist for "Post-connection" check →  42

10.2 Switching on the measuring device

- ▶ Switch on the device upon successful completion of the post-mounting and post-connection check.
 - ↳ After a successful startup, the local display switches automatically from the startup display to the operational display.

 If nothing appears on the local display or if a diagnostic message is displayed, refer to the section on "Diagnostics and troubleshooting" →  148.

10.3 Connecting via FieldCare

- For connecting FieldCare →  65
- For connecting via FieldCare →  68
- For user interface of FieldCare →  69

10.4 Setting the operating language

Factory setting: English or ordered local language

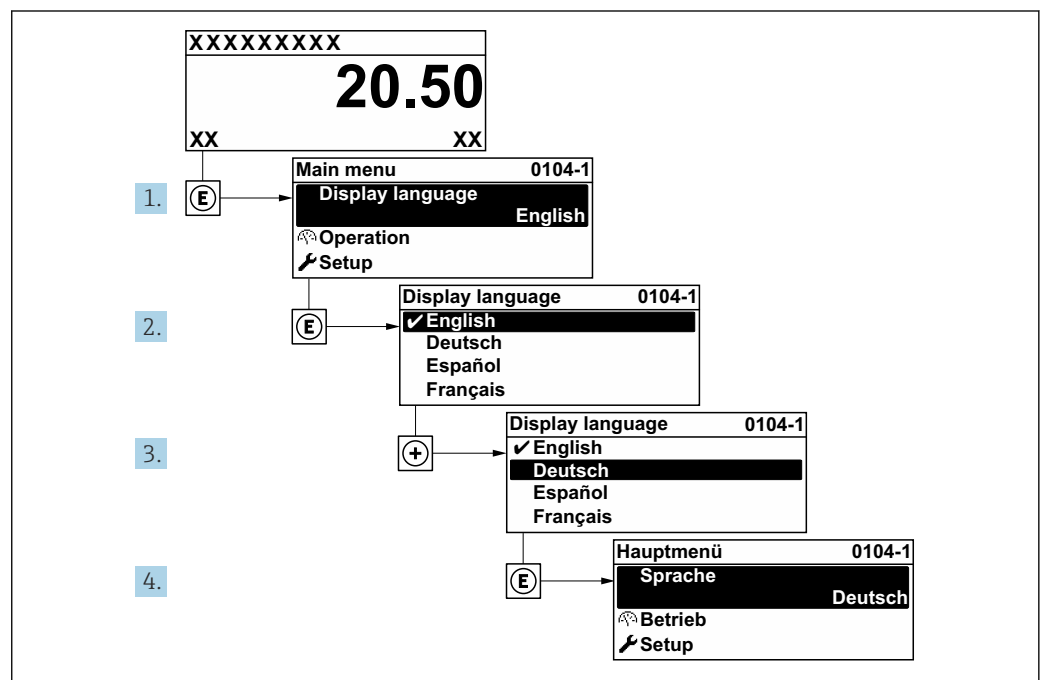

 26 Taking the example of the local display

A0029420

10.5 Configuring the measuring instrument

The **Setup** menu with its guided wizards contains all the parameters needed for standard operation.

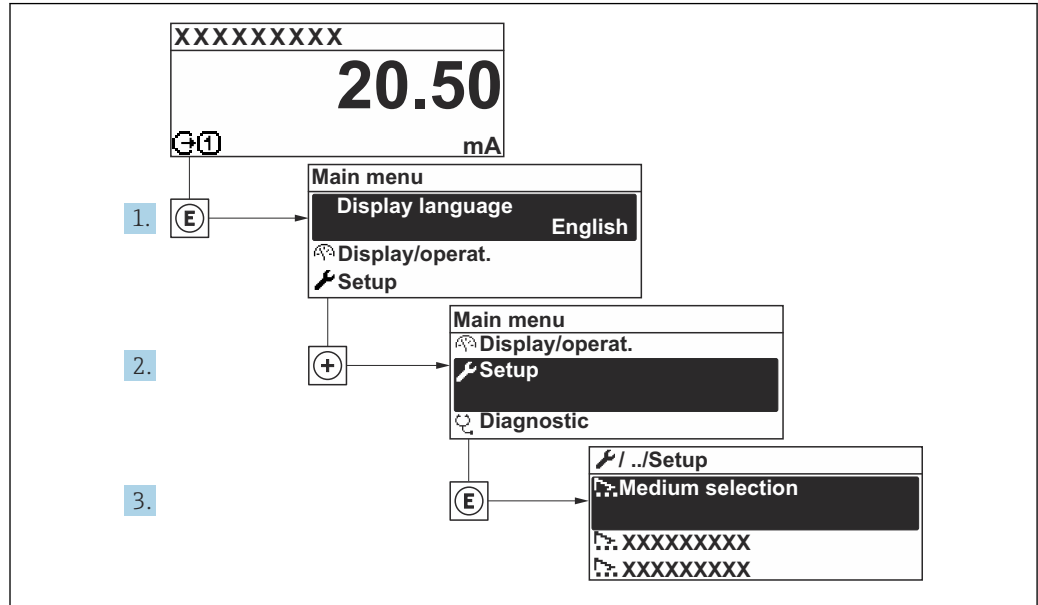

27 Navigation to "Setup" menu using the example of the local display

i The number of submenus and parameters can vary depending on the device version. Certain submenus and parameters in these submenus are not described in the Operating Instructions. Instead a description is provided in the Special Documentation for the device ("Supplementary documentation").

🔧 Setup	
Device tag	→ 79
▶ System units	→ 79
▶ Medium selection	→ 82
▶ Analog inputs	→ 84
▶ I/O configuration	→ 84
▶ Current input 1	→ 85
▶ Status input 1	→ 86
▶ Current output 1	→ 87
▶ Pulse/frequency/switch output 1	→ 90
▶ Relay output 1	→ 97

▶ Display	→ 99
▶ Low flow cut off	→ 102
▶ Partially filled pipe detection	→ 103
▶ Advanced setup	→ 104

10.5.1 Defining the device tag

To enable fast identification of the measuring point within the system, you can enter a unique designation using the **Device tag** parameter and thus change the factory setting.

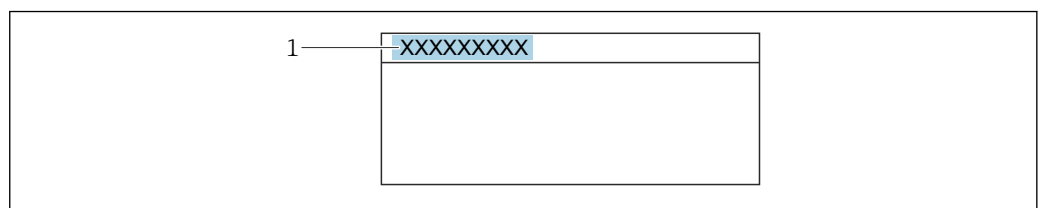

A0029422

28 Header of the operational display with tag name

1 Tag name

i Enter the tag name in the "FieldCare" operating tool → 69

Navigation

"Setup" menu → Device tag

Parameter overview with brief description

Parameter	Description	User entry
Device tag	Enter the name for the measuring point.	Max. 32 characters, such as letters, numbers or special characters (e.g. @, %, /)

10.5.2 Setting the system units









In the **System units** submenu the units of all the measured values can be set.

i The number of submenus and parameters can vary depending on the device version. Certain submenus and parameters in these submenus are not described in the Operating Instructions. Instead a description is provided in the Special Documentation for the device ("Supplementary documentation").

Navigation



"Setup" menu → System units

▶ System units	
Mass flow unit	→ 80
Mass unit	→ 80

Volume flow unit	→  80
Volume unit	→  80
Corrected volume flow unit	→  80
Corrected volume unit	→  80
Density unit	→  80
Reference density unit	→  81
Temperature unit	→  81
Pressure unit	→  81

Parameter overview with brief description

Parameter	Description	Selection	Factory setting
Mass flow unit	Select mass flow unit. <i>Effect</i> The selected unit applies to: <ul style="list-style-type: none"> ▪ Output ▪ Low flow cut off ▪ Simulation process variable 	Unit choose list	Country-specific: <ul style="list-style-type: none"> ▪ kg/h ▪ lb/min
Mass unit	Select mass unit.	Unit choose list	Country-specific: <ul style="list-style-type: none"> ▪ kg ▪ lb
Volume flow unit	Select volume flow unit. <i>Effect</i> The selected unit applies to: <ul style="list-style-type: none"> ▪ Output ▪ Low flow cut off ▪ Simulation process variable 	Unit choose list	Country-specific: <ul style="list-style-type: none"> ▪ l/h ▪ gal/min (us)
Volume unit	Select volume unit.	Unit choose list	Country-specific: <ul style="list-style-type: none"> ▪ l (DN > 150 (6)): m³ option) ▪ gal (us)
Corrected volume flow unit	Select corrected volume flow unit. <i>Effect</i> The selected unit applies to: Corrected volume flow parameter (→  131)	Unit choose list	Country-specific: <ul style="list-style-type: none"> ▪ NI/h ▪ Sft³/min
Corrected volume unit	Select corrected volume unit.	Unit choose list	Country-specific: <ul style="list-style-type: none"> ▪ NI ▪ Sft³
Density unit	Select density unit. <i>Effect</i> The selected unit applies to: <ul style="list-style-type: none"> ▪ Output ▪ Simulation process variable ▪ Density adjustment (Expert menu) 	Unit choose list	Country-specific: <ul style="list-style-type: none"> ▪ kg/l ▪ lb/ft³

Parameter	Description	Selection	Factory setting
Reference density unit	Select reference density unit.	Unit choose list	Country-specific: <ul style="list-style-type: none"> ■ kg/Nl ■ lb/Sft³
Density 2 unit	Select second density unit.	Unit choose list	Country-specific: <ul style="list-style-type: none"> ■ kg/l ■ lb/ft³
Temperature unit	Select temperature unit. <i>Effect</i> The selected unit applies to: <ul style="list-style-type: none"> ■ Electronic temperature parameter (6053) ■ Maximum value parameter (6051) ■ Minimum value parameter (6052) ■ Maximum value parameter (6108) ■ Minimum value parameter (6109) ■ Carrier pipe temperature parameter (6027) ■ Maximum value parameter (6029) ■ Minimum value parameter (6030) ■ Reference temperature parameter (1816) ■ Temperature parameter 	Unit choose list	Country-specific: <ul style="list-style-type: none"> ■ °C ■ °F
Pressure unit	Select process pressure unit. <i>Effect</i> The unit is taken from: <ul style="list-style-type: none"> ■ Pressure value parameter (→  83) ■ External pressure parameter (→  83) ■ Pressure value 	Unit choose list	Country-specific: <ul style="list-style-type: none"> ■ bar a ■ psi a

10.5.3 Selecting and setting the medium

The **Select medium** wizard submenu contains parameters that must be configured in order to select and set the medium.

Navigation

"Setup" menu → Medium selection

► Medium selection	
Select medium	→ ⓘ 82
Select gas type	→ ⓘ 82
Reference sound velocity	→ ⓘ 83
Temperature coefficient sound velocity	→ ⓘ 83
Pressure compensation	→ ⓘ 83
Pressure value	→ ⓘ 83
External pressure	→ ⓘ 83

Parameter overview with brief description

Parameter	Prerequisite	Description	Selection / User entry / User interface
Select medium	–	Use this function to select the type of medium: "Gas" or "Liquid". Select the "Other" option in exceptional cases in order to enter the properties of the medium manually (e.g. for highly compressive liquids such as sulfuric acid).	<ul style="list-style-type: none"> ▪ Liquid ▪ Gas
Select gas type	In the Medium selection submenu, the Gas option is selected.	Select measured gas type.	<ul style="list-style-type: none"> ▪ Air ▪ Ammonia NH₃ ▪ Argon Ar ▪ Sulfur hexafluoride SF₆ ▪ Oxygen O₂ ▪ Ozone O₃ ▪ Nitrogen oxide NO_x ▪ Nitrogen N₂ ▪ Nitrous oxide N₂O ▪ Methane CH₄ ▪ Hydrogen H₂ ▪ Helium He ▪ Hydrogen chloride HCl ▪ Hydrogen sulfide H₂S ▪ Ethylene C₂H₄ ▪ Carbon dioxide CO₂ ▪ Carbon monoxide CO ▪ Chlorine Cl₂ ▪ Butane C₄H₁₀ ▪ Propane C₃H₈ ▪ Propylene C₃H₆ ▪ Ethane C₂H₆ ▪ Others

Parameter	Prerequisite	Description	Selection / User entry / User interface
Reference sound velocity	In the Select gas type parameter, the Others option is selected.	Enter sound velocity of gas at 0 °C (32 °F).	1 to 99999.9999 m/s
Reference sound velocity	In the Select medium type parameter, the Others option is selected.	Enter sound velocity of gas at 0 °C (32 °F).	Signed floating-point number
Temperature coefficient sound velocity	In the Select gas type parameter, the Others option is selected.	Enter temperature coefficient for the gas sound velocity.	Positive floating point number
Temperature coefficient sound velocity	In the Select medium type parameter, the Others option is selected.	Enter temperature coefficient for the gas sound velocity.	Signed floating-point number
Pressure compensation	–	Select pressure compensation type.	<ul style="list-style-type: none"> ■ Off ■ Fixed value ■ External value ■ Current input 1 *
Pressure value	In the Pressure compensation parameter, the Fixed value option is selected.	Enter process pressure to be used for pressure correction.	Positive floating-point number
External pressure	In the Pressure compensation parameter, the External value option or the Current input 1...n option is selected.	Shows the external process pressure value.	

* Visibility depends on order options or device settings

10.5.4 Configuring the analog inputs

The **Analog inputs** submenu guides the user systematically to the individual **Analog input 1 to n** submenu. From here you get to the parameters of the individual analog input.

Navigation

"Setup" menu → Analog inputs

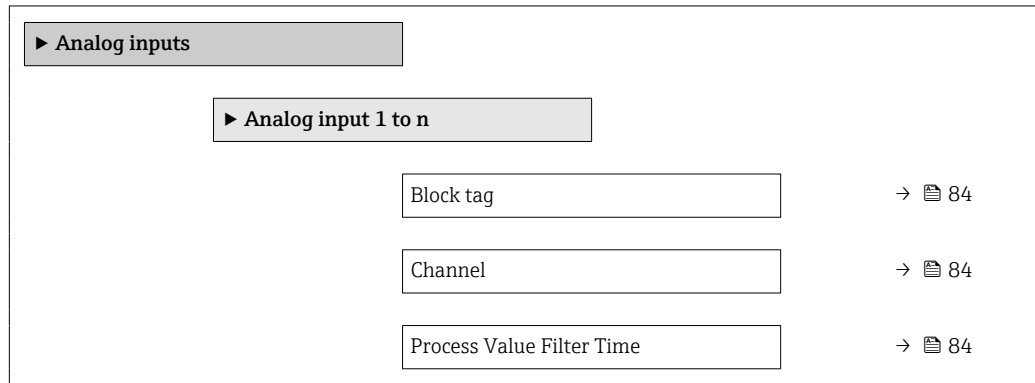

Parameter overview with brief description

Parameter	Description	User entry / Selection	Factory setting
Block tag	Unique name of the measuring device.	Max. 32 characters such as letters, numbers or special characters (e. g. @, %, /).	ANALOG_INPUT_1 ... 4_Serial number
Channel	Use this function to select the process variable.	<ul style="list-style-type: none"> ▪ Mass flow ▪ Volume flow ▪ Corrected volume flow ▪ Target mass flow * ▪ Carrier mass flow * ▪ Density ▪ Reference density ▪ Concentration * ▪ Temperature ▪ Carrier pipe temperature * ▪ Electronic temperature ▪ Oscillation frequency 0 ▪ Oscillation amplitude 0 ▪ Frequency fluctuation 0 ▪ Oscillation damping 0 ▪ Oscillation damping fluctuation 0 ▪ Signal asymmetry ▪ Exciter current 0 ▪ HBSI * ▪ Totalizer 1 ▪ Totalizer 2 ▪ Totalizer 3 ▪ Current input 1 * ▪ Uninitialized 	–
Process Value Filter Time	Enter the filter time specification for the filtering of the unconverted input value (PV).	Positive floating-point number	–

* Visibility depends on order options or device settings

10.5.5 Displaying the I/O configuration

The **I/O configuration** submenu guides the user systematically through all the parameters in which the configuration of the I/O modules is displayed.

Navigation
 "Setup" menu → I/O configuration

► I/O configuration		
I/O module 1 to n terminal numbers	→	85
I/O module 1 to n information	→	85
I/O module 1 to n type	→	85
Apply I/O configuration	→	85
Conversion code	→	85

Parameter overview with brief description





Parameter	Description	User interface / Selection / User entry
I/O module terminal numbers	Shows the terminal numbers used by the I/O module.	<ul style="list-style-type: none"> ■ Not used ■ 26-27 (I/O 1) ■ 24-25 (I/O 2)
I/O module information	Shows information of the plugged I/O module.	<ul style="list-style-type: none"> ■ Not plugged ■ Invalid ■ Not configurable ■ Configurable ■ Fieldbus
I/O module type	Shows the I/O module type.	<ul style="list-style-type: none"> ■ Off ■ Current output ■ Current input ■ Status input ■ Pulse/frequency/switch output ■ Double pulse output ■ Relay output
Apply I/O configuration	Apply parameterization of the freely configurable I/O module.	<ul style="list-style-type: none"> ■ No ■ Yes
Conversion code	Enter the code in order to change the I/O configuration.	Positive integer

10.5.6 Configuring the current input

The "**Current input**" wizard guides the user systematically through all the parameters that have to be set for configuring the current input.

Navigation
 "Setup" menu → Current input

► Current input 1		
Terminal number	→	86
Signal mode	→	86

0/4 mA value	→  86
20 mA value	→  86
Current span	→  86
Failure mode	→  86
Failure value	→  86

Parameter overview with brief description



Parameter	Prerequisite	Description	User interface / Selection / User entry	Factory setting
Terminal number	–	Shows the terminal numbers used by the current input module.	<ul style="list-style-type: none"> ▪ Not used ▪ 24-25 (I/O 2) 	–
Signal mode	The measuring device is not approved for use in the hazardous area with type of protection Ex-i.	Select the signal mode for the current input.	<ul style="list-style-type: none"> ▪ Passive ▪ Active 	Active
0/4 mA value	–	Enter 4 mA value.	Signed floating-point number	–
20 mA value	–	Enter 20 mA value.	Signed floating-point number	Depends on country and nominal diameter
Current span	–	Select current range for process value output and upper/lower level for alarm signal.	<ul style="list-style-type: none"> ▪ 4...20 mA ▪ 4...20 mA NAMUR ▪ 4...20 mA US ▪ 0...20 mA 	Country-specific: <ul style="list-style-type: none"> ▪ 4...20 mA NAMUR ▪ 4...20 mA US
Failure mode	–	Define input behavior in alarm condition.	<ul style="list-style-type: none"> ▪ Alarm ▪ Last valid value ▪ Defined value 	–
Failure value	In the Failure mode parameter, the Defined value option is selected.	Enter value to be used by the device if input value from external device is missing.	Signed floating-point number	–

10.5.7 Configuring the status input

The **Status input** submenu guides the user systematically through all the parameters that have to be set for configuring the status input.

Navigation

"Setup" menu → Status input 1 to n

▶ Status input 1 to n	
Assign status input	→  87
Terminal number	→  87

Active level	→ 87
Terminal number	→ 87
Response time status input	→ 87
Terminal number	→ 87

Parameter overview with brief description

Parameter	Description	Selection / User interface / User entry
Assign status input	Select function for the status input.	<ul style="list-style-type: none"> ■ Off ■ Reset totalizer 1 ■ Reset totalizer 2 ■ Reset totalizer 3 ■ Reset all totalizers ■ Flow override
Terminal number	Shows the terminal numbers used by the status input module.	<ul style="list-style-type: none"> ■ Not used ■ 24-25 (I/O 2)
Active level	Define input signal level at which the assigned function is triggered.	<ul style="list-style-type: none"> ■ High ■ Low
Response time status input	Define the minimum amount of time the input signal level must be present before the selected function is triggered.	5 to 200 ms



10.5.8 Configuring the current output

The **Current output** wizard guides you systematically through all the parameters that have to be set for configuring the current output.



Navigation

"Setup" menu → Current output

► Current output 1	
Terminal number	→ 88
Signal mode	→ 88
Assign current output 1	→ 88
Current span	→ 88
0/4 mA value	→ 88
20 mA value	→ 88
Fixed current	→ 89

Failure mode	→  89
Failure current	→  89

Parameter overview with brief description

Parameter	Prerequisite	Description	User interface / Selection / User entry	Factory setting
Terminal number	–	Shows the terminal numbers used by the current output module.	<ul style="list-style-type: none"> ▪ Not used ▪ 24-25 (I/O 2) 	–
Signal mode	–	Select the signal mode for the current output.	<ul style="list-style-type: none"> ▪ Passive ▪ Active 	Active
Assign current output	–	Select process variable for current output.	<ul style="list-style-type: none"> ▪ Off ▪ Mass flow ▪ Volume flow ▪ Corrected volume flow ▪ Target mass flow * ▪ Carrier mass flow * ▪ Density ▪ Reference density ▪ Concentration * ▪ Temperature ▪ Carrier pipe temperature * ▪ Electronic temperature ▪ Oscillation frequency 0 ▪ Oscillation amplitude 0 * ▪ Frequency fluctuation 0 ▪ Oscillation damping 0 ▪ Oscillation damping fluctuation 0 ▪ Signal asymmetry ▪ Exciter current 0 ▪ HBSI * 	–
Current span	–	Select current range for process value output and upper/lower level for alarm signal.	<ul style="list-style-type: none"> ▪ 4...20 mA NAMUR ▪ 4...20 mA US ▪ 4...20 mA ▪ 0...20 mA ▪ Fixed current 	Depends on country: <ul style="list-style-type: none"> ▪ 4...20 mA NAMUR ▪ 4...20 mA US
0/4 mA value	In Current span parameter (→  88), one of the following options is selected: <ul style="list-style-type: none"> ▪ 4...20 mA NAMUR ▪ 4...20 mA US ▪ 4...20 mA ▪ 0...20 mA 	Enter 4 mA value.	Signed floating-point number	Depends on country: <ul style="list-style-type: none"> ▪ 0 kg/h ▪ 0 lb/min
20 mA value	In Current span parameter (→  88), one of the following options is selected: <ul style="list-style-type: none"> ▪ 4...20 mA NAMUR ▪ 4...20 mA US ▪ 4...20 mA ▪ 0...20 mA 	Enter 20 mA value.	Signed floating-point number	Depends on country and nominal diameter

Parameter	Prerequisite	Description	User interface / Selection / User entry	Factory setting
Fixed current	The Fixed current option is selected in the Current span parameter (→ 88).	Defines the fixed output current.	0 to 22.5 mA	22.5 mA
Damping output	A process variable is selected in the Assign current output parameter (→ 88) and one of the following options is selected in the Current span parameter (→ 88): <ul style="list-style-type: none"> ▪ 4...20 mA NAMUR ▪ 4...20 mA US ▪ 4...20 mA ▪ 0...20 mA 	Set reaction time for output signal to fluctuations in the measured value.	0.0 to 999.9 s	–
Failure mode	A process variable is selected in the Assign current output parameter (→ 88) and one of the following options is selected in the Current span parameter (→ 88): <ul style="list-style-type: none"> ▪ 4...20 mA NAMUR ▪ 4...20 mA US ▪ 4...20 mA ▪ 0...20 mA 	Define output behavior in alarm condition.	<ul style="list-style-type: none"> ▪ Min. ▪ Max. ▪ Last valid value ▪ Actual value ▪ Defined value 	–
Failure current	The Defined value option is selected in the Failure mode parameter.	Enter current output value in alarm condition.	0 to 22.5 mA	22.5 mA

* Visibility depends on order options or device settings

10.5.9 Configuring the pulse/frequency/switch output

The **Pulse/frequency/switch output** wizard guides you systematically through all the parameters that can be set for configuring the selected output type.

Navigation

"Setup" menu → Advanced setup → Pulse/frequency/switch output

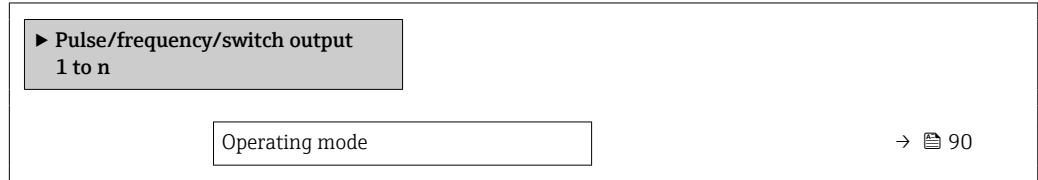

Parameter overview with brief description

Parameter	Description	Selection
Operating mode	Define the output as a pulse, frequency or switch output.	<ul style="list-style-type: none"> ■ Pulse ■ Frequency ■ Switch

Configuring the pulse output

Navigation

"Setup" menu → Pulse/frequency/switch output

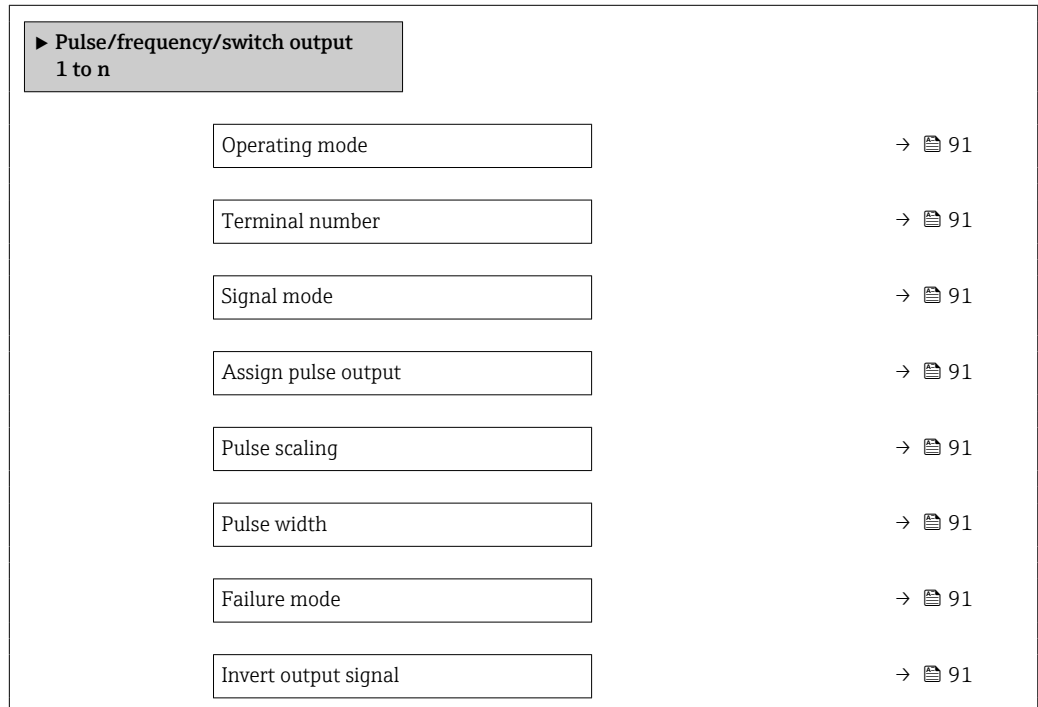

Parameter overview with brief description

Parameter	Prerequisite	Description	Selection / User interface / User entry	Factory setting
Operating mode	–	Define the output as a pulse, frequency or switch output.	<ul style="list-style-type: none"> ■ Pulse ■ Frequency ■ Switch 	–
Terminal number	–	Shows the terminal numbers used by the PFS output module.	<ul style="list-style-type: none"> ■ Not used ■ 24-25 (I/O 2) 	–
Signal mode	–	Select the signal mode for the PFS output.	<ul style="list-style-type: none"> ■ Passive ■ Active 	–
Assign pulse output 1 to n	The Pulse option is selected in Operating mode parameter.	Select process variable for pulse output.	<ul style="list-style-type: none"> ■ Off ■ Mass flow ■ Volume flow ■ Corrected volume flow ■ Target mass flow * ■ Carrier mass flow * 	–
Value per pulse	The Pulse option is selected in the Operating mode parameter (→ 90) and a process variable is selected in the Assign pulse output parameter (→ 91).	Enter measured value at which a pulse is output.	Positive floating point number	Depends on country and nominal diameter
Pulse width	The Pulse option is selected in the Operating mode parameter (→ 90) and a process variable is selected in the Assign pulse output parameter (→ 91).	Define time width of the output pulse.	0.05 to 2 000 ms	–
Failure mode	The Pulse option is selected in the Operating mode parameter (→ 90) and a process variable is selected in the Assign pulse output parameter (→ 91).	Define output behavior in alarm condition.	<ul style="list-style-type: none"> ■ Actual value ■ No pulses 	–
Invert output signal	–	Invert the output signal.	<ul style="list-style-type: none"> ■ No ■ Yes 	–







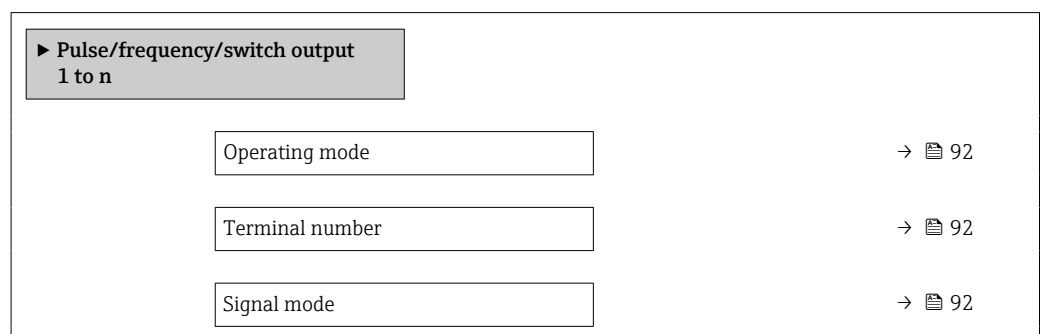

* Visibility depends on order options or device settings

Configuring the frequency output

Navigation

"Setup" menu → Pulse/frequency/switch output



Assign frequency output	→  93
Minimum frequency value	→  93
Maximum frequency value	→  93
Measuring value at minimum frequency	→  93
Measuring value at maximum frequency	→  93
Failure mode	→  93
Failure frequency	→  94
Invert output signal	→  94

Parameter overview with brief description

Parameter	Prerequisite	Description	Selection / User interface / User entry	Factory setting
Operating mode	–	Define the output as a pulse, frequency or switch output.	<ul style="list-style-type: none"> ▪ Pulse ▪ Frequency ▪ Switch 	–
Terminal number	–	Shows the terminal numbers used by the PFS output module.	<ul style="list-style-type: none"> ▪ Not used ▪ 24-25 (I/O 2) 	–
Signal mode	–	Select the signal mode for the PFS output.	<ul style="list-style-type: none"> ▪ Passive ▪ Active 	–

Parameter	Prerequisite	Description	Selection / User interface / User entry	Factory setting
Assign frequency output	The Frequency option is selected in Operating mode parameter (→ 90).	Select process variable for frequency output.	<ul style="list-style-type: none"> ■ Off ■ Mass flow ■ Volume flow ■ Corrected volume flow * ■ Density ■ Reference density * ■ Temperature ■ Concentration * ■ Target mass flow * ■ Carrier mass flow * ■ HBSI * ■ Exciter current 0 ■ Oscillation damping 0 ■ Oscillation damping fluctuation 0 * ■ Oscillation frequency 0 ■ Frequency fluctuation 0 * ■ Oscillation amplitude 0 * ■ Signal asymmetry ■ Carrier pipe temperature * ■ Electronic temperature 	–
Minimum frequency value	The Frequency option is selected in the Operating mode parameter (→ 90) and a process variable is selected in the Assign frequency output parameter (→ 93).	Enter minimum frequency.	0.0 to 10000.0 Hz	–
Maximum frequency value	The Frequency option is selected in the Operating mode parameter (→ 90) and a process variable is selected in the Assign frequency output parameter (→ 93).	Enter maximum frequency.	0.0 to 10000.0 Hz	–
Measuring value at minimum frequency	The Frequency option is selected in the Operating mode parameter (→ 90) and a process variable is selected in the Assign frequency output parameter (→ 93).	Enter measured value for minimum frequency.	Signed floating-point number	Depends on country and nominal diameter
Measuring value at maximum frequency	The Frequency option is selected in the Operating mode parameter (→ 90) and a process variable is selected in the Assign frequency output parameter (→ 93).	Enter measured value for maximum frequency.	Signed floating-point number	Depends on country and nominal diameter
Failure mode	The Frequency option is selected in the Operating mode parameter (→ 90) and a process variable is selected in the Assign frequency output parameter (→ 93).	Define output behavior in alarm condition.	<ul style="list-style-type: none"> ■ Actual value ■ Defined value ■ 0 Hz 	–

Parameter	Prerequisite	Description	Selection / User interface / User entry	Factory setting
Failure frequency	In the Operating mode parameter (→ 90), the Frequency option is selected, in the Assign frequency output parameter (→ 93) a process variable is selected, and in the Failure mode parameter, the Defined value option is selected.	Enter frequency output value in alarm condition.	0.0 to 12 500.0 Hz	–
Invert output signal	–	Invert the output signal.	<ul style="list-style-type: none"> ▪ No ▪ Yes 	–

* Visibility depends on order options or device settings

Configuring the switch output

Navigation

"Setup" menu → Pulse/frequency/switch output

► Pulse/frequency/switch output
1 to n

Operating mode	→ ⓘ 95
Terminal number	→ ⓘ 95
Signal mode	→ ⓘ 95
Switch output function	→ ⓘ 96
Assign diagnostic behavior	→ ⓘ 96
Assign limit	→ ⓘ 96
Assign flow direction check	→ ⓘ 96
Assign status	→ ⓘ 96
Switch-on value	→ ⓘ 96
Switch-off value	→ ⓘ 96
Switch-on delay	→ ⓘ 96
Switch-off delay	→ ⓘ 97
Failure mode	→ ⓘ 97
Invert output signal	→ ⓘ 97

Parameter overview with brief description

Parameter	Prerequisite	Description	Selection / User interface / User entry	Factory setting
Operating mode	-	Define the output as a pulse, frequency or switch output.	<ul style="list-style-type: none"> ■ Pulse ■ Frequency ■ Switch 	-
Terminal number	-	Shows the terminal numbers used by the PFS output module.	<ul style="list-style-type: none"> ■ Not used ■ 24-25 (I/O 2) 	-
Signal mode	-	Select the signal mode for the PFS output.	<ul style="list-style-type: none"> ■ Passive ■ Active 	-

Parameter	Prerequisite	Description	Selection / User interface / User entry	Factory setting
Switch output function	The Switch option is selected in the Operating mode parameter.	Select function for switch output.	<ul style="list-style-type: none"> ▪ Off ▪ On ▪ Diagnostic behavior ▪ Limit ▪ Flow direction check ▪ Status 	–
Assign diagnostic behavior	<ul style="list-style-type: none"> ▪ In the Operating mode parameter, the Switch option is selected. ▪ In the Switch output function parameter, the Diagnostic behavior option is selected. 	Select diagnostic behavior for switch output.	<ul style="list-style-type: none"> ▪ Alarm ▪ Alarm or warning ▪ Warning 	–
Assign limit	<ul style="list-style-type: none"> ▪ The Switch option is selected in Operating mode parameter. ▪ The Limit option is selected in Switch output function parameter. 	Select process variable for limit function.	<ul style="list-style-type: none"> ▪ Mass flow ▪ Volume flow ▪ Corrected volume flow ▪ Target mass flow * ▪ Carrier mass flow * ▪ Density ▪ Reference density ▪ Concentration * ▪ Temperature ▪ Totalizer 1 ▪ Totalizer 2 ▪ Totalizer 3 ▪ Oscillation damping 	–
Assign flow direction check	<ul style="list-style-type: none"> ▪ The Switch option is selected in the Operating mode parameter. ▪ The Flow direction check option is selected in the Switch output function parameter. 	Select process variable for flow direction monitoring.		–
Assign status	<ul style="list-style-type: none"> ▪ The Switch option is selected in Operating mode parameter. ▪ The Status option is selected in Switch output function parameter. 	Select device status for switch output.	<ul style="list-style-type: none"> ▪ Partially filled pipe detection ▪ Low flow cut off ▪ Digital output 6 	–
Switch-on value	<ul style="list-style-type: none"> ▪ The Switch option is selected in the Operating mode parameter. ▪ The Limit option is selected in the Switch output function parameter. 	Enter measured value for the switch-on point.	Signed floating-point number	Depends on country: <ul style="list-style-type: none"> ▪ 0 kg/h ▪ 0 lb/min
Switch-off value	<ul style="list-style-type: none"> ▪ The Switch option is selected in the Operating mode parameter. ▪ The Limit option is selected in the Switch output function parameter. 	Enter measured value for the switch-off point.	Signed floating-point number	Depends on country: <ul style="list-style-type: none"> ▪ 0 kg/h ▪ 0 lb/min
Switch-on delay	<ul style="list-style-type: none"> ▪ The Switch option is selected in the Operating mode parameter. ▪ The Limit option is selected in the Switch output function parameter. 	Define delay for the switch-on of status output.	0.0 to 100.0 s	–

Parameter	Prerequisite	Description	Selection / User interface / User entry	Factory setting
Switch-off delay	<ul style="list-style-type: none"> ▪ The Switch option is selected in the Operating mode parameter. ▪ The Limit option is selected in the Switch output function parameter. 	Define delay for the switch-off of status output.	0.0 to 100.0 s	–
Failure mode	–	Define output behavior in alarm condition.	<ul style="list-style-type: none"> ▪ Actual status ▪ Open ▪ Closed 	–
Invert output signal	–	Invert the output signal.	<ul style="list-style-type: none"> ▪ No ▪ Yes 	–

* Visibility depends on order options or device settings

10.5.10 Configuring the relay output

The **Relay output** wizard guides the user systematically through all the parameters that have to be set for configuring the relay output.

Navigation

"Setup" menu → Relay output 1 to n

▶ Relay output 1 to n

Terminal number	→ 98
Relay output function	→ 98
Assign flow direction check	→ 98
Assign limit	→ 98
Assign diagnostic behavior	→ 98
Assign status	→ 98
Switch-off value	→ 98
Switch-off delay	→ 98
Switch-on value	→ 98
Switch-on delay	→ 98
Failure mode	→ 98
Switch status	→ 98
Powerless relay status	→ 98

Parameter overview with brief description

Parameter	Prerequisite	Description	User interface / Selection / User entry	Factory setting
Terminal number	–	Shows the terminal numbers used by the relay output module.	<ul style="list-style-type: none"> ▪ Not used ▪ 24-25 (I/O 2) 	–
Relay output function	–	Select the function for the relay output.	<ul style="list-style-type: none"> ▪ Closed ▪ Open ▪ Diagnostic behavior ▪ Limit ▪ Flow direction check ▪ Digital Output 	–
Assign flow direction check	The Flow direction check option is selected in the Relay output function parameter.	Select process variable for flow direction monitoring.		–
Assign limit	The Limit option is selected in the Relay output function parameter.	Select process variable for limit function.	<ul style="list-style-type: none"> ▪ Mass flow ▪ Volume flow ▪ Corrected volume flow ▪ Target mass flow[*] ▪ Carrier mass flow[*] ▪ Density ▪ Reference density[*] ▪ Concentration[*] ▪ Temperature ▪ Totalizer 1 ▪ Totalizer 2 ▪ Totalizer 3 ▪ Oscillation damping 	–
Assign diagnostic behavior	In the Relay output function parameter, the Diagnostic behavior option is selected.	Select diagnostic behavior for switch output.	<ul style="list-style-type: none"> ▪ Alarm ▪ Alarm or warning ▪ Warning 	–
Assign status	In the Relay output function parameter, the Digital Output option is selected.	Select device status for switch output.	<ul style="list-style-type: none"> ▪ Partially filled pipe detection ▪ Low flow cut off ▪ Digital output 6 	–
Switch-off value	The Limit option is selected in the Relay output function parameter.	Enter measured value for the switch-off point.	Signed floating-point number	Depends on country: <ul style="list-style-type: none"> ▪ 0 kg/h ▪ 0 lb/min
Switch-off delay	In the Relay output function parameter, the Limit option is selected.	Define delay for the switch-off of status output.	0.0 to 100.0 s	–
Switch-on value	The Limit option is selected in the Relay output function parameter.	Enter measured value for the switch-on point.	Signed floating-point number	Depends on country: <ul style="list-style-type: none"> ▪ 0 kg/h ▪ 0 lb/min
Switch-on delay	In the Relay output function parameter, the Limit option is selected.	Define delay for the switch-on of status output.	0.0 to 100.0 s	–
Failure mode	–	Define output behavior in alarm condition.	<ul style="list-style-type: none"> ▪ Actual status ▪ Open ▪ Closed 	–
Switch status	–	Shows the current relay switch status.	<ul style="list-style-type: none"> ▪ Open ▪ Closed 	–
Powerless relay status	–		<ul style="list-style-type: none"> ▪ Open ▪ Closed 	–

* Visibility depends on order options or device settings

10.5.11 Configuring the local display

The **Display** wizard guides you systematically through all the parameters that can be configured for configuring the local display.





Navigation

"Setup" menu → Display

► Display	
Format display	→ 100
Value 1 display	→ 100
0% bargraph value 1	→ 100
100% bargraph value 1	→ 100
Value 2 display	→ 100
Value 3 display	→ 100
0% bargraph value 3	→ 100
100% bargraph value 3	→ 100
Value 4 display	→ 101

Parameter overview with brief description

Parameter	Prerequisite	Description	Selection / User entry	Factory setting
Format display	A local display is provided.	Select how measured values are shown on the display.	<ul style="list-style-type: none"> ▪ 1 value, max. size ▪ 1 bargraph + 1 value ▪ 2 values ▪ 1 value large + 2 values ▪ 4 values 	–
Value 1 display	A local display is provided.	Select the measured value that is shown on the local display.	<ul style="list-style-type: none"> ▪ Mass flow ▪ Volume flow ▪ Corrected volume flow * ▪ Density ▪ Reference density * ▪ Temperature ▪ Totalizer 1 ▪ Totalizer 2 ▪ Totalizer 3 ▪ Concentration * ▪ Target mass flow * ▪ Carrier mass flow * ▪ HBSI * ▪ Exciter current 0 ▪ Oscillation damping 0 ▪ Oscillation damping fluctuation 0 * ▪ Oscillation frequency 0 ▪ Frequency fluctuation 0 * ▪ Oscillation amplitude 0 * ▪ Signal asymmetry ▪ Carrier pipe temperature * ▪ Electronic temperature ▪ Current output 1 ▪ Current output 2 * ▪ Current output 3 * ▪ Current output 4 * 	–
0% bargraph value 1	A local display is provided.	Enter 0% value for bar graph display.	Signed floating-point number	Country-specific: <ul style="list-style-type: none"> ▪ 0 kg/h ▪ 0 lb/min
100% bargraph value 1	A local display is provided.	Enter 100% value for bar graph display.	Signed floating-point number	Depends on country and nominal diameter
Value 2 display	A local display is provided.	Select the measured value that is shown on the local display.	For the picklist, see Value 1 display parameter (→ 100)	–
Value 3 display	A local display is provided.	Select the measured value that is shown on the local display.	For the picklist, see Value 1 display parameter (→ 100)	–
0% bargraph value 3	A selection was made in the Value 3 display parameter.	Enter 0% value for bar graph display.	Signed floating-point number	Country-specific: <ul style="list-style-type: none"> ▪ 0 kg/h ▪ 0 lb/min
100% bargraph value 3	A selection was made in the Value 3 display parameter.	Enter 100% value for bar graph display.	Signed floating-point number	–

Parameter	Prerequisite	Description	Selection / User entry	Factory setting
Value 4 display	A local display is provided.	Select the measured value that is shown on the local display.	For the picklist, see Value 1 display parameter (→  100)	–
Value 5 display	A local display is provided.	Select the measured value that is shown on the local display.	For the picklist, see Value 1 display parameter (→  100)	–
Value 6 display	A local display is provided.	Select the measured value that is shown on the local display.	For the picklist, see Value 1 display parameter (→  100)	–
Value 7 display	A local display is provided.	Select the measured value that is shown on the local display.	For the picklist, see Value 1 display parameter (→  100)	–
Value 8 display	A local display is provided.	Select the measured value that is shown on the local display.	For the picklist, see Value 1 display parameter (→  100)	–

* Visibility depends on order options or device settings

10.5.12 Configuring the low flow cut off

The **Low flow cut off** wizard systematically guides the user through all the parameters that must be set to configure low flow cut off.

Navigation

"Setup" menu → Low flow cut off

► Low flow cut off	
Assign process variable	→ ⓘ 102
On value low flow cutoff	→ ⓘ 102
Off value low flow cutoff	→ ⓘ 102
Pressure shock suppression	→ ⓘ 102

Parameter overview with brief description

Parameter	Prerequisite	Description	Selection / User entry	Factory setting
Assign process variable	–	Select process variable for low flow cut off.	<ul style="list-style-type: none"> ■ Off ■ Mass flow ■ Volume flow ■ Corrected volume flow 	–
On value low flow cutoff	A process variable is selected in the Assign process variable parameter (→ ⓘ 102).	Enter on value for low flow cut off.	Positive floating-point number	Depends on country and nominal diameter
Off value low flow cutoff	A process variable is selected in the Assign process variable parameter (→ ⓘ 102).	Enter off value for low flow cut off.	0 to 100.0 %	–
Pressure shock suppression	A process variable is selected in the Assign process variable parameter (→ ⓘ 102).	Enter time frame for signal suppression (= active pressure shock suppression).	0 to 100 s	–

10.5.13 Configuring partially filled pipe detection

The **Partial filled pipe detection** wizard guides you systematically through all parameters that have to be set for configuring the monitoring of the pipe filling.

Navigation

"Setup" menu → Partially filled pipe detection

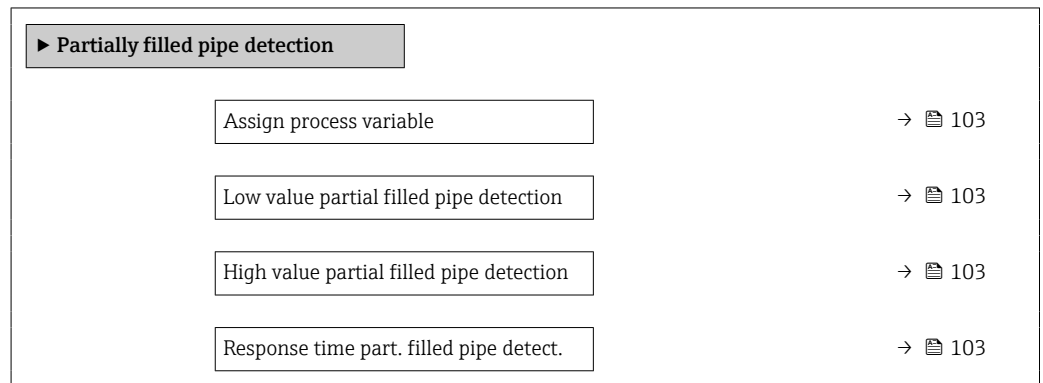

Parameter overview with brief description

Parameter	Prerequisite	Description	Selection / User entry	Factory setting
Assign process variable	–	Select process variable for partially filled pipe detection.	<ul style="list-style-type: none"> ■ Off ■ Density ■ Reference density 	Density
Low value partial filled pipe detection	A process variable is selected in the Assign process variable parameter (→ 103).	Enter lower limit value for deactivating partially filled pipe detection.	Signed floating-point number	Depends on country: <ul style="list-style-type: none"> ■ 200 kg/m³ ■ 12.5 lb/ft³
High value partial filled pipe detection	A process variable is selected in the Assign process variable parameter (→ 103).	Enter upper limit value for deactivating partially filled pipe detection.	Signed floating-point number	Depends on country: <ul style="list-style-type: none"> ■ 6 000 kg/m³ ■ 374.6 lb/ft³
Response time part. filled pipe detect.	A process variable is selected in the Assign process variable parameter (→ 103).	Use this function to enter the minimum time (hold time) the signal must be present before diagnostic message S962 "Pipe only partly filled" is triggered in the event of a partially filled or empty measuring pipe.	0 to 100 s	–

10.6 Advanced settings

The **Advanced setup** submenu with its submenus contains parameters for specific settings.

Navigation to the "Advanced setup" submenu

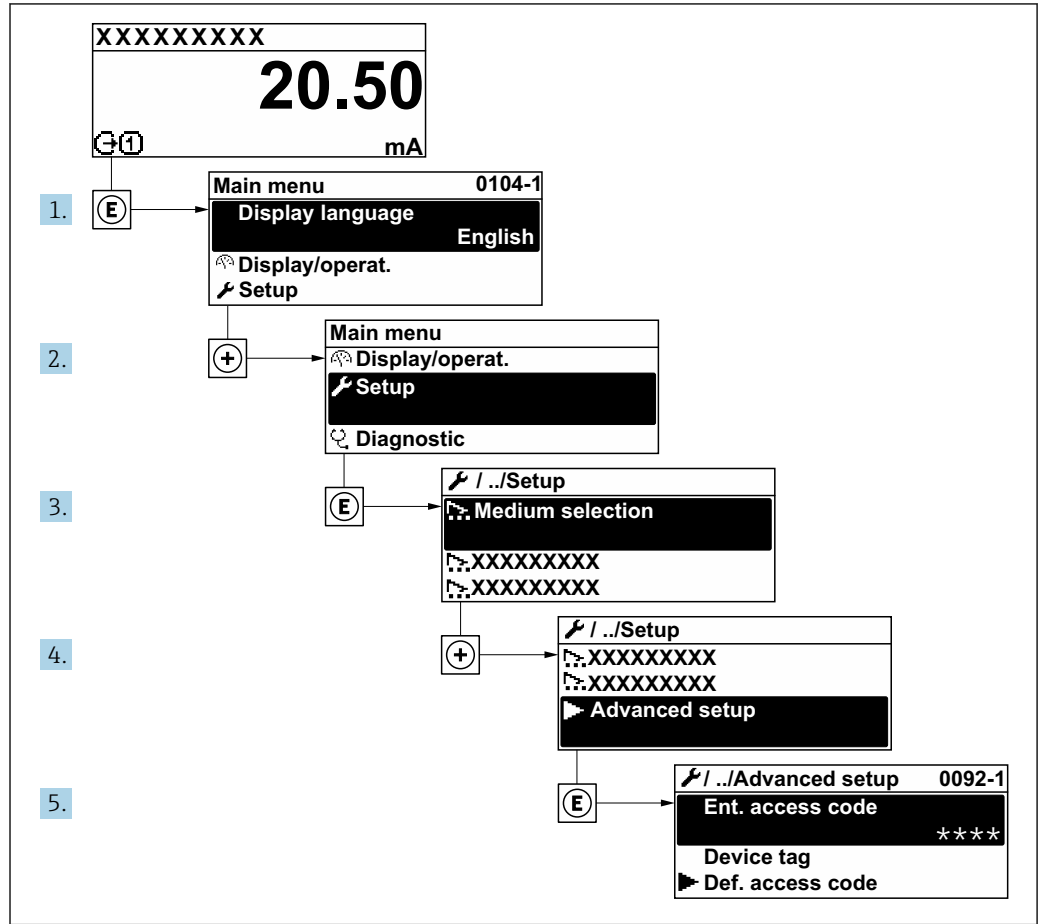

A0032223-EN

i The number of submenus and parameters can vary depending on the device version and the available application packages. These submenus and their parameters are explained in the Special Documentation for the device and not in Operating Instructions.

For detailed information on the parameter descriptions for application packages or for operation in custody transfer mode: Special Documentation for the device → 225

Navigation

"Setup" menu → Advanced setup

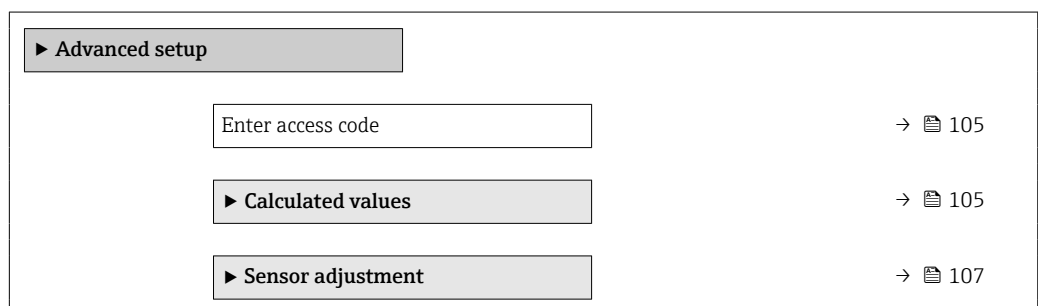

▶ Totalizer 1 to n	→ 113
▶ Display	→ 115
▶ WLAN settings	
▶ Concentration	
▶ Heartbeat setup	
▶ Configuration backup	→ 119
▶ Administration	→ 120

10.6.1 Using the parameter to enter the access code

Navigation

"Setup" menu → Advanced setup

Parameter overview with brief description

Parameter	Description	User entry
Enter access code	Enter access code to disable write protection of parameters.	Max. 16-digit character string comprising numbers, letters and special characters

10.6.2 Calculated process variables

The **Calculated values** submenu contains parameters for calculating the corrected volume flow.

 The **Calculated values** submenu is **not** available if one of the following options was selected in the **Petroleum mode** parameter in the "Application package", option **EJ** "Petroleum": **API referenced correction** option, **Net oil & water cut** option or **ASTM D4311** option

Navigation

"Setup" menu → Advanced setup → Calculated values

▶ Calculated values	
▶ Corrected volume flow calculation	→ 106

"Corrected volume flow calculation" submenu**Navigation**

"Setup" menu → Advanced setup → Calculated values → Corrected volume flow calculation

▶ Corrected volume flow calculation	
Corrected volume flow calculation (1812)	→ 106
External reference density (6198)	→ 106
Fixed reference density (1814)	→ 106
Reference temperature (1816)	→ 106
Linear expansion coefficient (1817)	→ 107
Square expansion coefficient (1818)	→ 107

Parameter overview with brief description

Parameter	Prerequisite	Description	Selection / User interface / User entry	Factory setting
Corrected volume flow calculation	–	Select reference density for calculating the corrected volume flow.	<ul style="list-style-type: none"> ▪ Fixed reference density ▪ Calculated reference density ▪ Reference density by API table 53 ▪ External reference density ▪ Current input 1 * 	–
External reference density	–	Shows external reference density.	Floating point number with sign	–
Fixed reference density	The Fixed reference density option is selected in the Corrected volume flow calculation parameter parameter.	Enter fixed value for reference density.	Positive floating-point number	–
Reference temperature	The Calculated reference density option is selected in the Corrected volume flow calculation parameter parameter.	Enter reference temperature for calculating the reference density.	–273.15 to 99 999 °C	Country-specific: <ul style="list-style-type: none"> ▪ +20 °C ▪ +68 °F

Parameter	Prerequisite	Description	Selection / User interface / User entry	Factory setting
Linear expansion coefficient	The Calculated reference density option is selected in the Corrected volume flow calculation parameter parameter.	Enter linear, medium-specific expansion coefficient for calculating the reference density.	Signed floating-point number	-
Square expansion coefficient	The Calculated reference density option is selected in the Corrected volume flow calculation parameter parameter.	For media with a non-linear expansion pattern: enter the quadratic, medium-specific expansion coefficient for calculating the reference density.	Signed floating-point number	-

* Visibility depends on order options or device settings

10.6.3 Carrying out a sensor adjustment

The **Sensor adjustment** submenu contains parameters that pertain to the functionality of the sensor.

Navigation

"Setup" menu → Advanced setup → Sensor adjustment

▶ **Sensor adjustment**

Installation direction

→ ⓘ 107

▶ **Density adjustment**

▶ **Zero verification**

→ ⓘ 110

▶ **Zero adjustment**

→ ⓘ 112

Parameter overview with brief description

Parameter	Description	Selection
Installation direction	Set sign of flow direction to match the direction of the arrow on the sensor.	<ul style="list-style-type: none"> ▪ Flow in arrow direction ▪ Flow against arrow direction

Density adjustment

 With density adjustment, a high level of accuracy is achieved only at the point of adjustment and at the relevant density and temperature. However, the accuracy of a density adjustment is only ever as good as the quality of the reference measuring data provided. Therefore it is not a substitute for special density calibration.

Performing density adjustment

- i** Note the following before performing the adjustment:
- A density adjustment only makes sense if there is little variation in the operating conditions and the density adjustment is performed under the operating conditions.
 - The density adjustment scales the internally computed density value with a user-specific slope and offset.
 - A 1-point or 2-point density adjustment can be performed.
 - For a 2-point density adjustment, there must be a difference of at least 0.2 kg/l between the two target density values.
 - The reference media must be gas-free or pressurized so that any gas they contain is compressed.
 - The reference density measurements must be performed at the same medium temperature that prevails in the process, as otherwise the density adjustment will not be accurate.
 - The correction resulting from the density adjustment can be deleted with the **Restore original** option.

"1 point adjustment" option

1. In the **Density adjustment mode** parameter, select the **1 point adjustment** option and confirm.
2. In the **Density setpoint 1** parameter, enter the density value and confirm.
 - ↳ In the **Execute density adjustment** parameter the following options are now available:
 - Ok
 - Measure density 1 option**
 - Restore original
3. Select the **Measure density 1 option** and confirm.
4. If 100% was reached in the **Progress** parameter on the display and the **Ok** option is displayed in the **Execute density adjustment** parameter, then confirm.
 - ↳ In the **Execute density adjustment** parameter the following options are now available:
 - Ok
 - Calculate
 - Cancel
5. Select the **Calculate** option and confirm.

If the adjustment was completed successfully, the **Density adjustment factor** parameter and the **Density adjustment offset** parameter and the values calculated for them are shown on the display.

"2 point adjustment" option

1. In the **Density adjustment mode** parameter, select the **2 point adjustment** option and confirm.
2. In the **Density setpoint 1** parameter, enter the density value and confirm.
3. In the **Density setpoint 2** parameter, enter the density value and confirm.
 - ↳ In the **Execute density adjustment** parameter the following options are now available:
 - Ok
 - Measure density 1
 - Restore original

4. Select the **Measure density 1** option and confirm.
 - ↳ In the **Execute density adjustment** parameter the following options are now available:
 - Ok
 - Measure density 2
 - Restore original
5. Select the **Measure density 2** option and confirm.
 - ↳ In the **Execute density adjustment** parameter the following options are now available:
 - Ok
 - Calculate
 - Cancel
6. Select the **Calculate** option and confirm.

If the **Density adjust failure** option is displayed in the **Execute density adjustment** parameter, call up the options and select the **Cancel** option. The density adjustment is canceled and can be repeated.

If the adjustment was completed successfully, the **Density adjustment factor** parameter and the **Density adjustment offset** parameter and the values calculated for them are shown on the display.

Navigation

"Expert" menu → Sensor → Sensor adjustment → Density adjustment

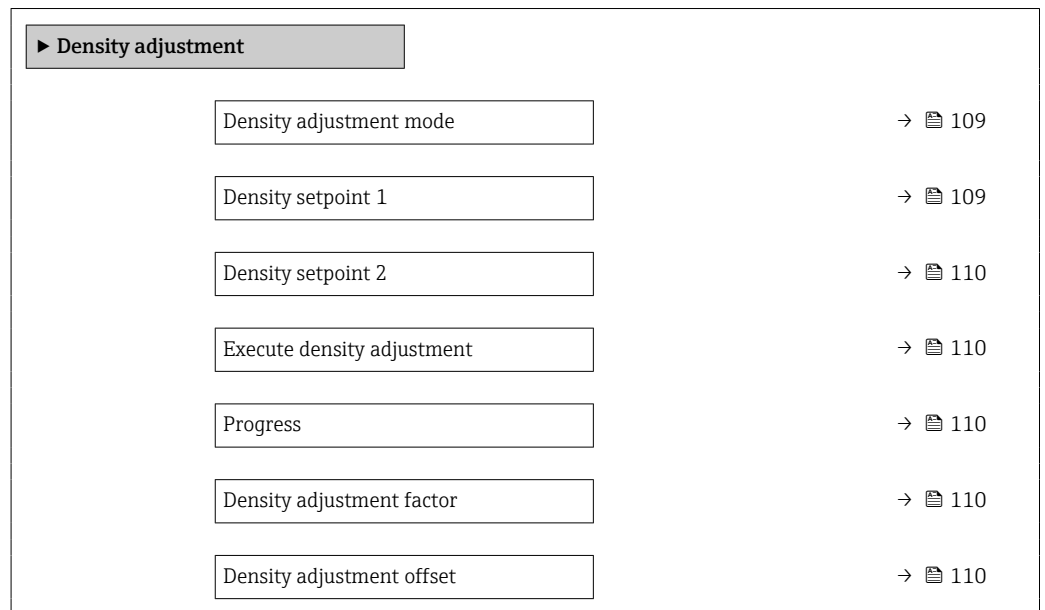

Parameter overview with brief description

Parameter	Prerequisite	Description	Selection / User entry / User interface	Factory setting
Density adjustment mode	-		<ul style="list-style-type: none"> ■ 1 point adjustment ■ 2 point adjustment 	-
Density setpoint 1	-		The entry depends on the unit selected in the Density unit parameter (0555).	-

Parameter	Prerequisite	Description	Selection / User entry / User interface	Factory setting
Density setpoint 2	In the Density adjustment mode parameter, the 2 point adjustment option is selected.		The entry depends on the unit selected in the Density unit parameter (0555).	–
Execute density adjustment	–		<ul style="list-style-type: none"> ▪ Cancel ▪ Busy ▪ Ok ▪ Density adjust failure ▪ Measure density 1 ▪ Measure density 2 ▪ Calculate ▪ Restore original 	–
Progress	–	Shows the progress of the process.	0 to 100 %	–
Density adjustment factor	–		Signed floating-point number	–
Density adjustment offset	–		Signed floating-point number	–

Zero verification and zero adjustment

All measuring instruments are calibrated in accordance with state-of-the-art technology. Calibration takes place under reference conditions →  206. Therefore, a zero adjustment in the field is generally not required.

Experience shows that zero adjustment is advisable only in special cases:

- To achieve maximum measurement accuracy even with low flow rates.
- Under extreme process or operating conditions (e.g. very high process temperatures or very high-viscosity fluids).
- For gas applications with low pressure



To achieve the highest possible measurement accuracy at low flow rates, the installation must protect the sensor from mechanical stresses during operation.

To get a representative zero point, ensure that:

- any flow in the device is prevented during the adjustment
- the process conditions (e.g. pressure, temperature) are stable and representative

Zero verification and zero adjustment cannot be performed if the following process conditions are present:

- Gas pockets
Ensure that the system has been sufficiently flushed with the medium. Repeat flushing can help to eliminate gas pockets
- Thermal circulation
In the event of temperature differences (e.g. between the measuring tube inlet and outlet section), induced flow can occur even if the valves are closed due to thermal circulation in the device
- Leaks at the valves
If the valves are not leak-tight, flow is not sufficiently prevented when determining the zero point

If these conditions cannot be avoided, it is advisable to keep the factory setting for the zero point.

Zero point verification

The zero point can be verified with the **Zero verification** wizard.

Navigation

"Setup" menu → Advanced setup → Sensor adjustment → Zero verification

<div style="background-color: #cccccc; padding: 2px; margin-bottom: 5px;">▶ Zero verification</div>		
Process conditions	→	📄 111
Progress	→	📄 111
Status	→	📄 111
Additional information	→	📄 111
Recommendation:	→	📄 111
Root cause	→	📄 111
Abort cause	→	📄 111
Zero point measured	→	📄 112
Zero point standard deviation	→	📄 112

Parameter overview with brief description

Parameter	Description	Selection / User interface	Factory setting
Process conditions	Ensure process conditions as follows.	<ul style="list-style-type: none"> ▪ Tubes are completely filled ▪ Process operational pressure applied ▪ No-flow conditions (closed valves) ▪ Process and ambient temperatures stable 	-
Progress	Shows the progress of the process.	0 to 100 %	-
Zero point adjustment status		<ul style="list-style-type: none"> ▪ Busy ▪ Alarm ▪ Ok 	-
Additional information	Indicate whether to display additional information.	<ul style="list-style-type: none"> ▪ Hide ▪ Show 	-
Recommendation:	Indicates whether an adjustment is recommended. Only recommended if the measured zero point deviates significantly from the current zero point.	<ul style="list-style-type: none"> ▪ Do not adjust zero point ▪ Adjust zero point 	-
Abort cause	Indicates why the wizard was aborted.	<ul style="list-style-type: none"> ▪ Check process conditions! ▪ A technical issue has occurred 	-
Root cause	Shows the diagnostic and remedy.	<ul style="list-style-type: none"> ▪ Zero point too high. Ensure no-flow. ▪ Zero point is unstable. Ensure no-flow. ▪ Fluctuation high. Avoid 2-phase medium. 	-

Parameter	Description	Selection / User interface	Factory setting
Zero point measured	Shows the zero point measured for the adjustment.	Signed floating-point number	-
Zero point standard deviation	Shows the standard deviation of the zero point measured.	Positive floating-point number	-

Zero adjust

The zero point can be adjusted with the **Zero adjustment** wizard.



- A zero point verification should be performed before a zero adjustment.
- The zero point can also be adjusted manually: Expert → Sensor → Calibration

Navigation

"Setup" menu → Advanced setup → Sensor adjustment → Zero adjustment

► Zero adjustment	
Process conditions	→ 113
Progress	→ 113
Status	→ 113
Root cause	→ 113
Abort cause	→ 113
Root cause	→ 113
Reliability of measured zero point	→ 113
Additional information	→ 113
Reliability of measured zero point	→ 113
Zero point measured	→ 113
Zero point standard deviation	→ 113
Select action	→ 113

Parameter overview with brief description

Parameter	Description	Selection / User interface	Factory setting
Process conditions	Ensure process conditions as follows.	<ul style="list-style-type: none"> ■ Tubes are completely filled ■ Process operational pressure applied ■ No-flow conditions (closed valves) ■ Process and ambient temperatures stable 	–
Progress	Shows the progress of the process.	0 to 100 %	–
Zero point adjustment status		<ul style="list-style-type: none"> ■ Busy ■ Alarm ■ Ok 	–
Abort cause	Indicates why the wizard was aborted.	<ul style="list-style-type: none"> ■ Check process conditions! ■ A technical issue has occurred 	–
Root cause	Shows the diagnostic and remedy.	<ul style="list-style-type: none"> ■ Zero point too high. Ensure no-flow. ■ Zero point is unstable. Ensure no-flow. ■ Fluctuation high. Avoid 2-phase medium. 	–
Reliability of measured zero point	Indicates the reliability of the zero point measured.	<ul style="list-style-type: none"> ■ Not done ■ Good ■ Uncertain 	–
Additional information	Indicate whether to display additional information.	<ul style="list-style-type: none"> ■ Hide ■ Show 	–
Zero point measured	Shows the zero point measured for the adjustment.	Signed floating-point number	–
Zero point standard deviation	Shows the standard deviation of the zero point measured.	Positive floating-point number	–
Select action	Select the zero point value to apply.	<ul style="list-style-type: none"> ■ Keep current zero point ■ Apply zero point measured ■ Apply factory zero point * 	–

* Visibility depends on order options or device settings

10.6.4 Configuring the totalizer

In the "**Totalizer 1 to n**" submenu, you can configure the specific totalizer.

Navigation

"Setup" menu → Advanced setup → Totalizer 1 to n

► Totalizer 1 to n	
Assign process variable	→ ⓘ 114
Unit totalizer 1 to n	→ ⓘ 114
Totalizer operation mode	→ ⓘ 114
Failure mode	→ ⓘ 114

Parameter overview with brief description

Parameter	Prerequisite	Description	Selection	Factory setting
Assign process variable	–	Select process variable for totalizer.	<ul style="list-style-type: none"> ▪ Off ▪ Mass flow ▪ Volume flow ▪ Corrected volume flow[*] ▪ Target mass flow[*] ▪ Carrier mass flow[*] 	–
Unit totalizer 1 to n	A process variable is selected in the Assign process variable parameter (→ 114) of the Totalizer 1 to n submenu.	Select process variable totalizer unit.	Unit choose list	Depends on country: <ul style="list-style-type: none"> ▪ kg ▪ lb
Totalizer operation mode	A process variable is selected in the Assign process variable parameter (→ 114) of the Totalizer 1 to n submenu.	Select totalizer calculation mode.	<ul style="list-style-type: none"> ▪ Net flow total ▪ Forward flow total ▪ Reverse flow total 	–
Failure mode	A process variable is selected in the Assign process variable parameter (→ 114) of the Totalizer 1 to n submenu.	Define totalizer behavior in alarm condition.	<ul style="list-style-type: none"> ▪ Stop ▪ Actual value ▪ Last valid value 	–

* Visibility depends on order options or device settings

10.6.5 Carrying out additional display configurations

In the **Display** submenu you can set all the parameters associated with the configuration of the local display.



Navigation

"Setup" menu → Advanced setup → Display

► Display	
Format display	→ 116
Value 1 display	→ 116
0% bargraph value 1	→ 116
100% bargraph value 1	→ 116
Decimal places 1	→ 116
Value 2 display	→ 116
Decimal places 2	→ 116
Value 3 display	→ 117
0% bargraph value 3	→ 117
100% bargraph value 3	→ 117
Decimal places 3	→ 117
Value 4 display	→ 117
Decimal places 4	→ 117
Display language	→ 117
Display interval	→ 117
Display damping	→ 117
Header	→ 117
Header text	→ 117
Separator	→ 118
Backlight	→ 118

Parameter overview with brief description

Parameter	Prerequisite	Description	Selection / User entry	Factory setting
Format display	A local display is provided.	Select how measured values are shown on the display.	<ul style="list-style-type: none"> ▪ 1 value, max. size ▪ 1 bargraph + 1 value ▪ 2 values ▪ 1 value large + 2 values ▪ 4 values 	–
Value 1 display	A local display is provided.	Select the measured value that is shown on the local display.	<ul style="list-style-type: none"> ▪ Mass flow ▪ Volume flow ▪ Corrected volume flow * ▪ Density ▪ Reference density * ▪ Temperature ▪ Totalizer 1 ▪ Totalizer 2 ▪ Totalizer 3 ▪ Concentration * ▪ Target mass flow * ▪ Carrier mass flow * ▪ HBSI * ▪ Exciter current 0 ▪ Oscillation damping 0 ▪ Oscillation damping fluctuation 0 * ▪ Oscillation frequency 0 ▪ Frequency fluctuation 0 * ▪ Oscillation amplitude 0 * ▪ Signal asymmetry ▪ Carrier pipe temperature * ▪ Electronic temperature ▪ Current output 1 ▪ Current output 2 * ▪ Current output 3 * ▪ Current output 4 * 	–
0% bargraph value 1	A local display is provided.	Enter 0% value for bar graph display.	Signed floating-point number	Country-specific: <ul style="list-style-type: none"> ▪ 0 kg/h ▪ 0 lb/min
100% bargraph value 1	A local display is provided.	Enter 100% value for bar graph display.	Signed floating-point number	Depends on country and nominal diameter
Decimal places 1	A measured value is specified in the Value 1 display parameter.	Select the number of decimal places for the display value.	<ul style="list-style-type: none"> ▪ x ▪ x.x ▪ x.xx ▪ x.xxx ▪ x.xxxx 	–
Value 2 display	A local display is provided.	Select the measured value that is shown on the local display.	For the picklist, see Value 1 display parameter (→ 100)	–
Decimal places 2	A measured value is specified in the Value 2 display parameter.	Select the number of decimal places for the display value.	<ul style="list-style-type: none"> ▪ x ▪ x.x ▪ x.xx ▪ x.xxx ▪ x.xxxx 	–

Parameter	Prerequisite	Description	Selection / User entry	Factory setting
Value 3 display	A local display is provided.	Select the measured value that is shown on the local display.	For the picklist, see Value 1 display parameter (→  100)	–
0% bargraph value 3	A selection was made in the Value 3 display parameter.	Enter 0% value for bar graph display.	Signed floating-point number	Country-specific: ■ 0 kg/h ■ 0 lb/min
100% bargraph value 3	A selection was made in the Value 3 display parameter.	Enter 100% value for bar graph display.	Signed floating-point number	–
Decimal places 3	A measured value is specified in the Value 3 display parameter.	Select the number of decimal places for the display value.	<ul style="list-style-type: none"> ■ x ■ x.x ■ x.xx ■ x.xxx ■ x.xxxx 	–
Value 4 display	A local display is provided.	Select the measured value that is shown on the local display.	For the picklist, see Value 1 display parameter (→  100)	–
Decimal places 4	A measured value is specified in the Value 4 display parameter.	Select the number of decimal places for the display value.	<ul style="list-style-type: none"> ■ x ■ x.x ■ x.xx ■ x.xxx ■ x.xxxx 	–
Display language	A local display is provided.	Set display language.	<ul style="list-style-type: none"> ■ English ■ Deutsch * ■ Français * ■ Español * ■ Italiano * ■ Nederlands * ■ Portuguesa * ■ Polski * ■ русский язык (Russian) * ■ Svenska * ■ Türkçe * ■ 中文 (Chinese) * ■ 日本語 (Japanese) * ■ 한국어 (Korean) * ■ tiếng Việt (Vietnamese) * ■ čeština (Czech) * 	English (alternatively, the ordered language is preset in the device)
Display interval	A local display is provided.	Set time measured values are shown on display if display alternates between values.	1 to 10 s	–
Display damping	A local display is provided.	Set display reaction time to fluctuations in the measured value.	0.0 to 999.9 s	–
Header	A local display is provided.	Select header contents on local display.	<ul style="list-style-type: none"> ■ Device tag ■ Free text 	–
Header text	The Free text option is selected in the Header parameter.	Enter display header text.	Max. 12 characters, such as letters, numbers or special characters (e.g. @, %, /)	–

Parameter	Prerequisite	Description	Selection / User entry	Factory setting
Separator	A local display is provided.	Select decimal separator for displaying numerical values.	<ul style="list-style-type: none"> ▪ . (point) ▪ , (comma) 	. (point)
Backlight	One of the following conditions is met: <ul style="list-style-type: none"> ▪ Order code for "Display; operation", option F "4-line, illum.; touch control" ▪ Order code for "Display; operation", option G "4-line, illum.; touch control +WLAN" ▪ Order code for "Display; operation", option O "Remote display 4-line illuminated; 10m/30ft cable; touch control" 	Switch the local display backlight on and off.	<ul style="list-style-type: none"> ▪ Disable ▪ Enable 	–

* Visibility depends on order options or device settings

10.6.6 WLAN configuration

The **WLAN Settings** submenu guides the user systematically through all the parameters that have to be set for the WLAN configuration.



Navigation

"Setup" menu → Advanced setup → WLAN settings

▶ WLAN settings	
WLAN IP address	→ ⓘ 118
Security type	→ ⓘ 118
WLAN passphrase	→ ⓘ 119
Assign SSID name	→ ⓘ 119
SSID name	→ ⓘ 119
Apply changes	→ ⓘ 119

Parameter overview with brief description

Parameter	Prerequisite	Description	User entry / Selection	Factory setting
WLAN IP address	–	Enter IP address of the device WLAN interface.	4 octet: 0 to 255 (in the particular octet)	–
Security type	–	Select the security type of the WLAN interface.	<ul style="list-style-type: none"> ▪ Unsecured ▪ WPA2-PSK 	–

Parameter	Prerequisite	Description	User entry / Selection	Factory setting
WLAN passphrase	The WPA2-PSK option is selected in the Security type parameter.	Enter the network key (8 to 32 characters).  The network key supplied with the device should be changed during commissioning for security reasons.	8 to 32-digit character string comprising numbers, letters and special characters (without spaces)	Serial number of the measuring device (e.g. L100A802000)
Assign SSID name	–	Select which name will be used for SSID: device tag or user-defined name.	<ul style="list-style-type: none"> ▪ Device tag ▪ User-defined 	–
SSID name	<ul style="list-style-type: none"> ▪ The User-defined option is selected in the Assign SSID name parameter. ▪ The WLAN access point option is selected in the WLAN mode parameter. 	Enter the user-defined SSID name (max. 32 characters).  The user-defined SSID name may only be assigned once. If the SSID name is assigned more than once, the devices can interfere with one another.	Max. 32-digit character string comprising numbers, letters and special characters	EH_device designation_last 7 digits of the serial number (e.g. EH_Promass_300_A 802000)
Apply changes	–	Use changed WLAN settings.	<ul style="list-style-type: none"> ▪ Cancel ▪ Ok 	–

10.6.7 Configuration management

After commissioning, you can save the current device configuration or restore the previous device configuration. The device configuration is managed via the **Configuration management** parameter.

Navigation

"Setup" menu → Advanced setup → Configuration backup

► Configuration backup	
Operating time	→ ⓘ 119
Last backup	→ ⓘ 119
Configuration management	→ ⓘ 120
Backup state	→ ⓘ 120
Comparison result	→ ⓘ 120

Parameter overview with brief description

Parameter	Description	User interface / Selection
Operating time	Indicates how long the device has been in operation.	Days (d), hours (h), minutes (m) and seconds (s)
Last backup	Shows when the last data backup was saved to embedded HistoROM.	Days (d), hours (h), minutes (m) and seconds (s)

Parameter	Description	User interface / Selection
Configuration management	Select action for managing the device data in the embedded HistoROM.	<ul style="list-style-type: none"> ■ Cancel ■ Execute backup ■ Restore ■ Compare ■ Clear backup data
Backup state	Shows the current status of data saving or restoring.	<ul style="list-style-type: none"> ■ None ■ Backup in progress ■ Restoring in progress ■ Delete in progress ■ Compare in progress ■ Restoring failed ■ Backup failed
Comparison result	Comparison of current device data with embedded HistoROM.	<ul style="list-style-type: none"> ■ Settings identical ■ Settings not identical ■ No backup available ■ Backup settings corrupt ■ Check not done ■ Dataset incompatible

Function scope of the "Configuration management" parameter

Options	Description
Cancel	No action is executed and the user exits the parameter.
Execute backup	A backup copy of the current device configuration is saved from the HistoROM backup to the memory of the device. The backup copy includes the transmitter data of the device.
Restore	The last backup copy of the device configuration is restored from the device memory to the device's HistoROM backup. The backup copy includes the transmitter data of the device.
Compare	The device configuration saved in the device memory is compared with the current device configuration of the HistoROM backup.
Clear backup data	The backup copy of the device configuration is deleted from the memory of the device.

HistoROM backup

A HistoROM is a "non-volatile" device memory in the form of an EEPROM.

 While this action is in progress, the configuration cannot be edited via the local display and a message on the processing status appears on the display.

10.6.8 Using parameters for device administration

The **Administration** submenu systematically guides the user through all the parameters that can be used for device administration purposes.

Navigation

"Setup" menu → Advanced setup → Administration

▶ Administration	
▶ Define access code	→  121

▶ Reset access code	→ ⓘ 121
Device reset	→ ⓘ 122

Using the parameter to define the access code

Navigation

"Setup" menu → Advanced setup → Administration → Define access code

▶ Define access code	
Define access code	→ ⓘ 121
Confirm access code	→ ⓘ 121

Parameter overview with brief description

Parameter	Description	User entry
Define access code	Restrict write-access to parameters to protect the configuration of the device against unintentional changes.	Max. 16-digit character string comprising numbers, letters and special characters
Confirm access code	Confirm the entered access code.	Max. 16-digit character string comprising numbers, letters and special characters

Using the parameter to reset the access code

Navigation

"Setup" menu → Advanced setup → Administration → Reset access code

▶ Reset access code	
Operating time	→ ⓘ 121
Reset access code	→ ⓘ 121

Parameter overview with brief description

Parameter	Description	User interface / User entry
Operating time	Indicates how long the device has been in operation.	Days (d), hours (h), minutes (m) and seconds (s)
Reset access code	Reset access code to factory settings.  For a reset code, contact your Endress+Hauser service organization. The reset code can only be entered via: <ul style="list-style-type: none"> ▪ Web browser ▪ DeviceCare, FieldCare (via CDI-RJ45 service interface) ▪ Fieldbus 	Character string comprising numbers, letters and special characters

Using the parameter to reset the device

Navigation

"Setup" menu → Advanced setup → Administration

Parameter overview with brief description

Parameter	Description	Selection
Device reset	Reset the device configuration - either entirely or in part - to a defined state.	<ul style="list-style-type: none"> ■ Cancel ■ To delivery settings ■ Restart device ■ Restore S-DAT backup ■ ENP restart

10.7 Simulation

Via the **Simulation** submenu, it is possible to simulate various process variables in the process and the device alarm mode and verify downstream signal chains (switching valves or closed-control loops). The simulation can be performed without a real measurement (no flow of medium through the device).

Activating and deactivating simulation mode via DIP switch

The following hardware settings can be made for the FOUNDATION Fieldbus via DIP switch 4 on the main electronics module:

- Enable/block simulation mode in the function blocks (e.g. **Analog Input** or **Discrete Output** function block)
- Simulation mode enabled (factory setting) = simulation in the **Analog Input** or **Discrete Output** function block possible
- Simulation mode blocked = simulation in the **Analog Input** or **Discrete Output** function block not possible

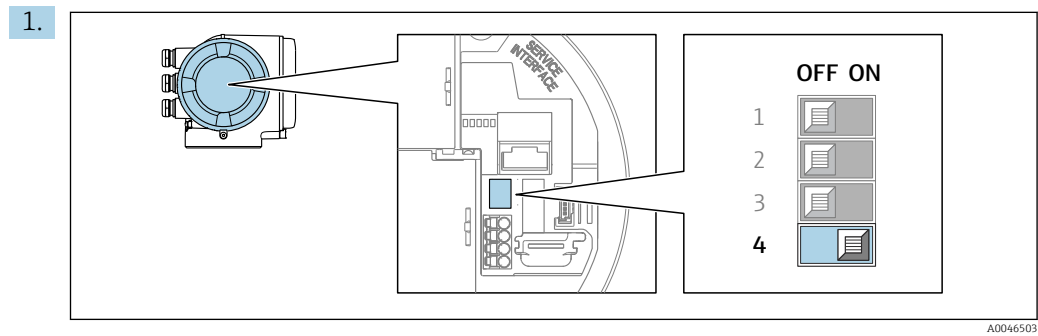

Set the write protection switch (SIM) on the main electronics module to the **ON** position (factory setting):

- ↳ Simulation mode enabled.









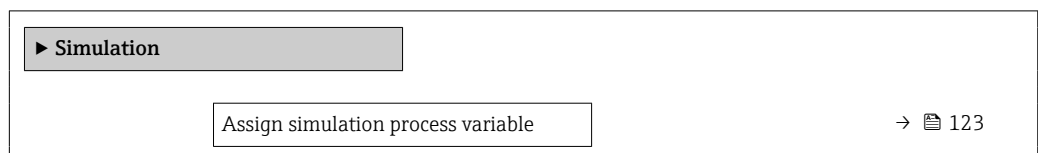









2. Set the write protection switch (SIM) on the main electronics module to the **OFF** position:

- ↳ Simulation mode disabled.

Navigation

"Diagnostics" menu → Simulation



Process variable value	→  123
Status input simulation	→  124
Input signal level	→  124
Current input 1 to n simulation	→  124
Value current input 1 to n	→  124
Current output 1 to n simulation	→  124
Value current output 1 to n	→  124
Frequency output simulation 1 to n	→  124
Frequency value 1 to n	→  124
Pulse output simulation 1 to n	→  124
Pulse value 1 to n	→  124
Switch output simulation 1 to n	→  124
Switch status 1 to n	→  124
Relay output 1 to n simulation	→  124
Switch status 1 to n	→  124
Device alarm simulation	→  124
Diagnostic event category	→  124
Diagnostic event simulation	→  124

Parameter overview with brief description





Parameter	Prerequisite	Description	Selection / User entry
Assign simulation process variable	–	Select a process variable for the simulation process that is activated.	<ul style="list-style-type: none"> ■ Off ■ Mass flow ■ Volume flow ■ Corrected volume flow ■ Density ■ Reference density ■ Temperature ■ Target mass flow * ■ Carrier mass flow * ■ Concentration *
Process variable value	A process variable is selected in the Assign simulation process variable parameter (→  123).	Enter the simulation value for the selected process variable.	Depends on the process variable selected

Parameter	Prerequisite	Description	Selection / User entry
Current output simulation	–	Switch the simulation of the current output on and off.	<ul style="list-style-type: none"> ■ Off ■ On
Value current output	In the Current output 1 to n simulation parameter, the On option is selected.	Enter the current value for simulation.	3.59 to 22.5 mA
Frequency output simulation	In the Operating mode parameter, the Frequency option is selected.	Switch the simulation of the frequency output on and off.	<ul style="list-style-type: none"> ■ Off ■ On
Frequency value	In the Frequency output simulation 1 to n parameter, the On option is selected.	Enter the frequency value for the simulation.	0.0 to 12 500.0 Hz
Pulse output simulation	In the Operating mode parameter, the Pulse option is selected.	Set and switch off the pulse output simulation.  For Fixed value option: Pulse width parameter (→ 91) defines the pulse width of the pulses output.	<ul style="list-style-type: none"> ■ Off ■ Fixed value ■ Down-counting value
Pulse value	In the Pulse output simulation 1 to n parameter, the Down-counting value option is selected.	Enter the number of pulses for simulation.	0 to 65 535
Switch output simulation	In the Operating mode parameter, the Switch option is selected.	Switch the simulation of the switch output on and off.	<ul style="list-style-type: none"> ■ Off ■ On
Switch status	–	Select the status of the status output for the simulation.	<ul style="list-style-type: none"> ■ Open ■ Closed
Relay output simulation	–	Switch simulation of the relay output on and off.	<ul style="list-style-type: none"> ■ Off ■ On
Switch status	The On option is selected in the Switch output simulation 1 to n parameter parameter.	Select status of the relay output for the simulation.	<ul style="list-style-type: none"> ■ Open ■ Closed
Device alarm simulation	–	Switch the device alarm on and off.	<ul style="list-style-type: none"> ■ Off ■ On
Diagnostic event category	–	Select a diagnostic event category.	<ul style="list-style-type: none"> ■ Sensor ■ Electronics ■ Configuration ■ Process
Diagnostic event simulation	–	Select a diagnostic event to simulate this event.	<ul style="list-style-type: none"> ■ Off ■ Diagnostic event picklist (depends on the category selected)
Current input simulation	–	Switch simulation of the current input on and off.	<ul style="list-style-type: none"> ■ Off ■ On
Value current input	In the Current input 1 to n simulation parameter, the On option is selected.	Enter the current value for simulation.	0 to 22.5 mA
Status input simulation	–	Switch simulation of the status input on and off.	<ul style="list-style-type: none"> ■ Off ■ On
Input signal level	In the Status input simulation parameter, the On option is selected.	Select the signal level for the simulation of the status input.	<ul style="list-style-type: none"> ■ High ■ Low

* Visibility depends on order options or device settings

10.8 Protecting settings from unauthorized access

The following write protection options exist in order to protect the configuration of the measuring device from unintentional modification:



- Protect access to parameters via access code →  125
- Protect access to local operation via key locking →  58
- Protect access to measuring device via write protection switch →  126
- Protect access to parameters via block operation →  127

10.8.1 Write protection via access code





The effects of the user-specific access code are as follows:

- Via local operation, the parameters for the measuring device configuration are write-protected and their values can no longer be changed.
- Device access is protected via the Web browser, as are the parameters for the measuring device configuration.
- Device access is protected via FieldCare or DeviceCare (via CDI-RJ45 service interface), as are the parameters for the measuring device configuration.

Defining the access code via the local display

1. Navigate to the **Define access code** parameter (→  121).
2. Maximum of 16-digit character string comprising numbers, letters and special characters as the access code.
3. Enter the access code again in the **Confirm access code** parameter (→  121) to confirm.

↳ The  symbol appears in front of all write-protected parameters.

- 
 - Disabling parameter write protection via access code →  57.
 - If the access code is lost: Resetting the access code →  126.
 - The user role with which the user is currently logged in is displayed in **Access status** parameter.
 - Navigation path: Operation → Access status
 - User roles and their access rights →  57
- The device automatically locks the write-protected parameters again if a key is not pressed for 10 minutes in the navigation and editing view.
- The device locks the write-protected parameters automatically after 60 s if the user skips back to the operational display mode from the navigation and editing view.



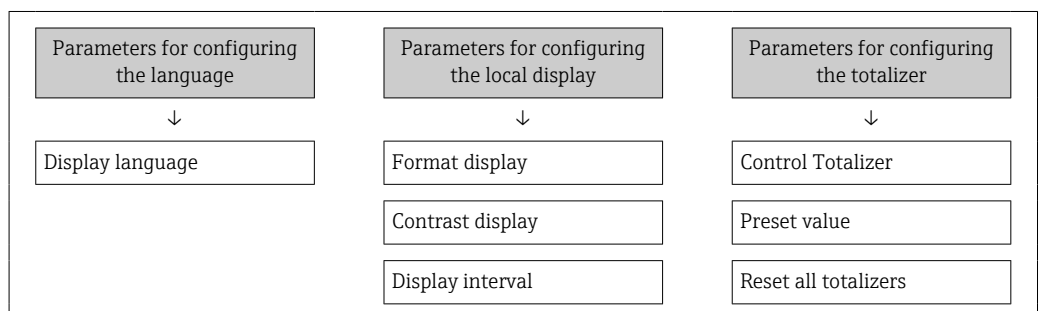

Parameters which can always be modified via the local display

Certain parameters that do not affect the measurement are excepted from parameter write protection via the local display. Despite the user-specific access code, they can always be modified, even if the other parameters are locked.



Defining the access code via the web browser

1. Navigate to the **Define access code** parameter (→  121).





2. Define a 16-digit (max.) numeric code as the access code.
 3. Enter the access code again in the **Confirm access code** parameter (→  121) to confirm.
 - ↳ The web browser switches to the login page.
-  ■ Disabling parameter write protection via access code →  57.
- If the access code is lost: Resetting the access code →  126.
- The **Access status** parameter shows which user role the user is currently logged in with.
- Navigation path: Operation → Access status
 - User roles and their access rights →  57

If no action is performed for 10 minutes, the web browser automatically returns to the login page.

Resetting the access code

If you misplace the user-specific access code, it is possible to reset the code to the factory setting. A reset code must be entered for this purpose. The user-specific access code can then be defined again afterwards.

Via Web browser, FieldCare, DeviceCare (via CDI-RJ45 service interface), fieldbus

-  You can only obtain a reset code from your local Endress+Hauser service organization. The code must be calculated explicitly for every device.
1. Note down the serial number of the device.
 2. Read off the **Operating time** parameter.
 3. Contact the local Endress+Hauser service organization and tell them the serial number and the operating time.
 - ↳ Get the calculated reset code.
 4. Enter the reset code in the **Reset access code** parameter (→  121).
 - ↳ The access code has been reset to the factory setting **0000**. It can be redefined →  125.
-  For IT security reasons, the calculated reset code is only valid for 96 hours from the specified operating time and for the specific serial number. If you cannot return to the device within 96 hours, you should either increase the operating time you read out by a few days or switch off the device.

10.8.2 Write protection via write protection switch

Unlike parameter write protection via a user-specific access code, this allows the user to lock write access to the entire operating menu - apart from the **"Contrast display" parameter**.

The parameter values are now read only and cannot be edited any more (exception **"Contrast display" parameter**):

- Via local display
- Via FOUNDATION Fieldbus

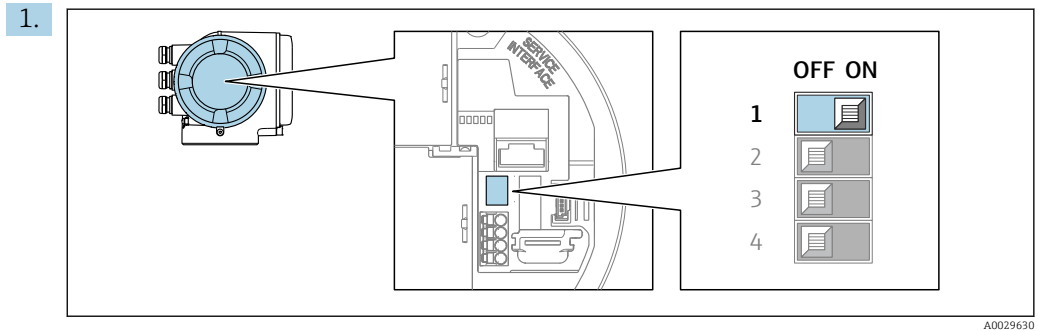

Setting the write protection (WP) switch on the main electronics module to the **ON** position enables hardware write protection.

- ↳ In the **Locking status** parameter, the **Hardware locked** option is displayed → 128. In addition, on the local display the symbol appears in front of the parameters in the header of the operational display and in the navigation view.

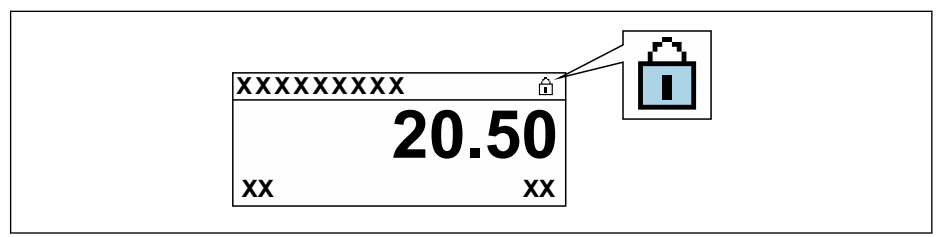

2. Setting the write protection (WP) switch on the main electronics module to the **OFF** position (factory setting) disables hardware write protection.

- ↳ No option is displayed in the **Locking status** parameter → 128. On the local display, the symbol disappears from in front of the parameters in the header of the operational display and in the navigation view.

10.8.3 Write protection via block operation

Locking via block operation:

- Block: **DISPLAY (TRDDISP)**; parameter: **Define access code**
- Block: **EXPERT_CONFIG (TRDEXP)**; parameter: **Enter access code**



11 Operation

11.1 Reading off the device locking status

Device active write protection: **Locking status** parameter



Operation → Locking status

Function scope of the "Locking status" parameter

Options	Description
None	The access authorization displayed in the Access status parameter applies →  57. Only appears on local display.
Hardware locked	The DIP switch for hardware locking is activated on the PCB board. This locks write access to the parameters (e.g. via local display or operating tool) →  126.
Temporarily locked	Write access to the parameters is temporarily locked on account of internal processes running in the device (e.g. data upload/download, reset, etc.). Once the internal processing has been completed, the parameters can be changed once again.



11.2 Adjusting the operating language

 Detailed information:

- To configure the operating language →  77
- For information on the operating languages supported by the measuring device →  215

11.3 Configuring the display

Detailed information:





- On the basic settings for the local display →  99
- On the advanced settings for the local display →  115

11.4 Reading off measured values

With the **Measured values** submenu, it is possible to read all the measured values.

Navigation

"Diagnostics" menu → Measured values

▶ Measured values	
▶ Measured variables	→  129
▶ Input values	→  139
▶ Output values	→  141
▶ Totalizer	→  139

























11.4.1 "Measured variables" submenu

The **Measured variables** submenu contains all the parameters needed to display the current measured values for each process variable.









Navigation











"Diagnostics" menu → Measured values → Measured variables





► Measured variables	
Mass flow	→ 131
Volume flow	→ 131
Corrected volume flow	→ 131
Density	→ 131
Reference density	→ 131
Temperature	→ 131
Pressure	→ 131
Concentration	→ 131
Target mass flow	→ 132
Carrier mass flow	→ 132
Target corrected volume flow	→ 132
Carrier corrected volume flow	→ 132
Target volume flow	→ 132
Carrier volume flow	→ 133
CTL	→ 133
CPL	→ 133
CTPL	→ 133
S&W volume flow	→ 134
S&W correction value	→ 134
Reference density alternative	→ 134



GSV flow	→  134
GSV flow alternative	→  134
NSV flow	→  135
NSV flow alternative	→  135
Oil CTL	→  135
Oil CPL	→  135
Oil CTPL	→  135
Water CTL	→  136
CTL alternative	→  136
CPL alternative	→  136
CTPL alternative	→  136
Oil reference density	→  136
Water reference density	→  137
Oil density	→  137
Water density	→  137
Water cut	→  137
Oil volume flow	→  137
Oil corrected volume flow	→  138
Oil mass flow	→  138
Water volume flow	→  138
Water corrected volume flow	→  138
Water mass flow	→  138
Weighted density average	→  139
Weighted temperature average	→  139





Parameter overview with brief description





Parameter	Prerequisite	Description	User interface	Factory setting
Mass flow	–	Displays the mass flow that is currently measured. <i>Dependency</i> The unit is taken from: Mass flow unit parameter (→  80)	Signed floating-point number	–
Volume flow	–	Displays the volume flow that is currently calculated. <i>Dependency</i> The unit is taken from the Volume flow unit parameter (→  80).	Signed floating-point number	–
Corrected volume flow	–	Displays the corrected volume flow that is currently calculated. <i>Dependency</i> The unit is taken from: Corrected volume flow unit parameter (→  80)	Signed floating-point number	–
Density	–	Shows the density currently measured. <i>Dependency</i> The unit is taken from the Density unit parameter (→  80).	Signed floating-point number	–
Reference density	–	Displays the reference density that is currently calculated. <i>Dependency</i> The unit is taken from: Reference density unit parameter (→  81)	Signed floating-point number	–
Temperature	–	Shows the medium temperature currently measured. <i>Dependency</i> The unit is taken from: Temperature unit parameter (→  81)	Signed floating-point number	–
Pressure value	–	Displays either a fixed or external pressure value. <i>Dependency</i> The unit is taken from the Pressure unit parameter (→  81).	Signed floating-point number	–
Concentration	For the following order code: Order code for "Application package", option ED "Concentration"  The software options currently enabled are displayed in the Software option overview parameter.	Displays the concentration that is currently calculated. <i>Dependency</i> The unit is taken from the Concentration unit parameter.	Signed floating-point number	–





Parameter	Prerequisite	Description	User interface	Factory setting
Target mass flow	<p>With the following conditions: Order code for "Application package", option ED "Concentration"</p> <p> The software options currently enabled are displayed in the Software option overview parameter.</p>	<p>Displays the mass flow that is currently measured for the target medium.</p> <p><i>Dependency</i> The unit is taken from: Mass flow unit parameter (→  80)</p>	Signed floating-point number	–
Carrier mass flow	<p>With the following conditions: Order code for "Application package", option ED "Concentration"</p> <p> The software options currently enabled are displayed in the Software option overview parameter.</p>	<p>Displays the mass flow of the carrier medium that is currently measured.</p> <p><i>Dependency</i> The unit is taken from: Mass flow unit parameter (→  80)</p>	Signed floating-point number	–
Target corrected volume flow	<p>With the following conditions:</p> <ul style="list-style-type: none"> Order code for "Application package", option ED "Concentration" The Ethanol in water option or %mass / %volume option is selected in the Liquid type parameter. <p> The software options currently enabled are displayed in the Software option overview parameter.</p>	<p>Displays the corrected volume flow that is currently measured for the target fluid.</p> <p><i>Dependency</i> The unit is taken from the Volume flow unit parameter (→  80).</p>	Signed floating-point number	–
Carrier corrected volume flow	<p>With the following conditions:</p> <ul style="list-style-type: none"> Order code for "Application package", option ED "Concentration" In the Liquid type parameter, the Ethanol in water option or %mass / %volume option is selected. <p> The software options currently enabled are displayed in the Software option overview parameter.</p>	<p>Displays the corrected volume flow currently measured for the carrier fluid.</p> <p><i>Dependency</i> The unit is taken from the Volume flow unit parameter (→  80).</p>	Signed floating-point number	–
Target volume flow	<p>With the following conditions:</p> <ul style="list-style-type: none"> Order code for "Application package", option ED "Concentration" The Ethanol in water option or %mass / %volume option is selected in the Liquid type parameter. The %vol option is selected in the Concentration unit parameter. <p> The software options currently enabled are displayed in the Software option overview parameter.</p>	<p>Displays the volume flow currently measured for the target medium.</p> <p><i>Dependency</i> The unit is taken from the Volume flow unit parameter (→  80).</p>	Signed floating-point number	–





Parameter	Prerequisite	Description	User interface	Factory setting
Carrier volume flow	<p>With the following conditions:</p> <ul style="list-style-type: none"> ▪ Order code for "Application package", option ED "Concentration" ▪ The Ethanol in water option or %mass / %volume option is selected in the Liquid type parameter. ▪ The %vol option is selected in the Concentration unit parameter. <p> The software options currently enabled are displayed in the Software option overview parameter.</p>	<p>Displays the volume flow currently measured for the carrier medium.</p> <p><i>Dependency</i> The unit is taken from the Volume flow unit parameter (→  80).</p>	Signed floating-point number	–
CTL	<p>For the following order code:</p> <ul style="list-style-type: none"> ▪ "Application package", option EJ "Petroleum" ▪ The API referenced correction option is selected in Petroleum mode parameter. <p> The software options currently enabled are displayed in the Software option overview parameter.</p>	<p>Displays the calibration factor which represents the effect of temperature on the fluid. This is used to convert the measured volume flow and the measured density to values at reference temperature.</p>	Positive floating-point number	–
CPL	<p>For the following order code:</p> <ul style="list-style-type: none"> ▪ "Application package", option EJ "Petroleum" ▪ The API referenced correction option is selected in Petroleum mode parameter. <p> The software options currently enabled are displayed in the Software option overview parameter.</p>	<p>Displays the calibration factor which represents the effect of pressure on the fluid. This is used to convert the measured volume flow and the measured density to values at reference pressure.</p>	Positive floating-point number	–
CTPL	<p>For the following order code:</p> <ul style="list-style-type: none"> ▪ "Application package", option EJ "Petroleum" ▪ The API referenced correction option is selected in Petroleum mode parameter. <p> The software options currently enabled are displayed in the Software option overview parameter.</p>	<p>Displays the combined calibration factor which represents the effect of temperature and pressure on the fluid. This is used to convert the measured volume flow and the measured density to values at reference temperature and reference pressure.</p>	Positive floating-point number	–



Parameter	Prerequisite	Description	User interface	Factory setting
S&W volume flow	<p>For the following order code:</p> <ul style="list-style-type: none"> ▪ "Application package", option EJ "Petroleum" ▪ The API referenced correction option is selected in Petroleum mode parameter. <p> The software options currently enabled are displayed in the Software option overview parameter.</p>	<p>Displays the S&W volume flow which is calculated from the measured total volume flow minus the net volume flow.</p> <p><i>Dependency</i> The unit is taken from: Volume flow unit parameter</p>	Signed floating-point number	-
S&W correction value	<p>For the following order code:</p> <ul style="list-style-type: none"> ▪ "Application package", option EJ "Petroleum" ▪ The External value option or Current input 1...n option is selected in the S&W input mode parameter. <p> The software options currently enabled are displayed in the Software option overview parameter.</p>	<p>Shows the correction value for sediment and water.</p>	Positive floating-point number	-
Reference density alternative	<p>For the following order code:</p> <ul style="list-style-type: none"> ▪ "Application package", option EJ "Petroleum" ▪ In the Petroleum mode parameter, the API referenced correction option is selected. <p> The software options currently enabled are displayed in the Software option overview parameter.</p>	<p>Displays the fluid density at the alternative reference temperature.</p> <p><i>Dependency</i> The unit is taken from: Reference density unit parameter</p>	Signed floating-point number	-
GSV flow	<p>For the following order code:</p> <ul style="list-style-type: none"> ▪ "Application package", option EJ "Petroleum" ▪ The API referenced correction option is selected in Petroleum mode parameter. <p> The software options currently enabled are displayed in the Software option overview parameter.</p>	<p>Displays the measured total volume flow, corrected to the reference temperature and the reference pressure.</p> <p><i>Dependency</i> The unit is taken from: Corrected volume flow unit parameter</p>	Signed floating-point number	-
GSV flow alternative	<p>For the following order code:</p> <ul style="list-style-type: none"> ▪ "Application package", option EJ "Petroleum" ▪ In the Petroleum mode parameter, the API referenced correction option is selected. <p> The software options currently enabled are displayed in the Software option overview parameter.</p>	<p>Displays the measured total volume flow, corrected to the alternative reference temperature and the alternative reference pressure.</p> <p><i>Dependency</i> The unit is taken from: Corrected volume flow unit parameter</p>	Signed floating-point number	-

Parameter	Prerequisite	Description	User interface	Factory setting
NSV flow	<p>For the following order code:</p> <ul style="list-style-type: none"> ▪ "Application package", option EJ "Petroleum" ▪ The API referenced correction option is selected in Petroleum mode parameter. <p> The software options currently enabled are displayed in the Software option overview parameter.</p>	<p>Displays the net volume flow which is calculated from the measured total volume flow minus the value for sediment & water and minus the shrinkage.</p> <p><i>Dependency</i> The unit is taken from: Corrected volume flow unit parameter</p>	Signed floating-point number	–
NSV flow alternative	<p>For the following order code:</p> <ul style="list-style-type: none"> ▪ "Application package", option EJ "Petroleum" ▪ In the Petroleum mode parameter, the API referenced correction option is selected. <p> The software options currently enabled are displayed in the Software option overview parameter.</p>	<p>Displays the net volume flow which is calculated from the measured alternative total volume minus the value for sediment & water and minus the shrinkage.</p> <p><i>Dependency</i> The unit is taken from: Corrected volume flow unit parameter</p>	Signed floating-point number	–
Oil CTL	<p>For the following order code:</p> <ul style="list-style-type: none"> ▪ "Application package", option EJ "Petroleum" ▪ In the Petroleum mode parameter, the Net oil & water cut option is selected. <p> The software options currently enabled are displayed in the Software option overview parameter.</p>	<p>Displays the correction factor which represents the effect of temperature on the oil. This is used to convert the measured oil volume flow and the measured oil density to values at reference temperature.</p>	Positive floating-point number	–
Oil CPL	<p>For the following order code:</p> <ul style="list-style-type: none"> ▪ "Application package", option EJ "Petroleum" ▪ In the Petroleum mode parameter, the Net oil & water cut option is selected. <p> The software options currently enabled are displayed in the Software option overview parameter.</p>	<p>Displays the correction factor which represents the effect of pressure on the oil. This is used to convert the measured oil volume flow and the measured oil density to values at reference pressure.</p>	Positive floating-point number	–
Oil CTPL	<p>For the following order code:</p> <ul style="list-style-type: none"> ▪ "Application package", option EJ "Petroleum" ▪ In the Petroleum mode parameter, the Net oil & water cut option is selected. <p> The software options currently enabled are displayed in the Software option overview parameter.</p>	<p>Displays the combined correction factor which represents the effect of temperature and pressure on the oil. This is used to convert the measured oil volume flow and the measured oil density to values at reference temperature and reference pressure.</p>	Positive floating-point number	–

Parameter	Prerequisite	Description	User interface	Factory setting
Water CTL	<p>For the following order code:</p> <ul style="list-style-type: none"> ▪ "Application package", option EJ "Petroleum" ▪ In the Petroleum mode parameter, the Net oil & water cut option is selected. <p> The software options currently enabled are displayed in the Software option overview parameter.</p>	Displays the correction factor which represents the effect of temperature on the water. This is used to convert the measured water volume flow and the measured water density to values at reference temperature.	Positive floating-point number	-
CTL alternative	<p>For the following order code:</p> <ul style="list-style-type: none"> ▪ "Application package", option EJ "Petroleum" ▪ In the Petroleum mode parameter, the API referenced correction option is selected. <p> The software options currently enabled are displayed in the Software option overview parameter.</p>	Displays the correction factor which represents the effect of temperature on the fluid. This is used to convert the measured volume flow and the measured density to values at the alternative reference temperature.	Positive floating-point number	-
CPL alternative	<p>For the following order code:</p> <ul style="list-style-type: none"> ▪ "Application package", option EJ "Petroleum" ▪ In the Petroleum mode parameter, the API referenced correction option is selected. <p> The software options currently enabled are displayed in the Software option overview parameter.</p>	Displays the correction factor which represents the effect of pressure on the fluid. This is used to convert the measured volume flow and the measured density to values at the alternative reference pressure.	Positive floating-point number	-
CTPL alternative	<p>For the following order code:</p> <ul style="list-style-type: none"> ▪ "Application package", option EJ "Petroleum" ▪ In the Petroleum mode parameter, the API referenced correction option is selected. <p> The software options currently enabled are displayed in the Software option overview parameter.</p>	Displays the combined correction factor which represents the effect of temperature and pressure on the fluid. This is used to convert the measured volume flow and the measured density to values at the alternative reference temperature and the alternative reference pressure.	Positive floating-point number	-
Oil reference density	<p>For the following order code:</p> <ul style="list-style-type: none"> ▪ "Application package", option EJ "Petroleum" ▪ In the Petroleum mode parameter, the Net oil & water cut option is selected. <p> The software options currently enabled are displayed in the Software option overview parameter.</p>		Signed floating-point number	-

Parameter	Prerequisite	Description	User interface	Factory setting
Water reference density	<p>For the following order code:</p> <ul style="list-style-type: none"> ▪ "Application package", option EJ "Petroleum" ▪ In the Petroleum mode parameter, the Net oil & water cut option is selected. <p> The software options currently enabled are displayed in the Software option overview parameter.</p>		Signed floating-point number	–
Oil density	<p>For the following order code:</p> <ul style="list-style-type: none"> ▪ "Application package", option EJ "Petroleum" ▪ In the Petroleum mode parameter, the Net oil & water cut option is selected. <p> The software options currently enabled are displayed in the Software option overview parameter.</p>	Displays the density of the oil currently measured.	Signed floating-point number	–
Water density	<p>For the following order code:</p> <ul style="list-style-type: none"> ▪ "Application package", option EJ "Petroleum" ▪ In the Petroleum mode parameter, the Net oil & water cut option is selected. <p> The software options currently enabled are displayed in the Software option overview parameter.</p>	Displays the density of the water currently measured.	Signed floating-point number	–
Water cut	<p>For the following order code:</p> <ul style="list-style-type: none"> ▪ "Application package", option EJ "Petroleum" ▪ In the Petroleum mode parameter, the API referenced correction option is selected. <p> The software options currently enabled are displayed in the Software option overview parameter.</p>	Displays the percentage water volume flow in relation to the total volume flow of the fluid.	0 to 100 %	–
Oil volume flow	<p>For the following order code:</p> <ul style="list-style-type: none"> ▪ "Application package", option EJ "Petroleum" ▪ In the Petroleum mode parameter, the Net oil & water cut option is selected. <p> The software options currently enabled are displayed in the Software option overview parameter.</p>	<p>Displays the currently calculated volume flow of the oil.</p> <p>Dependency:</p> <ul style="list-style-type: none"> ▪ Based on the value displayed in the Water cut parameter ▪ The unit is taken from: Volume flow unit parameter 	Signed floating-point number	–

Parameter	Prerequisite	Description	User interface	Factory setting
Oil corrected volume flow	<p>For the following order code:</p> <ul style="list-style-type: none"> ▪ "Application package", option EJ "Petroleum" ▪ In the Petroleum mode parameter, the Net oil & water cut option is selected. <p> The software options currently enabled are displayed in the Software option overview parameter.</p>	<p>Displays the currently calculated volume flow of the oil, calculated to values at reference temperature and reference pressure.</p> <p>Dependency:</p> <ul style="list-style-type: none"> ▪ Based on the value displayed in the Water cut parameter ▪ The unit is taken from: Corrected volume flow unit parameter 	Signed floating-point number	-
Oil mass flow	<p>For the following order code:</p> <ul style="list-style-type: none"> ▪ "Application package", option EJ "Petroleum" ▪ In the Petroleum mode parameter, the Net oil & water cut option is selected. <p> The software options currently enabled are displayed in the Software option overview parameter.</p>	<p>Displays the currently calculated mass flow of the oil.</p> <p>Dependency:</p> <ul style="list-style-type: none"> ▪ Based on the value displayed in the Water cut parameter ▪ The unit is taken from: Mass flow unit parameter 	Signed floating-point number	-
Water volume flow	<p>For the following order code:</p> <ul style="list-style-type: none"> ▪ "Application package", option EJ "Petroleum" ▪ In the Petroleum mode parameter, the Net oil & water cut option is selected. <p> The software options currently enabled are displayed in the Software option overview parameter.</p>	<p>Displays the currently calculated volume flow of the water.</p> <p>Dependency:</p> <ul style="list-style-type: none"> ▪ Based on the value displayed in the Water cut parameter ▪ The unit is taken from: Volume flow unit parameter 	Signed floating-point number	-
Water corrected volume flow	<p>For the following order code:</p> <ul style="list-style-type: none"> ▪ "Application package", option EJ "Petroleum" ▪ In the Petroleum mode parameter, the Net oil & water cut option is selected. <p> The software options currently enabled are displayed in the Software option overview parameter.</p>	<p>Displays the currently calculated volume flow of the water, calculated to values at reference temperature and reference pressure.</p> <p>Dependency:</p> <ul style="list-style-type: none"> ▪ Based on the value displayed in the Water cut parameter ▪ The unit is taken from: Corrected volume flow unit parameter 	Signed floating-point number	-
Water mass flow	<p>For the following order code:</p> <ul style="list-style-type: none"> ▪ "Application package", option EJ "Petroleum" ▪ In the Petroleum mode parameter, the Net oil & water cut option is selected. <p> The software options currently enabled are displayed in the Software option overview parameter.</p>	<p>Displays the currently calculated mass flow of the water.</p> <p>Dependency:</p> <ul style="list-style-type: none"> ▪ Based on the value displayed in the Water cut parameter ▪ The unit is taken from: Mass flow unit parameter 	Signed floating-point number	-

Parameter	Prerequisite	Description	User interface	Factory setting
Weighted density average	For the following order code: <ul style="list-style-type: none"> ▪ "Application package", option EJ "Petroleum" ▪ "Application package", option EM "Petroleum + Locking function"  The software options currently enabled are displayed in the Software option overview parameter.	Displays the weighted average for the density since the last time the density averages were reset. Dependency: <ul style="list-style-type: none"> ▪ The unit is taken from: Density unit parameter ▪ The value is reset to NaN (Not a Number) via the Reset weighted averages parameter 	Signed floating-point number	-
Weighted temperature average	For the following order code: <ul style="list-style-type: none"> ▪ "Application package", option EJ "Petroleum" ▪ "Application package", option EM "Petroleum + Locking function"  The software options currently enabled are displayed in the Software option overview parameter.	Displays the weighted average for the temperature since the last time the temperature averages were reset. Dependency: <ul style="list-style-type: none"> ▪ The unit is taken from: Temperature unit parameter ▪ The value is reset to NaN (Not a Number) via the Reset weighted averages parameter 	Signed floating-point number	-

11.4.2 "Totalizer" submenu



The **Totalizer** submenu contains all the parameters needed to display the current measured values for every totalizer.

Navigation

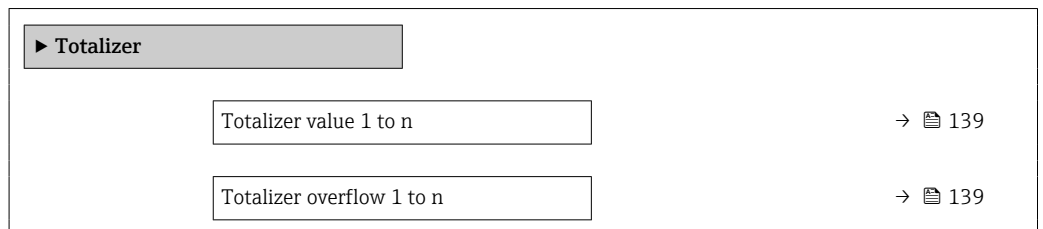
"Diagnostics" menu → Measured values → Totalizer



Parameter overview with brief description

Parameter	Prerequisite	Description	User interface
Totalizer value 1 to n	A process variable is selected in the Assign process variable parameter (→  114) of the Totalizer 1 to n submenu.	Displays the current totalizer counter value.	Signed floating-point number
Totalizer overflow 1 to n	A process variable is selected in the Assign process variable parameter (→  114) of the Totalizer 1 to n submenu.	Displays the current totalizer overflow.	Integer with sign

11.4.3 "Input values" submenu

The **Input values** submenu guides you systematically to the individual input values.

Navigation

"Diagnostics" menu → Measured values → Input values

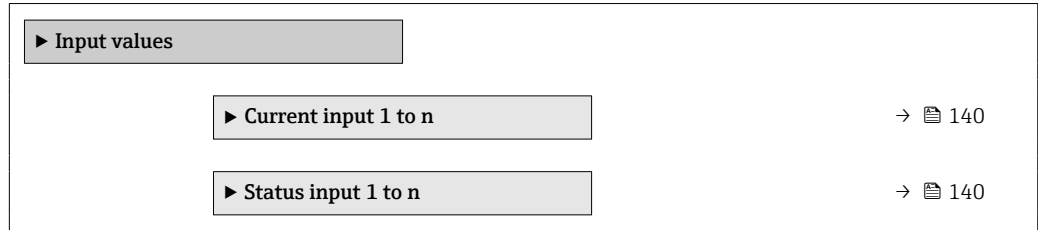

Input values of current input

The **Current input 1 to n** submenu contains all the parameters needed to display the current measured values for every current input.

Navigation

"Diagnostics" menu → Measured values → Input values → Current input 1 to n

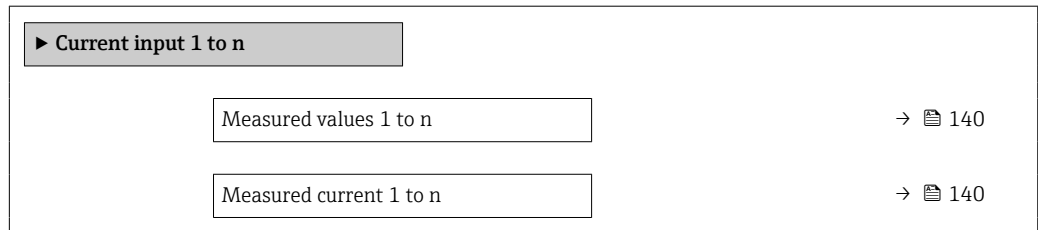

Parameter overview with brief description

Parameter	Description	User interface
Measured values	Displays the current input value.	Signed floating-point number
Measured current	Displays the current value of the current input.	0 to 22.5 mA

Input values of status input

The **Status input 1 to n** submenu contains all the parameters needed to display the current measured values for every status input.

Navigation

"Diagnostics" menu → Measured values → Input values → Status input 1 to n

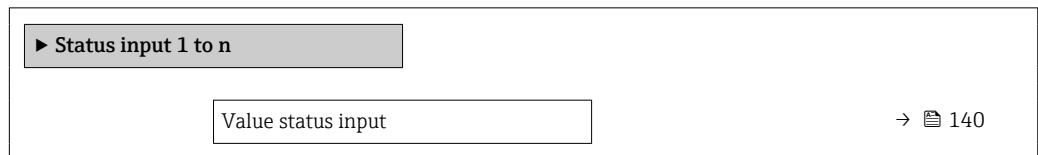

Parameter overview with brief description

Parameter	Description	User interface
Value status input	Shows the current input signal level.	<ul style="list-style-type: none"> ▪ High ▪ Low

11.4.4 Output values

The **Output values** submenu contains all the parameters needed to display the current measured values for every output.

Navigation

"Diagnostics" menu → Measured values → Output values

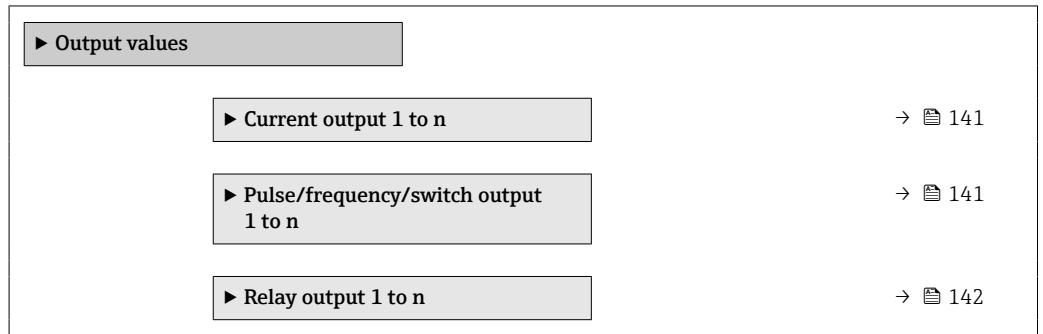

Output values of current output

The **Value current output** submenu contains all the parameters needed to display the current measured values for every current output.

Navigation

"Diagnostics" menu → Measured values → Output values → Value current output 1 to n

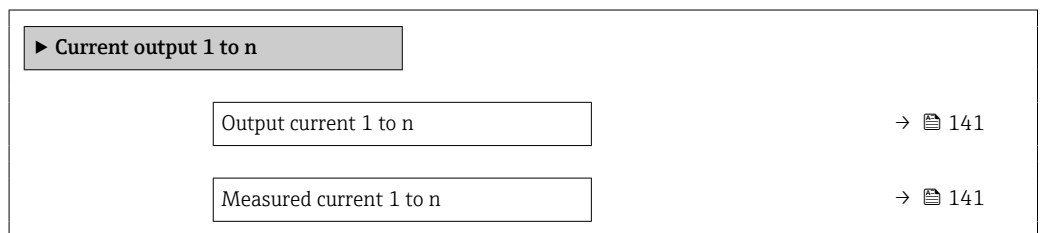

Parameter overview with brief description

Parameter	Description	User interface
Output current 1	Displays the current value currently calculated for the current output.	3.59 to 22.5 mA
Measured current	Displays the current value currently measured for the current output.	0 to 30 mA

Output values for pulse/frequency/switch output

The **Pulse/frequency/switch output 1 to n** submenu contains all the parameters needed to display the current measured values for every pulse/frequency/switch output.

Navigation

"Diagnostics" menu → Measured values → Output values → Pulse/frequency/switch output 1 to n

▶ Pulse/frequency/switch output 1 to n

Output frequency 1 to n	→ 142
Pulse output 1 to n	→ 142
Switch status 1 to n	→ 142

Parameter overview with brief description

Parameter	Prerequisite	Description	User interface
Output frequency	In the Operating mode parameter, the Frequency option is selected.	Displays the value currently measured for the frequency output.	0.0 to 12 500.0 Hz
Pulse output	The Pulse option is selected in the Operating mode parameter parameter.	Displays the pulse frequency currently output.	Positive floating-point number
Switch status	The Switch option is selected in the Operating mode parameter.	Displays the current switch output status.	<ul style="list-style-type: none"> ■ Open ■ Closed

Output values for relay output

The **Relay output 1 to n** submenu contains all the parameters needed to display the current measured values for every relay output.

Navigation

"Diagnostics" menu → Measured values → Output values → Relay output 1 to n

▶ Relay output 1 to n



Switch status	→ 142
Switch cycles	→ 142
Max. switch cycles number	→ 142

Parameter overview with brief description

Parameter	Description	User interface
Switch status	Shows the current relay switch status.	<ul style="list-style-type: none"> ■ Open ■ Closed
Switch cycles	Shows number of all performed switch cycles.	Positive integer
Max. switch cycles number	Shows the maximal number of guaranteed switch cycles.	Positive integer

11.5 Adapting the measuring device to the process conditions

The following are available for this purpose:

- Basic settings using the **Setup** menu (→  78)
- Advanced settings using the **Advanced setup** submenu (→  104)







11.6 Performing a totalizer reset

The totalizers are reset in the **Operation** submenu:





- Control Totalizer
- Reset all totalizers



Navigation

"Operation" menu → Totalizer handling

► Totalizer handling	
Control Totalizer 1 to n	→  143
Preset value 1 to n	→  143
Totalizer value 1 to n	→  144
Weighted density average	→  144
Weighted temperature average	→  144
Reset weighted averages	→  144
Reset all totalizers	→  144

Parameter overview with brief description

Parameter	Prerequisite	Description	Selection / User entry / User interface	Factory setting
Control Totalizer 1 to n	A process variable is selected in the Assign process variable parameter (→  114) of the Totalizer 1 to n submenu.	Control totalizer value.	<ul style="list-style-type: none"> ■ Totalize ■ Reset + hold ■ Preset + hold ■ Reset + totalize ■ Preset + totalize ■ Hold 	-
Preset value 1 to n	A process variable is selected in the Assign process variable parameter (→  114) of the Totalizer 1 to n submenu.	Specify start value for totalizer. <i>Dependency</i>  The unit of the selected process variable is defined in the Unit totalizer parameter (→  114) for the totalizer.	Signed floating-point number	Depends on country: <ul style="list-style-type: none"> ■ 0 kg ■ 0 lb

Parameter	Prerequisite	Description	Selection / User entry / User interface	Factory setting
Totalizer value	A process variable is selected in the Assign process variable parameter (→ 114) of the Totalizer 1 to n submenu.	Displays the current totalizer counter value.	Signed floating-point number	–
Weighted density average	For the following order code: <ul style="list-style-type: none"> ▪ "Application package", option EJ "Petroleum" ▪ "Application package", option EM "Petroleum + Locking function"  The software options currently enabled are displayed in the Software option overview parameter.	Displays the weighted average for the density since the last time the density averages were reset. Dependency: <ul style="list-style-type: none"> ▪ The unit is taken from: Density unit parameter ▪ The value is reset to NaN (Not a Number) via the Reset weighted averages parameter 	Signed floating-point number	–
Weighted temperature average	For the following order code: <ul style="list-style-type: none"> ▪ "Application package", option EJ "Petroleum" ▪ "Application package", option EM "Petroleum + Locking function"  The software options currently enabled are displayed in the Software option overview parameter.	Displays the weighted average for the temperature since the last time the temperature averages were reset. Dependency: <ul style="list-style-type: none"> ▪ The unit is taken from: Temperature unit parameter ▪ The value is reset to NaN (Not a Number) via the Reset weighted averages parameter 	Signed floating-point number	–
Reset weighted averages	The values can only be reset at zero flow. For the following order code: "Application package", option EJ "Petroleum"  The software options currently enabled are displayed in the Software option overview parameter.	Resets the weighted averages for density and temperature to NaN (Not a Number) and then starts determining the weighted averages.	<ul style="list-style-type: none"> ▪ Totalize ▪ Preset + totalize 	–
Reset all totalizers	–	Reset all totalizers to 0 and start.	<ul style="list-style-type: none"> ▪ Cancel ▪ Reset + totalize 	–

11.6.1 Function scope of "Control Totalizer" parameter

Options	Description
Totalize	The totalizer is started or continues running.
Reset + hold	The totaling process is stopped and the totalizer is reset to 0.
Preset + hold ¹⁾	The totaling process is stopped and the totalizer is set to its defined start value from the Preset value parameter.
Reset + totalize	The totalizer is reset to 0 and the totaling process is restarted.
Preset + totalize ¹⁾	The totalizer is set to the defined start value in the Preset value parameter and the totaling process is restarted.
Hold	Totalizing is stopped.



1) Visible depending on the order options or device settings

11.6.2 Function range of "Reset all totalizers" parameter

Options	Description
Cancel	No action is executed and the user exits the parameter.
Reset + totalize	Resets all totalizers to 0 and restarts the totaling process. This deletes all the previously aggregated flow values.

11.7 Displaying the measured value history

The **Extended HistoROM** application package must be enabled in the device (order option) for the **Data logging** submenu to appear. This contains all the parameters for the measured value history.

-  Data logging is also available via:
 - Plant Asset Management Tool FieldCare →  68.
 - Web browser

Function range

- A total of 1000 measured values can be stored
- 4 logging channels
- Adjustable logging interval for data logging
- Measured value trend for each logging channel displayed in the form of a chart

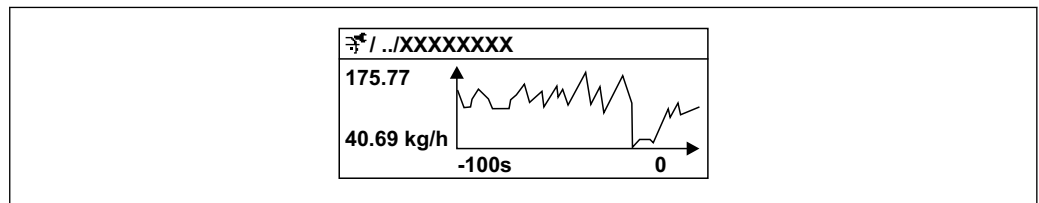

A0016357





 29 Chart of a measured value trend







- x-axis: depending on the number of channels selected displays 250 to 1000 measured values of a process variable.
 - y-axis: displays the approximate measured value span and constantly adapts this to the ongoing measurement.
-  If the length of the logging interval or the assignment of the process variables to the channels is changed, the content of the data logging is deleted.

Navigation



"Diagnostics" menu → Data logging





▶ Data logging

- Assign channel 1 →  146
- Assign channel 2 →  146
- Assign channel 3 →  147
- Assign channel 4 →  147
- Logging interval →  147

Clear logging data	→  147
Data logging	→  147
Logging delay	→  147
Data logging control	→  147
Data logging status	→  147
Entire logging duration	→  147
▶ Display channel 1	
▶ Display channel 2	
▶ Display channel 3	
▶ Display channel 4	

Parameter overview with brief description

Parameter	Prerequisite	Description	Selection / User entry / User interface
Assign channel 1	The Extended HistoROM application package is available.	Assign process variable to logging channel.	<ul style="list-style-type: none"> ▪ Off ▪ Mass flow ▪ Volume flow ▪ Corrected volume flow * ▪ Density ▪ Reference density * ▪ Temperature ▪ Concentration * ▪ Target mass flow * ▪ Carrier mass flow * ▪ Oscillation amplitude ▪ Current output 1 ▪ Current output 2 * ▪ Current output 3 * ▪ Current output 4 * ▪ HBSI * ▪ Exciter current 0 ▪ Oscillation damping 0 ▪ Oscillation damping fluctuation 0 * ▪ Oscillation frequency 0 ▪ Frequency fluctuation 0 * ▪ Oscillation amplitude ▪ Oscillation amplitude 1 * ▪ Signal asymmetry ▪ Carrier pipe temperature * ▪ Electronic temperature
Assign channel 2	The Extended HistoROM application package is available.  The software options currently enabled are displayed in the Software option overview parameter.	Assign a process variable to logging channel.	For the picklist, see Assign channel 1 parameter (→  146)

Parameter	Prerequisite	Description	Selection / User entry / User interface
Assign channel 3	The Extended HistoROM application package is available.  The software options currently enabled are displayed in the Software option overview parameter.	Assign a process variable to logging channel.	For the picklist, see Assign channel 1 parameter (→  146)
Assign channel 4	The Extended HistoROM application package is available.  The software options currently enabled are displayed in the Software option overview parameter.	Assign a process variable to logging channel.	For the picklist, see Assign channel 1 parameter (→  146)
Logging interval	The Extended HistoROM application package is available.	Define the logging interval for data logging. This value defines the time interval between the individual data points in the memory.	0.1 to 999.0 s
Clear logging data	The Extended HistoROM application package is available.	Clear the entire logging data.	<ul style="list-style-type: none"> ■ Cancel ■ Clear data
Data logging	–	Select the type of data logging.	<ul style="list-style-type: none"> ■ Overwriting ■ Not overwriting
Logging delay	In the Data logging parameter, the Not overwriting option is selected.	Enter the time delay for measured value logging.	0 to 999 h
Data logging control	In the Data logging parameter, the Not overwriting option is selected.	Start and stop measured value logging.	<ul style="list-style-type: none"> ■ None ■ Delete + start ■ Stop
Data logging status	In the Data logging parameter, the Not overwriting option is selected.	Displays the measured value logging status.	<ul style="list-style-type: none"> ■ Done ■ Delay active ■ Active ■ Stopped
Entire logging duration	In the Data logging parameter, the Not overwriting option is selected.	Displays the total logging duration.	Positive floating-point number

* Visibility depends on order options or device settings

12 Diagnostics and troubleshooting

12.1 General troubleshooting

For local display

Error	Possible causes	Remedial action
Local display is dark, but signal output is within the valid range	The cable of the display module is not plugged in correctly.	Insert the plug correctly into the main electronics module and display module.
Local display dark and no output signals	Supply voltage does not match the voltage specified on the nameplate.	Apply the correct supply voltage → 35.
Local display dark and no output signals	Supply voltage has incorrect polarity.	Reverse polarity of supply voltage.
Local display dark and no output signals	No contact between connecting cables and terminals.	Ensure electrical contact between the cable and the terminal.
Local display dark and no output signals	<ul style="list-style-type: none"> ▪ Terminals are not plugged into the I/O electronics module correctly. ▪ Terminals are not plugged into the main electronics module correctly. 	Check terminals.
Local display dark and no output signals	<ul style="list-style-type: none"> ▪ I/O electronics module is defective. ▪ Main electronics module is defective. 	Order spare part → 190.
Local display cannot be read, but signal output is within the valid range	Display is set too bright or too dark.	<ul style="list-style-type: none"> ▪ Set the display brighter by simultaneously pressing $\square + \square$. ▪ Set the display darker by simultaneously pressing $\square + \square$.
Local display is dark, but signal output is within the valid range	Display module is defective.	Order spare part → 190.
Backlighting of local display is red	Diagnostic event with "Alarm" diagnostic behavior has occurred.	Take remedial measures → 160
Text on local display appears in a language that cannot be understood.	The selected operating language cannot be understood.	<ol style="list-style-type: none"> 1. Press $\square + \square$ for 2 s ("home position"). 2. Press \square. 3. Configure the required language in the Display language parameter (→ 117).
Message on local display: "Communication Error" "Check Electronics"	Communication between the display module and the electronics is interrupted.	<ul style="list-style-type: none"> ▪ Check the cable and the connector between the main electronics module and display module. ▪ Order spare part → 190.

For output signals

Error	Possible causes	Remedial action
Signal output outside the valid range	Main electronics module is defective.	Order spare part → 190.
Device shows correct value on local display, but signal output is incorrect, though in the valid range.	Parameter configuration error	Check and adjust parameter configuration.
Device measures incorrectly.	Configuration error or device is operated outside the application.	<ol style="list-style-type: none"> 1. Check and correct parameter configuration. 2. Observe limit values specified in the "Technical Data".

For access

Fault	Possible causes	Remedial action
Write access to parameters is not possible.	Hardware write protection is enabled.	Set the write protection switch on the main electronics module to the OFF position → ☰ 126.
Write access to parameters is not possible.	Current user role has limited access authorization.	1. Check user role → ☰ 57. 2. Enter correct customer-specific access code → ☰ 57.
Connection via FOUNDATION Fieldbus is not possible.	Device plug is incorrectly connected.	Check the pin assignment of the device plugs .
Unable to connect to the web server.	Web server is disabled.	Using the "FieldCare" or "DeviceCare" operating tool, check whether the web server of the device is enabled, and enable it if necessary → ☰ 64.
	The Ethernet interface on the PC is incorrectly configured.	<ul style="list-style-type: none"> ▶ Check the properties of the Internet protocol (TCP/IP) → ☰ 60. ▶ Check the network settings with the IT manager.
Unable to connect to the web server.	The IP address on the PC is incorrectly configured.	Check the IP address: 192.168.1.212 → ☰ 60
Unable to connect to the web server.	WLAN access data are incorrect.	<ul style="list-style-type: none"> ▪ Check WLAN network status. ▪ Log on to the device again using WLAN access data. ▪ Check that WLAN is enabled on the measuring instrument and operating unit → ☰ 60.
	WLAN communication is disabled.	–
Unable to connect to web server, FieldCare or DeviceCare.	WLAN network is not available.	<ul style="list-style-type: none"> ▪ Check if WLAN reception is present: LED on display module is lit blue. ▪ Check if WLAN connection is enabled: LED on display module flashes blue. ▪ Switch on instrument function.
Network connection not present or unstable	WLAN network is weak.	<ul style="list-style-type: none"> ▪ Operating unit outside reception range: Check network status on operating unit. ▪ To improve network performance, use an external WLAN antenna.
	Parallel WLAN and Ethernet communication	<ul style="list-style-type: none"> ▪ Check network settings. ▪ Temporarily enable only the WLAN as an interface.
Web browser frozen and operation no longer possible	Data transfer is active.	Wait until data transfer or current action is finished.
	Connection lost	<ul style="list-style-type: none"> ▶ Check cable connection and power supply. ▶ Refresh the web browser and restart if necessary.
Display of web browser content is difficult to read or incomplete.	Web browser version used is not optimal.	<ul style="list-style-type: none"> ▶ Use correct web browser version → ☰ 59. ▶ Empty the web browser cache. ▶ Restart the web browser.
	Unsuitable view settings.	Change the font size/display ratio of the Web browser.
Incomplete or no display of content in the web browser	<ul style="list-style-type: none"> ▪ JavaScript is not enabled. ▪ JavaScript cannot be enabled. 	<ul style="list-style-type: none"> ▶ Enable JavaScript. ▶ Enter http://XXX.XXX.X.XX/servlet/basic.html as the IP address.

Fault	Possible causes	Remedial action
Operation with FieldCare or DeviceCare via service interface CDI-RJ45 (port 8000) is not possible.	Firewall of the PC or network is blocking communication.	Depending on the settings of the firewall used on the PC or in the network, the firewall must be adapted or disabled to allow FieldCare/ DeviceCare access.
Flashing the firmware with FieldCare or DeviceCare via service interface CDI-RJ45 (port 8000 or TFTP ports) is not possible.	Firewall of the PC or network is blocking communication.	Depending on the settings of the firewall used on the PC or in the network, the firewall must be adapted or disabled to allow FieldCare/ DeviceCare access.

12.2 Diagnostic information via light emitting diodes

12.2.1 Transmitter

Different LEDs in the transmitter provide information on the device status.

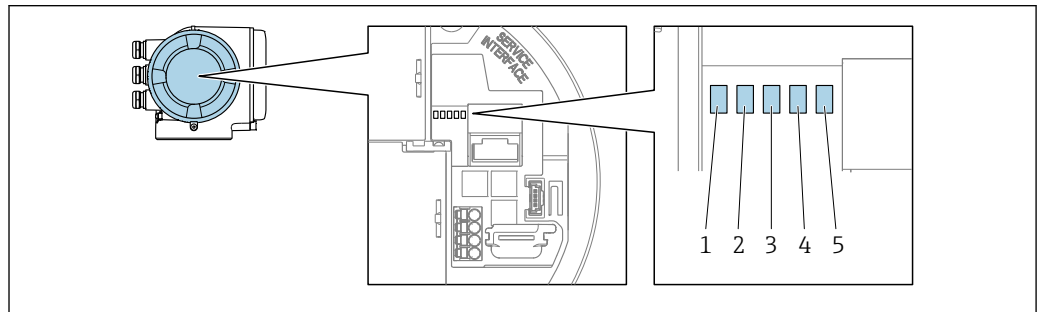

A0029629

- 1 Supply voltage
- 2 Device status
- 3 Not used
- 4 Communication
- 5 Service interface (CDI) active

LED	Color	Meaning
1 Supply voltage	Green	Supply voltage is OK.
	Off	Supply voltage is off or too low.
2 Device status (normal operation)	Red	Error
	Flashing red	Warning
2 Device status (during start-up)	Flashes red slowly	If > 30 seconds: problem with the boot loader.
	Flashes red quickly	If > 30 seconds: compatibility problem when reading the firmware.
3 Not used	–	–
4 Communication	White	Communication active.
5 Service interface (CDI)	Yellow	Connection established.
	Flashing yellow	Communication active.
	Off	No connection.

12.3 Diagnostic information on local display

12.3.1 Diagnostic message

Faults detected by the self-monitoring system of the measuring device are displayed as a diagnostic message in alternation with the operational display.

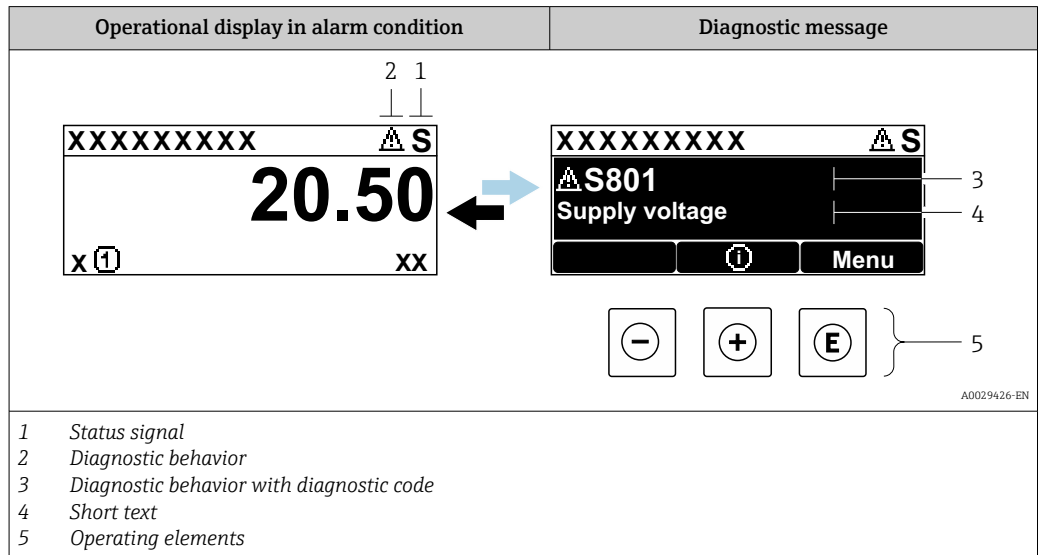

If two or more diagnostic events are pending simultaneously, only the message of the diagnostic event with the highest priority is shown.

- i** Other diagnostic events that have occurred can be displayed in the **Diagnostics** menu:
 - Via parameter → 181
 - Via submenus → 182



Status signals

The status signals provide information on the state and reliability of the device by categorizing the cause of the diagnostic information (diagnostic event).

- i** The status signals are categorized according to VDI/VDE 2650 and NAMUR Recommendation NE 107: F = Failure, C = Function Check, S = Out of Specification, M = Maintenance Required

Symbol	Meaning
F	Failure A device error has occurred. The measured value is no longer valid.
C	Function check The device is in service mode (e.g. during a simulation).
S	Out of specification The device is being operated: Outside its technical specification limits (e.g. outside the process temperature range)
M	Maintenance required Maintenance is required. The measured value remains valid.

Diagnostic behavior



Symbol	Meaning
	Alarm <ul style="list-style-type: none"> Measurement is interrupted. Signal outputs and totalizers assume the defined alarm condition. A diagnostic message is generated.
	Warning <ul style="list-style-type: none"> Measurement is resumed. The signal outputs and totalizers are not affected. A diagnostic message is generated.

Diagnostic information

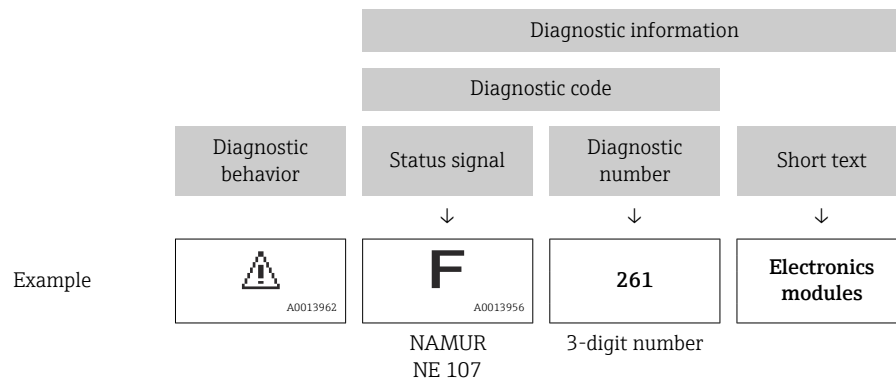
The fault can be identified using the diagnostic information. The short text helps you by providing information about the fault. In addition, the corresponding symbol for the diagnostic behavior is displayed in front of the diagnostic information on the local display.



Operating elements

Operating key	Meaning
	Plus key <i>In menu, submenu</i> Opens the message about the remedial measures.
	Enter key <i>In menu, submenu</i> Opens the operating menu.

12.3.2 Calling up remedial measures

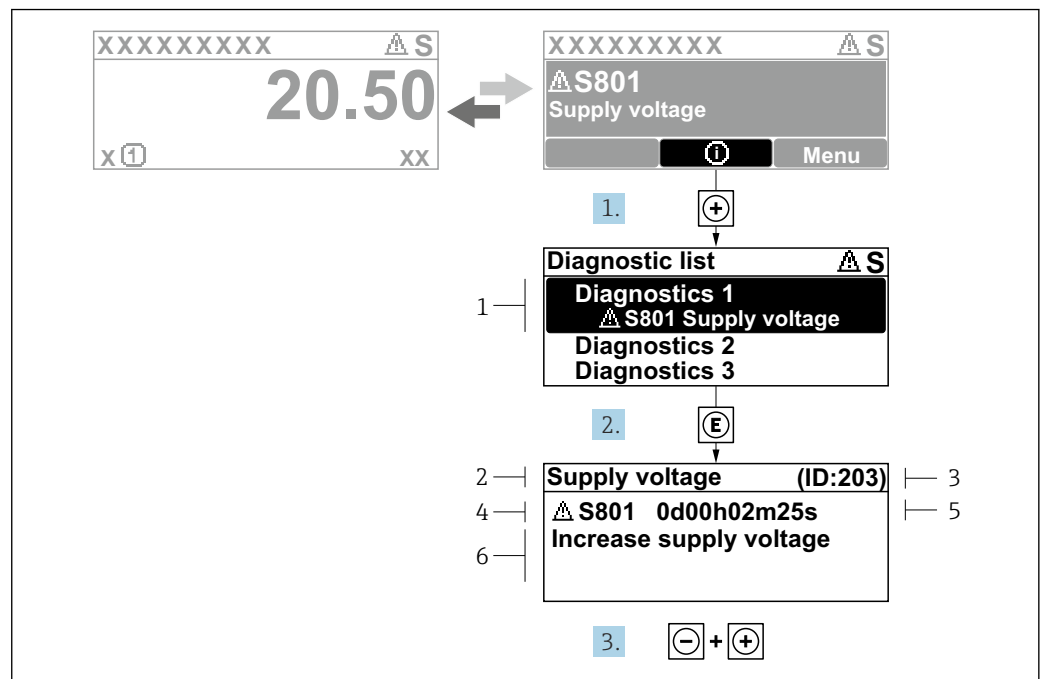

A0029431-EN

30 Message for remedial measures

- 1 Diagnostic information
- 2 Short text
- 3 Service ID
- 4 Diagnostic behavior with diagnostic code
- 5 Operation time when error occurred
- 6 Remedial measures

1. The user is in the diagnostic message.
Press \oplus ($\textcircled{1}$ symbol).
↳ The **Diagnostic list** submenu opens.
2. Select the desired diagnostic event with \oplus or \ominus and press E .
↳ The message about the remedial measures opens.
3. Press \ominus + \oplus simultaneously.
↳ The message about the remedial measures closes.

The user is in the **Diagnostics** menu at an entry for a diagnostics event, e.g. in the **Diagnostic list** submenu or **Previous diagnostics** parameter.

1. Press E .
↳ The message for the remedial measures for the selected diagnostic event opens.
2. Press \ominus + \oplus simultaneously.
↳ The message for the remedial measures closes.

12.4 Diagnostic information in the web browser

12.4.1 Diagnostic options

Any faults detected by the measuring device are displayed in the Web browser on the home page once the user has logged on.

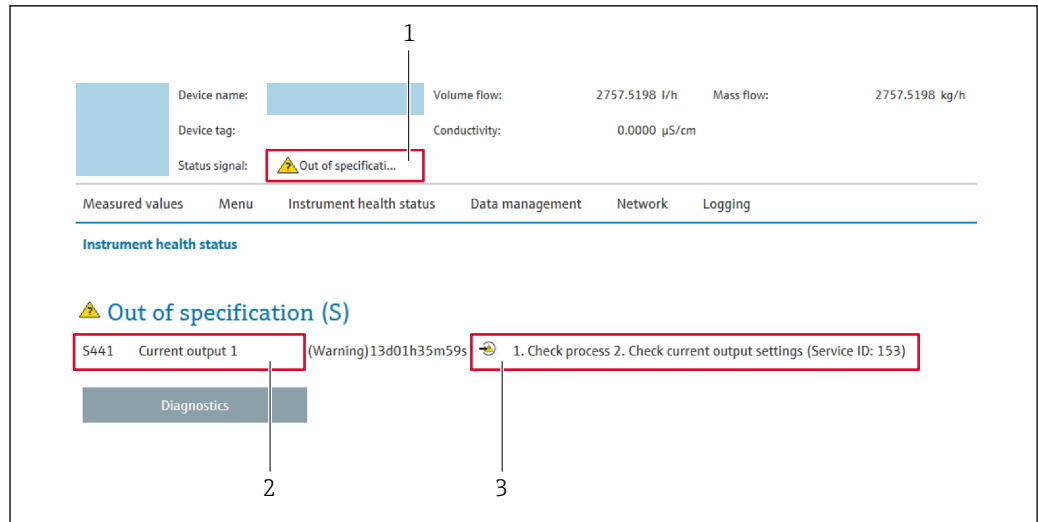

- 1 Status area with status signal
- 2 Diagnostic information
- 3 Remedial measures with service ID

i In addition, diagnostic events which have occurred can be shown in the **Diagnostics** menu:

- Via parameter → 181
- Via submenu → 182

Status signals

The status signals provide information on the state and reliability of the device by categorizing the cause of the diagnostic information (diagnostic event).

Symbol	Meaning
	Failure A device error has occurred. The measured value is no longer valid.
	Function check The device is in service mode (e.g. during a simulation).
	Out of specification The device is being operated: Outside its technical specification limits (e.g. outside the process temperature range)
	Maintenance required Maintenance is required. The measured value remains valid.

i The status signals are categorized in accordance with VDI/VDE 2650 and NAMUR Recommendation NE 107.

12.4.2 Calling up remedy information

Remedy information is provided for every diagnostic event to ensure that problems can be rectified quickly. These measures are displayed in red along with the diagnostic event and the related diagnostic information.

12.5 Diagnostic information in FieldCare or DeviceCare

12.5.1 Diagnostic options

Any faults detected by the measuring device are displayed on the home page of the operating tool once the connection has been established.

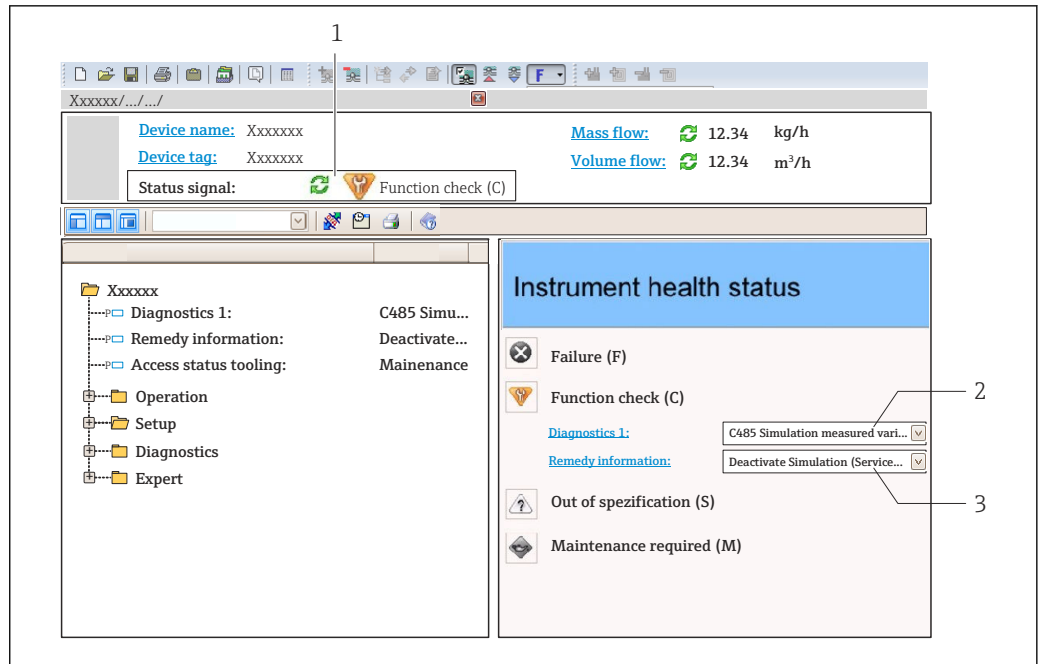

- 1 Status area with status signal → 151
- 2 Diagnostic information → 152
- 3 Remedial measures with service ID

i In addition, diagnostic events which have occurred can be shown in the **Diagnostics** menu:

- Via parameter → 181
- Via submenu → 182

Diagnostic information

The fault can be identified using the diagnostic information. The short text helps you by providing information about the fault. In addition, the corresponding symbol for the diagnostic behavior is displayed in front of the diagnostic information on the local display.

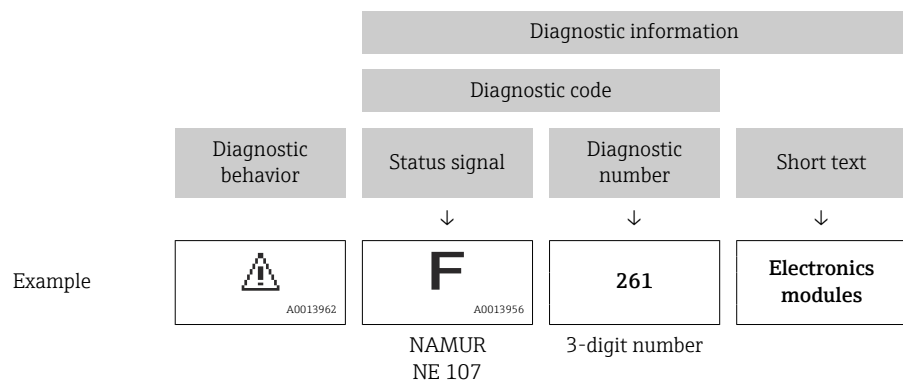

12.5.2 Calling up remedy information

Remedy information is provided for every diagnostic event to ensure that problems can be rectified quickly:

- On the home page
Remedy information is displayed in a separate field below the diagnostics information.
- In the **Diagnostics** menu
Remedy information can be called up in the working area of the user interface.

The user is in the **Diagnostics** menu.

1. Call up the desired parameter.
2. On the right in the working area, mouse over the parameter.
 - ↳ A tool tip with remedy information for the diagnostic event appears.

12.6 Adapting the diagnostic information

12.6.1 Adapting the diagnostic behavior

Each item of diagnostic information is assigned a specific diagnostic behavior at the factory. The user can change this assignment for specific diagnostic information in the **Diagnostic behavior** submenu.

Expert → System → Diagnostic handling → Diagnostic behavior

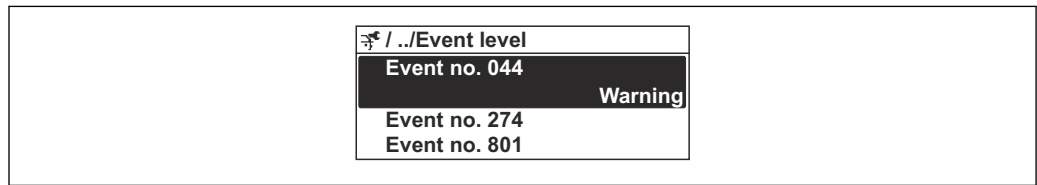

A0014048-EN

31 Using the example of the local display

You can assign the following options to the diagnostic number as the diagnostic behavior:

Options	Description
Alarm	The device stops measurement. The signal outputs and totalizers assume the defined alarm condition. A diagnostic message is generated. The background lighting changes to red.
Warning	The device continues to measure. The signal outputs and totalizers are not affected. A diagnostic message is generated.
Logbook entry only	The device continues to measure. The diagnostic message is only displayed in the Event logbook submenu (Event list submenu) and is not displayed in alternating sequence with the operational display.
Off	The diagnostic event is ignored, and no diagnostic message is generated or entered.

12.6.2 Adapting the status signal

Each item of diagnostic information is assigned a specific status signal at the factory. The user can change this assignment for specific diagnostic information in the **Diagnostic event category** submenu.

Expert → Communication → Diagnostic event category

Available status signals

Configuration as per FOUNDATION Fieldbus Specification (FF912), in accordance with NAMUR NE107.

Symbol	Meaning
F A0013956	Failure A device error has occurred. The measured value is no longer valid.
C A0013959	Function check The device is in service mode (e.g. during a simulation).

Symbol	Meaning
S <small>A0013958</small>	Out of specification The device is being operated: Outside its technical specification limits (e.g. outside the process temperature range)
M <small>A0013957</small>	Maintenance required Maintenance is required. The measured value remains valid.

Enabling the configuration of the diagnostic information according to FF912

For compatibility reasons, the configuration of the diagnostic information according to FOUNDATION Fieldbus Specification FF912 is not enabled when the device is delivered from the factory.

Enabling the configuration of the diagnostic information according to FOUNDATION Fieldbus Specification FF912

1. Open the Resource block.
2. In **Feature Selection** parameter, select **Multi-bit Alarm (Bit-Alarm) Support** option.
 - ↳ The diagnostic information can be configured according to FOUNDATION Fieldbus Specification FF912.

Grouping the diagnostic information

Diagnostic information is assigned to different groups. The groups differ depending on the weighting (severity) of the diagnostic event:

- Highest weighting
- High weighting
- Low weighting

Assignment of the diagnostic information (factory setting)

The assignment of the diagnostic information ex-works is indicated in the following tables.

The individual ranges of the diagnostic information can be assigned to another status signal → 158.

Some diagnostic information can be assigned individually, irrespective of their range → 159.

 Overview and description of all diagnostic information → 160

Weighting	Status signal (factory setting)	Allocation	Diagnostic information range
Highest	Failure (F)	Sensor	F000 to 199
		Electronics	F200 to 399
		Configuration	F400 to 700
		Process	F800 to 999



Weighting	Status signal (factory setting)	Allocation	Diagnostic information range
High	Function check (C)	Sensor	C000 to 199
		Electronics	C200 to 399
		Configuration	C400 to 700
		Process	C800 to 999

Weighting	Status signal (factory setting)	Allocation	Diagnostic information range
Low	Out of specification (S)	Sensor	S000 to 199
		Electronics	S200 to 399
		Configuration	S400 to 700
		Process	S800 to 999

Weighting	Status signal (factory setting)	Allocation	Diagnostic information range
Low	Maintenance required (M)	Sensor	M000 to 199
		Electronics	M200 to 399
		Configuration	M400 to 700
		Process	M800 to 999

Changing the assignment of the diagnostic information

The individual ranges of the diagnostic information can be assigned to another status signal. This is done by changing the bit in the associated parameter. The bit change always applies for the entire range of the diagnostic information.

 Some diagnostic information can be assigned individually, irrespective of their range
→  159

Each status signal has a parameter in the Resource Block in which it is possible to define the diagnostic event for which the status signal is transmitted:

- Failure (F): **FD_FAIL_MAP** parameter
- Function check (C): **FD_CHECK_MAP** parameter
- Out of specification (S): **FD_OFFSPEC_MAP** parameter
- Maintenance required (M): **FD_MAINT_MAP** parameter

Structure and assignment of the parameters for the status signals (factory setting)

Weighting	Allocation	Bit	FD_FAIL_MAP	FD_CHECK_MAP	FD_OFFSPEC_MAP	FD_MAINT_MAP
Highest	Sensor	31	1	0	0	0
	Electronics	30	1	0	0	0
	Configuration	29	1	0	0	0
	Process	28	1	0	0	0
High	Sensor	27	0	1	0	0
	Electronics	26	0	1	0	0
	Configuration	25	0	1	0	0
	Process	24	0	1	0	0
Low	Sensor	23	0	0	1	0
	Electronics	22	0	0	1	0
	Configuration	21	0	0	1	0
	Process	20	0	0	1	0
Low	Sensor	19	0	0	0	1
	Electronics	18	0	0	0	1
	Configuration	17	0	0	0	1
	Process	16	0	0	0	1

Weighting	Allocation	Bit	FD_FAIL_MAP	FD_CHECK_MAP	FD_OFFSPEC_MAP	FD_MAINT_MAP
Configurable range →  159		15 to 1	0	0	0	0
Reserved (Fieldbus Foundation)		0	0	0	0	0

Changing the status signal for a range of diagnostic information

Example: The status signal for the diagnostic information for electronics with the "Highest" weighting is to be changed from failure (F) to function check (C).

1. Set the Resource Block to the **OOS** block mode.
2. Open the **FD_FAIL_MAP** parameter in the Resource Block.
3. Change **Bit 30** to **0** in the parameter.
4. Open the **FD_CHECK_MAP** parameter in the Resource Block.
5. Change **Bit 26** to **1** in the parameter.
 - ↳ If a diagnostic event occurs for electronics with the "Highest weighting", the diagnostic information to this effect is displayed with the function check (C) status signal.
6. Set the Resource Block to the **AUTO** block mode.

NOTICE

No status signal is assigned to an area of diagnostic information.

If a diagnostic event occurs in this area, no status signal is transmitted to the control system.

- ▶ If you are changing the parameters, make sure that a status signal is assigned to all areas.



If FieldCare is used, the status signal is enabled and disabled using the check box of the particular parameter.

Assigning diagnostic information individually to a status signal

Some diagnostic information can be individually assigned to a status signal, irrespective of their original range.

Assigning diagnostic information individually to a status signal via FieldCare.

1. In the FieldCare navigation window: **Expert** → **Communication** → **Field diagnostics** → **Alarm detection enable**
2. Select the desired diagnostic information from one of the fields **Configurable Area Bits 1** to **Configurable Area Bits 15**.
3. Press Enter to confirm.
4. When selecting the desired status signal (e.g. Offspec Map), also select the **Configurable Area Bit 1** to **Configurable Area Bit 15** that was assigned previously to the diagnostic information (step 2).
5. Press Enter to confirm.
 - ↳ The diagnostic event of the selected diagnostic information is recorded.
6. In the FieldCare navigation window: **Expert** → **Communication** → **Field diagnostics** → **Alarm broadcast enable**
7. Select the desired diagnostic information from one of the fields **Configurable Area Bits 1** to **Configurable Area Bits 15**.
8. Press Enter to confirm.

9. When selecting the desired status signal (e.g. Offspec Map), also select the **Configurable Area Bit 1** to **Configurable Area Bit 15** that was assigned previously to the diagnostic information (step 7).
 10. Press Enter to confirm.
 - ↳ The selected diagnostic information is transmitted over the bus when a diagnostic event to this effect occurs.
- i** A change in the status signal does not affect diagnostic information that already exists. The new status signal is only assigned if this error occurs again after the status signal has changed.

Transmitting the diagnostic information over the bus

Prioritizing diagnostic information for transmission over the bus

Diagnostic information is only transmitted over the bus if its priority is between 2 and 15. Priority 1-events are displayed but are not transmitted over the bus. Diagnostic information with priority 0 (factory setting) is ignored.

It is possible to change the priority individually for the different status signals. The following parameters of the Resource Block are used for this purpose:

- FD_FAIL_PRI
- FD_CHECK_PRI
- FD_OFFSPEC_PRI
- FD_MAINT_PRI

Suppressing certain diagnostic information

It is possible to suppress certain events during transmission over the bus using a mask. While these events are displayed they are not transmitted over the bus. This mask is in FieldCare **Expert** → **Communication** → **Field diagnostics** → **Alarm broadcast enable**. The mask is a negative selection mask, i.e. if a field is selected the associated diagnostic information is not transmitted over the bus.

12.7 Overview of diagnostic information

- i** The amount of diagnostic information and the number of measured variables affected increase if the measuring device has one or more application packages.
- All of the measured variables affected in the entire Promass instrument family are always listed under "Measured variables affected". The measured variables available for the device in question depend on the device version. When assigning the measured variables to the device functions, for example to the individual outputs, all of the measured variables available for the device version in question are available for selection.
- i** In the case of some items of diagnostic information, the status signal and the diagnostic behavior can be changed. Change the diagnostic information → 📖 156

12.7.1 Diagnostic of sensor

Diagnostic information		Remedy instructions	Influenced measured variables	
No.	Short text			
022	Temperature sensor defective	1. Check or replace sensor electronic module (ISEM) 2. If available: Check connection cable between sensor and transmitter 3. Replace sensor	<ul style="list-style-type: none"> ▪ Empty pipe detection option ▪ Low flow cut off option ▪ Switch output status option ▪ Pressure option 	
	Measured variable status			
	Quality			Bad
	Quality substatus			Sensor failure
	Status signal [from the factory] ¹⁾			F
Diagnostic behavior	Alarm			

1) Status signal can be changed.

Diagnostic information		Remedy instructions	Influenced measured variables	
No.	Short text			
046	Sensor limit exceeded	1. Inspect sensor 2. Check process condition	<ul style="list-style-type: none"> ▪ Empty pipe detection option ▪ Low flow cut off option ▪ Switch output status option ▪ Pressure option 	
	Measured variable status [from the factory] ¹⁾			
	Quality			Good
	Quality substatus			Non specific
	Status signal [from the factory] ²⁾			S
Diagnostic behavior [from the factory] ³⁾	Warning			

1) Quality can be changed. This causes the overall status of the measured variable to change.

2) Status signal can be changed.

3) Diagnostic behavior can be changed.

Diagnostic information		Remedy instructions	Influenced measured variables	
No.	Short text			
062	Sensor connection faulty	1. Check or replace sensor electronic module (ISEM) 2. If available: Check connection cable between sensor and transmitter 3. Replace sensor	<ul style="list-style-type: none"> ▪ Empty pipe detection option ▪ Low flow cut off option ▪ Switch output status option ▪ Pressure option 	
	Measured variable status			
	Quality			Bad
	Quality substatus			Sensor failure
	Status signal [from the factory] ¹⁾			F
Diagnostic behavior	Alarm			

1) Status signal can be changed.

Diagnostic information		Remedy instructions	Influenced measured variables	
No.	Short text			
063	Exciter current faulty	<ol style="list-style-type: none"> 1. Check or replace sensor electronic module (ISEM) 2. If available: Check connection cable between sensor and transmitter 3. Replace sensor 	<ul style="list-style-type: none"> ▪ Empty pipe detection option ▪ Low flow cut off option 	
	Measured variable status			
	Quality			Bad
	Quality substatus			Sensor failure
	Status signal [from the factory] ¹⁾			S
	Diagnostic behavior			Alarm

1) Status signal can be changed.

Diagnostic information		Remedy instructions	Influenced measured variables	
No.	Short text			
082	Data storage	<ol style="list-style-type: none"> 1. Check module connections 2. Contact service 	<ul style="list-style-type: none"> ▪ Empty pipe detection option ▪ Low flow cut off option ▪ Switch output status option ▪ Pressure option 	
	Measured variable status			
	Quality			Bad
	Quality substatus			Sensor failure
	Status signal [from the factory] ¹⁾			F
	Diagnostic behavior			Alarm

1) Status signal can be changed.

Diagnostic information		Remedy instructions	Influenced measured variables	
No.	Short text			
083	Memory content	<ol style="list-style-type: none"> 1. Restart device 2. Restore HistoROM S-DAT backup ('Device reset' parameter) 3. Replace HistoROM S-DAT 	<ul style="list-style-type: none"> ▪ Empty pipe detection option ▪ Low flow cut off option ▪ Switch output status option ▪ Pressure option 	
	Measured variable status			
	Quality			Bad
	Quality substatus			Sensor failure
	Status signal [from the factory] ¹⁾			F
	Diagnostic behavior			Alarm

1) Status signal can be changed.

Diagnostic information		Remedy instructions	Influenced measured variables	
No.	Short text			
140	Sensor signal asymmetrical	<ol style="list-style-type: none"> 1. Check or replace sensor electronic module (ISEM) 2. If available: Check connection cable between sensor and transmitter 3. Replace sensor 	<ul style="list-style-type: none"> ▪ Empty pipe detection option ▪ Low flow cut off option ▪ Switch output status option ▪ Pressure option 	
	Measured variable status [from the factory] ¹⁾			
	Quality			Good
	Quality substatus			Non specific
	Status signal [from the factory] ²⁾			S
	Diagnostic behavior [from the factory] ³⁾			Alarm

1) Quality can be changed. This causes the overall status of the measured variable to change.

2) Status signal can be changed.

3) Diagnostic behavior can be changed.

Diagnostic information		Remedy instructions	Influenced measured variables	
No.	Short text			
144	Measuring error too high	1. Check or change sensor 2. Check process conditions	<ul style="list-style-type: none"> ▪ Empty pipe detection option ▪ Low flow cut off option ▪ Switch output status option ▪ Pressure option 	
	Measured variable status [from the factory] ¹⁾			
	Quality			Good
	Quality substatus			Non specific
	Status signal [from the factory] ²⁾			F
Diagnostic behavior [from the factory] ³⁾	Alarm			

- 1) Quality can be changed. This causes the overall status of the measured variable to change.
- 2) Status signal can be changed.
- 3) Diagnostic behavior can be changed.

12.7.2 Diagnostic of electronic

Diagnostic information		Remedy instructions	Influenced measured variables	
No.	Short text			
201	Device failure	1. Restart device 2. Contact service	<ul style="list-style-type: none"> ▪ Empty pipe detection option ▪ Low flow cut off option ▪ Switch output status option ▪ Pressure option 	
	Measured variable status			
	Quality			Bad
	Quality substatus			Device failure
	Status signal [from the factory] ¹⁾			F
Diagnostic behavior	Alarm			

- 1) Status signal can be changed.

Diagnostic information		Remedy instructions	Influenced measured variables	
No.	Short text			
242	Software incompatible	1. Check software 2. Flash or change main electronics module	<ul style="list-style-type: none"> ▪ Empty pipe detection option ▪ Low flow cut off option ▪ Switch output status option ▪ Pressure option 	
	Measured variable status			
	Quality			Bad
	Quality substatus			Device failure
	Status signal [from the factory] ¹⁾			F
Diagnostic behavior	Alarm			

- 1) Status signal can be changed.

Diagnostic information		Remedy instructions	Influenced measured variables	
No.	Short text			
252	Modules incompatible	1. Check electronic modules 2. Change electronic modules	<ul style="list-style-type: none"> ▪ Empty pipe detection option ▪ Low flow cut off option ▪ Switch output status option ▪ Pressure option 	
	Measured variable status			
	Quality			Bad
	Quality substatus			Device failure
	Status signal [from the factory] ¹⁾			F
Diagnostic behavior	Alarm			

1) Status signal can be changed.

Diagnostic information		Remedy instructions	Influenced measured variables	
No.	Short text			
262	Sensor electronic connection faulty	1. Check or replace connection cable between sensor electronic module (ISEM) and main electronics 2. Check or replace ISEM or main electronics	<ul style="list-style-type: none"> ▪ Empty pipe detection option ▪ Low flow cut off option ▪ Pressure option 	
	Measured variable status			
	Quality			Bad
	Quality substatus			Device failure
	Status signal [from the factory] ¹⁾			F
Diagnostic behavior	Alarm			

1) Status signal can be changed.

Diagnostic information		Remedy instructions	Influenced measured variables	
No.	Short text			
270	Main electronic failure	Change main electronic module	<ul style="list-style-type: none"> ▪ Empty pipe detection option ▪ Low flow cut off option ▪ Switch output status option ▪ Pressure option 	
	Measured variable status			
	Quality			Bad
	Quality substatus			Device failure
	Status signal [from the factory] ¹⁾			F
Diagnostic behavior	Alarm			

1) Status signal can be changed.

Diagnostic information		Remedy instructions	Influenced measured variables	
No.	Short text			
271	Main electronic failure	1. Restart device 2. Change main electronic module	<ul style="list-style-type: none"> ▪ Empty pipe detection option ▪ Low flow cut off option ▪ Switch output status option ▪ Pressure option 	
	Measured variable status			
	Quality			Bad
	Quality substatus			Device failure
	Status signal [from the factory] ¹⁾			F
Diagnostic behavior	Alarm			

1) Status signal can be changed.

Diagnostic information		Remedy instructions	Influenced measured variables	
No.	Short text			
272	Main electronic failure	1. Restart device 2. Contact service	<ul style="list-style-type: none"> ▪ Empty pipe detection option ▪ Low flow cut off option ▪ Switch output status option ▪ Pressure option 	
	Measured variable status			
	Quality			Bad
	Quality substatus			Device failure
	Status signal [from the factory] ¹⁾			F
Diagnostic behavior	Alarm			

1) Status signal can be changed.

Diagnostic information		Remedy instructions	Influenced measured variables	
No.	Short text			
273	Main electronic failure	Change electronic	<ul style="list-style-type: none"> ▪ Empty pipe detection option ▪ Low flow cut off option ▪ Switch output status option ▪ Pressure option 	
	Measured variable status			
	Quality			Bad
	Quality substatus			Device failure
	Status signal [from the factory] ¹⁾			F
Diagnostic behavior	Alarm			

1) Status signal can be changed.

Diagnostic information		Remedy instructions	Influenced measured variables	
No.	Short text			
275	I/O module 1 to n defective	Change I/O module	<ul style="list-style-type: none"> ▪ Empty pipe detection option ▪ Low flow cut off option ▪ Switch output status option ▪ Pressure option 	
	Measured variable status			
	Quality			Bad
	Quality substatus			Device failure
	Status signal [from the factory] ¹⁾			F
Diagnostic behavior	Alarm			

1) Status signal can be changed.

Diagnostic information		Remedy instructions	Influenced measured variables	
No.	Short text			
276	I/O module 1 to n faulty	1. Restart device 2. Change I/O module	<ul style="list-style-type: none"> ▪ Empty pipe detection option ▪ Low flow cut off option ▪ Switch output status option ▪ Pressure option 	
	Measured variable status			
	Quality			Uncertain
	Quality substatus			Non specific
	Status signal [from the factory] ¹⁾			F
Diagnostic behavior	Alarm			

1) Status signal can be changed.

Diagnostic information		Remedy instructions	Influenced measured variables	
No.	Short text			
276	I/O module 1 to n faulty	1. Restart device 2. Change I/O module	<ul style="list-style-type: none"> ▪ Empty pipe detection option ▪ Low flow cut off option ▪ Switch output status option ▪ Pressure option 	
	Measured variable status			
	Quality			Bad
	Quality substatus			Device failure
	Status signal [from the factory] ¹⁾			F
Diagnostic behavior	Alarm			

1) Status signal can be changed.

Diagnostic information		Remedy instructions	Influenced measured variables	
No.	Short text			
283	Memory content	1. Reset device 2. Contact service	<ul style="list-style-type: none"> ▪ Empty pipe detection option ▪ Low flow cut off option ▪ Switch output status option ▪ Pressure option 	
	Measured variable status			
	Quality			Bad
	Quality substatus			Device failure
	Status signal [from the factory] ¹⁾			F
Diagnostic behavior	Alarm			

1) Status signal can be changed.

Diagnostic information		Remedy instructions	Influenced measured variables	
No.	Short text			
302	Device verification active	Device verification active, please wait.	<ul style="list-style-type: none"> ▪ Empty pipe detection option ▪ Low flow cut off option ▪ Switch output status option ▪ Pressure option 	
	Measured variable status			
	Quality			Bad
	Quality substatus			Device failure
	Status signal [from the factory] ¹⁾			C
Diagnostic behavior	Warning			

1) Status signal can be changed.

Diagnostic information		Remedy instructions	Influenced measured variables	
No.	Short text			
311	Electronic failure	1. Do not reset device 2. Contact service	<ul style="list-style-type: none"> ▪ Empty pipe detection option ▪ Low flow cut off option ▪ Switch output status option ▪ Pressure option 	
	Measured variable status			
	Quality			Bad
	Quality substatus			Device failure
	Status signal [from the factory] ¹⁾			M
Diagnostic behavior	Warning			

1) Status signal can be changed.

Diagnostic information		Remedy instructions	Influenced measured variables		
No.	Short text				
332	Writing in embedded HistoROM failed	Replace user interface board Ex d/XP: replace transmitter	<ul style="list-style-type: none"> ▪ Empty pipe detection option ▪ Low flow cut off option ▪ Switch output status option ▪ Pressure option 		
	Measured variable status				
	Quality			Bad	
	Quality substatus			Device failure	
	Status signal [from the factory] ¹⁾			F	
	Diagnostic behavior			Alarm	

1) Status signal can be changed.

Diagnostic information		Remedy instructions	Influenced measured variables		
No.	Short text				
361	I/O module 1 to n faulty	<ol style="list-style-type: none"> 1. Restart device 2. Check electronic modules 3. Change I/O Modul or main electronics 	<ul style="list-style-type: none"> ▪ Empty pipe detection option ▪ Low flow cut off option ▪ Switch output status option ▪ Pressure option 		
	Measured variable status				
	Quality			Bad	
	Quality substatus			Device failure	
	Status signal [from the factory] ¹⁾			F	
	Diagnostic behavior			Alarm	

1) Status signal can be changed.

Diagnostic information		Remedy instructions	Influenced measured variables		
No.	Short text				
372	Sensor electronic (ISEM) faulty	<ol style="list-style-type: none"> 1. Restart device 2. Check if failure recurs 3. Replace sensor electronic module (ISEM) 	<ul style="list-style-type: none"> ▪ Empty pipe detection option ▪ Low flow cut off option ▪ Switch output status option ▪ Pressure option 		
	Measured variable status				
	Quality			Bad	
	Quality substatus			Device failure	
	Status signal [from the factory] ¹⁾			F	
	Diagnostic behavior			Alarm	

1) Status signal can be changed.

Diagnostic information		Remedy instructions	Influenced measured variables		
No.	Short text				
373	Sensor electronic (ISEM) faulty	<ol style="list-style-type: none"> 1. Transfer data or reset device 2. Contact service 	<ul style="list-style-type: none"> ▪ Empty pipe detection option ▪ Low flow cut off option ▪ Switch output status option ▪ Pressure option 		
	Measured variable status				
	Quality			Bad	
	Quality substatus			Device failure	
	Status signal [from the factory] ¹⁾			F	
	Diagnostic behavior			Alarm	

1) Status signal can be changed.

Diagnostic information		Remedy instructions	Influenced measured variables	
No.	Short text			
374	Sensor electronic (ISEM) faulty	<ol style="list-style-type: none"> Restart device Check if failure recurs Replace sensor electronic module (ISEM) 	<ul style="list-style-type: none"> ▪ Empty pipe detection option ▪ Low flow cut off option ▪ Switch output status option ▪ Pressure option 	
	Measured variable status [from the factory] ¹⁾			
	Quality			Good
	Quality substatus			Non specific
	Status signal [from the factory] ²⁾			S
Diagnostic behavior [from the factory] ³⁾	Warning			

1) Quality can be changed. This causes the overall status of the measured variable to change.

2) Status signal can be changed.

3) Diagnostic behavior can be changed.

Diagnostic information		Remedy instructions	Influenced measured variables	
No.	Short text			
375	I/O- 1 to n communication failed	<ol style="list-style-type: none"> Restart device Check if failure recurs Replace module rack inclusive electronic modules 	<ul style="list-style-type: none"> ▪ Empty pipe detection option ▪ Low flow cut off option ▪ Switch output status option ▪ Pressure option 	
	Measured variable status			
	Quality			Bad
	Quality substatus			Device failure
	Status signal [from the factory] ¹⁾			F
Diagnostic behavior	Alarm			

1) Status signal can be changed.

Diagnostic information		Remedy instructions	Influenced measured variables	
No.	Short text			
382	Data storage	<ol style="list-style-type: none"> Insert T-DAT Replace T-DAT 	<ul style="list-style-type: none"> ▪ Empty pipe detection option ▪ Low flow cut off option ▪ Pressure option 	
	Measured variable status			
	Quality			Bad
	Quality substatus			Device failure
	Status signal [from the factory] ¹⁾			F
Diagnostic behavior	Alarm			

1) Status signal can be changed.

Diagnostic information		Remedy instructions	Influenced measured variables	
No.	Short text			
383	Memory content	<ol style="list-style-type: none"> Restart device Delete T-DAT via 'Reset device' parameter Replace T-DAT 	<ul style="list-style-type: none"> ▪ Empty pipe detection option ▪ Low flow cut off option ▪ Switch output status option ▪ Pressure option 	
	Measured variable status			
	Quality			Bad
	Quality substatus			Device failure
	Status signal [from the factory] ¹⁾			F
Diagnostic behavior	Alarm			

1) Status signal can be changed.

Diagnostic information		Remedy instructions	Influenced measured variables	
No.	Short text			
387	Embedded HistoROM failed	Contact service organization	<ul style="list-style-type: none"> ▪ Empty pipe detection option ▪ Low flow cut off option ▪ Switch output status option ▪ Pressure option 	
	Measured variable status			
	Quality			Bad
	Quality substatus			Device failure
	Status signal [from the factory] ¹⁾			F
	Diagnostic behavior			Alarm

1) Status signal can be changed.

12.7.3 Diagnostic of configuration

Diagnostic information		Remedy instructions	Influenced measured variables	
No.	Short text			
303	I/O 1 to n configuration changed	<ol style="list-style-type: none"> 1. Apply I/O module configuration (parameter 'Apply I/O configuration') 2. Afterwards reload device description and check wiring 	-	
	Measured variable status			
	Quality			Good
	Quality substatus			Non specific
	Status signal [from the factory] ¹⁾			M
	Diagnostic behavior			Warning

1) Status signal can be changed.

Diagnostic information		Remedy instructions	Influenced measured variables	
No.	Short text			
330	Flash file invalid	<ol style="list-style-type: none"> 1. Update firmware of device 2. Restart device 	<ul style="list-style-type: none"> ▪ Empty pipe detection option ▪ Low flow cut off option ▪ Switch output status option ▪ Pressure option 	
	Measured variable status			
	Quality			Bad
	Quality substatus			Configuration error
	Status signal [from the factory] ¹⁾			M
	Diagnostic behavior			Warning

1) Status signal can be changed.

Diagnostic information		Remedy instructions	Influenced measured variables	
No.	Short text			
331	Firmware update failed	<ol style="list-style-type: none"> 1. Update firmware of device 2. Restart device 	<ul style="list-style-type: none"> ▪ Empty pipe detection option ▪ Low flow cut off option ▪ Switch output status option ▪ Pressure option 	
	Measured variable status			
	Quality			Bad
	Quality substatus			Configuration error
	Status signal [from the factory] ¹⁾			F
	Diagnostic behavior			Warning

1) Status signal can be changed.

Diagnostic information		Remedy instructions	Influenced measured variables	
No.	Short text			
410	Data transfer	1. Check connection 2. Retry data transfer	<ul style="list-style-type: none"> ▪ Empty pipe detection option ▪ Low flow cut off option ▪ Switch output status option ▪ Pressure option 	
	Measured variable status			
	Quality			Bad
	Quality substatus			Configuration error
	Status signal [from the factory] ¹⁾			F
Diagnostic behavior	Alarm			

1) Status signal can be changed.

Diagnostic information		Remedy instructions	Influenced measured variables	
No.	Short text			
412	Processing download	Download active, please wait	<ul style="list-style-type: none"> ▪ Empty pipe detection option ▪ Low flow cut off option ▪ Switch output status option ▪ Pressure option 	
	Measured variable status			
	Quality			Uncertain
	Quality substatus			Non specific
	Status signal [from the factory] ¹⁾			C
Diagnostic behavior	Warning			

1) Status signal can be changed.

Diagnostic information		Remedy instructions	Influenced measured variables	
No.	Short text			
431	Trim 1 to n	Carry out trim	-	
	Measured variable status			
	Quality			Good
	Quality substatus			Non specific
	Status signal [from the factory] ¹⁾			C
Diagnostic behavior	Warning			

1) Status signal can be changed.

Diagnostic information		Remedy instructions	Influenced measured variables	
No.	Short text			
437	Configuration incompatible	1. Restart device 2. Contact service	<ul style="list-style-type: none"> ▪ Empty pipe detection option ▪ Low flow cut off option ▪ Switch output status option ▪ Pressure option 	
	Measured variable status			
	Quality			Bad
	Quality substatus			Configuration error
	Status signal [from the factory] ¹⁾			F
Diagnostic behavior	Alarm			

1) Status signal can be changed.

Diagnostic information		Remedy instructions	Influenced measured variables		
No.	Short text				
438	Dataset	1. Check data set file 2. Check device configuration 3. Up- and download new configuration	<ul style="list-style-type: none"> ▪ Empty pipe detection option ▪ Low flow cut off option ▪ Switch output status option ▪ Pressure option 		
	Measured variable status				
	Quality			Uncertain	
	Quality substatus			Non specific	
	Status signal [from the factory] ¹⁾			M	
	Diagnostic behavior			Warning	

1) Status signal can be changed.

Diagnostic information		Remedy instructions	Influenced measured variables		
No.	Short text				
441	Current output 1 to n	1. Check process 2. Check current output settings	-		
	Measured variable status				
	Quality			Good	
	Quality substatus			Non specific	
	Status signal [from the factory] ¹⁾			S	
	Diagnostic behavior [from the factory] ²⁾			Warning	

1) Status signal can be changed.

2) Diagnostic behavior can be changed.

Diagnostic information		Remedy instructions	Influenced measured variables		
No.	Short text				
442	Frequency output 1 to n	1. Check process 2. Check frequency output settings	-		
	Measured variable status				
	Quality			Good	
	Quality substatus			Non specific	
	Status signal [from the factory] ¹⁾			S	
	Diagnostic behavior [from the factory] ²⁾			Warning	

1) Status signal can be changed.

2) Diagnostic behavior can be changed.

Diagnostic information		Remedy instructions	Influenced measured variables	
No.	Short text			
443	Pulse output 1 to n	1. Check process 2. Check pulse output settings	-	
	Measured variable status			
	Quality			Good
	Quality substatus			Non specific
	Status signal [from the factory] ¹⁾			S
Diagnostic behavior [from the factory] ²⁾	Warning			

- 1) Status signal can be changed.
2) Diagnostic behavior can be changed.

Diagnostic information		Remedy instructions	Influenced measured variables	
No.	Short text			
444	Current input 1 to n	1. Check process 2. Check current input settings	-	
	Measured variable status			
	Quality			Good
	Quality substatus			Non specific
	Status signal [from the factory] ¹⁾			S
Diagnostic behavior [from the factory] ²⁾	Warning			

- 1) Status signal can be changed.
2) Diagnostic behavior can be changed.

Diagnostic information		Remedy instructions	Influenced measured variables	
No.	Short text			
453	Flow override	Deactivate flow override	<ul style="list-style-type: none"> ■ Empty pipe detection option ■ Low flow cut off option ■ Switch output status option ■ Pressure option 	
	Measured variable status			
	Quality			Good
	Quality substatus			Non specific
	Status signal [from the factory] ¹⁾			C
Diagnostic behavior	Warning			

- 1) Status signal can be changed.

Diagnostic information		Remedy instructions	Influenced measured variables	
No.	Short text			
463	Analog input 1 to n selection invalid	1. Check module/channel configuration 2. Check I/O module configuration	<ul style="list-style-type: none"> ▪ Empty pipe detection option ▪ Low flow cut off option ▪ Switch output status option ▪ Pressure option 	
	Measured variable status			
	Quality			Bad
	Quality substatus			Configuration error
	Status signal [from the factory] ¹⁾			F
Diagnostic behavior	Alarm			

1) Status signal can be changed.

Diagnostic information		Remedy instructions	Influenced measured variables	
No.	Short text			
484	Failure mode simulation	Deactivate simulation	<ul style="list-style-type: none"> ▪ Empty pipe detection option ▪ Low flow cut off option ▪ Switch output status option ▪ Pressure option 	
	Measured variable status			
	Quality			Bad
	Quality substatus			Configuration error
	Status signal [from the factory] ¹⁾			C
Diagnostic behavior	Alarm			

1) Status signal can be changed.

Diagnostic information		Remedy instructions	Influenced measured variables	
No.	Short text			
485	Measured variable simulation	Deactivate simulation	<ul style="list-style-type: none"> ▪ Empty pipe detection option ▪ Low flow cut off option ▪ Switch output status option ▪ Pressure option 	
	Measured variable status			
	Quality			Good
	Quality substatus			Non specific
	Status signal [from the factory] ¹⁾			C
Diagnostic behavior	Warning			

1) Status signal can be changed.

Diagnostic information		Remedy instructions	Influenced measured variables	
No.	Short text			
486	Current input 1 to n simulation	Deactivate simulation	-	
	Measured variable status			
	Quality			Good
	Quality substatus			Non specific
	Status signal [from the factory] ¹⁾			C
Diagnostic behavior	Warning			

1) Status signal can be changed.

Diagnostic information		Remedy instructions	Influenced measured variables	
No.	Short text			
491	Current output 1 to n simulation	Deactivate simulation	-	
	Measured variable status			
	Quality			Good
	Quality substatus			Non specific
	Status signal [from the factory] ¹⁾			C
Diagnostic behavior	Warning			

1) Status signal can be changed.

Diagnostic information		Remedy instructions	Influenced measured variables	
No.	Short text			
492	Simulation frequency output 1 to n	Deactivate simulation frequency output	-	
	Measured variable status			
	Quality			Good
	Quality substatus			Non specific
	Status signal [from the factory] ¹⁾			C
Diagnostic behavior	Warning			

1) Status signal can be changed.

Diagnostic information		Remedy instructions	Influenced measured variables	
No.	Short text			
493	Simulation pulse output 1 to n	Deactivate simulation pulse output	-	
	Measured variable status			
	Quality			Good
	Quality substatus			Non specific
	Status signal [from the factory] ¹⁾			C
Diagnostic behavior	Warning			

1) Status signal can be changed.

Diagnostic information		Remedy instructions	Influenced measured variables	
No.	Short text			
494	Switch output simulation 1 to n	Deactivate simulation switch output	-	
	Measured variable status			
	Quality			Good
	Quality substatus			Non specific
	Status signal [from the factory] ¹⁾			C
Diagnostic behavior	Warning			

1) Status signal can be changed.

Diagnostic information		Remedy instructions	Influenced measured variables	
No.	Short text			
495	Diagnostic event simulation	Deactivate simulation	-	
	Measured variable status			
	Quality			Good
	Quality substatus			Non specific
	Status signal [from the factory] ¹⁾			C
Diagnostic behavior	Warning			

1) Status signal can be changed.

Diagnostic information		Remedy instructions	Influenced measured variables	
No.	Short text			
496	Status input simulation	Deactivate simulation status input	-	
	Measured variable status			
	Quality			Good
	Quality substatus			Non specific
	Status signal [from the factory] ¹⁾			C
Diagnostic behavior	Warning			

1) Status signal can be changed.

Diagnostic information		Remedy instructions	Influenced measured variables	
No.	Short text			
497	Simulation block output	Deactivate simulation	-	
	Measured variable status			
	Quality			Good
	Quality substatus			Non specific
	Status signal [from the factory] ¹⁾			C
Diagnostic behavior	Warning			

1) Status signal can be changed.

Diagnostic information		Remedy instructions	Influenced measured variables	
No.	Short text			
520	I/O 1 to n hardware configuration invalid	1. Check I/O hardware configuration 2. Replace wrong I/O module 3. Plug the module of double pulse output on correct slot	-	
	Measured variable status			
	Quality			Good
	Quality substatus			Non specific
	Status signal [from the factory] ¹⁾			F
Diagnostic behavior	Alarm			

1) Status signal can be changed.

Diagnostic information		Remedy instructions	Influenced measured variables	
No.	Short text			
537	Configuration	1. Check IP addresses in network 2. Change IP address	-	
	Measured variable status			
	Quality			Good
	Quality substatus			Non specific
	Status signal [from the factory] ¹⁾			F
Diagnostic behavior	Warning			

1) Status signal can be changed.

Diagnostic information		Remedy instructions	Influenced measured variables	
No.	Short text			
594	Relay output simulation	Deactivate simulation switch output	-	
	Measured variable status			
	Quality			Good
	Quality substatus			Non specific
	Status signal [from the factory] ¹⁾			C
Diagnostic behavior	Warning			

1) Status signal can be changed.

12.7.4 Diagnostic of process

Diagnostic information		Remedy instructions	Influenced measured variables	
No.	Short text			
803	Current loop 1 to n	1. Check wiring 2. Change I/O module	-	
	Measured variable status			
	Quality			Good
	Quality substatus			Non specific
	Status signal [from the factory] ¹⁾			F
Diagnostic behavior	Alarm			

1) Status signal can be changed.

Diagnostic information		Remedy instructions	Influenced measured variables	
No.	Short text			
830	Sensor temperature too high	Reduce ambient temp. around the sensor housing	<ul style="list-style-type: none"> ▪ Empty pipe detection option ▪ Low flow cut off option ▪ Switch output status option ▪ Pressure option 	
	Measured variable status [from the factory] ¹⁾			
	Quality			Good
	Quality substatus			Non specific
	Status signal [from the factory] ²⁾			S
Diagnostic behavior [from the factory] ³⁾	Warning			

- 1) Quality can be changed. This causes the overall status of the measured variable to change.
- 2) Status signal can be changed.
- 3) Diagnostic behavior can be changed.

Diagnostic information		Remedy instructions	Influenced measured variables	
No.	Short text			
831	Sensor temperature too low	Increase ambient temp. around the sensor housing	<ul style="list-style-type: none"> ▪ Empty pipe detection option ▪ Low flow cut off option ▪ Switch output status option ▪ Pressure option 	
	Measured variable status [from the factory] ¹⁾			
	Quality			Good
	Quality substatus			Non specific
	Status signal [from the factory] ²⁾			S
Diagnostic behavior [from the factory] ³⁾	Warning			

- 1) Quality can be changed. This causes the overall status of the measured variable to change.
- 2) Status signal can be changed.
- 3) Diagnostic behavior can be changed.

Diagnostic information		Remedy instructions	Influenced measured variables	
No.	Short text			
832	Electronic temperature too high	Reduce ambient temperature	<ul style="list-style-type: none"> ▪ Empty pipe detection option ▪ Low flow cut off option ▪ Switch output status option ▪ Pressure option 	
	Measured variable status [from the factory] ¹⁾			
	Quality			Good
	Quality substatus			Non specific
	Status signal [from the factory] ²⁾			S
Diagnostic behavior [from the factory] ³⁾	Warning			

- 1) Quality can be changed. This causes the overall status of the measured variable to change.
- 2) Status signal can be changed.
- 3) Diagnostic behavior can be changed.

Diagnostic information		Remedy instructions	Influenced measured variables	
No.	Short text			
833	Electronic temperature too low	Increase ambient temperature	<ul style="list-style-type: none"> ▪ Empty pipe detection option ▪ Low flow cut off option ▪ Switch output status option ▪ Pressure option 	
	Measured variable status [from the factory] ¹⁾			
	Quality			Good
	Quality substatus			Non specific
	Status signal [from the factory] ²⁾			S
Diagnostic behavior [from the factory] ³⁾	Warning			

- 1) Quality can be changed. This causes the overall status of the measured variable to change.
 2) Status signal can be changed.
 3) Diagnostic behavior can be changed.

Diagnostic information		Remedy instructions	Influenced measured variables	
No.	Short text			
834	Process temperature too high	Reduce process temperature	<ul style="list-style-type: none"> ▪ Empty pipe detection option ▪ Low flow cut off option ▪ Switch output status option ▪ Pressure option 	
	Measured variable status [from the factory] ¹⁾			
	Quality			Good
	Quality substatus			Non specific
	Status signal [from the factory] ²⁾			S
Diagnostic behavior [from the factory] ³⁾	Warning			

- 1) Quality can be changed. This causes the overall status of the measured variable to change.
 2) Status signal can be changed.
 3) Diagnostic behavior can be changed.

Diagnostic information		Remedy instructions	Influenced measured variables	
No.	Short text			
835	Process temperature too low	Increase process temperature	<ul style="list-style-type: none"> ▪ Empty pipe detection option ▪ Low flow cut off option ▪ Switch output status option ▪ Pressure option 	
	Measured variable status [from the factory] ¹⁾			
	Quality			Good
	Quality substatus			Non specific
	Status signal [from the factory] ²⁾			S
Diagnostic behavior [from the factory] ³⁾	Warning			

- 1) Quality can be changed. This causes the overall status of the measured variable to change.
 2) Status signal can be changed.
 3) Diagnostic behavior can be changed.

Diagnostic information		Remedy instructions	Influenced measured variables		
No.	Short text				
842	Process limit	Low flow cut off active! 1. Check low flow cut off configuration	<ul style="list-style-type: none"> ▪ Empty pipe detection option ▪ Low flow cut off option ▪ Switch output status option ▪ Pressure option 		
	Measured variable status				
	Quality			Good	
	Quality substatus			Non specific	
	Status signal [from the factory] ¹⁾			S	
	Diagnostic behavior			Warning	

1) Status signal can be changed.

Diagnostic information		Remedy instructions	Influenced measured variables		
No.	Short text				
843	Process limit	Check process conditions	<ul style="list-style-type: none"> ▪ Empty pipe detection option ▪ Low flow cut off option ▪ Switch output status option ▪ Pressure option 		
	Measured variable status				
	Quality			Good	
	Quality substatus			Non specific	
	Status signal [from the factory] ¹⁾			S	
	Diagnostic behavior			Alarm	

1) Status signal can be changed.

Diagnostic information		Remedy instructions	Influenced measured variables		
No.	Short text				
862	Partly filled pipe	1. Check for gas in process 2. Adjust detection limits	-		
	Measured variable status [from the factory] ¹⁾				
	Quality			Good	
	Quality substatus			Non specific	
	Status signal [from the factory] ²⁾			S	
	Diagnostic behavior [from the factory] ³⁾			Warning	

1) Quality can be changed. This causes the overall status of the measured variable to change.

2) Status signal can be changed.

3) Diagnostic behavior can be changed.

Diagnostic information		Remedy instructions	Influenced measured variables		
No.	Short text				
882	Input signal	1. Check input configuration 2. Check external device or process conditions	-		
	Measured variable status				
	Quality			Bad	
	Quality substatus			Non specific	
	Status signal [from the factory] ¹⁾			F	
	Diagnostic behavior			Alarm	

1) Status signal can be changed.

Diagnostic information		Remedy instructions	Influenced measured variables	
No.	Short text			
910	Tubes not oscillating	1. Check electronic 2. Inspect sensor	<ul style="list-style-type: none"> ▪ Empty pipe detection option ▪ Low flow cut off option ▪ Switch output status option ▪ Pressure option 	
	Measured variable status			
	Quality			Bad
	Quality substatus			Non specific
	Status signal [from the factory] ¹⁾			F
Diagnostic behavior	Alarm			

1) Status signal can be changed.

Diagnostic information		Remedy instructions	Influenced measured variables	
No.	Short text			
912	Medium inhomogeneous	1. Check process cond. 2. Increase system pressure	<ul style="list-style-type: none"> ▪ Empty pipe detection option ▪ Low flow cut off option ▪ Switch output status option ▪ Pressure option 	
	Measured variable status [from the factory] ¹⁾			
	Quality			Good
	Quality substatus			Non specific
	Status signal [from the factory] ²⁾			S
Diagnostic behavior [from the factory] ³⁾	Warning			

1) Quality can be changed. This causes the overall status of the measured variable to change.

2) Status signal can be changed.

3) Diagnostic behavior can be changed.

Diagnostic information		Remedy instructions	Influenced measured variables	
No.	Short text			
913	Medium unsuitable	1. Check process conditions 2. Check electronic modules or sensor	<ul style="list-style-type: none"> ▪ Empty pipe detection option ▪ Low flow cut off option ▪ Switch output status option ▪ Pressure option 	
	Measured variable status [from the factory] ¹⁾			
	Quality			Good
	Quality substatus			Non specific
	Status signal [from the factory] ²⁾			S
Diagnostic behavior [from the factory] ³⁾	Warning			

1) Quality can be changed. This causes the overall status of the measured variable to change.

2) Status signal can be changed.

3) Diagnostic behavior can be changed.

Diagnostic information		Remedy instructions	Influenced measured variables	
No.	Short text			
944	Monitoring failed	Check process conditions for Heartbeat Monitoring	<ul style="list-style-type: none"> ▪ Empty pipe detection option ▪ Low flow cut off option ▪ Switch output status option ▪ Pressure option 	
	Measured variable status [from the factory] ¹⁾			
	Quality			Good
	Quality substatus			Non specific
	Status signal [from the factory] ²⁾			S
Diagnostic behavior [from the factory] ³⁾	Warning			





- 1) Quality can be changed. This causes the overall status of the measured variable to change.
- 2) Status signal can be changed.
- 3) Diagnostic behavior can be changed.



Diagnostic information		Remedy instructions	Influenced measured variables	
No.	Short text			
948	Oscillation damping too high	Check process conditions	<ul style="list-style-type: none"> ▪ Empty pipe detection option ▪ Low flow cut off option ▪ Switch output status option ▪ Pressure option 	
	Measured variable status [from the factory] ¹⁾			
	Quality			Good
	Quality substatus			Non specific
	Status signal [from the factory] ²⁾			S
Diagnostic behavior [from the factory] ³⁾	Warning			

- 1) Quality can be changed. This causes the overall status of the measured variable to change.
- 2) Status signal can be changed.
- 3) Diagnostic behavior can be changed.



12.8 Pending diagnostic events



The **Diagnostics** menu allows the user to view the current diagnostic event and the previous diagnostic event separately.

-  To call up the measures to rectify a diagnostic event:
 - Via local display →  153
 - Via web browser →  154
 - Via "FieldCare" operating tool →  155
 - Via "DeviceCare" operating tool →  155

-  Other pending diagnostic events can be displayed in the **Diagnostic list** submenu →  182.

Navigation
 "Diagnostics" menu

 Diagnostics	
Actual diagnostics	→  182
Previous diagnostics	→  182

Operating time from restart	→  182
Operating time	→  182

Parameter overview with brief description

Parameter	Prerequisite	Description	User interface
Actual diagnostics	A diagnostic event has occurred.	Shows the current occurred diagnostic event along with its diagnostic information.  If two or more messages occur simultaneously, the message with the highest priority is shown on the display.	Symbol for diagnostic behavior, diagnostic code and short message.
Previous diagnostics	Two diagnostic events have already occurred.	Shows the diagnostic event that occurred prior to the current diagnostic event along with its diagnostic information.	Symbol for diagnostic behavior, diagnostic code and short message.
Operating time from restart	–	Shows the time the device has been in operation since the last device restart.	Days (d), hours (h), minutes (m) and seconds (s)
Operating time	–	Indicates how long the device has been in operation.	Days (d), hours (h), minutes (m) and seconds (s)

12.9 Diagnostic messages in the DIAGNOSTIC Transducer Block

- The **Actual diagnostics** parameter (**actual diagnostics**) displays the message with the highest priority.
- A list of the active alarms can be viewed via the **Diagnostics 1** parameter (**diagnostics_1**) to Diagnostics 5 (**diagnostics 5**). If more than 5 messages are pending, the messages with the highest priority are shown on the display.
- You can view the last alarm that is no longer active via the **Previous diagnostics** parameter (**previous_diagnostics**).

12.10 Diagnostics list

Up to 5 currently pending diagnostic events can be displayed in the **Diagnostic list** submenu along with the associated diagnostic information. If more than 5 diagnostic events are pending, the events with the highest priority are shown on the display.

Navigation path

Diagnostics → Diagnostic list

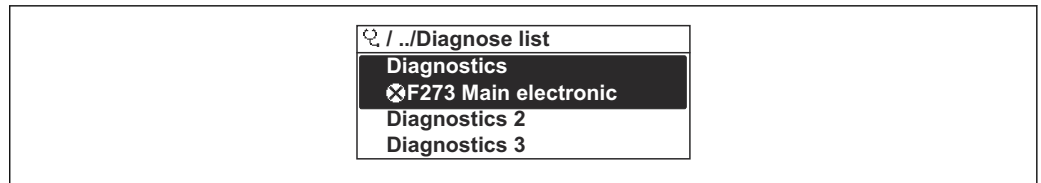

A0014006-EN

32 Using the example of the local display

- i** To call up the measures to rectify a diagnostic event:
- Via local display → 153
 - Via web browser → 154
 - Via "FieldCare" operating tool → 155
 - Via "DeviceCare" operating tool → 155

12.11 Event logbook

12.11.1 Reading out the event logbook

A chronological overview of the event messages that have occurred is provided in the **Events list** submenu.

Navigation path

Diagnostics menu → **Event logbook** submenu → Events list

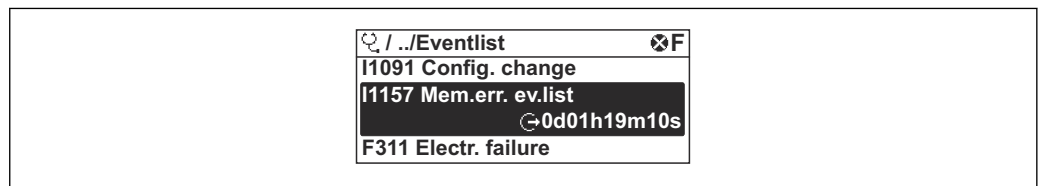

A0014008-EN

33 Using the example of the local display

- A maximum of 20 event messages can be displayed in chronological order.
- If the **Extended HistoROM** application package (order option) is enabled in the device, the event list can contain up to 100 entries.

The event history includes entries for:

- Diagnostic events → 160
- Information events → 184

In addition to the operating time when the event occurred, each event is also assigned a symbol that indicates whether the event has occurred or is finished:

- Diagnostics event
 - ⌚: Occurrence of the event
 - ⌚: End of the event
- Information event
 - ⌚: Occurrence of the event

- i** To call up the measures to rectify a diagnostic event:
- Via local display → 153
 - Via web browser → 154
 - Via "FieldCare" operating tool → 155
 - Via "DeviceCare" operating tool → 155

- i** For filtering the displayed event messages → 184

12.11.2 Filtering the event logbook

Using the **Filter options** parameter you can define which category of event message is displayed in the **Events list** submenu.

Navigation path

Diagnostics → Event logbook → Filter options

Filter categories

- All
- Failure (F)
- Function check (C)
- Out of specification (S)
- Maintenance required (M)
- Information (I)

12.11.3 Overview of information events

Unlike a diagnostic event, an information event is displayed in the event logbook only and not in the diagnostic list.

Info number	Info name
I1000	----- (Device ok)
I1079	Sensor changed
I1089	Power on
I1090	Configuration reset
I1091	Configuration changed
I1092	Embedded HistoROM deleted
I1111	Density adjust failure
I1137	Electronic changed
I1151	History reset
I1155	Reset electronic temperature
I1156	Memory error trend
I1157	Memory error event list
I1184	Display connected
I1209	Density adjustment ok
I1221	Zero point adjust failure
I1222	Zero point adjustment ok
I1256	Display: access status changed
I1278	I/O module reset detected
I1335	Firmware changed
I1361	Web server login failed
I1397	Fieldbus: access status changed
I1398	CDI: access status changed
I1444	Device verification passed
I1445	Device verification failed
I1447	Record application reference data
I1448	Application reference data recorded
I1449	Recording application ref. data failed
I1450	Monitoring off

Info number	Info name
I1451	Monitoring on
I1457	Measured error verification failed
I1459	I/O module verification failed
I1460	HBSI verification failed
I1461	Sensor verification failed
I1462	Sensor electronic module verific. failed
I1512	Download started
I1513	Download finished
I1514	Upload started
I1515	Upload finished
I1618	I/O module replaced
I1619	I/O module replaced
I1621	I/O module replaced
I1622	Calibration changed
I1624	Reset all totalizers
I1625	Write protection activated
I1626	Write protection deactivated
I1627	Web server login successful
I1628	Display login successful
I1629	CDI login successful
I1631	Web server access changed
I1632	Display login failed
I1633	CDI login failed
I1634	Parameter factory reset
I1635	Parameter delivery reset
I1637	FOUNDATION Fieldbus specific reset done
I1639	Max. switch cycles number reached
I1649	Hardware write protection activated
I1650	Hardware write protection deactivated
I1712	New flash file received
I1725	Sensor electronic module (ISEM) changed
I1726	Configuration backup failed

12.12 Resetting the measuring instrument

The entire device configuration or some of the configuration can be reset to a defined state with the **Restart** parameter.

12.12.1 Function range of "Restart" parameter

Options	Description
Uninitialized	The selection has no effect on the device.
Run	The selection has no effect on the device.
Resource	The selection has no effect on the device.

Options	Description
Defaults	All FOUNDATION Fieldbus blocks are reset to their factory settings. Example: Analog Input Channel to the Uninitialized option.
Processor	The device is restarted.
To delivery settings	Advanced FOUNDATION Fieldbus parameters (FOUNDATION Fieldbus blocks, schedule information) and device parameters for which a customer-specific default setting was ordered are reset to this customer-specific value.

12.12.2 Function range of "Service reset" parameter

Options	Description
Uninitialized	The selection has no effect on the device.
To delivery settings + MIB	Advanced FOUNDATION Fieldbus parameters (FOUNDATION Fieldbus blocks, schedule information, device tag and device address) and the device parameters for which a customer-specific default setting was ordered, are reset to this customer-specific value.
ENP restart	The parameters of the electronic name plate are reset. The device is restarted.

12.13 Device information





The **Device information** submenu contains all parameters that display different information for device identification.

Navigation

"Diagnostics" menu → Device information

► Device information	
Device tag	→ ⓘ 187
Serial number	→ ⓘ 187
Device name	→ ⓘ 187
Firmware version	→ ⓘ 187
Order code	→ ⓘ 187
Extended order code 1	→ ⓘ 187
Extended order code 2	→ ⓘ 187
ENP version	→ ⓘ 187

Parameter overview with brief description

Parameter	Description	User entry / User interface	Factory setting
Device tag	Enter the name for the measuring point.	Max. 32 characters, such as letters, numbers or special characters (e.g. @, %, /)	–
Serial number	Displays the serial number of the measuring device.	Max. 11-digit character string comprising letters and numbers.	–
Device name	Shows the name of the transmitter.  The name can be found on the nameplate of the transmitter.	Promass 300/500	–
Firmware version	Shows the device firmware version installed.	Character string with the following format: xx.yy.zz	–
Order code	Shows the device order code.  The order code can be found on the nameplate of the sensor and transmitter in the "Order code" field.	Character string composed of letters, numbers and certain punctuation marks	–
Extended order code 1	Shows the 1st part of the extended order code.  The extended order code can also be found on the nameplate of the sensor and transmitter in the "Ext. ord. cd." field.	Character string	–
Extended order code 2	Shows the 2nd part of the extended order code.  The extended order code can also be found on the nameplate of the sensor and transmitter in the "Ext. ord. cd." field.	Character string	–
ENP version	Shows the version of the electronic nameplate (ENP).	Character string in the format xx.yy.zz	–

12.14 Firmware history

Release date	Firmware version	Order code for "Firmware version"	Firmware Changes	Documentation type	Documentation
02.2017	01.00.zz	Option 74	Original firmware	Operating Instructions	BA01525D/06/EN/01.16

 It is possible to flash the firmware to the current version or the previous version using the service interface.

 For the compatibility of the firmware version with the previous version, the installed device description files and operating tools, observe the information about the device in the "Manufacturer's information" document.

 The manufacturer's information is available:

- In the Download Area of the Endress+Hauser web site: www.endress.com → Downloads
- Specify the following details:
 - Product root: e.g. 8X3B
The product root is the first part of the order code: see the nameplate on the device.
 - Text search: Manufacturer's information
 - Media type: Documentation – Technical Documentation

13 Maintenance

13.1 Maintenance work

No special maintenance work is required.

13.1.1 Exterior cleaning

When cleaning the exterior of measuring devices, always use cleaning agents that do not attack the surface of the housing or the seals.

13.2 Measuring and test equipment

Endress+Hauser offers a variety of measuring and testing equipment, such as Netilion or device tests.

 Your Endress+Hauser Sales Center can provide detailed information on the services.

List of some of the measuring and testing equipment: →  193

13.3 Endress+Hauser services

Endress+Hauser offers a wide variety of services for maintenance such as recalibration, maintenance service or device tests.

 Your Endress+Hauser Sales Center can provide detailed information on the services.

14 Repair

14.1 General notes

14.1.1 Repair and conversion concept

The Endress+Hauser repair and conversion concept provides for the following:

- The measuring devices have a modular design.
- Spare parts are grouped into logical kits with the associated Installation Instructions.
- Repairs are carried out by Endress+Hauser Service or by appropriately trained customers.
- Certified devices can only be converted to other certified devices by Endress+Hauser Service or at the factory.

14.1.2 Notes for repair and conversion

For repair and conversion of a measuring device, observe the following notes:

- ▶ Use only original Endress+Hauser spare parts.
- ▶ Carry out the repair according to the Installation Instructions.
- ▶ Observe the applicable standards, federal/national regulations, Ex documentation (XA) and certificates.
- ▶ Document all repairs and conversions and enter the details in Netilion Analytics.

14.2 Spare parts

Device Viewer (www.endress.com/deviceviewer):

All the spare parts for the measuring device, along with the order code, are listed here and can be ordered. If available, users can also download the associated Installation Instructions.

-  Measuring device serial number:
 - Is located on the nameplate of the device.
 - Can be read out via the **Serial number** parameter in the **Device information** submenu.

14.3 Endress+Hauser services

Endress+Hauser offers a wide range of services.

-  Your Endress+Hauser Sales Center can provide detailed information on the services.

14.4 Return

The requirements for safe device return can vary depending on the device type and national legislation.

1. Refer to the web page for information:
<https://www.endress.com/support/return-material>
 - ↳ Select the region.
2. If returning the device, pack the device in such a way that it is reliably protected against impact and external influences. The original packaging offers the best protection.

14.5 Disposal



If required by the Directive 2012/19/EU on waste electrical and electronic equipment (WEEE), the product is marked with the depicted symbol in order to minimize the disposal of WEEE as unsorted municipal waste. Do not dispose of products bearing this marking as unsorted municipal waste. Instead, return them to the manufacturer for disposal under the applicable conditions.

14.5.1 Removing the measuring device

1. Switch off the device.

WARNING

Danger to persons from process conditions!

- ▶ Beware of hazardous process conditions such as pressure in the measuring device, high temperatures or aggressive media.

2. Carry out the mounting and connection steps from the "Mounting the measuring device" and "Connecting the measuring device" sections in reverse order. Observe the safety instructions.

14.5.2 Disposing of the measuring device

WARNING

Danger to personnel and environment from fluids that are hazardous to health.

- ▶ Ensure that the measuring device and all cavities are free of fluid residues that are hazardous to health or the environment, e.g. substances that have permeated into crevices or diffused through plastic.

Observe the following notes during disposal:











- ▶ Observe valid federal/national regulations.
- ▶ Ensure proper separation and reuse of the device components.

15 Accessories













Various accessories, which can be ordered with the device or subsequently from Endress+Hauser, are available for the device. Detailed information on the order code in question is available from your local Endress+Hauser sales center or on the product page of the Endress+Hauser website: www.endress.com.

15.1 Device-specific accessories





15.1.1 For the transmitter



Accessories	Description
Proline 300 transmitter	<p>Transmitter for replacement or storage. Use the order code to define the following specifications:</p> <ul style="list-style-type: none"> ▪ Approvals ▪ Output ▪ Input ▪ Display/operation ▪ Housing ▪ Software <p> Order code: 8X3BXX</p> <p> Installation Instructions EA01200D</p>
Remote display and operating module DKX001	<ul style="list-style-type: none"> ▪ If ordered directly with the measuring device: Order code for "Display; operation", option O "Remote display 4-line, illuminated; 10 m (30 ft) cable; touch control" ▪ If ordered separately: <ul style="list-style-type: none"> ▪ Measuring device: order code for "Display; operation", option M "W/o, prepared for remote display" ▪ DKX001: Via the separate product structure DKX001 ▪ If ordered subsequently: DKX001: Via the separate product structure DKX001 <p>Mounting bracket for DKX001</p> <ul style="list-style-type: none"> ▪ If ordered directly: order code for "Accessory enclosed", option RA "Mounting bracket, pipe 1/2" ▪ If ordered subsequently: order number: 71340960 <p>Connecting cable (replacement cable) Via the separate product structure: DKX002</p> <p> Further information on display and operating module DKX001 →  216.</p> <p> Special Documentation SD01763D</p>
External WLAN antenna	<p>External WLAN antenna with 1.5 m (59.1 in) connecting cable and two angle brackets. Order code for "Accessory enclosed", option P8 "Wireless antenna wide area".</p> <p> <ul style="list-style-type: none"> ▪ The external WLAN antenna is not suitable for use in hygienic applications. ▪ Additional information regarding the WLAN interface →  66. </p> <p> Order number: 71351317</p> <p> Installation Instructions EA01238D</p>
Weather protection cover	<p>Is used to protect the measuring device from the effects of the weather: e.g. rainwater, excess heating from direct sunlight.</p> <p> Order number: 71343505</p> <p> Installation Instructions EA01160D</p>

15.2 Communication-specific accessories





Accessories	Description
Fieldgate FXA42	<p>Transmission of the measured values of connected 4 to 20 mA analog measuring instruments, as well as digital measuring instruments</p> <ul style="list-style-type: none">  Technical Information TI01297S  Operating Instructions BA01778S  Product page: www.endress.com/fxa42
Field Xpert SMT50	<p>The Field Xpert SMT50 tablet PC for device configuration enables mobile plant asset management in the non-hazardous areas. It is suitable for commissioning and maintenance staff to manage field instruments with a digital communication interface and to record progress.</p> <p>This tablet PC is designed as an all-in-one solution with a preinstalled driver library and is an easy-to-use, touch-sensitive tool which can be used to manage field instruments throughout their entire life cycle.</p> <ul style="list-style-type: none">  Technical Information TI01555S  Operating Instructions BA02053S  Product page: www.endress.com/smt50
Field Xpert SMT70	<p>The Field Xpert SMT70 tablet PC for device configuration enables mobile plant asset management in hazardous and non-hazardous areas. It is suitable for commissioning and maintenance staff to manage field instruments with a digital communication interface and to record progress.</p> <p>This tablet PC is designed as an all-in-one solution with a preinstalled driver library and is an easy-to-use, touch-sensitive tool which can be used to manage the field instruments throughout their entire life cycle.</p> <ul style="list-style-type: none">  Technical Information TI01342S  Operating Instructions BA01709S  Product page: www.endress.com/smt70
Field Xpert SMT77	<p>The Field Xpert SMT77 tablet PC for device configuration enables mobile plant asset management in areas categorized as Ex Zone 1.</p> <ul style="list-style-type: none">  Technical Information TI01418S  Operating Instructions BA01923S  Product page: www.endress.com/smt77

15.3 Service-specific accessories

Accessories	Description
Applicator	<p>Software for selecting and sizing Endress+Hauser measuring instruments:</p> <ul style="list-style-type: none">  Choice of measuring instruments for industrial requirements  Calculation of all the necessary data for identifying the optimum flowmeter: e.g. nominal diameter, pressure loss, flow velocity and measurement accuracy.  Graphic display of the calculation results  Determination of the partial order code, administration, documentation and access to all project-related data and parameters over the entire life cycle of a project. <p>Applicator is available: Via the Internet: https://portal.endress.com/webapp/applicator</p>
Netilion	<p>IloT ecosystem: Unlock knowledge</p> <p>With the Netilion IloT ecosystem, Endress+Hauser allows you to optimize your plant performance, digitize workflows, share knowledge, and enhance collaboration.</p> <p>Drawing upon decades of experience in process automation, Endress+Hauser offers the process industry an IloT ecosystem designed to effortlessly extract insights from data. These insights allow process optimization, leading to increased plant availability, efficiency, and reliability - ultimately resulting in a more profitable plant.</p> <p>www.netilion.endress.com</p>

Accessories	Description
FieldCare	<p>FDT-based plant asset management tool from Endress+Hauser. It can configure all intelligent field units in your system and helps you manage them. By using the status information, it is also a simple but effective way of checking their status and condition.</p> <p> Operating Instructions BA00027S and BA00059S</p>
DeviceCare	<p>Tool to connect and configure Endress+Hauser field devices.</p> <p> Innovation brochure IN01047S</p>

15.4 System components

Accessories	Description
Memograph M graphic data manager	<p>The Memograph M graphic data manager provides information on all the relevant measured variables. Measured values are recorded correctly, limit values are monitored and measuring points analyzed. The data are stored in the 256 MB internal memory and also on a SD card or USB stick.</p> <p> <ul style="list-style-type: none"> ▪ Technical Information TI00133R ▪ Operating Instructions BA00247R </p>
Cerabar M	<p>The pressure transmitter for measuring the absolute and gauge pressure of gases, steam and liquids. It can be used to read in the operating pressure value.</p> <p> <ul style="list-style-type: none"> ▪ Technical Information TI00426P and TI00436P ▪ Operating Instructions BA00200P and BA00382P </p>
Cerabar S	<p>The pressure transmitter for measuring the absolute and gauge pressure of gases, steam and liquids. It can be used to read in the operating pressure value.</p> <p> <ul style="list-style-type: none"> ▪ Technical Information TI00383P ▪ Operating Instructions BA00271P </p>
iTEMP	<p>The temperature transmitters can be used in all applications and are suitable for the measurement of gases, steam and liquids. They can be used to read in the medium temperature.</p> <p> "Fields of Activity" document FA00006T</p>

16 Technical data

16.1 Application

The measuring device is intended only for the flow measurement of liquids and gases.

Depending on the version ordered, the measuring device can also measure potentially explosive, flammable, poisonous and oxidizing media.

To ensure that the device remains in proper operating condition for its service life, use the measuring device only for media against which the process-wetted materials are sufficiently resistant.

16.2 Function and system design

Measuring principle	Mass flow measurement based on the Coriolis measuring principle
Measuring system	<p>The device consists of a transmitter and a sensor.</p> <p>The device is available as a compact version: The transmitter and sensor form a mechanical unit.</p> <p>For information on the structure of the measuring instrument →  13</p>

16.3 Input

Measured variable

Direct measured variables

- Mass flow
- Density
- Temperature

Calculated measured variables

- Volume flow
- Corrected volume flow
- Reference density

Measuring range

Measuring range for liquids

DN		Measuring range full scale values $\dot{m}_{\min(F)}$ to $\dot{m}_{\max(F)}$	
[mm]	[in]	[t/h]	[tn. sh./h]
300	12	0 to 4 100	0 to 4 520
350	14	0 to 4 100	0 to 4 520
400	16	0 to 4 100	0 to 4 520

Measuring range for gases

The full scale value depends on the density and the sound velocity of the gas used. The full scale value can be calculated with the following formulas:

$$\dot{m}_{\max(G)} = \text{Minimum of } (\dot{m}_{\max(F)} \cdot \rho_G \cdot x) \text{ and } (\rho_G \cdot (c_G/2) \cdot d_i^2 \cdot (\pi/4) \cdot 3600 \cdot n)$$

$\dot{m}_{\max(G)}$	Maximum full scale value for gas [kg/h]
$\dot{m}_{\max(F)}$	Maximum full scale value for liquid [kg/h]
$\dot{m}_{\max(G)} < \dot{m}_{\max(F)}$	$\dot{m}_{\max(G)}$ can never be greater than $\dot{m}_{\max(F)}$
ρ_G	Gas density in [kg/m ³] at operating conditions
x	Limitation constant for max. gas flow [kg/m ³]
c_G	Sound velocity (gas) [m/s]
d_i	Measuring tube internal diameter [m]
π	Pi
$n = 4$	Number of measuring tubes



DN		x
[mm]	[in]	[kg/m ³]
300	12	200
350	14	200
400	16	200

If calculating the full scale value using the two formulas:

1. Calculate the full scale value with both formulas.

2. The smaller value is the value that must be used.

Recommended measuring range

 Flow limit →  212

Operable flow range

Over 1000 : 1.



Flow rates above the preset full scale value do not override the electronics unit, with the result that the totalizer values are registered correctly.

Input signal

External measured values

To increase the measurement accuracy of certain measured variables or to calculate the corrected volume flow for gases, the automation system can continuously write different measured values to the measuring instrument:

- Operating pressure to increase measurement accuracy (Endress+Hauser recommends the use of a pressure measuring device for absolute pressure, e.g. Cerabar M or Cerabar S)
- Medium temperature to increase measurement accuracy (e.g. iTEMP)
- Reference density for calculating the corrected volume flow for gases

 Various pressure and temperature measuring devices can be ordered from Endress +Hauser: see "Accessories" section →  194

It is recommended to read in external measured values to calculate the corrected volume flow.

Current input

The measured values are written from the automation system to the measuring device via the current input →  197.

Digital communication

The measured values are written by the automation system via FOUNDATION fieldbus.

Current input 0/4 to 20 mA

Current input	0/4 to 20 mA (active/passive)
Current span	<ul style="list-style-type: none"> ▪ 4 to 20 mA (active) ▪ 0/4 to 20 mA (passive)
Resolution	1 µA
Voltage drop	Typically: 0.6 to 2 V for 3.6 to 22 mA (passive)
Maximum input voltage	≤ 30 V (passive)
Open-circuit voltage	≤ 28.8 V (active)
Possible input variables	<ul style="list-style-type: none"> ▪ Pressure ▪ Temperature ▪ Density

Status input

Maximum input values	<ul style="list-style-type: none"> ▪ DC -3 to 30 V ▪ If status input is active (ON): $R_i > 3 \text{ k}\Omega$
Response time	Configurable: 5 to 200 ms

Input signal level	<ul style="list-style-type: none">▪ Low signal: DC -3 to +5 V▪ High signal: DC 12 to 30 V
Assignable functions	<ul style="list-style-type: none">▪ Off▪ Reset the individual totalizers separately▪ Reset all totalizers▪ Flow override

16.4 Output

Output signal

FOUNDATION Fieldbus

FOUNDATION Fieldbus	H1, IEC 61158-2, galvanically isolated
Data transfer	31.25 kbit/s
Current consumption	10 mA
Permitted supply voltage	9 to 32 V
Bus connection	With integrated reverse polarity protection

Current output 4 to 20 mA



Signal mode	Can be set to: <ul style="list-style-type: none"> ▪ Active ▪ Passive
Current range	Can be set to: <ul style="list-style-type: none"> ▪ 4 to 20 mA NAMUR ▪ 4 to 20 mA US ▪ 4 to 20 mA ▪ 0 to 20 mA (only if the signal mode is active) ▪ Fixed current
Maximum output values	22.5 mA
Open-circuit voltage	DC 28.8 V (active)
Maximum input voltage	DC 30 V (passive)
Load	0 to 700 Ω
Resolution	0.38 μA
Damping	Configurable: 0 to 999.9 s
Assignable measured variables	<ul style="list-style-type: none"> ▪ Mass flow ▪ Volume flow ▪ Corrected volume flow ▪ Density ▪ Reference density ▪ Temperature ▪ Electronics temperature ▪ Oscillation frequency 0 ▪ Oscillation damping 0 ▪ Signal asymmetry ▪ Exciter current 0 <p> The range of options increases if the measuring device has one or more application packages.</p>



Current output 4 to 20 mA Ex i passive

Order code	"Output; input 2" (21), "Output; input 3" (022): Option C: current output 4 to 20 mA Ex i passive
Signal mode	Passive
Current range	Can be set to: <ul style="list-style-type: none"> ▪ 4 to 20 mA NAMUR ▪ 4 to 20 mA US ▪ 4 to 20 mA ▪ Fixed current
Maximum output values	22.5 mA
Maximum input voltage	DC 30 V

Load	0 to 700 Ω
Resolution	0.38 μA
Damping	Configurable: 0 to 999 s
Assignable measured variables	<ul style="list-style-type: none"> ■ Mass flow ■ Volume flow ■ Corrected volume flow ■ Density ■ Reference density ■ Temperature ■ Electronics temperature ■ Oscillation frequency 0 ■ Oscillation damping 0 ■ Signal asymmetry ■ Exciter current 0 <p> The range of options increases if the measuring device has one or more application packages.</p>

Pulse/frequency/switch output

Function	Can be configured as pulse, frequency or switch output
Version	Open collector Can be set to: <ul style="list-style-type: none"> ■ Active ■ Passive ■ Passive NAMUR <p> Ex-i, passive</p>
Maximum input values	DC 30 V, 250 mA (passive)
Open-circuit voltage	DC 28.8 V (active)
Voltage drop	For 22.5 mA: ≤ DC 2 V
Pulse output	
Maximum input values	DC 30 V, 250 mA (passive)
Maximum output current	22.5 mA (active)
Open-circuit voltage	DC 28.8 V (active)
Pulse width	Configurable: 0.05 to 2 000 ms
Maximum pulse rate	10 000 Impulse/s
Pulse value	Configurable
Assignable measured variables	<ul style="list-style-type: none"> ■ Mass flow ■ Volume flow ■ Corrected volume flow <p> The range of options increases if the measuring device has one or more application packages.</p>
Frequency output	
Maximum input values	DC 30 V, 250 mA (passive)
Maximum output current	22.5 mA (active)
Open-circuit voltage	DC 28.8 V (active)
Output frequency	Configurable: end value frequency 2 to 10 000 Hz (f _{max} = 12 500 Hz)
Damping	Configurable: 0 to 999.9 s
Pulse/pause ratio	1:1

Assignable measured variables	<ul style="list-style-type: none"> ■ Mass flow ■ Volume flow ■ Corrected volume flow ■ Density ■ Reference density ■ Temperature ■ Electronics temperature ■ Oscillation frequency 0 ■ Oscillation damping 0 ■ Signal asymmetry ■ Exciter current 0 <p> The range of options increases if the measuring device has one or more application packages.</p>
Switch output	
Maximum input values	DC 30 V, 250 mA (passive)
Open-circuit voltage	DC 28.8 V (active)
Switching behavior	Binary, conductive or non-conductive
Switching delay	Configurable: 0 to 100 s
Number of switching cycles	Unlimited
Assignable functions	<ul style="list-style-type: none"> ■ Disable ■ On ■ Diagnostic behavior ■ Limit <ul style="list-style-type: none"> ■ Mass flow ■ Volume flow ■ Corrected volume flow ■ Density ■ Reference density ■ Temperature ■ Totalizer 1-3 ■ Flow direction monitoring ■ Status <ul style="list-style-type: none"> ■ Partially filled pipe detection ■ Low flow cut off <p> The range of options increases if the measuring device has one or more application packages.</p>

Relay output

Function	Switch output
Version	Relay output, galvanically isolated
Switching behavior	Can be set to: <ul style="list-style-type: none"> ■ NO (normally open), factory setting ■ NC (normally closed)

Maximum switching capacity (passive)	<ul style="list-style-type: none"> ▪ DC 30 V, 0.1 A ▪ AC 30 V, 0.5 A
Assignable functions	<ul style="list-style-type: none"> ▪ Disable ▪ On ▪ Diagnostic behavior ▪ Limit <ul style="list-style-type: none"> ▪ Mass flow ▪ Volume flow ▪ Corrected volume flow ▪ Density ▪ Reference density ▪ Temperature ▪ Totalizer 1-3 ▪ Flow direction monitoring ▪ Status <ul style="list-style-type: none"> ▪ Partially filled pipe detection ▪ Low flow cut off <p> The range of options increases if the measuring device has one or more application packages.</p>

User-configurable input/output

One specific input or output is assigned to a user-configurable input/output (configurable I/O) during device commissioning.

The following inputs and outputs are available for assignment:

- Choice of current output: 4 to 20 mA (active), 0/4 to 20 mA (passive)
- Pulse/frequency/switch output
- Choice of current input: 4 to 20 mA (active), 0/4 to 20 mA (passive)
- Status input

Signal on alarm

Depending on the interface, failure information is displayed as follows:

FOUNDATION Fieldbus

Status and alarm messages	Diagnostics in accordance with FF-891
Failure current FDE (Fault Disconnection Electronic)	0 mA

Current output 0/4 to 20 mA

4 to 20 mA

Failure mode	Choose from: <ul style="list-style-type: none"> ▪ 4 to 20 mA in accordance with NAMUR recommendation NE 43 ▪ 4 to 20 mA in accordance with US ▪ Min. value: 3.59 mA ▪ Max. value: 22.5 mA ▪ Definable value between: 3.59 to 22.5 mA ▪ Actual value ▪ Last valid value
---------------------	---

0 to 20 mA

Failure mode	Choose from: <ul style="list-style-type: none"> ▪ Maximum alarm: 22 mA ▪ Definable value between: 0 to 20.5 mA
---------------------	--

Pulse/frequency/switch output

Pulse output	
Fault mode	Choose from: <ul style="list-style-type: none"> ▪ Actual value ▪ No pulses
Frequency output	
Fault mode	Choose from: <ul style="list-style-type: none"> ▪ Actual value ▪ 0 Hz ▪ Definable value between: 2 to 12 500 Hz
Switch output	
Fault mode	Choose from: <ul style="list-style-type: none"> ▪ Current status ▪ Open ▪ Closed

Relay output

Failure mode	Choose from: <ul style="list-style-type: none"> ▪ Current status ▪ Open ▪ Closed
---------------------	---

Local display

Plain text display	With information on cause and remedial measures
Backlight	Red lighting indicates a device error.

 Status signal as per NAMUR recommendation NE 107

Interface/protocol



- Via digital communication: FOUNDATION Fieldbus
- Via service interface
 - CDI-RJ45 service interface
 - WLAN interface

Plain text display	With information on cause and remedial measures
---------------------------	---

Web browser

Plain text display	With information on cause and remedial measures
---------------------------	---

Light emitting diodes (LED)

Status information	Status indicated by various light emitting diodes The following information is displayed depending on the device version: <ul style="list-style-type: none"> ▪ Supply voltage active ▪ Data transmission active ▪ Device alarm/error has occurred  Diagnostic information via light emitting diodes →  150
---------------------------	--

Low flow cut off The switch points for low flow cut off are user-selectable.

Galvanic isolation The outputs are galvanically isolated:

- from the power supply
- from one another
- from the potential equalization (PE) terminal

protocol-specific data

Manufacturer ID	0x452B48 (hex)
Ident number	0x103B (hex)
Device revision	1
DD revision	Information and files under:
CFF revision	<ul style="list-style-type: none"> ■ www.endress.com ■ www.fieldcommgroup.org
Interoperability Test Kit (ITK)	Version 6.2.0
ITK Test Campaign Number	Information: <ul style="list-style-type: none"> ■ www.endress.com ■ www.fieldcommgroup.org
Link Master capability (LAS)	Yes
Choice of "Link Master" and "Basic Device"	Yes Factory setting: Basic Device
Node address	Factory setting: 247 (0xF7)
Supported functions	The following methods are supported: <ul style="list-style-type: none"> ■ Restart ■ ENP Restart ■ Diagnostic ■ Set to OOS ■ Set to AUTO ■ Read trend data ■ Read event logbook
Virtual Communication Relationships (VCRs)	
Number of VCRs	44
Number of link objects in VFD	50
Permanent entries	1
Client VCRs	0
Server VCRs	10
Source VCRs	43
Sink VCRs	0
Subscriber VCRs	43
Publisher VCRs	43
Device Link Capabilities	
Slot time	4
Min. delay between PDU	8
Max. response delay	16
System integration	Information regarding system integration →  71. <ul style="list-style-type: none"> ■ Cyclic data transmission ■ Description of the modules ■ Execution times ■ Methods

16.5 Power supply

Terminal assignment →  33

Available device plugs →  33

Available device plugs →  33

Supply voltage	Order code "Power supply"		Terminal voltage		Frequency range
	Option D		DC 24 V	±20%	–
Option E		AC 100 to 240 V	–15...+10%	50/60 Hz	
Option I		DC 24 V	±20%	–	
		AC 100 to 240 V	–15...+10%	50/60 Hz	

Power consumption

Transmitter

Max. 10 W (active power)

switch-on current	Max. 36 A (<5 ms) as per NAMUR Recommendation NE 21
-------------------	---

Current consumption

Transmitter

- Max. 400 mA (24 V)
- Max. 200 mA (110 V, 50/60 Hz; 230 V, 50/60 Hz)

Power supply failure

- Totalizers stop at the last value measured.
- Depending on the device version, the configuration is retained in the device memory or in the pluggable data memory (HistoROM DAT).
- Error messages (incl. total operated hours) are stored.

Overcurrent protection element

The device must be operated with a dedicated circuit breaker, as it does not have an ON/OFF switch of its own.

- The circuit breaker must be easy to reach and labeled accordingly.
- Permitted nominal current of the circuit breaker: 2 A up to maximum 10 A.

Electrical connection →  35

Potential equalization →  38

Terminals



Spring-loaded terminals: Suitable for strands and strands with ferrules.
Conductor cross-section 0.2 to 2.5 mm² (24 to 12 AWG).

- Cable entries
- Cable gland: M20 × 1.5 with cable Ø 6 to 12 mm (0.24 to 0.47 in)
 - Thread for cable entry:
 - NPT ½"
 - G ½"
 - M20
 - Device plug for digital communication: M12

Cable specification →  30

Overvoltage protection	Mains voltage fluctuations	→  205
	Overvoltage category	Overvoltage category II
	Short-term, temporary overvoltage	Between cable and ground up to 1200 V, for max. 5 s
	Long-term, temporary overvoltage	Between cable and ground up to 500 V

16.6 Performance characteristics

- Reference operating conditions
- Error limits based on ISO 11631
 - Water
 - +15 to +45 °C (+59 to +113 °F)
 - 2 to 6 bar (29 to 87 psi)
 - Data as indicated in the calibration protocol
 - Accuracy based on accredited calibration rigs according to ISO 17025
-  To obtain measured errors, use the *Applicator* sizing tool →  193

Maximum measurement error o.r. = of reading; 1 g/cm³ = 1 kg/l; T = medium temperature

Base accuracy

 Design fundamentals →  209

Mass flow and volume flow (liquids)

- ±0.05 % o.r. (optional for mass flow: PremiumCal; order code for "Calibration flow", option D)
- ±0.10 % o.r. (standard)

Mass flow (gases)

±0.35 % o.r.

Density (liquids)

Under reference conditions [g/cm ³]	Standard density calibration [g/cm ³]	Extended density calibration ^{1) 2)} [g/cm ³]
±0.0005	±0.0005	±0.0005

1) Valid range for extended density calibration: 0 to 2 g/cm³, +20 to +60 °C (+68 to +140 °F)
 2) order code for "Application package", option E1 "Extended density"

Temperature

±0.5 °C ± 0.005 · T °C (±0.9 °F ± 0.003 · (T - 32) °F)

Zero point stability

DN		Zero point stability	
[mm]	[in]	[kg/h]	[lb/min]
300	12	137	5.03
350	14	137	5.03
400	16	137	5.03

Flow values

Flow values as turndown parameters depending on nominal diameter.

SI units

DN	1:1	1:10	1:20	1:50	1:100	1:500
[mm]	[kg/h]	[kg/h]	[kg/h]	[kg/h]	[kg/h]	[kg/h]
300	4 100 000	410 000	205 000	82 000	41 000	8 200
350	4 100 000	410 000	205 000	82 000	41 000	8 200
400	4 100 000	410 000	205 000	82 000	41 000	8 200

US units

DN	1:1	1:10	1:20	1:50	1:100	1:500
[inch]	[lb/min]	[lb/min]	[lb/min]	[lb/min]	[lb/min]	[lb/min]
12	150 700	15 070	7 535	3 014	1 507	301.4
14	150 700	15 070	7 535	3 014	1 507	301.4
16	150 700	15 070	7 535	3 014	1 507	301.4

Accuracy of outputs

The outputs have the following base accuracy specifications.

Current output

Accuracy	±5 µA
----------	-------

Pulse/frequency output

o.r. = of reading

Accuracy	Max. ±50 ppm o.r. (over the entire ambient temperature range)
----------	---

Repeatability

o.r. = of reading; 1 g/cm³ = 1 kg/l; T = medium temperature

Base repeatability

 Design fundamentals → 209

Mass flow and volume flow (liquids)

±0.025 % o.r. (PremiumCal)

±0.05 % o.r.

Mass flow (gases)

±0.25 % o.r.

Density (liquids)

±0.00025 g/cm³

Temperature

±0.25 °C ± 0.0025 · T °C (±0.45 °F ± 0.0015 · (T-32) °F)

Response time

The response time depends on the configuration (damping).

Influence of ambient temperature

Current output

Temperature coefficient	Max. 1 µA/°C
-------------------------	--------------

Pulse/frequency output

Temperature coefficient	No additional effect. Included in accuracy.
-------------------------	---

Influence of medium temperature

Mass flow

o.f.s. = of full scale value

If there is a difference between the temperature during zero adjustment and the process temperature, the additional measurement error of the sensors is typically ±0.0002 %o.f.s./°C (±0.0001 % o. f.s./°F).

The influence is reduced when the zero adjustment is performed at process temperature.

Density

If there is a difference between the density calibration temperature and the process temperature, the measurement error of the sensors is typically ±0.00005 g/cm³/°C (±0.000025 g/cm³/°F). Field density adjustment is possible.

Extended density specification

If the process temperature is outside the valid range (→ ☰ 206) the measurement error is ±0.000025 g/cm³ /°C (±0.0000125 g/cm³ /°F)

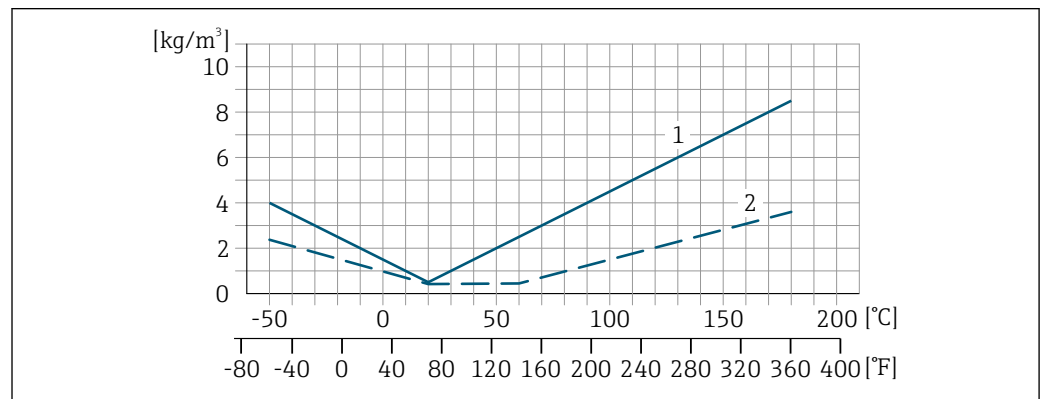

- 1 Field density adjustment, for example at +20 °C (+68 °F)
- 2 Extended density calibration

Temperature

±0.005 · T °C (± 0.005 · (T - 32) °F)

Influence of medium pressure

The following shows how the process pressure (gauge pressure) affects the accuracy of the mass flow.

o.r. = of reading



It is possible to compensate for the effect by:

- Reading in the current pressure measured value via the current input or a digital input.
- Specifying a fixed value for the pressure in the device parameters.



Operating Instructions .

DN		[% o.r./bar]	[% o.r./psi]
[mm]	[in]		
300	12	-0.009	-0.0006
350	14	-0.009	-0.0006
400	16	-0.009	-0.0006

Design fundamentals

o.r. = of reading, o.f.s. = of full scale value

BaseAccu = base accuracy in % o.r., BaseRepeat = base repeatability in % o.r.

MeasValue = measured value; ZeroPoint = zero point stability

Calculation of the maximum measured error as a function of the flow rate

Flow rate	Maximum measured error in % o.r.
$\geq \frac{\text{ZeroPoint}}{\text{BaseAccu}} \cdot 100$ <small>A0021332</small>	$\pm \text{BaseAccu}$ <small>A0021339</small>
$< \frac{\text{ZeroPoint}}{\text{BaseAccu}} \cdot 100$ <small>A0021333</small>	$\pm \frac{\text{ZeroPoint}}{\text{MeasValue}} \cdot 100$ <small>A0021334</small>

Calculation of the maximum repeatability as a function of the flow rate

Flow rate	Maximum repeatability in % o.r.
$\geq \frac{1/2 \cdot \text{ZeroPoint}}{\text{BaseRepeat}} \cdot 100$ <small>A0021335</small>	$\pm \text{BaseRepeat}$ <small>A0021340</small>
$< \frac{1/2 \cdot \text{ZeroPoint}}{\text{BaseRepeat}} \cdot 100$ <small>A0021336</small>	$\pm 1/2 \cdot \frac{\text{ZeroPoint}}{\text{MeasValue}} \cdot 100$ <small>A0021337</small>

Example of maximum measurement error

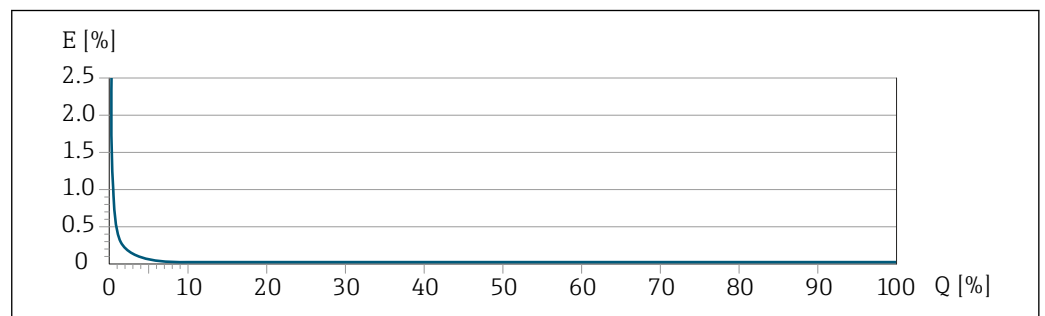

E Maximum measurement error in % o.r. (example with PremiumCal)
 Q Flow rate in % of maximum full scale value



16.7 Mounting

Mounting requirements →  20

16.8 Environment

Ambient temperature range →  22

Temperature tables

-  Observe the interdependencies between the permitted ambient and fluid temperatures when operating the device in hazardous areas.
-  For detailed information on the temperature tables, see the separate document entitled "Safety Instructions" (XA) for the device.

Storage temperature

Climate class DIN EN 60068-2-38 (test Z/AD)

Relative humidity The device is suitable for use outdoors and indoors with a relative humidity of 4 to 95 %.

Operating height According to EN 61010-1

- ≤ 2 000 m (6 562 ft)
- > 2 000 m (6 562 ft) with additional overvoltage protection (e.g. Endress+Hauser HAW Series)

Degree of protection **Transmitter**

- IP66/67, Type 4X enclosure, suitable for pollution degree 4
- When the housing is open: IP20, Type 1 enclosure, suitable for pollution degree 2
- Display module: IP20, Type 1 enclosure, suitable for pollution degree 2

Optional

Order code for "Sensor options", option CM "IP69"

External WLAN antenna

IP67

Shock and vibration resistance **Vibration sinusoidal, in accordance with IEC 60068-2-6**

- 2 to 8.4 Hz, 3.5 mm peak
- 8.4 to 2 000 Hz, 1 g peak



Vibration broad-band random, according to IEC 60068-2-64

- 10 to 200 Hz, 0.003 g²/Hz
- 200 to 2 000 Hz, 0.001 g²/Hz
- Total: 1.54 g rms



Shock half-sine, according to IEC 60068-2-27

6 ms 30 g

Rough handling shocks according to IEC 60068-2-31

Mechanical load	<p>Transmitter housing:</p> <ul style="list-style-type: none"> ■ Protect against mechanical effects, such as shock or impact ■ Do not use as a ladder or climbing aid
Electromagnetic compatibility (EMC)	<p> Details are provided in the Declaration of Conformity.</p> <p> This unit is not intended for use in residential environments and cannot guarantee adequate protection of the radio reception in such environments.</p>

16.9 Process

Medium temperature range	-50 to +180 °C (-58 to +356 °F)
Pressure-temperature ratings	<p> For an overview of the pressure-temperature ratings for the process connections, see the Technical Information</p>
Sensor housing	<p>The sensor housing is filled with dry nitrogen gas and protects the electronics and mechanics inside.</p> <p> If a measuring tube fails (e.g. due to process characteristics like corrosive or abrasive fluids), the fluid will initially be contained by the sensor housing.</p> <p>In the event of a tube failure, the pressure level inside the sensor housing will rise according to the operating process pressure. If the user judges that the sensor housing burst pressure does not provide an adequate safety margin, the device can be fitted with a rupture disk. This prevents excessively high pressure from forming inside the sensor housing. Therefore, the use of a rupture disk is strongly recommended in applications involving high gas pressures, and particularly in applications in which the process pressure is greater than 2/3 of the sensor housing burst pressure.</p> <p>If there is a need to drain the leaking medium into a discharge device, the sensor should be fitted with a rupture disk. Connect the discharge to the additional threaded connection .</p> <p>If the sensor is to be purged with gas (gas detection), it should be equipped with purge connections.</p> <p> Do not open the purge connections unless the containment can be filled immediately with a dry, inert gas. Use only low pressure to purge.</p> <p style="padding-left: 40px;">Maximum pressure: 2 bar (29.0 psi)</p>

Burst pressure of the sensor housing

The following sensor housing burst pressures are only valid for standard devices and/or devices equipped with closed purge connections (not opened/as delivered).

If a device fitted with purge connections (order code for "Sensor option", option CH "Purge connection") is connected to the purge system, the maximum pressure is determined by the purge system itself or by the device, depending on which component has the lower pressure classification.

If the device is fitted with a rupture disk (order code for "Sensor option", option CA "Rupture disk"), the rupture disk trigger pressure is decisive .

The sensor housing burst pressure refers to a typical internal pressure which is reached prior to mechanical failure of the sensor housing and which was determined during type testing. The corresponding type test declaration can be ordered with the device (order code for "Additional approval", option LN "Sensor housing burst pressure, type test").

DN		Sensor housing burst pressure	
[mm]	[in]	[bar]	[psi]
300	12	28	406
350	14	28	406
400	16	28	406

 For information on the dimensions: see the "Mechanical construction" section of the "Technical Information" document

Rupture disk

To increase the level of safety, a device version with a rupture disk with a trigger pressure of 5.5 to 6.5 bar (80 to 94 psi) can be used (order code for "Sensor option", option CA "rupture disk").



 For information on the dimensions of the rupture disk: see the "Mechanical construction" section of the "Technical Information" document

Flow limit



Select the nominal diameter by optimizing between the required flow range and permissible pressure loss.

 For an overview of the full scale values for the measuring range, see the "Measuring range" section →  196

- The minimum recommended full scale value is approx. 1/20 of the maximum full scale value
- In most applications, 20 to 50 % of the maximum full scale value can be considered ideal
- A low full scale value must be selected for abrasive media (such as liquids with entrained solids): flow velocity < 1 m/s (< 3 ft/s).
- For gas measurement the following rules apply:
 - The flow velocity in the measuring tubes should not exceed half the sound velocity (0.5 Mach).
 - The maximum mass flow depends on the density of the gas: formula

 To calculate the flow limit, use the *Applicator* sizing tool →  193

Pressure loss

 To calculate the pressure loss, use the *Applicator* sizing tool →  193

System pressure

→  22

16.10 Mechanical construction

Design, dimensions

 For the dimensions and installation lengths of the device, see the "Technical Information" document, "Mechanical construction" section

Weight

All values (weight exclusive of packaging material) refer to devices with ASME B16.5 Class 150 flanges. Weight specifications including transmitter as per order code for "Housing", option A "Aluminum, coated".

Different values due to different transmitter versions:

- Transmitter version for the hazardous area
(Order code for "Housing", option A "Aluminum, coated"; Ex d): +2 kg (+4.4 lbs)
- Cast transmitter version, stainless
(Order code for "Housing", option L "Cast, stainless"): +6 kg (+13 lbs)

Weight in SI units

DN [mm]	Weight [kg]
300	553
350	577
400	601

Weight in US units

DN [in]	Weight [lbs]
12	1219
14	1272
16	1325

Materials

Transmitter housing

Order code for "Housing":

- Option **A** "Aluminum, coated": aluminum, AlSi10Mg, coated
- Option **L** "Cast, stainless": cast, stainless steel, 1.4409 (CF3M) similar to 316L

Window material

Order code for "Housing":

- Option **A** "Aluminum, coated": glass
- Option **L** "Cast, stainless": glass

Cable entries/cable glands

Order code for "Housing", option A "Aluminum, coated"

The various cable entries are suitable for hazardous and non-hazardous areas.

Cable entry/cable gland	Material
Compression fitting M20 × 1.5	Non-Ex: plastic
	Z2, D2, Ex d/de: brass with plastic
Adapter for cable entry with female thread G ½"	Nickel-plated brass
Adapter for cable entry with female thread NPT ½"	

Order code for "Housing", option L "Cast, stainless"

The various cable entries are suitable for hazardous and non-hazardous areas.

Cable entry/cable gland	Material
Cable gland M20 × 1.5	Stainless steel, 1.4404 (316L)
Adapter for cable entry with female thread G ½"	
Adapter for cable entry with female thread NPT ½"	

Device plug

Electrical connection	Material
Plug M12×1	<ul style="list-style-type: none"> ■ Socket: Stainless steel, 1.4404 (316L) ■ Contact housing: Polyamide ■ Contacts: Gold-plated brass

Sensor housing



- Acid and alkali-resistant outer surface
- Stainless steel, 1.4404 (316L)

Measuring tubes

Stainless steel, 1.4404 (316/316L);
 Manifold: stainless steel, 1.4404 (316/316L)

Process connections

Flanges in accordance with EN 1092-1 (DIN2501) / ASME B 16.5:
 Stainless steel, 1.4404 (F316/F316L)

 Available process connections →  214

Seals

Welded process connections without internal seals

Accessories

Protective cover

Stainless steel, 1.4404 (316L)



External WLAN antenna

- Antenna: ASA plastic (acrylonitrile styrene acrylate) and nickel-plated brass
- Adapter: Stainless steel and nickel-plated brass
- Cable: Polyethylene
- Plug: Nickel-plated brass
- Angle bracket: Stainless steel

Process connections

Fixed flange connections:

- EN 1092-1 (DIN 2501) flange
- EN 1092-1 (DIN 2512N) flange
- ASME B16.5 flange



 Process connection materials →  214

Surface roughness	All data refer to parts in contact with the medium. The following surface roughness categories can be ordered: Not polished
-------------------	---

16.11 Operability

Languages	Can be operated in the following languages: <ul style="list-style-type: none"> ■ Via local operation English, German, French, Spanish, Italian, Dutch, Portuguese, Polish, Russian, Turkish, Chinese, Japanese, Korean, Vietnamese, Czech, Swedish ■ Via web browser English, German, French, Spanish, Italian, Dutch, Portuguese, Polish, Russian, Turkish, Chinese, Japanese, Vietnamese, Czech, Swedish ■ Via "FieldCare", "DeviceCare" operating tool: English, German, French, Spanish, Italian, Chinese, Japanese
-----------	--

Onsite operation	<p>Via display module</p> <p>Features:</p> <ul style="list-style-type: none"> ■ Order code for "Display; operation", option F "4-line, illuminated, graphic display; touch control" ■ Order code for "Display; operation", option G "4-line, illuminated, graphic display; touch control + WLAN"
------------------	---

 Information about WLAN interface →  66

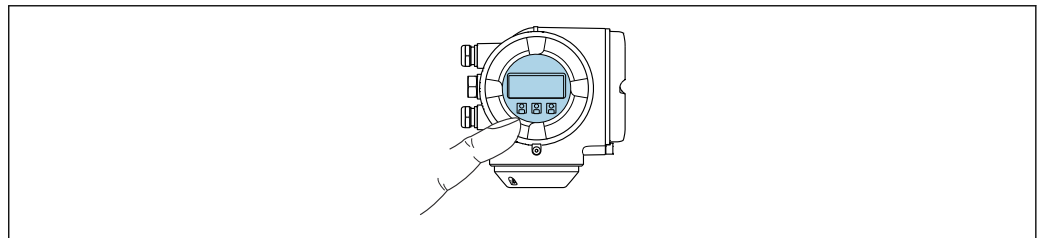



 34 Operation with touch control



Display elements

- 4-line, illuminated, graphic display
- White background lighting; switches to red in event of device errors
- Format for displaying measured variables and status variables can be individually configured

Operating elements

- External operation via touch control (3 optical keys) without opening the housing: , , 
- Operating elements also accessible in the various zones of the hazardous area

Via remote display and operating module DKX001

 The remote display and operating module DKX001 is available as an optional extra →  192..

- The measuring instrument is always supplied with a dummy cover when the remote display and operating module DKX001 is ordered directly with the measuring instrument. Display or operation at the transmitter is not possible in this case.
- If ordered subsequently, the remote display and operating module DKX001 may not be connected at the same time as the existing measuring instrument display module. Only one display or operation unit may be connected to the transmitter at any one time.

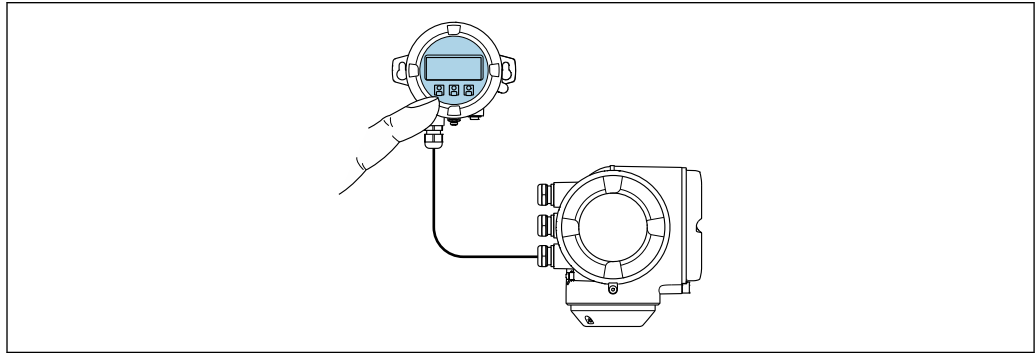

A0026786

 35 Operation via remote display and operating module DKX001

Display and operating elements

The display and operating elements correspond to those of the display module →  215.

Housing material

The housing material of the display and operating module DKX001 depends on the choice of transmitter housing material.

Transmitter housing		Remote display and operating module
Order code for "Housing"	Material	Material
Option A "Aluminum, coated"	AlSi10Mg, coated	AlSi10Mg, coated
Option L "Cast, stainless"	Cast stainless steel, 1.4409 (CF3M) similar to 316L	1.4409 (CF3M)

Cable entry

Corresponds to the choice of transmitter housing, order code for "Electrical connection".

Connecting cable

→  31





Dimensions

 Information on the dimensions:
"Mechanical construction" section of the "Technical Information" document.

Remote operation →  65

Service interface →  65

Supported operating tools Different operating tools can be used for local or remote access to the measuring device. Depending on the operating tool used, access is possible with different operating units and via a variety of interfaces.

Supported operating tools	Operating unit	Interface	Additional information
Web browser	Notebook, PC or tablet with Web browser	<ul style="list-style-type: none"> ▪ CDI-RJ45 service interface ▪ WLAN interface 	Special Documentation for device →  225
DeviceCare SFE100	Notebook, PC or tablet with Microsoft Windows system	<ul style="list-style-type: none"> ▪ CDI-RJ45 service interface ▪ WLAN interface ▪ Fieldbus protocol 	→  193
FieldCare SFE500	Notebook, PC or tablet with Microsoft Windows system	<ul style="list-style-type: none"> ▪ CDI-RJ45 service interface ▪ WLAN interface ▪ Fieldbus protocol 	→  193
Field Xpert	SMT70/77/50	<ul style="list-style-type: none"> ▪ All fieldbus protocols ▪ WLAN interface ▪ Bluetooth ▪ CDI-RJ45 service interface 	Operating Instructions BA01202S Device description files: Use update function of handheld terminal
SmartBlue app	Smartphone or tablet with iOS or Android	WLAN	→  193



Other operating tools based on FDT technology with a device driver such as DTM/iDTM or DD/EDD can be used for device operation. These operating tools are available from the individual manufacturers. Integration into the following operating tools, among others, is supported:

- FactoryTalk AssetCentre (FTAC) from Rockwell Automation → www.rockwellautomation.com
- Asset Management Solutions (AMS) from Emerson → www.emersonprocess.com
- FieldCommunicator 375/475 from Emerson → www.emersonprocess.com
- Field Device Manager (FDM) from Honeywell → www.process.honeywell.com
- FieldMate from Yokogawa → www.yokogawa.com
- PACTWare → www.pactware.com

The related device description files are available: www.endress.com → Download Area

Web server



With the integrated web server, the device can be operated and configured via a web browser service interface (CDI-RJ45) or WLAN interface. The structure of the operating menu is the same as for the local display. In addition to the measured values, status information on the device is displayed and can be used to monitor device health. Furthermore the device data can be managed and the network parameters can be configured.

A device that has a WLAN interface (can be ordered as an option) is required for the WLAN connection: order code for "Display; operation", option G "4-line, illuminated; touch control + WLAN". The device acts as an Access Point and enables communication by computer or a mobile handheld terminal.

Supported functions

Data exchange between the operating unit (such as a notebook, for example,) and measuring instrument:

- Upload the configuration from the measuring instrument (XML format, configuration backup)
- Save the configuration to the measuring instrument (XML format, restore configuration)
- Export event list (.csv file)

- Export parameter settings (.csv file or PDF file, document the measuring point configuration)
- Export the Heartbeat Technology verification report (PDF file, only available with the **Heartbeat Verification** →  2.2.2 application package)
- Flash firmware version for device firmware upgrade, for example
- Download driver for system integration
- Visualize up to 1000 saved measured values (only available with the **Extended HistoROM** application package →  2.2.2)

HistoROM data management

The measuring device features HistoROM data management. HistoROM data management comprises both the storage and import/export of key device and process data, making operation and servicing far more reliable, secure and efficient.

 When the device is delivered, the factory settings of the configuration data are stored as a backup in the device memory. This memory can be overwritten with an updated data record, for example after commissioning.

Additional information on the data storage concept

There are different types of data storage units in which device data are stored and used by the device:

	HistoROM backup	T-DAT	S-DAT
Available data	<ul style="list-style-type: none"> ■ Event logbook, e.g. diagnostic events ■ Parameter data record backup ■ Device firmware package ■ Driver for system integration for exporting via web server, e.g.: DD for FOUNDATION Fieldbus 	<ul style="list-style-type: none"> ■ Measured value logging ("Extended HistoROM" order option) ■ Current parameter data record (used by firmware at run time) ■ Indicator (minimum/maximum values) ■ Totalizer value 	<ul style="list-style-type: none"> ■ Sensor data: e.g. nominal diameter ■ Serial number ■ Calibration data ■ Device configuration (e.g. SW options, fixed I/O or multi I/O)
Storage location	Fixed on the user interface PC board in the connection compartment	Can be plugged into the user interface PC board in the connection compartment	In the sensor plug in the transmitter neck part

Data backup

Automatic

- The most important device data (sensor and transmitter) are automatically saved in the DAT modules
- If the transmitter or measuring device is replaced: once the T-DAT containing the previous device data has been exchanged, the new measuring device is ready for operation again immediately without any errors
- If exchanging the electronics module (e.g. I/O electronics module): Once the electronics module has been replaced, the software of the module is compared against the current device firmware. The module software is upgraded or downgraded where necessary. The electronics module is available for use immediately afterwards and no compatibility problems occur.

Manual

Additional parameter data record (complete parameter settings) in the integrated device memory HistoROM backup for:

- Data backup function
Backup and subsequent restoration of a device configuration in the device memory HistoROM backup
- Data comparison function
Comparison of the current device configuration with the device configuration saved in the device memory HistoROM backup

Data transmission**Manual**

- Transfer of a device configuration to another device using the export function of the specific operating tool, e.g. with FieldCare, DeviceCare or Web server: to duplicate the configuration or to store in an archive (e.g. for backup purposes)
- Transmission of the drivers for system integration via Web server, e.g.: DD for FOUNDATION Fieldbus

Event list**Automatic**

- Chronological display of up to 20 event messages in the events list
- If the **Extended HistoROM** application package (order option) is enabled: up to 100 event messages are displayed in the events list along with a time stamp, plain text description and remedial measures
- The events list can be exported and displayed via a variety of interfaces and operating tools e.g. DeviceCare, FieldCare or Web server

Data logging**Manual**

If the **Extended HistoROM** application package (order option) is enabled:

- Recording of 1 to 4 channels of up to 1 000 measured values (up to 250 measured values per channel)
- User configurable recording interval
- Export the measured value log via a variety of interfaces and operating tools e.g. FieldCare, DeviceCare or web server

16.12 Certificates and approvals

Current certificates and approvals for the product are available at www.endress.com on the relevant product page:

1. Select the product using the filters and search field.
2. Open the product page.
3. Select **Downloads**.

CE mark	<p>The device meets the legal requirements of the applicable EU Directives. These are listed in the corresponding EU Declaration of Conformity along with the standards applied.</p> <p>Endress+Hauser confirms successful testing of the device by affixing to it the CE mark.</p>
UKCA marking	<p>The device meets the legal requirements of the applicable UK regulations (Statutory Instruments). These are listed in the UKCA Declaration of Conformity along with the designated standards. By selecting the order option for UKCA marking, Endress+Hauser confirms a successful evaluation and testing of the device by affixing the UKCA mark.</p> <p>Contact address Endress+Hauser UK: Endress+Hauser Ltd. Floats Road Manchester M23 9NF United Kingdom www.uk.endress.com</p>
RCM marking	<p>The measuring system meets the EMC requirements of the "Australian Communications and Media Authority (ACMA)".</p>

FOUNDATION Fieldbus certification

FOUNDATION Fieldbus interface

The measuring device is certified and registered by the FieldComm Group. The measuring system meets all the requirements of the following specifications:



- Certified in accordance with FOUNDATION Fieldbus H1
- Interoperability Test Kit (ITK), revision version 6.2.0 (certificate available on request)
- Physical Layer Conformance Test
- The device can also be operated with certified devices of other manufacturers (interoperability)

Pressure Equipment Directive

- With the marking
 - a) PED/G1/x (x = category) or
 - b) PESR/G1/x (x = category)
 on the sensor nameplate, Endress+Hauser confirms compliance with the "Essential Safety Requirements"
 - a) specified in Annex I of the Pressure Equipment Directive 2014/68/EU or
 - b) Schedule 2 of Statutory Instruments 2016 No. 1105.
- Devices not bearing this marking (without PED or PESR) are designed and manufactured according to sound engineering practice. They meet the requirements of
 - a) Art. 4 Para. 3 of the Pressure Equipment Directive 2014/68/EU or
 - b) Part 1, Para. 8 of Statutory Instruments 2016 No. 1105.
 The scope of application is indicated
 - a) in diagrams 6 to 9 in Annex II of the Pressure Equipment Directive 2014/68/EU or
 - b) Schedule 3, Para. 2 of Statutory Instruments 2016 No. 1105.

Radio approval

The measuring device has radio approval.

 For detailed information on the radio approval, see the Special Documentation →  225

Additional certification

CRN approval

Some device versions have CRN approval. A CRN-approved process connection with a CSA approval must be ordered for a CRN-approved device.

Tests and certificates

- ISO 23277 ZG2x (PT)+ISO 10675-1 ZG1 (RT) measuring pipe (PT) + process connection (RT) weld seam, Heartbeat Technology verification report
- Penetrant + radiographic testing ASME B31.3 NFS(RT) measuring pipe (PT) + process connection (RT) weld seam, Heartbeat Technology verification report
- Penetrant + radiographic testing ASME VIII Div.1(RT) measuring pipe (PT) + process connection (RT) weld seam, Heartbeat Technology verification report
- Visual+penetrant+radiographic testing NORSOK M-601 (RT) measuring pipe (VT+PT) +process connection (VT+RT) weld seam, Heartbeat Technology verification report

Testing of welded connections

Option	Test standard				Component	
	ISO 23277 AL2x (PT) ISO 10675-1 AL1 (RT, DR)	ASME B31.3 NFS	ASME VIII Div.1 Appx. 4+8	NORSOK M-601	Measuring pipe	Process connection
KF	x				PT	RT
KK		x			PT	RT
KP			x		PT	RT

Option	Test standard				Component	
	ISO 23277 AL2x (PT) ISO 10675-1 AL1 (RT, DR)	ASME B31.3 NFS	ASME VIII Div.1 Appx. 4+8	NORSOK M-601	Measuring pipe	Process connection
KR				x	VT, PT	VT, RT
PT = penetrant testing, RT = radiographic testing, VT = visual testing All options with test report						



External standards and guidelines

- EN 60529
Degrees of protection provided by enclosures (IP code)
- IEC/EN 60068-2-6
Environmental influences: Test procedure - Test Fc: vibrate (sinusoidal).
- IEC/EN 60068-2-31
Environmental influences: Test procedure - Test Ec: shocks due to rough handling, primarily for devices.
- EN 61010-1
Safety requirements for electrical equipment for measurement, control and laboratory use - general requirements
- EN 61326-1/-2-3
EMC requirements for electrical equipment for measurement, control and laboratory use
- NAMUR NE 21
Electromagnetic compatibility (EMC) of industrial process and laboratory control equipment
- NAMUR NE 32
Data retention in the event of a power failure in field and control instruments with microprocessors
- NAMUR NE 43
Standardization of the signal level for the breakdown information of digital transmitters with analog output signal.
- NAMUR NE 53
Software of field devices and signal-processing devices with digital electronics
- NAMUR NE 80
The application of the pressure equipment directive to process control devices
- NAMUR NE 105
Specifications for integrating fieldbus devices in engineering tools for field devices
- NAMUR NE 107
Self-monitoring and diagnosis of field devices
- NAMUR NE 131
Requirements for field devices for standard applications
- NAMUR NE 132
Coriolis mass meter
- NACE MR0103
Materials resistant to sulfide stress cracking in corrosive petroleum refining environments.
- NACE MR0175/ISO 15156-1
Materials for use in H₂S-containing Environments in Oil and Gas Production.
- ETSI EN 300 328
Guidelines for 2.4 GHz radio components.
- EN 301489
Electromagnetic compatibility and radio spectrum matters (ERM).

16.13 Application packages

Many different application packages are available to enhance the functionality of the device. Such packages might be needed to address safety aspects or specific application requirements.

The application packages can be ordered with the device or subsequently from Endress+Hauser. Detailed information on the order code in question is available from your local Endress+Hauser sales center or on the product page of the Endress+Hauser website: www.endress.com.

 Detailed information on the application packages:
Special Documentation →  224

Diagnostic functionality

Order code for "Application package", option EA "Extended HistoROM"

Comprises extended functions concerning the event log and the activation of the measured value memory.

Event log:

Memory volume is extended from 20 message entries (standard version) to up to 100 entries.

Data logging (line recorder):

- Memory capacity for up to 1000 measured values is activated.
- 250 measured values can be output via each of the 4 memory channels. The recording interval can be defined and configured by the user.
- Measured value logs can be accessed via the local display or operating tool e.g. FieldCare, DeviceCare or Web server.

 For detailed information, see the Operating Instructions for the device.

Heartbeat Technology

Order code for "Application package", option EB "Heartbeat Verification + Monitoring"

Heartbeat Verification

Meets the requirement for traceable verification to DIN ISO 9001:2008 Chapter 7.6 a) "Control of monitoring and measuring equipment".

- Functional testing in the installed state without interrupting the process.
- Traceable verification results on request, including a report.
- Simple testing process via local operation or other operating interfaces.
- Clear measuring point assessment (pass/fail) with high test coverage within the framework of manufacturer specifications.
- Extension of calibration intervals according to operator's risk assessment.

Heartbeat Monitoring

Continuously supplies data, which are characteristic of the measuring principle, to an external condition monitoring system for the purpose of preventive maintenance or process analysis. These data enable the operator to:

- Draw conclusions - using these data and other information - about the impact process influences (e.g. corrosion, abrasion, buildup etc.) have on the measuring performance over time.
- Schedule servicing in time.
- Monitor the process or product quality, e.g. gas pockets .

 For detailed information, see the Special Documentation for the device.

Concentration measurement

Order code for "Application package", option ED "Concentration"

Calculation and outputting of fluid concentrations.

The measured density is converted to the concentration of a substance of a binary mixture using the "Concentration" application package:

- Choice of predefined fluids (e.g. various sugar solutions, acids, alkalis, salts, ethanol etc.).
- Common or user-defined units (°Brix, °Plato, % mass, % volume, mol/l etc.) for standard applications.
- Concentration calculation from user-defined tables.



For detailed information, see the Special Documentation for the device.

Extended density

Order code for "Application package", option E1 "Extended density"

For volume-based applications, the device can calculate and output a volume flow rate by dividing the mass flow rate by the measured density.

This application package is the standard calibration for custody transfer applications according to national and international standards (e.g. OIML, MID). It is recommended for volume-based fiscal dosing applications over a wide temperature range.

The calibration certificate supplied describes the density performance in air and water at various temperatures in detail.



For detailed information, see the Operating Instructions for the device.

Petroleum

Order code for "Application package", option EJ "Petroleum"

The most important parameters for the Oil & Gas Industry can be calculated and displayed with this application package.

- Corrected volume flow and calculated reference density in accordance with the "API Manual of Petroleum Measurement Standards, Chapter 11.1"
- Water content, based on density measurement
- Weighted mean of the density and temperature



For detailed information, see the Special Documentation for the device.

Petroleum & locking function

Order code for "Application package", option EM "Petroleum & locking function"

The most important parameters for the Oil & Gas Industry can be calculated and displayed with this application package. It is also possible to lock the settings.

- Corrected volume flow and calculated reference density in accordance with the "API Manual of Petroleum Measurement Standards, Chapter 11.1"
- Water content, based on density measurement
- Weighted mean of the density and temperature



For detailed information, see the Special Documentation for the device.

16.14 Accessories



Overview of accessories available to order → 192

16.15 Supplementary documentation

 For an overview of the scope of the associated Technical Documentation, refer to the following:

- *Device Viewer* (www.endress.com/deviceviewer): Enter the serial number from the nameplate
- *Endress+Hauser Operations app*: Enter serial number from nameplate or scan matrix code on nameplate.

Standard documentation **Brief Operating Instructions**

Brief Operating Instructions for the sensor

Measuring instrument	Documentation code
Proline Promass X	KA01288D

Brief Operating Instructions for transmitter

Measuring device	Documentation code
Proline 300	KA01229D

Technical Information

Measuring device	Documentation code
Promass X 300	TI01279D

Description of Device Parameters

Measuring device	Documentation code							PROFINET with Ethernet-APL
	HART	FOUNDATION Fieldbus	PROFIBUS PA	PROFIBUS DP	Modbus RS485	EtherNet/IP	PROFINET	
Promass 300	GP01057D	GP01094D	GP01058D	GP01134D	GP01059D	GP01114D	GP01115D	GP01168D

Supplementary device-dependent documentation

Safety instructions

Safety instructions for electrical equipment for hazardous areas.

Contents	Documentation code
ATEX/IECEX Ex d/Ex de	XA01405D
ATEX/IECEX Ex ec	XA01439D
cCSAus XP	XA01373D
cCSAus Ex d/ Ex de	XA01372D
cCSAus Ex nA	XA01507D
INMETRO Ex d/Ex de	XA01468D
INMETRO Ex ec	XA01470D
NEPSI Ex d/Ex de	XA01469D
NEPSI Ex nA	XA01471D
EAC Ex d/Ex de	XA01656D

Contents	Documentation code
EAC Ex nA	XA01657D
JPN Ex d	XA01778D



Remote display and operating module DKX001

Contents	Documentation code
ATEX/IECEX Ex i	XA01494D
ATEX/IECEX Ex ec	XA01498D
cCSAus IS	XA01499D
cCSAus Ex nA	XA01513D
INMETRO Ex i	XA01500D
INMETRO Ex ec	XA01501D
NEPSI Ex i	XA01502D
NEPSI Ex nA	XA01503D

Special documentation

Contents	Documentation code
Information on the Pressure Equipment Directive	SD01614D
Remote display and operating module DKX001	SD01763D
Radio approvals for WLAN interface for A309/A310 display module	SD01793D
Web server	SD01665D
Heartbeat Technology	SD01696D
Concentration measurement	SD01706D
Petroleum	-

Installation instructions

Contents	Note
Installation instructions for spare part sets and accessories	<ul style="list-style-type: none"> ▪ Access the overview of all the available spare part sets via <i>Device Viewer</i> →  190 ▪ Accessories available for order with Installation Instructions →  192

Index

A

- Access authorization to parameters
 - Read access 57
 - Write access 57
- Access code 57
 - Incorrect input 57
- Adapting the diagnostic behavior 156
- Adapting the status signal 156
- Additional certification 220
- Ambient conditions
 - Mechanical load 211
 - Operating height 210
 - Relative humidity 210
 - Shock and vibration resistance 210
 - Storage temperature 210
- Ambient temperature
 - Influence 208
- Ambient temperature range 210
- AMS Device Manager 69
 - Function 69
- Application 195
- Application packages 221
- Applicator 196
- Approvals 219

C

- Cable entries
 - Technical data 206
- Cable entry
 - Degree of protection 42
- CE mark 10, 219
- Certificates 219
- Checklist
 - Post-connection check 42
 - Post-installation check 29
- Cleaning
 - Exterior cleaning 189
- Climate class 210
- Commissioning 77
 - Advanced settings 104
 - Configuring the measuring instrument 78
- Connecting cable 31
- Connecting the measuring instrument 35
- Connecting the signal cables 35
- Connecting the supply voltage cables 35
- Connection
 - see Electrical connection
- Connection cable 30
- Connection preparations 34
- Connection tools 30
- Context menu
 - Calling up 53
 - Closing 53
 - Explanation 53
- Current consumption 205
- Cyclic data transmission 71

D

- Date of manufacture 15, 16
- Declaration of Conformity 10
- Defining the access code 125
- Degree of protection 42, 210
- Density adjustment 107
- Design
 - Operating menu 44
- Design fundamentals
 - Measurement error 209
 - Repeatability 209
- Device components 13
- Device description files 71
- Device locking, status 128
- Device name
 - Sensor 16
 - Transmitter 15
- Device repair 190
- Device revision 71
- Device type code 71
- Device Viewer 190
- DeviceCare 69
 - Device description file 71
- Diagnosis
 - Symbols 151
- Diagnostic behavior
 - Explanation 152
 - Symbols 152
- Diagnostic information
 - Design, description 152, 155
 - DeviceCare 154
 - FieldCare 154
 - Light emitting diodes 150
 - Local display 151
 - Overview 160
 - Remedial measures 160
 - Web browser 153
- Diagnostic message 151
- DIAGNOSTIC Transducer Block 182
- Diagnostics list 182
- DIP switch
 - see Write protection switch
- Direct access 55
- Disabling write protection 125
- Display
 - see Local display
- Display and operating module DKX001 216
- Display area
 - For operational display 47
 - In the navigation view 49
- Display values
 - For locking status 128
- Displaying the measured value history 145
- Disposal 191
- Document
 - Function 6

- Symbols 6
- Document function 6
- Down pipe 20
- E**
- Editing view 51
 - Input screen 52
 - Using operating elements 51, 52
- Electrical connection
 - Degree of protection 42
 - Measuring instrument 30
 - Operating tools
 - Via FOUNDATION Fieldbus network 65
 - Via service interface (CDI-RJ45) 65
 - Via WLAN interface 66
 - Web server 65
 - WLAN interface 66
- Electromagnetic compatibility 211
- Electronics module 13
- Enabling write protection 125
- Enabling/disabling the keypad lock 58
- Endress+Hauser services
 - Maintenance 189
 - Repair 190
- Error messages
 - see Diagnostic messages
- Event logbook 183
- Events list 183
- Extended order code
 - Sensor 16
 - Transmitter 15
- Exterior cleaning 189
- F**
- Field Communicator
 - Function 70
- Field Communicator 475 70
- Field of application
 - Residual risks 10
- Field Xpert
 - Function 67
- Field Xpert SFX350 67
- FieldCare 68
 - Device description file 71
 - Establishing a connection 68
 - Function 68
 - User interface 69
- Filtering the event logbook 184
- Firmware
 - Release date 71
 - Version 71
- Firmware history 188
- Flow direction 21, 27
- Flow limit 212
- FOUNDATION Fieldbus certification 220
- Function range
 - AMS Device Manager 69
- Function scope
 - Field Communicator 70
 - Field Communicator 475 70
 - Field Xpert 67
- Functions
 - see Parameters
- G**
- Galvanic isolation 204
- H**
- Hardware write protection 126
- Help text
 - Calling up 56
 - Closing 56
 - Explanation 56
- HistoROM 119
- I**
- Identifying the measuring instrument 14
- Incoming acceptance 14
- Indication
 - Current diagnostic event 181
 - Previous diagnostic event 181
- Influence
 - Ambient temperature 208
 - Medium pressure 209
 - Medium temperature 208
- Information about this document 6
- Inlet runs 22
- Input variables 196
- Inspection
 - Connection 42
 - Installation 29
 - Received goods 14
- Installation dimensions 22
- Installation point 20
- Intended use 9
- L**
- Languages, operation options 215
- Line recorder 145
- Local display 215
 - Navigation view 49
 - see Diagnostic message
 - see In alarm condition
 - see Operational display
 - Text editor 51
- Low flow cut off 204
- M**
- Main electronics module 13
- Maintenance work 189
- Managing the device configuration 119
- Manufacturer ID 71
- Materials 213
- Maximum measurement error 206
- Measured variables
 - see Process variables
- Measurement accuracy 206
- Measuring and test equipment 189

Measuring device	
Conversion	190
Disposal	191
Mounting the sensor	27
Preparing for electrical connection	34
Removing	191
Repairs	190
Structure	13
Switching on	77
Measuring instrument	
Configuring	78
Preparing for mounting	27
Measuring principle	195
Measuring range	
For gases	196
For liquids	196
Measuring range, recommended	212
Measuring system	195
Mechanical load	211
Medium pressure	
Influence	209
Medium temperature	
Influence	208
Menu	
Diagnostics	181
Setup	79
Menus	
For measuring instrument configuration	78
For specific settings	104
Mounting	20
Mounting dimensions	
see Installation dimensions	
Mounting preparations	27
Mounting requirements	
Down pipe	20
Inlet and outlet runs	22
Installation dimensions	22
Installation point	20
Orientation	21
Rupture disk	24
Sensor heating	23
Static pressure	22
Thermal insulation	23
Vibrations	24
Mounting tool	26
N	
Nameplate	
Sensor	16
Transmitter	15
Navigation path (navigation view)	49
Navigation view	
In the submenu	49
In the wizard	49
Netilion	189
Numeric editor	51

O

Onsite display	
Numeric editor	51
Operable flow range	197
Operating elements	53, 152
Operating height	210
Operating keys	
see Operating elements	
Operating menu	
Design	44
Menus, submenus	44
Submenus and user roles	45
Operating philosophy	45
Operation	128
Operation options	43
Operational display	46
Operational safety	10
Order code	15, 16
Orientation (vertical, horizontal)	21
Outlet runs	22
Output signal	199
Output variables	199

P

Packaging disposal	19
Parameter	
Changing	56
Entering values or text	56
Parameter settings	
Administration (Submenu)	122
Advanced setup (Submenu)	105
Analog inputs (Submenu)	84
Configuration backup (Submenu)	119
Corrected volume flow calculation (Submenu)	106
Current input	85
Current input (Wizard)	85
Current input 1 to n (Submenu)	140
Current output	87
Current output (Wizard)	87
Data logging (Submenu)	145
Define access code (Wizard)	121
Density adjustment (Wizard)	108
Device information (Submenu)	186
Diagnostics (Menu)	181
Display (Submenu)	115
Display (Wizard)	99
I/O configuration	84
I/O configuration (Submenu)	84
Low flow cut off (Wizard)	102
Measured variables (Submenu)	129
Medium selection (Wizard)	82
Partially filled pipe detection (Wizard)	103
Pulse/frequency/switch output	90
Pulse/frequency/switch output (Wizard)	90, 91, 95
Pulse/frequency/switch output 1 to n (Submenu)	141
Relay output	97
Relay output 1 to n (Submenu)	142
Relay output 1 to n (Wizard)	97
Reset access code (Submenu)	121

- Sensor adjustment (Submenu) 107
 - Setup (Menu) 79
 - Simulation (Submenu) 122
 - Status input 86
 - Status input 1 to n (Submenu) 140
 - Status input 1 to n (Wizard) 86
 - System units (Submenu) 79
 - Totalizer (Submenu) 139
 - Totalizer 1 to n (Submenu) 113
 - Totalizer handling (Submenu) 143
 - Value current output 1 to n (Submenu) 141
 - Web server (Submenu) 64
 - WLAN settings (Wizard) 118
 - Zero adjustment (Wizard) 112
 - Zero verification (Wizard) 110
 - Performance characteristics 206
 - Performing density adjustment 108
 - Post-connection check 77
 - Post-connection check (checklist) 42
 - Post-installation check 77
 - Post-installation check (checklist) 29
 - Potential equalization 38
 - Power consumption 205
 - Power supply failure 205
 - Pressure Equipment Directive 220
 - Pressure loss 212
 - Pressure-temperature ratings 211
 - Process connections 214
 - Process variables
 - Calculated 196
 - Measured 196
 - Product safety 10
 - Protecting parameter settings 125
- R**
- Radio approval 220
 - RCM marking 219
 - Read access 57
 - Reading off measured values 128
 - Recalibration 189
 - Reference operating conditions 206
 - Registered trademarks 8
 - Remedial measures
 - Calling up 153
 - Closing 153
 - Remote operation 216
 - Repair 190
 - Notes 190
 - Repair of a device 190
 - Repeatability 207
 - Replacement
 - Device components 190
 - Requirements for personnel 9
 - Response time 208
 - Return 190
 - Rupture disk
 - Safety instructions 24
 - Triggering pressure 212
- S**
- Safety 9
 - Sensor
 - Installing 27
 - Sensor heating 23
 - Sensor housing 211
 - Serial number 15, 16
 - Setting the operating language 77
 - Settings
 - Adapting the measuring device to the process conditions 143
 - Administration 120
 - Advanced display configurations 115
 - Analog input 84
 - Current input 85
 - Current output 87
 - Device tag 79
 - I/O configuration 84
 - Local display 99
 - Low flow cut off 102
 - Managing the device configuration 119
 - Medium 82
 - Operating language 77
 - Partially filled pipe detection 103
 - Pulse output 90
 - Pulse/frequency/switch output 90, 91
 - Relay output 97
 - Resetting the device 185
 - Resetting the totalizer 143
 - Restarting the device 185
 - Sensor adjustment 107
 - Simulation 122
 - Status input 86
 - Switch output 95
 - System units 79
 - Totalizer 113
 - Totalizer reset 143
 - WLAN 118
 - Shock and vibration resistance 210
 - Signal on alarm 202
 - Software release 71
 - Spare part 190
 - Spare parts 190
 - Special connection instructions 39
 - Special mounting instructions
 - Hygienic compatibility 24
 - Standards and guidelines 221
 - Static pressure 22
 - Status area
 - For operational display 47
 - In the navigation view 49
 - Status signals 151, 154
 - Storage concept 218
 - Storage conditions 18
 - Storage temperature 18
 - Storage temperature range 210
 - Structure
 - Measuring device 13

Submenu

Administration	120, 122
Advanced setup	104, 105
Analog inputs	84
Calculated values	105
Configuration backup	119
Corrected volume flow calculation	106
Current input 1 to n	140
Data logging	145
Device information	186
Display	115
Events list	183
I/O configuration	84
Input values	139
Measured values	128
Measured variables	129
Output values	141
Overview	45
Process variables	105
Pulse/frequency/switch output 1 to n	141
Relay output 1 to n	142
Reset access code	121
Sensor adjustment	107
Simulation	122
Status input 1 to n	140
System units	79
Totalizer	139
Totalizer 1 to n	113
Totalizer handling	143
Value current output 1 to n	141
Web server	64
Supply voltage	205
Surface roughness	215
Switch output	201

Symbols

Controlling data entries	52
For communication	47
For diagnostic behavior	47
For locking	47
For measured variable	47
For measurement channel number	47
For menus	49
For parameters	49
For status signal	47
For submenu	49
For wizards	49
In the status area of the local display	47
Input screen	52
Operating elements	51

System design

Measuring system	195
see Measuring device design	
System integration	71

T

Technical data, overview	195
Temperature range	
Ambient temperature range for display	215
Medium temperature	211

Storage temperature	18
Terminal assignment	33
Terminals	205
Tests and certificates	220
Text editor	51
Thermal insulation	23
Tool	
For mounting	26
Transport	18
Tool tip	
see Help text	
Tools	
Electrical connection	30
Totalizer	
Configuring	113
Transmitter	
Turning the display module	28
Turning the housing	27
Transporting the measuring device	18
Troubleshooting	
General	148
Turning the display module	28
Turning the electronics housing	
see Turning the transmitter housing	
Turning the transmitter housing	27

U

UKCA marking	219
Use of measuring device	
Borderline cases	9
Incorrect use	9
Use of measuring instrument	
see Intended use	
User roles	45

V

Version data for the device	71
Vibrations	24

W

W@M Device Viewer	14
Weight	
SI units	213
Transport (notes)	18
US units	213
Wizard	
Current input	85
Current output	87
Define access code	121
Density adjustment	108
Display	99
Low flow cut off	102
Medium selection	82
Partially filled pipe detection	103
Pulse/frequency/switch output	90, 91, 95
Relay output 1 to n	97
Status input 1 to n	86
WLAN settings	118
Zero adjustment	112

Zero verification	110
WLAN settings	118
Workplace safety	10
Write access	57
Write protection	
Via access code	125
Via block operation	127
Via write protection switch	126
Write protection switch	126



www.addresses.endress.com
