

Operating Instructions

Proline Promass S 500

Coriolis flowmeter
PROFIBUS PA

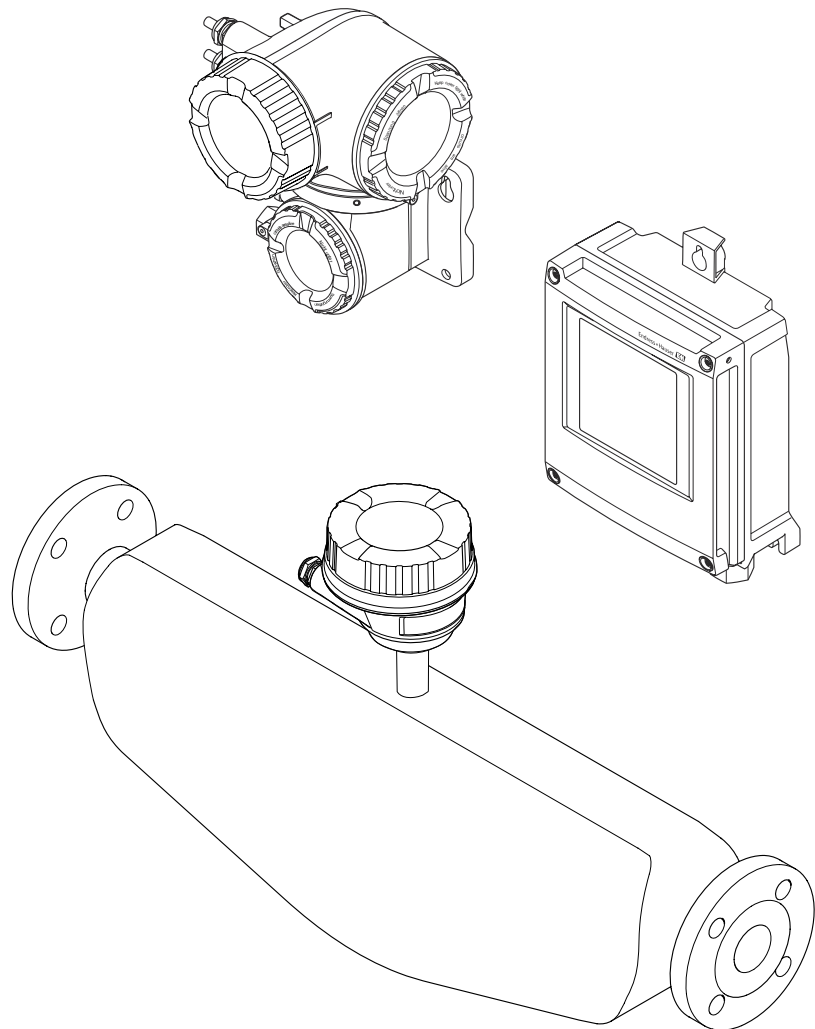

- Make sure the document is stored in a safe place such that it is always available when working on or with the device.
- To avoid danger to individuals or the facility, read the "Basic safety instructions" section carefully, as well as all other safety instructions in the document that are specific to working procedures.
- The manufacturer reserves the right to modify technical data without prior notice. Your Endress+Hauser sales organization will supply you with current information and updates to this manual.

Table of contents

1	About this document	6	6	Installation	21
1.1	Document function	6	6.1	Mounting requirements	21
1.2	Symbols	6	6.1.1	Installation position	21
1.2.1	Safety symbols	6	6.1.2	Environmental and process requirements	24
1.2.2	Electrical symbols	6	6.1.3	Special installation instructions	25
1.2.3	Communication-specific symbols	6	6.2	Installing the measuring instrument	28
1.2.4	Tool symbols	7	6.2.1	Required tools	28
1.2.5	Symbols for certain types of information	7	6.2.2	Preparing the measuring instrument	28
1.2.6	Symbols in graphics	7	6.2.3	Mounting the measuring device	28
1.3	Documentation	8	6.2.4	Mounting the transmitter housing: Proline 500 – digital	29
1.4	Registered trademarks	8	6.2.5	Mounting the transmitter housing: Proline 500	30
2	Safety instructions	9	6.2.6	Turning the transmitter housing: Proline 500	31
2.1	Requirements for the personnel	9	6.2.7	Turning the display module: Proline 500	32
2.2	Intended use	9	6.3	Post-installation check	33
2.3	Workplace safety	10	7	Electrical connection	34
2.4	Operational safety	10	7.1	Electrical safety	34
2.5	Product safety	10	7.2	Connecting requirements	34
2.6	IT security	10	7.2.1	Required tools	34
2.7	Device-specific IT security	11	7.2.2	Requirements for connection cable	34
2.7.1	Protecting access via hardware write protection	11	7.2.3	Terminal assignment	39
2.7.2	Protecting access via a password	11	7.2.4	Available device plugs	39
2.7.3	Access via web server	12	7.2.5	device plug pin assignment	40
2.7.4	Access via service interface (CDI-RJ45)	12	7.2.6	Shielding and grounding	40
3	Product description	13	7.2.7	Preparing the measuring device	41
3.1	Product design	13	7.3	Connecting the measuring instrument: Proline 500 - digital	42
3.1.1	Proline 500 – digital	13	7.3.1	Connecting the connecting cable	42
3.1.2	Proline 500	14	7.3.2	Connecting the signal cable and the supply voltage cable	47
4	Incoming acceptance and product identification	15	7.4	Connecting the measuring instrument: Proline 500	49
4.1	Incoming acceptance	15	7.4.1	Fitting the connecting cable	49
4.2	Product identification	15	7.4.2	Connecting the signal cable and the supply voltage cable	53
4.2.1	Transmitter nameplate	16	7.5	Potential equalization	55
4.2.2	Sensor nameplate	18	7.5.1	Requirements	55
4.2.3	Symbols on the device	19	7.6	Special connection instructions	56
5	Storage and transport	20	7.6.1	Connection examples	56
5.1	Storage conditions	20	7.7	Hardware settings	59
5.2	Transporting the product	20	7.7.1	Setting the device address	59
5.2.1	Measuring devices without lifting lugs	20	7.7.2	Activating the default IP address	60
5.2.2	Measuring devices with lifting lugs	21	7.8	Ensuring the degree of protection	62
5.2.3	Transporting with a fork lift	21	7.9	Post-connection check	62
5.3	Packaging disposal	21	8	Operation options	63
			8.1	Overview of operation options	63

8.2	Structure and function of the operating menu	64			
8.2.1	Structure of the operating menu	64			
8.2.2	Operating philosophy	65			
8.3	Access to operating menu via local display	66			
8.3.1	Operational display	66			
8.3.2	Navigation view	69			
8.3.3	Editing view	71			
8.3.4	Operating elements	73			
8.3.5	Opening the context menu	73			
8.3.6	Navigating and selecting from list	75			
8.3.7	Calling the parameter directly	75			
8.3.8	Calling up help text	76			
8.3.9	Changing the parameters	76			
8.3.10	User roles and related access authorization	77			
8.3.11	Disabling write protection via access code	77			
8.3.12	Enabling and disabling the keypad lock	78			
8.4	Access to operating menu via web browser	78			
8.4.1	Function range	78			
8.4.2	Requirements	79			
8.4.3	Connecting the device	80			
8.4.4	Logging on	82			
8.4.5	User interface	83			
8.4.6	Disabling the Web server	84			
8.4.7	Logging out	84			
8.5	Access to the operating menu via the operating tool	85			
8.5.1	Connecting the operating tool	85			
8.5.2	FieldCare	88			
8.5.3	DeviceCare	90			
8.5.4	SIMATIC PDM	90			
9	System integration	91			
9.1	Overview of device description files	91			
9.1.1	Current version data for the device	91			
9.1.2	Operating tools	91			
9.2	Device master file (GSD)	91			
9.2.1	Manufacturer-specific GSD	92			
9.2.2	Profile GSD	92			
9.3	Compatibility with earlier model	93			
9.3.1	Automatic identification (factory setting)	93			
9.3.2	Manual setting	93			
9.3.3	Replacing the measuring devices without changing the GSD file or restarting the controller	93			
9.4	Using the GSD modules of the previous model	94			
9.4.1	Using the CONTROL_BLOCK module in the previous model	94			
9.5	Cyclic data transmission	96			
9.5.1	Block model	96			
9.5.2	Description of the modules	96			
10	Commissioning	104			
10.1	Post-mounting and post-connection check	104			
10.2	Switching on the measuring device	104			
10.3	Connecting via FieldCare	104			
10.4	Configuring the device address via software	104			
10.4.1	PROFIBUS network	104			
10.5	Setting the operating language	104			
10.6	Configuring the measuring instrument	105			
10.6.1	Defining the tag name	106			
10.6.2	Setting the system units	107			
10.6.3	Selecting and setting the medium	110			
10.6.4	Configuring communication interface	110			
10.6.5	Configuration of the Analog Inputs	112			
10.6.6	Displaying the I/O configuration	113			
10.6.7	Configuring the current input	114			
10.6.8	Configuring the status input	115			
10.6.9	Configuring the current output	115			
10.6.10	Configuring the pulse/frequency/switch output	119			
10.6.11	Configuring the relay output	126			
10.6.12	Configuring the local display	128			
10.6.13	Configuring the low flow cut off	131			
10.6.14	Configuring partially filled pipe detection	132			
10.7	Advanced settings	133			
10.7.1	Calculated process variables	134			
10.7.2	Carrying out a sensor adjustment	135			
10.7.3	Configuring the totalizer	141			
10.7.4	Carrying out additional display configurations	143			
10.7.5	WLAN configuration	146			
10.7.6	Configuration management	147			
10.7.7	Using parameters for device administration	149			
10.8	Simulation	150			
10.9	Protecting settings from unauthorized access	152			
10.9.1	Write protection via access code	153			
10.9.2	Write protection via write protection switch	154			
11	Operation	157			
11.1	Reading off the device locking status	157			
11.2	Adjusting the operating language	157			
11.3	Configuring the display	157			
11.4	Reading off measured values	157			
11.4.1	"Measured variables" submenu	158			
11.4.2	Totalizer	160			
11.4.3	"Input values" submenu	161			
11.4.4	Output values	162			
11.5	Adapting the measuring device to the process conditions	164			
11.6	Performing a totalizer reset	164			
11.7	Displaying the measured value history	165			
12	Diagnostics and troubleshooting	169			
12.1	General troubleshooting	169			

12.2	Diagnostic information via light emitting diodes	172	16	Technical data	248
12.2.1	Transmitter	172	16.1	Application	248
12.2.2	Sensor connection housing	174	16.2	Function and system design	248
12.3	Diagnostic information on local display	175	16.3	Input	249
12.3.1	Diagnostic message	175	16.4	Output	251
12.3.2	Calling up remedial measures	177	16.5	Power supply	256
12.4	Diagnostic information in the web browser	177	16.6	Performance characteristics	258
12.4.1	Diagnostic options	177	16.7	Mounting	262
12.4.2	Calling up remedy information	178	16.8	Environment	262
12.5	Diagnostic information in FieldCare or DeviceCare	178	16.9	Process	263
12.5.1	Diagnostic options	178	16.10	Mechanical construction	265
12.5.2	Calling up remedy information	179	16.11	User interface	268
12.6	Adapting the diagnostic information	180	16.12	Certificates and approvals	271
12.6.1	Adapting the diagnostic behavior	180	16.13	Application packages	274
12.7	Overview of diagnostic information	183	16.14	Accessories	275
12.7.1	Diagnostic of sensor	183	16.15	Supplemental documentation	275
12.7.2	Diagnostic of electronic	191			
12.7.3	Diagnostic of configuration	208	Index	278	
12.7.4	Diagnostic of process	222			
12.8	Pending diagnostic events	235			
12.9	Diagnostics list	235			
12.10	Event logbook	236			
12.10.1	Reading out the event logbook	236			
12.10.2	Filtering the event logbook	237			
12.10.3	Overview of information events	237			
12.11	Resetting the measuring device	238			
12.11.1	Function range of "Device reset" parameter	238			
12.12	Device information	239			
12.13	Firmware history	241			
13	Maintenance	242			
13.1	Maintenance work	242			
13.1.1	Exterior cleaning	242			
13.1.2	Internal cleaning	242			
13.2	Measuring and test equipment	242			
13.3	Endress+Hauser services	242			
14	Repair	243			
14.1	General notes	243			
14.1.1	Repair and conversion concept	243			
14.1.2	Notes for repair and conversion	243			
14.2	Spare parts	243			
14.3	Endress+Hauser services	243			
14.4	Return	243			
14.5	Disposal	244			
14.5.1	Removing the measuring device	244			
14.5.2	Disposing of the measuring device	244			
15	Accessories	245			
15.1	Device-specific accessories	245			
15.1.1	For the transmitter	245			
15.1.2	For the sensor	246			
15.2	Service-specific accessories	246			
15.3	System components	247			

1 About this document

1.1 Document function

These Operating Instructions contain all the information required in the various life cycle phases of the device: from product identification, incoming acceptance and storage, to installation, connection, operation and commissioning, through to troubleshooting, maintenance and disposal.

1.2 Symbols

1.2.1 Safety symbols

DANGER

This symbol alerts you to a dangerous situation. Failure to avoid this situation will result in serious or fatal injury.

WARNING

This symbol alerts you to a potentially dangerous situation. Failure to avoid this situation can result in serious or fatal injury.





CAUTION

This symbol alerts you to a potentially dangerous situation. Failure to avoid this situation can result in minor or medium injury.

NOTICE

This symbol alerts you to a potentially harmful situation. Failure to avoid this situation can result in damage to the product or something in its vicinity.

1.2.2 Electrical symbols

Symbol	Meaning
	Direct current
	Alternating current
	Direct current and alternating current
	Ground connection A grounded terminal which, as far as the operator is concerned, is grounded via a grounding system.
	Potential equalization connection (PE: protective earth) Ground terminals that must be connected to ground prior to establishing any other connections. The ground terminals are located on the interior and exterior of the device: <ul style="list-style-type: none"> ▪ Interior ground terminal: potential equalization is connected to the supply network. ▪ Exterior ground terminal: device is connected to the plant grounding system.

1.2.3 Communication-specific symbols

Symbol	Meaning
	Wireless Local Area Network (WLAN) Communication via a wireless, local network.





1.2.4 Tool symbols

Symbol	Meaning
	Torx screwdriver
	Phillips head screwdriver
	Open-ended wrench

1.2.5 Symbols for certain types of information

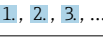
Symbol	Meaning
	Permitted Procedures, processes or actions that are permitted.
	Preferred Procedures, processes or actions that are preferred.
	Forbidden Procedures, processes or actions that are forbidden.
	Tip Indicates additional information.
	Reference to documentation
	Reference to page
	Reference to graphic
	Notice or individual step to be observed
	Series of steps
	Result of a step
	Help in the event of a problem
	Visual inspection

1.2.6 Symbols in graphics

Symbol	Meaning
1, 2, 3, ...	Item numbers
	Series of steps
A, B, C, ...	Views
A-A, B-B, C-C, ...	Sections
	Hazardous area
	Safe area (non-hazardous area)
	Flow direction

1.3 Documentation

 For an overview of the scope of the associated Technical Documentation, refer to the following:

- *Device Viewer* (www.endress.com/deviceviewer): Enter the serial number from the nameplate
- *Endress+Hauser Operations app*: Enter serial number from nameplate or scan matrix code on nameplate.

The following documentation may be available depending on the device version ordered:

Document type	Purpose and content of the document
Technical Information (TI)	Planning aid for your device The document contains all the technical data on the device and provides an overview of the accessories and other products that can be ordered for the device.
Brief Operating Instructions (KA)	Guide that takes you quickly to the 1st measured value The Brief Operating Instructions contain all the essential information from incoming acceptance to initial commissioning.
Operating Instructions (BA)	Your reference document These Operating Instructions contain all the information that is required in the various life cycle phases of the device: from product identification, incoming acceptance and storage, to mounting, connection, operation and commissioning, through to troubleshooting, maintenance and disposal.
Description of Device Parameters (GP)	Reference for your parameters The document provides a detailed explanation of each individual parameter. The description is aimed at those who work with the device over the entire life cycle and perform specific configurations.
Safety Instructions (XA)	Depending on the approval, safety instructions for electrical equipment in hazardous areas are also supplied with the device. The Safety Instructions are a constituent part of the Operating Instructions.  Information on the Safety Instructions (XA) that are relevant for the device is provided on the nameplate.
Supplementary device-dependent documentation (SD/FY)	Always comply strictly with the instructions in the relevant supplementary documentation. The supplementary documentation is a constituent part of the device documentation.

1.4 Registered trademarks

PROFIBUS®

Registered trademark of the PROFIBUS Nutzerorganisation e.V. (PROFIBUS User Organization), Karlsruhe, Germany

TRI-CLAMP®

Registered trademark of Ladish & Co., Inc., Kenosha, USA

2 Safety instructions

2.1 Requirements for the personnel

The personnel for installation, commissioning, diagnostics and maintenance must fulfill the following requirements:

- ▶ Trained, qualified specialists must have a relevant qualification for this specific function and task.
- ▶ Are authorized by the plant owner/operator.
- ▶ Are familiar with federal/national regulations.
- ▶ Before starting work, read and understand the instructions in the manual and supplementary documentation as well as the certificates (depending on the application).
- ▶ Follow instructions and comply with basic conditions.

The operating personnel must fulfill the following requirements:

- ▶ Are instructed and authorized according to the requirements of the task by the facility's owner-operator.
- ▶ Follow the instructions in this manual.

2.2 Intended use

Application and media

The measuring instrument described in this manual is intended only for the flow measurement of liquids.

Depending on the version ordered, the measuring instrument can also be used to measure potentially explosive ¹⁾, flammable, toxid and oxidizing media.

Measuring instruments for use in hazardous areas, in hygienic applications, or where there is an increased risk due to pressure, are specially labeled on the nameplate.

To ensure that the measuring instrument is in perfect condition during operation:

- ▶ Only use the measuring instrument in full compliance with the data on the nameplate and the general conditions listed in the Operating Instructions and supplementary documentation.
- ▶ Using the nameplate, check whether the ordered device is permitted for the intended use in the hazardous area (e.g. explosion protection, pressure vessel safety).
- ▶ Use the measuring instrument only for media to which the process-wetted materials are sufficiently resistant.
- ▶ Keep within the specified pressure and temperature range.
- ▶ Keep within the specified ambient temperature range.
- ▶ Protect the measuring instrument permanently against corrosion from environmental influences.

Incorrect use

Non-designated use can compromise safety. The manufacturer is not liable for damage caused by improper or non-designated use.

WARNING

Danger of breakage due to corrosive or abrasive fluids and ambient conditions!

- ▶ Verify the compatibility of the process fluid with the sensor material.
- ▶ Ensure the resistance of all fluid-wetted materials in the process.
- ▶ Keep within the specified pressure and temperature range.

1) Not applicable for IO-Link measuring instruments

NOTICE**Verification for borderline cases:**

- ▶ For special fluids and fluids for cleaning, Endress+Hauser is glad to provide assistance in verifying the corrosion resistance of fluid-wetted materials, but does not accept any warranty or liability as minute changes in the temperature, concentration or level of contamination in the process can alter the corrosion resistance properties.

Residual risks**⚠ CAUTION**

Risk of hot or cold burns! The use of media and electronics with high or low temperatures can produce hot or cold surfaces on the device.

- ▶ Mount suitable touch protection.

2.3 Workplace safety

When working on and with the device:

- ▶ Wear the required personal protective equipment as per national regulations.

2.4 Operational safety

Damage to the device!

- ▶ Operate the device in proper technical condition and fail-safe condition only.
- ▶ The operator is responsible for the interference-free operation of the device.

Modifications to the device

Unauthorized modifications to the device are not permitted and can lead to unforeseeable dangers!

- ▶ If modifications are nevertheless required, consult with the manufacturer.

Repair

To ensure continued operational safety and reliability:

- ▶ Carry out repairs on the device only if they are expressly permitted.
- ▶ Observe federal/national regulations pertaining to the repair of an electrical device.
- ▶ Use only original spare parts and accessories.

2.5 Product safety

This measuring device is designed in accordance with good engineering practice to meet state-of-the-art safety requirements, has been tested, and left the factory in a condition in which it is safe to operate.

It meets general safety standards and legal requirements. It also complies with the EU directives listed in the device-specific EU Declaration of Conformity. The manufacturer confirms this by affixing the CE mark to the device..





2.6 IT security

The manufacturer warranty is valid only if the product is installed and used as described in the Operating Instructions. The product is equipped with security mechanisms to protect it against any inadvertent changes to the settings.

IT security measures, which provide additional protection for the product and associated data transfer, must be implemented by the operators themselves in line with their security standards.

2.7 Device-specific IT security

The device offers a range of specific functions to support protective measures on the operator's side. These functions can be configured by the user and guarantee greater in-operation safety if used correctly. The following list provides an overview of the most important functions:

Function/interface	Factory setting	Recommendation
Write protection via hardware write protection switch →  11	Not enabled	On an individual basis following risk assessment
Access code (also applies to web server login or FieldCare connection) →  11	Not enabled (0000)	Assign a customized access code during commissioning
WLAN (order option in display module)	Enabled	On an individual basis following risk assessment
WLAN security mode	Enabled (WPA2-PSK)	Do not change
WLAN passphrase (Password) →  12	Serial number	Assign an individual WLAN passphrase during commissioning
WLAN mode	Access point	On an individual basis following risk assessment
Web server →  12	Enabled	On an individual basis following risk assessment
Service interface CDI-RJ45 →  12	–	On an individual basis following risk assessment

2.7.1 Protecting access via hardware write protection

Write access to the parameters of the device via the local display, web browser or operating tool (e.g. FieldCare, DeviceCare) can be disabled via a write protection switch (DIP switch on the main electronics module). When hardware write protection is enabled, only read access to the parameters is possible.

Hardware write protection is disabled when the device is delivered →  154.

2.7.2 Protecting access via a password

Different passwords are available to protect write access to the device parameters or access to the device via the WLAN interface.

- **User-specific access code**
Protect write access to the device parameters via the local display, web browser or operating tool (e.g. FieldCare, DeviceCare). Access authorization is clearly regulated through the use of a user-specific access code.
- **WLAN passphrase**
The network key protects a connection between an operating unit (e.g. notebook or tablet) and the device via the WLAN interface which can be ordered as an option.
- **Infrastructure mode**
When the device is operated in infrastructure mode, the WLAN passphrase corresponds to the WLAN passphrase configured on the operator side.

User-specific access code

Write access to the device parameters via the local display, web browser or operating tool (e.g. FieldCare, DeviceCare) can be protected by the modifiable, user-specific access code (→  153).

When the device is delivered, the device does not have an access code and is equivalent to 0000 (open).

WLAN passphrase: Operation as WLAN access point

A connection between an operating unit (e.g. notebook or tablet) and the device via the WLAN interface (→  86), which can be ordered as an optional extra, is protected by the network key. The WLAN authentication of the network key complies with the IEEE 802.11 standard.

When the device is delivered, the network key is pre-defined depending on the device. It can be changed via the **WLAN settings** submenu in the **WLAN passphrase** parameter (→  147).

Infrastructure mode

A connection between the device and WLAN access point is protected by means of an SSID and passphrase on the system side. Please contact the relevant system administrator for access.

General notes on the use of passwords

- The access code and network key supplied with the device should be changed during commissioning for safety reasons.
- Follow the general rules for generating a secure password when defining and managing the access code and network key.
- The user is responsible for the management and careful handling of the access code and network key.
- For information on configuring the access code or on what to do if you lose the password, for example, see "Write protection via access code" →  153.

2.7.3 Access via web server

The integrated web server can be used to operate and configure the device via a web browser →  78. The connection is established via the service interface (CDI-RJ45) or the WLAN interface.

The web server is enabled when the device is delivered. The web server can be disabled via the **Web server functionality** parameter if necessary (e.g., after commissioning).

The device and status information can be hidden on the login page. This prevents unauthorized access to the information.



Detailed information on the device parameters:
"Description of device parameters" document .

2.7.4 Access via service interface (CDI-RJ45)

The device can be connected to a network via the service interface (CDI-RJ45). Device-specific functions guarantee the secure operation of the device in a network.

The use of relevant industrial standards and guidelines that have been defined by national and international safety committees, such as IEC/ISA62443 or the IEEE, is recommended. This includes organizational security measures such as the assignment of access authorization as well as technical measures such as network segmentation.



Transmitters with an Ex de approval may not be connected via the service interface (CDI-RJ45)!

Order code for "Approval transmitter + sensor", options (Ex de): BA, BB, C1, C2, GA, GB, MA, MB, NA, NB BB, C2, GB, MB, NB

3 Product description

The measuring system consists of a transmitter and a sensor. The transmitter and sensor are mounted in physically separate locations. They are interconnected by connecting cables.

3.1 Product design

Two versions of the transmitter are available.

3.1.1 Proline 500 – digital

Signal transmission: digital

Order code for "Integrated ISEM electronics", option **A** "Sensor"

For use in applications not required to meet special requirements due to ambient or operating conditions.

As the electronics are located in the sensor, the device is ideal:
For simple transmitter replacement.

- A standard cable can be used as the connecting cable.
- Not sensitive to external EMC interference.

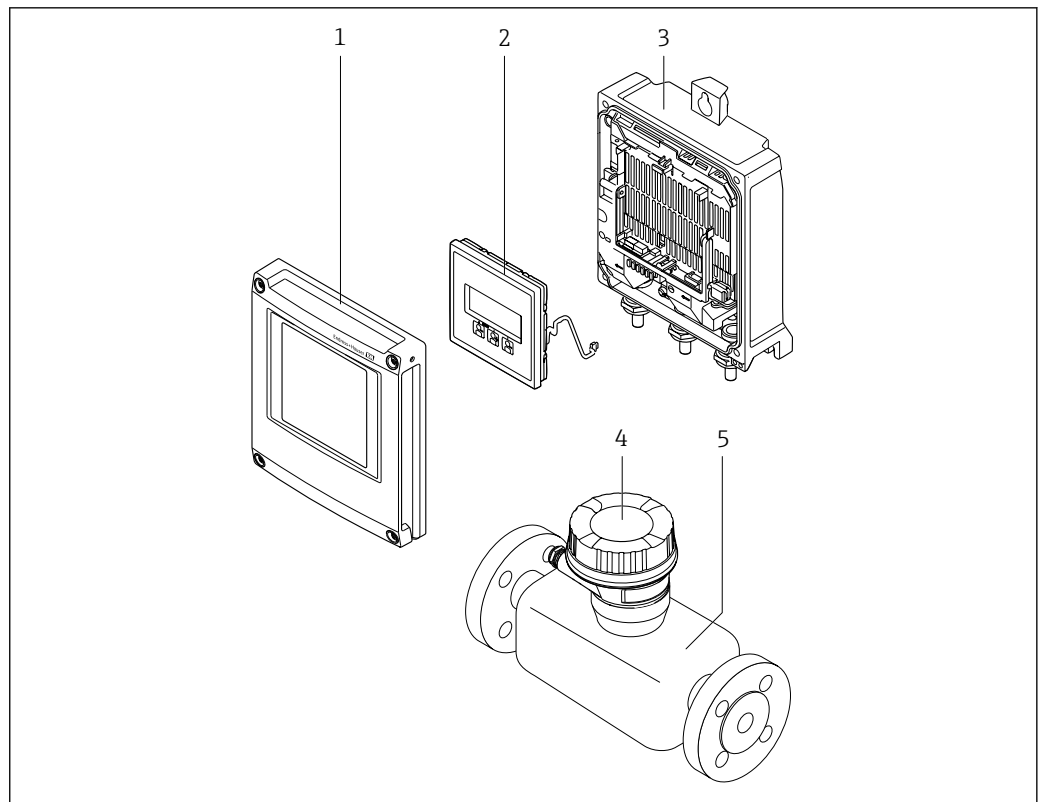

A0029593

1 Important components of a measuring device

- 1 Electronics compartment cover
- 2 Display module
- 3 Transmitter housing
- 4 Sensor connection housing with integrated ISEM electronics: connecting cable connection
- 5 Sensor

3.1.2 Proline 500

Signal transmission: analog

Order code for "Integrated ISEM electronics", option **B** "Transmitter"

For use in applications required to meet special requirements due to ambient or operating conditions.

As the electronics are located in the transmitter, the device is ideal in the event of:

- Strong vibrations at the sensor.
- Sensor operation in underground installations.
- Permanent sensor immersion in water.

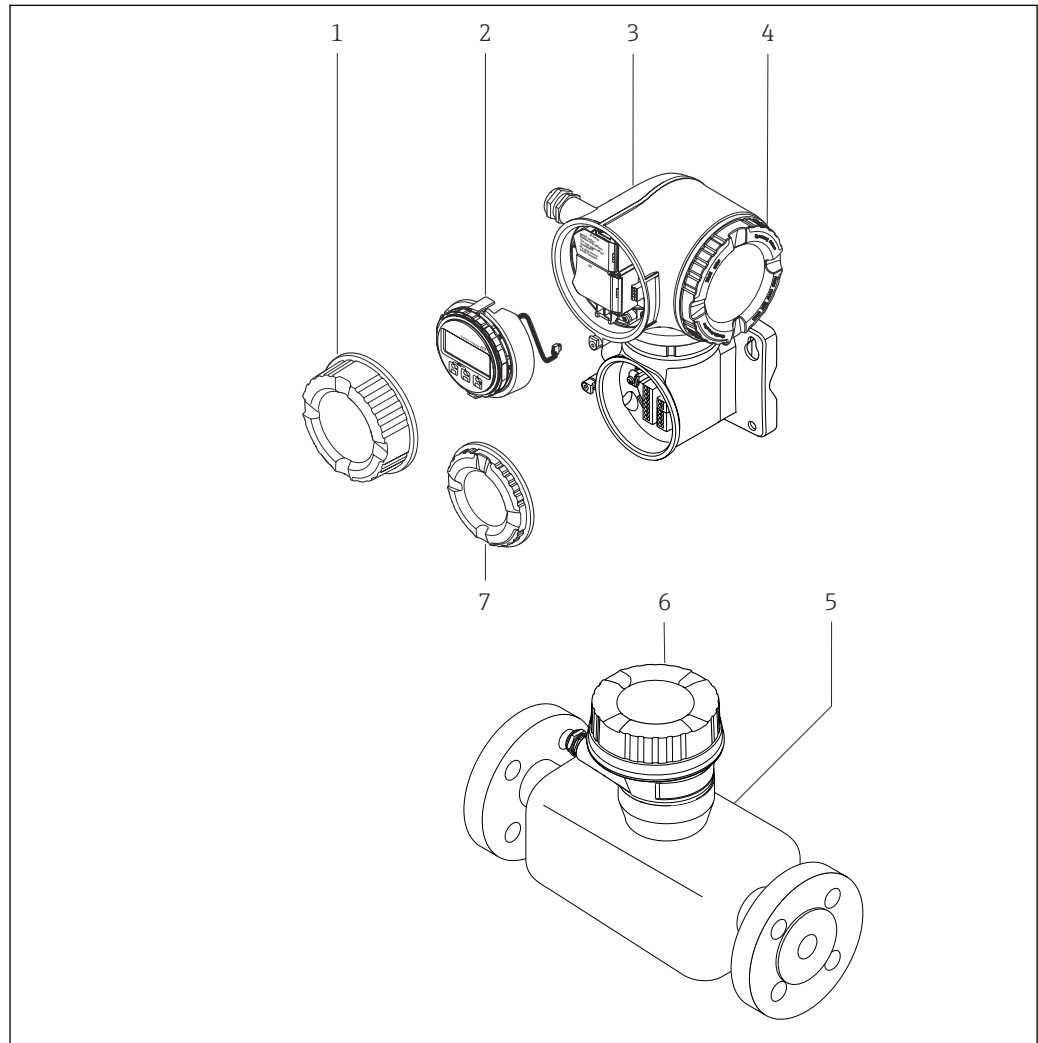

A0029589

2 Important components of a measuring device

- 1 Connection compartment cover
- 2 Display module
- 3 Transmitter housing with integrated ISEM electronics
- 4 Electronics compartment cover
- 5 Sensor
- 6 Sensor connection housing: connecting cable connection
- 7 Connection compartment cover: connecting cable connection

4 Incoming acceptance and product identification

4.1 Incoming acceptance

On receipt of the delivery:

1. Check the packaging for damage.
 - ↳ Report all damage immediately to the manufacturer.
Do not install damaged components.
2. Check the scope of delivery using the delivery note.
3. Compare the data on the nameplate with the order specifications on the delivery note.
4. Check the technical documentation and all other necessary documents, e.g. certificates, to ensure they are complete.

 If one of the conditions is not satisfied, contact the manufacturer.

4.2 Product identification

The device can be identified in the following ways:

- Nameplate
- Order code with details of the device features on the delivery note
- Enter the serial numbers from the nameplates in the *Device Viewer* (www.endress.com/deviceviewer): all the information about the device is displayed.
- Enter the serial numbers from the nameplates into the *Endress+Hauser Operations app* or scan the DataMatrix code on the nameplate with the *Endress+Hauser Operations app*: all the information about the device is displayed.

For an overview of the scope of the associated Technical Documentation, refer to the following:

- The "Additional standard device documentation" and "Supplementary device-dependent documentation" sections
- The *Device Viewer*: Enter the serial number from the nameplate (www.endress.com/deviceviewer)
- The *Endress+Hauser Operations app*: Enter the serial number from the nameplate or scan the DataMatrix code on the nameplate.

4.2.1 Transmitter nameplate

Proline 500 – digital

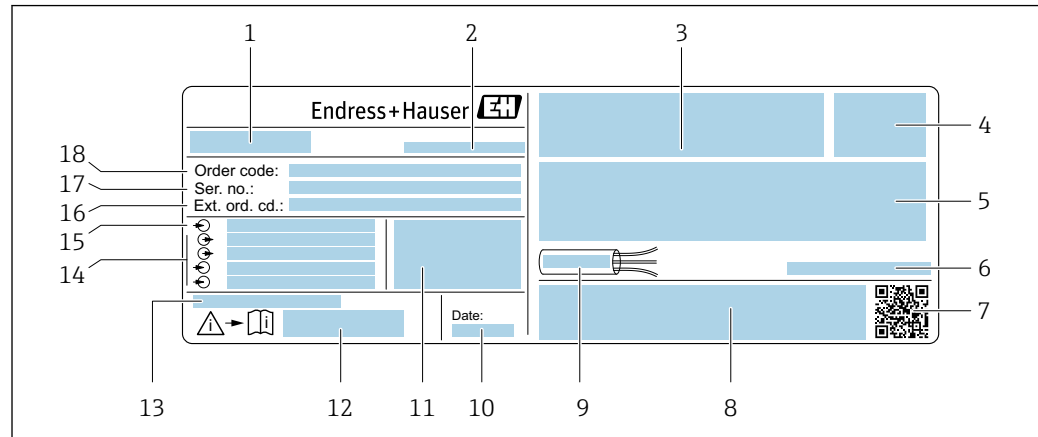

A0029194

3 Example of a transmitter nameplate

- 1 Name of the transmitter
- 2 Manufacturer address/certificate holder
- 3 Space for approvals: Use in hazardous areas
- 4 Degree of protection
- 5 Electrical connection data: available inputs and outputs
- 6 Allowable ambient temperature (T_a)
- 7 2-D matrix code
- 8 Space for approvals and certificates: e.g. CE mark, RCM tick
- 9 Permitted temperature range for cable
- 10 Date of manufacture: year-month
- 11 Firmware version (FW) and device revision (Dev. rev.) from the factory
- 12 Document number of safety-related supplementary documentation
- 13 Space for additional information in the case of special products
- 14 Available inputs and outputs, supply voltage
- 15 Electrical connection data: supply voltage
- 16 Extended order code (Ext. ord. cd.)
- 17 Serial number (Ser. no.)
- 18 Order code

Proline 500

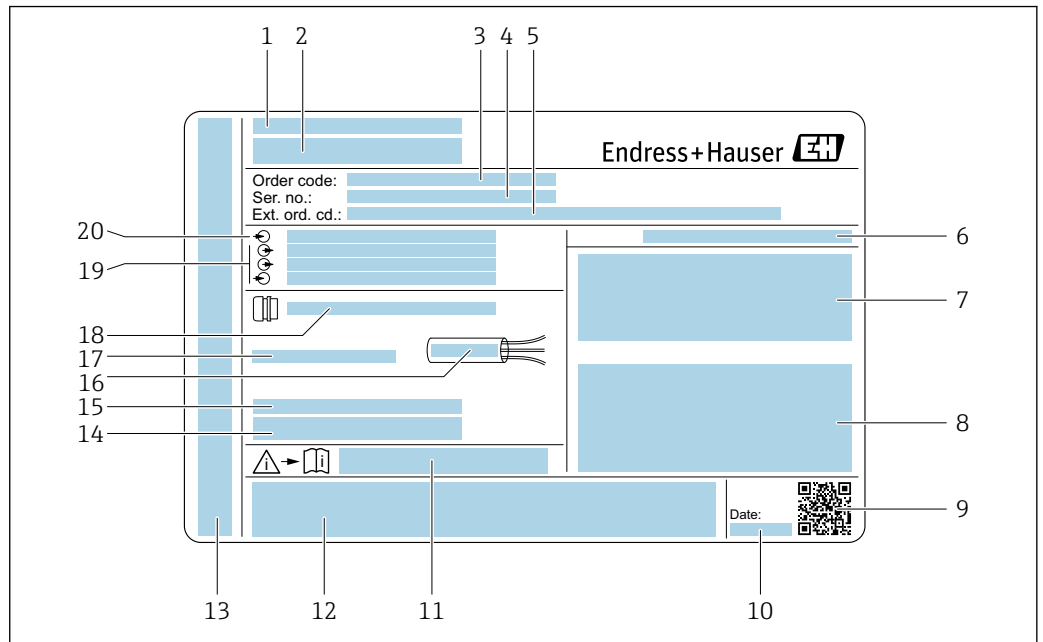

A0029192

4 Example of a transmitter nameplate

- 1 Manufacturer address/certificate holder
- 2 Name of the transmitter
- 3 Order code
- 4 Serial number (Ser. no.)
- 5 Extended order code (Ext. ord. cd.)
- 6 Degree of protection
- 7 Space for approvals: use in hazardous areas
- 8 Electrical connection data: available inputs and outputs
- 9 2-D matrix code
- 10 Date of manufacture: year-month
- 11 Document number of safety-related supplementary documentation
- 12 Space for approvals and certificates: e.g. CE mark, RCM tick
- 13 Space for degree of protection of connection and electronics compartment when used in hazardous areas
- 14 Firmware version (FW) and device revision (Dev. rev.) from the factory
- 15 Space for additional information in the case of special products
- 16 Permitted temperature range for cable
- 17 Allowable ambient temperature (T_a)
- 18 Information on cable gland
- 19 Available inputs and outputs, supply voltage
- 20 Electrical connection data: supply voltage

4.2.2 Sensor nameplate

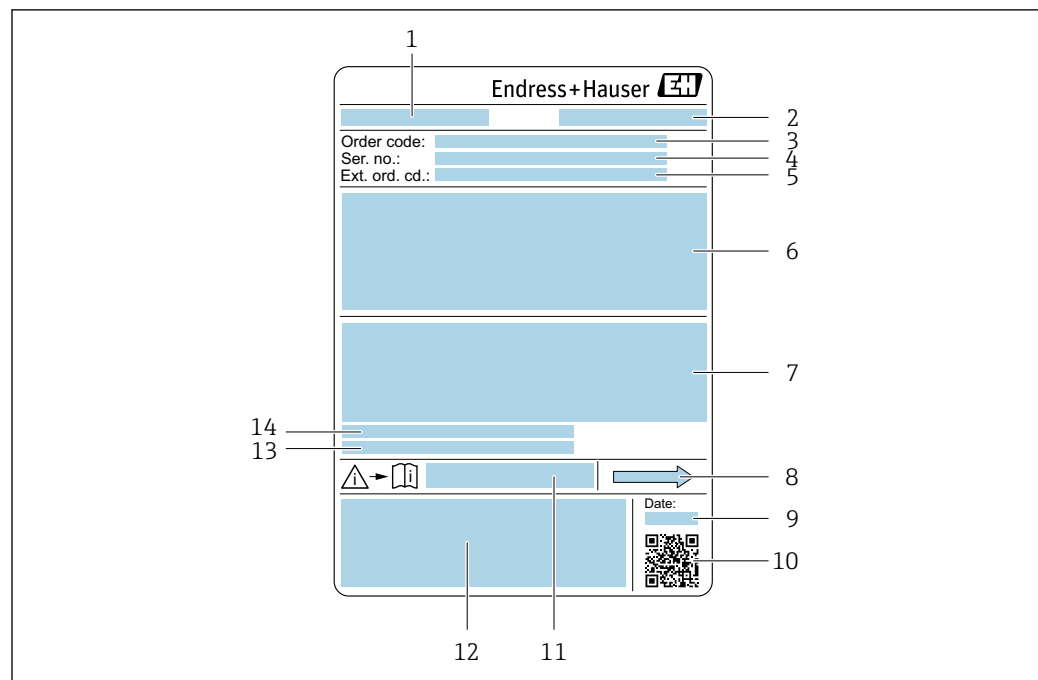

A0029199

 5 Example of a sensor nameplate

- 1 Name of the sensor
- 2 Manufacturer address/certificate holder
- 3 Order code
- 4 Serial number (Ser. no.)
- 5 Extended order code (Ext. ord. cd.)
- 6 Nominal diameter of the sensor; flange nominal diameter/nominal pressure; sensor test pressure; medium temperature range; material of measuring tube and manifold; sensor-specific information: e.g. pressure range of sensor housing, wide-range density specification (special density calibration)
- 7 Approval information for explosion protection, Pressure Equipment Directive and degree of protection
- 8 Flow direction
- 9 Date of manufacture: year-month
- 10 2-D matrix code
- 11 Document number of safety-related supplementary documentation
- 12 CE mark, RCM-Tick mark
- 13 Surface roughness
- 14 Allowable ambient temperature (T_a)



Order code

The measuring device is reordered using the order code.

Extended order code

- The device type (product root) and basic specifications (mandatory features) are always listed.
- Of the optional specifications (optional features), only the safety and approval-related specifications are listed (e.g. LA). If other optional specifications are also ordered, these are indicated collectively using the # placeholder symbol (e.g. #LA#).
- If the ordered optional specifications do not include any safety and approval-related specifications, they are indicated by the + placeholder symbol (e.g. XXXXXX-ABCDE +).

4.2.3 Symbols on the device

Symbol	Meaning
	WARNING! This symbol alerts you to a dangerous situation. Failure to avoid this situation can result in serious or fatal injury. Please consult the documentation for the measuring instrument to discover the type of potential danger and measures to avoid it.
	Reference to documentation Refers to the corresponding device documentation.
	Protective ground connection A terminal that must be connected to the ground prior to establishing any other connections.

5 Storage and transport

5.1 Storage conditions

Observe the following notes for storage:

- ▶ Store in the original packaging to ensure protection from shock.
- ▶ Do not remove protective covers or protective caps installed on process connections. They prevent mechanical damage to the sealing surfaces and contamination in the measuring tube.
- ▶ Protect from direct sunlight. Avoid unacceptably high surface temperatures.
- ▶ Store in a dry and dust-free place.
- ▶ Do not store outdoors.

Storage temperature → 📄 262

5.2 Transporting the product

Transport the measuring device to the measuring point in the original packaging.

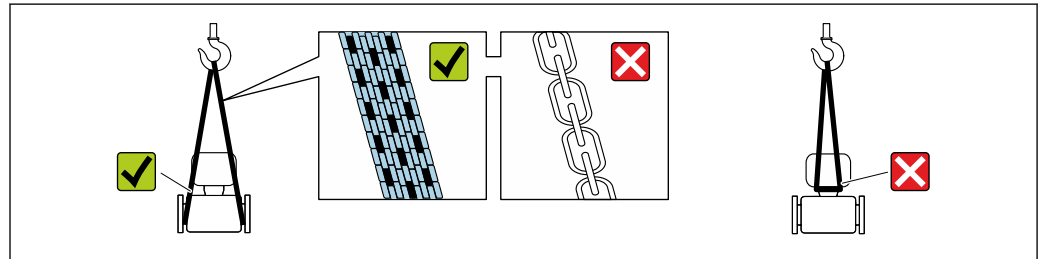

A0029252

i Do not remove protective covers or caps installed on process connections. They prevent mechanical damage to the sealing surfaces and contamination in the measuring tube.

5.2.1 Measuring devices without lifting lugs

⚠ WARNING

Center of gravity of the measuring device is higher than the suspension points of the webbing slings.

Risk of injury if the measuring device slips.

- ▶ Secure the measuring device against slipping or turning.
- ▶ Observe the weight specified on the packaging (stick-on label).

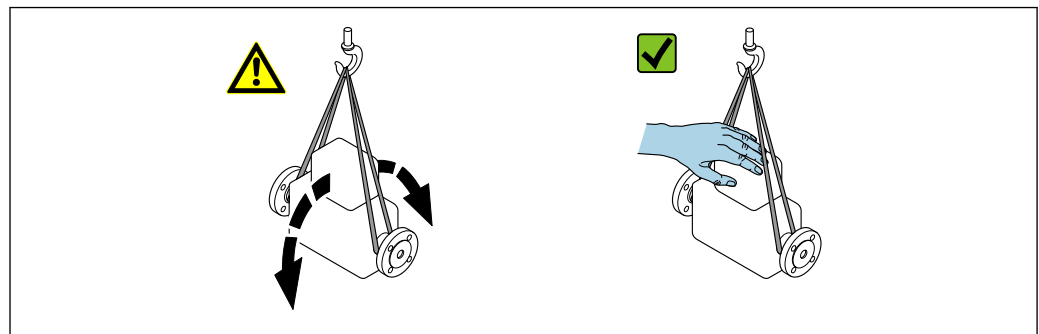

A0029214

5.2.2 Measuring devices with lifting lugs

⚠ CAUTION

Special transportation instructions for devices with lifting lugs

- ▶ Only use the lifting lugs fitted on the device or flanges to transport the device.
- ▶ The device must always be secured at two lifting lugs at least.

5.2.3 Transporting with a fork lift

If transporting in wood crates, the floor structure enables the crates to be lifted lengthwise or at both sides using a forklift.

5.3 Packaging disposal

All packaging materials are environmentally friendly and 100% recyclable:

- Outer packaging of device
 - Stretch wrap made of polymer in accordance with EU Directive 2002/95/EC (RoHS)
- Packaging
 - Wood crate treated in accordance with ISPM 15 standard, confirmed by IPPC logo
 - Cardboard box in accordance with European packaging guideline 94/62/EC, recyclability confirmed by Resy symbol
- Transport material and fastening fixtures
 - Disposable plastic pallet
 - Plastic straps
 - Plastic adhesive strips
- Filler material
 - Paper pads

6 Installation

6.1 Mounting requirements

6.1.1 Installation position

Installation point

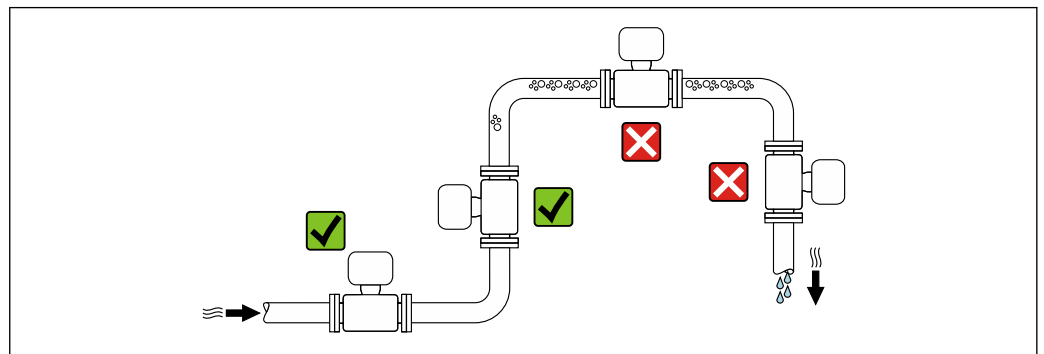

A0028772

To prevent measuring errors arising from accumulation of gas bubbles in the measuring pipe, avoid the following mounting locations in the piping:

- Highest point of a pipeline.
- Directly upstream of a free pipe outlet in a down pipe.

Installation in down pipes

However, the following installation suggestion allows for installation in an open vertical pipeline. Pipe restrictions or the use of an orifice with a smaller cross-section than the nominal diameter prevent the sensor running empty while measurement is in progress.

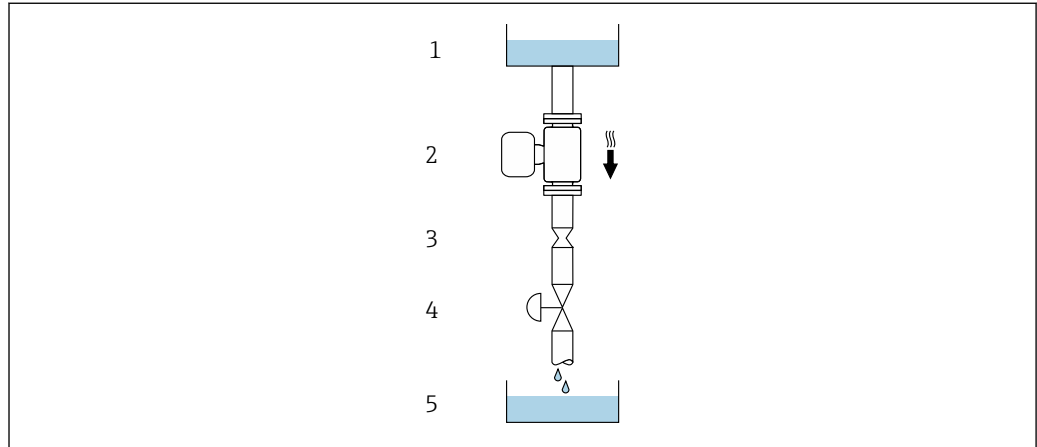

A0028773

6 Installation in a down pipe (e.g. for batching applications)





- 1 Supply tank
- 2 Sensor
- 3 Orifice plate, pipe restriction
- 4 Valve
- 5 Filling vessel

DN		Ø orifice plate, pipe restriction	
[mm]	[in]	[mm]	[in]
8	3/8	6	0.24
15	1/2	10	0.40
25	1	14	0.55
40	1 1/2	22	0.87
50	2	28	1.10

Orientation

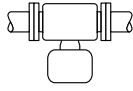
The direction of the arrow on the sensor nameplate helps you to install the sensor according to the flow direction (direction of medium flow through the piping).

Orientation		Recommendation
A	Vertical orientation	 A0015591 ✓✓ ¹⁾
B	Horizontal orientation, transmitter at top	 A0015589 ✓✓ ²⁾ Exception: → 7, 23

Orientation		Recommendation
C	Horizontal orientation, transmitter at bottom	 A0015590 ✓✓ ³⁾ Exception: →  , 
D	Horizontal orientation, transmitter at side	 A0015592 ✓✓

- 1) This orientation is recommended to ensure self-draining.
- 2) Applications with low process temperatures may reduce the ambient temperature. To maintain the minimum ambient temperature for the transmitter, this orientation is recommended.
- 3) Applications with high process temperatures may increase the ambient temperature. To maintain the maximum ambient temperature for the transmitter, this orientation is recommended.

If a sensor is installed horizontally with a curved measuring tube, match the position of the sensor to the fluid properties.

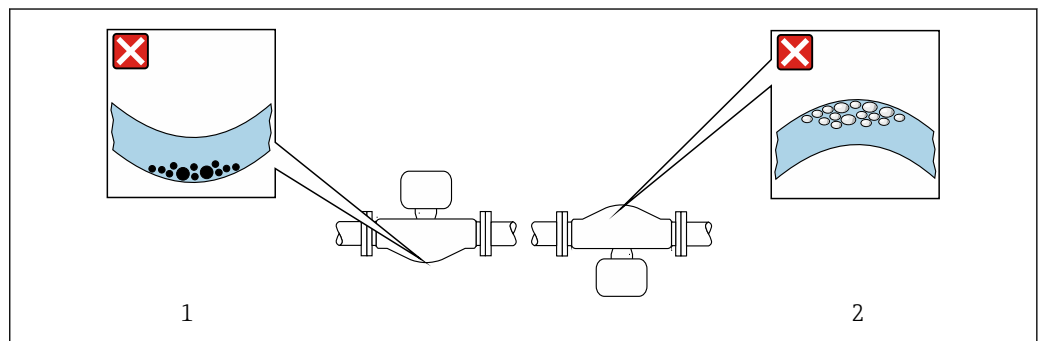

 7 Orientation of sensor with curved measuring tube

- 1 Avoid this orientation for fluids with entrained solids: Risk of solids accumulating
- 2 Avoid this orientation for outgassing fluids: Risk of gas accumulating

Inlet and outlet runs

No special precautions need to be taken for fittings that create turbulence, such as valves, elbows or T-pieces, as long as no cavitation occurs →  24.

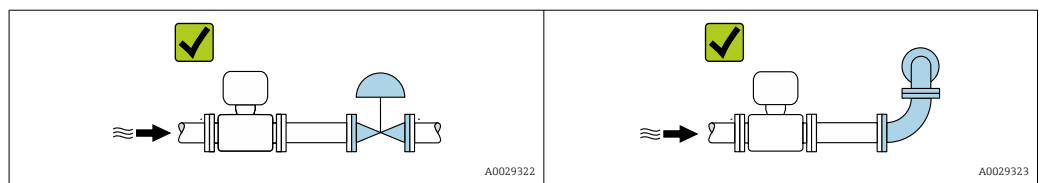

Installation dimensions

 For the dimensions and installation lengths of the device, see the "Technical Information" document, "Mechanical construction" section

6.1.2 Environmental and process requirements

Ambient temperature range

Measuring device	<ul style="list-style-type: none"> ▪ -40 to +60 °C (-40 to +140 °F) ▪ Order code for "Test, certificate", option JP: -50 to +60 °C (-58 to +140 °F)
Readability of the local display	-20 to +60 °C (-4 to +140 °F) The readability of the display may be impaired at temperatures outside the temperature range.

 Dependency of ambient temperature on medium temperature →  263

- ▶ If operating outdoors:
Avoid direct sunlight, particularly in warm climatic regions.

Static pressure

It is important that cavitation does not occur, or that gases entrained in the liquids do not outgas.

Cavitation is caused if the pressure drops below the vapor pressure:

- In liquids that have a low boiling point (e.g. hydrocarbons, solvents, liquefied gases)
 - In suction lines
- ▶ Ensure the static pressure is sufficiently high to prevent cavitation and outgassing.

For this reason, the following mounting locations are recommended:

- At the lowest point in a vertical pipe
- Downstream from pumps (no danger of vacuum)

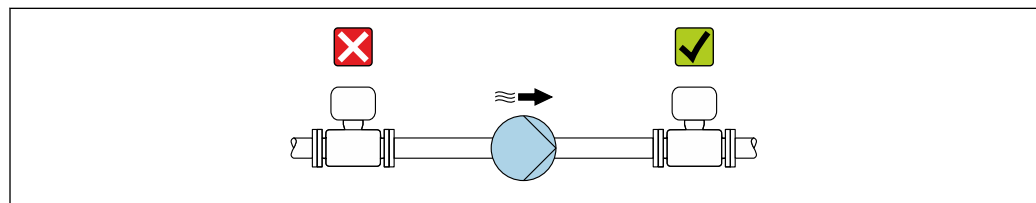

A0028777

Thermal insulation

In the case of some fluids, it is important to keep the heat radiated from the sensor to the transmitter to a low level. A wide range of materials can be used for the required insulation.

The following device versions are recommended for versions with thermal insulation:

Version with extended neck for insulation:

Order code for "Sensor option", option CG with an extended neck length of 105 mm (4.13 in).

NOTICE

Electronics overheating on account of thermal insulation!

- ▶ Recommended orientation: horizontal orientation, sensor connection housing pointing downwards.
- ▶ Do not insulate the sensor connection housing.
- ▶ Maximum permissible temperature at the lower end of the sensor connection housing: 80 °C (176 °F)
- ▶ Regarding thermal insulation with an exposed extended neck: We advise against insulating the extended neck to ensure optimal heat dissipation.

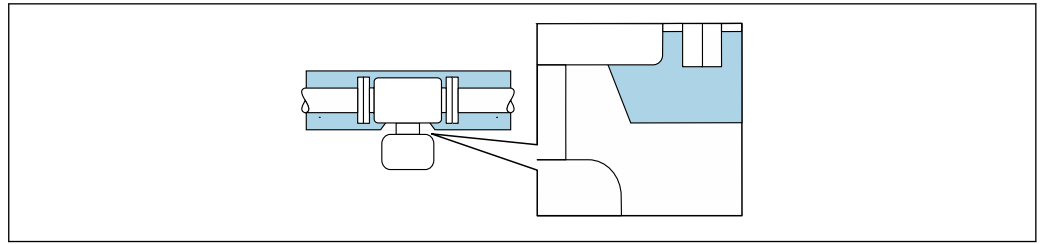

A0034391

8 Thermal insulation with exposed extended neck

Heating

NOTICE

Electronics can overheat due to elevated ambient temperature!

- ▶ Observe maximum permitted ambient temperature for the transmitter.
- ▶ Depending on the medium temperature, take the device orientation requirements into account.

NOTICE

Danger of overheating when heating

- ▶ Ensure that the temperature at the lower end of the transmitter housing does not exceed 80 °C (176 °F).
- ▶ Ensure that sufficient convection takes place at the transmitter neck.
- ▶ Ensure that a sufficiently large area of the transmitter neck remains exposed. The uncovered part serves as a radiator and protects the electronics from overheating and excessive cooling.
- ▶ When using in potentially explosive atmospheres, observe the information in the device-specific Ex documentation. For detailed information on the temperature tables, see the separate document entitled "Safety Instructions" (XA) for the device.
- ▶ Consider the "830 ambient temperature too high" and "832 electronics temperature too high" process diagnostics if overheating cannot be ruled out based on a suitable system design.

Heating options

If a fluid requires that no heat loss should occur at the sensor, users can avail of the following heating options:

- Electrical heating, e.g. with electric band heaters²⁾
- Via pipes carrying hot water or steam
- Via heating jackets

Vibrations

The high oscillation frequency of the measuring tubes ensures that the correct operation of the measuring system is not influenced by plant vibrations.

6.1.3 Special installation instructions

Drainability

When installed vertically, the measuring tubes can be drained completely and protected against buildup.

2) The use of parallel electric band heaters is generally recommended (bidirectional electricity flow). Particular considerations must be made if a single-wire heating cable is to be used. For additional information, refer to EA01339D "Installation Instructions for Electrical Trace Heating Systems".

Hygienic compatibility

i When installing in hygienic applications, please refer to the information in the "Certificates and approvals/hygienic compatibility" section → 272

Securing with mounting clamp in the case of hygiene connections

It is not necessary to provide additional support for the sensor for operational performance purposes. If, however, additional support is required for installation purposes, the following dimensions must be observed.

Use mounting clamp with lining between clamp and measuring instrument.

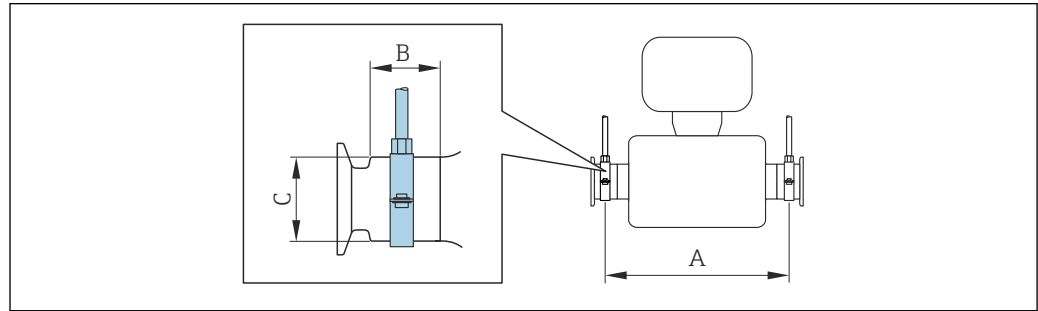

A0030298

DN		A		B		C	
[mm]	[in]	[mm]	[in]	[mm]	[in]	[mm]	[in]
8	3/8	298	11.73	33	1.3	28	1.1
15	1/2	402	15.83	33	1.3	28	1.1
25	1	542	21.34	33	1.3	38	1.5
40	1 1/2	658	25.91	36.5	1.44	56	2.2
50	2	772	30.39	44.1	1.74	75	2.95

Zero verification and zero adjustment

All measuring instruments are calibrated in accordance with state-of-the-art technology. Calibration takes place under reference conditions → 258. Therefore, a zero adjustment in the field is generally not required.

Experience shows that zero adjustment is advisable only in special cases:

- To achieve maximum measurement accuracy even with low flow rates.
- Under extreme process or operating conditions (e.g. very high process temperatures or very high-viscosity fluids).
- For gas applications with low pressure

i To achieve the highest possible measurement accuracy at low flow rates, the installation must protect the sensor from mechanical stresses during operation.

To get a representative zero point, ensure that:

- any flow in the device is prevented during the adjustment
- the process conditions (e.g. pressure, temperature) are stable and representative

Verification and adjustment cannot be carried out if the following process conditions are present:

- Gas pockets
Ensure that the system has been sufficiently flushed with the medium. Repeat flushing can help to eliminate gas pockets
- Thermal circulation
In the event of temperature differences (e.g. between the measuring tube inlet and outlet section), induced flow can occur even if the valves are closed due to thermal circulation in the device
- Leaks at the valves
If the valves are not leak-tight, flow is not sufficiently prevented when determining the zero point

If these conditions cannot be avoided, it is advisable to keep the factory setting for the zero point.

Weather protection cover

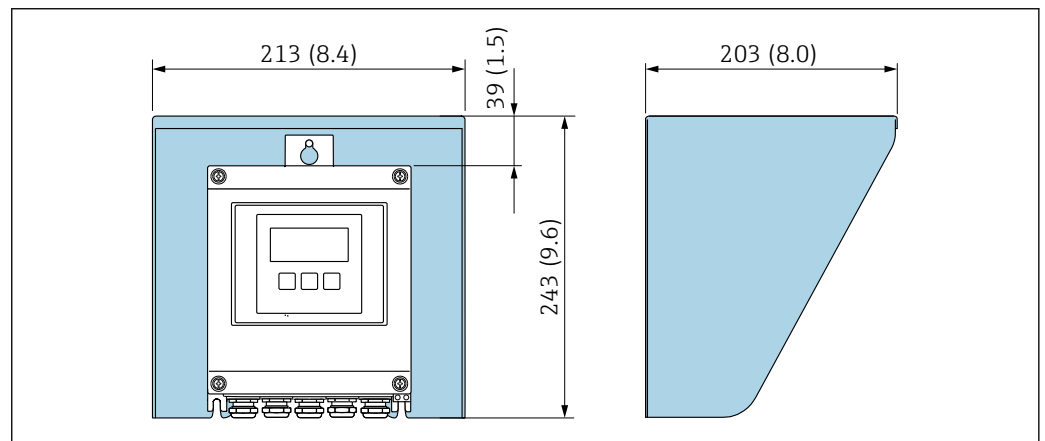

A0029552

9 Weather protection cover for Proline 500 – digital; engineering unit mm (in)

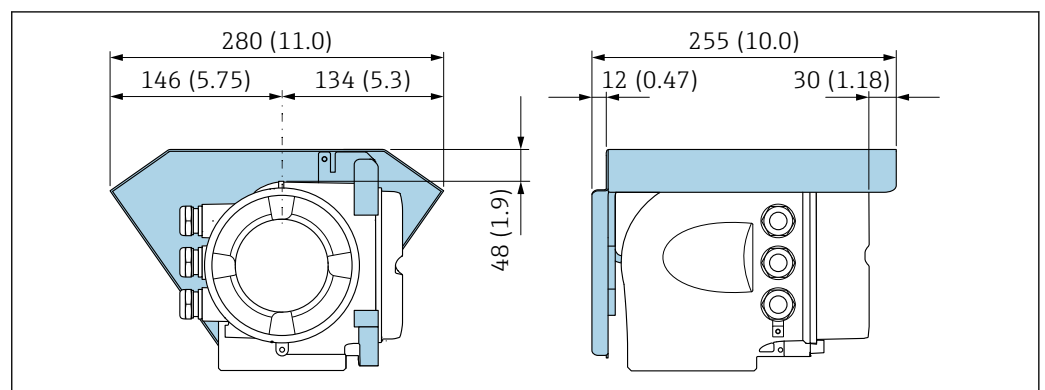

A0029553

10 Weather protection cover for Proline 500; engineering unit mm (in)

6.2 Installing the measuring instrument

6.2.1 Required tools

For transmitter

For mounting on a post:

- Proline 500 – digital transmitter
 - Open-ended wrench AF 10
 - Torx screwdriver TX 25
- Proline 500 transmitter
 - Open-ended wrench AF 13

For wall mounting:

Drill with drill bit \varnothing 6.0 mm

For sensor

For flanges and other process connections: Use a suitable mounting tool.

6.2.2 Preparing the measuring instrument

1. Remove all remaining transport packaging.
2. Remove any protective covers or protective caps present from the sensor.
3. Remove stick-on label on the electronics compartment cover.

6.2.3 Mounting the measuring device

⚠ WARNING

Danger due to improper process sealing!

- ▶ Ensure that the inside diameters of the gaskets are greater than or equal to that of the process connections and piping.
- ▶ Ensure that the seals are clean and undamaged.
- ▶ Secure the seals correctly.

1. Ensure that the direction of the arrow on the nameplate of the sensor matches the flow direction of the medium.
2. Install the measuring device or turn the transmitter housing so that the cable entries do not point upwards.

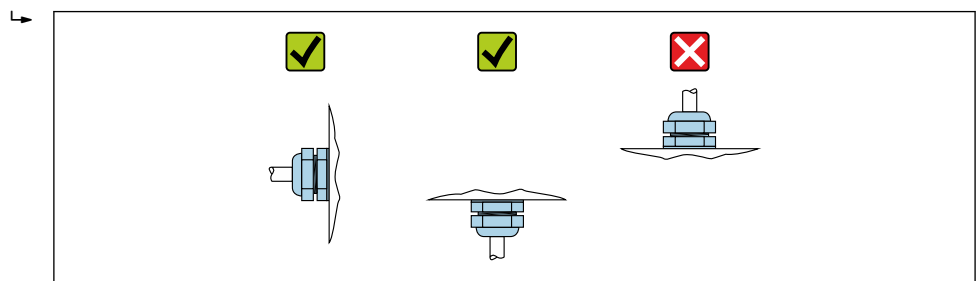

A0029263

6.2.4 Mounting the transmitter housing: Proline 500 – digital

⚠ CAUTION

Ambient temperature too high!

Danger of electronics overheating and housing deformation.

- ▶ Do not exceed the permitted maximum ambient temperature.
- ▶ If operating outdoors: Avoid direct sunlight and exposure to weathering, particularly in warm climatic regions.

⚠ CAUTION

Excessive force can damage the housing!

- ▶ Avoid excessive mechanical stress.

The transmitter can be mounted in the following ways:

- Post mounting
- Wall mounting

Pipe mounting

Required tools:

- Open-ended wrench AF 10
- Torx screwdriver TX 25

NOTICE

Excessive tightening torque applied to the fixing screws!

Risk of damaging the plastic transmitter.

- ▶ Tighten the fixing screws as per the tightening torque: 2.5 Nm (1.8 lbf ft)

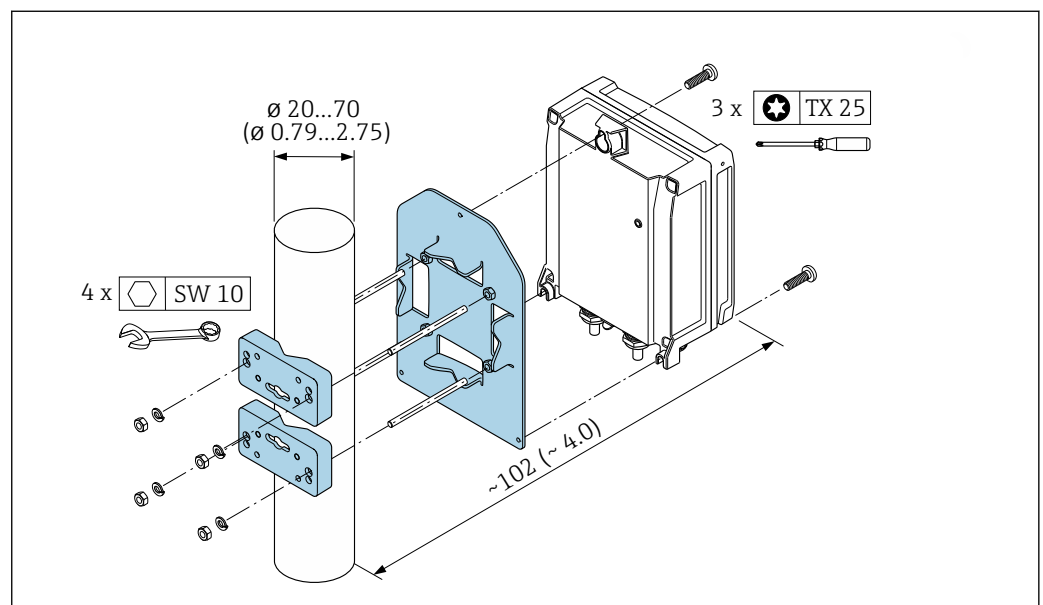

11 Unit mm (in)

A0029051

Wall mounting

Required tools:

Drill with drill bit \varnothing 6.0 mm

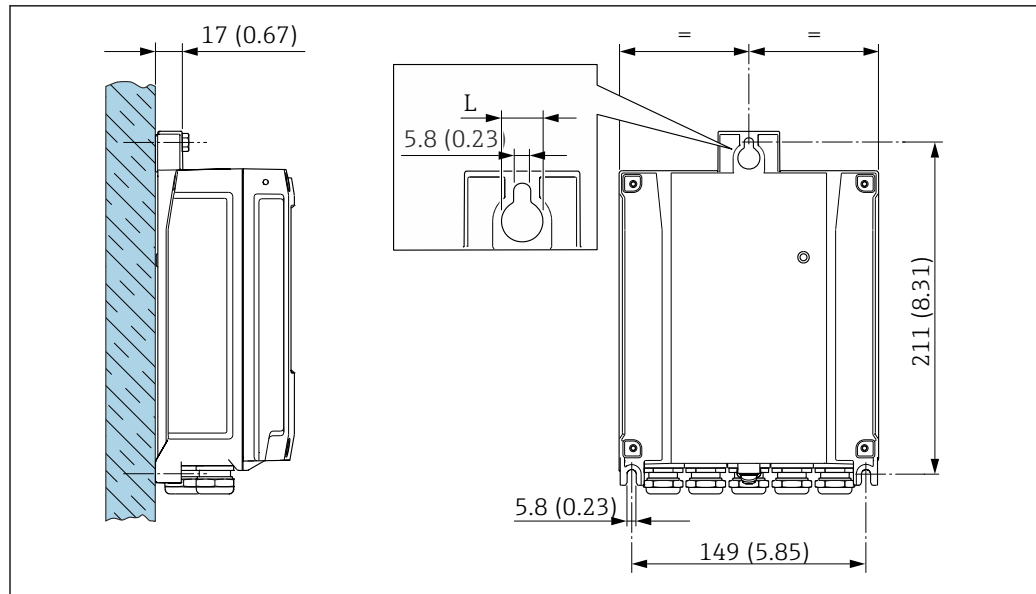

12 Engineering unit mm (in)

L Depends on order code for "Transmitter housing"

Order code for "Transmitter housing"

- Option **A**, aluminum, coated: L = 14 mm (0.55 in)
- Option **D**, polycarbonate: L = 13 mm (0.51 in)

1. Drill the holes.
2. Insert wall plugs into the drilled holes.
3. Screw in the fixing screws slightly.
4. Fit the transmitter housing over the fixing screws and mount in place.
5. Tighten the fixing screws.

6.2.5 Mounting the transmitter housing: Proline 500

⚠ CAUTION

Ambient temperature too high!

Danger of electronics overheating and housing deformation.

- ▶ Do not exceed the permitted maximum ambient temperature.
- ▶ If operating outdoors: Avoid direct sunlight and exposure to weathering, particularly in warm climatic regions.

⚠ CAUTION

Excessive force can damage the housing!

- ▶ Avoid excessive mechanical stress.

The transmitter can be mounted in the following ways:

- Post mounting
- Wall mounting

Wall mounting

Required tools

Drill with drill bit \varnothing 6.0 mm

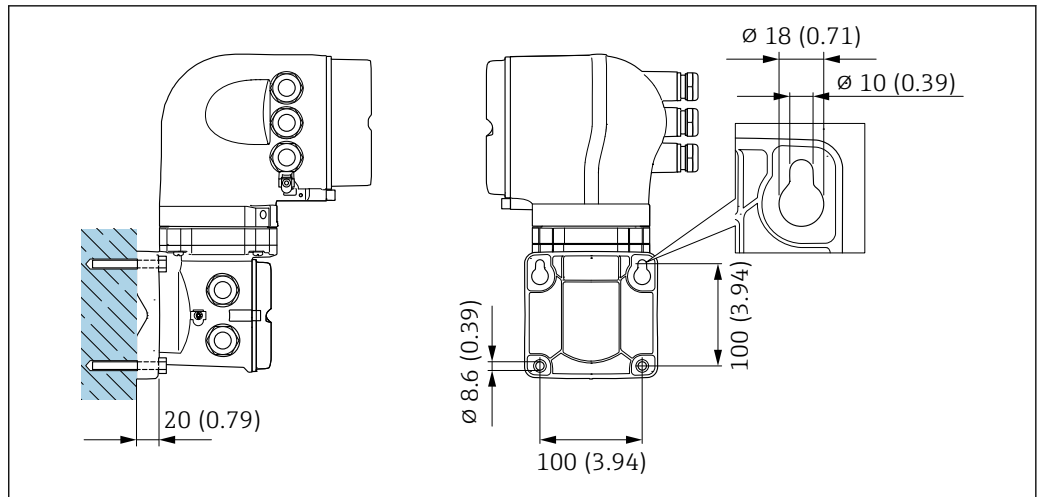

13 Engineering unit mm (in)

1. Drill the holes.
2. Insert wall plugs into the drilled holes.
3. Screw in the fixing screws slightly.
4. Fit the transmitter housing over the fixing screws and mount in place.
5. Tighten the fixing screws.

Pipe mounting

Required tools

Open-ended wrench AF 13

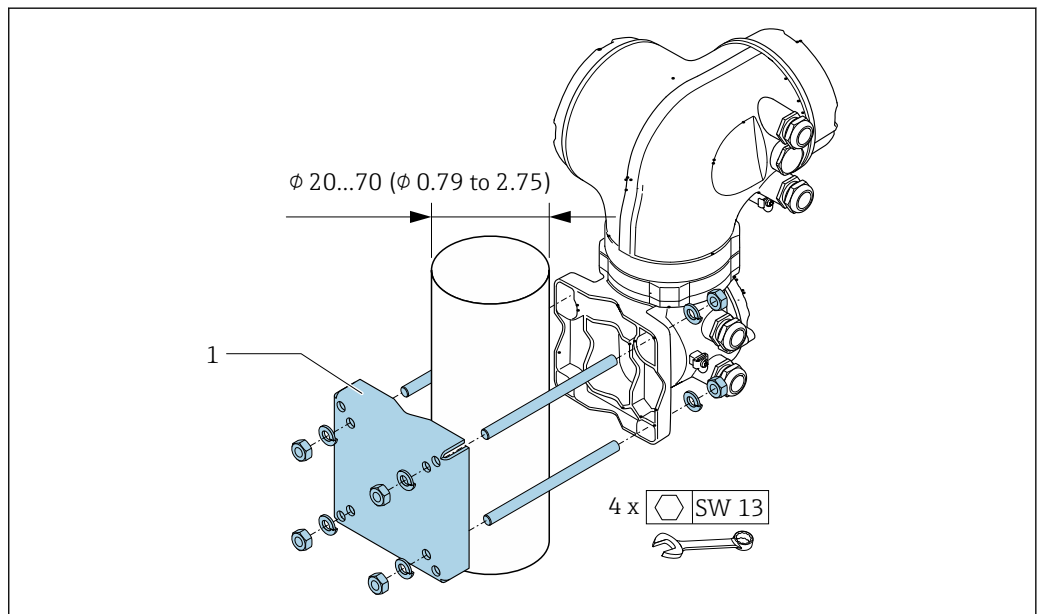

14 Engineering unit mm (in)

6.2.6 Turning the transmitter housing: Proline 500

To provide easier access to the connection compartment or display module, the transmitter housing can be turned.

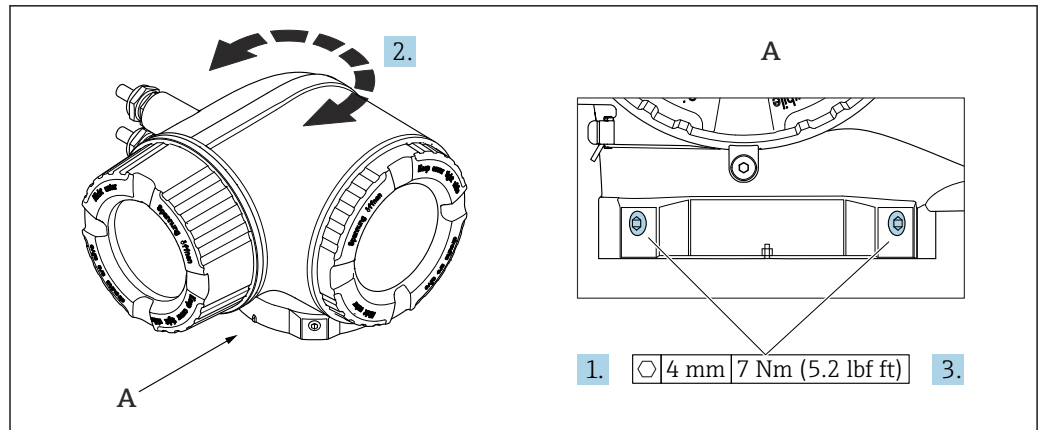

A0043150

15 Ex housing

1. Loosen the fixing screws.
2. Turn the housing to the desired position.
3. Tighten the securing screws.

6.2.7 Turning the display module: Proline 500

The display module can be turned to optimize display readability and operability.

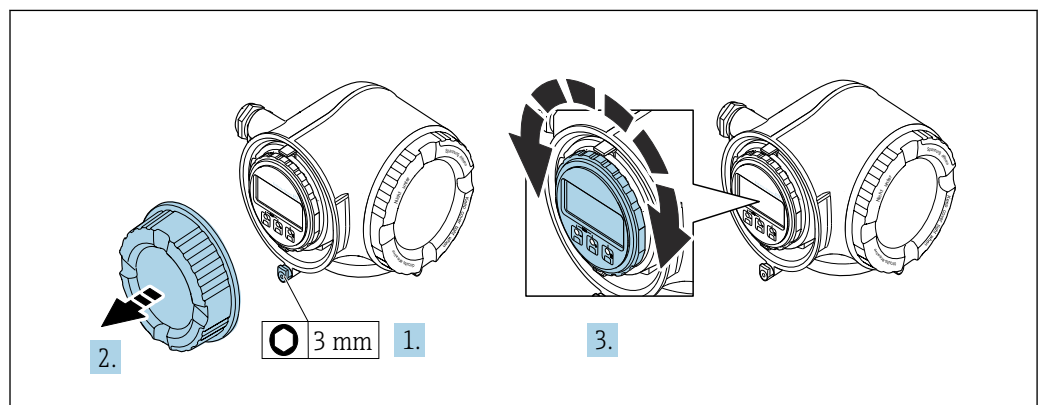

A0030035

1. Depending on the device version: Loosen the securing clamp of the connection compartment cover.
2. Unscrew the connection compartment cover.
3. Turn the display module to the desired position: max. $8 \times 45^\circ$ in each direction.
4. Screw on the connection compartment cover.
5. Depending on the device version: Attach the securing clamp of the connection compartment cover.

6.3 Post-installation check

Is the device undamaged (visual inspection)?	<input type="checkbox"/>
Does the measuring instrument correspond to the measuring point specifications? For example: <ul style="list-style-type: none"> ▪ Process temperature → 263 ▪ Pressure (refer to the "Pressure-temperature ratings" section of the "Technical Information" document). ▪ Ambient temperature ▪ Measuring range 	<input type="checkbox"/>
Has the correct orientation for the sensor been selected → 22? <ul style="list-style-type: none"> ▪ According to sensor type ▪ According to medium temperature ▪ According to medium properties (outgassing, with entrained solids) 	<input type="checkbox"/>
Does the arrow on the sensor match the direction of flow of the medium? → 22?	<input type="checkbox"/>
Is the tag name and labeling correct (visual inspection)?	<input type="checkbox"/>
Is the device sufficiently protected from precipitation and direct sunlight?	<input type="checkbox"/>
Are the securing screw and securing clamp tightened securely?	<input type="checkbox"/>

7 Electrical connection

WARNING

Live parts! Incorrect work performed on the electrical connections can result in an electric shock.

- ▶ Set up a disconnecting device (switch or power-circuit breaker) to easily disconnect the device from the supply voltage.
- ▶ In addition to the device fuse, include an overcurrent protection unit with max. 10 A in the plant installation.

7.1 Electrical safety

In accordance with applicable national regulations.

7.2 Connecting requirements

7.2.1 Required tools

- For cable entries: use appropriate tool
- For securing clamp: Allen key 3 mm
- Wire stripper
- When using stranded cables: crimper for wire end ferrule
- For removing cables from terminal: flat blade screwdriver ≤ 3 mm (0.12 in)

7.2.2 Requirements for connection cable

The connecting cables provided by the customer must fulfill the following requirements.

Protective grounding cable for the outer ground terminal

Conductor cross-section < 2.1 mm² (14 AWG)

The use of a cable lug enables the connection of larger cross-sections.

The grounding impedance must be less than 2 Ω .

Permitted temperature range

- The installation guidelines that apply in the country of installation must be observed.
- The cables must be suitable for the minimum and maximum temperatures to be expected.

Power supply cable (incl. conductor for the inner ground terminal)

Standard installation cable is sufficient.

Signal cable

-  For custody transfer, all signal lines must be shielded cables (tinned copper braiding, optical coverage ≥ 85 %). The cable shield must be connected on both sides.

PROFIBUS PA

Shielded twisted-pair cable. Cable type A is recommended.

-  See <https://www.profibus.com> "PROFIBUS Installation Guidelines".

Ethernet-APL

Shielded twisted-pair cable. Cable type A is recommended.



See <https://www.profibus.com> Ethernet-APL White Paper "

Current output 0 /4 to 20 mA (excluding HART)

Standard installation cable is sufficient.

Pulse /frequency /switch output

Standard installation cable is sufficient.

Relay output

Standard installation cable is sufficient.

Current input 4 to 20 mA

Standard installation cable is sufficient.

Status input

Standard installation cable is sufficient.

Cable diameter

- Cable glands supplied:
M20 × 1.5 with cable Ø 6 to 12 mm (0.24 to 0.47 in)
- Spring-loaded terminals: Suitable for strands and strands with ferrules.
Conductor cross-section 0.2 to 2.5 mm² (24 to 12 AWG).

Choice of connecting cable between the transmitter and sensor

Depends on the type of transmitter and the installation zones

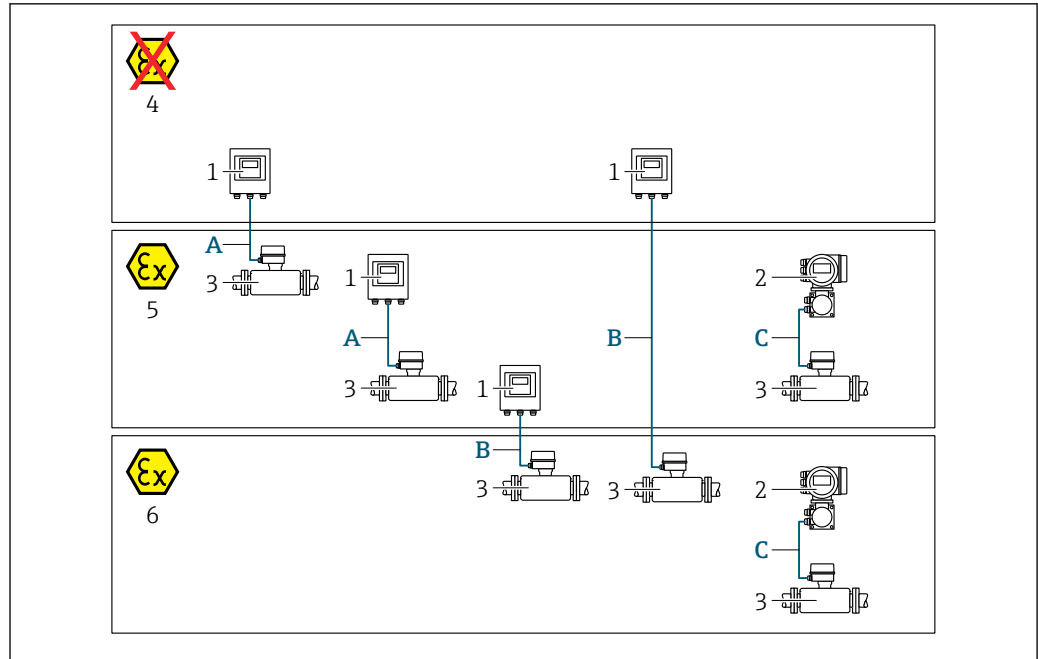

A0032476

- 1 Proline 500 digital transmitter
- 2 Proline 500 transmitter
- 3 Sensor Promass
- 4 Non-hazardous area
- 5 Hazardous area: Zone 2; Class I, Division 2
- 6 Hazardous area: Zone 1; Class I, Division 1
- A Standard cable to 500 digital transmitter → 36
Transmitter installed in the non-hazardous area or hazardous area: Zone 2; Class I, Division 2/sensor installed in the hazardous area: Zone 2; Class I, Division 2
- B Standard cable to 500 digital transmitter → 37
Transmitter installed in the hazardous area: Zone 2; Class I, Division 2/sensor installed in the hazardous area: Zone 1; Class I, Division 1
- C Signal cable to 500 transmitter → 39
Transmitter and sensor installed in the hazardous area: Zone 2; Class I, Division 2 or Zone 1; Class I, Division 1

A: Connecting cable between sensor and transmitter: Proline 500 – digital Standard cable

A standard cable with the following specifications can be used as the connecting cable.

Design	4 cores (2 pairs); uninsulated stranded CU wires; pair-stranded with common shield
Shield	Tin-plated copper braid, optical cover ≥ 85 %
Loop resistance	Power supply line (+, -): maximum 10 Ω
Cable length	Maximum 300 m (900 ft), see the following table.
Device plug, side 1	M12 socket, 5-pin, A-coded.
Device plug, side 2	M12 plug, 5-pin, A-coded.
Pins 1+2	Connected cores as twisted pair.
Pins 3+4	Connected cores as twisted pair.

Cross-section	Cable length [max.]
0.34 mm ² (AWG 22)	80 m (240 ft)
0.50 mm ² (AWG 20)	120 m (360 ft)
0.75 mm ² (AWG 18)	180 m (540 ft)

Cross-section	Cable length [max.]
1.00 mm ² (AWG 17)	240 m (720 ft)
1.50 mm ² (AWG 15)	300 m (900 ft)

Optionally available connecting cable

Design	2 × 2 × 0.34 mm ² (AWG 22) PVC cable ¹⁾ with common shield (2 pairs, uninsulated stranded CU wires; pair-stranded)
Flame resistance	According to DIN EN 60332-1-2
Oil resistance	According to DIN EN 60811-2-1
Shield	Tin-plated copper braid, optical cover ≥ 85 %
Continuous operating temperature	When mounted in a fixed position: -50 to +105 °C (-58 to +221 °F); when cable can move freely: -25 to +105 °C (-13 to +221 °F)
Available cable length	Fixed: 20 m (60 ft); variable: up to maximum 50 m (150 ft)

1) UV radiation can impair the cable outer sheath. Protect the cable from direct sunshine where possible.

B: Connecting cable between sensor and transmitter: Proline 500 - digital

Standard cable

A standard cable with the following specifications can be used as the connecting cable.

Design	4, 6, 8 cores (2, 3, 4 pairs); uninsulated stranded CU wires; pair-stranded with common shield
Shielding	Tin-plated copper braid, optical cover ≥ 85 %
Capacitance C	Maximum 760 nF IIC, maximum 4.2 μF IIB
Inductance L	Maximum 26 μH IIC, maximum 104 μH IIB
Inductance/resistance ratio (L/R)	Maximum 8.9 μH/Ω IIC, maximum 35.6 μH/Ω IIB (e.g. according to IEC 60079-25)
Loop resistance	Power supply line (+, -): maximum 5 Ω
Cable length	Maximum 150 m (450 ft), see the following table.

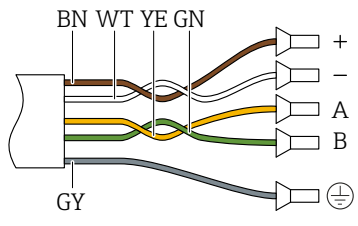
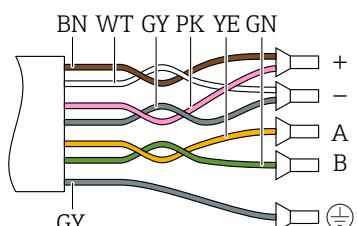
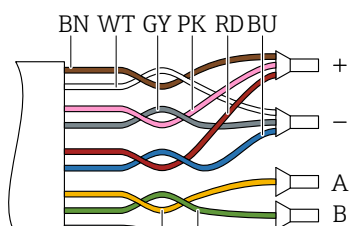
Cross-section	Cable length [max.]	Termination
2 x 2 x 0.50 mm ² (AWG 20)	50 m (150 ft)	2 x 2 x 0.50 mm ² (AWG 20)  ■ +, - = 0.5 mm ² ■ A, B = 0.5 mm ²
3 x 2 x 0.50 mm ² (AWG 20)	100 m (300 ft)	3 x 2 x 0.50 mm ² (AWG 20)  ■ +, - = 1.0 mm ² ■ A, B = 0.5 mm ²
4 x 2 x 0.50 mm ² (AWG 20)	150 m (450 ft)	4 x 2 x 0.50 mm ² (AWG 20)  ■ +, - = 1.5 mm ² ■ A, B = 0.5 mm ²

Optionally available connecting cable

Connecting cable for	Zone 1; Class I, Division 1
Standard cable	2 × 2 × 0.5 mm ² (AWG 20) PVC cable ¹⁾ with common shield (2 pairs, pair-stranded)
Flame resistance	According to DIN EN 60332-1-2
Oil-resistance	According to DIN EN 60811-2-1
Shielding	Tin-plated copper braid, optical cover ≥ 85 %
Operating temperature	When mounted in a fixed position: -50 to +105 °C (-58 to +221 °F); when cable can move freely: -25 to +105 °C (-13 to +221 °F)
Available cable length	Fixed: 20 m (60 ft); variable: up to maximum 50 m (150 ft)

1) UV radiation can impair the cable outer sheath. Protect the cable from direct sunshine where possible.

C: Connecting cable between sensor and transmitter: Proline 500

Design	6 × 0.38 mm ² PVC cable ¹⁾ with individual shielded cores and common copper shield
Conductor resistance	≤ 50 Ω/km (0.015 Ω/ft)
Capacitance: core/shield	≤ 420 pF/m (128 pF/ft)
Cable length (max.)	20 m (60 ft)
Cable lengths (available for order)	5 m (15 ft), 10 m (30 ft), 20 m (60 ft)
Cable diameter	11 mm (0.43 in) ± 0.5 mm (0.02 in)
Continuous operating temperature	Max. 105 °C (221 °F)

1) UV radiation can impair the cable outer sheath. Protect the cable from direct sunshine where possible.

7.2.3 Terminal assignment

Transmitter: supply voltage, input/outputs



The terminal assignment of the inputs and outputs depends on the individual order version of the device. The device-specific terminal assignment is documented on an adhesive label in the terminal cover.

Supply voltage		Input/output 1		Input/output 2		Input/output 3		Input/output 4	
1 (+)	2 (-)	26 (B)	27 (A)	24 (+)	25 (-)	22 (+)	23 (-)	20 (+)	21 (-)
Device-specific terminal assignment: adhesive label in terminal cover.									

Transmitter and sensor connection housing: connecting cable

The sensor and transmitter, which are mounted in separate locations, are interconnected by a connecting cable. The cable is connected via the sensor connection housing and the transmitter housing.

Terminal assignment and connection of the connecting cable:

- Proline 500 – digital →  42
- Proline 500 →  49

7.2.4 Available device plugs

 Device plugs may not be used in hazardous areas!

Order code for "Input; output 1", option GA "PROFIBUS PA"

Order code for "Electrical connection"	Cable entry/connection	
	2	3
L, N, P, U	Connector M12 × 1	-

7.2.5 device plug pin assignment

Pin	Assignment		Coding	Plug/socket
1	+	PROFIBUS PA +	A	Plug
2		Grounding		
3	-	PROFIBUS PA -		
4		Not assigned		

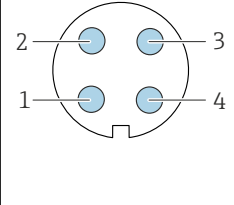

7.2.6 Shielding and grounding

Optimal electromagnetic compatibility (EMC) of the fieldbus system can be guaranteed only if the system components and, in particular, the lines are shielded and the shield forms as complete a cover as possible. A shield coverage of 90 % is ideal.

1. To ensure optimal EMC protection, connect the shield to the reference ground as often as possible.
2. For reasons concerning explosion protection, it is recommended that grounding be dispensed with.

To comply with both requirements, there are basically three different types of shielding in the fieldbus system:

- Shielding at both ends
- Shielding at one end on the feed side with capacitance termination at the field device
- Shielding at one end on the feed side

Experience shows that the best results with regard to EMC are achieved in most cases in installations with one-sided shielding on the feed side (without capacitance termination at the field device). Appropriate measures with regard to input wiring must be taken to allow unrestricted operation when EMC interference is present. These measures have been taken into account for this device. Operation in the event of disturbance variables as per NAMUR NE21 is thus guaranteed.

1. Observe national installation requirements and guidelines during installation.
2. Where there are large differences in potential between the individual grounding points, connect only one point of the shielding directly to the reference ground.
3. In systems without potential equalization, the cable shielding of fieldbus systems should be grounded on one side only, for example at the fieldbus supply unit or at safety barriers.

NOTICE

In systems without potential matching, the multiple grounding of the cable shield causes mains frequency equalizing currents!

Damage to the bus cable shield.

- ▶ Only ground the bus cable shield to either the local ground or the protective ground at one end.
- ▶ Insulate the shield that is not connected.

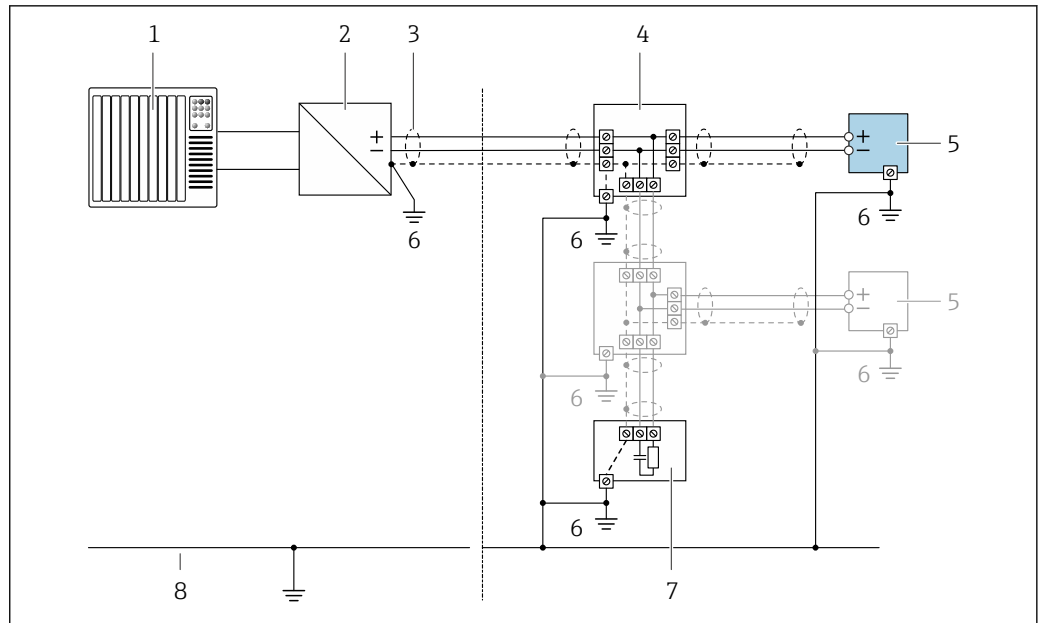

16 Connection example for PROFIBUS PA

- 1 Control system (e.g. PLC)
- 2 PROFIBUS PA segment coupler
- 3 Cable shield: the cable shield must be grounded at both ends to comply with EMC requirements; observe cable specifications
- 4 T-box
- 5 Measuring device
- 6 Local grounding
- 7 Bus terminator
- 8 Potential equalization conductor

7.2.7 Preparing the measuring device

Carry out the steps in the following order:

1. Mount the sensor and transmitter.
2. Sensor connection housing: Connect connecting cable.
3. Transmitter: Connect connecting cable.
4. Transmitter: Connect signal cable and cable for supply voltage.

NOTICE

Insufficient sealing of the housing!

Operational reliability of the measuring device could be compromised.

- Use suitable cable glands corresponding to the degree of protection.

1. Remove dummy plug if present.
2. If the measuring device is supplied without cable glands:
Provide suitable cable gland for corresponding connecting cable.
3. If the measuring device is supplied with cable glands:
Observe requirements for connecting cables → 34.

7.3 Connecting the measuring instrument: Proline 500 - digital

NOTICE

An incorrect connection compromises electrical safety!

- ▶ Only properly trained specialist staff may perform electrical connection work.
- ▶ Observe applicable federal/national installation codes and regulations.
- ▶ Comply with local workplace safety regulations.
- ▶ Always connect the protective ground cable ⊕ before connecting additional cables.
- ▶ When using in potentially explosive atmospheres, observe the information in the device-specific Ex documentation.

7.3.1 Connecting the connecting cable

⚠ WARNING

Risk of damaging electronic components!

- ▶ Connect the sensor and transmitter to the same potential equalization.
- ▶ Only connect the sensor to a transmitter with the same serial number.

Connecting cable terminal assignment

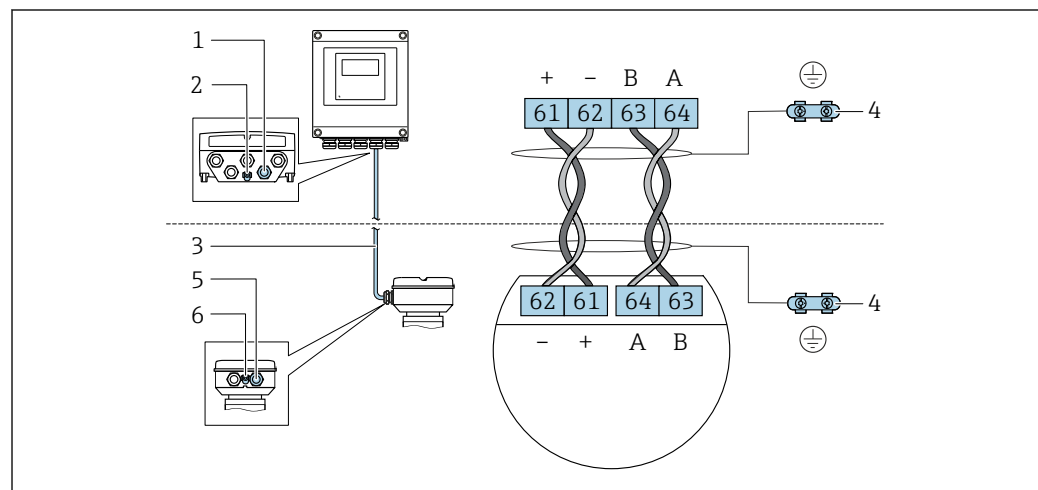

A0028198

- 1 Cable entry for cable on transmitter housing
- 2 Protective earth (PE)
- 3 Connecting cable ISEM communication
- 4 Grounding via ground connection; in the version with a device plug, grounding is ensured through the plug itself
- 5 Cable entry for cable or connection of device plug on sensor connection housing
- 6 Protective earth (PE)

Connecting the connecting cable to the sensor connection housing

- Connection via terminals with order code for "Sensor connection housing":
 - Option A "Aluminum, coated" → 📄 43
 - Option B "Stainless" → 📄 44
- Connection via connectors with order code for "Sensor connection housing":
 - Option C "Ultra-compact hygienic, stainless" → 📄 45

Connecting the connecting cable to the transmitter

The cable is connected to the transmitter via terminals → 📄 46.

Connecting the sensor connection housing via terminals

For the device version with the order code for "Sensor connection housing":
Option **A** "Aluminum coated"

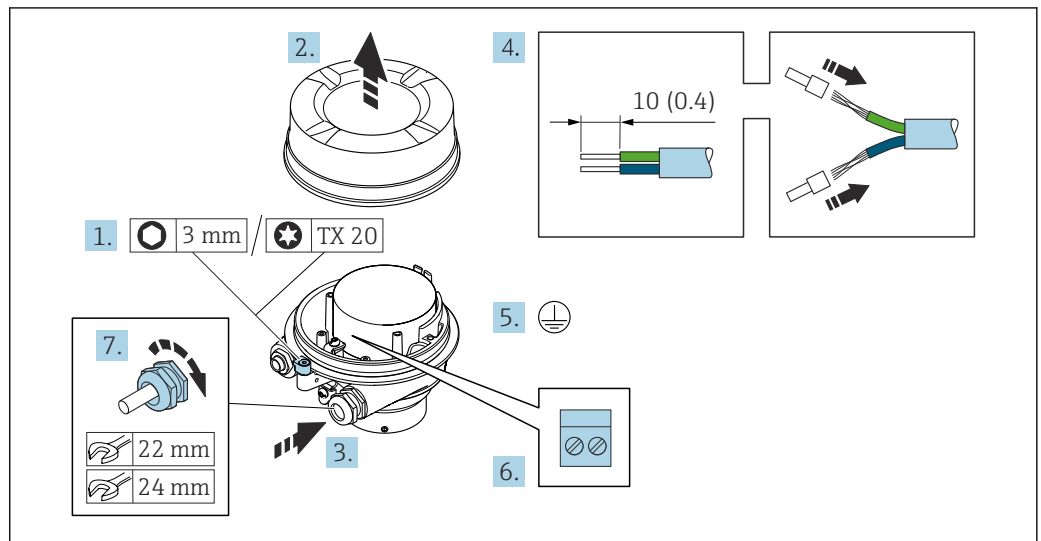

A0029616

1. Loosen the securing clamp of the housing cover.
2. Unscrew the housing cover.
3. Push the cable through the cable entry. To ensure tight sealing, do not remove the sealing ring from the cable entry.
4. Strip the cable and cable ends. In the case of stranded cables, fit ferrules.
5. Connect the protective ground.
6. Connect the cable in accordance with the connecting cable terminal assignment.
7. Firmly tighten the cable glands.
 - ↳ This concludes the process for connecting the connecting cable.

⚠ WARNING

Housing degree of protection voided due to insufficient sealing of the housing.

- ▶ Screw in the thread on the cover without using any lubricant. The thread on the cover is coated with a dry lubricant.
8. Screw on the housing cover.
 9. Tighten the securing clamp of the housing cover.

Connecting the sensor connection housing via terminals

For the device version with the order code for "Sensor connection housing":
Option B "Stainless"

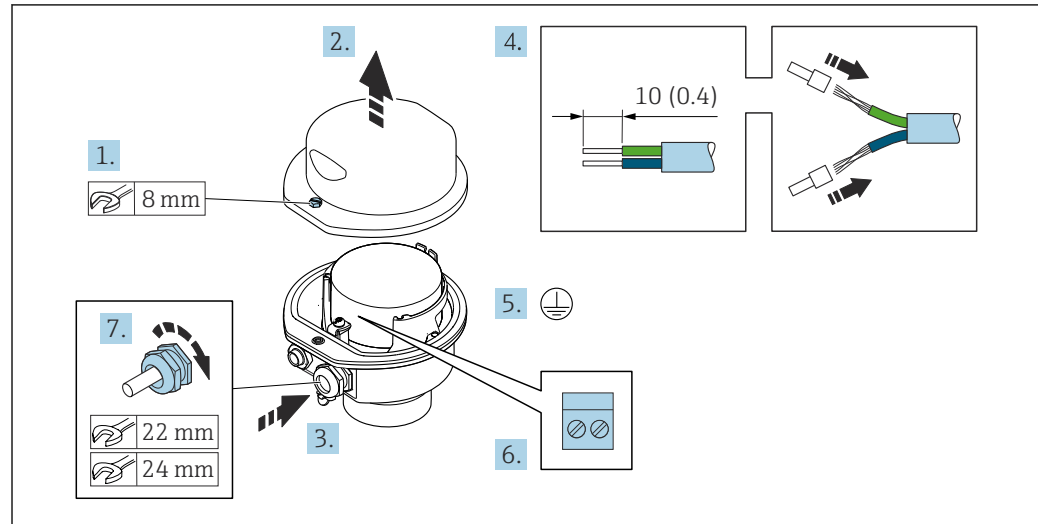

A0029613

1. Release the securing screw of the housing cover.
2. Open the housing cover.
3. Push the cable through the cable entry . To ensure tight sealing, do not remove the sealing ring from the cable entry.
4. Strip the cable and cable ends. In the case of stranded cables, fit ferrules.
5. Connect the protective ground.
6. Connect the cable in accordance with the connecting cable terminal assignment.
7. Firmly tighten the cable glands.
 - ↳ This concludes the process for connecting the connecting cable.
8. Close the housing cover.
9. Tighten the securing screw of the housing cover.

Connecting the sensor connection housing via the connector

For the device version with the order code for "Sensor connection housing":
Option C "Ultra-compact hygienic, stainless"

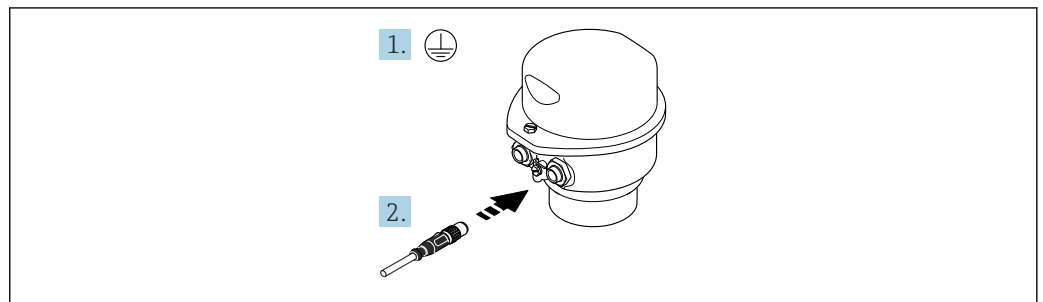

A0029615

1. Connect the protective ground.
2. Connect the connector.

Connecting the connecting cable to the transmitter

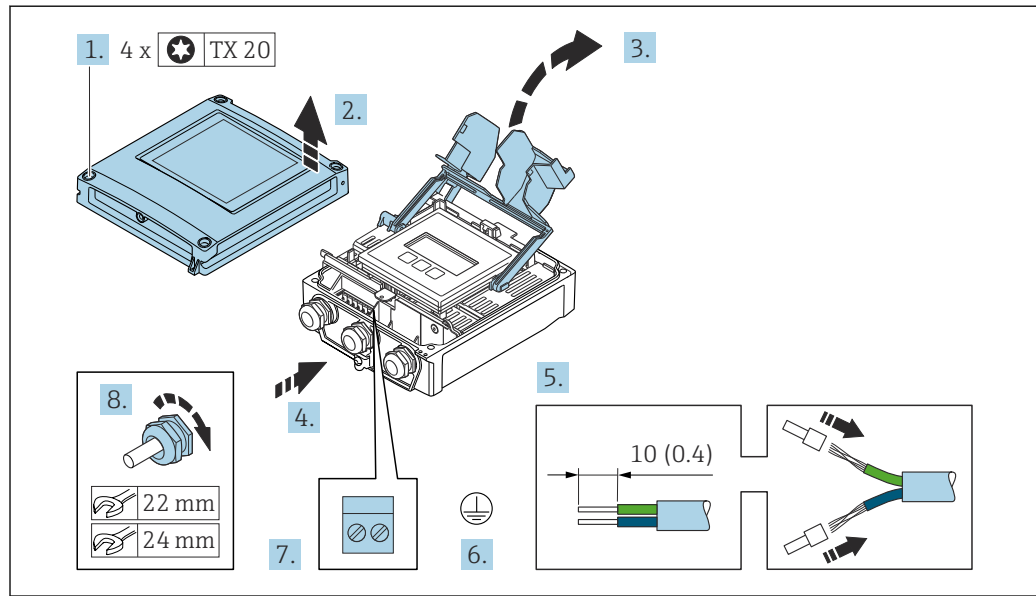

A0029597

1. Loosen the 4 fixing screws on the housing cover.
2. Open the housing cover.
3. Fold open the terminal cover.
4. Push the cable through the cable entry. To ensure tight sealing, do not remove the sealing ring from the cable entry.
5. Strip the cable and cable ends. In the case of stranded cables, fit ferrules.
6. Connect the protective ground.
7. Connect the cable according to the terminal assignment for the connecting cable → 42.
8. Firmly tighten the cable glands.
 - ↳ The process for connecting the connecting cable is now complete.
9. Close the housing cover.
10. Tighten the securing screw of the housing cover.
11. After connecting the connecting cable:
 - Connect the signal cable and the supply voltage cable → 47.

7.3.2 Connecting the signal cable and the supply voltage cable

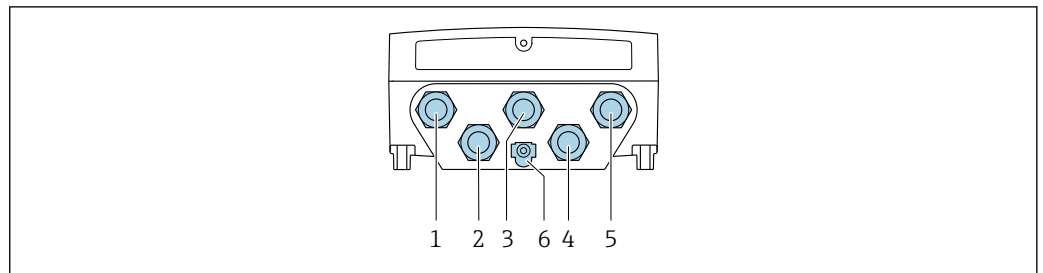

A0028200

- 1 Terminal connection for supply voltage
- 2 Terminal connection for signal transmission, input/output
- 3 Terminal connection for signal transmission, input/output
- 4 Terminal connection for connecting cable between sensor and transmitter
- 5 Terminal connection for signal transmission, input/output; optional: connection for external WLAN antenna
- 6 Protective earth (PE)

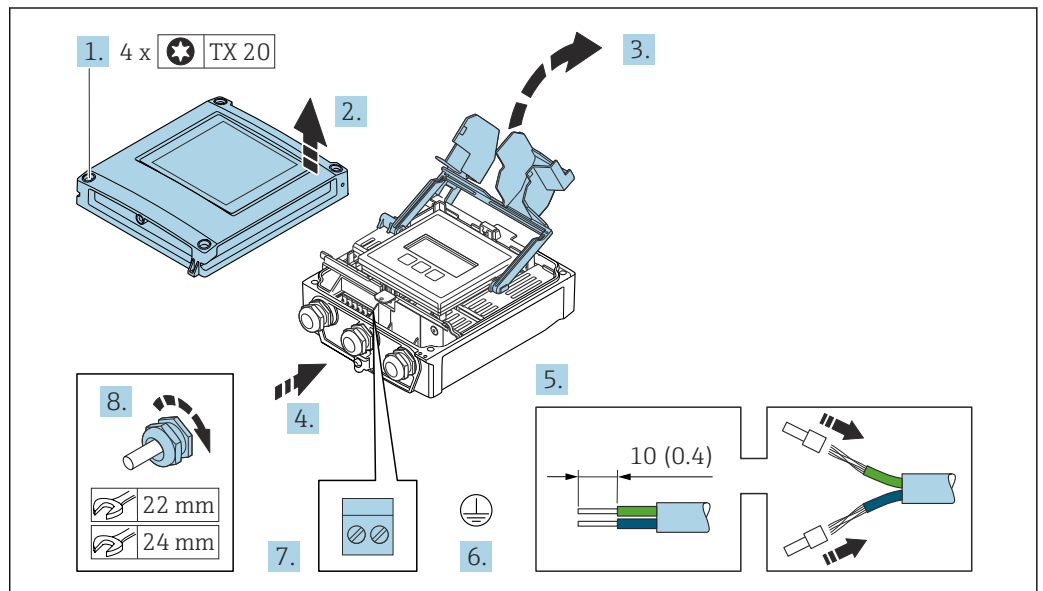

A0029597

1. Loosen the 4 fixing screws on the housing cover.
2. Open the housing cover.
3. Fold open the terminal cover.
4. Push the cable through the cable entry. To ensure tight sealing, do not remove the sealing ring from the cable entry.
5. Strip the cable and cable ends. In the case of stranded cables, fit ferrules.
6. Connect the protective ground.
7. Connect the cable according to the terminal assignment.
 - ↳ **Signal cable terminal assignment:** The device-specific terminal assignment is documented on an adhesive label in the terminal cover.
 - Supply voltage terminal assignment:** Adhesive label in the terminal cover or → 39.
8. Firmly tighten the cable glands.
 - ↳ This concludes the cable connection process.
9. Close the terminal cover.
10. Close the housing cover.

⚠ WARNING

Housing degree of protection may be voided due to insufficient sealing of the housing.

- ▶ Screw in the screw without using any lubricant.

NOTICE

Excessive tightening torque applied to the fixing screws!

Risk of damaging the plastic transmitter.

- ▶ Tighten the fixing screws as per the tightening torque: 2.5 Nm (1.8 lbf ft)

11. Tighten the 4 fixing screws on the housing cover.

Removing a cable

To remove a cable from the terminal:

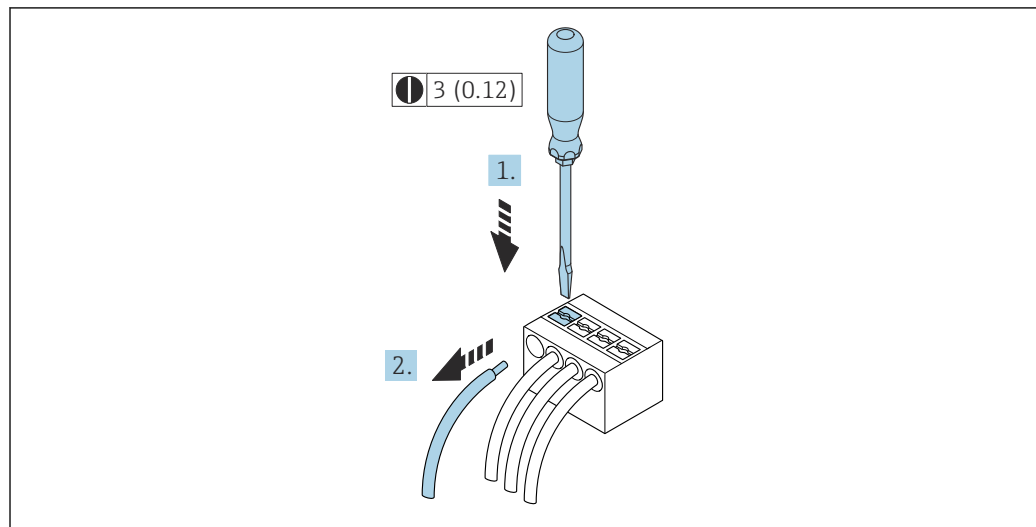

17 Engineering unit mm (in)

1. Use a flat-blade screwdriver to press down on the slot between the two terminal holes.
2. Remove the cable end from the terminal.

7.4 Connecting the measuring instrument: Proline 500

NOTICE

An incorrect connection compromises electrical safety!

- ▶ Only properly trained specialist staff may perform electrical connection work.
- ▶ Observe applicable federal/national installation codes and regulations.
- ▶ Comply with local workplace safety regulations.
- ▶ Always connect the protective ground cable ⊕ before connecting additional cables.
- ▶ When using in potentially explosive atmospheres, observe the information in the device-specific Ex documentation.

7.4.1 Fitting the connecting cable

⚠ WARNING

Risk of damaging electronic components!

- ▶ Connect the sensor and transmitter to the same potential equalization.
- ▶ Only connect the sensor to a transmitter with the same serial number.

⚠ CAUTION

Measurement error due to shortening of the connecting cable

- ▶ The connecting cable is ready for installation and must be used in the length supplied. Shortening the connecting cable can affect the sensor's measurement accuracy.

Connecting cable terminal assignment

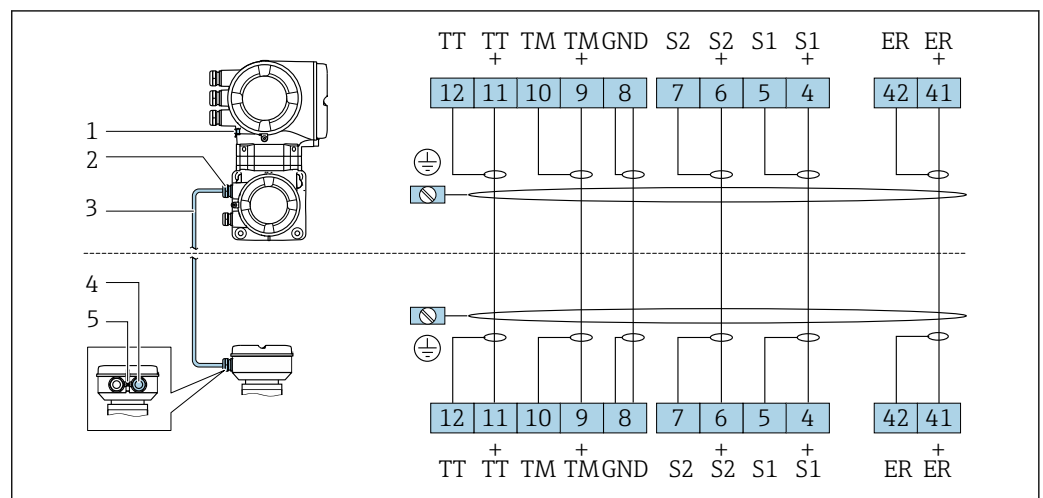

- 1 Protective earth (PE)
- 2 Cable entry for connecting cable on transmitter connection housing
- 3 Connecting cable
- 4 Cable entry for connecting cable on sensor connection housing
- 5 Protective earth (PE)

Connecting the connecting cable to the sensor connection housing

Connection via terminals with order code for "Housing":

- Option A "Aluminum coated" → 50
- Option B "Stainless" → 51

Connecting the sensor connection housing via terminals

For the device version with the order code for "Housing":
Option A "Aluminum coated"

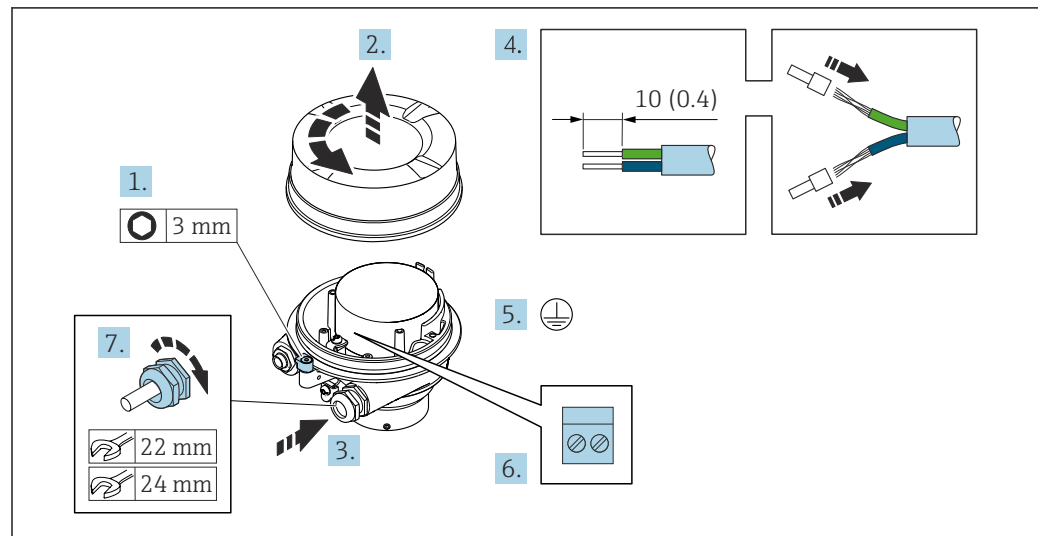

A0029612

1. Loosen the securing clamp of the housing cover.
2. Unscrew the housing cover.
3. Push the cable through the cable entry . To ensure tight sealing, do not remove the sealing ring from the cable entry.
4. Strip the cable and cable ends. In the case of stranded cables, fit ferrules.
5. Connect the protective ground.
6. Connect the cable in accordance with the connecting cable terminal assignment.
7. Firmly tighten the cable glands.
 - ↳ The process for connecting the connecting cable is now complete.

⚠ WARNING

Housing degree of protection voided due to insufficient sealing of the housing.

- ▶ Screw in the thread on the cover without using any lubricant. The thread on the cover is coated with a dry lubricant.
8. Screw on the housing cover.
 9. Tighten the securing clamp of the housing cover.

Connecting the sensor connection housing via terminals

For the device version with the order code for "Housing":
Option B "Stainless"

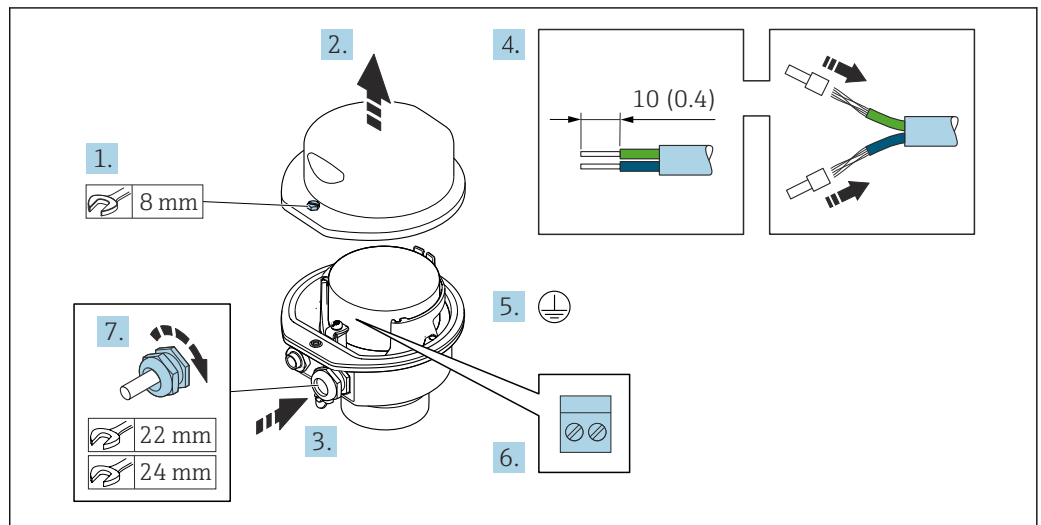

A0029613

1. Release the securing screw of the housing cover.
2. Open the housing cover.
3. Push the cable through the cable entry . To ensure tight sealing, do not remove the sealing ring from the cable entry.
4. Strip the cable and cable ends. In the case of stranded cables, fit ferrules.
5. Connect the protective ground.
6. Connect the cable in accordance with the connecting cable terminal assignment.
7. Firmly tighten the cable glands.
 - ↳ This concludes the process for connecting the connecting cable.
8. Close the housing cover.
9. Tighten the securing screw of the housing cover.

Attaching the connecting cable to the transmitter

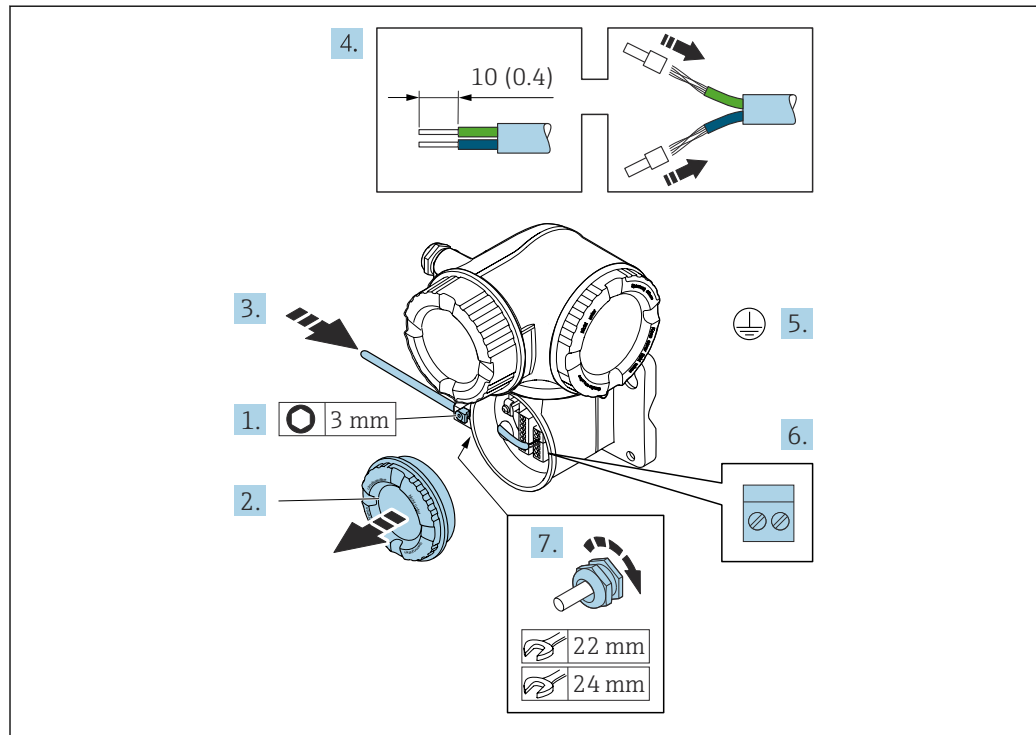

A0029592

1. Loosen the securing clamp of the connection compartment cover.
2. Unscrew the connection compartment cover.
3. Push the cable through the cable entry. To ensure tight sealing, do not remove the sealing ring from the cable entry.
4. Strip the cable and cable ends. In the case of stranded cables, also fit ferrules.
5. Connect the protective ground.
6. Connect the cable in accordance with the connecting cable terminal assignment
→ 49.
7. Firmly tighten the cable glands.
↳ This concludes the process for attaching the connecting cable.
8. Screw on the connection compartment cover.
9. Tighten the securing clamp of the connection compartment cover.
10. After connecting the connecting cable:
Connect the signal cable and the supply voltage cable → 53.

7.4.2 Connecting the signal cable and the supply voltage cable

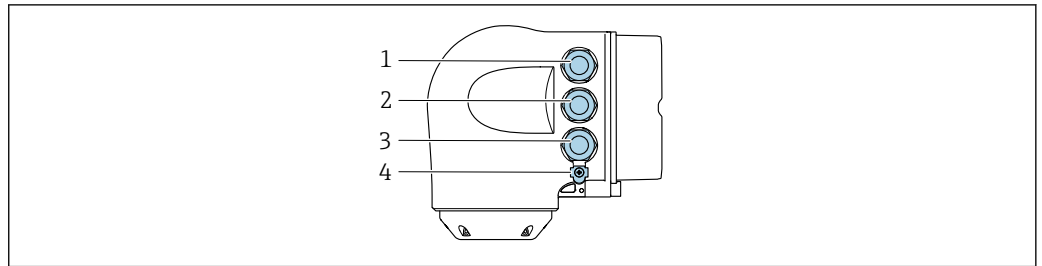

A0026781

- 1 Terminal connection for supply voltage
- 2 Terminal connection for signal transmission, input/output
- 3 Terminal connection for signal transmission, input/output or terminal connection for network connection via service interface (CDI-RJ45)
- 4 Protective earth (PE)

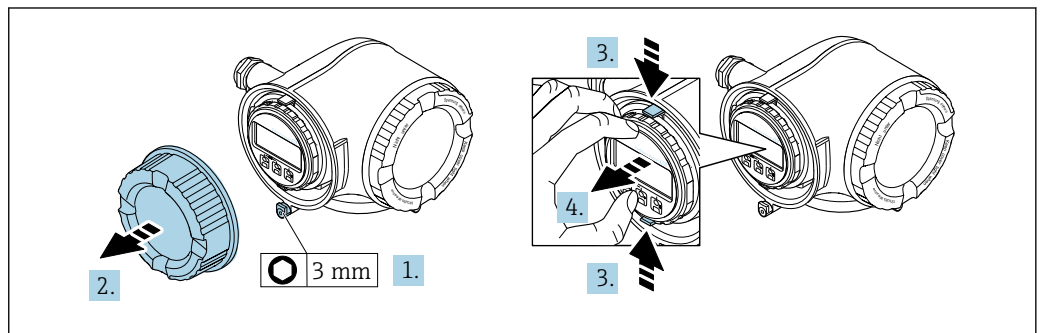

A0029813

1. Loosen the securing clamp of the connection compartment cover.
2. Unscrew the connection compartment cover.
3. Squeeze the tabs of the display module holder together.
4. Remove the display module holder.

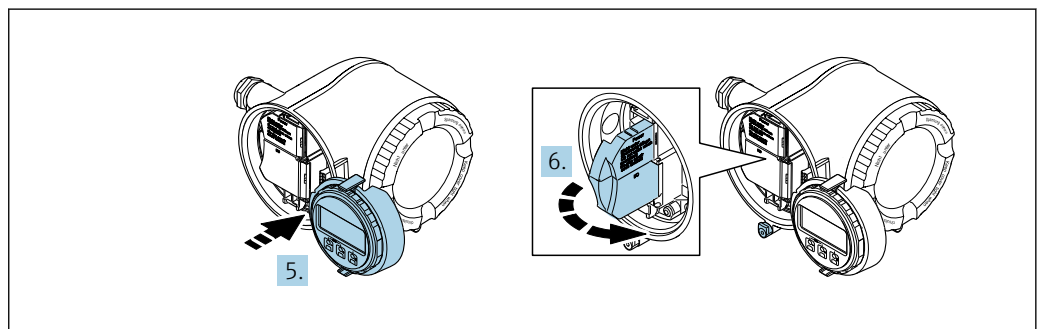

A0029814

5. Attach the holder to the edge of the electronics compartment.
6. Open the terminal cover.

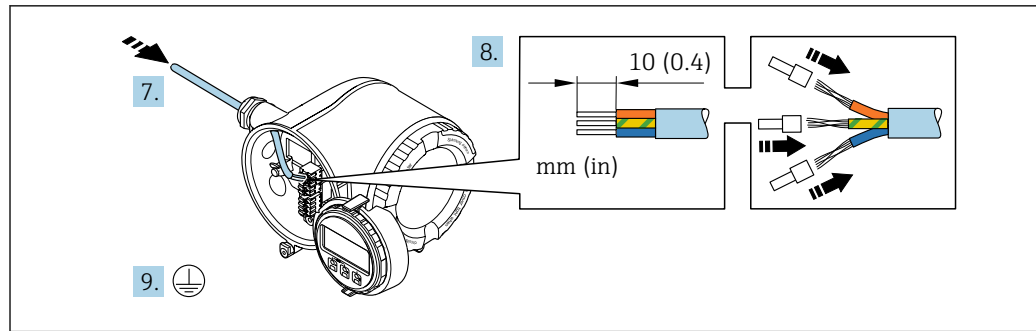

A0029815

7. Push the cable through the cable entry. To ensure tight sealing, do not remove the sealing ring from the cable entry.
8. Strip the cable and cable ends. In the case of stranded cables, also fit ferrules.
9. Connect the protective ground.

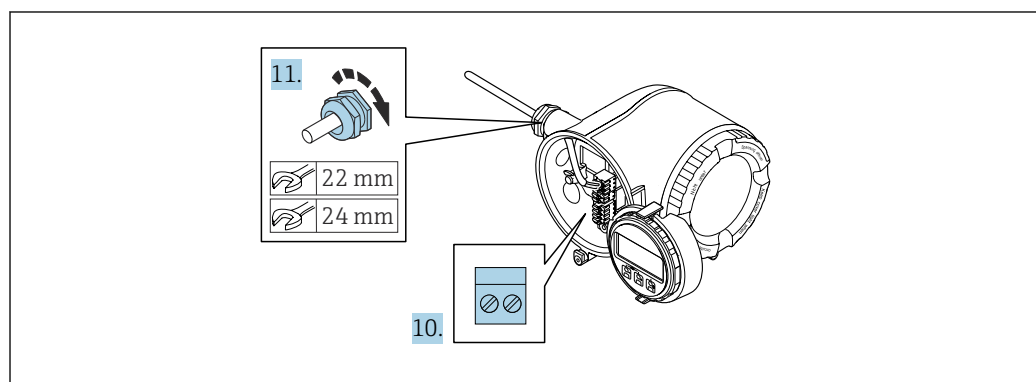

A0029816

10. Connect the cable according to the terminal assignment.
 - ↳ **Signal cable terminal assignment:** The device-specific terminal assignment is documented on an adhesive label in the terminal cover.
 - Supply voltage connection terminal assignment:** Adhesive label in the terminal cover or → [39](#).
11. Firmly tighten the cable glands.
 - ↳ This concludes the cable connection process.
12. Close the terminal cover.
13. Fit the display module holder in the electronics compartment.
14. Screw on the connection compartment cover.
15. Secure the securing clamp of the connection compartment cover.

Removing a cable

To remove a cable from the terminal:

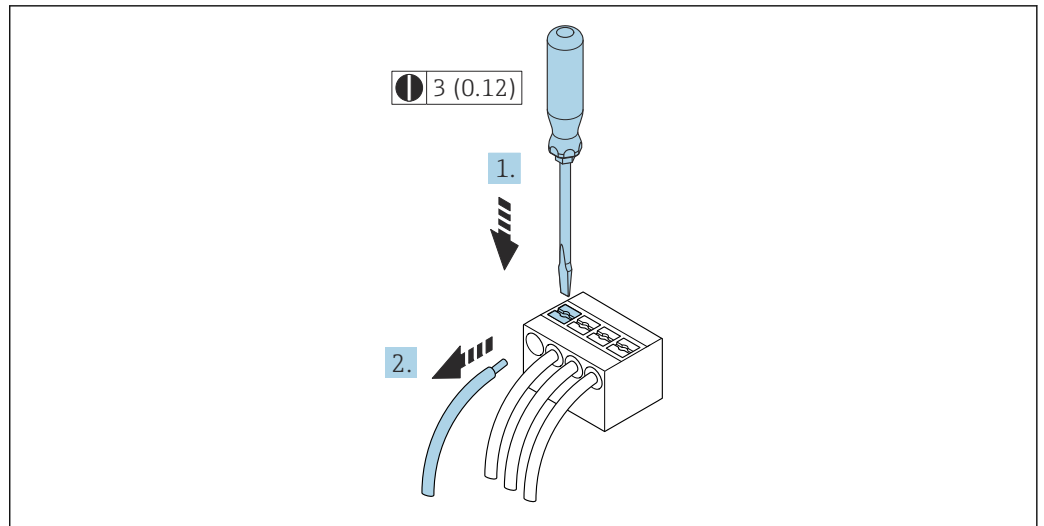

18 Engineering unit mm (in)

1. Use a flat-blade screwdriver to press down on the slot between the two terminal holes.
2. Remove the cable end from the terminal.

7.5 Potential equalization

7.5.1 Requirements

For potential equalization:

- Pay attention to in-house grounding concepts
- Take account of operating conditions, such as the pipe material and grounding
- Connect the medium, sensor and transmitter to the same electric potential
- Use a ground cable with a minimum cross-section of 6 mm^2 (10 AWG) and a cable lug for potential equalization connections

7.6 Special connection instructions

7.6.1 Connection examples

PROFIBUS PA

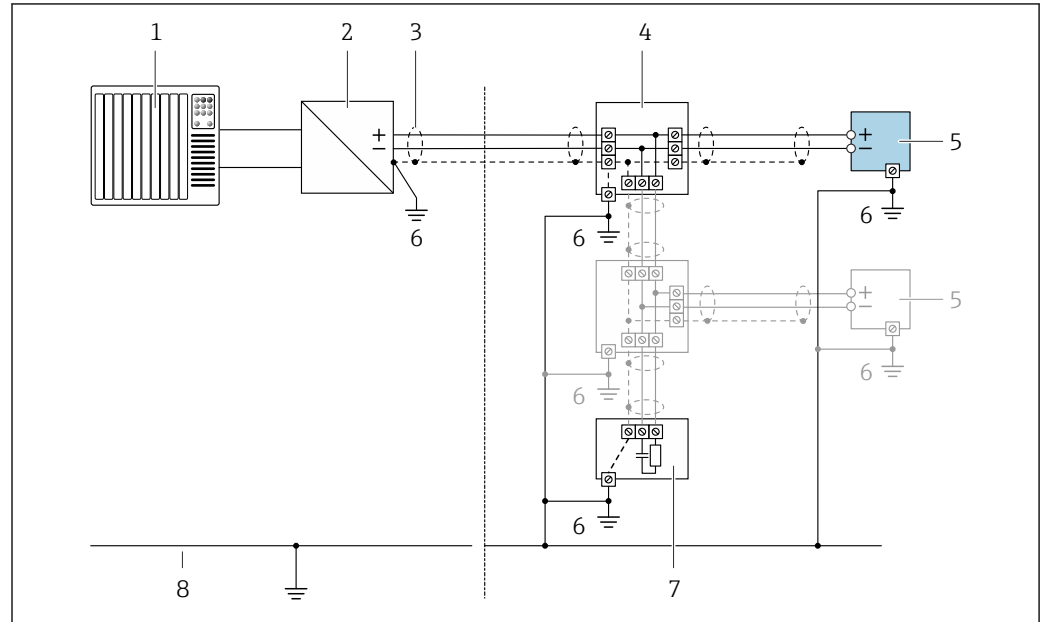

A0028768

19 Connection example for PROFIBUS PA

- 1 Control system (e.g. PLC)
- 2 PROFIBUS PA segment coupler
- 3 Cable shield provided at one end. The cable shield must be grounded at both ends to comply with EMC requirements; observe cable specifications
- 4 T-box
- 5 Measuring device
- 6 Local grounding
- 7 Bus terminator
- 8 Potential matching line

Current output 4-20 mA

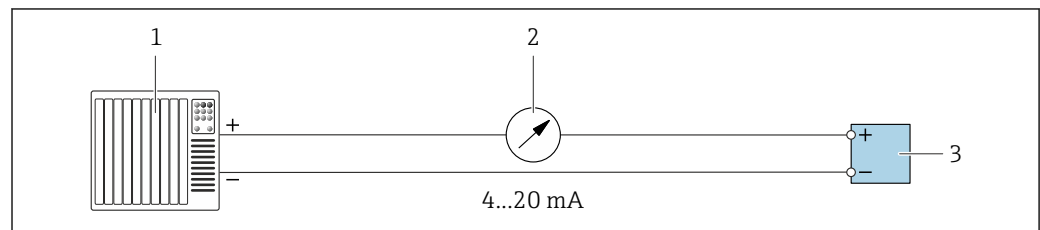

A0028758

20 Connection example for 4-20 mA current output (active)

- 1 Automation system with current input (e.g. PLC)
- 2 Analog display unit: observe maximum load
- 3 Transmitter

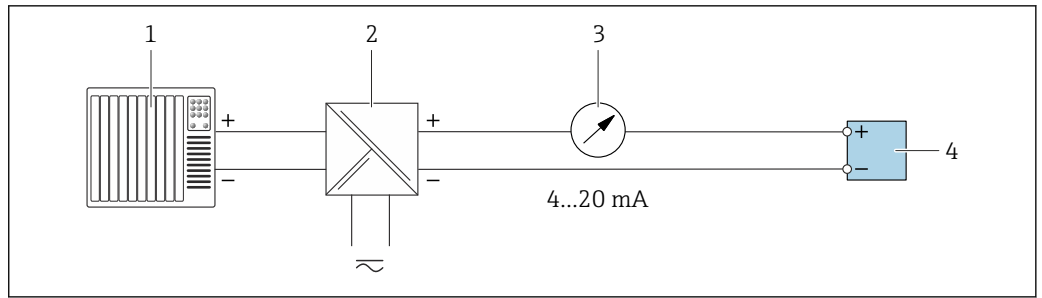

A0028759

21 Connection example for 4-20 mA current output (passive)

- 1 Automation system with current input (e.g. PLC)
- 2 Active barrier for power supply (e.g. RN221N)
- 3 Analog display unit: observe maximum load
- 4 Transmitter

Pulse/frequency output

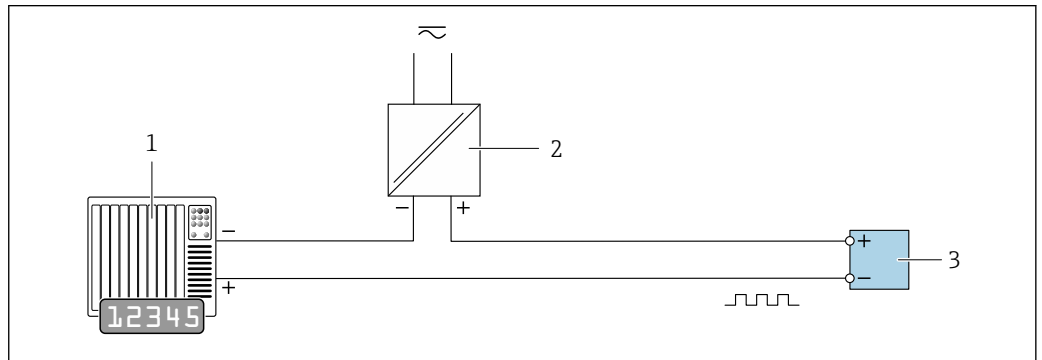

A0028761

22 Connection example for pulse/frequency output (passive)

- 1 Automation system with pulse/frequency input (e.g. PLC with 10 kΩ pull-up or pull-down resistor)
- 2 Power supply
- 3 Transmitter: observe input values → 252

Switch output

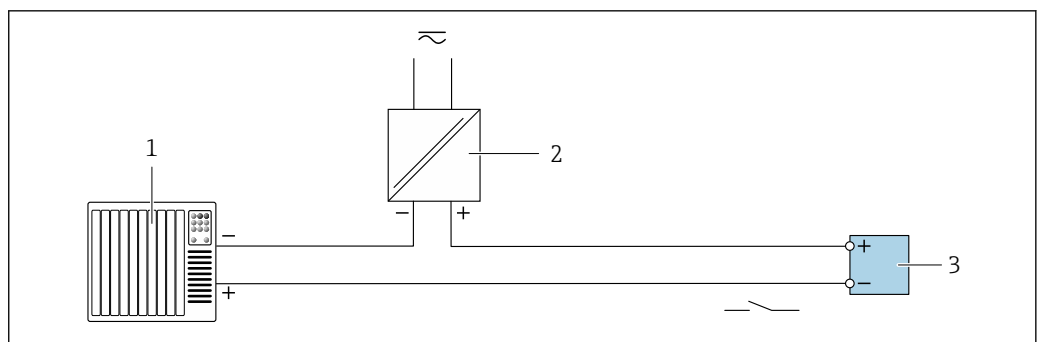

A0028760

23 Connection example for switch output (passive)

- 1 Automation system with switch input (e.g. PLC with a 10 kΩ pull-up or pull-down resistor)
- 2 Power supply
- 3 Transmitter: observe input values → 252

Relay output

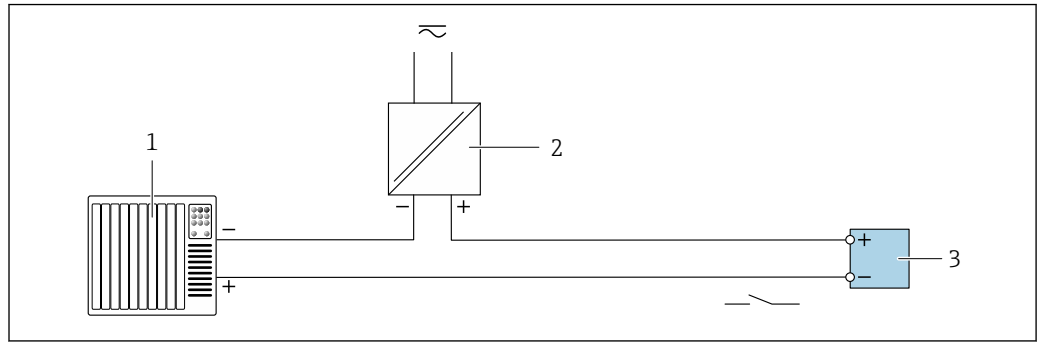

A0028760

24 Connection example for relay output (passive)

- 1 Automation system with relay input (e.g. PLC)
- 2 Power supply
- 3 Transmitter: observe input values → 253

Current input

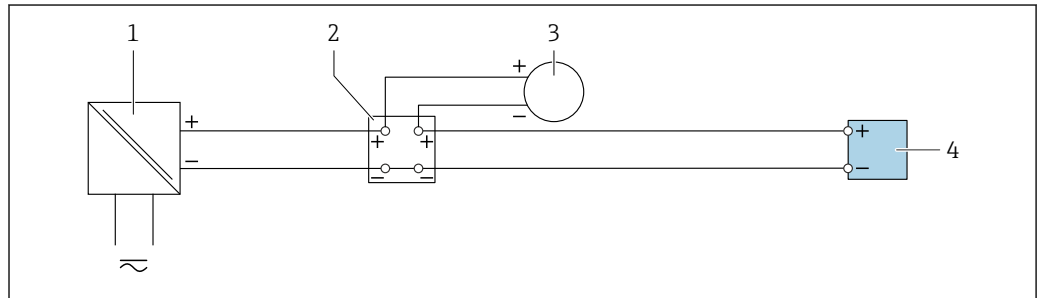

A0028915

25 Connection example for 4 to 20 mA current input

- 1 Power supply
- 2 Terminal box
- 3 External measuring device (to read in pressure or temperature, for instance)
- 4 Transmitter

Status input

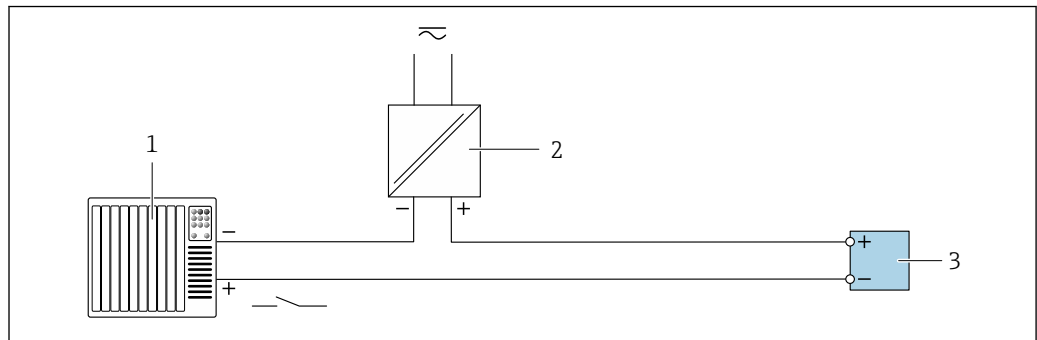

A0028764

26 Connection example for status input

- 1 Automation system with status output (e.g. PLC)
- 2 Power supply
- 3 Transmitter

7.7 Hardware settings

7.7.1 Setting the device address

The address must always be configured for a PROFIBUS DP/PA device. The valid address range is between 1 and 126. In a PROFIBUS DP/PA network, each address can only be assigned once. If an address is not configured correctly, the device is not recognized by the master. All measuring devices are delivered from the factory with the device address 126 and with the software addressing method.

Risk of electric shock when opening the transmitter housing.

- ▶ Before opening the transmitter housing:
- ▶ Disconnect the device from the power supply.

Proline 500 – digital transmitter

Hardware addressing

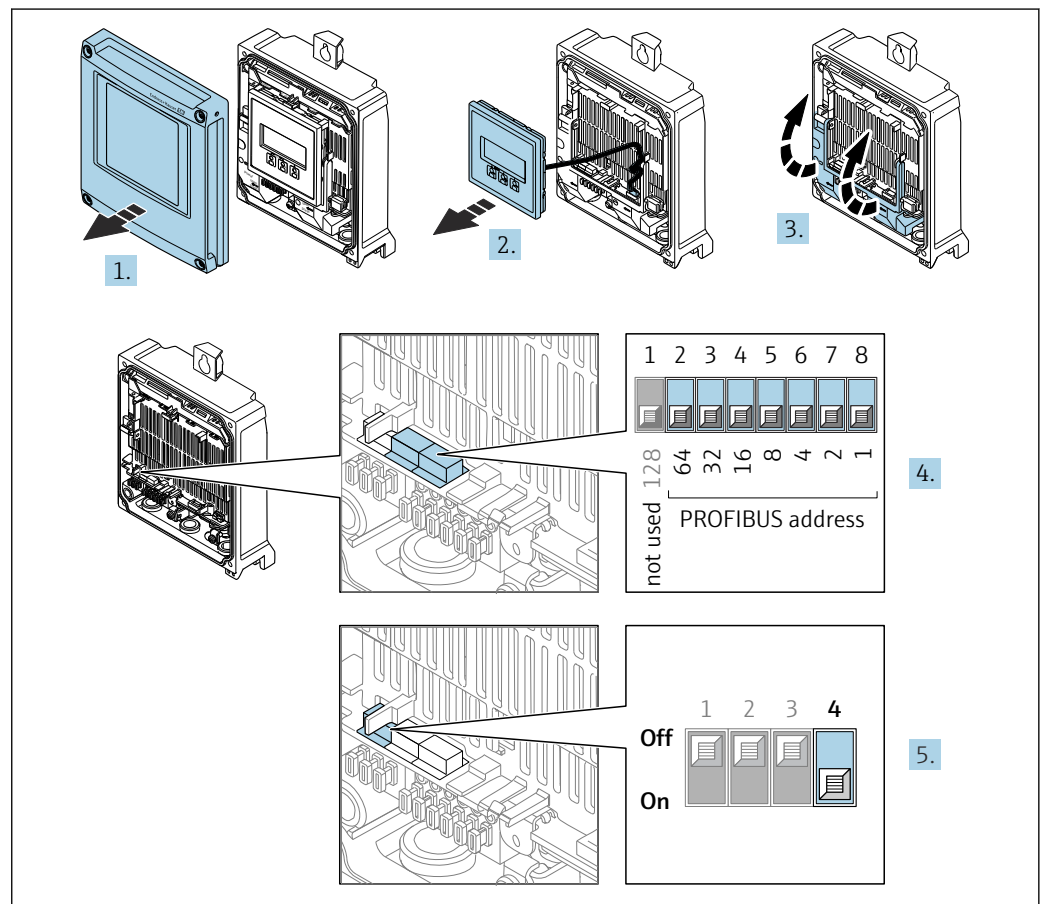

A0029679

1. Open the housing cover.
2. Remove the display module.
3. Fold open the terminal cover.
4. Set the desired device address using the DIP switches.
5. To switch addressing from software addressing to hardware addressing: set the DIP switch to **On**.
 - ↳ The change of device address takes effect after 10 seconds. The device is restarted.

Software addressing

- ▶ To switch addressing from hardware addressing to software addressing: set DIP switch No. 4 to **Off**.
 - ↳ The device address set in the **Device address** parameter (→ 📄 111) takes effect after 10 seconds. The device is restarted.

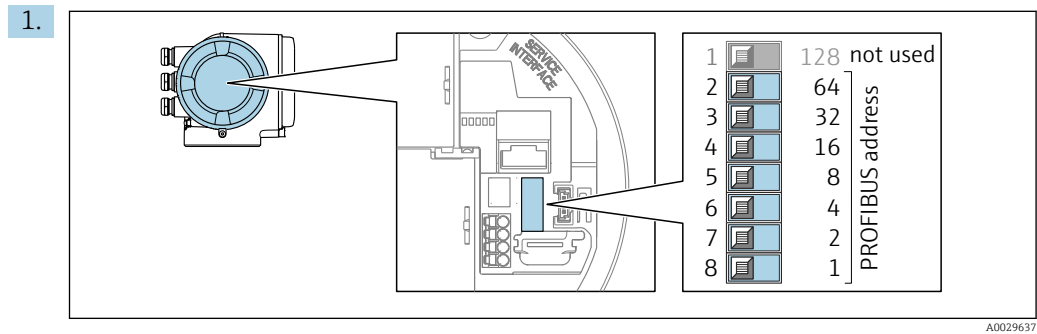
Proline 500 transmitter*Hardware addressing*

Set the desired device address using the DIP switches in the connection compartment.

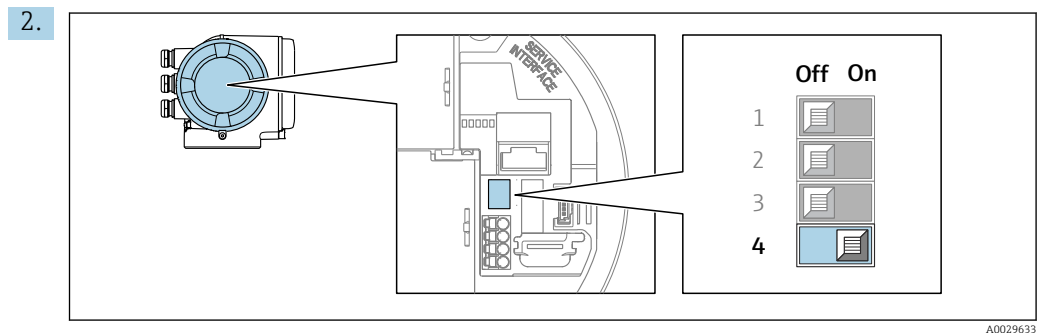

To switch addressing from software addressing to hardware addressing: set the DIP switch to **On**.

- ↳ The change of device address takes effect after 10 seconds. The device is restarted.

Software addressing

- ▶ To switch addressing from hardware addressing to software addressing: set DIP switch No. 4 to **Off**.
 - ↳ The device address configured in the **Device address** parameter (→ 📄 111) takes effect after 10 seconds. The device is restarted.

7.7.2 Activating the default IP address**Activating the default IP address by DIP switch: Proline 500 - digital**

Risk of electric shock when opening the transmitter housing.

- ▶ Before opening the transmitter housing:
- ▶ Disconnect the device from the power supply.

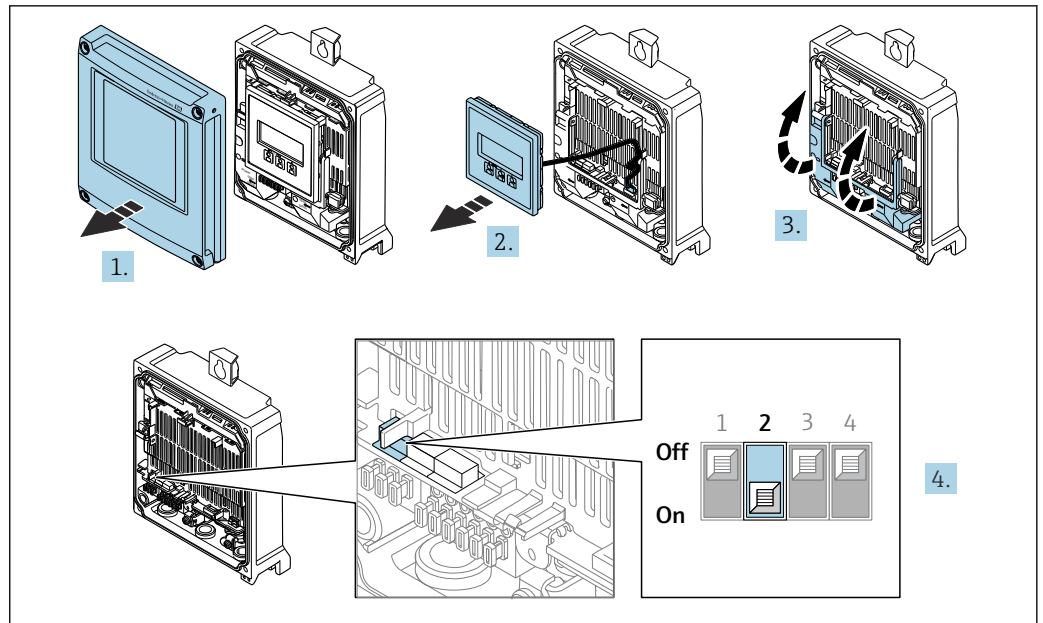

A0034500

1. Loosen the 4 fixing screws on the housing cover.
2. Open the housing cover.
3. Fold open the terminal cover.
4. Set DIP switch no. 2 on the I/O electronics module from **OFF** → **ON**.
5. Reassemble the transmitter in the reverse order.
6. Reconnect the device to the power supply.
 - ↳ The default IP address is used once the device is restarted.

Activating the default IP address by DIP switch: Proline 500

Risk of electric shock when opening the transmitter housing.

- ▶ Before opening the transmitter housing:
- ▶ Disconnect the device from the power supply.

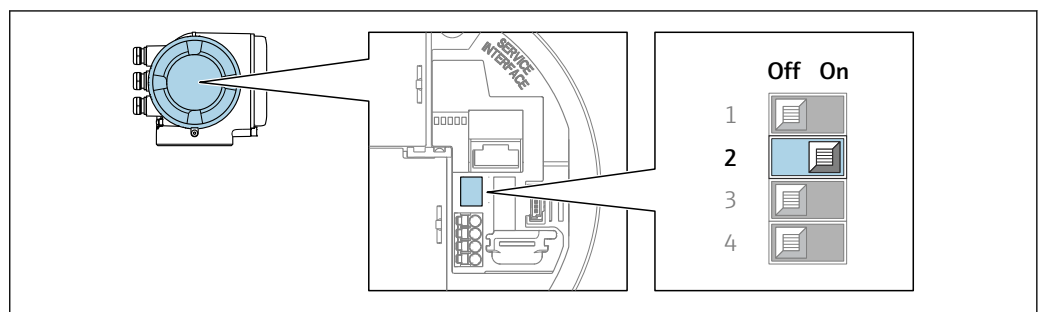

A0034499

1. Depending on the housing version, loosen the securing clamp or fixing screw of the housing cover.
2. Depending on the housing version, unscrew or open the housing cover and disconnect the local display from the main electronics module where necessary .
3. Set DIP switch no. 2 on the I/O electronics module from **OFF** → **ON**.
4. Reassemble the transmitter in the reverse order.
5. Reconnect the device to the power supply.
 - ↳ The default IP address is used once the device is restarted.

7.8 Ensuring the degree of protection

The measuring instrument fulfills all the requirements for the degree of protection IP66/67, Type 4X enclosure.

To guarantee the degree of protection IP66/67, Type 4X enclosure, carry out the following steps after the electrical connection:

1. Check that the housing seals are clean and fitted correctly.
2. Dry, clean or replace the seals if necessary.
3. Tighten all housing screws and screw covers.
4. Firmly tighten the cable glands.
5. To ensure that moisture does not enter the cable entry:
Route the cable so that it loops down before the cable entry ("water trap").

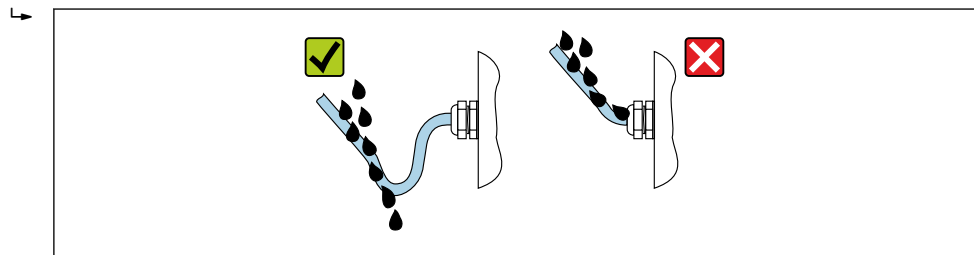

A0029278

6. The cable glands supplied do not ensure housing protection when not in use. They must therefore be replaced by dummy plugs corresponding to the housing protection.

7.9 Post-connection check

Are the device and cable undamaged (visual inspection)?	<input type="checkbox"/>
Is the protective earthing established correctly?	<input type="checkbox"/>
Do the cables used comply with the requirements ?	<input type="checkbox"/>
Are the installed cables strain-relieved and securely routed?	<input type="checkbox"/>
Are all cable glands installed, securely tightened and leak-tight? Cable run with "water trap" → 62?	<input type="checkbox"/>
Is the terminal assignment correct ?	<input type="checkbox"/>
Are dummy plugs inserted in unused cable entries and have transportation plugs been replaced with dummy plugs?	<input type="checkbox"/>

8 Operation options

8.1 Overview of operation options

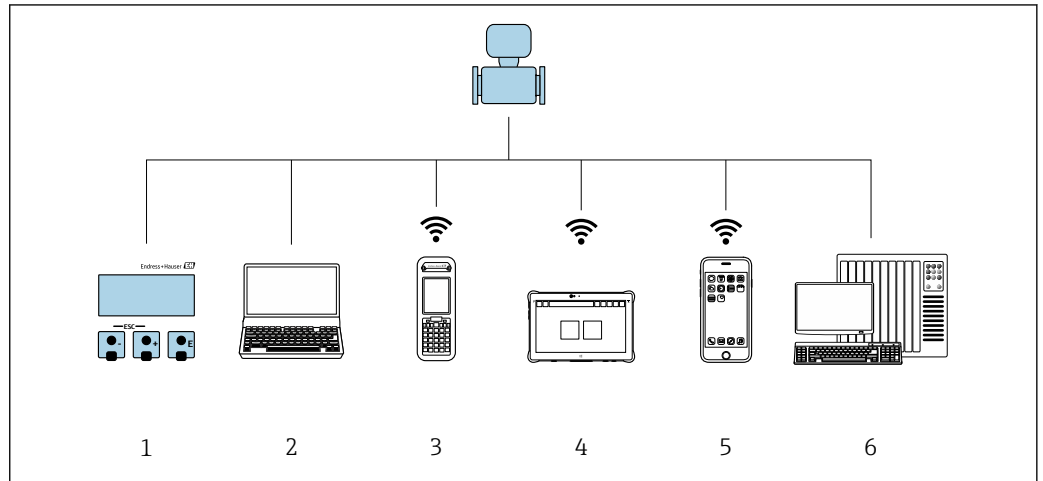



A0034513

- 1 Local operation via display module
- 2 Computer with web browser or operating tool (e.g. FieldCare, DeviceCare, AMS Device Manager, SIMATIC PDM)
- 3 Field Xpert SFX350 or SFX370
- 4 Field Xpert SMT70
- 5 Mobile handheld terminal
- 6 Automation system (e.g. PLC)

8.2 Structure and function of the operating menu

8.2.1 Structure of the operating menu

 For an overview of the operating menu for experts: see the "Description of Device Parameters" document supplied with the device →  276

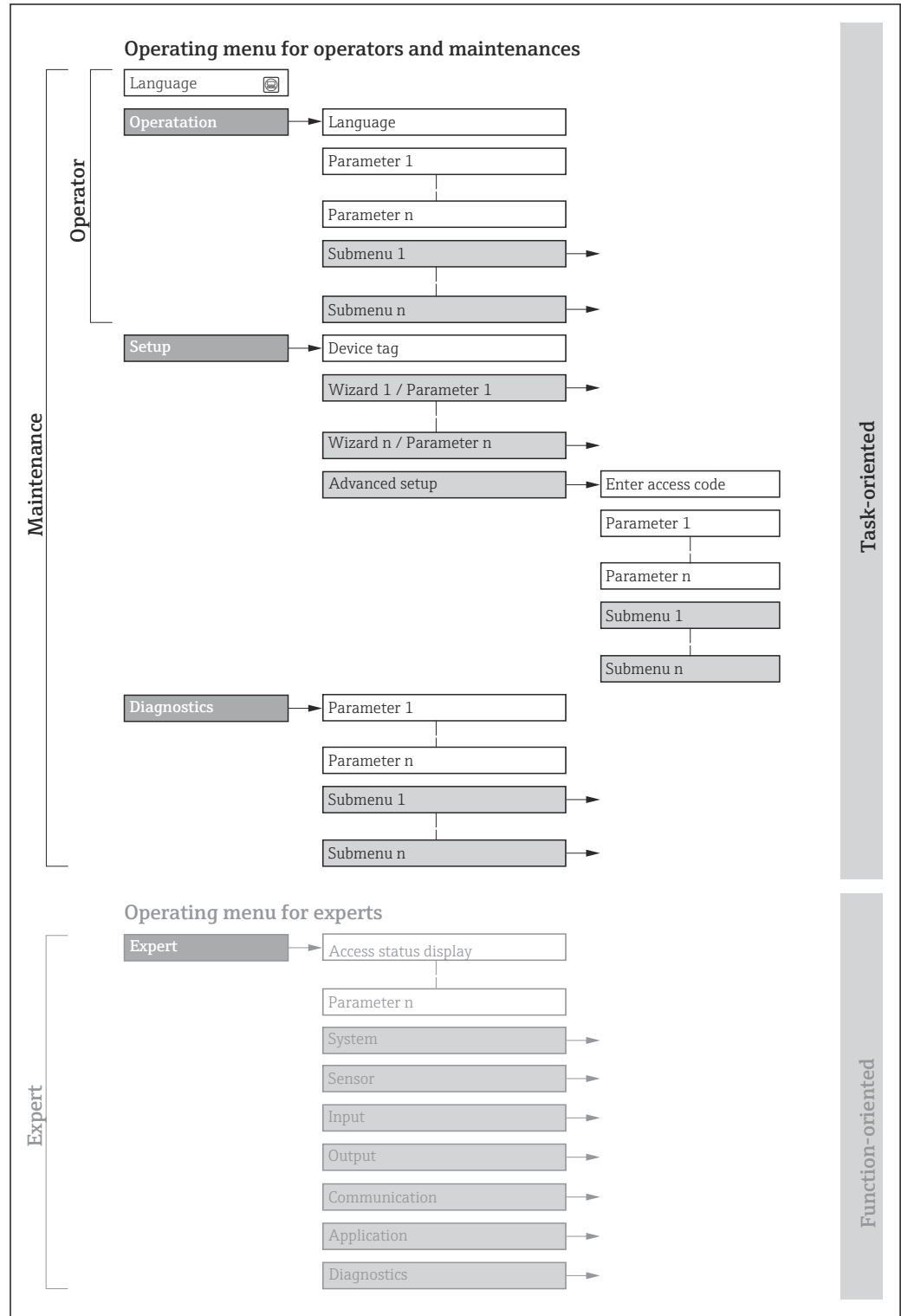

A0018237-EN

 27 Schematic structure of the operating menu

8.2.2 Operating philosophy

The individual parts of the operating menu are assigned to certain user roles (e.g. operator, maintenance etc.). Each user role contains typical tasks within the device life cycle.

Menu/parameter		User role and tasks	Content/meaning
Language	Task-oriented	Role "Operator", "Maintenance" Tasks during operation: <ul style="list-style-type: none"> ▪ Configuration of the operational display ▪ Reading measured values 	<ul style="list-style-type: none"> ▪ Defining the operating language ▪ Defining the Web server operating language ▪ Resetting and controlling totalizers
Operation			<ul style="list-style-type: none"> ▪ Configuration of the operational display (e.g. display format, display contrast) ▪ Resetting and controlling totalizers
Setup		"Maintenance" role Commissioning: <ul style="list-style-type: none"> ▪ Configuration of the measurement ▪ Configuration of the inputs and outputs ▪ Configuration of the communication interface 	Wizards for fast commissioning: <ul style="list-style-type: none"> ▪ Configuring the system units ▪ Configuration of the communication interface ▪ Definition of the medium ▪ Displaying the I/O configuration ▪ Configuring the inputs ▪ Configuring the outputs ▪ Configuration of the operational display ▪ Configuring the low flow cut off ▪ Configuring partial and empty pipe detection Advanced setup <ul style="list-style-type: none"> ▪ For more customized configuration of the measurement (adaptation to special measuring conditions) ▪ Configuration of totalizers ▪ Configuration of WLAN settings ▪ Administration (define access code, reset measuring device)
Diagnostics		"Maintenance" role Troubleshooting: <ul style="list-style-type: none"> ▪ Diagnostics and elimination of process and device errors ▪ Measured value simulation 	Contains all parameters for error detection and analyzing process and device errors: <ul style="list-style-type: none"> ▪ Diagnostic list Contains up to 5 currently pending diagnostic messages. ▪ Event logbook Contains event messages that have occurred. ▪ Device information Contains information for identifying the device ▪ Measured values Contains all current measured values. ▪ Analog inputs Is used to display the analog input. ▪ Data logging submenu with the "Extended HistoROM" order option Storage and visualization of measured values ▪ Heartbeat Technology Verification of device functionality on request and documentation of verification results ▪ Simulation Used to simulate measured values or output values.

Menu/parameter	User role and tasks	Content/meaning
Expert	Function-oriented	<p>Tasks that require detailed knowledge of the function of the device:</p> <ul style="list-style-type: none"> ▪ Commissioning measurements under difficult conditions ▪ Optimal adaptation of the measurement to difficult conditions ▪ Detailed configuration of the communication interface ▪ Error diagnostics in difficult cases <p>Contains all of the device parameters and allows direct access to these by means of an access code. The structure of this menu is based on the function blocks of the device:</p> <ul style="list-style-type: none"> ▪ System Contains all higher-level device parameters that do not affect measurement or measured value communication ▪ Sensor Configuration of the measurement. ▪ Output Configuration of the pulse/frequency/switch output ▪ Input Configuration of the status input ▪ Output Configuration of the analog current outputs as well as the pulse/frequency and switch output ▪ Communication Configuration of the digital communication interface and the Web server ▪ Submenus for function blocks (e.g. "Analog Inputs") Configuration of function blocks ▪ Application Configuration of the functions that go beyond the actual measurement (e.g. totalizer) ▪ Diagnostics Error detection and analysis of process and device errors and for device simulation and Heartbeat Technology.

8.3 Access to operating menu via local display

8.3.1 Operational display

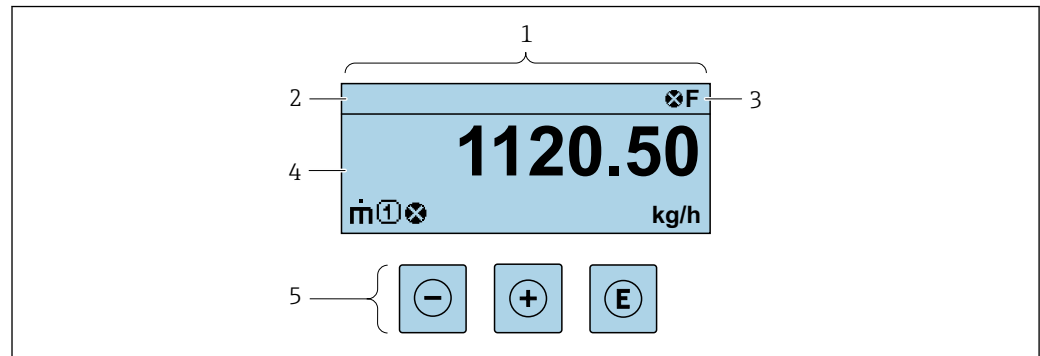

A0029348

- 1 Operational display
- 2 Device tag
- 3 Status area
- 4 Display range for measured values (up to 4 lines)
- 5 Operating elements → 73

Status area

The following symbols appear in the status area of the operational display at the top right:

- Status signals → 175
 - **F**: Failure
 - **C**: Function check
 - **S**: Out of specification
 - **M**: Maintenance required
- Diagnostic behavior → 176
 - : Alarm
 - : Warning
- : Locking (the device is locked via the hardware)
- : Communication (communication via remote operation is active)

Display area

In the display area, each measured value is prefaced by certain symbol types for further description:

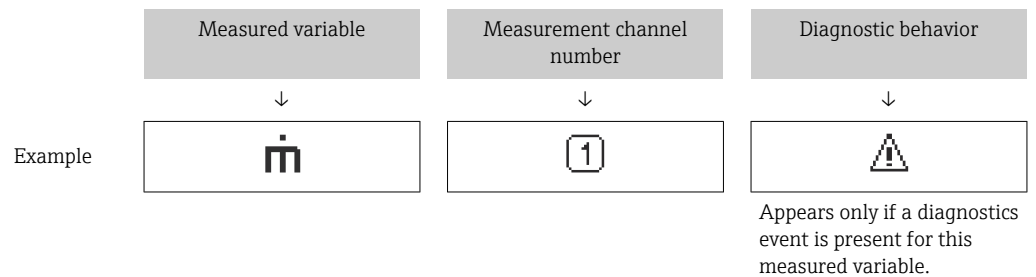

Measured variables

Symbol	Meaning
	Mass flow
	<ul style="list-style-type: none"> ▪ Volume flow ▪ Corrected volume flow
	<ul style="list-style-type: none"> ▪ Density ▪ Reference density
	Temperature

The number and display format of the measured variables can be configured via the **Format display** parameter (→ 129).



Totalizer

Symbol	Meaning
	Totalizer The measurement channel number indicates which of the three totalizers is displayed.



Input

Symbol	Meaning
	Status input

Measurement channel numbers

Symbol	Meaning
	Measurement channel 1 to 4  The measurement channel number is displayed only if more than one channel is present for the same measured variable type (e.g. totalizer 1 to 3).

Diagnostic behavior

Symbol	Meaning
	Alarm <ul style="list-style-type: none"> ▪ Measurement is interrupted. ▪ Signal outputs and totalizers assume the defined alarm condition. ▪ A diagnostic message is generated.
	Warning <ul style="list-style-type: none"> ▪ Measurement is resumed. ▪ The signal outputs and totalizers are not affected. ▪ A diagnostic message is generated.

 The diagnostic behavior pertains to a diagnostic event that is relevant to the displayed measured variable.

8.3.2 Navigation view

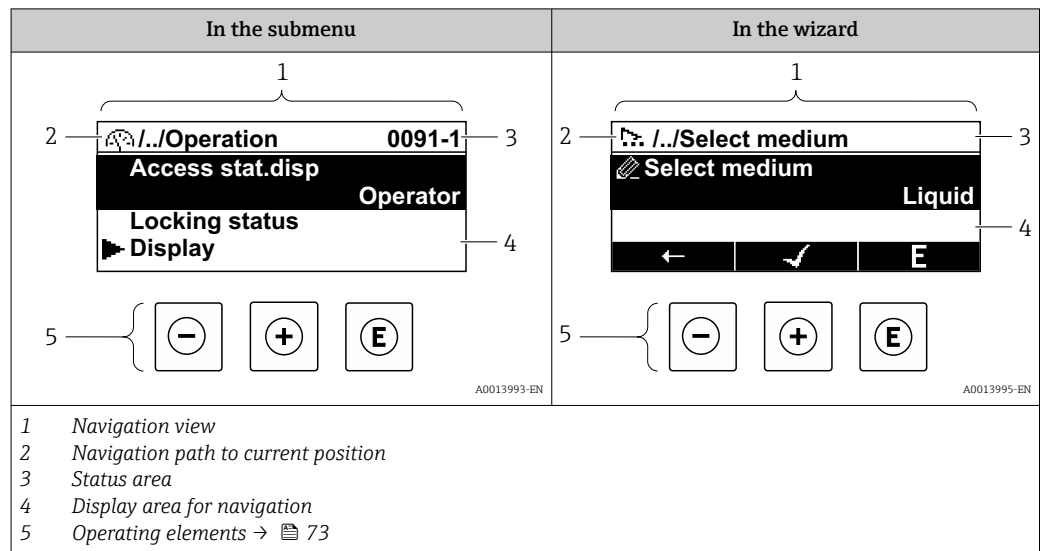

Navigation path

The navigation path to the current position is displayed at the top left in the navigation view and consists of the following elements:

- The display symbol for the menu/submenu (▶) or the wizard (⚙).
- An omission symbol (/ ../) for operating menu levels in between.
- Name of the current submenu, wizard or parameter

	Display symbol	Omission symbol	Parameter
	↓	↓	↓
Example	▶	/ ../	Indication

i For more information about the icons in the menu, refer to the "Display area" section → 69

Status area

The following appears in the status area of the navigation view in the top right corner:



- In the submenu
 - The direct access code to the parameter (e.g., 0022-1)
 - If a diagnostic event is present, the diagnostic behavior and status signal
- In the wizard
 - If a diagnostic event is present, the diagnostic behavior and status signal

i ▪ For information on the diagnostic behavior and status signal → 175
 ▪ For information on the function and entry of the direct access code → 75





Display area

Menus

Symbol	Meaning
	Operation Is displayed: <ul style="list-style-type: none"> ▪ In the menu next to the "Operation" selection ▪ At the left in the navigation path in the Operation menu

	<p>Setup Is displayed:</p> <ul style="list-style-type: none"> ▪ In the menu next to the "Setup" selection ▪ At the left in the navigation path in the Setup menu
	<p>Diagnosis Is displayed:</p> <ul style="list-style-type: none"> ▪ In the menu next to the "Diagnostics" selection ▪ At the left in the navigation path in the Diagnostics menu
	<p>Expert Is displayed:</p> <ul style="list-style-type: none"> ▪ In the menu next to the "Expert" selection ▪ At the left in the navigation path in the Expert menu



Submenus, wizards, parameters

Symbol	Meaning
	Submenu
	Wizards
	Parameters within a wizard  No display symbol exists for parameters in submenus.

Locking procedure

Symbol	Meaning
	<p>Parameter locked When displayed in front of a parameter name, indicates that the parameter is locked.</p> <ul style="list-style-type: none"> ▪ By a user-specific access code ▪ By the hardware write protection switch

Wizards

Symbol	Meaning
	Switches to the previous parameter.
	Confirms the parameter value and switches to the next parameter.
	Opens the editing view of the parameter.

8.3.3 Editing view

Numeric editor



A0034250

28 For entering values in parameters (e.g. limit values)

- 1 Entry display area
- 2 Input screen
- 3 Confirm, delete or reject entry
- 4 Operating elements

Text editor





A0034114

29 For entering text in parameters (e.g. device tag)



- 1 Entry display area
- 2 Current input screen
- 3 Change input screen
- 4 Operating elements
- 5 Move entry position
- 6 Delete entry
- 7 Reject or confirm entry

Using the operating elements in the editing view





Operating key	Meaning
⊖	Minus key Move the entry position to the left.
⊕	Plus key Move the entry position to the right.

Operating key	Meaning
	Enter key <ul style="list-style-type: none"> ▪ Pressing the key briefly confirms your selection. ▪ Pressing the key for 2 s confirms your entry.
	Escape key combination (press keys simultaneously) Close the editing view without accepting a change.





Input screens

Symbol	Meaning
A..	Upper case
a..	Lower case
1..	Numbers
	Punctuation marks and special characters: = + - * / ² ³ ¼ ½ ¾ () [] < > { }
	Punctuation marks and special characters: " ` ^ . , ; : ? ! % μ ° € \$ £ ¥ \$ @ # / \ ~ & _
ä..	Umlauts and accents

Controlling data entries

Symbol	Meaning
	Move entry position
	Reject entry
	Confirm entry
	Delete character immediately to the left of the entry position
del	Delete character immediately to the right of the entry position
C	Clear all the characters entered

8.3.4 Operating elements

Operating key	Meaning
	<p>Minus key</p> <p><i>In menu, submenu</i> Moves the selection bar upwards in a picklist</p> <p><i>In wizards</i> Goes to previous parameter</p> <p><i>In the text and numeric editor</i> Move the entry position to the left.</p>
	<p>Plus key</p> <p><i>In menu, submenu</i> Moves the selection bar downwards in a picklist</p> <p><i>In wizards</i> Goes to the next parameter</p> <p><i>In the text and numeric editor</i> Move the entry position to the right.</p>
	<p>Enter key</p> <p><i>In the operational display</i> Pressing the key briefly opens the operating menu.</p> <p><i>In menu, submenu</i></p> <ul style="list-style-type: none"> ▪ Pressing the key briefly: <ul style="list-style-type: none"> ▪ Opens the selected menu, submenu or parameter. ▪ Starts the wizard. ▪ If help text is open, closes the help text of the parameter. ▪ Pressing the key for 2 s in a parameter: <ul style="list-style-type: none"> ▪ If present, opens the help text for the function of the parameter. <p><i>In wizards</i> Opens the editing view of the parameter and confirms the parameter value</p> <p><i>In the text and numeric editor</i></p> <ul style="list-style-type: none"> ▪ Pressing the key briefly confirms your selection. ▪ Pressing the key for 2 s confirms your entry.
	<p>Escape key combination (press keys simultaneously)</p> <p><i>In menu, submenu</i></p> <ul style="list-style-type: none"> ▪ Pressing the key briefly: <ul style="list-style-type: none"> ▪ Exits the current menu level and takes you to the next higher level. ▪ If help text is open, closes the help text of the parameter. ▪ Pressing the key for 2 s returns you to the operational display ("home position"). <p><i>In wizards</i> Exits the wizard and takes you to the next higher level</p> <p><i>In the text and numeric editor</i> Exits the Editing view without applying the changes.</p>
	<p>Minus/Enter key combination (press and hold down the keys simultaneously)</p> <ul style="list-style-type: none"> ▪ If keypad lock is active: <ul style="list-style-type: none"> ▪ Pressing the key for 3 s deactivates the keypad lock. ▪ If keypad lock is not active: <ul style="list-style-type: none"> ▪ Pressing the key for 3 s opens the context menu including the option for activating the keypad lock.

8.3.5 Opening the context menu

Using the context menu, the user can call up the following menus quickly and directly from the operational display:

- Setup
- Data backup
- Simulation

Calling up and closing the context menu

The user is in the operational display.

1. Press the \square and \square keys for longer than 3 seconds.
↳ The context menu opens.

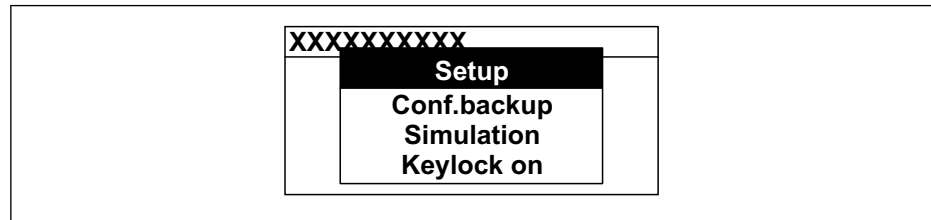

A0034608-EN

2. Press \square + \square simultaneously.
↳ The context menu is closed and the operational display appears.

Calling up the menu via the context menu

1. Open the context menu.
2. Press \square to navigate to the desired menu.
3. Press \square to confirm the selection.
↳ The selected menu opens.

8.3.6 Navigating and selecting from list

Different operating elements are used to navigate through the operating menu. The navigation path is displayed on the left in the header. Icons are displayed in front of the individual menus. These icons are also shown in the header during navigation.

i For an explanation of the navigation view with symbols and operating elements → 69

Example: Setting the number of displayed measured values to "2 values"

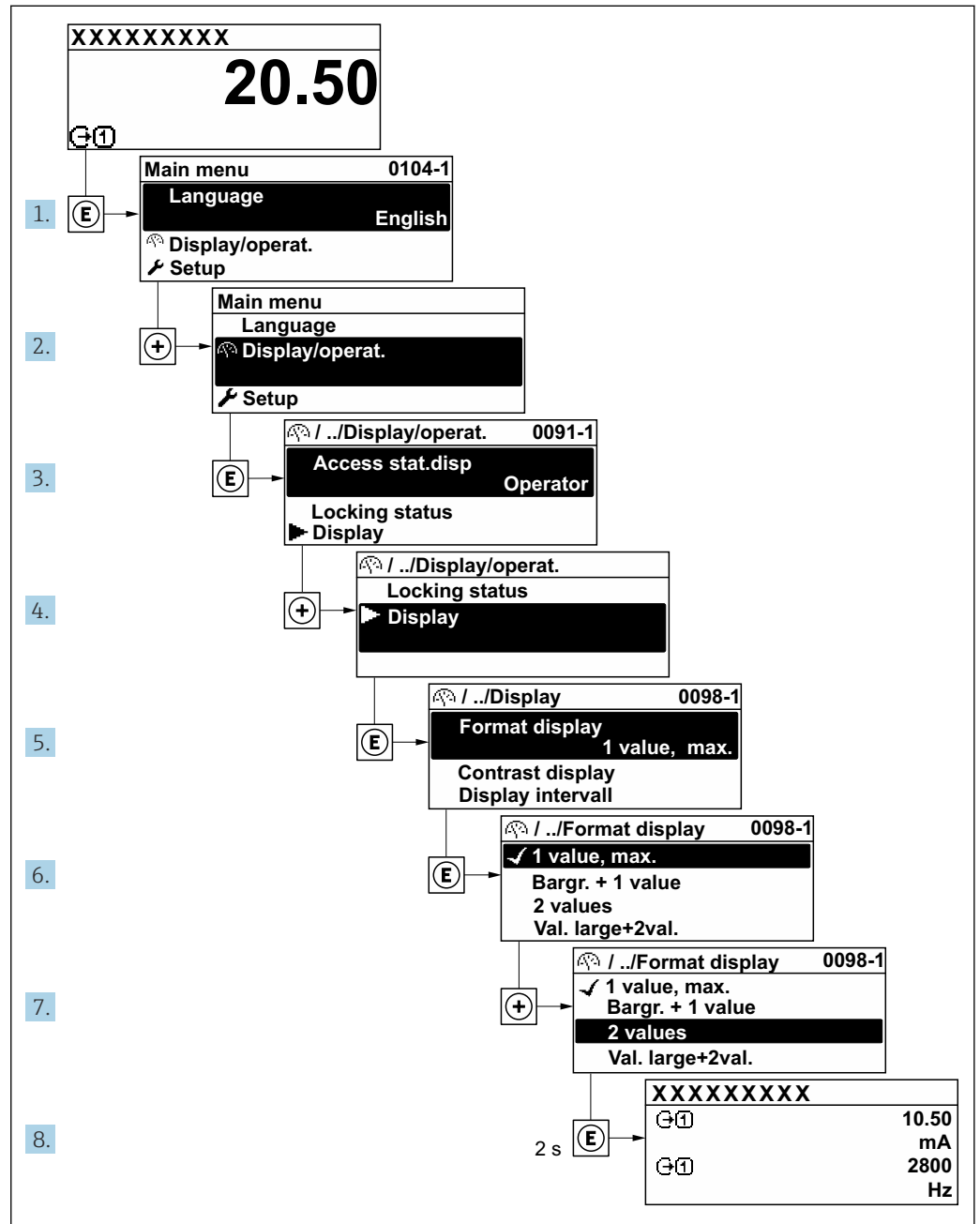

A0029562-EN

8.3.7 Calling the parameter directly

A parameter number is assigned to every parameter to be able to access a parameter directly via the onsite display. Entering this access code in the **Direct access** parameter calls up the desired parameter directly.

Navigation path

Expert → Direct access

The direct access code consists of a 5-digit number (at maximum) and the channel number, which identifies the channel of a process variable: e.g. 00914-2. In the navigation view, this appears on the right-hand side in the header of the selected parameter.

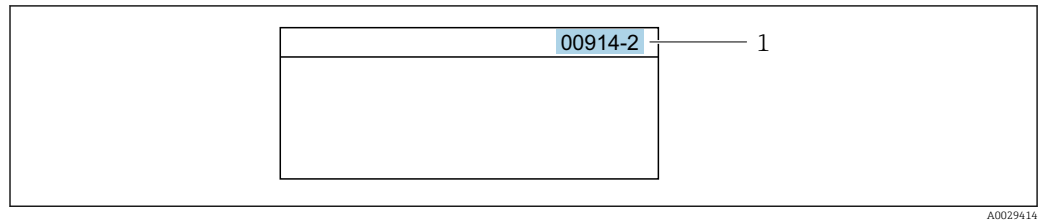

1 Direct access code

Note the following when entering the direct access code:

- The leading zeros in the direct access code do not have to be entered.
Example: Enter "914" instead of "00914"
- If no channel number is entered, channel 1 is opened automatically.
Example: Enter 00914 → **Assign process variable** parameter
- If a different channel is opened: Enter the direct access code with the corresponding channel number.
Example: Enter 00914-2 → **Assign process variable** parameter



For the direct access codes of the individual parameters, see the "Description of Device Parameters" document for the device

8.3.8 Calling up help text

Help text is available for some parameters and can be called up from the navigation view. The help text provides a brief explanation of the parameter function and thereby supports swift and safe commissioning.

Calling up and closing the help text

The user is in the navigation view and the selection bar is on a parameter.

1. Press **Enter** for 2 s.
↳ The help text for the selected parameter opens.

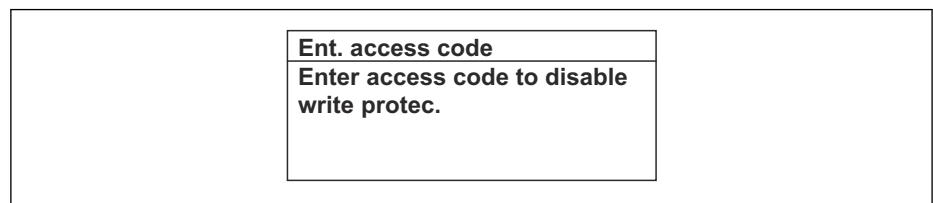

30 Example: Help text for parameter "Enter access code"

2. Press **Esc** + **Enter** simultaneously.
↳ The help text is closed.

8.3.9 Changing the parameters

Parameters can be changed via the numeric editor or text editor.

- Numeric editor: Change values in a parameter, e.g. specifications for limit values.
- Text editor: Enter text in a parameter, e.g. tag name.

A message is displayed if the value entered is outside the permitted value range.

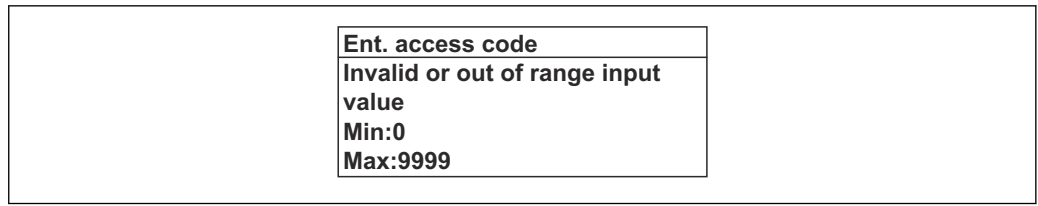

A0014049-EN

For a description of the editing view - consisting of the text editor and numeric editor - with symbols → 71, for a description of the operating elements → 73

8.3.10 User roles and related access authorization

The two user roles "Operator" and "Maintenance" have different write access to the parameters if the customer defines a user-specific access code. This protects the device configuration via the local display from unauthorized access → 153.

Defining access authorization for user roles

An access code is not yet defined when the device is delivered from the factory. Access authorization (read and write access) to the device is not restricted and corresponds to the "Maintenance" user role.

- ▶ Define the access code.
 - ↳ The "Operator" user role is redefined in addition to the "Maintenance" user role. Access authorization differs for the two user roles.

Access authorization to parameters: "Maintenance" user role

Access code status	Read access	Write access
An access code has not yet been defined (factory setting).	✓	✓
After an access code has been defined.	✓	✓ ¹⁾

1) The user only has write access after entering the access code.

Access authorization to parameters: "Operator" user role

Access code status	Read access	Write access
After an access code has been defined.	✓	_ ¹⁾

1) Despite the defined access code, certain parameters can always be modified and thus are excluded from the write protection as they do not affect the measurement: write protection via access code → 153

The user role with which the user is currently logged on is indicated by the **Access status** parameter. Navigation path: Operation → Access status

8.3.11 Disabling write protection via access code

If the -symbol appears on the local display in front of a parameter, the parameter is write-protected by a user-specific access code and its value cannot be changed at the moment using local operation → 153.

Parameter write protection via local operation can be disabled by entering the user-specific access code in the **Enter access code** parameter via the respective access option.

1. After you press , the input prompt for the access code appears.

2. Enter the access code.
 - ↳ The -symbol in front of the parameters disappears; all previously write-protected parameters are now re-enabled.

8.3.12 Enabling and disabling the keypad lock



The keypad lock makes it possible to block access to the entire operating menu via local operation. As a result, it is no longer possible to navigate through the operating menu or change the values of individual parameters. Users can only read the measured values on the operational display.

The keypad lock is switched on and off via the context menu.

Switching on the keypad lock



-  The keypad lock is switched on automatically:
- If the device has not been operated via the display for > 1 minute.
 - Each time the device is restarted.

To activate the keylock manually:

1. The device is in the measured value display.
Press the  and  keys for 3 seconds.
 - ↳ A context menu appears.
2. In the context menu select the **Keylock on** option.
 - ↳ The keypad lock is switched on.

-  If the user attempts to access the operating menu while the keypad lock is active, the **Keylock on** message appears.

Switching off the keypad lock



- ▶ The keypad lock is switched on.
Press the  and  keys for 3 seconds.
 - ↳ The keypad lock is switched off.

8.4 Access to operating menu via web browser

8.4.1 Function range

With the integrated web server, the device can be operated and configured via a web browser service interface (CDI-RJ45) or WLAN interface. The structure of the operating menu is the same as for the local display. In addition to the measured values, status information on the device is displayed and can be used to monitor device health. Furthermore the device data can be managed and the network parameters can be configured.

A device that has a WLAN interface (can be ordered as an option) is required for the WLAN connection: order code for "Display; operation", option G "4-line, illuminated; touch control + WLAN". The device acts as an Access Point and enables communication by computer or a mobile handheld terminal.

-  For additional information on the web server, see the Special Documentation for the device. →  276

8.4.2 Requirements

Computer hardware



Hardware	Interface	
	CDI-RJ45	WLAN
Interface	The computer must have a RJ45 interface. ¹⁾	The operating unit must have a WLAN interface.
Connection	Standard Ethernet cable	Connection via Wireless LAN.
Screen	Recommended size: ≥ 12" (depends on the screen resolution)	

1) Recommended cable: CAT5e, CAT6 or CAT7, with shielded plug (e.g. YAMAICHI product; part no. Y-ConProfixPlug63/Prod. ID: 82-006660)

Computer software



Software	Interface	
	CDI-RJ45	WLAN
Recommended operating systems	<ul style="list-style-type: none"> ▪ Microsoft Windows 8 or higher. ▪ Mobile operating systems: <ul style="list-style-type: none"> ▪ iOS ▪ Android  Microsoft Windows XP and Windows 7 is supported.	
Web browsers supported	<ul style="list-style-type: none"> ▪ Microsoft Internet Explorer 8 or higher ▪ Microsoft Edge ▪ Mozilla Firefox ▪ Google Chrome ▪ Safari 	

Computer settings



Settings	Interface	
	CDI-RJ45	WLAN
User rights	Appropriate user rights (e.g. administrator rights) for TCP/IP and proxy server settings are necessary (e.g. for adjusting the IP address, subnet mask etc.).	
Proxy server settings of the web browser	The web browser setting <i>Use a proxy server for your LAN</i> must be disabled .	
JavaScript	JavaScript must be enabled.  If JavaScript cannot be enabled: Enter <code>http://192.168.1.212/servlet/basic.html</code> in the address bar of the web browser. A fully functional but simplified version of the operating menu structure starts in the web browser.  When installing a new firmware version: To enable correct data display, clear the temporary memory (cache) under Internet options in the web browser.	JavaScript must be enabled.  The WLAN display requires JavaScript support.
Network connections	Only use the active network connections to the measuring device.	
	Switch off all other network connections such as WLAN for example.	Switch off all other network connections.

 In the event of connection problems: →  170

Measuring device: Via CDI-RJ45 service interface

Device	CDI-RJ45 service interface
Measuring device	The measuring device has an RJ45 interface.
Web server	Web server must be enabled; factory setting: ON  For information on enabling the Web server →  84

Measuring device: via WLAN interface

Device	WLAN interface
Measuring device	The measuring device has a WLAN antenna: <ul style="list-style-type: none"> ▪ Transmitter with integrated WLAN antenna ▪ Transmitter with external WLAN antenna
Web server	Web server and WLAN must be enabled; factory setting: ON  For information on enabling the Web server →  84

8.4.3 Connecting the device

Via service interface (CDI-RJ45)

Preparing the measuring device

Proline 500 – digital

1. Loosen the 4 fixing screws on the housing cover.
2. Open the housing cover.
3. The location of the connection socket depends on the measuring device and the communication protocol.
Connect the computer to the RJ45 plug via the standard Ethernet cable .

Proline 500

1. Depending on the housing version:
Loosen the securing clamp or fixing screw of the housing cover.
2. Depending on the housing version:
Unscrew or open the housing cover.
3. Connect the computer to the RJ45 plug via the standard Ethernet connecting cable..

Configuring the Internet protocol of the computer

The following information refers to the default Ethernet settings of the device.

IP address of the device: 192.168.1.212 (factory setting)

1. Switch on the measuring device.
2. Connect the computer to the RJ45 plug via the standard Ethernet cable →  85.
3. If a 2nd network card is not used, close all the applications on the notebook.
 - ↳ Applications requiring Internet or a network, such as e-mail, SAP applications, Internet or Windows Explorer.
4. Close any open Internet browsers.
5. Configure the properties of the Internet protocol (TCP/IP) as defined in the table:

IP address	192.168.1.XXX; for XXX all numerical sequences except: 0, 212 and 255 → e.g. 192.168.1.213
Subnet mask	255.255.255.0
Default gateway	192.168.1.212 or leave cells empty

Via WLAN interface

Configuring the Internet protocol of the mobile terminal

NOTICE

If the WLAN connection is lost during the configuration, settings made may be lost.

- ▶ Make sure that the WLAN connection is not disconnected while configuring the device.

NOTICE

Note the following to avoid a network conflict:

- ▶ Avoid accessing the measuring device simultaneously from the same mobile terminal via the service interface (CDI-RJ45) and the WLAN interface.
- ▶ Only activate one service interface (CDI-RJ45 or WLAN interface).
- ▶ If simultaneous communication is necessary: configure different IP address ranges, e.g. 192.168.0.1 (WLAN interface) and 192.168.1.212 (CDI-RJ45 service interface).

Preparing the mobile terminal

- ▶ Enable WLAN on the mobile terminal.

Establishing a WLAN connection from the mobile terminal to the measuring device

1. In the WLAN settings of the mobile terminal:
Select the measuring device using the SSID (e.g. EH_Promass_500_A802000).
2. If necessary, select the WPA2 encryption method.
3. Enter the password:
Serial number of the measuring device ex-works (e.g. L100A802000).
↳ The LED on the display module flashes. It is now possible to operate the measuring device with the web browser, FieldCare or DeviceCare.

 The serial number can be found on the nameplate.

 To ensure the safe and swift assignment of the WLAN network to the measuring point, it is advisable to change the SSID name. It should be possible to clearly assign the new SSID name to the measuring point (e.g. tag name) because it is displayed as the WLAN network.

Terminating the WLAN connection

- ▶ After configuring the device:
Terminate the WLAN connection between the mobile terminal and measuring device.

Starting the web browser

1. Start the web browser on the computer.

2. Enter the IP address of the web server in the address line of the web browser:
192.168.1.212
↳ The login page appears.

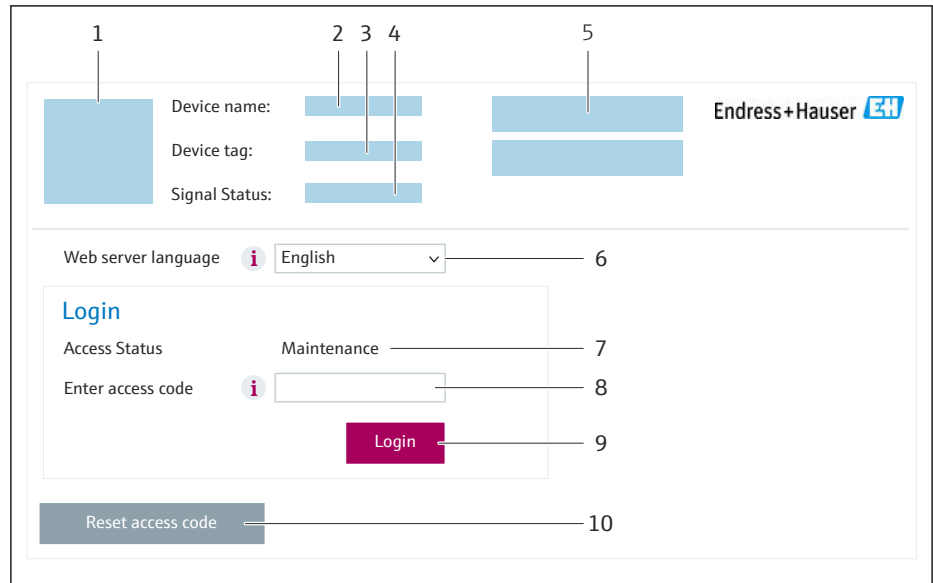

- 1 Picture of device
- 2 Device name
- 3 Device tag
- 4 Status signal
- 5 Current measured values
- 6 Operating language
- 7 User role
- 8 Access code
- 9 Login
- 10 Reset access code (→ 150)

i If a login page does not appear, or if the page is incomplete → 170

8.4.4 Logging on

1. Select the preferred operating language for the Web browser.
2. Enter the user-specific access code.
3. Press **OK** to confirm your entry.

Access code	0000 (factory setting); can be changed by customer
--------------------	--

i If no action is performed for 10 minutes, the Web browser automatically returns to the login page.

8.4.5 User interface

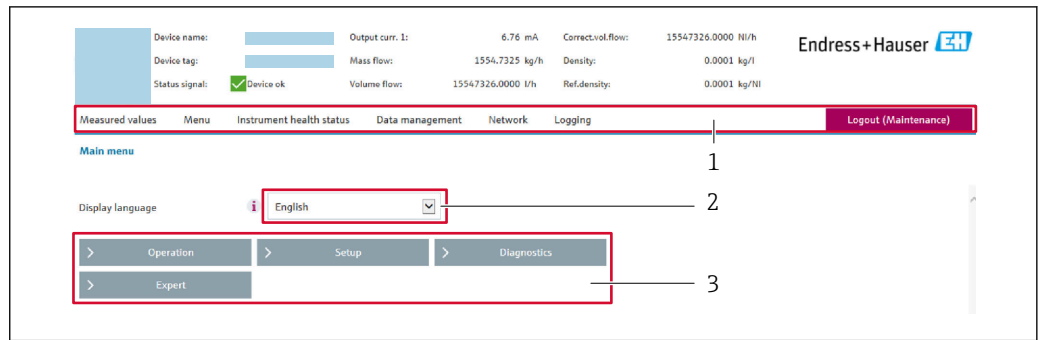

A0029418

- 1 Function row
- 2 Local display language
- 3 Navigation area

Header

The following information appears in the header:

- Device name
- Device tag
- Device status with status signal → 📄 178
- Current measured values

Function row

Functions	Meaning
Measured values	Displays the measured values of the device
Menu	<ul style="list-style-type: none"> ■ Access to the operating menu from the measuring device ■ The structure of the operating menu is the same as for the local display 📄 Detailed information on the operating menu structure: Description of Device Parameters
Device status	Displays the diagnostic messages currently pending, listed in order of priority
Data management	<p>Data exchange between computer and measuring device:</p> <ul style="list-style-type: none"> ■ Device configuration: <ul style="list-style-type: none"> ■ Load settings from the device (XML format, save configuration) ■ Save settings to the device (XML format, restore configuration) ■ Logbook - Export Event logbook (.csv file) ■ Documents - Export documents: <ul style="list-style-type: none"> ■ Export backup data record (.csv file, create documentation of the measuring point configuration) ■ Verification report (PDF file, only available with the "Heartbeat Verification" application package) ■ File for system integration - If using fieldbuses, upload device drivers for system integration from the measuring device: <ul style="list-style-type: none"> PROFIBUS PA: GSD file ■ Firmware update - Flashing a firmware version
Network	<p>Configuration and checking of all the parameters required for establishing the connection to the measuring device:</p> <ul style="list-style-type: none"> ■ Network settings (e.g. IP address, MAC address) ■ Device information (e.g. serial number, firmware version)
Logout	End the operation and call up the login page

Navigation area

The menus, the associated submenus and parameters can be selected in the navigation area.

Working area

Depending on the selected function and the related submenus, various actions can be performed in this area:

- Configuring parameters
- Reading measured values
- Calling up help text
- Starting an upload/download

8.4.6 Disabling the Web server

The Web server of the measuring device can be switched on and off as required using the **Web server functionality** parameter.

Navigation

"Expert" menu → Communication → Web server

Parameter overview with brief description

Parameter	Description	Selection
Web server functionality	Switch the Web server on and off.	<ul style="list-style-type: none"> ▪ Off ▪ HTML Off ▪ On

Function scope of the "Web server functionality" parameter

Option	Description
Off	<ul style="list-style-type: none"> ▪ The Web server is completely disabled. ▪ Port 80 is locked.
HTML Off	The HTML version of the Web server is not available.
On	<ul style="list-style-type: none"> ▪ The complete Web server functionality is available. ▪ JavaScript is used. ▪ The password is transferred in an encrypted state. ▪ Any change to the password is also transferred in an encrypted state.

Enabling the Web server

If the Web server is disabled it can only be re-enabled with the **Web server functionality** parameter via the following operating options:

- Via local display
- Via Bedientool "FieldCare"
- Via "DeviceCare" operating tool

8.4.7 Logging out

 Before logging out, perform a data backup via the **Data management** function (upload configuration from device) if necessary.

1. Select the **Logout** entry in the function row.
↳ The home page with the Login box appears.
2. Close the Web browser.

3. If no longer needed:
Reset the modified properties of the Internet protocol (TCP/IP) → 80.

8.5 Access to the operating menu via the operating tool

The structure of the operating menu in the operating tools is the same as for operation via the local display.

8.5.1 Connecting the operating tool

Via PROFIBUS PA network

This communication interface is available in device versions with PROFIBUS PA.

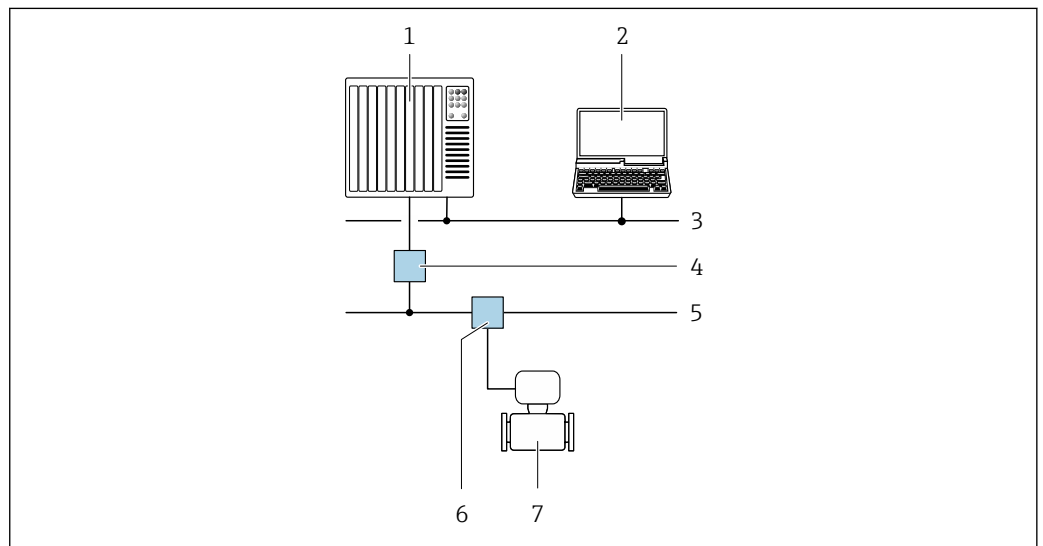

31 Options for remote operation via PROFIBUS PA network

- 1 Automation system
- 2 Computer with PROFIBUS network card
- 3 PROFIBUS DP network
- 4 Segment coupler PROFIBUS DP/PA
- 5 PROFIBUS PA network
- 6 T-box
- 7 Measuring device

Service interface

Via service interface (CDI-RJ45)

A point-to-point connection can be established to configure the device onsite. With the housing open, the connection is established directly via the service interface (CDI-RJ45) of the device.

- i** An adapter for the RJ45 to the M12 plug is optionally available for the non-hazardous area:

Order code for "Accessories", option **NB**: "Adapter RJ45 M12 (service interface)"

The adapter connects the service interface (CDI-RJ45) to an M12 plug mounted in the cable entry. The connection to the service interface can be established via an M12 plug without opening the device.

Proline 500 – digital transmitter

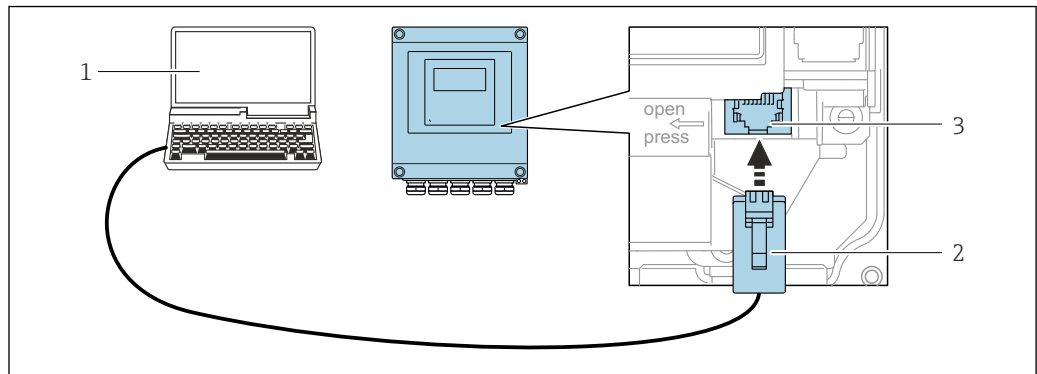

32 Connection via service interface (CDI-RJ45)

- 1 Computer with web browser (e.g. Microsoft Internet Explorer, Microsoft Edge) for accessing the integrated web server or with "FieldCare" operating tool, "DeviceCare" with COM DTM "CDI Communication TCP/IP"
- 2 Standard Ethernet connecting cable with RJ45 plug
- 3 Service interface (CDI-RJ45) of the measuring device with access to the integrated Web server

Proline 500 transmitter

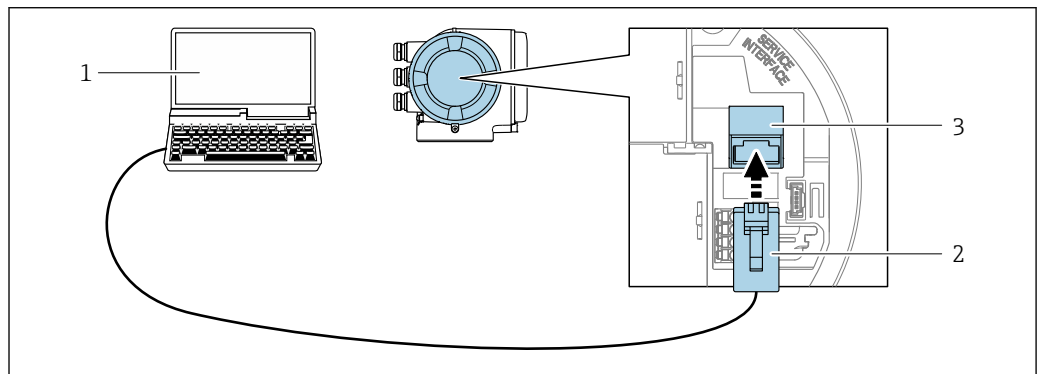

33 Connection via service interface (CDI-RJ45)

- 1 Computer with web browser (e.g. Microsoft Internet Explorer, Microsoft Edge) for accessing the integrated web server or with "FieldCare" operating tool, "DeviceCare" with COM DTM "CDI Communication TCP/IP"
- 2 Standard Ethernet connecting cable with RJ45 plug
- 3 Service interface (CDI-RJ45) of the measuring device with access to the integrated Web server

Via WLAN interface

The optional WLAN interface is available on the following device version:
 Order code for "Display; operation", option G "4-line, illuminated; touch control + WLAN"

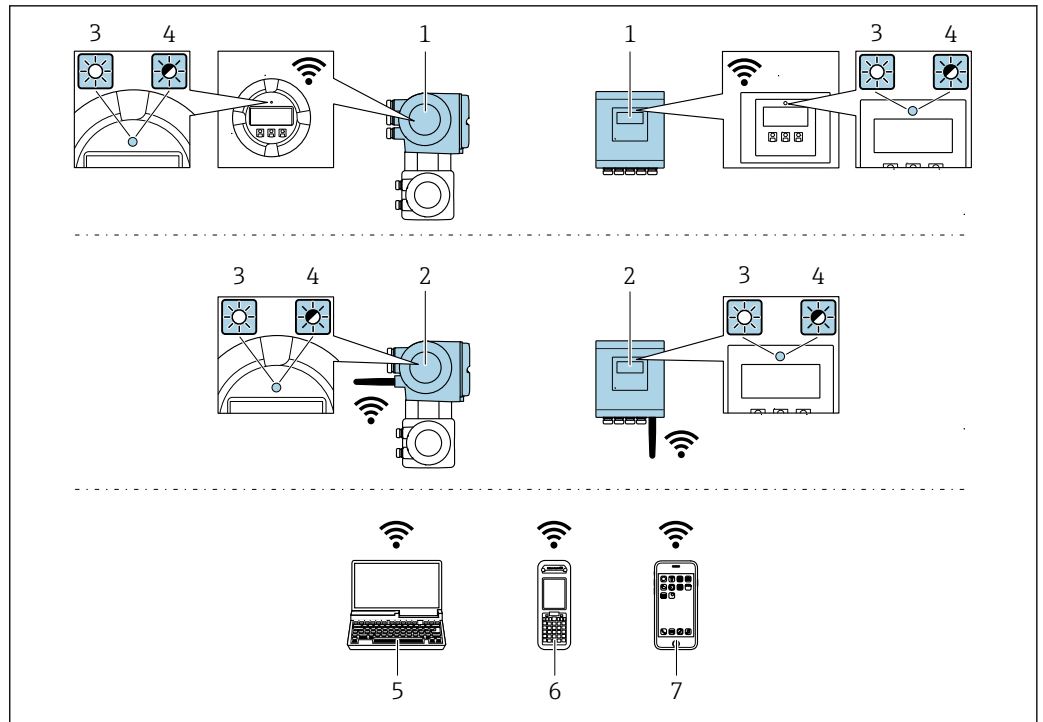

A0034569

- 1 Transmitter with integrated WLAN antenna
- 2 Transmitter with external WLAN antenna
- 3 LED lit constantly: WLAN reception is enabled on measuring device
- 4 LED flashing: WLAN connection established between operating unit and measuring device
- 5 Computer with WLAN interface and web browser (e.g. Microsoft Internet Explorer, Microsoft Edge) for accessing the integrated device web server or with operating tool (e.g. FieldCare, DeviceCare)
- 6 Mobile handheld terminal with WLAN interface and web browser (e.g. Microsoft Internet Explorer, Microsoft Edge) for accessing the integrated device web server or operating tool (e.g. FieldCare, DeviceCare)
- 7 Smart phone or tablet (e.g. Field Xpert SMT70)

Function	WLAN: IEEE 802.11 b/g (2.4 GHz)
Encryption	WPA2-PSK AES-128 (in accordance with IEEE 802.11i)
Configurable WLAN channels	1 to 11
Degree of protection	IP67
Available antennas	<ul style="list-style-type: none"> ▪ Internal antenna ▪ External antenna (optional) In the event of poor transmission/reception conditions at the place of installation. ⓘ Only 1 antenna is active at any one time!
Range	<ul style="list-style-type: none"> ▪ Internal antenna: typically 10 m (32 ft) ▪ External antenna: typically 50 m (164 ft)
Materials (external antenna)	<ul style="list-style-type: none"> ▪ Antenna: ASA plastic (acrylonitrile styrene acrylate) and nickel-plated brass ▪ Adapter: Stainless steel and nickel-plated brass ▪ Cable: Polyethylene ▪ Plug: Nickel-plated brass ▪ Angle bracket: Stainless steel

Configuring the Internet protocol of the mobile terminal

NOTICE

If the WLAN connection is lost during the configuration, settings made may be lost.

- ▶ Make sure that the WLAN connection is not disconnected while configuring the device.

NOTICE**Note the following to avoid a network conflict:**

- ▶ Avoid accessing the measuring device simultaneously from the same mobile terminal via the service interface (CDI-RJ45) and the WLAN interface.
- ▶ Only activate one service interface (CDI-RJ45 or WLAN interface).
- ▶ If simultaneous communication is necessary: configure different IP address ranges, e.g. 192.168.0.1 (WLAN interface) and 192.168.1.212 (CDI-RJ45 service interface).

Preparing the mobile terminal

- ▶ Enable WLAN on the mobile terminal.

Establishing a WLAN connection from the mobile terminal to the measuring device

1. In the WLAN settings of the mobile terminal:
Select the measuring device using the SSID (e.g. EH_Promass_500_A802000).
2. If necessary, select the WPA2 encryption method.
3. Enter the password:
Serial number of the measuring device ex-works (e.g. L100A802000).
 - ↳ The LED on the display module flashes. It is now possible to operate the measuring device with the web browser, FieldCare or DeviceCare.



The serial number can be found on the nameplate.



To ensure the safe and swift assignment of the WLAN network to the measuring point, it is advisable to change the SSID name. It should be possible to clearly assign the new SSID name to the measuring point (e.g. tag name) because it is displayed as the WLAN network.

Terminating the WLAN connection

- ▶ After configuring the device:
Terminate the WLAN connection between the mobile terminal and measuring device.

8.5.2 FieldCare

Function range

FDT-based (Field Device Technology) plant asset management tool from Endress+Hauser. It can configure all smart field units in a system and helps you manage them. By using the status information, it is also a simple but effective way of checking their status and condition.

Access is via:

- PROFIBUS PA protocol → 85
- CDI-RJ45 service interface → 85
- WLAN interface → 86

Typical functions:

- Transmitter parameter configuration
- Loading and saving of device data (upload/download)
- Documentation of the measuring point
- Visualization of the measured value memory (line recorder) and event logbook



- Operating Instructions BA00027S
- Operating Instructions BA00059S



Source for device description files → 91

Establishing a connection

1. Start FieldCare and launch the project.
2. In the network: Add a device.
 - ↳ The **Add device** window opens.
3. Select the **CDI Communication TCP/IP** option from the list and press **OK** to confirm.
4. Right-click **CDI Communication TCP/IP** and select the **Add device** option in the context menu that opens.
5. Select the desired device from the list and press **OK** to confirm.
 - ↳ The **CDI Communication TCP/IP (Configuration)** window opens.
6. Enter the device address in the **IP address** field: 192.168.1.212 and press **Enter** to confirm.
7. Establish the online connection to the device.



- Operating Instructions BA00027S
- Operating Instructions BA00059S

User interface

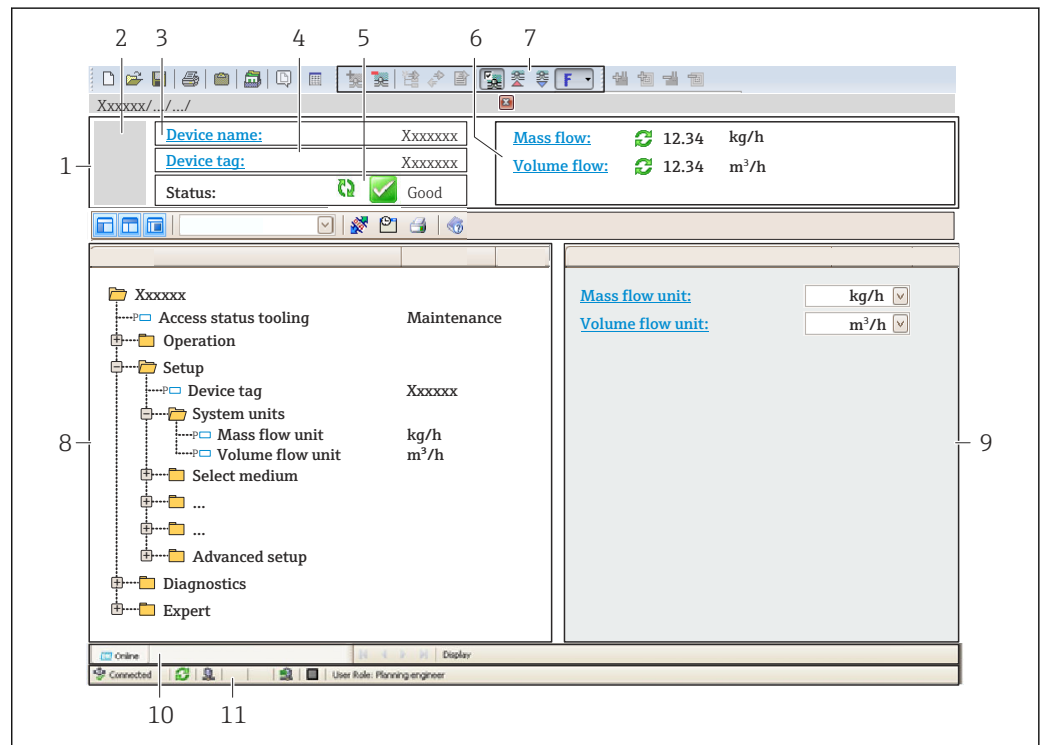

A0021051-EN

- 1 Header
- 2 Picture of device
- 3 Device name
- 4 Device tag
- 5 Status area with status signal → 178
- 6 Display area for current measured values
- 7 Editing toolbar with additional functions such as save/load, event list and create documentation
- 8 Navigation area with operating menu structure
- 9 Work area
- 10 Action area
- 11 Status area

8.5.3 DeviceCare

Function range

Tool for connecting and configuring Endress+Hauser field devices.

The fastest way to configure Endress+Hauser field devices is with the dedicated "DeviceCare" tool. Together with the device type managers (DTMs) it presents a convenient, comprehensive solution.



Innovation brochure IN01047S



Source for device description files → 91

8.5.4 SIMATIC PDM

Function range

Standardized, vendor-independent program from Siemens for the operation, configuration, maintenance and diagnosis of intelligent field devices via the PROFIBUS PA protocol.



Source for device description files → 91

9 System integration

9.1 Overview of device description files

9.1.1 Current version data for the device

Firmware version	01.01.zz	<ul style="list-style-type: none"> ▪ On the title page of the manual ▪ On the transmitter nameplate ▪ Firmware version Diagnostics → Device information → Firmware version
Release date of firmware version	11.2018	---
Manufacturer ID	0x11	Manufacturer ID Diagnostics → Device information → Manufacturer ID
Device type ID	0x156D	Device type Diagnostics → Device information → Device type
Profile version	3.02	---

 For an overview of the various firmware versions for the device →  241

9.1.2 Operating tools

The suitable device description file for the individual operating tools is listed in the table below, along with information on where the file can be acquired.

Operating tool via PROFIBUS protocol	Sources for obtaining device descriptions
FieldCare	<ul style="list-style-type: none"> ▪ www.endress.com → Downloads area ▪ USB stick (contact Endress+Hauser) ▪ DVD (contact Endress+Hauser)
DeviceCare	<ul style="list-style-type: none"> ▪ www.endress.com → Downloads area ▪ CD-ROM (contact Endress+Hauser) ▪ DVD (contact Endress+Hauser)
SIMATIC PDM (Siemens)	www.endress.com → Downloads area

9.2 Device master file (GSD)

In order to integrate field devices into a bus system, the PROFIBUS system needs a description of the device parameters, such as output data, input data, data format, data volume and supported transmission rate.

These data are available in the device master file (GSD) which is provided to the PROFIBUS Master when the communication system is commissioned. In addition device bit maps, which appear as icons in the network structure, can also be integrated.

With the Profile 3.02 device master file (GSD) it is possible to exchange field devices made by different manufacturers without having to reconfigure.

Generally speaking, it is possible to use two different GSDs with Profile 3.02 and higher: the manufacturer-specific GSD and the Profile GSD.

-  Before configuring, the user must decide which GSD should be used to operate the system.
 - The setting can be changed via a Class 2 master.

9.2.1 Manufacturer-specific GSD

This GSD guarantees the unrestricted functionality of the measuring device. Device-specific process parameters and functions are therefore available.

Manufacturer-specific GSD	ID number	File name
PROFIBUS PA	0x156D	EH3x156D.gsd

Use manufacturer-specific GSD

Assignment is performed in the **Ident number selector** parameter via the **Manufacturer** option.

-  Sources of supply for the manufacturer-specific GSD:
- Export directly from the device via the integrated web server:
Data management → Documents → Export GSD file
 - Download via the Endress+Hauser website:
www.endress.com → Download-Area

9.2.2 Profile GSD

Differs in terms of the number of Analog Input blocks (AI) and the measured values. If a system is configured with a Profile GSD, it is possible to exchange devices made by different manufacturers. However, it is essential to ensure that the order of the cyclic process values is correct.

ID number	Supported blocks	Supported channels
0x9740	<ul style="list-style-type: none"> ▪ 1 Analog Input ▪ 1 Totalizer 	<ul style="list-style-type: none"> ▪ Channel Analog Input: volume flow ▪ Channel totalizer: volume flow
0x9741	<ul style="list-style-type: none"> ▪ 2 Analog Input ▪ 1 Totalizer 	<ul style="list-style-type: none"> ▪ Channel Analog Input 1: volume flow ▪ Channel Analog Input 2: mass flow ▪ Channel totalizer: volume flow
0x9742	<ul style="list-style-type: none"> ▪ 3 Analog Input ▪ 1 Totalizer 	<ul style="list-style-type: none"> ▪ Channel Analog Input 1: volume flow ▪ Channel Analog Input 2: mass flow ▪ Channel Analog Input 3: corrected volume flow ▪ Channel totalizer: volume flow

Use profile GSD

Assignment is performed in the **Ident number selector** parameter:

- ID number 0x9740: **1 AI, 1 Totalizer (0x9740)** option
- ID number 0x9741: **2 AI, 1 Totalizer (0x9741)** option
- ID number 0x9742: **Profile** option

9.3 Compatibility with earlier model

If the device is replaced, the measuring device Promass 500 supports the compatibility of the cyclic data with previous models. It is not necessary to adjust the engineering parameters of the PROFIBUS network with the Promass 500 GSD file.

Earlier models:

- Promass 80PROFIBUS PA
 - ID No.: 1528 (hex)
 - Extended GSD file: EH3x1528.gsd
 - Standard GSD file: EH3_1528.gsd
- Promass 83PROFIBUS PA
 - ID No.: 152A (hex)
 - Extended GSD file: EH3x152A.gsd
 - Standard GSD file: EH3_152A.gsd

9.3.1 Automatic identification (factory setting)

The Promass 500 PROFIBUS PA automatically recognizes the measuring device configured in the automation system (Promass 80 PROFIBUS PA or Promass 83 PROFIBUS PA) and makes the same input and output data and measured value status information available for cyclic data exchange.

Automatic identification is set in the **Ident number selector** parameter using the **Automatic mode** option (factory setting).

9.3.2 Manual setting

The manual setting is made in the **Ident number selector** parameter via the **Promass 80 (0x1528)** option or **Promass 83 (0x152A)** option.

Afterwards the Promass 500 PROFIBUS PA makes the same input and output data and measured value status information available for cyclic data exchange.

- If the Promass 500 PROFIBUS PA is acyclically configured via an operating program (Class 2 master), access is directly via the block structure or the parameters of the measuring device.
- If parameters have been changed in the device to be replaced (Promass 80 PROFIBUS PA or Promass 83 PROFIBUS PA) (parameter setting no longer corresponds to the original factory setting), these parameters must be changed accordingly in the new replacement Promass 500 PROFIBUS PA via an operating program (Class 2 master).

Example

The setting for low flow cut off has been changed from mass flow (factory setting) to corrected volume flow in a Promass 80 PROFIBUS PA currently in operation. This device is now replaced by a Promass 500 PROFIBUS PA.

After replacing the device, the assignment for the low flow cut off must also be changed manually in the Promass 500 PROFIBUS PA, i.e. to corrected volume flow, to ensure the measuring device behaves identically.

9.3.3 Replacing the measuring devices without changing the GSD file or restarting the controller

In the procedure described below, the device can be replaced without interrupting ongoing operation or restarting the controller. However with this procedure the measuring device is not fully integrated!

1. Replace the measuring device Promass 80 PROFIBUS PA or Promass 83 PROFIBUS PA with a Promass 500 PROFIBUS PA.

2. Set the device address: The same device address that was set for the Promass 80 or Promass 83 PROFIBUS PA must be used.
3. Connect the measuring device Promass 500 PROFIBUS PA.

If the factory setting had been changed on the replaced device (Promass 80 PROFIBUS PA or Promass 83 PROFIBUS PA), the following settings may need to be changed:

1. Configuration of the application-specific parameters.
2. Choice of process variables to be transmitted via the **Channel** parameter in the Analog Input or Totalizer function block.
3. Setting of the units for the process variables.

9.4 Using the GSD modules of the previous model

In the compatibility mode, all the modules already configured in the automation system are generally supported during cyclic data transmission. However, Promass 500 does not perform further processing for the following modules, i.e. the function is not executed:

- DISPLAY_VALUE
- BATCHING_QUANTITY
- BATCHING_FIX_COMP_QUANTITY

If the device is replaced, the Promass 500 device supports the compatibility of the cyclic data with previous models. It is not necessary to adjust the engineering parameters of the PROFIBUS network with the Promass 500 GSD file.

The diagnostic messages transmitted to the distributed control system with the GSD of the previous model may differ from the diagnostic messages of the device. The diagnostic messages of the device are critical.

9.4.1 Using the CONTROL_BLOCK module in the previous model

If the CONTROL_BLOCK module is used in the previous model, the control variables are processed further if relevant functionalities can be assigned for the Promass 500.

The functions are supported as follows depending on the previous model:

Previous model: Promass 80 PROFIBUS PA

Control variable	Function	Support
0 → 2	Positive zero return: ON	Yes
0 → 3	Positive zero return: OFF	Yes
0 → 4	Zero point adjustment: START	Yes
0 → 8	Measuring mode: UNIDIRECTIONAL	No
0 → 9	Measuring mode: BIDIRECTIONAL	<p>Cause: The Profile Transducer Block Flow is no longer supported.</p> <p>To continue to use the functionality: Use the Totalizer operation mode parameter in the Totalizer function block.</p>
0 → 24	UNIT TO BUS	<p>No</p> <p>Cause: Functionality is no longer required as the unit is adopted automatically.</p>

Previous model: Promass 83 PROFIBUS PA

Control variable	Function	Support
0 → 2	Positive zero return: ON	Yes
0 → 3	Positive zero return: OFF	Yes
0 → 4	Zero point adjustment: START	Yes
0 → 8	Measuring mode: UNIDIRECTIONAL	No
0 → 9	Measuring mode: BIDIRECTIONAL	<p>Cause: The Profile Transducer Block Flow is no longer supported.</p> <p>To continue to use the functionality: Use the Totalizer operation mode parameter in the Totalizer function block.</p>
0 → 24	UNIT TO BUS	<p>No</p> <p>Cause: Functionality is no longer required as the unit is adopted automatically.</p>
0 → 25	Advanced diagnostics – Warning mode: ON	No
0 → 26	Advanced diagnostics – Warning mode: OFF	<p>To continue to use the functionality: The functionalities are offered in the "Heartbeat Technology" application package.</p>
0 → 70 to 78	Additional functions: Advanced diagnostics	

9.5 Cyclic data transmission

Cyclic data transmission when using the device master file (GSD).

9.5.1 Block model

The block model shows which input and output data the measuring device makes available for cyclic data exchange. Cyclic data exchange takes place with a PROFIBUS master (Class 1), e.g. a control system.

Measuring instrument				Control system
Flow Block	Analog Input block 1 to 8	→	📄 97	Output value AI →
				Output value TOTAL →
	Totalizer block 1 to 3	→	📄 98	Controller SETTOT ←
				Configuration MODETOT ←
	Analog Output block 1 to 3	→	📄 100	Input values AO ←
	Discrete Input block 1 to 2	→	📄 100	Output values DI →
	Discrete Output block 1 to 4	→	📄 101	Input values DO ←
				PROFIBUS PA

Defined order of modules

The measuring device works as a modular PROFIBUS slave. In contrast to a compact slave, a modular slave has a variable design and consists of several individual modules. The device master file (GSD) contains a description of the individual modules (input and output data) along with their individual properties.

The modules are permanently assigned to the slots, i.e. when configuring the modules, the order and the arrangement of the modules must be respected.

Slot	Module	Function block
1 to 8	AI	Analog Input block 1 to 8
9	TOTAL or SETTOT_TOTAL or SETTOT_MODETOT_TOTAL	Totalizer block 1
10		Totalizer block 2
11		Totalizer block 3
12 to 14	AO	Analog Output block 1 to 3
15 to 16	DI	Discrete Input block 1 to 2
17 to 21	DO	Discrete Output block 1 to 5
22 to 23	AO	Analog Output block 4 to 5

To optimize the data throughput rate of the PROFIBUS network, it is advisable to only configure modules that are processed in the PROFIBUS master system. If this results in gaps between the configured modules, these gaps must be assigned to the EMPTY_MODULE.

9.5.2 Description of the modules

The data structure is described from the perspective of the PROFIBUS master:

- Input data: Are sent from the measuring device to the PROFIBUS master.
- Output data: Are sent from the PROFIBUS master to the measuring device.

AI module (Analog Input)

Transmit an input variable from the measuring device to the PROFIBUS master (Class 1).

The selected input variable including its status is cyclically transmitted to the PROFIBUS master (Class 1) via the AI module. The input variable is depicted in the first four bytes in the form of a floating point number as per the IEEE 754 standard. The fifth byte contains standardized status information pertaining to the input variable.

Eight Analog Input blocks are available (slot 1 to 8).

Selection: input variable

Input variable
Mass flow
Volume flow
Corrected volume flow
Density
Reference density
Temperature
Electronics temperature
Oscillation frequency 0
Frequency fluctuation 0
Oscillation damping 0
Tube damping fluctuation 0
Signal asymmetry
Exciter current 0
Concentration ¹⁾
Target mass flow ¹⁾
Carrier mass flow ¹⁾
Target volume flow ¹⁾
Carrier volume flow ¹⁾
Target corrected volume flow ¹⁾
Carrier corrected volume flow ¹⁾
Carrier tube temperature ²⁾
Oscillation frequency 1 ²⁾
Oscillation amplitude 0 ²⁾
Oscillation amplitude 1 ²⁾
Frequency fluctuation 1 ²⁾
Oscillation damping 1 ²⁾
Tube damping fluctuation 1 ²⁾
Exciter current 1 ²⁾
HBSI ²⁾
Current input 1
Current input 2
Current input 3

1) Only available with the Concentration application package

2) Only available with the Heartbeat Verification application package

Factory setting

Function block	Factory setting
AI 1	Mass flow
AI 2	Volume flow
AI 3	Corrected volume flow
AI 4	Density
AI 5	Mass flow
AI 6	Temperature
AI 7	Mass flow
AI 8	Mass flow

*Data structure**Input data of Analog Input*

Byte 1	Byte 2	Byte 3	Byte 4	Byte 5
Measured value: floating point number (IEEE 754)				Status

TOTAL module

Transmit a totalizer value from the measuring device to the PROFIBUS master (Class 1).

A selected totalizer value, along with the status, is cyclically transmitted to a PROFIBUS Master (Class 1) via the TOTAL module. The totalizer value is depicted in the first four bytes in the form of a floating point number as per the IEEE 754 standard. The fifth byte contains standardized status information pertaining to the totalizer value.

Three Totalizer blocks are available (slot 9 to 11).

Selection: totalizer value

Input variable
Mass flow
Volume flow
Corrected volume flow
Target fluid mass flow ¹⁾
Carrier mass flow ¹⁾

1) Only available with the "Concentration" application package

Factory setting

Function block	Factory setting: TOTAL
Totalizer 1, 2 and 3	Mass flow

*Data structure**Input data of TOTAL*

Byte 1	Byte 2	Byte 3	Byte 4	Byte 5
Measured value: floating point number (IEEE 754)				Status

SETTOT_TOTAL module

The module combination consists of the SET_TOT and TOTAL functions:

- SETTOT: Control the totalizers via the PROFIBUS master.
- TOTAL: Transmit totalizer value incl. status to PROFIBUS master.

Three Totalizer blocks are available (slot 9 to 11).

Selection: control totalizer

Value SETTOT	Control totalizer
0	Totalize
1	Reset + hold
2	Preset + hold

Factory setting

Function block	Factory setting: Value SETTOT (meaning)
Totalizer 1, 2 and 3	0 (totalizing)

Data structure

Output data of SETTOT

Byte 1
Control variable 1

Input data of TOTAL

Byte 1	Byte 2	Byte 3	Byte 4	Byte 5
Measured value: floating point number (IEEE 754)				Status

SETTOT_MODETOT_TOTAL module

The module combination consists of the SETTOT, MODETOT and TOTAL functions:

- SETTOT: Control the totalizers via the PROFIBUS master.
- MODETOT: Configure the totalizers via the PROFIBUS master.
- TOTAL: Transmit totalizer value, along with the status, to the PROFIBUS master.

Three Totalizer blocks are available (slot 9 to 11).

Selection: totalizer configuration

MODETOT value	Totalizer configuration
0	Balancing
1	Balance the positive flow
2	Balance the negative flow
3	Stop totalizing

Factory setting

Function block	Factory setting: Value MODETOT (meaning)
Totalizer 1, 2 and 3	0 (balancing)

*Data structure**Output data of SETTOT and MODETOT*

Byte 1	Byte 2
Control variable 1: SETTOT	Control variable 2: MODETOT

Input data of TOTAL

Byte 1	Byte 2	Byte 3	Byte 4	Byte 5
Measured value: floating point number (IEEE 754)				Status

AO module (Analog Output)

Transmit a compensation value from the PROFIBUS master (class 1) to the measuring device.

A compensation value, including the status, is cyclically transmitted from the PROFIBUS master (class 1) to the measuring device via the AO module. The compensation value is depicted in the first four bytes in the form of a floating point number as per the IEEE 754 standard. The fifth byte contains standardized status information pertaining to the compensation value.

Five Analog Output blocks are available (slot 12 to 14, 22 to 23).

Assigned compensation values

A compensation value is permanently assigned to the individual Analog Output blocks.

Function block	Compensation value
AO 1	External pressure ¹⁾
AO 2	External temperature ¹⁾
AO 3	External reference density
AO 4	–
AO 5	–

1) The compensation values must be transmitted to the device in the SI basic unit



The selection is made via: Expert → Sensor → External compensation

*Data structure**Output data of Analog Output*

Byte 1	Byte 2	Byte 3	Byte 4	Byte 5
Measured value: floating point number (IEEE 754)				Status ¹⁾

1) Status coding

DI module (Discrete Input)

Transmit discrete input values from the measuring device to the PROFIBUS master (class 1). Discrete input values are used by the measuring device to transmit the state of device functions to the PROFIBUS master (class 1).

The DI module cyclically transmits the discrete input value, including the status, to the PROFIBUS master (class 1). The discrete input value is depicted in the first byte. The second byte contains standardized status information pertaining to the input value.

Two Discrete Input blocks are available (slot 15 to 16).

Selection: device function

Device function	Factory setting: Status (meaning)
Empty pipe detection	<ul style="list-style-type: none"> ■ 0 (device function not active) ■ 1 (device function active)
Low flow cut off	
Verification status ¹⁾	<ul style="list-style-type: none"> ■ Bit 0: Verification status - Check not done ■ Bit 1: Verification status - Failed ■ Bit 2: Verification status - Busy ■ Bit 3: Verification status - Ready ■ Bit 4: Verification overall result - Failed ■ Bit 5: Verification overall result - Passed ■ Bit 6: Verification overall result - Check not done ■ Bit 7: Not used

1) Only available with the Heartbeat Verification application package

Factory setting

Function block	Factory setting
DI 1	Empty pipe detection
DI 2	Low flow cut off

Data structure

Input data of Discrete Input

Byte 1	Byte 2
Discrete	Status

DO module (Discrete Output)

Transmit discrete output values from the PROFIBUS master (class 1) to the measuring device. Discrete output values are used by the PROFIBUS master (class 1) to enable and disable device functions.

The DO module cyclically transmits the discrete output value, including the status, to the measuring device. The discrete output value is depicted in the first byte. The second byte contains standardized status information pertaining to the output value.

Five Discrete Output blocks are available (slot 17 to 21).

Assigned device functions

A device function is permanently assigned to the individual Discrete Output blocks.

Function block	Device function	Values: control (meaning)
DO 1	Flow override	<ul style="list-style-type: none"> ■ 0 (disable device function) ■ 1 (enable device function)
DO 2	Zero adjustment	
DO 3	Start verification ¹⁾	

Function block	Device function	Values: control (meaning)
DO 4	Relay output	<ul style="list-style-type: none"> ■ 0 (non-conductive) ■ 1 (conductive)
DO 5	Concentration ²⁾	Assignment of medium type (see the following table)

1) Only available with the Heartbeat Verification application package

2) Only available with the Concentration application package

Assignment of medium type: function block DO 5	
101	Fructose in water
102	Glucose in water
104	Hydrogen peroxide in water
105	Sucrose in water
106	Invert sugar in water
107	Nitric acid
108	Phosphoric acid
109	Potassium hydroxide
100	Off
110	Sodium hydroxide
111	Ethanol in water
112	Methanol in water
113	Ammonium nitrate in water
114	Iron(III) chloride in water
115	HFCS42
116	HFCS55
117	HFCS90
118	Original wort
119	% mass / % volume
121	Coef Set No. 1
122	Coef Set No. 2
123	Coef Set No. 3
124	Hydrochloric acid
125	Sulfuric acid

Data structure

Output data of Discrete Output

Byte 1	Byte 2
Discrete	Status

EMPTY_MODULE module

This module is used to assign empty spaces arising from modules not being used in the slots .

The measuring device works as a modular PROFIBUS slave. In contrast to a compact slave, a modular PROFIBUS slave has a variable design and consists of several individual



modules. The GSD file contains a description of the individual modules along with their individual properties.

The modules are permanently assigned to the slots. When configuring the modules, it is absolutely essential to observe the sequence/arrangement of the modules. Any gaps between the configured modules must be filled with the `EMPTY_MODULE`.

10 Commissioning



10.1 Post-mounting and post-connection check

Before commissioning the device:



- ▶ Make sure that the post-installation and post-connection checks have been performed successfully.
- Checklist for "Post-installation" check →  33
- Checklist for "Post-connection" check →  62

10.2 Switching on the measuring device

- ▶ Switch on the device upon successful completion of the post-mounting and post-connection check.
 - ↳ After a successful startup, the local display switches automatically from the startup display to the operational display.

 If nothing appears on the local display or if a diagnostic message is displayed, refer to the section on "Diagnostics and troubleshooting" →  169.

10.3 Connecting via FieldCare

- For connecting FieldCare →  85
- For connecting via FieldCare →  89
- For user interface of FieldCare →  89

10.4 Configuring the device address via software

In the "**Communication**" submenu the device address can be set.



Navigation

"Setup" menu → Communication → Device address

10.4.1 PROFIBUS network

At time of delivery, the measuring device has the following factory setting:

Device address	126
----------------	-----

-  ▪ To display the current device address: **Device address** parameter →  110
- If hardware addressing is active, software addressing is blocked →  59

10.5 Setting the operating language

Factory setting: English or ordered local language

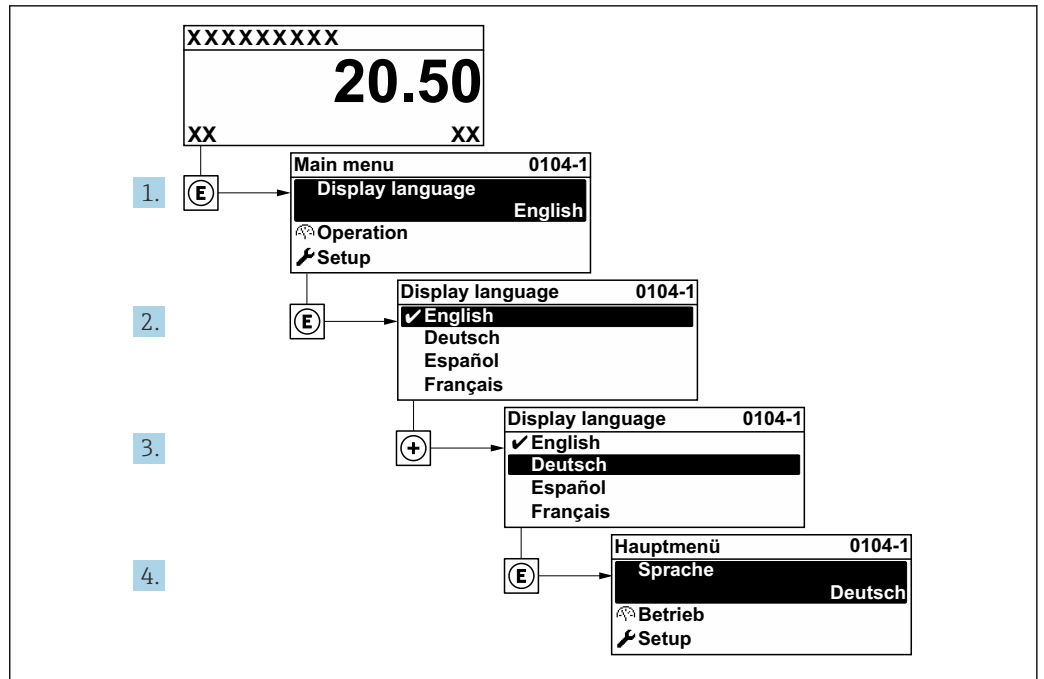

A0029420

34 Taking the example of the local display

10.6 Configuring the measuring instrument

The **Setup** menu with its guided wizards contains all the parameters needed for standard operation.

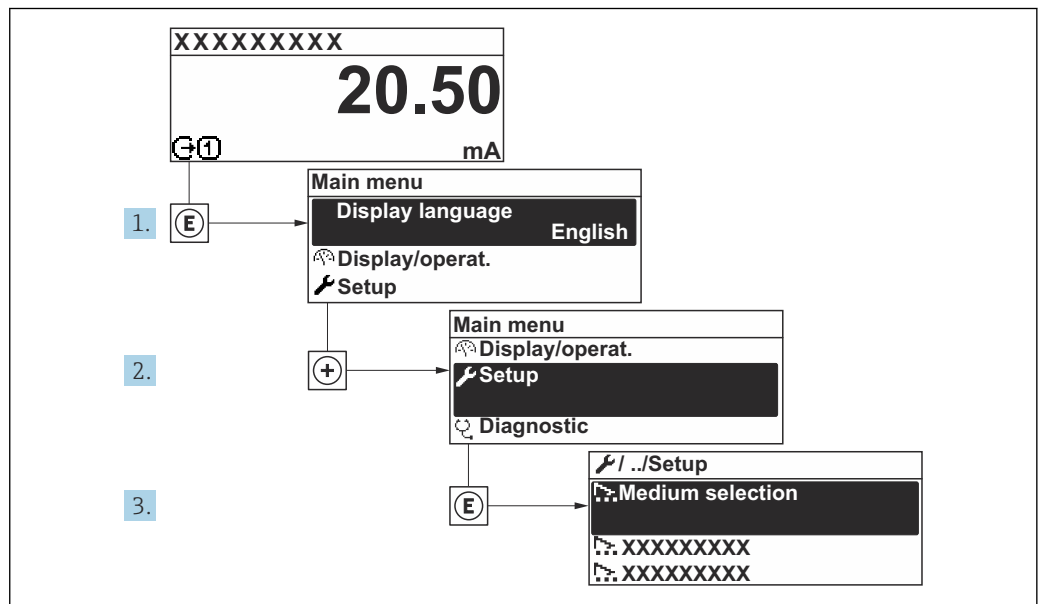

A003222-EN

35 Navigation to "Setup" menu using the example of the local display

i The number of submenus and parameters can vary depending on the device version. Certain submenus and parameters in these submenus are not described in the Operating Instructions. Instead a description is provided in the Special Documentation for the device ("Supplementary documentation").

Navigation

"Setup" menu

🔧 Setup	
Device tag	→ 📖 107
▶ System units	→ 📖 107
▶ Medium selection	→ 📖 110
▶ Communication	→ 📖 110
▶ Analog inputs	→ 📖 112
▶ I/O configuration	→ 📖 113
▶ Current input 1 to n	→ 📖 114
▶ Status input 1 to n	→ 📖 115
▶ Current output 1 to n	→ 📖 115
▶ Pulse/frequency/switch output 1 to n	→ 📖 119
▶ Relay output 1 to n	→ 📖 126
▶ Display	→ 📖 128
▶ Low flow cut off	→ 📖 131
▶ Partially filled pipe detection	→ 📖 132
▶ Advanced setup	→ 📖 133

10.6.1 Defining the tag name

To enable fast identification of the measuring point within the system, you can enter a unique designation using the **Device tag** parameter and thus change the factory setting.

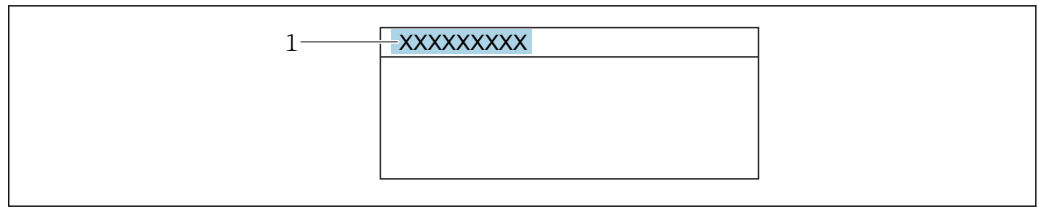

A0029422

36 Header of the operational display with tag name

1 Tag name

Enter the tag name in the "FieldCare" operating tool → 89

Navigation

"Setup" menu → Device tag

Parameter overview with brief description

Parameter	Description	User entry	Factory setting
Device tag	Enter the name for the measuring point.	Max. 32 characters, such as letters, numbers or special characters (e.g. @, %, /).	Promass 500 PA

10.6.2 Setting the system units



In the **System units** submenu the units of all the measured values can be set.

The number of submenus and parameters can vary depending on the device version. Certain submenus and parameters in these submenus are not described in the Operating Instructions. Instead a description is provided in the Special Documentation for the device ("Supplementary documentation").

Navigation

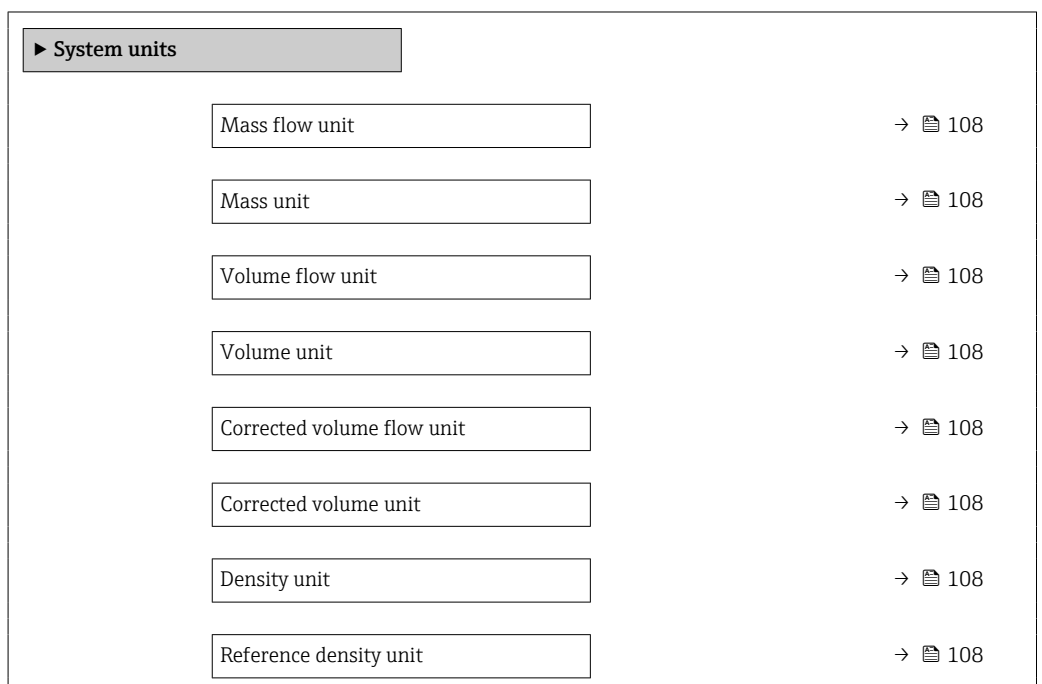
"Setup" menu → System units



Temperature unit	→  109
Pressure unit	→  109

Parameter overview with brief description

Parameter	Description	Selection	Factory setting
Mass flow unit	Select mass flow unit. <i>Effect</i> The selected unit applies to: <ul style="list-style-type: none"> ▪ Output ▪ Low flow cut off ▪ Simulation process variable 	Unit choose list	Country-specific: <ul style="list-style-type: none"> ▪ kg/h ▪ lb/min
Mass unit	Select mass unit.	Unit choose list	Country-specific: <ul style="list-style-type: none"> ▪ kg ▪ lb
Volume flow unit	Select volume flow unit. <i>Effect</i> The selected unit applies to: <ul style="list-style-type: none"> ▪ Output ▪ Low flow cut off ▪ Simulation process variable 	Unit choose list	Country-specific: <ul style="list-style-type: none"> ▪ l/h ▪ gal/min (us)
Volume unit	Select volume unit.	Unit choose list	Country-specific: <ul style="list-style-type: none"> ▪ l (DN > 150 (6"): m³ option) ▪ gal (us)
Corrected volume flow unit	Select corrected volume flow unit. <i>Effect</i> The selected unit applies to: Corrected volume flow parameter (→  159)	Unit choose list	Country-specific: <ul style="list-style-type: none"> ▪ NI/h ▪ Sft³/min
Corrected volume unit	Select corrected volume unit.	Unit choose list	Country-specific: <ul style="list-style-type: none"> ▪ NI ▪ Sft³
Density unit	Select density unit. <i>Effect</i> The selected unit applies to: <ul style="list-style-type: none"> ▪ Output ▪ Simulation process variable ▪ Density adjustment (Expert menu) 	Unit choose list	Country-specific: <ul style="list-style-type: none"> ▪ kg/l ▪ lb/ft³
Reference density unit	Select reference density unit.	Unit choose list	Country-specific <ul style="list-style-type: none"> ▪ kg/NI ▪ lb/Sft³
Density 2 unit	Select second density unit.	Unit choose list	Country-specific: <ul style="list-style-type: none"> ▪ kg/l ▪ lb/ft³

Parameter	Description	Selection	Factory setting
Temperature unit	<p>Select temperature unit.</p> <p><i>Effect</i></p> <p>The selected unit applies to:</p> <ul style="list-style-type: none"> ▪ Electronic temperature parameter (6053) ▪ Maximum value parameter (6051) ▪ Minimum value parameter (6052) ▪ Maximum value parameter (6108) ▪ Minimum value parameter (6109) ▪ Carrier pipe temperature parameter (6027) ▪ Maximum value parameter (6029) ▪ Minimum value parameter (6030) ▪ Reference temperature parameter (1816) ▪ Temperature parameter 	Unit choose list	<p>Country-specific:</p> <ul style="list-style-type: none"> ▪ °C ▪ °F
Pressure unit	<p>Select process pressure unit.</p> <p><i>Effect</i></p> <p>The unit is taken from:</p> <ul style="list-style-type: none"> ▪ Pressure value parameter (→ ⓘ 110) ▪ External pressure parameter (→ ⓘ 110) ▪ Pressure value 	Unit choose list	<p>Country-specific:</p> <ul style="list-style-type: none"> ▪ bar a ▪ psi a

10.6.3 Selecting and setting the medium

The **Select medium** wizard submenu contains parameters that must be configured in order to select and set the medium.

Navigation

"Setup" menu → Medium selection

▶ Medium selection

→ 110

Select gas type

Reference sound velocity

Temperature coefficient sound velocity

→ 110

→ 110

→ 110

Parameter overview with brief description

Parameter	Prerequisite	Description	Selection / User entry / User interface
Select medium	–	Use this function to select the type of medium: "Gas" or "Liquid". Select the "Other" option in exceptional cases in order to enter the properties of the medium manually (e.g. for highly compressive liquids such as sulfuric acid).	<ul style="list-style-type: none"> ■ Liquid ■ Gas
Pressure compensation	–	Select pressure compensation type.	<ul style="list-style-type: none"> ■ Off ■ Fixed value ■ External value ■ Current input 1 * ■ Current input 3 *
Pressure value	In the Pressure compensation parameter, the Fixed value option is selected.	Enter process pressure to be used for pressure correction.	Positive floating-point number
External pressure	In the Pressure compensation parameter, the External value option or the Current input 1...n option is selected.	Shows the external process pressure value.	

* Visibility depends on order options or device settings

10.6.4 Configuring communication interface

The **Communication** submenu guides you systematically through all the parameters that have to be configured for selecting and setting the communication interface.

Navigation

"Setup" menu → Communication

▶ Communication

→ 111

Parameter overview with brief description

Parameter	Description	User entry
Device address	Enter device address.	0 to 126

10.6.5 Configuration of the Analog Inputs

The **Analog inputs** submenu guides the user systematically to the individual **Analog input 1 to n** submenu. From here you get to the parameters of the individual analog input.

Navigation

"Setup" menu → Analog inputs

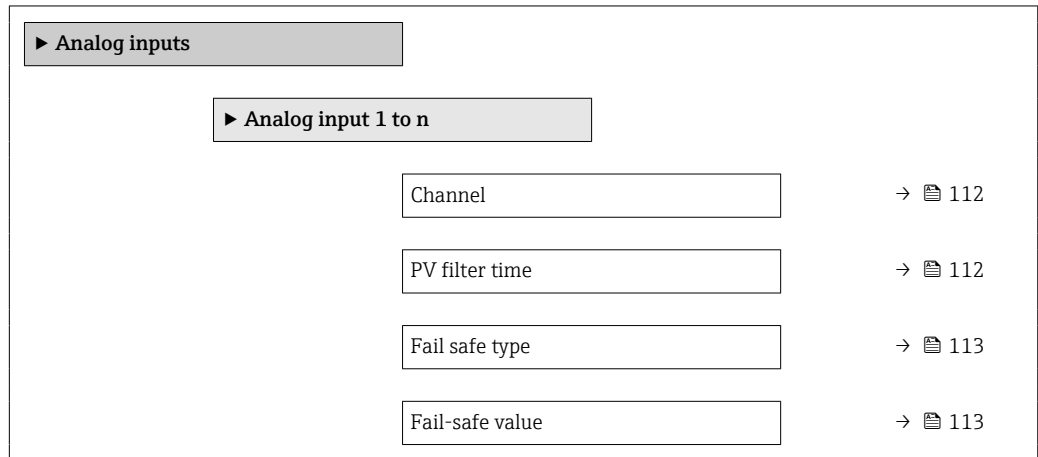

Parameter overview with brief description

Parameter	Prerequisite	Description	Selection / User entry
Channel	–	Select the process variable.	<ul style="list-style-type: none"> ■ Mass flow ■ Volume flow ■ Corrected volume flow * ■ Density ■ Reference density * ■ Target mass flow * ■ Carrier mass flow * ■ Concentration * ■ Target volume flow * ■ Carrier volume flow * ■ Target corrected volume flow * ■ Carrier corrected volume flow * ■ Temperature ■ Carrier pipe temperature * ■ Electronic temperature ■ Oscillation frequency 0 ■ Frequency fluctuation 0 * ■ Oscillation damping 0 * ■ Oscillation damping fluctuation 0 * ■ Oscillation damping fluctuation 1 * ■ Signal asymmetry * ■ Exciter current 0 * ■ Current input 1 *
PV filter time	–	Specify the time to suppress signal peaks. During the specified time the Analog Input does not respond to an erratic increase in the process variable.	Positive floating-point number

Parameter	Prerequisite	Description	Selection / User entry
Fail safe type	–	Select the failure mode.	<ul style="list-style-type: none"> ■ Fail-safe value ■ Fallback value ■ Off
Fail-safe value	In Fail safe type parameter, the Fail-safe value option is selected.	Specify the values to be output when an error occurs.	Signed floating-point number

* Visibility depends on order options or device settings

10.6.6 Displaying the I/O configuration

The **I/O configuration** submenu guides the user systematically through all the parameters in which the configuration of the I/O modules is displayed.

Navigation

"Setup" menu → I/O configuration

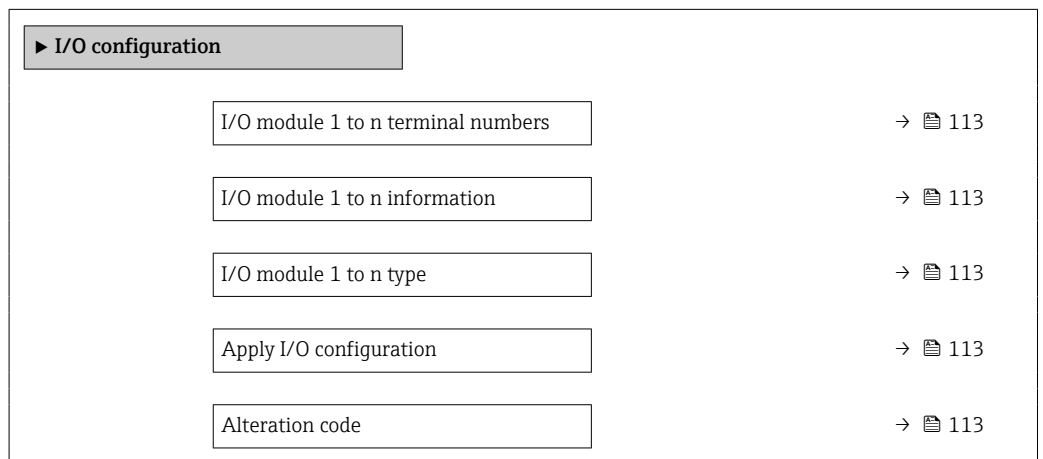

Parameter overview with brief description

Parameter	Description	User interface / Selection / User entry
I/O module 1 to n terminal numbers	Shows the terminal numbers used by the I/O module.	<ul style="list-style-type: none"> ■ Not used ■ 26-27 (I/O 1) ■ 24-25 (I/O 2)
I/O module 1 to n information	Shows information of the plugged I/O module.	<ul style="list-style-type: none"> ■ Not plugged ■ Invalid ■ Not configurable ■ Configurable ■ Profibus PA
I/O module 1 to n type	Shows the I/O module type.	<ul style="list-style-type: none"> ■ Off ■ Current output * ■ Current input * ■ Status input * ■ Pulse/frequency/switch output * ■ Double pulse output * ■ Relay output *
Apply I/O configuration	Apply parameterization of the freely configurable I/O module.	<ul style="list-style-type: none"> ■ No ■ Yes
Alteration code	Enter the code in order to change the I/O configuration.	Positive integer

* Visibility depends on order options or device settings

10.6.7 Configuring the current input

The "Current input" wizard guides the user systematically through all the parameters that have to be set for configuring the current input.

Navigation

"Setup" menu → Current input

► Current input 1 to n	
Terminal number	→ ⓘ 114
Signal mode	→ ⓘ 114
0/4 mA value	→ ⓘ 114
20 mA value	→ ⓘ 114
Current span	→ ⓘ 114
Failure mode	→ ⓘ 114
Failure value	→ ⓘ 114

Parameter overview with brief description

Parameter	Prerequisite	Description	User interface / Selection / User entry	Factory setting
Terminal number	–	Shows the terminal numbers used by the current input module.	<ul style="list-style-type: none"> ▪ Not used ▪ 24-25 (I/O 2) ▪ 20-21 (I/O 4) * 	–
Signal mode	The measuring device is not approved for use in the hazardous area with type of protection Ex-i.	Select the signal mode for the current input.	<ul style="list-style-type: none"> ▪ Passive ▪ Active * 	Active
0/4 mA value	–	Enter 4 mA value.	Signed floating-point number	–
20 mA value	–	Enter 20 mA value.	Signed floating-point number	Depends on country and nominal diameter
Current span	–	Select current range for process value output and upper/lower level for alarm signal.	<ul style="list-style-type: none"> ▪ 4...20 mA ▪ 4...20 mA NAMUR ▪ 4...20 mA US ▪ 0...20 mA 	Country-specific: <ul style="list-style-type: none"> ▪ 4...20 mA NAMUR ▪ 4...20 mA US
Failure mode	–	Define input behavior in alarm condition.	<ul style="list-style-type: none"> ▪ Alarm ▪ Last valid value ▪ Defined value 	–
Failure value	In the Failure mode parameter, the Defined value option is selected.	Enter value to be used by the device if input value from external device is missing.	Signed floating-point number	–

* Visibility depends on order options or device settings

10.6.8 Configuring the status input

The **Status input** submenu guides the user systematically through all the parameters that have to be set for configuring the status input.

Navigation

"Setup" menu → Status input 1 to n

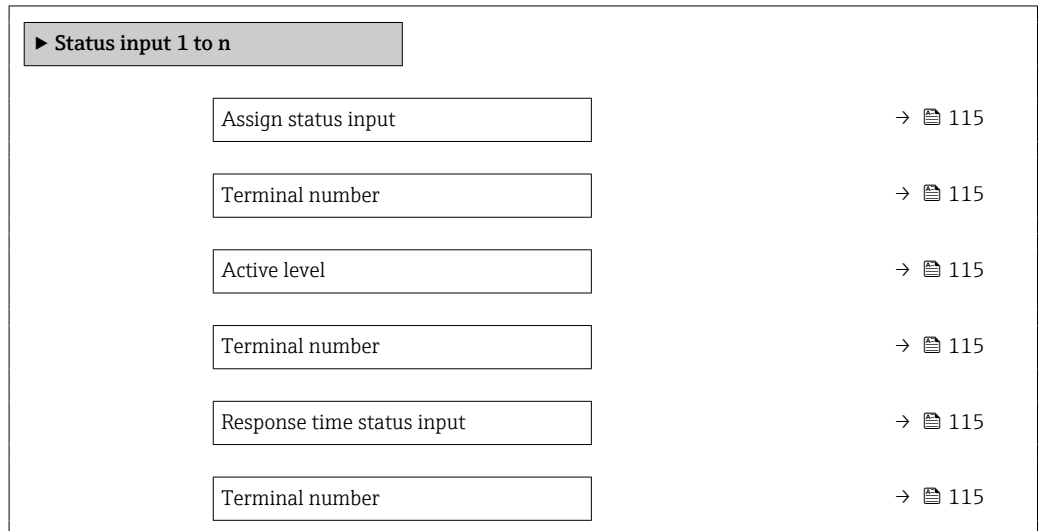

Parameter overview with brief description

Parameter	Description	Selection / User interface / User entry
Assign status input	Select function for the status input.	<ul style="list-style-type: none"> ■ Off ■ Reset totalizer 1 ■ Reset totalizer 2 ■ Reset totalizer 3 ■ Reset all totalizers ■ Flow override
Terminal number	Shows the terminal numbers used by the status input module.	<ul style="list-style-type: none"> ■ Not used ■ 24-25 (I/O 2) ■ 20-21 (I/O 4) *
Active level	Define input signal level at which the assigned function is triggered.	<ul style="list-style-type: none"> ■ High ■ Low
Response time status input	Define the minimum amount of time the input signal level must be present before the selected function is triggered.	5 to 200 ms

* Visibility depends on order options or device settings







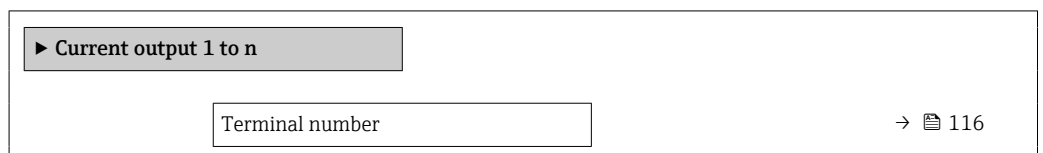

10.6.9 Configuring the current output

The **Current output** wizard guides you systematically through all the parameters that have to be set for configuring the current output.

Navigation



"Setup" menu → Current output



Signal mode	→  116
Assign current output 1 to n	→  117
Current span	→  117
0/4 mA value	→  117
20 mA value	→  117
Fixed current	→  117
Damping output 1 to n	→  118
Failure mode	→  118
Failure current	→  118

Parameter overview with brief description

Parameter	Prerequisite	Description	User interface / Selection / User entry	Factory setting
Terminal number	-	Shows the terminal numbers used by the current output module.	<ul style="list-style-type: none"> ▪ Not used ▪ 24-25 (I/O 2) ▪ 20-21 (I/O 4) * 	-
Signal mode	-	Select the signal mode for the current output.	<ul style="list-style-type: none"> ▪ Passive * ▪ Active * 	Active

Parameter	Prerequisite	Description	User interface / Selection / User entry	Factory setting
Assign current output 1 to n	–	Select process variable for current output.	<ul style="list-style-type: none"> ▪ Off * ▪ Mass flow ▪ Volume flow ▪ Corrected volume flow * ▪ Target mass flow * ▪ Carrier mass flow * ▪ Target volume flow * ▪ Carrier volume flow * ▪ Target corrected volume flow * ▪ Carrier corrected volume flow * ▪ Density ▪ Reference density * ▪ Concentration * ▪ Temperature ▪ Carrier pipe temperature * ▪ Electronic temperature ▪ Oscillation frequency 0 ▪ Oscillation amplitude 0 * ▪ Frequency fluctuation 0 * ▪ Oscillation damping 0 * ▪ Oscillation damping fluctuation 0 * ▪ Signal asymmetry * ▪ Exciter current 0 * ▪ HBSI * ▪ Pressure * 	–
Current span	–	Select current range for process value output and upper/lower level for alarm signal.	<ul style="list-style-type: none"> ▪ 4...20 mA NAMUR ▪ 4...20 mA US ▪ 4...20 mA ▪ 0...20 mA ▪ Fixed current 	Depends on country: <ul style="list-style-type: none"> ▪ 4...20 mA NAMUR ▪ 4...20 mA US
0/4 mA value	In Current span parameter (→  117), one of the following options is selected: <ul style="list-style-type: none"> ▪ 4...20 mA NAMUR ▪ 4...20 mA US ▪ 4...20 mA ▪ 0...20 mA 	Enter 4 mA value.	Signed floating-point number	Depends on country: <ul style="list-style-type: none"> ▪ 0 kg/h ▪ 0 lb/min
20 mA value	In Current span parameter (→  117), one of the following options is selected: <ul style="list-style-type: none"> ▪ 4...20 mA NAMUR ▪ 4...20 mA US ▪ 4...20 mA ▪ 0...20 mA 	Enter 20 mA value.	Signed floating-point number	Depends on country and nominal diameter
Fixed current	The Fixed current option is selected in the Current span parameter (→  117).	Defines the fixed output current.	0 to 22.5 mA	22.5 mA

Parameter	Prerequisite	Description	User interface / Selection / User entry	Factory setting
Damping output 1 to n	A process variable is selected in the Assign current output parameter (→ 117) and one of the following options is selected in the Current span parameter (→ 117): <ul style="list-style-type: none"> ■ 4...20 mA NAMUR ■ 4...20 mA US ■ 4...20 mA ■ 0...20 mA 	Set reaction time for output signal to fluctuations in the measured value.	0.0 to 999.9 s	–
Failure mode	A process variable is selected in the Assign current output parameter (→ 117) and one of the following options is selected in the Current span parameter (→ 117): <ul style="list-style-type: none"> ■ 4...20 mA NAMUR ■ 4...20 mA US ■ 4...20 mA ■ 0...20 mA 	Define output behavior in alarm condition.	<ul style="list-style-type: none"> ■ Min. ■ Max. ■ Last valid value ■ Actual value ■ Defined value 	–
Failure current	The Defined value option is selected in the Failure mode parameter.	Enter current output value in alarm condition.	0 to 22.5 mA	22.5 mA

* Visibility depends on order options or device settings

10.6.10 Configuring the pulse/frequency/switch output

The **Pulse/frequency/switch output** wizard guides you systematically through all the parameters that can be set for configuring the selected output type.

Navigation

"Setup" menu → Advanced setup → Pulse/frequency/switch output

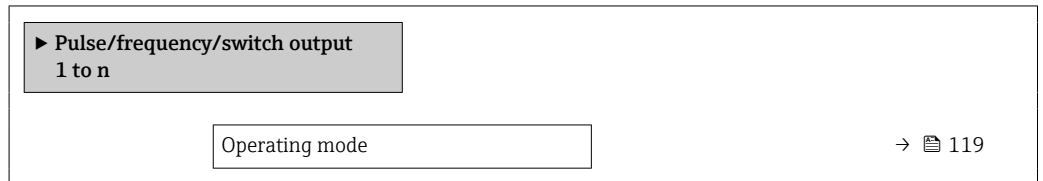

Parameter overview with brief description

Parameter	Description	Selection
Operating mode	Define the output as a pulse, frequency or switch output.	<ul style="list-style-type: none"> ■ Pulse ■ Frequency ■ Switch

Configuring the pulse output

Navigation

"Setup" menu → Pulse/frequency/switch output

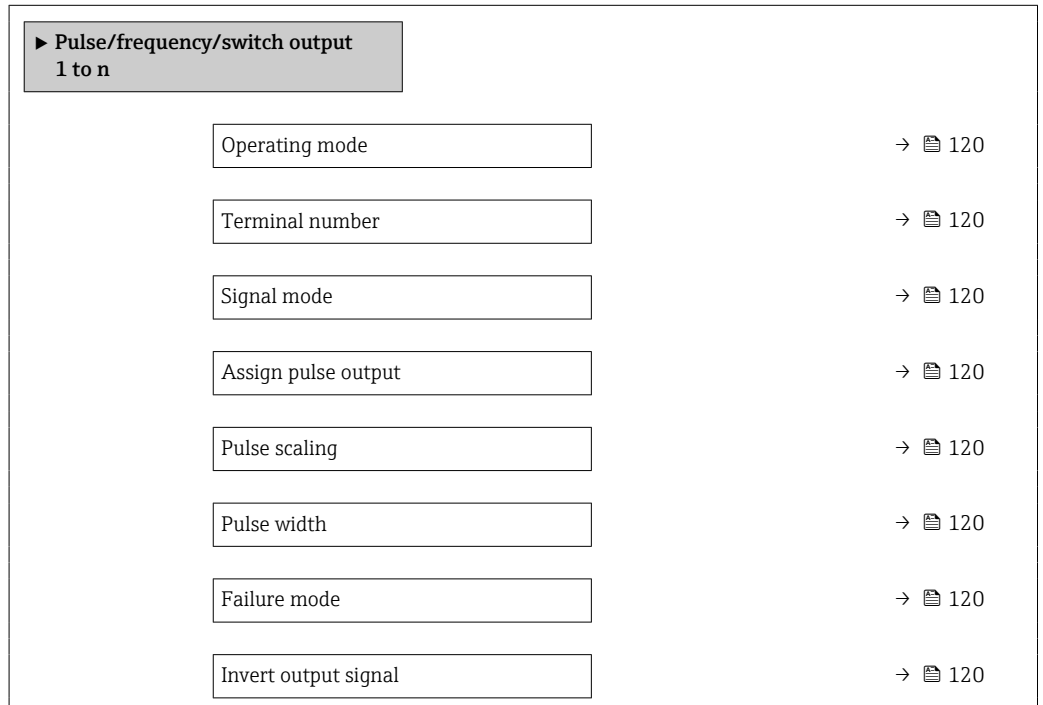

Parameter overview with brief description

Parameter	Prerequisite	Description	Selection / User interface / User entry	Factory setting
Operating mode	–	Define the output as a pulse, frequency or switch output.	<ul style="list-style-type: none"> ▪ Pulse ▪ Frequency ▪ Switch 	–
Terminal number	–	Shows the terminal numbers used by the PFS output module.	<ul style="list-style-type: none"> ▪ Not used ▪ 24-25 (I/O 2) ▪ 20-21 (I/O 4) * 	–
Signal mode	–	Select the signal mode for the PFS output.	<ul style="list-style-type: none"> ▪ Passive ▪ Active 	–
Assign pulse output 1 to n	The Pulse option is selected in Operating mode parameter.	Select process variable for pulse output.	<ul style="list-style-type: none"> ▪ Off ▪ Mass flow ▪ Volume flow ▪ Corrected volume flow * ▪ Target mass flow * ▪ Carrier mass flow * ▪ Target volume flow * ▪ Carrier volume flow * ▪ Target corrected volume flow * ▪ Carrier corrected volume flow * 	–
Value per pulse	The Pulse option is selected in the Operating mode parameter (→ 119) and a process variable is selected in the Assign pulse output parameter (→ 120).	Enter measured value at which a pulse is output.	Positive floating point number	Depends on country and nominal diameter
Pulse width	The Pulse option is selected in the Operating mode parameter (→ 119) and a process variable is selected in the Assign pulse output parameter (→ 120).	Define time width of the output pulse.	0.05 to 2 000 ms	–
Failure mode	The Pulse option is selected in the Operating mode parameter (→ 119) and a process variable is selected in the Assign pulse output parameter (→ 120).	Define output behavior in alarm condition.	<ul style="list-style-type: none"> ▪ Actual value ▪ No pulses 	–
Invert output signal	–	Invert the output signal.	<ul style="list-style-type: none"> ▪ No ▪ Yes 	–

* Visibility depends on order options or device settings

Configuring the frequency output

Navigation

"Setup" menu → Pulse/frequency/switch output

▶ Pulse/frequency/switch output
1 to n

Operating mode

→ 121

Terminal number	→  121
Signal mode	→  121
Assign frequency output	→  122
Minimum frequency value	→  122
Maximum frequency value	→  122
Measuring value at minimum frequency	→  122
Measuring value at maximum frequency	→  123
Failure mode	→  123
Failure frequency	→  123
Invert output signal	→  123

Parameter overview with brief description

Parameter	Prerequisite	Description	Selection / User interface / User entry	Factory setting
Operating mode	–	Define the output as a pulse, frequency or switch output.	<ul style="list-style-type: none"> ■ Pulse ■ Frequency ■ Switch 	–
Terminal number	–	Shows the terminal numbers used by the PFS output module.	<ul style="list-style-type: none"> ■ Not used ■ 24-25 (I/O 2) ■ 20-21 (I/O 4) * 	–
Signal mode	–	Select the signal mode for the PFS output.	<ul style="list-style-type: none"> ■ Passive ■ Active 	–

Parameter	Prerequisite	Description	Selection / User interface / User entry	Factory setting
Assign frequency output	The Frequency option is selected in Operating mode parameter (→ 119).	Select process variable for frequency output.	<ul style="list-style-type: none"> ▪ Off ▪ Mass flow ▪ Volume flow ▪ Corrected volume flow * ▪ Density ▪ Reference density * ▪ Temperature ▪ Pressure ▪ Concentration * ▪ Target mass flow * ▪ Carrier mass flow * ▪ Target volume flow * ▪ Carrier volume flow * ▪ Target corrected volume flow * ▪ Carrier corrected volume flow * ▪ HBSI * ▪ Exciter current 0 ▪ Oscillation damping 0 ▪ Oscillation damping fluctuation 0 * ▪ Oscillation frequency 0 ▪ Frequency fluctuation 0 * ▪ Oscillation amplitude 0 * ▪ Signal asymmetry ▪ Carrier pipe temperature * ▪ Electronic temperature 	–
Minimum frequency value	The Frequency option is selected in the Operating mode parameter (→ 119) and a process variable is selected in the Assign frequency output parameter (→ 122).	Enter minimum frequency.	0.0 to 10 000.0 Hz	–
Maximum frequency value	The Frequency option is selected in the Operating mode parameter (→ 119) and a process variable is selected in the Assign frequency output parameter (→ 122).	Enter maximum frequency.	0.0 to 10 000.0 Hz	–
Measuring value at minimum frequency	The Frequency option is selected in the Operating mode parameter (→ 119) and a process variable is selected in the Assign frequency output parameter (→ 122).	Enter measured value for minimum frequency.	Signed floating-point number	Depends on country and nominal diameter

Parameter	Prerequisite	Description	Selection / User interface / User entry	Factory setting
Measuring value at maximum frequency	The Frequency option is selected in the Operating mode parameter (→ 119) and a process variable is selected in the Assign frequency output parameter (→ 122).	Enter measured value for maximum frequency.	Signed floating-point number	Depends on country and nominal diameter
Failure mode	The Frequency option is selected in the Operating mode parameter (→ 119) and a process variable is selected in the Assign frequency output parameter (→ 122).	Define output behavior in alarm condition.	<ul style="list-style-type: none"> ■ Actual value ■ Defined value ■ 0 Hz 	–
Failure frequency	In the Operating mode parameter (→ 119), the Frequency option is selected, in the Assign frequency output parameter (→ 122) a process variable is selected, and in the Failure mode parameter, the Defined value option is selected.	Enter frequency output value in alarm condition.	0.0 to 12 500.0 Hz	–
Invert output signal	–	Invert the output signal.	<ul style="list-style-type: none"> ■ No ■ Yes 	–

* Visibility depends on order options or device settings

Configuring the switch output

Navigation

"Setup" menu → Pulse/frequency/switch output

► Pulse/frequency/switch output 1 to n	
Operating mode	→ 124
Terminal number	→ 124
Signal mode	→ 124
Switch output function	→ 125
Assign diagnostic behavior	→ 125
Assign limit	→ 125
Assign flow direction check	→ 125
Assign status	→ 125
Switch-on value	→ 125
Switch-off value	→ 126
Switch-on delay	→ 126
Switch-off delay	→ 126
Failure mode	→ 126
Invert output signal	→ 126

Parameter overview with brief description

Parameter	Prerequisite	Description	Selection / User interface / User entry	Factory setting
Operating mode	–	Define the output as a pulse, frequency or switch output.	<ul style="list-style-type: none"> ▪ Pulse ▪ Frequency ▪ Switch 	–
Terminal number	–	Shows the terminal numbers used by the PFS output module.	<ul style="list-style-type: none"> ▪ Not used ▪ 24-25 (I/O 2) ▪ 20-21 (I/O 4) * 	–
Signal mode	–	Select the signal mode for the PFS output.	<ul style="list-style-type: none"> ▪ Passive ▪ Active 	–

Parameter	Prerequisite	Description	Selection / User interface / User entry	Factory setting
Switch output function	The Switch option is selected in the Operating mode parameter.	Select function for switch output.	<ul style="list-style-type: none"> ■ Off ■ On ■ Diagnostic behavior ■ Limit ■ Flow direction check ■ Status 	–
Assign diagnostic behavior	<ul style="list-style-type: none"> ■ In the Operating mode parameter, the Switch option is selected. ■ In the Switch output function parameter, the Diagnostic behavior option is selected. 	Select diagnostic behavior for switch output.	<ul style="list-style-type: none"> ■ Alarm ■ Alarm or warning ■ Warning 	–
Assign limit	<ul style="list-style-type: none"> ■ The Switch option is selected in Operating mode parameter. ■ The Limit option is selected in Switch output function parameter. 	Select process variable for limit function.	<ul style="list-style-type: none"> ■ Mass flow ■ Volume flow ■ Corrected volume flow[*] ■ Target mass flow[*] ■ Carrier mass flow[*] ■ Target volume flow[*] ■ Carrier volume flow[*] ■ Target corrected volume flow[*] ■ Carrier corrected volume flow[*] ■ Density ■ Reference density[*] ■ Concentration[*] ■ Temperature ■ Oscillation damping ■ Pressure ■ Totalizer 1 ■ Totalizer 2 ■ Totalizer 3 	–
Assign flow direction check	<ul style="list-style-type: none"> ■ The Switch option is selected in the Operating mode parameter. ■ The Flow direction check option is selected in the Switch output function parameter. 	Select process variable for flow direction monitoring.		–
Assign status	<ul style="list-style-type: none"> ■ The Switch option is selected in Operating mode parameter. ■ The Status option is selected in Switch output function parameter. 	Select device status for switch output.	<ul style="list-style-type: none"> ■ Partially filled pipe detection ■ Low flow cut off ■ Digital output 4[*] 	–
Switch-on value	<ul style="list-style-type: none"> ■ The Switch option is selected in the Operating mode parameter. ■ The Limit option is selected in the Switch output function parameter. 	Enter measured value for the switch-on point.	Signed floating-point number	Depends on country: <ul style="list-style-type: none"> ■ 0 kg/h ■ 0 lb/min

Parameter	Prerequisite	Description	Selection / User interface / User entry	Factory setting
Switch-off value	<ul style="list-style-type: none"> The Switch option is selected in the Operating mode parameter. The Limit option is selected in the Switch output function parameter. 	Enter measured value for the switch-off point.	Signed floating-point number	Depends on country: <ul style="list-style-type: none"> 0 kg/h 0 lb/min
Switch-on delay	<ul style="list-style-type: none"> The Switch option is selected in the Operating mode parameter. The Limit option is selected in the Switch output function parameter. 	Define delay for the switch-on of status output.	0.0 to 100.0 s	–
Switch-off delay	<ul style="list-style-type: none"> The Switch option is selected in the Operating mode parameter. The Limit option is selected in the Switch output function parameter. 	Define delay for the switch-off of status output.	0.0 to 100.0 s	–
Failure mode	–	Define output behavior in alarm condition.	<ul style="list-style-type: none"> Actual status Open Closed 	–
Invert output signal	–	Invert the output signal.	<ul style="list-style-type: none"> No Yes 	–

* Visibility depends on order options or device settings





10.6.11 Configuring the relay output

The **Relay output** wizard guides the user systematically through all the parameters that have to be set for configuring the relay output.

Navigation

"Setup" menu → Relay output 1 to n

► Relay output 1 to n	
Terminal number	→ 127
Relay output function	→ 127
Assign flow direction check	→ 127
Assign limit	→ 127
Assign diagnostic behavior	→ 127
Assign status	→ 127
Switch-off value	→ 128
Switch-off delay	→ 128

Switch-on value	→  128
Switch-on delay	→  128
Failure mode	→  128
Switch status	→  128
Powerless relay status	→  128

Parameter overview with brief description

Parameter	Prerequisite	Description	User interface / Selection / User entry	Factory setting
Terminal number	–	Shows the terminal numbers used by the relay output module.	<ul style="list-style-type: none"> ■ Not used ■ 24-25 (I/O 2) 	–
Relay output function	–	Select the function for the relay output.	<ul style="list-style-type: none"> ■ Closed ■ Open ■ Diagnostic behavior ■ Limit ■ Flow direction check ■ Digital Output 	–
Assign flow direction check	The Flow direction check option is selected in the Relay output function parameter.	Select process variable for flow direction monitoring.		–
Assign limit	The Limit option is selected in Relay output function parameter.	Select process variable for limit function.	<ul style="list-style-type: none"> ■ Mass flow ■ Volume flow ■ Corrected volume flow * ■ Target mass flow * ■ Carrier mass flow * ■ Target volume flow * ■ Carrier volume flow * ■ Target corrected volume flow * ■ Carrier corrected volume flow * ■ Density ■ Reference density * ■ Concentration * ■ Temperature ■ Oscillation damping ■ Pressure ■ Totalizer 1 ■ Totalizer 2 ■ Totalizer 3 	–
Assign diagnostic behavior	In the Relay output function parameter, the Diagnostic behavior option is selected.	Select diagnostic behavior for switch output.	<ul style="list-style-type: none"> ■ Alarm ■ Alarm or warning ■ Warning 	–
Assign status	In the Relay output function parameter, the Digital Output option is selected.	Select device status for switch output.	<ul style="list-style-type: none"> ■ Partially filled pipe detection ■ Low flow cut off ■ Digital output 4 * 	–

Parameter	Prerequisite	Description	User interface / Selection / User entry	Factory setting
Switch-off value	The Limit option is selected in the Relay output function parameter.	Enter measured value for the switch-off point.	Signed floating-point number	Depends on country: <ul style="list-style-type: none"> ■ 0 kg/h ■ 0 lb/min
Switch-off delay	In the Relay output function parameter, the Limit option is selected.	Define delay for the switch-off of status output.	0.0 to 100.0 s	–
Switch-on value	The Limit option is selected in the Relay output function parameter.	Enter measured value for the switch-on point.	Signed floating-point number	Depends on country: <ul style="list-style-type: none"> ■ 0 kg/h ■ 0 lb/min
Switch-on delay	In the Relay output function parameter, the Limit option is selected.	Define delay for the switch-on of status output.	0.0 to 100.0 s	–
Failure mode	–	Define output behavior in alarm condition.	<ul style="list-style-type: none"> ■ Actual status ■ Open ■ Closed 	–
Switch status	–	Shows the current relay switch status.	<ul style="list-style-type: none"> ■ Open ■ Closed 	–
Powerless relay status	–		<ul style="list-style-type: none"> ■ Open ■ Closed 	–

* Visibility depends on order options or device settings

10.6.12 Configuring the local display

The **Display** wizard guides you systematically through all the parameters that can be configured for configuring the local display.

Navigation

"Setup" menu → Display

► Display	
Format display	→ ⓘ 129
Value 1 display	→ ⓘ 129
0% bargraph value 1	→ ⓘ 129
100% bargraph value 1	→ ⓘ 129
Value 2 display	→ ⓘ 129
Value 3 display	→ ⓘ 130
0% bargraph value 3	→ ⓘ 130
100% bargraph value 3	→ ⓘ 130
Value 4 display	→ ⓘ 130

Parameter overview with brief description

Parameter	Prerequisite	Description	Selection / User entry	Factory setting
Format display	A local display is provided.	Select how measured values are shown on the display.	<ul style="list-style-type: none"> ■ 1 value, max. size ■ 1 bargraph + 1 value ■ 2 values ■ 1 value large + 2 values ■ 4 values 	–
Value 1 display	A local display is provided.	Select the measured value that is shown on the local display.	<ul style="list-style-type: none"> ■ Mass flow ■ Volume flow ■ Corrected volume flow * ■ Density ■ Reference density * ■ Temperature ■ Current output 1 * ■ Current output 2 * ■ Current output 4 * ■ Pressure ■ Totalizer 1 ■ Totalizer 2 ■ Totalizer 3 ■ Concentration * ■ Target mass flow * ■ Carrier mass flow * ■ Target volume flow * ■ Carrier volume flow * ■ Target corrected volume flow * ■ Carrier corrected volume flow * ■ HBSI * ■ Exciter current 0 ■ Oscillation damping 0 ■ Oscillation damping fluctuation 0 * ■ Oscillation frequency 0 ■ Frequency fluctuation 0 * ■ Oscillation amplitude 0 * ■ Signal asymmetry ■ Carrier pipe temperature * ■ Electronic temperature ■ Current output 1 * ■ Current output 2 * ■ Current output 3 * 	–
0% bargraph value 1	A local display is provided.	Enter 0% value for bar graph display.	Signed floating-point number	Country-specific: <ul style="list-style-type: none"> ■ 0 kg/h ■ 0 lb/min
100% bargraph value 1	A local display is provided.	Enter 100% value for bar graph display.	Signed floating-point number	Depends on country and nominal diameter
Value 2 display	A local display is provided.	Select the measured value that is shown on the local display.	For the picklist, see Value 1 display parameter (→ 129)	–

Parameter	Prerequisite	Description	Selection / User entry	Factory setting
Value 3 display	A local display is provided.	Select the measured value that is shown on the local display.	For the picklist, see Value 1 display parameter (→ 129)	–
0% bargraph value 3	A selection was made in the Value 3 display parameter.	Enter 0% value for bar graph display.	Signed floating-point number	Country-specific: ■ 0 kg/h ■ 0 lb/min
100% bargraph value 3	A selection was made in the Value 3 display parameter.	Enter 100% value for bar graph display.	Signed floating-point number	–
Value 4 display	A local display is provided.	Select the measured value that is shown on the local display.	For the picklist, see Value 1 display parameter (→ 129)	–
Value 5 display	A local display is provided.	Select the measured value that is shown on the local display.	For the picklist, see Value 1 display parameter (→ 129)	–
Value 6 display	A local display is provided.	Select the measured value that is shown on the local display.	For the picklist, see Value 1 display parameter (→ 129)	–
Value 7 display	A local display is provided.	Select the measured value that is shown on the local display.	For the picklist, see Value 1 display parameter (→ 129)	–
Value 8 display	A local display is provided.	Select the measured value that is shown on the local display.	For the picklist, see Value 1 display parameter (→ 129)	–

* Visibility depends on order options or device settings

10.6.13 Configuring the low flow cut off

The **Low flow cut off** wizard systematically guides the user through all the parameters that must be set to configure low flow cut off.

Navigation

"Setup" menu → Low flow cut off

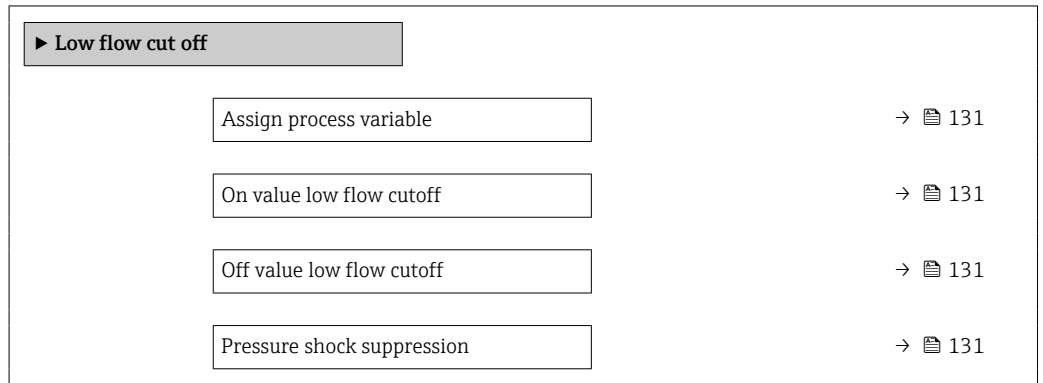

Parameter overview with brief description

Parameter	Prerequisite	Description	Selection / User entry	Factory setting
Assign process variable	–	Select process variable for low flow cut off.	<ul style="list-style-type: none"> ■ Off ■ Mass flow ■ Volume flow ■ Corrected volume flow[*] 	–
On value low flow cutoff	A process variable is selected in the Assign process variable parameter (→ 131).	Enter on value for low flow cut off.	Positive floating-point number	Depends on country and nominal diameter
Off value low flow cutoff	A process variable is selected in the Assign process variable parameter (→ 131).	Enter off value for low flow cut off.	0 to 100.0 %	–
Pressure shock suppression	A process variable is selected in the Assign process variable parameter (→ 131).	Enter time frame for signal suppression (= active pressure shock suppression).	0 to 100 s	–





* Visibility depends on order options or device settings

10.6.14 Configuring partially filled pipe detection



The **Partial filled pipe detection** wizard guides you systematically through all parameters that have to be set for configuring the monitoring of the pipe filling.

Navigation

"Setup" menu → Partially filled pipe detection

▶ Partially filled pipe detection	
Assign process variable	→  132
Low value partial filled pipe detection	→  132
High value partial filled pipe detection	→  132
Response time part. filled pipe detect.	→  132

Parameter overview with brief description

Parameter	Prerequisite	Description	Selection / User entry	Factory setting
Assign process variable	–	Select process variable for partially filled pipe detection.	<ul style="list-style-type: none"> ■ Off ■ Density ■ Reference density 	Density
Low value partial filled pipe detection	A process variable is selected in the Assign process variable parameter (→  132).	Enter lower limit value for deactivating partially filled pipe detection.	Signed floating-point number	Depends on country: <ul style="list-style-type: none"> ■ 200 kg/m³ ■ 12.5 lb/ft³
High value partial filled pipe detection	A process variable is selected in the Assign process variable parameter (→  132).	Enter upper limit value for deactivating partially filled pipe detection.	Signed floating-point number	Depends on country: <ul style="list-style-type: none"> ■ 6 000 kg/m³ ■ 374.6 lb/ft³
Response time part. filled pipe detect.	A process variable is selected in the Assign process variable parameter (→  132).	Use this function to enter the minimum time (hold time) the signal must be present before diagnostic message S962 "Pipe only partly filled" is triggered in the event of a partially filled or empty measuring pipe.	0 to 100 s	–

10.7 Advanced settings

The **Advanced setup** submenu with its submenus contains parameters for specific settings.

Navigation to the "Advanced setup" submenu

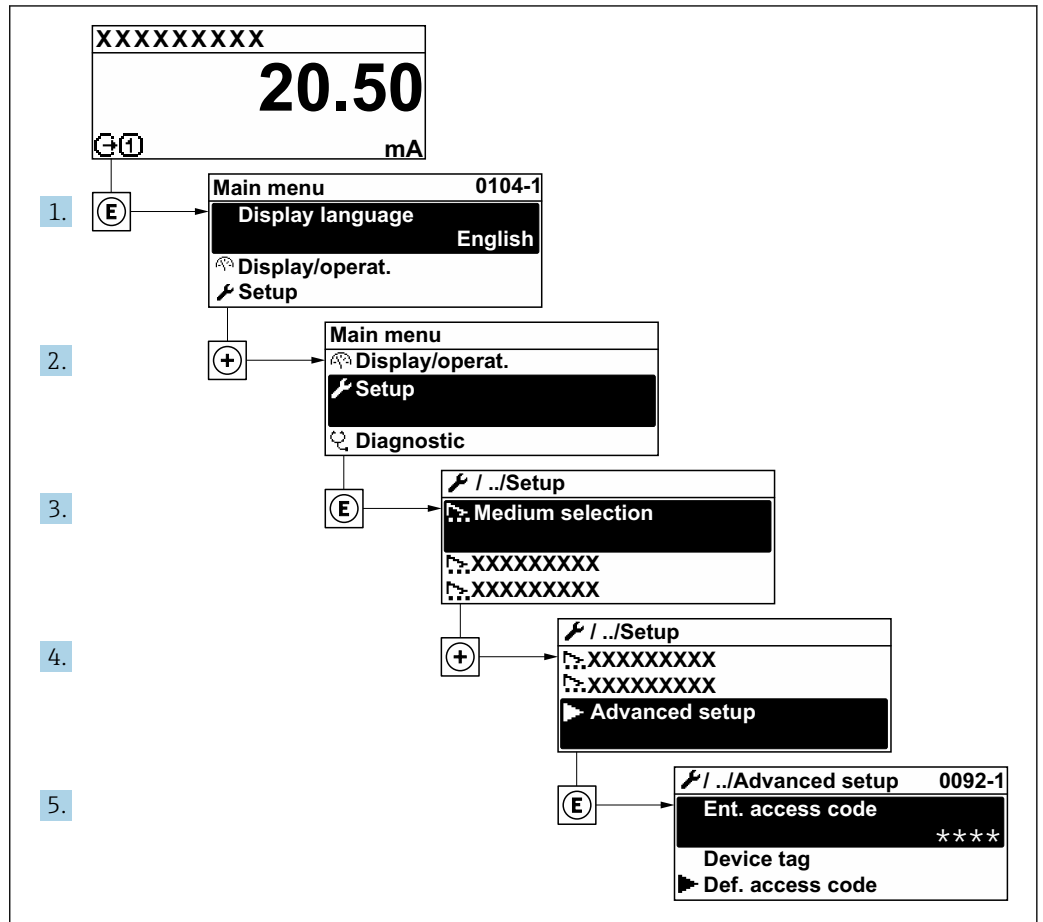

A003223-EN

i The number of submenus and parameters can vary depending on the device version and the available application packages. These submenus and their parameters are explained in the Special Documentation for the device and not in Operating Instructions.

For detailed information on the parameter descriptions for application packages: Special Documentation for the device → 276

Navigation

"Setup" menu → Advanced setup

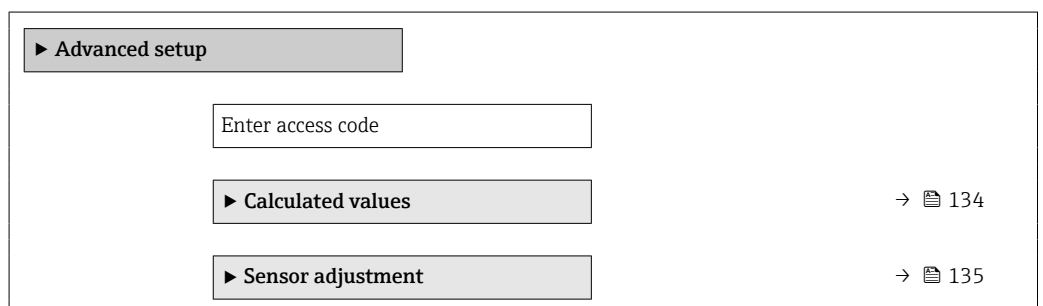

▶ Totalizer 1 to n	→ 141
▶ Display	→ 143
▶ WLAN settings	
▶ Concentration	
▶ Heartbeat setup	
▶ Configuration backup	→ 147
▶ Administration	→ 149

10.7.1 Calculated process variables

The **Calculated values** submenu contains parameters for calculating the corrected volume flow.

Navigation

"Setup" menu → Advanced setup → Calculated values

▶ Calculated values	
▶ Corrected volume flow calculation	→ 134

"Corrected volume flow calculation" submenu

Navigation

"Setup" menu → Advanced setup → Calculated values → Corrected volume flow calculation

▶ Corrected volume flow calculation	
Corrected volume flow calculation (1812)	→ 135
External reference density (6198)	→ 135
Fixed reference density (1814)	→ 135
Reference temperature (1816)	→ 135
Linear expansion coefficient (1817)	→ 135
Square expansion coefficient (1818)	→ 135

Parameter overview with brief description

Parameter	Prerequisite	Description	Selection / User interface / User entry	Factory setting
Corrected volume flow calculation	–	Select reference density for calculating the corrected volume flow.	<ul style="list-style-type: none"> ■ Fixed reference density ■ Calculated reference density ■ External reference density ■ Current input 1 * ■ Current input 3 * 	–
External reference density	–	Shows external reference density.	Floating point number with sign	–
Fixed reference density	The Fixed reference density option is selected in the Corrected volume flow calculation parameter parameter.	Enter fixed value for reference density.	Positive floating-point number	–
Reference temperature	The Calculated reference density option is selected in the Corrected volume flow calculation parameter parameter.	Enter reference temperature for calculating the reference density.	–273.15 to 99999 °C	Country-specific: <ul style="list-style-type: none"> ■ +20 °C ■ +68 °F
Linear expansion coefficient	The Calculated reference density option is selected in the Corrected volume flow calculation parameter parameter.	Enter linear, medium-specific expansion coefficient for calculating the reference density.	Signed floating-point number	–
Square expansion coefficient	The Calculated reference density option is selected in the Corrected volume flow calculation parameter parameter.	For media with a non-linear expansion pattern: enter the quadratic, medium-specific expansion coefficient for calculating the reference density.	Signed floating-point number	–

* Visibility depends on order options or device settings

10.7.2 Carrying out a sensor adjustment

The **Sensor adjustment** submenu contains parameters that pertain to the functionality of the sensor.

Navigation

"Setup" menu → Advanced setup → Sensor adjustment

▶ **Sensor adjustment**

Installation direction

→ ⓘ 136

▶ **Density adjustment**

▶ **Zero verification**

→ ⓘ 139

▶ **Zero adjustment**

→ ⓘ 140

Parameter overview with brief description

Parameter	Description	Selection
Installation direction	Set sign of flow direction to match the direction of the arrow on the sensor.	<ul style="list-style-type: none"> ■ Flow in arrow direction ■ Flow against arrow direction

Density adjustment

 With density adjustment, a high level of accuracy is achieved only at the point of adjustment and at the relevant density and temperature. However, the accuracy of a density adjustment is only ever as good as the quality of the reference measuring data provided. Therefore it is not a substitute for special density calibration.

Performing density adjustment

-  Note the following before performing the adjustment:
- A density adjustment only makes sense if there is little variation in the operating conditions and the density adjustment is performed under the operating conditions.
 - The density adjustment scales the internally computed density value with a user-specific slope and offset.
 - A 1-point or 2-point density adjustment can be performed.
 - For a 2-point density adjustment, there must be a difference of at least 0.2 kg/l between the two target density values.
 - The reference media must be gas-free or pressurized so that any gas they contain is compressed.
 - The reference density measurements must be performed at the same medium temperature that prevails in the process, as otherwise the density adjustment will not be accurate.
 - The correction resulting from the density adjustment can be deleted with the **Restore original** option.

"1 point adjustment" option

1. In the **Density adjustment mode** parameter, select the **1 point adjustment** option and confirm.
2. In the **Density setpoint 1** parameter, enter the density value and confirm.
 - ↳ In the **Execute density adjustment** parameter the following options are now available:
 - Ok
 - Measure density 1** option
 - Restore original
3. Select the **Measure density 1** option and confirm.
4. If 100% was reached in the **Progress** parameter on the display and the **Ok** option is displayed in the **Execute density adjustment** parameter, then confirm.
 - ↳ In the **Execute density adjustment** parameter the following options are now available:
 - Ok
 - Calculate
 - Cancel
5. Select the **Calculate** option and confirm.

If the adjustment was completed successfully, the **Density adjustment factor** parameter and the **Density adjustment offset** parameter and the values calculated for them are shown on the display.

"2 point adjustment" option

1. In the **Density adjustment mode** parameter, select the **2 point adjustment** option and confirm.

2. In the **Density setpoint 1** parameter, enter the density value and confirm.
3. In the **Density setpoint 2** parameter, enter the density value and confirm.
 - ↳ In the **Execute density adjustment** parameter the following options are now available:
 - Ok
 - Measure density 1
 - Restore original
4. Select the **Measure density 1** option and confirm.
 - ↳ In the **Execute density adjustment** parameter the following options are now available:
 - Ok
 - Measure density 2
 - Restore original
5. Select the **Measure density 2** option and confirm.
 - ↳ In the **Execute density adjustment** parameter the following options are now available:
 - Ok
 - Calculate
 - Cancel
6. Select the **Calculate** option and confirm.

If the **Density adjust failure** option is displayed in the **Execute density adjustment** parameter, call up the options and select the **Cancel** option. The density adjustment is canceled and can be repeated.

If the adjustment was completed successfully, the **Density adjustment factor** parameter and the **Density adjustment offset** parameter and the values calculated for them are shown on the display.

Navigation

"Expert" menu → Sensor → Sensor adjustment → Density adjustment

► Density adjustment	
Density adjustment mode	→ ⓘ 138
Density setpoint 1	→ ⓘ 138
Density setpoint 2	→ ⓘ 138
Execute density adjustment	→ ⓘ 138
Progress	→ ⓘ 138
Density adjustment factor	→ ⓘ 138
Density adjustment offset	→ ⓘ 138

Parameter overview with brief description

Parameter	Prerequisite	Description	Selection / User entry / User interface	Factory setting
Density adjustment mode	–		<ul style="list-style-type: none"> ▪ 1 point adjustment ▪ 2 point adjustment 	–
Density setpoint 1	–		The entry depends on the unit selected in the Density unit parameter (0555).	–
Density setpoint 2	In the Density adjustment mode parameter, the 2 point adjustment option is selected.		The entry depends on the unit selected in the Density unit parameter (0555).	–
Execute density adjustment	–		<ul style="list-style-type: none"> ▪ Cancel[*] ▪ Busy[*] ▪ Ok[*] ▪ Density adjust failure[*] ▪ Measure density 1[*] ▪ Measure density 2[*] ▪ Calculate[*] ▪ Restore original[*] 	–
Progress	–	Shows the progress of the process.	0 to 100 %	–
Density adjustment factor	–		Signed floating-point number	–
Density adjustment offset	–		Signed floating-point number	–

* Visibility depends on order options or device settings

Zero verification and zero adjustment

All measuring instruments are calibrated in accordance with state-of-the-art technology. Calibration takes place under reference conditions →  258. Therefore, a zero adjustment in the field is generally not required.

Experience shows that zero adjustment is advisable only in special cases:

- To achieve maximum measurement accuracy even with low flow rates.
- Under extreme process or operating conditions (e.g. very high process temperatures or very high-viscosity fluids).
- For gas applications with low pressure

 To achieve the highest possible measurement accuracy at low flow rates, the installation must protect the sensor from mechanical stresses during operation.

To get a representative zero point, ensure that:

- any flow in the device is prevented during the adjustment
- the process conditions (e.g. pressure, temperature) are stable and representative

Zero verification and zero adjustment cannot be performed if the following process conditions are present:

- Gas pockets
Ensure that the system has been sufficiently flushed with the medium. Repeat flushing can help to eliminate gas pockets
- Thermal circulation
In the event of temperature differences (e.g. between the measuring tube inlet and outlet section), induced flow can occur even if the valves are closed due to thermal circulation in the device
- Leaks at the valves
If the valves are not leak-tight, flow is not sufficiently prevented when determining the zero point

If these conditions cannot be avoided, it is advisable to keep the factory setting for the zero point.

Zero point verification

The zero point can be verified with the **Zero verification** wizard.

Navigation

"Setup" menu → Advanced setup → Sensor adjustment → Zero verification

► Zero verification	
Process conditions	→ 139
Progress	→ 139
Status	→ 140
Additional information	→ 140
Recommendation:	→ 140
Root cause	→ 140
Abort cause	→ 140
Zero point measured	→ 140
Zero point standard deviation	→ 140

Parameter overview with brief description

Parameter	Description	Selection / User interface	Factory setting
Process conditions	Ensure process conditions as follows.	<ul style="list-style-type: none"> ■ Tubes are completely filled ■ Process operational pressure applied ■ No-flow conditions (closed valves) ■ Process and ambient temperatures stable 	–
Progress	Shows the progress of the process.	0 to 100 %	–

Parameter	Description	Selection / User interface	Factory setting
Zero point adjustment status		<ul style="list-style-type: none"> ▪ Busy ▪ Zero point adjust failure ▪ Ok 	–
Additional information	Indicate whether to display additional information.	<ul style="list-style-type: none"> ▪ Hide ▪ Show 	–
Recommendation:	Indicates whether an adjustment is recommended. Only recommended if the measured zero point deviates significantly from the current zero point.	<ul style="list-style-type: none"> ▪ Do not adjust zero point ▪ Adjust zero point 	–
Abort cause	Indicates why the wizard was aborted.	<ul style="list-style-type: none"> ▪ Check process conditions! ▪ A technical issue has occurred 	–
Root cause	Shows the diagnostic and remedy.	<ul style="list-style-type: none"> ▪ Zero point too high. Ensure no-flow. ▪ Zero point is unstable. Ensure no-flow. ▪ Fluctuation high. Avoid 2-phase medium. 	–
Zero point measured	Shows the zero point measured for the adjustment.	Signed floating-point number	–
Zero point standard deviation	Shows the standard deviation of the zero point measured.	Positive floating-point number	–









Zero adjust

The zero point can be adjusted with the **Zero adjustment** wizard.

-  ▪ A zero point verification should be performed before a zero adjustment.
- The zero point can also be adjusted manually: Expert → Sensor → Calibration

Navigation

"Setup" menu → Advanced setup → Sensor adjustment → Zero adjustment

► Zero adjustment	
Process conditions	→  141
Progress	→  141
Status	→  141
Root cause	→  141
Abort cause	→  141
Root cause	→  141
Reliability of measured zero point	→  141
Additional information	→  141
Reliability of measured zero point	→  141

Zero point measured	→ ⓘ 141
Zero point standard deviation	→ ⓘ 141
Select action	→ ⓘ 141

Parameter overview with brief description

Parameter	Description	Selection / User interface	Factory setting
Process conditions	Ensure process conditions as follows.	<ul style="list-style-type: none"> ▪ Tubes are completely filled ▪ Process operational pressure applied ▪ No-flow conditions (closed valves) ▪ Process and ambient temperatures stable 	-
Progress	Shows the progress of the process.	0 to 100 %	-
Zero point adjustment status		<ul style="list-style-type: none"> ▪ Busy ▪ Zero point adjust failure ▪ Ok 	-
Abort cause	Indicates why the wizard was aborted.	<ul style="list-style-type: none"> ▪ Check process conditions! ▪ A technical issue has occurred 	-
Root cause	Shows the diagnostic and remedy.	<ul style="list-style-type: none"> ▪ Zero point too high. Ensure no-flow. ▪ Zero point is unstable. Ensure no-flow. ▪ Fluctuation high. Avoid 2-phase medium. 	-
Reliability of measured zero point	Indicates the reliability of the zero point measured.	<ul style="list-style-type: none"> ▪ Not done ▪ Good ▪ Uncertain 	-
Additional information	Indicate whether to display additional information.	<ul style="list-style-type: none"> ▪ Hide ▪ Show 	-
Zero point measured	Shows the zero point measured for the adjustment.	Signed floating-point number	-
Zero point standard deviation	Shows the standard deviation of the zero point measured.	Positive floating-point number	-
Select action	Select the zero point value to apply.	<ul style="list-style-type: none"> ▪ Keep current zero point ▪ Apply zero point measured ▪ Apply factory zero point * 	-

* Visibility depends on order options or device settings





10.7.3 Configuring the totalizer

In the "Totalizer 1 to n" submenu, you can configure the specific totalizer.

Navigation

"Setup" menu → Advanced setup → Totalizer 1 to n

▶ Totalizer 1 to n	
Assign process variable	→ ⓘ 142

Unit totalizer	→  142
Totalizer operation mode	→  142
Control Totalizer 1 to n	→  142
Failure mode	→  142

Parameter overview with brief description

Parameter	Description	Selection	Factory setting
Assign process variable	Select process variable for totalizer.	<ul style="list-style-type: none"> ■ Mass flow ■ Volume flow ■ Corrected volume flow[*] ■ Target mass flow[*] ■ Carrier mass flow[*] ■ Target volume flow[*] ■ Carrier volume flow[*] ■ Target corrected volume flow[*] ■ Carrier corrected volume flow[*] 	–
Unit totalizer	Select the unit for the process variable of the totalizer.	Unit choose list	Country-specific: <ul style="list-style-type: none"> ■ kg ■ lb
Control Totalizer 1 to n	Control the totalizer value.	<ul style="list-style-type: none"> ■ Totalize ■ Reset + hold ■ Preset + hold 	–
Totalizer operation mode	Select totalizer calculation mode.	<ul style="list-style-type: none"> ■ Net flow total ■ Forward flow total ■ Reverse flow total ■ Last valid value 	–
Failure mode	Define the totalizer behavior in the event of a device alarm.	<ul style="list-style-type: none"> ■ Stop ■ Actual value ■ Last valid value 	–

* Visibility depends on order options or device settings

10.7.4 Carrying out additional display configurations

In the **Display** submenu you can set all the parameters associated with the configuration of the local display.



Navigation

"Setup" menu → Advanced setup → Display

► Display	
Format display	→ 144
Value 1 display	→ 144
0% bargraph value 1	→ 144
100% bargraph value 1	→ 144
Decimal places 1	→ 145
Value 2 display	→ 145
Decimal places 2	→ 145
Value 3 display	→ 145
0% bargraph value 3	→ 145
100% bargraph value 3	→ 145
Decimal places 3	→ 145
Value 4 display	→ 145
Decimal places 4	→ 145
Display language	→ 145
Display interval	→ 145
Display damping	→ 146
Header	→ 146
Header text	→ 146
Separator	→ 146
Backlight	→ 146

Parameter overview with brief description

Parameter	Prerequisite	Description	Selection / User entry	Factory setting
Format display	A local display is provided.	Select how measured values are shown on the display.	<ul style="list-style-type: none"> ■ 1 value, max. size ■ 1 bargraph + 1 value ■ 2 values ■ 1 value large + 2 values ■ 4 values 	–
Value 1 display	A local display is provided.	Select the measured value that is shown on the local display.	<ul style="list-style-type: none"> ■ Mass flow ■ Volume flow ■ Corrected volume flow * ■ Density ■ Reference density * ■ Temperature ■ Current output 1 * ■ Current output 2 * ■ Current output 4 * ■ Pressure ■ Totalizer 1 ■ Totalizer 2 ■ Totalizer 3 ■ Concentration * ■ Target mass flow * ■ Carrier mass flow * ■ Target volume flow * ■ Carrier volume flow * ■ Target corrected volume flow * ■ Carrier corrected volume flow * ■ HBSI * ■ Exciter current 0 ■ Oscillation damping 0 ■ Oscillation damping fluctuation 0 * ■ Oscillation frequency 0 ■ Frequency fluctuation 0 * ■ Oscillation amplitude 0 * ■ Signal asymmetry ■ Carrier pipe temperature * ■ Electronic temperature ■ Current output 1 * ■ Current output 2 * ■ Current output 3 * 	–
0% bargraph value 1	A local display is provided.	Enter 0% value for bar graph display.	Signed floating-point number	Country-specific: <ul style="list-style-type: none"> ■ 0 kg/h ■ 0 lb/min
100% bargraph value 1	A local display is provided.	Enter 100% value for bar graph display.	Signed floating-point number	Depends on country and nominal diameter

Parameter	Prerequisite	Description	Selection / User entry	Factory setting
Decimal places 1	A measured value is specified in the Value 1 display parameter.	Select the number of decimal places for the display value.	<ul style="list-style-type: none"> ■ x ■ x.x ■ x.xx ■ x.xxx ■ x.xxxx 	–
Value 2 display	A local display is provided.	Select the measured value that is shown on the local display.	For the picklist, see Value 1 display parameter (→  129)	–
Decimal places 2	A measured value is specified in the Value 2 display parameter.	Select the number of decimal places for the display value.	<ul style="list-style-type: none"> ■ x ■ x.x ■ x.xx ■ x.xxx ■ x.xxxx 	–
Value 3 display	A local display is provided.	Select the measured value that is shown on the local display.	For the picklist, see Value 1 display parameter (→  129)	–
0% bargraph value 3	A selection was made in the Value 3 display parameter.	Enter 0% value for bar graph display.	Signed floating-point number	Country-specific: <ul style="list-style-type: none"> ■ 0 kg/h ■ 0 lb/min
100% bargraph value 3	A selection was made in the Value 3 display parameter.	Enter 100% value for bar graph display.	Signed floating-point number	–
Decimal places 3	A measured value is specified in the Value 3 display parameter.	Select the number of decimal places for the display value.	<ul style="list-style-type: none"> ■ x ■ x.x ■ x.xx ■ x.xxx ■ x.xxxx 	–
Value 4 display	A local display is provided.	Select the measured value that is shown on the local display.	For the picklist, see Value 1 display parameter (→  129)	–
Decimal places 4	A measured value is specified in the Value 4 display parameter.	Select the number of decimal places for the display value.	<ul style="list-style-type: none"> ■ x ■ x.x ■ x.xx ■ x.xxx ■ x.xxxx 	–
Display language	A local display is provided.	Set display language.	<ul style="list-style-type: none"> ■ English ■ Deutsch * ■ Français * ■ Español * ■ Italiano * ■ Nederlands * ■ Portuguesa * ■ Polski * ■ русский язык (Russian) * ■ Svenska * ■ Türkçe * ■ 中文 (Chinese) * ■ 日本語 (Japanese) * ■ 한국어 (Korean) * ■ tiếng Việt (Vietnamese) * ■ čeština (Czech) * 	English (alternatively, the ordered language is preset in the device)
Display interval	A local display is provided.	Set time measured values are shown on display if display alternates between values.	1 to 10 s	–

Parameter	Prerequisite	Description	Selection / User entry	Factory setting
Display damping	A local display is provided.	Set display reaction time to fluctuations in the measured value.	0.0 to 999.9 s	–
Header	A local display is provided.	Select header contents on local display.	<ul style="list-style-type: none"> ▪ Device tag ▪ Free text 	–
Header text	The Free text option is selected in the Header parameter.	Enter display header text.	Max. 12 characters, such as letters, numbers or special characters (e.g. @, %, /)	–
Separator	A local display is provided.	Select decimal separator for displaying numerical values.	<ul style="list-style-type: none"> ▪ . (point) ▪ , (comma) 	. (point)
Backlight	One of the following conditions is met: <ul style="list-style-type: none"> ▪ Order code for "Display; operation", option F "4-line, illum.; touch control" ▪ Order code for "Display; operation", option G "4-line, illum.; touch control +WLAN" 	Switch the local display backlight on and off.	<ul style="list-style-type: none"> ▪ Disable ▪ Enable 	–

* Visibility depends on order options or device settings

10.7.5 WLAN configuration



The **WLAN Settings** submenu guides the user systematically through all the parameters that have to be set for the WLAN configuration.

Navigation

"Setup" menu → Advanced setup → WLAN settings

▶ WLAN settings	
WLAN IP address	→ ⓘ 147
Security type	→ ⓘ 147
WLAN passphrase	→ ⓘ 147
Assign SSID name	→ ⓘ 147
SSID name	→ ⓘ 147
Apply changes	→ ⓘ 147

Parameter overview with brief description

Parameter	Prerequisite	Description	User entry / Selection	Factory setting
WLAN IP address	–	Enter IP address of the device WLAN interface.	4 octet: 0 to 255 (in the particular octet)	–
Network security	–	Select the security type of the WLAN network.	<ul style="list-style-type: none"> ■ Unsecured ■ WPA2-PSK ■ EAP-PEAP with MSCHAPv2 * ■ EAP-PEAP MSCHAPv2 no server authentic. * ■ EAP-TLS * 	–
WLAN passphrase	The WPA2-PSK option is selected in the Security type parameter.	Enter the network key (8 to 32 characters).  The network key supplied with the device should be changed during commissioning for security reasons.	8 to 32-digit character string comprising numbers, letters and special characters (without spaces)	Serial number of the measuring device (e.g. L100A802000)
Assign SSID name	–	Select which name will be used for SSID: device tag or user-defined name.	<ul style="list-style-type: none"> ■ Device tag ■ User-defined 	–
SSID name	<ul style="list-style-type: none"> ■ The User-defined option is selected in the Assign SSID name parameter. ■ The WLAN access point option is selected in the WLAN mode parameter. 	Enter the user-defined SSID name (max. 32 characters).  The user-defined SSID name may only be assigned once. If the SSID name is assigned more than once, the devices can interfere with one another.	Max. 32-digit character string comprising numbers, letters and special characters	EH_device designation_last 7 digits of the serial number (e.g. EH_Promass_500_A 802000)
Apply changes	–	Use changed WLAN settings.	<ul style="list-style-type: none"> ■ Cancel ■ Ok 	–

* Visibility depends on order options or device settings

10.7.6 Configuration management



After commissioning, you can save the current device configuration or restore the previous device configuration. The device configuration is managed via the **Configuration management** parameter.

Navigation

"Setup" menu → Advanced setup → Configuration backup

► Configuration backup

Operating time	→ ⓘ 148
Last backup	→ ⓘ 148
Configuration management	→ ⓘ 148

Backup state	→  148
Comparison result	→  148

Parameter overview with brief description

Parameter	Description	User interface / Selection
Operating time	Indicates how long the device has been in operation.	Days (d), hours (h), minutes (m) and seconds (s)
Last backup	Shows when the last data backup was saved to HistoROM backup.	Days (d), hours (h), minutes (m) and seconds (s)
Configuration management	Select action for managing the device data in the HistoROM backup.	<ul style="list-style-type: none"> ▪ Cancel ▪ Execute backup ▪ Restore * ▪ Compare * ▪ Clear backup data
Backup state	Shows the current status of data saving or restoring.	<ul style="list-style-type: none"> ▪ None ▪ Backup in progress ▪ Restoring in progress ▪ Delete in progress ▪ Compare in progress ▪ Restoring failed ▪ Backup failed
Comparison result	Comparison of current device data with HistoROM backup.	<ul style="list-style-type: none"> ▪ Settings identical ▪ Settings not identical ▪ No backup available ▪ Backup settings corrupt ▪ Check not done ▪ Dataset incompatible

* Visibility depends on order options or device settings

Function scope of the "Configuration management" parameter

Options	Description
Cancel	No action is executed and the user exits the parameter.
Execute backup	A backup copy of the current device configuration is saved from the HistoROM backup to the memory of the device. The backup copy includes the transmitter data of the device.
Restore	The last backup copy of the device configuration is restored from the device memory to the device's HistoROM backup. The backup copy includes the transmitter data of the device.
Compare	The device configuration saved in the device memory is compared with the current device configuration of the HistoROM backup.
Clear backup data	The backup copy of the device configuration is deleted from the memory of the device.



HistoROM backup

A HistoROM is a "non-volatile" device memory in the form of an EEPROM.



While this action is in progress, the configuration cannot be edited via the local display and a message on the processing status appears on the display.

10.7.7 Using parameters for device administration

The **Administration** submenu systematically guides the user through all the parameters that can be used for device administration purposes.

Navigation

"Setup" menu → Advanced setup → Administration

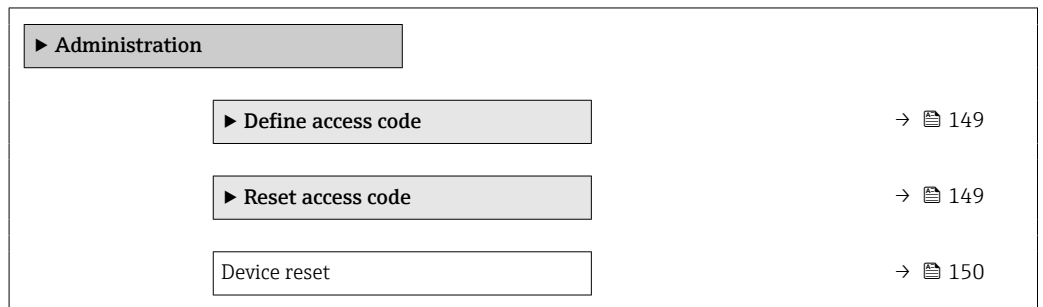

Using the parameter to define the access code

Navigation

"Setup" menu → Advanced setup → Administration → Define access code

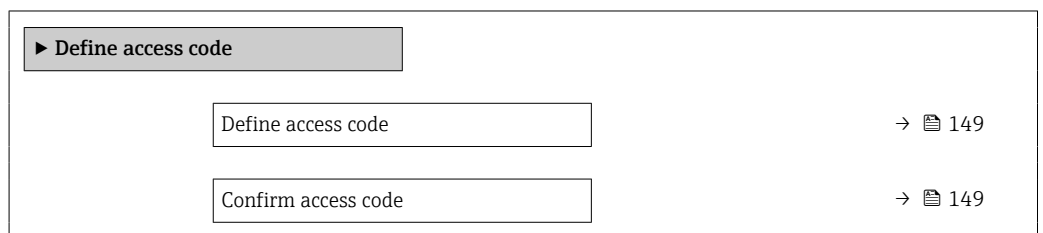

Parameter overview with brief description

Parameter	Description	User entry
Define access code	Restrict write-access to parameters to protect the configuration of the device against unintentional changes.	Max. 16-digit character string comprising numbers, letters and special characters
Confirm access code	Confirm the entered access code.	Max. 16-digit character string comprising numbers, letters and special characters

Using the parameter to reset the access code

Navigation

"Setup" menu → Advanced setup → Administration → Reset access code

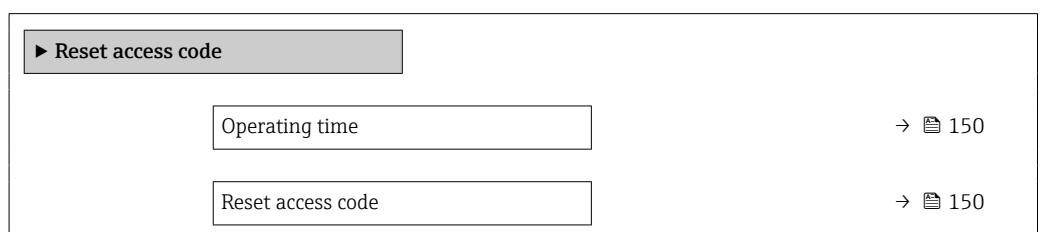

Parameter overview with brief description

Parameter	Description	User interface / User entry
Operating time	Indicates how long the device has been in operation.	Days (d), hours (h), minutes (m) and seconds (s)
Reset access code	Reset access code to factory settings.  For a reset code, contact your Endress+Hauser service organization. The reset code can only be entered via: <ul style="list-style-type: none"> ▪ Web browser ▪ DeviceCare, FieldCare (via CDI-RJ45 service interface) ▪ Fieldbus 	Character string comprising numbers, letters and special characters

Using the parameter to reset the device

Navigation

"Setup" menu → Advanced setup → Administration

Parameter overview with brief description

Parameter	Description	Selection
Device reset	Reset the device configuration - either entirely or in part - to a defined state.	<ul style="list-style-type: none"> ▪ Cancel ▪ To delivery settings ▪ Restart device ▪ Restore S-DAT backup *

* Visibility depends on order options or device settings

10.8 Simulation

Via the **Simulation** submenu, it is possible to simulate various process variables in the process and the device alarm mode and verify downstream signal chains (switching valves or closed-control loops). The simulation can be performed without a real measurement (no flow of medium through the device).

Navigation

"Diagnostics" menu → Simulation

▶ Simulation	
Assign simulation process variable	→ ⓘ 151
Process variable value	→ ⓘ 151
Status input simulation	→ ⓘ 152
Input signal level	→ ⓘ 152
Current input 1 to n simulation	→ ⓘ 152
Value current input 1 to n	→ ⓘ 152

Current output 1 to n simulation	→ 151
Value current output 1 to n	→ 151
Frequency output simulation 1 to n	→ 152
Frequency value 1 to n	→ 152
Pulse output simulation 1 to n	→ 152
Pulse value 1 to n	→ 152
Switch output simulation 1 to n	→ 152
Switch status 1 to n	→ 152
Relay output 1 to n simulation	→ 152
Switch status 1 to n	→ 152
Device alarm simulation	→ 152
Diagnostic event category	→ 152
Diagnostic event simulation	→ 152

Parameter overview with brief description



Parameter	Prerequisite	Description	Selection / User entry
Assign simulation process variable	–	Select a process variable for the simulation process that is activated.	<ul style="list-style-type: none"> ■ Off ■ Mass flow ■ Volume flow ■ Corrected volume flow * ■ Target mass flow * ■ Carrier mass flow * ■ Target volume flow * ■ Carrier volume flow * ■ Target corrected volume flow * ■ Carrier corrected volume flow * ■ Density ■ Reference density * ■ Temperature ■ Concentration *
Process variable value	A process variable is selected in the Assign simulation process variable parameter (→ 151).	Enter the simulation value for the selected process variable.	Depends on the process variable selected
Current output 1 to n simulation	–	Switch the simulation of the current output on and off.	<ul style="list-style-type: none"> ■ Off ■ On
Value current output 1 to n	In the Current output 1 to n simulation parameter, the On option is selected.	Enter the current value for simulation.	3.59 to 22.5 mA

Parameter	Prerequisite	Description	Selection / User entry
Frequency output simulation 1 to n	In the Operating mode parameter, the Frequency option is selected.	Switch the simulation of the frequency output on and off.	<ul style="list-style-type: none"> ■ Off ■ On
Frequency value 1 to n	In the Frequency output simulation 1 to n parameter, the On option is selected.	Enter the frequency value for the simulation.	0.0 to 12 500.0 Hz
Pulse output simulation 1 to n	In the Operating mode parameter, the Pulse option is selected.	Set and switch off the pulse output simulation.  For Fixed value option: Pulse width parameter (→  120) defines the pulse width of the pulses output.	<ul style="list-style-type: none"> ■ Off ■ Fixed value ■ Down-counting value
Pulse value 1 to n	In the Pulse output simulation 1 to n parameter, the Down-counting value option is selected.	Enter the number of pulses for simulation.	0 to 65 535
Switch output simulation 1 to n	In the Operating mode parameter, the Switch option is selected.	Switch the simulation of the switch output on and off.	<ul style="list-style-type: none"> ■ Off ■ On
Switch status 1 to n	–	Select the status of the status output for the simulation.	<ul style="list-style-type: none"> ■ Open ■ Closed
Relay output 1 to n simulation	–	Switch simulation of the relay output on and off.	<ul style="list-style-type: none"> ■ Off ■ On
Switch status 1 to n	The On option is selected in the Switch output simulation 1 to n parameter.	Select status of the relay output for the simulation.	<ul style="list-style-type: none"> ■ Open ■ Closed
Device alarm simulation	–	Switch the device alarm on and off.	<ul style="list-style-type: none"> ■ Off ■ On
Diagnostic event category	–	Select a diagnostic event category.	<ul style="list-style-type: none"> ■ Sensor ■ Electronics ■ Configuration ■ Process
Diagnostic event simulation	–	Select a diagnostic event to simulate this event.	<ul style="list-style-type: none"> ■ Off ■ Diagnostic event picklist (depends on the category selected)
Current input 1 to n simulation	–	Switch simulation of the current input on and off.	<ul style="list-style-type: none"> ■ Off ■ On
Value current input 1 to n	In the Current input 1 to n simulation parameter, the On option is selected.	Enter the current value for simulation.	0 to 22.5 mA
Status input simulation	–	Switch simulation of the status input on and off.	<ul style="list-style-type: none"> ■ Off ■ On
Input signal level	In the Status input simulation parameter, the On option is selected.	Select the signal level for the simulation of the status input.	<ul style="list-style-type: none"> ■ High ■ Low

* Visibility depends on order options or device settings

10.9 Protecting settings from unauthorized access

The following write protection options exist in order to protect the configuration of the measuring device from unintentional modification:







- Protect access to parameters via access code →  153
- Protect access to local operation via key locking →  78
- Protect access to measuring device via write protection switch →  154

10.9.1 Write protection via access code

The effects of the user-specific access code are as follows:

- Via local operation, the parameters for the measuring device configuration are write-protected and their values can no longer be changed.
- Device access is protected via the Web browser, as are the parameters for the measuring device configuration.
- Device access is protected via FieldCare or DeviceCare (via CDI-RJ45 service interface), as are the parameters for the measuring device configuration.

Defining the access code via the local display

1. Navigate to the **Define access code** parameter (→  149).
 2. Maximum of 16-digit character string comprising numbers, letters and special characters as the access code.
 3. Enter the access code again in the **Confirm access code** parameter (→  149) to confirm.
 - ↳ The  symbol appears in front of all write-protected parameters.
-  **Disabling parameter write protection via access code** →  77.
 - If the access code is lost: Resetting the access code →  154.
 - The user role with which the user is currently logged in is displayed in **Access status** parameter.
 - Navigation path: Operation → Access status
 - User roles and their access rights →  77
 - The device automatically locks the write-protected parameters again if a key is not pressed for 10 minutes in the navigation and editing view.
 - The device locks the write-protected parameters automatically after 60 s if the user skips back to the operational display mode from the navigation and editing view.



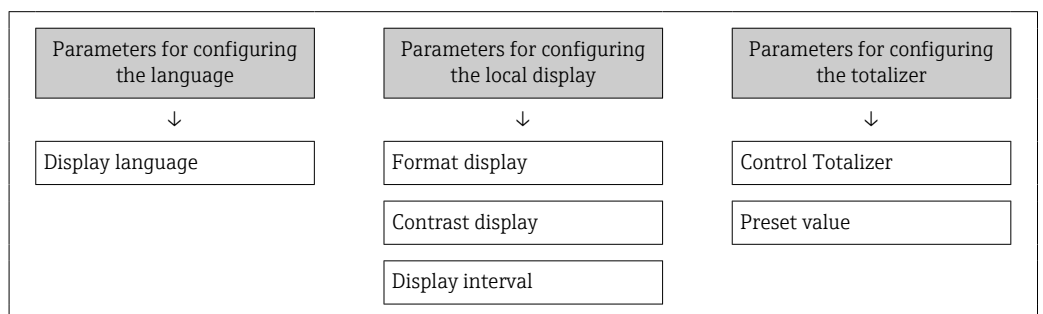

Parameters which can always be modified via the local display

Certain parameters that do not affect the measurement are excepted from parameter write protection via the local display. Despite the user-specific access code, they can always be modified, even if the other parameters are locked.



Defining the access code via the web browser

1. Navigate to the **Define access code** parameter (→  149).
2. Define a 16-digit (max.) numeric code as the access code.





3. Enter the access code again in the **Confirm access code** parameter (→  149) to confirm.
 - ↳ The web browser switches to the login page.
-  ■ Disabling parameter write protection via access code →  77.
- If the access code is lost: Resetting the access code →  154.
 - The **Access status** parameter shows which user role the user is currently logged in with.
 - Navigation path: Operation → Access status
 - User roles and their access rights →  77

If no action is performed for 10 minutes, the web browser automatically returns to the login page.

Resetting the access code

If you misplace the user-specific access code, it is possible to reset the code to the factory setting. A reset code must be entered for this purpose. The user-specific access code can then be defined again afterwards.

Via Web browser, FieldCare, DeviceCare (via CDI-RJ45 service interface), fieldbus

-  You can only obtain a reset code from your local Endress+Hauser service organization. The code must be calculated explicitly for every device.
1. Note down the serial number of the device.
 2. Read off the **Operating time** parameter.
 3. Contact the local Endress+Hauser service organization and tell them the serial number and the operating time.
 - ↳ Get the calculated reset code.
 4. Enter the reset code in the **Reset access code** parameter (→  150).
 - ↳ The access code has been reset to the factory setting **0000**. It can be redefined →  153.
-  For IT security reasons, the calculated reset code is only valid for 96 hours from the specified operating time and for the specific serial number. If you cannot return to the device within 96 hours, you should either increase the operating time you read out by a few days or switch off the device.

10.9.2 Write protection via write protection switch

Unlike parameter write protection via a user-specific access code, this allows the user to lock write access to the entire operating menu - apart from the **"Contrast display" parameter**.

The parameter values are now read only and cannot be edited any more (exception **"Contrast display" parameter**):

- Via local display
- Via PROFIBUS PA protocol

Proline 500 – digital

Enable/disable write protection

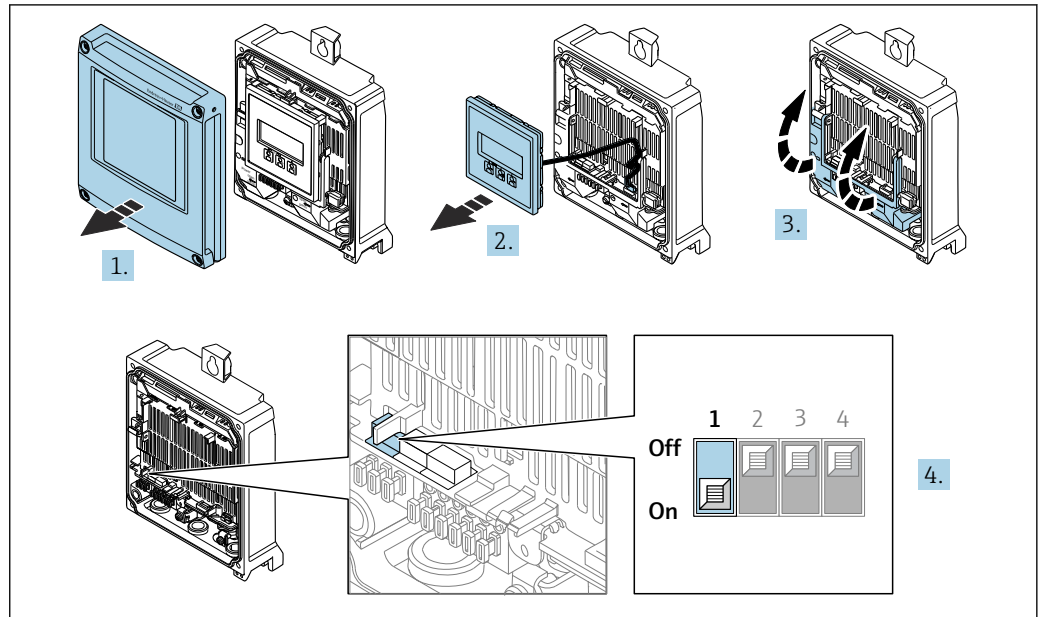

A0029673

1. Open the housing cover.
2. Remove the display module.
3. Fold open the terminal cover.
4. **Enable or disable write protection:**

Setting the write protection (WP) switch on the main electronics module to the **ON** position enables hardware write protection/setting to **OFF** (factory setting) disables hardware write protection.

↳ In the **Locking status** parameter, the **Hardware locked** option is displayed → 157. When hardware write protection is enabled, the  symbol appears in the header of the measured value display and in the navigation view in front of the parameters.

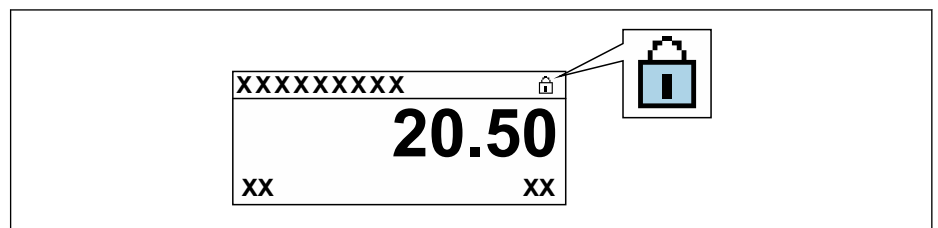

A0029425

5. Insert the display module.
6. Close the housing cover.
7. **NOTICE**

Excessive tightening torque applied to the fixing screws!

Risk of damaging the plastic transmitter.

▶ Tighten the fixing screws as per the tightening torque: 2.5 Nm (1.8 lbf ft)

Tighten the fixing screws.

Proline 500

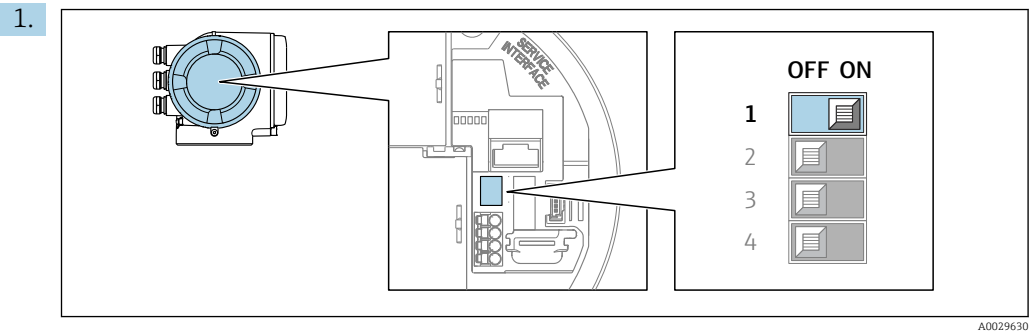

Setting the write protection (WP) switch on the main electronics module to the **ON** position enables hardware write protection.

- ↳ In the **Locking status** parameter, the **Hardware locked** option is displayed → 157. In addition, on the local display the  symbol appears in front of the parameters in the header of the operational display and in the navigation view.

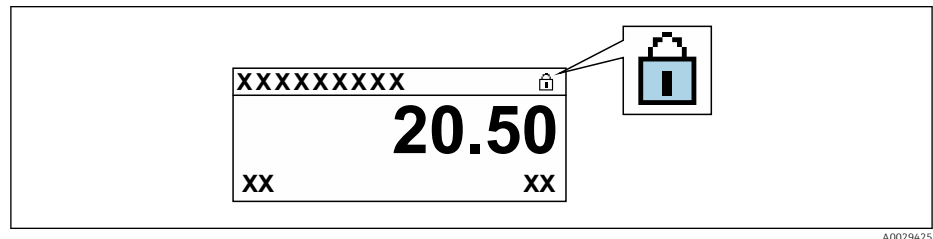

2. Setting the write protection (WP) switch on the main electronics module to the **OFF** position (factory setting) disables hardware write protection.

- ↳ No option is displayed in the **Locking status** parameter → 157. On the local display, the  symbol disappears from in front of the parameters in the header of the operational display and in the navigation view.



11 Operation

11.1 Reading off the device locking status

Device active write protection: **Locking status** parameter



Operation → Locking status

Function scope of the "Locking status" parameter

Options	Description
None	The access authorization displayed in the Access status parameter applies →  77. Only appears on local display.
Hardware locked	The DIP switch for hardware locking is activated on the PCB board. This locks write access to the parameters (e.g. via local display or operating tool) →  154.
Temporarily locked	Write access to the parameters is temporarily locked on account of internal processes running in the device (e.g. data upload/download, reset, etc.). Once the internal processing has been completed, the parameters can be changed once again.



11.2 Adjusting the operating language

 Detailed information:

- To configure the operating language →  104
- For information on the operating languages supported by the measuring device →  268

11.3 Configuring the display

Detailed information:





- On the basic settings for the local display →  128
- On the advanced settings for the local display →  143

11.4 Reading off measured values

With the **Measured values** submenu, it is possible to read all the measured values.

Navigation

"Diagnostics" menu → Measured values

▶ Measured values	
▶ Measured variables	→  158
▶ Input values	→  161
▶ Output values	→  162
▶ Totalizer 1 to n	→  141

11.4.1 "Measured variables" submenu

The **Measured variables** submenu contains all the parameters needed to display the current measured values for each process variable.





Navigation







"Diagnostics" menu → Measured values → Measured variables

► Measured variables	
Mass flow	→ ⓘ 158
Volume flow	→ ⓘ 158
Corrected volume flow	→ ⓘ 159
Density	→ ⓘ 159
Reference density	→ ⓘ 159
Temperature	→ ⓘ 159
Pressure	→ ⓘ 159
Concentration	→ ⓘ 159
Target mass flow	→ ⓘ 159
Carrier mass flow	→ ⓘ 159
Target corrected volume flow	→ ⓘ 159
Carrier corrected volume flow	→ ⓘ 160
Target volume flow	→ ⓘ 160
Carrier volume flow	→ ⓘ 160

Parameter overview with brief description

Parameter	Prerequisite	Description	User interface
Mass flow	–	Displays the mass flow that is currently measured. <i>Dependency</i> The unit is taken from: Mass flow unit parameter (→ ⓘ 108)	Signed floating-point number
Volume flow	–	Displays the volume flow that is currently calculated. <i>Dependency</i> The unit is taken from the Volume flow unit parameter (→ ⓘ 108).	Signed floating-point number

Parameter	Prerequisite	Description	User interface
Corrected volume flow	–	Displays the corrected volume flow that is currently calculated. <i>Dependency</i> The unit is taken from: Corrected volume flow unit parameter (→ 108)	Signed floating-point number
Density	–	Shows the density currently measured. <i>Dependency</i> The unit is taken from the Density unit parameter (→ 108).	Signed floating-point number
Reference density	–	Displays the reference density that is currently calculated. <i>Dependency</i> The unit is taken from: Reference density unit parameter (→ 108)	Signed floating-point number
Temperature	–	Shows the medium temperature currently measured. <i>Dependency</i> The unit is taken from: Temperature unit parameter (→ 109)	Signed floating-point number
Pressure value	–	Displays either a fixed or external pressure value. <i>Dependency</i> The unit is taken from the Pressure unit parameter (→ 109).	Signed floating-point number
Concentration	For the following order code: Order code for "Application package", option ED "Concentration"  The software options currently enabled are displayed in the Software option overview parameter.	Displays the concentration that is currently calculated. <i>Dependency</i> The unit is taken from the Concentration unit parameter.	Signed floating-point number
Target mass flow	With the following conditions: Order code for "Application package", option ED "Concentration"  The software options currently enabled are displayed in the Software option overview parameter.	Displays the mass flow that is currently measured for the target medium. <i>Dependency</i> The unit is taken from: Mass flow unit parameter (→ 108)	Signed floating-point number
Carrier mass flow	With the following conditions: Order code for "Application package", option ED "Concentration"  The software options currently enabled are displayed in the Software option overview parameter.	Displays the mass flow of the carrier medium that is currently measured. <i>Dependency</i> The unit is taken from: Mass flow unit parameter (→ 108)	Signed floating-point number
Target corrected volume flow	With the following conditions: <ul style="list-style-type: none"> ▪ Order code for "Application package", option ED "Concentration" ▪ The Ethanol in water option or %mass / %volume option is selected in the Liquid type parameter.  The software options currently enabled are displayed in the Software option overview parameter.	Displays the corrected volume flow that is currently measured for the target fluid. <i>Dependency</i> The unit is taken from the Volume flow unit parameter (→ 108).	Signed floating-point number

Parameter	Prerequisite	Description	User interface
Carrier corrected volume flow	<p>With the following conditions:</p> <ul style="list-style-type: none"> Order code for "Application package", option ED "Concentration" In the Liquid type parameter, the Ethanol in water option or %mass / %volume option is selected. <p> The software options currently enabled are displayed in the Software option overview parameter.</p>	<p>Displays the corrected volume flow currently measured for the carrier fluid.</p> <p><i>Dependency</i> The unit is taken from the Volume flow unit parameter (→  108).</p>	Signed floating-point number
Target volume flow	<p>With the following conditions:</p> <ul style="list-style-type: none"> Order code for "Application package", option ED "Concentration" The Ethanol in water option or %mass / %volume option is selected in the Liquid type parameter. The %vol option is selected in the Concentration unit parameter. <p> The software options currently enabled are displayed in the Software option overview parameter.</p>	<p>Displays the volume flow currently measured for the target medium.</p> <p><i>Dependency</i> The unit is taken from the Volume flow unit parameter (→  108).</p>	Signed floating-point number
Carrier volume flow	<p>With the following conditions:</p> <ul style="list-style-type: none"> Order code for "Application package", option ED "Concentration" The Ethanol in water option or %mass / %volume option is selected in the Liquid type parameter. The %vol option is selected in the Concentration unit parameter. <p> The software options currently enabled are displayed in the Software option overview parameter.</p>	<p>Displays the volume flow currently measured for the carrier medium.</p> <p><i>Dependency</i> The unit is taken from the Volume flow unit parameter (→  108).</p>	Signed floating-point number

11.4.2 Totalizer

The **Totalizer** submenu contains all the parameters needed to display the current measured values for every totalizer.

Navigation

"Diagnostics" menu → Measured values → Totalizer

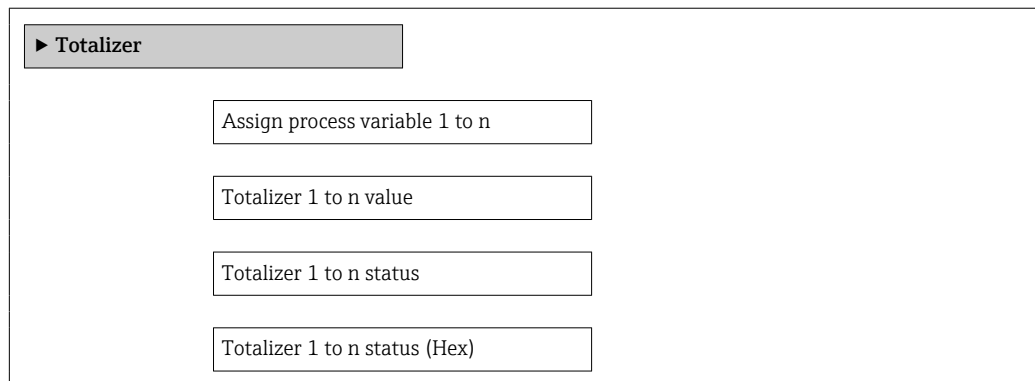

Parameter overview with brief description

Parameter	Prerequisite	Description	Selection / User entry / User interface
Assign process variable	–	Select process variable for totalizer.	<ul style="list-style-type: none"> ■ Mass flow ■ Volume flow ■ Corrected volume flow * ■ Target mass flow * ■ Carrier mass flow * ■ Target volume flow * ■ Carrier volume flow * ■ Target corrected volume flow * ■ Carrier corrected volume flow *
Totalizer value 1 to n	One of the following options is selected in the Assign process variable parameter: <ul style="list-style-type: none"> ■ Volume flow ■ Mass flow ■ Corrected volume flow ■ Total mass flow ■ Condensate mass flow ■ Energy flow ■ Heat flow difference 	Displays the current totalizer counter value.	Signed floating-point number
Totalizer status 1 to n	–	Displays the current totalizer status.	<ul style="list-style-type: none"> ■ Good ■ Uncertain ■ Bad
Totalizer status (Hex) 1 to n	In Target mode parameter, the Auto option is selected.	Displays the current status value (hex) of the totalizer.	0 to 0xFF

* Visibility depends on order options or device settings

11.4.3 "Input values" submenu

The **Input values** submenu guides you systematically to the individual input values.

Navigation

"Diagnostics" menu → Measured values → Input values

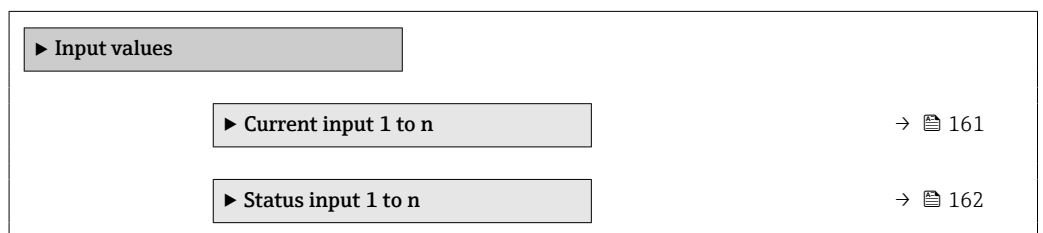

Input values of current input

The **Current input 1 to n** submenu contains all the parameters needed to display the current measured values for every current input.

Navigation

"Diagnostics" menu → Measured values → Input values → Current input 1 to n

▶ Current input 1 to n

Measured values 1 to n

→ 162

Measured current 1 to n

→ 162

Parameter overview with brief description

Parameter	Description	User interface
Measured values 1 to n	Displays the current input value.	Signed floating-point number
Measured current 1 to n	Displays the current value of the current input.	0 to 22.5 mA

Input values of status input

The **Status input 1 to n** submenu contains all the parameters needed to display the current measured values for every status input.

Navigation

"Diagnostics" menu → Measured values → Input values → Status input 1 to n

▶ Status input 1 to n

Value status input

→ 162

Parameter overview with brief description

Parameter	Description	User interface
Value status input	Shows the current input signal level.	<ul style="list-style-type: none"> ▪ High ▪ Low

11.4.4 Output values

The **Output values** submenu contains all the parameters needed to display the current measured values for every output.

Navigation

"Diagnostics" menu → Measured values → Output values

▶ Output values

▶ Current output 1 to n

→ 163

▶ Pulse/frequency/switch output 1 to n	→ 163
▶ Relay output 1 to n	→ 164

Output values of current output

The **Value current output** submenu contains all the parameters needed to display the current measured values for every current output.

Navigation

"Diagnostics" menu → Measured values → Output values → Value current output 1 to n

▶ Current output 1 to n	
Output current 1 to n	→ 163
Measured current 1 to n	→ 163

Parameter overview with brief description

Parameter	Description	User interface
Output current 1	Displays the current value currently calculated for the current output.	3.59 to 22.5 mA
Measured current	Displays the current value currently measured for the current output.	0 to 30 mA

Output values for pulse/frequency/switch output

The **Pulse/frequency/switch output 1 to n** submenu contains all the parameters needed to display the current measured values for every pulse/frequency/switch output.

Navigation

"Diagnostics" menu → Measured values → Output values → Pulse/frequency/switch output 1 to n

▶ Pulse/frequency/switch output 1 to n	
Output frequency 1 to n	→ 164
Pulse output 1 to n	→ 164
Switch status 1 to n	→ 164

Parameter overview with brief description

Parameter	Prerequisite	Description	User interface
Output frequency 1 to n	In the Operating mode parameter, the Frequency option is selected.	Displays the value currently measured for the frequency output.	0.0 to 12 500.0 Hz
Pulse output 1 to n	The Pulse option is selected in the Operating mode parameter parameter.	Displays the pulse frequency currently output.	Positive floating-point number
Switch status 1 to n	The Switch option is selected in the Operating mode parameter.	Displays the current switch output status.	<ul style="list-style-type: none"> ▪ Open ▪ Closed

Output values for relay output

The **Relay output 1 to n** submenu contains all the parameters needed to display the current measured values for every relay output.

Navigation

"Diagnostics" menu → Measured values → Output values → Relay output 1 to n

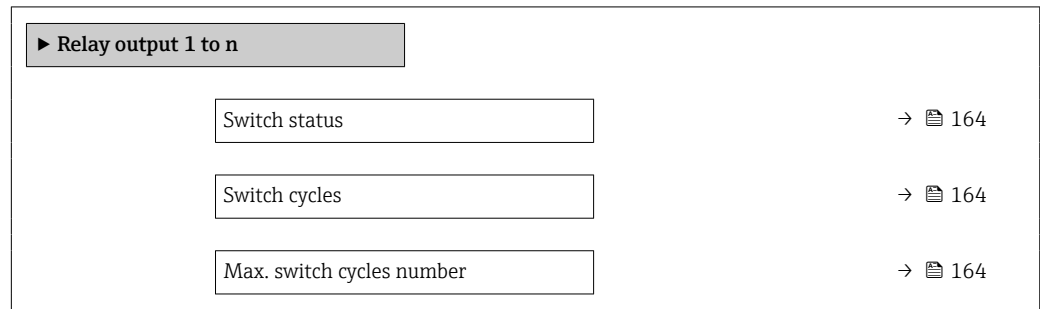

Parameter overview with brief description

Parameter	Description	User interface
Switch status	Shows the current relay switch status.	<ul style="list-style-type: none"> ▪ Open ▪ Closed
Switch cycles	Shows number of all performed switch cycles.	Positive integer
Max. switch cycles number	Shows the maximal number of guaranteed switch cycles.	Positive integer

11.5 Adapting the measuring device to the process conditions

The following are available for this purpose:

- Basic settings using the **Setup** menu (→ 105)
- Advanced settings using the **Advanced setup** submenu (→ 133)

11.6 Performing a totalizer reset

The totalizers are reset in the **Operation** submenu:
Control Totalizer

Function range of "Control Totalizer " parameter

Options	Description
Totalize	The totalizer is started.
Reset + hold	The totaling process is stopped and the totalizer is reset to 0.
Preset + hold	The totaling process is stopped and the totalizer is set to its defined start value from the Preset value 1 to n parameter.

Navigation

"Operation" menu → Totalizer handling

▶ **Totalizer handling**

Control Totalizer 1 to n

→ 165

Preset value 1 to n

→ 165

Reset all totalizers

→ 165

Parameter overview with brief description

Parameter	Prerequisite	Description	Selection / User entry
Control Totalizer 1 to n	–	Control the totalizer value.	<ul style="list-style-type: none"> ■ Totalize ■ Reset + hold ■ Preset + hold
Preset value 1 to n	In the Assign process variable parameter one of the following options is selected: <ul style="list-style-type: none"> ■ Volume flow ■ Mass flow ■ Corrected volume flow ■ Total mass flow ■ Condensate mass flow ■ Energy flow ■ Heat flow difference 	Specify start value for totalizer.	Signed floating-point number
Reset all totalizers	–	Reset all totalizers to 0 and start.	<ul style="list-style-type: none"> ■ Cancel ■ Reset + totalize

11.7 Displaying the measured value history

The **Extended HistoROM** application package must be enabled in the device (order option) for the **Data logging** submenu to appear. This contains all the parameters for the measured value history.

- Data logging is also available via:
- Plant Asset Management Tool FieldCare → 88.
 - Web browser

Function range

- A total of 1000 measured values can be stored
- 4 logging channels
- Adjustable logging interval for data logging
- Measured value trend for each logging channel displayed in the form of a chart

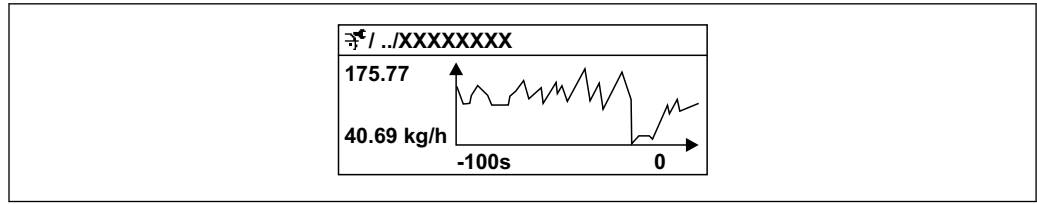

A0016357

37 Chart of a measured value trend

- x-axis: depending on the number of channels selected displays 250 to 1000 measured values of a process variable.
- y-axis: displays the approximate measured value span and constantly adapts this to the ongoing measurement.

i If the length of the logging interval or the assignment of the process variables to the channels is changed, the content of the data logging is deleted.







Navigation

"Diagnostics" menu → Data logging

▶ Data logging

Assign channel 1	→ 167
Assign channel 2	→ 167
Assign channel 3	→ 167
Assign channel 4	→ 167
Logging interval	→ 167
Clear logging data	→ 167
Data logging	→ 168
Logging delay	→ 168
Data logging control	→ 168
Data logging status	→ 168
Entire logging duration	→ 168
▶ Display channel 1	
▶ Display channel 2	
▶ Display channel 3	
▶ Display channel 4	

Parameter overview with brief description

Parameter	Prerequisite	Description	Selection / User entry / User interface
Assign channel 1	The Extended HistoROM application package is available.	Assign process variable to logging channel.	<ul style="list-style-type: none"> ■ Off ■ Mass flow ■ Volume flow ■ Corrected volume flow * ■ Density ■ Reference density * ■ Temperature ■ Oscillation amplitude * ■ Current output 1 * ■ Current output 2 * ■ Current output 3 * ■ Current output 4 * ■ Pressure ■ Concentration * ■ Target mass flow * ■ Carrier mass flow * ■ Target volume flow * ■ Carrier volume flow * ■ Target corrected volume flow * ■ Carrier corrected volume flow * ■ Oscillation amplitude * ■ HBSI * ■ Exciter current 0 ■ Oscillation damping 0 ■ Oscillation damping fluctuation 0 * ■ Oscillation frequency 0 ■ Oscillation amplitude * ■ Frequency fluctuation 0 * ■ Oscillation amplitude 1 * ■ Signal asymmetry ■ Carrier pipe temperature * ■ Electronic temperature
Assign channel 2	<p>The Extended HistoROM application package is available.</p> <p> The software options currently enabled are displayed in the Software option overview parameter.</p>	Assign a process variable to logging channel.	For the picklist, see Assign channel 1 parameter (→  167)
Assign channel 3	<p>The Extended HistoROM application package is available.</p> <p> The software options currently enabled are displayed in the Software option overview parameter.</p>	Assign a process variable to logging channel.	For the picklist, see Assign channel 1 parameter (→  167)
Assign channel 4	<p>The Extended HistoROM application package is available.</p> <p> The software options currently enabled are displayed in the Software option overview parameter.</p>	Assign a process variable to logging channel.	For the picklist, see Assign channel 1 parameter (→  167)
Logging interval	The Extended HistoROM application package is available.	Define the logging interval for data logging. This value defines the time interval between the individual data points in the memory.	0.1 to 3 600.0 s
Clear logging data	The Extended HistoROM application package is available.	Clear the entire logging data.	<ul style="list-style-type: none"> ■ Cancel ■ Clear data















Parameter	Prerequisite	Description	Selection / User entry / User interface
Data logging	–	Select the type of data logging.	<ul style="list-style-type: none"> ▪ Overwriting ▪ Not overwriting
Logging delay	In the Data logging parameter, the Not overwriting option is selected.	Enter the time delay for measured value logging.	0 to 999 h
Data logging control	In the Data logging parameter, the Not overwriting option is selected.	Start and stop measured value logging.	<ul style="list-style-type: none"> ▪ None ▪ Delete + start ▪ Stop
Data logging status	In the Data logging parameter, the Not overwriting option is selected.	Displays the measured value logging status.	<ul style="list-style-type: none"> ▪ Done ▪ Delay active ▪ Active ▪ Stopped
Entire logging duration	In the Data logging parameter, the Not overwriting option is selected.	Displays the total logging duration.	Positive floating-point number

* Visibility depends on order options or device settings

12 Diagnostics and troubleshooting

12.1 General troubleshooting

For local display

Error	Possible causes	Remedial action
Local display is dark, but signal output is within the valid range	The cable of the display module is not plugged in correctly.	Insert the plug correctly into the main electronics module and display module.
Local display dark and no output signals	Supply voltage does not match the voltage specified on the nameplate.	Apply the correct supply voltage →  53 →  47.
Local display dark and no output signals	Supply voltage has incorrect polarity.	Reverse polarity of supply voltage.
Local display dark and no output signals	No contact between connecting cables and terminals.	Ensure electrical contact between the cable and the terminal.
Local display dark and no output signals	<ul style="list-style-type: none"> ▪ Terminals are not plugged into the I/O electronics module correctly. ▪ Terminals are not plugged into the main electronics module correctly. 	Check terminals.
Local display dark and no output signals	<ul style="list-style-type: none"> ▪ I/O electronics module is defective. ▪ Main electronics module is defective. 	Order spare part →  243.
Local display dark and no output signals	The connector between the main electronics module and display module is not plugged in correctly.	Check the connection and correct if necessary.
Local display cannot be read, but signal output is within the valid range	Display is set too bright or too dark.	<ul style="list-style-type: none"> ▪ Set the display brighter by simultaneously pressing  + . ▪ Set the display darker by simultaneously pressing  + .
Local display is dark, but signal output is within the valid range	Display module is defective.	Order spare part →  243.
Backlighting of local display is red	Diagnostic event with "Alarm" diagnostic behavior has occurred.	Take remedial measures →  183
Text on local display appears in a language that cannot be understood.	The selected operating language cannot be understood.	<ol style="list-style-type: none"> 1. Press  +  for 2 s ("home position"). 2. Press . 3. Configure the required language in the Display language parameter (→  145).
Message on local display: "Communication Error" "Check Electronics"	Communication between the display module and the electronics is interrupted.	<ul style="list-style-type: none"> ▪ Check the cable and the connector between the main electronics module and display module. ▪ Order spare part →  243.

For output signals

Error	Possible causes	Remedial action
Signal output outside the valid range	Main electronics module is defective.	Order spare part →  243.
Device shows correct value on local display, but signal output is incorrect, though in the valid range.	Parameter configuration error	Check and adjust parameter configuration.
Device measures incorrectly.	Configuration error or device is operated outside the application.	<ol style="list-style-type: none"> 1. Check and correct parameter configuration. 2. Observe limit values specified in the "Technical Data".

For access

Fault	Possible causes	Remedial action
Write access to parameters is not possible.	Hardware write protection is enabled.	Set the write protection switch on the main electronics module to the OFF position → ☰ 154.
Write access to parameters is not possible.	Current user role has limited access authorization.	1. Check user role → ☰ 77. 2. Enter correct customer-specific access code → ☰ 77.
Connection via PROFIBUS PA is not possible.	Device plug is incorrectly connected.	Check the pin assignment of the device plugs .
Connection via PROFIBUS PA is not possible.	PROFIBUS PA cable is incorrectly terminated.	Check the terminating resistor .
Unable to connect to the web server.	Web server is disabled.	Using the "FieldCare" or "DeviceCare" operating tool, check whether the web server of the device is enabled, and enable it if necessary → ☰ 84.
	The Ethernet interface on the PC is incorrectly configured.	<ul style="list-style-type: none"> ▶ Check the properties of the Internet protocol (TCP/IP)→ ☰ 80. ▶ Check the network settings with the IT manager.
Unable to connect to the web server.	The IP address on the PC is incorrectly configured.	Check the IP address: 192.168.1.212 → ☰ 80
Unable to connect to the web server.	WLAN access data are incorrect.	<ul style="list-style-type: none"> ▪ Check WLAN network status. ▪ Log on to the device again using WLAN access data. ▪ Check that WLAN is enabled on the measuring instrument and operating unit → ☰ 80.
	WLAN communication is disabled.	–
Unable to connect to web server, FieldCare or DeviceCare.	WLAN network is not available.	<ul style="list-style-type: none"> ▪ Check if WLAN reception is present: LED on display module is lit blue. ▪ Check if WLAN connection is enabled: LED on display module flashes blue. ▪ Switch on instrument function.
Network connection not present or unstable	WLAN network is weak.	<ul style="list-style-type: none"> ▪ Operating unit outside reception range: Check network status on operating unit. ▪ To improve network performance, use an external WLAN antenna.
	Parallel WLAN and Ethernet communication	<ul style="list-style-type: none"> ▪ Check network settings. ▪ Temporarily enable only the WLAN as an interface.
Web browser frozen and operation no longer possible	Data transfer is active.	Wait until data transfer or current action is finished.
	Connection lost	<ul style="list-style-type: none"> ▶ Check cable connection and power supply. ▶ Refresh the web browser and restart if necessary.
Display of web browser content is difficult to read or incomplete.	Web browser version used is not optimal.	<ul style="list-style-type: none"> ▶ Use correct web browser version → ☰ 79. ▶ Empty the web browser cache. ▶ Restart the web browser.
	Unsuitable view settings.	Change the font size/display ratio of the Web browser.
Incomplete or no display of content in the web browser	<ul style="list-style-type: none"> ▪ JavaScript is not enabled. ▪ JavaScript cannot be enabled. 	<ul style="list-style-type: none"> ▶ Enable JavaScript. ▶ Enter http://XXX.XXX.X.XX/servlet/basic.html as the IP address.

Fault	Possible causes	Remedial action
Operation with FieldCare or DeviceCare via service interface CDI-RJ45 (port 8000) is not possible.	Firewall of the PC or network is blocking communication.	Depending on the settings of the firewall used on the PC or in the network, the firewall must be adapted or disabled to allow FieldCare/ DeviceCare access.
Flashing the firmware with FieldCare or DeviceCare via service interface CDI-RJ45 (port 8000 or TFTP ports) is not possible.	Firewall of the PC or network is blocking communication.	Depending on the settings of the firewall used on the PC or in the network, the firewall must be adapted or disabled to allow FieldCare/ DeviceCare access.

12.2 Diagnostic information via light emitting diodes

12.2.1 Transmitter

Proline 500 – digital

Different LEDs in the transmitter provide information on the device status.

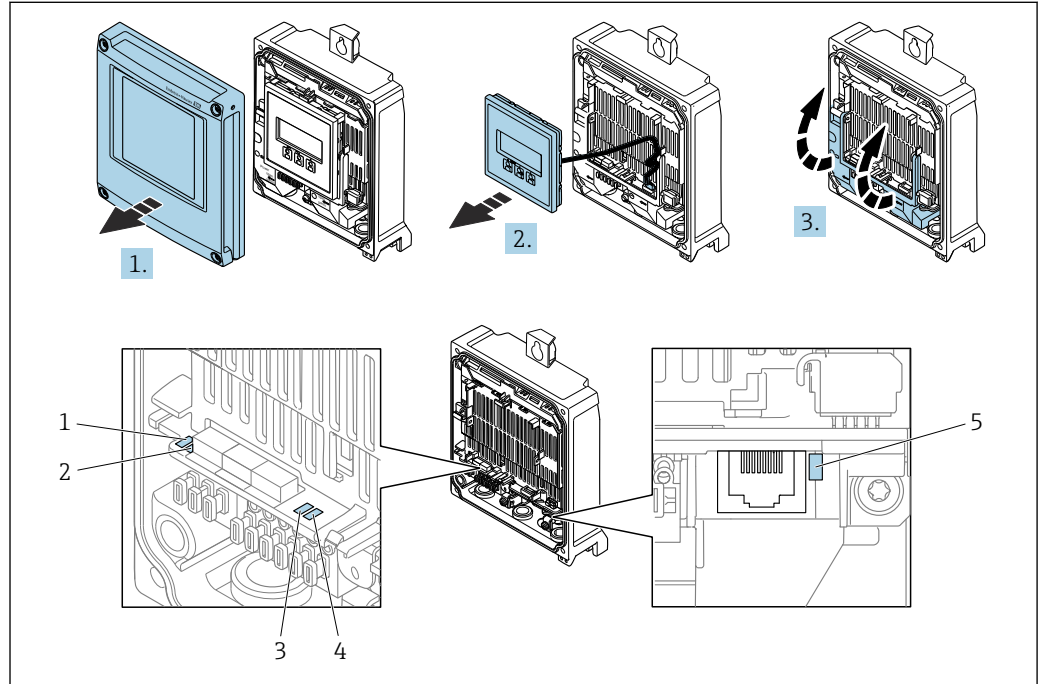

A0029689

- 1 Supply voltage
- 2 Device status
- 3 Not used
- 4 Communication
- 5 Service interface (CDI) active, Ethernet Link/Activity

1. Open the housing cover.
2. Remove the display module.
3. Fold open the terminal cover.

LED	Color	Meaning
1 Supply voltage	Off	Supply voltage is off or too low.
	Green	Supply voltage is OK.
2 Device status (normal operation)	Off	Firmware error
	Green	Device status is OK.
	Flashing green	Device is not configured.
	Flashing red	A diagnostic event with "Warning" diagnostic behavior has occurred.
	Red	A diagnostic event with "Alarm" diagnostic behavior has occurred.
	Flashing red or green	The device restarts.
2 Device status (during start-up)	Flashes red slowly	If > 30 seconds: problem with the boot loader.
	Flashes red quickly	If > 30 seconds: compatibility problem when reading the firmware.
3 Not used	-	-

LED	Color	Meaning
4 Communication	Off	Device does not receive any Profibus data.
	White	Device receives Profibus data.
5 Service interface (CDI), Ethernet Link/Activity	Off	Not connected or no connection established.
	Yellow	Connected and connection established.
	Flashing yellow	Service interface active.

Proline 500

Different LEDs in the transmitter provide information on the device status.

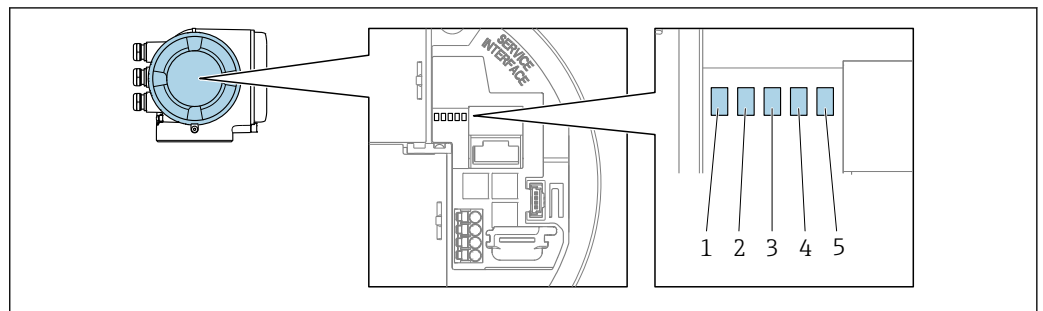

A0029629

- 1 Supply voltage
- 2 Device status
- 3 Not used
- 4 Communication
- 5 Service interface (CDI) active, Ethernet Link/Activity

LED	Color	Meaning
1 Supply voltage	Off	Supply voltage is off or too low.
	Green	Supply voltage is OK.
2 Device status (normal operation)	Off	Firmware error
	Green	Device status is OK.
	Flashing green	Device is not configured.
	Red	A diagnostic event with "Alarm" diagnostic behavior has occurred.
	Flashing red	A diagnostic event with "Warning" diagnostic behavior has occurred.
	Flashing red or green	The device restarts.
2 Device status (during start-up)	Flashes red slowly	If > 30 seconds: problem with the boot loader.
	Flashes red quickly	If > 30 seconds: compatibility problem when reading the firmware.
3 Not used	-	-
4 Communication	Off	Device does not receive any Profibus data.
	White	Device receives Profibus data.
5 Service interface (CDI), Ethernet Link/Activity	Off	Not connected or no connection established.
	Yellow	Connected and connection established.
	Flashing yellow	Service interface active.

12.2.2 Sensor connection housing

Proline 500 – digital

Various light emitting diodes (LED) on the ISEM electronics unit (intelligent sensor electronics module) in the sensor connection housing provide information about the device status.

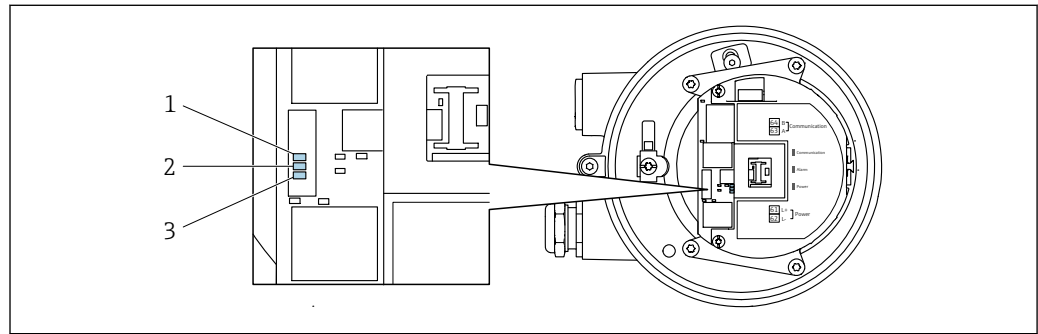

A0029699

- 1 *Communication*
- 2 *Device status*
- 3 *Supply voltage*

LED	Color	Meaning
1 Communication	White	Communication active.
2 Device status (normal operation)	Red	Error
	Flashing red	Warning
2 Device status (during start-up)	Flashes red slowly	If > 30 seconds: problem with the boot loader.
	Flashes red quickly	If > 30 seconds: compatibility problem when reading the firmware.
3 Supply voltage	Green	Supply voltage is ok.
	Off	Supply voltage is off or too low.

12.3 Diagnostic information on local display

12.3.1 Diagnostic message

Faults detected by the self-monitoring system of the measuring device are displayed as a diagnostic message in alternation with the operational display.

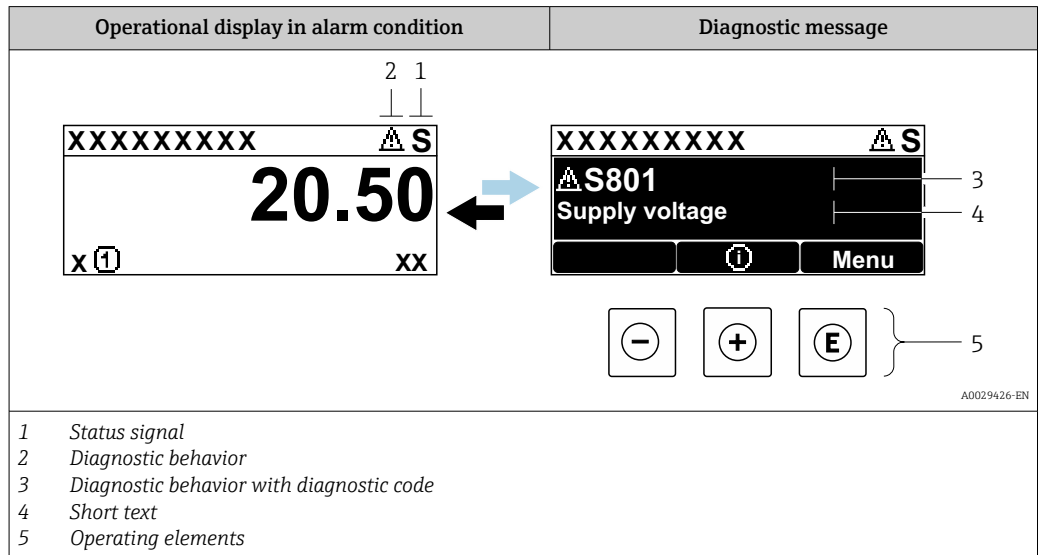

If two or more diagnostic events are pending simultaneously, only the message of the diagnostic event with the highest priority is shown.

- i** Other diagnostic events that have occurred can be displayed in the **Diagnostics** menu:
 - Via parameter → 235
 - Via submenus → 235



Status signals

The status signals provide information on the state and reliability of the device by categorizing the cause of the diagnostic information (diagnostic event).

- i** The status signals are categorized according to VDI/VDE 2650 and NAMUR Recommendation NE 107: F = Failure, C = Function Check, S = Out of Specification, M = Maintenance Required

Symbol	Meaning
F	Failure A device error has occurred. The measured value is no longer valid.
C	Function check The device is in service mode (e.g. during a simulation).
S	Out of specification The device is being operated: Outside its technical specification limits (e.g. outside the process temperature range)
M	Maintenance required Maintenance is required. The measured value remains valid.

Diagnostic behavior



Symbol	Meaning
	Alarm <ul style="list-style-type: none"> ▪ Measurement is interrupted. ▪ Signal outputs and totalizers assume the defined alarm condition. ▪ A diagnostic message is generated.
	Warning <ul style="list-style-type: none"> ▪ Measurement is resumed. ▪ The signal outputs and totalizers are not affected. ▪ A diagnostic message is generated.

Diagnostic information

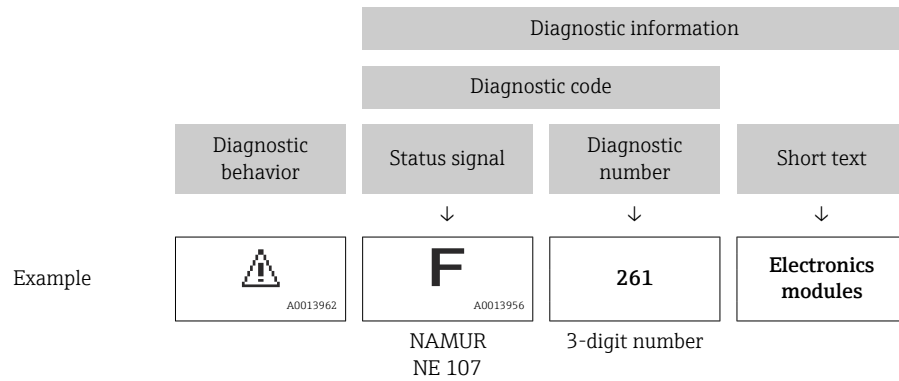
The fault can be identified using the diagnostic information. The short text helps you by providing information about the fault. In addition, the corresponding symbol for the diagnostic behavior is displayed in front of the diagnostic information on the local display.



Operating elements

Operating key	Meaning
	Plus key <i>In menu, submenu</i> Opens the message about the remedial measures.
	Enter key <i>In menu, submenu</i> Opens the operating menu.

12.3.2 Calling up remedial measures

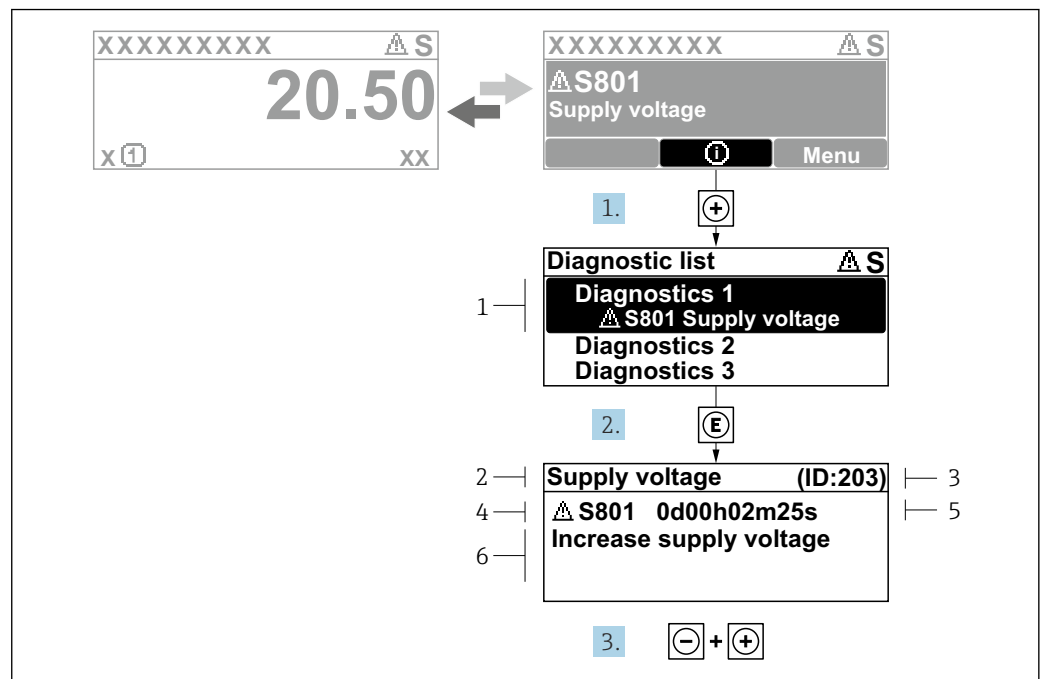

38 Message for remedial measures

- 1 Diagnostic information
- 2 Short text
- 3 Service ID
- 4 Diagnostic behavior with diagnostic code
- 5 Operation time when error occurred
- 6 Remedial measures

1. The user is in the diagnostic message.
Press \oplus ($\text{\textcircled{1}}$ symbol).
↳ The **Diagnostic list** submenu opens.
2. Select the desired diagnostic event with \oplus or \ominus and press $\text{\textcircled{E}}$.
↳ The message about the remedial measures opens.
3. Press \ominus + \oplus simultaneously.
↳ The message about the remedial measures closes.

The user is in the **Diagnostics** menu at an entry for a diagnostics event, e.g. in the **Diagnostic list** submenu or **Previous diagnostics** parameter.

1. Press $\text{\textcircled{E}}$.
↳ The message for the remedial measures for the selected diagnostic event opens.
2. Press \ominus + \oplus simultaneously.
↳ The message for the remedial measures closes.



12.4 Diagnostic information in the web browser

12.4.1 Diagnostic options

Any faults detected by the measuring device are displayed in the Web browser on the home page once the user has logged on.





- 1 Status area with status signal
- 2 Diagnostic information
- 3 Remedial measures with service ID

 In addition, diagnostic events which have occurred can be shown in the **Diagnostics** menu:

- Via parameter →  235
- Via submenu →  235

Status signals

The status signals provide information on the state and reliability of the device by categorizing the cause of the diagnostic information (diagnostic event).

Symbol	Meaning
	Failure A device error has occurred. The measured value is no longer valid.
	Function check The device is in service mode (e.g. during a simulation).
	Out of specification The device is being operated: Outside its technical specification limits (e.g. outside the process temperature range)
	Maintenance required Maintenance is required. The measured value remains valid.

 The status signals are categorized in accordance with VDI/VDE 2650 and NAMUR Recommendation NE 107.

12.4.2 Calling up remedy information

Remedy information is provided for every diagnostic event to ensure that problems can be rectified quickly. These measures are displayed in red along with the diagnostic event and the related diagnostic information.

12.5 Diagnostic information in FieldCare or DeviceCare

12.5.1 Diagnostic options

Any faults detected by the measuring device are displayed on the home page of the operating tool once the connection has been established.

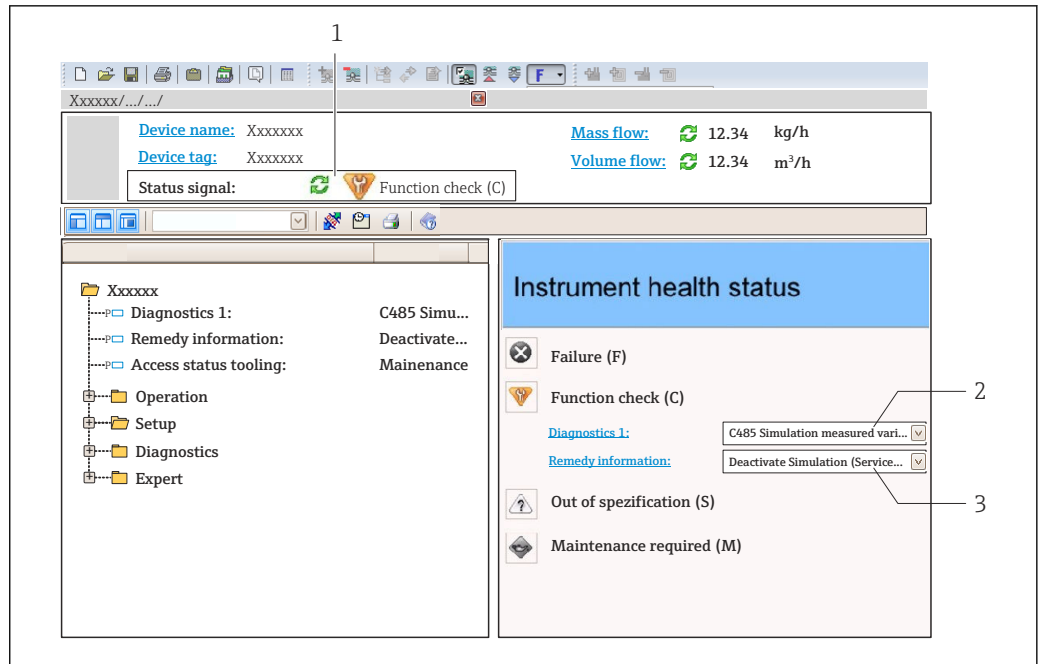

- 1 Status area with status signal → 175
- 2 Diagnostic information → 176
- 3 Remedial measures with service ID

i In addition, diagnostic events which have occurred can be shown in the **Diagnostics** menu:

- Via parameter → 235
- Via submenu → 235

Diagnostic information

The fault can be identified using the diagnostic information. The short text helps you by providing information about the fault. In addition, the corresponding symbol for the diagnostic behavior is displayed in front of the diagnostic information on the local display.

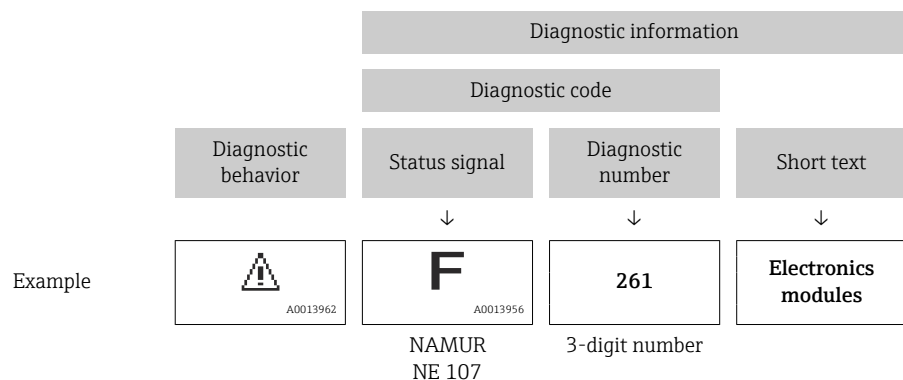

12.5.2 Calling up remedy information

Remedy information is provided for every diagnostic event to ensure that problems can be rectified quickly:

- On the home page
Remedy information is displayed in a separate field below the diagnostics information.
- In the **Diagnostics** menu
Remedy information can be called up in the working area of the user interface.

The user is in the **Diagnostics** menu.

1. Call up the desired parameter.
2. On the right in the working area, mouse over the parameter.
 - ↳ A tool tip with remedy information for the diagnostic event appears.

12.6 Adapting the diagnostic information

12.6.1 Adapting the diagnostic behavior

Each item of diagnostic information is assigned a specific diagnostic behavior at the factory. The user can change this assignment for specific diagnostic information in the **Diagnostic behavior** submenu.

i Diagnostic behavior in accordance with Specification PROFIBUS PA Profile 3.02, Condensed Status.

Expert → System → Diagnostic handling → Diagnostic behavior

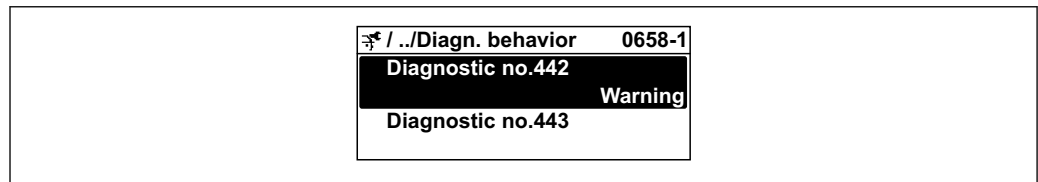

A0019179-EN

Available diagnostic behaviors

The following diagnostic behaviors can be assigned:

Diagnostic behavior	Description
Alarm	The device stops measurement. The totalizers assume the defined alarm condition. A diagnostic message is generated.
Warning	The device continues to measure. Measured value output via PROFIBUS and totalizers are not affected. A diagnostic message is generated.
Logbook entry only	The device continues to measure. The diagnostic message is only displayed in the Event logbook submenu (Event list submenu) and is not displayed in alternating sequence with the operational display.
Off	The diagnostic event is ignored, and no diagnostic message is generated or entered.

Displaying the measured value status

If the Analog Input, Digital Input and Totalizer function blocks are configured for cyclic data transmission, the device status is coded as per PROFIBUS PA Profile 3.02 Specification and transmitted along with the measured value to the PROFIBUS Master (Class 1) via the coding byte (byte 5). The coding byte is split into three segments: Quality, Quality Substatus and Limits.

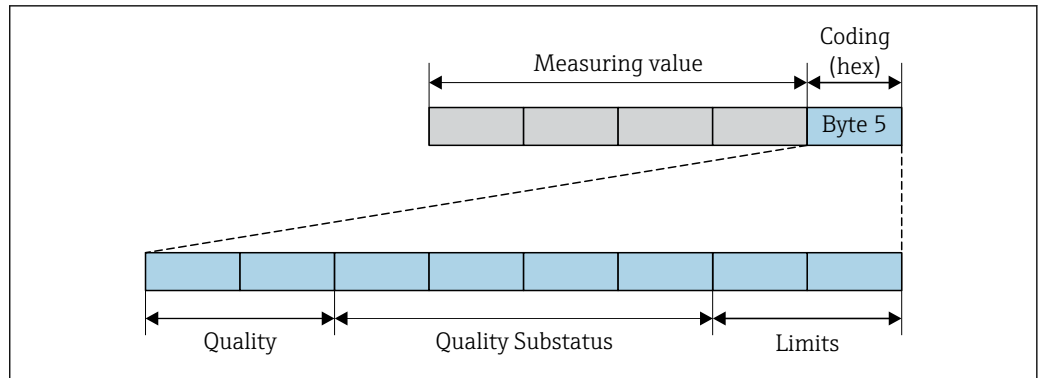

A0032228-EN

39 Structure of the coding byte

The content of the coding byte depends on the configured failure mode in the individual function block. Depending on which failure mode has been configured, status information in accordance with PROFINET PA Profile Specification 4 is transmitted to the PROFIBUS master (Class 1) via the coding byte status information.

Determining the measured value status and device status via the diagnostic behavior

When the diagnostic behavior is assigned, this also changes the measured value status and device status for the diagnostic information. The measured value status and device status depend on the choice of diagnostic behavior and on the group in which the diagnostic information is located.

The diagnostic information is grouped as follows:

- Diagnostic information pertaining to the sensor: diagnostic number 000 to 199
→ 181
- Diagnostic information pertaining to the electronics: diagnostic number 200 to 399
→ 182
- Diagnostic information pertaining to the configuration: diagnostic number 400 to 599
→ 182
- Diagnostic information pertaining to the process: diagnostic number 800 to 999
→ 182

Depending on the group in which the diagnostic information is located, the following measured value status and device status are firmly assigned to the particular diagnostic behavior:

Diagnostic information pertaining to the sensor: diagnostic number 000 to 199

Diagnostic behavior (configurable)	Measured value status (fixed assignment)				Device diagnosis (fixed assignment)
	Quality	Quality Substatus	Coding (hex)	Category (NE107)	
Alarm	BAD	Maintenance alarm	0x24 to 0x27	F (Failure)	Maintenance alarm
Warning	GOOD	Maintenance demanded	0xA8 to 0xAB	M (Maintenance)	Maintenance demanded
Logbook entry only	GOOD	ok	0x80 to 0x8E	-	-
Off					

*Diagnostic information pertaining to the electronics: diagnostic number 200 to 399**Diagnostic number 200 to 301, 303 to 399*

Diagnostic behavior (configurable)	Measured value status (fixed assignment)				Device diagnostics (fixed assignment)
	Quality	Quality Substatus	Coding (hex)	Category (NE107)	
Alarm	BAD	Maintenance alarm	0x24 to 0x27	F (Failure)	Maintenance alarm
Warning					
Logbook entry only	GOOD	ok	0x80 to 0x8E	-	-
Off					

Diagnostic information 302

Diagnostic behavior (configurable)	Measured value status (fixed assignment)				Device diagnostics (fixed assignment)
	Quality	Quality Substatus	Coding (hex)	Category (NE107)	
Alarm	BAD	Function check, local override	0x24 to 0x27	C	Function check
Warning	GOOD	Function check	0xBC to 0xBF	-	-

Data logging continues when Heartbeat Verification is started. The signal outputs and totalizers are not affected.

- Signal status: Function check
- Choice of diagnostic behavior: alarm or warning (factory setting)

When the Heartbeat Verification is started, data logging is interrupted, the last valid measured value is output and the totalizer counter is stopped.

Diagnostic information pertaining to the configuration: diagnostic number 400 to 599

Diagnostic behavior (configurable)	Measured value status (fixed assignment)				Device diagnosis (fixed assignment)
	Quality	Quality Substatus	Coding (hex)	Category (NE107)	
Alarm	BAD	Process related	0x28 to 0x2B	F (Failure)	Invalid process condition
Warning	UNCERTAIN	Process related	0x78 to 0x7B	S (Out of specification)	Invalid process condition
Logbook entry only	GOOD	ok	0x80 to 0x8E	-	-
Off					



Diagnostic information pertaining to the process: diagnostic number 800 to 999

Diagnostic behavior (configurable)	Measured value status (fixed assignment)				Device diagnosis (fixed assignment)
	Quality	Quality Substatus	Coding (hex)	Category (NE107)	
Alarm	BAD	Process related	0x28 to 0x2B	F (Failure)	Invalid process condition
Warning	UNCERTAIN	Process related	0x78 to 0x7B	S (Out of specification)	Invalid process condition

Diagnostic behavior (configurable)	Measured value status (fixed assignment)				Device diagnosis (fixed assignment)
	Quality	Quality Substatus	Coding (hex)	Category (NE107)	
Logbook entry only	GOOD	ok	0x80 to 0x8E	-	-
Off					

12.7 Overview of diagnostic information

-  The amount of diagnostic information and the number of measured variables affected increase if the measuring device has one or more application packages.
- All of the measured variables affected in the entire Promass instrument family are always listed under "Measured variables affected". The measured variables available for the device in question depend on the device version. When assigning the measured variables to the device functions, for example to the individual outputs, all of the measured variables available for the device version in question are available for selection.

 In the case of some items of diagnostic information, the diagnostic behavior can be changed. Adapting the diagnostic information →  180

12.7.1 Diagnostic of sensor

Diagnostic information		Remedy instructions	
No.	Short text		
022	Temperature sensor defective	1. Check or replace sensor electronic module (ISEM) 2. If available: Check connection cable between sensor and transmitter 3. Replace sensor	
	Measured variable status		
	Quality: Bad		
	Quality substatus: Maintenance alarm		
	Coding (hex): 0x24 to 0x27		
	Status signal: F		
	Diagnostic behavior: Alarm		
	Influenced measured variables		
	<ul style="list-style-type: none"> ▪ Oscillation amplitude 1 ▪ Oscillation amplitude 2 ▪ Signal asymmetry ▪ Carrier mass flow ▪ Carrier pipe temperature ▪ Target corrected volume flow ▪ Carrier corrected volume flow ▪ Concentration ▪ Oscillation damping 1 ▪ Oscillation damping 2 ▪ Density ▪ Oil density ▪ Water density ▪ Dynamic viscosity ▪ Sensor electronic temperature (ISEM) ▪ Empty pipe detection option ▪ GSV flow ▪ GSV flow alternative 	<ul style="list-style-type: none"> ▪ Kinematic viscosity ▪ Low flow cut off option ▪ Mass flow ▪ Oil mass flow ▪ Water mass flow ▪ HBSI ▪ NSV flow ▪ NSV flow alternative ▪ External pressure ▪ Exciter current 1 ▪ Exciter current 2 ▪ Oscillation frequency 1 ▪ Oscillation frequency 2 ▪ S&W volume flow ▪ Reference density ▪ Reference density alternative ▪ Corrected volume flow ▪ Oil corrected volume flow 	<ul style="list-style-type: none"> ▪ Water corrected volume flow ▪ Oscillation damping fluctuation 1 ▪ Oscillation damping fluctuation 2 ▪ Frequency fluctuation 1 ▪ Frequency fluctuation 2 ▪ Target mass flow ▪ Carrier volume flow ▪ Target volume flow ▪ Temp. compensated dynamic viscosity ▪ Temp. compensated kinematic viscosity ▪ Temperature ▪ Status ▪ Volume flow ▪ Oil volume flow ▪ Water volume flow ▪ Water cut

Diagnostic information		Remedy instructions	
No.	Short text		
046	Sensor limit exceeded	1. Inspect sensor 2. Check process condition	
	Measured variable status [from the factory] ¹⁾		
	Quality		Good
	Quality substatus		Maintenance demanded
	Coding (hex)		0xA8 to 0xAB
	Status signal		S
	Diagnostic behavior		Warning
Influenced measured variables			
<ul style="list-style-type: none"> ▪ Oscillation amplitude 1 ▪ Oscillation amplitude 2 ▪ Signal asymmetry ▪ Carrier mass flow ▪ Carrier pipe temperature ▪ Target corrected volume flow ▪ Carrier corrected volume flow ▪ Concentration ▪ Oscillation damping 1 ▪ Oscillation damping 2 ▪ Density ▪ Oil density ▪ Water density ▪ Dynamic viscosity ▪ Sensor electronic temperature (ISEM) ▪ Empty pipe detection option ▪ GSV flow ▪ GSV flow alternative ▪ Kinematic viscosity ▪ Low flow cut off option ▪ Mass flow ▪ Oil mass flow ▪ Water mass flow ▪ HBSI ▪ NSV flow ▪ NSV flow alternative ▪ External pressure ▪ Exciter current 1 ▪ Exciter current 2 ▪ Oscillation frequency 1 ▪ Oscillation frequency 2 ▪ S&W volume flow ▪ Reference density ▪ Reference density alternative ▪ Corrected volume flow ▪ Oil corrected volume flow ▪ Water corrected volume flow ▪ Oscillation damping fluctuation 1 ▪ Oscillation damping fluctuation 2 ▪ Frequency fluctuation 1 ▪ Frequency fluctuation 2 ▪ Target mass flow ▪ Carrier volume flow ▪ Target volume flow ▪ Temp. compensated dynamic viscosity ▪ Temp. compensated kinematic viscosity ▪ Temperature ▪ Status ▪ Volume flow ▪ Oil volume flow ▪ Water volume flow ▪ Water cut 			

1) Diagnostic behavior can be changed. This causes the overall status of the measured variable to change.

Diagnostic information		Remedy instructions	
No.	Short text		
062	Sensor connection faulty	1. Check or replace sensor electronic module (ISEM) 2. If available: Check connection cable between sensor and transmitter 3. Replace sensor	
	Measured variable status		
	Quality		Bad
	Quality substatus		Maintenance alarm
	Coding (hex)		0x24 to 0x27
	Status signal		F
	Diagnostic behavior		Alarm
Influenced measured variables			
<ul style="list-style-type: none"> ▪ Oscillation amplitude 1 ▪ Oscillation amplitude 2 ▪ Signal asymmetry ▪ Carrier mass flow ▪ Carrier pipe temperature ▪ Target corrected volume flow ▪ Carrier corrected volume flow ▪ Concentration ▪ Oscillation damping 1 ▪ Oscillation damping 2 ▪ Density ▪ Oil density ▪ Water density ▪ Dynamic viscosity ▪ Sensor electronic temperature (ISEM) ▪ Empty pipe detection option ▪ GSV flow ▪ GSV flow alternative 		<ul style="list-style-type: none"> ▪ Kinematic viscosity ▪ Low flow cut off option ▪ Mass flow ▪ Oil mass flow ▪ Water mass flow ▪ HBSI ▪ NSV flow ▪ NSV flow alternative ▪ External pressure ▪ Exciter current 1 ▪ Exciter current 2 ▪ Oscillation frequency 1 ▪ Oscillation frequency 2 ▪ S&W volume flow ▪ Reference density ▪ Reference density alternative ▪ Corrected volume flow ▪ Oil corrected volume flow 	
		<ul style="list-style-type: none"> ▪ Water corrected volume flow ▪ Oscillation damping fluctuation 1 ▪ Oscillation damping fluctuation 2 ▪ Frequency fluctuation 1 ▪ Frequency fluctuation 2 ▪ Target mass flow ▪ Carrier volume flow ▪ Target volume flow ▪ Temp. compensated dynamic viscosity ▪ Temp. compensated kinematic viscosity ▪ Temperature ▪ Status ▪ Volume flow ▪ Oil volume flow ▪ Water volume flow ▪ Water cut 	

Diagnostic information		Remedy instructions	
No.	Short text		
063	Exciter current faulty	1. Check or replace sensor electronic module (ISEM) 2. If available: Check connection cable between sensor and transmitter 3. Replace sensor	
	Measured variable status		
	Quality		Bad
	Quality substatus		Maintenance alarm
	Coding (hex)		0x24 to 0x27
	Status signal		S
	Diagnostic behavior		Alarm
Influenced measured variables			
<ul style="list-style-type: none"> ▪ Oscillation amplitude 1 ▪ Oscillation amplitude 2 ▪ Signal asymmetry ▪ Carrier mass flow ▪ Carrier pipe temperature ▪ Target corrected volume flow ▪ Carrier corrected volume flow ▪ Concentration ▪ Oscillation damping 1 ▪ Oscillation damping 2 ▪ Density ▪ Oil density ▪ Water density ▪ Dynamic viscosity ▪ Sensor electronic temperature (ISEM) ▪ Empty pipe detection option ▪ GSV flow ▪ GSV flow alternative ▪ Kinematic viscosity ▪ Low flow cut off option ▪ Mass flow ▪ Oil mass flow ▪ Water mass flow ▪ HBSI ▪ NSV flow ▪ NSV flow alternative ▪ External pressure ▪ Exciter current 1 ▪ Exciter current 2 ▪ Oscillation frequency 1 ▪ Oscillation frequency 2 ▪ S&W volume flow ▪ Reference density ▪ Reference density alternative ▪ Corrected volume flow ▪ Oil corrected volume flow ▪ Water corrected volume flow ▪ Oscillation damping fluctuation 1 ▪ Oscillation damping fluctuation 2 ▪ Frequency fluctuation 1 ▪ Frequency fluctuation 2 ▪ Target mass flow ▪ Carrier volume flow ▪ Target volume flow ▪ Temp. compensated dynamic viscosity ▪ Temp. compensated kinematic viscosity ▪ Temperature ▪ Status ▪ Volume flow ▪ Oil volume flow ▪ Water volume flow ▪ Water cut 			

Diagnostic information		Remedy instructions	
No.	Short text		
082	Data storage	1. Check module connections 2. Contact service	
	Measured variable status		
	Quality		Bad
	Quality substatus		Maintenance alarm
	Coding (hex)		0x24 to 0x27
	Status signal		F
	Diagnostic behavior		Alarm
Influenced measured variables			
<ul style="list-style-type: none"> ▪ Oscillation amplitude 1 ▪ Oscillation amplitude 2 ▪ Signal asymmetry ▪ Carrier mass flow ▪ Carrier pipe temperature ▪ Target corrected volume flow ▪ Carrier corrected volume flow ▪ Concentration ▪ Measured values 1 ▪ Measured values 2 ▪ Measured values 3 ▪ Oscillation damping 1 ▪ Oscillation damping 2 ▪ Density ▪ Oil density ▪ Water density ▪ Dynamic viscosity ▪ Sensor electronic temperature (ISEM) ▪ Empty pipe detection option ▪ GSV flow ▪ GSV flow alternative ▪ Kinematic viscosity ▪ Low flow cut off option ▪ Mass flow ▪ Oil mass flow ▪ Water mass flow ▪ HBSI ▪ NSV flow ▪ NSV flow alternative ▪ External pressure ▪ Exciter current 1 ▪ Exciter current 2 ▪ Oscillation frequency 1 ▪ Oscillation frequency 2 ▪ S&W volume flow ▪ Reference density ▪ Reference density alternative ▪ Corrected volume flow ▪ Oil corrected volume flow ▪ Water corrected volume flow ▪ Oscillation damping fluctuation 1 ▪ Oscillation damping fluctuation 2 ▪ Frequency fluctuation 1 ▪ Frequency fluctuation 2 ▪ Target mass flow ▪ Carrier volume flow ▪ Target volume flow ▪ Temp. compensated dynamic viscosity ▪ Temp. compensated kinematic viscosity ▪ Temperature ▪ Status ▪ Volume flow ▪ Oil volume flow ▪ Water volume flow ▪ Water cut 			

Diagnostic information		Remedy instructions	
No.	Short text		
083	Memory content	1. Restart device 2. Restore HistoROM S-DAT backup ('Device reset' parameter) 3. Replace HistoROM S-DAT	
Measured variable status			
Quality	Bad		
Quality substatus	Maintenance alarm		
Coding (hex)	0x24 to 0x27		
Status signal	F		
Diagnostic behavior	Alarm		
Influenced measured variables			
<ul style="list-style-type: none"> ▪ Oscillation amplitude 1 ▪ Oscillation amplitude 2 ▪ Signal asymmetry ▪ Carrier mass flow ▪ Carrier pipe temperature ▪ Target corrected volume flow ▪ Carrier corrected volume flow ▪ Concentration ▪ Measured values 1 ▪ Measured values 2 ▪ Measured values 3 ▪ Oscillation damping 1 ▪ Oscillation damping 2 ▪ Density ▪ Oil density ▪ Water density ▪ Dynamic viscosity ▪ Sensor electronic temperature (ISEM) ▪ Empty pipe detection option 		<ul style="list-style-type: none"> ▪ GSV flow ▪ GSV flow alternative ▪ Kinematic viscosity ▪ Low flow cut off option ▪ Mass flow ▪ Oil mass flow ▪ Water mass flow ▪ HBSI ▪ NSV flow ▪ NSV flow alternative ▪ External pressure ▪ Exciter current 1 ▪ Exciter current 2 ▪ Oscillation frequency 1 ▪ Oscillation frequency 2 ▪ S&W volume flow ▪ Reference density ▪ Reference density alternative ▪ Corrected volume flow 	<ul style="list-style-type: none"> ▪ Oil corrected volume flow ▪ Water corrected volume flow ▪ Oscillation damping fluctuation 1 ▪ Oscillation damping fluctuation 2 ▪ Frequency fluctuation 1 ▪ Frequency fluctuation 2 ▪ Target mass flow ▪ Carrier volume flow ▪ Target volume flow ▪ Temp. compensated dynamic viscosity ▪ Temp. compensated kinematic viscosity ▪ Temperature ▪ Status ▪ Volume flow ▪ Oil volume flow ▪ Water volume flow ▪ Water cut

Diagnostic information		Remedy instructions	
No.	Short text		
140	Sensor signal asymmetrical	1. Check or replace sensor electronic module (ISEM) 2. If available: Check connection cable between sensor and transmitter 3. Replace sensor	
	Measured variable status [from the factory] ¹⁾		
	Quality		Bad
	Quality substatus		Maintenance alarm
	Coding (hex)		0x24 to 0x27
	Status signal		S
	Diagnostic behavior		Alarm
Influenced measured variables			
<ul style="list-style-type: none"> ▪ Oscillation amplitude 1 ▪ Oscillation amplitude 2 ▪ Signal asymmetry ▪ Carrier mass flow ▪ Carrier pipe temperature ▪ Target corrected volume flow ▪ Carrier corrected volume flow ▪ Concentration ▪ Measured values 1 ▪ Measured values 2 ▪ Measured values 3 ▪ Oscillation damping 1 ▪ Oscillation damping 2 ▪ Density ▪ Oil density ▪ Water density ▪ Dynamic viscosity ▪ Sensor electronic temperature (ISEM) ▪ Empty pipe detection option ▪ GSV flow ▪ GSV flow alternative ▪ Kinematic viscosity ▪ Low flow cut off option ▪ Mass flow ▪ Oil mass flow ▪ Water mass flow ▪ HBSI ▪ NSV flow ▪ NSV flow alternative ▪ External pressure ▪ Exciter current 1 ▪ Exciter current 2 ▪ Oscillation frequency 1 ▪ Oscillation frequency 2 ▪ S&W volume flow ▪ Reference density ▪ Reference density alternative ▪ Corrected volume flow ▪ Oil corrected volume flow ▪ Water corrected volume flow ▪ Oscillation damping fluctuation 1 ▪ Oscillation damping fluctuation 2 ▪ Frequency fluctuation 1 ▪ Frequency fluctuation 2 ▪ Target mass flow ▪ Carrier volume flow ▪ Target volume flow ▪ Temp. compensated dynamic viscosity ▪ Temp. compensated kinematic viscosity ▪ Temperature ▪ Status ▪ Volume flow ▪ Oil volume flow ▪ Water volume flow ▪ Water cut 			

1) Diagnostic behavior can be changed. This causes the overall status of the measured variable to change.

Diagnostic information		Remedy instructions	
No.	Short text		
144	Measuring error too high	1. Check or change sensor 2. Check process conditions	
	Measured variable status [from the factory] ¹⁾		
	Quality		Bad
	Quality substatus		Maintenance alarm
	Coding (hex)		0x24 to 0x27
	Status signal		F
	Diagnostic behavior		Alarm
Influenced measured variables			
<ul style="list-style-type: none"> ▪ Oscillation amplitude 1 ▪ Oscillation amplitude 2 ▪ Signal asymmetry ▪ Carrier mass flow ▪ Carrier pipe temperature ▪ Target corrected volume flow ▪ Carrier corrected volume flow ▪ Concentration ▪ Oscillation damping 1 ▪ Oscillation damping 2 ▪ Density ▪ Oil density ▪ Water density ▪ Dynamic viscosity ▪ Sensor electronic temperature (ISEM) ▪ Empty pipe detection option ▪ GSV flow ▪ GSV flow alternative ▪ Kinematic viscosity ▪ Low flow cut off option ▪ Mass flow ▪ Oil mass flow ▪ Water mass flow ▪ HBSI ▪ NSV flow ▪ NSV flow alternative ▪ External pressure ▪ Exciter current 1 ▪ Exciter current 2 ▪ Oscillation frequency 1 ▪ Oscillation frequency 2 ▪ S&W volume flow ▪ Reference density ▪ Reference density alternative ▪ Corrected volume flow ▪ Oil corrected volume flow ▪ Water corrected volume flow ▪ Oscillation damping fluctuation 1 ▪ Oscillation damping fluctuation 2 ▪ Frequency fluctuation 1 ▪ Frequency fluctuation 2 ▪ Target mass flow ▪ Carrier volume flow ▪ Target volume flow ▪ Temp. compensated dynamic viscosity ▪ Temp. compensated kinematic viscosity ▪ Temperature ▪ Status ▪ Volume flow ▪ Oil volume flow ▪ Water volume flow ▪ Water cut 			

1) Diagnostic behavior can be changed. This causes the overall status of the measured variable to change.

12.7.2 Diagnostic of electronic

Diagnostic information		Remedy instructions			
No.	Short text				
201	Device failure	1. Restart device 2. Contact service			
	Measured variable status				
	Quality		Bad		
	Quality substatus		Maintenance alarm		
	Coding (hex)		0x24 to 0x27		
	Status signal		F		
	Diagnostic behavior		Alarm		
Influenced measured variables					
<table border="0"> <tr> <td style="vertical-align: top;"> <ul style="list-style-type: none"> ▪ Oscillation amplitude 1 ▪ Oscillation amplitude 2 ▪ Signal asymmetry ▪ Carrier mass flow ▪ Carrier pipe temperature ▪ Target corrected volume flow ▪ Carrier corrected volume flow ▪ Concentration ▪ Measured values 1 ▪ Measured values 2 ▪ Measured values 3 ▪ Oscillation damping 1 ▪ Oscillation damping 2 ▪ Density ▪ Oil density ▪ Water density ▪ Dynamic viscosity ▪ Sensor electronic temperature (ISEM) ▪ Empty pipe detection option </td> <td style="vertical-align: top;"> <ul style="list-style-type: none"> ▪ GSV flow ▪ GSV flow alternative ▪ Kinematic viscosity ▪ Low flow cut off option ▪ Mass flow ▪ Oil mass flow ▪ Water mass flow ▪ HBSI ▪ NSV flow ▪ NSV flow alternative ▪ External pressure ▪ Exciter current 1 ▪ Exciter current 2 ▪ Oscillation frequency 1 ▪ Oscillation frequency 2 ▪ S&W volume flow ▪ Reference density ▪ Reference density alternative ▪ Corrected volume flow </td> <td style="vertical-align: top;"> <ul style="list-style-type: none"> ▪ Oil corrected volume flow ▪ Water corrected volume flow ▪ Oscillation damping fluctuation 1 ▪ Oscillation damping fluctuation 2 ▪ Frequency fluctuation 1 ▪ Frequency fluctuation 2 ▪ Target mass flow ▪ Carrier volume flow ▪ Target volume flow ▪ Temp. compensated dynamic viscosity ▪ Temp. compensated kinematic viscosity ▪ Temperature ▪ Status ▪ Volume flow ▪ Oil volume flow ▪ Water volume flow ▪ Water cut </td> </tr> </table>			<ul style="list-style-type: none"> ▪ Oscillation amplitude 1 ▪ Oscillation amplitude 2 ▪ Signal asymmetry ▪ Carrier mass flow ▪ Carrier pipe temperature ▪ Target corrected volume flow ▪ Carrier corrected volume flow ▪ Concentration ▪ Measured values 1 ▪ Measured values 2 ▪ Measured values 3 ▪ Oscillation damping 1 ▪ Oscillation damping 2 ▪ Density ▪ Oil density ▪ Water density ▪ Dynamic viscosity ▪ Sensor electronic temperature (ISEM) ▪ Empty pipe detection option 	<ul style="list-style-type: none"> ▪ GSV flow ▪ GSV flow alternative ▪ Kinematic viscosity ▪ Low flow cut off option ▪ Mass flow ▪ Oil mass flow ▪ Water mass flow ▪ HBSI ▪ NSV flow ▪ NSV flow alternative ▪ External pressure ▪ Exciter current 1 ▪ Exciter current 2 ▪ Oscillation frequency 1 ▪ Oscillation frequency 2 ▪ S&W volume flow ▪ Reference density ▪ Reference density alternative ▪ Corrected volume flow 	<ul style="list-style-type: none"> ▪ Oil corrected volume flow ▪ Water corrected volume flow ▪ Oscillation damping fluctuation 1 ▪ Oscillation damping fluctuation 2 ▪ Frequency fluctuation 1 ▪ Frequency fluctuation 2 ▪ Target mass flow ▪ Carrier volume flow ▪ Target volume flow ▪ Temp. compensated dynamic viscosity ▪ Temp. compensated kinematic viscosity ▪ Temperature ▪ Status ▪ Volume flow ▪ Oil volume flow ▪ Water volume flow ▪ Water cut
<ul style="list-style-type: none"> ▪ Oscillation amplitude 1 ▪ Oscillation amplitude 2 ▪ Signal asymmetry ▪ Carrier mass flow ▪ Carrier pipe temperature ▪ Target corrected volume flow ▪ Carrier corrected volume flow ▪ Concentration ▪ Measured values 1 ▪ Measured values 2 ▪ Measured values 3 ▪ Oscillation damping 1 ▪ Oscillation damping 2 ▪ Density ▪ Oil density ▪ Water density ▪ Dynamic viscosity ▪ Sensor electronic temperature (ISEM) ▪ Empty pipe detection option 	<ul style="list-style-type: none"> ▪ GSV flow ▪ GSV flow alternative ▪ Kinematic viscosity ▪ Low flow cut off option ▪ Mass flow ▪ Oil mass flow ▪ Water mass flow ▪ HBSI ▪ NSV flow ▪ NSV flow alternative ▪ External pressure ▪ Exciter current 1 ▪ Exciter current 2 ▪ Oscillation frequency 1 ▪ Oscillation frequency 2 ▪ S&W volume flow ▪ Reference density ▪ Reference density alternative ▪ Corrected volume flow 	<ul style="list-style-type: none"> ▪ Oil corrected volume flow ▪ Water corrected volume flow ▪ Oscillation damping fluctuation 1 ▪ Oscillation damping fluctuation 2 ▪ Frequency fluctuation 1 ▪ Frequency fluctuation 2 ▪ Target mass flow ▪ Carrier volume flow ▪ Target volume flow ▪ Temp. compensated dynamic viscosity ▪ Temp. compensated kinematic viscosity ▪ Temperature ▪ Status ▪ Volume flow ▪ Oil volume flow ▪ Water volume flow ▪ Water cut 			

Diagnostic information		Remedy instructions
No.	Short text	
242	Software incompatible	1. Check software 2. Flash or change main electronics module
Measured variable status		
Quality	Bad	
Quality substatus	Maintenance alarm	
Coding (hex)	0x24 to 0x27	
Status signal	F	
Diagnostic behavior	Alarm	
Influenced measured variables		
<ul style="list-style-type: none"> ▪ Oscillation amplitude 1 ▪ Oscillation amplitude 2 ▪ Signal asymmetry ▪ Carrier mass flow ▪ Carrier pipe temperature ▪ Target corrected volume flow ▪ Carrier corrected volume flow ▪ Concentration ▪ Measured values 1 ▪ Measured values 2 ▪ Measured values 3 ▪ Oscillation damping 1 ▪ Oscillation damping 2 ▪ Density ▪ Oil density ▪ Water density ▪ Dynamic viscosity ▪ Sensor electronic temperature (ISEM) ▪ Empty pipe detection option 		<ul style="list-style-type: none"> ▪ GSV flow ▪ GSV flow alternative ▪ Kinematic viscosity ▪ Low flow cut off option ▪ Mass flow ▪ Oil mass flow ▪ Water mass flow ▪ HBSI ▪ NSV flow ▪ NSV flow alternative ▪ External pressure ▪ Exciter current 1 ▪ Exciter current 2 ▪ Oscillation frequency 1 ▪ Oscillation frequency 2 ▪ S&W volume flow ▪ Reference density ▪ Reference density alternative ▪ Corrected volume flow
		<ul style="list-style-type: none"> ▪ Oil corrected volume flow ▪ Water corrected volume flow ▪ Oscillation damping fluctuation 1 ▪ Oscillation damping fluctuation 2 ▪ Frequency fluctuation 1 ▪ Frequency fluctuation 2 ▪ Target mass flow ▪ Carrier volume flow ▪ Target volume flow ▪ Temp. compensated dynamic viscosity ▪ Temp. compensated kinematic viscosity ▪ Temperature ▪ Status ▪ Volume flow ▪ Oil volume flow ▪ Water volume flow ▪ Water cut

Diagnostic information		Remedy instructions	
No.	Short text		
252	Modules incompatible	1. Check electronic modules 2. Check if correct modules are available (e.g. NEx, Ex) 3. Replace electronic modules	
	Measured variable status		
	Quality		Bad
	Quality substatus		Maintenance alarm
	Coding (hex)		0x24 to 0x27
	Status signal		F
	Diagnostic behavior		Alarm
Influenced measured variables			
<ul style="list-style-type: none"> ▪ Oscillation amplitude 1 ▪ Oscillation amplitude 2 ▪ Signal asymmetry ▪ Carrier mass flow ▪ Carrier pipe temperature ▪ Target corrected volume flow ▪ Carrier corrected volume flow ▪ Concentration ▪ Measured values 1 ▪ Measured values 2 ▪ Measured values 3 ▪ Oscillation damping 1 ▪ Oscillation damping 2 ▪ Density ▪ Oil density ▪ Water density ▪ Dynamic viscosity ▪ Sensor electronic temperature (ISEM) ▪ Empty pipe detection option ▪ GSV flow ▪ GSV flow alternative ▪ Kinematic viscosity ▪ Low flow cut off option ▪ Mass flow ▪ Oil mass flow ▪ Water mass flow ▪ HBSI ▪ NSV flow ▪ NSV flow alternative ▪ External pressure ▪ Exciter current 1 ▪ Exciter current 2 ▪ Oscillation frequency 1 ▪ Oscillation frequency 2 ▪ S&W volume flow ▪ Reference density ▪ Reference density alternative ▪ Corrected volume flow ▪ Oil corrected volume flow ▪ Water corrected volume flow ▪ Oscillation damping fluctuation 1 ▪ Oscillation damping fluctuation 2 ▪ Frequency fluctuation 1 ▪ Frequency fluctuation 2 ▪ Target mass flow ▪ Carrier volume flow ▪ Target volume flow ▪ Temp. compensated dynamic viscosity ▪ Temp. compensated kinematic viscosity ▪ Temperature ▪ Status ▪ Volume flow ▪ Oil volume flow ▪ Water volume flow ▪ Water cut 			

Diagnostic information		Remedy instructions	
No.	Short text		
252	Modules incompatible	1. Check if correct electronic modul is plugged 2. Replace electronic module	
	Measured variable status		
	Quality		Bad
	Quality substatus		Maintenance alarm
	Coding (hex)		0x24 to 0x27
	Status signal		F
	Diagnostic behavior		Alarm
Influenced measured variables			
<ul style="list-style-type: none"> ▪ Oscillation amplitude 1 ▪ Oscillation amplitude 2 ▪ Signal asymmetry ▪ Carrier mass flow ▪ Carrier pipe temperature ▪ Concentration ▪ Measured values 1 ▪ Measured values 2 ▪ Measured values 3 ▪ Oscillation damping 1 ▪ Oscillation damping 2 ▪ Density ▪ Dynamic viscosity ▪ Sensor electronic temperature (ISEM) ▪ Empty pipe detection option ▪ Kinematic viscosity ▪ Low flow cut off option ▪ Mass flow ▪ HBSI ▪ External pressure ▪ Exciter current 1 ▪ Exciter current 2 ▪ Oscillation frequency 1 ▪ Oscillation frequency 2 ▪ Reference density ▪ Corrected volume flow ▪ Oscillation damping fluctuation 1 ▪ Oscillation damping fluctuation 2 ▪ Frequency fluctuation 1 ▪ Frequency fluctuation 2 ▪ Target mass flow ▪ Temp. compensated dynamic viscosity ▪ Temp. compensated kinematic viscosity ▪ Temperature ▪ Status ▪ Volume flow 			

Diagnostic information		Remedy instructions
No.	Short text	
262	Sensor electronic connection faulty	1. Check or replace connection cable between sensor electronic module (ISEM) and main electronics 2. Check or replace ISEM or main electronics
Measured variable status		
Quality	Bad	
Quality substatus	Maintenance alarm	
Coding (hex)	0x24 to 0x27	
Status signal	F	
Diagnostic behavior	Alarm	
Influenced measured variables		
<ul style="list-style-type: none"> ▪ Oscillation amplitude 1 ▪ Oscillation amplitude 2 ▪ Signal asymmetry ▪ Carrier mass flow ▪ Carrier pipe temperature ▪ Target corrected volume flow ▪ Carrier corrected volume flow ▪ Concentration ▪ Measured values 1 ▪ Measured values 2 ▪ Measured values 3 ▪ Oscillation damping 1 ▪ Oscillation damping 2 ▪ Density ▪ Oil density ▪ Water density ▪ Dynamic viscosity ▪ Sensor electronic temperature (ISEM) ▪ Empty pipe detection option 		<ul style="list-style-type: none"> ▪ GSV flow ▪ GSV flow alternative ▪ Kinematic viscosity ▪ Low flow cut off option ▪ Mass flow ▪ Oil mass flow ▪ Water mass flow ▪ HBSI ▪ NSV flow ▪ NSV flow alternative ▪ External pressure ▪ Exciter current 1 ▪ Exciter current 2 ▪ Oscillation frequency 1 ▪ Oscillation frequency 2 ▪ S&W volume flow ▪ Reference density ▪ Reference density alternative ▪ Corrected volume flow
		<ul style="list-style-type: none"> ▪ Oil corrected volume flow ▪ Water corrected volume flow ▪ Oscillation damping fluctuation 1 ▪ Oscillation damping fluctuation 2 ▪ Frequency fluctuation 1 ▪ Frequency fluctuation 2 ▪ Target mass flow ▪ Carrier volume flow ▪ Target volume flow ▪ Temp. compensated dynamic viscosity ▪ Temp. compensated kinematic viscosity ▪ Temperature ▪ Status ▪ Volume flow ▪ Oil volume flow ▪ Water volume flow ▪ Water cut

Diagnostic information		Remedy instructions	
No.	Short text		
270	Main electronic failure	Change main electronic module	
	Measured variable status		
	Quality		Bad
	Quality substatus		Maintenance alarm
	Coding (hex)		0x24 to 0x27
	Status signal		F
	Diagnostic behavior		Alarm
Influenced measured variables			
<ul style="list-style-type: none"> ▪ Oscillation amplitude 1 ▪ Oscillation amplitude 2 ▪ Signal asymmetry ▪ Carrier mass flow ▪ Carrier pipe temperature ▪ Target corrected volume flow ▪ Carrier corrected volume flow ▪ Concentration ▪ Measured values 1 ▪ Measured values 2 ▪ Measured values 3 ▪ Oscillation damping 1 ▪ Oscillation damping 2 ▪ Density ▪ Oil density ▪ Water density ▪ Dynamic viscosity ▪ Sensor electronic temperature (ISEM) ▪ Empty pipe detection option ▪ GSV flow ▪ GSV flow alternative ▪ Kinematic viscosity ▪ Low flow cut off option ▪ Mass flow ▪ Oil mass flow ▪ Water mass flow ▪ HBSI ▪ NSV flow ▪ NSV flow alternative ▪ External pressure ▪ Exciter current 1 ▪ Exciter current 2 ▪ Oscillation frequency 1 ▪ Oscillation frequency 2 ▪ S&W volume flow ▪ Reference density ▪ Reference density alternative ▪ Corrected volume flow ▪ Oil corrected volume flow ▪ Water corrected volume flow ▪ Oscillation damping fluctuation 1 ▪ Oscillation damping fluctuation 2 ▪ Frequency fluctuation 1 ▪ Frequency fluctuation 2 ▪ Target mass flow ▪ Carrier volume flow ▪ Target volume flow ▪ Temp. compensated dynamic viscosity ▪ Temp. compensated kinematic viscosity ▪ Temperature ▪ Status ▪ Volume flow ▪ Oil volume flow ▪ Water volume flow ▪ Water cut 			

Diagnostic information		Remedy instructions	
No.	Short text		
271	Main electronic failure	1. Restart device 2. Change main electronic module	
	Measured variable status		
	Quality		Bad
	Quality substatus		Maintenance alarm
	Coding (hex)		0x24 to 0x27
	Status signal		F
	Diagnostic behavior		Alarm
Influenced measured variables			
<ul style="list-style-type: none"> ▪ Oscillation amplitude 1 ▪ Oscillation amplitude 2 ▪ Signal asymmetry ▪ Carrier mass flow ▪ Carrier pipe temperature ▪ Target corrected volume flow ▪ Carrier corrected volume flow ▪ Concentration ▪ Measured values 1 ▪ Measured values 2 ▪ Measured values 3 ▪ Oscillation damping 1 ▪ Oscillation damping 2 ▪ Density ▪ Oil density ▪ Water density ▪ Dynamic viscosity ▪ Sensor electronic temperature (ISEM) ▪ Empty pipe detection option ▪ GSV flow ▪ GSV flow alternative ▪ Kinematic viscosity ▪ Low flow cut off option ▪ Mass flow ▪ Oil mass flow ▪ Water mass flow ▪ HBSI ▪ NSV flow ▪ NSV flow alternative ▪ External pressure ▪ Exciter current 1 ▪ Exciter current 2 ▪ Oscillation frequency 1 ▪ Oscillation frequency 2 ▪ S&W volume flow ▪ Reference density ▪ Reference density alternative ▪ Corrected volume flow ▪ Oil corrected volume flow ▪ Water corrected volume flow ▪ Oscillation damping fluctuation 1 ▪ Oscillation damping fluctuation 2 ▪ Frequency fluctuation 1 ▪ Frequency fluctuation 2 ▪ Target mass flow ▪ Carrier volume flow ▪ Target volume flow ▪ Temp. compensated dynamic viscosity ▪ Temp. compensated kinematic viscosity ▪ Temperature ▪ Status ▪ Volume flow ▪ Oil volume flow ▪ Water volume flow ▪ Water cut 			

Diagnostic information		Remedy instructions	
No.	Short text		
272	Main electronic failure	1. Restart device 2. Contact service	
	Measured variable status		
	Quality		Bad
	Quality substatus		Maintenance alarm
	Coding (hex)		0x24 to 0x27
	Status signal		F
	Diagnostic behavior		Alarm
Influenced measured variables			
<ul style="list-style-type: none"> ▪ Oscillation amplitude 1 ▪ Oscillation amplitude 2 ▪ Signal asymmetry ▪ Carrier mass flow ▪ Carrier pipe temperature ▪ Target corrected volume flow ▪ Carrier corrected volume flow ▪ Concentration ▪ Measured values 1 ▪ Measured values 2 ▪ Measured values 3 ▪ Oscillation damping 1 ▪ Oscillation damping 2 ▪ Density ▪ Oil density ▪ Water density ▪ Dynamic viscosity ▪ Sensor electronic temperature (ISEM) ▪ Empty pipe detection option ▪ GSV flow ▪ GSV flow alternative ▪ Kinematic viscosity ▪ Low flow cut off option ▪ Mass flow ▪ Oil mass flow ▪ Water mass flow ▪ HBSI ▪ NSV flow ▪ NSV flow alternative ▪ External pressure ▪ Exciter current 1 ▪ Exciter current 2 ▪ Oscillation frequency 1 ▪ Oscillation frequency 2 ▪ S&W volume flow ▪ Reference density ▪ Reference density alternative ▪ Corrected volume flow ▪ Oil corrected volume flow ▪ Water corrected volume flow ▪ Oscillation damping fluctuation 1 ▪ Oscillation damping fluctuation 2 ▪ Frequency fluctuation 1 ▪ Frequency fluctuation 2 ▪ Target mass flow ▪ Carrier volume flow ▪ Target volume flow ▪ Temp. compensated dynamic viscosity ▪ Temp. compensated kinematic viscosity ▪ Temperature ▪ Status ▪ Volume flow ▪ Oil volume flow ▪ Water volume flow ▪ Water cut 			

Diagnostic information		Remedy instructions	
No.	Short text		
273	Main electronic failure	Change electronic	
Measured variable status			
Quality	Bad		
Quality substatus	Maintenance alarm		
Coding (hex)	0x24 to 0x27		
Status signal	F		
Diagnostic behavior	Alarm		
Influenced measured variables			
<ul style="list-style-type: none"> ▪ Oscillation amplitude 1 ▪ Oscillation amplitude 2 ▪ Signal asymmetry ▪ Carrier mass flow ▪ Carrier pipe temperature ▪ Target corrected volume flow ▪ Carrier corrected volume flow ▪ Concentration ▪ Measured values 1 ▪ Measured values 2 ▪ Measured values 3 ▪ Oscillation damping 1 ▪ Oscillation damping 2 ▪ Density ▪ Oil density ▪ Water density ▪ Dynamic viscosity ▪ Sensor electronic temperature (ISEM) ▪ Empty pipe detection option 		<ul style="list-style-type: none"> ▪ GSV flow ▪ GSV flow alternative ▪ Kinematic viscosity ▪ Low flow cut off option ▪ Mass flow ▪ Oil mass flow ▪ Water mass flow ▪ HBSI ▪ NSV flow ▪ NSV flow alternative ▪ External pressure ▪ Exciter current 1 ▪ Exciter current 2 ▪ Oscillation frequency 1 ▪ Oscillation frequency 2 ▪ S&W volume flow ▪ Reference density ▪ Reference density alternative ▪ Corrected volume flow 	<ul style="list-style-type: none"> ▪ Oil corrected volume flow ▪ Water corrected volume flow ▪ Oscillation damping fluctuation 1 ▪ Oscillation damping fluctuation 2 ▪ Frequency fluctuation 1 ▪ Frequency fluctuation 2 ▪ Target mass flow ▪ Carrier volume flow ▪ Target volume flow ▪ Temp. compensated dynamic viscosity ▪ Temp. compensated kinematic viscosity ▪ Temperature ▪ Status ▪ Volume flow ▪ Oil volume flow ▪ Water volume flow ▪ Water cut

Diagnostic information		Remedy instructions	
No.	Short text		
275	I/O module 1 to n defective	Change I/O module	
Measured variable status			
Quality	Bad		
Quality substatus	Maintenance alarm		
Coding (hex)	0x24 to 0x27		
Status signal	F		
Diagnostic behavior	Alarm		
Influenced measured variables			
<ul style="list-style-type: none"> ▪ Oscillation amplitude 1 ▪ Oscillation amplitude 2 ▪ Signal asymmetry ▪ Carrier mass flow ▪ Carrier pipe temperature ▪ Concentration ▪ Measured values 1 ▪ Measured values 2 ▪ Measured values 3 ▪ Oscillation damping 1 ▪ Oscillation damping 2 ▪ Density 		<ul style="list-style-type: none"> ▪ Dynamic viscosity ▪ Sensor electronic temperature (ISEM) ▪ Empty pipe detection option ▪ Kinematic viscosity ▪ Low flow cut off option ▪ Mass flow ▪ HBSI ▪ External pressure ▪ Exciter current 1 ▪ Exciter current 2 ▪ Oscillation frequency 1 ▪ Oscillation frequency 2 	<ul style="list-style-type: none"> ▪ Reference density ▪ Corrected volume flow ▪ Oscillation damping fluctuation 1 ▪ Oscillation damping fluctuation 2 ▪ Frequency fluctuation 1 ▪ Frequency fluctuation 2 ▪ Target mass flow ▪ Temp. compensated dynamic viscosity ▪ Temp. compensated kinematic viscosity ▪ Temperature ▪ Status ▪ Volume flow

Diagnostic information		Remedy instructions	
No.	Short text		
276	I/O module 1 to n faulty	1. Restart device 2. Change I/O module	
	Measured variable status		
	Quality		Bad
	Quality substatus		Maintenance alarm
	Coding (hex)		0x24 to 0x27
	Status signal		F
	Diagnostic behavior		Alarm
Influenced measured variables			
<ul style="list-style-type: none"> ▪ Oscillation amplitude 1 ▪ Oscillation amplitude 2 ▪ Signal asymmetry ▪ Carrier mass flow ▪ Carrier pipe temperature ▪ Target corrected volume flow ▪ Carrier corrected volume flow ▪ Concentration ▪ Measured values 1 ▪ Measured values 2 ▪ Measured values 3 ▪ Oscillation damping 1 ▪ Oscillation damping 2 ▪ Density 		<ul style="list-style-type: none"> ▪ Dynamic viscosity ▪ Sensor electronic temperature (ISEM) ▪ Empty pipe detection option ▪ Kinematic viscosity ▪ Low flow cut off option ▪ Mass flow ▪ HBSI ▪ External pressure ▪ Exciter current 1 ▪ Exciter current 2 ▪ Oscillation frequency 1 ▪ Oscillation frequency 2 ▪ Reference density ▪ Corrected volume flow 	
<ul style="list-style-type: none"> ▪ Oscillation damping fluctuation 1 ▪ Oscillation damping fluctuation 2 ▪ Frequency fluctuation 1 ▪ Frequency fluctuation 2 ▪ Target mass flow ▪ Carrier volume flow ▪ Target volume flow ▪ Temp. compensated dynamic viscosity ▪ Temp. compensated kinematic viscosity ▪ Temperature ▪ Status ▪ Volume flow 			

Diagnostic information		Remedy instructions	
No.	Short text		
283	Memory content	1. Reset device 2. Contact service	
	Measured variable status		
	Quality		Bad
	Quality substatus		Maintenance alarm
	Coding (hex)		0x24 to 0x27
	Status signal		F
	Diagnostic behavior		Alarm
Influenced measured variables			
<ul style="list-style-type: none"> ▪ Oscillation amplitude 1 ▪ Oscillation amplitude 2 ▪ Signal asymmetry ▪ Carrier mass flow ▪ Carrier pipe temperature ▪ Target corrected volume flow ▪ Carrier corrected volume flow ▪ Concentration ▪ Measured values 1 ▪ Measured values 2 ▪ Measured values 3 ▪ Oscillation damping 1 ▪ Oscillation damping 2 ▪ Density ▪ Oil density ▪ Water density ▪ Dynamic viscosity ▪ Sensor electronic temperature (ISEM) ▪ Empty pipe detection option 		<ul style="list-style-type: none"> ▪ GSV flow ▪ GSV flow alternative ▪ Kinematic viscosity ▪ Low flow cut off option ▪ Mass flow ▪ Oil mass flow ▪ Water mass flow ▪ HBSI ▪ NSV flow ▪ NSV flow alternative ▪ External pressure ▪ Exciter current 1 ▪ Exciter current 2 ▪ Oscillation frequency 1 ▪ Oscillation frequency 2 ▪ S&W volume flow ▪ Reference density ▪ Reference density alternative ▪ Corrected volume flow 	
<ul style="list-style-type: none"> ▪ Oil corrected volume flow ▪ Water corrected volume flow ▪ Oscillation damping fluctuation 1 ▪ Oscillation damping fluctuation 2 ▪ Frequency fluctuation 1 ▪ Frequency fluctuation 2 ▪ Target mass flow ▪ Carrier volume flow ▪ Target volume flow ▪ Temp. compensated dynamic viscosity ▪ Temp. compensated kinematic viscosity ▪ Temperature ▪ Status ▪ Volume flow ▪ Oil volume flow ▪ Water volume flow ▪ Water cut 			

Diagnostic information		Remedy instructions	
No.	Short text		
302	Device verification active	Device verification active, please wait.	
	Measured variable status [from the factory] ¹⁾		
	Quality		Good
	Quality substatus		Function check
	Coding (hex)		0xBC to 0xBF
	Status signal		C
	Diagnostic behavior		Warning
Influenced measured variables			
<ul style="list-style-type: none"> ▪ Oscillation amplitude 1 ▪ Oscillation amplitude 2 ▪ Signal asymmetry ▪ Carrier mass flow ▪ Carrier pipe temperature ▪ Target corrected volume flow ▪ Carrier corrected volume flow ▪ Concentration ▪ Measured values 1 ▪ Measured values 2 ▪ Measured values 3 ▪ Oscillation damping 1 ▪ Oscillation damping 2 ▪ Density ▪ Oil density ▪ Water density ▪ Dynamic viscosity ▪ Sensor electronic temperature (ISEM) ▪ Empty pipe detection option ▪ GSV flow ▪ GSV flow alternative ▪ Kinematic viscosity ▪ Low flow cut off option ▪ Mass flow ▪ Oil mass flow ▪ Water mass flow ▪ HBSI ▪ NSV flow ▪ NSV flow alternative ▪ External pressure ▪ Exciter current 1 ▪ Exciter current 2 ▪ Oscillation frequency 1 ▪ Oscillation frequency 2 ▪ S&W volume flow ▪ Reference density ▪ Reference density alternative ▪ Corrected volume flow ▪ Oil corrected volume flow ▪ Water corrected volume flow ▪ Oscillation damping fluctuation 1 ▪ Oscillation damping fluctuation 2 ▪ Frequency fluctuation 1 ▪ Frequency fluctuation 2 ▪ Target mass flow ▪ Carrier volume flow ▪ Target volume flow ▪ Temp. compensated dynamic viscosity ▪ Temp. compensated kinematic viscosity ▪ Temperature ▪ Status ▪ Volume flow ▪ Oil volume flow ▪ Water volume flow ▪ Water cut 			

1) Diagnostic behavior can be changed. This causes the overall status of the measured variable to change.

Diagnostic information		Remedy instructions	
No.	Short text		
303	I/O 1 to n configuration changed	1. Apply I/O module configuration (parameter 'Apply I/O configuration') 2. Afterwards reload device description and check wiring	
	Measured variable status		
	Quality		Bad
	Quality substatus		Maintenance alarm
	Coding (hex)		0x24 to 0x27
	Status signal		M
	Diagnostic behavior		Warning
Influenced measured variables			
-			

Diagnostic information		Remedy instructions	
No.	Short text		
311	Electronic failure	1. Do not reset device 2. Contact service	
	Measured variable status		
	Quality		Bad
	Quality substatus		Maintenance alarm
	Coding (hex)		0x24 to 0x27
	Status signal		M
	Diagnostic behavior		Warning
Influenced measured variables			
<ul style="list-style-type: none"> ▪ Oscillation amplitude 1 ▪ Oscillation amplitude 2 ▪ Signal asymmetry ▪ Carrier mass flow ▪ Carrier pipe temperature ▪ Target corrected volume flow ▪ Carrier corrected volume flow ▪ Concentration ▪ Measured values 1 ▪ Measured values 2 ▪ Measured values 3 ▪ Oscillation damping 1 ▪ Oscillation damping 2 ▪ Density ▪ Oil density ▪ Water density ▪ Dynamic viscosity ▪ Sensor electronic temperature (ISEM) ▪ Empty pipe detection option ▪ GSV flow ▪ GSV flow alternative ▪ Kinematic viscosity ▪ Low flow cut off option ▪ Mass flow ▪ Oil mass flow ▪ Water mass flow ▪ HBSI ▪ NSV flow ▪ NSV flow alternative ▪ External pressure ▪ Exciter current 1 ▪ Exciter current 2 ▪ Oscillation frequency 1 ▪ Oscillation frequency 2 ▪ S&W volume flow ▪ Reference density ▪ Reference density alternative ▪ Corrected volume flow ▪ Oil corrected volume flow ▪ Water corrected volume flow ▪ Oscillation damping fluctuation 1 ▪ Oscillation damping fluctuation 2 ▪ Frequency fluctuation 1 ▪ Frequency fluctuation 2 ▪ Target mass flow ▪ Carrier volume flow ▪ Target volume flow ▪ Temp. compensated dynamic viscosity ▪ Temp. compensated kinematic viscosity ▪ Temperature ▪ Status ▪ Volume flow ▪ Oil volume flow ▪ Water volume flow ▪ Water cut 			

Diagnostic information		Remedy instructions
No.	Short text	
332	Writing in HistoROM backup failed	Replace user interface board Ex d/XP: replace transmitter
Measured variable status		
Quality	Bad	
Quality substatus	Maintenance alarm	
Coding (hex)	0x24 to 0x27	
Status signal	F	
Diagnostic behavior	Alarm	
Influenced measured variables		
<ul style="list-style-type: none"> ▪ Oscillation amplitude 1 ▪ Oscillation amplitude 2 ▪ Signal asymmetry ▪ Carrier mass flow ▪ Carrier pipe temperature ▪ Target corrected volume flow ▪ Carrier corrected volume flow ▪ Concentration ▪ Oscillation damping 1 ▪ Oscillation damping 2 ▪ Density ▪ Oil density ▪ Water density ▪ Dynamic viscosity ▪ Sensor electronic temperature (ISEM) ▪ Empty pipe detection option ▪ GSV flow ▪ GSV flow alternative 		<ul style="list-style-type: none"> ▪ Kinematic viscosity ▪ Low flow cut off option ▪ Mass flow ▪ Oil mass flow ▪ Water mass flow ▪ HBSI ▪ NSV flow ▪ NSV flow alternative ▪ External pressure ▪ Exciter current 1 ▪ Exciter current 2 ▪ Oscillation frequency 1 ▪ Oscillation frequency 2 ▪ S&W volume flow ▪ Reference density ▪ Reference density alternative ▪ Corrected volume flow ▪ Oil corrected volume flow
		<ul style="list-style-type: none"> ▪ Water corrected volume flow ▪ Oscillation damping fluctuation 1 ▪ Oscillation damping fluctuation 2 ▪ Frequency fluctuation 1 ▪ Frequency fluctuation 2 ▪ Target mass flow ▪ Carrier volume flow ▪ Target volume flow ▪ Temp. compensated dynamic viscosity ▪ Temp. compensated kinematic viscosity ▪ Temperature ▪ Status ▪ Volume flow ▪ Oil volume flow ▪ Water volume flow ▪ Water cut

Diagnostic information		Remedy instructions
No.	Short text	
361	I/O module 1 to n faulty	1. Restart device 2. Check electronic modules 3. Change I/O Modul or main electronics
Measured variable status		
Quality	Bad	
Quality substatus	Maintenance alarm	
Coding (hex)	0x24 to 0x27	
Status signal	F	
Diagnostic behavior	Alarm	
Influenced measured variables		
<ul style="list-style-type: none"> ▪ Oscillation amplitude 1 ▪ Oscillation amplitude 2 ▪ Signal asymmetry ▪ Carrier mass flow ▪ Carrier pipe temperature ▪ Concentration ▪ Measured values 1 ▪ Measured values 2 ▪ Measured values 3 ▪ Oscillation damping 1 ▪ Oscillation damping 2 ▪ Density 		<ul style="list-style-type: none"> ▪ Dynamic viscosity ▪ Sensor electronic temperature (ISEM) ▪ Empty pipe detection option ▪ Kinematic viscosity ▪ Low flow cut off option ▪ Mass flow ▪ HBSI ▪ External pressure ▪ Exciter current 1 ▪ Exciter current 2 ▪ Oscillation frequency 1 ▪ Oscillation frequency 2
		<ul style="list-style-type: none"> ▪ Reference density ▪ Corrected volume flow ▪ Oscillation damping fluctuation 1 ▪ Oscillation damping fluctuation 2 ▪ Frequency fluctuation 1 ▪ Frequency fluctuation 2 ▪ Target mass flow ▪ Temp. compensated dynamic viscosity ▪ Temp. compensated kinematic viscosity ▪ Temperature ▪ Status ▪ Volume flow

Diagnostic information		Remedy instructions	
No.	Short text		
372	Sensor electronic (ISEM) faulty	1. Restart device 2. Check if failure recurs 3. Replace sensor electronic module (ISEM)	
	Measured variable status		
	Quality		Bad
	Quality substatus		Maintenance alarm
	Coding (hex)		0x24 to 0x27
	Status signal		F
	Diagnostic behavior		Alarm
Influenced measured variables			
<ul style="list-style-type: none"> ▪ Oscillation amplitude 1 ▪ Oscillation amplitude 2 ▪ Signal asymmetry ▪ Carrier mass flow ▪ Carrier pipe temperature ▪ Target corrected volume flow ▪ Carrier corrected volume flow ▪ Concentration ▪ Measured values 1 ▪ Measured values 2 ▪ Measured values 3 ▪ Oscillation damping 1 ▪ Oscillation damping 2 ▪ Density ▪ Oil density ▪ Water density ▪ Dynamic viscosity ▪ Sensor electronic temperature (ISEM) ▪ Empty pipe detection option 		<ul style="list-style-type: none"> ▪ GSV flow ▪ GSV flow alternative ▪ Kinematic viscosity ▪ Low flow cut off option ▪ Mass flow ▪ Oil mass flow ▪ Water mass flow ▪ HBSI ▪ NSV flow ▪ NSV flow alternative ▪ External pressure ▪ Exciter current 1 ▪ Exciter current 2 ▪ Oscillation frequency 1 ▪ Oscillation frequency 2 ▪ S&W volume flow ▪ Reference density ▪ Reference density alternative ▪ Corrected volume flow 	
		<ul style="list-style-type: none"> ▪ Oil corrected volume flow ▪ Water corrected volume flow ▪ Oscillation damping fluctuation 1 ▪ Oscillation damping fluctuation 2 ▪ Frequency fluctuation 1 ▪ Frequency fluctuation 2 ▪ Target mass flow ▪ Carrier volume flow ▪ Target volume flow ▪ Temp. compensated dynamic viscosity ▪ Temp. compensated kinematic viscosity ▪ Temperature ▪ Status ▪ Volume flow ▪ Oil volume flow ▪ Water volume flow ▪ Water cut 	

Diagnostic information		Remedy instructions	
No.	Short text		
373	Sensor electronic (ISEM) faulty	1. Transfer data or reset device 2. Contact service	
	Measured variable status		
	Quality		Bad
	Quality substatus		Maintenance alarm
	Coding (hex)		0x24 to 0x27
	Status signal		F
	Diagnostic behavior		Alarm
	Influenced measured variables		
<ul style="list-style-type: none"> ▪ Oscillation amplitude 1 ▪ Oscillation amplitude 2 ▪ Signal asymmetry ▪ Carrier mass flow ▪ Carrier pipe temperature ▪ Target corrected volume flow ▪ Carrier corrected volume flow ▪ Concentration ▪ Measured values 1 ▪ Measured values 2 ▪ Measured values 3 ▪ Oscillation damping 1 ▪ Oscillation damping 2 ▪ Density ▪ Oil density ▪ Water density ▪ Dynamic viscosity ▪ Sensor electronic temperature (ISEM) ▪ Empty pipe detection option 		<ul style="list-style-type: none"> ▪ GSV flow ▪ GSV flow alternative ▪ Kinematic viscosity ▪ Low flow cut off option ▪ Mass flow ▪ Oil mass flow ▪ Water mass flow ▪ HBSI ▪ NSV flow ▪ NSV flow alternative ▪ External pressure ▪ Exciter current 1 ▪ Exciter current 2 ▪ Oscillation frequency 1 ▪ Oscillation frequency 2 ▪ S&W volume flow ▪ Reference density ▪ Reference density alternative ▪ Corrected volume flow 	<ul style="list-style-type: none"> ▪ Oil corrected volume flow ▪ Water corrected volume flow ▪ Oscillation damping fluctuation 1 ▪ Oscillation damping fluctuation 2 ▪ Frequency fluctuation 1 ▪ Frequency fluctuation 2 ▪ Target mass flow ▪ Carrier volume flow ▪ Target volume flow ▪ Temp. compensated dynamic viscosity ▪ Temp. compensated kinematic viscosity ▪ Temperature ▪ Status ▪ Volume flow ▪ Oil volume flow ▪ Water volume flow ▪ Water cut

Diagnostic information		Remedy instructions	
No.	Short text		
374	Sensor electronic (ISEM) faulty	1. Restart device 2. Check if failure recurs 3. Replace sensor electronic module (ISEM)	
	Measured variable status [from the factory] ¹⁾		
	Quality		Bad
	Quality substatus		Maintenance alarm
	Coding (hex)		0x24 to 0x27
	Status signal		S
	Diagnostic behavior		Warning
	Influenced measured variables		
<ul style="list-style-type: none"> ▪ Oscillation amplitude 1 ▪ Oscillation amplitude 2 ▪ Signal asymmetry ▪ Carrier mass flow ▪ Carrier pipe temperature ▪ Concentration ▪ Oscillation damping 1 ▪ Oscillation damping 2 ▪ Density ▪ Dynamic viscosity ▪ Sensor electronic temperature (ISEM) 		<ul style="list-style-type: none"> ▪ Empty pipe detection option ▪ Kinematic viscosity ▪ Low flow cut off option ▪ Mass flow ▪ HBSI ▪ External pressure ▪ Exciter current 1 ▪ Exciter current 2 ▪ Oscillation frequency 1 ▪ Oscillation frequency 2 ▪ Reference density 	<ul style="list-style-type: none"> ▪ Corrected volume flow ▪ Oscillation damping fluctuation 1 ▪ Oscillation damping fluctuation 2 ▪ Frequency fluctuation 1 ▪ Frequency fluctuation 2 ▪ Target mass flow ▪ Temp. compensated dynamic viscosity ▪ Temp. compensated kinematic viscosity ▪ Temperature ▪ Status ▪ Volume flow

1) Diagnostic behavior can be changed. This causes the overall status of the measured variable to change.

Diagnostic information		Remedy instructions	
No.	Short text		
375	I/O- 1 to n communication failed	1. Restart device 2. Check if failure recurs 3. Replace module rack inclusive electronic modules	
	Measured variable status		
	Quality		Bad
	Quality substatus		Maintenance alarm
	Coding (hex)		0x24 to 0x27
	Status signal		F
	Diagnostic behavior		Alarm
Influenced measured variables			
<ul style="list-style-type: none"> ▪ Oscillation amplitude 1 ▪ Oscillation amplitude 2 ▪ Signal asymmetry ▪ Carrier mass flow ▪ Carrier pipe temperature ▪ Target corrected volume flow ▪ Carrier corrected volume flow ▪ Concentration ▪ Measured values 1 ▪ Measured values 2 ▪ Measured values 3 ▪ Oscillation damping 1 ▪ Oscillation damping 2 ▪ Density ▪ Oil density ▪ Water density ▪ Dynamic viscosity ▪ Sensor electronic temperature (ISEM) 		<ul style="list-style-type: none"> ▪ Empty pipe detection option ▪ GSV flow ▪ GSV flow alternative ▪ Kinematic viscosity ▪ Low flow cut off option ▪ Mass flow ▪ Oil mass flow ▪ Water mass flow ▪ HBSI ▪ NSV flow ▪ NSV flow alternative ▪ External pressure ▪ Exciter current 1 ▪ Exciter current 2 ▪ Oscillation frequency 1 ▪ Oscillation frequency 2 ▪ S&W volume flow ▪ Reference density 	
		<ul style="list-style-type: none"> ▪ Reference density alternative ▪ Corrected volume flow ▪ Oil corrected volume flow ▪ Water corrected volume flow ▪ Oscillation damping fluctuation 1 ▪ Oscillation damping fluctuation 2 ▪ Frequency fluctuation 1 ▪ Frequency fluctuation 2 ▪ Target mass flow ▪ Carrier volume flow ▪ Target volume flow ▪ Temp. compensated dynamic viscosity ▪ Temp. compensated kinematic viscosity ▪ Temperature ▪ Status ▪ Volume flow 	

Diagnostic information		Remedy instructions
No.	Short text	
382	Data storage	1. Insert T-DAT 2. Replace T-DAT
Measured variable status		
Quality	Bad	
Quality substatus	Maintenance alarm	
Coding (hex)	0x24 to 0x27	
Status signal	F	
Diagnostic behavior	Alarm	
Influenced measured variables		
<ul style="list-style-type: none"> ▪ Oscillation amplitude 1 ▪ Oscillation amplitude 2 ▪ Signal asymmetry ▪ Carrier mass flow ▪ Carrier pipe temperature ▪ Target corrected volume flow ▪ Carrier corrected volume flow ▪ Concentration ▪ Measured values 1 ▪ Measured values 2 ▪ Measured values 3 ▪ Oscillation damping 1 ▪ Oscillation damping 2 ▪ Density ▪ Oil density ▪ Water density ▪ Dynamic viscosity ▪ Sensor electronic temperature (ISEM) ▪ Empty pipe detection option 		<ul style="list-style-type: none"> ▪ GSV flow ▪ GSV flow alternative ▪ Kinematic viscosity ▪ Low flow cut off option ▪ Mass flow ▪ Oil mass flow ▪ Water mass flow ▪ HBSI ▪ NSV flow ▪ NSV flow alternative ▪ External pressure ▪ Exciter current 1 ▪ Exciter current 2 ▪ Oscillation frequency 1 ▪ Oscillation frequency 2 ▪ S&W volume flow ▪ Reference density ▪ Reference density alternative ▪ Corrected volume flow
		<ul style="list-style-type: none"> ▪ Oil corrected volume flow ▪ Water corrected volume flow ▪ Oscillation damping fluctuation 1 ▪ Oscillation damping fluctuation 2 ▪ Frequency fluctuation 1 ▪ Frequency fluctuation 2 ▪ Target mass flow ▪ Carrier volume flow ▪ Target volume flow ▪ Temp. compensated dynamic viscosity ▪ Temp. compensated kinematic viscosity ▪ Temperature ▪ Status ▪ Volume flow ▪ Oil volume flow ▪ Water volume flow ▪ Water cut

Diagnostic information		Remedy instructions	
No.	Short text		
383	Memory content	1. Restart device 2. Delete T-DAT via 'Reset device' parameter 3. Replace T-DAT	
	Measured variable status		
	Quality		Bad
	Quality substatus		Maintenance alarm
	Coding (hex)		0x24 to 0x27
	Status signal		F
	Diagnostic behavior		Alarm
Influenced measured variables			
<ul style="list-style-type: none"> ▪ Oscillation amplitude 1 ▪ Oscillation amplitude 2 ▪ Signal asymmetry ▪ Carrier mass flow ▪ Carrier pipe temperature ▪ Target corrected volume flow ▪ Carrier corrected volume flow ▪ Concentration ▪ Measured values 1 ▪ Measured values 2 ▪ Measured values 3 ▪ Oscillation damping 1 ▪ Oscillation damping 2 ▪ Density ▪ Oil density ▪ Water density ▪ Dynamic viscosity ▪ Sensor electronic temperature (ISEM) 		<ul style="list-style-type: none"> ▪ Empty pipe detection option ▪ GSV flow ▪ GSV flow alternative ▪ Kinematic viscosity ▪ Low flow cut off option ▪ Mass flow ▪ Oil mass flow ▪ Water mass flow ▪ HBSI ▪ NSV flow ▪ NSV flow alternative ▪ External pressure ▪ Exciter current 1 ▪ Exciter current 2 ▪ Oscillation frequency 1 ▪ Oscillation frequency 2 ▪ S&W volume flow ▪ Reference density 	
		<ul style="list-style-type: none"> ▪ Reference density alternative ▪ Corrected volume flow ▪ Oil corrected volume flow ▪ Water corrected volume flow ▪ Oscillation damping fluctuation 1 ▪ Oscillation damping fluctuation 2 ▪ Frequency fluctuation 1 ▪ Frequency fluctuation 2 ▪ Target mass flow ▪ Carrier volume flow ▪ Target volume flow ▪ Temp. compensated dynamic viscosity ▪ Temp. compensated kinematic viscosity ▪ Temperature ▪ Status ▪ Volume flow 	

Diagnostic information		Remedy instructions	
No.	Short text		
387	HistoROM backup failed	Contact service organization	
	Measured variable status		
	Quality		Bad
	Quality substatus		Maintenance alarm
	Coding (hex)		0x24 to 0x27
	Status signal		F
	Diagnostic behavior		Alarm
Influenced measured variables			
<ul style="list-style-type: none"> ▪ Oscillation amplitude 1 ▪ Oscillation amplitude 2 ▪ Signal asymmetry ▪ Carrier mass flow ▪ Carrier pipe temperature ▪ Target corrected volume flow ▪ Carrier corrected volume flow ▪ Concentration ▪ Measured values 1 ▪ Measured values 2 ▪ Measured values 3 ▪ Oscillation damping 1 ▪ Oscillation damping 2 ▪ Density ▪ Oil density ▪ Water density ▪ Dynamic viscosity ▪ Sensor electronic temperature (ISEM) ▪ Empty pipe detection option ▪ GSV flow ▪ GSV flow alternative ▪ Kinematic viscosity ▪ Low flow cut off option ▪ Mass flow ▪ Oil mass flow ▪ Water mass flow ▪ HBSI ▪ NSV flow ▪ NSV flow alternative ▪ External pressure ▪ Exciter current 1 ▪ Exciter current 2 ▪ Oscillation frequency 1 ▪ Oscillation frequency 2 ▪ S&W volume flow ▪ Reference density ▪ Reference density alternative ▪ Corrected volume flow ▪ Oil corrected volume flow ▪ Water corrected volume flow ▪ Oscillation damping fluctuation 1 ▪ Oscillation damping fluctuation 2 ▪ Frequency fluctuation 1 ▪ Frequency fluctuation 2 ▪ Target mass flow ▪ Carrier volume flow ▪ Target volume flow ▪ Temp. compensated dynamic viscosity ▪ Temp. compensated kinematic viscosity ▪ Temperature ▪ Status ▪ Volume flow ▪ Oil volume flow ▪ Water volume flow ▪ Water cut 			

12.7.3 Diagnostic of configuration

Diagnostic information		Remedy instructions	
No.	Short text		
330	Flash file invalid	<ol style="list-style-type: none"> 1. Update firmware of device 2. Restart device 	
	Measured variable status		
	Quality		Bad
	Quality substatus		Maintenance alarm
	Coding (hex)		0x24 to 0x27
	Status signal		M
	Diagnostic behavior		Warning
Influenced measured variables			
<ul style="list-style-type: none"> ▪ Oscillation amplitude 1 ▪ Oscillation amplitude 2 ▪ Signal asymmetry ▪ Carrier mass flow ▪ Carrier pipe temperature ▪ Concentration ▪ Measured values 1 ▪ Measured values 2 ▪ Measured values 3 ▪ Oscillation damping 1 ▪ Oscillation damping 2 ▪ Density ▪ Dynamic viscosity ▪ Sensor electronic temperature (ISEM) ▪ Empty pipe detection option ▪ Kinematic viscosity ▪ Low flow cut off option ▪ Mass flow ▪ HBSI ▪ External pressure ▪ Exciter current 1 ▪ Exciter current 2 ▪ Oscillation frequency 1 ▪ Oscillation frequency 2 ▪ Reference density ▪ Corrected volume flow ▪ Oscillation damping fluctuation 1 ▪ Oscillation damping fluctuation 2 ▪ Frequency fluctuation 1 ▪ Frequency fluctuation 2 ▪ Target mass flow ▪ Temp. compensated dynamic viscosity ▪ Temp. compensated kinematic viscosity ▪ Temperature ▪ Status ▪ Volume flow 			

Diagnostic information		Remedy instructions	
No.	Short text		
331	Firmware update failed	1. Update firmware of device 2. Restart device	
	Measured variable status		
	Quality		Bad
	Quality substatus		Maintenance alarm
	Coding (hex)		0x24 to 0x27
	Status signal		F
	Diagnostic behavior		Warning
Influenced measured variables			
<ul style="list-style-type: none"> ▪ Oscillation amplitude 1 ▪ Oscillation amplitude 2 ▪ Signal asymmetry ▪ Carrier mass flow ▪ Carrier pipe temperature ▪ Target corrected volume flow ▪ Carrier corrected volume flow ▪ Concentration ▪ Measured values 1 ▪ Measured values 2 ▪ Measured values 3 ▪ Oscillation damping 1 ▪ Oscillation damping 2 ▪ Density ▪ Oil density ▪ Water density ▪ Dynamic viscosity ▪ Sensor electronic temperature (ISEM) ▪ Empty pipe detection option ▪ GSV flow ▪ GSV flow alternative ▪ Kinematic viscosity ▪ Low flow cut off option ▪ Mass flow ▪ Oil mass flow ▪ Water mass flow ▪ HBSI ▪ NSV flow ▪ NSV flow alternative ▪ External pressure ▪ Exciter current 1 ▪ Exciter current 2 ▪ Oscillation frequency 1 ▪ Oscillation frequency 2 ▪ S&W volume flow ▪ Reference density ▪ Reference density alternative ▪ Corrected volume flow ▪ Oil corrected volume flow ▪ Water corrected volume flow ▪ Oscillation damping fluctuation 1 ▪ Oscillation damping fluctuation 2 ▪ Frequency fluctuation 1 ▪ Frequency fluctuation 2 ▪ Target mass flow ▪ Carrier volume flow ▪ Target volume flow ▪ Temp. compensated dynamic viscosity ▪ Temp. compensated kinematic viscosity ▪ Temperature ▪ Status ▪ Volume flow ▪ Oil volume flow ▪ Water volume flow ▪ Water cut 			

Diagnostic information		Remedy instructions	
No.	Short text		
410	Data transfer	1. Check connection 2. Retry data transfer	
	Measured variable status		
	Quality		Bad
	Quality substatus		Maintenance alarm
	Coding (hex)		0x24 to 0x27
	Status signal		F
	Diagnostic behavior		Alarm
Influenced measured variables			
<ul style="list-style-type: none"> ▪ Oscillation amplitude 1 ▪ Oscillation amplitude 2 ▪ Signal asymmetry ▪ Carrier mass flow ▪ Carrier pipe temperature ▪ Target corrected volume flow ▪ Carrier corrected volume flow ▪ Concentration ▪ Measured values 1 ▪ Measured values 2 ▪ Measured values 3 ▪ Oscillation damping 1 ▪ Oscillation damping 2 ▪ Density ▪ Oil density ▪ Water density ▪ Dynamic viscosity ▪ Sensor electronic temperature (ISEM) ▪ Empty pipe detection option ▪ GSV flow ▪ GSV flow alternative ▪ Kinematic viscosity ▪ Low flow cut off option ▪ Mass flow ▪ Oil mass flow ▪ Water mass flow ▪ HBSI ▪ NSV flow ▪ NSV flow alternative ▪ External pressure ▪ Exciter current 1 ▪ Exciter current 2 ▪ Oscillation frequency 1 ▪ Oscillation frequency 2 ▪ S&W volume flow ▪ Reference density ▪ Reference density alternative ▪ Corrected volume flow ▪ Oil corrected volume flow ▪ Water corrected volume flow ▪ Oscillation damping fluctuation 1 ▪ Oscillation damping fluctuation 2 ▪ Frequency fluctuation 1 ▪ Frequency fluctuation 2 ▪ Target mass flow ▪ Carrier volume flow ▪ Target volume flow ▪ Temp. compensated dynamic viscosity ▪ Temp. compensated kinematic viscosity ▪ Temperature ▪ Status ▪ Volume flow ▪ Oil volume flow ▪ Water volume flow ▪ Water cut 			

Diagnostic information		Remedy instructions	
No.	Short text		
412	Processing download	Download active, please wait	
	Measured variable status		
	Quality		Uncertain
	Quality substatus		Initial value
	Coding (hex)		0x4C to 0x4F
	Status signal		C
	Diagnostic behavior		Warning
Influenced measured variables			
<ul style="list-style-type: none"> ▪ Oscillation amplitude 1 ▪ Oscillation amplitude 2 ▪ Signal asymmetry ▪ Carrier mass flow ▪ Carrier pipe temperature ▪ Target corrected volume flow ▪ Carrier corrected volume flow ▪ Concentration ▪ Measured values 1 ▪ Measured values 2 ▪ Measured values 3 ▪ Oscillation damping 1 ▪ Oscillation damping 2 ▪ Density ▪ Oil density ▪ Water density ▪ Dynamic viscosity ▪ Sensor electronic temperature (ISEM) ▪ Empty pipe detection option 		<ul style="list-style-type: none"> ▪ GSV flow ▪ GSV flow alternative ▪ Kinematic viscosity ▪ Low flow cut off option ▪ Mass flow ▪ Oil mass flow ▪ Water mass flow ▪ HBSI ▪ NSV flow ▪ NSV flow alternative ▪ External pressure ▪ Exciter current 1 ▪ Exciter current 2 ▪ Oscillation frequency 1 ▪ Oscillation frequency 2 ▪ S&W volume flow ▪ Reference density ▪ Reference density alternative ▪ Corrected volume flow 	<ul style="list-style-type: none"> ▪ Oil corrected volume flow ▪ Water corrected volume flow ▪ Oscillation damping fluctuation 1 ▪ Oscillation damping fluctuation 2 ▪ Frequency fluctuation 1 ▪ Frequency fluctuation 2 ▪ Target mass flow ▪ Carrier volume flow ▪ Target volume flow ▪ Temp. compensated dynamic viscosity ▪ Temp. compensated kinematic viscosity ▪ Temperature ▪ Status ▪ Volume flow ▪ Oil volume flow ▪ Water volume flow ▪ Water cut

Diagnostic information		Remedy instructions	
No.	Short text		
431	Trim 1 to n	Carry out trim	
	Measured variable status		
	Quality		Good
	Quality substatus		Function check
	Coding (hex)		0xBC to 0xBF
	Status signal		C
	Diagnostic behavior		Warning
Influenced measured variables			
-			

Diagnostic information		Remedy instructions	
No.	Short text		
437	Configuration incompatible	1. Restart device 2. Contact service	
	Measured variable status		
	Quality		Bad
	Quality substatus		Maintenance alarm
	Coding (hex)		0x24 to 0x27
	Status signal		F
	Diagnostic behavior		Alarm
Influenced measured variables			
<ul style="list-style-type: none"> ▪ Oscillation amplitude 1 ▪ Oscillation amplitude 2 ▪ Signal asymmetry ▪ Carrier mass flow ▪ Carrier pipe temperature ▪ Target corrected volume flow ▪ Carrier corrected volume flow ▪ Concentration ▪ Measured values 1 ▪ Measured values 2 ▪ Measured values 3 ▪ Oscillation damping 1 ▪ Oscillation damping 2 ▪ Density ▪ Oil density ▪ Water density ▪ Dynamic viscosity ▪ Sensor electronic temperature (ISEM) ▪ Empty pipe detection option ▪ GSV flow ▪ GSV flow alternative ▪ Kinematic viscosity ▪ Low flow cut off option ▪ Mass flow ▪ Oil mass flow ▪ Water mass flow ▪ HBSI ▪ NSV flow ▪ NSV flow alternative ▪ External pressure ▪ Exciter current 1 ▪ Exciter current 2 ▪ Oscillation frequency 1 ▪ Oscillation frequency 2 ▪ S&W volume flow ▪ Reference density ▪ Reference density alternative ▪ Corrected volume flow ▪ Oil corrected volume flow ▪ Water corrected volume flow ▪ Oscillation damping fluctuation 1 ▪ Oscillation damping fluctuation 2 ▪ Frequency fluctuation 1 ▪ Frequency fluctuation 2 ▪ Target mass flow ▪ Carrier volume flow ▪ Target volume flow ▪ Temp. compensated dynamic viscosity ▪ Temp. compensated kinematic viscosity ▪ Temperature ▪ Status ▪ Volume flow ▪ Oil volume flow ▪ Water volume flow ▪ Water cut 			

Diagnostic information		Remedy instructions	
No.	Short text		
438	Dataset	1. Check data set file 2. Check device configuration 3. Up- and download new configuration	
	Measured variable status		
	Quality		Uncertain
	Quality substatus		Maintenance demanded
	Coding (hex)		0x68 to 0x6B
	Status signal		M
	Diagnostic behavior		Warning
	Influenced measured variables		
<ul style="list-style-type: none"> ▪ Oscillation amplitude 1 ▪ Oscillation amplitude 2 ▪ Signal asymmetry ▪ Carrier mass flow ▪ Carrier pipe temperature ▪ Target corrected volume flow ▪ Carrier corrected volume flow ▪ Concentration ▪ Measured values 1 ▪ Measured values 2 ▪ Measured values 3 ▪ Oscillation damping 1 ▪ Oscillation damping 2 ▪ Density ▪ Oil density ▪ Water density ▪ Dynamic viscosity ▪ Sensor electronic temperature (ISEM) ▪ Empty pipe detection option ▪ GSV flow ▪ GSV flow alternative ▪ Kinematic viscosity ▪ Low flow cut off option ▪ Mass flow ▪ Oil mass flow ▪ Water mass flow ▪ HBSI ▪ NSV flow ▪ NSV flow alternative ▪ External pressure ▪ Exciter current 1 ▪ Exciter current 2 ▪ Oscillation frequency 1 ▪ Oscillation frequency 2 ▪ S&W volume flow ▪ Reference density ▪ Reference density alternative ▪ Corrected volume flow ▪ Oil corrected volume flow ▪ Water corrected volume flow ▪ Oscillation damping fluctuation 1 ▪ Oscillation damping fluctuation 2 ▪ Frequency fluctuation 1 ▪ Frequency fluctuation 2 ▪ Target mass flow ▪ Carrier volume flow ▪ Target volume flow ▪ Temp. compensated dynamic viscosity ▪ Temp. compensated kinematic viscosity ▪ Temperature ▪ Status ▪ Volume flow ▪ Oil volume flow ▪ Water volume flow ▪ Water cut 			

Diagnostic information		Remedy instructions	
No.	Short text		
441	Current output 1 to n	1. Check process 2. Check current output settings	
	Measured variable status [from the factory] ¹⁾		
	Quality		Good
	Quality substatus		Function check
	Coding (hex)		0xBC to 0xBF
	Status signal		S
	Diagnostic behavior		Warning
	Influenced measured variables		
-			

1) Diagnostic behavior can be changed. This causes the overall status of the measured variable to change.

Diagnostic information		Remedy instructions	
No.	Short text		
442	Frequency output 1 to n	1. Check process 2. Check frequency output settings	
	Measured variable status [from the factory] ¹⁾		
	Quality		Good
	Quality substatus		Function check
	Coding (hex)		0xBC to 0xBF
	Status signal		S
	Diagnostic behavior		Warning
	Influenced measured variables		
-			

1) Diagnostic behavior can be changed. This causes the overall status of the measured variable to change.

Diagnostic information		Remedy instructions	
No.	Short text		
443	Pulse output 1 to n	1. Check process 2. Check pulse output settings	
	Measured variable status [from the factory] ¹⁾		
	Quality		Good
	Quality substatus		Function check
	Coding (hex)		0xBC to 0xBF
	Status signal		S
	Diagnostic behavior		Warning
	Influenced measured variables		
-			

1) Diagnostic behavior can be changed. This causes the overall status of the measured variable to change.

Diagnostic information		Remedy instructions	
No.	Short text		
444	Current input 1 to n	1. Check process 2. Check current input settings	
	Measured variable status [from the factory] ¹⁾		
	Quality		Good
	Quality substatus		Function check
	Coding (hex)		0xBC to 0xBF
	Status signal		S
	Diagnostic behavior		Warning
	Influenced measured variables		
<ul style="list-style-type: none"> ▪ Measured values 1 ▪ Measured values 2 ▪ Measured values 3 			

1) Diagnostic behavior can be changed. This causes the overall status of the measured variable to change.

Diagnostic information		Remedy instructions	
No.	Short text		
453	Flow override	Deactivate flow override	
	Measured variable status		
	Quality		Good
	Quality substatus		Function check
	Coding (hex)		0xBC to 0xBF
	Status signal		C
	Diagnostic behavior		Warning
Influenced measured variables			
<ul style="list-style-type: none"> ▪ Oscillation amplitude 1 ▪ Oscillation amplitude 2 ▪ Signal asymmetry ▪ Carrier mass flow ▪ Carrier pipe temperature ▪ Target corrected volume flow ▪ Carrier corrected volume flow ▪ Concentration ▪ Oscillation damping 1 ▪ Oscillation damping 2 ▪ Density ▪ Oil density ▪ Water density ▪ Dynamic viscosity ▪ Sensor electronic temperature (ISEM) ▪ Empty pipe detection option ▪ GSV flow ▪ GSV flow alternative 		<ul style="list-style-type: none"> ▪ Kinematic viscosity ▪ Low flow cut off option ▪ Mass flow ▪ Oil mass flow ▪ Water mass flow ▪ HBSI ▪ NSV flow ▪ NSV flow alternative ▪ External pressure ▪ Exciter current 1 ▪ Exciter current 2 ▪ Oscillation frequency 1 ▪ Oscillation frequency 2 ▪ S&W volume flow ▪ Reference density ▪ Reference density alternative ▪ Corrected volume flow ▪ Oil corrected volume flow 	
		<ul style="list-style-type: none"> ▪ Water corrected volume flow ▪ Oscillation damping fluctuation 1 ▪ Oscillation damping fluctuation 2 ▪ Frequency fluctuation 1 ▪ Frequency fluctuation 2 ▪ Target mass flow ▪ Carrier volume flow ▪ Target volume flow ▪ Temp. compensated dynamic viscosity ▪ Temp. compensated kinematic viscosity ▪ Temperature ▪ Status ▪ Volume flow ▪ Oil volume flow ▪ Water volume flow ▪ Water cut 	

Diagnostic information		Remedy instructions	
No.	Short text		
463	Analog input 1 to n selection invalid	1. Check module/channel configuration 2. Check I/O module configuration	
	Measured variable status		
	Quality		Bad
	Quality substatus		Maintenance alarm
	Coding (hex)		0x24 to 0x27
	Status signal		F
	Diagnostic behavior		Alarm
Influenced measured variables			
<ul style="list-style-type: none"> ▪ Measured values 1 ▪ Measured values 2 ▪ Measured values 3 			

Diagnostic information		Remedy instructions	
No.	Short text		
482	FB not Auto/Cas	Set Block in AUTO mode	
	Measured variable status		
	Quality		Good
	Quality substatus		Ok
	Coding (hex)		0x80 to 0x83
	Status signal		F
	Diagnostic behavior		Alarm
	Influenced measured variables		
-			

Diagnostic information		Remedy instructions	
No.	Short text		
484	Failure mode simulation	Deactivate simulation	
	Measured variable status		
	Quality		Bad
	Quality substatus		Function check
	Coding (hex)		0x3C to 0x3F
	Status signal		C
	Diagnostic behavior		Alarm
	Influenced measured variables		
<ul style="list-style-type: none"> ▪ Oscillation amplitude 1 ▪ Oscillation amplitude 2 ▪ Signal asymmetry ▪ Carrier mass flow ▪ Carrier pipe temperature ▪ Target corrected volume flow ▪ Carrier corrected volume flow ▪ Concentration ▪ Oscillation damping 1 ▪ Oscillation damping 2 ▪ Density ▪ Oil density ▪ Water density ▪ Dynamic viscosity ▪ Sensor electronic temperature (ISEM) ▪ Empty pipe detection option ▪ GSV flow ▪ GSV flow alternative ▪ Kinematic viscosity ▪ Low flow cut off option ▪ Mass flow ▪ Oil mass flow ▪ Water mass flow ▪ HBSI ▪ NSV flow ▪ NSV flow alternative ▪ External pressure ▪ Exciter current 1 ▪ Exciter current 2 ▪ Oscillation frequency 1 ▪ Oscillation frequency 2 ▪ S&W volume flow ▪ Reference density ▪ Reference density alternative ▪ Corrected volume flow ▪ Oil corrected volume flow ▪ Water corrected volume flow ▪ Oscillation damping fluctuation 1 ▪ Oscillation damping fluctuation 2 ▪ Frequency fluctuation 1 ▪ Frequency fluctuation 2 ▪ Target mass flow ▪ Carrier volume flow ▪ Target volume flow ▪ Temp. compensated dynamic viscosity ▪ Temp. compensated kinematic viscosity ▪ Temperature ▪ Status ▪ Volume flow ▪ Oil volume flow ▪ Water volume flow ▪ Water cut 			

Diagnostic information		Remedy instructions	
No.	Short text		
485	Measured variable simulation	Deactivate simulation	
	Measured variable status		
	Quality		Good
	Quality substatus		Function check
	Coding (hex)		0xBC to 0xBF
	Status signal		C
	Diagnostic behavior		Warning
Influenced measured variables			
<ul style="list-style-type: none"> ▪ Oscillation amplitude 1 ▪ Oscillation amplitude 2 ▪ Signal asymmetry ▪ Carrier mass flow ▪ Carrier pipe temperature ▪ Target corrected volume flow ▪ Carrier corrected volume flow ▪ Concentration ▪ Oscillation damping 1 ▪ Oscillation damping 2 ▪ Density ▪ Oil density ▪ Water density ▪ Dynamic viscosity ▪ Sensor electronic temperature (ISEM) ▪ Empty pipe detection option ▪ GSV flow ▪ GSV flow alternative 		<ul style="list-style-type: none"> ▪ Kinematic viscosity ▪ Low flow cut off option ▪ Mass flow ▪ Oil mass flow ▪ Water mass flow ▪ HBSI ▪ NSV flow ▪ NSV flow alternative ▪ External pressure ▪ Exciter current 1 ▪ Exciter current 2 ▪ Oscillation frequency 1 ▪ Oscillation frequency 2 ▪ S&W volume flow ▪ Reference density ▪ Reference density alternative ▪ Corrected volume flow ▪ Oil corrected volume flow 	
<ul style="list-style-type: none"> ▪ Water corrected volume flow ▪ Oscillation damping fluctuation 1 ▪ Oscillation damping fluctuation 2 ▪ Frequency fluctuation 1 ▪ Frequency fluctuation 2 ▪ Target mass flow ▪ Carrier volume flow ▪ Target volume flow ▪ Temp. compensated dynamic viscosity ▪ Temp. compensated kinematic viscosity ▪ Temperature ▪ Status ▪ Volume flow ▪ Oil volume flow ▪ Water volume flow ▪ Water cut 			

Diagnostic information		Remedy instructions	
No.	Short text		
486	Current input 1 to n simulation	Deactivate simulation	
	Measured variable status		
	Quality		Good
	Quality substatus		Function check
	Coding (hex)		0xBC to 0xBF
	Status signal		C
	Diagnostic behavior		Warning
Influenced measured variables			
<ul style="list-style-type: none"> ▪ Measured values 1 ▪ Measured values 2 ▪ Measured values 3 			

Diagnostic information		Remedy instructions
No.	Short text	
491	Current output 1 to n simulation	Deactivate simulation
Measured variable status		
Quality	Good	
Quality substatus	Function check	
Coding (hex)	0xBC to 0xBF	
Status signal	C	
Diagnostic behavior	Warning	
Influenced measured variables		
-		

Diagnostic information		Remedy instructions
No.	Short text	
492	Simulation frequency output 1 to n	Deactivate simulation frequency output
Measured variable status		
Quality	Good	
Quality substatus	Function check	
Coding (hex)	0xBC to 0xBF	
Status signal	C	
Diagnostic behavior	Warning	
Influenced measured variables		
-		

Diagnostic information		Remedy instructions
No.	Short text	
493	Simulation pulse output 1 to n	Deactivate simulation pulse output
Measured variable status		
Quality	Good	
Quality substatus	Function check	
Coding (hex)	0xBC to 0xBF	
Status signal	C	
Diagnostic behavior	Warning	
Influenced measured variables		
-		

Diagnostic information		Remedy instructions	
No.	Short text		
494	Switch output simulation 1 to n	Deactivate simulation switch output	
	Measured variable status		
	Quality		Good
	Quality substatus		Function check
	Coding (hex)		0xBC to 0xBF
	Status signal		C
	Diagnostic behavior		Warning
	Influenced measured variables		
-			

Diagnostic information		Remedy instructions	
No.	Short text		
495	Diagnostic event simulation	Deactivate simulation	
	Measured variable status		
	Quality		Good
	Quality substatus		Ok
	Coding (hex)		0x80 to 0x83
	Status signal		C
	Diagnostic behavior		Warning
	Influenced measured variables		
-			

Diagnostic information		Remedy instructions	
No.	Short text		
496	Status input simulation	Deactivate simulation status input	
	Measured variable status		
	Quality		Good
	Quality substatus		Function check
	Coding (hex)		0xBC to 0xBF
	Status signal		C
	Diagnostic behavior		Warning
	Influenced measured variables		
-			

Diagnostic information		Remedy instructions
No.	Short text	
497	Simulation block output	Deactivate simulation
Measured variable status		
Quality	Good	
Quality substatus	Ok	
Coding (hex)	0x80 to 0x83	
Status signal	C	
Diagnostic behavior	Warning	
Influenced measured variables		
-		

Diagnostic information		Remedy instructions
No.	Short text	
520	I/O 1 to n hardware configuration invalid	<ol style="list-style-type: none"> 1. Check I/O hardware configuration 2. Replace wrong I/O module 3. Plug the module of double pulse output on correct slot
Measured variable status		
Quality	Bad	
Quality substatus	Function check	
Coding (hex)	0x3C to 0x3F	
Status signal	F	
Diagnostic behavior	Alarm	
Influenced measured variables		
-		

Diagnostic information		Remedy instructions
No.	Short text	
528	Concentration settings faulty	<ol style="list-style-type: none"> 1. Check concentration settings 2. Check input values e.g. pressure, temperature
Measured variable status		
Quality	Bad	
Quality substatus	Function check	
Coding (hex)	0x3C to 0x3F	
Status signal	S	
Diagnostic behavior	Alarm	
Influenced measured variables		
<ul style="list-style-type: none"> ▪ Carrier mass flow ▪ Target corrected volume flow ▪ Carrier corrected volume flow ▪ Concentration ▪ Density ▪ Mass flow ▪ Target mass flow ▪ Carrier volume flow ▪ Target volume flow ▪ Volume flow 		

Diagnostic information		Remedy instructions	
No.	Short text		
529	Concentration settings faulty	1. Check concentration settings 2. Check input values e.g. pressure, temperature	
	Measured variable status		
	Quality		Bad
	Quality substatus		Function check
	Coding (hex)		0x3C to 0x3F
	Status signal		S
	Diagnostic behavior		Warning
	Influenced measured variables		
<ul style="list-style-type: none"> ▪ Carrier mass flow ▪ Target corrected volume flow ▪ Carrier corrected volume flow ▪ Concentration ▪ Density ▪ Mass flow ▪ Target mass flow ▪ Carrier volume flow ▪ Target volume flow ▪ Volume flow 			

Diagnostic information		Remedy instructions	
No.	Short text		
537	Configuration	1. Check IP addresses in network 2. Change IP address	
	Measured variable status		
	Quality		Good
	Quality substatus		Function check
	Coding (hex)		0xBC to 0xBF
	Status signal		F
	Diagnostic behavior		Warning
	Influenced measured variables		
-			

Diagnostic information		Remedy instructions	
No.	Short text		
594	Relay output simulation	Deactivate simulation switch output	
	Measured variable status		
	Quality		Good
	Quality substatus		Function check
	Coding (hex)		0xBC to 0xBF
	Status signal		C
	Diagnostic behavior		Warning
	Influenced measured variables		
-			

12.7.4 Diagnostic of process

Diagnostic information		Remedy instructions
No.	Short text	
803	Current loop	1. Check wiring 2. Change I/O module
Measured variable status		
Quality	Bad	
Quality substatus	Process related	
Coding (hex)	0x28 to 0x2B	
Status signal	F	
Diagnostic behavior	Alarm	
Influenced measured variables		
-		

Diagnostic information		Remedy instructions
No.	Short text	
830	Sensor temperature too high	Reduce ambient temp. around the sensor housing
Measured variable status [from the factory] ¹⁾		
Quality	Uncertain	
Quality substatus	Process related	
Coding (hex)	0x78 to 0x7B	
Status signal	S	
Diagnostic behavior	Warning	
Influenced measured variables		
<ul style="list-style-type: none"> ▪ Oscillation amplitude 1 ▪ Oscillation amplitude 2 ▪ Signal asymmetry ▪ Carrier mass flow ▪ Carrier pipe temperature ▪ Target corrected volume flow ▪ Carrier corrected volume flow ▪ Concentration ▪ Oscillation damping 1 ▪ Oscillation damping 2 ▪ Density ▪ Oil density ▪ Water density ▪ Dynamic viscosity ▪ Sensor electronic temperature (ISEM) ▪ Empty pipe detection option ▪ GSV flow ▪ GSV flow alternative ▪ Kinematic viscosity ▪ Low flow cut off option ▪ Mass flow ▪ Oil mass flow ▪ Water mass flow ▪ HBSI ▪ NSV flow ▪ NSV flow alternative ▪ External pressure ▪ Exciter current 1 ▪ Exciter current 2 ▪ Oscillation frequency 1 ▪ Oscillation frequency 2 ▪ S&W volume flow ▪ Reference density ▪ Reference density alternative ▪ Corrected volume flow ▪ Oil corrected volume flow ▪ Water corrected volume flow ▪ Oscillation damping fluctuation 1 ▪ Oscillation damping fluctuation 2 ▪ Frequency fluctuation 1 ▪ Frequency fluctuation 2 ▪ Target mass flow ▪ Carrier volume flow ▪ Target volume flow ▪ Temp. compensated dynamic viscosity ▪ Temp. compensated kinematic viscosity ▪ Temperature ▪ Status ▪ Volume flow ▪ Oil volume flow ▪ Water volume flow ▪ Water cut 		

1) Diagnostic behavior can be changed. This causes the overall status of the measured variable to change.

Diagnostic information		Remedy instructions
No.	Short text	
831	Sensor temperature too low	Increase ambient temp. around the sensor housing
Measured variable status [from the factory] ¹⁾		
Quality	Uncertain	
Quality substatus	Process related	
Coding (hex)	0x78 to 0x7B	
Status signal	S	
Diagnostic behavior	Warning	
Influenced measured variables		
<ul style="list-style-type: none"> ▪ Oscillation amplitude 1 ▪ Oscillation amplitude 2 ▪ Signal asymmetry ▪ Carrier mass flow ▪ Carrier pipe temperature ▪ Target corrected volume flow ▪ Carrier corrected volume flow ▪ Concentration ▪ Oscillation damping 1 ▪ Oscillation damping 2 ▪ Density ▪ Oil density ▪ Water density ▪ Dynamic viscosity ▪ Sensor electronic temperature (ISEM) ▪ Empty pipe detection option ▪ GSV flow ▪ GSV flow alternative 		<ul style="list-style-type: none"> ▪ Kinematic viscosity ▪ Low flow cut off option ▪ Mass flow ▪ Oil mass flow ▪ Water mass flow ▪ HBSI ▪ NSV flow ▪ NSV flow alternative ▪ External pressure ▪ Exciter current 1 ▪ Exciter current 2 ▪ Oscillation frequency 1 ▪ Oscillation frequency 2 ▪ S&W volume flow ▪ Reference density ▪ Reference density alternative ▪ Corrected volume flow ▪ Oil corrected volume flow
		<ul style="list-style-type: none"> ▪ Water corrected volume flow ▪ Oscillation damping fluctuation 1 ▪ Oscillation damping fluctuation 2 ▪ Frequency fluctuation 1 ▪ Frequency fluctuation 2 ▪ Target mass flow ▪ Carrier volume flow ▪ Target volume flow ▪ Temp. compensated dynamic viscosity ▪ Temp. compensated kinematic viscosity ▪ Temperature ▪ Status ▪ Volume flow ▪ Oil volume flow ▪ Water volume flow ▪ Water cut

1) Diagnostic behavior can be changed. This causes the overall status of the measured variable to change.

Diagnostic information		Remedy instructions
No.	Short text	
832	Electronic temperature too high	Reduce ambient temperature
Measured variable status [from the factory] ¹⁾		
Quality	Bad	
Quality substatus	Process related	
Coding (hex)	0x28 to 0x2B	
Status signal	S	
Diagnostic behavior	Warning	
Influenced measured variables		
<ul style="list-style-type: none"> ▪ Oscillation amplitude 1 ▪ Oscillation amplitude 2 ▪ Signal asymmetry ▪ Carrier mass flow ▪ Carrier pipe temperature ▪ Target corrected volume flow ▪ Carrier corrected volume flow ▪ Concentration ▪ Measured values 1 ▪ Measured values 2 ▪ Measured values 3 ▪ Oscillation damping 1 ▪ Oscillation damping 2 ▪ Density ▪ Oil density ▪ Water density ▪ Dynamic viscosity ▪ Sensor electronic temperature (ISEM) ▪ Empty pipe detection option 		<ul style="list-style-type: none"> ▪ GSV flow ▪ GSV flow alternative ▪ Kinematic viscosity ▪ Low flow cut off option ▪ Mass flow ▪ Oil mass flow ▪ Water mass flow ▪ HBSI ▪ NSV flow ▪ NSV flow alternative ▪ External pressure ▪ Exciter current 1 ▪ Exciter current 2 ▪ Oscillation frequency 1 ▪ Oscillation frequency 2 ▪ S&W volume flow ▪ Reference density ▪ Reference density alternative ▪ Corrected volume flow
		<ul style="list-style-type: none"> ▪ Oil corrected volume flow ▪ Water corrected volume flow ▪ Oscillation damping fluctuation 1 ▪ Oscillation damping fluctuation 2 ▪ Frequency fluctuation 1 ▪ Frequency fluctuation 2 ▪ Target mass flow ▪ Carrier volume flow ▪ Target volume flow ▪ Temp. compensated dynamic viscosity ▪ Temp. compensated kinematic viscosity ▪ Temperature ▪ Status ▪ Volume flow ▪ Oil volume flow ▪ Water volume flow ▪ Water cut

1) Diagnostic behavior can be changed. This causes the overall status of the measured variable to change.

Diagnostic information		Remedy instructions
No.	Short text	
833	Electronic temperature too low	Increase ambient temperature
Measured variable status [from the factory] ¹⁾		
Quality	Bad	
Quality substatus	Process related	
Coding (hex)	0x28 to 0x2B	
Status signal	S	
Diagnostic behavior	Warning	
Influenced measured variables		
<ul style="list-style-type: none"> ▪ Oscillation amplitude 1 ▪ Oscillation amplitude 2 ▪ Signal asymmetry ▪ Carrier mass flow ▪ Carrier pipe temperature ▪ Target corrected volume flow ▪ Carrier corrected volume flow ▪ Concentration ▪ Measured values 1 ▪ Measured values 2 ▪ Measured values 3 ▪ Oscillation damping 1 ▪ Oscillation damping 2 ▪ Density ▪ Oil density ▪ Water density ▪ Dynamic viscosity ▪ Sensor electronic temperature (ISEM) ▪ Empty pipe detection option 		<ul style="list-style-type: none"> ▪ GSV flow ▪ GSV flow alternative ▪ Kinematic viscosity ▪ Low flow cut off option ▪ Mass flow ▪ Oil mass flow ▪ Water mass flow ▪ HBSI ▪ NSV flow ▪ NSV flow alternative ▪ External pressure ▪ Exciter current 1 ▪ Exciter current 2 ▪ Oscillation frequency 1 ▪ Oscillation frequency 2 ▪ S&W volume flow ▪ Reference density ▪ Reference density alternative ▪ Corrected volume flow
		<ul style="list-style-type: none"> ▪ Oil corrected volume flow ▪ Water corrected volume flow ▪ Oscillation damping fluctuation 1 ▪ Oscillation damping fluctuation 2 ▪ Frequency fluctuation 1 ▪ Frequency fluctuation 2 ▪ Target mass flow ▪ Carrier volume flow ▪ Target volume flow ▪ Temp. compensated dynamic viscosity ▪ Temp. compensated kinematic viscosity ▪ Temperature ▪ Status ▪ Volume flow ▪ Oil volume flow ▪ Water volume flow ▪ Water cut

1) Diagnostic behavior can be changed. This causes the overall status of the measured variable to change.

Diagnostic information		Remedy instructions	
No.	Short text		
834	Process temperature too high	Reduce process temperature	
	Measured variable status [from the factory] ¹⁾		
	Quality		Uncertain
	Quality substatus		Process related
	Coding (hex)		0x78 to 0x7B
	Status signal		S
	Diagnostic behavior		Warning
Influenced measured variables			
<ul style="list-style-type: none"> ▪ Oscillation amplitude 1 ▪ Oscillation amplitude 2 ▪ Signal asymmetry ▪ Carrier mass flow ▪ Carrier pipe temperature ▪ Target corrected volume flow ▪ Carrier corrected volume flow ▪ Concentration ▪ Oscillation damping 1 ▪ Oscillation damping 2 ▪ Density ▪ Oil density ▪ Water density ▪ Dynamic viscosity ▪ Sensor electronic temperature (ISEM) ▪ Empty pipe detection option ▪ GSV flow ▪ GSV flow alternative ▪ Kinematic viscosity ▪ Low flow cut off option ▪ Mass flow ▪ Oil mass flow ▪ Water mass flow ▪ HBSI ▪ NSV flow ▪ NSV flow alternative ▪ External pressure ▪ Exciter current 1 ▪ Exciter current 2 ▪ Oscillation frequency 1 ▪ Oscillation frequency 2 ▪ S&W volume flow ▪ Reference density ▪ Reference density alternative ▪ Corrected volume flow ▪ Oil corrected volume flow ▪ Water corrected volume flow ▪ Oscillation damping fluctuation 1 ▪ Oscillation damping fluctuation 2 ▪ Frequency fluctuation 1 ▪ Frequency fluctuation 2 ▪ Target mass flow ▪ Carrier volume flow ▪ Target volume flow ▪ Temp. compensated dynamic viscosity ▪ Temp. compensated kinematic viscosity ▪ Temperature ▪ Status ▪ Volume flow ▪ Oil volume flow ▪ Water volume flow ▪ Water cut 			

1) Diagnostic behavior can be changed. This causes the overall status of the measured variable to change.

Diagnostic information		Remedy instructions
No.	Short text	
835	Process temperature too low	Increase process temperature
	Measured variable status [from the factory] ¹⁾	
	Quality	Uncertain
	Quality substatus	Process related
	Coding (hex)	0x78 to 0x7B
	Status signal	S
	Diagnostic behavior	Warning
	Influenced measured variables	
	<ul style="list-style-type: none"> ▪ Oscillation amplitude 1 ▪ Oscillation amplitude 2 ▪ Signal asymmetry ▪ Carrier mass flow ▪ Carrier pipe temperature ▪ Target corrected volume flow ▪ Carrier corrected volume flow ▪ Concentration ▪ Oscillation damping 1 ▪ Oscillation damping 2 ▪ Density ▪ Oil density ▪ Water density ▪ Dynamic viscosity ▪ Sensor electronic temperature (ISEM) ▪ Empty pipe detection option ▪ GSV flow ▪ GSV flow alternative 	<ul style="list-style-type: none"> ▪ Kinematic viscosity ▪ Low flow cut off option ▪ Mass flow ▪ Oil mass flow ▪ Water mass flow ▪ HBSI ▪ NSV flow ▪ NSV flow alternative ▪ External pressure ▪ Exciter current 1 ▪ Exciter current 2 ▪ Oscillation frequency 1 ▪ Oscillation frequency 2 ▪ S&W volume flow ▪ Reference density ▪ Reference density alternative ▪ Corrected volume flow ▪ Oil corrected volume flow
		<ul style="list-style-type: none"> ▪ Water corrected volume flow ▪ Oscillation damping fluctuation 1 ▪ Oscillation damping fluctuation 2 ▪ Frequency fluctuation 1 ▪ Frequency fluctuation 2 ▪ Target mass flow ▪ Carrier volume flow ▪ Target volume flow ▪ Temp. compensated dynamic viscosity ▪ Temp. compensated kinematic viscosity ▪ Temperature ▪ Status ▪ Volume flow ▪ Oil volume flow ▪ Water volume flow ▪ Water cut

1) Diagnostic behavior can be changed. This causes the overall status of the measured variable to change.

Diagnostic information		Remedy instructions	
No.	Short text		
842	Process limit	Low flow cut off active! 1. Check low flow cut off configuration	
	Measured variable status [from the factory] ¹⁾		
	Quality		Uncertain
	Quality substatus		Process related
	Coding (hex)		0x78 to 0x7B
	Status signal		S
	Diagnostic behavior		Warning
	Influenced measured variables		
<ul style="list-style-type: none"> ▪ Oscillation amplitude 1 ▪ Oscillation amplitude 2 ▪ Signal asymmetry ▪ Carrier mass flow ▪ Carrier pipe temperature ▪ Target corrected volume flow ▪ Carrier corrected volume flow ▪ Concentration ▪ Oscillation damping 1 ▪ Oscillation damping 2 ▪ Density ▪ Oil density ▪ Water density ▪ Dynamic viscosity ▪ Sensor electronic temperature (ISEM) ▪ Empty pipe detection option ▪ GSV flow ▪ GSV flow alternative ▪ Kinematic viscosity ▪ Low flow cut off option ▪ Mass flow ▪ Oil mass flow ▪ Water mass flow ▪ HBSI ▪ NSV flow ▪ NSV flow alternative ▪ External pressure ▪ Exciter current 1 ▪ Exciter current 2 ▪ Oscillation frequency 1 ▪ Oscillation frequency 2 ▪ S&W volume flow ▪ Reference density ▪ Reference density alternative ▪ Corrected volume flow ▪ Oil corrected volume flow ▪ Water corrected volume flow ▪ Oscillation damping fluctuation 1 ▪ Oscillation damping fluctuation 2 ▪ Frequency fluctuation 1 ▪ Frequency fluctuation 2 ▪ Target mass flow ▪ Carrier volume flow ▪ Target volume flow ▪ Temp. compensated dynamic viscosity ▪ Temp. compensated kinematic viscosity ▪ Temperature ▪ Status ▪ Volume flow ▪ Oil volume flow ▪ Water volume flow ▪ Water cut 			

1) Diagnostic behavior can be changed. This causes the overall status of the measured variable to change.

Diagnostic information		Remedy instructions	
No.	Short text		
862	Partly filled pipe	1. Check for gas in process 2. Adjust detection limits	
	Measured variable status [from the factory] ¹⁾		
	Quality		Bad
	Quality substatus		Process related
	Coding (hex)		0x28 to 0x2B
	Status signal		S
	Diagnostic behavior		Warning
	Influenced measured variables		
<ul style="list-style-type: none"> ▪ Carrier mass flow ▪ Target corrected volume flow ▪ Carrier corrected volume flow ▪ Concentration ▪ Density ▪ Oil density ▪ Water density ▪ Dynamic viscosity ▪ Empty pipe detection option ▪ GSV flow ▪ GSV flow alternative ▪ Kinematic viscosity ▪ Low flow cut off option ▪ Mass flow ▪ Oil mass flow ▪ Water mass flow ▪ HBSI ▪ NSV flow ▪ NSV flow alternative ▪ External pressure ▪ S&W volume flow ▪ Reference density ▪ Reference density alternative ▪ Corrected volume flow ▪ Oil corrected volume flow ▪ Water corrected volume flow ▪ Target mass flow ▪ Carrier volume flow ▪ Target volume flow ▪ Temp. compensated dynamic viscosity ▪ Temp. compensated kinematic viscosity ▪ Temperature ▪ Status ▪ Volume flow ▪ Oil volume flow ▪ Water volume flow ▪ Water cut 			

1) Diagnostic behavior can be changed. This causes the overall status of the measured variable to change.

Diagnostic information		Remedy instructions	
No.	Short text		
882	Input signal	1. Check input configuration 2. Check external device or process conditions	
	Measured variable status		
	Quality		Bad
	Quality substatus		Maintenance alarm
	Coding (hex)		0x24 to 0x27
	Status signal		F
	Diagnostic behavior		Alarm
Influenced measured variables			
<ul style="list-style-type: none"> ▪ Oscillation amplitude 1 ▪ Oscillation amplitude 2 ▪ Signal asymmetry ▪ Carrier mass flow ▪ Carrier pipe temperature ▪ Target corrected volume flow ▪ Carrier corrected volume flow ▪ Concentration ▪ Measured values 1 ▪ Measured values 2 ▪ Measured values 3 ▪ Oscillation damping 1 ▪ Oscillation damping 2 ▪ Density ▪ Oil density ▪ Water density ▪ Dynamic viscosity ▪ Sensor electronic temperature (ISEM) ▪ Empty pipe detection option ▪ GSV flow ▪ GSV flow alternative ▪ Kinematic viscosity ▪ Low flow cut off option ▪ Mass flow ▪ Oil mass flow ▪ Water mass flow ▪ HBSI ▪ NSV flow ▪ NSV flow alternative ▪ External pressure ▪ Exciter current 1 ▪ Exciter current 2 ▪ Oscillation frequency 1 ▪ Oscillation frequency 2 ▪ S&W volume flow ▪ Reference density ▪ Reference density alternative ▪ Corrected volume flow ▪ Oil corrected volume flow ▪ Water corrected volume flow ▪ Oscillation damping fluctuation 1 ▪ Oscillation damping fluctuation 2 ▪ Frequency fluctuation 1 ▪ Frequency fluctuation 2 ▪ Target mass flow ▪ Carrier volume flow ▪ Target volume flow ▪ Temp. compensated dynamic viscosity ▪ Temp. compensated kinematic viscosity ▪ Temperature ▪ Status ▪ Volume flow ▪ Oil volume flow ▪ Water volume flow ▪ Water cut 			

Diagnostic information		Remedy instructions	
No.	Short text		
910	Tubes not oscillating	1. Check electronic 2. Inspect sensor	
	Measured variable status		
	Quality		Bad
	Quality substatus		Maintenance alarm
	Coding (hex)		0x24 to 0x27
	Status signal		F
	Diagnostic behavior		Alarm
Influenced measured variables			
<ul style="list-style-type: none"> ▪ Oscillation amplitude 1 ▪ Oscillation amplitude 2 ▪ Signal asymmetry ▪ Carrier mass flow ▪ Carrier pipe temperature ▪ Target corrected volume flow ▪ Carrier corrected volume flow ▪ Concentration ▪ Oscillation damping 1 ▪ Oscillation damping 2 ▪ Density ▪ Oil density ▪ Water density ▪ Dynamic viscosity ▪ Sensor electronic temperature (ISEM) ▪ Empty pipe detection option ▪ GSV flow ▪ GSV flow alternative ▪ Kinematic viscosity ▪ Low flow cut off option ▪ Mass flow ▪ Oil mass flow ▪ Water mass flow ▪ HBSI ▪ NSV flow ▪ NSV flow alternative ▪ External pressure ▪ Exciter current 1 ▪ Exciter current 2 ▪ Oscillation frequency 1 ▪ Oscillation frequency 2 ▪ S&W volume flow ▪ Reference density ▪ Reference density alternative ▪ Corrected volume flow ▪ Oil corrected volume flow ▪ Water corrected volume flow ▪ Oscillation damping fluctuation 1 ▪ Oscillation damping fluctuation 2 ▪ Frequency fluctuation 1 ▪ Frequency fluctuation 2 ▪ Target mass flow ▪ Carrier volume flow ▪ Target volume flow ▪ Temp. compensated dynamic viscosity ▪ Temp. compensated kinematic viscosity ▪ Temperature ▪ Status ▪ Volume flow ▪ Oil volume flow ▪ Water volume flow ▪ Water cut 			

Diagnostic information		Remedy instructions	
No.	Short text		
912	Medium inhomogeneous	1. Check process cond. 2. Increase system pressure	
	Measured variable status [from the factory] ¹⁾		
	Quality		Uncertain
	Quality substatus		Process related
	Coding (hex)		0x78 to 0x7B
	Status signal		S
	Diagnostic behavior		Warning
Influenced measured variables			
<ul style="list-style-type: none"> ▪ Oscillation amplitude 1 ▪ Oscillation amplitude 2 ▪ Signal asymmetry ▪ Carrier mass flow ▪ Carrier pipe temperature ▪ Target corrected volume flow ▪ Carrier corrected volume flow ▪ Concentration ▪ Oscillation damping 1 ▪ Oscillation damping 2 ▪ Density ▪ Oil density ▪ Water density ▪ Dynamic viscosity ▪ Sensor electronic temperature (ISEM) ▪ Empty pipe detection option ▪ GSV flow ▪ GSV flow alternative ▪ Kinematic viscosity ▪ Low flow cut off option ▪ Mass flow ▪ Oil mass flow ▪ Water mass flow ▪ HBSI ▪ NSV flow ▪ NSV flow alternative ▪ External pressure ▪ Exciter current 1 ▪ Exciter current 2 ▪ Oscillation frequency 1 ▪ Oscillation frequency 2 ▪ S&W volume flow ▪ Reference density ▪ Reference density alternative ▪ Corrected volume flow ▪ Oil corrected volume flow ▪ Water corrected volume flow ▪ Oscillation damping fluctuation 1 ▪ Oscillation damping fluctuation 2 ▪ Frequency fluctuation 1 ▪ Frequency fluctuation 2 ▪ Target mass flow ▪ Carrier volume flow ▪ Target volume flow ▪ Temp. compensated dynamic viscosity ▪ Temp. compensated kinematic viscosity ▪ Temperature ▪ Status ▪ Volume flow ▪ Oil volume flow ▪ Water volume flow ▪ Water cut 			

1) Diagnostic behavior can be changed. This causes the overall status of the measured variable to change.

Diagnostic information		Remedy instructions	
No.	Short text		
913	Medium unsuitable	1. Check process conditions 2. Check electronic modules or sensor	
	Measured variable status [from the factory] ¹⁾		
	Quality		Uncertain
	Quality substatus		Process related
	Coding (hex)		0x78 to 0x7B
	Status signal		S
	Diagnostic behavior		Warning
Influenced measured variables			
<ul style="list-style-type: none"> ▪ Oscillation amplitude 1 ▪ Oscillation amplitude 2 ▪ Signal asymmetry ▪ Carrier mass flow ▪ Carrier pipe temperature ▪ Target corrected volume flow ▪ Carrier corrected volume flow ▪ Concentration ▪ Oscillation damping 1 ▪ Oscillation damping 2 ▪ Density ▪ Oil density ▪ Water density ▪ Dynamic viscosity ▪ Sensor electronic temperature (ISEM) ▪ Empty pipe detection option ▪ GSV flow ▪ GSV flow alternative ▪ Kinematic viscosity ▪ Low flow cut off option ▪ Mass flow ▪ Oil mass flow ▪ Water mass flow ▪ HBSI ▪ NSV flow ▪ NSV flow alternative ▪ External pressure ▪ Exciter current 1 ▪ Exciter current 2 ▪ Oscillation frequency 1 ▪ Oscillation frequency 2 ▪ S&W volume flow ▪ Reference density ▪ Reference density alternative ▪ Corrected volume flow ▪ Oil corrected volume flow ▪ Water corrected volume flow ▪ Oscillation damping fluctuation 1 ▪ Oscillation damping fluctuation 2 ▪ Frequency fluctuation 1 ▪ Frequency fluctuation 2 ▪ Target mass flow ▪ Carrier volume flow ▪ Target volume flow ▪ Temp. compensated dynamic viscosity ▪ Temp. compensated kinematic viscosity ▪ Temperature ▪ Status ▪ Volume flow ▪ Oil volume flow ▪ Water volume flow ▪ Water cut 			

1) Diagnostic behavior can be changed. This causes the overall status of the measured variable to change.

Diagnostic information		Remedy instructions	
No.	Short text		
941	API temperature out of specification	1. Check process temperature with selected API commodity group 2. Check API related parameters	
	Measured variable status		
	Quality		Bad
	Quality substatus		Maintenance alarm
	Coding (hex)		0x24 to 0x27
	Status signal		S
	Diagnostic behavior		Alarm
Influenced measured variables			
<ul style="list-style-type: none"> ▪ Oil density ▪ Water density ▪ GSV flow ▪ GSV flow alternative ▪ Mass flow ▪ Oil mass flow ▪ Water mass flow ▪ NSV flow ▪ NSV flow alternative ▪ External pressure ▪ S&W volume flow ▪ Reference density alternative ▪ Corrected volume flow ▪ Oil corrected volume flow ▪ Water corrected volume flow ▪ Oil volume flow ▪ Water volume flow ▪ Water cut 			

Diagnostic information		Remedy instructions	
No.	Short text		
942	API density out of specification	1. Check process density with selected API commodity group 2. Check API related parameters	
	Measured variable status		
	Quality		Bad
	Quality substatus		Maintenance alarm
	Coding (hex)		0x24 to 0x27
	Status signal		S
	Diagnostic behavior		Alarm
	Influenced measured variables		
Mass flow			

Diagnostic information		Remedy instructions	
No.	Short text		
943	API pressure out of specification	1. Check process pressure with selected API commodity group 2. Check API related parameters	
	Measured variable status		
	Quality		Bad
	Quality substatus		Maintenance alarm
	Coding (hex)		0x24 to 0x27
	Status signal		S
	Diagnostic behavior		Alarm
	Influenced measured variables		
<ul style="list-style-type: none"> ▪ Oil density ▪ Water density ▪ GSV flow ▪ GSV flow alternative ▪ Mass flow ▪ Oil mass flow ▪ Water mass flow ▪ NSV flow ▪ NSV flow alternative ▪ External pressure ▪ S&W volume flow ▪ Reference density alternative ▪ Corrected volume flow ▪ Oil corrected volume flow ▪ Water corrected volume flow ▪ Oil volume flow ▪ Water volume flow ▪ Water cut 			

Diagnostic information		Remedy instructions	
No.	Short text		
944	Monitoring failed	Check process conditions for Heartbeat Monitoring	
	Measured variable status [from the factory] ¹⁾		
	Quality		Bad
	Quality substatus		Maintenance alarm
	Coding (hex)		0x24 to 0x27
	Status signal		S
	Diagnostic behavior		Warning
	Influenced measured variables		
<ul style="list-style-type: none"> ▪ Oscillation amplitude 1 ▪ Oscillation amplitude 2 ▪ Signal asymmetry ▪ Carrier mass flow ▪ Carrier pipe temperature ▪ Concentration ▪ Oscillation damping 1 ▪ Oscillation damping 2 ▪ Density ▪ Dynamic viscosity ▪ Sensor electronic temperature (ISEM) ▪ Empty pipe detection option ▪ Kinematic viscosity ▪ Low flow cut off option ▪ Mass flow ▪ HBSI ▪ External pressure ▪ Exciter current 1 ▪ Exciter current 2 ▪ Oscillation frequency 1 ▪ Oscillation frequency 2 ▪ Reference density ▪ Corrected volume flow ▪ Oscillation damping fluctuation 1 ▪ Oscillation damping fluctuation 2 ▪ Frequency fluctuation 1 ▪ Frequency fluctuation 2 ▪ Target mass flow ▪ Temp. compensated dynamic viscosity ▪ Temp. compensated kinematic viscosity ▪ Temperature ▪ Status ▪ Volume flow 			

1) Diagnostic behavior can be changed. This causes the overall status of the measured variable to change.





Diagnostic information		Remedy instructions	
No.	Short text		
948	Oscillation damping too high	Check process conditions	
	Measured variable status [from the factory] ¹⁾		
	Quality		Uncertain
	Quality substatus		Process related
	Coding (hex)		0x78 to 0x7B
	Status signal		S
	Diagnostic behavior		Warning
	Influenced measured variables		
<ul style="list-style-type: none"> ▪ Oscillation amplitude 1 ▪ Oscillation amplitude 2 ▪ Signal asymmetry ▪ Carrier mass flow ▪ Carrier pipe temperature ▪ Target corrected volume flow ▪ Carrier corrected volume flow ▪ Concentration ▪ Oscillation damping 1 ▪ Oscillation damping 2 ▪ Density ▪ Oil density ▪ Water density ▪ Dynamic viscosity ▪ Sensor electronic temperature (ISEM) ▪ Empty pipe detection option ▪ GSV flow ▪ GSV flow alternative ▪ Kinematic viscosity ▪ Low flow cut off option ▪ Mass flow ▪ Oil mass flow ▪ Water mass flow ▪ HBSI ▪ NSV flow ▪ NSV flow alternative ▪ External pressure ▪ Exciter current 1 ▪ Exciter current 2 ▪ Oscillation frequency 1 ▪ Oscillation frequency 2 ▪ S&W volume flow ▪ Reference density ▪ Reference density alternative ▪ Corrected volume flow ▪ Oil corrected volume flow ▪ Water corrected volume flow ▪ Oscillation damping fluctuation 1 ▪ Oscillation damping fluctuation 2 ▪ Frequency fluctuation 1 ▪ Frequency fluctuation 2 ▪ Target mass flow ▪ Carrier volume flow ▪ Target volume flow ▪ Temp. compensated dynamic viscosity ▪ Temp. compensated kinematic viscosity ▪ Temperature ▪ Status ▪ Volume flow ▪ Oil volume flow ▪ Water volume flow ▪ Water cut 			



1) Diagnostic behavior can be changed. This causes the overall status of the measured variable to change.

12.8 Pending diagnostic events

The **Diagnostics** menu allows the user to view the current diagnostic event and the previous diagnostic event separately.

 To call up the measures to rectify a diagnostic event:

- Via local display →  177
- Via web browser →  178
- Via "FieldCare" operating tool →  179
- Via "DeviceCare" operating tool →  179

 Other pending diagnostic events can be displayed in the **Diagnostic list** submenu →  235.

Navigation

"Diagnostics" menu

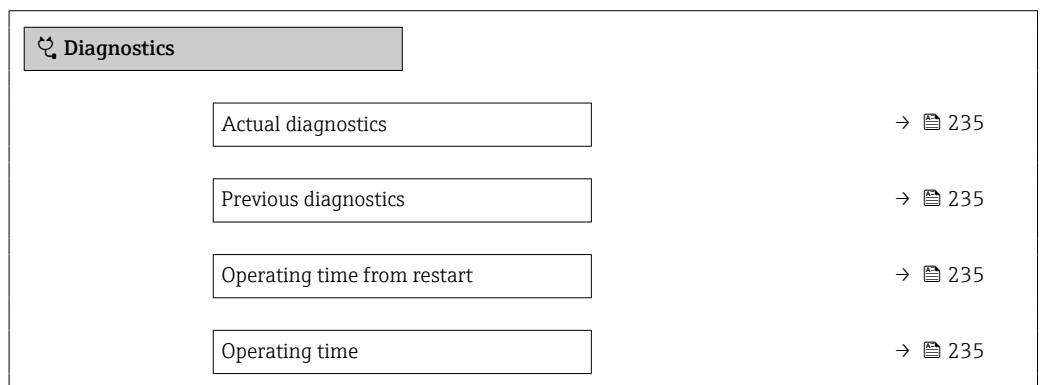

Parameter overview with brief description

Parameter	Prerequisite	Description	User interface
Actual diagnostics	A diagnostic event has occurred.	Shows the current occurred diagnostic event along with its diagnostic information.  If two or more messages occur simultaneously, the message with the highest priority is shown on the display.	Symbol for diagnostic behavior, diagnostic code and short message.
Previous diagnostics	Two diagnostic events have already occurred.	Shows the diagnostic event that occurred prior to the current diagnostic event along with its diagnostic information.	Symbol for diagnostic behavior, diagnostic code and short message.
Operating time from restart	–	Shows the time the device has been in operation since the last device restart.	Days (d), hours (h), minutes (m) and seconds (s)
Operating time	–	Indicates how long the device has been in operation.	Days (d), hours (h), minutes (m) and seconds (s)

12.9 Diagnostics list

Up to 5 currently pending diagnostic events can be displayed in the **Diagnostic list** submenu along with the associated diagnostic information. If more than 5 diagnostic events are pending, the events with the highest priority are shown on the display.

Navigation path

Diagnostics → Diagnostic list

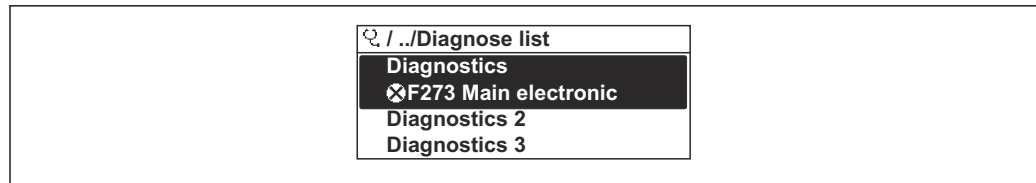

A0014006-EN

40 Using the example of the local display

To call up the measures to rectify a diagnostic event:

- Via local display → 177
- Via web browser → 178
- Via "FieldCare" operating tool → 179
- Via "DeviceCare" operating tool → 179

12.10 Event logbook

12.10.1 Reading out the event logbook

A chronological overview of the event messages that have occurred is provided in the **Events list** submenu.

Navigation path

Diagnostics menu → **Event logbook** submenu → Events list

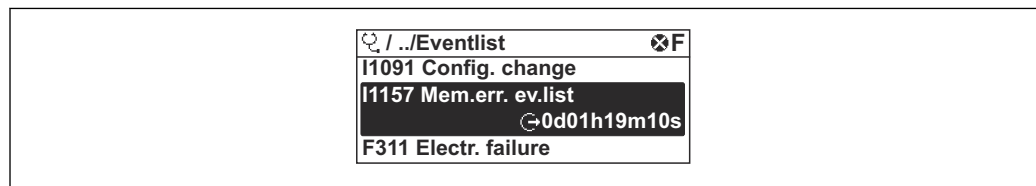

A0014006-EN

41 Using the example of the local display

- A maximum of 20 event messages can be displayed in chronological order.
- If the **Extended HistoROM** application package (order option) is enabled in the device, the event list can contain up to 100 entries.

The event history includes entries for:

- Diagnostic events → 183
- Information events → 237

In addition to the operating time when the event occurred, each event is also assigned a symbol that indicates whether the event has occurred or is finished:

- Diagnostics event
 - ☹: Occurrence of the event
 - ⌚: End of the event
- Information event
 - ☹: Occurrence of the event

To call up the measures to rectify a diagnostic event:

- Via local display → 177
- Via web browser → 178
- Via "FieldCare" operating tool → 179
- Via "DeviceCare" operating tool → 179

For filtering the displayed event messages → 237

12.10.2 Filtering the event logbook

Using the **Filter options** parameter you can define which category of event message is displayed in the **Events list** submenu.

Navigation path

Diagnostics → Event logbook → Filter options

Filter categories

- All
- Failure (F)
- Function check (C)
- Out of specification (S)
- Maintenance required (M)
- Information (I)

12.10.3 Overview of information events

Unlike a diagnostic event, an information event is displayed in the event logbook only and not in the diagnostic list.

Info number	Info name
I1000	----- (Device ok)
I1079	Sensor changed
I1089	Power on
I1090	Configuration reset
I1091	Configuration changed
I1092	HistoROM backup deleted
I1111	Density adjust failure
I1137	Electronic changed
I1151	History reset
I1155	Reset electronic temperature
I1156	Memory error trend
I1157	Memory error event list
I1184	Display connected
I1209	Density adjustment ok
I1221	Zero point adjust failure
I1222	Zero point adjustment ok
I1256	Display: access status changed
I1278	I/O module reset detected
I1335	Firmware changed
I1361	Web server: login failed
I1397	Fieldbus: access status changed
I1398	CDI: access status changed
I1444	Device verification passed
I1445	Device verification failed
I1447	Record application reference data
I1448	Application reference data recorded
I1449	Recording application ref. data failed
I1450	Monitoring off

Info number	Info name
I1451	Monitoring on
I1457	Measured error verification failed
I1459	I/O module verification failed
I1460	HBSI verification failed
I1461	Sensor verification failed
I1462	Sensor electronic module verific. failed
I1512	Download started
I1513	Download finished
I1514	Upload started
I1515	Upload finished
I1618	I/O module 2 replaced
I1619	I/O module 3 replaced
I1621	I/O module 4 replaced
I1622	Calibration changed
I1624	Reset all totalizers
I1625	Write protection activated
I1626	Write protection deactivated
I1627	Web server: login successful
I1628	Display: login successful
I1629	CDI: login successful
I1631	Web server access changed
I1632	Display: login failed
I1633	CDI: login failed
I1634	Reset to factory settings
I1635	Reset to delivery settings
I1636	Fieldbus address reset
I1639	Max. switch cycles number reached
I1649	Hardware write protection activated
I1650	Hardware write protection deactivated
I1712	New flash file received
I1725	Sensor electronic module (ISEM) changed
I1726	Configuration backup failed

12.11 Resetting the measuring device

The entire device configuration or some of the configuration can be reset to a defined state with the **Device reset** parameter (→  150).

12.11.1 Function range of "Device reset" parameter

Options	Description
Cancel	No action is executed and the user exits the parameter.
To delivery settings	Every parameter for which a customer-specific default setting was ordered is reset to the customer-specific value. All other parameters are reset to the factory setting.

Options	Description
Restart device	The restart resets every parameter with data stored in volatile memory (RAM) to the factory setting (e.g. measured value data). The device configuration remains unchanged.
Restore S-DAT backup	Restores the data that is saved on the S-DAT. Additional information: This function can be used to resolve the memory issue "083 Memory content inconsistent" or to restore the S-DAT data when a new S-DAT has been installed.  This option is displayed only in an alarm condition.











12.12 Device information

The **Device information** submenu contains all parameters that display different information for device identification.

Navigation





"Diagnostics" menu → Device information

▶ Device information

Device tag	→  239
Serial number	→  239
Firmware version	→  240
Device name	→  240
Order code	→  240
Extended order code 1	→  240
Extended order code 2	→  240
Extended order code 3	→  240
ENP version	→  240
PROFIBUS ident number	→  240
Status PROFIBUS Master Config	→  240

Parameter overview with brief description

Parameter	Description	User interface	Factory setting
Device tag	Shows name of measuring point.	Max. 32 characters, such as letters, numbers or special characters (e.g. @, %, /).	Promass 500 PA
Serial number	Shows the serial number of the measuring device.	Max. 11-digit character string comprising letters and numbers.	-

Parameter	Description	User interface	Factory setting
Firmware version	Shows the device firmware version installed.	Character string in the format xx.yy.zz	–
Device name	Shows the name of the transmitter.  The name can be found on the nameplate of the transmitter.	Promass 300/500	–
Order code	Shows the device order code.  The order code can be found on the nameplate of the sensor and transmitter in the "Order code" field.	Character string composed of letters, numbers and certain punctuation marks (e.g. /).	–
Extended order code 1	Shows the 1st part of the extended order code.  The extended order code can also be found on the nameplate of the sensor and transmitter in the "Ext. ord. cd." field.	Character string	–
Extended order code 2	Shows the 2nd part of the extended order code.  The extended order code can also be found on the nameplate of the sensor and transmitter in the "Ext. ord. cd." field.	Character string	–
Extended order code 3	Shows the 3rd part of the extended order code.  The extended order code can also be found on the nameplate of the sensor and transmitter in the "Ext. ord. cd." field.	Character string	–
ENP version	Shows the version of the electronic nameplate (ENP).	Character string	–
PROFIBUS ident number	Displays the PROFIBUS identification number.	0 to FFFF	0x156D
Status PROFIBUS Master Config	Displays the status of the PROFIBUS Master configuration.	<ul style="list-style-type: none"> ■ Active ■ Not active 	–

12.13 Firmware history

Release date	Firmware version	Order code for "Firmware version"	Firmware Changes	Documentation type	Documentation
08.2016	01.00.zz	Option 72	Original firmware	Operating Instructions	BA01557D/06/EN/01.16
11.2018	01.01.zz	Option 68	<ul style="list-style-type: none"> ■ Concentration update ■ Local display - enhanced performance and data entry via text editor ■ Optimized keypad lock for local display ■ Web server feature update <ul style="list-style-type: none"> ■ Support for trend data function ■ Heartbeat function enhanced to include detailed results (page 3/4 of the report) ■ Device configuration as PDF (parameter log, similar to FDT print) ■ Network capability of Ethernet (service) interface ■ Comprehensive Heartbeat feature update ■ Local display - support for WLAN infrastructure mode ■ Implementation of reset code 	Operating Instructions	BA01557D/06/EN/02.18

 It is possible to flash the firmware to the current version or the previous version using the service interface.

 For the compatibility of the firmware version with the previous version, the installed device description files and operating tools, observe the information about the device in the "Manufacturer's information" document.

 The manufacturer's information is available:

- In the Download Area of the Endress+Hauser web site: www.endress.com → Downloads
- Specify the following details:
 - Product root: e.g. 8S5B
The product root is the first part of the order code: see the nameplate on the device.
 - Text search: Manufacturer's information
 - Media type: Documentation – Technical Documentation

13 Maintenance

13.1 Maintenance work

No special maintenance work is required.

13.1.1 Exterior cleaning

When cleaning the exterior of measuring devices, always use cleaning agents that do not attack the surface of the housing or the seals.

13.1.2 Internal cleaning

Observe the following points for CIP and SIP cleaning:

- Use only cleaning agents to which the process-wetted materials are adequately resistant.
- Observe the maximum permitted medium temperature for the measuring device .

Observe the following point for cleaning with pigs:

Observe the inside diameter of the measuring tube and process connection.

13.2 Measuring and test equipment

Endress+Hauser offers a variety of measuring and testing equipment, such as Netilion or device tests.

 Your Endress+Hauser Sales Center can provide detailed information on the services.

List of some of the measuring and testing equipment: →  246

13.3 Endress+Hauser services

Endress+Hauser offers a wide variety of services for maintenance such as recalibration, maintenance service or device tests.

 Your Endress+Hauser Sales Center can provide detailed information on the services.

14 Repair

14.1 General notes

14.1.1 Repair and conversion concept

The Endress+Hauser repair and conversion concept provides for the following:

- The measuring devices have a modular design.
- Spare parts are grouped into logical kits with the associated Installation Instructions.
- Repairs are carried out by Endress+Hauser Service or by appropriately trained customers.
- Certified devices can only be converted to other certified devices by Endress+Hauser Service or at the factory.

14.1.2 Notes for repair and conversion



For repair and conversion of a measuring device, observe the following notes:

- ▶ Use only original Endress+Hauser spare parts.
- ▶ Carry out the repair according to the Installation Instructions.
- ▶ Observe the applicable standards, federal/national regulations, Ex documentation (XA) and certificates.
- ▶ Document all repairs and conversions and enter the details in Netilion Analytics.

14.2 Spare parts

Device Viewer (www.endress.com/deviceviewer):

All the spare parts for the measuring device, along with the order code, are listed here and can be ordered. If available, users can also download the associated Installation Instructions.

-  Measuring device serial number:
 - Is located on the nameplate of the device.
 - Can be read out via the **Serial number** parameter (→  239) in the **Device information** submenu.

14.3 Endress+Hauser services

Endress+Hauser offers a wide range of services.

-  Your Endress+Hauser Sales Center can provide detailed information on the services.

14.4 Return

The requirements for safe device return can vary depending on the device type and national legislation.

1. Refer to the web page for information:
<https://www.endress.com/support/return-material>
↳ Select the region.
2. If returning the device, pack the device in such a way that it is reliably protected against impact and external influences. The original packaging offers the best protection.

14.5 Disposal



If required by the Directive 2012/19/EU on waste electrical and electronic equipment (WEEE), the product is marked with the depicted symbol in order to minimize the disposal of WEEE as unsorted municipal waste. Do not dispose of products bearing this marking as unsorted municipal waste. Instead, return them to the manufacturer for disposal under the applicable conditions.

14.5.1 Removing the measuring device

1. Switch off the device.

WARNING

Danger to persons from process conditions!

- ▶ Beware of hazardous process conditions such as pressure in the measuring device, high temperatures or aggressive media.

2. Carry out the mounting and connection steps from the "Mounting the measuring device" and "Connecting the measuring device" sections in reverse order. Observe the safety instructions.

14.5.2 Disposing of the measuring device

WARNING

Danger to personnel and environment from fluids that are hazardous to health.

- ▶ Ensure that the measuring device and all cavities are free of fluid residues that are hazardous to health or the environment, e.g. substances that have permeated into crevices or diffused through plastic.

Observe the following notes during disposal:













- ▶ Observe valid federal/national regulations.
- ▶ Ensure proper separation and reuse of the device components.





15 Accessories

Various accessories, which can be ordered with the device or subsequently from Endress+Hauser, are available for the device. Detailed information on the order code in question is available from your local Endress+Hauser sales center or on the product page of the Endress+Hauser website: www.endress.com.



15.1 Device-specific accessories

15.1.1 For the transmitter

Accessories	Description
Transmitter <ul style="list-style-type: none"> ▪ Proline 500 – digital ▪ Proline 500 	Transmitter for replacement or storage. Use the order code to define the following specifications: <ul style="list-style-type: none"> ▪ Approvals ▪ Output ▪ Input ▪ Display/operation ▪ Housing ▪ Software <ul style="list-style-type: none">  ▪ Proline 500 – digital transmitter: Order number: 8X5BXX-*****A ▪ Proline 500 transmitter: Order number: 8X5BXX-*****B <ul style="list-style-type: none">  Proline 500 transmitter for replacement: It is essential to specify the serial number of the current transmitter when ordering. On the basis of the serial number, the device-specific data (e.g. calibration factors) of the replaced device can be used for the new transmitter. <ul style="list-style-type: none">  ▪ Proline 500 – digital transmitter: Installation Instructions EA01151D ▪ Proline 500 transmitter: Installation Instructions EA01152D
External WLAN antenna	External WLAN antenna with 1.5 m (59.1 in) connecting cable and two angle brackets. Order code for "Accessory enclosed", option P8 "Wireless antenna wide area". <ul style="list-style-type: none">  ▪ The external WLAN antenna is not suitable for use in hygienic applications. ▪ Additional information regarding the WLAN interface →  86. <ul style="list-style-type: none">  Order number: 71351317 <ul style="list-style-type: none">  Installation Instructions EA01238D
Pipe mounting set	Pipe mounting set for transmitter. <ul style="list-style-type: none">  Proline 500 – digital transmitter Order number: 71346427 <ul style="list-style-type: none">  Installation Instructions EA01195D <ul style="list-style-type: none">  Proline 500 transmitter Order number: 71346428
Weather protection cover Transmitter <ul style="list-style-type: none"> ▪ Proline 500 – digital ▪ Proline 500 	Is used to protect the measuring device from the effects of the weather: e.g. rainwater, excess heating from direct sunlight. <ul style="list-style-type: none">  ▪ Proline 500 – digital transmitter Order number: 71343504 ▪ Proline 500 transmitter Order number: 71343505 <ul style="list-style-type: none">  Installation Instructions EA01191D



Display guard Proline 500 – digital	<p>Is used to protect the display against impact or scoring, for example from sand in desert areas.</p> <p> Order number: 71228792</p> <p> Installation Instructions EA01093D</p>
Connecting cable Proline 500 – digital Sensor – Transmitter	<p>The connecting cable can be ordered directly with the measuring device (order code for "Cable, sensor connection) or as an accessory (order number DK8012).</p> <p>The following cable lengths are available: order code for "Cable, sensor connection"</p> <ul style="list-style-type: none"> ▪ Option B: 20 m (65 ft) ▪ Option E: User-configurable up to max. 50 m ▪ Option F: User-configurable up to max. 165 ft <p> Maximum possible cable length for a Proline 500 – digital connecting cable: 300 m (1 000 ft)</p>
Connecting cables Proline 500 Sensor – Transmitter	<p>The connecting cable can be ordered directly with the measuring device (order code for "Cable, sensor connection") or as an accessory (order number DK8012).</p> <p>The following cable lengths are available: order code for "Cable, sensor connection"</p> <ul style="list-style-type: none"> ▪ Option 1: 5 m (16 ft) ▪ Option 2: 10 m (32 ft) ▪ Option 3: 20 m (65 ft) <p> Possible cable length for a Proline 500 connecting cable: max. 20 m (65 ft)</p>

15.1.2 For the sensor





Accessories	Description
Heating jacket	<p>Is used to stabilize the temperature of the fluids in the sensor. Water, water vapor and other non-corrosive liquids are permitted for use as fluids.</p> <p> If using oil as a heating medium, please consult with Endress+Hauser.</p> <p>Use the order code with the product root DK8003.</p> <p> Special Documentation SD02162D</p>

15.2 Service-specific accessories

Accessories	Description
Applicator	<p>Software for selecting and sizing Endress+Hauser measuring instruments:</p> <ul style="list-style-type: none"> ▪ Choice of measuring instruments for industrial requirements ▪ Calculation of all the necessary data for identifying the optimum flowmeter: e.g. nominal diameter, pressure loss, flow velocity and measurement accuracy. ▪ Graphic display of the calculation results ▪ Determination of the partial order code, administration, documentation and access to all project-related data and parameters over the entire life cycle of a project. <p>Applicator is available: Via the Internet: https://portal.endress.com/webapp/applicator</p>
Netilion	<p>IIoT ecosystem: Unlock knowledge</p> <p>With the Netilion IIoT ecosystem, Endress+Hauser allows you to optimize your plant performance, digitize workflows, share knowledge, and enhance collaboration.</p> <p>Drawing upon decades of experience in process automation, Endress+Hauser offers the process industry an IIoT ecosystem designed to effortlessly extract insights from data. These insights allow process optimization, leading to increased plant availability, efficiency, and reliability - ultimately resulting in a more profitable plant.</p> <p>www.netilion.endress.com</p>

Accessories	Description
FieldCare	<p>FDT-based plant asset management tool from Endress+Hauser. It can configure all intelligent field units in your system and helps you manage them. By using the status information, it is also a simple but effective way of checking their status and condition.</p> <p> Operating Instructions BA00027S and BA00059S</p>
DeviceCare	<p>Tool to connect and configure Endress+Hauser field devices.</p> <p> Innovation brochure IN01047S</p>

15.3 System components

Accessories	Description
Memograph M graphic data manager	<p>The Memograph M graphic data manager provides information on all the relevant measured variables. Measured values are recorded correctly, limit values are monitored and measuring points analyzed. The data are stored in the 256 MB internal memory and also on a SD card or USB stick.</p> <p> <ul style="list-style-type: none"> ▪ Technical Information TI00133R ▪ Operating Instructions BA00247R </p>
Cerabar M	<p>The pressure transmitter for measuring the absolute and gauge pressure of gases, steam and liquids. It can be used to read in the operating pressure value.</p> <p> <ul style="list-style-type: none"> ▪ Technical Information TI00426P and TI00436P ▪ Operating Instructions BA00200P and BA00382P </p>
Cerabar S	<p>The pressure transmitter for measuring the absolute and gauge pressure of gases, steam and liquids. It can be used to read in the operating pressure value.</p> <p> <ul style="list-style-type: none"> ▪ Technical Information TI00383P ▪ Operating Instructions BA00271P </p>
iTEMP	<p>The temperature transmitters can be used in all applications and are suitable for the measurement of gases, steam and liquids. They can be used to read in the medium temperature.</p> <p> "Fields of Activity" document FA00006T</p>

16 Technical data

16.1 Application

The measuring device is intended only for the flow measurement of liquids.

Depending on the version ordered, the measuring device can also measure potentially explosive, flammable, poisonous and oxidizing media.

To ensure that the device remains in proper operating condition for its service life, use the measuring device only for media against which the process-wetted materials are sufficiently resistant.

16.2 Function and system design

Measuring principle

Mass flow measurement based on the Coriolis measuring principle

Measuring system

The measuring system consists of a transmitter and a sensor. The transmitter and sensor are mounted in physically separate locations. They are interconnected by connecting cables.

For information on the structure of the measuring instrument →  13

16.3 Input

Measured variable

Direct measured variables

- Mass flow
- Density
- Temperature

Calculated measured variables



- Volume flow
- Corrected volume flow
- Reference density

Measuring range

Measuring range for liquids

DN		Measuring range full scale values $\dot{m}_{\min(F)}$ to $\dot{m}_{\max(F)}$	
[mm]	[in]	[kg/h]	[lb/min]
8	$\frac{3}{8}$	0 to 2 000	0 to 73.50
15	$\frac{1}{2}$	0 to 6 500	0 to 238.9
25	1	0 to 18 000	0 to 661.5
40	$1\frac{1}{2}$	0 to 45 000	0 to 1 654
50	2	0 to 70 000	0 to 2 573

Recommended measuring range

 Flow limit →  264

Operable flow range

Over 1000 : 1.



Flow rates above the preset full scale value do not override the electronics unit, with the result that the totalizer values are registered correctly.

Input signal

External measured values

To increase the measurement accuracy of certain measured variables, the automation system can continuously write various measured values to the measuring instrument:

- Operating pressure to increase measurement accuracy (Endress+Hauser recommends the use of a pressure measuring device for absolute pressure, e.g. Cerabar M or Cerabar S)
- Medium temperature to increase measurement accuracy (e.g. iTEMP)

 Various pressure and temperature measuring devices can be ordered from Endress +Hauser: see "Accessories" section →  247

Current input

The measured values are written from the automation system to the measuring device via the current input →  250.

Digital communication

The measured values are written by the automation system via PROFIBUS PA.

Current input 0/4 to 20 mA

Current input	0/4 to 20 mA (active/passive)
Current span	<ul style="list-style-type: none"> ▪ 4 to 20 mA (active) ▪ 0/4 to 20 mA (passive)
Resolution	1 μ A
Voltage drop	Typically: 0.6 to 2 V for 3.6 to 22 mA (passive)
Maximum input voltage	≤ 30 V (passive)
Open-circuit voltage	≤ 28.8 V (active)
Possible input variables	<ul style="list-style-type: none"> ▪ Pressure ▪ Temperature ▪ Density

Status input

Maximum input values	<ul style="list-style-type: none"> ▪ DC -3 to 30 V ▪ If status input is active (ON): $R_i > 3$ kΩ
Response time	Configurable: 5 to 200 ms
Input signal level	<ul style="list-style-type: none"> ▪ Low signal: DC -3 to +5 V ▪ High signal: DC 12 to 30 V
Assignable functions	<ul style="list-style-type: none"> ▪ Off ▪ Reset the individual totalizers separately ▪ Reset all totalizers ▪ Flow override

16.4 Output

Output signal

PROFIBUS PA

PROFIBUS PA	In accordance with EN 50170 Volume 2, IEC 61158-2 (MBP), galvanically isolated
Data transmission	31.25 kbit/s
Current consumption	10 mA
Permitted supply voltage	9 to 32 V
Bus connection	With integrated reverse polarity protection

Current output 4 to 20 mA



Signal mode	Can be set to: <ul style="list-style-type: none"> ▪ Active ▪ Passive
Current range	Can be set to: <ul style="list-style-type: none"> ▪ 4 to 20 mA NAMUR ▪ 4 to 20 mA US ▪ 4 to 20 mA ▪ 0 to 20 mA (only if the signal mode is active) ▪ Fixed current
Maximum output values	22.5 mA
Open-circuit voltage	DC 28.8 V (active)
Maximum input voltage	DC 30 V (passive)
Load	0 to 700 Ω
Resolution	0.38 μA
Damping	Configurable: 0 to 999.9 s
Assignable measured variables	<ul style="list-style-type: none"> ▪ Mass flow ▪ Volume flow ▪ Corrected volume flow ▪ Density ▪ Reference density ▪ Temperature ▪ Electronics temperature ▪ Oscillation frequency 0 ▪ Oscillation damping 0 ▪ Signal asymmetry ▪ Exciter current 0 <p> The range of options increases if the measuring device has one or more application packages.</p>



Current output 4 to 20 mA Ex i passive

Order code	"Output; input 2" (21), "Output; input 3" (022): Option C: current output 4 to 20 mA Ex i passive
Signal mode	Passive
Current range	Can be set to: <ul style="list-style-type: none"> ▪ 4 to 20 mA NAMUR ▪ 4 to 20 mA US ▪ 4 to 20 mA ▪ Fixed current
Maximum output values	22.5 mA
Maximum input voltage	DC 30 V

Load	0 to 700 Ω
Resolution	0.38 μA
Damping	Configurable: 0 to 999 s
Assignable measured variables	<ul style="list-style-type: none"> ■ Mass flow ■ Volume flow ■ Corrected volume flow ■ Density ■ Reference density ■ Temperature ■ Electronics temperature ■ Oscillation frequency 0 ■ Oscillation damping 0 ■ Signal asymmetry ■ Exciter current 0 <p> The range of options increases if the measuring device has one or more application packages.</p>

Pulse/frequency/switch output

Function	Can be configured as pulse, frequency or switch output
Version	Open collector Can be set to: <ul style="list-style-type: none"> ■ Active ■ Passive ■ Passive NAMUR <p> Ex-i, passive</p>
Maximum input values	DC 30 V, 250 mA (passive)
Open-circuit voltage	DC 28.8 V (active)
Voltage drop	For 22.5 mA: ≤ DC 2 V
Pulse output	
Maximum input values	DC 30 V, 250 mA (passive)
Maximum output current	22.5 mA (active)
Open-circuit voltage	DC 28.8 V (active)
Pulse width	Configurable: 0.05 to 2 000 ms
Maximum pulse rate	10 000 Impulse/s
Pulse value	Configurable
Assignable measured variables	<ul style="list-style-type: none"> ■ Mass flow ■ Volume flow ■ Corrected volume flow <p> The range of options increases if the measuring device has one or more application packages.</p>
Frequency output	
Maximum input values	DC 30 V, 250 mA (passive)
Maximum output current	22.5 mA (active)
Open-circuit voltage	DC 28.8 V (active)
Output frequency	Configurable: end value frequency 2 to 10 000 Hz (f _{max} = 12 500 Hz)
Damping	Configurable: 0 to 999.9 s
Pulse/pause ratio	1:1

Assignable measured variables	<ul style="list-style-type: none"> ▪ Mass flow ▪ Volume flow ▪ Corrected volume flow ▪ Density ▪ Reference density ▪ Temperature ▪ Electronics temperature ▪ Oscillation frequency 0 ▪ Oscillation damping 0 ▪ Signal asymmetry ▪ Exciter current 0 <p> The range of options increases if the measuring device has one or more application packages.</p>
Switch output	
Maximum input values	DC 30 V, 250 mA (passive)
Open-circuit voltage	DC 28.8 V (active)
Switching behavior	Binary, conductive or non-conductive
Switching delay	Configurable: 0 to 100 s
Number of switching cycles	Unlimited
Assignable functions	<ul style="list-style-type: none"> ▪ Disable ▪ On ▪ Diagnostic behavior ▪ Limit <ul style="list-style-type: none"> ▪ Mass flow ▪ Volume flow ▪ Corrected volume flow ▪ Density ▪ Reference density ▪ Temperature ▪ Totalizer 1-3 ▪ Flow direction monitoring ▪ Status <ul style="list-style-type: none"> ▪ Partially filled pipe detection ▪ Low flow cut off <p> The range of options increases if the measuring device has one or more application packages.</p>

Relay output

Function	Switch output
Version	Relay output, galvanically isolated
Switching behavior	Can be set to: <ul style="list-style-type: none"> ▪ NO (normally open), factory setting ▪ NC (normally closed)

Maximum switching capacity (passive)	<ul style="list-style-type: none"> ▪ DC 30 V, 0.1 A ▪ AC 30 V, 0.5 A
Assignable functions	<ul style="list-style-type: none"> ▪ Disable ▪ On ▪ Diagnostic behavior ▪ Limit <ul style="list-style-type: none"> ▪ Mass flow ▪ Volume flow ▪ Corrected volume flow ▪ Density ▪ Reference density ▪ Temperature ▪ Totalizer 1-3 ▪ Flow direction monitoring ▪ Status <ul style="list-style-type: none"> ▪ Partially filled pipe detection ▪ Low flow cut off <p> The range of options increases if the measuring device has one or more application packages.</p>

User-configurable input/output

One specific input or output is assigned to a user-configurable input/output (configurable I/O) during device commissioning.

The following inputs and outputs are available for assignment:

- Choice of current output: 4 to 20 mA (active), 0/4 to 20 mA (passive)
- Pulse/frequency/switch output
- Choice of current input: 4 to 20 mA (active), 0/4 to 20 mA (passive)
- Status input

Signal on alarm

Depending on the interface, failure information is displayed as follows:

PROFIBUS PA

Status and alarm messages	Diagnostics in accordance with PROFIBUS PA Profile 3.02
Failure current FDE (Fault Disconnection Electronic)	0 mA

Current output 0/4 to 20 mA

4 to 20 mA

Failure mode	Choose from: <ul style="list-style-type: none"> ▪ 4 to 20 mA in accordance with NAMUR recommendation NE 43 ▪ 4 to 20 mA in accordance with US ▪ Min. value: 3.59 mA ▪ Max. value: 22.5 mA ▪ Definable value between: 3.59 to 22.5 mA ▪ Actual value ▪ Last valid value
---------------------	---

0 to 20 mA

Failure mode	Choose from: <ul style="list-style-type: none"> ▪ Maximum alarm: 22 mA ▪ Definable value between: 0 to 20.5 mA
---------------------	--

Pulse/frequency/switch output

Pulse output	
Fault mode	Choose from: <ul style="list-style-type: none"> ▪ Actual value ▪ No pulses
Frequency output	
Fault mode	Choose from: <ul style="list-style-type: none"> ▪ Actual value ▪ 0 Hz ▪ Definable value between: 2 to 12 500 Hz
Switch output	
Fault mode	Choose from: <ul style="list-style-type: none"> ▪ Current status ▪ Open ▪ Closed

Relay output

Failure mode	Choose from: <ul style="list-style-type: none"> ▪ Current status ▪ Open ▪ Closed
---------------------	---

Local display

Plain text display	With information on cause and remedial measures
Backlight	Red lighting indicates a device error.

 Status signal as per NAMUR recommendation NE 107

Interface/protocol



- Via digital communication:
 - PROFIBUS PA
- Via service interface
 - CDI-RJ45 service interface
 - WLAN interface

Plain text display	With information on cause and remedial measures
---------------------------	---

Web browser

Plain text display	With information on cause and remedial measures
---------------------------	---

Light emitting diodes (LED)

Status information	<p>Status indicated by various light emitting diodes</p> <p>The following information is displayed depending on the device version:</p> <ul style="list-style-type: none"> ▪ Supply voltage active ▪ Data transmission active ▪ Device alarm/error has occurred <p> Diagnostic information via light emitting diodes →  172</p>
---------------------------	--

Low flow cut off The switch points for low flow cut off are user-selectable.

Galvanic isolation The outputs are galvanically isolated:

- from the power supply
- from one another
- from the potential equalization (PE) terminal





protocol-specific data	Manufacturer ID	0x11
	Ident number	0x156D
	Profile version	3.02
	Device description files (GSD, DTM, DD)	Information and files under: <ul style="list-style-type: none"> ▪ https://www.endress.com/download On the device product page: PRODUCTS → Product Finder → Links ▪ https://www.profibus.com
	Supported functions	<ul style="list-style-type: none"> ▪ Identification & Maintenance Simplest device identification on the part of the control system and nameplate ▪ PROFIBUS upload/download Reading and writing parameters is up to ten times faster with PROFIBUS upload/download ▪ Condensed status Simplest and self-explanatory diagnostic information by categorizing diagnostic messages that occur
	Configuration of the device address	<ul style="list-style-type: none"> ▪ DIP switches on the I/O electronics module ▪ Local display ▪ Via operating tools (e.g. FieldCare)
	Compatibility with earlier model	<p>If the device is replaced, the measuring device Promass 500 supports the compatibility of the cyclic data with previous models. It is not necessary to adjust the engineering parameters of the PROFIBUS network with the Promass 500 GSD file.</p> <p>Earlier models:</p> <ul style="list-style-type: none"> ▪ Promass 80 PROFIBUS PA <ul style="list-style-type: none"> ▪ ID No.: 1528 (hex) ▪ Extended GSD file: EH3x1528.gsd ▪ Standard GSD file: EH3_1528.gsd ▪ Promass 83 PROFIBUS PA <ul style="list-style-type: none"> ▪ ID No.: 152A (hex) ▪ Extended GSD file: EH3x152A.gsd ▪ Standard GSD file: EH3_152A.gsd
	System integration	<p>Information regarding system integration →  96.</p> <ul style="list-style-type: none"> ▪ Cyclic data transmission ▪ Block model ▪ Description of the modules

16.5 Power supply

Terminal assignment →  39

Available device plugs →  39



Available device plugs →  40

Supply voltage	Order code "Power supply"	Terminal voltage		Frequency range
	Option D	DC 24 V	±20%	–
	Option E	AC 100 to 240 V	–15...+10%	50/60 Hz
	Option I	DC 24 V	±20%	–
AC 100 to 240 V		–15...+10%	50/60 Hz	
Power consumption	Transmitter			
	Max. 10 W (active power)			
	switch-on current	Max. 36 A (<5 ms) as per NAMUR Recommendation NE 21		
Current consumption	Transmitter			
	<ul style="list-style-type: none"> ■ Max. 400 mA (24 V) ■ Max. 200 mA (110 V, 50/60 Hz; 230 V, 50/60 Hz) 			
Power supply failure	<ul style="list-style-type: none"> ■ Totalizers stop at the last value measured. ■ Depending on the device version, the configuration is retained in the device memory or in the pluggable data memory (HistoROM DAT). ■ Error messages (incl. total operated hours) are stored. 			
Overcurrent protection element	<p>The device must be operated with a dedicated circuit breaker, as it does not have an ON/OFF switch of its own.</p> <ul style="list-style-type: none"> ■ The circuit breaker must be easy to reach and labeled accordingly. ■ Permitted nominal current of the circuit breaker: 2 A up to maximum 10 A. 			
Electrical connection	<ul style="list-style-type: none"> ■ →  42 ■ →  49 			
Potential equalization	→  55			
Terminals	Spring-loaded terminals: Suitable for strands and strands with ferrules. Conductor cross-section 0.2 to 2.5 mm ² (24 to 12 AWG).			
Cable entries	<ul style="list-style-type: none"> ■ Cable gland: M20 × 1.5 with cable Ø 6 to 12 mm (0.24 to 0.47 in) ■ Thread for cable entry: <ul style="list-style-type: none"> ■ NPT ½" ■ G ½" ■ M20 ■ Device plug for digital communication: M12 ■ Device plug for connecting cable: M12 <p>A device plug is always used for the device version with the order code for "Sensor connection housing", option C "Ultra-compact, hygienic, stainless".</p>			
Cable specification	→  34			

Overvoltage protection	Mains voltage fluctuations	→  257
	Overvoltage category	Overvoltage category II
	Short-term, temporary overvoltage	Between cable and ground up to 1200 V, for max. 5 s
	Long-term, temporary overvoltage	Between cable and ground up to 500 V

16.6 Performance characteristics

Reference operating conditions

- Error limits based on ISO 11631
 - Water
 - +15 to +45 °C (+59 to +113 °F)
 - 2 to 6 bar (29 to 87 psi)
 - Data as indicated in the calibration protocol
 - Accuracy based on accredited calibration rigs according to ISO 17025
-  To obtain measured errors, use the *Applicator* sizing tool →  246

Maximum measurement error

o.r. = of reading; 1 g/cm³ = 1 kg/l; T = medium temperature

Base accuracy

 Design fundamentals →  261

Mass flow and volume flow (liquids)

±0.10 % o.r.

Density (liquids)

Under reference conditions	Standard density calibration ¹⁾	Wide-range Density specification ^{2) 3)}
[g/cm ³]	[g/cm ³]	[g/cm ³]
±0.0005	±0.01	±0.002

- 1) Valid over the entire temperature and density range
- 2) Valid range for special density calibration: 0 to 2 g/cm³, +10 to +80 °C (+50 to +176 °F)
- 3) order code for "Application package", option EE "Special density"

Temperature

±0.5 °C ± 0.005 · T °C (±0.9 °F ± 0.003 · (T - 32) °F)

Zero point stability

DN		Zero point stability	
[mm]	[in]	[kg/h]	[lb/min]
8	³ / ₈	0.20	0.007
15	¹ / ₂	0.65	0.024
25	1	1.80	0.066
40	1 ¹ / ₂	4.50	0.165
50	2	7.0	0.257

Flow values

Flow values as turndown parameters depending on nominal diameter.

SI units

DN	1:1	1:10	1:20	1:50	1:100	1:500
[mm]	[kg/h]	[kg/h]	[kg/h]	[kg/h]	[kg/h]	[kg/h]
8	2 000	200	100	40	20	4
15	6 500	650	325	130	65	13
25	18 000	1 800	900	360	180	36
40	45 000	4 500	2 250	900	450	90
50	70 000	7 000	3 500	1 400	700	140

US units

DN	1:1	1:10	1:20	1:50	1:100	1:500
[inch]	[lb/min]	[lb/min]	[lb/min]	[lb/min]	[lb/min]	[lb/min]
$\frac{3}{8}$	73.50	7.350	3.675	1.470	0.735	0.147
$\frac{1}{2}$	238.9	23.89	11.95	4.778	2.389	0.478
1	661.5	66.15	33.08	13.23	6.615	1.323
1½	1 654	165.4	82.70	33.08	16.54	3.308
2	2 573	257.3	128.7	51.46	25.73	5.146

Accuracy of outputs

The outputs have the following base accuracy specifications.

Current output

Accuracy	±5 µA
-----------------	-------

Pulse/frequency output

o.r. = of reading

Accuracy	Max. ±50 ppm o.r. (over the entire ambient temperature range)
-----------------	---

Repeatability

o.r. = of reading; 1 g/cm³ = 1 kg/l; T = medium temperature

Base repeatability

 Design fundamentals →  261

Mass flow and volume flow (liquids)

±0.05 % o.r.

Density (liquids)

±0.00025 g/cm³

Temperature

±0.25 °C ± 0.0025 · T °C (±0.45 °F ± 0.0015 · (T-32) °F)

Response time The response time depends on the configuration (damping).

Influence of ambient temperature

Current output

Temperature coefficient	Max. 1 $\mu\text{A}/^\circ\text{C}$
-------------------------	-------------------------------------

Pulse/frequency output

Temperature coefficient	No additional effect. Included in accuracy.
-------------------------	---

Influence of medium temperature

Mass flow

o.f.s. = of full scale value

If there is a difference between the temperature during zero adjustment and the process temperature, the additional measurement error of the sensors is typically $\pm 0.0002\% \text{ o.f.s.}/^\circ\text{C}$ ($\pm 0.0001\% \text{ o.f.s.}/^\circ\text{F}$).

The influence is reduced when the zero adjustment is performed at process temperature.

Density

If there is a difference between the density calibration temperature and the process temperature, the measurement error of the sensors is typically $\pm 0.0001 \text{ g/cm}^3/^\circ\text{C}$ ($\pm 0.00005 \text{ g/cm}^3/^\circ\text{F}$). Field density adjustment is possible.

Wide-range density specification (special density calibration)

If the process temperature is outside the valid range (\rightarrow  258) the measurement error is $\pm 0.0001 \text{ g/cm}^3/^\circ\text{C}$ ($\pm 0.00005 \text{ g/cm}^3/^\circ\text{F}$)

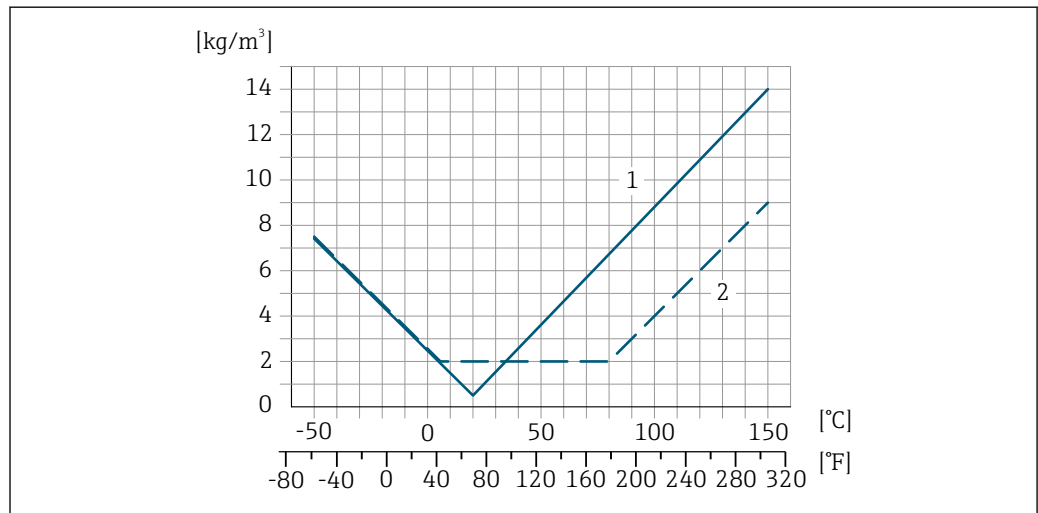

- 1 Field density adjustment, for example at $+20^\circ\text{C}$ ($+68^\circ\text{F}$)
- 2 Special density calibration

Temperature

$\pm 0.005 \cdot T \text{ } ^\circ\text{C}$ ($\pm 0.005 \cdot (T - 32) \text{ } ^\circ\text{F}$)

Influence of medium pressure

The following shows how the process pressure (gauge pressure) affects the accuracy of the mass flow.

o.r. = of reading



It is possible to compensate for the effect by:

- Reading in the current pressure measured value via the current input or a digital input.
- Specifying a fixed value for the pressure in the device parameters.



Operating Instructions .

DN		[% o.r./bar]	[% o.r./psi]
[mm]	[in]		
8	3/8	-0.002	-0.0001
15	1/2	-0.006	-0.0004
25	1	-0.005	-0.0003
40	1 1/2	-0.007	-0.0005
50	2	-0.006	-0.0004

Design fundamentals

o.r. = of reading, o.f.s. = of full scale value

BaseAccu = base accuracy in % o.r., BaseRepeat = base repeatability in % o.r.

MeasValue = measured value; ZeroPoint = zero point stability

Calculation of the maximum measured error as a function of the flow rate

Flow rate	Maximum measured error in % o.r.
$\geq \frac{\text{ZeroPoint}}{\text{BaseAccu}} \cdot 100$ <small>A0021332</small>	$\pm \text{BaseAccu}$ <small>A0021339</small>
$< \frac{\text{ZeroPoint}}{\text{BaseAccu}} \cdot 100$ <small>A0021333</small>	$\pm \frac{\text{ZeroPoint}}{\text{MeasValue}} \cdot 100$ <small>A0021334</small>

Calculation of the maximum repeatability as a function of the flow rate

Flow rate	Maximum repeatability in % o.r.
$\geq \frac{1/2 \cdot \text{ZeroPoint}}{\text{BaseRepeat}} \cdot 100$ <small>A0021335</small>	$\pm \text{BaseRepeat}$ <small>A0021340</small>
$< \frac{1/2 \cdot \text{ZeroPoint}}{\text{BaseRepeat}} \cdot 100$ <small>A0021336</small>	$\pm 1/2 \cdot \frac{\text{ZeroPoint}}{\text{MeasValue}} \cdot 100$ <small>A0021337</small>

Example of maximum measurement error

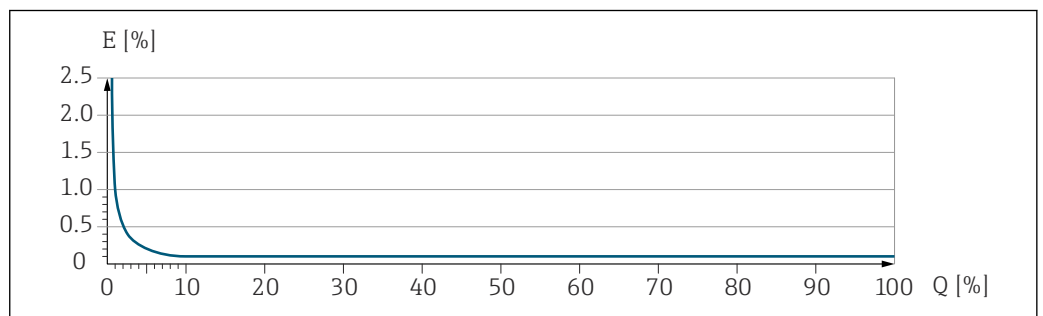

E Maximum measurement error in % o.r. (example)
 Q Flow rate in % of maximum full scale value



16.7 Mounting

Mounting requirements →  21

16.8 Environment

Ambient temperature range →  24

Temperature tables

-  Observe the interdependencies between the permitted ambient and fluid temperatures when operating the device in hazardous areas.
-  For detailed information on the temperature tables, see the separate document entitled "Safety Instructions" (XA) for the device.

Storage temperature

Climate class DIN EN 60068-2-38 (test Z/AD)

Relative humidity The device is suitable for use outdoors and indoors with a relative humidity of 4 to 95 %.

Operating height According to EN 61010-1

- ≤ 2 000 m (6 562 ft)
- > 2 000 m (6 562 ft) with additional overvoltage protection (e.g. Endress+Hauser HAW Series)

Degree of protection **Transmitter**

- IP66/67, Type 4X enclosure, suitable for pollution degree 4
- When the housing is open: IP20, Type 1 enclosure, suitable for pollution degree 2
- Display module: IP20, Type 1 enclosure, suitable for pollution degree 2

Sensor

- IP66/67, Type 4X enclosure, suitable for pollution degree 4
- When the housing is open: IP20, Type 1 enclosure, suitable for pollution degree 2

Optional

Order code for "Sensor options", option CM "IP69

External WLAN antenna

IP67

Shock and vibration resistance **Vibration sinusoidal, in accordance with IEC 60068-2-6**

Sensor

- 2 to 8.4 Hz, 3.5 mm peak
- 8.4 to 2 000 Hz, 1 g peak

Transmitter

- 2 to 8.4 Hz, 7.5 mm peak
- 8.4 to 2 000 Hz, 2 g peak

Vibration broad-band random, according to IEC 60068-2-64

Sensor

- 10 to 200 Hz, 0.003 g²/Hz
- 200 to 2 000 Hz, 0.001 g²/Hz
- Total: 1.54 g rms

Transmitter

- 10 to 200 Hz, 0.01 g²/Hz
- 200 to 2 000 Hz, 0.003 g²/Hz
- Total: 2.70 g rms

Shock half-sine, according to IEC 60068-2-27

- Sensor
6 ms 30 g
- Transmitter
6 ms 50 g

Rough handling shocks according to IEC 60068-2-31

Internal cleaning

- CIP cleaning
- SIP cleaning
- Cleaning with pigs

Options

Oil- and grease-free version for wetted parts, without declaration
Order code for "Service", option HA³⁾

Mechanical load

- Transmitter housing and sensor connection housing:
- Protect against mechanical effects, such as shock or impact
 - Do not use as a ladder or climbing aid

Electromagnetic compatibility (EMC)

- As per IEC/EN 61326 and NAMUR Recommendation 21 (NE 21)
- As per IEC/EN 61000-6-2 and IEC/EN 61000-6-4



Details are provided in the Declaration of Conformity.



This unit is not intended for use in residential environments and cannot guarantee adequate protection of the radio reception in such environments.

16.9 Process

Medium temperature range -50 to +150 °C (-58 to +302 °F)

Pressure-temperature ratings



For an overview of the pressure-temperature ratings for the process connections, see the Technical Information

Sensor housing

The sensor housing is filled with dry nitrogen gas and protects the electronics and mechanics inside.



If a measuring tube fails (e.g. due to process characteristics like corrosive or abrasive fluids), the fluid will initially be contained by the sensor housing.

3) The cleaning refers to the measuring instrument only. Any accessories supplied are not cleaned.

If the sensor is to be purged with gas (gas detection), it should be equipped with purge connections.

 Do not open the purge connections unless the containment can be filled immediately with a dry, inert gas. Use only low pressure to purge.

Maximum pressure: 5 bar (72.5 psi)

Burst pressure of the sensor housing

The following sensor housing burst pressures are only valid for standard devices and/or devices equipped with closed purge connections (not opened/as delivered).

If a device fitted with purge connections (order code for "Sensor option", option CH "Purge connection") is connected to the purge system, the maximum pressure is determined by the purge system itself or by the device, depending on which component has the lower pressure classification.

The sensor housing burst pressure refers to a typical internal pressure which is reached prior to mechanical failure of the sensor housing and which was determined during type testing. The corresponding type test declaration can be ordered with the device (order code for "Additional approval", option LN "Sensor housing burst pressure, type test").

DN		Sensor housing burst pressure	
[mm]	[in]	[bar]	[psi]
8	3/8	190	2755
15	1/2	175	2538
25	1	165	2392
40	1 1/2	152	2204
50	2	103	1494

 For information on the dimensions: see the "Mechanical construction" section of the "Technical Information" document

Flow limit



Select the nominal diameter by optimizing between the required flow range and permissible pressure loss.

 For an overview of the full scale values for the measuring range, see the "Measuring range" section →  249

- The minimum recommended full scale value is approx. 1/20 of the maximum full scale value
- In most applications, 20 to 50 % of the maximum full scale value can be considered ideal
- A low full scale value must be selected for abrasive media (such as liquids with entrained solids): flow velocity < 1 m/s (< 3 ft/s).

 To calculate the flow limit, use the *Applicator* sizing tool →  246

Pressure loss

 To calculate the pressure loss, use the *Applicator* sizing tool →  246

System pressure

→  24

16.10 Mechanical construction

Design, dimensions



For the dimensions and installation lengths of the device, see the "Technical Information" document, "Mechanical construction" section

Weight

All values (weight exclusive of packaging material) refer to devices with EN/DIN PN 40 flanges.

Transmitter

- Proline 500 – digital polycarbonate: 1.4 kg (3.1 lbs)
- Proline 500 – digital aluminum: 2.4 kg (5.3 lbs)
- Proline 500 aluminum: 6.5 kg (14.3 lbs)

Sensor

Sensor with aluminum connection housing version:

Weight in SI units

DN [mm]	Weight [kg]
8	11
15	13
25	19
40	35
50	58

Weight in US units

DN [in]	Weight [lbs]
3/8	24
1/2	29
1	42
1 1/2	77
2	128

Materials

Transmitter housing

Housing of Proline 500 – digital transmitter

Order code for "Transmitter housing":

- Option **A** "Aluminum coated": aluminum, AlSi10Mg, coated
- Option **D** "Polycarbonate": polycarbonate

Housing of Proline 500 transmitter

Order code for "Transmitter housing":

Option **A** "Aluminum coated": aluminum, AlSi10Mg, coated

Window material

Order code for "Transmitter housing":

- Option **A** "Aluminum, coated": glass
- Option **D** "Polycarbonate": plastic

Fastening components for mounting on a post



- Screws, threaded bolts, washers, nuts: stainless A2 (chrome-nickel steel)
- Metal plates: stainless steel, 1.4301 (304)

Sensor connection housing

Order code for "Sensor connection housing":

- Option **A** "Aluminum coated": aluminum, AlSi10Mg, coated
- Option **B** "Stainless":
 - Stainless steel 1.4301 (304)
 - Optional: Order code for "Sensor feature", option **CC** "Hygienic version, for maximum corrosion resistance": stainless steel, 1.4404 (316L)
- Option **C** "Ultra-compact, stainless":
 - Stainless steel 1.4301 (304)
 - Optional: Order code for "Sensor feature", option **CC** "Hygienic version, for maximum corrosion resistance": stainless steel, 1.4404 (316L)

Cable entries/cable glands

Cable entries and adapters	Material
Cable gland M20 × 1.5	Plastic
<ul style="list-style-type: none"> ■ Adapter for cable entry with female thread G ½" ■ Adapter for cable entry with female thread NPT ½" <p> Only available for certain device versions:</p> <ul style="list-style-type: none"> ■ Order code for "Transmitter housing": <ul style="list-style-type: none"> ■ Option A "Aluminum, coated" ■ Option D "Polycarbonate" ■ Order code for "Sensor connection housing": <ul style="list-style-type: none"> ■ Proline 500 – digital: <ul style="list-style-type: none"> Option A "Aluminum coated" Option B "Stainless" ■ Proline 500: <ul style="list-style-type: none"> Option B "Stainless" 	Nickel-plated brass
<p>Adapter for device plug</p> <p> <ul style="list-style-type: none"> ■ Device plug for digital communication: Only available for certain device versions . ■ Device plug for connecting cable: A device plug is always used for the device version, order code for "Sensor connection housing", option C (ultra-compact, hygienic, stainless). </p>	Stainless steel, 1.4404 (316L)

Device plug

Electrical connection	Material
Plug M12x1	<ul style="list-style-type: none"> ■ Socket: Stainless steel, 1.4404 (316L) ■ Contact housing: Polyamide ■ Contacts: Gold-plated brass

Connecting cables

 UV rays can impair the cable outer sheath. Protect the cable from exposure to sun as much as possible.

Connecting cable for sensor - Proline 500 – digital transmitter

PVC cable with copper shield

Connecting cable for sensor - Proline 500 transmitter

PVC cable with copper shield

Sensor housing

- Acid and alkali-resistant outer surface
- Stainless steel 1.4301 (304)

Measuring tubes

Stainless steel, 1.4435 (316L)

Process connections

Flange according to EN 1092-1 (DIN 2501)/ASME B16.5/JIS B2220:	Stainless steel, 1.4404 (F316/F316L)
All other process connections:	Stainless steel, 1.4435 (316L)



Available process connections → 267

Seals

Welded process connections without internal seals

Accessories

Protective cover

Stainless steel, 1.4404 (316L)

External WLAN antenna

- Antenna: ASA plastic (acrylonitrile styrene acrylate) and nickel-plated brass
- Adapter: Stainless steel and nickel-plated brass
- Cable: Polyethylene
- Plug: Nickel-plated brass
- Angle bracket: Stainless steel

Process connections

- Fixed flange connections:
 - EN 1092-1 (DIN 2501) flange
 - EN 1092-1 (DIN 2512N) flange
 - ASME B16.5 flange
 - JIS B2220 flange
 - DIN 11864-2 Form A flange, DIN 11866 series A, flange with notch
- Clamp connections:
 - Tri-Clamp (OD tubes), DIN 11866 series C
 - DIN 11864-3 Form A clamp, DIN 11866 series A, with notch
 - DIN 32676 clamp, DIN 11866 series A
 - ISO 2852 clamp, ISO 2037
- Thread:
 - DIN 11851 thread, DIN 11866 series A
 - SMS 1145 thread
 - ISO 2853 thread, ISO 2037
 - DIN 11864-1 Form A thread, DIN 11866 series A



Process connection materials → 267

Surface roughness

All data refer to parts in contact with the medium.

The following surface roughness categories can be ordered:

Category	Method	Option(s) order code "Measuring tube mat., wetted surface"
Ra ≤ 0.76 µm (30 µin) ¹⁾	Mechanically polished	SB

1) Ra according to ISO 21920

16.11 User interface

Languages

Can be operated in the following languages:

- Via local operation
English, German, French, Spanish, Italian, Dutch, Portuguese, Polish, Russian, Turkish, Chinese, Japanese, Korean, Vietnamese, Czech, Swedish
- Via web browser
English, German, French, Spanish, Italian, Dutch, Portuguese, Polish, Russian, Turkish, Chinese, Japanese, Vietnamese, Czech, Swedish
- Via "FieldCare", "DeviceCare" operating tool: English, German, French, Spanish, Italian, Chinese, Japanese

Onsite operation

Via display module

Features:

- Order code for "Display; operation", option F "4-line, illuminated, graphic display; touch control"
- Order code for "Display; operation", option G "4-line, illuminated, graphic display; touch control + WLAN"

 Information about WLAN interface →  86

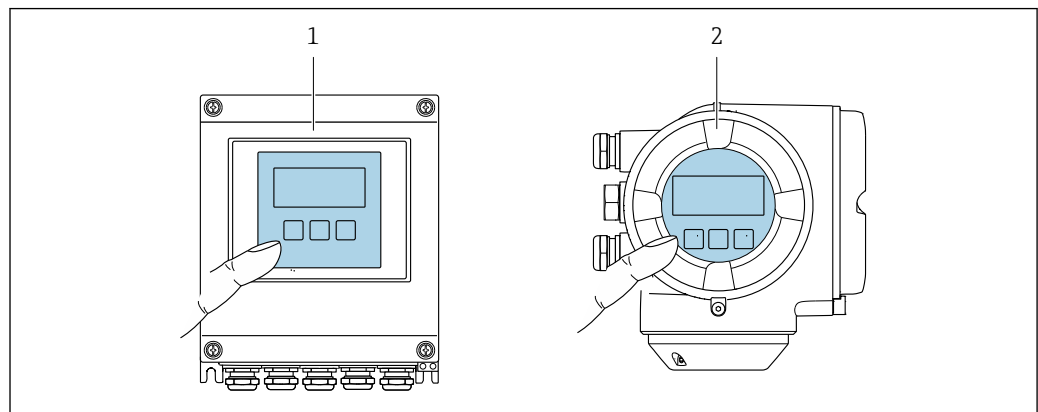



 42 Operation with touch control

- 1 Proline 500 – digital
- 2 Proline 500

Display elements

- 4-line, illuminated, graphic display
- White background lighting; switches to red in event of device errors
- Format for displaying measured variables and status variables can be individually configured





Operating elements

- External operation via touch control (3 optical keys) without opening the housing: , , 
- Operating elements also accessible in the various zones of the hazardous area

Remote operation →  85

Service interface →  85

Supported operating tools Different operating tools can be used for local or remote access to the measuring device. Depending on the operating tool used, access is possible with different operating units and via a variety of interfaces.

Supported operating tools	Operating unit	Interface	Additional information
Web browser	Notebook, PC or tablet with Web browser	<ul style="list-style-type: none"> ■ CDI-RJ45 service interface ■ WLAN interface 	Special Documentation for device →  276
DeviceCare SFE100	Notebook, PC or tablet with Microsoft Windows system	<ul style="list-style-type: none"> ■ CDI-RJ45 service interface ■ WLAN interface ■ Fieldbus protocol 	→  246
FieldCare SFE500	Notebook, PC or tablet with Microsoft Windows system	<ul style="list-style-type: none"> ■ CDI-RJ45 service interface ■ WLAN interface ■ Fieldbus protocol 	→  246
Field Xpert	SMT70/77/50	<ul style="list-style-type: none"> ■ All fieldbus protocols ■ WLAN interface ■ Bluetooth ■ CDI-RJ45 service interface 	Operating Instructions BA01202S Device description files: Use update function of handheld terminal
SmartBlue app	Smartphone or tablet with iOS or Android	WLAN	→  246

 Other operating tools based on FDT technology with a device driver such as DTM/iDTM or DD/EDD can be used for device operation. These operating tools are available from the individual manufacturers. Integration into the following operating tools, among others, is supported:

- FactoryTalk AssetCentre (FTAC) from Rockwell Automation → www.rockwellautomation.com
- Process Device Manager (PDM) from Siemens → www.siemens.com
- Field Device Manager (FDM) from Honeywell → www.process.honeywell.com
- FieldMate from Yokogawa → www.yokogawa.com
- PACTWare → www.pactware.com

The related device description files are available: www.endress.com → Download Area



Web server

With the integrated web server, the device can be operated and configured via a web browser service interface (CDI-RJ45) or WLAN interface. The structure of the operating menu is the same as for the local display. In addition to the measured values, status information on the device is displayed and can be used to monitor device health. Furthermore the device data can be managed and the network parameters can be configured.

A device that has a WLAN interface (can be ordered as an option) is required for the WLAN connection: order code for "Display; operation", option G "4-line, illuminated; touch control + WLAN". The device acts as an Access Point and enables communication by computer or a mobile handheld terminal.

Supported functions

Data exchange between the operating unit (such as a notebook, for example,) and measuring instrument:

- Upload the configuration from the measuring instrument (XML format, configuration backup)
- Save the configuration to the measuring instrument (XML format, restore configuration)
- Export event list (.csv file)
- Export parameter settings (.csv file or PDF file, document the measuring point configuration)
- Export the Heartbeat Technology verification report (PDF file, only available with the **Heartbeat Verification** →  274 application package)
- Flash firmware version for device firmware upgrade, for example
- Download driver for system integration
- Visualize up to 1000 saved measured values (only available with the **Extended HistoROM** application package →  274)

HistoROM data management

The measuring device features HistoROM data management. HistoROM data management comprises both the storage and import/export of key device and process data, making operation and servicing far more reliable, secure and efficient.

 When the device is delivered, the factory settings of the configuration data are stored as a backup in the device memory. This memory can be overwritten with an updated data record, for example after commissioning.

Additional information on the data storage concept

There are different types of data storage units in which device data are stored and used by the device:

	HistoROM backup	T-DAT	S-DAT
Available data	<ul style="list-style-type: none"> ▪ Event logbook, e.g. diagnostic events ▪ Parameter data record backup ▪ Device firmware package ▪ Driver for system integration for exporting via web server, e.g.: GSD for PROFIBUS PA 	<ul style="list-style-type: none"> ▪ Measured value logging ("Extended HistoROM" order option) ▪ Current parameter data record (used by firmware at run time) ▪ Indicator (minimum/maximum values) ▪ Totalizer value 	<ul style="list-style-type: none"> ▪ Sensor data: e.g. nominal diameter ▪ Serial number ▪ Calibration data ▪ Device configuration (e.g. SW options, fixed I/O or multi I/O)
Storage location	Fixed on the user interface PC board in the connection compartment	Can be plugged into the user interface PC board in the connection compartment	In the sensor plug in the transmitter neck part

Data backup

Automatic

- The most important device data (sensor and transmitter) are automatically saved in the DAT modules
- If the transmitter or measuring device is replaced: once the T-DAT containing the previous device data has been exchanged, the new measuring device is ready for operation again immediately without any errors
- If the sensor is replaced: once the sensor has been replaced, new sensor data are transferred from the S-DAT in the measuring device and the measuring device is ready for operation again immediately without any errors
- If exchanging the electronics module (e.g. I/O electronics module): Once the electronics module has been replaced, the software of the module is compared against the current device firmware. The module software is upgraded or downgraded where necessary. The electronics module is available for use immediately afterwards and no compatibility problems occur.

Manual

Additional parameter data record (complete parameter settings) in the integrated device memory HistoROM backup for:

- Data backup function
Backup and subsequent restoration of a device configuration in the device memory HistoROM backup
- Data comparison function
Comparison of the current device configuration with the device configuration saved in the device memory HistoROM backup

Data transmission**Manual**

- Transfer of a device configuration to another device using the export function of the specific operating tool, e.g. with FieldCare, DeviceCare or Web server: to duplicate the configuration or to store in an archive (e.g. for backup purposes)
- Transmission of the drivers for system integration via Web server, e.g.:
GSD for PROFIBUS PA

Event list**Automatic**

- Chronological display of up to 20 event messages in the events list
- If the **Extended HistoROM** application package (order option) is enabled: up to 100 event messages are displayed in the events list along with a time stamp, plain text description and remedial measures
- The events list can be exported and displayed via a variety of interfaces and operating tools e.g. DeviceCare, FieldCare or Web server

Data logging**Manual**

If the **Extended HistoROM** application package (order option) is enabled:

- Recording of 1 to 4 channels of up to 1 000 measured values (up to 250 measured values per channel)
- User configurable recording interval
- Export the measured value log via a variety of interfaces and operating tools e.g. FieldCare, DeviceCare or web server

16.12 Certificates and approvals

Current certificates and approvals for the product are available at www.endress.com on the relevant product page:

1. Select the product using the filters and search field.
2. Open the product page.
3. Select **Downloads**.

CE mark

The device meets the legal requirements of the applicable EU Directives. These are listed in the corresponding EU Declaration of Conformity along with the standards applied.

Endress+Hauser confirms successful testing of the device by affixing to it the CE mark.

UKCA marking

The device meets the legal requirements of the applicable UK regulations (Statutory Instruments). These are listed in the UKCA Declaration of Conformity along with the designated standards. By selecting the order option for UKCA marking, Endress+Hauser confirms a successful evaluation and testing of the device by affixing the UKCA mark.

Contact address Endress+Hauser UK:
 Endress+Hauser Ltd.
 Floats Road
 Manchester M23 9NF
 United Kingdom
www.uk.endress.com

RCM marking

The measuring system meets the EMC requirements of the "Australian Communications and Media Authority (ACMA)".

Hygienic compatibility



- 3-A approval
 - Only measuring instruments with the order code for "Additional approval", option LP "3A" have 3-A approval.
 - The 3-A approval refers to the measuring instrument.
 - When installing the measuring instrument, ensure that no liquid can accumulate on the outside of the measuring instrument.
A remote display module must be installed in accordance with the 3-A Standard.
 - Accessories (e.g. heating jacket, weather protection cover, wall holder unit) must be installed in accordance with the 3-A Standard.
Each accessory can be cleaned. Disassembly may be necessary under certain circumstances.
 - EHEDG-tested
 Only devices with the order code for "Additional approval", option LT "EHEDG" have been tested and meet the requirements of the EHEDG.
 To meet the requirements for EHEDG certification, the device must be used with process connections in accordance with the EHEDG position paper entitled "Easy cleanable Pipe couplings and Process connections" (www.ehedg.org).
 To meet the requirements for EHEDG certification, the device must be installed in a position that ensures drainability.
 - FDA
 - Food Contact Materials Regulation (EC) 1935/2004
-  Observe the special installation instructions

Certification PROFIBUS

PROFIBUS interface

The measuring device is certified and registered by the PNO (PROFIBUS Nutzerorganisation e.V./PROFIBUS User Organization). The measuring system meets all the requirements of the following specifications:

- Certified according to PA Profile 3.02
- The device can also be operated with certified devices of other manufacturers (interoperability)



Pressure Equipment Directive	<ul style="list-style-type: none"> ■ With the marking <ul style="list-style-type: none"> a) PED/G1/x (x = category) or b) PESR/G1/x (x = category) on the sensor nameplate, Endress+Hauser confirms compliance with the "Essential Safety Requirements" <ul style="list-style-type: none"> a) specified in Annex I of the Pressure Equipment Directive 2014/68/EU or b) Schedule 2 of Statutory Instruments 2016 No. 1105. ■ Devices not bearing this marking (without PED or PESR) are designed and manufactured according to sound engineering practice. They meet the requirements of <ul style="list-style-type: none"> a) Art. 4 Para. 3 of the Pressure Equipment Directive 2014/68/EU or b) Part 1, Para. 8 of Statutory Instruments 2016 No. 1105. The scope of application is indicated <ul style="list-style-type: none"> a) in diagrams 6 to 9 in Annex II of the Pressure Equipment Directive 2014/68/EU or b) Schedule 3, Para. 2 of Statutory Instruments 2016 No. 1105.
Radio approval	<p>The measuring device has radio approval.</p> <p> For detailed information on the radio approval, see the Special Documentation →  276</p>
Additional certification	<p>CRN approval</p> <p>Some device versions have CRN approval. A CRN-approved process connection with a CSA approval must be ordered for a CRN-approved device.</p> <p>Tests and certificates</p>
External standards and guidelines	<ul style="list-style-type: none"> ■ EN 60529 Degrees of protection provided by enclosures (IP code) ■ IEC/EN 60068-2-6 Environmental influences: Test procedure - Test Fc: vibrate (sinusoidal). ■ IEC/EN 60068-2-31 Environmental influences: Test procedure - Test Ec: shocks due to rough handling, primarily for devices. ■ EN 61010-1 Safety requirements for electrical equipment for measurement, control and laboratory use - general requirements ■ EN 61326-1/-2-3 EMC requirements for electrical equipment for measurement, control and laboratory use ■ NAMUR NE 21 Electromagnetic compatibility (EMC) of industrial process and laboratory control equipment ■ NAMUR NE 32 Data retention in the event of a power failure in field and control instruments with microprocessors ■ NAMUR NE 43 Standardization of the signal level for the breakdown information of digital transmitters with analog output signal. ■ NAMUR NE 53 Software of field devices and signal-processing devices with digital electronics ■ NAMUR NE 80 The application of the pressure equipment directive to process control devices ■ NAMUR NE 105 Specifications for integrating fieldbus devices in engineering tools for field devices ■ NAMUR NE 107 Self-monitoring and diagnosis of field devices

- NAMUR NE 131
Requirements for field devices for standard applications
- NAMUR NE 132
Coriolis mass meter
- ETSI EN 300 328
Guidelines for 2.4 GHz radio components.
- EN 301489
Electromagnetic compatibility and radio spectrum matters (ERM).

16.13 Application packages

Many different application packages are available to enhance the functionality of the device. Such packages might be needed to address safety aspects or specific application requirements.

The application packages can be ordered with the device or subsequently from Endress+Hauser. Detailed information on the order code in question is available from your local Endress+Hauser sales center or on the product page of the Endress+Hauser website: www.endress.com.

 Detailed information on the application packages:
Special Documentation →  276

Diagnostic functionality	<p>Order code for "Application package", option EA "Extended HistoROM"</p> <p>Comprises extended functions concerning the event log and the activation of the measured value memory.</p> <p>Event log: Memory volume is extended from 20 message entries (standard version) to up to 100 entries.</p> <p>Data logging (line recorder):</p> <ul style="list-style-type: none"> ■ Memory capacity for up to 1000 measured values is activated. ■ 250 measured values can be output via each of the 4 memory channels. The recording interval can be defined and configured by the user. ■ Measured value logs can be accessed via the local display or operating tool e.g. FieldCare, DeviceCare or Web server. <p> For detailed information, see the Operating Instructions for the device.</p>
--------------------------	--

Heartbeat Technology	<p>Order code for "Application package", option EB "Heartbeat Verification + Monitoring"</p> <p>Heartbeat Verification Meets the requirement for traceable verification to DIN ISO 9001:2008 Chapter 7.6 a) "Control of monitoring and measuring equipment".</p> <ul style="list-style-type: none"> ■ Functional testing in the installed state without interrupting the process. ■ Traceable verification results on request, including a report. ■ Simple testing process via local operation or other operating interfaces. ■ Clear measuring point assessment (pass/fail) with high test coverage within the framework of manufacturer specifications. ■ Extension of calibration intervals according to operator's risk assessment.
----------------------	--

Heartbeat Monitoring

Continuously supplies data, which are characteristic of the measuring principle, to an external condition monitoring system for the purpose of preventive maintenance or process analysis. These data enable the operator to:

- Draw conclusions - using these data and other information - about the impact process influences (e.g. corrosion, abrasion, buildup etc.) have on the measuring performance over time.
- Schedule servicing in time.
- Monitor the process or product quality, e.g. gas pockets .



For detailed information, see the Special Documentation for the device.

Concentration measurement

Order code for "Application package", option ED "Concentration"

Calculation and outputting of fluid concentrations.

The measured density is converted to the concentration of a substance of a binary mixture using the "Concentration" application package:

- Choice of predefined fluids (e.g. various sugar solutions, acids, alkalis, salts, ethanol etc.).
- Common or user-defined units (°Brix, °Plato, % mass, % volume, mol/l etc.) for standard applications.
- Concentration calculation from user-defined tables.



For detailed information, see the Special Documentation for the device.

Special density

Order code for "Application package", option EE "Special density"

Many applications use density as a key measured value for monitoring quality or controlling processes. The measuring instrument measures the density of the fluid as standard and makes this value available to the control system.

The "Special Density" application package offers high-precision density measurement over a wide density and temperature range particularly for applications subject to varying process conditions.



For detailed information, see the Operating Instructions for the device.

16.14 Accessories



Overview of accessories available to order → 245

16.15 Supplemental documentation



For an overview of the scope of the associated Technical Documentation, refer to the following:

- *Device Viewer* (www.endress.com/deviceviewer): Enter the serial number from the nameplate
- *Endress+Hauser Operations app*: Enter serial number from nameplate or scan matrix code on nameplate.

Standard documentation **Brief operating instructions**

Brief Operating Instructions for the sensor

Measuring instrument	Documentation code
Proline Promass S	KA01287D

Brief Operating Instructions for the transmitter

Measuring device	Documentation code
Proline 500 – digital	KA01392D
Proline 500	KA01391D

Technical information

Measuring device	Documentation code
Promass S 500	TI01288D

Description of device parameters

Measuring instrument	Documentation code
Promass 500	GP01061D

Supplementary device-
dependent documentation

Safety instructions

Safety instructions for electrical equipment for hazardous areas.



Contents	Documentation code
	Measuring device
ATEX/IECEX Ex i	XA01473D
ATEX/IECEX Ex ec	XA01474D
cCSAus IS	XA01475D
cCSAus Ex i	XA01509D
cCSAus Ex nA	XA01510D
INMETRO Ex i	XA01476D
INMETRO Ex ec	XA01477D
NEPSI Ex i	XA01478D
NEPSI Ex nA	XA01479D
NEPSI Ex i	XA01658D
NEPSI Ex nA	XA01659D
JPN	XA01780D

Special documentation

Contents	Documentation code
Information on the Pressure Equipment Directive	SD01614D
Radio approvals for WLAN interface for A309/A310 display module	SD01793D
Web server	SD01668D

Contents	Documentation code
Heartbeat Technology	SD01705D
Concentration measurement	SD01711D

Installation instructions

Contents	Note
Installation instructions for spare part sets and accessories	<ul style="list-style-type: none">▪ Access the overview of all the available spare part sets via <i>Device Viewer</i> →  243▪ Accessories available for order with Installation Instructions →  245

Index

- 0 ... 9**
 3-A approval 272
- A**
 Access authorization to parameters
 Read access 77
 Write access 77
 Access code 77
 Incorrect input 77
 Adapting the diagnostic behavior 180
 Additional certification 273
 Ambient conditions
 Mechanical load 263
 Operating height 262
 Relative humidity 262
 Shock and vibration resistance 262
 Storage temperature 262
 Ambient temperature
 Influence 260
 Ambient temperature range 262
 Analog Input module 97
 Analog Output module 100
 Application 248
 Application packages 274
 Approvals 271
 Attaching the connecting cable
 Proline 500 transmitter 52
- C**
 Cable entries
 Technical data 257
 Cable entry
 Degree of protection 62
 CE mark 10, 271
 Certificates 271
 Certification PROFIBUS 272
 Checklist
 Post-connection check 62
 Post-installation check 33
 CIP cleaning 263
 Cleaning
 CIP cleaning 242
 Exterior cleaning 242
 Internal cleaning 242
 SIP cleaning 242
 Climate class 262
 Commissioning 104
 Advanced settings 133
 Configuring the measuring instrument 105
 Compatibility with earlier model 91
 Connecting the connecting cable
 Proline 500 – digital transmitter 46
 Sensor connection housing, Proline 500 - digital 42
 Terminal assignment of Proline 500 - digital 42
 Connecting the measuring instrument
 Proline 500 49
 Proline 500 – digital 42
 Connecting the signal cable/supply voltage cable
 Proline 500 – digital transmitter 47
 Proline 500 transmitter 53
 Connection
 see Electrical connection
 Connection cable 34
 Connection preparations 41
 Connection tool 34
 Context menu
 Calling up 73
 Closing 73
 Explanation 73
 Current consumption 257
 Cyclic data transmission 96
- D**
 Date of manufacture 16, 18
 Declaration of Conformity 10
 Defining the access code 153
 Degree of protection 62, 262
 Density adjustment 136
 Design
 Measuring device 13
 Operating menu 64
 Design fundamentals
 Measurement error 261
 Repeatability 261
 Device components 13
 Device description files 91
 Device locking, status 157
 Device master file
 GSD 91
 Device name
 Sensor 18
 Transmitter 16
 Device repair 243
 Device type ID 91
 Device Viewer 243
 DeviceCare 90
 Device description file 91
 Diagnosis
 Symbols 175
 Diagnostic behavior
 Explanation 176
 Symbols 176
 Diagnostic information
 Design, description 176, 179
 DeviceCare 178
 FieldCare 178
 Light emitting diodes 172
 Local display 175
 Overview 183
 Remedial measures 183
 Web browser 177
 Diagnostic message 175

- Diagnostics list 235
 - DIP switch
 - see Write protection switch
 - Direct access 75
 - Disabling write protection 152
 - Discrete Input module 100
 - Discrete Output module 101
 - Display
 - see Local display
 - Display area
 - For operational display 67
 - In the navigation view 69
 - Display values
 - For locking status 157
 - Displaying the measured value history 165
 - Disposal 244
 - Document
 - Function 6
 - Symbols 6
 - Document function 6
 - Down pipe 22
- E**
- Editing view 71
 - Input screen 72
 - Using operating elements 71, 72
 - EHEDG-tested 272
 - Electrical connection
 - Degree of protection 62
 - Measuring instrument 34
 - Operating tools
 - Via PROFIBUS PA network 85
 - Via service interface (CDI-RJ45) 85
 - Via WLAN interface 86
 - Web server 85
 - WLAN interface 86
 - Electromagnetic compatibility 263
 - Electronics module 13
 - EMPTY_MODULE module 102
 - Enabling write protection 152
 - Enabling/disabling the keypad lock 78
 - Endress+Hauser services
 - Maintenance 242
 - Repair 243
 - Error messages
 - see Diagnostic messages
 - Event logbook 236
 - Events list 236
 - Extended order code
 - Sensor 18
 - Transmitter 16
 - Exterior cleaning 242
- F**
- FDA 272
 - Field of application
 - Residual risks 10
 - FieldCare 88
 - Device description file 91
 - Establishing a connection 89
 - Function 88
 - User interface 89
 - Filtering the event logbook 237
 - Firmware
 - Release date 91
 - Version 91
 - Firmware history 241
 - Fitting the connecting cable
 - Proline 500 terminal assignment 49
 - Sensor connection housing, Proline 500 49
 - Flow direction 22, 28
 - Flow limit 264
 - Food Contact Materials Regulation 272
 - Function range
 - SIMATIC PDM 90
 - Functions
 - see Parameters
- G**
- Galvanic isolation 256
- H**
- Hardware write protection 154
 - Help text
 - Calling up 76
 - Closing 76
 - Explanation 76
 - HistoROM 147
 - Hygienic compatibility 272
- I**
- Identifying the measuring instrument 15
 - Incoming acceptance 15
 - Indication
 - Current diagnostic event 235
 - Previous diagnostic event 235
 - Influence
 - Ambient temperature 260
 - Medium pressure 260
 - Medium temperature 260
 - Information about this document 6
 - Inlet runs 23
 - Input variables 249
 - Inspection
 - Connection 62
 - Installation 33
 - Received goods 15
 - Installation 21
 - Installation dimensions 23
 - Installation point 21
 - Intended use 9
 - Internal cleaning 242, 263
- L**
- Languages, operation options 268
 - Line recorder 165
 - Local display 268
 - Navigation view 69
 - see Diagnostic message

see In alarm condition	
see Operational display	
Text editor	71
Low flow cut off	256
M	
Main electronics module	13
Maintenance work	242
Managing the device configuration	147
Manufacturer ID	91
Materials	265
Maximum measurement error	258
Measured variables	
see Process variables	
Measurement accuracy	258
Measuring and test equipment	242
Measuring device	
Conversion	243
Design	13
Disposal	244
Mounting the sensor	28
Preparing for electrical connection	41
Removing	244
Repairs	243
Switching on	104
Measuring instrument	
Configuring	105
Preparing for mounting	28
Measuring principle	248
Measuring range	
For liquids	249
Measuring range, recommended	264
Measuring system	248
Mechanical load	263
Medium pressure	
Influence	260
Medium temperature	
Influence	260
Menu	
Diagnostics	235
Setup	105, 106
Menus	
For measuring instrument configuration	105
For specific settings	133
Module	
Analog Input	97
Analog output	100
Discrete Input	100
Discrete Output	101
EMPTY_MODULE	102
Totalizer	
SETTOT_MODETOT_TOTAL	99
SETTOT_TOTAL	99
TOTAL	98
Mounting dimensions	
see Installation dimensions	
Mounting preparations	28
Mounting requirements	
Down pipe	22

Inlet and outlet runs	23
Installation dimensions	23
Installation point	21
Orientation	22
Sensor heating	25
Static pressure	24
Thermal insulation	24
Vibrations	25
Mounting tool	28

N

Nameplate	
Sensor	18
Transmitter	16
Navigation path (navigation view)	69
Navigation view	
In the submenu	69
In the wizard	69
Netilion	242
Numeric editor	71

O

Onsite display	
Numeric editor	71
Operable flow range	249
Operating elements	73, 176
Operating height	262
Operating keys	
see Operating elements	
Operating menu	
Design	64
Menus, submenus	64
Submenus and user roles	65
Operating philosophy	65
Operation	157
Operation options	63
Operational display	66
Operational safety	10
Order code	16, 18
Orientation (vertical, horizontal)	22
Outlet runs	23
Output signal	251
Output variables	251

P

Packaging disposal	21
Parameter	
Changing	76
Entering values or text	76
Parameter settings	
Administration (Submenu)	150
Analog inputs (Submenu)	112
Communication (Submenu)	110
Configuration backup (Submenu)	147
Corrected volume flow calculation (Submenu)	134
Current input	114
Current input (Wizard)	114
Current input 1 to n (Submenu)	161
Current output	115

- Current output (Wizard) 115
- Data logging (Submenu) 165
- Define access code (Wizard) 149
- Density adjustment (Wizard) 136
- Device information (Submenu) 239
- Diagnostics (Menu) 235
- Display (Submenu) 143
- Display (Wizard) 128
- I/O configuration 113
- I/O configuration (Submenu) 113
- Low flow cut off (Wizard) 131
- Measured variables (Submenu) 158
- Medium selection (Wizard) 110
- Partially filled pipe detection (Wizard) 132
- Pulse/frequency/switch output 119
- Pulse/frequency/switch output (Wizard) 119, 120, 124
- Pulse/frequency/switch output 1 to n (Submenu) 163
- Relay output 126
- Relay output 1 to n (Submenu) 164
- Relay output 1 to n (Wizard) 126
- Reset access code (Submenu) 149
- Sensor adjustment (Submenu) 135
- Setup (Menu) 106
- Simulation (Submenu) 150
- Status input 115
- Status input 1 to n (Submenu) 162
- Status input 1 to n (Wizard) 115
- System units (Submenu) 107
- Totalizer (Submenu) 160
- Totalizer 1 to n (Submenu) 141
- Totalizer handling (Submenu) 164
- Value current output 1 to n (Submenu) 163
- Web server (Submenu) 84
- WLAN settings (Wizard) 146
- Zero adjustment (Wizard) 140
- Zero verification (Wizard) 139
- Performance characteristics 258
- Performing density adjustment 136
- Post-connection check 104
- Post-connection check (checklist) 62
- Post-installation check 104
- Post-installation check (checklist) 33
- Potential equalization 55
- Power consumption 257
- Power supply failure 257
- Pressure Equipment Directive 273
- Pressure loss 264
- Pressure-temperature ratings 263
- Process connections 267
- Process variables
 - Calculated 249
 - Measured 249
- Product safety 10
- Profile version 91
- Proline 500 – digital transmitter
 - Connecting the signal cable/supply voltage cable . . . 47
- Proline 500 connecting cable terminal assignment
 - Sensor connection housing 49
- Proline 500 transmitter
 - Connecting the signal cable/supply voltage cable . . . 53
 - Protecting parameter settings 152
- R**
- Radio approval 273
- RCM marking 272
- Read access 77
- Reading off measured values 157
- Recalibration 242
- Reference operating conditions 258
- Registered trademarks 8
- Remedial measures
 - Calling up 177
 - Closing 177
- Remote operation 269
- Repair 243
 - Notes 243
- Repair of a device 243
- Repeatability 259
- Replacement
 - Device components 243
- Requirements for personnel 9
- Response time 260
- Return 243
- S**
- Safety 9
- Sensor
 - Installing 28
- Sensor heating 25
- Sensor housing 263
- Serial number 16, 18
- Setting the operating language 104
- Settings
 - Adapting the measuring device to the process conditions 164
 - Administration 149
 - Advanced display configurations 143
 - Analog Input 112
 - Communication interface 110
 - Current input 114
 - Current output 115
 - I/O configuration 113
 - Local display 128
 - Low flow cut off 131
 - Managing the device configuration 147
 - Medium 110
 - Operating language 104
 - Partially filled pipe detection 132
 - Pulse output 119
 - Pulse/frequency/switch output 119, 120
 - Relay output 126
 - Resetting the device 238
 - Resetting the totalizer 164
 - Sensor adjustment 135
 - Simulation 150
 - Status input 115
 - Switch output 124

System units	107	Supply voltage	257
Tag name	106	Surface roughness	268
Totalizer	141	Switch output	253
Totalizer reset	164	Symbols	
WLAN	146	Controlling data entries	72
SETTOT_MODETOT_TOTAL module	99	For communication	67
SETTOT_TOTAL module	99	For diagnostic behavior	67
Shock and vibration resistance	262	For locking	67
Signal on alarm	254	For measured variable	67
SIMATIC PDM	90	For measurement channel number	67
Function	90	For menus	69
SIP cleaning	263	For parameters	69
Spare part	243	For status signal	67
Spare parts	243	For submenu	69
Special connection instructions	56	For wizards	69
Special mounting instructions		In the status area of the local display	67
Hygienic compatibility	26	Input screen	72
Standards and guidelines	273	Operating elements	71
Static pressure	24	System design	
Status area		Measuring system	248
For operational display	67	see Measuring device design	
In the navigation view	69	System integration	91
Status signals	175, 178	T	
Storage concept	270	Technical data, overview	248
Storage conditions	20	Temperature range	
Storage temperature	20	Ambient temperature range for display	268
Storage temperature range	262	Medium temperature	263
Submenu		Storage temperature	20
Administration	149, 150	Terminal assignment	39
Advanced setup	133	Terminal assignment of connecting cable for Proline	
Analog inputs	112	500- digital	
Calculated values	134	Sensor connection housing	42
Communication	104, 110	Terminals	257
Configuration backup	147	Tests and certificates	273
Corrected volume flow calculation	134	Text editor	71
Current input 1 to n	161	Thermal insulation	24
Data logging	165	Tool	
Device information	239	For electrical connection	34
Display	143	For mounting	28
Events list	236	Transport	20
I/O configuration	113	Tool tip	
Input values	161	see Help text	
Measured values	157	TOTAL module	98
Measured variables	158	Totalizer	
Output values	162	Assign process variable	160
Overview	65	Configuring	141
Process variables	134	Operating	164
Pulse/frequency/switch output 1 to n	163	Reset	164
Relay output 1 to n	164	Transmitter	
Reset access code	149	Turning the display module	32
Sensor adjustment	135	Turning the housing	31
Simulation	150	Transporting the measuring device	20
Status input 1 to n	162	Troubleshooting	
System units	107	General	169
Totalizer	160	Turning the display module	32
Totalizer 1 to n	141	Turning the electronics housing	
Totalizer handling	164	see Turning the transmitter housing	
Value current output 1 to n	163	Turning the transmitter housing	31
Web server	84		

U

- UKCA marking 271
- Use of measuring device
 - Borderline cases 9
 - Incorrect use 9
- Use of measuring instrument
 - see Intended use
- User roles 65

V

- Vibrations 25

W

- W@M Device Viewer 15
- Weight
 - SI units 265
 - Transport (notes) 20
 - US units 265
- Wizard
 - Current input 114
 - Current output 115
 - Define access code 149
 - Density adjustment 136
 - Display 128
 - Low flow cut off 131
 - Medium selection 110
 - Partially filled pipe detection 132
 - Pulse/frequency/switch output 119, 120, 124
 - Relay output 1 to n 126
 - Status input 1 to n 115
 - WLAN settings 146
 - Zero adjustment 140
 - Zero verification 139
- WLAN settings 146
- Workplace safety 10
- Write access 77
- Write protection
 - Via access code 153
 - Via write protection switch 154
- Write protection switch 154



71674912

www.addresses.endress.com
