

# Operating Instructions

## Proline Promass E 200

Coriolis flowmeter  
FOUNDATION fieldbus

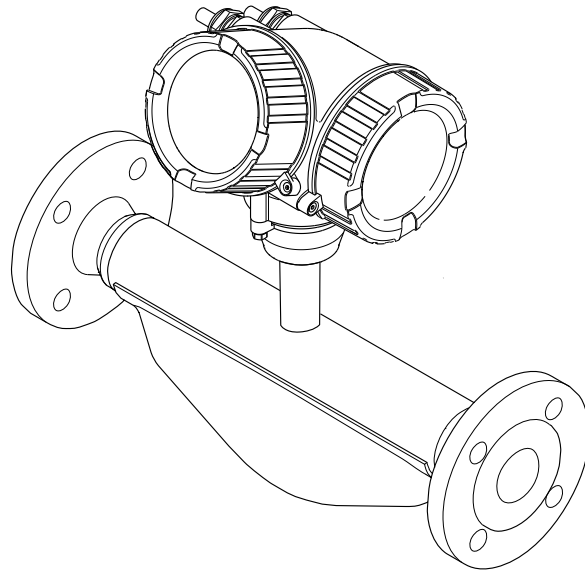

- Make sure the document is stored in a safe place such that it is always available when working on or with the device.
- To avoid danger to individuals or the facility, read the "Basic safety instructions" section carefully, as well as all other safety instructions in the document that are specific to working procedures.
- The manufacturer reserves the right to modify technical data without prior notice. Your Endress+Hauser sales organization will supply you with current information and updates to this manual.

## Table of contents

<b>1</b>	<b>About this document</b> . . . . .	<b>6</b>		
1.1	Document function . . . . .	6		
1.2	Symbols . . . . .	6		
1.2.1	Safety symbols . . . . .	6		
1.2.2	Electrical symbols . . . . .	6		
1.2.3	Communication-specific symbols . . . . .	6		
1.2.4	Tool symbols . . . . .	7		
1.2.5	Symbols for certain types of information . . . . .	7		
1.2.6	Symbols in graphics . . . . .	7		
1.3	Documentation . . . . .	8		
1.4	Registered trademarks . . . . .	8		
<b>2</b>	<b>Safety instructions</b> . . . . .	<b>9</b>		
2.1	Requirements for the personnel . . . . .	9		
2.2	Intended use . . . . .	9		
2.3	Workplace safety . . . . .	10		
2.4	Operational safety . . . . .	10		
2.5	Product safety . . . . .	10		
2.6	IT security . . . . .	11		
2.7	Device-specific IT security . . . . .	11		
2.7.1	Protecting access via hardware write protection . . . . .	11		
2.7.2	Protecting access via a password . . . . .	11		
2.7.3	Access via fieldbus . . . . .	11		
<b>3</b>	<b>Product description</b> . . . . .	<b>13</b>		
3.1	Product design . . . . .	13		
<b>4</b>	<b>Incoming acceptance and product identification</b> . . . . .	<b>14</b>		
4.1	Incoming acceptance . . . . .	14		
4.2	Product identification . . . . .	14		
4.2.1	Transmitter nameplate . . . . .	15		
4.2.2	Sensor nameplate . . . . .	16		
4.2.3	Symbols on the device . . . . .	17		
<b>5</b>	<b>Storage and transport</b> . . . . .	<b>18</b>		
5.1	Storage conditions . . . . .	18		
5.2	Transporting the product . . . . .	18		
5.2.1	Measuring devices without lifting lugs . . . . .	18		
5.2.2	Measuring devices with lifting lugs . . . . .	19		
5.2.3	Transporting with a fork lift . . . . .	19		
5.3	Packaging disposal . . . . .	19		
<b>6</b>	<b>Installation</b> . . . . .	<b>20</b>		
6.1	Installation requirements . . . . .	20		
6.1.1	Installation position . . . . .	20		
6.1.2	Environmental and process requirements . . . . .	22		
6.1.3	Special installation instructions . . . . .	24		
6.2	Installing the measuring instrument . . . . .	25		
6.2.1	Required tools . . . . .	25		
6.2.2	Preparing the measuring instrument . . . . .	25		
6.2.3	Mounting the measuring device . . . . .	25		
6.2.4	Turning the transmitter housing . . . . .	26		
6.2.5	Turning the display module . . . . .	26		
6.3	Post-installation check . . . . .	27		
<b>7</b>	<b>Electrical connection</b> . . . . .	<b>28</b>		
7.1	Electrical safety . . . . .	28		
7.2	Connecting requirements . . . . .	28		
7.2.1	Required tools . . . . .	28		
7.2.2	Requirements for connecting cable . . . . .	28		
7.2.3	Terminal assignment . . . . .	29		
7.2.4	device plug pin assignment . . . . .	29		
7.2.5	Shielding and grounding . . . . .	29		
7.2.6	Requirements for the supply unit . . . . .	31		
7.2.7	Preparing the measuring device . . . . .	31		
7.3	Connecting the measuring instrument . . . . .	31		
7.3.1	Connecting the transmitter . . . . .	31		
7.3.2	Potential equalization . . . . .	33		
7.4	Special connection instructions . . . . .	33		
7.4.1	Connection examples . . . . .	33		
7.5	Ensuring the degree of protection . . . . .	34		
7.6	Post-connection check . . . . .	35		
<b>8</b>	<b>Operation options</b> . . . . .	<b>36</b>		
8.1	Overview of operation options . . . . .	36		
8.2	Structure and function of the operating menu . . . . .	37		
8.2.1	Structure of the operating menu . . . . .	37		
8.2.2	Operating philosophy . . . . .	38		
8.3	Access to operating menu via local display . . . . .	39		
8.3.1	Operational display . . . . .	39		
8.3.2	Navigation view . . . . .	41		
8.3.3	Editing view . . . . .	42		
8.3.4	Operating elements . . . . .	44		
8.3.5	Opening the context menu . . . . .	45		
8.3.6	Navigating and selecting from list . . . . .	46		
8.3.7	Calling the parameter directly . . . . .	46		
8.3.8	Calling up help text . . . . .	47		
8.3.9	Changing the parameters . . . . .	48		
8.3.10	User roles and related access authorization . . . . .	49		
8.3.11	Disabling write protection via access code . . . . .	49		
8.3.12	Enabling and disabling the keypad lock . . . . .	50		
8.4	Access to the operating menu via the operating tool . . . . .	50		
8.4.1	Connecting the operating tool . . . . .	50		
8.4.2	Field Xpert SFX350, SFX370 . . . . .	52		
8.4.3	FieldCare . . . . .	52		

8.4.4	DeviceCare .....	53	11.4.2	"Totalizer" submenu .....	98
8.4.5	AMS Device Manager .....	53	11.4.3	Output variables .....	99
8.4.6	Field Communicator 475 .....	54	11.5	Adapting the measuring device to the process conditions .....	99
<b>9</b>	<b>System integration .....</b>	<b>55</b>	11.6	Performing a totalizer reset .....	99
9.1	Overview of device description files .....	55	11.6.1	Function scope of "Control Totalizer" parameter .....	101
9.1.1	Current version data for the device ...	55	11.6.2	Function range of "Reset all totalizers" parameter .....	101
9.1.2	Operating tools .....	55	11.7	Displaying the measured value history .....	101
9.2	Cyclic data transmission .....	55	<b>12</b>	<b>Diagnostics and troubleshooting ..</b>	<b>105</b>
9.2.1	Block model .....	55	12.1	General troubleshooting .....	105
9.2.2	Description of the modules .....	56	12.2	Diagnostic information on local display .....	107
9.2.3	Execution times .....	59	12.2.1	Diagnostic message .....	107
9.2.4	Methods .....	60	12.2.2	Calling up remedial measures .....	109
<b>10</b>	<b>Commissioning .....</b>	<b>61</b>	12.3	Diagnostic information in FieldCare or DeviceCare .....	109
10.1	Post-mounting and post-connection check ...	61	12.3.1	Diagnostic options .....	109
10.2	Switching on the measuring device .....	61	12.3.2	Calling up remedy information .....	111
10.3	Setting the operating language .....	61	12.4	Adapting the diagnostic information .....	111
10.4	Configuring the measuring instrument .....	61	12.4.1	Adapting the diagnostic behavior ...	111
10.4.1	Defining the device tag .....	62	12.4.2	Adapting the status signal .....	112
10.4.2	Setting the system units .....	63	12.5	Overview of diagnostic information .....	116
10.4.3	Selecting and setting the medium ...	66	12.5.1	Diagnostic of sensor .....	116
10.4.4	Configuring the analog inputs .....	67	12.5.2	Diagnostic of electronic .....	118
10.4.5	Configuring the local display .....	67	12.5.3	Diagnostic of configuration .....	124
10.4.6	Configuring the low flow cut off .....	70	12.5.4	Diagnostic of process .....	129
10.4.7	Configuring the partial filled pipe detection .....	71	12.6	Pending diagnostic events .....	133
10.5	Advanced settings .....	72	12.7	Diagnostic messages in the DIAGNOSTIC Transducer Block .....	134
10.5.1	Carrying out a sensor adjustment ...	73	12.8	Diagnostics list .....	134
10.5.2	Configuring the pulse/frequency/switch output .....	76	12.9	Event logbook .....	135
10.5.3	Configuring the totalizer .....	82	12.9.1	Reading out the event logbook .....	135
10.5.4	Carrying out additional display configurations .....	83	12.9.2	Filtering the event logbook .....	135
10.5.5	Using parameters for device administration .....	85	12.9.3	Overview of information events ...	135
10.6	Configuration management .....	86	12.10	Resetting the measuring instrument .....	136
10.6.1	Function scope of the "Configuration management" parameter .....	87	12.10.1	Function range of "Restart" parameter .....	136
10.7	Simulation .....	87	12.10.2	Function range of "Service reset" parameter .....	137
10.8	Protecting settings from unauthorized access .	90	12.11	Device information .....	137
10.8.1	Write protection via access code .....	90	12.12	Firmware history .....	139
10.8.2	Write protection via write protection switch .....	91	<b>13</b>	<b>Maintenance .....</b>	<b>140</b>
10.8.3	Write protection via block operation .	92	13.1	Maintenance work .....	140
10.9	Configuring the measuring device via FOUNDATION Fieldbus .....	93	13.1.1	Exterior cleaning .....	140
10.9.1	Block configuration .....	93	13.1.2	Internal cleaning .....	140
10.9.2	Scaling the measured value in the Analog Input Block .....	94	13.2	Measuring and test equipment .....	140
<b>11</b>	<b>Operation .....</b>	<b>96</b>	13.3	Endress+Hauser services .....	140
11.1	Reading off the device locking status .....	96	<b>14</b>	<b>Repair .....</b>	<b>141</b>
11.2	Adjusting the operating language .....	96	14.1	General notes .....	141
11.3	Configuring the display .....	96	14.1.1	Repair and conversion concept .....	141
11.4	Reading off measured values .....	96	14.1.2	Notes for repair and conversion ...	141
11.4.1	Process variables .....	97	14.2	Spare parts .....	141
			14.3	Endress+Hauser services .....	142

---

14.4	Return .....	142
14.5	Disposal .....	142
	14.5.1 Removing the measuring device . . . .	142
	14.5.2 Disposing of the measuring device . .	143
<b>15</b>	<b>Accessories .....</b>	<b>144</b>
15.1	Device-specific accessories .....	144
	15.1.1 For the transmitter .....	144
	15.1.2 For the sensor .....	145
15.2	Communication-specific accessories .....	145
15.3	Service-specific accessories .....	146
15.4	System components .....	147
<b>16</b>	<b>Technical data .....</b>	<b>148</b>
16.1	Application .....	148
16.2	Function and system design .....	148
16.3	Input .....	149
16.4	Output .....	150
16.5	Power supply .....	153
16.6	Performance characteristics .....	155
16.7	Mounting .....	159
16.8	Environment .....	159
16.9	Process .....	160
16.10	Mechanical construction .....	161
16.11	Operability .....	164
16.12	Certificates and approvals .....	166
16.13	Application packages .....	168
16.14	Accessories .....	169
16.15	Supplemental documentation .....	169
<b>Index</b>	<b>.....</b>	<b>172</b>

# 1 About this document

## 1.1 Document function

These Operating Instructions contain all the information required in the various life cycle phases of the device: from product identification, incoming acceptance and storage, to installation, connection, operation and commissioning, through to troubleshooting, maintenance and disposal.

## 1.2 Symbols

### 1.2.1 Safety symbols

#### DANGER

This symbol alerts you to a dangerous situation. Failure to avoid this situation will result in serious or fatal injury.

#### WARNING

This symbol alerts you to a potentially dangerous situation. Failure to avoid this situation can result in serious or fatal injury.





#### CAUTION

This symbol alerts you to a potentially dangerous situation. Failure to avoid this situation can result in minor or medium injury.



#### NOTICE

This symbol alerts you to a potentially harmful situation. Failure to avoid this situation can result in damage to the product or something in its vicinity.



### 1.2.2 Electrical symbols

Symbol	Meaning
	Direct current
	Alternating current
	Direct current and alternating current
	<b>Ground connection</b> A grounded terminal which, as far as the operator is concerned, is grounded via a grounding system.
	<b>Potential equalization connection (PE: protective earth)</b> Ground terminals that must be connected to ground prior to establishing any other connections.  The ground terminals are located on the interior and exterior of the device: <ul style="list-style-type: none"> <li>▪ Interior ground terminal: potential equalization is connected to the supply network.</li> <li>▪ Exterior ground terminal: device is connected to the plant grounding system.</li> </ul>













### 1.2.3 Communication-specific symbols

Symbol	Meaning
	<b>Wireless Local Area Network (WLAN)</b> Communication via a wireless, local network.
	<b>Bluetooth</b> Wireless data transmission between devices over a short distance via radio technology.





### 1.2.4 Tool symbols

Symbol	Meaning
	Flat-blade screwdriver
	Allen key
	Open-ended wrench

### 1.2.5 Symbols for certain types of information

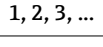
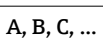
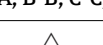
Symbol	Meaning
	<b>Permitted</b> Procedures, processes or actions that are permitted.
	<b>Preferred</b> Procedures, processes or actions that are preferred.
	<b>Forbidden</b> Procedures, processes or actions that are forbidden.
	<b>Tip</b> Indicates additional information.
	Reference to documentation
	Reference to page
	Reference to graphic
	Notice or individual step to be observed
	Series of steps
	Result of a step
	Help in the event of a problem
	Visual inspection

### 1.2.6 Symbols in graphics

Symbol	Meaning
	Item numbers
	Series of steps
	Views
	Sections
	Hazardous area
	Safe area (non-hazardous area)
	Flow direction

## 1.3 Documentation

 For an overview of the scope of the associated Technical Documentation, refer to the following:

- *Device Viewer* ([www.endress.com/deviceviewer](http://www.endress.com/deviceviewer)): Enter the serial number from the nameplate
- *Endress+Hauser Operations app*: Enter serial number from nameplate or scan matrix code on nameplate.

The following documentation may be available depending on the device version ordered:

Document type	Purpose and content of the document
Technical Information (TI)	<b>Planning aid for your device</b> The document contains all the technical data on the device and provides an overview of the accessories and other products that can be ordered for the device.
Brief Operating Instructions (KA)	<b>Guide that takes you quickly to the 1st measured value</b> The Brief Operating Instructions contain all the essential information from incoming acceptance to initial commissioning.
Operating Instructions (BA)	<b>Your reference document</b> These Operating Instructions contain all the information that is required in the various life cycle phases of the device: from product identification, incoming acceptance and storage, to mounting, connection, operation and commissioning, through to troubleshooting, maintenance and disposal.
Description of Device Parameters (GP)	<b>Reference for your parameters</b> The document provides a detailed explanation of each individual parameter. The description is aimed at those who work with the device over the entire life cycle and perform specific configurations.
Safety Instructions (XA)	Depending on the approval, safety instructions for electrical equipment in hazardous areas are also supplied with the device. The Safety Instructions are a constituent part of the Operating Instructions.   Information on the Safety Instructions (XA) that are relevant for the device is provided on the nameplate.
Supplementary device-dependent documentation (SD/FY)	Always comply strictly with the instructions in the relevant supplementary documentation. The supplementary documentation is a constituent part of the device documentation.

## 1.4 Registered trademarks

### FOUNDATION™ Fieldbus

Registration-pending trademark of the FieldComm Group, Austin, Texas, USA

### TRI-CLAMP®

Registered trademark of Ladish & Co., Inc., Kenosha, USA



## 2 Safety instructions

### 2.1 Requirements for the personnel

The personnel for installation, commissioning, diagnostics and maintenance must fulfill the following requirements:

- ▶ Trained, qualified specialists must have a relevant qualification for this specific function and task.
- ▶ Are authorized by the plant owner/operator.
- ▶ Are familiar with federal/national regulations.
- ▶ Before starting work, read and understand the instructions in the manual and supplementary documentation as well as the certificates (depending on the application).
- ▶ Follow instructions and comply with basic conditions.

The operating personnel must fulfill the following requirements:

- ▶ Are instructed and authorized according to the requirements of the task by the facility's owner-operator.
- ▶ Follow the instructions in this manual.

### 2.2 Intended use

#### Application and media

The measuring instrument described in this manual is intended only for the flow measurement of liquids and gases.

Depending on the version ordered, the measuring instrument can also be used to measure potentially explosive <sup>1)</sup>, flammable, toxid and oxidizing media.

Measuring instruments for use in hazardous areas, in hygienic applications, or where there is an increased risk due to pressure, are specially labeled on the nameplate.

To ensure that the measuring instrument is in perfect condition during operation:

- ▶ Only use the measuring instrument in full compliance with the data on the nameplate and the general conditions listed in the Operating Instructions and supplementary documentation.
- ▶ Using the nameplate, check whether the ordered device is permitted for the intended use in the hazardous area (e.g. explosion protection, pressure vessel safety).
- ▶ Use the measuring instrument only for media to which the process-wetted materials are sufficiently resistant.
- ▶ Keep within the specified pressure and temperature range.
- ▶ Keep within the specified ambient temperature range.
- ▶ Protect the measuring instrument permanently against corrosion from environmental influences.

#### Incorrect use

Non-designated use can compromise safety. The manufacturer is not liable for damage caused by improper or non-designated use.

#### **WARNING**

#### **Danger of breakage due to corrosive or abrasive fluids and ambient conditions!**

- ▶ Verify the compatibility of the process fluid with the sensor material.
- ▶ Ensure the resistance of all fluid-wetted materials in the process.
- ▶ Keep within the specified pressure and temperature range.

---

1) Not applicable for IO-Link measuring instruments

**NOTICE****Verification for borderline cases:**

- ▶ For special fluids and fluids for cleaning, Endress+Hauser is glad to provide assistance in verifying the corrosion resistance of fluid-wetted materials, but does not accept any warranty or liability as minute changes in the temperature, concentration or level of contamination in the process can alter the corrosion resistance properties.

**Residual risks****⚠ CAUTION**

**Risk of hot or cold burns! The use of media and electronics with high or low temperatures can produce hot or cold surfaces on the device.**

- ▶ Mount suitable touch protection.

**⚠ WARNING**

**Danger of housing breaking due to measuring tube breakage!**

If a measuring tube ruptures, the pressure inside the sensor housing will rise according to the operating process pressure.

- ▶ Use a rupture disk.

**⚠ WARNING**

**Danger from medium escaping!**

For device versions with a rupture disk: medium escaping under pressure can cause injury or material damage.

- ▶ Take precautions to prevent injury and material damage if the rupture disk is actuated.

## 2.3 Workplace safety

When working on and with the device:

- ▶ Wear the required personal protective equipment as per national regulations.

## 2.4 Operational safety

Damage to the device!

- ▶ Operate the device in proper technical condition and fail-safe condition only.
- ▶ The operator is responsible for the interference-free operation of the device.

**Modifications to the device**

Unauthorized modifications to the device are not permitted and can lead to unforeseeable dangers!

- ▶ If modifications are nevertheless required, consult with the manufacturer.

**Repair**

To ensure continued operational safety and reliability:

- ▶ Carry out repairs on the device only if they are expressly permitted.
- ▶ Observe federal/national regulations pertaining to the repair of an electrical device.
- ▶ Use only original spare parts and accessories.

## 2.5 Product safety

This measuring device is designed in accordance with good engineering practice to meet state-of-the-art safety requirements, has been tested, and left the factory in a condition in which it is safe to operate.

It meets general safety standards and legal requirements. It also complies with the EU directives listed in the device-specific EU Declaration of Conformity. The manufacturer confirms this by affixing the CE mark to the device..

## 2.6 IT security

Our warranty is valid only if the product is installed and used as described in the Operating Instructions. The product is equipped with security mechanisms to protect it against any inadvertent changes to the settings.

IT security measures, which provide additional protection for the product and associated data transfer, must be implemented by the operators themselves in line with their security standards.

## 2.7 Device-specific IT security

The device offers a range of specific functions to support protective measures on the operator's side. These functions can be configured by the user and guarantee greater in-operation safety if used correctly. The following list provides an overview of the most important functions:

### 2.7.1 Protecting access via hardware write protection

Write access to the parameters of the device via the local display or operating tool (e.g. FieldCare, DeviceCare) can be disabled via a write protection switch (DIP switch on the main electronics module). When hardware write protection is enabled, only read access to the parameters is possible.

### 2.7.2 Protecting access via a password

A password can be used to protect against write access to the device parameters.

This controls write access to the device parameters via the local display or other operating tools (e.g. FieldCare, DeviceCare) and, in terms of functionality, corresponds to hardware write protection. If the CDI service interface is used, read access is only possible by first entering the password.

#### User-specific access code

Write access to the device parameters via the local display or operating tool (e.g. FieldCare, DeviceCare) can be protected by the modifiable, user-specific access code (→  90).

When the device is delivered, the device does not have an access code and is equivalent to 0000 (open).

#### General notes on the use of passwords

- The access code and network key supplied with the device should be changed during commissioning for safety reasons.
- Follow the general rules for generating a secure password when defining and managing the access code and network key.
- The user is responsible for the management and careful handling of the access code and network key.
- For information on configuring the access code or on what to do if you lose the password, for example, see "Write protection via access code" →  90.

### 2.7.3 Access via fieldbus

When communicating via fieldbus, access to the device parameters can be restricted to "Read only" access. The option can be changed in the **Fieldbus writing access** parameter.

This does not affect cyclic measured value transmission to the higher-order system, which is always guaranteed.



Detailed information on the device parameters:  
"Description of device parameters" document .

### 3 Product description

The device consists of a transmitter and a sensor.

The device is available as a compact version:

The transmitter and sensor form a mechanical unit.

#### 3.1 Product design

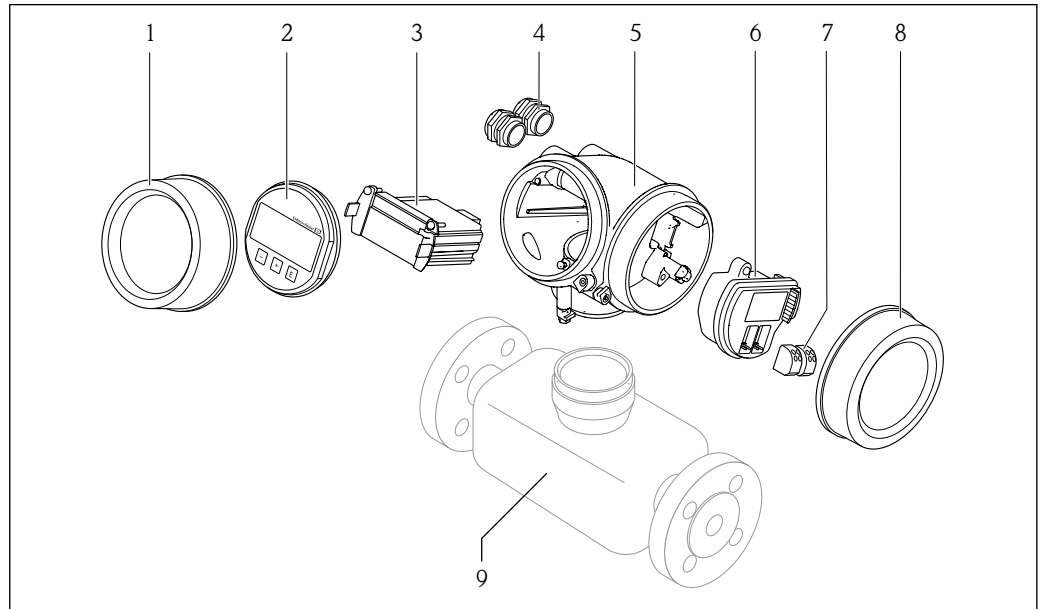

A0014056

##### 1 Important components of a measuring device

- 1 Electronics compartment cover
- 2 Display module
- 3 Main electronics module
- 4 Cable glands
- 5 Transmitter housing (incl. integrated HistoROM)
- 6 I/O electronics module
- 7 Terminals (pluggable spring terminals)
- 8 Connection compartment cover
- 9 Sensor

## 4 Incoming acceptance and product identification

### 4.1 Incoming acceptance

On receipt of the delivery:

1. Check the packaging for damage.
  - ↳ Report all damage immediately to the manufacturer.  
Do not install damaged components.
2. Check the scope of delivery using the delivery note.
3. Compare the data on the nameplate with the order specifications on the delivery note.
4. Check the technical documentation and all other necessary documents, e.g. certificates, to ensure they are complete.



If one of the conditions is not satisfied, contact the manufacturer.

### 4.2 Product identification

The device can be identified in the following ways:

- Nameplate
- Order code with details of the device features on the delivery note
- Enter the serial numbers from the nameplates in the *Device Viewer* ([www.endress.com/deviceviewer](http://www.endress.com/deviceviewer)): all the information about the device is displayed.
- Enter the serial numbers from the nameplates into the *Endress+Hauser Operations app* or scan the DataMatrix code on the nameplate with the *Endress+Hauser Operations app*: all the information about the device is displayed.

For an overview of the scope of the associated Technical Documentation, refer to the following:

- The "Additional standard device documentation" and "Supplementary device-dependent documentation" sections
- The *Device Viewer*: Enter the serial number from the nameplate ([www.endress.com/deviceviewer](http://www.endress.com/deviceviewer))
- The *Endress+Hauser Operations app*: Enter the serial number from the nameplate or scan the DataMatrix code on the nameplate.

### 4.2.1 Transmitter nameplate

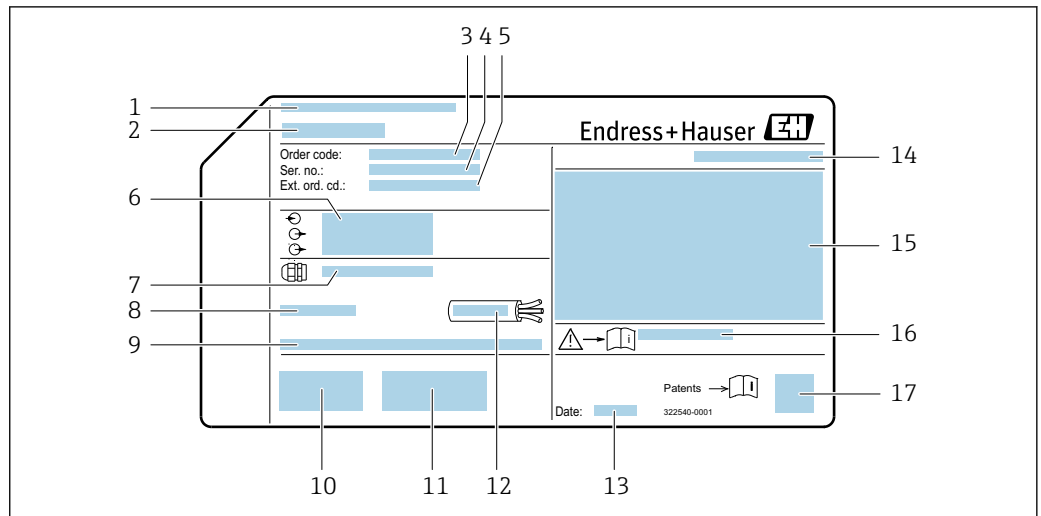

A0032237

2 Example of a transmitter nameplate

- 1 Manufacturer address/certificate holder
- 2 Name of the transmitter
- 3 Order code
- 4 Serial number
- 5 Extended order code
- 6 Electrical connection data, e.g. available inputs and outputs, supply voltage
- 7 Type of cable glands
- 8 Permitted ambient temperature ( $T_a$ )
- 9 Firmware version (FW) from the factory
- 10 CE mark, RCM-Tick mark
- 11 Additional information on version: certificates, approvals
- 12 Permitted temperature range for cable
- 13 Date of manufacture: year-month
- 14 Degree of protection
- 15 Approval information for explosion protection
- 16 Document number of safety-related supplementary documentation → 170
- 17 2-D matrix code

### 4.2.2 Sensor nameplate

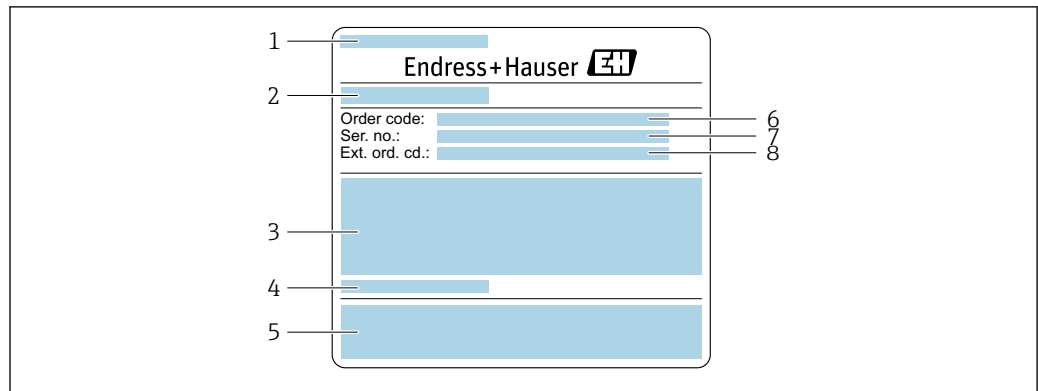

A0029206

3 Example of a sensor nameplate, part 1

- 1 Name of the sensor
- 2 Manufacturer address/certificate holder
- 3 Nominal diameter of the sensor; flange nominal diameter/nominal pressure; sensor test pressure; medium temperature range; material of measuring tube and manifold
- 4 Sensor-specific information
- 5 CE mark, RCM-Tick mark
- 6 Order code
- 7 Serial number (Ser. no.)
- 8 Extended order code (Ext. ord. cd.)

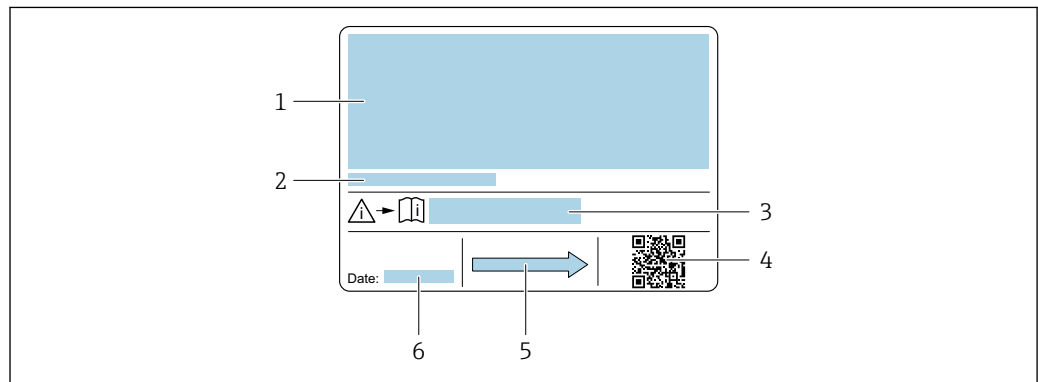

A0029207

4 Example of a sensor nameplate, part 2

- 1 Approval information for explosion protection, Pressure Equipment Directive and degree of protection
- 2 Allowable ambient temperature ( $T_a$ )
- 3 Document number of safety-related supplementary documentation
- 4 2-D matrix code
- 5 Flow direction
- 6 Date of manufacture: year-month

#### **i** Order code



The measuring device is reordered using the order code.

#### Extended order code

- The device type (product root) and basic specifications (mandatory features) are always listed.
- Of the optional specifications (optional features), only the safety and approval-related specifications are listed (e.g. LA). If other optional specifications are also ordered, these are indicated collectively using the # placeholder symbol (e.g. #LA#).
- If the ordered optional specifications do not include any safety and approval-related specifications, they are indicated by the + placeholder symbol (e.g. XXXXXX-ABCDE+).



### 4.2.3 Symbols on the device

Symbol	Meaning
	<b>WARNING!</b> This symbol alerts you to a dangerous situation. Failure to avoid this situation can result in serious or fatal injury. Please consult the documentation for the measuring instrument to discover the type of potential danger and measures to avoid it.
	<b>Reference to documentation</b> Refers to the corresponding device documentation.
	<b>Protective ground connection</b> A terminal that must be connected to the ground prior to establishing any other connections.

## 5 Storage and transport

### 5.1 Storage conditions

Observe the following notes for storage:

- ▶ Store in the original packaging to ensure protection from shock.
- ▶ Do not remove protective covers or protective caps installed on process connections. They prevent mechanical damage to the sealing surfaces and contamination in the measuring tube.
- ▶ Protect from direct sunlight. Avoid unacceptably high surface temperatures.
- ▶ Store in a dry and dust-free place.
- ▶ Do not store outdoors.

Storage temperature → 📄 159

### 5.2 Transporting the product

Transport the measuring device to the measuring point in the original packaging.

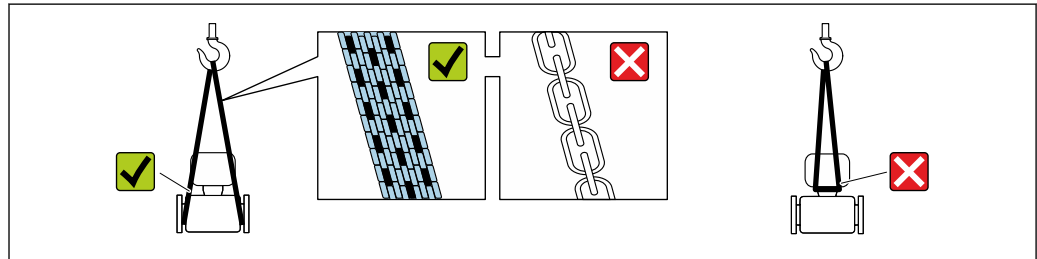

A0029252

- i** Do not remove protective covers or caps installed on process connections. They prevent mechanical damage to the sealing surfaces and contamination in the measuring tube.

#### 5.2.1 Measuring devices without lifting lugs

##### **⚠ WARNING**

**Center of gravity of the measuring device is higher than the suspension points of the webbing slings.**

Risk of injury if the measuring device slips.

- ▶ Secure the measuring device against slipping or turning.
- ▶ Observe the weight specified on the packaging (stick-on label).

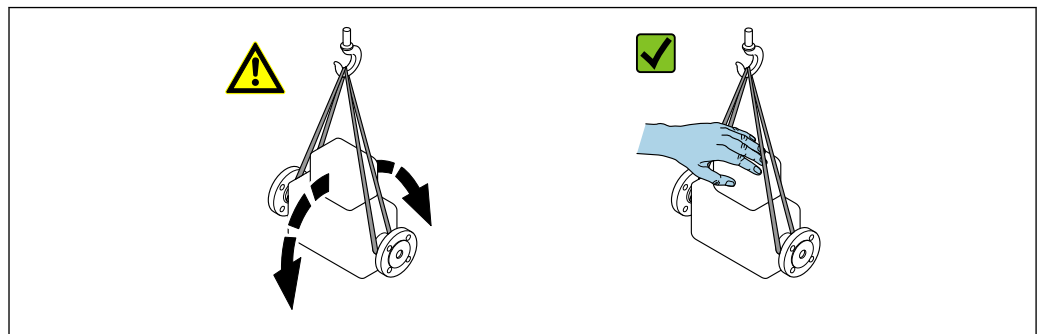

A0029214

## 5.2.2 Measuring devices with lifting lugs

### CAUTION

#### Special transportation instructions for devices with lifting lugs

- ▶ Only use the lifting lugs fitted on the device or flanges to transport the device.
- ▶ The device must always be secured at two lifting lugs at least.

## 5.2.3 Transporting with a fork lift

If transporting in wood crates, the floor structure enables the crates to be lifted lengthwise or at both sides using a forklift.

## 5.3 Packaging disposal

All packaging materials are environmentally friendly and 100% recyclable:

- Outer packaging of device
  - Stretch wrap made of polymer in accordance with EU Directive 2002/95/EC (RoHS)
- Packaging
  - Wood crate treated in accordance with ISPM 15 standard, confirmed by IPPC logo
  - Cardboard box in accordance with European packaging guideline 94/62/EC, recyclability confirmed by Resy symbol
- Transport material and fastening fixtures
  - Disposable plastic pallet
  - Plastic straps
  - Plastic adhesive strips
- Filler material
  - Paper pads

## 6 Installation

### 6.1 Installation requirements

#### 6.1.1 Installation position

##### Installation point

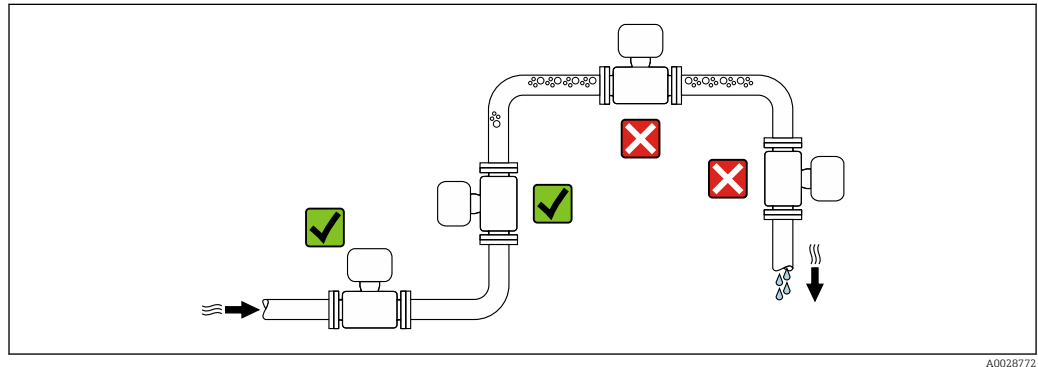

A0028772

To prevent measuring errors arising from accumulation of gas bubbles in the measuring pipe, avoid the following mounting locations in the piping:

- Highest point of a pipeline.
- Directly upstream of a free pipe outlet in a down pipe.

##### Installation in down pipes

However, the following installation suggestion allows for installation in an open vertical pipeline. Pipe restrictions or the use of an orifice with a smaller cross-section than the nominal diameter prevent the sensor running empty while measurement is in progress.

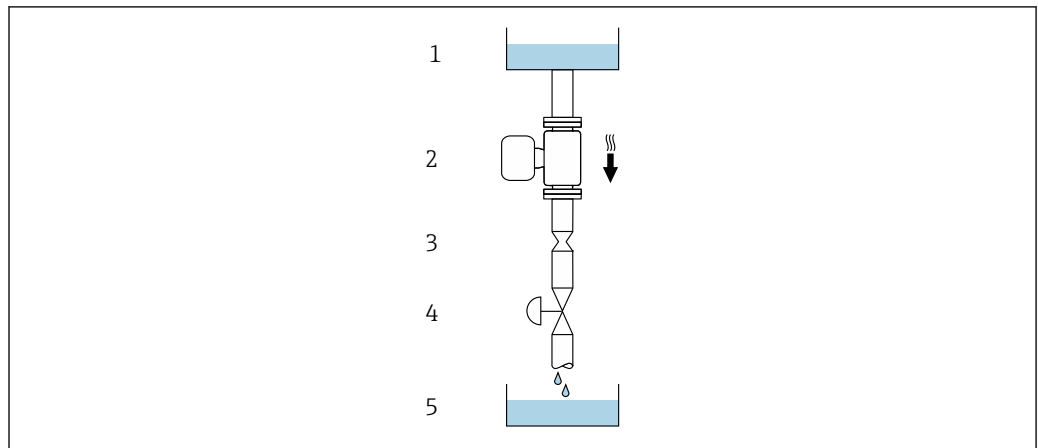

A0028773







 5 Installation in a down pipe (e.g. for batching applications)

- 1 Supply tank
- 2 Sensor
- 3 Orifice plate, pipe restriction
- 4 Valve
- 5 Filling vessel

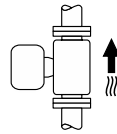
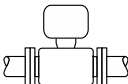
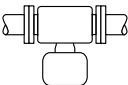
DN		Ø orifice plate, pipe restriction	
[mm]	[in]	[mm]	[in]
8	3/8	6	0.24
15	1/2	10	0.40
25	1	14	0.55
40	1 1/2	22	0.87
50	2	28	1.10

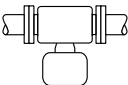
**Orientation**

The direction of the arrow on the sensor nameplate helps you to install the sensor according to the flow direction (direction of medium flow through the piping).

Orientation		Recommendation
<b>A</b>	Vertical orientation	 <input checked="" type="checkbox"/> <input checked="" type="checkbox"/> <sup>1)</sup>
<b>B</b>	Horizontal orientation, transmitter at top	 <input checked="" type="checkbox"/> <input checked="" type="checkbox"/> <sup>2)</sup> Exception: →  6,  21
<b>C</b>	Horizontal orientation, transmitter at bottom	 <input checked="" type="checkbox"/> <input checked="" type="checkbox"/> <sup>3)</sup> Exception: →  6,  21
<b>D</b>	Horizontal orientation, transmitter at side	 <input checked="" type="checkbox"/>

- 1) This orientation is recommended to ensure self-draining.
- 2) Applications with low process temperatures may reduce the ambient temperature. To maintain the minimum ambient temperature for the transmitter, this orientation is recommended.
- 3) Applications with high process temperatures may increase the ambient temperature. To maintain the maximum ambient temperature for the transmitter, this orientation is recommended.

If a sensor is installed horizontally with a curved measuring tube, match the position of the sensor to the fluid properties.

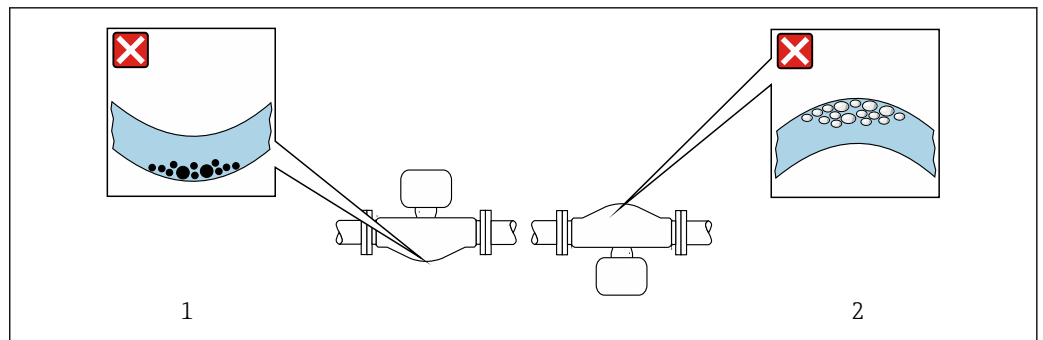

 6 Orientation of sensor with curved measuring tube

- 1 Avoid this orientation for fluids with entrained solids: Risk of solids accumulating
- 2 Avoid this orientation for outgassing fluids: Risk of gas accumulating

**Inlet and outlet runs**

No special precautions need to be taken for fittings that create turbulence, such as valves, elbows or T-pieces, as long as no cavitation occurs → 22.

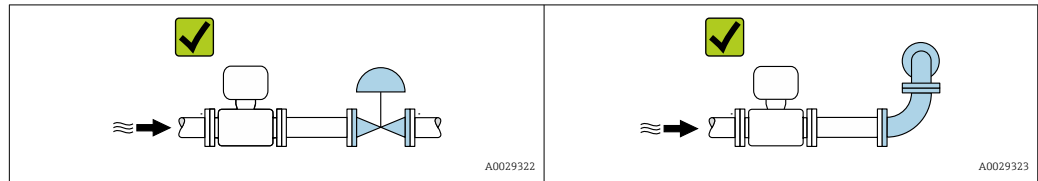

*Installation dimensions*

 For the dimensions and installation lengths of the device, see the "Technical Information" document, "Mechanical construction" section

**6.1.2 Environmental and process requirements**

**Ambient temperature range**

Measuring device	-40 to +60 °C (-40 to +140 °F)
Readability of the local display	-20 to +60 °C (-4 to +140 °F) The readability of the display may be impaired at temperatures outside the temperature range.

- ▶ If operating outdoors:  
Avoid direct sunlight, particularly in warm climatic regions.

**Static pressure**

It is important that cavitation does not occur, or that gases entrained in the liquids do not outgas.

Cavitation is caused if the pressure drops below the vapor pressure:

- In liquids that have a low boiling point (e.g. hydrocarbons, solvents, liquefied gases)
- In suction lines
- ▶ Ensure the static pressure is sufficiently high to prevent cavitation and outgassing.

For this reason, the following mounting locations are recommended:

- At the lowest point in a vertical pipe
- Downstream from pumps (no danger of vacuum)

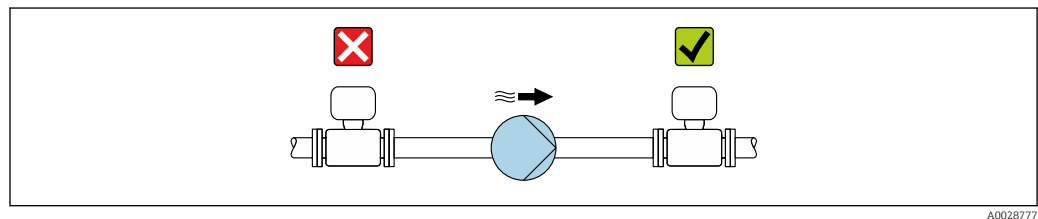

**Thermal insulation**

In the case of some fluids, it is important to keep the heat radiated from the sensor to the transmitter to a low level. A wide range of materials can be used for the required insulation.

**NOTICE****Electronics overheating on account of thermal insulation!**

- ▶ Recommended orientation: horizontal orientation, transmitter housing pointing downwards.
- ▶ Do not insulate the transmitter housing .
- ▶ Maximum permissible temperature at the lower end of the transmitter housing: 80 °C (176 °F)
- ▶ Regarding thermal insulation with an exposed extended neck: We advise against insulating the extended neck to ensure optimal heat dissipation.

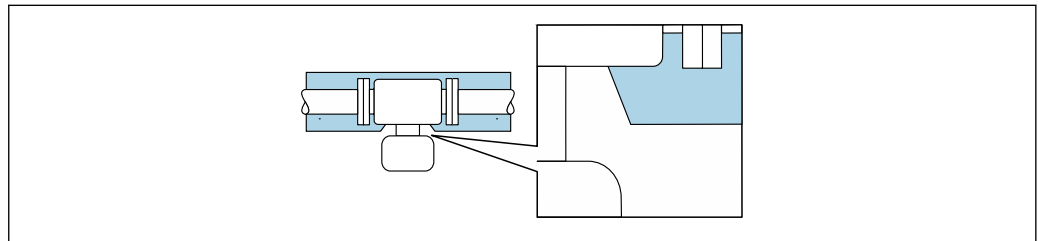

A0034391

 7 Thermal insulation with exposed extended neck

**Heating****NOTICE****Electronics can overheat due to elevated ambient temperature!**

- ▶ Observe maximum permitted ambient temperature for the transmitter.
- ▶ Depending on the medium temperature, take the device orientation requirements into account.

**NOTICE****Danger of overheating when heating**

- ▶ Ensure that the temperature at the lower end of the transmitter housing does not exceed 80 °C (176 °F).
- ▶ Ensure that sufficient convection takes place at the transmitter neck.
- ▶ Ensure that a sufficiently large area of the transmitter neck remains exposed. The uncovered part serves as a radiator and protects the electronics from overheating and excessive cooling.
- ▶ When using in potentially explosive atmospheres, observe the information in the device-specific Ex documentation. For detailed information on the temperature tables, see the separate document entitled "Safety Instructions" (XA) for the device.
- ▶ Consider the "830 ambient temperature too high" and "832 electronics temperature too high" process diagnostics if overheating cannot be ruled out based on a suitable system design.

*Heating options*

If a fluid requires that no heat loss should occur at the sensor, users can avail of the following heating options:

- Electrical heating, e.g. with electric band heaters <sup>2)</sup>
- Via pipes carrying hot water or steam
- Via heating jackets

**Vibrations**

The high oscillation frequency of the measuring tubes ensures that the correct operation of the measuring system is not influenced by plant vibrations.

2) The use of parallel electric band heaters is generally recommended (bidirectional electricity flow). Particular considerations must be made if a single-wire heating cable is to be used. For additional information, refer to EA01339D "Installation Instructions for Electrical Trace Heating Systems".

### 6.1.3 Special installation instructions

#### Drainability

When installed vertically, the measuring tubes can be drained completely and protected against buildup.

#### Hygienic compatibility

**i** When installing in hygienic applications, please refer to the information in the "Certificates and approvals/hygienic compatibility" section →  167

#### Rupture disk

Process-related information: →  161.

#### **WARNING**

#### **Danger from medium escaping!**

Medium escaping under pressure can cause injury or material damage.

- ▶ Take precautions to prevent danger to persons and damage if the rupture disk is actuated.
- ▶ Observe the information on the rupture disk sticker.
- ▶ Make sure that the function and operation of the rupture disk is not impeded through the installation of the device.
- ▶ Do not use a heating jacket.
- ▶ Do not remove or damage the rupture disk.
  
- ▶ After the rupture disk is actuated, do not operate the measuring device any more.

The position of the rupture disk is indicated on a sticker applied over it. If the rupture disk is triggered, the sticker is destroyed. The disk can therefore be visually monitored.

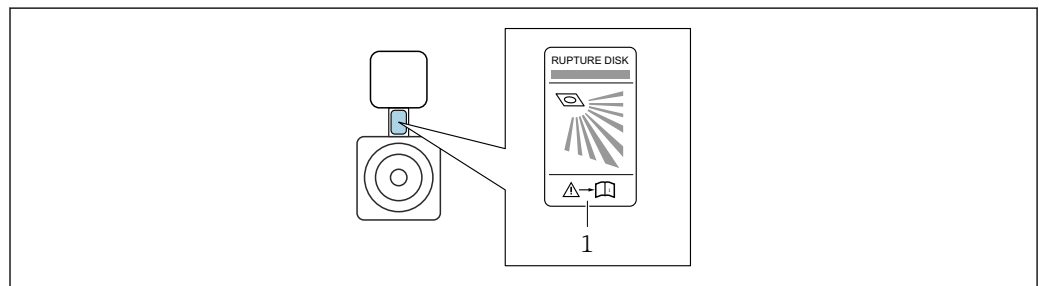

A0032051

1 Rupture disk label

#### Zero verification and zero adjustment

All measuring instruments are calibrated in accordance with state-of-the-art technology. Calibration takes place under reference conditions →  155. Therefore, a zero adjustment in the field is generally not required.

Experience shows that zero adjustment is advisable only in special cases:

- To achieve maximum measurement accuracy even with low flow rates.
- Under extreme process or operating conditions (e.g. very high process temperatures or very high-viscosity fluids).
- For gas applications with low pressure

**i** To achieve the highest possible measurement accuracy at low flow rates, the installation must protect the sensor from mechanical stresses during operation.

To get a representative zero point, ensure that:

- any flow in the device is prevented during the adjustment
- the process conditions (e.g. pressure, temperature) are stable and representative



Verification and adjustment cannot be carried out if the following process conditions are present:

- Gas pockets  
Ensure that the system has been sufficiently flushed with the medium. Repeat flushing can help to eliminate gas pockets
- Thermal circulation  
In the event of temperature differences (e.g. between the measuring tube inlet and outlet section), induced flow can occur even if the valves are closed due to thermal circulation in the device
- Leaks at the valves  
If the valves are not leak-tight, flow is not sufficiently prevented when determining the zero point

If these conditions cannot be avoided, it is advisable to keep the factory setting for the zero point.

## 6.2 Installing the measuring instrument

### 6.2.1 Required tools

**For transmitter**

- For turning the transmitter housing: Open-ended wrench 8 mm
- For opening the securing clamps: Allen key 3 mm

**For sensor**

For flanges and other process connections: Use a suitable mounting tool.

### 6.2.2 Preparing the measuring instrument

1. Remove all remaining transport packaging.
2. Remove any protective covers or protective caps present from the sensor.
3. If present, remove transport protection of the rupture disk.
4. Remove stick-on label on the electronics compartment cover.

### 6.2.3 Mounting the measuring device

#### **WARNING**

**Danger due to improper process sealing!**

- ▶ Ensure that the inside diameters of the gaskets are greater than or equal to that of the process connections and piping.
- ▶ Ensure that the seals are clean and undamaged.
- ▶ Secure the seals correctly.

1. Ensure that the direction of the arrow on the nameplate of the sensor matches the flow direction of the medium.

2. Install the measuring device or turn the transmitter housing so that the cable entries do not point upwards.

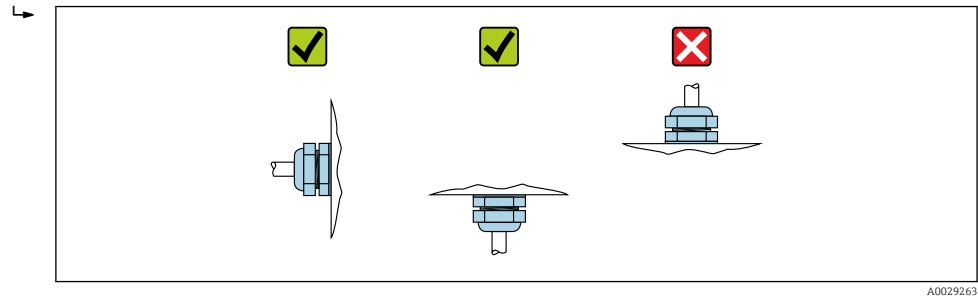

A0029263

### 6.2.4 Turning the transmitter housing

To provide easier access to the connection compartment or display module, the transmitter housing can be turned.

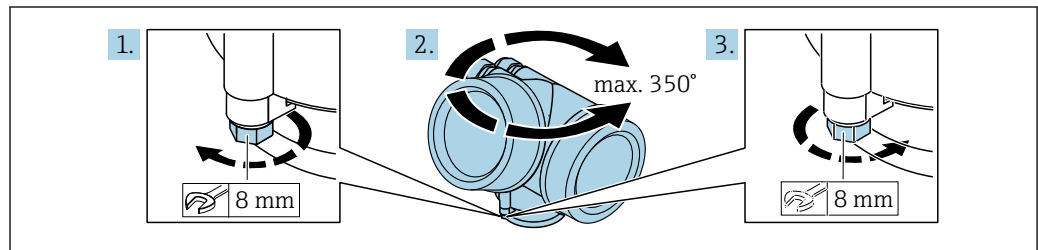

A0032242

1. Loosen the securing screw.
2. Turn the housing to the desired position.
3. Firmly tighten the securing screw.

### 6.2.5 Turning the display module

The display module can be turned to optimize display readability and operability.

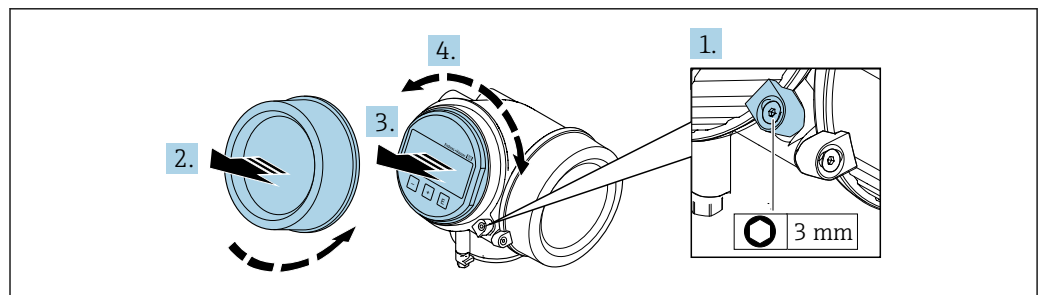

A0032238

1. Loosen the securing clamp of the electronics compartment cover using an Allen key.
2. Unscrew cover of the electronics compartment from the transmitter housing.
3. Optional: pull out the display module with a gentle rotational movement.
4. Turn the display module to the desired position: Max.  $8 \times 45^\circ$  in each direction.
5. Without display module pulled out:  
Allow display module to engage at desired position.
6. With display module pulled out:  
Feed the cable into the gap between the housing and main electronics module and plug the display module into the electronics compartment until it engages.
7. Reassemble the transmitter in the reverse order.

### 6.3 Post-installation check

Is the device undamaged (visual inspection)?	<input type="checkbox"/>
Does the measuring instrument correspond to the measuring point specifications? For example: <ul style="list-style-type: none"> <li>▪ Process temperature → 160</li> <li>▪ Pressure (refer to the "Pressure-temperature ratings" section of the "Technical Information" document).</li> <li>▪ Ambient temperature → 159</li> <li>▪ Measuring range</li> </ul>	<input type="checkbox"/>
Has the correct orientation for the sensor been selected → 21? <ul style="list-style-type: none"> <li>▪ According to sensor type</li> <li>▪ According to medium temperature</li> <li>▪ According to medium properties (outgassing, with entrained solids)</li> </ul>	<input type="checkbox"/>
Does the arrow on the sensor match the direction of flow of the medium? → 21?	<input type="checkbox"/>
Is the tag name and labeling correct (visual inspection)?	<input type="checkbox"/>
Is the device sufficiently protected from precipitation and direct sunlight?	<input type="checkbox"/>
Are the securing screw and securing clamp tightened securely?	<input type="checkbox"/>

## 7 Electrical connection

### 7.1 Electrical safety

In accordance with applicable national regulations.

### 7.2 Connecting requirements

#### 7.2.1 Required tools

- For cable entries: Use corresponding tools
- For securing clamp: Allen key 3 mm
- Wire stripper
- When using stranded cables: Crimper for wire end ferrule
- For removing cables from terminal: Flat blade screwdriver  $\leq 3$  mm (0.12 in)

#### 7.2.2 Requirements for connecting cable

The connecting cables provided by the customer must fulfill the following requirements.

##### Permitted temperature range

- The installation guidelines that apply in the country of installation must be observed.
- The cables must be suitable for the minimum and maximum temperatures to be expected.

##### Signal cable

-  For custody transfer, all signal lines must be shielded cables (tinned copper braiding, optical coverage  $\geq 85\%$ ). The cable shield must be connected on both sides.

##### *Pulse/frequency/switch output*

Standard installation cable is sufficient.

##### *FOUNDATION Fieldbus*

Twisted, shielded two-wire cable.

-  For further information on planning and installing FOUNDATION Fieldbus networks see:

- Operating Instructions for "FOUNDATION Fieldbus Overview" (BA00013S)
- FOUNDATION Fieldbus Guideline
- IEC 61158-2 (MBP)

##### *Ethernet-APL*

Shielded twisted-pair cable. Cable type A is recommended.

-  See <https://www.profibus.com> Ethernet-APL White Paper "

##### Cable diameter

- Cable glands supplied:
  - M20  $\times$  1.5 with cable  $\phi$  6 to 12 mm (0.24 to 0.47 in)
- Plug-in spring terminals for device version without integrated overvoltage protection:
  - wire cross-sections 0.5 to 2.5 mm<sup>2</sup> (20 to 14 AWG)

### 7.2.3 Terminal assignment

#### Transmitter

Connection version for FOUNDATION Fieldbus, pulse/frequency/switch output

<small>A0013570</small>	<small>A0018161</small>
Maximum number of terminals	Maximum number of terminals for order code for "Accessory mounted", option NA "Overvoltage protection"
<p>1 Output 1: FOUNDATION Fieldbus                  2 Output 2 (passive): pulse/frequency/switch output                  3 Ground terminal for cable shield</p>	

Order code for "Output"	Terminal numbers			
	Output 1		Output 2	
	1 (+)	2 (-)	3 (+)	4 (-)
Option E <sup>1) 2)</sup>	FOUNDATION Fieldbus		Pulse/frequency/switch output (passive)	

- 1) Output 1 must always be used; output 2 is optional.
- 2) FOUNDATION Fieldbus with integrated reverse polarity protection.

### 7.2.4 device plug pin assignment

	Pin	Assignment	Coding	Plug/socket
1	+	Signal +	A	Plug
2	-	Signal -		
3		Grounding		
4		Not assigned		

### 7.2.5 Shielding and grounding

Optimal electromagnetic compatibility (EMC) of the fieldbus system can be guaranteed only if the system components and, in particular, the lines are shielded and the shield forms as complete a cover as possible. A shield coverage of 90 % is ideal.

1. To ensure optimal EMC protection, connect the shield to the reference ground as often as possible.
2. For reasons concerning explosion protection, it is recommended that grounding be dispensed with.

To comply with both requirements, there are basically three different types of shielding in the fieldbus system:

- Shielding at both ends
- Shielding at one end on the feed side with capacitance termination at the field device
- Shielding at one end on the feed side

Experience shows that the best results with regard to EMC are achieved in most cases in installations with one-sided shielding on the feed side (without capacitance termination at the field device). Appropriate measures with regard to input wiring must be taken to allow unrestricted operation when EMC interference is present. These measures have been taken into account for this device. Operation in the event of disturbance variables as per NAMUR NE21 is thus guaranteed.

1. Observe national installation requirements and guidelines during installation.
2. Where there are large differences in potential between the individual grounding points, connect only one point of the shielding directly to the reference ground.
3. In systems without potential equalization, the cable shielding of fieldbus systems should be grounded on one side only, for example at the fieldbus supply unit or at safety barriers.

#### NOTICE

**In systems without potential matching, the multiple grounding of the cable shield causes mains frequency equalizing currents!**

Damage to the bus cable shield.

- ▶ Only ground the bus cable shield to either the local ground or the protective ground at one end.
- ▶ Insulate the shield that is not connected.

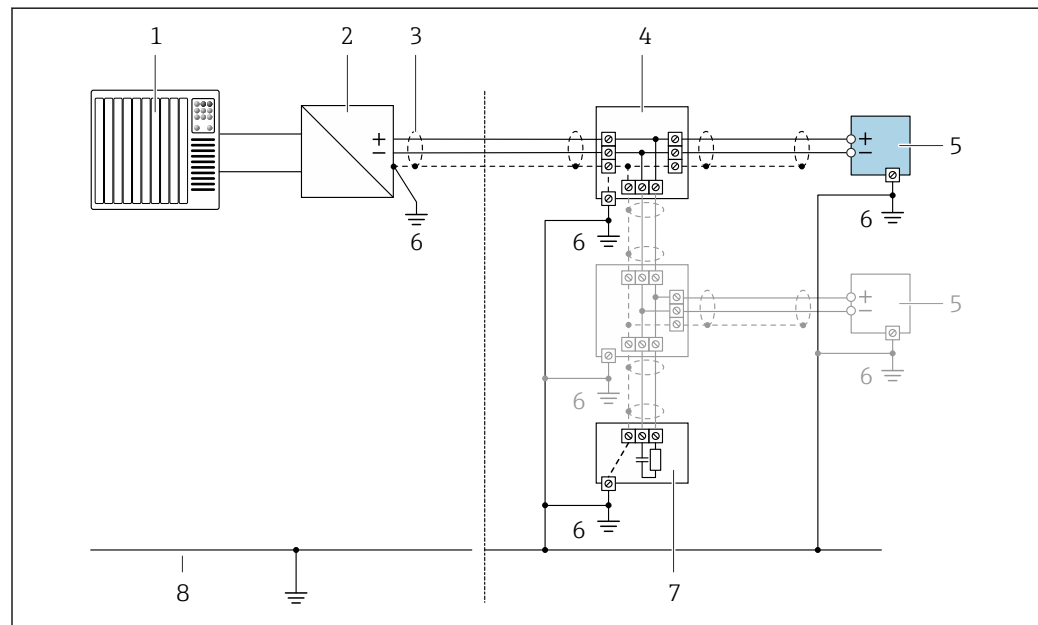

8 Connection example for FOUNDATION Fieldbus

- 1 Control system (e.g. PLC)
- 2 Power conditioner (FOUNDATION Fieldbus)
- 3 Cable shield: the cable shield must be grounded at both ends to comply with EMC requirements; observe cable specifications
- 4 T-box
- 5 Measuring device
- 6 Local grounding
- 7 Bus terminator
- 8 Potential equalization conductor

## 7.2.6 Requirements for the supply unit

### Supply voltage

#### Transmitter

An external power supply is required for each output.

The following supply voltage values apply for the outputs available:

Order code for "Output"	Minimum terminal voltage	Maximum terminal voltage
Option <b>E</b> <sup>1)</sup> : FOUNDATION Fieldbus, pulse/frequency/switch output	≥ DC 9 V	DC 32 V

1) For device version with SD03 local display: The terminal voltage must be increased by DC 0.5 V if backlighting is used.

## 7.2.7 Preparing the measuring device

### NOTICE

#### Insufficient sealing of the housing!

Operational reliability of the measuring device could be compromised.

► Use suitable cable glands corresponding to the degree of protection.

1. Remove dummy plug if present.
2. If the measuring device is supplied without cable glands:  
Provide suitable cable gland for corresponding connecting cable.
3. If the measuring device is supplied with cable glands:  
Observe requirements for connecting cables →  28.

## 7.3 Connecting the measuring instrument

### NOTICE

#### An incorrect connection compromises electrical safety!

- Only properly trained specialist staff may perform electrical connection work.
- Observe applicable federal/national installation codes and regulations.
- Comply with local workplace safety regulations.
- Always connect the protective ground cable  before connecting additional cables.
- When using in potentially explosive atmospheres, observe the information in the device-specific Ex documentation.

### 7.3.1 Connecting the transmitter

### Connection via terminals

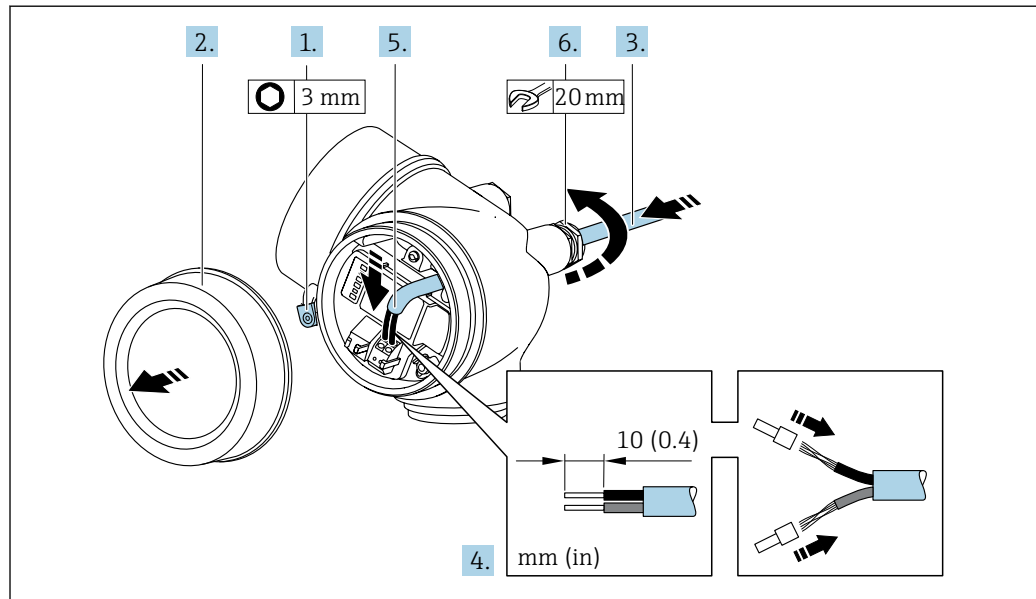

A0048825

1. Loosen the securing clamp of the connection compartment cover.
2. Unscrew the connection compartment cover.
3. Push the cable through the cable entry . To ensure tight sealing, do not remove the sealing ring from the cable entry.
4. Strip the cable and cable ends. In the case of stranded cables, also fit ferrules.
5. Connect cable in accordance with terminal assignment → 29.

6. **⚠ WARNING**

**Housing degree of protection may be voided due to insufficient sealing of the housing.**

- ▶ Screw in the screw without using any lubricant. The threads on the cover are coated with a dry lubricant.

Firmly tighten the cable glands.

7. Reassemble the transmitter in the reverse order.

### Removing a cable

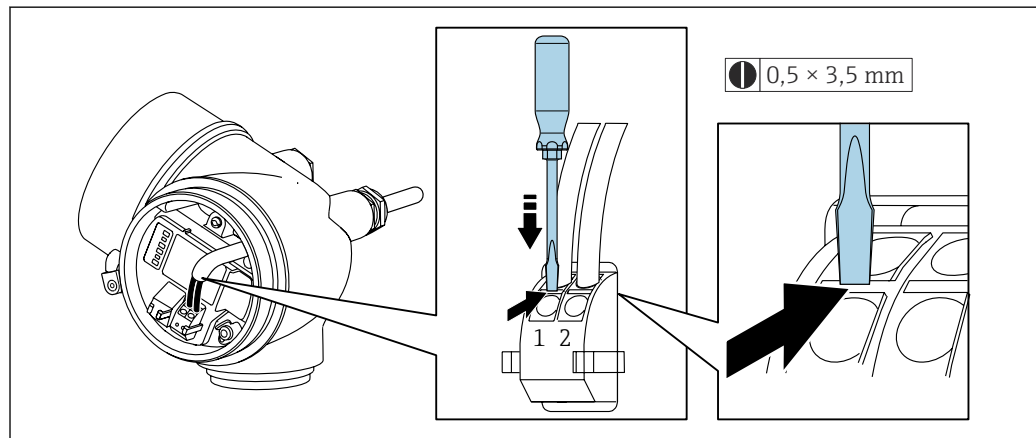

A0048822



- ▶ To remove a cable from the terminal, use a flat-blade screwdriver to push the slot between the two terminal holes while simultaneously pulling the cable end out of the terminal.

### 7.3.2 Potential equalization

#### Requirements

No special measures for potential equalization are required.

#### Connection example, standard scenario

#### Connection example in special situations

## 7.4 Special connection instructions

### 7.4.1 Connection examples

#### Pulse/frequency output

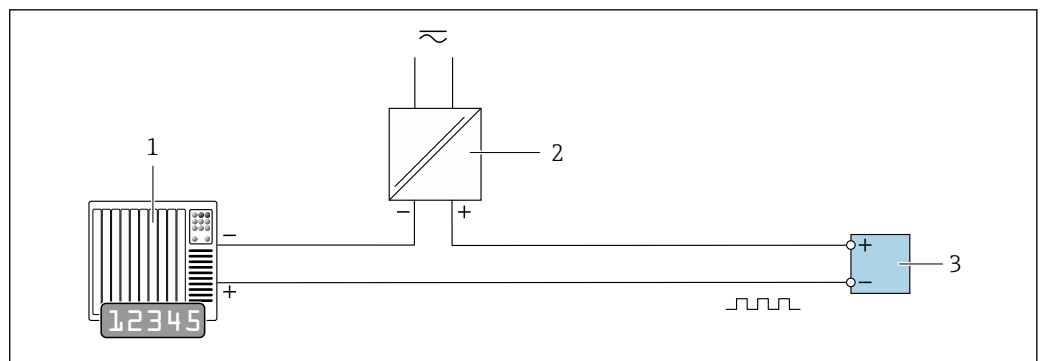

9 Connection example for pulse/frequency output (passive)

- 1 Automation system with pulse/frequency input (e.g. PLC with 10 k $\Omega$  pull-up or pull-down resistor)
- 2 Power supply
- 3 Transmitter: observe input values

#### Switch output

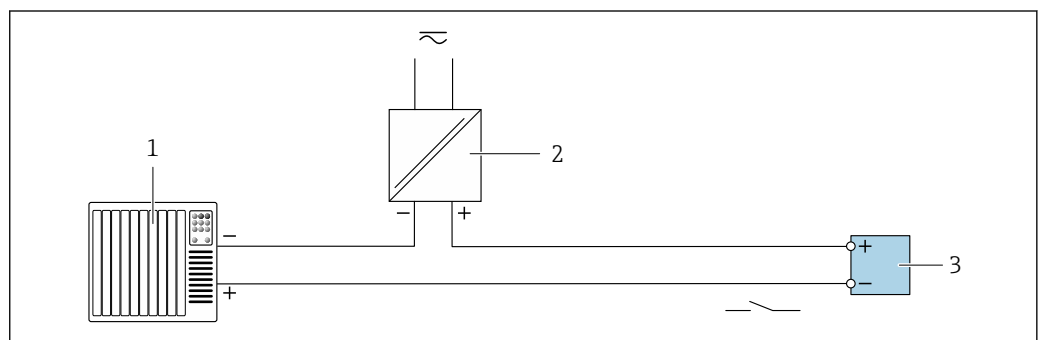

10 Connection example for switch output (passive)

- 1 Automation system with switch input (e.g. PLC with a 10 k $\Omega$  pull-up or pull-down resistor)
- 2 Power supply
- 3 Transmitter: observe input values

## FOUNDATION Fieldbus

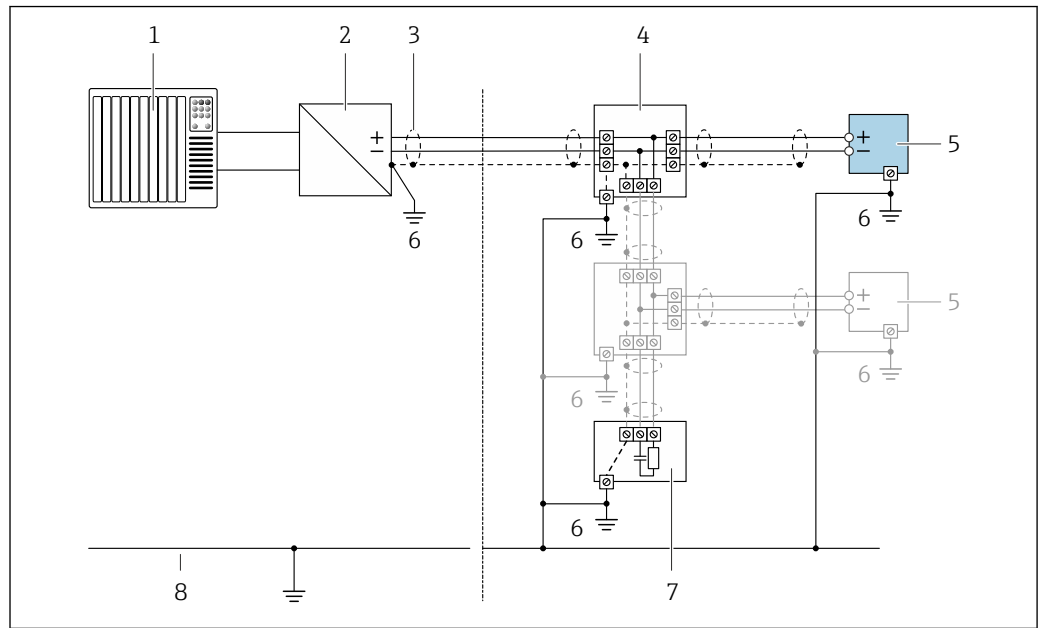

11 Connection example for FOUNDATION Fieldbus

- 1 Control system (e.g. PLC)
- 2 Power Conditioner (FOUNDATION Fieldbus)
- 3 Cable shield provided at one end. The cable shield must be grounded at both ends to comply with EMC requirements; observe cable specifications
- 4 T-box
- 5 Measuring device
- 6 Local grounding
- 7 Bus terminator
- 8 Potential matching line

## 7.5 Ensuring the degree of protection

The measuring instrument fulfills all the requirements for the degree of protection IP66/67, Type 4X enclosure.



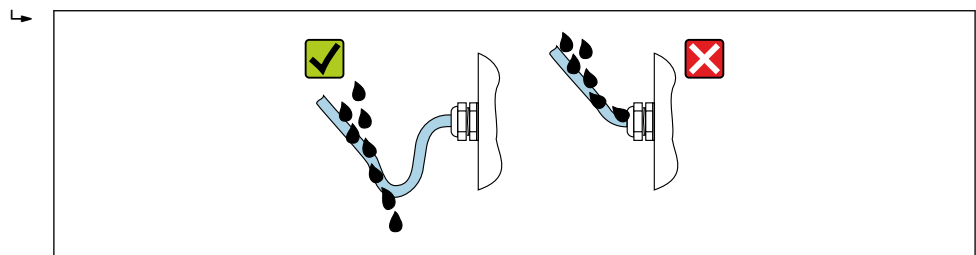

To guarantee the degree of protection IP66/67, Type 4X enclosure, carry out the following steps after the electrical connection:

1. Check that the housing seals are clean and fitted correctly.
2. Dry, clean or replace the seals if necessary.
3. Tighten all housing screws and screw covers.
4. Firmly tighten the cable glands.
5. To ensure that moisture does not enter the cable entry:  
Route the cable so that it loops down before the cable entry ("water trap").



6. The cable glands supplied do not ensure housing protection when not in use. They must therefore be replaced by dummy plugs corresponding to the housing protection.

## 7.6 Post-connection check

Are the device and cable undamaged (visual inspection)?	<input type="checkbox"/>
Do the cables used comply with the requirements →  28?	<input type="checkbox"/>
Are the installed cables strain-relieved and securely routed?	<input type="checkbox"/>
Are all cable glands installed, securely tightened and leak-tight? Cable run with "water trap" →  34?	<input type="checkbox"/>
Depending on the device version: Are all connectors securely tightened →  31?	<input type="checkbox"/>
Does the supply voltage match the specifications on the transmitter nameplate →  31?	<input type="checkbox"/>
Is the terminal assignment correct ?	<input type="checkbox"/>
If supply voltage is present: Does an indication appear on the display module?	<input type="checkbox"/>
Are all housing covers installed and securely tightened?	<input type="checkbox"/>
Is the securing clamp securely tightened?	<input type="checkbox"/>

## 8 Operation options

### 8.1 Overview of operation options

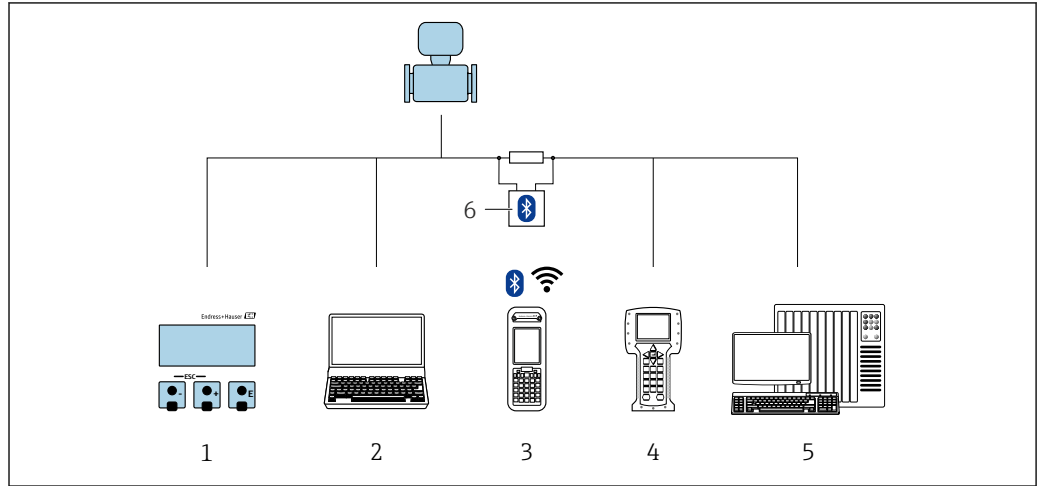

A0032226

- 1 Local operation via display module
- 2 Computer with operating tool (e.g., FieldCare, DeviceCare, AMS Device Manager, SIMATIC PDM)
- 3 Field Xpert SFX350 or SFX370
- 4 Field Communicator 475
- 5 Automation system (e.g. PLC)
- 6 VIATOR Bluetooth modem with connecting cable

## 8.2 Structure and function of the operating menu

### 8.2.1 Structure of the operating menu

 For an overview of the operating menu for experts: see the "Description of Device Parameters" document supplied with the device



 12 Schematic structure of the operating menu

A0018237-EN

### 8.2.2 Operating philosophy

The individual parts of the operating menu are assigned to certain user roles (e.g. operator, maintenance etc.). Each user role contains typical tasks within the device life cycle.

Menu/parameter		User role and tasks	Content/meaning
Language	Task-oriented	<b>Role "Operator", "Maintenance"</b> Tasks during operation: <ul style="list-style-type: none"> <li>▪ Configuration of the operational display</li> <li>▪ Reading measured values</li> </ul>	<ul style="list-style-type: none"> <li>▪ Defining the operating language</li> <li>▪ Resetting and controlling totalizers</li> </ul>
Operation			<ul style="list-style-type: none"> <li>▪ Configuration of the operational display (e.g. display format, display contrast)</li> <li>▪ Resetting and controlling totalizers</li> </ul>
Setup		<b>"Maintenance" role</b> Commissioning: <ul style="list-style-type: none"> <li>▪ Configuration of the measurement</li> <li>▪ Configuration of the inputs and outputs</li> </ul>	Wizards for fast commissioning: <ul style="list-style-type: none"> <li>▪ Configuring the system units</li> <li>▪ Definition of the medium</li> <li>▪ Configuring the outputs</li> <li>▪ Configuration of the operational display</li> <li>▪ Definition of output conditioning</li> <li>▪ Configuring the low flow cut off</li> <li>▪ Configuring partial and empty pipe detection</li> </ul> Advanced setup <ul style="list-style-type: none"> <li>▪ For more customized configuration of the measurement (adaptation to special measuring conditions)</li> <li>▪ Configuration of totalizers</li> <li>▪ Administration (define access code, reset measuring device)</li> </ul>
Diagnostics		<b>"Maintenance" role</b> Troubleshooting: <ul style="list-style-type: none"> <li>▪ Diagnostics and elimination of process and device errors</li> <li>▪ Measured value simulation</li> </ul>	Contains all parameters for error detection and analyzing process and device errors: <ul style="list-style-type: none"> <li>▪ Diagnostic list Contains up to 5 currently pending diagnostic messages.</li> <li>▪ Event logbook Contains event messages that have occurred.</li> <li>▪ Device information Contains information for identifying the device</li> <li>▪ Measured values Contains all current measured values.</li> <li>▪ <b>Data logging</b> submenu with the "Extended HistoROM" order option Storage and visualization of measured values</li> <li>▪ Heartbeat Technology Verification of device functionality on request and documentation of verification results</li> <li>▪ Simulation Used to simulate measured values or output values.</li> </ul>
Expert	Function-oriented	Tasks that require detailed knowledge of the function of the device: <ul style="list-style-type: none"> <li>▪ Commissioning measurements under difficult conditions</li> <li>▪ Optimal adaptation of the measurement to difficult conditions</li> <li>▪ Detailed configuration of the communication interface</li> <li>▪ Error diagnostics in difficult cases</li> </ul>	Contains all of the device parameters and allows direct access to these by means of an access code. The structure of this menu is based on the function blocks of the device: <ul style="list-style-type: none"> <li>▪ System Contains all higher-level device parameters that do not affect measurement or measured value communication</li> <li>▪ Sensor Configuration of the measurement.</li> <li>▪ Output Configuration of the pulse/frequency/switch output</li> <li>▪ Communication Configuration of the digital communication interface</li> <li>▪ Submenus for function blocks (e.g. "Analog Inputs") Configuration of function blocks</li> <li>▪ Application Configuration of the functions that go beyond the actual measurement (e.g. totalizer)</li> <li>▪ Diagnostics Error detection and analysis of process and device errors and for device simulation and Heartbeat Technology.</li> </ul>

## 8.3 Access to operating menu via local display

### 8.3.1 Operational display

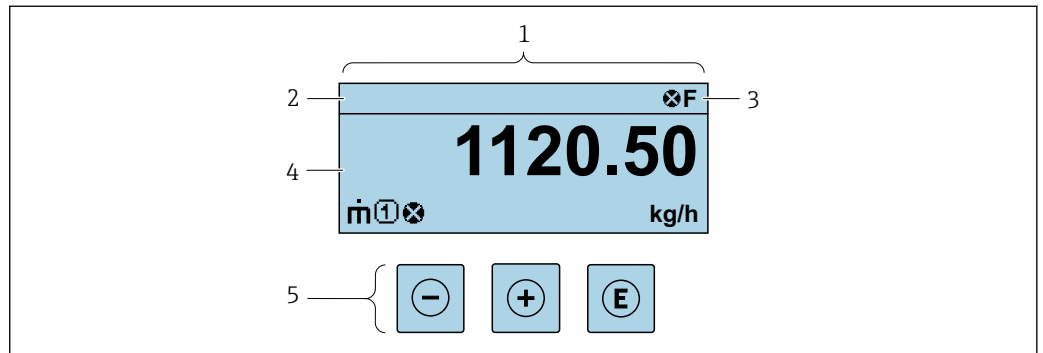

A0029348

- 1 Operational display
- 2 Device tag
- 3 Status area
- 4 Display range for measured values (up to 4 lines)
- 5 Operating elements → 44

#### Status area

The following symbols appear in the status area of the operational display at the top right:

- Status signals → 107
  - **F**: Failure
  - **C**: Function check
  - **S**: Out of specification
  - **M**: Maintenance required
- Diagnostic behavior → 108
  - : Alarm
  - : Warning
- : Locking (the device is locked via the hardware )
- : Communication (communication via remote operation is active)

#### Display area



In the display area, each measured value is prefaced by certain symbol types for further description:

#### Measured variables



Symbol	Meaning
	Mass flow
	<ul style="list-style-type: none"> <li>▪ Volume flow</li> <li>▪ Corrected volume flow</li> </ul>
	<ul style="list-style-type: none"> <li>▪ Density</li> <li>▪ Reference density</li> </ul>
	Temperature

- The number and display format of the measured variables can be configured via the **Format display** parameter (→ 68).



*Totalizer*

Symbol	Meaning
	Totalizer  The measurement channel number indicates which of the three totalizers is displayed.

*Measurement channel numbers*

Symbol	Meaning
	Measurement channel 1 to 4  The measurement channel number is displayed only if more than one channel is present for the same measured variable type (e.g. totalizer 1 to 3).

*Diagnostic behavior*

Symbol	Meaning
	<b>Alarm</b> <ul style="list-style-type: none"> <li>▪ Measurement is interrupted.</li> <li>▪ Signal outputs and totalizers assume the defined alarm condition.</li> <li>▪ A diagnostic message is generated.</li> <li>▪ For local display with touch control: the background lighting changes to red.</li> </ul>
	<b>Warning</b> <ul style="list-style-type: none"> <li>▪ Measurement is resumed.</li> <li>▪ The signal outputs and totalizers are not affected.</li> <li>▪ A diagnostic message is generated.</li> </ul>

 The diagnostic behavior pertains to a diagnostic event that is relevant to the displayed measured variable.



### 8.3.2 Navigation view

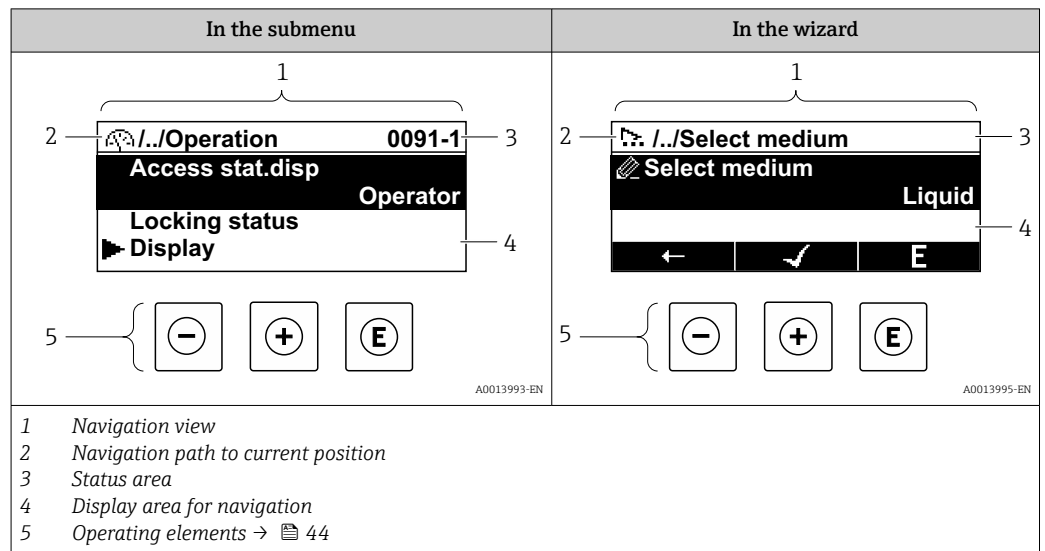

#### Navigation path

The navigation path to the current position is displayed at the top left in the navigation view and consists of the following elements:

- The display symbol for the menu/submenu (▶) or the wizard (⚙).
- An omission symbol (/ ../) for operating menu levels in between.
- Name of the current submenu, wizard or parameter

	Display symbol	Omission symbol	Parameter
	↓	↓	↓
Example	▶	/ ../	Indication

For more information about the icons in the menu, refer to the "Display area" section → 41

#### Status area

The following appears in the status area of the navigation view in the top right corner:



- In the submenu
  - The direct access code to the parameter (e.g., 0022-1)
  - If a diagnostic event is present, the diagnostic behavior and status signal
- In the wizard
  - If a diagnostic event is present, the diagnostic behavior and status signal

- For information on the diagnostic behavior and status signal → 107
- For information on the function and entry of the direct access code → 46





#### Display area

##### Menus

Symbol	Meaning
	<p><b>Operation</b>                      Is displayed:</p> <ul style="list-style-type: none"> <li>▪ In the menu next to the "Operation" selection</li> <li>▪ At the left in the navigation path in the <b>Operation</b> menu</li> </ul>

	<p><b>Setup</b> Is displayed:</p> <ul style="list-style-type: none"> <li>▪ In the menu next to the "Setup" selection</li> <li>▪ At the left in the navigation path in the <b>Setup</b> menu</li> </ul>
	<p><b>Diagnosis</b> Is displayed:</p> <ul style="list-style-type: none"> <li>▪ In the menu next to the "Diagnostics" selection</li> <li>▪ At the left in the navigation path in the <b>Diagnostics</b> menu</li> </ul>
	<p><b>Expert</b> Is displayed:</p> <ul style="list-style-type: none"> <li>▪ In the menu next to the "Expert" selection</li> <li>▪ At the left in the navigation path in the <b>Expert</b> menu</li> </ul>



*Submenus, wizards, parameters*

Symbol	Meaning
	Submenu
	Wizards
	Parameters within a wizard
	No display symbol exists for parameters in submenus.

*Locking procedure*

Symbol	Meaning
	<p><b>Parameter locked</b> When displayed in front of a parameter name, indicates that the parameter is locked.</p> <ul style="list-style-type: none"> <li>▪ By a user-specific access code</li> <li>▪ By the hardware write protection switch</li> </ul>

*Wizards*

Symbol	Meaning
	Switches to the previous parameter.
	Confirms the parameter value and switches to the next parameter.
	Opens the editing view of the parameter.



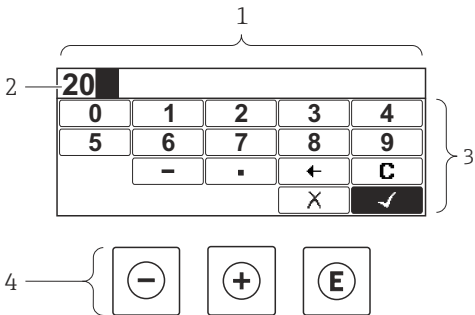
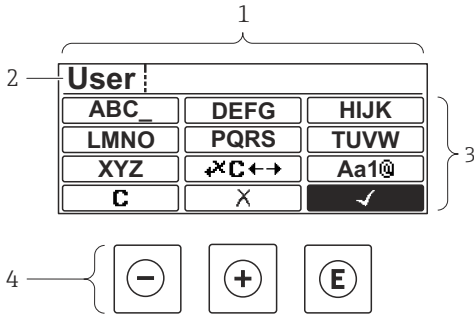



**8.3.3 Editing view**

Numeric editor	Text editor
	
<p>1 Editing view 2 Display area of the entered values 3 Input mask 4 Operating elements → 44</p>	<p>1 Editing view 2 Display area of the entered values 3 Input mask 4 Operating elements → 44</p>

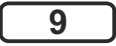



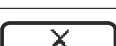



**Input screen**

The following input symbols are available in the input mask of the numeric and text editor:

*Numeric editor*

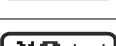
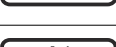
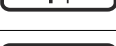

Symbol	Meaning
 ... 	Selection of numbers from 0 to 9
	Inserts a decimal separator at the cursor position.
	Inserts a minus sign at the cursor position.
	Confirms the selection.
	Moves the input position one position to the left.
	Exits the input without applying the changes.
	Clears all entered characters.

*Text editor*







Symbol	Meaning
	Toggle <ul style="list-style-type: none"> <li>▪ Between upper-case and lower-case letters</li> <li>▪ For entering numbers</li> <li>▪ For entering special characters</li> </ul>
 ... 	Selection of letters from A to Z.
 ... 	Selection of letters from a to z.
 ... 	Selection of special characters.
	Confirms the selection.
	Switches to the selection of the correction tools.
	Exits the input without applying the changes.
	Clears all entered characters.

*Text correction under *

Symbol	Meaning
	Clears all entered characters.

	Moves the input position one position to the right.
	Moves the input position one position to the left.
	Deletes one character immediately to the left of the input position.

### 8.3.4 Operating elements

Operating key	Meaning
	<p><b>Minus key</b></p> <p><i>In menu, submenu</i> Moves the selection bar upwards in a picklist</p> <p><i>In wizards</i> Goes to previous parameter</p> <p><i>In the text and numeric editor</i> In the input screen, moves the selection bar to the left (backwards)</p>
	<p><b>Plus key</b></p> <p><i>In menu, submenu</i> Moves the selection bar downwards in a picklist</p> <p><i>In wizards</i> Goes to the next parameter</p> <p><i>In the text and numeric editor</i> In the input screen, moves the selection bar to the right (forwards)</p>
	<p><b>Enter key</b></p> <p><i>In the operational display</i> Pressing the key for 2 s opens the context menu.</p> <p><i>In menu, submenu</i></p> <ul style="list-style-type: none"> <li>▪ Pressing the key briefly: <ul style="list-style-type: none"> <li>▪ Opens the selected menu, submenu or parameter.</li> <li>▪ Starts the wizard.</li> <li>▪ If help text is open, closes the help text of the parameter.</li> </ul> </li> <li>▪ Pressing the key for 2 s in a parameter: <ul style="list-style-type: none"> <li>▪ If present, opens the help text for the function of the parameter.</li> </ul> </li> </ul> <p><i>In wizards</i> Opens the editing view of the parameter and confirms the parameter value</p> <p><i>In the text and numeric editor</i></p> <ul style="list-style-type: none"> <li>▪ Pressing the key briefly: <ul style="list-style-type: none"> <li>▪ Opens the selected group.</li> <li>▪ Carries out the selected action.</li> </ul> </li> <li>▪ Pressing the key for 2 s confirms the edited parameter value.</li> </ul>
	<p><b>Escape key combination (press keys simultaneously)</b></p> <p><i>In menu, submenu</i></p> <ul style="list-style-type: none"> <li>▪ Pressing the key briefly: <ul style="list-style-type: none"> <li>▪ Exits the current menu level and takes you to the next higher level.</li> <li>▪ If help text is open, closes the help text of the parameter.</li> </ul> </li> <li>▪ Pressing the key for 2 s returns you to the operational display ("home position").</li> </ul> <p><i>In wizards</i> Exits the wizard and takes you to the next higher level</p> <p><i>In the text and numeric editor</i> Closes the text or numeric editor without applying changes.</p>
	<p><b>Plus/Enter key combination (press and hold down the keys simultaneously)</b></p> <p>Increases the contrast (darker setting).</p>
	<p><b>Minus/Plus/Enter key combination (press the keys simultaneously)</b></p> <p><i>In the operational display</i> Enables or disables the keypad lock (only SD02 display module).</p>



### 8.3.5 Opening the context menu

Using the context menu, the user can call up the following menus quickly and directly from the operational display:

- Setup
- Configuration backup display
- Simulation



#### Calling up and closing the context menu

The user is in the operational display.

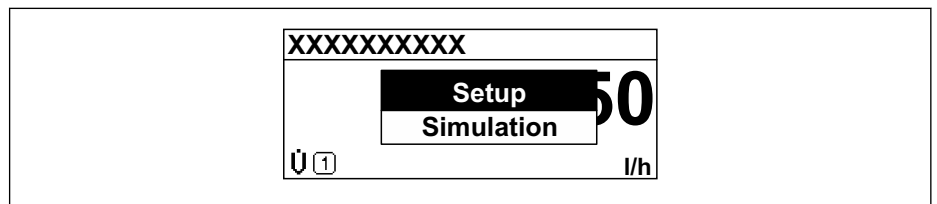

1. Press the  and  keys for longer than 3 seconds.
  - ↳ The context menu opens.



A0017421-EN

2. Press  +  simultaneously.
  - ↳ The context menu is closed and the operational display appears.

#### Calling up the menu via the context menu

1. Open the context menu.
2. Press  to navigate to the desired menu.
3. Press  to confirm the selection.
  - ↳ The selected menu opens.

### 8.3.6 Navigating and selecting from list

Different operating elements are used to navigate through the operating menu. The navigation path is displayed on the left in the header. Icons are displayed in front of the individual menus. These icons are also shown in the header during navigation.

**i** For an explanation of the navigation view with symbols and operating elements → 41

**Example: Setting the number of displayed measured values to "2 values"**

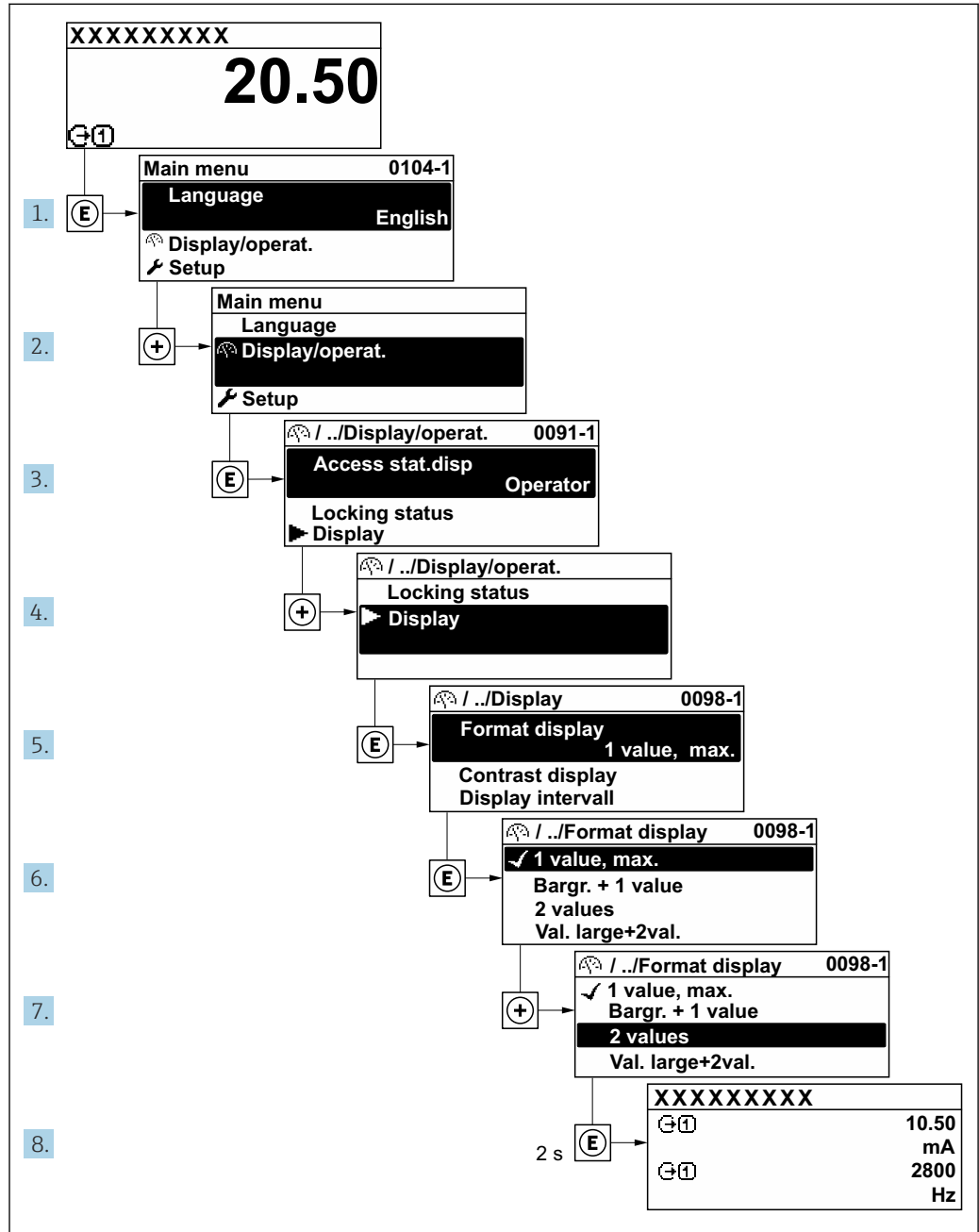

A0029562-EN

### 8.3.7 Calling the parameter directly

A parameter number is assigned to every parameter to be able to access a parameter directly via the onsite display. Entering this access code in the **Direct access** parameter calls up the desired parameter directly.

#### Navigation path

Expert → Direct access

The direct access code consists of a 5-digit number (at maximum) and the channel number, which identifies the channel of a process variable: e.g. 00914-2. In the navigation view, this appears on the right-hand side in the header of the selected parameter.

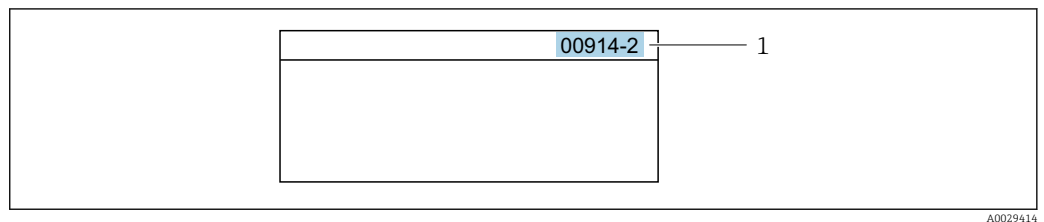

1 Direct access code

Note the following when entering the direct access code:

- The leading zeros in the direct access code do not have to be entered.  
Example: Enter "914" instead of "00914"
- If no channel number is entered, channel 1 is opened automatically.  
Example: Enter 00914 → **Assign process variable** parameter
- If a different channel is opened: Enter the direct access code with the corresponding channel number.  
Example: Enter 00914-2 → **Assign process variable** parameter



For the direct access codes of the individual parameters, see the "Description of Device Parameters" document for the device

### 8.3.8 Calling up help text

Help text is available for some parameters and can be called up from the navigation view. The help text provides a brief explanation of the parameter function and thereby supports swift and safe commissioning.



#### Calling up and closing the help text

The user is in the navigation view and the selection bar is on a parameter.

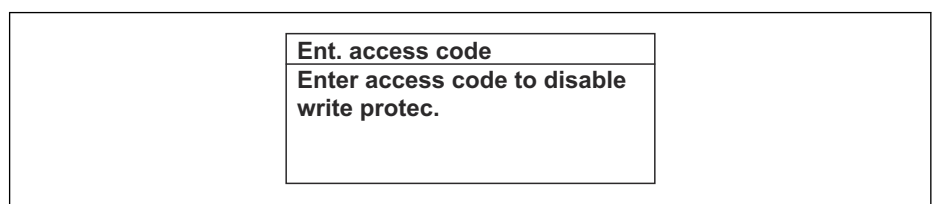
1. Press  for 2 s.  
↳ The help text for the selected parameter opens.



13 Example: Help text for parameter "Enter access code"

2. Press  +  simultaneously.  
↳ The help text is closed.

### 8.3.9 Changing the parameters

**i** For a description of the editing view - consisting of the text editor and numeric editor - with symbols → 42, for a description of the operating elements → 44

**Example:** Changing the tag name in the "Tag description" parameter from 001-FT-101 to 001-FT-102

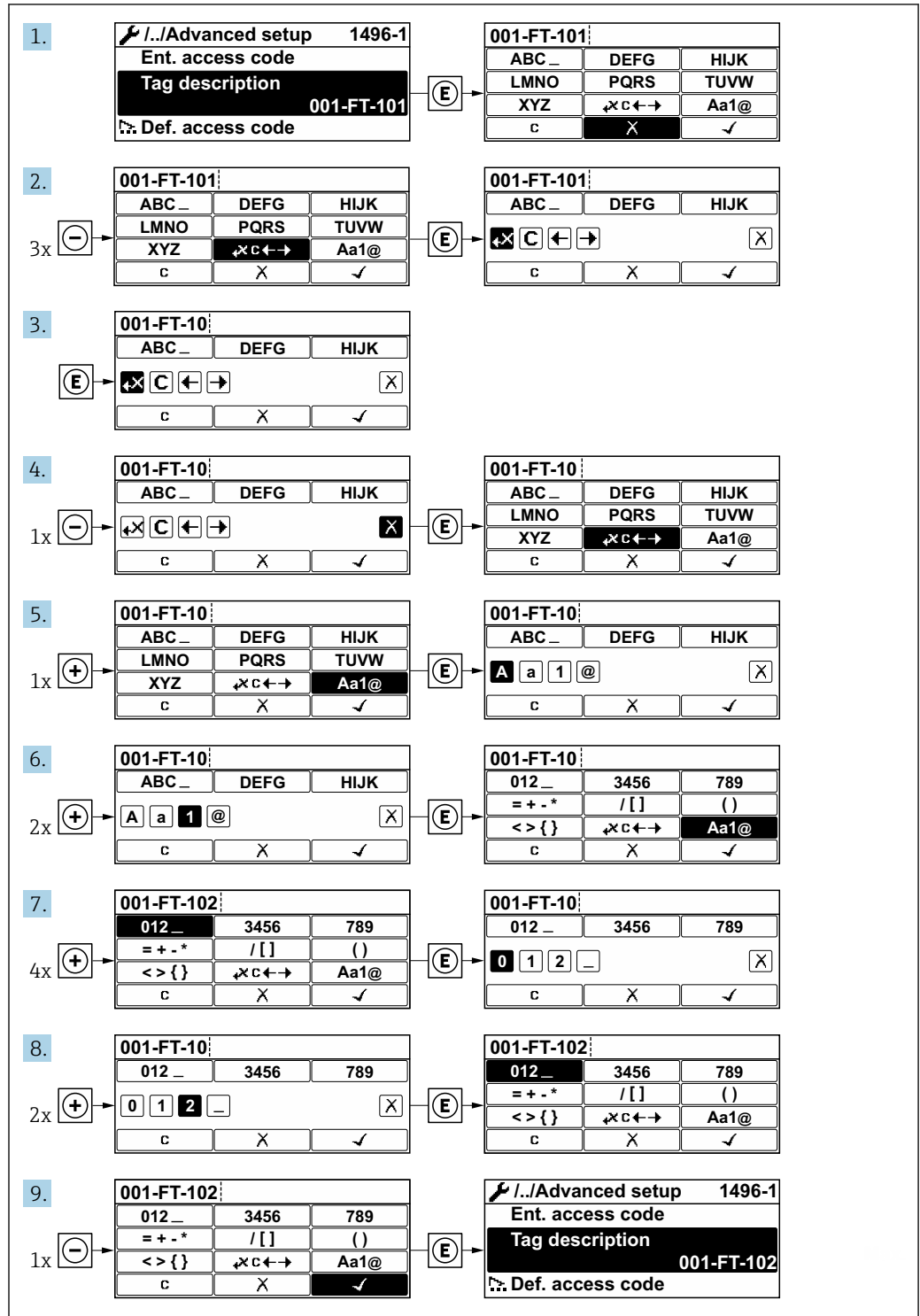

A0029563-EN

A message is displayed if the value entered is outside the permitted value range.



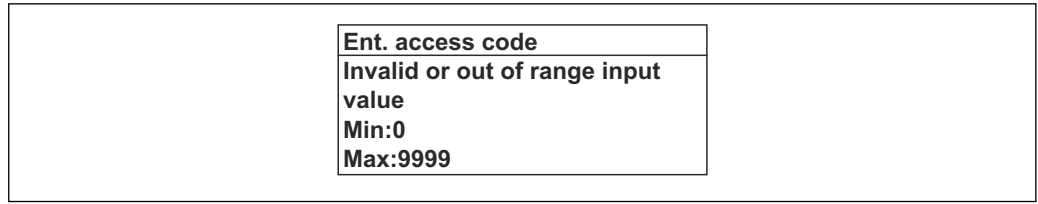

A0014049-EN

### 8.3.10 User roles and related access authorization

The two user roles "Operator" and "Maintenance" have different write access to the parameters if the customer defines a user-specific access code. This protects the device configuration via the local display from unauthorized access .

#### Defining access authorization for user roles

An access code is not yet defined when the device is delivered from the factory. Access authorization (read and write access) to the device is not restricted and corresponds to the "Maintenance" user role.

- ▶ Define the access code.
  - ↳ The "Operator" user role is redefined in addition to the "Maintenance" user role. Access authorization differs for the two user roles.

*Access authorization to parameters: "Maintenance" user role*

Access code status	Read access	Write access
An access code has not yet been defined (factory setting).	✓	✓
After an access code has been defined.	✓	✓ <sup>1)</sup>

1) The user only has write access after entering the access code.



*Access authorization to parameters: "Operator" user role*

Access code status	Read access	Write access
After an access code has been defined.	✓	– <sup>1)</sup>



1) Despite the defined access code, certain parameters can always be modified and thus are excluded from the write protection as they do not affect the measurement: write protection via access code

 The user role with which the user is currently logged on is indicated by the **Access status display** parameter. Navigation path: Operation → Access status display

### 8.3.11 Disabling write protection via access code

If the -symbol appears on the local display in front of a parameter, the parameter is write-protected by a user-specific access code and its value cannot be changed at the moment using local operation →  90.

Parameter write protection via local operation can be disabled by entering the user-specific access code in the **Enter access code** parameter via the respective access option.

1. After you press , the input prompt for the access code appears.
2. Enter the access code.
  - ↳ The -symbol in front of the parameters disappears; all previously write-protected parameters are now re-enabled.

### 8.3.12 Enabling and disabling the keypad lock

The keypad lock makes it possible to block access to the entire operating menu via local operation. As a result, it is no longer possible to navigate through the operating menu or change the values of individual parameters. Users can only read the measured values on the operational display.

The keypad lock is switched on and off via the context menu.

#### Switching on the keypad lock





##### For the SD03 display only

The keypad lock is switched on automatically:

- If the device has not been operated via the display for > 1 minute.
- Each time the device is restarted.



#### To activate the keylock manually:

1. The device is in the measured value display.  
Press the  and  keys for 3 seconds.  
↳ A context menu appears.
2. In the context menu select the **Keylock on** option.  
↳ The keypad lock is switched on.



If the user attempts to access the operating menu while the keypad lock is active, the **Keylock on** message appears.

#### Switching off the keypad lock

- ▶ The keypad lock is switched on.  
Press the  and  keys for 3 seconds.  
↳ The keypad lock is switched off.

## 8.4 Access to the operating menu via the operating tool

The structure of the operating menu in the operating tools is the same as for operation via the local display.

### 8.4.1 Connecting the operating tool

#### Via FOUNDATION Fieldbus network

This communication interface is available in device versions with FOUNDATION Fieldbus.

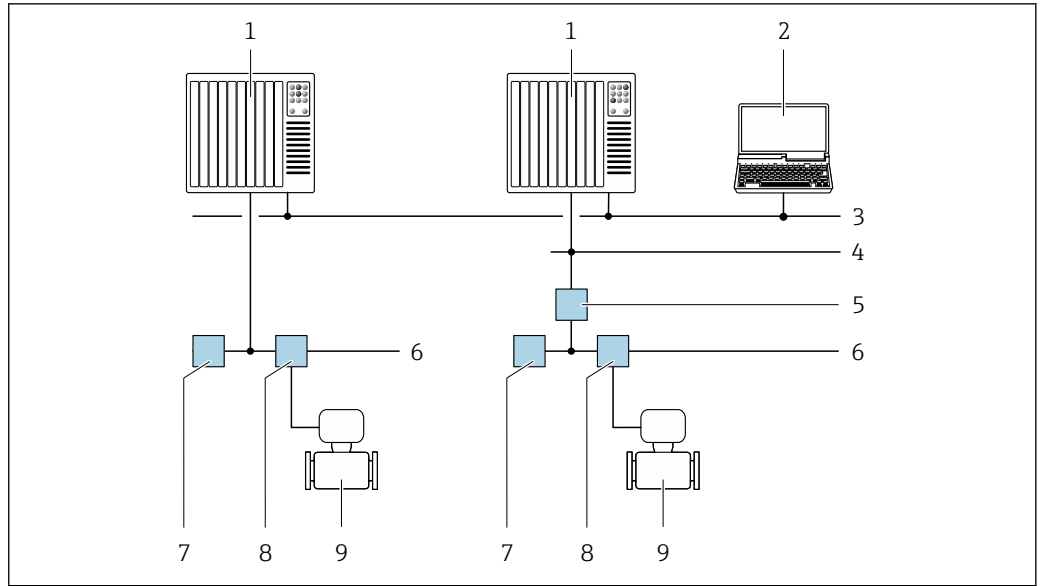

A0028837

14 Options for remote operation via FOUNDATION Fieldbus network

- 1 Automation system
- 2 Computer with FOUNDATION Fieldbus network card
- 3 Industry network
- 4 High Speed Ethernet FF-HSE network
- 5 Segment coupler FF-HSE/FF-H1
- 6 FOUNDATION Fieldbus FF-H1 network
- 7 Power supply FF-H1 network
- 8 T-box
- 9 Measuring device

Via service interface (CDI)

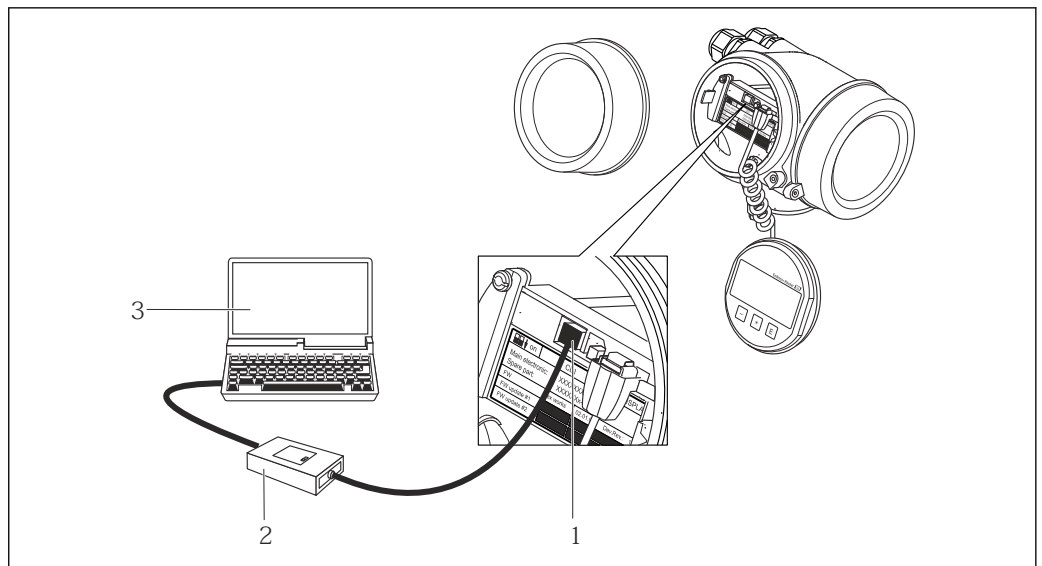

A0014019

- 1 Service interface (CDI = Endress+Hauser Common Data Interface) of the measuring device
- 2 Commubox FXA291
- 3 Computer with FieldCare operating tool with COM DTM CDI Communication FXA291

## 8.4.2 Field Xpert SFX350, SFX370

### Function scope

Field Xpert SFX350 and Field Xpert SFX370 are mobile computers for commissioning and maintenance. They enable efficient device configuration and diagnostics for HART and FOUNDATION Fieldbus devices in the **non-hazardous area** (SFX350, SFX370) and **hazardous area** (SFX370).



For details, see Operating Instructions BA01202S

### Source for device description files

See information →  55

## 8.4.3 FieldCare

### Function range

FDT-based (Field Device Technology) plant asset management tool from Endress+Hauser. It can configure all smart field units in a system and helps you manage them. By using the status information, it is also a simple but effective way of checking their status and condition.

Access is via:

Typical functions:

- Transmitter parameter configuration
- Loading and saving of device data (upload/download)
- Documentation of the measuring point
- Visualization of the measured value memory (line recorder) and event logbook



- Operating Instructions BA00027S
- Operating Instructions BA00059S



Source for device description files →  55

### Establishing a connection



- Operating Instructions BA00027S
- Operating Instructions BA00059S

## User interface

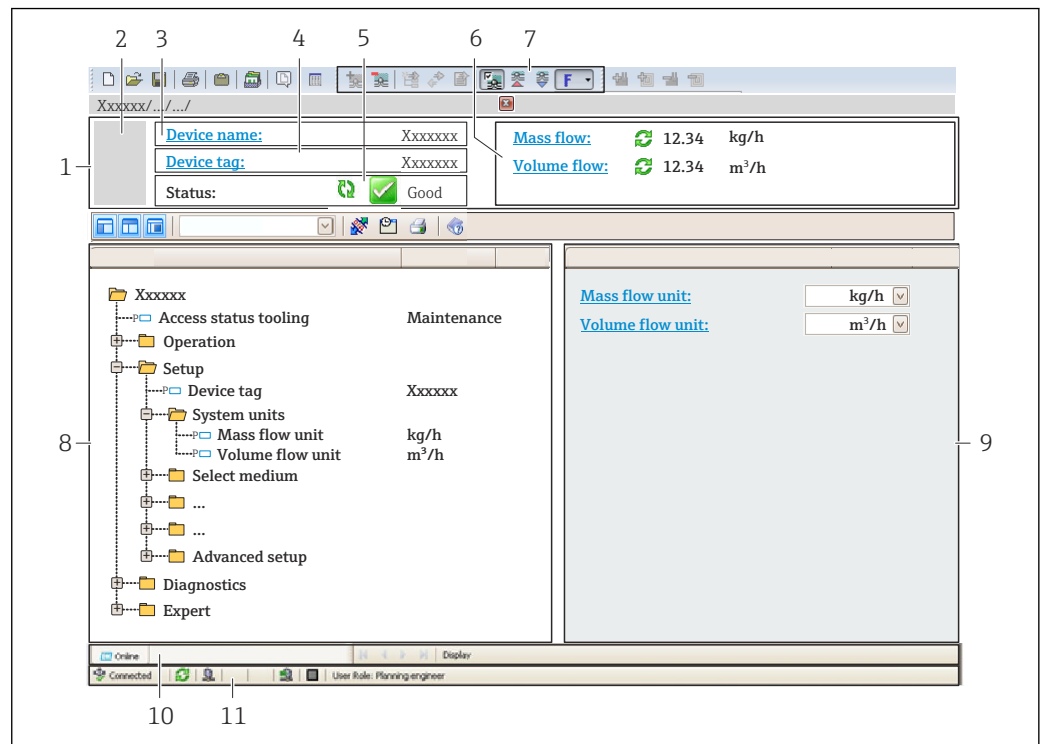

A0021051-EN

- 1 Header
- 2 Picture of device
- 3 Device name
- 4 Device tag
- 5 Status area with status signal → 110
- 6 Display area for current measured values
- 7 Editing toolbar with additional functions such as save/load, event list and create documentation
- 8 Navigation area with operating menu structure
- 9 Work area
- 10 Action area
- 11 Status area

### 8.4.4 DeviceCare

#### Function range

Tool for connecting and configuring Endress+Hauser field devices.

The fastest way to configure Endress+Hauser field devices is with the dedicated "DeviceCare" tool. Together with the device type managers (DTMs) it presents a convenient, comprehensive solution.

 Innovation brochure IN01047S

 Source for device description files → 55

### 8.4.5 AMS Device Manager

#### Function range

Program from Emerson Process Management for operating and configuring measuring devices via FOUNDATION Fieldbus H1 protocol.

 Source for device description files → 55

## 8.4.6 Field Communicator 475

### Function scope

Industrial handheld terminal from Emerson Process Management for remote configuration and measured value display via FOUNDATION Fieldbus H1 protocol.

### Source for device description files

See information →  55

## 9 System integration

### 9.1 Overview of device description files

#### 9.1.1 Current version data for the device

Firmware version	01.00.zz	<ul style="list-style-type: none"> <li>▪ On the title page of the manual</li> <li>▪ On the transmitter nameplate</li> <li>▪ Parameter: <b>Firmware version</b> parameter Diagnostics → Device information → Firmware version</li> </ul>
Release date of firmware version	06.2015	---
Manufacturer ID	452B48 hex	Parameter: <b>Manufacturer ID</b> parameter Diagnostics → Device information → Manufacturer ID
Device type ID	0x1054	Parameter: <b>Device type</b> parameter Diagnostics → Device information → Device type
Device revision	1	<ul style="list-style-type: none"> <li>▪ On the transmitter nameplate</li> <li>▪ Parameter: <b>Device revision</b> parameter Diagnostics → Device information → Device revision</li> </ul>
DD revision	Information and files available at: <ul style="list-style-type: none"> <li>▪ <a href="http://www.endress.com">www.endress.com</a></li> <li>▪ <a href="http://www.fieldbus.org">www.fieldbus.org</a></li> </ul>	
CFF revision		



For an overview of the various firmware versions for the device → 139

#### 9.1.2 Operating tools

The suitable device description file for the individual operating tools is listed in the table below, along with information on where the file can be acquired.

Operating tool via FOUNDATION Fieldbus	Sources for obtaining device descriptions
FieldCare	<ul style="list-style-type: none"> <li>▪ <a href="http://www.endress.com">www.endress.com</a> → Downloads area</li> <li>▪ USB stick (contact Endress+Hauser)</li> <li>▪ DVD (contact Endress+Hauser)</li> </ul>
DeviceCare	<ul style="list-style-type: none"> <li>▪ <a href="http://www.endress.com">www.endress.com</a> → Downloads area</li> <li>▪ CD-ROM (contact Endress+Hauser)</li> <li>▪ DVD (contact Endress+Hauser)</li> </ul>
<ul style="list-style-type: none"> <li>▪ Field Xpert SMT70</li> <li>▪ Field Xpert SMT77</li> </ul>	Use update function of handheld terminal
AMS Device Manager (Emerson Process Management)	<a href="http://www.endress.com">www.endress.com</a> → Downloads area
Field Communicator 475 (Emerson Process Management)	Use update function of handheld terminal

## 9.2 Cyclic data transmission

Cyclic data transmission when using the device master file (GSD).

### 9.2.1 Block model

The block model shows which input and output data the measuring device makes available for cyclic data exchange. Cyclic data exchange takes place with a FOUNDATION Fieldbus master (Class 1), e.g. a control system etc.

Display text (xxxx... = serial number)	Base index	Description
RESOURCE_ xxxxxxxxxxxx	400	Resource block
SETUP_ xxxxxxxxxxxx	600	"Setup" Transducer block
TRDDISP_ xxxxxxxxxxxx	800	"Display" Transducer block
TRDHROM_ xxxxxxxxxxxx	1000	"HistoROM" Transducer block
TRDDIAG_ xxxxxxxxxxxx	1200	"Diagnostic" Transducer block
EXPERT_CONFIG_ xxxxxxxxxxxx	1400	"Expert configuration" Transducer block
SERVICE_SENSOR_ xxxxxxxxxxxx	1600	"Service sensor" Transducer block
TRDTIC_ xxxxxxxxxxxx	1800	"Totalizer" Transducer block
TRDHBT_ xxxxxxxxxxxx	2000	"Heartbeat results" Transducer block
ANALOG_INPUT_1_ xxxxxxxxxxxx	3400	Analog Input function block 1 (AI)
ANALOG_INPUT_2_ xxxxxxxxxxxx	3600	Analog Input function block 2 (AI)
ANALOG_INPUT_3_ xxxxxxxxxxxx	3800	Analog Input function block 3 (AI)
ANALOG_INPUT_4_ xxxxxxxxxxxx	4000	Analog Input function block 4 (AI)
ANALOG_INPUT_5_ xxxxxxxxxxxx	4200	Analog Input function block 5 (AI)
ANALOG_INPUT_6_ xxxxxxxxxxxx	4400	Analog Input function block 6 (AI)
ANALOG_INPUT_7_ xxxxxxxxxxxx	4600	Analog Input function block 7 (AI)
ANALOG_INPUT_8_ xxxxxxxxxxxx	4800	Analog Input function block 8 (AI)
MAO_ xxxxxxxxxxxx	5000	Multiple Analog Output block (MAO)
DIGITAL_INPUT_1_ xxxxxxxxxxxx	5200	Digital Input function block 1 (DI)
DIGITAL_INPUT_2_ xxxxxxxxxxxx	5400	Digital Input function block 2 (DI)
MDO_ xxxxxxxxxxxx	5600	Multiple Digital Output block (MDO)
PID_ xxxxxxxxxxxx	5800	PID function block (PID)
INTEGRATOR_ xxxxxxxxxxxx	6000	Integrator function block (INTG)

## 9.2.2 Description of the modules

The input value of a module/function block is defined via the CHANNEL parameter.

### AI module (Analog Input)

Six Analog Input blocks are available.

CHANNEL	Measured variable
0	Uninitialized (factory setting)
7	Temperature
9	Volume flow
10	Concentration <sup>1)</sup>
11	Mass flow
13	Corrected volume flow
14	Density
15	Reference density
16	Totalizer 1
17	Totalizer 2
18	Totalizer 3
33	Oscillation frequency <sup>1)</sup>



CHANNEL	Measured variable
43	Frequency fluctuation <sup>1)</sup>
51	Carrier pipe temperature <sup>1)</sup>
57	Carrier mass flow <sup>1)</sup>
58	Target mass flow <sup>1)</sup>
63	Oscillation damping <sup>1)</sup>
65	Electronic temperature
66	Tube damping fluctuation <sup>1)</sup>
68	Exciter current <sup>1)</sup>
81	HBSI <sup>1)</sup>
99	Current input 1 <sup>1)</sup>

1) Visible depending on the order options or device settings

### MAO module (Multiple Analog Output)

Channel	Description
121	Channel_0

#### Structure

Channel_0							
Value 1	Value 2	Value 3	Value 4	Value 5	Value 6	Value 7	Value 8

Values	Measured variable
Value 1	External pressure <sup>1)</sup>
Value 2	External temperature <sup>1)</sup>
Value 3	External reference density <sup>1)</sup>
Value 4	Not assigned
Value 5	Not assigned
Value 6	Not assigned
Value 7	Not assigned
Value 8	Not assigned

1) The external measured values must be transmitted to the device in the SI basic unit

 The selection is made via: Expert → Sensor → External compensation

### DI module (Discrete Input)

Two Discrete Input blocks are available.

CHANNEL	Device function	Status
0	Uninitialized (factory setting)	-
101	Switch output state	0 = off, 1 = active
103	Low flow cut off	0 = off, 1 = active

CHANNEL	Device function	Status
104	Empty pipe detection	0 = off, 1 = active
105	Verification status <sup>1)</sup>	<p><b>Overall result of verification</b></p> <p>Verification:</p> <ul style="list-style-type: none"> <li>▪ 16 = Failed</li> <li>▪ 32 = Passed</li> <li>▪ 64 = Not performed</li> </ul> <p><b>Verification status</b></p> <p>Verification:</p> <ul style="list-style-type: none"> <li>▪ 1 = Not performed</li> <li>▪ 2 = Failed</li> <li>▪ 4 = Being performed</li> <li>▪ 8 = Finished</li> </ul> <p><b>Status; result</b></p> <ul style="list-style-type: none"> <li>▪ 17 = Status: not performed; Result: failed</li> <li>▪ 18 = Status: failed; Result: failed</li> <li>▪ 20 = Status: being performed; Result: failed</li> <li>▪ 24 = Status: finished; Result: failed</li> <li>▪ 33 = Status: not performed; Result: passed</li> <li>▪ 34 = Status: failed; Result: passed</li> <li>▪ 36 = Status: being performed; Result: passed</li> <li>▪ 40 = Status: finished; Result: passed</li> <li>▪ 65 = Status: not performed; Result: not performed</li> <li>▪ 66 = Status: failed; Result: not performed</li> <li>▪ 68 = Status: being performed; Result: not performed</li> <li>▪ 72 = Status: finished; Result: not performed</li> </ul>

1) Only available with the Heartbeat Verification application package

### MDO module (Multiple Discrete Output)

Channel	Description
122	Channel_DO

#### Structure

Channel_DO							
Value 1	Value 2	Value 3	Value 4	Value 5	Value 6	Value 7	Value 8

Value	Device function	Status
Value 1	Reset totalizer 1	0 = off, 1 = execute
Value 2	Reset totalizer 2	0 = off, 1 = execute
Value 3	Reset totalizer 3	0 = off, 1 = execute
Value 4	Flow override	0 = off, 1 = active
Value 5	Start Heartbeat Verification <sup>1)</sup>	0 = off, 1 = start
Value 6	Status output	0 = off, 1 = active

Value	Device function	Status
Value 7	Zero adjustment	0 = off, 1 = on
Value 8	Not used	–

1) Only available with the Heartbeat Verification application package

### 9.2.3 Execution times

Function block	Execution time (ms)
Analog Input function block (AI)	6
Digital Input function block (DI)	4
PID function block (PID)	5
Multiple Analog Output block (MAO)	4
Multiple Digital Output block (MDO)	4
Integrator function block (INTG)	5

## 9.2.4 Methods

Method	Block	Navigation	Description
Set to "AUTO" mode	Resource block	Via menu: Expert → Communication → Resource block → Target mode	This method sets the Resource Block and all the Transducer Blocks to the AUTO (Automatic) mode.
Set to "OOS" mode	Resource block	Via menu: Expert → Communication → Resource block → Target mode	This method sets the Resource Block and all the Transducer Blocks to the OOS (Out of service) mode.
Restart	Resource block	Via menu: Expert → Communication → Resource block → Restart	This method is used to select the configuration for the <b>Restart</b> parameter in the Resource Block. This resets device parameters to a specific value.  The following options are supported: <ul style="list-style-type: none"> <li>▪ Uninitialized</li> <li>▪ Run</li> <li>▪ Resource</li> <li>▪ Defaults</li> <li>▪ Processor</li> <li>▪ To delivery settings</li> </ul>
ENP parameter	Resource block	Via menu: Actions → Methods → Calibrate → ENP parameter	This method is used to display and configure the parameters of the electronic nameplate (ENP).
Overview diagnostics - Remedy information	Diagnostic Transducer Block	Via link: Namur symbol	This method is used to display the diagnostic event with the highest priority that is currently active and the corresponding remedial measures.
Actual diagnostics - Remedy information	Diagnostic Transducer Block	Via menu: <ul style="list-style-type: none"> <li>▪ Configure/Setup → Diagnostics → Actual diagnostics</li> <li>▪ Device/Diagnostics → Diagnostics</li> </ul>	This method is used to display remedial measures for the diagnostic event with the highest priority that is currently active.  This method is available only if an appropriate diagnostic event has occurred.
Previous diagnostics - Remedy information	Diagnostic Transducer Block	Via menu: <ul style="list-style-type: none"> <li>▪ Configure/Setup → Diagnostics → Previous diagnostics</li> <li>▪ Device/Diagnostics → Diagnostics</li> </ul>	This method is used to display remedial measures for the previous diagnostic event.  This method is available only if an appropriate diagnostic event has occurred.
Diagnostics 1 - Remedy information	Diagnostic Transducer Block	<ul style="list-style-type: none"> <li>▪ Via menu: Configure/Setup → Diagnostics → Diagnostic list → Diagnostics 1</li> <li>▪ Via menu <ul style="list-style-type: none"> <li>▪ Device/Diagnostics → Diagnostics list</li> <li>▪ Instrument health status → Diagnostic list</li> </ul> </li> </ul>	This method is used to display remedial measures for the diagnostic event with the highest priority that is currently active.  This method is available only if an appropriate diagnostic event has occurred.
Diagnostics 2 - Remedy information	Diagnostic Transducer Block	<ul style="list-style-type: none"> <li>▪ Via menu: Configure/Setup → Diagnostics → Diagnostic list → Diagnostics 2</li> <li>▪ Via menu: <ul style="list-style-type: none"> <li>▪ Device/Diagnostics → Diagnostics list</li> <li>▪ Instrument health status → Diagnostic list</li> </ul> </li> </ul>	This method is used to display remedial measures for an additional active diagnostic event.  This method is available only if an appropriate diagnostic event has occurred.

## 10 Commissioning

### 10.1 Post-mounting and post-connection check

Before commissioning the device:

- ▶ Make sure that the post-installation and post-connection checks have been performed successfully.
- Checklist for "Post-installation" check → 27
- Checklist for "Post-connection" check → 35

### 10.2 Switching on the measuring device

- ▶ Switch on the device upon successful completion of the post-mounting and post-connection check.
  - ↳ After a successful startup, the local display switches automatically from the startup display to the operational display.

If nothing appears on the local display or if a diagnostic message is displayed, refer to the section on "Diagnostics and troubleshooting" → 105.

### 10.3 Setting the operating language

Factory setting: English or ordered local language

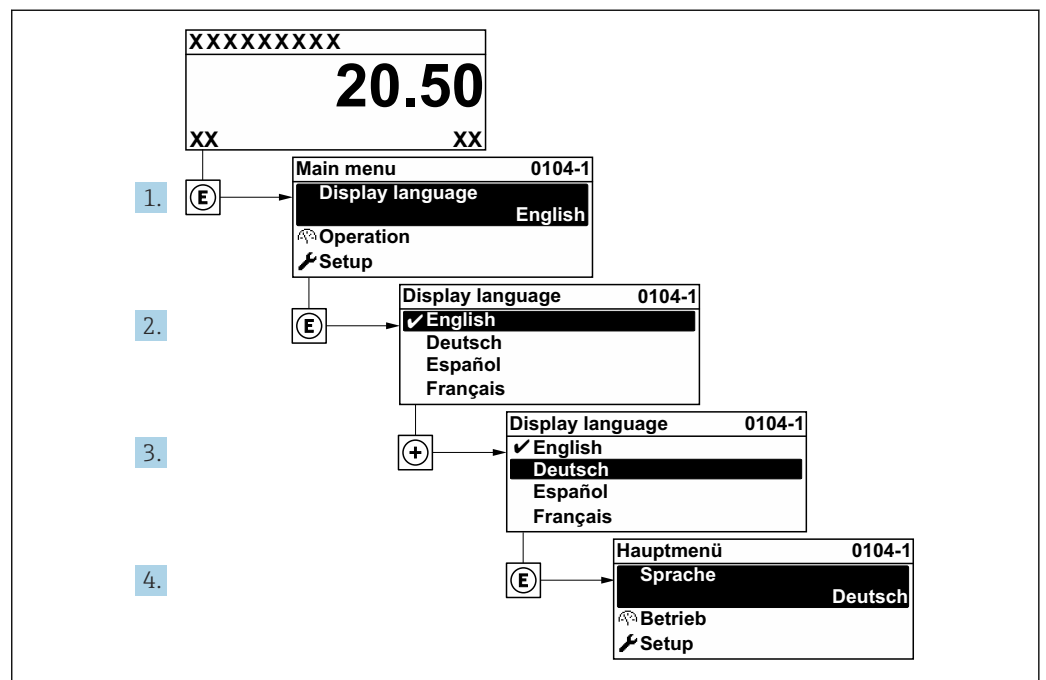

15 Taking the example of the local display

### 10.4 Configuring the measuring instrument

The **Setup** menu with its guided wizards contains all the parameters needed for standard operation.

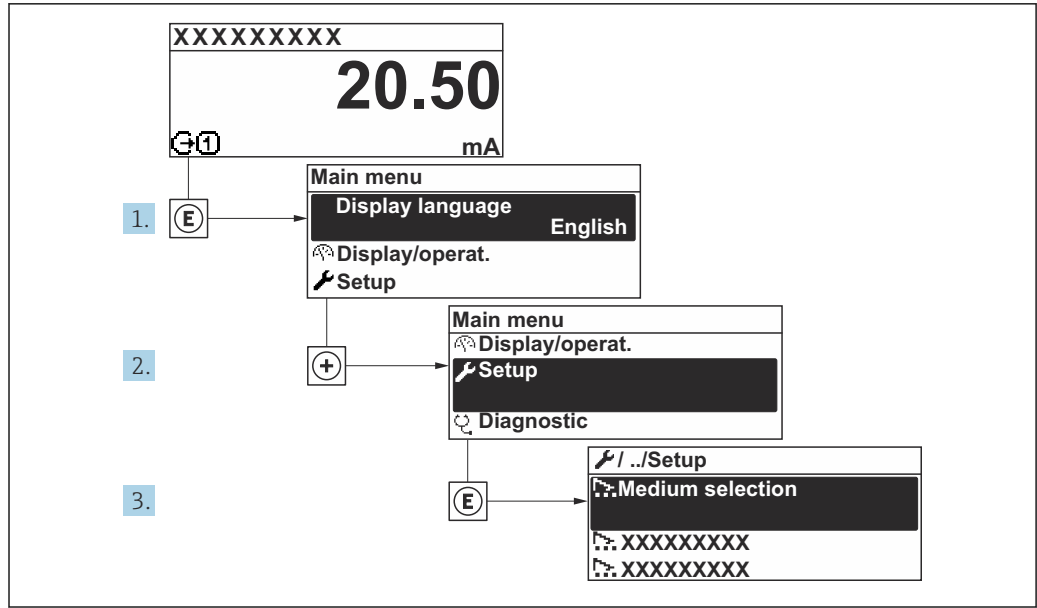

A0032222-EN

16 Navigation to "Setup" menu using the example of the local display

🔧 Setup	
Device tag	→ 📖 63
▶ System units	→ 📖 63
▶ Select medium	
▶ Analog inputs	→ 📖 67
▶ Display	→ 📖 67
▶ Low flow cut off	→ 📖 70
▶ Partially filled pipe detection	→ 📖 71
▶ Advanced setup	→ 📖 72

### 10.4.1 Defining the device tag

To enable fast identification of the measuring point within the system, you can enter a unique designation using the **Device tag** parameter and thus change the factory setting.

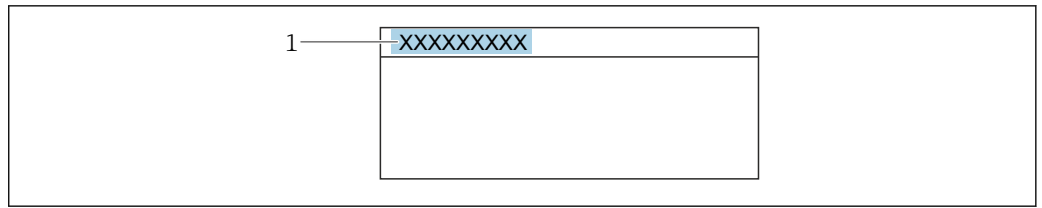

A0029422

17 Header of the operational display with tag name

1 Tag name

**i** Enter the tag name in the "FieldCare" operating tool → 53

**Navigation**

"Setup" menu → Device tag

**Parameter overview with brief description**

Parameter	Description	User entry
Device tag	Enter the name for the measuring point.	Max. 32 characters, such as letters, numbers or special characters (e.g. @, %, /)

**10.4.2 Setting the system units**



In the **System units** submenu the units of all the measured values can be set.

**i** The number of submenus and parameters can vary depending on the device version. Certain submenus and parameters in these submenus are not described in the Operating Instructions. Instead a description is provided in the Special Documentation for the device ("Supplementary documentation").

**Navigation**

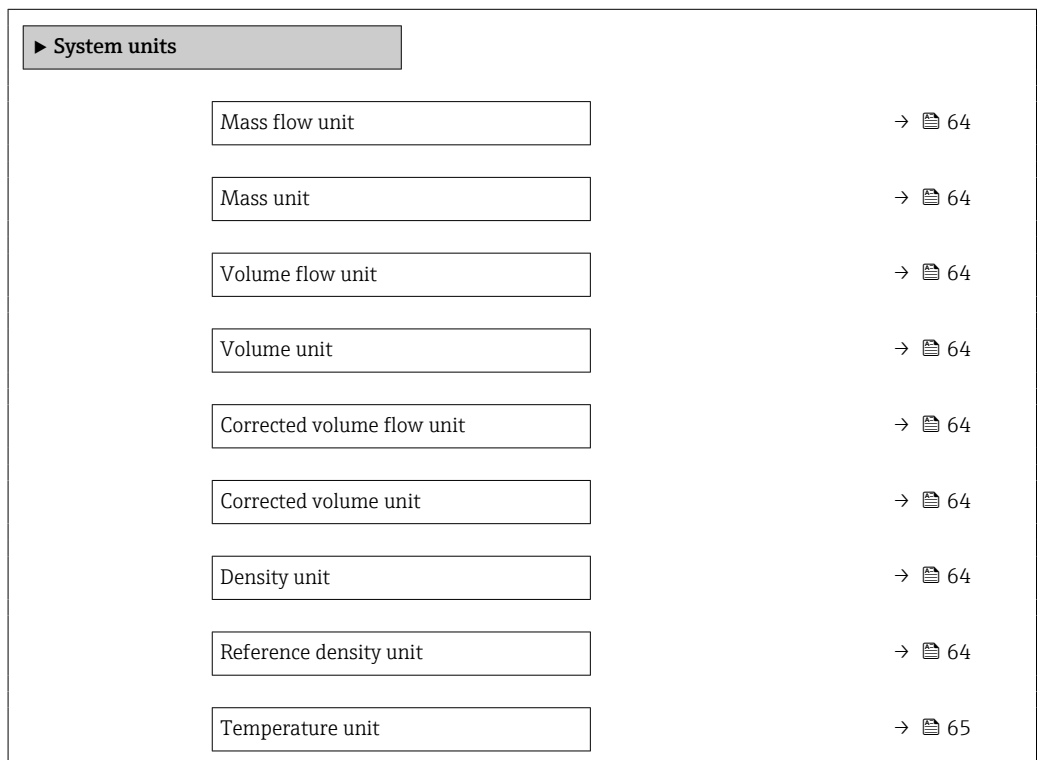
"Setup" menu → System units



Length unit	→  65
Pressure unit	→  65

### Parameter overview with brief description

Parameter	Description	Selection	Factory setting
Mass flow unit	Select mass flow unit. <i>Effect</i> The selected unit applies to: <ul style="list-style-type: none"> <li>▪ Output</li> <li>▪ Low flow cut off</li> <li>▪ Simulation process variable</li> </ul>	Unit choose list	Country-specific: <ul style="list-style-type: none"> <li>▪ kg/h</li> <li>▪ lb/min</li> </ul>
Mass unit	Select mass unit.	Unit choose list	Country-specific: <ul style="list-style-type: none"> <li>▪ kg</li> <li>▪ lb</li> </ul>
Volume flow unit	Select volume flow unit. <i>Effect</i> The selected unit applies to: <ul style="list-style-type: none"> <li>▪ Output</li> <li>▪ Low flow cut off</li> <li>▪ Simulation process variable</li> </ul>	Unit choose list	Country-specific: <ul style="list-style-type: none"> <li>▪ l/h</li> <li>▪ gal/min (us)</li> </ul>
Volume unit	Select volume unit.	Unit choose list	Country-specific: <ul style="list-style-type: none"> <li>▪ l (DN &gt; 150 (6"): m<sup>3</sup> option)</li> <li>▪ gal (us)</li> </ul>
Corrected volume flow unit	Select corrected volume flow unit. <i>Effect</i> The selected unit applies to: <b>Corrected volume flow</b> parameter (→  98)	Unit choose list	Country-specific: <ul style="list-style-type: none"> <li>▪ NI/h</li> <li>▪ Sft<sup>3</sup>/min</li> </ul>
Corrected volume unit	Select corrected volume unit.	Unit choose list	Country-specific: <ul style="list-style-type: none"> <li>▪ NI</li> <li>▪ Sft<sup>3</sup></li> </ul>
Density unit	Select density unit. <i>Effect</i> The selected unit applies to: <ul style="list-style-type: none"> <li>▪ Output</li> <li>▪ Simulation process variable</li> <li>▪ Density adjustment (<b>Expert</b> menu)</li> </ul>	Unit choose list	Country-specific: <ul style="list-style-type: none"> <li>▪ kg/l</li> <li>▪ lb/ft<sup>3</sup></li> </ul>
Reference density unit	Select reference density unit.	Unit choose list	Country-specific <ul style="list-style-type: none"> <li>▪ kg/NI</li> <li>▪ lb/Sft<sup>3</sup></li> </ul>
Density 2 unit	Select second density unit.	Unit choose list	Country-specific: <ul style="list-style-type: none"> <li>▪ kg/l</li> <li>▪ lb/ft<sup>3</sup></li> </ul>



Parameter	Description	Selection	Factory setting
Temperature unit	Select temperature unit. <i>Effect</i> The selected unit applies to: <ul style="list-style-type: none"> <li>■ Minimum value</li> <li>■ Maximum value</li> <li>■ Maximum value</li> <li>■ Minimum value</li> <li>■ Average value</li> <li>■ Minimum value</li> <li>■ Maximum value</li> <li>■ Minimum value</li> <li>■ Maximum value</li> <li>■ Reference temperature</li> </ul>	Unit choose list	Country-specific: <ul style="list-style-type: none"> <li>■ °C</li> <li>■ °F</li> </ul>
Length unit	Select length unit for nominal diameter.	Unit choose list	Country-specific: <ul style="list-style-type: none"> <li>■ mm</li> <li>■ in</li> </ul>
Pressure unit	Select process pressure unit.	Unit choose list	Country-specific: <ul style="list-style-type: none"> <li>■ bar a</li> <li>■ psi a</li> </ul>

### 10.4.3 Selecting and setting the medium

The **Medium selection** wizard systematically guides the user through all the parameters that must be configured in order to select and set the medium.

#### Navigation

"Setup" menu → Medium selection

▶ Select medium

Select medium	→ ⓘ 66
Select gas type	→ ⓘ 66
Reference sound velocity	→ ⓘ 66
Temperature coefficient sound velocity	→ ⓘ 66
Pressure compensation	→ ⓘ 66
Pressure value	→ ⓘ 66
External pressure	

#### Parameter overview with brief description

Parameter	Prerequisite	Description	Selection / User entry	Factory setting
Select medium	–	Select medium type.	<ul style="list-style-type: none"> <li>■ Liquid</li> <li>■ Gas</li> </ul>	–
Select gas type	In the <b>Select medium</b> parameter the <b>Gas</b> option is selected.	Select measured gas type.	Gas type choose list	–
Reference sound velocity	In the <b>Select gas type</b> parameter the <b>Others</b> option is selected.	Enter sound velocity of gas at 0 °C (32 °F).	1 to 99 999.9999 m/s	–
Temperature coefficient sound velocity	In the <b>Select gas type</b> parameter the <b>Others</b> option is selected.	Enter temperature coefficient for the gas sound velocity.	Positive floating-point number	–
Pressure compensation	–	Select pressure compensation type.	<ul style="list-style-type: none"> <li>■ Off</li> <li>■ Fixed value</li> <li>■ External value</li> </ul>	–
Pressure value	In the <b>Pressure compensation</b> parameter the <b>Fixed value</b> option is selected.	Enter process pressure to be used for pressure correction.	Positive floating-point number	Country-specific: <ul style="list-style-type: none"> <li>■ 1.01 bar a</li> <li>■ 14.7 psi a</li> </ul>

### 10.4.4 Configuring the analog inputs

The **Analog inputs** submenu guides the user systematically to the individual **Analog input 1 to n** submenu. From here you get to the parameters of the individual analog input.

**Navigation**

"Setup" menu → Analog inputs

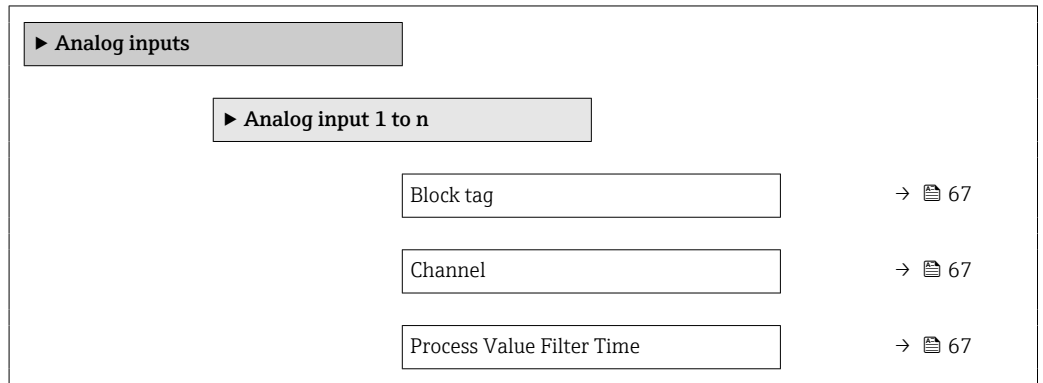

**Parameter overview with brief description**

Parameter	Description	User entry / Selection	Factory setting
Block tag	Unique name of the measuring device.	Max. 32 characters such as letters, numbers or special characters (e. g. @, %, /).	ANALOG_INPUT_1 ... 4_Serial number
Channel	Use this function to select the process variable.	<ul style="list-style-type: none"> <li>■ Uninitialized</li> <li>■ Mass flow</li> <li>■ Volume flow</li> <li>■ Corrected volume flow</li> <li>■ Density</li> <li>■ Reference density</li> <li>■ Temperature</li> <li>■ Totalizer 1</li> <li>■ Totalizer 2</li> <li>■ Totalizer 3</li> </ul>	-
Process Value Filter Time	Enter the filter time specification for the filtering of the unconverted input value (PV).	Positive floating-point number	-





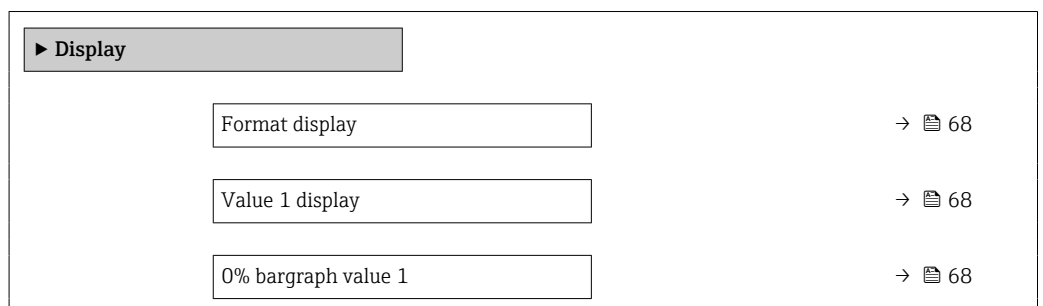

### 10.4.5 Configuring the local display

The **Display** wizard guides you systematically through all the parameters that can be configured for configuring the local display.





**Navigation**



"Setup" menu → Display



100% bargraph value 1	→  68
Value 2 display	→  68
Value 3 display	→  68
0% bargraph value 3	→  68
100% bargraph value 3	→  68
Value 4 display	→  68

### Parameter overview with brief description

Parameter	Prerequisite	Description	Selection / User entry	Factory setting
Format display	A local display is provided.	Select how measured values are shown on the display.	<ul style="list-style-type: none"> <li>▪ 1 value, max. size</li> <li>▪ 1 bargraph + 1 value</li> <li>▪ 2 values</li> <li>▪ 1 value large + 2 values</li> <li>▪ 4 values</li> </ul>	–
Value 1 display	A local display is provided.	Select the measured value that is shown on the local display.	<ul style="list-style-type: none"> <li>▪ Mass flow</li> <li>▪ Volume flow</li> <li>▪ Corrected volume flow</li> <li>▪ Density</li> <li>▪ Reference density</li> <li>▪ Temperature</li> <li>▪ Totalizer 1</li> <li>▪ Totalizer 2</li> <li>▪ Totalizer 3</li> </ul>	–
0% bargraph value 1	A local display is provided.	Enter 0% value for bar graph display.	Signed floating-point number	Country-specific: <ul style="list-style-type: none"> <li>▪ 0 kg/h</li> <li>▪ 0 lb/min</li> </ul>
100% bargraph value 1	A local display is provided.	Enter 100% value for bar graph display.	Signed floating-point number	Depends on country and nominal diameter
Value 2 display	A local display is provided.	Select the measured value that is shown on the local display.	For the picklist, see <b>Value 1 display</b> parameter (→  68)	–
Value 3 display	A local display is provided.	Select the measured value that is shown on the local display.	For the picklist, see <b>Value 1 display</b> parameter (→  68)	–
0% bargraph value 3	A selection was made in the <b>Value 3 display</b> parameter.	Enter 0% value for bar graph display.	Signed floating-point number	Country-specific: <ul style="list-style-type: none"> <li>▪ 0 kg/h</li> <li>▪ 0 lb/min</li> </ul>
100% bargraph value 3	A selection was made in the <b>Value 3 display</b> parameter.	Enter 100% value for bar graph display.	Signed floating-point number	–
Value 4 display	A local display is provided.	Select the measured value that is shown on the local display.	For the picklist, see <b>Value 1 display</b> parameter (→  68)	–
Value 5 display	A local display is provided.	Select the measured value that is shown on the local display.	For the picklist, see <b>Value 1 display</b> parameter (→  68)	–

Parameter	Prerequisite	Description	Selection / User entry	Factory setting
Value 6 display	A local display is provided.	Select the measured value that is shown on the local display.	For the picklist, see <b>Value 1 display</b> parameter (→  68)	-
Value 7 display	A local display is provided.	Select the measured value that is shown on the local display.	For the picklist, see <b>Value 1 display</b> parameter (→  68)	-
Value 8 display	A local display is provided.	Select the measured value that is shown on the local display.	For the picklist, see <b>Value 1 display</b> parameter (→  68)	-

## 10.4.6 Configuring the low flow cut off

The **Low flow cut off** wizard systematically guides the user through all the parameters that must be set to configure low flow cut off.

### Navigation

"Setup" menu → Low flow cut off

► Low flow cut off	
Assign process variable	→ 70
On value low flow cutoff	→ 70
Off value low flow cutoff	→ 70
Pressure shock suppression	→ 70

### Parameter overview with brief description

Parameter	Prerequisite	Description	Selection / User entry	Factory setting
Assign process variable	–	Select process variable for low flow cut off.	<ul style="list-style-type: none"> <li>▪ Off</li> <li>▪ Mass flow</li> <li>▪ Volume flow</li> <li>▪ Corrected volume flow</li> </ul>	–
On value low flow cutoff	A process variable is selected in the <b>Assign process variable</b> parameter (→ 70).	Enter on value for low flow cut off.	Positive floating-point number	Depends on country and nominal diameter
Off value low flow cutoff	A process variable is selected in the <b>Assign process variable</b> parameter (→ 70).	Enter off value for low flow cut off.	0 to 100.0 %	–
Pressure shock suppression	A process variable is selected in the <b>Assign process variable</b> parameter (→ 70).	Enter time frame for signal suppression (= active pressure shock suppression).	0 to 100 s	–

### 10.4.7 Configuring the partial filled pipe detection

The **Partial filled pipe detection** wizard guides you systematically through all parameters that have to be set for configuring the monitoring of the pipe filling.

#### Navigation

"Setup" menu → Partially filled pipe detection

▶ **Partially filled pipe detection**

Assign process variable	→  71
Low value partial filled pipe detection	→  71
High value partial filled pipe detection	→  71
Response time part. filled pipe detect.	→  71

#### Parameter overview with brief description

Parameter	Prerequisite	Description	Selection / User entry
Assign process variable	–	Select process variable for partially filled pipe detection.	<ul style="list-style-type: none"> <li>■ Off</li> <li>■ Density</li> <li>■ Reference density</li> </ul>
Low value partial filled pipe detection	One of the following options is selected in the <b>Assign process variable</b> parameter: <ul style="list-style-type: none"> <li>■ Density</li> <li>■ Reference density</li> </ul>	Enter lower limit value for deactivating partialy filled pipe detection.	Positive floating-point number
High value partial filled pipe detection	One of the following options is selected in the <b>Assign process variable</b> parameter: <ul style="list-style-type: none"> <li>■ Density</li> <li>■ Reference density</li> </ul>	Enter upper limit value for deactivating partialy filled pipe detection.	Signed floating-point number
Response time part. filled pipe detect.	One of the following options is selected in the <b>Assign process variable</b> parameter: <ul style="list-style-type: none"> <li>■ Density</li> <li>■ Reference density</li> </ul>	Enter time before diagnostic message is displayed for partially filled pipe detection.	0 to 100 s

## 10.5 Advanced settings

The **Advanced setup** submenu with its submenus contains parameters for specific settings.

*Navigation to the "Advanced setup" submenu*

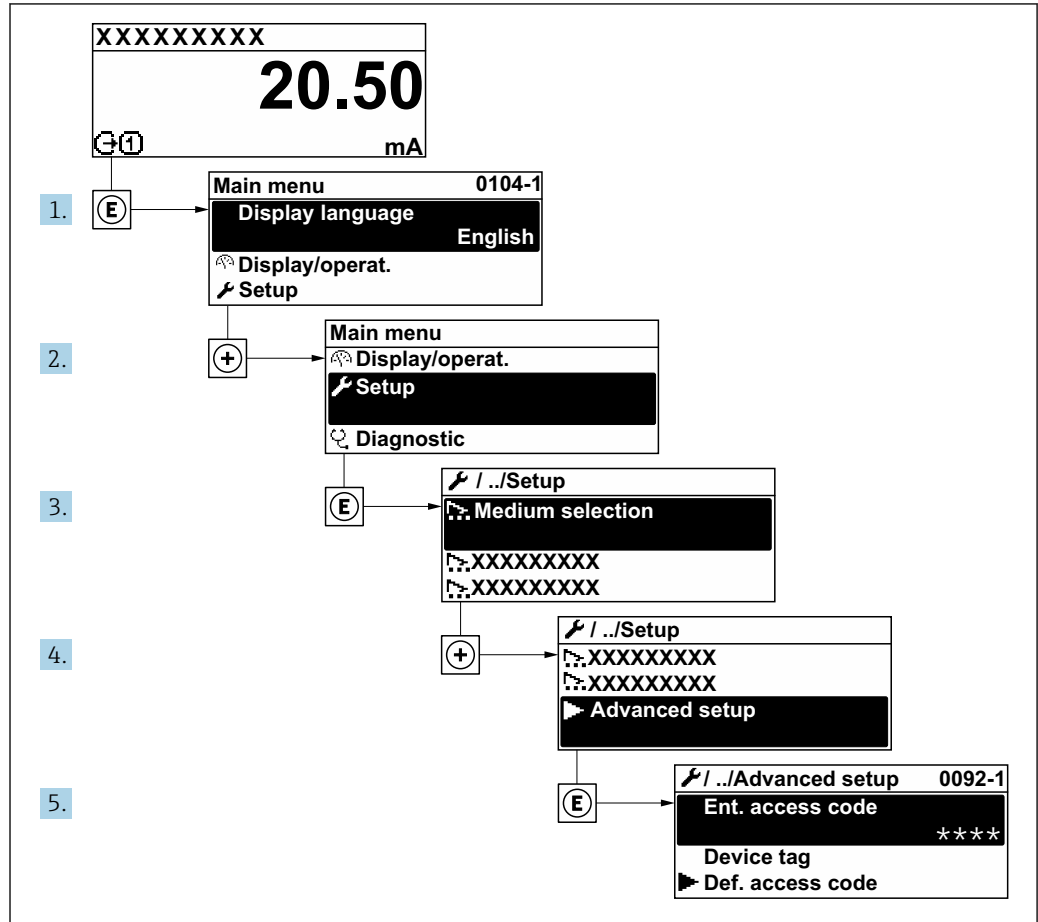

A0032223-EN

### Navigation

"Setup" menu → Advanced setup

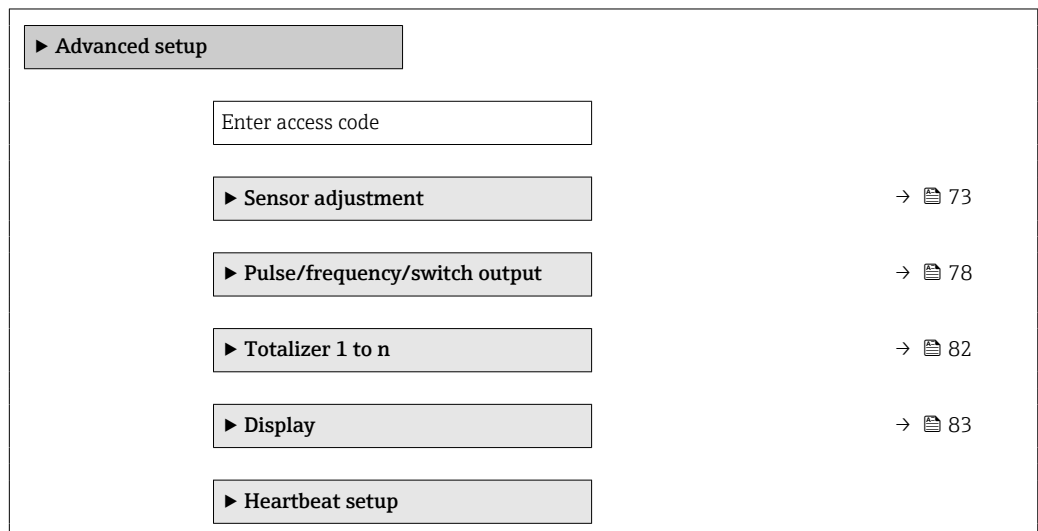



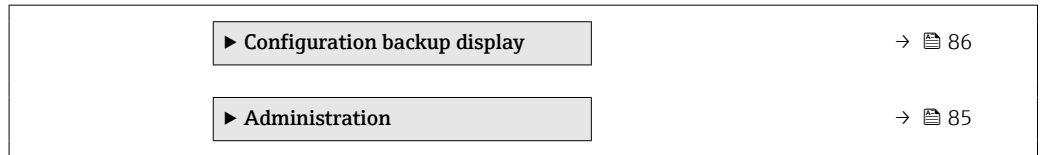

### 10.5.1 Carrying out a sensor adjustment

The **Sensor adjustment** submenu contains parameters that pertain to the functionality of the sensor.

#### Navigation

"Setup" menu → Advanced setup → Sensor adjustment

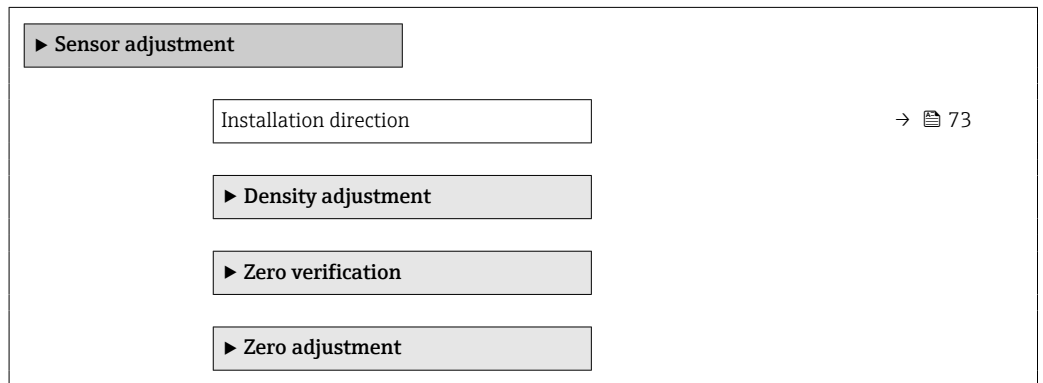

#### Parameter overview with brief description

Parameter	Description	Selection
Installation direction	Set sign of flow direction to match the direction of the arrow on the sensor.	<ul style="list-style-type: none"> <li>■ Flow in arrow direction</li> <li>■ Flow against arrow direction</li> </ul>

#### Density adjustment

**i** With density adjustment, a high level of accuracy is achieved only at the point of adjustment and at the relevant density and temperature. However, the accuracy of a density adjustment is only ever as good as the quality of the reference measuring data provided. Therefore it is not a substitute for special density calibration.

#### Performing density adjustment

- i** Note the following before performing the adjustment:
- A density adjustment only makes sense if there is little variation in the operating conditions and the density adjustment is performed under the operating conditions.
  - The density adjustment scales the internally computed density value with a user-specific slope and offset.
  - A 1-point or 2-point density adjustment can be performed.
  - For a 2-point density adjustment, there must be a difference of at least 0.2 kg/l between the two target density values.
  - The reference media must be gas-free or pressurized so that any gas they contain is compressed.
  - The reference density measurements must be performed at the same medium temperature that prevails in the process, as otherwise the density adjustment will not be accurate.
  - The correction resulting from the density adjustment can be deleted with the **Restore original** option.

**"1 point adjustment" option**

1. In the **Density adjustment mode** parameter, select the **1 point adjustment** option and confirm.
2. In the **Density setpoint 1** parameter, enter the density value and confirm.
  - ↳ In the **Execute density adjustment** parameter the following options are now available:
    - Ok
    - Measure density 1** option
    - Restore original
3. Select the **Measure density 1** option and confirm.
4. If 100% was reached in the **Progress** parameter on the display and the **Ok** option is displayed in the **Execute density adjustment** parameter, then confirm.
  - ↳ In the **Execute density adjustment** parameter the following options are now available:
    - Ok
    - Calculate
    - Cancel
5. Select the **Calculate** option and confirm.

If the adjustment was completed successfully, the **Density adjustment factor** parameter and the **Density adjustment offset** parameter and the values calculated for them are shown on the display.

**"2 point adjustment" option**

1. In the **Density adjustment mode** parameter, select the **2 point adjustment** option and confirm.
2. In the **Density setpoint 1** parameter, enter the density value and confirm.
3. In the **Density setpoint 2** parameter, enter the density value and confirm.
  - ↳ In the **Execute density adjustment** parameter the following options are now available:
    - Ok
    - Measure density 1
    - Restore original
4. Select the **Measure density 1** option and confirm.
  - ↳ In the **Execute density adjustment** parameter the following options are now available:
    - Ok
    - Measure density 2
    - Restore original
5. Select the **Measure density 2** option and confirm.
  - ↳ In the **Execute density adjustment** parameter the following options are now available:
    - Ok
    - Calculate
    - Cancel
6. Select the **Calculate** option and confirm.

If the **Density adjust failure** option is displayed in the **Execute density adjustment** parameter, call up the options and select the **Cancel** option. The density adjustment is canceled and can be repeated.

If the adjustment was completed successfully, the **Density adjustment factor** parameter and the **Density adjustment offset** parameter and the values calculated for them are shown on the display.

**Navigation**

"Expert" menu → Sensor → Sensor adjustment → Density adjustment

► **Density adjustment**

Density adjustment mode	→ ⓘ 75
Density setpoint 1	→ ⓘ 75
Density setpoint 2	→ ⓘ 75
Execute density adjustment	→ ⓘ 75
Progress	→ ⓘ 75
Density adjustment factor	→ ⓘ 75
Density adjustment offset	→ ⓘ 75

**Parameter overview with brief description**

Parameter	Prerequisite	Description	Selection / User entry / User interface	Factory setting
Density adjustment mode	-		<ul style="list-style-type: none"> <li>■ 1 point adjustment</li> <li>■ 2 point adjustment</li> </ul>	-
Density setpoint 1	-		The entry depends on the unit selected in the <b>Density unit</b> parameter (0555).	-
Density setpoint 2	In the <b>Density adjustment mode</b> parameter, the <b>2 point adjustment</b> option is selected.		The entry depends on the unit selected in the <b>Density unit</b> parameter (0555).	-
Execute density adjustment	-		<ul style="list-style-type: none"> <li>■ Cancel</li> <li>■ Busy</li> <li>■ Ok</li> <li>■ Density adjust failure</li> <li>■ Measure density 1</li> <li>■ Measure density 2</li> <li>■ Calculate</li> <li>■ Restore original</li> </ul>	-
Progress	-	Shows the progress of the process.	0 to 100 %	-
Density adjustment factor	-		Signed floating-point number	-
Density adjustment offset	-		Signed floating-point number	-

### Zero verification and zero adjustment

All measuring instruments are calibrated in accordance with state-of-the-art technology. Calibration takes place under reference conditions →  155. Therefore, a zero adjustment in the field is generally not required.

Experience shows that zero adjustment is advisable only in special cases:

- To achieve maximum measurement accuracy even with low flow rates.
- Under extreme process or operating conditions (e.g. very high process temperatures or very high-viscosity fluids).
- For gas applications with low pressure

 To achieve the highest possible measurement accuracy at low flow rates, the installation must protect the sensor from mechanical stresses during operation.

To get a representative zero point, ensure that:

- any flow in the device is prevented during the adjustment
- the process conditions (e.g. pressure, temperature) are stable and representative

Zero verification and zero adjustment cannot be performed if the following process conditions are present:

- Gas pockets  
Ensure that the system has been sufficiently flushed with the medium. Repeat flushing can help to eliminate gas pockets
- Thermal circulation  
In the event of temperature differences (e.g. between the measuring tube inlet and outlet section), induced flow can occur even if the valves are closed due to thermal circulation in the device
- Leaks at the valves  
If the valves are not leak-tight, flow is not sufficiently prevented when determining the zero point

If these conditions cannot be avoided, it is advisable to keep the factory setting for the zero point.

### Navigation

"Setup" menu → Advanced setup → Sensor adjustment → Zero point adjustment

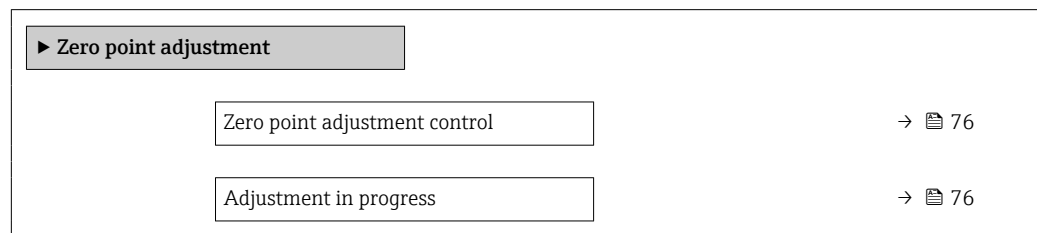

### Parameter overview with brief description

Parameter	Prerequisite	Description	Selection / User interface
Zero point adjustment control	-	Start zero point adjustment.	<ul style="list-style-type: none"> <li>▪ Cancel</li> <li>▪ Busy</li> <li>▪ Zero point adjust failure</li> <li>▪ Start</li> </ul>
Adjustment in progress	In the <b>Zero point adjustment control</b> parameter, the <b>Start</b> option is selected.		0 to 100 %

## 10.5.2 Configuring the pulse/frequency/switch output

The **Pulse/frequency/switch output** wizard guides you systematically through all the parameters that can be set for configuring the selected output type.

**Navigation**

"Setup" menu → Pulse/frequency/switch output

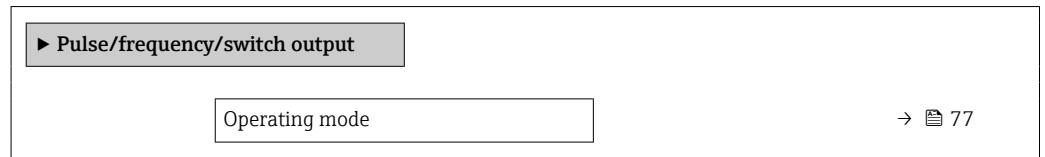

**Parameter overview with brief description**

Parameter	Description	Selection
Operating mode	Define the output as a pulse, frequency or switch output.	<ul style="list-style-type: none"> <li>■ Pulse</li> <li>■ Frequency</li> <li>■ Switch</li> </ul>

**Configuring the pulse output**

**Navigation**

"Setup" menu → Advanced setup → Pulse/frequency/switch output

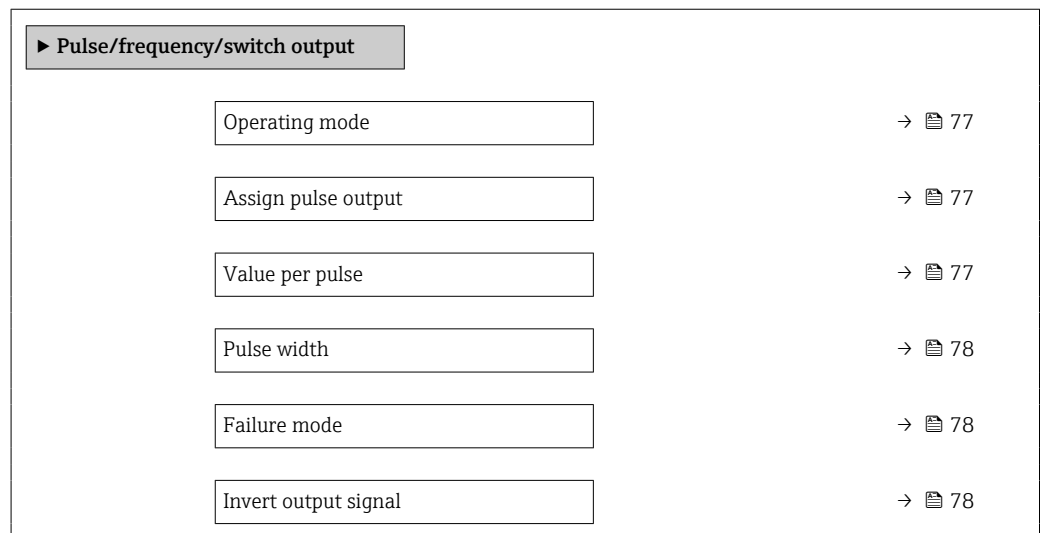

**Parameter overview with brief description**

Parameter	Prerequisite	Description	Selection / User entry	Factory setting
Operating mode	–	Define the output as a pulse, frequency or switch output.	<ul style="list-style-type: none"> <li>■ Pulse</li> <li>■ Frequency</li> <li>■ Switch</li> </ul>	–
Assign pulse output	The <b>Pulse</b> option is selected in <b>Operating mode</b> parameter.	Select process variable for pulse output.	<ul style="list-style-type: none"> <li>■ Off</li> <li>■ Mass flow</li> <li>■ Volume flow</li> <li>■ Corrected volume flow</li> </ul>	–
Value per pulse	The <b>Pulse</b> option is selected in the <b>Operating mode</b> parameter (→ 77) and a process variable is selected in the <b>Assign pulse output</b> parameter (→ 77).	Enter measured value at which a pulse is output.	Positive floating point number	Depends on country and nominal diameter

Parameter	Prerequisite	Description	Selection / User entry	Factory setting
Pulse width	The <b>Pulse</b> option is selected in the <b>Operating mode</b> parameter (→ 77) and a process variable is selected in the <b>Assign pulse output</b> parameter (→ 77).	Define time width of the output pulse.	5 to 2 000 ms	–
Failure mode	The <b>Pulse</b> option is selected in the <b>Operating mode</b> parameter (→ 77) and a process variable is selected in the <b>Assign pulse output</b> parameter (→ 77).	Define output behavior in alarm condition.	<ul style="list-style-type: none"> <li>▪ Actual value</li> <li>▪ No pulses</li> </ul>	–
Invert output signal	–	Invert the output signal.	<ul style="list-style-type: none"> <li>▪ No</li> <li>▪ Yes</li> </ul>	–

### Configuring the frequency output

#### Navigation

"Setup" menu → Advanced setup → Pulse/frequency/switch output

► Pulse/frequency/switch output	
Operating mode	→ 79
Assign frequency output	→ 79
Minimum frequency value	→ 79
Maximum frequency value	→ 79
Measuring value at minimum frequency	→ 79
Measuring value at maximum frequency	→ 79
Failure mode	→ 79
Failure frequency	→ 80
Invert output signal	→ 80

## Parameter overview with brief description

Parameter	Prerequisite	Description	Selection / User entry	Factory setting
Operating mode	–	Define the output as a pulse, frequency or switch output.	<ul style="list-style-type: none"> <li>■ Pulse</li> <li>■ Frequency</li> <li>■ Switch</li> </ul>	–
Assign frequency output	The <b>Frequency</b> option is selected in <b>Operating mode</b> parameter (→ 77).	Select process variable for frequency output.	<ul style="list-style-type: none"> <li>■ Off</li> <li>■ Mass flow</li> <li>■ Volume flow</li> <li>■ Corrected volume flow</li> <li>■ Density</li> <li>■ Reference density</li> <li>■ Temperature</li> <li>■ Carrier pipe temperature</li> <li>■ Electronic temperature</li> <li>■ Oscillation frequency</li> <li>■ Oscillation amplitude</li> <li>■ Oscillation damping</li> <li>■ Signal asymmetry</li> </ul>	–
Minimum frequency value	The <b>Frequency</b> option is selected in the <b>Operating mode</b> parameter (→ 77) and a process variable is selected in the <b>Assign frequency output</b> parameter (→ 79).	Enter minimum frequency.	0 to 1000 Hz	0 Hz
Maximum frequency value	The <b>Frequency</b> option is selected in the <b>Operating mode</b> parameter (→ 77) and a process variable is selected in the <b>Assign frequency output</b> parameter (→ 79).	Enter maximum frequency.	0 to 1000 Hz	1000 Hz
Measuring value at minimum frequency	The <b>Frequency</b> option is selected in the <b>Operating mode</b> parameter (→ 77) and a process variable is selected in the <b>Assign frequency output</b> parameter (→ 79).	Enter measured value for minimum frequency.	Signed floating-point number	Depends on country and nominal diameter
Measuring value at maximum frequency	The <b>Frequency</b> option is selected in the <b>Operating mode</b> parameter (→ 77) and a process variable is selected in the <b>Assign frequency output</b> parameter (→ 79).	Enter measured value for maximum frequency.	Signed floating-point number	Depends on country and nominal diameter
Failure mode	The <b>Frequency</b> option is selected in the <b>Operating mode</b> parameter (→ 77) and a process variable is selected in the <b>Assign frequency output</b> parameter (→ 79).	Define output behavior in alarm condition.	<ul style="list-style-type: none"> <li>■ Actual value</li> <li>■ Defined value</li> <li>■ 0 Hz</li> </ul>	–

Parameter	Prerequisite	Description	Selection / User entry	Factory setting
Failure frequency	In the <b>Operating mode</b> parameter (→ 77), the <b>Frequency</b> option is selected, in the <b>Assign frequency output</b> parameter (→ 79) a process variable is selected, and in the <b>Failure mode</b> parameter, the <b>Defined value</b> option is selected.	Enter frequency output value in alarm condition.	0.0 to 1 250.0 Hz	–
Invert output signal	–	Invert the output signal.	<ul style="list-style-type: none"> <li>▪ No</li> <li>▪ Yes</li> </ul>	–

### Configuring the switch output

#### Navigation

"Setup" menu → Advanced setup → Pulse/frequency/switch output

► Pulse/frequency/switch output	
Operating mode	→ 81
Switch output function	→ 81
Assign diagnostic behavior	→ 81
Assign limit	→ 81
Assign flow direction check	→ 81
Assign status	→ 81
Switch-on value	→ 81
Switch-off value	→ 81
Switch-on delay	→ 81
Switch-off delay	→ 82
Failure mode	→ 82
Invert output signal	→ 82



## Parameter overview with brief description

Parameter	Prerequisite	Description	Selection / User entry	Factory setting
Operating mode	–	Define the output as a pulse, frequency or switch output.	<ul style="list-style-type: none"> <li>■ Pulse</li> <li>■ Frequency</li> <li>■ Switch</li> </ul>	–
Switch output function	The <b>Switch</b> option is selected in the <b>Operating mode</b> parameter.	Select function for switch output.	<ul style="list-style-type: none"> <li>■ Off</li> <li>■ On</li> <li>■ Diagnostic behavior</li> <li>■ Limit</li> <li>■ Flow direction check</li> <li>■ Status</li> </ul>	–
Assign diagnostic behavior	<ul style="list-style-type: none"> <li>■ In the <b>Operating mode</b> parameter, the <b>Switch</b> option is selected.</li> <li>■ In the <b>Switch output function</b> parameter, the <b>Diagnostic behavior</b> option is selected.</li> </ul>	Select diagnostic behavior for switch output.	<ul style="list-style-type: none"> <li>■ Alarm</li> <li>■ Alarm or warning</li> <li>■ Warning</li> </ul>	–
Assign limit	<ul style="list-style-type: none"> <li>■ The <b>Switch</b> option is selected in <b>Operating mode</b> parameter.</li> <li>■ The <b>Limit</b> option is selected in <b>Switch output function</b> parameter.</li> </ul>	Select process variable for limit function.	<ul style="list-style-type: none"> <li>■ Mass flow</li> <li>■ Volume flow</li> <li>■ Corrected volume flow</li> <li>■ Density</li> <li>■ Reference density</li> <li>■ Temperature</li> <li>■ Totalizer 1</li> <li>■ Totalizer 2</li> <li>■ Totalizer 3</li> </ul>	–
Assign flow direction check	<ul style="list-style-type: none"> <li>■ The <b>Switch</b> option is selected in the <b>Operating mode</b> parameter.</li> <li>■ The <b>Flow direction check</b> option is selected in the <b>Switch output function</b> parameter.</li> </ul>	Select process variable for flow direction monitoring.		–
Assign status	<ul style="list-style-type: none"> <li>■ The <b>Switch</b> option is selected in <b>Operating mode</b> parameter.</li> <li>■ The <b>Status</b> option is selected in <b>Switch output function</b> parameter.</li> </ul>	Select device status for switch output.	<ul style="list-style-type: none"> <li>■ Partially filled pipe detection</li> <li>■ Low flow cut off</li> <li>■ Digital output 6</li> </ul>	–
Switch-on value	<ul style="list-style-type: none"> <li>■ The <b>Switch</b> option is selected in the <b>Operating mode</b> parameter.</li> <li>■ The <b>Limit</b> option is selected in the <b>Switch output function</b> parameter.</li> </ul>	Enter measured value for the switch-on point.	Signed floating-point number	Depends on country: <ul style="list-style-type: none"> <li>■ 0 kg/h</li> <li>■ 0 lb/min</li> </ul>
Switch-off value	<ul style="list-style-type: none"> <li>■ The <b>Switch</b> option is selected in the <b>Operating mode</b> parameter.</li> <li>■ The <b>Limit</b> option is selected in the <b>Switch output function</b> parameter.</li> </ul>	Enter measured value for the switch-off point.	Signed floating-point number	Depends on country: <ul style="list-style-type: none"> <li>■ 0 kg/h</li> <li>■ 0 lb/min</li> </ul>
Switch-on delay	<ul style="list-style-type: none"> <li>■ The <b>Switch</b> option is selected in the <b>Operating mode</b> parameter.</li> <li>■ The <b>Limit</b> option is selected in the <b>Switch output function</b> parameter.</li> </ul>	Define delay for the switch-on of status output.	0.0 to 100.0 s	–

Parameter	Prerequisite	Description	Selection / User entry	Factory setting
Switch-off delay	<ul style="list-style-type: none"> <li>The <b>Switch</b> option is selected in the <b>Operating mode</b> parameter.</li> <li>The <b>Limit</b> option is selected in the <b>Switch output function</b> parameter.</li> </ul>	Define delay for the switch-off of status output.	0.0 to 100.0 s	-
Failure mode	-	Define output behavior in alarm condition.	<ul style="list-style-type: none"> <li>Actual status</li> <li>Open</li> <li>Closed</li> </ul>	-
Invert output signal	-	Invert the output signal.	<ul style="list-style-type: none"> <li>No</li> <li>Yes</li> </ul>	-

### 10.5.3 Configuring the totalizer

In the "**Totalizer 1 to n**" submenu, you can configure the specific totalizer.

#### Navigation

"Setup" menu → Advanced setup → Totalizer 1 to n

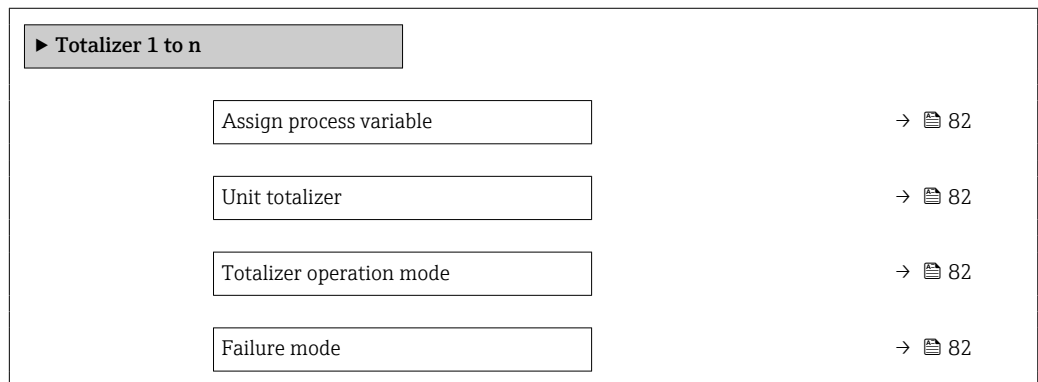

#### Parameter overview with brief description

Parameter	Prerequisite	Description	Selection	Factory setting
Assign process variable	-	Select process variable for totalizer.	<ul style="list-style-type: none"> <li>Off</li> <li>Volume flow</li> <li>Mass flow</li> <li>Corrected volume flow</li> </ul>	-
Unit totalizer	A process variable is selected in the <b>Assign process variable</b> parameter (→ 82) of the <b>Totalizer 1 to n</b> submenu.	Select process variable totalizer unit.	Unit choose list	Depends on country: <ul style="list-style-type: none"> <li>l</li> <li>gal (us)</li> </ul>
Totalizer operation mode	A process variable is selected in the <b>Assign process variable</b> parameter (→ 82) of the <b>Totalizer 1 to n</b> submenu.	Select totalizer calculation mode.	<ul style="list-style-type: none"> <li>Net flow total</li> <li>Forward flow total</li> <li>Reverse flow total</li> </ul>	-
Failure mode	A process variable is selected in the <b>Assign process variable</b> parameter (→ 82) of the <b>Totalizer 1 to n</b> submenu.	Define totalizer behavior in alarm condition.	<ul style="list-style-type: none"> <li>Stop</li> <li>Actual value</li> <li>Last valid value</li> </ul>	-

### 10.5.4 Carrying out additional display configurations

In the **Display** submenu you can set all the parameters associated with the configuration of the local display.

#### Navigation

"Setup" menu → Advanced setup → Display

► Display	
Format display	→ 84
Value 1 display	→ 84
0% bargraph value 1	→ 84
100% bargraph value 1	→ 84
Decimal places 1	→ 84
Value 2 display	→ 84
Decimal places 2	→ 84
Value 3 display	→ 84
0% bargraph value 3	→ 84
100% bargraph value 3	→ 84
Decimal places 3	→ 84
Value 4 display	→ 84
Decimal places 4	→ 84
Language	→ 85
Display interval	→ 85
Display damping	→ 85
Header	→ 85
Header text	→ 85
Separator	→ 85
Backlight	→ 85

## Parameter overview with brief description

Parameter	Prerequisite	Description	Selection / User entry	Factory setting
Format display	A local display is provided.	Select how measured values are shown on the display.	<ul style="list-style-type: none"> <li>▪ 1 value, max. size</li> <li>▪ 1 bargraph + 1 value</li> <li>▪ 2 values</li> <li>▪ 1 value large + 2 values</li> <li>▪ 4 values</li> </ul>	–
Value 1 display	A local display is provided.	Select the measured value that is shown on the local display.	<ul style="list-style-type: none"> <li>▪ Mass flow</li> <li>▪ Volume flow</li> <li>▪ Corrected volume flow</li> <li>▪ Density</li> <li>▪ Reference density</li> <li>▪ Temperature</li> <li>▪ Totalizer 1</li> <li>▪ Totalizer 2</li> <li>▪ Totalizer 3</li> </ul>	–
0% bargraph value 1	A local display is provided.	Enter 0% value for bar graph display.	Signed floating-point number	Country-specific: <ul style="list-style-type: none"> <li>▪ 0 kg/h</li> <li>▪ 0 lb/min</li> </ul>
100% bargraph value 1	A local display is provided.	Enter 100% value for bar graph display.	Signed floating-point number	Depends on country and nominal diameter
Decimal places 1	A measured value is specified in the <b>Value 1 display</b> parameter.	Select the number of decimal places for the display value.	<ul style="list-style-type: none"> <li>▪ x</li> <li>▪ x.x</li> <li>▪ x.xx</li> <li>▪ x.xxx</li> <li>▪ x.xxxx</li> </ul>	–
Value 2 display	A local display is provided.	Select the measured value that is shown on the local display.	For the picklist, see <b>Value 1 display</b> parameter (→ 68)	–
Decimal places 2	A measured value is specified in the <b>Value 2 display</b> parameter.	Select the number of decimal places for the display value.	<ul style="list-style-type: none"> <li>▪ x</li> <li>▪ x.x</li> <li>▪ x.xx</li> <li>▪ x.xxx</li> <li>▪ x.xxxx</li> </ul>	–
Value 3 display	A local display is provided.	Select the measured value that is shown on the local display.	For the picklist, see <b>Value 1 display</b> parameter (→ 68)	–
0% bargraph value 3	A selection was made in the <b>Value 3 display</b> parameter.	Enter 0% value for bar graph display.	Signed floating-point number	Country-specific: <ul style="list-style-type: none"> <li>▪ 0 kg/h</li> <li>▪ 0 lb/min</li> </ul>
100% bargraph value 3	A selection was made in the <b>Value 3 display</b> parameter.	Enter 100% value for bar graph display.	Signed floating-point number	–
Decimal places 3	A measured value is specified in the <b>Value 3 display</b> parameter.	Select the number of decimal places for the display value.	<ul style="list-style-type: none"> <li>▪ x</li> <li>▪ x.x</li> <li>▪ x.xx</li> <li>▪ x.xxx</li> <li>▪ x.xxxx</li> </ul>	–
Value 4 display	A local display is provided.	Select the measured value that is shown on the local display.	For the picklist, see <b>Value 1 display</b> parameter (→ 68)	–
Decimal places 4	A measured value is specified in the <b>Value 4 display</b> parameter.	Select the number of decimal places for the display value.	<ul style="list-style-type: none"> <li>▪ x</li> <li>▪ x.x</li> <li>▪ x.xx</li> <li>▪ x.xxx</li> <li>▪ x.xxxx</li> </ul>	–

Parameter	Prerequisite	Description	Selection / User entry	Factory setting
Language	A local display is provided.	Set display language.	<ul style="list-style-type: none"> <li>■ English *</li> <li>■ Deutsch *</li> <li>■ Français *</li> <li>■ Español *</li> <li>■ Italiano *</li> <li>■ Nederlands *</li> <li>■ Portuguesa *</li> <li>■ Polski *</li> <li>■ русский язык (Russian) *</li> <li>■ Svenska *</li> <li>■ Türkçe *</li> <li>■ 中文 (Chinese) *</li> <li>■ 日本語 (Japanese) *</li> <li>■ 한국어 (Korean) *</li> <li>■ tiếng Việt (Vietnamese) *</li> <li>■ čeština (Czech) *</li> </ul>	English (alternatively, the ordered language is preset in the device)
Display interval	A local display is provided.	Set time measured values are shown on display if display alternates between values.	1 to 10 s	–
Display damping	A local display is provided.	Set display reaction time to fluctuations in the measured value.	0.0 to 999.9 s	–
Header	A local display is provided.	Select header contents on local display.	<ul style="list-style-type: none"> <li>■ Device tag</li> <li>■ Free text</li> </ul>	–
Header text	The <b>Free text</b> option is selected in the <b>Header</b> parameter.	Enter display header text.	Max. 12 characters, such as letters, numbers or special characters (e.g. @, %, /)	–
Separator	A local display is provided.	Select decimal separator for displaying numerical values.	<ul style="list-style-type: none"> <li>■ . (point)</li> <li>■ , (comma)</li> </ul>	. (point)
Backlight	Order code for "Display; operation", option <b>E</b> "SD03 4-line, illum.; touch control + data backup function"	Switch the local display backlight on and off.	<ul style="list-style-type: none"> <li>■ Disable</li> <li>■ Enable</li> </ul>	–

\* Visibility depends on order options or device settings

### 10.5.5 Using parameters for device administration

The **Administration** submenu systematically guides the user through all the parameters that can be used for device administration purposes.

**Navigation**

"Setup" menu → Advanced setup → Administration

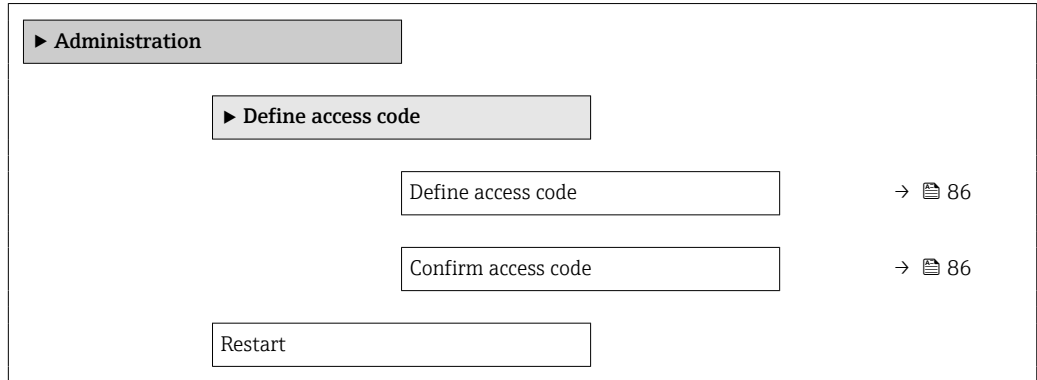

**Parameter overview with brief description**

Parameter	Description	User entry / Selection
Define access code	Restrict write-access to parameters to protect the configuration of the device against unintentional changes via the local display.	0 to 9 999
Confirm access code	Confirm the entered access code.	0 to 9 999
Device reset	Reset the device configuration - either entirely or in part - to a defined state.	<ul style="list-style-type: none"> <li>▪ Cancel</li> <li>▪ To delivery settings</li> <li>▪ Restart device</li> <li>▪ Restore S-DAT backup *</li> </ul>

\* Visibility depends on order options or device settings

**10.6 Configuration management**

After commissioning, you can save the current device configuration, copy it to another measuring point or restore the previous device configuration. The device configuration is managed via the **Configuration management** parameter.

**Navigation**

"Setup" menu → Advanced setup → Configuration backup display

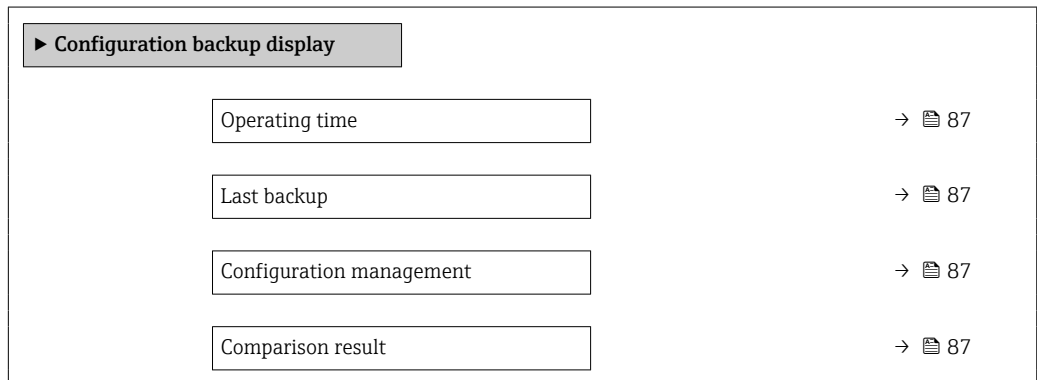

### Parameter overview with brief description

Parameter	Prerequisite	Description	User interface / Selection
Operating time	–	Indicates how long the device has been in operation.	Days (d), hours (h), minutes (m) and seconds (s)
Last backup	A local display is provided.	Indicates when the last data backup was saved to the display module.	Days (d), hours (h), minutes (m) and seconds (s)
Configuration management	A local display is provided.	Select action for managing the device data in the display module.	<ul style="list-style-type: none"> <li>■ Cancel</li> <li>■ Execute backup</li> <li>■ Restore</li> <li>■ Duplicate</li> <li>■ Compare</li> <li>■ Clear backup data</li> <li>■ Display incompatible</li> </ul>
Comparison result	A local display is provided.	Comparison between present device data and display backup.	<ul style="list-style-type: none"> <li>■ Settings identical</li> <li>■ Settings not identical</li> <li>■ No backup available</li> <li>■ Backup settings corrupt</li> <li>■ Check not done</li> <li>■ Dataset incompatible</li> </ul>

#### 10.6.1 Function scope of the "Configuration management" parameter

Options	Description
Cancel	No action is executed and the user exits the parameter.
Execute backup	A backup copy of the current device configuration is saved from the HistoROM backup to the display module of the device. The backup copy includes the transmitter data of the device.
Restore	The last backup copy of the device configuration is restored from the display module to the device's HistoROM backup. The backup copy includes the transmitter data of the device.
Compare	The device configuration saved in the display module is compared with the current device configuration of the HistoROM backup.
Duplicate	The transmitter configuration from another device is duplicated to the device using the display module.
Clear backup data	The backup copy of the device configuration is deleted from the display module of the device.
Display incompatible	This option is displayed if the display module is incompatible. All of the other options are not available. Selection is therefore not possible. This option is displayed if it is not possible to save the device and fieldbus data. The display module should be updated to the latest software version so that the data can be saved.

#### *HistoROM backup*

A HistoROM is a "non-volatile" device memory in the form of an EEPROM.

 While this action is in progress, the configuration cannot be edited via the local display and a message on the processing status appears on the display.

## 10.7 Simulation

Via the **Simulation** submenu, it is possible to simulate various process variables in the process and the device alarm mode and verify downstream signal chains (switching valves or closed-control loops). The simulation can be performed without a real measurement (no flow of medium through the device).

### Activating and deactivating simulation mode via DIP switch

The following hardware settings can be made for the FOUNDATION Fieldbus via DIP switch 4 on the main electronics module:

- Enable/block simulation mode in the function blocks (e.g. **Analog Input** or **Discrete Output** function block)
- Simulation mode enabled (factory setting) = simulation in the **Analog Input** or **Discrete Output** function block possible
- Simulation mode blocked = simulation in the **Analog Input** or **Discrete Output** function block not possible

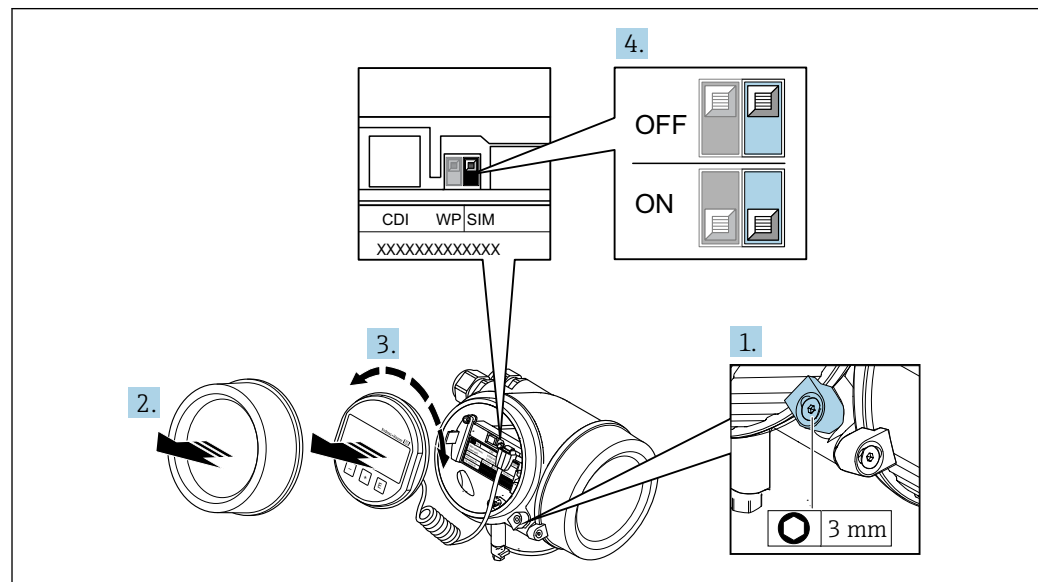

A0046502





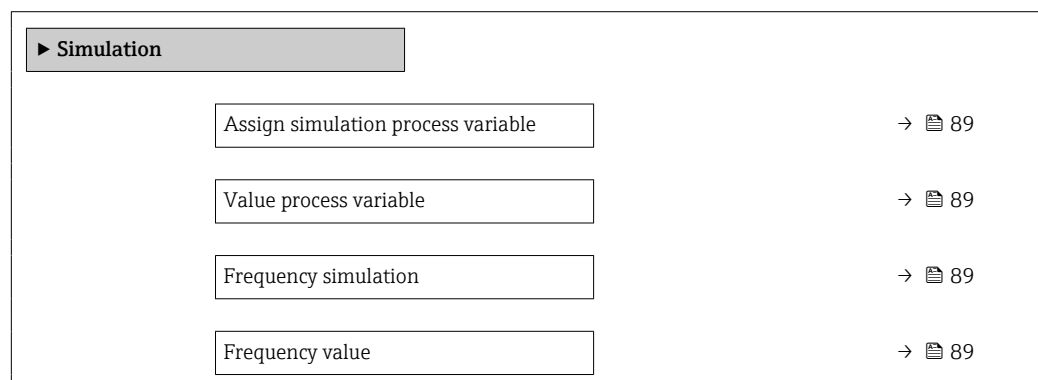

1. Loosen the securing clamp.
2. Unscrew the electronics compartment cover.
3. Pull out the display module with a gentle rotational movement. To make it easier to access the write protection switch, attach the display module to the edge of the electronics compartment.
4. Set the write protection switch (SIM) on the main electronics module to the **ON** position (factory setting): simulation mode is enabled. Set the write protection switch (SIM) on the main electronics module to the **OFF** position: simulation mode is disabled.
5. Reassemble the transmitter in the reverse order.

### Navigation





"Diagnostics" menu → Simulation





Pulse simulation	→  89
Pulse value	→  89
Switch output simulation	→  90
Switch status	→  90
Simulation device alarm	→  89
Diagnostic event category	→  89
Simulation diagnostic event	→  89

**Parameter overview with brief description**

Parameter	Prerequisite	Description	Selection / User entry
Assign simulation process variable	–	Select a process variable for the simulation process that is activated.	<ul style="list-style-type: none"> <li>▪ Off</li> <li>▪ Mass flow</li> <li>▪ Volume flow</li> <li>▪ Corrected volume flow</li> <li>▪ Density</li> <li>▪ Reference density</li> <li>▪ Temperature</li> </ul>
Value process variable	A process variable is selected in the <b>Assign simulation process variable</b> parameter (→  89).	Enter the simulation value for the selected process variable.	Depends on the process variable selected
Simulation device alarm	–	Switch the device alarm on and off.	<ul style="list-style-type: none"> <li>▪ Off</li> <li>▪ On</li> </ul>
Diagnostic event category	–	Select a diagnostic event category.	<ul style="list-style-type: none"> <li>▪ Sensor</li> <li>▪ Electronics</li> <li>▪ Configuration</li> <li>▪ Process</li> </ul>
Simulation diagnostic event	–		<ul style="list-style-type: none"> <li>▪ Off</li> <li>▪ Diagnostic event picklist (depends on the category selected)</li> </ul>
Frequency simulation	In the <b>Operating mode</b> parameter, the <b>Frequency</b> option is selected.	Switch the simulation of the frequency output on and off.	<ul style="list-style-type: none"> <li>▪ Off</li> <li>▪ On</li> </ul>
Frequency value	In the <b>Frequency simulation</b> parameter, the <b>On</b> option is selected.	Enter the frequency value for the simulation.	0.0 to 1 250.0 Hz
Pulse simulation	In the <b>Operating mode</b> parameter, the <b>Pulse</b> option is selected.	Set and switch off the pulse output simulation.  For <b>Fixed value</b> option: <b>Pulse width</b> parameter (→  78) defines the pulse width of the pulses output.	<ul style="list-style-type: none"> <li>▪ Off</li> <li>▪ Fixed value</li> <li>▪ Down-counting value</li> </ul>
Pulse value	In the <b>Pulse simulation</b> parameter (→  89), the <b>Down-counting value</b> option is selected.	Enter the number of pulses for simulation.	0 to 65 535

Parameter	Prerequisite	Description	Selection / User entry
Switch output simulation	In the <b>Operating mode</b> parameter, the <b>Switch</b> option is selected.	Switch the simulation of the switch output on and off.	<ul style="list-style-type: none"> <li>▪ Off</li> <li>▪ On</li> </ul>
Switch status	In the <b>Switch output simulation</b> parameter (→ ⓘ 90) <b>Switch output simulation 1 to n</b> parameter <b>Switch output simulation 1 to n</b> parameter, the <b>On</b> option is selected.	Select the status of the status output for the simulation.	<ul style="list-style-type: none"> <li>▪ Open</li> <li>▪ Closed</li> </ul>

## 10.8 Protecting settings from unauthorized access

The following options exist for protecting the configuration of the measuring device from unintentional modification after commissioning:

- Write protection via access code
- Write protection via write protection switch
- Write protection via keypad lock
- FOUNDATION Fieldbus: write protection via block operation → ⓘ 92

### 10.8.1 Write protection via access code

The effects of the user-specific access code are as follows:

- Via local operation, the parameters for the measuring device configuration are write-protected and their values can no longer be changed.
- Device access is protected via the Web browser, as are the parameters for the measuring device configuration.

#### Defining the access code via the local display

1. Navigate to the **Enter access code** parameter.
2. Maximum of 16-digit character string comprising numbers, letters and special characters as the access code.
3. Enter the access code again in the to confirm.
  - ↳ The ⓘ symbol appears in front of all write-protected parameters.

- i
  - Disabling parameter write protection via access code → ⓘ 49.
  - If the access code is lost: Resetting the access code .
  - The user role with which the user is currently logged in is displayed in **Access status display** parameter.
    - Navigation path: Operation → Access status display
    - User roles and their access rights → ⓘ 49
- The device automatically locks the write-protected parameters again if a key is not pressed for 10 minutes in the navigation and editing view.
- The device locks the write-protected parameters automatically after 60 s if the user skips back to the operational display mode from the navigation and editing view.

#### Parameters which can always be modified via the local display

Certain parameters that do not affect the measurement are excepted from parameter write protection via the local display. Despite the user-specific access code, they can always be modified, even if the other parameters are locked.

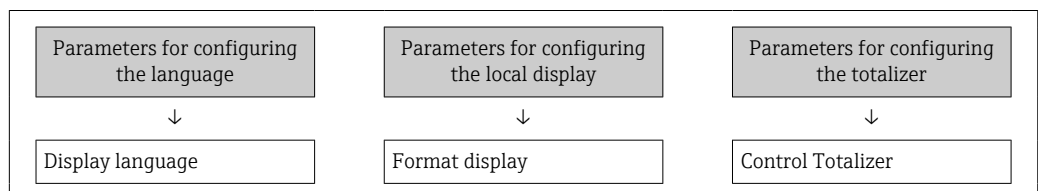

Contrast display	Preset value
Display interval	Reset all totalizers

### 10.8.2 Write protection via write protection switch

Unlike parameter write protection via a user-specific access code, this allows the user to lock write access to the entire operating menu - apart from the **"Contrast display" parameter**.

The parameter values are now read only and cannot be edited any more (exception **"Contrast display" parameter**):

- Via local display
- Via FOUNDATION Fieldbus

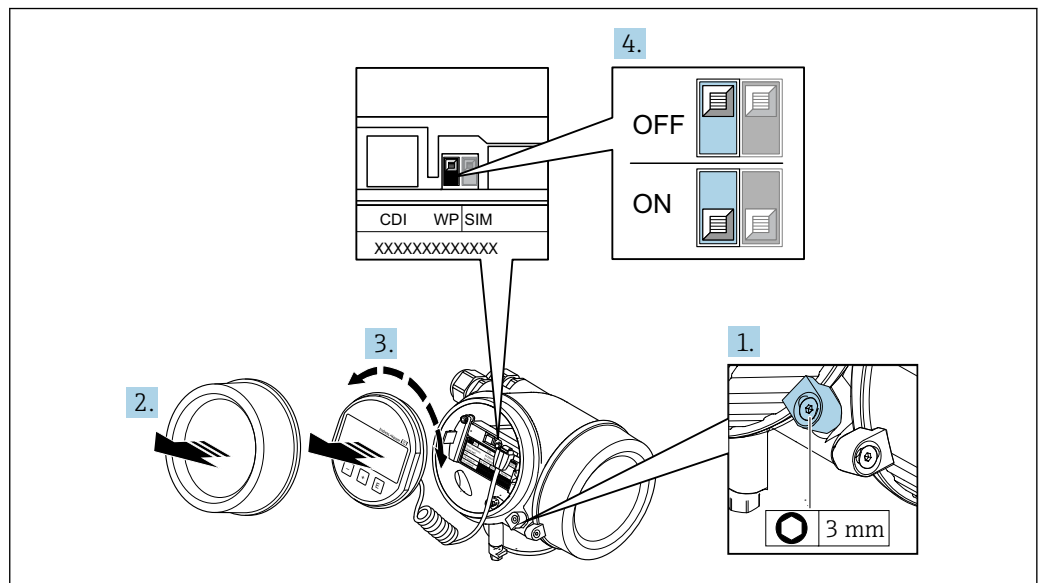

1. Loosen the securing clamp.
2. Unscrew the electronics compartment cover.
3. Pull out the display module with a gentle rotational movement. To make it easier to access the write protection switch, attach the display module to the edge of the electronics compartment.
  - ↳ Display module is attached to the edge of the electronics compartment.

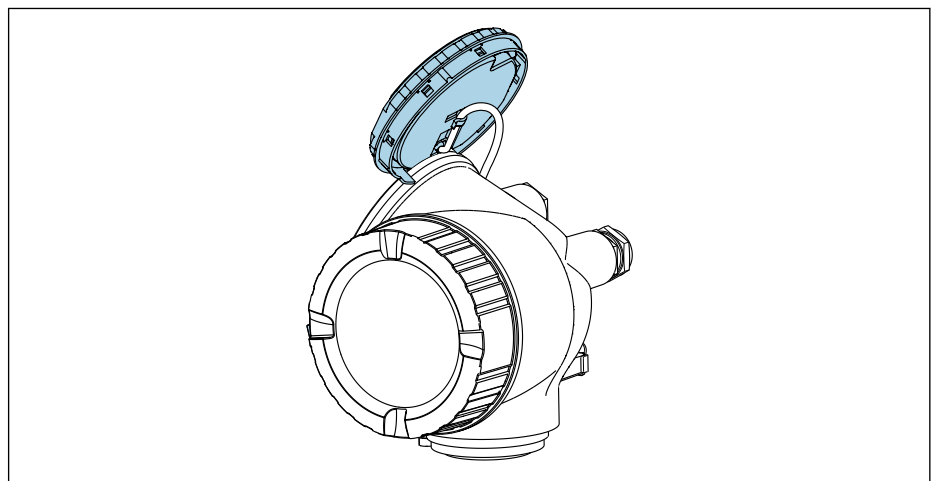

4. Setting the write protection switch (WP) on the main electronics module to the **ON** position enables hardware write protection. Setting the write protection switch (WP) on the main electronics module to the **OFF** position (factory setting) disables hardware write protection.
- ↳ If the hardware write protection is enabled: The **Hardware locked** option is displayed in the **Locking status** parameter . In addition to this, the  symbol appears in the header of the measured value display and in the navigation view in front of the parameters.

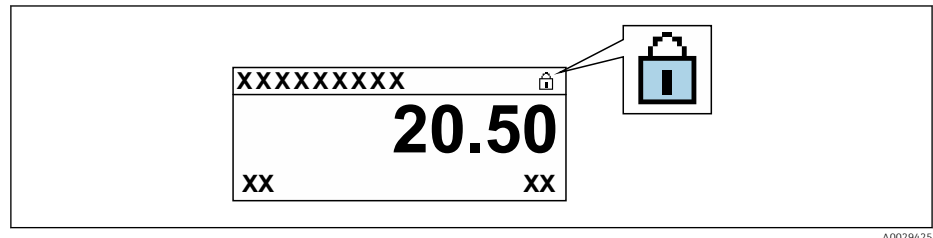

A0029425

If hardware write protection is disabled: No option is displayed in the **Locking status** parameter . On the local display, the  symbol disappears from in front of the parameters in the header of the operational display and in the navigation view.

5. Feed the cable into the gap between the housing and main electronics module and plug the display module into the electronics compartment in the desired direction until it engages.
6. Reassemble the transmitter in the reverse order.

### 10.8.3 Write protection via block operation

Locking via block operation:

- Block: **DISPLAY (TRDDISP)**; parameter: **Define access code**
- Block: **EXPERT\_CONFIG (TRDEXP)**; parameter: **Enter access code**

## 10.9 Configuring the measuring device via FOUNDATION Fieldbus

### 10.9.1 Block configuration

#### Preparation

 The correct Cff and device description files are needed for preparatory purposes.

1. Switch on the device.
2. Make a note of the **DEVICE\_ID**.
3. Open the configuration program.
4. Load Cff and device description files into the host system or the configuration program.
5. Identify the device using the **DEVICE\_ID**.
6. Assign the desired tag name to the device via the **Pd-tag/FF\_PD\_TAG** parameter.

#### Configuring the Resource Block

1. Open the Resource Block.
2. Disable the lock for device operation.
3. Change the block name (optional). Factory setting: RB-xxxxxxxxxxx (RB2)
4. Assign a description to the block via the **Description of the identification tag/TAG\_DESC** parameter.
5. Change other parameters as required.

#### Configuring the Transducer Blocks

The measurement and the display module are configured via the Transducer Blocks.

The basic procedure is the same for all Transducer Blocks.

1. Open the specific Transducer Block.
2. Change the block name (optional).
3. Set the block mode to **OOS** via the **Block mode/MODE\_BLK** parameter, **TARGET** element.
4. Configure the device in accordance with the measuring task
5. Set the block mode to **Auto** via the **Block mode/MODE\_BLK** parameter, **TARGET** element.

 The block mode must be set to **Auto** to ensure the smooth operation of the device.

#### Configuring the Analog Input Blocks

1. Open the Analog Input Block.
2. Change the block name (optional).
3. Set the block mode to **OOS** via the **Block mode/MODE\_BLK** parameter, **TARGET** element.
4. Via the **Channel/CHANNEL** parameter, select the process variable which should be used as the input value for the Analog Input Block.

5. Via the **Transducer scale/XD\_SCALE** parameter, select the desired unit and the block input range for the process variable. The selected unit must suit the selected process variable. If the process variable does not suit the unit, the **Block error/BLOCK\_ERR** parameter reports *Block Configuration Error* and the block mode cannot be set to **Auto**.
6. Via the **Linearization type/L\_TYPE** parameter, select the type of linearization for the input variable (factory setting: **Direct**). In the **Direct** linearization mode, the settings for the **Transducer scale/XD\_SCALE** and **Output scale/OUT\_SCALE** parameters must be identical. If the values do not suit the units, the **Block error/BLOCK\_ERR** parameter reports *Block Configuration Error* and the block mode cannot be set to **Auto**.
7. Enter the alarms and critical alarm messages via the **High alarm limit/ HI\_HI\_LIM**, **High early warning limit/HI\_LIM**, **Low alarm limit/ LO\_LO\_LIM** and **Low early warning limit/LO\_LIM** parameters. The limit values entered must be within the value range specified for the **Output scale/OUT\_SCALE** parameter.
8. Specify the alarm priorities via the **Priority for high limit value alarm/HI\_HI\_PRI**, **Priority for high early warning/HI\_PRI**, **Priority for low limit value alarm/LO\_LO\_PRI** and **Priority for low limit value early warning/LO\_PRI** parameters. Reporting to the field host system only takes place with alarms with a priority greater than 2.
9. Set the block mode to **Auto** via the **Block mode/MODE\_BLK** parameter, **TARGET** element. For this purpose, the Resource Block must also be set to the **Auto** block mode.

#### Additional configuration

1. Link the function blocks and output blocks.
2. After specifying the active LAS, download all the data and parameters to the field device.

### 10.9.2 Scaling the measured value in the Analog Input Block

The measured value can be scaled if the **L\_TYPE = Indirect** linearization type has been selected in the Analog Input Block. **XD\_SCALE** defines the input range with the **EU\_0** and **EU\_100** elements. This is mapped linearly to the output range, defined by **OUT\_SCALE** also with the elements **EU\_0** and **EU\_100**.

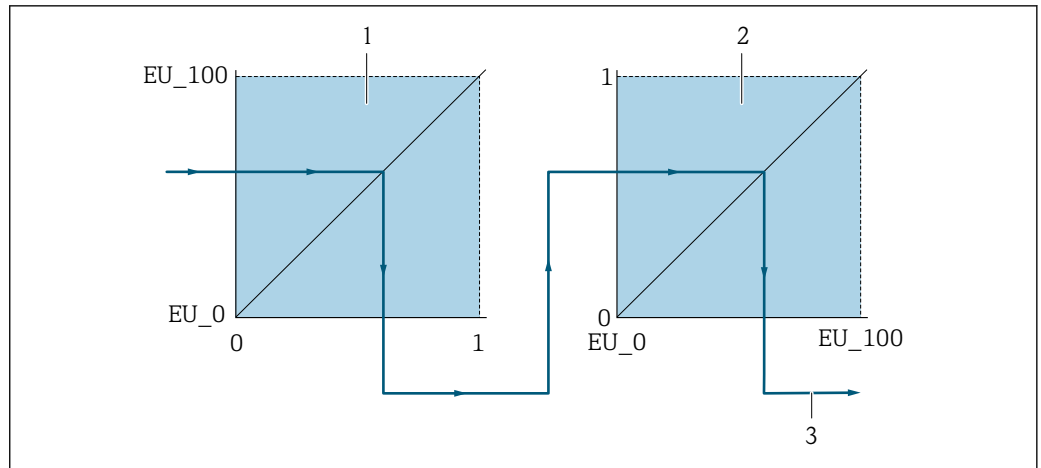

A0032233

18 Scaling the measured value in the Analog Input Block

- 1 XD\_SCALE
- 2 OUT\_SCALE
- 2 OUT\_VALUE

- i
  - If you have selected the **Direct** mode in the **L\_TYPE** parameter, you cannot change the values and units for **XD\_SCALE** and **OUT\_SCALE**.
  - The **L\_TYPE**, **XD\_SCALE** and **OUT\_SCALE** parameters can only be changed in the **OOS** block mode.



## 11 Operation

### 11.1 Reading off the device locking status

Device active write protection: **Locking status** parameter



Operation → Locking status

*Function scope of the "Locking status" parameter*

Options	Description
None	The access authorization displayed in the <b>Access status display</b> parameter applies →  49. Only appears on local display.
Hardware locked	The DIP switch for hardware locking is activated on the main electronics module. This locks write access to the parameters (e.g. via local display or operating tool) →  91.
Temporarily locked	Write access to the parameters is temporarily locked on account of internal processes running in the device (e.g. data upload/download, reset, etc.). Once the internal processing has been completed, the parameters can be changed once again.



### 11.2 Adjusting the operating language

 Detailed information:

- To configure the operating language →  61
- For information on the operating languages supported by the measuring device →  164

### 11.3 Configuring the display

Detailed information:

- On the basic settings for the local display →  67
- On the advanced settings for the local display →  83

### 11.4 Reading off measured values

With the **Measured values** submenu, it is possible to read all the measured values.

#### Navigation

"Diagnostics" menu → Measured values

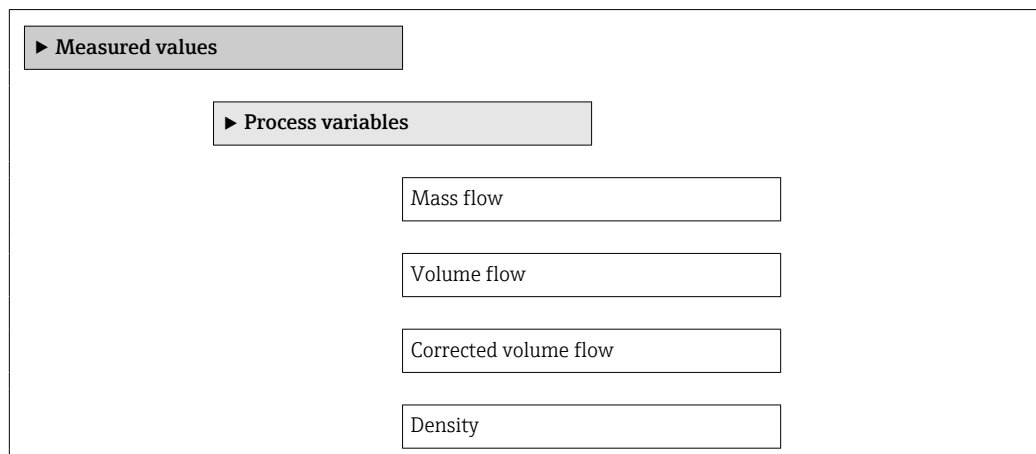



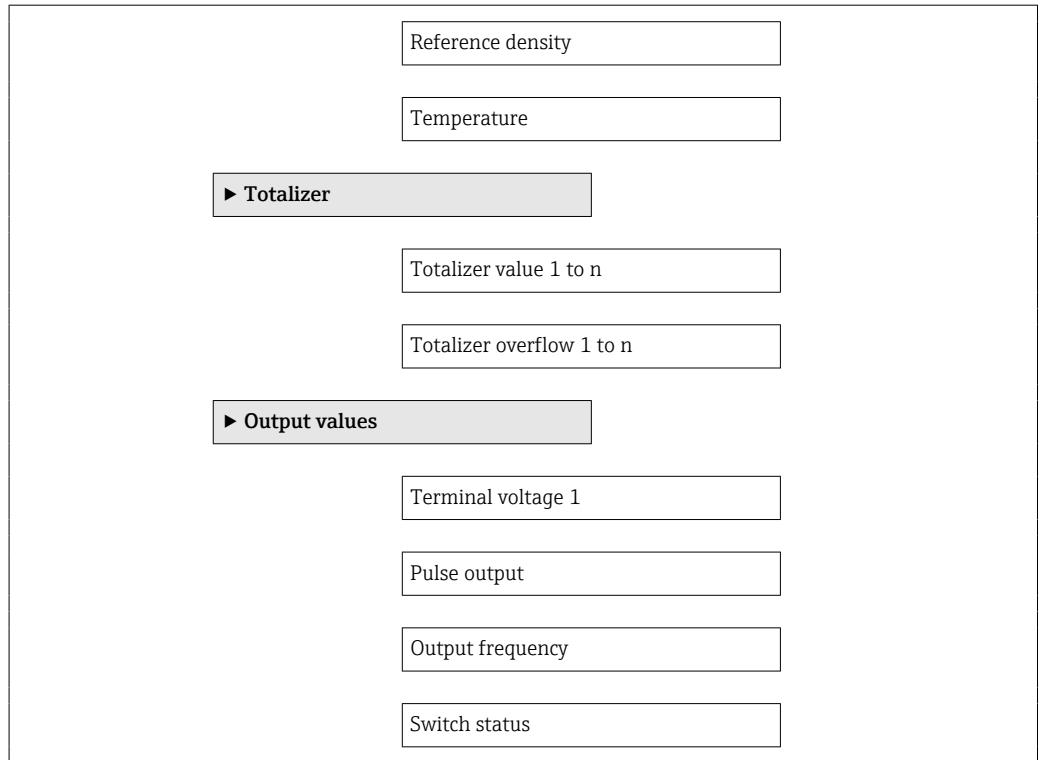

### 11.4.1 Process variables

The **Process variables** submenu contains all the parameters needed to display the current measured values for each process variable.

#### Navigation

"Diagnostics" menu → Measured values → Process variables

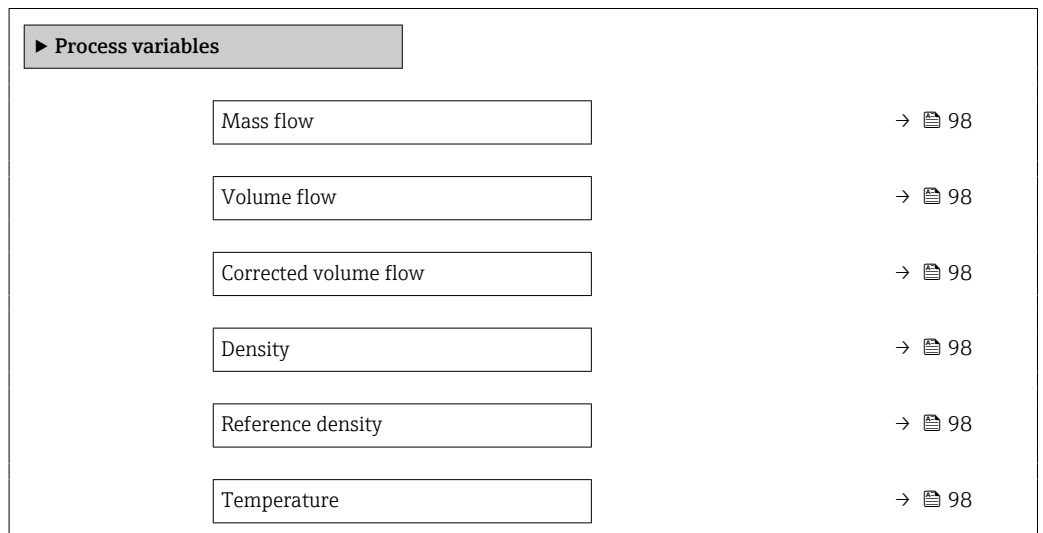

**Parameter overview with brief description**

Parameter	Description	User interface
Mass flow	Displays the mass flow currently measured. <i>Dependency</i> The unit is taken from the <b>Mass flow unit</b> parameter	Signed floating-point number
Volume flow	Displays the volume flow currently measured. <i>Dependency</i> The unit is taken from the <b>Volume flow unit</b> parameter	Signed floating-point number
Corrected volume flow	Displays the corrected volume flow currently calculated. <i>Dependency</i> The unit is taken from the <b>Corrected volume flow unit</b> parameter	Signed floating-point number
Density	Displays the density or specific density currently measured. <i>Dependency</i> The unit is taken from the <b>Density unit</b> parameter	Positive floating-point number
Reference density	Displays the density at the reference temperature. <i>Dependency</i> The unit is taken from the <b>Reference density unit</b> parameter	Positive floating-point number
Temperature	Displays the temperature currently measured. <i>Dependency</i> The unit is taken from the <b>Temperature unit</b> parameter	Positive floating-point number

**11.4.2 "Totalizer" submenu**

The **Totalizer** submenu contains all the parameters needed to display the current measured values for every totalizer.

**Navigation**

"Diagnostics" menu → Measured values → Totalizer

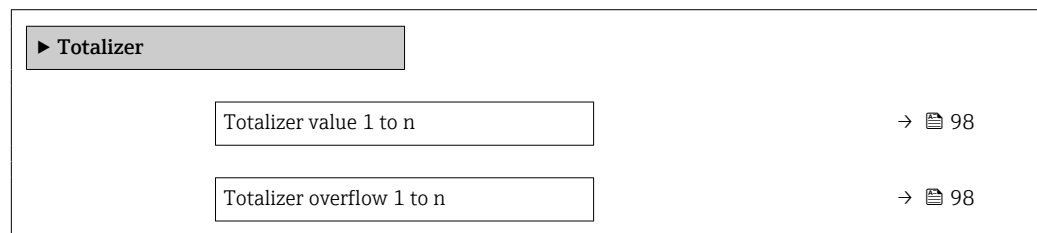

**Parameter overview with brief description**

Parameter	Prerequisite	Description	User interface
Totalizer value 1 to n	One of the following options is selected in the <b>Assign process variable</b> parameter (→ 82) of the <b>Totalizer 1 to n</b> submenu: <ul style="list-style-type: none"> <li>▪ Volume flow</li> <li>▪ Mass flow</li> <li>▪ Corrected volume flow</li> </ul>	Displays the current totalizer counter value.	Signed floating-point number
Totalizer overflow 1 to n	One of the following options is selected in the <b>Assign process variable</b> parameter (→ 82) of the <b>Totalizer 1 to n</b> submenu: <ul style="list-style-type: none"> <li>▪ Volume flow</li> <li>▪ Mass flow</li> <li>▪ Corrected volume flow</li> </ul>	Displays the current totalizer overflow.	Integer with sign

### 11.4.3 Output variables

The **Output values** submenu contains all the parameters needed to display the current measured values for every output.

#### Navigation

"Diagnostics" menu → Measured values → Output values

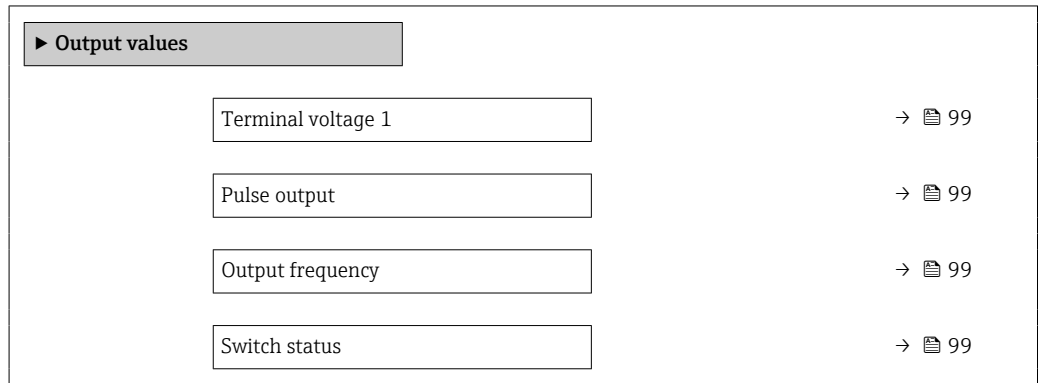

#### Parameter overview with brief description

Parameter	Prerequisite	Description	User interface
Terminal voltage 1	–	Displays the current terminal voltage that is applied at the output.	0.0 to 50.0 V
Pulse output	The <b>Pulse</b> option is selected in the <b>Operating mode</b> parameter parameter.	Displays the pulse frequency currently output.	Positive floating-point number
Output frequency	In the <b>Operating mode</b> parameter, the <b>Frequency</b> option is selected.	Displays the value currently measured for the frequency output.	0 to 1250 Hz
Switch status	The <b>Switch</b> option is selected in the <b>Operating mode</b> parameter.	Displays the current switch output status.	<ul style="list-style-type: none"> <li>▪ Open</li> <li>▪ Closed</li> </ul>

## 11.5 Adapting the measuring device to the process conditions

The following are available for this purpose:

- Basic settings using the **Setup** menu (→ 61)
- Advanced settings using the **Advanced setup** submenu (→ 72)

## 11.6 Performing a totalizer reset





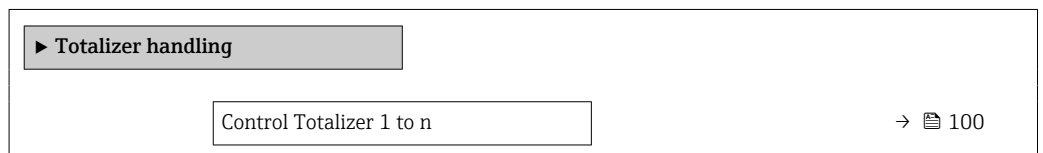

The totalizers are reset in the **Operation** submenu:

- Control Totalizer
- Reset all totalizers







#### Navigation



"Operation" menu → Totalizer handling



Preset value 1 to n	→  100
Totalizer value 1 to n	→  100
Weighted density average	→  100
Weighted temperature average	→  101
Reset weighted averages	→  101
Reset all totalizers	→  101

**Parameter overview with brief description**

Parameter	Prerequisite	Description	Selection / User entry / User interface	Factory setting
Control Totalizer 1 to n	A process variable is selected in the <b>Assign process variable</b> parameter (→  82) of the <b>Totalizer 1 to n</b> submenu.	Control totalizer value.	<ul style="list-style-type: none"> <li>▪ Totalize</li> <li>▪ Reset + hold</li> <li>▪ Preset + hold</li> <li>▪ Reset + totalize</li> <li>▪ Preset + totalize</li> </ul>	-
Preset value 1 to n	A process variable is selected in the <b>Assign process variable</b> parameter (→  82) of the <b>Totalizer 1 to n</b> submenu.	Specify start value for totalizer. <i>Dependency</i>  The unit of the selected process variable is defined in the <b>Unit totalizer</b> parameter (→  82) for the totalizer.	Signed floating-point number	Depends on country: <ul style="list-style-type: none"> <li>▪ 0 l</li> <li>▪ 0 gal (us)</li> </ul>
Totalizer value	One of the following options is selected in the <b>Assign process variable</b> parameter (→  82) of the <b>Totalizer 1 to n</b> submenu: <ul style="list-style-type: none"> <li>▪ Volume flow</li> <li>▪ Mass flow</li> <li>▪ Corrected volume flow</li> </ul>	Displays the current totalizer counter value.	Signed floating-point number	-
Weighted density average	For the following order code: <ul style="list-style-type: none"> <li>▪ "Application package", option <b>EJ</b> "Petroleum"</li> <li>▪ "Application package", option <b>EM</b> "Petroleum + Locking function"</li> </ul>  The software options currently enabled are displayed in the <b>Software option overview</b> parameter.	Displays the weighted average for the density since the last time the density averages were reset. <i>Dependency:</i> <ul style="list-style-type: none"> <li>▪ The unit is taken from: <b>Density unit</b> parameter</li> <li>▪ The value is reset to NaN (Not a Number) via the <b>Reset weighted averages</b> parameter</li> </ul>	Signed floating-point number	-

Parameter	Prerequisite	Description	Selection / User entry / User interface	Factory setting
Weighted temperature average	For the following order code: <ul style="list-style-type: none"> <li>▪ "Application package", option <b>EJ</b> "Petroleum"</li> <li>▪ "Application package", option <b>EM</b> "Petroleum + Locking function"</li> </ul> <p> The software options currently enabled are displayed in the <b>Software option overview</b> parameter.</p>	Displays the weighted average for the temperature since the last time the temperature averages were reset.  Dependency: <ul style="list-style-type: none"> <li>▪ The unit is taken from: <b>Temperature unit</b> parameter</li> <li>▪ The value is reset to NaN (Not a Number) via the <b>Reset weighted averages</b> parameter</li> </ul>	Signed floating-point number	-
Reset weighted averages	The values can only be reset at zero flow.  For the following order code: "Application package", option <b>EJ</b> "Petroleum"  <p> The software options currently enabled are displayed in the <b>Software option overview</b> parameter.</p>	Resets the weighted averages for density and temperature to NaN (Not a Number) and then starts determining the weighted averages.	<ul style="list-style-type: none"> <li>▪ Totalize</li> <li>▪ Preset + totalize</li> </ul>	-
Reset all totalizers	-	Reset all totalizers to 0 and start.	<ul style="list-style-type: none"> <li>▪ Cancel</li> <li>▪ Reset + totalize</li> </ul>	-

### 11.6.1 Function scope of "Control Totalizer" parameter

Options	Description
Totalize	The totalizer is started or continues running.
Reset + hold	The totaling process is stopped and the totalizer is reset to 0.
Preset + hold <sup>1)</sup>	The totaling process is stopped and the totalizer is set to its defined start value from the <b>Preset value</b> parameter.
Reset + totalize	The totalizer is reset to 0 and the totaling process is restarted.
Preset + totalize <sup>1)</sup>	The totalizer is set to the defined start value in the <b>Preset value</b> parameter and the totaling process is restarted.



1) Visible depending on the order options or device settings

### 11.6.2 Function range of "Reset all totalizers" parameter

Options	Description
Cancel	No action is executed and the user exits the parameter.
Reset + totalize	Resets all totalizers to 0 and restarts the totaling process. This deletes all the previously aggregated flow values.

## 11.7 Displaying the measured value history

The **Extended HistoROM** application package must be enabled in the device (order option) for the **Data logging** submenu to appear. This contains all the parameters for the measured value history.

 Data logging is also available via:  
 Plant Asset Management Tool FieldCare →  52.

**Function range**

- A total of 1000 measured values can be stored
- 4 logging channels
- Adjustable logging interval for data logging
- Measured value trend for each logging channel displayed in the form of a chart

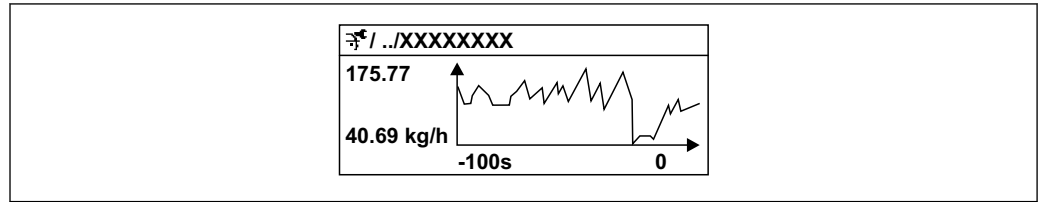

19 Chart of a measured value trend

- x-axis: depending on the number of channels selected displays 250 to 1000 measured values of a process variable.
- y-axis: displays the approximate measured value span and constantly adapts this to the ongoing measurement.

**i** If the length of the logging interval or the assignment of the process variables to the channels is changed, the content of the data logging is deleted.





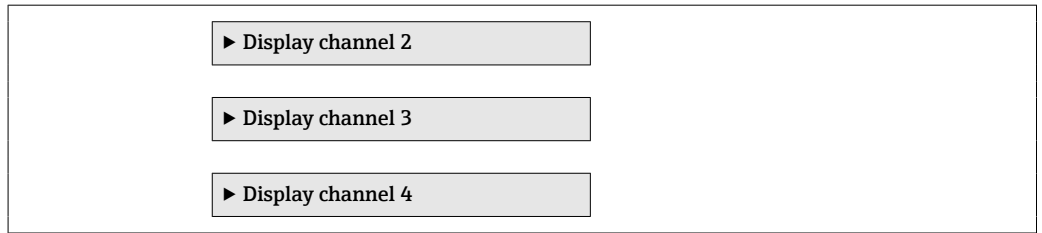

**Navigation**

"Diagnostics" menu → Data logging

<b>► Data logging</b>	
Assign channel 1	→ 103
Assign channel 2	→ 103
Assign channel 3	→ 103
Assign channel 4	→ 103
Logging interval	→ 103
Clear logging data	→ 103
Data logging	→ 103
Logging delay	→ 103
Data logging control	→ 103
Data logging status	→ 104
Entire logging duration	→ 104
<b>► Display channel 1</b>	



**Parameter overview with brief description**

Parameter	Prerequisite	Description	Selection / User entry / User interface
Assign channel 1	The <b>Extended HistoROM</b> application package is available.	Assign process variable to logging channel.	<ul style="list-style-type: none"> <li>■ Off</li> <li>■ Mass flow</li> <li>■ Volume flow</li> <li>■ Corrected volume flow</li> <li>■ Density</li> <li>■ Reference density</li> <li>■ Temperature</li> <li>■ Carrier pipe temperature</li> <li>■ Electronic temperature</li> <li>■ Oscillation frequency</li> <li>■ Oscillation amplitude</li> <li>■ Oscillation damping</li> <li>■ Signal asymmetry</li> </ul>
Assign channel 2	The <b>Extended HistoROM</b> application package is available.  The software options currently enabled are displayed in the <b>Software option overview</b> parameter.		For the picklist, see <b>Assign channel 1</b> parameter (→  103)
Assign channel 3	The <b>Extended HistoROM</b> application package is available.  The software options currently enabled are displayed in the <b>Software option overview</b> parameter.		For the picklist, see <b>Assign channel 1</b> parameter (→  103)
Assign channel 4	The <b>Extended HistoROM</b> application package is available.  The software options currently enabled are displayed in the <b>Software option overview</b> parameter.		For the picklist, see <b>Assign channel 1</b> parameter (→  103)
Logging interval	The <b>Extended HistoROM</b> application package is available.	Define the logging interval for data logging. This value defines the time interval between the individual data points in the memory.	1.0 to 3 600.0 s
Clear logging data	The <b>Extended HistoROM</b> application package is available.	Clear the entire logging data.	<ul style="list-style-type: none"> <li>■ Cancel</li> <li>■ Clear data</li> </ul>
Data logging	–	Select the type of data logging.	<ul style="list-style-type: none"> <li>■ Overwriting</li> <li>■ Not overwriting</li> </ul>
Logging delay	In the <b>Data logging</b> parameter, the <b>Not overwriting</b> option is selected.	Enter the time delay for measured value logging.	0 to 999 h
Data logging control	In the <b>Data logging</b> parameter, the <b>Not overwriting</b> option is selected.	Start and stop measured value logging.	<ul style="list-style-type: none"> <li>■ None</li> <li>■ Delete + start</li> <li>■ Stop</li> </ul>

Parameter	Prerequisite	Description	Selection / User entry / User interface
Data logging status	In the <b>Data logging</b> parameter, the <b>Not overwriting</b> option is selected.	Displays the measured value logging status.	<ul style="list-style-type: none"><li>■ Done</li><li>■ Delay active</li><li>■ Active</li><li>■ Stopped</li></ul>
Entire logging duration	In the <b>Data logging</b> parameter, the <b>Not overwriting</b> option is selected.	Displays the total logging duration.	Positive floating-point number



## 12 Diagnostics and troubleshooting

### 12.1 General troubleshooting





*For local display*

Error	Possible causes	Remedial action
Local display is dark, but signal output is within the valid range	The cable of the display module is not plugged in correctly.	Insert the plug correctly into the main electronics module and display module.
Local display dark and no output signals	Supply voltage does not match the voltage specified on the nameplate.	Apply the correct supply voltage → 31.
Local display dark and no output signals	Supply voltage has incorrect polarity.	Reverse polarity of supply voltage.
Local display dark and no output signals	No contact between connecting cables and terminals.	Ensure electrical contact between the cable and the terminal.
Local display dark and no output signals	<ul style="list-style-type: none"> <li>▪ Terminals are not plugged into the I/O electronics module correctly.</li> <li>▪</li> </ul>	Check terminals.
Local display dark and no output signals	<ul style="list-style-type: none"> <li>▪ I/O electronics module is defective.</li> <li>▪</li> </ul>	Order spare part → 141.
Local display cannot be read, but signal output is within the valid range	Display is set too bright or too dark.	<ul style="list-style-type: none"> <li>▪ Set the display brighter by simultaneously pressing <math>\boxplus</math> + <math>\boxminus</math>.</li> <li>▪ Set the display darker by simultaneously pressing <math>\boxminus</math> + <math>\boxplus</math>.</li> </ul>
Local display is dark, but signal output is within the valid range	Display module is defective.	Order spare part → 141.
Backlighting of local display is red	Diagnostic event with "Alarm" diagnostic behavior has occurred.	Take remedial measures → 116
Text on local display appears in a language that cannot be understood.	The selected operating language cannot be understood.	<ol style="list-style-type: none"> <li>1. Press <math>\boxplus</math> + <math>\boxplus</math> for 2 s ("home position").</li> <li>2. Press <math>\boxminus</math>.</li> <li>3. Configure the required language in the <b>Display language</b> parameter (→ 85).</li> </ol>
Message on local display: "Communication Error" "Check Electronics"	Communication between the display module and the electronics is interrupted.	<ul style="list-style-type: none"> <li>▪ Check the cable and the connector between the main electronics module and display module.</li> <li>▪ Order spare part → 141.</li> </ul>

*For output signals*

Error	Possible causes	Remedial action
Signal output outside the valid range	Main electronics module is defective.	Order spare part → 141.
Device shows correct value on local display, but signal output is incorrect, though in the valid range.	Parameter configuration error	Check and adjust parameter configuration.
Device measures incorrectly.	Configuration error or device is operated outside the application.	<ol style="list-style-type: none"> <li>1. Check and correct parameter configuration.</li> <li>2. Observe limit values specified in the "Technical Data".</li> </ol>

*For access*

Fault	Possible causes	Remedial action
Write access to parameters is not possible.	Hardware write protection is enabled.	Set the write protection switch on the main electronics module to the <b>OFF</b> position →  91.
Write access to parameters is not possible.	Current user role has limited access authorization.	1. Check user role →  49. 2. Enter correct customer-specific access code →  49.
Connection via service interface is not possible.	<ul style="list-style-type: none"> <li>▪ The USB port on the PC is incorrectly configured.</li> <li>▪ The driver is not installed correctly.</li> </ul>	Refer to the documentation on Commubox FXA291:  Technical Information TI00405C

## 12.2 Diagnostic information on local display

### 12.2.1 Diagnostic message

Faults detected by the self-monitoring system of the measuring device are displayed as a diagnostic message in alternation with the operational display.

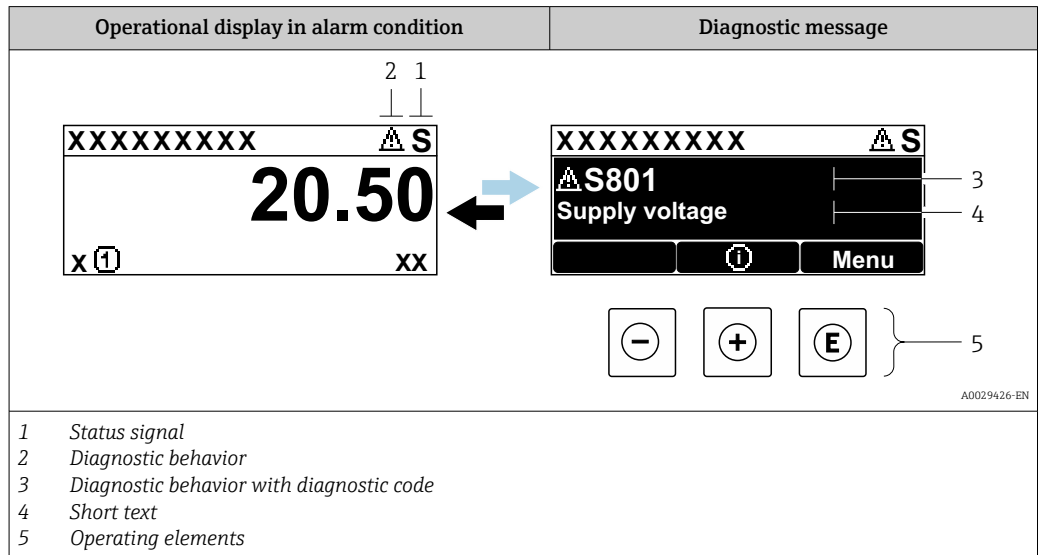

If two or more diagnostic events are pending simultaneously, only the message of the diagnostic event with the highest priority is shown.

- i** Other diagnostic events that have occurred can be displayed in the **Diagnostics** menu:
  - Via parameter → 133
  - Via submenus → 134



#### Status signals

The status signals provide information on the state and reliability of the device by categorizing the cause of the diagnostic information (diagnostic event).

- i** The status signals are categorized according to VDI/VDE 2650 and NAMUR Recommendation NE 107: F = Failure, C = Function Check, S = Out of Specification, M = Maintenance Required

Symbol	Meaning
<b>F</b>	<b>Failure</b> A device error has occurred. The measured value is no longer valid.
<b>C</b>	<b>Function check</b> The device is in service mode (e.g. during a simulation).
<b>S</b>	<b>Out of specification</b> The device is being operated: Outside its technical specification limits (e.g. outside the process temperature range)
<b>M</b>	<b>Maintenance required</b> Maintenance is required. The measured value remains valid.

### Diagnostic behavior



Symbol	Meaning
	<b>Alarm</b> <ul style="list-style-type: none"> <li>Measurement is interrupted.</li> <li>Signal outputs and totalizers assume the defined alarm condition.</li> <li>A diagnostic message is generated.</li> <li>For local display with touch control: the background lighting changes to red.</li> </ul>
	<b>Warning</b> <ul style="list-style-type: none"> <li>Measurement is resumed.</li> <li>The signal outputs and totalizers are not affected.</li> <li>A diagnostic message is generated.</li> </ul>

### Diagnostic information

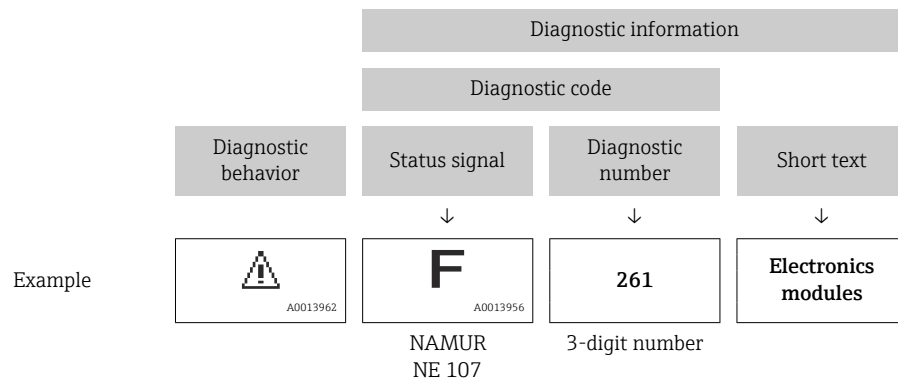
The fault can be identified using the diagnostic information. The short text helps you by providing information about the fault. In addition, the corresponding symbol for the diagnostic behavior is displayed in front of the diagnostic information on the local display.



### Operating elements

Operating key	Meaning
	<b>Plus key</b> <i>In menu, submenu</i> Opens the message about the remedial measures.
	<b>Enter key</b> <i>In menu, submenu</i> Opens the operating menu.

## 12.2.2 Calling up remedial measures

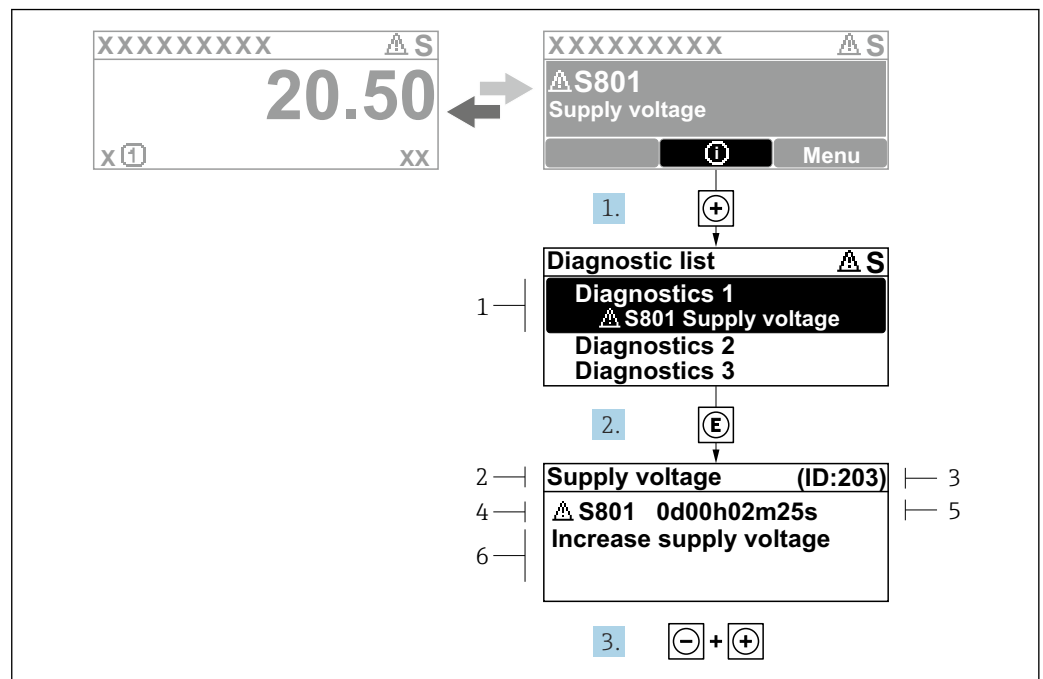

A0029431-EN

### 20 Message for remedial measures

- 1 Diagnostic information
- 2 Short text
- 3 Service ID
- 4 Diagnostic behavior with diagnostic code
- 5 Operation time when error occurred
- 6 Remedial measures

1. The user is in the diagnostic message.  
Press  $\oplus$  ( $\textcircled{1}$  symbol).  
↳ The **Diagnostic list** submenu opens.
2. Select the desired diagnostic event with  $\oplus$  or  $\ominus$  and press  $\textcircled{E}$ .  
↳ The message about the remedial measures opens.
3. Press  $\ominus$  +  $\oplus$  simultaneously.  
↳ The message about the remedial measures closes.

The user is in the **Diagnostics** menu at an entry for a diagnostics event, e.g. in the **Diagnostic list** submenu or **Previous diagnostics** parameter.

1. Press  $\textcircled{E}$ .  
↳ The message for the remedial measures for the selected diagnostic event opens.
2. Press  $\ominus$  +  $\oplus$  simultaneously.  
↳ The message for the remedial measures closes.

## 12.3 Diagnostic information in FieldCare or DeviceCare

### 12.3.1 Diagnostic options

Any faults detected by the measuring device are displayed on the home page of the operating tool once the connection has been established.

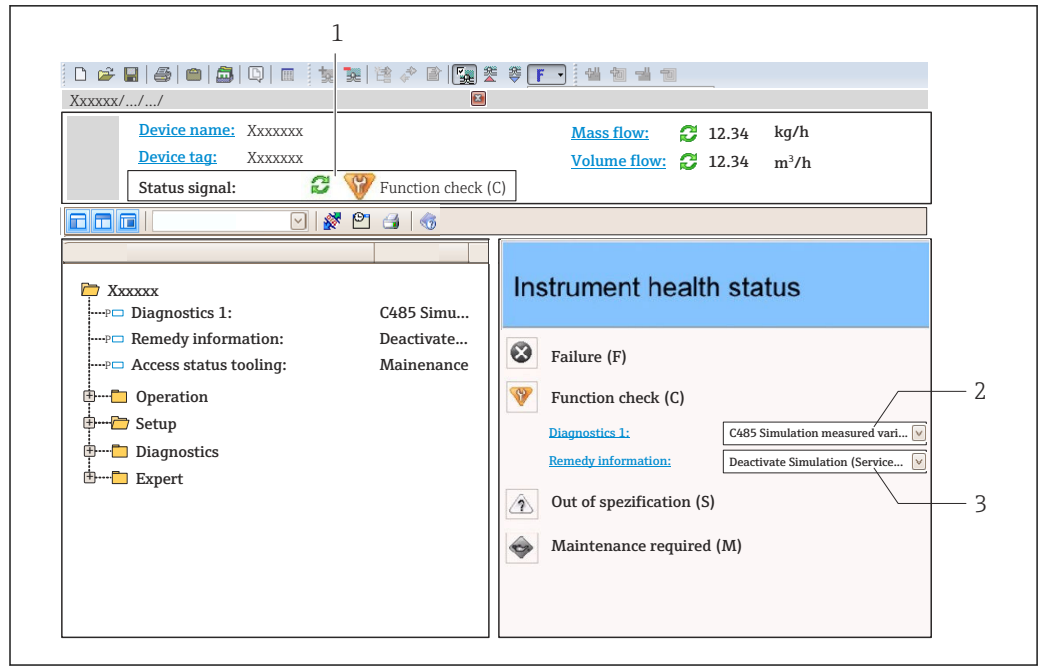

A0021799-EN

- 1 Status area with status signal → 107
- 2 Diagnostic information → 108
- 3 Remedial measures with service ID

**i** In addition, diagnostic events which have occurred can be shown in the **Diagnostics** menu:

- Via parameter → 133
- Via submenu → 134

**Status signals**

The status signals provide information on the state and reliability of the device by categorizing the cause of the diagnostic information (diagnostic event).

Symbol	Meaning
	<b>Failure</b> A device error has occurred. The measured value is no longer valid.
	<b>Function check</b> The device is in service mode (e.g. during a simulation).
	<b>Out of specification</b> The device is being operated: Outside its technical specification limits (e.g. outside the process temperature range)
	<b>Maintenance required</b> Maintenance is required. The measured value remains valid.

**i** The status signals are categorized in accordance with VDI/VDE 2650 and NAMUR Recommendation NE 107.

**Diagnostic information**

The fault can be identified using the diagnostic information. The short text helps you by providing information about the fault. In addition, the corresponding symbol for the diagnostic behavior is displayed in front of the diagnostic information on the local display.

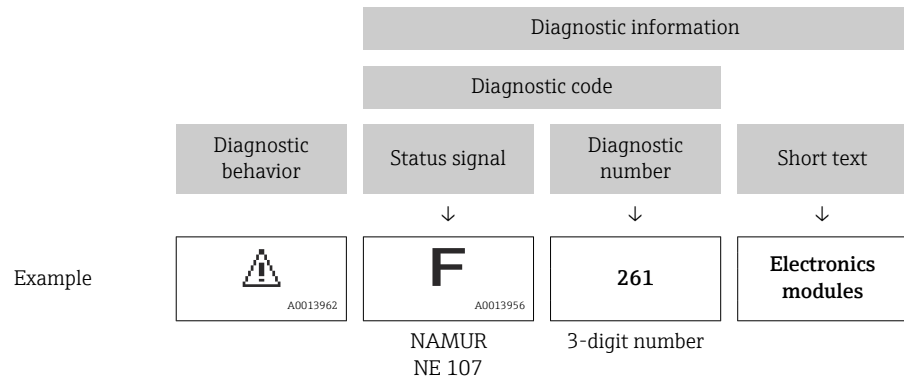

### 12.3.2 Calling up remedy information

Remedy information is provided for every diagnostic event to ensure that problems can be rectified quickly:

- On the home page  
Remedy information is displayed in a separate field below the diagnostics information.
- In the **Diagnostics** menu  
Remedy information can be called up in the working area of the user interface.

The user is in the **Diagnostics** menu.

1. Call up the desired parameter.
2. On the right in the working area, mouse over the parameter.
  - ↳ A tool tip with remedy information for the diagnostic event appears.

## 12.4 Adapting the diagnostic information

### 12.4.1 Adapting the diagnostic behavior

Each item of diagnostic information is assigned a specific diagnostic behavior at the factory. The user can change this assignment for specific diagnostic information in the **Diagnostic behavior** submenu.

Expert → System → Diagnostic handling → Diagnostic behavior

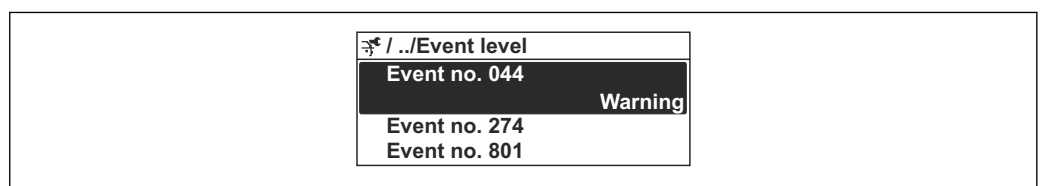

A0014048-EN

21 Using the example of the local display

You can assign the following options to the diagnostic number as the diagnostic behavior:

Options	Description
Alarm	The device stops measurement. The signal outputs and totalizers assume the defined alarm condition. A diagnostic message is generated. For local display with touch control: the background lighting changes to red.
Warning	The device continues to measure. The signal outputs and totalizers are not affected. A diagnostic message is generated.

Options	Description
Logbook entry only	The device continues to measure. The diagnostic message is only displayed in the <b>Event logbook</b> submenu ( <b>Event list</b> submenu) and is not displayed in alternating sequence with the operational display.
Off	The diagnostic event is ignored, and no diagnostic message is generated or entered.

## 12.4.2 Adapting the status signal

Each item of diagnostic information is assigned a specific status signal at the factory. The user can change this assignment for specific diagnostic information in the **Diagnostic event category** submenu.

Expert → Communication → Diagnostic event category

### Available status signals

Configuration as per FOUNDATION Fieldbus Specification (FF912), in accordance with NAMUR NE107.

Symbol	Meaning
<b>F</b> <small>A0013956</small>	<b>Failure</b> A device error has occurred. The measured value is no longer valid.
<b>C</b> <small>A0013959</small>	<b>Function check</b> The device is in service mode (e.g. during a simulation).
<b>S</b> <small>A0013958</small>	<b>Out of specification</b> The device is being operated: Outside its technical specification limits (e.g. outside the process temperature range)
<b>M</b> <small>A0013957</small>	<b>Maintenance required</b> Maintenance is required. The measured value remains valid.

### Enabling the configuration of the diagnostic information according to FF912

For compatibility reasons, the configuration of the diagnostic information according to FOUNDATION Fieldbus Specification FF912 is not enabled when the device is delivered from the factory.

### Enabling the configuration of the diagnostic information according to FOUNDATION Fieldbus Specification FF912

1. Open the Resource block.
2. In **Feature Selection** parameter, select **Multi-bit Alarm (Bit-Alarm) Support** option.
  - ↳ The diagnostic information can be configured according to FOUNDATION Fieldbus Specification FF912.

### Grouping the diagnostic information

Diagnostic information is assigned to different groups. The groups differ depending on the weighting (severity) of the diagnostic event:

- Highest weighting
- High weighting
- Low weighting



*Assignment of the diagnostic information (factory setting)*

The assignment of the diagnostic information ex-works is indicated in the following tables.



The individual ranges of the diagnostic information can be assigned to another status signal →  113.

Some diagnostic information can be assigned individually, irrespective of their range →  115.

 Overview and description of all diagnostic information →  116

Weighting	Status signal (factory setting)	Allocation	Diagnostic information range
Highest	Failure (F)	Sensor	F000 to 199
		Electronics	F200 to 399
		Configuration	F400 to 700
		Process	F800 to 999



Weighting	Status signal (factory setting)	Allocation	Diagnostic information range
High	Function check (C)	Sensor	C000 to 199
		Electronics	C200 to 399
		Configuration	C400 to 700
		Process	C800 to 999

Weighting	Status signal (factory setting)	Allocation	Diagnostic information range
Low	Out of specification (S)	Sensor	S000 to 199
		Electronics	S200 to 399
		Configuration	S400 to 700
		Process	S800 to 999

Weighting	Status signal (factory setting)	Allocation	Diagnostic information range
Low	Maintenance required (M)	Sensor	M000 to 199
		Electronics	M200 to 399
		Configuration	M400 to 700
		Process	M800 to 999

#### *Changing the assignment of the diagnostic information*

The individual ranges of the diagnostic information can be assigned to another status signal. This is done by changing the bit in the associated parameter. The bit change always applies for the entire range of the diagnostic information.

 Some diagnostic information can be assigned individually, irrespective of their range →  115

Each status signal has a parameter in the Resource Block in which it is possible to define the diagnostic event for which the status signal is transmitted:

- Failure (F): **FD\_FAIL\_MAP** parameter
- Function check (C): **FD\_CHECK\_MAP** parameter
- Out of specification (S): **FD\_OFFSPEC\_MAP** parameter
- Maintenance required (M): **FD\_MAINT\_MAP** parameter

*Structure and assignment of the parameters for the status signals (factory setting)*

Weighting	Allocation	Bit	FD_FAIL_MAP	FD_CHECK_MAP	FD_OFFSPEC_MAP	FD_MAINT_MAP
Highest	Sensor	31	1	0	0	0
	Electronics	30	1	0	0	0
	Configuration	29	1	0	0	0
	Process	28	1	0	0	0
High	Sensor	27	0	1	0	0
	Electronics	26	0	1	0	0
	Configuration	25	0	1	0	0
	Process	24	0	1	0	0
Low	Sensor	23	0	0	1	0
	Electronics	22	0	0	1	0
	Configuration	21	0	0	1	0
	Process	20	0	0	1	0
Low	Sensor	19	0	0	0	1
	Electronics	18	0	0	0	1
	Configuration	17	0	0	0	1
	Process	16	0	0	0	1
Configurable range →  115		15 to 1	0	0	0	0
Reserved (Fieldbus Foundation)		0	0	0	0	0

**Changing the status signal for a range of diagnostic information**

Example: The status signal for the diagnostic information for electronics with the "Highest" weighting is to be changed from failure (F) to function check (C).

1. Set the Resource Block to the **OOS** block mode.
2. Open the **FD\_FAIL\_MAP** parameter in the Resource Block.
3. Change **Bit 30** to **0** in the parameter.
4. Open the **FD\_CHECK\_MAP** parameter in the Resource Block.
5. Change **Bit 26** to **1** in the parameter.
  - ↳ If a diagnostic event occurs for electronics with the "Highest weighting", the diagnostic information to this effect is displayed with the function check (C) status signal.
6. Set the Resource Block to the **AUTO** block mode.

**NOTICE****No status signal is assigned to an area of diagnostic information.**

If a diagnostic event occurs in this area, no status signal is transmitted to the control system.

- ▶ If you are changing the parameters, make sure that a status signal is assigned to all areas.

 If FieldCare is used, the status signal is enabled and disabled using the check box of the particular parameter.

*Assigning diagnostic information individually to a status signal*

Some diagnostic information can be individually assigned to a status signal, irrespective of their original range.

Assigning diagnostic information individually to a status signal via FieldCare.

1. In the FieldCare navigation window: **Expert** → **Communication** → **Field diagnostics** → **Alarm detection enable**
  2. Select the desired diagnostic information from one of the fields **Configurable Area Bits 1** to **Configurable Area Bits 15**.
  3. Press Enter to confirm.
  4. When selecting the desired status signal (e.g. Offspec Map), also select the **Configurable Area Bit 1** to **Configurable Area Bit 15** that was assigned previously to the diagnostic information (step 2).
  5. Press Enter to confirm.
    - ↳ The diagnostic event of the selected diagnostic information is recorded.
  6. In the FieldCare navigation window: **Expert** → **Communication** → **Field diagnostics** → **Alarm broadcast enable**
  7. Select the desired diagnostic information from one of the fields **Configurable Area Bits 1** to **Configurable Area Bits 15**.
  8. Press Enter to confirm.
  9. When selecting the desired status signal (e.g. Offspec Map), also select the **Configurable Area Bit 1** to **Configurable Area Bit 15** that was assigned previously to the diagnostic information (step 7).
  10. Press Enter to confirm.
    - ↳ The selected diagnostic information is transmitted over the bus when a diagnostic event to this effect occurs.
-  A change in the status signal does not affect diagnostic information that already exists. The new status signal is only assigned if this error occurs again after the status signal has changed.

**Transmitting the diagnostic information over the bus***Prioritizing diagnostic information for transmission over the bus*

Diagnostic information is only transmitted over the bus if its priority is between 2 and 15. Priority 1-events are displayed but are not transmitted over the bus. Diagnostic information with priority 0 (factory setting) is ignored.



It is possible to change the priority individually for the different status signals. The following parameters of the Resource Block are used for this purpose:

- FD\_FAIL\_PRI
- FD\_CHECK\_PRI
- FD\_OFFSPEC\_PRI
- FD\_MAINT\_PRI

*Suppressing certain diagnostic information*

It is possible to suppress certain events during transmission over the bus using a mask. While these events are displayed they are not transmitted over the bus. This mask is in FieldCare **Expert** → **Communication** → **Field diagnostics** → **Alarm broadcast enable**. The mask is a negative selection mask, i.e. if a field is selected the associated diagnostic information is not transmitted over the bus.

## 12.5 Overview of diagnostic information

-  The amount of diagnostic information and the number of measured variables affected increase if the measuring device has one or more application packages.
  - All of the measured variables affected in the entire Promass instrument family are always listed under "Measured variables affected". The measured variables available for the device in question depend on the device version. When assigning the measured variables to the device functions, for example to the individual outputs, all of the measured variables available for the device version in question are available for selection.
-  In the case of some items of diagnostic information, the status signal and the diagnostic behavior can be changed. Change the diagnostic information →  111

### 12.5.1 Diagnostic of sensor

Diagnostic information		Remedy instructions	Influenced measured variables		
No.	Short text				
022	Sensor temperature	1. Change main electronic module 2. Change sensor	<ul style="list-style-type: none"> <li>▪ Density</li> <li>▪ Mass flow</li> <li>▪ Reference density</li> <li>▪ Corrected volume flow</li> <li>▪ Temperature</li> <li>▪ Volume flow</li> </ul>		
	<b>Measured variable status</b>				
	Quality			Bad	
	Quality substatus			Sensor failure	
	Status signal [from the factory] <sup>1)</sup>			F	
	Diagnostic behavior			Alarm	

1) Status signal can be changed.

Diagnostic information		Remedy instructions	Influenced measured variables		
No.	Short text				
046	Sensor limit exceeded	1. Inspect sensor 2. Check process condition	<ul style="list-style-type: none"> <li>▪ Density</li> <li>▪ Mass flow</li> <li>▪ Reference density</li> <li>▪ Corrected volume flow</li> <li>▪ Volume flow</li> </ul>		
	<b>Measured variable status [from the factory] <sup>1)</sup></b>				
	Quality			Uncertain	
	Quality substatus			Sensor conversion not accurate	
	Status signal [from the factory] <sup>2)</sup>			S	
	Diagnostic behavior [from the factory] <sup>3)</sup>			Warning	

1) Quality can be changed. This causes the overall status of the measured variable to change.

2) Status signal can be changed.

3) Diagnostic behavior can be changed.

Diagnostic information		Remedy instructions	Influenced measured variables		
No.	Short text				
062	Sensor connection	1. Change main electronic module 2. Change sensor	<ul style="list-style-type: none"> <li>■ Mass flow</li> <li>■ Corrected volume flow</li> <li>■ Volume flow</li> </ul>		
	<b>Measured variable status</b>				
	Quality			Bad	
	Quality substatus			Sensor failure	
	Status signal [from the factory] <sup>1)</sup>			F	
	Diagnostic behavior			Alarm	

1) Status signal can be changed.

Diagnostic information		Remedy instructions	Influenced measured variables		
No.	Short text				
082	Data storage	1. Change main electronic module 2. Change sensor	<ul style="list-style-type: none"> <li>■ Density</li> <li>■ <b>Empty pipe detection</b> option</li> <li>■ <b>Low flow cut off</b> option</li> <li>■ Mass flow</li> <li>■ <b>Switch output status</b> option</li> <li>■ Reference density</li> <li>■ Corrected volume flow</li> <li>■ Temperature</li> <li>■ Volume flow</li> </ul>		
	<b>Measured variable status</b>				
	Quality			Bad	
	Quality substatus			Sensor failure	
	Status signal [from the factory] <sup>1)</sup>			F	
	Diagnostic behavior			Alarm	

1) Status signal can be changed.

Diagnostic information		Remedy instructions	Influenced measured variables		
No.	Short text				
083	Memory content	1. Restart device 2. Restore S-Dat data 3. Change sensor	<ul style="list-style-type: none"> <li>■ Density</li> <li>■ <b>Empty pipe detection</b> option</li> <li>■ <b>Low flow cut off</b> option</li> <li>■ Mass flow</li> <li>■ <b>Switch output status</b> option</li> <li>■ Reference density</li> <li>■ Corrected volume flow</li> <li>■ Temperature</li> <li>■ Volume flow</li> </ul>		
	<b>Measured variable status</b>				
	Quality			Bad	
	Quality substatus			Sensor failure	
	Status signal [from the factory] <sup>1)</sup>			F	
	Diagnostic behavior			Alarm	

1) Status signal can be changed.

Diagnostic information		Remedy instructions	Influenced measured variables	
No.	Short text			
140	Sensor signal	1. Check or change main electronics 2. Change sensor	<ul style="list-style-type: none"> <li>▪ Density</li> <li>▪ Mass flow</li> <li>▪ Reference density</li> <li>▪ Corrected volume flow</li> <li>▪ Temperature</li> </ul>	
	<b>Measured variable status [from the factory] <sup>1)</sup></b>			
	Quality			Bad
	Quality substatus			Sensor failure
	Status signal [from the factory] <sup>2)</sup>			S
Diagnostic behavior [from the factory] <sup>3)</sup>	Warning			

1) Quality can be changed. This causes the overall status of the measured variable to change.

2) Status signal can be changed.

3) Diagnostic behavior can be changed.

## 12.5.2 Diagnostic of electronic

Diagnostic information		Remedy instructions	Influenced measured variables	
No.	Short text			
242	Software incompatible	1. Check software 2. Flash or change main electronics module	<ul style="list-style-type: none"> <li>▪ Density</li> <li>▪ <b>Empty pipe detection</b> option</li> <li>▪ <b>Low flow cut off</b> option</li> <li>▪ Mass flow</li> <li>▪ <b>Switch output status</b> option</li> <li>▪ Reference density</li> <li>▪ Corrected volume flow</li> <li>▪ Temperature</li> <li>▪ Volume flow</li> </ul>	
	<b>Measured variable status</b>			
	Quality			Bad
	Quality substatus			Device failure
	Status signal [from the factory] <sup>1)</sup>			F
Diagnostic behavior	Alarm			

1) Status signal can be changed.

Diagnostic information		Remedy instructions	Influenced measured variables	
No.	Short text			
252	Modules incompatible	1. Check electronic modules 2. Change I/O or main electronic module	<ul style="list-style-type: none"> <li>▪ Density</li> <li>▪ <b>Empty pipe detection</b> option</li> <li>▪ <b>Low flow cut off</b> option</li> <li>▪ Mass flow</li> <li>▪ <b>Switch output status</b> option</li> <li>▪ Reference density</li> <li>▪ Corrected volume flow</li> <li>▪ Temperature</li> <li>▪ Volume flow</li> </ul>	
	<b>Measured variable status</b>			
	Quality			Bad
	Quality substatus			Device failure
	Status signal [from the factory] <sup>1)</sup>			F
Diagnostic behavior	Alarm			

1) Status signal can be changed.

Diagnostic information		Remedy instructions	Influenced measured variables	
No.	Short text			
261	Electronic modules	1. Restart device 2. Check electronic modules 3. Change I/O Modul or main electronics	<ul style="list-style-type: none"> <li>▪ Density</li> <li>▪ <b>Empty pipe detection</b> option</li> <li>▪ <b>Low flow cut off</b> option</li> <li>▪ Mass flow</li> <li>▪ <b>Switch output status</b> option</li> <li>▪ Reference density</li> <li>▪ Corrected volume flow</li> <li>▪ Temperature</li> <li>▪ Volume flow</li> </ul>	
	<b>Measured variable status</b>			
	Quality			Bad
	Quality substatus			Device failure
	Status signal [from the factory] <sup>1)</sup>			F
Diagnostic behavior	Alarm			

1) Status signal can be changed.

Diagnostic information		Remedy instructions	Influenced measured variables	
No.	Short text			
262	Module connection	1. Check module connections 2. Change electronic modules	<ul style="list-style-type: none"> <li>▪ Density</li> <li>▪ <b>Empty pipe detection</b> option</li> <li>▪ <b>Low flow cut off</b> option</li> <li>▪ Mass flow</li> <li>▪ <b>Switch output status</b> option</li> <li>▪ Reference density</li> <li>▪ Corrected volume flow</li> <li>▪ Temperature</li> <li>▪ Volume flow</li> </ul>	
	<b>Measured variable status</b>			
	Quality			Bad
	Quality substatus			Device failure
	Status signal [from the factory] <sup>1)</sup>			F
Diagnostic behavior	Alarm			

1) Status signal can be changed.

Diagnostic information		Remedy instructions	Influenced measured variables	
No.	Short text			
270	Main electronic failure	Change main electronic module	<ul style="list-style-type: none"> <li>▪ Density</li> <li>▪ <b>Empty pipe detection</b> option</li> <li>▪ <b>Low flow cut off</b> option</li> <li>▪ Mass flow</li> <li>▪ <b>Switch output status</b> option</li> <li>▪ Reference density</li> <li>▪ Corrected volume flow</li> <li>▪ Temperature</li> <li>▪ Volume flow</li> </ul>	
	<b>Measured variable status</b>			
	Quality			Bad
	Quality substatus			Device failure
	Status signal [from the factory] <sup>1)</sup>			F
Diagnostic behavior	Alarm			

1) Status signal can be changed.

Diagnostic information		Remedy instructions	Influenced measured variables	
No.	Short text			
271	Main electronic failure	1. Restart device 2. Change main electronic module	<ul style="list-style-type: none"> <li>▪ Density</li> <li>▪ Mass flow</li> <li>▪ Reference density</li> <li>▪ Corrected volume flow</li> <li>▪ Volume flow</li> </ul>	
	<b>Measured variable status</b>			
	Quality			Bad
	Quality substatus			Device failure
	Status signal [from the factory] <sup>1)</sup>			F
Diagnostic behavior	Alarm			

1) Status signal can be changed.

Diagnostic information		Remedy instructions	Influenced measured variables	
No.	Short text			
272	Main electronic failure	1. Restart device 2. Contact service	<ul style="list-style-type: none"> <li>▪ Density</li> <li>▪ <b>Empty pipe detection</b> option</li> <li>▪ <b>Low flow cut off</b> option</li> <li>▪ Mass flow</li> <li>▪ <b>Switch output status</b> option</li> <li>▪ Reference density</li> <li>▪ Corrected volume flow</li> <li>▪ Temperature</li> <li>▪ Volume flow</li> </ul>	
	<b>Measured variable status</b>			
	Quality			Bad
	Quality substatus			Device failure
	Status signal [from the factory] <sup>1)</sup>			F
Diagnostic behavior	Alarm			

1) Status signal can be changed.

Diagnostic information		Remedy instructions	Influenced measured variables	
No.	Short text			
273	Main electronic failure	1. Emergency operation via display 2. Change main electronics	<ul style="list-style-type: none"> <li>▪ Density</li> <li>▪ <b>Empty pipe detection</b> option</li> <li>▪ <b>Low flow cut off</b> option</li> <li>▪ Mass flow</li> <li>▪ <b>Switch output status</b> option</li> <li>▪ Reference density</li> <li>▪ Corrected volume flow</li> <li>▪ Temperature</li> <li>▪ Volume flow</li> </ul>	
	<b>Measured variable status</b>			
	Quality			Bad
	Quality substatus			Device failure
	Status signal [from the factory] <sup>1)</sup>			F
Diagnostic behavior	Alarm			

1) Status signal can be changed.



Diagnostic information		Remedy instructions	Influenced measured variables		
No.	Short text				
274	Main electronic failure	Unstable measurement 1. Change main electronics	<ul style="list-style-type: none"> <li>■ Mass flow</li> <li>■ Corrected volume flow</li> <li>■ Volume flow</li> </ul>		
	<b>Measured variable status [from the factory] <sup>1)</sup></b>				
	Quality			Uncertain	
	Quality substatus			Non specific	
	Status signal [from the factory] <sup>2)</sup>			S	
	Diagnostic behavior [from the factory] <sup>3)</sup>			Warning	

- 1) Quality can be changed. This causes the overall status of the measured variable to change.
- 2) Status signal can be changed.
- 3) Diagnostic behavior can be changed.

Diagnostic information		Remedy instructions	Influenced measured variables		
No.	Short text				
275	I/O module failure	Change I/O module	<ul style="list-style-type: none"> <li>■ Density</li> <li>■ <b>Empty pipe detection</b> option</li> <li>■ <b>Low flow cut off</b> option</li> <li>■ Mass flow</li> <li>■ <b>Switch output status</b> option</li> <li>■ Reference density</li> <li>■ Corrected volume flow</li> <li>■ Temperature</li> <li>■ Volume flow</li> </ul>		
	<b>Measured variable status</b>				
	Quality			Bad	
	Quality substatus			Device failure	
	Status signal [from the factory] <sup>1)</sup>			F	
	Diagnostic behavior			Alarm	

- 1) Status signal can be changed.

Diagnostic information		Remedy instructions	Influenced measured variables		
No.	Short text				
276	I/O module failure	1. Restart device 2. Change I/O module	<ul style="list-style-type: none"> <li>■ Density</li> <li>■ <b>Empty pipe detection</b> option</li> <li>■ <b>Low flow cut off</b> option</li> <li>■ Mass flow</li> <li>■ <b>Switch output status</b> option</li> <li>■ Reference density</li> <li>■ Corrected volume flow</li> <li>■ Temperature</li> <li>■ Volume flow</li> </ul>		
	<b>Measured variable status</b>				
	Quality			Bad	
	Quality substatus			Device failure	
	Status signal [from the factory] <sup>1)</sup>			F	
	Diagnostic behavior			Alarm	

- 1) Status signal can be changed.

Diagnostic information		Remedy instructions	Influenced measured variables	
No.	Short text			
282	Data storage	1. Restart device 2. Contact service	<ul style="list-style-type: none"> <li>▪ Density</li> <li>▪ <b>Empty pipe detection</b> option</li> <li>▪ <b>Low flow cut off</b> option</li> <li>▪ Mass flow</li> <li>▪ <b>Switch output status</b> option</li> <li>▪ Reference density</li> <li>▪ Corrected volume flow</li> <li>▪ Temperature</li> <li>▪ Volume flow</li> </ul>	
	<b>Measured variable status</b>			
	Quality			Bad
	Quality substatus			Device failure
	Status signal [from the factory] <sup>1)</sup>			F
Diagnostic behavior	Alarm			

1) Status signal can be changed.

Diagnostic information		Remedy instructions	Influenced measured variables	
No.	Short text			
283	Memory content	1. Transfer data or reset device 2. Contact service	<ul style="list-style-type: none"> <li>▪ Density</li> <li>▪ <b>Empty pipe detection</b> option</li> <li>▪ <b>Low flow cut off</b> option</li> <li>▪ Mass flow</li> <li>▪ <b>Switch output status</b> option</li> <li>▪ Reference density</li> <li>▪ Corrected volume flow</li> <li>▪ Temperature</li> <li>▪ Volume flow</li> </ul>	
	<b>Measured variable status</b>			
	Quality			Bad
	Quality substatus			Device failure
	Status signal [from the factory] <sup>1)</sup>			F
Diagnostic behavior	Alarm			

1) Status signal can be changed.

Diagnostic information		Remedy instructions	Influenced measured variables	
No.	Short text			
302	Device verification active	Device verification active, please wait.	<ul style="list-style-type: none"> <li>▪ Density</li> <li>▪ <b>Empty pipe detection</b> option</li> <li>▪ <b>Low flow cut off</b> option</li> <li>▪ Mass flow</li> <li>▪ <b>Switch output status</b> option</li> <li>▪ Reference density</li> <li>▪ Corrected volume flow</li> <li>▪ Temperature</li> <li>▪ Volume flow</li> </ul>	
	<b>Measured variable status</b>			
	Quality			Good
	Quality substatus			Non specific
	Status signal [from the factory] <sup>1)</sup>			C
Diagnostic behavior	Warning			

1) Status signal can be changed.

Diagnostic information		Remedy instructions	Influenced measured variables	
No.	Short text			
311	Electronic failure	1. Transfer data or reset device 2. Contact service	<ul style="list-style-type: none"> <li>▪ Density</li> <li>▪ <b>Empty pipe detection</b> option</li> <li>▪ <b>Low flow cut off</b> option</li> <li>▪ Mass flow</li> <li>▪ <b>Switch output status</b> option</li> <li>▪ Reference density</li> <li>▪ Corrected volume flow</li> <li>▪ Temperature</li> <li>▪ Volume flow</li> </ul>	
	<b>Measured variable status</b>			
	Quality			Bad
	Quality substatus			Device failure
	Status signal [from the factory] <sup>1)</sup>			F
Diagnostic behavior	Alarm			

1) Status signal can be changed.

Diagnostic information		Remedy instructions	Influenced measured variables	
No.	Short text			
311	Electronic failure	Maintenance required! 1. Do not perform reset 2. Contact service	<ul style="list-style-type: none"> <li>▪ Density</li> <li>▪ <b>Empty pipe detection</b> option</li> <li>▪ <b>Low flow cut off</b> option</li> <li>▪ Mass flow</li> <li>▪ <b>Switch output status</b> option</li> <li>▪ Reference density</li> <li>▪ Corrected volume flow</li> <li>▪ Temperature</li> <li>▪ Volume flow</li> </ul>	
	<b>Measured variable status</b>			
	Quality			Bad
	Quality substatus			Device failure
	Status signal [from the factory] <sup>1)</sup>			M
Diagnostic behavior	Warning			

1) Status signal can be changed.

Diagnostic information		Remedy instructions	Influenced measured variables	
No.	Short text			
362	Main electronic failure	1. Change main electronic module 2. Change sensor	<ul style="list-style-type: none"> <li>▪ Density</li> <li>▪ <b>Empty pipe detection</b> option</li> <li>▪ <b>Low flow cut off</b> option</li> <li>▪ Mass flow</li> <li>▪ <b>Switch output status</b> option</li> <li>▪ Reference density</li> <li>▪ Corrected volume flow</li> <li>▪ Temperature</li> <li>▪ Volume flow</li> </ul>	
	<b>Measured variable status</b>			
	Quality			Bad
	Quality substatus			Device failure
	Status signal [from the factory] <sup>1)</sup>			F
Diagnostic behavior	Alarm			

1) Status signal can be changed.

### 12.5.3 Diagnostic of configuration

Diagnostic information		Remedy instructions	Influenced measured variables	
No.	Short text			
410	Data transfer	1. Check connection 2. Retry data transfer	<ul style="list-style-type: none"> <li>▪ Density</li> <li>▪ <b>Empty pipe detection</b> option</li> <li>▪ <b>Low flow cut off</b> option</li> <li>▪ Mass flow</li> <li>▪ <b>Switch output status</b> option</li> <li>▪ Reference density</li> <li>▪ Corrected volume flow</li> <li>▪ Temperature</li> <li>▪ Volume flow</li> </ul>	
	<b>Measured variable status</b>			
	Quality			Bad
	Quality substatus			Configuration error
	Status signal [from the factory] <sup>1)</sup>			F
Diagnostic behavior	Alarm			

1) Status signal can be changed.

Diagnostic information		Remedy instructions	Influenced measured variables	
No.	Short text			
412	Processing Download	Download active, please wait	-	
	<b>Measured variable status</b>			
	Quality			Good
	Quality substatus			Non specific
	Status signal [from the factory] <sup>1)</sup>			C
Diagnostic behavior	Warning			

1) Status signal can be changed.

Diagnostic information		Remedy instructions	Influenced measured variables	
No.	Short text			
437	Configuration incompatible	1. Restart device 2. Contact service	<ul style="list-style-type: none"> <li>▪ Density</li> <li>▪ <b>Empty pipe detection</b> option</li> <li>▪ <b>Low flow cut off</b> option</li> <li>▪ Mass flow</li> <li>▪ <b>Switch output status</b> option</li> <li>▪ Reference density</li> <li>▪ Corrected volume flow</li> <li>▪ Temperature</li> <li>▪ Volume flow</li> </ul>	
	<b>Measured variable status</b>			
	Quality			Bad
	Quality substatus			Configuration error
	Status signal [from the factory] <sup>1)</sup>			F
Diagnostic behavior	Alarm			

1) Status signal can be changed.

Diagnostic information		Remedy instructions	Influenced measured variables		
No.	Short text				
438	Dataset	1. Check data set file 2. Check device configuration 3. Up- and download new configuration	<ul style="list-style-type: none"> <li>■ Density</li> <li>■ <b>Empty pipe detection</b> option</li> <li>■ <b>Low flow cut off</b> option</li> <li>■ Mass flow</li> <li>■ <b>Switch output status</b> option</li> <li>■ Reference density</li> <li>■ Corrected volume flow</li> <li>■ Temperature</li> <li>■ Volume flow</li> </ul>		
	<b>Measured variable status</b>				
	Quality			Uncertain	
	Quality substatus			Non specific	
	Status signal [from the factory] <sup>1)</sup>			M	
	Diagnostic behavior			Warning	

1) Status signal can be changed.

Diagnostic information		Remedy instructions	Influenced measured variables		
No.	Short text				
442	Frequency output	1. Check process 2. Check frequency output settings	-		
	<b>Measured variable status</b>				
	Quality			Good	
	Quality substatus			Non specific	
	Status signal [from the factory] <sup>1)</sup>			S	
	Diagnostic behavior [from the factory] <sup>2)</sup>			Warning	

1) Status signal can be changed.

2) Diagnostic behavior can be changed.

Diagnostic information		Remedy instructions	Influenced measured variables		
No.	Short text				
443	Pulse output	1. Check process 2. Check pulse output settings	-		
	<b>Measured variable status</b>				
	Quality			Good	
	Quality substatus			Non specific	
	Status signal [from the factory] <sup>1)</sup>			S	
	Diagnostic behavior [from the factory] <sup>2)</sup>			Warning	

1) Status signal can be changed.

2) Diagnostic behavior can be changed.

Diagnostic information		Remedy instructions	Influenced measured variables	
No.	Short text			
453	Flow override	Deactivate flow override	<ul style="list-style-type: none"> <li>▪ Density</li> <li>▪ <b>Empty pipe detection</b> option</li> <li>▪ <b>Low flow cut off</b> option</li> <li>▪ Mass flow</li> <li>▪ <b>Switch output status</b> option</li> <li>▪ Reference density</li> <li>▪ Corrected volume flow</li> <li>▪ Temperature</li> <li>▪ Volume flow</li> </ul>	
	<b>Measured variable status</b>			
	Quality			Good
	Quality substatus			Non specific
	Status signal [from the factory] <sup>1)</sup>			C
Diagnostic behavior	Warning			

1) Status signal can be changed.

Diagnostic information		Remedy instructions	Influenced measured variables	
No.	Short text			
482	Block in OOS	Set Block in AUTO mode	-	
	<b>Measured variable status</b>			
	Quality			Good
	Quality substatus			Non specific
	Status signal [from the factory] <sup>1)</sup>			F
Diagnostic behavior	Alarm			

1) Status signal can be changed.

Diagnostic information		Remedy instructions	Influenced measured variables	
No.	Short text			
484	Simulation failure mode	Deactivate simulation	<ul style="list-style-type: none"> <li>▪ Density</li> <li>▪ <b>Empty pipe detection</b> option</li> <li>▪ <b>Low flow cut off</b> option</li> <li>▪ Mass flow</li> <li>▪ <b>Switch output status</b> option</li> <li>▪ Reference density</li> <li>▪ Corrected volume flow</li> <li>▪ Temperature</li> <li>▪ Volume flow</li> </ul>	
	<b>Measured variable status</b>			
	Quality			Bad
	Quality substatus			Configuration error
	Status signal [from the factory] <sup>1)</sup>			C
Diagnostic behavior	Alarm			

1) Status signal can be changed.

Diagnostic information		Remedy instructions	Influenced measured variables		
No.	Short text				
485	Simulation measured variable	Deactivate simulation	<ul style="list-style-type: none"> <li>▪ Density</li> <li>▪ <b>Empty pipe detection</b> option</li> <li>▪ <b>Low flow cut off</b> option</li> <li>▪ Mass flow</li> <li>▪ <b>Switch output status</b> option</li> <li>▪ Reference density</li> <li>▪ Corrected volume flow</li> <li>▪ Temperature</li> <li>▪ Volume flow</li> </ul>		
	<b>Measured variable status</b>				
	Quality			Good	
	Quality substatus			Non specific	
	Status signal [from the factory] <sup>1)</sup>			C	
	Diagnostic behavior			Warning	

1) Status signal can be changed.

Diagnostic information		Remedy instructions	Influenced measured variables		
No.	Short text				
492	Simulation frequency output	Deactivate simulation frequency output	<ul style="list-style-type: none"> <li>▪ Density</li> <li>▪ <b>Empty pipe detection</b> option</li> <li>▪ <b>Low flow cut off</b> option</li> <li>▪ Mass flow</li> <li>▪ <b>Switch output status</b> option</li> <li>▪ Reference density</li> <li>▪ Corrected volume flow</li> <li>▪ Temperature</li> <li>▪ Volume flow</li> </ul>		
	<b>Measured variable status</b>				
	Quality			Good	
	Quality substatus			Non specific	
	Status signal [from the factory] <sup>1)</sup>			C	
	Diagnostic behavior			Warning	

1) Status signal can be changed.

Diagnostic information		Remedy instructions	Influenced measured variables		
No.	Short text				
493	Simulation pulse output	Deactivate simulation pulse output	<ul style="list-style-type: none"> <li>▪ Density</li> <li>▪ <b>Empty pipe detection</b> option</li> <li>▪ <b>Low flow cut off</b> option</li> <li>▪ Mass flow</li> <li>▪ <b>Switch output status</b> option</li> <li>▪ Reference density</li> <li>▪ Corrected volume flow</li> <li>▪ Temperature</li> <li>▪ Volume flow</li> </ul>		
	<b>Measured variable status</b>				
	Quality			Good	
	Quality substatus			Non specific	
	Status signal [from the factory] <sup>1)</sup>			C	
	Diagnostic behavior			Warning	

1) Status signal can be changed.

Diagnostic information		Remedy instructions	Influenced measured variables	
No.	Short text			
494	Switch output simulation	Deactivate simulation switch output	<ul style="list-style-type: none"> <li>▪ Density</li> <li>▪ <b>Empty pipe detection</b> option</li> <li>▪ <b>Low flow cut off</b> option</li> <li>▪ Mass flow</li> <li>▪ <b>Switch output status</b> option</li> <li>▪ Reference density</li> <li>▪ Corrected volume flow</li> <li>▪ Temperature</li> <li>▪ Volume flow</li> </ul>	
	<b>Measured variable status</b>			
	Quality			Good
	Quality substatus			Non specific
	Status signal [from the factory] <sup>1)</sup>			C
Diagnostic behavior	Warning			

1) Status signal can be changed.

Diagnostic information		Remedy instructions	Influenced measured variables	
No.	Short text			
495	Simulation diagnostic event	Deactivate simulation	-	
	<b>Measured variable status</b>			
	Quality			Good
	Quality substatus			Non specific
	Status signal [from the factory] <sup>1)</sup>			C
Diagnostic behavior	Warning			

1) Status signal can be changed.

Diagnostic information		Remedy instructions	Influenced measured variables	
No.	Short text			
497	Simulation block output	Deactivate simulation	-	
	<b>Measured variable status</b>			
	Quality			Good
	Quality substatus			Non specific
	Status signal [from the factory] <sup>1)</sup>			C
Diagnostic behavior	Warning			

1) Status signal can be changed.



### 12.5.4 Diagnostic of process

Diagnostic information		Remedy instructions	Influenced measured variables	
No.	Short text			
801	Supply voltage too low	Increase supply voltage	<ul style="list-style-type: none"> <li>▪ Density</li> <li>▪ <b>Empty pipe detection</b> option</li> <li>▪ <b>Low flow cut off</b> option</li> <li>▪ Mass flow</li> <li>▪ <b>Switch output status</b> option</li> <li>▪ Reference density</li> <li>▪ Corrected volume flow</li> <li>▪ Temperature</li> <li>▪ Volume flow</li> </ul>	
	<b>Measured variable status [from the factory] <sup>1)</sup></b>			
	Quality			Uncertain
	Quality substatus			Non specific
	Status signal [from the factory] <sup>2)</sup>			S
Diagnostic behavior [from the factory] <sup>3)</sup>	Warning			

- 1) Quality can be changed. This causes the overall status of the measured variable to change.
- 2) Status signal can be changed.
- 3) Diagnostic behavior can be changed.

Diagnostic information		Remedy instructions	Influenced measured variables	
No.	Short text			
830	Sensor temperature too high	Reduce ambient temp. around the sensor housing	<ul style="list-style-type: none"> <li>▪ Density</li> <li>▪ Mass flow</li> <li>▪ Reference density</li> <li>▪ Corrected volume flow</li> <li>▪ Volume flow</li> </ul>	
	<b>Measured variable status [from the factory] <sup>1)</sup></b>			
	Quality			Uncertain
	Quality substatus			Non specific
	Status signal [from the factory] <sup>2)</sup>			S
Diagnostic behavior [from the factory] <sup>3)</sup>	Warning			

- 1) Quality can be changed. This causes the overall status of the measured variable to change.
- 2) Status signal can be changed.
- 3) Diagnostic behavior can be changed.

Diagnostic information		Remedy instructions	Influenced measured variables	
No.	Short text			
831	Sensor temperature too low	Increase ambient temp. around the sensor housing	<ul style="list-style-type: none"> <li>▪ Density</li> <li>▪ Mass flow</li> <li>▪ Reference density</li> <li>▪ Corrected volume flow</li> <li>▪ Volume flow</li> </ul>	
	<b>Measured variable status [from the factory] <sup>1)</sup></b>			
	Quality			Uncertain
	Quality substatus			Non specific
	Status signal [from the factory] <sup>2)</sup>			S
Diagnostic behavior [from the factory] <sup>3)</sup>	Warning			

- 1) Quality can be changed. This causes the overall status of the measured variable to change.
- 2) Status signal can be changed.
- 3) Diagnostic behavior can be changed.

Diagnostic information		Remedy instructions	Influenced measured variables	
No.	Short text			
832	Electronic temperature too high	Reduce ambient temperature	<ul style="list-style-type: none"> <li>▪ Density</li> <li>▪ <b>Empty pipe detection</b> option</li> <li>▪ <b>Low flow cut off</b> option</li> <li>▪ Mass flow</li> <li>▪ <b>Switch output status</b> option</li> <li>▪ Reference density</li> <li>▪ Corrected volume flow</li> <li>▪ Temperature</li> <li>▪ Volume flow</li> </ul>	
	<b>Measured variable status [from the factory] <sup>1)</sup></b>			
	Quality			Uncertain
	Quality substatus			Non specific
	Status signal [from the factory] <sup>2)</sup>			S
Diagnostic behavior [from the factory] <sup>3)</sup>	Warning			

1) Quality can be changed. This causes the overall status of the measured variable to change.

2) Status signal can be changed.

3) Diagnostic behavior can be changed.

Diagnostic information		Remedy instructions	Influenced measured variables	
No.	Short text			
833	Electronic temperature too low	Increase ambient temperature	<ul style="list-style-type: none"> <li>▪ Density</li> <li>▪ <b>Empty pipe detection</b> option</li> <li>▪ <b>Low flow cut off</b> option</li> <li>▪ Mass flow</li> <li>▪ <b>Switch output status</b> option</li> <li>▪ Reference density</li> <li>▪ Corrected volume flow</li> <li>▪ Volume flow</li> </ul>	
	<b>Measured variable status [from the factory] <sup>1)</sup></b>			
	Quality			Uncertain
	Quality substatus			Non specific
	Status signal [from the factory] <sup>2)</sup>			S
Diagnostic behavior [from the factory] <sup>3)</sup>	Warning			

1) Quality can be changed. This causes the overall status of the measured variable to change.

2) Status signal can be changed.

3) Diagnostic behavior can be changed.

Diagnostic information		Remedy instructions	Influenced measured variables	
No.	Short text			
834	Process temperature too high	Reduce process temperature	<ul style="list-style-type: none"> <li>▪ Density</li> <li>▪ Mass flow</li> <li>▪ Reference density</li> <li>▪ Corrected volume flow</li> <li>▪ Temperature</li> <li>▪ Volume flow</li> </ul>	
	<b>Measured variable status [from the factory] <sup>1)</sup></b>			
	Quality			Uncertain
	Quality substatus			Non specific
	Status signal [from the factory] <sup>2)</sup>			S
Diagnostic behavior [from the factory] <sup>3)</sup>	Warning			

1) Quality can be changed. This causes the overall status of the measured variable to change.

2) Status signal can be changed.

3) Diagnostic behavior can be changed.

Diagnostic information		Remedy instructions	Influenced measured variables		
No.	Short text				
835	Process temperature too low	Increase process temperature	<ul style="list-style-type: none"> <li>■ Density</li> <li>■ Mass flow</li> <li>■ Reference density</li> <li>■ Corrected volume flow</li> <li>■ Temperature</li> <li>■ Volume flow</li> </ul>		
	<b>Measured variable status [from the factory] <sup>1)</sup></b>				
	Quality			Uncertain	
	Quality substatus			Non specific	
	Status signal [from the factory] <sup>2)</sup>			S	
	Diagnostic behavior [from the factory] <sup>3)</sup>			Warning	

- 1) Quality can be changed. This causes the overall status of the measured variable to change.
- 2) Status signal can be changed.
- 3) Diagnostic behavior can be changed.

Diagnostic information		Remedy instructions	Influenced measured variables		
No.	Short text				
842	Process limit	Low flow cut off active! 1. Check low flow cut off configuration	<ul style="list-style-type: none"> <li>■ Density</li> <li>■ <b>Empty pipe detection option</b></li> <li>■ <b>Low flow cut off option</b></li> <li>■ Mass flow</li> <li>■ <b>Switch output status option</b></li> <li>■ Reference density</li> <li>■ Corrected volume flow</li> <li>■ Temperature</li> <li>■ Volume flow</li> </ul>		
	<b>Measured variable status</b>				
	Quality			Good	
	Quality substatus			Non specific	
	Status signal [from the factory] <sup>1)</sup>			S	
	Diagnostic behavior			Warning	

- 1) Status signal can be changed.

Diagnostic information		Remedy instructions	Influenced measured variables		
No.	Short text				
862	Partly filled pipe	1. Check for gas in process 2. Adjust detection limits	<ul style="list-style-type: none"> <li>■ Density</li> <li>■ <b>Empty pipe detection option</b></li> <li>■ <b>Low flow cut off option</b></li> <li>■ Mass flow</li> <li>■ <b>Switch output status option</b></li> <li>■ Reference density</li> <li>■ Corrected volume flow</li> <li>■ Temperature</li> <li>■ Volume flow</li> </ul>		
	<b>Measured variable status [from the factory] <sup>1)</sup></b>				
	Quality			Uncertain	
	Quality substatus			Non specific	
	Status signal [from the factory] <sup>2)</sup>			S	
	Diagnostic behavior [from the factory] <sup>3)</sup>			Warning	

- 1) Quality can be changed. This causes the overall status of the measured variable to change.
- 2) Status signal can be changed.
- 3) Diagnostic behavior can be changed.

Diagnostic information		Remedy instructions	Influenced measured variables	
No.	Short text			
882	Input signal	1. Check input configuration 2. Check external device or process conditions	<ul style="list-style-type: none"> <li>▪ Density</li> <li>▪ Mass flow</li> <li>▪ Reference density</li> <li>▪ Corrected volume flow</li> <li>▪ Volume flow</li> </ul>	
	<b>Measured variable status</b>			
	Quality			Bad
	Quality substatus			Non specific
	Status signal [from the factory] <sup>1)</sup>			F
Diagnostic behavior	Alarm			

1) Status signal can be changed.

Diagnostic information		Remedy instructions	Influenced measured variables	
No.	Short text			
910	Tubes not oscillating	1. Check process conditions 2. Increase supply 3. Check main electronic or sensor	<ul style="list-style-type: none"> <li>▪ Density</li> <li>▪ <b>Empty pipe detection</b> option</li> <li>▪ <b>Low flow cut off</b> option</li> <li>▪ Mass flow</li> <li>▪ <b>Switch output status</b> option</li> <li>▪ Reference density</li> <li>▪ Corrected volume flow</li> <li>▪ Temperature</li> <li>▪ Volume flow</li> </ul>	
	<b>Measured variable status</b>			
	Quality			Bad
	Quality substatus			Non specific
	Status signal [from the factory] <sup>1)</sup>			F
Diagnostic behavior	Alarm			

1) Status signal can be changed.

Diagnostic information		Remedy instructions	Influenced measured variables	
No.	Short text			
912	Medium inhomogeneous	1. Check process cond. 2. Increase system pressure	<ul style="list-style-type: none"> <li>▪ Density</li> <li>▪ <b>Empty pipe detection</b> option</li> <li>▪ <b>Low flow cut off</b> option</li> <li>▪ Mass flow</li> <li>▪ <b>Switch output status</b> option</li> <li>▪ Reference density</li> <li>▪ Corrected volume flow</li> <li>▪ Temperature</li> <li>▪ Volume flow</li> </ul>	
	<b>Measured variable status [from the factory] <sup>1)</sup></b>			
	Quality			Uncertain
	Quality substatus			Non specific
	Status signal [from the factory] <sup>2)</sup>			S
Diagnostic behavior [from the factory] <sup>3)</sup>	Warning			

1) Quality can be changed. This causes the overall status of the measured variable to change.

2) Status signal can be changed.





3) Diagnostic behavior can be changed.



Diagnostic information		Remedy instructions	Influenced measured variables	
No.	Short text			
913	Medium unsuitable	1. Check process conditions 2. Increase supply 3. Check main electronic or sensor	<ul style="list-style-type: none"> <li>■ Density</li> <li>■ Mass flow</li> <li>■ Reference density</li> <li>■ Corrected volume flow</li> <li>■ Volume flow</li> </ul>	
	<b>Measured variable status [from the factory] <sup>1)</sup></b>			
	Quality			Uncertain
	Quality substatus			Non specific
Status signal [from the factory] <sup>2)</sup>		S		
Diagnostic behavior [from the factory] <sup>3)</sup>		Warning		

- 1) Quality can be changed. This causes the overall status of the measured variable to change.
- 2) Status signal can be changed.
- 3) Diagnostic behavior can be changed.

## 12.6 Pending diagnostic events





The **Diagnostics** menu allows the user to view the current diagnostic event and the previous diagnostic event separately.

-  To call up the measures to rectify a diagnostic event:
  - Via local display →  109
  - Via "FieldCare" operating tool →  111
  - Via "DeviceCare" operating tool →  111

-  Other pending diagnostic events can be displayed in the **Diagnostic list** submenu →  134.

### Navigation

"Diagnostics" menu

 <b>Diagnostics</b>	
Actual diagnostics	→  134
Previous diagnostics	→  134
Operating time from restart	→  134
Operating time	→  134

### Parameter overview with brief description

Parameter	Prerequisite	Description	User interface
Actual diagnostics	A diagnostic event has occurred.	Shows the current occurred diagnostic event along with its diagnostic information.  If two or more messages occur simultaneously, the message with the highest priority is shown on the display.	Symbol for diagnostic behavior, diagnostic code and short message.
Previous diagnostics	Two diagnostic events have already occurred.	Shows the diagnostic event that occurred prior to the current diagnostic event along with its diagnostic information.	Symbol for diagnostic behavior, diagnostic code and short message.
Operating time from restart	–	Shows the time the device has been in operation since the last device restart.	Days (d), hours (h), minutes (m) and seconds (s)
Operating time	–	Indicates how long the device has been in operation.	Days (d), hours (h), minutes (m) and seconds (s)

## 12.7 Diagnostic messages in the DIAGNOSTIC Transducer Block

- The **Actual diagnostics** parameter (**actual diagnostics**) displays the message with the highest priority.
- A list of the active alarms can be viewed via the **Diagnostics 1** parameter (**diagnostics\_1**) to Diagnostics 5 (**diagnostics 5**). If more than 5 messages are pending, the messages with the highest priority are shown on the display.
- You can view the last alarm that is no longer active via the **Previous diagnostics** parameter (**previous\_diagnostics**).

## 12.8 Diagnostics list

Up to 5 currently pending diagnostic events can be displayed in the **Diagnostic list** submenu along with the associated diagnostic information. If more than 5 diagnostic events are pending, the events with the highest priority are shown on the display.

### Navigation path

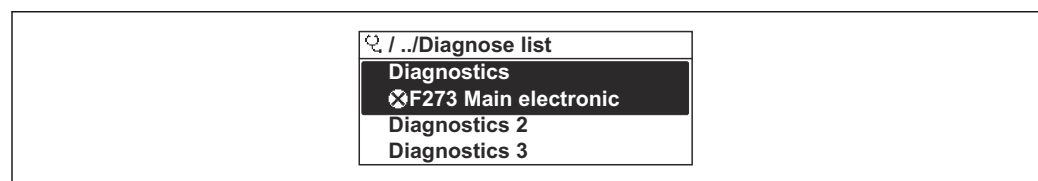

Diagnostics → Diagnostic list



A0014006-EN

 22 Using the example of the local display

 To call up the measures to rectify a diagnostic event:

- Via local display →  109
- Via "FieldCare" operating tool →  111
- Via "DeviceCare" operating tool →  111

## 12.9 Event logbook

### 12.9.1 Reading out the event logbook

A chronological overview of the event messages that have occurred is provided in the **Events list** submenu.

#### Navigation path

**Diagnostics** menu → **Event logbook** submenu → Events list

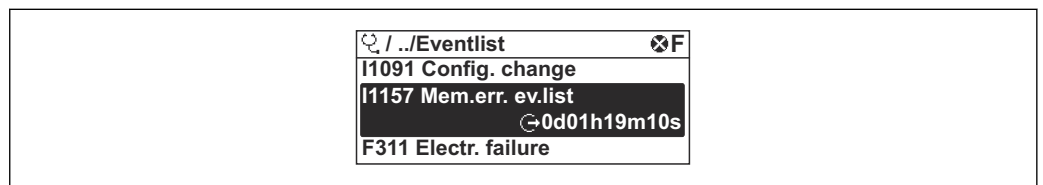

23 Using the example of the local display

- A maximum of 20 event messages can be displayed in chronological order.
- If the **Extended HistoROM** application package (order option) is enabled in the device, the event list can contain up to 100 entries.

The event history includes entries for:

- Diagnostic events → 116
- Information events → 135

In addition to the operating time when the event occurred, each event is also assigned a symbol that indicates whether the event has occurred or is finished:

- Diagnostics event
  - ☒: Occurrence of the event
  - ☑: End of the event
- Information event
  - ☒: Occurrence of the event

**i** To call up the measures to rectify a diagnostic event:

- Via local display → 109
- Via "FieldCare" operating tool → 111
- Via "DeviceCare" operating tool → 111

**i** For filtering the displayed event messages → 135

### 12.9.2 Filtering the event logbook

Using the **Filter options** parameter you can define which category of event message is displayed in the **Events list** submenu.

#### Navigation path

**Diagnostics** → **Event logbook** → **Filter options**

#### Filter categories

- All
- Failure (F)
- Function check (C)
- Out of specification (S)
- Maintenance required (M)
- Information (I)

### 12.9.3 Overview of information events

Unlike a diagnostic event, an information event is displayed in the event logbook only and not in the diagnostic list.

Info number	Info name
I1000	----- (Device ok)
I1079	Sensor changed
I1089	Power on
I1090	Configuration reset
I1091	Configuration changed
I1092	Trend data deleted
I1110	Write protection switch changed
I1111	Density adjust failure
I1137	Electronic changed
I1151	History reset
I1154	Reset terminal voltage min/max
I1155	Reset electronic temperature
I1156	Memory error trend
I1157	Memory error event list
I1185	Display backup done
I1186	Restore via display done
I1187	Settings downloaded with display
I1188	Display data cleared
I1189	Backup compared
I1209	Density adjustment ok
I1221	Zero point adjust failure
I1222	Zero point adjustment ok
I1227	Sensor emergency mode activated
I1228	Sensor emergency mode failed
I1256	Display: access status changed
I1264	Safety sequence aborted
I1335	Firmware changed
I1397	Fieldbus: access status changed
I1398	CDI: access status changed
I1512	Download started
I1513	Download finished
I1514	Upload started
I1515	Upload finished

## 12.10 Resetting the measuring instrument

The entire device configuration or some of the configuration can be reset to a defined state with the **Restart** parameter.

### 12.10.1 Function range of "Restart" parameter

Options	Description
Uninitialized	The selection has no effect on the device.
Run	The selection has no effect on the device.



Options	Description
Resource	The selection has no effect on the device.
Defaults	All FOUNDATION Fieldbus blocks are reset to their factory settings. Example: Analog Input Channel to the <b>Uninitialized</b> option.
Processor	The device is restarted.
To factory defaults	The FOUNDATION Fieldbus parameters (FOUNDATION Fieldbus blocks) and the device parameters are reset to their factory setting.
To delivery settings	Advanced FOUNDATION Fieldbus parameters (FOUNDATION Fieldbus blocks, schedule information) and device parameters for which a customer-specific default setting was ordered are reset to this customer-specific value.
ENP restart	The parameters of the electronic name plate are reset. The device is restarted.
To transducer defaults	Certain (measured-value specific) device parameters are reset. The parameters of the FOUNDATION Fieldbus blocks remain unchanged.
Factory Default Blocks	The extended FOUNDATION Fieldbus parameters (FOUNDATION Fieldbus blocks, schedule information) are reset to their factory settings.

### 12.10.2 Function range of "Service reset" parameter

Options	Description
Uninitialized	The selection has no effect on the device.
To delivery settings + MIB	Advanced FOUNDATION Fieldbus parameters (FOUNDATION Fieldbus blocks, schedule information, device tag and device address) and the device parameters for which a customer-specific default setting was ordered, are reset to this customer-specific value.
ENP restart	The parameters of the electronic name plate are reset. The device is restarted.



## 12.11 Device information

The **Device information** submenu contains all parameters that display different information for device identification.



### Navigation

"Diagnostics" menu → Device information

► Device information	
Device tag	→ ⓘ 138
Serial number	→ ⓘ 138
Firmware version	→ ⓘ 138
Order code	→ ⓘ 138
Extended order code 1	→ ⓘ 138
Extended order code 2	→ ⓘ 138



Device Revision	→  138
Device Type	→  138

### Parameter overview with brief description

Parameter	Description	User entry / User interface	Factory setting
Device tag	Enter the name for the measuring point.	Max. 32 characters, such as letters, numbers or special characters (e.g. @, %, /)	–
Serial number	Displays the serial number of the measuring device.	Max. 11-digit character string comprising letters and numbers.	–
Firmware version	Shows the device firmware version installed.	Character string with the following format: xx.yy.zz	–
Order code	Shows the device order code.  The order code can be found on the nameplate of the sensor and transmitter in the "Order code" field.	Character string composed of letters, numbers and certain punctuation marks	–
Extended order code 1	Shows the 1st part of the extended order code.  The extended order code can also be found on the nameplate of the sensor and transmitter in the "Ext. ord. cd." field.	Character string	–
Extended order code 2	Shows the 2nd part of the extended order code.  The extended order code can also be found on the nameplate of the sensor and transmitter in the "Ext. ord. cd." field.	Character string	–
ENP version	Shows the version of the electronic nameplate (ENP).	Character string in the format xx.yy.zz	–
Device Type	Shows the device type with which the measuring device is registered with the FOUNDATION Fieldbus.	Promass 200	–
Device Revision	Manufacturer revision number associated with the resource - used by an interface device to locate the DD file for the resource.	0 to 255	–

## 12.12 Firmware history

Release date	Firmware version	Order code for "Firmware version"	Firmware changes	Documentation type	Documentation
--------------	------------------	-----------------------------------	------------------	--------------------	---------------

-  It is possible to flash the firmware to the current version or the previous version using the service interface.
-  For the compatibility of the firmware version with the previous version, the installed device description files and operating tools, observe the information about the device in the "Manufacturer's information" document.
-  The manufacturer's information is available:
  - In the Download Area of the Endress+Hauser web site: [www.endress.com](http://www.endress.com) → Downloads
  - Specify the following details:
    - Product root: e.g. 8E2B  
The product root is the first part of the order code: see the nameplate on the device.
    - Text search: Manufacturer's information
    - Media type: Documentation – Technical Documentation

## 13 Maintenance

### 13.1 Maintenance work

No special maintenance work is required.

#### 13.1.1 Exterior cleaning

When cleaning the exterior of measuring devices, always use cleaning agents that do not attack the surface of the housing or the seals.

#### 13.1.2 Internal cleaning

Observe the following points for CIP and SIP cleaning:

- Use only cleaning agents to which the process-wetted materials are adequately resistant.
- Observe the maximum permitted medium temperature for the measuring device .

### 13.2 Measuring and test equipment

Endress+Hauser offers a variety of measuring and testing equipment, such as Netilion or device tests.

 Your Endress+Hauser Sales Center can provide detailed information on the services.

List of some of the measuring and testing equipment: →  146

### 13.3 Endress+Hauser services

Endress+Hauser offers a wide variety of services for maintenance such as recalibration, maintenance service or device tests.

 Your Endress+Hauser Sales Center can provide detailed information on the services.

## 14 Repair

### 14.1 General notes

#### 14.1.1 Repair and conversion concept

The Endress+Hauser repair and conversion concept provides for the following:

- The measuring devices have a modular design.
- Spare parts are grouped into logical kits with the associated Installation Instructions.
- Repairs are carried out by Endress+Hauser Service or by appropriately trained customers.
- Certified devices can only be converted to other certified devices by Endress+Hauser Service or at the factory.

#### 14.1.2 Notes for repair and conversion

For repair and conversion of a measuring device, observe the following notes:

- ▶ Use only original Endress+Hauser spare parts.
- ▶ Carry out the repair according to the Installation Instructions.
- ▶ Observe the applicable standards, federal/national regulations, Ex documentation (XA) and certificates.
- ▶ Document all repairs and conversions and enter the details in Netilion Analytics.

### 14.2 Spare parts

Some interchangeable measuring device components are listed on an overview sign in the connection compartment cover.

The spare part overview sign contains the following information:

- A list of the most important spare parts for the measuring device, including their ordering information.
- The URL to the *Device Viewer* ([www.endress.com/deviceviewer](http://www.endress.com/deviceviewer)):  
All the spare parts for the measuring device, along with the order code, are listed here and can be ordered. If available, users can also download the associated Installation Instructions.

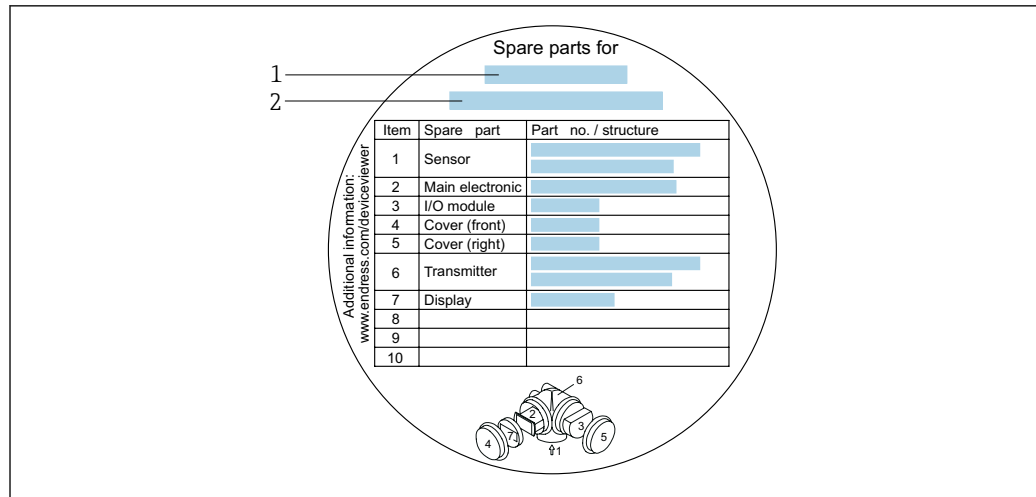

A0032235

24 Example for "Spare part overview sign" in connection compartment cover

- 1 Measuring device name
- 2 Measuring device serial number

- Measuring device serial number:
- Is located on the device nameplate and the spare part overview sign.
  - Can be read out via the **Serial number** parameter in the **Device information** submenu.

## 14.3 Endress+Hauser services

Endress+Hauser offers a wide range of services.

- Your Endress+Hauser Sales Center can provide detailed information on the services.

## 14.4 Return

The requirements for safe device return can vary depending on the device type and national legislation.

1. Refer to the web page for information:  
<https://www.endress.com/support/return-material>  
 ↳ Select the region.
2. If returning the device, pack the device in such a way that it is reliably protected against impact and external influences. The original packaging offers the best protection.

## 14.5 Disposal

- If required by the Directive 2012/19/EU on waste electrical and electronic equipment (WEEE), the product is marked with the depicted symbol in order to minimize the disposal of WEEE as unsorted municipal waste. Do not dispose of products bearing this marking as unsorted municipal waste. Instead, return them to the manufacturer for disposal under the applicable conditions.

### 14.5.1 Removing the measuring device

1. Switch off the device.

**⚠ WARNING****Danger to persons from process conditions!**

- ▶ Beware of hazardous process conditions such as pressure in the measuring device, high temperatures or aggressive media.
2. Carry out the mounting and connection steps from the "Mounting the measuring device" and "Connecting the measuring device" sections in reverse order. Observe the safety instructions.

### 14.5.2 Disposing of the measuring device

**⚠ WARNING****Danger to personnel and environment from fluids that are hazardous to health.**

- ▶ Ensure that the measuring device and all cavities are free of fluid residues that are hazardous to health or the environment, e.g. substances that have permeated into crevices or diffused through plastic.

Observe the following notes during disposal:



- ▶ Observe valid federal/national regulations.
- ▶ Ensure proper separation and reuse of the device components.

## 15 Accessories



Various accessories, which can be ordered with the device or subsequently from Endress+Hauser, are available for the device. Detailed information on the order code in question is available from your local Endress+Hauser sales center or on the product page of the Endress+Hauser website: [www.endress.com](http://www.endress.com).

### 15.1 Device-specific accessories



#### 15.1.1 For the transmitter

Accessories	Description
Promass 200 transmitter	<p>Transmitter for replacement or storage. Use the order code to define the following specifications:</p> <ul style="list-style-type: none"> <li>▪ Approvals</li> <li>▪ Output</li> <li>▪ Display/operation</li> <li>▪ Housing</li> <li>▪ Software</li> </ul> <p> Installation Instructions EA00104D</p> <p> (Order number: 8X2CXX)</p>
Remote display FHX50	<p>FHX50 housing for accommodating a display module .</p> <ul style="list-style-type: none"> <li>▪ FHX50 housing suitable for: <ul style="list-style-type: none"> <li>▪ SD02 display module (push buttons)</li> <li>▪ SD03 display module (touch control)</li> </ul> </li> <li>▪ Length of connecting cable: up to max. 60 m (196 ft) (cable lengths available for order: 5 m (16 ft), 10 m (32 ft), 20 m (65 ft), 30 m (98 ft))</li> </ul> <p>The measuring instrument can be ordered with the FHX50 housing and a display module. The following options must be selected in the separate order codes:</p> <ul style="list-style-type: none"> <li>▪ Order code for measuring instrument, feature 030: Option L or M "Prepared for FHX50 display"</li> <li>▪ Order code for FHX50 housing, feature 050 (measuring instrument version): Option A "Prepared for FHX50 display"</li> <li>▪ Order code for FHX50 housing, depends on the desired display module in feature 020 (display, operation): <ul style="list-style-type: none"> <li>▪ Option C: for an SD02 display module (push buttons)</li> <li>▪ Option E: for an SD03 display module (touch control)</li> </ul> </li> </ul> <p>The FHX50 housing can also be ordered as a retrofit kit. The measuring instrument display module is used in the FHX50 housing. The following options must be selected in the order code for the FHX50 housing:</p> <ul style="list-style-type: none"> <li>▪ Feature 050 (measuring instrument version): option B "Not prepared for FHX50 display"</li> <li>▪ Feature 020 (display, operation): option A "None, existing displayed used"</li> </ul> <p> Special Documentation SD01007F</p> <p>(Order number: FHX50)</p>







Accessories	Description
Overvoltage protection for 2-wire devices	<p>Ideally, the overvoltage protection module should be ordered directly with the device. See product structure, feature 610 "Accessory mounted", option NA "Overvoltage protection". Separate order necessary only if retrofitting.</p> <p>OVP10: For 1-channel devices (feature 020, option A):</p> <p> Special Documentation SD01090F</p> <p>(Order number OVP10: 71128617) (Order number OVP20: 71128619)</p>
Weather protective cover	<p>Is used to protect the measuring instrument from the effects of the weather: e.g. rainwater, excess heating from direct sunlight or extreme cold in winter.</p> <p> Special Documentation SD00333F</p> <p>(Order number: 71162242)</p>

### 15.1.2 For the sensor



Accessories	Description
Heating jacket	<p>Is used to stabilize the temperature of the fluids in the sensor. Water, water vapor and other non-corrosive liquids are permitted for use as fluids.</p> <p> If using oil as a heating medium, please consult with Endress+Hauser.</p> <p>Heating jackets cannot be used with sensors fitted with a rupture disk.</p> <ul style="list-style-type: none"> <li>▪ If ordered together with the measuring device: <ul style="list-style-type: none"> <li>Order code for "Accessory enclosed"</li> <li>▪ Option RB "Heating jacket, G 1/2" female thread"</li> <li>▪ Option RC "Heating jacket, G 3/4" female thread"</li> <li>▪ Option RD "Heating jacket, NPT 1/2" female thread"</li> <li>▪ Option RE "Heating jacket, NPT 3/4" female thread"</li> </ul> </li> <li>▪ If ordered subsequently: <ul style="list-style-type: none"> <li>Use the order code with the product root DK8003.</li> </ul> </li> </ul> <p> Special Documentation SD02151D</p>

## 15.2 Communication-specific accessories







Accessories	Description
Commubox FXA291	<p>Connects Endress+Hauser field devices with a CDI interface (= Endress+Hauser Common Data Interface) and the USB port of a computer or laptop.</p> <p> Technical Information TI00405C</p>
Fieldgate FXA42	<p>Transmission of the measured values of connected 4 to 20 mA analog measuring instruments, as well as digital measuring instruments</p> <p> <ul style="list-style-type: none"> <li>▪ Technical Information TI01297S</li> <li>▪ Operating Instructions BA01778S</li> <li>▪ Product page: <a href="http://www.endress.com/fxa42">www.endress.com/fxa42</a></li> </ul> </p>
Field Xpert SMT50	<p>The Field Xpert SMT50 tablet PC for device configuration enables mobile plant asset management in the non-hazardous areas. It is suitable for commissioning and maintenance staff to manage field instruments with a digital communication interface and to record progress.</p> <p>This tablet PC is designed as an all-in-one solution with a preinstalled driver library and is an easy-to-use, touch-sensitive tool which can be used to manage field instruments throughout their entire life cycle.</p> <p> <ul style="list-style-type: none"> <li>▪ Technical Information TI01555S</li> <li>▪ Operating Instructions BA02053S</li> <li>▪ Product page: <a href="http://www.endress.com/smt50">www.endress.com/smt50</a></li> </ul> </p>

Field Xpert SMT70	<p>The Field Xpert SMT70 tablet PC for device configuration enables mobile plant asset management in hazardous and non-hazardous areas. It is suitable for commissioning and maintenance staff to manage field instruments with a digital communication interface and to record progress.</p> <p>This tablet PC is designed as an all-in-one solution with a preinstalled driver library and is an easy-to-use, touch-sensitive tool which can be used to manage the field instruments throughout their entire life cycle.</p> <ul style="list-style-type: none"> <li> ■ Technical Information TI01342S</li> <li>■ Operating Instructions BA01709S</li> <li>■ Product page: <a href="http://www.endress.com/smt70">www.endress.com/smt70</a></li> </ul>
Field Xpert SMT77	<p>The Field Xpert SMT77 tablet PC for device configuration enables mobile plant asset management in areas categorized as Ex Zone 1.</p> <ul style="list-style-type: none"> <li> ■ Technical Information TI01418S</li> <li>■ Operating Instructions BA01923S</li> <li>■ Product page: <a href="http://www.endress.com/smt77">www.endress.com/smt77</a></li> </ul>

### 15.3 Service-specific accessories

Accessories	Description
Applicator	<p>Software for selecting and sizing Endress+Hauser measuring instruments:</p> <ul style="list-style-type: none"> <li>■ Choice of measuring instruments for industrial requirements</li> <li>■ Calculation of all the necessary data for identifying the optimum flowmeter: e.g. nominal diameter, pressure loss, flow velocity and measurement accuracy.</li> <li>■ Graphic display of the calculation results</li> <li>■ Determination of the partial order code, administration, documentation and access to all project-related data and parameters over the entire life cycle of a project.</li> </ul> <p>Applicator is available: Via the Internet: <a href="https://portal.endress.com/webapp/applicator">https://portal.endress.com/webapp/applicator</a></p>
Netilion	<p>IIoT ecosystem: Unlock knowledge</p> <p>With the Netilion IIoT ecosystem, Endress+Hauser allows you to optimize your plant performance, digitize workflows, share knowledge, and enhance collaboration.</p> <p>Drawing upon decades of experience in process automation, Endress+Hauser offers the process industry an IIoT ecosystem designed to effortlessly extract insights from data. These insights allow process optimization, leading to increased plant availability, efficiency, and reliability - ultimately resulting in a more profitable plant.</p> <p><a href="http://www.netilion.endress.com">www.netilion.endress.com</a></p>
FieldCare	<p>FDT-based plant asset management tool from Endress+Hauser.</p> <p>It can configure all intelligent field units in your system and helps you manage them. By using the status information, it is also a simple but effective way of checking their status and condition.</p> <ul style="list-style-type: none"> <li> Operating Instructions BA00027S and BA00059S</li> </ul>
DeviceCare	<p>Tool to connect and configure Endress+Hauser field devices.</p> <ul style="list-style-type: none"> <li> Innovation brochure IN01047S</li> </ul>

## 15.4 System components

Accessories	Description
Memograph M graphic data manager	<p>The Memograph M graphic data manager provides information on all the relevant measured variables. Measured values are recorded correctly, limit values are monitored and measuring points analyzed. The data are stored in the 256 MB internal memory and also on a SD card or USB stick.</p> <ul style="list-style-type: none"> <li> Technical Information TI00133R</li> <li> Operating Instructions BA00247R</li> </ul>
Cerabar M	<p>The pressure transmitter for measuring the absolute and gauge pressure of gases, steam and liquids. It can be used to read in the operating pressure value.</p> <ul style="list-style-type: none"> <li> Technical Information TI00426P and TI00436P</li> <li> Operating Instructions BA00200P and BA00382P</li> </ul>
Cerabar S	<p>The pressure transmitter for measuring the absolute and gauge pressure of gases, steam and liquids. It can be used to read in the operating pressure value.</p> <ul style="list-style-type: none"> <li> Technical Information TI00383P</li> <li> Operating Instructions BA00271P</li> </ul>

## 16 Technical data

### 16.1 Application

The measuring device is intended only for the flow measurement of liquids and gases.

Depending on the version ordered, the measuring device can also measure potentially explosive, flammable, poisonous and oxidizing media.

To ensure that the device remains in proper operating condition for its service life, use the measuring device only for media against which the process-wetted materials are sufficiently resistant.

### 16.2 Function and system design

---

Measuring principle	Mass flow measurement based on the Coriolis measuring principle
Measuring system	<p>The device consists of a transmitter and a sensor.</p> <p>The device is available as a compact version: The transmitter and sensor form a mechanical unit.</p> <p>For information on the structure of the measuring instrument →  13</p>

---

## 16.3 Input

Measured variable

### Direct measured variables

- Mass flow
- Density
- Temperature

### Calculated measured variables

- Volume flow
- Corrected volume flow
- Reference density

Measuring range

### Measuring range for liquids

DN		Measuring range full scale values $\dot{m}_{\min(F)}$ to $\dot{m}_{\max(F)}$	
[mm]	[in]	[kg/h]	[lb/min]
8	$\frac{3}{8}$	0 to 2 000	0 to 73.50
15	$\frac{1}{2}$	0 to 6 500	0 to 238.9
25	1	0 to 18 000	0 to 661.5
40	$1\frac{1}{2}$	0 to 45 000	0 to 1 654
50	2	0 to 70 000	0 to 2 573

### Measuring range for gases

The full scale value depends on the density and the sound velocity of the gas used. The full scale value can be calculated with the following formulas:

$$\dot{m}_{\max(G)} = \text{Minimum of } (\dot{m}_{\max(F)} \cdot \rho_G \cdot x) \text{ and } (\rho_G \cdot (c_G/2) \cdot d_i^2 \cdot (\pi/4) \cdot 3600 \cdot n)$$

$\dot{m}_{\max(G)}$	Maximum full scale value for gas [kg/h]
$\dot{m}_{\max(F)}$	Maximum full scale value for liquid [kg/h]
$\dot{m}_{\max(G)} < \dot{m}_{\max(F)}$	$\dot{m}_{\max(G)}$ can never be greater than $\dot{m}_{\max(F)}$
$\rho_G$	Gas density in [kg/m <sup>3</sup> ] at operating conditions
$x$	Limitation constant for max. gas flow [kg/m <sup>3</sup> ]
$c_G$	Sound velocity (gas) [m/s]
$d_i$	Measuring tube internal diameter [m]
$\pi$	Pi
$n = 2$	Number of measuring tubes



DN		$x$
[mm]	[in]	[kg/m <sup>3</sup> ]
8	$\frac{3}{8}$	85
15	$\frac{1}{2}$	110
25	1	125

DN		x
[mm]	[in]	[kg/m <sup>3</sup> ]
40	1½	125
50	2	125

If calculating the full scale value using the two formulas:

1. Calculate the full scale value with both formulas.
2. The smaller value is the value that must be used.

**Recommended measuring range**

 Flow limit →  161

Operable flow range



Over 1000 : 1.

Flow rates above the preset full scale value do not override the electronics unit, with the result that the totalizer values are registered correctly.

Input signal

**External measured values**

To increase the measurement accuracy of certain measured variables or to calculate the corrected volume flow for gases, the automation system can continuously write the operating pressure to the measuring instrument. Endress+Hauser recommends the use of a pressure measuring device for absolute pressure, e.g. Cerabar M or Cerabar S.

 Various pressure transmitters and temperature measuring devices can be ordered from Endress+Hauser: see "Accessories" section →  147

It is recommended to read in external measured values to calculate the following measured variables:

- Mass flow
- Corrected volume flow

*Digital communication*

The measured values are written by the automation system via FOUNDATION fieldbus.

## 16.4 Output

Output signal

**Pulse/frequency/switch output**

<b>Function</b>	Can be configured as pulse, frequency or switch output
<b>Version</b>	Passive, open collector
<b>Maximum input values</b>	<ul style="list-style-type: none"> <li>▪ DC 35 V</li> <li>▪ 50 mA</li> </ul>
<b>Voltage drop</b>	<ul style="list-style-type: none"> <li>▪ For ≤ 2 mA: 2 V</li> <li>▪ For 10 mA: 8 V</li> </ul>
<b>Residual current</b>	≤ 0.05 mA
<b>Pulse output</b>	
<b>Pulse width</b>	Configurable: 5 to 2 000 ms
<b>Maximum pulse rate</b>	100 Impulse/s
<b>Pulse value</b>	Configurable

<b>Assignable measured variables</b>	<ul style="list-style-type: none"> <li>▪ Mass flow</li> <li>▪ Volume flow</li> <li>▪ Corrected volume flow</li> </ul>
<b>Frequency output</b>	
<b>Output frequency</b>	Configurable: 0 to 1000 Hz
<b>Damping</b>	Configurable: 0 to 999 s
<b>Pulse/pause ratio</b>	1:1
<b>Assignable measured variables</b>	<ul style="list-style-type: none"> <li>▪ Mass flow</li> <li>▪ Volume flow</li> <li>▪ Corrected volume flow</li> <li>▪ Density</li> <li>▪ Reference density</li> <li>▪ Temperature</li> </ul>
<b>Switch output</b>	
<b>Switching behavior</b>	Binary, conductive or non-conductive
<b>Switching delay</b>	Configurable: 0 to 100 s
<b>Number of switching cycles</b>	Unlimited
<b>Assignable functions</b>	<ul style="list-style-type: none"> <li>▪ Off</li> <li>▪ On</li> <li>▪ Diagnostic behavior</li> <li>▪ Limit                             <ul style="list-style-type: none"> <li>▪ Mass flow</li> <li>▪ Volume flow</li> <li>▪ Corrected volume flow</li> <li>▪ Density</li> <li>▪ Reference density</li> <li>▪ Temperature</li> <li>▪ Totalizer 1-3</li> </ul> </li> <li>▪ Flow direction monitoring</li> <li>▪ Status                             <ul style="list-style-type: none"> <li>▪ Partially filled pipe detection</li> <li>▪ Low flow</li> </ul> </li> </ul>

**FOUNDATION Fieldbus**

<b>FOUNDATION Fieldbus</b>	H1, IEC 61158-2, galvanically isolated
<b>Data transfer</b>	31.25 kbit/s
<b>Current consumption</b>	10 mA
<b>Permitted supply voltage</b>	9 to 32 V
<b>Bus connection</b>	With integrated reverse polarity protection

Signal on alarm

Depending on the interface, failure information is displayed as follows:

**Pulse/frequency/switch output**

<b>Pulse output</b>	
<b>Fault mode</b>	Choose from: <ul style="list-style-type: none"> <li>▪ Actual value</li> <li>▪ No pulses</li> </ul>
<b>Frequency output</b>	
<b>Fault mode</b>	Choose from: <ul style="list-style-type: none"> <li>▪ Actual value</li> <li>▪ 0 Hz</li> <li>▪ Definable value between: 0 to 1250 Hz</li> </ul>

Switch output	
Fault mode	Choose from: <ul style="list-style-type: none"> <li>▪ Current status</li> <li>▪ Open</li> <li>▪ Closed</li> </ul>

**FOUNDATION Fieldbus**

Status and alarm messages	Diagnostics in accordance with FF-891
Failure current FDE (Fault Disconnection Electronic)	0 mA

**Onsite display**

Plain text display	With information on cause and remedial measures
Backlight	Additionally for device version with SD03 local display: red lighting indicates a device error.

 Status signal as per NAMUR recommendation NE 107

**Interface/protocol**

- Via digital communication:  
FOUNDATION Fieldbus
- Via service interface  
CDI service interface

Plain text display	With information on cause and remedial measures
--------------------	---

Low flow cut off                      The switch points for low flow cut off are user-selectable.

Galvanic isolation                    All outputs are galvanically isolated from one another.

Protocol-specific data

Manufacturer ID	0x452B48
Ident number	0x1054
Device revision	1
DD revision	Information and files at: <ul style="list-style-type: none"> <li>▪ <a href="http://www.endress.com">www.endress.com</a> → Download Area</li> <li>▪ <a href="http://www.fieldcommgroup.org">www.fieldcommgroup.org</a></li> </ul>
CFF revision	
Device Tester Version (ITK version)	6.1.1
ITK Test Campaign Number	IT094200
Link Master capability (LAS)	Yes
Choice of "Link Master" and "Basic Device"	Yes Factory setting: Basic Device
Node address	Factory setting: 247 (0xF7)
Supported functions	The following methods are supported: <ul style="list-style-type: none"> <li>▪ Restart</li> <li>▪ ENP Restart</li> <li>▪ Diagnostic</li> </ul>



Virtual Communication Relationships (VCRs)	
Number of VCRs	44
Number of link objects in VFD	50
Permanent entries	1
Client VCRs	0
Server VCRs	10
Source VCRs	43
Sink VCRs	0
Subscriber VCRs	43
Publisher VCRs	43
Device Link Capabilities	
Slot time	4
Min. delay between PDU	8
Max. response delay	Min. 5
System integration	For information on system integration, see <ul style="list-style-type: none"> <li>▪ Cyclic data transmission</li> <li>▪ Description of the modules</li> <li>▪ Execution times</li> <li>▪ Methods</li> </ul>

## 16.5 Power supply

### Terminal assignment

#### Transmitter

Connection version for FOUNDATION Fieldbus, pulse/frequency/switch output

Maximum number of terminals	Maximum number of terminals for order code for "Accessory mounted", option NA "Overvoltage protection"
<p>1 Output 1: FOUNDATION Fieldbus</p> <p>2 Output 2 (passive): pulse/frequency/switch output</p> <p>3 Ground terminal for cable shield</p>	

Order code for "Output"	Terminal numbers			
	Output 1		Output 2	
	1 (+)	2 (-)	3 (+)	4 (-)
Option E <sup>1) 2)</sup>	FOUNDATION Fieldbus		Pulse/frequency/switch output (passive)	

- 1) Output 1 must always be used; output 2 is optional.
- 2) FOUNDATION Fieldbus with integrated reverse polarity protection.

Supply voltage

**Transmitter**

An external power supply is required for each output.

The following supply voltage values apply for the outputs available:

Order code for "Output"	Minimum terminal voltage	Maximum terminal voltage
Option E <sup>1)</sup> : FOUNDATION Fieldbus, pulse/frequency/switch output	≥ DC 9 V	DC 32 V

1) For device version with SD03 local display: The terminal voltage must be increased by DC 0.5 V if backlighting is used.

Power consumption

**Transmitter**

Order code for "Output; input"	Maximum power consumption
Option E: FOUNDATION Fieldbus, pulse/frequency/switch output	<ul style="list-style-type: none"> <li>▪ Operation with output 1: 576 mW</li> <li>▪ Operation with output 1 and 2: 2 576 mW</li> </ul>

Current consumption

**FOUNDATION Fieldbus**

18 mA

Power supply failure

- Totalizers stop at the last value measured.
- Depending on the device version, the configuration is retained in the device memory or in the pluggable data memory (HistoROM DAT).
- Error messages (incl. total operated hours) are stored.

Electrical connection

→  31

Potential equalization

Terminals

- For device version without integrated overvoltage protection: plug-in spring terminals for wire cross-sections 0.5 to 2.5 mm<sup>2</sup> (20 to 14 AWG)
- For device version with integrated overvoltage protection: screw terminals for wire cross-sections 0.2 to 2.5 mm<sup>2</sup> (24 to 14 AWG)

Cable entries

- Cable gland: M20 × 1.5 with cable Ø 6 to 12 mm (0.24 to 0.47 in)
- Thread for cable entry:
  - NPT ½"
  - G ½"

Cable specification

→  28

Overvoltage protection

The device can be ordered with integrated overvoltage protection for diverse approvals: *Order code for "Accessory mounted", option NA "Overvoltage protection"*

<b>Input voltage range</b>	Values correspond to supply voltage specifications →  154 <sup>1)</sup>
<b>Resistance per channel</b>	2 · 0.5 Ω max.
<b>DC sparkover voltage</b>	400 to 700 V
<b>Trip surge voltage</b>	< 800 V

Capacitance at 1 MHz	< 1.5 pF
Nominal discharge current (8/20 µs)	10 kA
Temperature range	-40 to +85 °C (-40 to +185 °F)

1) The voltage is reduced by the amount of the internal resistance  $I_{min} \cdot R_i$



 Depending on the temperature class, restrictions apply to the ambient temperature for device versions with overvoltage protection .

 For detailed information on the temperature tables, see the "Safety Instructions" (XA) for the device.

## 16.6 Performance characteristics

Reference operating conditions

- Error limits based on ISO 11631
- Water
  - +15 to +45 °C (+59 to +113 °F)
  - 2 to 6 bar (29 to 87 psi)
- Data as indicated in the calibration protocol
- Accuracy based on accredited calibration rigs according to ISO 17025

 To obtain measured errors, use the *Applicator* sizing tool →  146

Maximum measurement error

o.r. = of reading; 1 g/cm<sup>3</sup> = 1 kg/l; T = medium temperature

### Base accuracy

 Design fundamentals →  158

*Mass flow and volume flow (liquids)*

±0.25 % o.r.

*Mass flow (gases)*

±0.50 % o.r.

*Density (liquids)*

Under reference conditions [g/cm <sup>3</sup> ]	Standard density calibration [g/cm <sup>3</sup> ]
±0.0005	±0.002

*Temperature*

±0.5 °C ± 0.005 · T °C (±0.9 °F ± 0.003 · (T - 32) °F)

### Zero point stability

DN		Zero point stability	
[mm]	[in]	[kg/h]	[lb/min]
8	3/8	0.24	0.0088
15	1/2	0.78	0.0287

DN		Zero point stability	
[mm]	[in]	[kg/h]	[lb/min]
25	1	2.16	0.0794
40	1½	5.40	0.1985
50	2	8.40	0.3087

**Flow values**

Flow values as turndown parameters depending on nominal diameter.

*SI units*

DN	1:1	1:10	1:20	1:50	1:100	1:500
[mm]	[kg/h]	[kg/h]	[kg/h]	[kg/h]	[kg/h]	[kg/h]
8	2 000	200	100	40	20	4
15	6 500	650	325	130	65	13
25	18 000	1 800	900	360	180	36
40	45 000	4 500	2 250	900	450	90
50	70 000	7 000	3 500	1 400	700	140

*US units*

DN	1:1	1:10	1:20	1:50	1:100	1:500
[inch]	[lb/min]	[lb/min]	[lb/min]	[lb/min]	[lb/min]	[lb/min]
¾	73.50	7.350	3.675	1.470	0.735	0.147
½	238.9	23.89	11.95	4.778	2.389	0.478
1	661.5	66.15	33.08	13.23	6.615	1.323
1½	1 654	165.4	82.70	33.08	16.54	3.308
2	2 573	257.3	128.7	51.46	25.73	5.146

**Accuracy of outputs**

The outputs have the following base accuracy specifications.

*Pulse/frequency output*

o.r. = of reading

Accuracy	Max. ±100 ppm o.r.
----------	--------------------

Repeatability

o.r. = of reading; 1 g/cm<sup>3</sup> = 1 kg/l; T = medium temperature

**Base repeatability**

 Design fundamentals →  158

*Mass flow and volume flow (liquids)*

±0.125 % o.r.

*Mass flow (gases)*

±0.25 % o.r. (up to a Mach number of 0.2)

*Density (liquids)*

$\pm 0.00025 \text{ g/cm}^3$

*Temperature*

$\pm 0.25 \text{ }^\circ\text{C} \pm 0.0025 \cdot T \text{ }^\circ\text{C} (\pm 0.45 \text{ }^\circ\text{F} \pm 0.0015 \cdot (T-32) \text{ }^\circ\text{F})$

Response time

- The response time depends on the configuration (damping).
- Response time in the event of erratic changes in the measured variable: After 500 ms → 95 % of full scale value

Influence of ambient temperature

**Pulse/frequency output**

o.r. = of reading

<b>Temperature coefficient</b>	Max. $\pm 100$ ppm o.r.
--------------------------------	-------------------------

Influence of medium temperature

**Mass flow**

o.f.s. = of full scale value

If there is a difference between the temperature during zero adjustment and the process temperature, the additional measurement error of the sensors is typically  $\pm 0.0002 \text{ \% o.f.s./}^\circ\text{C} (\pm 0.0001 \text{ \% o. f.s./}^\circ\text{F})$ .

The influence is reduced when the zero adjustment is performed at process temperature.

**Density**

If there is a difference between the density calibration temperature and the process temperature, the measurement error of the sensors is typically  $\pm 0.0001 \text{ g/cm}^3/^\circ\text{C} (\pm 0.00005 \text{ g/cm}^3/^\circ\text{F})$ . Field density adjustment is possible.

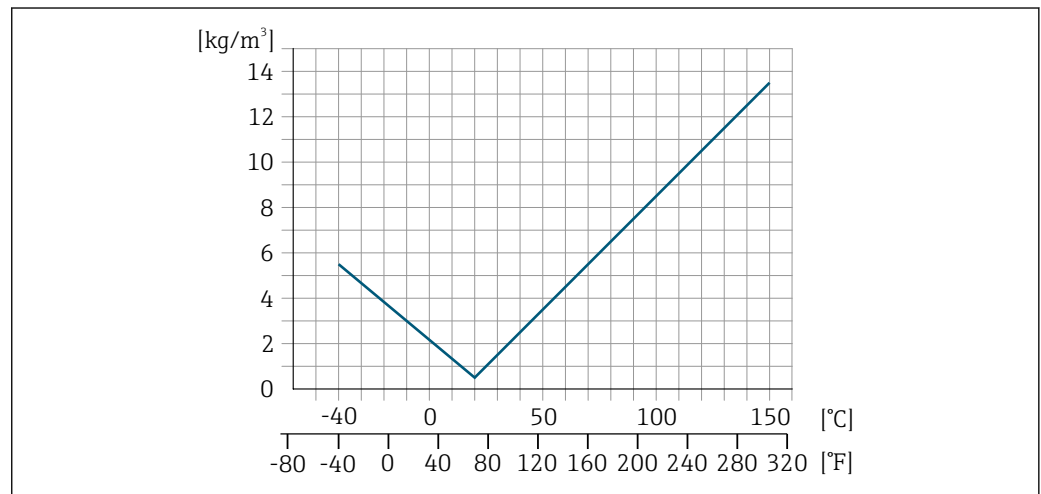

25 Field density adjustment, for example at  $+20 \text{ }^\circ\text{C} (+68 \text{ }^\circ\text{F})$

**Temperature**

$\pm 0.005 \cdot T \text{ }^\circ\text{C} (\pm 0.005 \cdot (T - 32) \text{ }^\circ\text{F})$

Influence of medium pressure

The following shows how the process pressure (gauge pressure) affects the accuracy of the mass flow.

o.r. = of reading



It is possible to compensate for the effect by:

- Reading in the current pressure measured value via the current input or a digital input.
- Specifying a fixed value for the pressure in the device parameters.



Operating Instructions .

DN		[% o.r./bar]	[% o.r./psi]
[mm]	[in]		
8	3/8	no influence	
15	1/2	no influence	
25	1	no influence	
40	1 1/2	no influence	
50	2	-0.009	-0.0006

Design fundamentals

o.r. = of reading, o.f.s. = of full scale value

BaseAccu = base accuracy in % o.r., BaseRepeat = base repeatability in % o.r.

MeasValue = measured value; ZeroPoint = zero point stability

*Calculation of the maximum measured error as a function of the flow rate*

Flow rate	Maximum measured error in % o.r.
$\geq \frac{\text{ZeroPoint}}{\text{BaseAccu}} \cdot 100$ <small>A0021332</small>	$\pm \text{BaseAccu}$ <small>A0021339</small>
$< \frac{\text{ZeroPoint}}{\text{BaseAccu}} \cdot 100$ <small>A0021333</small>	$\pm \frac{\text{ZeroPoint}}{\text{MeasValue}} \cdot 100$ <small>A0021334</small>

*Calculation of the maximum repeatability as a function of the flow rate*

Flow rate	Maximum repeatability in % o.r.
$\geq \frac{4/3 \cdot \text{ZeroPoint}}{\text{BaseAccu}} \cdot 100$ <small>A0021341</small>	$\pm 1/2 \cdot \text{BaseAccu}$ <small>A0021343</small>
$< \frac{4/3 \cdot \text{ZeroPoint}}{\text{BaseAccu}} \cdot 100$ <small>A0021342</small>	$\pm 2/3 \cdot \frac{\text{ZeroPoint}}{\text{MeasValue}} \cdot 100$ <small>A0021344</small>

**Example of maximum measurement error**

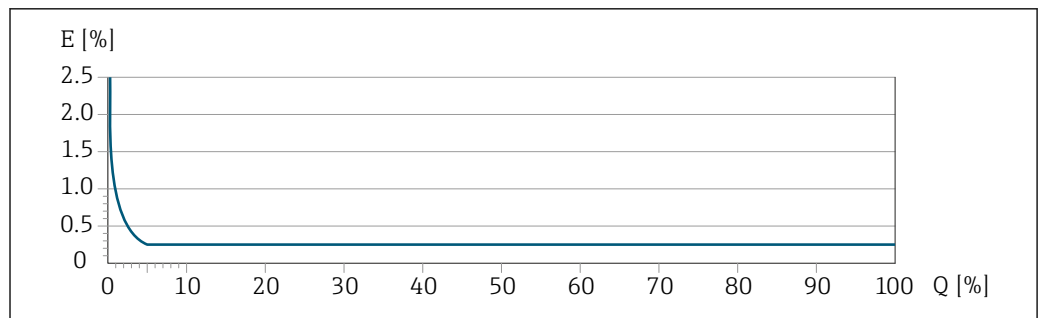



E Maximum measurement error in % o.r. (example: DN 25)

Q Flow rate in % of maximum full scale value

## 16.7 Mounting

Mounting requirements →  20

## 16.8 Environment

Ambient temperature range →  22 →  22

### Temperature tables



Observe the interdependencies between the permitted ambient and fluid temperatures when operating the device in hazardous areas.



For detailed information on the temperature tables, see the separate document entitled "Safety Instructions" (XA) for the device.

Storage temperature -40 to +80 °C (-40 to +176 °F), preferably at +20 °C (+68 °F)

Climate class DIN EN 60068-2-38 (test Z/AD)

Degree of protection

### Transmitter

- Standard: IP66/67, Type 4X enclosure, suitable for pollution degree 4
- When the housing is open: IP20, Type 1 enclosure, suitable for pollution degree 2
- Display module: IP20, Type 1 enclosure, suitable for pollution degree 2

### Sensor

IP66/67, Type 4X enclosure, suitable for pollution degree 4

### Device plug

IP67, only in screwed situation

Shock and vibration resistance

### Vibration sinusoidal, in accordance with IEC 60068-2-6

- 2 to 8.4 Hz, 3.5 mm peak
- 8.4 to 2 000 Hz, 1 g peak

### Vibration broad-band random, according to IEC 60068-2-64

- 10 to 200 Hz, 0.003 g<sup>2</sup>/Hz
- 200 to 2 000 Hz, 0.001 g<sup>2</sup>/Hz
- Total: 1.54 g rms

### Shock half-sine, according to IEC 60068-2-27

6 ms 30 g

### Rough handling shocks according to IEC 60068-2-31

Internal cleaning

- CIP cleaning
- SIP cleaning

### Options

Oil- and grease-free version for wetted parts, without declaration  
Order code for "Service", option HA <sup>3)</sup>

3) The cleaning refers to the measuring instrument only. Any accessories supplied are not cleaned.

Electromagnetic compatibility (EMC)



Details are provided in the Declaration of Conformity.



This unit is not intended for use in residential environments and cannot guarantee adequate protection of the radio reception in such environments.

## 16.9 Process

Medium temperature range -40 to +150 °C (-40 to +302 °F)

Medium density 0 to 2 000 kg/m<sup>3</sup> (0 to 125 lb/cf)

Pressure-temperature ratings



For an overview of the pressure-temperature ratings for the process connections, see the Technical Information

Sensor housing

The sensor housing is filled with dry nitrogen gas and protects the electronics and mechanics inside.



If a measuring tube fails (e.g. due to process characteristics like corrosive or abrasive fluids), the fluid will initially be contained by the sensor housing.

In the event of a tube failure, the pressure level inside the sensor housing will rise according to the operating process pressure. If the user judges that the sensor housing burst pressure does not provide an adequate safety margin, the device can be fitted with a rupture disk. This prevents excessively high pressure from forming inside the sensor housing. Therefore, the use of a rupture disk is strongly recommended in applications involving high gas pressures, and particularly in applications in which the process pressure is greater than 2/3 of the sensor housing burst pressure.

### Burst pressure of the sensor housing

If the device is fitted with a rupture disk (order code for "Sensor option", option CA "Rupture disk"), the rupture disk trigger pressure is decisive .

The sensor housing burst pressure refers to a typical internal pressure which is reached prior to mechanical failure of the sensor housing and which was determined during type testing. The corresponding type test declaration can be ordered with the device (order code for "Additional approval", option LN "Sensor housing burst pressure, type test").

DN		Sensor housing burst pressure	
[mm]	[in]	[bar]	[psi]
8	3/8	250	3 620
15	1/2	250	3 620
25	1	250	3 620
40	1 1/2	200	2 900
50	2	180	2 610
80	3	120	1 740





For information on the dimensions: see the "Mechanical construction" section of the "Technical Information" document





**Rupture disk** To increase the level of safety, a device version with a rupture disk with a trigger pressure of 10 to 15 bar (145 to 217.5 psi) can be used (order code for "Sensor option", option CA "rupture disk").

The use of rupture disks cannot be combined with the separately available heating jacket.

**Flow limit** Select the nominal diameter by optimizing between the required flow range and permissible pressure loss.

 For an overview of the full scale values for the measuring range, see the "Measuring range" section →  149

- The minimum recommended full scale value is approx. 1/20 of the maximum full scale value
- In most applications, 20 to 50 % of the maximum full scale value can be considered ideal
- A low full scale value must be selected for abrasive media (such as liquids with entrained solids): flow velocity < 1 m/s (< 3 ft/s).
- For gas measurement the following rules apply:
  - The flow velocity in the measuring tubes should not exceed half the sound velocity (0.5 Mach).
  - The maximum mass flow depends on the density of the gas: formula

 To calculate the flow limit, use the *Applicator* sizing tool →  146

**Pressure loss**  To calculate the pressure loss, use the *Applicator* sizing tool →  146

**System pressure** →  22

## 16.10 Mechanical construction

**Design, dimensions**  For the dimensions and installation lengths of the device, see the "Technical Information" document, "Mechanical construction" section

**Weight** All values (weight exclusive of packaging material) refer to devices with EN/DIN PN 40 flanges.

### Weight in SI units

DN [mm]	Weight [kg]
8	5
15	5.5
25	7
40	11
50	16

**Weight in US units**

DN [in]	Weight [lbs]
3/8	11
1/2	12
1	15
1 1/2	24
2	35

**Materials**

**Transmitter housing**

- Order code for "Housing", option C "Compact, aluminum coated":  
Aluminum, AlSi10Mg, coated
- Window material: glass

**Cable entries/cable glands**

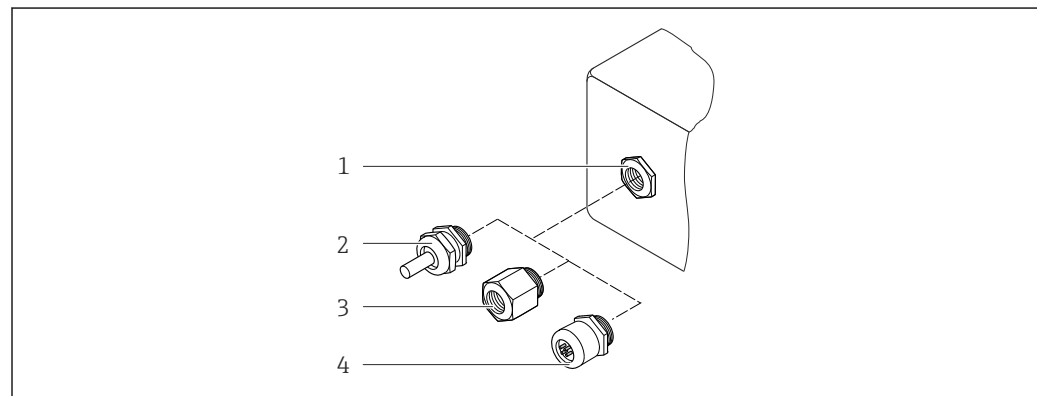

A0028352

26 Possible cable entries/cable glands

- 1 Female thread M20 × 1.5
- 2 Cable gland M20 × 1.5
- 3 Adapter for cable entry with female thread G 1/2" or NPT 1/2"
- 4 Device plug

Order code for "Housing", option C "GT20 dual compartment, aluminum coated"

Cable entry/cable gland	Type of protection	Material
Cable gland M20 × 1.5	<ul style="list-style-type: none"> <li>■ Non-hazardous area</li> <li>■ Ex ia</li> <li>■ Ex ic</li> </ul>	Plastic
	Adapter for cable entry with female thread G 1/2"	Nickel-plated brass
Adapter for cable entry with female thread NPT 1/2"	Non-hazardous area and hazardous area (except for CSA Ex d/XP)	Nickel-plated brass
Thread NPT 1/2" via adapter	Non-hazardous area and hazardous area	

**Device plug**

Electrical connection	Material
Plug M12x1	<ul style="list-style-type: none"> <li>▪ Socket: stainless steel, 1.4401/316</li> <li>▪ Contact housing: plastic, PUR, black</li> <li>▪ Contacts: metal, CuZn, gold-plated</li> <li>▪ Threaded connection seal: NBR</li> </ul>

**Sensor housing**



- Acid and alkali-resistant outer surface
- Stainless steel 1.4301 (304)

**Measuring tubes**

Stainless steel, 1.4539 (904L); manifold: stainless steel, 1.4404 (316L)

**Process connections**

- Flanges according to EN 1092-1 (DIN2501) / according to ASME B 16.5 / as per JIS B2220:  
Stainless steel, 1.4404 (F316/F316L)
- All other process connections:  
Stainless steel, 1.4404 (316/316L)

 Available process connections →  164

**Seals**

Welded process connections without internal seals

**Accessories**

*Protective cover*

Stainless steel, 1.4404 (316L)

*Remote display FHX50*

Housing material:

- Plastic PBT
- Stainless steel CF-3M (316L, 1.4404)

Process connections

- Fixed flange connections:
  - EN 1092-1 (DIN 2501) flange
  - EN 1092-1 (DIN 2512N) flange
  - NAMUR lengths in accordance with NE 132
  - ASME B16.5 flange
  - JIS B2220 flange
  - DIN 11864-2 Form A flange, DIN 11866 series A, flange with notch
- Clamp connections:
  - Tri-Clamp (OD tubes), DIN 11866 series C
- Thread:
  - DIN 11851 thread, DIN 11866 series A
  - SMS 1145 thread
  - ISO 2853 thread, ISO 2037
  - DIN 11864-1 Form A thread, DIN 11866 series A
- VCO connections:
  - 8-VCO-4
  - 12-VCO-4

 Process connection materials

Surface roughness

All data refer to parts in contact with the medium.

*The following surface roughness categories can be ordered:*

Category	Method	Option(s) order code "Measuring tube mat., wetted surface"
Not polished	–	SA
Ra ≤ 0.76 µm (30 µin) <sup>1)</sup>	Mechanically polished <sup>2)</sup>	SB
Ra ≤ 0.76 µm (30 µin) <sup>1)</sup>	Mechanically polished <sup>2)</sup> , welds in as-welded condition	SJ
Ra ≤ 0.38 µm (15 µin) <sup>1)</sup>	Mechanically polished <sup>2)</sup>	SC
Ra ≤ 0.38 µm (15 µin) <sup>1)</sup>	Mechanically polished <sup>2)</sup> , welds in as-welded condition	SK

1) Ra according to ISO 21920

2) Except for inaccessible welds between pipe and manifold

## 16.11 Operability

Languages

Can be operated in the following languages:

- Via local display:
  - English, German, French, Spanish, Italian, Dutch, Portuguese, Polish, Russian, Swedish, Turkish, Chinese, Japanese, Bahasa (Indonesian), Vietnamese, Czech
- Via "FieldCare" operating tool:
  - English, German, French, Spanish, Italian, Chinese, Japanese

## Onsite operation

**Via display module**



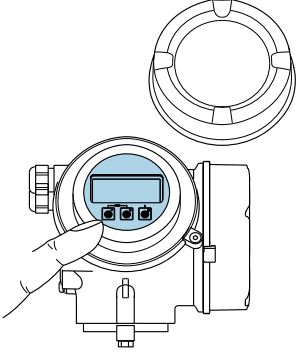
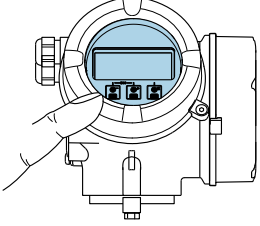



Two display modules are available:

Order code for "Display; Operation", option C "SD02"	Order code for "Display; Operation", option E "SD03"
	
1 Operation with pushbuttons	1 Operation with touch control

*Display elements*

- 4-line, illuminated, graphic display
- White background lighting; switches to red in event of device errors
- Format for displaying measured variables and status variables can be individually configured



*Operating elements*

- Operation with 3 push buttons with open housing: , , 
- or
- External operation via touch control (3 optical keys) without opening the housing: , , 
- Operating elements also accessible in the various zones of the hazardous area

*Additional functionality*

- Data backup function  
The device configuration can be saved in the display module.
- Data comparison function  
The device configuration saved in the display module can be compared to the current device configuration.
- Data transfer function  
The transmitter configuration can be transmitted to another device using the display module.

**Via remote display FHX50**

 The remote display FHX50 can be ordered as an optional extra →  144.

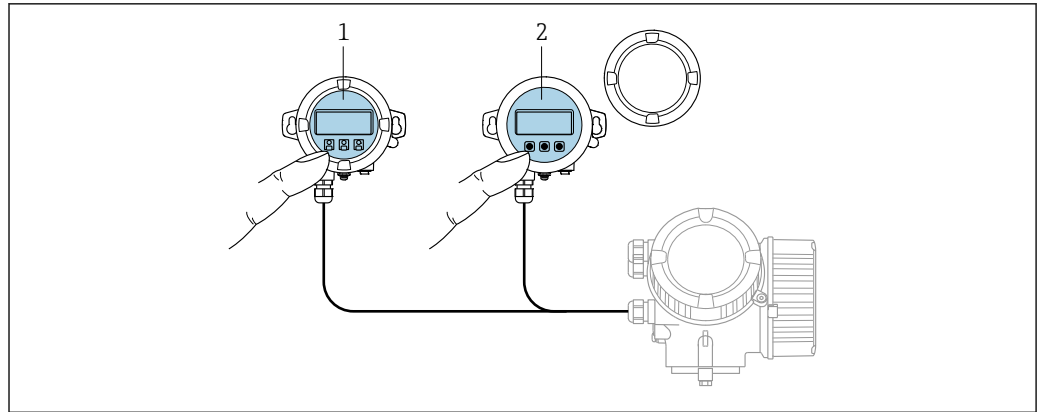

A0032215

27 FHX50 operating options

- 1 SD02 display and operating module, push buttons: cover must be opened for operation
- 2 SD03 display and operating module, optical buttons: operation possible through cover glass

*Display and operating elements*

The display and operating elements correspond to those of the display module .

Remote operation → 50

Service interface → 51

## 16.12 Certificates and approvals

Current certificates and approvals for the product are available at [www.endress.com](http://www.endress.com) on the relevant product page:

1. Select the product using the filters and search field.
2. Open the product page.
3. Select **Downloads**.

CE mark The device meets the legal requirements of the applicable EU Directives. These are listed in the corresponding EU Declaration of Conformity along with the standards applied. Endress+Hauser confirms successful testing of the device by affixing to it the CE mark.

UKCA marking The device meets the legal requirements of the applicable UK regulations (Statutory Instruments). These are listed in the UKCA Declaration of Conformity along with the designated standards. By selecting the order option for UKCA marking, Endress+Hauser confirms a successful evaluation and testing of the device by affixing the UKCA mark.

Contact address Endress+Hauser UK:  
 Endress+Hauser Ltd.  
 Floats Road  
 Manchester M23 9NF  
 United Kingdom  
[www.uk.endress.com](http://www.uk.endress.com)

RCM marking The measuring system meets the EMC requirements of the "Australian Communications and Media Authority (ACMA)".

Ex-approval	The devices are certified for use in hazardous areas and the relevant safety instructions are provided in the separate "Safety Instructions" (XA) document. Reference is made to this document on the nameplate.
Hygienic compatibility	<ul style="list-style-type: none"> <li>■ 3-A approval <ul style="list-style-type: none"> <li>■ Only measuring instruments with the order code for "Additional approval", option LP "3A" have 3-A approval.</li> <li>■ The 3-A approval refers to the measuring instrument.</li> <li>■ When installing the measuring instrument, ensure that no liquid can accumulate on the outside of the measuring instrument. A remote display module must be installed in accordance with the 3-A Standard.</li> <li>■ Accessories (e.g. heating jacket, weather protection cover, wall holder unit) must be installed in accordance with the 3-A Standard. Each accessory can be cleaned. Disassembly may be necessary under certain circumstances.</li> </ul> </li> <li>■ EHEDG-tested Only devices with the order code for "Additional approval", option LT "EHEDG" have been tested and meet the requirements of the EHEDG. To meet the requirements for EHEDG certification, the device must be used with process connections in accordance with the EHEDG position paper entitled "Easy cleanable Pipe couplings and Process connections" (<a href="http://www.ehedg.org">www.ehedg.org</a>). To meet the requirements for EHEDG certification, the device must be installed in a position that ensures drainability.</li> </ul> <p> Observe the special installation instructions</p>
Pharmaceutical compatibility	<ul style="list-style-type: none"> <li>■ FDA 21 CFR 177</li> <li>■ USP &lt;87&gt;</li> <li>■ USP &lt;88&gt; Class VI 121 °C</li> <li>■ TSE/BSE Certificate of Suitability</li> </ul>
FOUNDATION Fieldbus certification	<p><b>FOUNDATION Fieldbus interface</b></p> <p>The measuring device is certified and registered by the FieldComm Group. The measuring system meets all the requirements of the following specifications:</p> <ul style="list-style-type: none"> <li>■ Certified in accordance with FOUNDATION Fieldbus H1</li> <li>■ Interoperability Test Kit (ITK), revision version 6.1.1 (certificate available on request)</li> <li>■ Physical Layer Conformance Test</li> <li>■ The device can also be operated with certified devices of other manufacturers (interoperability)</li> </ul>
Pressure Equipment Directive	<ul style="list-style-type: none"> <li>■ With the marking <ul style="list-style-type: none"> <li>a) PED/G1/x (x = category) or</li> <li>b) PESR/G1/x (x = category)</li> </ul> on the sensor nameplate, Endress+Hauser confirms compliance with the "Essential Safety Requirements" <ul style="list-style-type: none"> <li>a) specified in Annex I of the Pressure Equipment Directive 2014/68/EU or</li> <li>b) Schedule 2 of Statutory Instruments 2016 No. 1105.</li> </ul> </li> <li>■ Devices not bearing this marking (without PED or PESR) are designed and manufactured according to sound engineering practice. They meet the requirements of <ul style="list-style-type: none"> <li>a) Art. 4 Para. 3 of the Pressure Equipment Directive 2014/68/EU or</li> <li>b) Part 1, Para. 8 of Statutory Instruments 2016 No. 1105.</li> </ul> The scope of application is indicated <ul style="list-style-type: none"> <li>a) in diagrams 6 to 9 in Annex II of the Pressure Equipment Directive 2014/68/EU or</li> <li>b) Schedule 3, Para. 2 of Statutory Instruments 2016 No. 1105.</li> </ul> </li> </ul>

## External standards and guidelines

- EN 60529  
Degrees of protection provided by enclosures (IP code)
- IEC/EN 60068-2-6  
Environmental influences: Test procedure - Test Fc: vibrate (sinusoidal).
- IEC/EN 60068-2-31  
Environmental influences: Test procedure - Test Ec: shocks due to rough handling, primarily for devices.
- EN 61010-1  
Safety requirements for electrical equipment for measurement, control and laboratory use - general requirements
- EN 61326-1/-2-3  
EMC requirements for electrical equipment for measurement, control and laboratory use
- IEC 61508  
Functional safety of electrical/electronic/programmable electronic safety-related systems
- NAMUR NE 21  
Electromagnetic compatibility (EMC) of industrial process and laboratory control equipment
- NAMUR NE 32  
Data retention in the event of a power failure in field and control instruments with microprocessors
- NAMUR NE 43  
Standardization of the signal level for the breakdown information of digital transmitters with analog output signal.
- NAMUR NE 53  
Software of field devices and signal-processing devices with digital electronics
- NAMUR NE 80  
The application of the pressure equipment directive to process control devices
- NAMUR NE 105  
Specifications for integrating fieldbus devices in engineering tools for field devices
- NAMUR NE 107  
Self-monitoring and diagnosis of field devices
- NAMUR NE 131  
Requirements for field devices for standard applications
- NAMUR NE 132  
Coriolis mass meter
- ETSI EN 300 328  
Guidelines for 2.4 GHz radio components.
- EN 301489  
Electromagnetic compatibility and radio spectrum matters (ERM).

## 16.13 Application packages

Many different application packages are available to enhance the functionality of the device. Such packages might be needed to address safety aspects or specific application requirements.

The application packages can be ordered with the device or subsequently from Endress+Hauser. Detailed information on the order code in question is available from your local Endress+Hauser sales center or on the product page of the Endress+Hauser website: [www.endress.com](http://www.endress.com).



Detailed information on the application packages:  
Special Documentation → 170

## Diagnostic functionality

Order code for "Application package", option EA "Extended HistoROM"

Comprises extended functions concerning the event log and the activation of the measured value memory.



Event log:

Memory volume is extended from 20 message entries (standard version) to up to 100 entries.

Data logging (line recorder):

- Memory capacity for up to 1000 measured values is activated.
- 250 measured values can be output via each of the 4 memory channels. The recording interval can be defined and configured by the user.
- Measured value logs can be accessed via the local display or operating tool e.g. FieldCare, DeviceCare or Web server.



For detailed information, see the Operating Instructions for the device.

Heartbeat Technology

Order code for "Application package", option EB "Heartbeat Verification + Monitoring"

#### Heartbeat Verification

Meets the requirement for traceable verification to DIN ISO 9001:2008 Chapter 7.6 a) "Control of monitoring and measuring equipment".

- Functional testing in the installed state without interrupting the process.
- Traceable verification results on request, including a report.
- Simple testing process via local operation or other operating interfaces.
- Clear measuring point assessment (pass/fail) with high test coverage within the framework of manufacturer specifications.
- Extension of calibration intervals according to operator's risk assessment.



For detailed information, see the Special Documentation for the device.

Petroleum & locking function

Order code for "Application package", option EM "Petroleum & locking function"

The most important parameters for the Oil & Gas Industry can be calculated and displayed with this application package. It is also possible to lock the settings.

- Corrected volume flow and calculated reference density in accordance with the "API Manual of Petroleum Measurement Standards, Chapter 11.1"
- Water content, based on density measurement
- Weighted mean of the density and temperature



For detailed information, see the Special Documentation for the device.

## 16.14 Accessories



Overview of accessories available to order → 144

## 16.15 Supplemental documentation



For an overview of the scope of the associated Technical Documentation, refer to the following:

- *Device Viewer* ([www.endress.com/deviceviewer](http://www.endress.com/deviceviewer)): Enter the serial number from the nameplate
- *Endress+Hauser Operations app*: Enter serial number from nameplate or scan matrix code on nameplate.

Standard documentation      **Brief operating instructions**

*Brief Operating Instructions for the sensor*

Measuring instrument	Documentation code
Proline Promass E	KA01260D

*Brief Operating Instructions for transmitter*

Measuring device	Documentation code
Proline Promass 200	KA01267D

**Technical information**

Measuring device	Documentation code
Promass E 200	TI01300D



Supplementary device-  
dependent documentation      **Safety instructions**

Contents	Documentation code
ATEX/IECEX Ex i	XA00144D
ATEX/IECEX Ex d	XA00143D
ATEX/IECEX Ex nA	XA00145D
cCSAus IS	XA00151D
cCSAus XP	XA00152D
INMETRO Ex i	XA01300D
INMETRO Ex d	XA01305D
INMETRO Ex nA	XA01306D
NEPSI Ex i	XA00156D
NEPSI Ex d	XA00155D
NEPSI Ex nA	XA00157D
NEPSI Ex i	XA1755D
NEPSI Ex d	XA1754D
NEPSI Ex nA	XA1756D
JPN Ex d	XA01763D

**Special documentation**

Contents	Documentation code
Information on the Pressure Equipment Directive	SD01614D
Display and operating module FHX50	SD01007F
Heartbeat Technology	SD01848D

**Installation instructions**

Contents	Note
Installation instructions for spare part sets and accessories	<ul style="list-style-type: none"><li data-bbox="1026 315 1525 367">▪ Access the overview of all the available spare part sets via <i>Device Viewer</i> →  141</li><li data-bbox="1026 367 1525 418">▪ Accessories available for order with Installation Instructions →  144</li></ul>

# Index

- 0 ... 9**
- 3-A approval . . . . . 167
- A**
- Access authorization to parameters
    - Read access . . . . . 49
    - Write access . . . . . 49
  - Access code . . . . . 49
    - Incorrect input . . . . . 49
  - Adapting the diagnostic behavior . . . . . 111
  - Adapting the status signal . . . . . 112
  - Ambient conditions
    - Shock and vibration resistance . . . . . 159
    - Storage temperature . . . . . 159
  - Ambient temperature
    - Influence . . . . . 157
  - AMS Device Manager . . . . . 53
    - Function . . . . . 53
  - Application . . . . . 148
  - Application packages . . . . . 168
  - Applicator . . . . . 149
  - Approvals . . . . . 166
- C**
- Cable entries
    - Technical data . . . . . 154
  - Cable entry
    - Degree of protection . . . . . 34
  - CE mark . . . . . 10, 166
  - Certificates . . . . . 166
  - cGMP . . . . . 167
  - Checklist
    - Post-connection check . . . . . 35
    - Post-installation check . . . . . 27
  - CIP cleaning . . . . . 159
  - Cleaning
    - CIP cleaning . . . . . 140
    - Exterior cleaning . . . . . 140
    - Internal cleaning . . . . . 140
    - SIP cleaning . . . . . 140
  - Climate class . . . . . 159
  - Commissioning . . . . . 61
    - Advanced settings . . . . . 72
    - Configuring the measuring instrument . . . . . 61
  - Connecting cable . . . . . 28
  - Connecting the measuring instrument . . . . . 31
  - Connection
    - see Electrical connection
  - Connection examples, potential equalization . . . . . 33
  - Connection preparations . . . . . 31
  - Connection tools . . . . . 28
  - Context menu
    - Calling up . . . . . 45
    - Closing . . . . . 45
    - Explanation . . . . . 45
  - Current consumption . . . . . 154
  - Cyclic data transmission . . . . . 55
- D**
- Date of manufacture . . . . . 15, 16
  - Declaration of Conformity . . . . . 10
  - Defining the access code . . . . . 90
  - Degree of protection . . . . . 34, 159
  - Density adjustment . . . . . 73
  - Design
    - Operating menu . . . . . 37
  - Design fundamentals
    - Measurement error . . . . . 158
    - Repeatability . . . . . 158
  - Device components . . . . . 13
  - Device description files . . . . . 55
  - Device locking, status . . . . . 96
  - Device name
    - Sensor . . . . . 16
    - Transmitter . . . . . 15
  - Device repair . . . . . 141
  - Device revision . . . . . 55
  - Device type ID . . . . . 55
  - Device Viewer . . . . . 141
  - DeviceCare . . . . . 53
    - Device description file . . . . . 55
  - Diagnosis
    - Symbols . . . . . 107
  - Diagnostic behavior
    - Explanation . . . . . 108
    - Symbols . . . . . 108
  - Diagnostic information
    - Design, description . . . . . 108, 110
    - DeviceCare . . . . . 109
    - FieldCare . . . . . 109
    - Local display . . . . . 107
    - Overview . . . . . 116
    - Remedial measures . . . . . 116
  - Diagnostic message . . . . . 107
  - DIAGNOSTIC Transducer Block . . . . . 134
  - Diagnostics list . . . . . 134
  - DIP switch
    - see Write protection switch
  - Direct access . . . . . 46
  - Disabling write protection . . . . . 90
  - Display
    - see Local display
  - Display area
    - For operational display . . . . . 39
    - In the navigation view . . . . . 41
  - Display values
    - For locking status . . . . . 96
  - Displaying the measured value history . . . . . 101
  - Disposal . . . . . 142
  - Document
    - Function . . . . . 6
    - Symbols . . . . . 6

- Document function . . . . . 6
- Down pipe . . . . . 20
- E**
- EHEDG-tested . . . . . 167
- Electrical connection
- Commubox FXA291 . . . . . 51
  - Degree of protection . . . . . 34
  - Measuring instrument . . . . . 28
  - Operating tools
    - Via FOUNDATION Fieldbus network . . . . . 50
    - Via service interface (CDI) . . . . . 51
- Electromagnetic compatibility . . . . . 160
- Enabling write protection . . . . . 90
- Enabling/disabling the keypad lock . . . . . 50
- Endress+Hauser services
- Maintenance . . . . . 140
  - Repair . . . . . 142
- Error messages
- see Diagnostic messages
- Event logbook . . . . . 135
- Events list . . . . . 135
- Ex-approval . . . . . 167
- Extended order code
- Sensor . . . . . 16
  - Transmitter . . . . . 15
- Exterior cleaning . . . . . 140
- F**
- FDA . . . . . 167
- Field Communicator
- Function . . . . . 54
- Field Communicator 475 . . . . . 54
- Field of application
- Residual risks . . . . . 10
- Field Xpert
- Function . . . . . 52
- Field Xpert SFX350 . . . . . 52
- FieldCare . . . . . 52
- Device description file . . . . . 55
  - Establishing a connection . . . . . 52
  - Function . . . . . 52
  - User interface . . . . . 53
- Filtering the event logbook . . . . . 135
- Firmware
- Release date . . . . . 55
  - Version . . . . . 55
- Firmware history . . . . . 139
- Flow direction . . . . . 21, 25
- Flow limit . . . . . 161
- Food Contact Materials Regulation . . . . . 167
- FOUNDATION Fieldbus block structure . . . . . 93
- FOUNDATION Fieldbus certification . . . . . 167
- Function range
- AMS Device Manager . . . . . 53
- Function scope
- Field Communicator . . . . . 54
  - Field Communicator 475 . . . . . 54
  - Field Xpert . . . . . 52
- Functions
- see Parameters
- G**
- Galvanic isolation . . . . . 152
- H**
- Hardware write protection . . . . . 91
- Help text
- Calling up . . . . . 47
  - Closing . . . . . 47
  - Explanation . . . . . 47
- HistoROM . . . . . 86
- Hygienic compatibility . . . . . 167
- I**
- I/O electronics module . . . . . 13, 31
- Identifying the measuring instrument . . . . . 14
- Incoming acceptance . . . . . 14
- Indication
- Current diagnostic event . . . . . 133
  - Previous diagnostic event . . . . . 133
- Influence
- Ambient temperature . . . . . 157
  - Medium pressure . . . . . 157
  - Medium temperature . . . . . 157
- Information about this document . . . . . 6
- Inlet runs . . . . . 22
- Input screen . . . . . 43
- Input variables . . . . . 149
- Inspection
- Connection . . . . . 35
  - Installation . . . . . 27
  - Received goods . . . . . 14
- Installation . . . . . 20
- Installation dimensions . . . . . 22
- Installation point . . . . . 20
- Intended use . . . . . 9
- Internal cleaning . . . . . 140, 159
- L**
- Languages, operation options . . . . . 164
- Line recorder . . . . . 101
- Local display
- Editing view . . . . . 42
  - Navigation view . . . . . 41
  - see Diagnostic message
  - see In alarm condition
  - see Operational display
- Low flow cut off . . . . . 152
- M**
- Main electronics module . . . . . 13
- Maintenance work . . . . . 140
- Managing the device configuration . . . . . 86
- Manufacturer ID . . . . . 55
- Materials . . . . . 162
- Maximum measurement error . . . . . 155
- Measured variables
- see Process variables

Measurement accuracy . . . . .	155
Measuring and test equipment . . . . .	140
Measuring device	
Conversion . . . . .	141
Disposal . . . . .	143
Mounting the sensor . . . . .	25
Preparing for electrical connection . . . . .	31
Removing . . . . .	142
Repairs . . . . .	141
Structure . . . . .	13
Switching on . . . . .	61
Measuring instrument	
Configuring . . . . .	61
Preparing for mounting . . . . .	25
Measuring principle . . . . .	148
Measuring range	
For gases . . . . .	149
For liquids . . . . .	149
Measuring range, recommended . . . . .	161
Measuring system . . . . .	148
Medium density . . . . .	160
Medium pressure	
Influence . . . . .	157
Medium temperature	
Influence . . . . .	157
Menu	
Diagnostics . . . . .	133
Setup . . . . .	62
Menus	
For measuring instrument configuration . . . . .	61
For specific settings . . . . .	72
Mounting dimensions	
see Installation dimensions	
Mounting preparations . . . . .	25
Mounting requirements	
Down pipe . . . . .	20
Inlet and outlet runs . . . . .	22
Installation dimensions . . . . .	22
Installation point . . . . .	20
Orientation . . . . .	21
Rupture disk . . . . .	24
Sensor heating . . . . .	23
Static pressure . . . . .	22
Thermal insulation . . . . .	22
Vibrations . . . . .	23
Mounting tools . . . . .	25

**N**

Nameplate	
Sensor . . . . .	16
Transmitter . . . . .	15
Navigation path (navigation view) . . . . .	41
Navigation view	
In the submenu . . . . .	41
In the wizard . . . . .	41
Netilion . . . . .	140
Numeric editor . . . . .	42

**O**

Onsite display . . . . .	165
Operable flow range . . . . .	150
Operating elements . . . . .	44, 108
Operating keys	
see Operating elements	
Operating menu	
Design . . . . .	37
Menus, submenus . . . . .	37
Submenus and user roles . . . . .	38
Operating philosophy . . . . .	38
Operation . . . . .	96
Operation options . . . . .	36
Operational display . . . . .	39
Operational safety . . . . .	10
Order code . . . . .	15, 16
Orientation (vertical, horizontal) . . . . .	21
Outlet runs . . . . .	22
Output signal . . . . .	150
Output variables . . . . .	150

**P**

Packaging disposal . . . . .	19
Parameter settings	
Administration (Submenu) . . . . .	85
Analog inputs (Submenu) . . . . .	67
Configuration backup display (Submenu) . . . . .	86
Data logging (Submenu) . . . . .	101
Density adjustment (Wizard) . . . . .	73
Device information (Submenu) . . . . .	137
Diagnostics (Menu) . . . . .	133
Display (Submenu) . . . . .	83
Display (Wizard) . . . . .	67
Low flow cut off (Wizard) . . . . .	70
Medium selection (Submenu) . . . . .	66
Output values (Submenu) . . . . .	99
Partially filled pipe detection (Wizard) . . . . .	71
Process variables (Submenu) . . . . .	97
Pulse/frequency/switch output (Wizard)	
. . . . .	76, 77, 78, 80
Sensor adjustment (Submenu) . . . . .	73
Setup (Menu) . . . . .	62
Simulation (Submenu) . . . . .	87
System units (Submenu) . . . . .	63
Totalizer (Submenu) . . . . .	98
Totalizer 1 to n (Submenu) . . . . .	82
Totalizer handling (Submenu) . . . . .	99
Zero point adjustment (Submenu) . . . . .	76
Parameters	
Changing . . . . .	48
Enter a value . . . . .	48
Performance characteristics . . . . .	155
Performing density adjustment . . . . .	73
Pharmaceutical compatibility . . . . .	167
Post-connection check . . . . .	61
Post-connection check (checklist) . . . . .	35
Post-installation check . . . . .	61
Post-installation check (checklist) . . . . .	27
Potential equalization . . . . .	33

- Power consumption . . . . . 154
- Power supply failure . . . . . 154
- Pressure Equipment Directive . . . . . 167
- Pressure loss . . . . . 161
- Pressure-temperature ratings . . . . . 160
- Process connections . . . . . 164
- Process variables
  - Calculated . . . . . 149
  - Measured . . . . . 149
- Product safety . . . . . 10
- Protecting parameter settings . . . . . 90
  
- R**
- RCM marking . . . . . 166
- Read access . . . . . 49
- Reading off measured values . . . . . 96
- Recalibration . . . . . 140
- Reference operating conditions . . . . . 155
- Registered trademarks . . . . . 8
- Remedial measures
  - Calling up . . . . . 109
  - Closing . . . . . 109
- Remote operation . . . . . 166
- Repair . . . . . 141
  - Notes . . . . . 141
- Repair of a device . . . . . 141
- Repeatability . . . . . 156
- Replacement
  - Device components . . . . . 141
- Requirements for personnel . . . . . 9
- Response time . . . . . 157
- Return . . . . . 142
- Rupture disk
  - Safety instructions . . . . . 24
  - Triggering pressure . . . . . 161
  
- S**
- Safety . . . . . 9
- Sensor
  - Installing . . . . . 25
- Sensor heating . . . . . 23
- Sensor housing . . . . . 160
- Serial number . . . . . 15, 16
- Setting the operating language . . . . . 61
- Settings
  - Adapting the measuring device to the process conditions . . . . . 99
  - Administration . . . . . 85
  - Advanced display configurations . . . . . 83
  - Analog input . . . . . 67
  - Device tag . . . . . 62
  - Local display . . . . . 67
  - Low flow cut off . . . . . 70
  - Managing the device configuration . . . . . 86
  - Medium . . . . . 66
  - Operating language . . . . . 61
  - Partial filled pipe detection . . . . . 71
  - Pulse output . . . . . 77
  - Pulse/frequency/switch output . . . . . 76, 78
  - Resetting the device . . . . . 136
  - Resetting the totalizer . . . . . 99
  - Restarting the device . . . . . 136
  - Sensor adjustment . . . . . 73
  - Simulation . . . . . 87
  - Switch output . . . . . 80
  - System units . . . . . 63
  - Totalizer . . . . . 82
  - Totalizer reset . . . . . 99
- Shock and vibration resistance . . . . . 159
- Signal on alarm . . . . . 151
- SIP cleaning . . . . . 159
- Software release . . . . . 55
- Spare part . . . . . 141
- Spare parts . . . . . 141
- Special connection instructions . . . . . 33
- Special mounting instructions
  - Hygienic compatibility . . . . . 24
- Standards and guidelines . . . . . 168
- Static pressure . . . . . 22
- Status area
  - For operational display . . . . . 39
  - In the navigation view . . . . . 41
- Status signals . . . . . 107, 110
- Storage conditions . . . . . 18
- Storage temperature . . . . . 18
- Storage temperature range . . . . . 159
- Structure
  - Measuring device . . . . . 13
- Submenu
  - Administration . . . . . 85
  - Advanced setup . . . . . 72
  - Analog inputs . . . . . 67
  - Configuration backup display . . . . . 86
  - Data logging . . . . . 101
  - Device information . . . . . 137
  - Display . . . . . 83
  - Events list . . . . . 135
  - Measured values . . . . . 96
  - Medium selection . . . . . 66
  - Output values . . . . . 99
  - Overview . . . . . 38
  - Process variables . . . . . 97
  - Sensor adjustment . . . . . 73
  - Simulation . . . . . 87
  - System units . . . . . 63
  - Totalizer . . . . . 98
  - Totalizer 1 to n . . . . . 82
  - Totalizer handling . . . . . 99
  - Zero point adjustment . . . . . 76
- Supply unit
  - Requirements . . . . . 31
- Supply voltage . . . . . 31, 154
- Surface roughness . . . . . 164
- Symbols
  - For communication . . . . . 39
  - For correction . . . . . 43
  - For diagnostic behavior . . . . . 39
  - For locking . . . . . 39

For measured variable . . . . .	39
For measurement channel number . . . . .	39
For menus . . . . .	41
For parameters . . . . .	41
For status signal . . . . .	39
For submenu . . . . .	41
For wizards . . . . .	41
In the status area of the local display . . . . .	39
In the text and numeric editor . . . . .	43
System design	
Measuring system . . . . .	148
see Measuring device design	
System integration . . . . .	55
<b>T</b>	
Technical data, overview . . . . .	148
Temperature range	
Medium temperature . . . . .	160
Storage temperature . . . . .	18
Terminal assignment . . . . .	29, 31, 153
Terminals . . . . .	154
Text editor . . . . .	42
Thermal insulation . . . . .	22
Tool	
Transport . . . . .	18
Tool tip	
see Help text	
Tools	
Electrical connection . . . . .	28
Installation . . . . .	25
Totalizer	
Configuring . . . . .	82
Transmitter	
Connecting the signal cables . . . . .	31
Turning the display module . . . . .	26
Turning the housing . . . . .	26
Transporting the measuring device . . . . .	18
Troubleshooting	
General . . . . .	105
TSE/BSE Certificate of Suitability . . . . .	167
Turning the display module . . . . .	26
Turning the electronics housing	
see Turning the transmitter housing	
Turning the transmitter housing . . . . .	26
<b>U</b>	
UKCA marking . . . . .	166
Use of measuring device	
Borderline cases . . . . .	9
Incorrect use . . . . .	9
Use of measuring instrument	
see Intended use	
User roles . . . . .	38
USP Class VI . . . . .	167
<b>V</b>	
Version data for the device . . . . .	55
Vibrations . . . . .	23

<b>W</b>	
W@M Device Viewer . . . . .	14
Weight	
SI units . . . . .	161
Transport (notes) . . . . .	18
US units . . . . .	162
Wizard	
Density adjustment . . . . .	73
Display . . . . .	67
Low flow cut off . . . . .	70
Partially filled pipe detection . . . . .	71
Pulse/frequency/switch output . . . . .	76, 77, 78, 80
Workplace safety . . . . .	10
Write access . . . . .	49
Write protection	
Via access code . . . . .	90
Via block operation . . . . .	92
Via write protection switch . . . . .	91
Write protection switch . . . . .	91







[www.addresses.endress.com](http://www.addresses.endress.com)

---