

Operating Instructions

Proline Promass E 200

Coriolis flowmeter
PROFIBUS PA

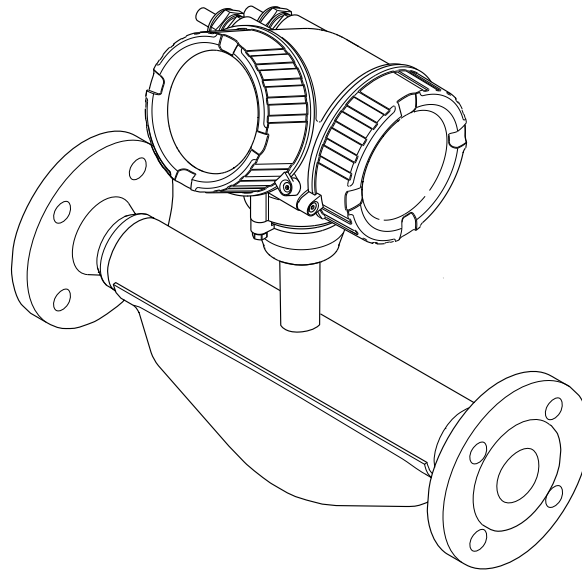

- Make sure the document is stored in a safe place such that it is always available when working on or with the device.
- To avoid danger to individuals or the facility, read the "Basic safety instructions" section carefully, as well as all other safety instructions in the document that are specific to working procedures.
- The manufacturer reserves the right to modify technical data without prior notice. Your Endress+Hauser sales organization will supply you with current information and updates to this manual.

Table of contents

1	About this document	6		
1.1	Document function	6		
1.2	Symbols	6		
1.2.1	Safety symbols	6		
1.2.2	Electrical symbols	6		
1.2.3	Communication-specific symbols	6		
1.2.4	Tool symbols	7		
1.2.5	Symbols for certain types of information	7		
1.2.6	Symbols in graphics	7		
1.3	Documentation	8		
1.4	Registered trademarks	8		
2	Safety instructions	9		
2.1	Requirements for the personnel	9		
2.2	Intended use	9		
2.3	Workplace safety	10		
2.4	Operational safety	10		
2.5	Product safety	10		
2.6	IT security	11		
2.7	Device-specific IT security	11		
2.7.1	Protecting access via hardware write protection	11		
2.7.2	Protecting access via a password	11		
2.7.3	Access via fieldbus	11		
3	Product description	13		
3.1	Product design	13		
4	Incoming acceptance and product identification	14		
4.1	Incoming acceptance	14		
4.2	Product identification	14		
4.2.1	Transmitter nameplate	15		
4.2.2	Sensor nameplate	16		
4.2.3	Symbols on the device	17		
5	Storage and transport	18		
5.1	Storage conditions	18		
5.2	Transporting the product	18		
5.2.1	Measuring devices without lifting lugs	18		
5.2.2	Measuring devices with lifting lugs	19		
5.2.3	Transporting with a fork lift	19		
5.3	Packaging disposal	19		
6	Installation	20		
6.1	Installation requirements	20		
6.1.1	Installation position	20		
6.1.2	Environmental and process requirements	22		
6.1.3	Special installation instructions	24		
6.2	Installing the measuring instrument	25		
6.2.1	Required tools	25		
6.2.2	Preparing the measuring instrument	25		
6.2.3	Mounting the measuring device	25		
6.2.4	Turning the transmitter housing	26		
6.2.5	Turning the display module	26		
6.3	Post-installation check	27		
7	Electrical connection	28		
7.1	Electrical safety	28		
7.2	Connecting requirements	28		
7.2.1	Required tools	28		
7.2.2	Requirements for connecting cable	28		
7.2.3	Terminal assignment	29		
7.2.4	device plug pin assignment	29		
7.2.5	Shielding and grounding	29		
7.2.6	Requirements for the supply unit	31		
7.2.7	Preparing the measuring device	31		
7.3	Connecting the measuring instrument	31		
7.3.1	Connecting the transmitter	31		
7.3.2	Potential equalization	33		
7.4	Special connection instructions	33		
7.4.1	Connection examples	33		
7.5	Hardware settings	35		
7.5.1	Setting the device address	35		
7.6	Ensuring the degree of protection	35		
7.7	Post-connection check	36		
8	Operation options	37		
8.1	Overview of operation options	37		
8.2	Structure and function of the operating menu	38		
8.2.1	Structure of the operating menu	38		
8.2.2	Operating philosophy	39		
8.3	Access to operating menu via local display	40		
8.3.1	Operational display	40		
8.3.2	Navigation view	42		
8.3.3	Editing view	43		
8.3.4	Operating elements	45		
8.3.5	Opening the context menu	46		
8.3.6	Navigating and selecting from list	47		
8.3.7	Calling the parameter directly	47		
8.3.8	Calling up help text	48		
8.3.9	Changing the parameters	49		
8.3.10	User roles and related access authorization	50		
8.3.11	Disabling write protection via access code	50		
8.3.12	Enabling and disabling the keypad lock	51		
8.4	Access to the operating menu via the operating tool	51		
8.4.1	Connecting the operating tool	51		

8.4.2	FieldCare	52	11.4.2	Totalizer	98
8.4.3	DeviceCare	54	11.4.3	Output variables	99
8.4.4	SIMATIC PDM	55	11.5	Adapting the measuring device to the process conditions	100
9	System integration	56	11.6	Performing a totalizer reset	100
9.1	Overview of device description files	56	11.7	Displaying the measured value history	101
9.1.1	Current version data for the device ...	56	12	Diagnostics and troubleshooting ..	104
9.1.2	Operating tools	56	12.1	General troubleshooting	104
9.2	Device master file (GSD)	56	12.2	Diagnostic information on local display	106
9.2.1	Manufacturer-specific GSD	57	12.2.1	Diagnostic message	106
9.2.2	Profile GSD	57	12.2.2	Calling up remedial measures	108
9.3	Cyclic data transmission	57	12.3	Diagnostic information in FieldCare or DeviceCare	108
9.3.1	Block model	57	12.3.1	Diagnostic options	108
9.3.2	Description of the modules	58	12.3.2	Calling up remedy information	110
10	Commissioning	64	12.4	Adapting the diagnostic information	110
10.1	Post-mounting and post-connection check ...	64	12.4.1	Adapting the diagnostic behavior ...	110
10.2	Switching on the measuring device	64	12.5	Overview of diagnostic information	113
10.3	Configuring the device address via software ..	64	12.5.1	Diagnostic of sensor	113
10.3.1	PROFIBUS network	64	12.5.2	Diagnostic of electronic	115
10.4	Setting the operating language	64	12.5.3	Diagnostic of configuration	119
10.5	Configuring the measuring instrument	65	12.5.4	Diagnostic of process	122
10.5.1	Defining the tag name	66	12.6	Pending diagnostic events	125
10.5.2	Setting the system units	66	12.7	Diagnostics list	126
10.5.3	Selecting and setting the medium ...	69	12.8	Event logbook	126
10.5.4	Configuring communication interface	69	12.8.1	Reading out the event logbook	126
10.5.5	Configuring the local display	70	12.8.2	Filtering the event logbook	127
10.5.6	Configuring the low flow cut off	72	12.8.3	Overview of information events	127
10.5.7	Configuring partially filled pipe detection	73	12.9	Resetting the measuring device	129
10.5.8	Configuring the partial filled pipe detection	74	12.9.1	Function range of "Device reset" parameter	129
10.6	Advanced settings	75	12.10	Device information	129
10.6.1	Carrying out a sensor adjustment	76	12.11	Firmware history	131
10.6.2	Configuring the pulse/frequency/switch output	79	13	Maintenance	132
10.6.3	Configuring the totalizer	85	13.1	Maintenance work	132
10.6.4	Carrying out additional display configurations	87	13.1.1	Exterior cleaning	132
10.6.5	Using parameters for device administration	89	13.1.2	Internal cleaning	132
10.7	Configuration management	90	13.2	Measuring and test equipment	132
10.7.1	Function scope of the "Configuration management" parameter	91	13.3	Endress+Hauser services	132
10.8	Simulation	91	14	Repair	133
10.9	Protecting settings from unauthorized access .	93	14.1	General notes	133
10.9.1	Write protection via access code	93	14.1.1	Repair and conversion concept	133
10.9.2	Write protection via write protection switch	94	14.1.2	Notes for repair and conversion	133
11	Operation	96	14.2	Spare parts	133
11.1	Reading off the device locking status	96	14.3	Endress+Hauser services	134
11.2	Adjusting the operating language	96	14.4	Return	134
11.3	Configuring the display	96	14.5	Disposal	134
11.4	Reading off measured values	96	14.5.1	Removing the measuring device	134
11.4.1	Process variables	97	14.5.2	Disposing of the measuring device ..	135
			15	Accessories	136
			15.1	Device-specific accessories	136
			15.1.1	For the transmitter	136

15.1.2	For the sensor	137
15.2	Communication-specific accessories	137
15.3	Service-specific accessories	138
15.4	System components	139
16	Technical data	140
16.1	Application	140
16.2	Function and system design	140
16.3	Input	141
16.4	Output	142
16.5	Power supply	145
16.6	Performance characteristics	147
16.7	Mounting	150
16.8	Environment	151
16.9	Process	152
16.10	Mechanical construction	153
16.11	Operability	156
16.12	Certificates and approvals	158
16.13	Application packages	160
16.14	Accessories	161
16.15	Supplemental documentation	161
Index		164

1 About this document

1.1 Document function

These Operating Instructions contain all the information required in the various life cycle phases of the device: from product identification, incoming acceptance and storage, to installation, connection, operation and commissioning, through to troubleshooting, maintenance and disposal.

1.2 Symbols

1.2.1 Safety symbols

DANGER

This symbol alerts you to a dangerous situation. Failure to avoid this situation will result in serious or fatal injury.

WARNING

This symbol alerts you to a potentially dangerous situation. Failure to avoid this situation can result in serious or fatal injury.





CAUTION

This symbol alerts you to a potentially dangerous situation. Failure to avoid this situation can result in minor or medium injury.



NOTICE

This symbol alerts you to a potentially harmful situation. Failure to avoid this situation can result in damage to the product or something in its vicinity.



1.2.2 Electrical symbols

Symbol	Meaning
	Direct current
	Alternating current
	Direct current and alternating current
	Ground connection A grounded terminal which, as far as the operator is concerned, is grounded via a grounding system.
	Potential equalization connection (PE: protective earth) Ground terminals that must be connected to ground prior to establishing any other connections. The ground terminals are located on the interior and exterior of the device: <ul style="list-style-type: none"> ▪ Interior ground terminal: potential equalization is connected to the supply network. ▪ Exterior ground terminal: device is connected to the plant grounding system.













1.2.3 Communication-specific symbols

Symbol	Meaning
	Wireless Local Area Network (WLAN) Communication via a wireless, local network.
	Bluetooth Wireless data transmission between devices over a short distance via radio technology.





1.2.4 Tool symbols

Symbol	Meaning
	Flat-blade screwdriver
	Allen key
	Open-ended wrench

1.2.5 Symbols for certain types of information

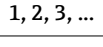
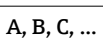
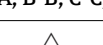
Symbol	Meaning
	Permitted Procedures, processes or actions that are permitted.
	Preferred Procedures, processes or actions that are preferred.
	Forbidden Procedures, processes or actions that are forbidden.
	Tip Indicates additional information.
	Reference to documentation
	Reference to page
	Reference to graphic
	Notice or individual step to be observed
	Series of steps
	Result of a step
	Help in the event of a problem
	Visual inspection

1.2.6 Symbols in graphics

Symbol	Meaning
	Item numbers
	Series of steps
	Views
	Sections
	Hazardous area
	Safe area (non-hazardous area)
	Flow direction

1.3 Documentation

 For an overview of the scope of the associated Technical Documentation, refer to the following:

- *Device Viewer* (www.endress.com/deviceviewer): Enter the serial number from the nameplate
- *Endress+Hauser Operations app*: Enter serial number from nameplate or scan matrix code on nameplate.

The following documentation may be available depending on the device version ordered:

Document type	Purpose and content of the document
Technical Information (TI)	Planning aid for your device The document contains all the technical data on the device and provides an overview of the accessories and other products that can be ordered for the device.
Brief Operating Instructions (KA)	Guide that takes you quickly to the 1st measured value The Brief Operating Instructions contain all the essential information from incoming acceptance to initial commissioning.
Operating Instructions (BA)	Your reference document These Operating Instructions contain all the information that is required in the various life cycle phases of the device: from product identification, incoming acceptance and storage, to mounting, connection, operation and commissioning, through to troubleshooting, maintenance and disposal.
Description of Device Parameters (GP)	Reference for your parameters The document provides a detailed explanation of each individual parameter. The description is aimed at those who work with the device over the entire life cycle and perform specific configurations.
Safety Instructions (XA)	Depending on the approval, safety instructions for electrical equipment in hazardous areas are also supplied with the device. The Safety Instructions are a constituent part of the Operating Instructions.  Information on the Safety Instructions (XA) that are relevant for the device is provided on the nameplate.
Supplementary device-dependent documentation (SD/FY)	Always comply strictly with the instructions in the relevant supplementary documentation. The supplementary documentation is a constituent part of the device documentation.

1.4 Registered trademarks

PROFIBUS®

Registered trademark of the PROFIBUS Nutzerorganisation e.V. (PROFIBUS User Organization), Karlsruhe, Germany

TRI-CLAMP®

Registered trademark of Ladish & Co., Inc., Kenosha, USA

2 Safety instructions

2.1 Requirements for the personnel

The personnel for installation, commissioning, diagnostics and maintenance must fulfill the following requirements:

- ▶ Trained, qualified specialists must have a relevant qualification for this specific function and task.
- ▶ Are authorized by the plant owner/operator.
- ▶ Are familiar with federal/national regulations.
- ▶ Before starting work, read and understand the instructions in the manual and supplementary documentation as well as the certificates (depending on the application).
- ▶ Follow instructions and comply with basic conditions.

The operating personnel must fulfill the following requirements:

- ▶ Are instructed and authorized according to the requirements of the task by the facility's owner-operator.
- ▶ Follow the instructions in this manual.

2.2 Intended use

Application and media

The measuring instrument described in this manual is intended only for the flow measurement of liquids and gases.

Depending on the version ordered, the measuring instrument can also be used to measure potentially explosive ¹⁾, flammable, toxid and oxidizing media.

Measuring instruments for use in hazardous areas, in hygienic applications, or where there is an increased risk due to pressure, are specially labeled on the nameplate.

To ensure that the measuring instrument is in perfect condition during operation:

- ▶ Only use the measuring instrument in full compliance with the data on the nameplate and the general conditions listed in the Operating Instructions and supplementary documentation.
- ▶ Using the nameplate, check whether the ordered device is permitted for the intended use in the hazardous area (e.g. explosion protection, pressure vessel safety).
- ▶ Use the measuring instrument only for media to which the process-wetted materials are sufficiently resistant.
- ▶ Keep within the specified pressure and temperature range.
- ▶ Keep within the specified ambient temperature range.
- ▶ Protect the measuring instrument permanently against corrosion from environmental influences.

Incorrect use

Non-designated use can compromise safety. The manufacturer is not liable for damage caused by improper or non-designated use.

WARNING

Danger of breakage due to corrosive or abrasive fluids and ambient conditions!

- ▶ Verify the compatibility of the process fluid with the sensor material.
- ▶ Ensure the resistance of all fluid-wetted materials in the process.
- ▶ Keep within the specified pressure and temperature range.

1) Not applicable for IO-Link measuring instruments

NOTICE**Verification for borderline cases:**

- ▶ For special fluids and fluids for cleaning, Endress+Hauser is glad to provide assistance in verifying the corrosion resistance of fluid-wetted materials, but does not accept any warranty or liability as minute changes in the temperature, concentration or level of contamination in the process can alter the corrosion resistance properties.

Residual risks**⚠ CAUTION**

Risk of hot or cold burns! The use of media and electronics with high or low temperatures can produce hot or cold surfaces on the device.

- ▶ Mount suitable touch protection.

⚠ WARNING

Danger of housing breaking due to measuring tube breakage!

If a measuring tube ruptures, the pressure inside the sensor housing will rise according to the operating process pressure.

- ▶ Use a rupture disk.

⚠ WARNING

Danger from medium escaping!

For device versions with a rupture disk: medium escaping under pressure can cause injury or material damage.

- ▶ Take precautions to prevent injury and material damage if the rupture disk is actuated.

2.3 Workplace safety

When working on and with the device:

- ▶ Wear the required personal protective equipment as per national regulations.

2.4 Operational safety

Damage to the device!

- ▶ Operate the device in proper technical condition and fail-safe condition only.
- ▶ The operator is responsible for the interference-free operation of the device.

Modifications to the device

Unauthorized modifications to the device are not permitted and can lead to unforeseeable dangers!

- ▶ If modifications are nevertheless required, consult with the manufacturer.

Repair

To ensure continued operational safety and reliability:

- ▶ Carry out repairs on the device only if they are expressly permitted.
- ▶ Observe federal/national regulations pertaining to the repair of an electrical device.
- ▶ Use only original spare parts and accessories.

2.5 Product safety

This measuring device is designed in accordance with good engineering practice to meet state-of-the-art safety requirements, has been tested, and left the factory in a condition in which it is safe to operate.

It meets general safety standards and legal requirements. It also complies with the EU directives listed in the device-specific EU Declaration of Conformity. The manufacturer confirms this by affixing the CE mark to the device..

2.6 IT security

Our warranty is valid only if the product is installed and used as described in the Operating Instructions. The product is equipped with security mechanisms to protect it against any inadvertent changes to the settings.

IT security measures, which provide additional protection for the product and associated data transfer, must be implemented by the operators themselves in line with their security standards.

2.7 Device-specific IT security

The device offers a range of specific functions to support protective measures on the operator's side. These functions can be configured by the user and guarantee greater in-operation safety if used correctly. The following list provides an overview of the most important functions:

2.7.1 Protecting access via hardware write protection

Write access to the parameters of the device via the local display or operating tool (e.g. FieldCare, DeviceCare) can be disabled via a write protection switch (DIP switch on the main electronics module). When hardware write protection is enabled, only read access to the parameters is possible.

2.7.2 Protecting access via a password

A password can be used to protect against write access to the device parameters.

This controls write access to the device parameters via the local display or other operating tools (e.g. FieldCare, DeviceCare) and, in terms of functionality, corresponds to hardware write protection. If the CDI service interface is used, read access is only possible by first entering the password.

User-specific access code

Write access to the device parameters via the local display or operating tool (e.g. FieldCare, DeviceCare) can be protected by the modifiable, user-specific access code (→  93).

When the device is delivered, the device does not have an access code and is equivalent to 0000 (open).

General notes on the use of passwords

- The access code and network key supplied with the device should be changed during commissioning for safety reasons.
- Follow the general rules for generating a secure password when defining and managing the access code and network key.
- The user is responsible for the management and careful handling of the access code and network key.
- For information on configuring the access code or on what to do if you lose the password, for example, see "Write protection via access code" →  93.

2.7.3 Access via fieldbus

When communicating via fieldbus, access to the device parameters can be restricted to "Read only" access. The option can be changed in the **Fieldbus writing access** parameter.

This does not affect cyclic measured value transmission to the higher-order system, which is always guaranteed.



Detailed information on the device parameters:
"Description of device parameters" document .

3 Product description

The device consists of a transmitter and a sensor.

The device is available as a compact version:

The transmitter and sensor form a mechanical unit.

3.1 Product design

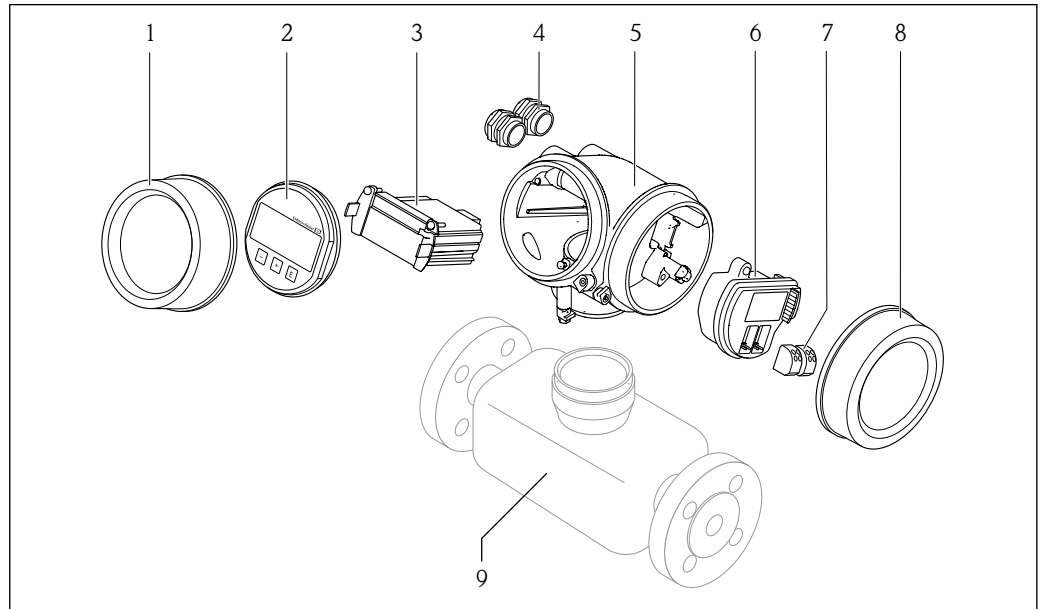

A0014056

1 Important components of a measuring device

- 1 Electronics compartment cover
- 2 Display module
- 3 Main electronics module
- 4 Cable glands
- 5 Transmitter housing (incl. integrated HistoROM)
- 6 I/O electronics module
- 7 Terminals (pluggable spring terminals)
- 8 Connection compartment cover
- 9 Sensor

4 Incoming acceptance and product identification

4.1 Incoming acceptance

On receipt of the delivery:

1. Check the packaging for damage.
 - ↳ Report all damage immediately to the manufacturer.
Do not install damaged components.
2. Check the scope of delivery using the delivery note.
3. Compare the data on the nameplate with the order specifications on the delivery note.
4. Check the technical documentation and all other necessary documents, e.g. certificates, to ensure they are complete.

 If one of the conditions is not satisfied, contact the manufacturer.

4.2 Product identification

The device can be identified in the following ways:

- Nameplate
- Order code with details of the device features on the delivery note
- Enter the serial numbers from the nameplates in the *Device Viewer* (www.endress.com/deviceviewer): all the information about the device is displayed.
- Enter the serial numbers from the nameplates into the *Endress+Hauser Operations app* or scan the DataMatrix code on the nameplate with the *Endress+Hauser Operations app*: all the information about the device is displayed.

For an overview of the scope of the associated Technical Documentation, refer to the following:

- The "Additional standard device documentation" and "Supplementary device-dependent documentation" sections
- The *Device Viewer*: Enter the serial number from the nameplate (www.endress.com/deviceviewer)
- The *Endress+Hauser Operations app*: Enter the serial number from the nameplate or scan the DataMatrix code on the nameplate.

4.2.1 Transmitter nameplate

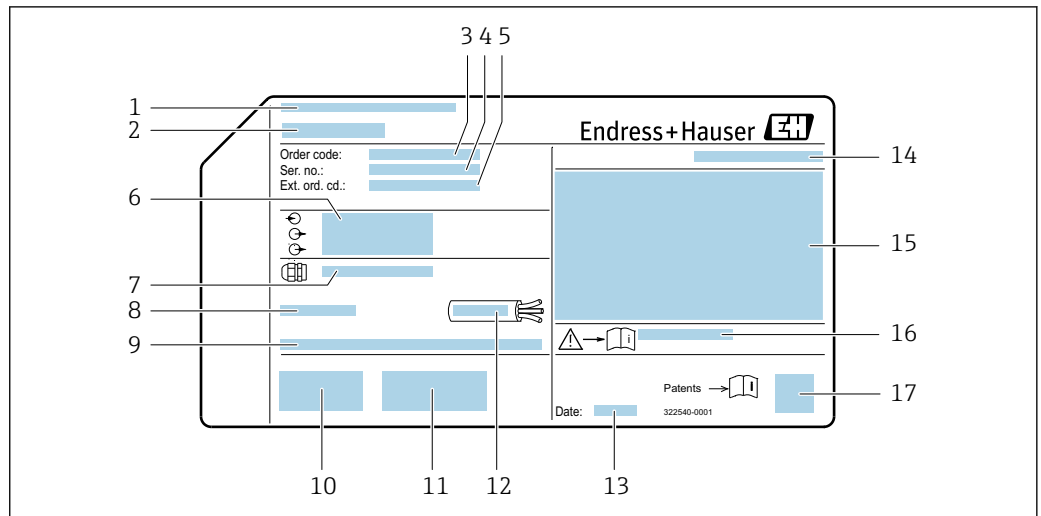

A0032237

2 Example of a transmitter nameplate

- 1 Manufacturer address/certificate holder
- 2 Name of the transmitter
- 3 Order code
- 4 Serial number
- 5 Extended order code
- 6 Electrical connection data, e.g. available inputs and outputs, supply voltage
- 7 Type of cable glands
- 8 Permitted ambient temperature (T_a)
- 9 Firmware version (FW) from the factory
- 10 CE mark, RCM-Tick mark
- 11 Additional information on version: certificates, approvals
- 12 Permitted temperature range for cable
- 13 Date of manufacture: year-month
- 14 Degree of protection
- 15 Approval information for explosion protection
- 16 Document number of safety-related supplementary documentation → 162
- 17 2-D matrix code

4.2.2 Sensor nameplate

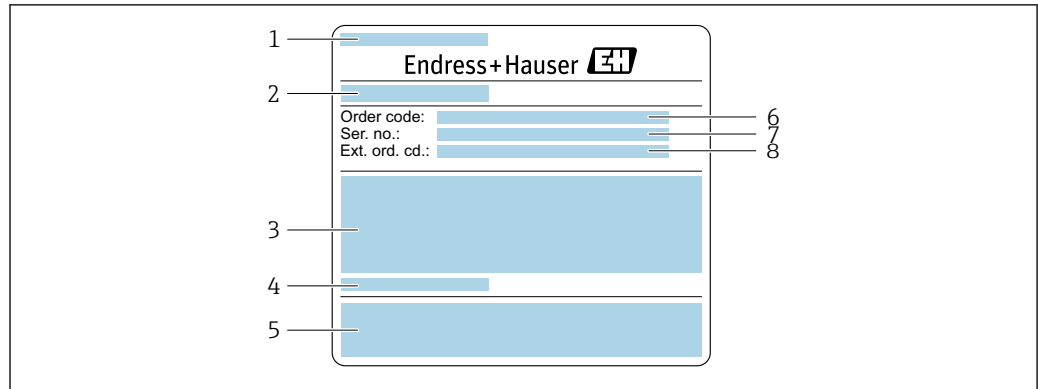

A0029206

3 Example of a sensor nameplate, part 1

- 1 Name of the sensor
- 2 Manufacturer address/certificate holder
- 3 Nominal diameter of the sensor; flange nominal diameter/nominal pressure; sensor test pressure; medium temperature range; material of measuring tube and manifold
- 4 Sensor-specific information
- 5 CE mark, RCM-Tick mark
- 6 Order code
- 7 Serial number (Ser. no.)
- 8 Extended order code (Ext. ord. cd.)

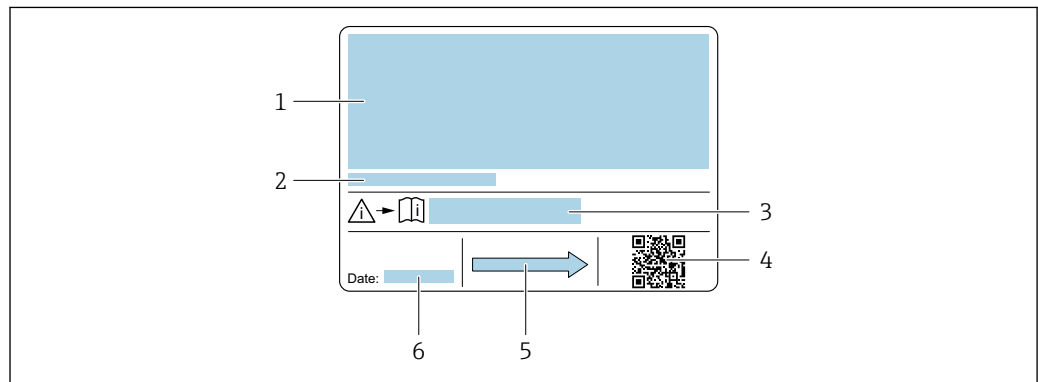

A0029207

4 Example of a sensor nameplate, part 2

- 1 Approval information for explosion protection, Pressure Equipment Directive and degree of protection
- 2 Allowable ambient temperature (T_a)
- 3 Document number of safety-related supplementary documentation
- 4 2-D matrix code
- 5 Flow direction
- 6 Date of manufacture: year-month



i Order code

The measuring device is reordered using the order code.

Extended order code

- The device type (product root) and basic specifications (mandatory features) are always listed.
- Of the optional specifications (optional features), only the safety and approval-related specifications are listed (e.g. LA). If other optional specifications are also ordered, these are indicated collectively using the # placeholder symbol (e.g. #LA#).
- If the ordered optional specifications do not include any safety and approval-related specifications, they are indicated by the + placeholder symbol (e.g. XXXXXX-ABCDE +).

4.2.3 Symbols on the device

Symbol	Meaning
	WARNING! This symbol alerts you to a dangerous situation. Failure to avoid this situation can result in serious or fatal injury. Please consult the documentation for the measuring instrument to discover the type of potential danger and measures to avoid it.
	Reference to documentation Refers to the corresponding device documentation.
	Protective ground connection A terminal that must be connected to the ground prior to establishing any other connections.

5 Storage and transport

5.1 Storage conditions

Observe the following notes for storage:

- ▶ Store in the original packaging to ensure protection from shock.
- ▶ Do not remove protective covers or protective caps installed on process connections. They prevent mechanical damage to the sealing surfaces and contamination in the measuring tube.
- ▶ Protect from direct sunlight. Avoid unacceptably high surface temperatures.
- ▶ Store in a dry and dust-free place.
- ▶ Do not store outdoors.

Storage temperature → 📄 151

5.2 Transporting the product

Transport the measuring device to the measuring point in the original packaging.

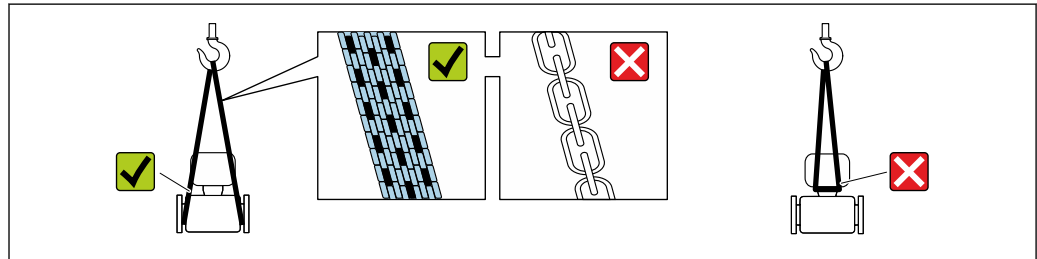

A0029252

- i** Do not remove protective covers or caps installed on process connections. They prevent mechanical damage to the sealing surfaces and contamination in the measuring tube.

5.2.1 Measuring devices without lifting lugs

⚠ WARNING

Center of gravity of the measuring device is higher than the suspension points of the webbing slings.

Risk of injury if the measuring device slips.

- ▶ Secure the measuring device against slipping or turning.
- ▶ Observe the weight specified on the packaging (stick-on label).

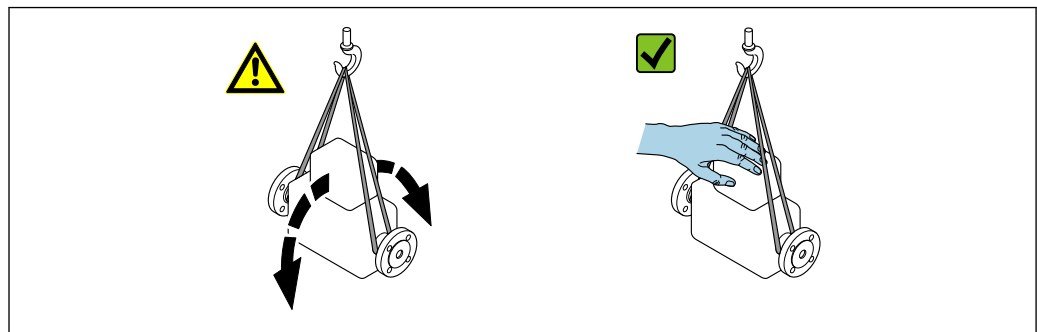

A0029214

5.2.2 Measuring devices with lifting lugs

⚠ CAUTION

Special transportation instructions for devices with lifting lugs

- ▶ Only use the lifting lugs fitted on the device or flanges to transport the device.
- ▶ The device must always be secured at two lifting lugs at least.

5.2.3 Transporting with a fork lift

If transporting in wood crates, the floor structure enables the crates to be lifted lengthwise or at both sides using a forklift.

5.3 Packaging disposal

All packaging materials are environmentally friendly and 100% recyclable:

- Outer packaging of device
 - Stretch wrap made of polymer in accordance with EU Directive 2002/95/EC (RoHS)
- Packaging
 - Wood crate treated in accordance with ISPM 15 standard, confirmed by IPPC logo
 - Cardboard box in accordance with European packaging guideline 94/62/EC, recyclability confirmed by Resy symbol
- Transport material and fastening fixtures
 - Disposable plastic pallet
 - Plastic straps
 - Plastic adhesive strips
- Filler material
 - Paper pads

6 Installation

6.1 Installation requirements

6.1.1 Installation position

Installation point

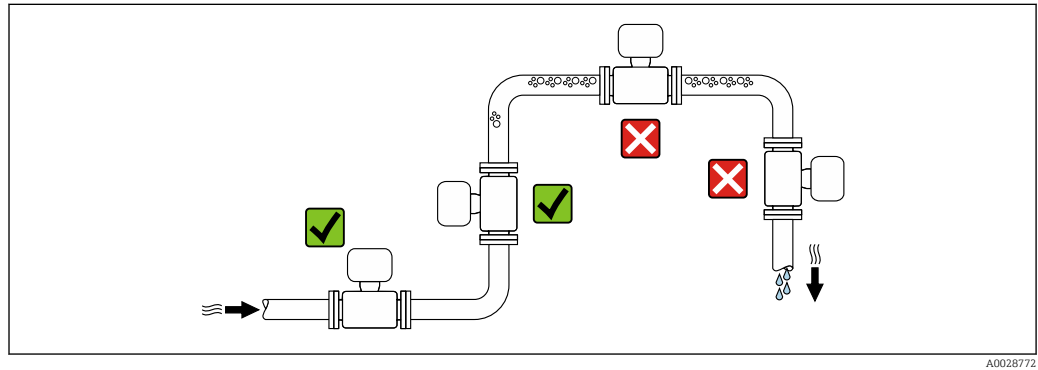



To prevent measuring errors arising from accumulation of gas bubbles in the measuring pipe, avoid the following mounting locations in the piping:

- Highest point of a pipeline.
- Directly upstream of a free pipe outlet in a down pipe.

Installation in down pipes

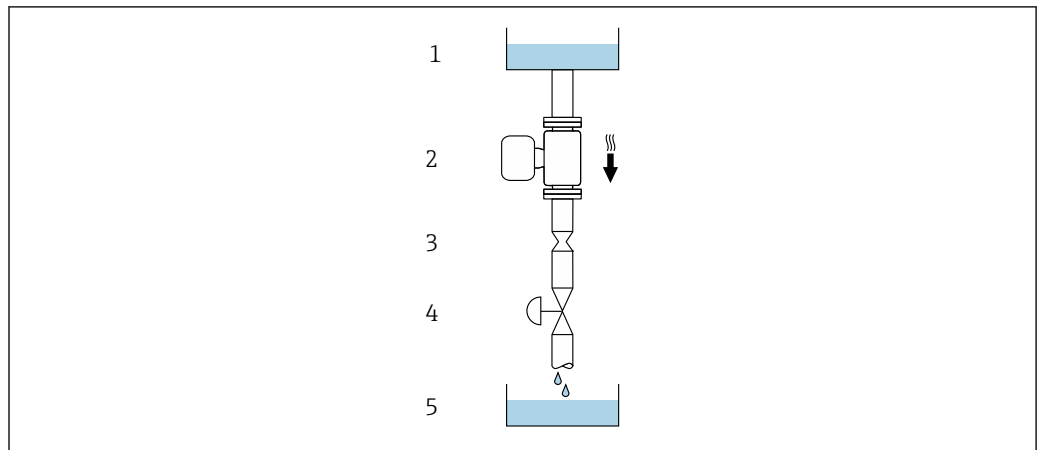
However, the following installation suggestion allows for installation in an open vertical pipeline. Pipe restrictions or the use of an orifice with a smaller cross-section than the nominal diameter prevent the sensor running empty while measurement is in progress.





 5 Installation in a down pipe (e.g. for batching applications)

- 1 Supply tank
- 2 Sensor
- 3 Orifice plate, pipe restriction
- 4 Valve
- 5 Filling vessel

DN		Ø orifice plate, pipe restriction	
[mm]	[in]	[mm]	[in]
8	3/8	6	0.24
15	1/2	10	0.40
25	1	14	0.55
40	1 1/2	22	0.87
50	2	28	1.10

Orientation

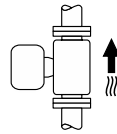
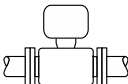
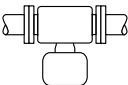
The direction of the arrow on the sensor nameplate helps you to install the sensor according to the flow direction (direction of medium flow through the piping).

Orientation			Recommendation
A	Vertical orientation	 <small>A0015591</small>	✓✓ ¹⁾
B	Horizontal orientation, transmitter at top	 <small>A0015589</small>	✓✓ ²⁾ Exception: → ☒ 6, ☒ 21
C	Horizontal orientation, transmitter at bottom	 <small>A0015590</small>	✓✓ ³⁾ Exception: → ☒ 6, ☒ 21
D	Horizontal orientation, transmitter at side	 <small>A0015592</small>	✗

- 1) This orientation is recommended to ensure self-draining.
- 2) Applications with low process temperatures may reduce the ambient temperature. To maintain the minimum ambient temperature for the transmitter, this orientation is recommended.
- 3) Applications with high process temperatures may increase the ambient temperature. To maintain the maximum ambient temperature for the transmitter, this orientation is recommended.

If a sensor is installed horizontally with a curved measuring tube, match the position of the sensor to the fluid properties.

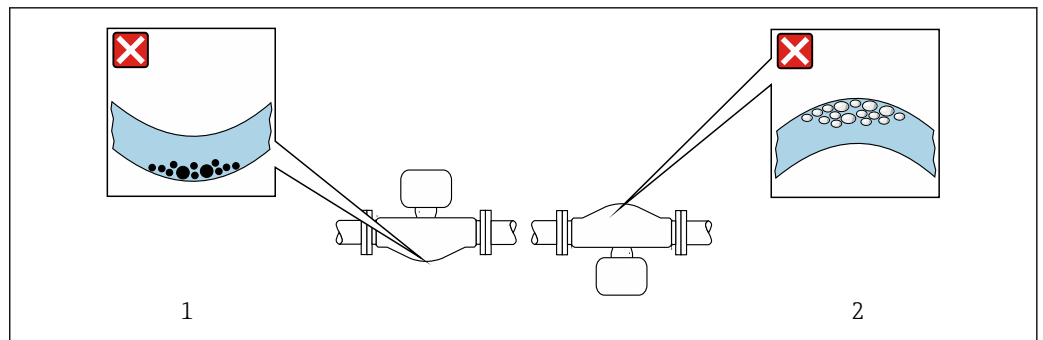

☒ 6 Orientation of sensor with curved measuring tube

- 1 Avoid this orientation for fluids with entrained solids: Risk of solids accumulating
- 2 Avoid this orientation for outgassing fluids: Risk of gas accumulating

Inlet and outlet runs

No special precautions need to be taken for fittings that create turbulence, such as valves, elbows or T-pieces, as long as no cavitation occurs → 22.

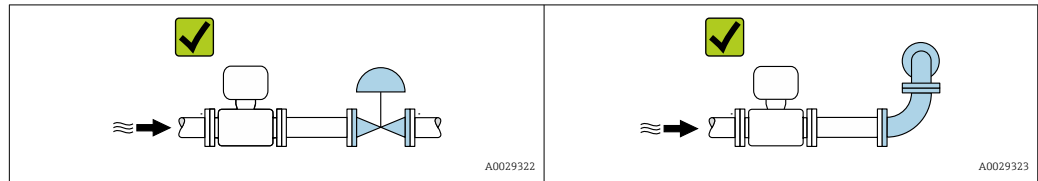

Installation dimensions



For the dimensions and installation lengths of the device, see the "Technical Information" document, "Mechanical construction" section

6.1.2 Environmental and process requirements

Ambient temperature range

Measuring device	-40 to +60 °C (-40 to +140 °F)
Readability of the local display	-20 to +60 °C (-4 to +140 °F) The readability of the display may be impaired at temperatures outside the temperature range.

- ▶ If operating outdoors:
Avoid direct sunlight, particularly in warm climatic regions.

Static pressure

It is important that cavitation does not occur, or that gases entrained in the liquids do not outgas.

Cavitation is caused if the pressure drops below the vapor pressure:

- In liquids that have a low boiling point (e.g. hydrocarbons, solvents, liquefied gases)
 - In suction lines
- ▶ Ensure the static pressure is sufficiently high to prevent cavitation and outgassing.

For this reason, the following mounting locations are recommended:

- At the lowest point in a vertical pipe
- Downstream from pumps (no danger of vacuum)

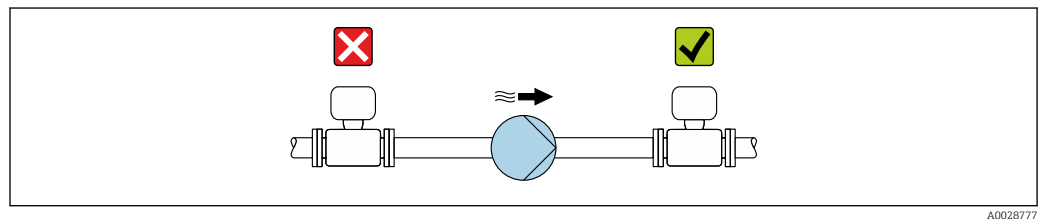

Thermal insulation

In the case of some fluids, it is important to keep the heat radiated from the sensor to the transmitter to a low level. A wide range of materials can be used for the required insulation.

NOTICE**Electronics overheating on account of thermal insulation!**

- ▶ Recommended orientation: horizontal orientation, transmitter housing pointing downwards.
- ▶ Do not insulate the transmitter housing .
- ▶ Maximum permissible temperature at the lower end of the transmitter housing: 80 °C (176 °F)
- ▶ Regarding thermal insulation with an exposed extended neck: We advise against insulating the extended neck to ensure optimal heat dissipation.

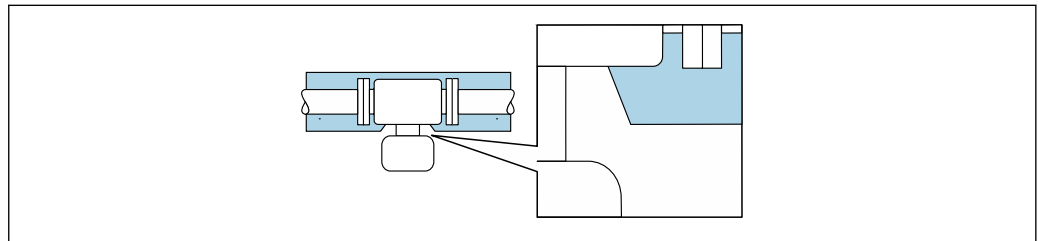

A0034391

 7 Thermal insulation with exposed extended neck

Heating**NOTICE****Electronics can overheat due to elevated ambient temperature!**

- ▶ Observe maximum permitted ambient temperature for the transmitter.
- ▶ Depending on the medium temperature, take the device orientation requirements into account.

NOTICE**Danger of overheating when heating**

- ▶ Ensure that the temperature at the lower end of the transmitter housing does not exceed 80 °C (176 °F).
- ▶ Ensure that sufficient convection takes place at the transmitter neck.
- ▶ Ensure that a sufficiently large area of the transmitter neck remains exposed. The uncovered part serves as a radiator and protects the electronics from overheating and excessive cooling.
- ▶ When using in potentially explosive atmospheres, observe the information in the device-specific Ex documentation. For detailed information on the temperature tables, see the separate document entitled "Safety Instructions" (XA) for the device.
- ▶ Consider the "830 ambient temperature too high" and "832 electronics temperature too high" process diagnostics if overheating cannot be ruled out based on a suitable system design.

Heating options

If a fluid requires that no heat loss should occur at the sensor, users can avail of the following heating options:

- Electrical heating, e.g. with electric band heaters ²⁾
- Via pipes carrying hot water or steam
- Via heating jackets

Vibrations

The high oscillation frequency of the measuring tubes ensures that the correct operation of the measuring system is not influenced by plant vibrations.

2) The use of parallel electric band heaters is generally recommended (bidirectional electricity flow). Particular considerations must be made if a single-wire heating cable is to be used. For additional information, refer to EA01339D "Installation Instructions for Electrical Trace Heating Systems".

6.1.3 Special installation instructions

Drainability

When installed vertically, the measuring tubes can be drained completely and protected against buildup.

Hygienic compatibility

i When installing in hygienic applications, please refer to the information in the "Certificates and approvals/hygienic compatibility" section →  159

Rupture disk

Process-related information: →  153.

WARNING

Danger from medium escaping!

Medium escaping under pressure can cause injury or material damage.

- ▶ Take precautions to prevent danger to persons and damage if the rupture disk is actuated.
- ▶ Observe the information on the rupture disk sticker.
- ▶ Make sure that the function and operation of the rupture disk is not impeded through the installation of the device.
- ▶ Do not use a heating jacket.
- ▶ Do not remove or damage the rupture disk.

- ▶ After the rupture disk is actuated, do not operate the measuring device any more.

The position of the rupture disk is indicated on a sticker applied over it. If the rupture disk is triggered, the sticker is destroyed. The disk can therefore be visually monitored.

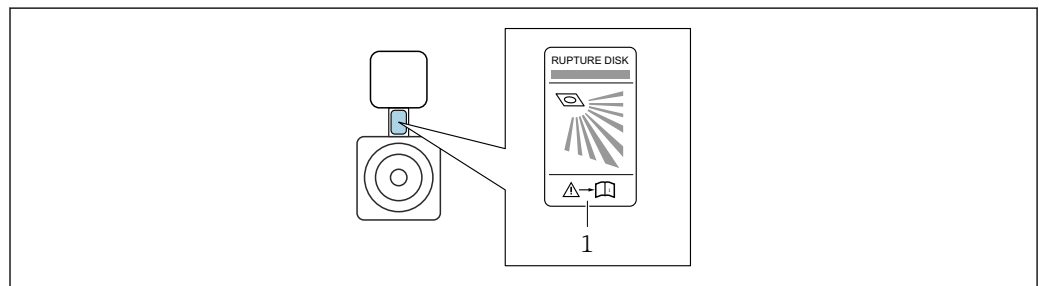

1 Rupture disk label

A0032051

Zero verification and zero adjustment

All measuring instruments are calibrated in accordance with state-of-the-art technology. Calibration takes place under reference conditions →  147. Therefore, a zero adjustment in the field is generally not required.

Experience shows that zero adjustment is advisable only in special cases:

- To achieve maximum measurement accuracy even with low flow rates.
- Under extreme process or operating conditions (e.g. very high process temperatures or very high-viscosity fluids).
- For gas applications with low pressure

i To achieve the highest possible measurement accuracy at low flow rates, the installation must protect the sensor from mechanical stresses during operation.

To get a representative zero point, ensure that:

- any flow in the device is prevented during the adjustment
- the process conditions (e.g. pressure, temperature) are stable and representative

Verification and adjustment cannot be carried out if the following process conditions are present:

- Gas pockets
Ensure that the system has been sufficiently flushed with the medium. Repeat flushing can help to eliminate gas pockets
- Thermal circulation
In the event of temperature differences (e.g. between the measuring tube inlet and outlet section), induced flow can occur even if the valves are closed due to thermal circulation in the device
- Leaks at the valves
If the valves are not leak-tight, flow is not sufficiently prevented when determining the zero point

If these conditions cannot be avoided, it is advisable to keep the factory setting for the zero point.

6.2 Installing the measuring instrument

6.2.1 Required tools

For transmitter

- For turning the transmitter housing: Open-ended wrench 8 mm
- For opening the securing clamps: Allen key 3 mm

For sensor

For flanges and other process connections: Use a suitable mounting tool.

6.2.2 Preparing the measuring instrument

1. Remove all remaining transport packaging.
2. Remove any protective covers or protective caps present from the sensor.
3. If present, remove transport protection of the rupture disk.
4. Remove stick-on label on the electronics compartment cover.

6.2.3 Mounting the measuring device

WARNING

Danger due to improper process sealing!

- ▶ Ensure that the inside diameters of the gaskets are greater than or equal to that of the process connections and piping.
- ▶ Ensure that the seals are clean and undamaged.
- ▶ Secure the seals correctly.

1. Ensure that the direction of the arrow on the nameplate of the sensor matches the flow direction of the medium.

2. Install the measuring device or turn the transmitter housing so that the cable entries do not point upwards.

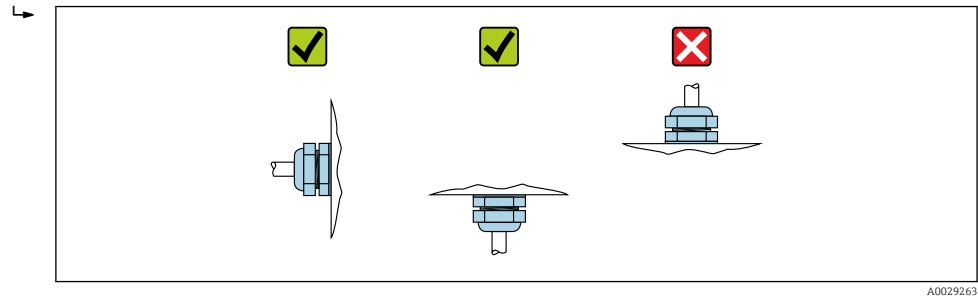

A0029263

6.2.4 Turning the transmitter housing

To provide easier access to the connection compartment or display module, the transmitter housing can be turned.

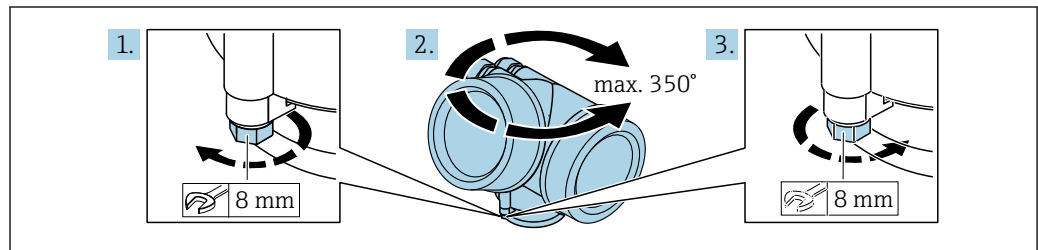

A0032242

1. Loosen the securing screw.
2. Turn the housing to the desired position.
3. Firmly tighten the securing screw.

6.2.5 Turning the display module

The display module can be turned to optimize display readability and operability.

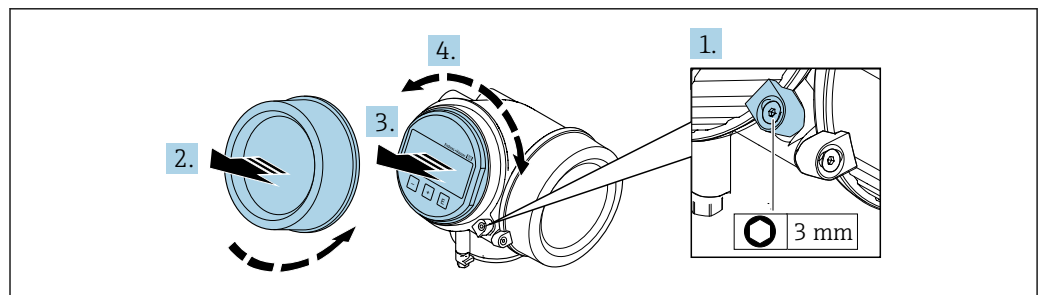

A0032238

1. Loosen the securing clamp of the electronics compartment cover using an Allen key.
2. Unscrew cover of the electronics compartment from the transmitter housing.
3. Optional: pull out the display module with a gentle rotational movement.
4. Turn the display module to the desired position: Max. $8 \times 45^\circ$ in each direction.
5. Without display module pulled out:
Allow display module to engage at desired position.
6. With display module pulled out:
Feed the cable into the gap between the housing and main electronics module and plug the display module into the electronics compartment until it engages.
7. Reassemble the transmitter in the reverse order.

6.3 Post-installation check

Is the device undamaged (visual inspection)?	<input type="checkbox"/>
Does the measuring instrument correspond to the measuring point specifications? For example: <ul style="list-style-type: none"> ▪ Process temperature → 152 ▪ Pressure (refer to the "Pressure-temperature ratings" section of the "Technical Information" document). ▪ Ambient temperature → 151 ▪ Measuring range 	<input type="checkbox"/>
Has the correct orientation for the sensor been selected → 21? <ul style="list-style-type: none"> ▪ According to sensor type ▪ According to medium temperature ▪ According to medium properties (outgassing, with entrained solids) 	<input type="checkbox"/>
Does the arrow on the sensor match the direction of flow of the medium? → 21?	<input type="checkbox"/>
Is the tag name and labeling correct (visual inspection)?	<input type="checkbox"/>
Is the device sufficiently protected from precipitation and direct sunlight?	<input type="checkbox"/>
Are the securing screw and securing clamp tightened securely?	<input type="checkbox"/>

7 Electrical connection

7.1 Electrical safety

In accordance with applicable national regulations.

7.2 Connecting requirements

7.2.1 Required tools

- For cable entries: Use corresponding tools
- For securing clamp: Allen key 3 mm
- Wire stripper
- When using stranded cables: Crimper for wire end ferrule
- For removing cables from terminal: Flat blade screwdriver ≤ 3 mm (0.12 in)

7.2.2 Requirements for connecting cable

The connecting cables provided by the customer must fulfill the following requirements.

Permitted temperature range

- The installation guidelines that apply in the country of installation must be observed.
- The cables must be suitable for the minimum and maximum temperatures to be expected.

Signal cable

-  For custody transfer, all signal lines must be shielded cables (tinned copper braiding, optical coverage $\geq 85\%$). The cable shield must be connected on both sides.

Pulse/frequency/switch output

Standard installation cable is sufficient.

PROFIBUS PA

Shielded twisted-pair cable. Cable type A is recommended.

-  See <https://www.profibus.com> "PROFIBUS Installation Guidelines".

Ethernet-APL

Shielded twisted-pair cable. Cable type A is recommended.

-  See <https://www.profibus.com> Ethernet-APL White Paper "

Cable diameter

- Cable glands supplied:
 - M20 \times 1.5 with cable ϕ 6 to 12 mm (0.24 to 0.47 in)
- Plug-in spring terminals for device version without integrated overvoltage protection:
 - wire cross-sections 0.5 to 2.5 mm² (20 to 14 AWG)

7.2.3 Terminal assignment

Transmitter

Connection version for PROFIBUS PA, pulse/frequency/switch output

<p style="text-align: right; font-size: small;">A0013570</p>	<p style="text-align: right; font-size: small;">A0018161</p>
Maximum number of terminals	Maximum number of terminals for order code for "Accessory mounted", option NA "Overvoltage protection"
<p>1 Output 1: PROFIBUS PA</p> <p>2 Output 2 (passive): pulse/frequency/switch output</p> <p>3 Ground terminal for cable shield</p>	

Order code for "Output"	Terminal numbers			
	Output 1		Output 2	
	1 (+)	2 (-)	3 (+)	4 (-)
Option G ^{1) 2)}	PROFIBUS PA		Pulse/frequency/switch output (passive)	

- 1) Output 1 must always be used; output 2 is optional.
- 2) PROFIBUS PA with integrated reverse polarity protection.

7.2.4 device plug pin assignment

	Pin	Assignment	Coding	Plug/socket
1	+	PROFIBUS PA +	A	Plug
2		Grounding		
3	-	PROFIBUS PA -		
4		Not assigned		

7.2.5 Shielding and grounding

Optimal electromagnetic compatibility (EMC) of the fieldbus system can be guaranteed only if the system components and, in particular, the lines are shielded and the shield forms as complete a cover as possible. A shield coverage of 90 % is ideal.

1. To ensure optimal EMC protection, connect the shield to the reference ground as often as possible.
2. For reasons concerning explosion protection, it is recommended that grounding be dispensed with.

To comply with both requirements, there are basically three different types of shielding in the fieldbus system:

- Shielding at both ends
- Shielding at one end on the feed side with capacitance termination at the field device
- Shielding at one end on the feed side

Experience shows that the best results with regard to EMC are achieved in most cases in installations with one-sided shielding on the feed side (without capacitance termination at the field device). Appropriate measures with regard to input wiring must be taken to allow unrestricted operation when EMC interference is present. These measures have been taken into account for this device. Operation in the event of disturbance variables as per NAMUR NE21 is thus guaranteed.

1. Observe national installation requirements and guidelines during installation.
2. Where there are large differences in potential between the individual grounding points, connect only one point of the shielding directly to the reference ground.
3. In systems without potential equalization, the cable shielding of fieldbus systems should be grounded on one side only, for example at the fieldbus supply unit or at safety barriers.

NOTICE

In systems without potential matching, the multiple grounding of the cable shield causes mains frequency equalizing currents!

Damage to the bus cable shield.

- ▶ Only ground the bus cable shield to either the local ground or the protective ground at one end.
- ▶ Insulate the shield that is not connected.

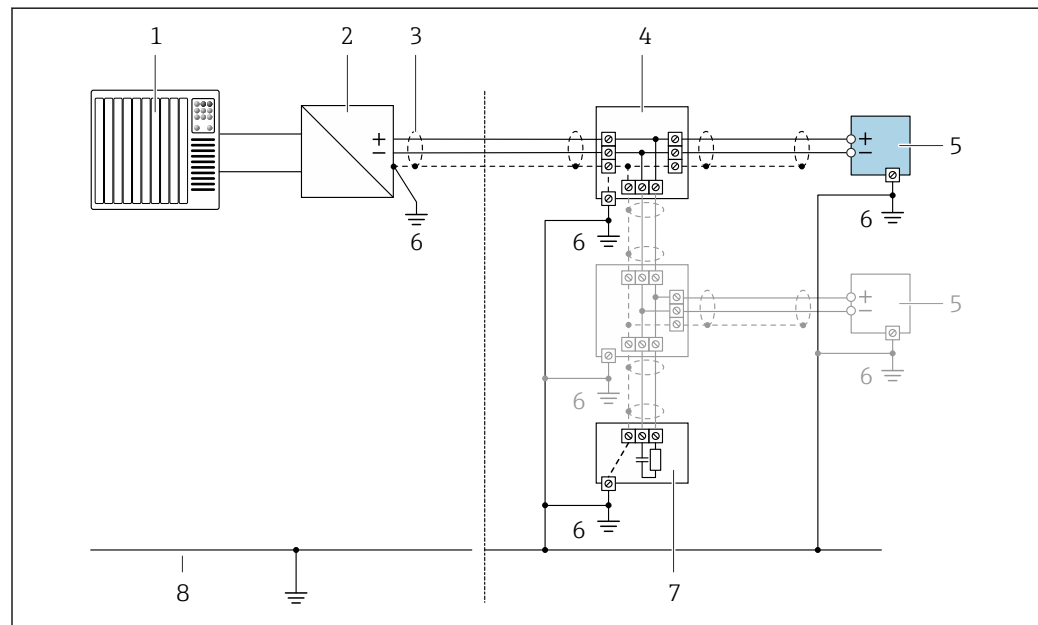

A0028766

8 Connection example for PROFIBUS PA

- 1 Control system (e.g. PLC)
- 2 PROFIBUS PA segment coupler
- 3 Cable shield: the cable shield must be grounded at both ends to comply with EMC requirements; observe cable specifications
- 4 T-box
- 5 Measuring device
- 6 Local grounding
- 7 Bus terminator
- 8 Potential equalization conductor

7.2.6 Requirements for the supply unit

Supply voltage

Transmitter

An external power supply is required for each output.

The following supply voltage values apply for the outputs available:

Order code for "Output"	Minimum terminal voltage	Maximum terminal voltage
Option G: PROFIBUS PA, pulse/frequency/switch output	≥ DC 9 V	DC 32 V

7.2.7 Preparing the measuring device

NOTICE

Insufficient sealing of the housing!

Operational reliability of the measuring device could be compromised.

► Use suitable cable glands corresponding to the degree of protection.

1. Remove dummy plug if present.
2. If the measuring device is supplied without cable glands:
Provide suitable cable gland for corresponding connecting cable.
3. If the measuring device is supplied with cable glands:
Observe requirements for connecting cables →  28.

7.3 Connecting the measuring instrument

NOTICE

An incorrect connection compromises electrical safety!

- Only properly trained specialist staff may perform electrical connection work.
- Observe applicable federal/national installation codes and regulations.
- Comply with local workplace safety regulations.
- Always connect the protective ground cable  before connecting additional cables.
- When using in potentially explosive atmospheres, observe the information in the device-specific Ex documentation.

7.3.1 Connecting the transmitter

The connection of the transmitter depends on the following order code:

"Electrical connection":

- Option A, B, C, D: terminals
- Option I: device plug

Connection via terminals

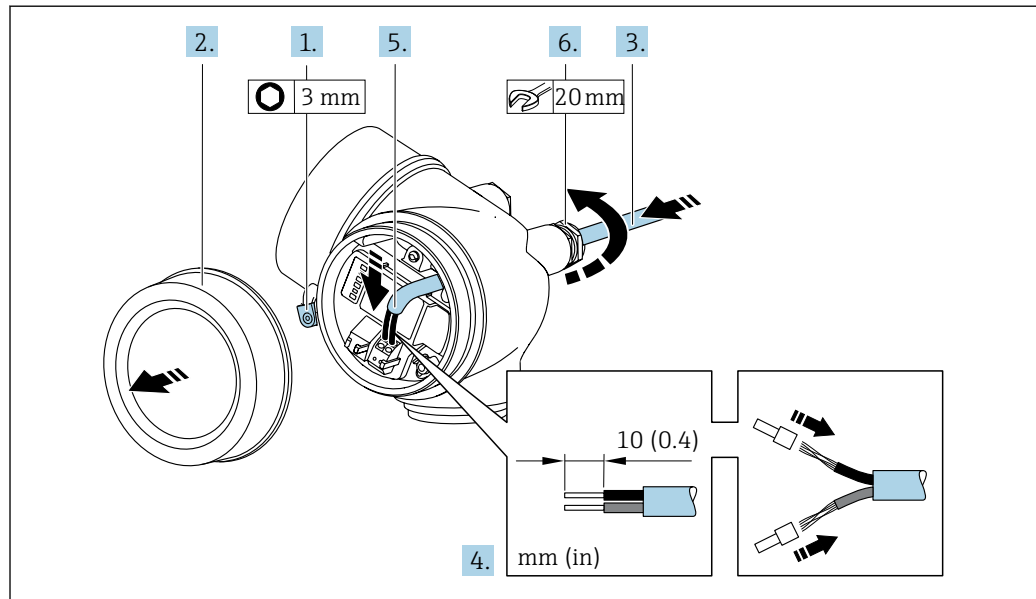

A0048825

1. Loosen the securing clamp of the connection compartment cover.
2. Unscrew the connection compartment cover.
3. Push the cable through the cable entry . To ensure tight sealing, do not remove the sealing ring from the cable entry.
4. Strip the cable and cable ends. In the case of stranded cables, also fit ferrules.
5. Connect cable in accordance with terminal assignment → 29.
6. **⚠ WARNING**
Housing degree of protection may be voided due to insufficient sealing of the housing.
 - ▶ Screw in the screw without using any lubricant. The threads on the cover are coated with a dry lubricant.

Firmly tighten the cable glands.

7. Reassemble the transmitter in the reverse order.

Connection via device plug

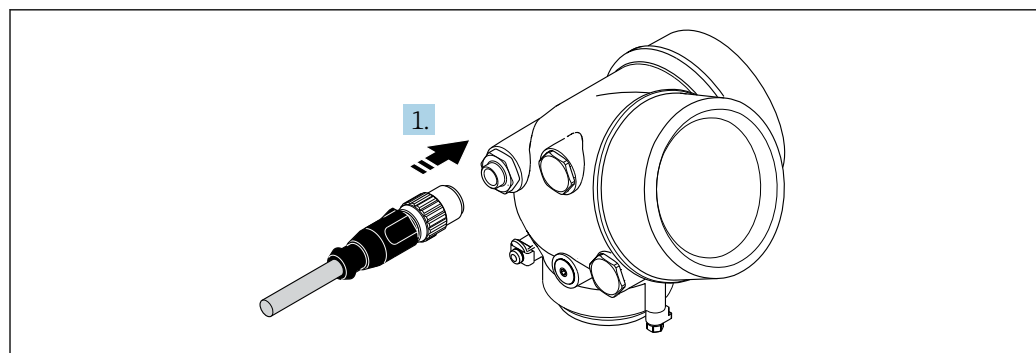

A0032229

- ▶ Plug in the device plug and tighten firmly.

Removing a cable

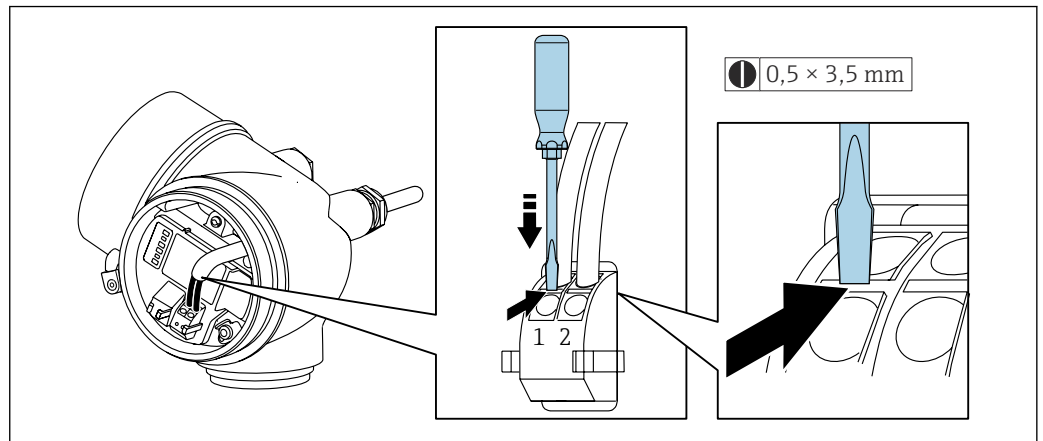

A0048822

- ▶ To remove a cable from the terminal, use a flat-blade screwdriver to push the slot between the two terminal holes while simultaneously pulling the cable end out of the terminal.

7.3.2 Potential equalization

Requirements

No special measures for potential equalization are required.

Connection example, standard scenario

Connection example in special situations

7.4 Special connection instructions

7.4.1 Connection examples

Pulse/frequency output

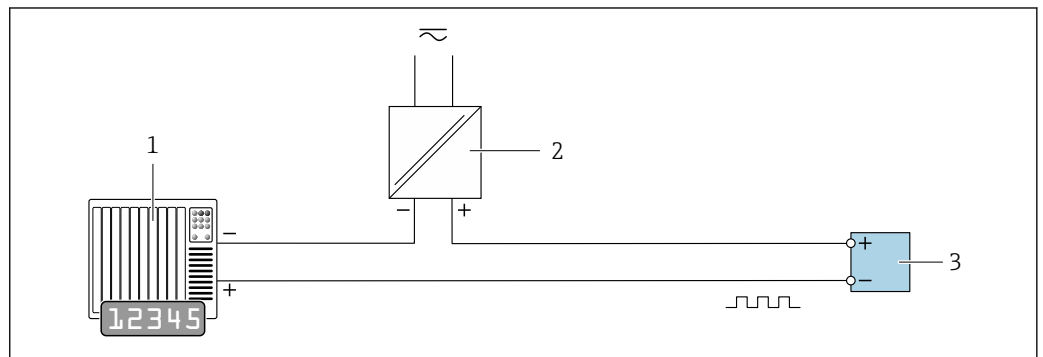

A0028761

9 Connection example for pulse/frequency output (passive)

- 1 Automation system with pulse/frequency input (e.g. PLC with 10 kΩ pull-up or pull-down resistor)
- 2 Power supply
- 3 Transmitter: observe input values

Switch output

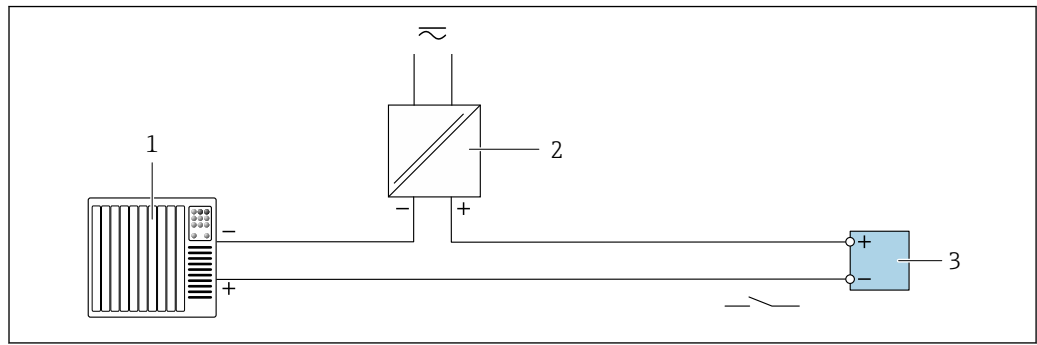

A0028760

10 Connection example for switch output (passive)

- 1 Automation system with switch input (e.g. PLC with a 10 kΩ pull-up or pull-down resistor)
- 2 Power supply
- 3 Transmitter: observe input values

PROFIBUS PA

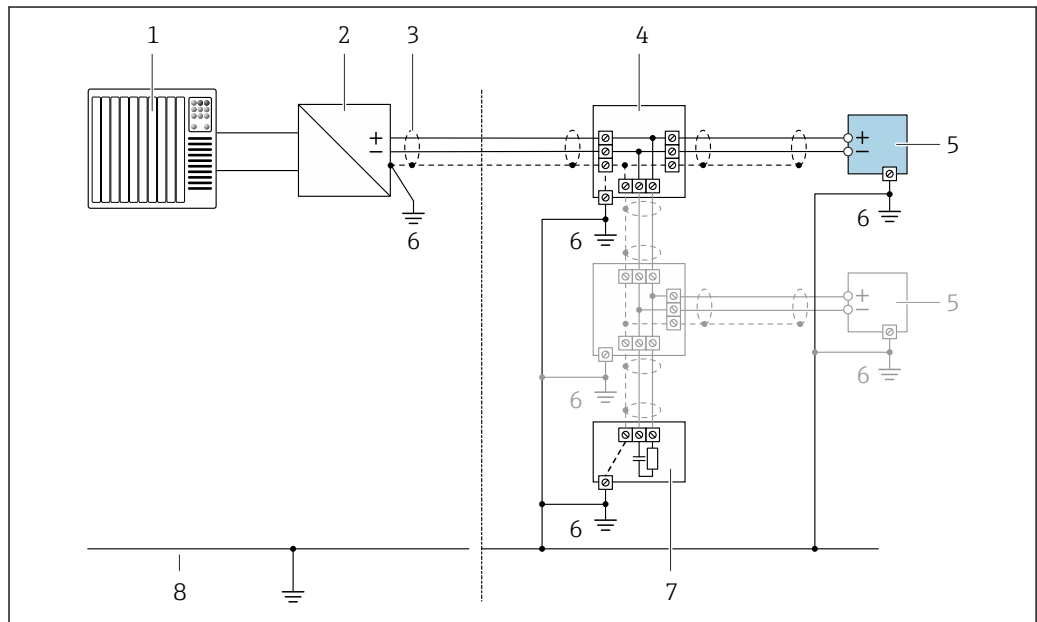

A0028768

11 Connection example for PROFIBUS PA

- 1 Control system (e.g. PLC)
- 2 PROFIBUS PA segment coupler
- 3 Cable shield provided at one end. The cable shield must be grounded at both ends to comply with EMC requirements; observe cable specifications
- 4 T-box
- 5 Measuring device
- 6 Local grounding
- 7 Bus terminator
- 8 Potential matching line

7.5 Hardware settings

7.5.1 Setting the device address

PROFIBUS PA

The address must always be configured for a PROFIBUS DP/PA device. The valid address range is between 1 and 126. In a PROFIBUS DP/PA network, each address can only be assigned once. If an address is not configured correctly, the device is not recognized by the master. All measuring devices are delivered from the factory with the device address 126 and with the software addressing method.

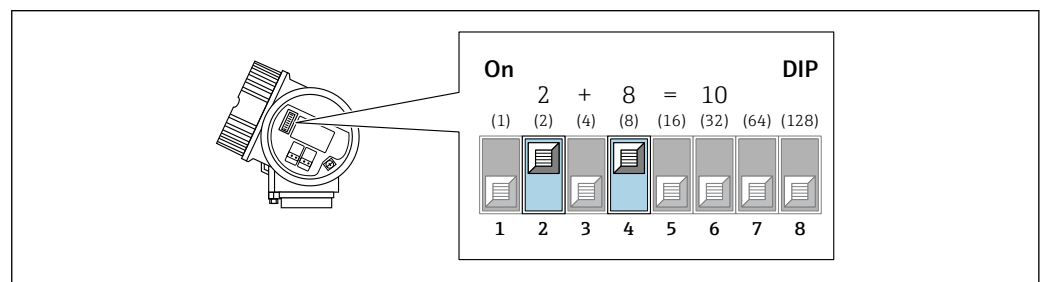

12 Address switch in the connection compartment; example of how to configure the device address 10.

Hardware addressing

1. Set switch 8 to the "OFF" position.
2. Set the address using switches 1 to 7.

The change of address takes effect after 10 seconds. The device is restarted.

Software addressing → 64

1. Set switches 1 to 7 to the "OFF" position.
2. Set switch 8 to "ON".
 - ↳ The device restarts automatically and reports the current address (factory setting: 126).
3. Configure the address via the operating menu: **Setup** menu → **Communication** submenu → **Device address** parameter

7.6 Ensuring the degree of protection

The measuring instrument fulfills all the requirements for the degree of protection IP66/67, Type 4X enclosure.

To guarantee the degree of protection IP66/67, Type 4X enclosure, carry out the following steps after the electrical connection:

1. Check that the housing seals are clean and fitted correctly.
2. Dry, clean or replace the seals if necessary.
3. Tighten all housing screws and screw covers.
4. Firmly tighten the cable glands.

5. To ensure that moisture does not enter the cable entry:
Route the cable so that it loops down before the cable entry ("water trap").

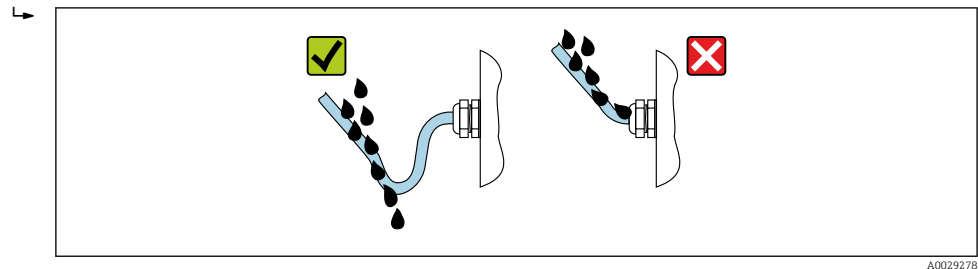

6. The cable glands supplied do not ensure housing protection when not in use. They must therefore be replaced by dummy plugs corresponding to the housing protection.

7.7 Post-connection check

Are the device and cable undamaged (visual inspection)?	<input type="checkbox"/>
Do the cables used comply with the requirements → 28?	<input type="checkbox"/>
Are the installed cables strain-relieved and securely routed?	<input type="checkbox"/>
Are all cable glands installed, securely tightened and leak-tight? Cable run with "water trap" → 35?	<input type="checkbox"/>
Depending on the device version: Are all connectors securely tightened → 31?	<input type="checkbox"/>
Does the supply voltage match the specifications on the transmitter nameplate → 31?	<input type="checkbox"/>
Is the terminal assignment correct ?	<input type="checkbox"/>
Is the terminal assignment or the device plug pin assignment correct?	<input type="checkbox"/>
If supply voltage is present: Does an indication appear on the display module?	<input type="checkbox"/>
Are all housing covers installed and securely tightened?	<input type="checkbox"/>
Is the securing clamp securely tightened?	<input type="checkbox"/>

8 Operation options

8.1 Overview of operation options

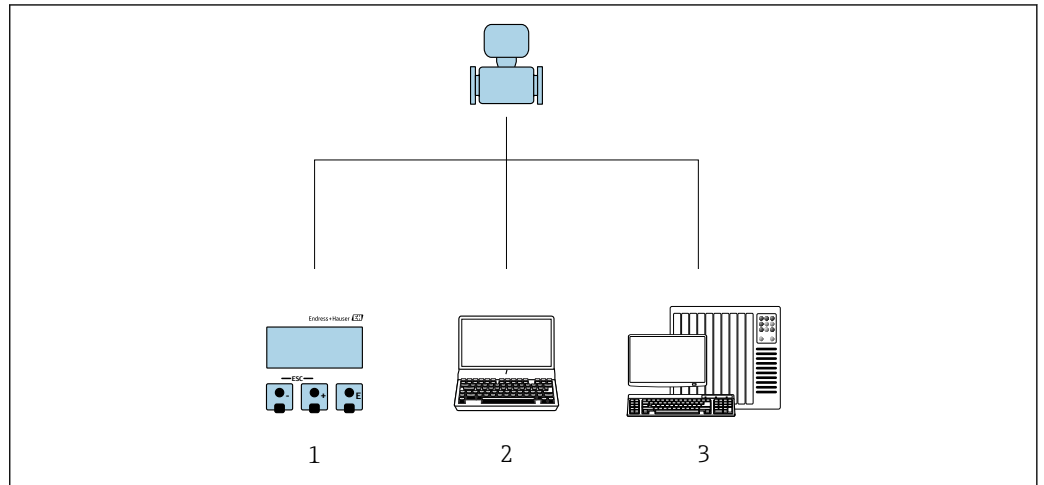

A0032227

- 1 Local operation via display module
- 2 Computer with operating tool (e.g. FieldCare, SIMATIC PDM)
- 3 Automation system (e.g. PLC)

8.2 Structure and function of the operating menu

8.2.1 Structure of the operating menu



For an overview of the operating menu for experts: see the "Description of Device Parameters" document supplied with the device

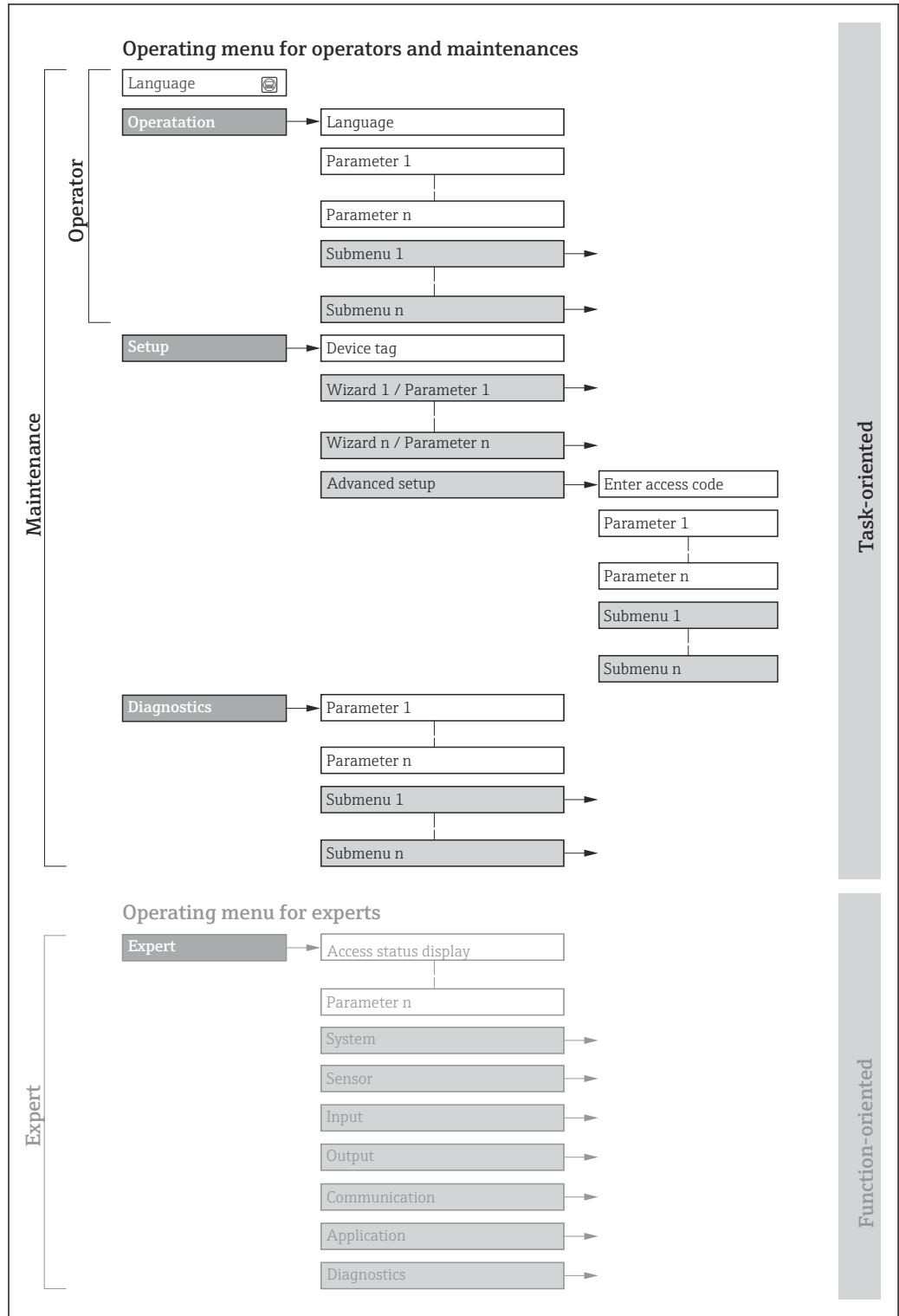

13 Schematic structure of the operating menu

A0018237-EN

8.2.2 Operating philosophy

The individual parts of the operating menu are assigned to certain user roles (e.g. operator, maintenance etc.). Each user role contains typical tasks within the device life cycle.

Menu/parameter		User role and tasks	Content/meaning
Language	Task-oriented	Role "Operator", "Maintenance" Tasks during operation: <ul style="list-style-type: none"> ▪ Configuration of the operational display ▪ Reading measured values 	<ul style="list-style-type: none"> ▪ Defining the operating language ▪ Resetting and controlling totalizers
Operation			<ul style="list-style-type: none"> ▪ Configuration of the operational display (e.g. display format, display contrast) ▪ Resetting and controlling totalizers
Setup		"Maintenance" role Commissioning: <ul style="list-style-type: none"> ▪ Configuration of the measurement ▪ Configuration of the inputs and outputs 	Wizards for fast commissioning: <ul style="list-style-type: none"> ▪ Configuring the system units ▪ Definition of the medium ▪ Configuring the outputs ▪ Configuration of the operational display ▪ Definition of output conditioning ▪ Configuring the low flow cut off ▪ Configuring partial and empty pipe detection Advanced setup <ul style="list-style-type: none"> ▪ For more customized configuration of the measurement (adaptation to special measuring conditions) ▪ Configuration of totalizers ▪ Administration (define access code, reset measuring device)
Diagnostics		"Maintenance" role Troubleshooting: <ul style="list-style-type: none"> ▪ Diagnostics and elimination of process and device errors ▪ Measured value simulation 	Contains all parameters for error detection and analyzing process and device errors: <ul style="list-style-type: none"> ▪ Diagnostic list Contains up to 5 currently pending diagnostic messages. ▪ Event logbook Contains event messages that have occurred. ▪ Device information Contains information for identifying the device ▪ Measured values Contains all current measured values. ▪ Analog inputs Is used to display the analog input. ▪ Data logging submenu with the "Extended HistoROM" order option Storage and visualization of measured values ▪ Heartbeat Technology Verification of device functionality on request and documentation of verification results ▪ Simulation Used to simulate measured values or output values.
Expert	Function-oriented	Tasks that require detailed knowledge of the function of the device: <ul style="list-style-type: none"> ▪ Commissioning measurements under difficult conditions ▪ Optimal adaptation of the measurement to difficult conditions ▪ Detailed configuration of the communication interface ▪ Error diagnostics in difficult cases 	Contains all of the device parameters and allows direct access to these by means of an access code. The structure of this menu is based on the function blocks of the device: <ul style="list-style-type: none"> ▪ System Contains all higher-level device parameters that do not affect measurement or measured value communication ▪ Sensor Configuration of the measurement. ▪ Output Configuration of the pulse/frequency/switch output ▪ Communication Configuration of the digital communication interface ▪ Submenus for function blocks (e.g. "Analog Inputs") Configuration of function blocks ▪ Application Configuration of the functions that go beyond the actual measurement (e.g. totalizer) ▪ Diagnostics Error detection and analysis of process and device errors and for device simulation and Heartbeat Technology.

8.3 Access to operating menu via local display

8.3.1 Operational display

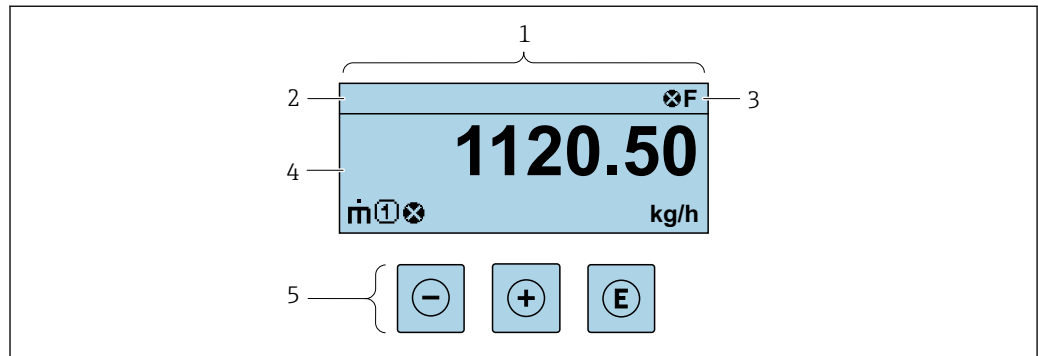

A0029348

- 1 Operational display
- 2 Device tag
- 3 Status area
- 4 Display range for measured values (up to 4 lines)
- 5 Operating elements → 45

Status area

The following symbols appear in the status area of the operational display at the top right:

- Status signals → 106
 - **F**: Failure
 - **C**: Function check
 - **S**: Out of specification
 - **M**: Maintenance required
- Diagnostic behavior → 107
 - : Alarm
 - : Warning
 - : Locking (the device is locked via the hardware)
 - : Communication (communication via remote operation is active)

Display area

In the display area, each measured value is prefaced by certain symbol types for further description:



	Measured variable	Measurement channel number	Diagnostic behavior
	↓	↓	↓
Example			

Appears only if a diagnostics event is present for this measured variable.



Measured variables

Symbol	Meaning
	Mass flow
	<ul style="list-style-type: none"> ■ Volume flow ■ Corrected volume flow



	<ul style="list-style-type: none"> ▪ Density ▪ Reference density
	Temperature

 The number and display format of the measured variables can be configured via the **Format display** parameter (→  71).



Totalizer

Symbol	Meaning
	Totalizer  The measurement channel number indicates which of the three totalizers is displayed.

Measurement channel numbers

Symbol	Meaning
	Measurement channel 1 to 4  The measurement channel number is displayed only if more than one channel is present for the same measured variable type (e.g. totalizer 1 to 3).

Diagnostic behavior

Symbol	Meaning
	Alarm <ul style="list-style-type: none"> ▪ Measurement is interrupted. ▪ Signal outputs and totalizers assume the defined alarm condition. ▪ A diagnostic message is generated. ▪ For local display with touch control: the background lighting changes to red.
	Warning <ul style="list-style-type: none"> ▪ Measurement is resumed. ▪ The signal outputs and totalizers are not affected. ▪ A diagnostic message is generated.

 The diagnostic behavior pertains to a diagnostic event that is relevant to the displayed measured variable.

8.3.2 Navigation view

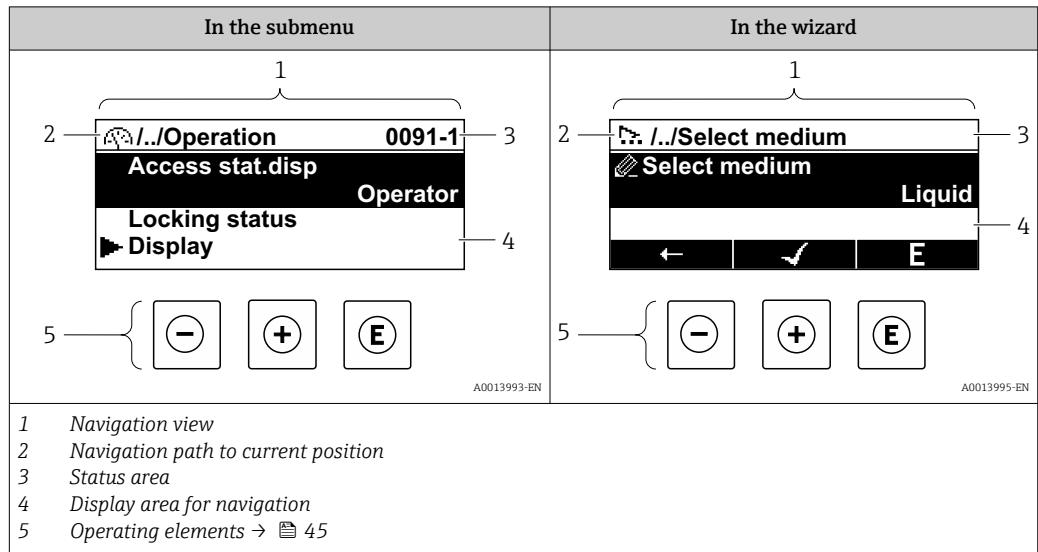

Navigation path

The navigation path to the current position is displayed at the top left in the navigation view and consists of the following elements:

- The display symbol for the menu/submenu (▶) or the wizard (⚙).
- An omission symbol (/ ../) for operating menu levels in between.
- Name of the current submenu, wizard or parameter

	Display symbol	Omission symbol	Parameter
	↓	↓	↓
Example	▶	/ ../	Indication

For more information about the icons in the menu, refer to the "Display area" section → 42

Status area

The following appears in the status area of the navigation view in the top right corner:



- In the submenu
 - The direct access code to the parameter (e.g., 0022-1)
 - If a diagnostic event is present, the diagnostic behavior and status signal
- In the wizard
 - If a diagnostic event is present, the diagnostic behavior and status signal

- For information on the diagnostic behavior and status signal → 106
- For information on the function and entry of the direct access code → 47





Display area

Menus

Symbol	Meaning
	<p>Operation Is displayed:</p> <ul style="list-style-type: none"> ▪ In the menu next to the "Operation" selection ▪ At the left in the navigation path in the Operation menu

	<p>Setup Is displayed:</p> <ul style="list-style-type: none"> ▪ In the menu next to the "Setup" selection ▪ At the left in the navigation path in the Setup menu
	<p>Diagnosis Is displayed:</p> <ul style="list-style-type: none"> ▪ In the menu next to the "Diagnostics" selection ▪ At the left in the navigation path in the Diagnostics menu
	<p>Expert Is displayed:</p> <ul style="list-style-type: none"> ▪ In the menu next to the "Expert" selection ▪ At the left in the navigation path in the Expert menu



Submenus, wizards, parameters

Symbol	Meaning
	Submenu
	Wizards
	Parameters within a wizard  No display symbol exists for parameters in submenus.



Locking procedure

Symbol	Meaning
	<p>Parameter locked When displayed in front of a parameter name, indicates that the parameter is locked.</p> <ul style="list-style-type: none"> ▪ By a user-specific access code ▪ By the hardware write protection switch

Wizards

Symbol	Meaning
	Switches to the previous parameter.
	Confirms the parameter value and switches to the next parameter.
	Opens the editing view of the parameter.

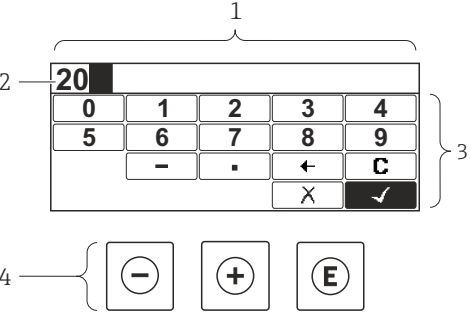
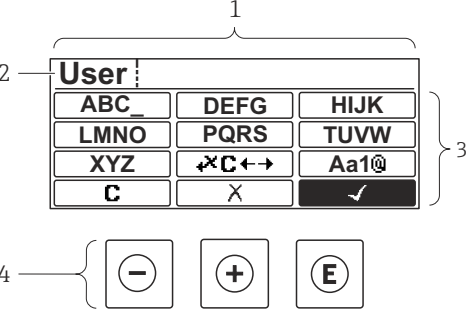





8.3.3 Editing view

Numeric editor	Text editor
	
<p>1 Editing view 2 Display area of the entered values 3 Input mask 4 Operating elements →  45</p>	<p>1 Editing view 2 Display area of the entered values 3 Input mask 4 Operating elements →  45</p>









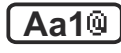

Input screen

The following input symbols are available in the input mask of the numeric and text editor:

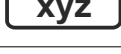
Numeric editor



Symbol	Meaning
	Selection of numbers from 0 to 9
	Inserts a decimal separator at the cursor position.
	Inserts a minus sign at the cursor position.
	Confirms the selection.
	Moves the input position one position to the left.
	Exits the input without applying the changes.
	Clears all entered characters.

Text editor







Symbol	Meaning
	Toggle <ul style="list-style-type: none"> ▪ Between upper-case and lower-case letters ▪ For entering numbers ▪ For entering special characters
 	Selection of letters from A to Z.
 	Selection of letters from a to z.
 	Selection of special characters.
	Confirms the selection.
	Switches to the selection of the correction tools.
	Exits the input without applying the changes.
	Clears all entered characters.

Text correction under 

Symbol	Meaning
	Clears all entered characters.

	Moves the input position one position to the right.
	Moves the input position one position to the left.
	Deletes one character immediately to the left of the input position.

8.3.4 Operating elements

Operating key	Meaning
	<p>Minus key</p> <p><i>In menu, submenu</i> Moves the selection bar upwards in a picklist</p> <p><i>In wizards</i> Goes to previous parameter</p> <p><i>In the text and numeric editor</i> In the input screen, moves the selection bar to the left (backwards)</p>
	<p>Plus key</p> <p><i>In menu, submenu</i> Moves the selection bar downwards in a picklist</p> <p><i>In wizards</i> Goes to the next parameter</p> <p><i>In the text and numeric editor</i> In the input screen, moves the selection bar to the right (forwards)</p>
	<p>Enter key</p> <p><i>In the operational display</i> Pressing the key for 2 s opens the context menu.</p> <p><i>In menu, submenu</i></p> <ul style="list-style-type: none"> ▪ Pressing the key briefly: <ul style="list-style-type: none"> ▪ Opens the selected menu, submenu or parameter. ▪ Starts the wizard. ▪ If help text is open, closes the help text of the parameter. ▪ Pressing the key for 2 s in a parameter: <ul style="list-style-type: none"> ▪ If present, opens the help text for the function of the parameter. <p><i>In wizards</i> Opens the editing view of the parameter and confirms the parameter value</p> <p><i>In the text and numeric editor</i></p> <ul style="list-style-type: none"> ▪ Pressing the key briefly: <ul style="list-style-type: none"> ▪ Opens the selected group. ▪ Carries out the selected action. ▪ Pressing the key for 2 s confirms the edited parameter value.
	<p>Escape key combination (press keys simultaneously)</p> <p><i>In menu, submenu</i></p> <ul style="list-style-type: none"> ▪ Pressing the key briefly: <ul style="list-style-type: none"> ▪ Exits the current menu level and takes you to the next higher level. ▪ If help text is open, closes the help text of the parameter. ▪ Pressing the key for 2 s returns you to the operational display ("home position"). <p><i>In wizards</i> Exits the wizard and takes you to the next higher level</p> <p><i>In the text and numeric editor</i> Closes the text or numeric editor without applying changes.</p>
	<p>Plus/Enter key combination (press and hold down the keys simultaneously)</p> <p>Increases the contrast (darker setting).</p>
	<p>Minus/Plus/Enter key combination (press the keys simultaneously)</p> <p><i>In the operational display</i> Enables or disables the keypad lock (only SD02 display module).</p>

8.3.5 Opening the context menu

Using the context menu, the user can call up the following menus quickly and directly from the operational display:

- Setup
- Configuration backup display
- Simulation

Calling up and closing the context menu

The user is in the operational display.

1. Press the \square and \square keys for longer than 3 seconds.
 - ↳ The context menu opens.

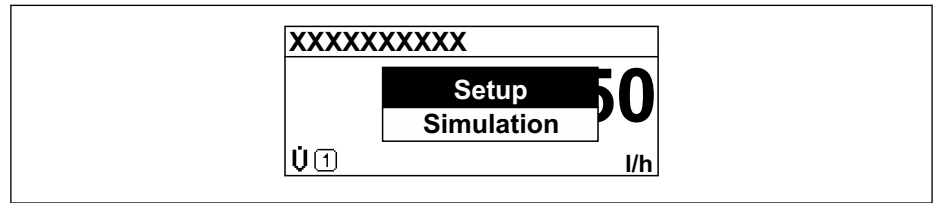

A0017421-EN

2. Press \square + \square simultaneously.
 - ↳ The context menu is closed and the operational display appears.

Calling up the menu via the context menu

1. Open the context menu.
2. Press \square to navigate to the desired menu.
3. Press \square to confirm the selection.
 - ↳ The selected menu opens.

8.3.6 Navigating and selecting from list

Different operating elements are used to navigate through the operating menu. The navigation path is displayed on the left in the header. Icons are displayed in front of the individual menus. These icons are also shown in the header during navigation.

i For an explanation of the navigation view with symbols and operating elements → 42

Example: Setting the number of displayed measured values to "2 values"

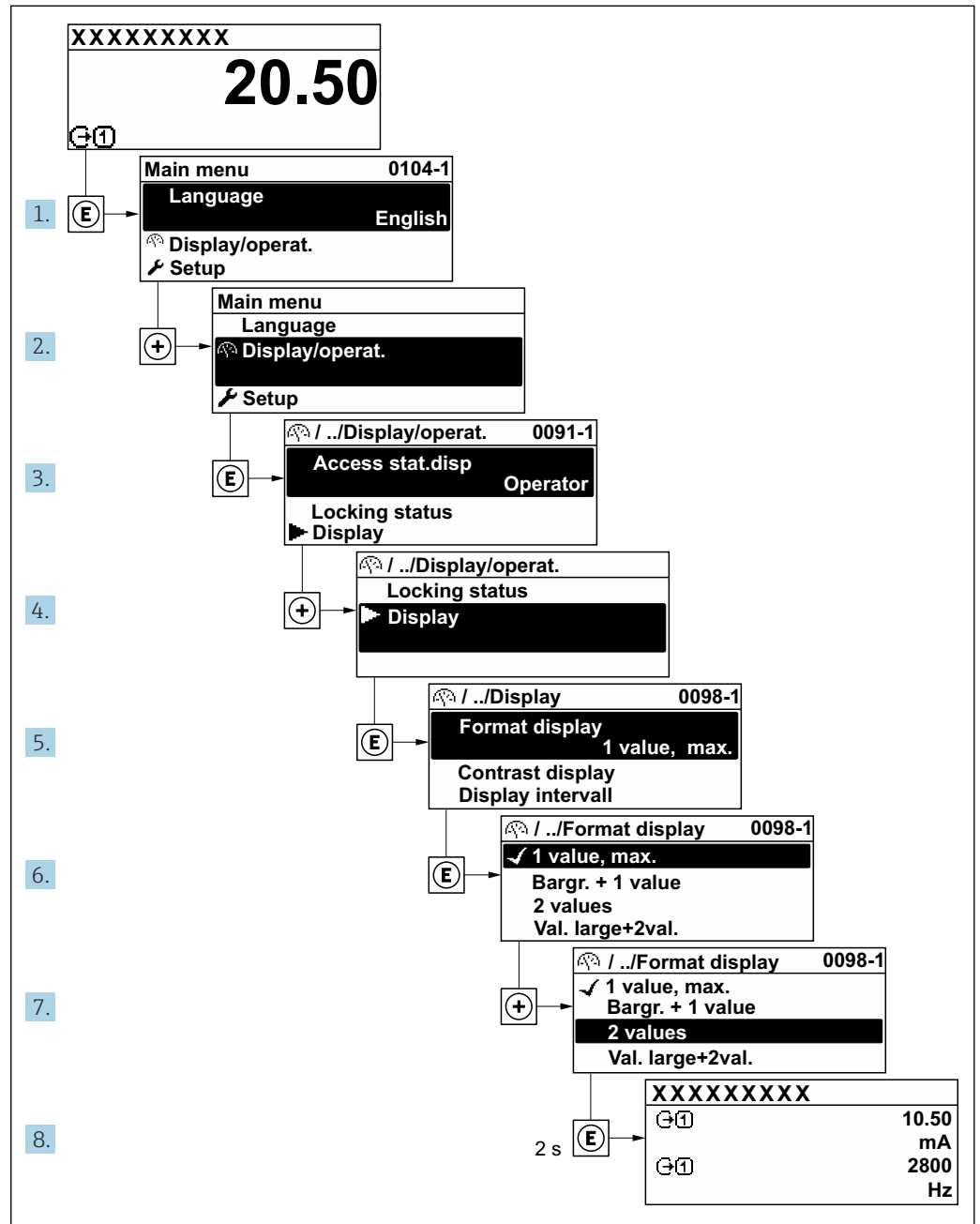

A0029562-EN

8.3.7 Calling the parameter directly

A parameter number is assigned to every parameter to be able to access a parameter directly via the onsite display. Entering this access code in the **Direct access** parameter calls up the desired parameter directly.

Navigation path

Expert → Direct access

The direct access code consists of a 5-digit number (at maximum) and the channel number, which identifies the channel of a process variable: e.g. 00914-2. In the navigation view, this appears on the right-hand side in the header of the selected parameter.

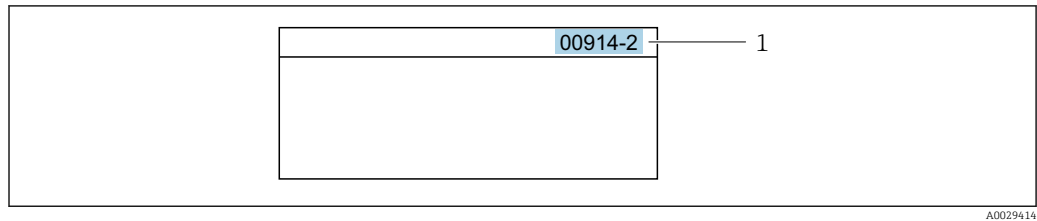

1 Direct access code

Note the following when entering the direct access code:

- The leading zeros in the direct access code do not have to be entered.
Example: Enter "914" instead of "00914"
- If no channel number is entered, channel 1 is opened automatically.
Example: Enter 00914 → **Assign process variable** parameter
- If a different channel is opened: Enter the direct access code with the corresponding channel number.
Example: Enter 00914-2 → **Assign process variable** parameter



For the direct access codes of the individual parameters, see the "Description of Device Parameters" document for the device

8.3.8 Calling up help text

Help text is available for some parameters and can be called up from the navigation view. The help text provides a brief explanation of the parameter function and thereby supports swift and safe commissioning.

Calling up and closing the help text

The user is in the navigation view and the selection bar is on a parameter.

1. Press for 2 s.
↳ The help text for the selected parameter opens.

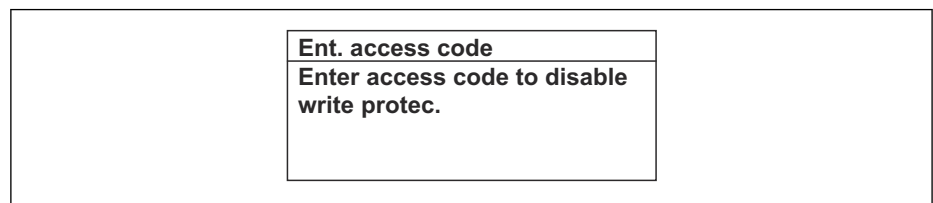

14 Example: Help text for parameter "Enter access code"

2. Press + simultaneously.
↳ The help text is closed.

8.3.9 Changing the parameters

i For a description of the editing view - consisting of the text editor and numeric editor - with symbols → 43, for a description of the operating elements → 45

Example: Changing the tag name in the "Tag description" parameter from 001-FT-101 to 001-FT-102

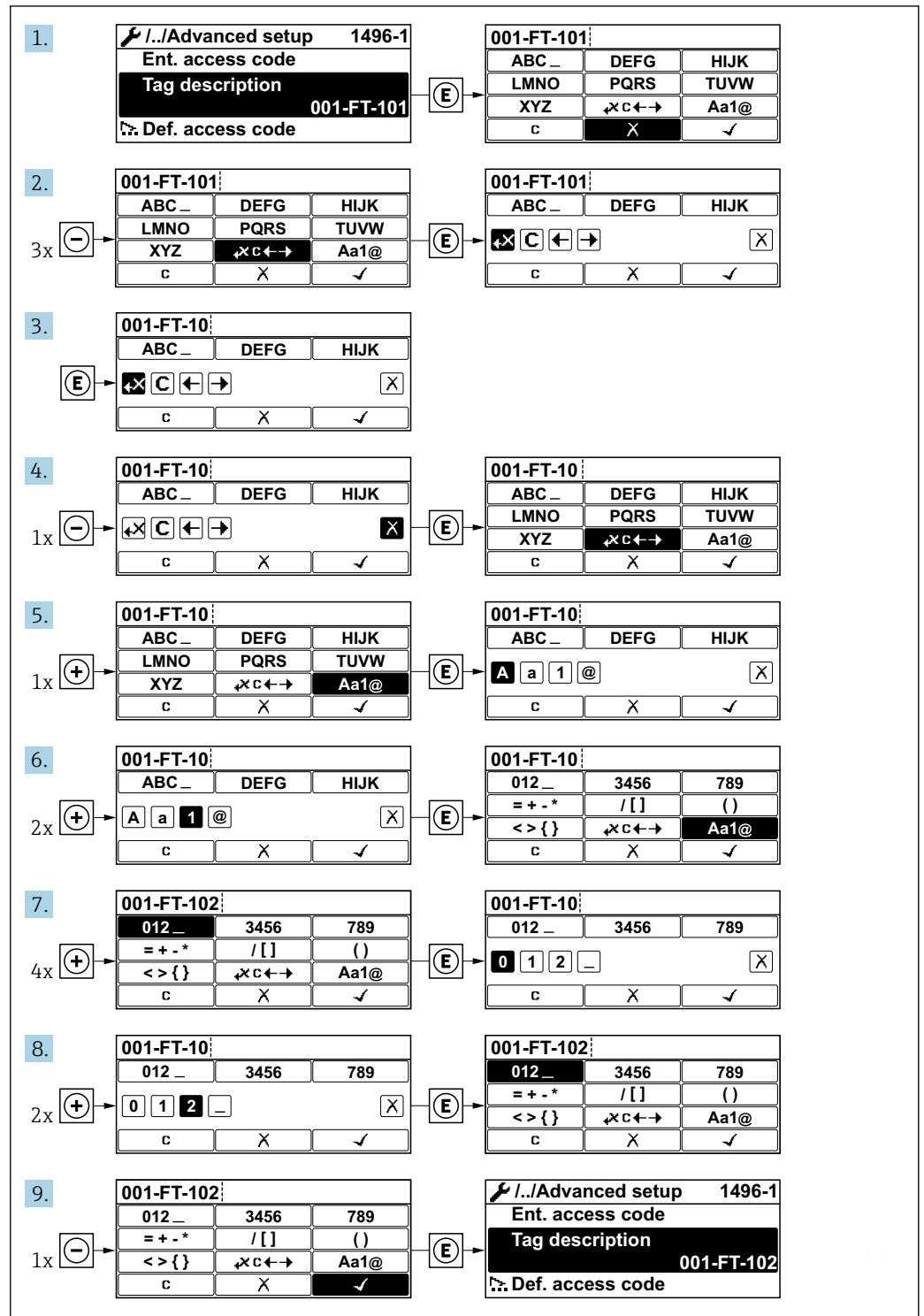

A message is displayed if the value entered is outside the permitted value range.

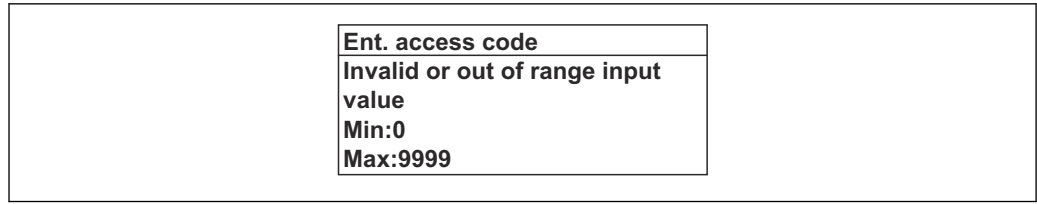

A0014049-EN

8.3.10 User roles and related access authorization

The two user roles "Operator" and "Maintenance" have different write access to the parameters if the customer defines a user-specific access code. This protects the device configuration via the local display from unauthorized access .

Defining access authorization for user roles

An access code is not yet defined when the device is delivered from the factory. Access authorization (read and write access) to the device is not restricted and corresponds to the "Maintenance" user role.

- ▶ Define the access code.
 - ↳ The "Operator" user role is redefined in addition to the "Maintenance" user role. Access authorization differs for the two user roles.

Access authorization to parameters: "Maintenance" user role

Access code status	Read access	Write access
An access code has not yet been defined (factory setting).	✓	✓
After an access code has been defined.	✓	✓ ¹⁾

1) The user only has write access after entering the access code.



Access authorization to parameters: "Operator" user role

Access code status	Read access	Write access
After an access code has been defined.	✓	– ¹⁾



1) Despite the defined access code, certain parameters can always be modified and thus are excluded from the write protection as they do not affect the measurement: write protection via access code

 The user role with which the user is currently logged on is indicated by the **Access status display** parameter. Navigation path: Operation → Access status display

8.3.11 Disabling write protection via access code

If the -symbol appears on the local display in front of a parameter, the parameter is write-protected by a user-specific access code and its value cannot be changed at the moment using local operation →  93.

Parameter write protection via local operation can be disabled by entering the user-specific access code in the **Enter access code** parameter via the respective access option.

1. After you press , the input prompt for the access code appears.
2. Enter the access code.
 - ↳ The -symbol in front of the parameters disappears; all previously write-protected parameters are now re-enabled.

8.3.12 Enabling and disabling the keypad lock

The keypad lock makes it possible to block access to the entire operating menu via local operation. As a result, it is no longer possible to navigate through the operating menu or change the values of individual parameters. Users can only read the measured values on the operational display.

The keypad lock is switched on and off via the context menu.



Switching on the keypad lock

For the SD03 display only

The keypad lock is switched on automatically:



- If the device has not been operated via the display for > 1 minute.
- Each time the device is restarted.

To activate the keylock manually:

1. The device is in the measured value display.
Press the  and  keys for 3 seconds.
↳ A context menu appears.
2. In the context menu select the **Keylock on** option.
↳ The keypad lock is switched on.

 If the user attempts to access the operating menu while the keypad lock is active, the **Keylock on** message appears.

Switching off the keypad lock

- ▶ The keypad lock is switched on.
Press the  and  keys for 3 seconds.
↳ The keypad lock is switched off.

8.4 Access to the operating menu via the operating tool

The structure of the operating menu in the operating tools is the same as for operation via the local display.

8.4.1 Connecting the operating tool

Via PROFIBUS PA network

This communication interface is available in device versions with PROFIBUS PA.

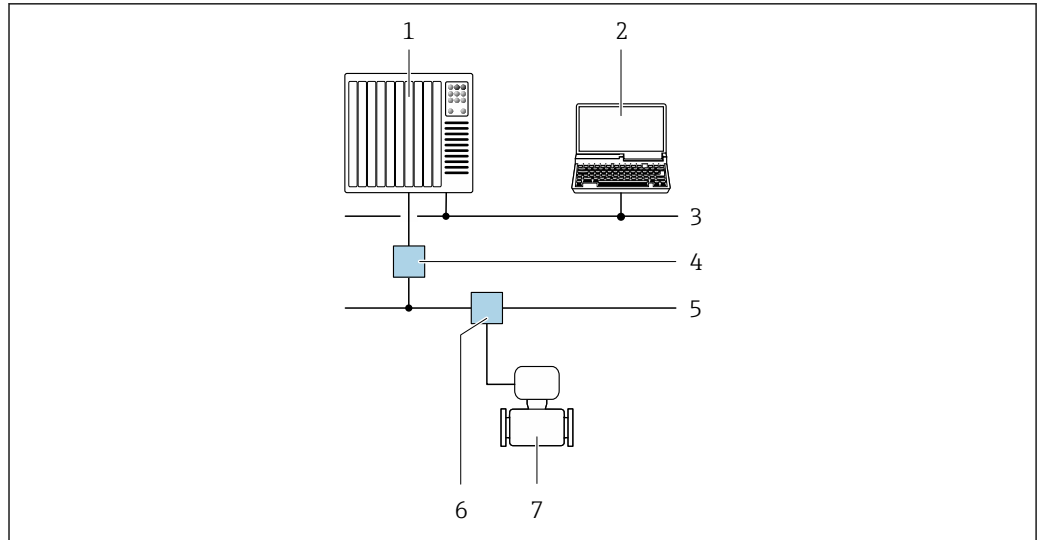

A0028836

15 Options for remote operation via PROFIBUS PA network

- 1 Automation system
- 2 Computer with PROFIBUS network card
- 3 PROFIBUS DP network
- 4 Segment coupler PROFIBUS DP/PA
- 5 PROFIBUS PA network
- 6 T-box
- 7 Measuring device

Via service interface (CDI)

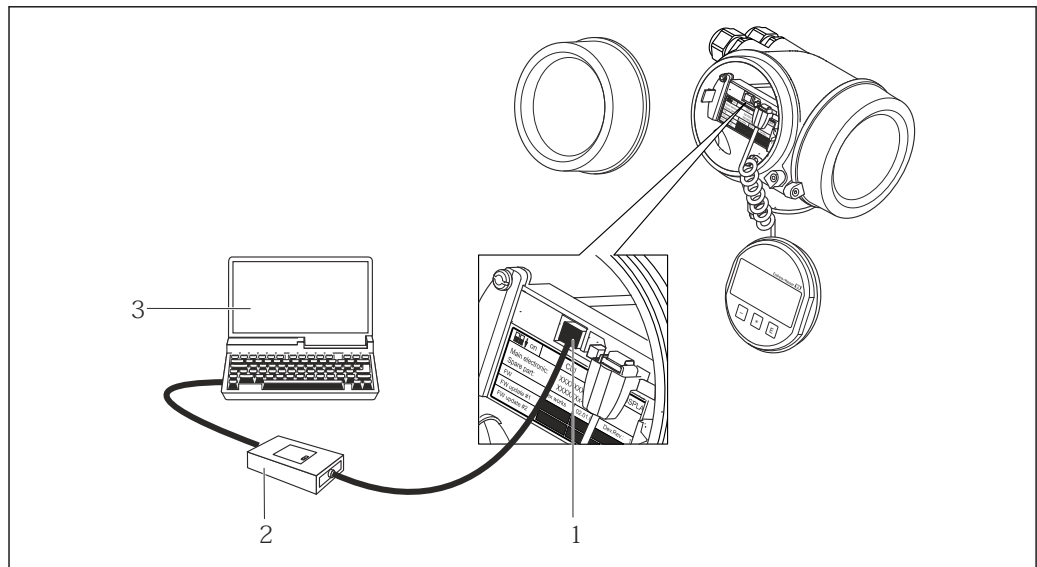

A0014019

- 1 Service interface (CDI = Endress+Hauser Common Data Interface) of the measuring device
- 2 Commubox FXA291
- 3 Computer with FieldCare operating tool with COM DTM CDI Communication FXA291

8.4.2 FieldCare

Function range

FDT-based (Field Device Technology) plant asset management tool from Endress+Hauser. It can configure all smart field units in a system and helps you manage them. By using the status information, it is also a simple but effective way of checking their status and condition.

Access is via:

- PROFIBUS PA protocol →  51
- CDI service interface →  52

Typical functions:

- Transmitter parameter configuration
- Loading and saving of device data (upload/download)
- Documentation of the measuring point
- Visualization of the measured value memory (line recorder) and event logbook



- Operating Instructions BA00027S
- Operating Instructions BA00059S



- Source for device description files →  56

Establishing a connection

1. Start FieldCare and launch the project.
2. In the network: Add a device.
 - ↳ The **Add device** window opens.
3. Select the **CDI Communication TCP/IP** option from the list and press **OK** to confirm.
4. Right-click **CDI Communication TCP/IP** and select the **Add device** option in the context menu that opens.
5. Select the desired device from the list and press **OK** to confirm.
 - ↳ The **CDI Communication TCP/IP (Configuration)** window opens.
6. Enter the device address in the **IP address** field: 192.168.1.212 and press **Enter** to confirm.
7. Establish the online connection to the device.



- Operating Instructions BA00027S
- Operating Instructions BA00059S

User interface

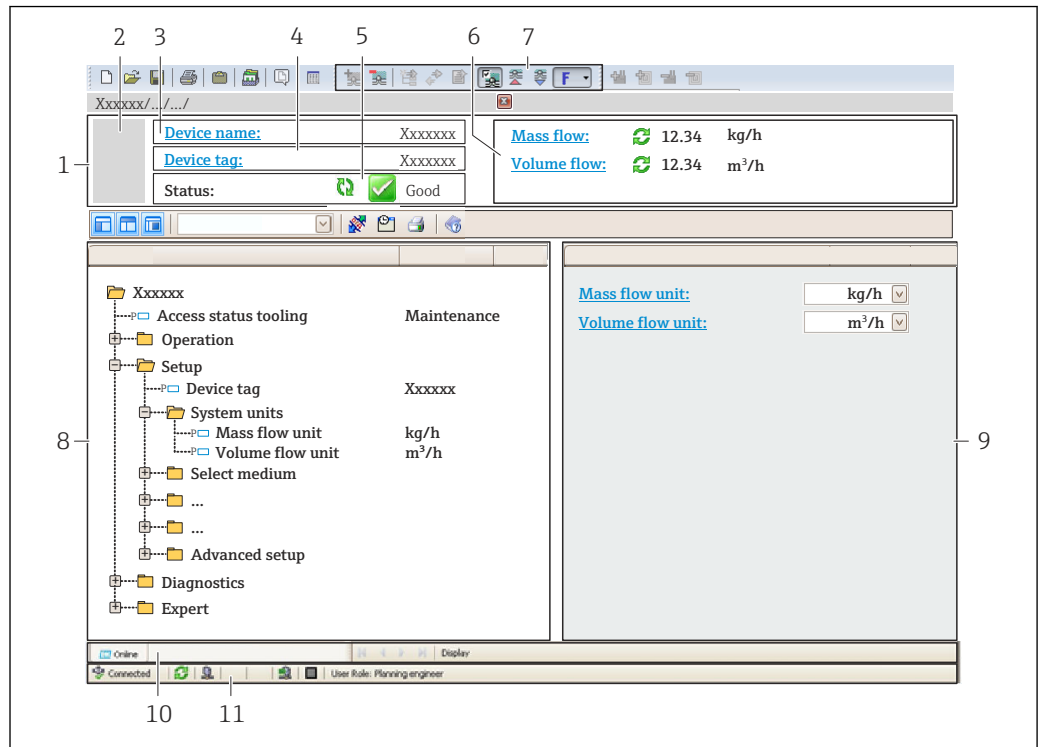

A0021051-EN

- 1 Header
- 2 Picture of device
- 3 Device name
- 4 Device tag
- 5 Status area with status signal → 109
- 6 Display area for current measured values
- 7 Editing toolbar with additional functions such as save/load, event list and create documentation
- 8 Navigation area with operating menu structure
- 9 Work area
- 10 Action area
- 11 Status area

8.4.3 DeviceCare

Function range

Tool for connecting and configuring Endress+Hauser field devices.

The fastest way to configure Endress+Hauser field devices is with the dedicated "DeviceCare" tool. Together with the device type managers (DTMs) it presents a convenient, comprehensive solution.

 Innovation brochure IN01047S

 Source for device description files → 56

8.4.4 SIMATIC PDM

Function range

Standardized, vendor-independent program from Siemens for the operation, configuration, maintenance and diagnosis of intelligent field devices via the PROFIBUS PA protocol.



Source for device description files →  56

9 System integration

9.1 Overview of device description files

9.1.1 Current version data for the device

Firmware Version	01.01.zz	<ul style="list-style-type: none"> ▪ On the title page of the manual ▪ On the transmitter nameplate →  15 ▪ Firmware version Diagnostics → Device information → Firmware version
Release date of firmware version	06.2015	---
Manufacturer ID	0x11	Manufacturer ID Diagnostics → Device information → Manufacturer ID
Device type code	0x155F	Device type Diagnostics → Device information → Device type
Profile version	3.02	---

 For an overview of the various firmware versions for the device →  131

9.1.2 Operating tools

The suitable device description file for the individual operating tools is listed in the table below, along with information on where the file can be acquired.

Operating tool via PROFIBUS protocol	Sources for obtaining device descriptions
FieldCare	<ul style="list-style-type: none"> ▪ www.endress.com → Downloads area ▪ USB stick (contact Endress+Hauser) ▪ DVD (contact Endress+Hauser)
DeviceCare	<ul style="list-style-type: none"> ▪ www.endress.com → Downloads area ▪ CD-ROM (contact Endress+Hauser) ▪ DVD (contact Endress+Hauser)
SIMATIC PDM (Siemens)	www.endress.com → Downloads area

9.2 Device master file (GSD)

In order to integrate field devices into a bus system, the PROFIBUS system needs a description of the device parameters, such as output data, input data, data format, data volume and supported transmission rate.

These data are available in the device master file (GSD) which is provided to the PROFIBUS Master when the communication system is commissioned. In addition device bit maps, which appear as icons in the network structure, can also be integrated.

With the Profile 3.0 device master file (GSD) it is possible to exchange field devices made by different manufacturers without having to reconfigure.

Generally speaking two different GSD versions are possible with Profile 3.0 and higher.

-  Before configuring, the user must decide which GSD should be used to operate the system.
 - The setting can be changed via a Class 2 master.

9.2.1 Manufacturer-specific GSD

This GSD guarantees the unrestricted functionality of the measuring device. Device-specific process parameters and functions are therefore available.

Manufacturer-specific GSD	ID number	File name
PROFIBUS PA	0x1564	EH3x1564.gsd

The fact that the manufacturer-specific GSD should be used is specified in the **Ident number selector** parameter by selecting the **Manufacturer** option.

 Where to acquire the manufacturer-specific GSD:
www.endress.com → Downloads area

9.2.2 Profile GSD

Differs in terms of the number of Analog Input blocks (AI) and the measured values. If a system is configured with a Profile GSD, it is possible to exchange devices made by different manufacturers. However, it is essential to ensure that the order of the cyclic process values is correct.

ID number	Supported blocks	Supported channels
0x9740	<ul style="list-style-type: none"> ▪ 1 Analog Input ▪ 1 Totalizer 	<ul style="list-style-type: none"> ▪ Channel Analog Input: volume flow ▪ Channel totalizer: volume flow
0x9741	<ul style="list-style-type: none"> ▪ 2 Analog Input ▪ 1 Totalizer 	<ul style="list-style-type: none"> ▪ Channel Analog Input 1: volume flow ▪ Channel Analog Input 2: mass flow ▪ Channel totalizer: volume flow
0x9742	<ul style="list-style-type: none"> ▪ 3 Analog Input ▪ 1 Totalizer 	<ul style="list-style-type: none"> ▪ Channel Analog Input 1: volume flow ▪ Channel Analog Input 2: mass flow ▪ Channel Analog Input 3: corrected volume flow ▪ Channel totalizer: volume flow





The Profile GSD that is to be used is specified in the **Ident number selector** parameter by selecting the **Profile 0x9740** option, **Profile 0x9741** option or **Profile 0x9742** option.

9.3 Cyclic data transmission

Cyclic data transmission when using the device master file (GSD).

9.3.1 Block model

The block model shows which input and output data the measuring device makes available for cyclic data exchange. Cyclic data exchange takes place with a PROFIBUS master (Class 1), e.g. a control system.

Measuring instrument				Control system	
Transducer Block	Analog Input block 1 to 6	→  58	Output value AI	→	
			Output value TOTAL	→	
	Totalizer block 1 to 3	→  59	Controller SETTOT	←	
			Configuration MODTOT	←	
	Analog Output block 1	→  61	Input values AO	←	
		Discrete Input block 1 to 2	→  61	Output values DI	→
				PROFIBUS PA	

	Discrete Output block 1 to 4	→ 62	Input values DO	←
--	------------------------------	------	-----------------	---

Defined order of modules

The measuring device works as a modular PROFIBUS slave. In contrast to a compact slave, a modular slave has a variable design and consists of several individual modules. The device master file (GSD) contains a description of the individual modules (input and output data) along with their individual properties.

The modules are permanently assigned to the slots, i.e. when configuring the modules, the order and the arrangement of the modules must be respected.

Slot	Module	Function block
1 ... 6	AI	Analog Input block 1 to 4
7	TOTAL or SETTOT_TOTAL or SETTOT_MODETOT_TOTAL	Totalizer block 1
8		Totalizer block 2
9		Totalizer block 3
10	AO	Analog Output block 1
11 ... 12	DI	Discrete Input block 1 to 2
13 ... 16	DO	Discrete Output block 1 to 3

To optimize the data throughput rate of the PROFIBUS network, it is advisable to only configure modules that are processed in the PROFIBUS master system. If this results in gaps between the configured modules, these gaps must be assigned to the EMPTY_MODULE.

9.3.2 Description of the modules

The data structure is described from the perspective of the PROFIBUS master:

- Input data: Are sent from the measuring device to the PROFIBUS master.
- Output data: Are sent from the PROFIBUS master to the measuring device.

AI module (Analog Input)

Transmit an input variable from the measuring device to the PROFIBUS master (Class 1).

The selected input variable including its status is cyclically transmitted to the PROFIBUS master (Class 1) via the AI module. The input variable is depicted in the first four bytes in the form of a floating point number as per the IEEE 754 standard. The fifth byte contains standardized status information pertaining to the input variable.

Four Analog Input blocks are available (slot 1 to 6).

Selection: input variable

The input variable can be determined using the **Channel** parameter.

Channel	Input variable
32961	Mass flow
33122	Volume flow
33093	Corrected volume flow
32850	Density
33092	Reference density
33101	Temperature

Factory setting

Function block	Factory setting
AI 1	Volume flow
AI 2	Mass flow
AI 3	Corrected volume flow
AI 4	Density
AI 5	Reference density
AI 6	Temperature

Data structure

Input data of Analog Input

Byte 1	Byte 2	Byte 3	Byte 4	Byte 5
Measured value: floating point number (IEEE 754)				Status

TOTAL module

Transmit a totalizer value from the measuring device to the PROFIBUS master (Class 1).

A selected totalizer value, along with the status, is cyclically transmitted to a PROFIBUS Master (Class 1) via the TOTAL module. The totalizer value is depicted in the first four bytes in the form of a floating point number as per the IEEE 754 standard. The fifth byte contains standardized status information pertaining to the totalizer value.

Three Totalizer blocks are available (slot 7 to 9).

Selection: totalizer value

The totalizer value can be specified using the CHANNEL parameter.

Channel	Input variable
32961	Mass flow
33122	Volume flow
33093	Corrected volume flow

Factory setting

Function block	Factory setting: TOTAL
Totalizer 1, 2 and 3	Volume flow

Data structure

Input data of TOTAL

Byte 1	Byte 2	Byte 3	Byte 4	Byte 5
Measured value: floating point number (IEEE 754)				Status

SET_TOT_TOTAL module

The module combination consists of the SET_TOT and TOTAL functions:

- SETTOT: Control the totalizers via the PROFIBUS master.
- TOTAL: Transmit totalizer value incl. status to PROFIBUS master.

Three totalizer blocks are available (slot 7 to 9).

Selection: control totalizer

Value SETTOT	Control totalizer
0	Totalize
1	Reset + hold
2	Preset + hold

Factory setting

Function block	Factory setting: Value SETTOT (meaning)
Totalizer 1, 2 and 3	0 (totalizing)

Data structure

Output data of SETTOT

Byte 1
Control variable 1

Input data of TOTAL

Byte 1	Byte 2	Byte 3	Byte 4	Byte 5
Measured value: floating point number (IEEE 754)				Status

SETTOT_MODETOT_TOTAL module

The module combination consists of the SETTOT, MODETOT and TOTAL functions:

- SETTOT: Control the totalizers via the PROFIBUS master.
- MODETOT: Configure the totalizers via the PROFIBUS master.
- TOTAL: Transmit totalizer value, along with the status, to the PROFIBUS master.

Three totalizer blocks are available (slot 7 to 9).

Selection: totalizer configuration

MODETOT value	Totalizer configuration
0	Balancing
1	Balance the positive flow
2	Balance the negative flow
3	Stop totalizing

Factory setting

Function block	Factory setting: Value MODETOT (meaning)
Totalizer 1, 2 and 3	0 (balancing)

Data structure

Output data of SETTOT and MODETOT

Byte 1	Byte 2
Control variable 1: SETTOT	Control variable 2: MODETOT

Input data of TOTAL

Byte 1	Byte 2	Byte 3	Byte 4	Byte 5
Measured value: floating point number (IEEE 754)				Status

AO module (Analog Output)

Transmit a compensation value from the PROFIBUS master (class 1) to the measuring device.

A compensation value, including the status, is cyclically transmitted from the PROFIBUS master (class 1) to the measuring device via the AO module. The compensation value is depicted in the first four bytes in the form of a floating point number as per the IEEE 754 standard. The fifth byte contains standardized status information pertaining to the compensation value.

One Analog Output block is available (slot 10).

Assigned compensation values

A compensation value is permanently assigned to the individual Analog Output blocks.

CHANNEL	Function block	Compensation value
306	AO 1	External pressure ¹⁾

1) The compensation values must be transmitted to the device in the SI basic unit

 The selection is made via: Expert → Sensor → External compensation

Data structure

Output data of Analog Output

Byte 1	Byte 2	Byte 3	Byte 4	Byte 5
Measured value: floating point number (IEEE 754)				Status ¹⁾

1) Status coding

DI module (Discrete Input)

Transmit discrete input values from the measuring device to the PROFIBUS master (class 1). Discrete input values are used by the measuring device to transmit the state of device functions to the PROFIBUS master (class 1).

The DI module cyclically transmits the discrete input value, including the status, to the PROFIBUS master (class 1). The discrete input value is depicted in the first byte. The second byte contains standardized status information pertaining to the input value.

Two Discrete Input blocks are available (slot 11 to 12).

Selection: device function

The device function can be specified using the CHANNEL parameter.

CHANNEL	Device function	Factory setting: Status (meaning)
893	Status switch output	<ul style="list-style-type: none"> ▪ 0 (device function not active) ▪ 1 (device function active)
894	Empty pipe detection	
895	Low flow	
1430	Verification status ¹⁾	

1) Only available with the Heartbeat Verification application package

Factory setting

Function block	Factory setting
DI 1	Empty pipe detection
DI 2	Low flow

*Data structure**Input data of Discrete Input*

Byte 1	Byte 2
Discrete	Status

DO module (Discrete Output)

Transmit discrete output values from the PROFIBUS master (class 1) to the measuring device. Discrete output values are used by the PROFIBUS master (class 1) to enable and disable device functions.

The DO module cyclically transmits the discrete output value, including the status, to the measuring device. The discrete output value is depicted in the first byte. The second byte contains standardized status information pertaining to the output value.

Four Discrete Output blocks are available (slot 13 to 16).

Assigned device functions

A device function is permanently assigned to the individual Discrete Output blocks.

CHANNEL	Function block	Device function	Values: control (meaning)
891	DO 1	Flow override	<ul style="list-style-type: none"> ▪ 0 (disable device function) ▪ 1 (enable device function)
890	DO 2	Zero adjustment	
253	DO 3	Pulse/freq./switch output	
1429	DO 4	Start verification ¹⁾	

1) Only available with the Heartbeat Verification application package

*Data structure**Output data of Discrete Output*

Byte 1	Byte 2
Discrete	Status

EMPTY_MODULE module

This module is used to assign empty spaces arising from modules not being used in the slots .



The measuring device works as a modular PROFIBUS slave. In contrast to a compact slave, a modular PROFIBUS slave has a variable design and consists of several individual modules. The GSD file contains a description of the individual modules along with their individual properties.

The modules are permanently assigned to the slots. When configuring the modules, it is absolutely essential to observe the sequence/arrangement of the modules. Any gaps between the configured modules must be filled with the EMPTY_MODULE.

10 Commissioning



10.1 Post-mounting and post-connection check

Before commissioning the device:

- ▶ Make sure that the post-installation and post-connection checks have been performed successfully.
- Checklist for "Post-installation" check →  27
- Checklist for "Post-connection" check →  36

10.2 Switching on the measuring device

- ▶ Switch on the device upon successful completion of the post-mounting and post-connection check.
 - ↳ After a successful startup, the local display switches automatically from the startup display to the operational display.

 If nothing appears on the local display or if a diagnostic message is displayed, refer to the section on "Diagnostics and troubleshooting" →  104.

10.3 Configuring the device address via software

In the "**Communication**" submenu the device address can be set.



Navigation

"Setup" menu → Communication → Device address

10.3.1 PROFIBUS network

At time of delivery, the measuring device has the following factory setting:

Device address	126
----------------	-----

-  ▪ To display the current device address: **Device address** parameter →  69
- If hardware addressing is active, software addressing is blocked

10.4 Setting the operating language

Factory setting: English or ordered local language

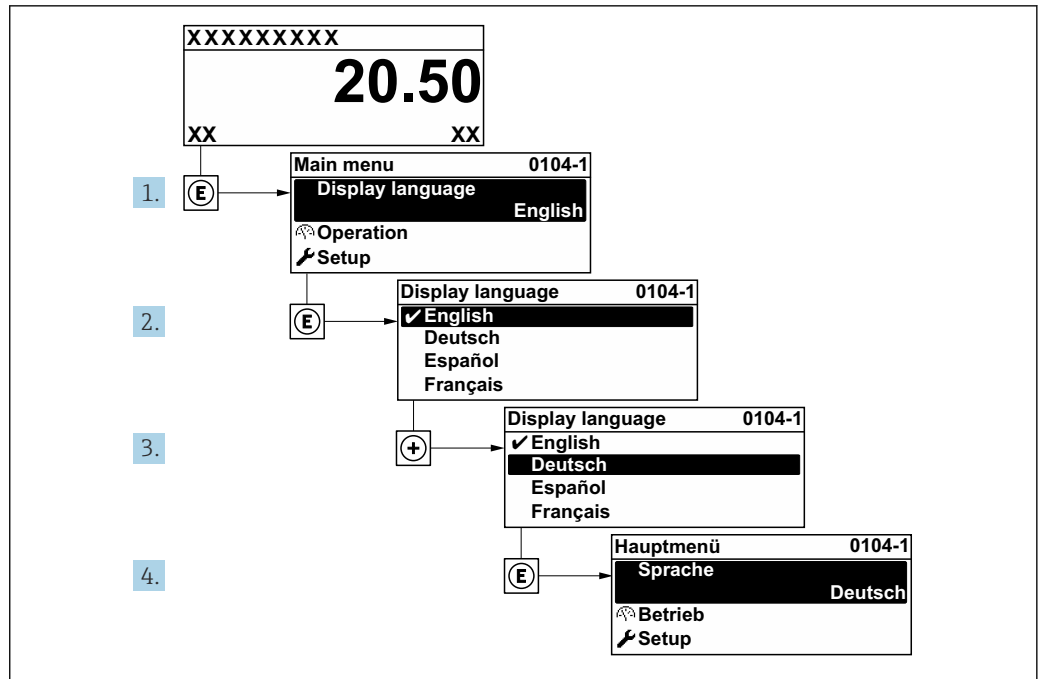

A0029420

16 Taking the example of the local display

10.5 Configuring the measuring instrument

The **Setup** menu with its guided wizards contains all the parameters needed for standard operation.

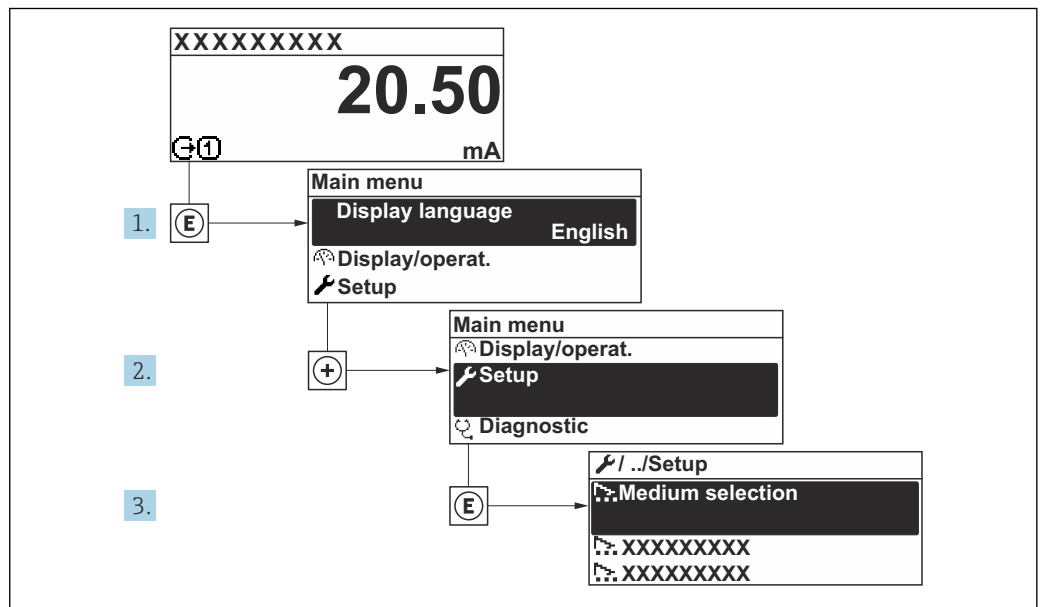

A0032222-EN

17 Navigation to "Setup" menu using the example of the local display

⚙️ Setup

Device tag

→ 📄 66

▶ System units

→ 📄 66

▶ Select medium	
▶ Communication	→ 69
▶ Display	→ 70
▶ Low flow cut off	→ 72
▶ Partially filled pipe detection	→ 73
▶ Analog inputs	
▶ Advanced setup	→ 75

10.5.1 Defining the tag name

To enable fast identification of the measuring point within the system, you can enter a unique designation using the **Device tag** parameter and thus change the factory setting.

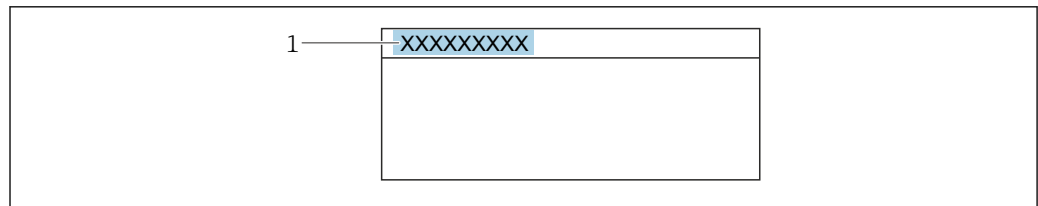

A0029422

18 Header of the operational display with tag name

1 Tag name

i Enter the tag name in the "FieldCare" operating tool → 54

Navigation

"Setup" menu → Device tag

Parameter overview with brief description

Parameter	Description	User entry
Device tag	Enter the name for the measuring point.	Max. 32 characters, such as letters, numbers or special characters (e.g. @, %, /).

10.5.2 Setting the system units

In the **System units** submenu the units of all the measured values can be set.



i The number of submenus and parameters can vary depending on the device version. Certain submenus and parameters in these submenus are not described in the Operating Instructions. Instead a description is provided in the Special Documentation for the device ("Supplementary documentation").

Navigation
 "Setup" menu → System units

► System units	
Mass flow unit	→ 67
Mass unit	→ 67
Volume flow unit	→ 67
Volume unit	→ 67
Corrected volume flow unit	→ 68
Corrected volume unit	→ 68
Density unit	→ 68
Reference density unit	→ 68
Temperature unit	→ 68
Length unit	→ 68
Pressure unit	→ 68

Parameter overview with brief description

Parameter	Description	Selection	Factory setting
Mass flow unit	Select mass flow unit. <i>Effect</i> The selected unit applies to: <ul style="list-style-type: none"> ■ Output ■ Low flow cut off ■ Simulation process variable 	Unit choose list	Country-specific: <ul style="list-style-type: none"> ■ kg/h ■ lb/min
Mass unit	Select mass unit.	Unit choose list	Country-specific: <ul style="list-style-type: none"> ■ kg ■ lb
Volume flow unit	Select volume flow unit. <i>Effect</i> The selected unit applies to: <ul style="list-style-type: none"> ■ Output ■ Low flow cut off ■ Simulation process variable 	Unit choose list	Country-specific: <ul style="list-style-type: none"> ■ l/h ■ gal/min (us)
Volume unit	Select volume unit.	Unit choose list	Country-specific: <ul style="list-style-type: none"> ■ 1 (DN > 150 (6"): m³ option) ■ gal (us)

Parameter	Description	Selection	Factory setting
Corrected volume flow unit	Select corrected volume flow unit. <i>Effect</i> The selected unit applies to: Corrected volume flow parameter (→  98)	Unit choose list	Country-specific: <ul style="list-style-type: none"> ▪ NI/h ▪ Sft³/min
Corrected volume unit	Select corrected volume unit.	Unit choose list	Country-specific: <ul style="list-style-type: none"> ▪ NI ▪ Sft³
Density unit	Select density unit. <i>Effect</i> The selected unit applies to: <ul style="list-style-type: none"> ▪ Output ▪ Simulation process variable ▪ Density adjustment (Expert menu) 	Unit choose list	Country-specific: <ul style="list-style-type: none"> ▪ kg/l ▪ lb/ft³
Reference density unit	Select reference density unit.	Unit choose list	Country-specific <ul style="list-style-type: none"> ▪ kg/NI ▪ lb/Sft³
Density 2 unit	Select second density unit.	Unit choose list	Country-specific: <ul style="list-style-type: none"> ▪ kg/l ▪ lb/ft³
Temperature unit	Select temperature unit. <i>Effect</i> The selected unit applies to: <ul style="list-style-type: none"> ▪ Minimum value ▪ Maximum value ▪ Maximum value ▪ Minimum value ▪ Average value ▪ Minimum value ▪ Maximum value ▪ Minimum value ▪ Maximum value ▪ Reference temperature 	Unit choose list	Country-specific: <ul style="list-style-type: none"> ▪ °C ▪ °F
Length unit	Select length unit for nominal diameter.	Unit choose list	Country-specific: <ul style="list-style-type: none"> ▪ mm ▪ in
Pressure unit	Select process pressure unit. <i>Effect</i> The unit is taken from: <ul style="list-style-type: none"> ▪ Pressure value parameter (→  69) ▪ External pressure parameter 	Unit choose list	Country-specific: <ul style="list-style-type: none"> ▪ bar a ▪ psi a

10.5.3 Selecting and setting the medium

The **Medium selection** wizard systematically guides the user through all the parameters that must be configured in order to select and set the medium.

Navigation

"Setup" menu → Medium selection

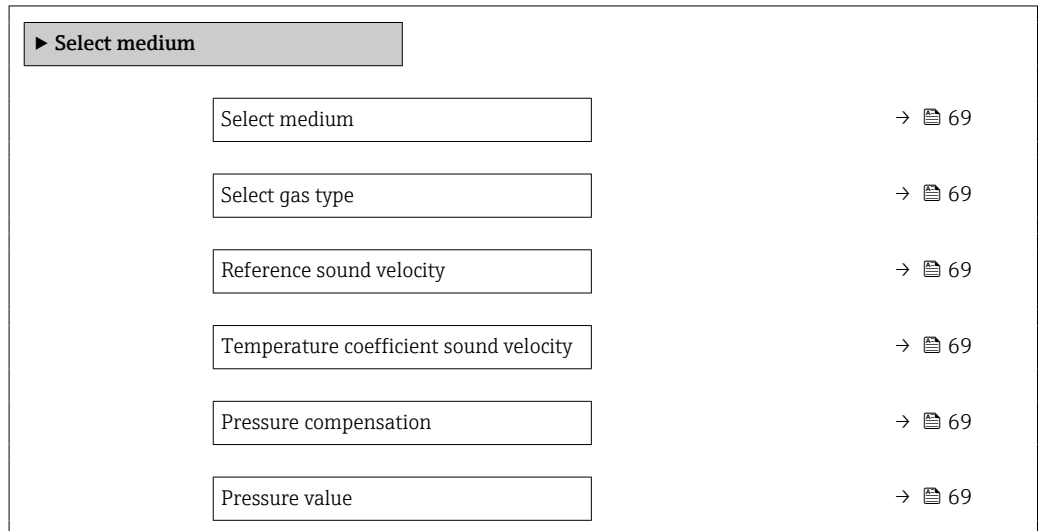

Parameter overview with brief description

Parameter	Prerequisite	Description	Selection / User entry	Factory setting
Select medium	–	Select medium type.	<ul style="list-style-type: none"> ■ Liquid ■ Gas 	–
Select gas type	In the Select medium parameter the Gas option is selected.	Select measured gas type.	Gas type choose list	–
Reference sound velocity	In the Select gas type parameter the Others option is selected.	Enter sound velocity of gas at 0 °C (32 °F).	1 to 99999.9999 m/s	–
Temperature coefficient sound velocity	In the Select gas type parameter the Others option is selected.	Enter temperature coefficient for the gas sound velocity.	Positive floating-point number	–
Pressure compensation	–	Select pressure compensation type.	<ul style="list-style-type: none"> ■ Off ■ Fixed value ■ External value 	–
Pressure value	In the Pressure compensation parameter the Fixed value option is selected.	Enter process pressure to be used for pressure correction.	Positive floating-point number	Country-specific: <ul style="list-style-type: none"> ■ 1.01 bar a ■ 14.7 psi a

10.5.4 Configuring communication interface

The **Communication** submenu guides you systematically through all the parameters that have to be configured for selecting and setting the communication interface.

Navigation

"Setup" menu → Communication

▶ Communication

Device address

→ 70

Parameter overview with brief description

Parameter	Description	User entry
Device address	Enter device address.	0 to 126

10.5.5 Configuring the local display

The **Display** wizard guides you systematically through all the parameters that can be configured for configuring the local display.

Navigation

"Setup" menu → Display

▶ Display

Format display

→ 71

Value 1 display

→ 71

0% bargraph value 1

→ 71

100% bargraph value 1

→ 71

Value 2 display

→ 71

Value 3 display

→ 71

0% bargraph value 3

→ 71







100% bargraph value 3

→ 71

Value 4 display

→ 71

Parameter overview with brief description

Parameter	Prerequisite	Description	Selection / User entry	Factory setting
Format display	A local display is provided.	Select how measured values are shown on the display.	<ul style="list-style-type: none"> ■ 1 value, max. size ■ 1 bargraph + 1 value ■ 2 values ■ 1 value large + 2 values ■ 4 values 	–
Value 1 display	A local display is provided.	Select the measured value that is shown on the local display.	<ul style="list-style-type: none"> ■ Mass flow ■ Volume flow ■ Corrected volume flow ■ Density ■ Reference density ■ Temperature ■ Totalizer 1 ■ Totalizer 2 ■ Totalizer 3 	–
0% bargraph value 1	A local display is provided.	Enter 0% value for bar graph display.	Signed floating-point number	Country-specific: <ul style="list-style-type: none"> ■ 0 kg/h ■ 0 lb/min
100% bargraph value 1	A local display is provided.	Enter 100% value for bar graph display.	Signed floating-point number	Depends on country and nominal diameter
Value 2 display	A local display is provided.	Select the measured value that is shown on the local display.	For the picklist, see Value 1 display parameter (→  71)	–
Value 3 display	A local display is provided.	Select the measured value that is shown on the local display.	For the picklist, see Value 1 display parameter (→  71)	–
0% bargraph value 3	A selection was made in the Value 3 display parameter.	Enter 0% value for bar graph display.	Signed floating-point number	Country-specific: <ul style="list-style-type: none"> ■ 0 kg/h ■ 0 lb/min
100% bargraph value 3	A selection was made in the Value 3 display parameter.	Enter 100% value for bar graph display.	Signed floating-point number	–
Value 4 display	A local display is provided.	Select the measured value that is shown on the local display.	For the picklist, see Value 1 display parameter (→  71)	–
Value 5 display	A local display is provided.	Select the measured value that is shown on the local display.	For the picklist, see Value 1 display parameter (→  71)	–
Value 6 display	A local display is provided.	Select the measured value that is shown on the local display.	For the picklist, see Value 1 display parameter (→  71)	–
Value 7 display	A local display is provided.	Select the measured value that is shown on the local display.	For the picklist, see Value 1 display parameter (→  71)	–
Value 8 display	A local display is provided.	Select the measured value that is shown on the local display.	For the picklist, see Value 1 display parameter (→  71)	–

10.5.6 Configuring the low flow cut off

The **Low flow cut off** wizard systematically guides the user through all the parameters that must be set to configure low flow cut off.

Navigation

"Setup" menu → Low flow cut off

► Low flow cut off	
Assign process variable	→ 72
On value low flow cutoff	→ 72
Off value low flow cutoff	→ 72
Pressure shock suppression	→ 72

Parameter overview with brief description

Parameter	Prerequisite	Description	Selection / User entry	Factory setting
Assign process variable	–	Select process variable for low flow cut off.	<ul style="list-style-type: none"> ▪ Off ▪ Mass flow ▪ Volume flow ▪ Corrected volume flow 	–
On value low flow cutoff	A process variable is selected in the Assign process variable parameter (→ 72).	Enter on value for low flow cut off.	Positive floating-point number	Depends on country and nominal diameter
Off value low flow cutoff	A process variable is selected in the Assign process variable parameter (→ 72).	Enter off value for low flow cut off.	0 to 100.0 %	–
Pressure shock suppression	A process variable is selected in the Assign process variable parameter (→ 72).	Enter time frame for signal suppression (= active pressure shock suppression).	0 to 100 s	–

10.5.7 Configuring partially filled pipe detection

The **Partial filled pipe detection** wizard guides you systematically through all parameters that have to be set for configuring the monitoring of the pipe filling.

Navigation

"Setup" menu → Partially filled pipe detection

▶ **Partially filled pipe detection**

Assign process variable	→ 74
Low value partial filled pipe detection	→ 74
High value partial filled pipe detection	→ 74
Response time part. filled pipe detect.	→ 74

Parameter overview with brief description

Parameter	Prerequisite	Description	Selection / User entry	Factory setting
Assign process variable	–	Select process variable for partially filled pipe detection.	<ul style="list-style-type: none"> ■ Off ■ Density ■ Reference density 	–
Low value partial filled pipe detection	A process variable is selected in the Assign process variable parameter (→ 73).	Enter lower limit value for deactivating partialy filled pipe detection.	Signed floating-point number	Depends on country: <ul style="list-style-type: none"> ■ 200 kg/m³ ■ 12.5 lb/ft³
High value partial filled pipe detection	A process variable is selected in the Assign process variable parameter (→ 73).	Enter upper limit value for deactivating partialy filled pipe detection.	Signed floating-point number	Depends on country: <ul style="list-style-type: none"> ■ 6 000 kg/m³ ■ 374.6 lb/ft³
Response time part. filled pipe detect.	A process variable is selected in the Assign process variable parameter (→ 73).	Use this function to enter the minimum time (hold time) the signal must be present before diagnostic message S962 "Pipe only partly filled" is triggered in the event of a partially filled or empty measuring pipe.	0 to 100 s	–

10.5.8 Configuring the partial filled pipe detection

The **Partial filled pipe detection** wizard guides you systematically through all parameters that have to be set for configuring the monitoring of the pipe filling.

Navigation

"Setup" menu → Partially filled pipe detection

▶ Partially filled pipe detection	
Assign process variable	→ 74
Low value partial filled pipe detection	→ 74
High value partial filled pipe detection	→ 74
Response time part. filled pipe detect.	→ 74

Parameter overview with brief description

Parameter	Prerequisite	Description	Selection / User entry
Assign process variable	–	Select process variable for partially filled pipe detection.	<ul style="list-style-type: none"> ■ Off ■ Density ■ Reference density
Low value partial filled pipe detection	One of the following options is selected in the Assign process variable parameter: <ul style="list-style-type: none"> ■ Density ■ Reference density 	Enter lower limit value for deactivating partially filled pipe detection.	Positive floating-point number
High value partial filled pipe detection	One of the following options is selected in the Assign process variable parameter: <ul style="list-style-type: none"> ■ Density ■ Reference density 	Enter upper limit value for deactivating partially filled pipe detection.	Signed floating-point number
Response time part. filled pipe detect.	One of the following options is selected in the Assign process variable parameter: <ul style="list-style-type: none"> ■ Density ■ Reference density 	Enter time before diagnostic message is displayed for partially filled pipe detection.	0 to 100 s

10.6 Advanced settings

The **Advanced setup** submenu with its submenus contains parameters for specific settings.

Navigation to the "Advanced setup" submenu

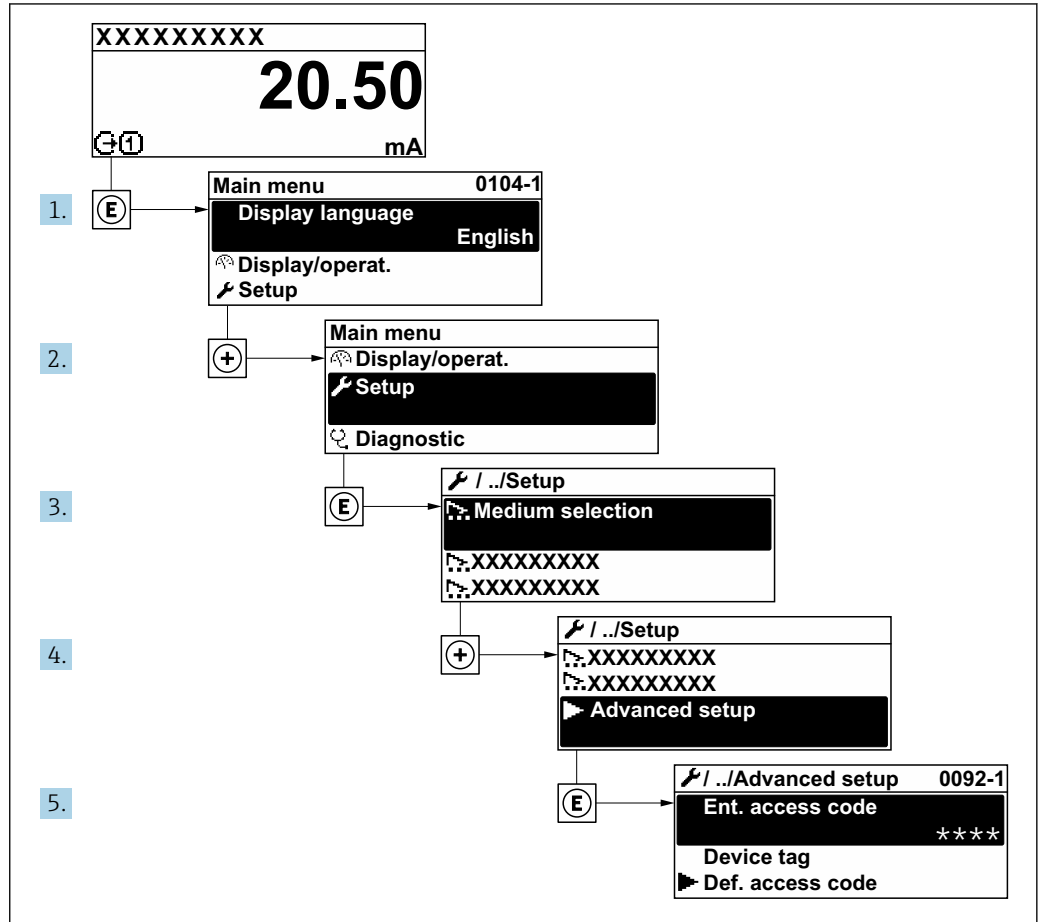

A003223-EN

Navigation

"Setup" menu → Advanced setup

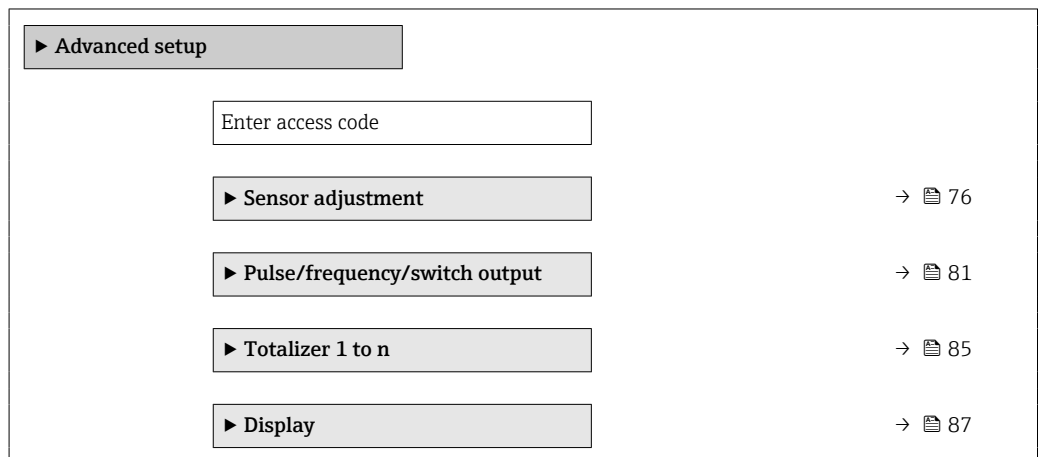

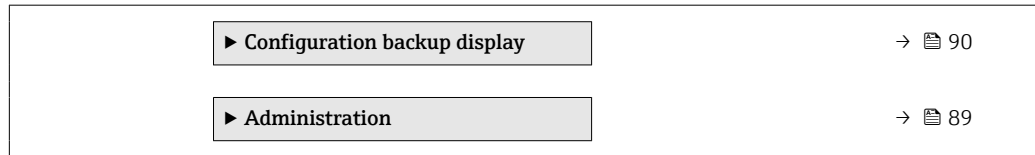

10.6.1 Carrying out a sensor adjustment

The **Sensor adjustment** submenu contains parameters that pertain to the functionality of the sensor.

Navigation

"Setup" menu → Advanced setup → Sensor adjustment

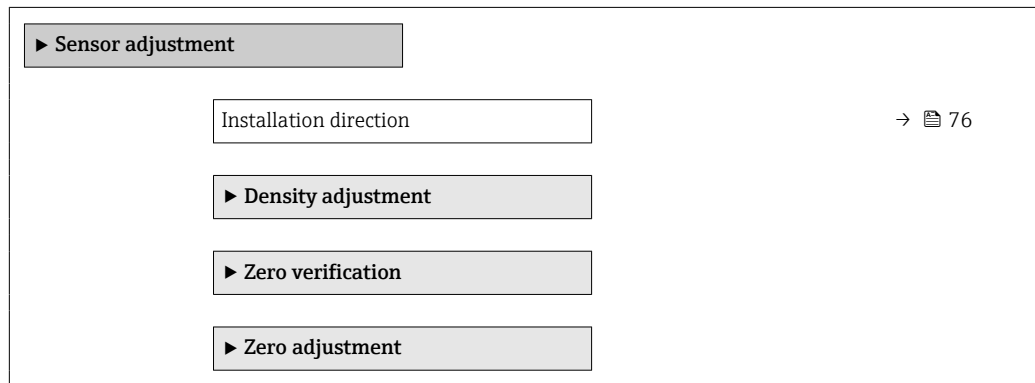

Parameter overview with brief description

Parameter	Description	Selection
Installation direction	Set sign of flow direction to match the direction of the arrow on the sensor.	<ul style="list-style-type: none"> ▪ Flow in arrow direction ▪ Flow against arrow direction

Density adjustment

i With density adjustment, a high level of accuracy is achieved only at the point of adjustment and at the relevant density and temperature. However, the accuracy of a density adjustment is only ever as good as the quality of the reference measuring data provided. Therefore it is not a substitute for special density calibration.

Performing density adjustment

- i** Note the following before performing the adjustment:
- A density adjustment only makes sense if there is little variation in the operating conditions and the density adjustment is performed under the operating conditions.
 - The density adjustment scales the internally computed density value with a user-specific slope and offset.
 - A 1-point or 2-point density adjustment can be performed.
 - For a 2-point density adjustment, there must be a difference of at least 0.2 kg/l between the two target density values.
 - The reference media must be gas-free or pressurized so that any gas they contain is compressed.
 - The reference density measurements must be performed at the same medium temperature that prevails in the process, as otherwise the density adjustment will not be accurate.
 - The correction resulting from the density adjustment can be deleted with the **Restore original** option.

"1 point adjustment" option

1. In the **Density adjustment mode** parameter, select the **1 point adjustment** option and confirm.
2. In the **Density setpoint 1** parameter, enter the density value and confirm.
 - ↳ In the **Execute density adjustment** parameter the following options are now available:
 - Ok
 - Measure density 1** option
 - Restore original
3. Select the **Measure density 1** option and confirm.
4. If 100% was reached in the **Progress** parameter on the display and the **Ok** option is displayed in the **Execute density adjustment** parameter, then confirm.
 - ↳ In the **Execute density adjustment** parameter the following options are now available:
 - Ok
 - Calculate
 - Cancel
5. Select the **Calculate** option and confirm.

If the adjustment was completed successfully, the **Density adjustment factor** parameter and the **Density adjustment offset** parameter and the values calculated for them are shown on the display.

"2 point adjustment" option

1. In the **Density adjustment mode** parameter, select the **2 point adjustment** option and confirm.
2. In the **Density setpoint 1** parameter, enter the density value and confirm.
3. In the **Density setpoint 2** parameter, enter the density value and confirm.
 - ↳ In the **Execute density adjustment** parameter the following options are now available:
 - Ok
 - Measure density 1
 - Restore original
4. Select the **Measure density 1** option and confirm.
 - ↳ In the **Execute density adjustment** parameter the following options are now available:
 - Ok
 - Measure density 2
 - Restore original
5. Select the **Measure density 2** option and confirm.
 - ↳ In the **Execute density adjustment** parameter the following options are now available:
 - Ok
 - Calculate
 - Cancel
6. Select the **Calculate** option and confirm.

If the **Density adjust failure** option is displayed in the **Execute density adjustment** parameter, call up the options and select the **Cancel** option. The density adjustment is canceled and can be repeated.

If the adjustment was completed successfully, the **Density adjustment factor** parameter and the **Density adjustment offset** parameter and the values calculated for them are shown on the display.

Navigation

"Expert" menu → Sensor → Sensor adjustment → Density adjustment

► Density adjustment	
Density adjustment mode	→ 78
Density setpoint 1	→ 78
Density setpoint 2	→ 78
Execute density adjustment	→ 78
Progress	→ 78
Density adjustment factor	→ 78
Density adjustment offset	→ 78

Parameter overview with brief description

Parameter	Prerequisite	Description	Selection / User entry / User interface	Factory setting
Density adjustment mode	-		<ul style="list-style-type: none"> ▪ 1 point adjustment ▪ 2 point adjustment 	-
Density setpoint 1	-		The entry depends on the unit selected in the Density unit parameter (0555).	-
Density setpoint 2	In the Density adjustment mode parameter, the 2 point adjustment option is selected.		The entry depends on the unit selected in the Density unit parameter (0555).	-
Execute density adjustment	-		<ul style="list-style-type: none"> ▪ Cancel ▪ Busy ▪ Ok ▪ Density adjust failure ▪ Measure density 1 ▪ Measure density 2 ▪ Calculate ▪ Restore original 	-
Progress	-	Shows the progress of the process.	0 to 100 %	-
Density adjustment factor	-		Signed floating-point number	-
Density adjustment offset	-		Signed floating-point number	-

Zero verification and zero adjustment

All measuring instruments are calibrated in accordance with state-of-the-art technology. Calibration takes place under reference conditions →  147. Therefore, a zero adjustment in the field is generally not required.

Experience shows that zero adjustment is advisable only in special cases:

- To achieve maximum measurement accuracy even with low flow rates.
- Under extreme process or operating conditions (e.g. very high process temperatures or very high-viscosity fluids).
- For gas applications with low pressure

 To achieve the highest possible measurement accuracy at low flow rates, the installation must protect the sensor from mechanical stresses during operation.

To get a representative zero point, ensure that:

- any flow in the device is prevented during the adjustment
- the process conditions (e.g. pressure, temperature) are stable and representative

Zero verification and zero adjustment cannot be performed if the following process conditions are present:

- Gas pockets
Ensure that the system has been sufficiently flushed with the medium. Repeat flushing can help to eliminate gas pockets
- Thermal circulation
In the event of temperature differences (e.g. between the measuring tube inlet and outlet section), induced flow can occur even if the valves are closed due to thermal circulation in the device
- Leaks at the valves
If the valves are not leak-tight, flow is not sufficiently prevented when determining the zero point

If these conditions cannot be avoided, it is advisable to keep the factory setting for the zero point.

Navigation

"Setup" menu → Advanced setup → Sensor adjustment → Zero point adjustment

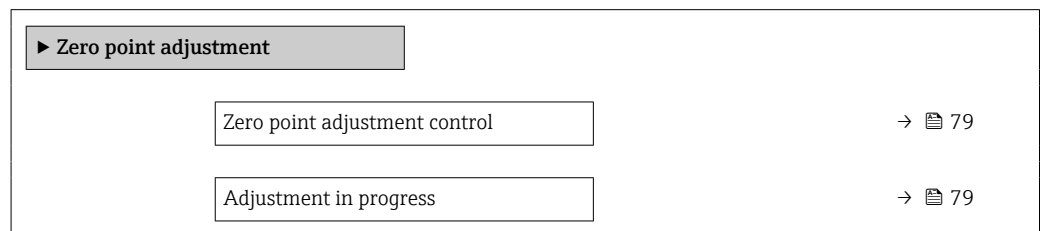

Parameter overview with brief description

Parameter	Prerequisite	Description	Selection / User interface
Zero point adjustment control	–	Start zero point adjustment.	<ul style="list-style-type: none"> ■ Cancel ■ Busy ■ Zero point adjust failure ■ Start
Adjustment in progress	In the Zero point adjustment control parameter, the Start option is selected.		0 to 100 %

10.6.2 Configuring the pulse/frequency/switch output

The **Pulse/frequency/switch output** wizard guides you systematically through all the parameters that can be set for configuring the selected output type.

Navigation

"Setup" menu → Pulse/frequency/switch output







▶ Pulse/frequency/switch output
<input type="text" value="Operating mode"/> →  80

Parameter overview with brief description



Parameter	Description	Selection
Operating mode	Define the output as a pulse, frequency or switch output.	<ul style="list-style-type: none"> ▪ Pulse ▪ Frequency ▪ Switch

Configuring the pulse output**Navigation**

"Setup" menu → Advanced setup → Pulse/frequency/switch output

▶ Pulse/frequency/switch output
<input type="text" value="Operating mode"/> →  80
<input type="text" value="Assign pulse output"/> →  80
<input type="text" value="Value per pulse"/> →  80
<input type="text" value="Pulse width"/> →  81
<input type="text" value="Failure mode"/> →  81
<input type="text" value="Invert output signal"/> →  81

Parameter overview with brief description

Parameter	Prerequisite	Description	Selection / User entry	Factory setting
Operating mode	–	Define the output as a pulse, frequency or switch output.	<ul style="list-style-type: none"> ▪ Pulse ▪ Frequency ▪ Switch 	–
Assign pulse output	The Pulse option is selected in Operating mode parameter.	Select process variable for pulse output.	<ul style="list-style-type: none"> ▪ Off ▪ Mass flow ▪ Volume flow ▪ Corrected volume flow 	–
Value per pulse	The Pulse option is selected in the Operating mode parameter (→  80) and a process variable is selected in the Assign pulse output parameter (→  80).	Enter measured value at which a pulse is output.	Positive floating point number	Depends on country and nominal diameter

Parameter	Prerequisite	Description	Selection / User entry	Factory setting
Pulse width	The Pulse option is selected in the Operating mode parameter (→ 80) and a process variable is selected in the Assign pulse output parameter (→ 80).	Define time width of the output pulse.	5 to 2 000 ms	–
Failure mode	The Pulse option is selected in the Operating mode parameter (→ 80) and a process variable is selected in the Assign pulse output parameter (→ 80).	Define output behavior in alarm condition.	<ul style="list-style-type: none"> ■ Actual value ■ No pulses 	–
Invert output signal	–	Invert the output signal.	<ul style="list-style-type: none"> ■ No ■ Yes 	–

Configuring the frequency output

Navigation

"Setup" menu → Advanced setup → Pulse/frequency/switch output

► Pulse/frequency/switch output

- Operating mode → 82
- Assign frequency output → 82
- Minimum frequency value → 82
- Maximum frequency value → 82
- Measuring value at minimum frequency → 82
- Measuring value at maximum frequency → 82
- Failure mode → 82
- Failure frequency → 83
- Invert output signal → 83

Parameter overview with brief description

Parameter	Prerequisite	Description	Selection / User entry	Factory setting
Operating mode	–	Define the output as a pulse, frequency or switch output.	<ul style="list-style-type: none"> ▪ Pulse ▪ Frequency ▪ Switch 	–
Assign frequency output	The Frequency option is selected in Operating mode parameter (→ 80).	Select process variable for frequency output.	<ul style="list-style-type: none"> ▪ Off ▪ Mass flow ▪ Volume flow ▪ Corrected volume flow ▪ Density ▪ Reference density ▪ Temperature ▪ Carrier pipe temperature ▪ Electronic temperature ▪ Oscillation frequency ▪ Oscillation amplitude ▪ Oscillation damping ▪ Signal asymmetry 	–
Minimum frequency value	The Frequency option is selected in the Operating mode parameter (→ 80) and a process variable is selected in the Assign frequency output parameter (→ 82).	Enter minimum frequency.	0 to 1 000 Hz	0 Hz
Maximum frequency value	The Frequency option is selected in the Operating mode parameter (→ 80) and a process variable is selected in the Assign frequency output parameter (→ 82).	Enter maximum frequency.	0 to 1 000 Hz	1 000 Hz
Measuring value at minimum frequency	The Frequency option is selected in the Operating mode parameter (→ 80) and a process variable is selected in the Assign frequency output parameter (→ 82).	Enter measured value for minimum frequency.	Signed floating-point number	Depends on country and nominal diameter
Measuring value at maximum frequency	The Frequency option is selected in the Operating mode parameter (→ 80) and a process variable is selected in the Assign frequency output parameter (→ 82).	Enter measured value for maximum frequency.	Signed floating-point number	Depends on country and nominal diameter
Failure mode	The Frequency option is selected in the Operating mode parameter (→ 80) and a process variable is selected in the Assign frequency output parameter (→ 82).	Define output behavior in alarm condition.	<ul style="list-style-type: none"> ▪ Actual value ▪ Defined value ▪ 0 Hz 	–

Parameter	Prerequisite	Description	Selection / User entry	Factory setting
Failure frequency	In the Operating mode parameter (→ 80), the Frequency option is selected, in the Assign frequency output parameter (→ 82) a process variable is selected, and in the Failure mode parameter, the Defined value option is selected.	Enter frequency output value in alarm condition.	0.0 to 1250.0 Hz	–
Invert output signal	–	Invert the output signal.	<ul style="list-style-type: none"> ■ No ■ Yes 	–

Configuring the switch output

Navigation

"Setup" menu → Advanced setup → Pulse/frequency/switch output

► Pulse/frequency/switch output

- Operating mode → 84
- Switch output function → 84
- Assign diagnostic behavior → 84
- Assign limit → 84
- Assign flow direction check → 84
- Assign status → 84
- Switch-on value → 84
- Switch-off value → 84
- Switch-on delay → 84
- Switch-off delay → 85
- Failure mode → 85
- Invert output signal → 85

Parameter overview with brief description

Parameter	Prerequisite	Description	Selection / User entry	Factory setting
Operating mode	–	Define the output as a pulse, frequency or switch output.	<ul style="list-style-type: none"> ▪ Pulse ▪ Frequency ▪ Switch 	–
Switch output function	The Switch option is selected in the Operating mode parameter.	Select function for switch output.	<ul style="list-style-type: none"> ▪ Off ▪ On ▪ Diagnostic behavior ▪ Limit ▪ Flow direction check ▪ Status 	–
Assign diagnostic behavior	<ul style="list-style-type: none"> ▪ In the Operating mode parameter, the Switch option is selected. ▪ In the Switch output function parameter, the Diagnostic behavior option is selected. 	Select diagnostic behavior for switch output.	<ul style="list-style-type: none"> ▪ Alarm ▪ Alarm or warning ▪ Warning 	–
Assign limit	<ul style="list-style-type: none"> ▪ The Switch option is selected in Operating mode parameter. ▪ The Limit option is selected in Switch output function parameter. 	Select process variable for limit function.	<ul style="list-style-type: none"> ▪ Mass flow ▪ Volume flow ▪ Corrected volume flow ▪ Density ▪ Reference density ▪ Temperature ▪ Totalizer 1 ▪ Totalizer 2 ▪ Totalizer 3 	–
Assign flow direction check	<ul style="list-style-type: none"> ▪ The Switch option is selected in the Operating mode parameter. ▪ The Flow direction check option is selected in the Switch output function parameter. 	Select process variable for flow direction monitoring.		–
Assign status	<ul style="list-style-type: none"> ▪ The Switch option is selected in Operating mode parameter. ▪ The Status option is selected in Switch output function parameter. 	Select device status for switch output.	<ul style="list-style-type: none"> ▪ Partially filled pipe detection ▪ Low flow cut off ▪ Digital output 3 	–
Switch-on value	<ul style="list-style-type: none"> ▪ The Switch option is selected in the Operating mode parameter. ▪ The Limit option is selected in the Switch output function parameter. 	Enter measured value for the switch-on point.	Signed floating-point number	Depends on country: <ul style="list-style-type: none"> ▪ 0 kg/h ▪ 0 lb/min
Switch-off value	<ul style="list-style-type: none"> ▪ The Switch option is selected in the Operating mode parameter. ▪ The Limit option is selected in the Switch output function parameter. 	Enter measured value for the switch-off point.	Signed floating-point number	Depends on country: <ul style="list-style-type: none"> ▪ 0 kg/h ▪ 0 lb/min
Switch-on delay	<ul style="list-style-type: none"> ▪ The Switch option is selected in the Operating mode parameter. ▪ The Limit option is selected in the Switch output function parameter. 	Define delay for the switch-on of status output.	0.0 to 100.0 s	–

Parameter	Prerequisite	Description	Selection / User entry	Factory setting
Switch-off delay	<ul style="list-style-type: none"> The Switch option is selected in the Operating mode parameter. The Limit option is selected in the Switch output function parameter. 	Define delay for the switch-off of status output.	0.0 to 100.0 s	-
Failure mode	-	Define output behavior in alarm condition.	<ul style="list-style-type: none"> Actual status Open Closed 	-
Invert output signal	-	Invert the output signal.	<ul style="list-style-type: none"> No Yes 	-

10.6.3 Configuring the totalizer

In the "Totalizer 1 to n" submenu, you can configure the specific totalizer.

Navigation

"Setup" menu → Advanced setup → Totalizer 1 to n

► Totalizer 1 to n	
Assign process variable	→ ⓘ 85
Unit totalizer	→ ⓘ 85
Totalizer operation mode	→ ⓘ 86
Failure mode	→ ⓘ 86

Parameter overview with brief description

Parameter	Prerequisite	Description	Selection	Factory setting
Assign process variable	-	Select process variable for totalizer.	<ul style="list-style-type: none"> Mass flow Volume flow Corrected volume flow 	-
Unit totalizer	One of the following options is selected in the Assign process variable parameter: <ul style="list-style-type: none"> Mass flow Volume flow Corrected volume flow 	Select the unit for the process variable of the totalizer.	Unit choose list	Country-specific: <ul style="list-style-type: none"> kg lb
Control Totalizer	One of the following options is selected in the Assign process variable parameter: <ul style="list-style-type: none"> Mass flow Volume flow Corrected volume flow 	Control the totalizer value.	<ul style="list-style-type: none"> Totalize Reset + hold Preset + hold 	-

Parameter	Prerequisite	Description	Selection	Factory setting
Totalizer operation mode	In the Assign process variable parameter, one of the following options is selected: <ul style="list-style-type: none"> ▪ Mass flow ▪ Volume flow ▪ Corrected volume flow 	Select totalizer calculation mode.	<ul style="list-style-type: none"> ▪ Net flow total ▪ Forward flow total ▪ Reverse flow total ▪ Last valid value 	–
Failure mode	In the Assign process variable parameter, one of the following options is selected: <ul style="list-style-type: none"> ▪ Mass flow ▪ Volume flow ▪ Corrected volume flow 	Define the totalizer behavior in the event of a device alarm.	<ul style="list-style-type: none"> ▪ Stop ▪ Actual value ▪ Last valid value 	–

10.6.4 Carrying out additional display configurations

In the **Display** submenu you can set all the parameters associated with the configuration of the local display.

Navigation

"Setup" menu → Advanced setup → Display

► Display	
Format display	→ 88
Value 1 display	→ 88
0% bargraph value 1	→ 88
100% bargraph value 1	→ 88
Decimal places 1	→ 88
Value 2 display	→ 88
Decimal places 2	→ 88
Value 3 display	→ 88
0% bargraph value 3	→ 88
100% bargraph value 3	→ 88
Decimal places 3	→ 88
Value 4 display	→ 88
Decimal places 4	→ 88
Language	→ 89
Display interval	→ 89
Display damping	→ 89
Header	→ 89
Header text	→ 89
Separator	→ 89
Backlight	→ 89

Parameter overview with brief description

Parameter	Prerequisite	Description	Selection / User entry	Factory setting
Format display	A local display is provided.	Select how measured values are shown on the display.	<ul style="list-style-type: none"> ▪ 1 value, max. size ▪ 1 bargraph + 1 value ▪ 2 values ▪ 1 value large + 2 values ▪ 4 values 	–
Value 1 display	A local display is provided.	Select the measured value that is shown on the local display.	<ul style="list-style-type: none"> ▪ Mass flow ▪ Volume flow ▪ Corrected volume flow ▪ Density ▪ Reference density ▪ Temperature ▪ Totalizer 1 ▪ Totalizer 2 ▪ Totalizer 3 	–
0% bargraph value 1	A local display is provided.	Enter 0% value for bar graph display.	Signed floating-point number	Country-specific: <ul style="list-style-type: none"> ▪ 0 kg/h ▪ 0 lb/min
100% bargraph value 1	A local display is provided.	Enter 100% value for bar graph display.	Signed floating-point number	Depends on country and nominal diameter
Decimal places 1	A measured value is specified in the Value 1 display parameter.	Select the number of decimal places for the display value.	<ul style="list-style-type: none"> ▪ x ▪ x.x ▪ x.xx ▪ x.xxx ▪ x.xxxx 	–
Value 2 display	A local display is provided.	Select the measured value that is shown on the local display.	For the picklist, see Value 1 display parameter (→ 71)	–
Decimal places 2	A measured value is specified in the Value 2 display parameter.	Select the number of decimal places for the display value.	<ul style="list-style-type: none"> ▪ x ▪ x.x ▪ x.xx ▪ x.xxx ▪ x.xxxx 	–
Value 3 display	A local display is provided.	Select the measured value that is shown on the local display.	For the picklist, see Value 1 display parameter (→ 71)	–
0% bargraph value 3	A selection was made in the Value 3 display parameter.	Enter 0% value for bar graph display.	Signed floating-point number	Country-specific: <ul style="list-style-type: none"> ▪ 0 kg/h ▪ 0 lb/min
100% bargraph value 3	A selection was made in the Value 3 display parameter.	Enter 100% value for bar graph display.	Signed floating-point number	–
Decimal places 3	A measured value is specified in the Value 3 display parameter.	Select the number of decimal places for the display value.	<ul style="list-style-type: none"> ▪ x ▪ x.x ▪ x.xx ▪ x.xxx ▪ x.xxxx 	–
Value 4 display	A local display is provided.	Select the measured value that is shown on the local display.	For the picklist, see Value 1 display parameter (→ 71)	–
Decimal places 4	A measured value is specified in the Value 4 display parameter.	Select the number of decimal places for the display value.	<ul style="list-style-type: none"> ▪ x ▪ x.x ▪ x.xx ▪ x.xxx ▪ x.xxxx 	–

Parameter	Prerequisite	Description	Selection / User entry	Factory setting
Language	A local display is provided.	Set display language.	<ul style="list-style-type: none"> ■ English * ■ Deutsch * ■ Français * ■ Español * ■ Italiano * ■ Nederlands * ■ Portuguesa * ■ Polski * ■ русский язык (Russian) * ■ Svenska * ■ Türkçe * ■ 中文 (Chinese) * ■ 日本語 (Japanese) * ■ 한국어 (Korean) * ■ tiếng Việt (Vietnamese) * ■ čeština (Czech) * 	English (alternatively, the ordered language is preset in the device)
Display interval	A local display is provided.	Set time measured values are shown on display if display alternates between values.	1 to 10 s	–
Display damping	A local display is provided.	Set display reaction time to fluctuations in the measured value.	0.0 to 999.9 s	–
Header	A local display is provided.	Select header contents on local display.	<ul style="list-style-type: none"> ■ Device tag ■ Free text 	–
Header text	The Free text option is selected in the Header parameter.	Enter display header text.	Max. 12 characters, such as letters, numbers or special characters (e.g. @, %, /)	–
Separator	A local display is provided.	Select decimal separator for displaying numerical values.	<ul style="list-style-type: none"> ■ . (point) ■ , (comma) 	. (point)
Backlight	Order code for "Display; operation", option E "SD03 4-line, illum.; touch control + data backup function"	Switch the local display backlight on and off.	<ul style="list-style-type: none"> ■ Disable ■ Enable 	–

* Visibility depends on order options or device settings

10.6.5 Using parameters for device administration

The **Administration** submenu systematically guides the user through all the parameters that can be used for device administration purposes.

Navigation

"Setup" menu → Advanced setup → Administration

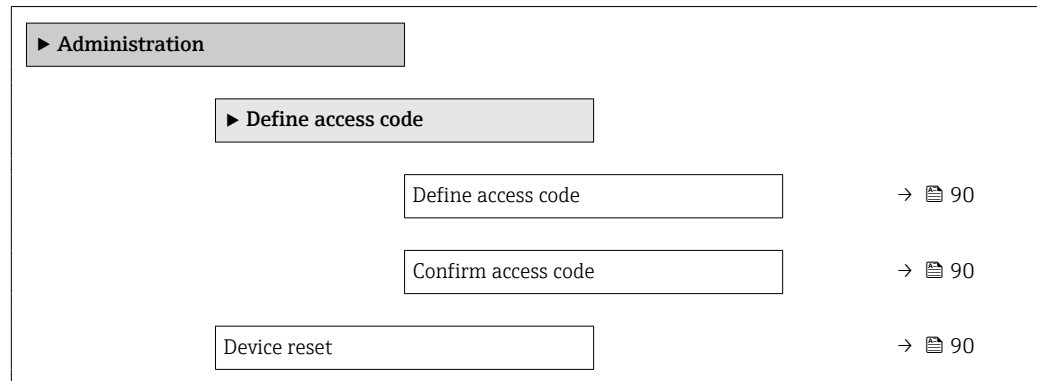
**Parameter overview with brief description**

Parameter	Description	User entry / Selection
Define access code	Restrict write-access to parameters to protect the configuration of the device against unintentional changes via the local display.	0 to 9999
Confirm access code	Confirm the entered access code.	0 to 9999
Device reset	Reset the device configuration - either entirely or in part - to a defined state.	<ul style="list-style-type: none"> ▪ Cancel ▪ To fieldbus defaults * ▪ To factory defaults ▪ To delivery settings ▪ Restart device

* Visibility depends on communication

10.7 Configuration management

After commissioning, you can save the current device configuration, copy it to another measuring point or restore the previous device configuration. The device configuration is managed via the **Configuration management** parameter.

Navigation

"Setup" menu → Advanced setup → Configuration backup display

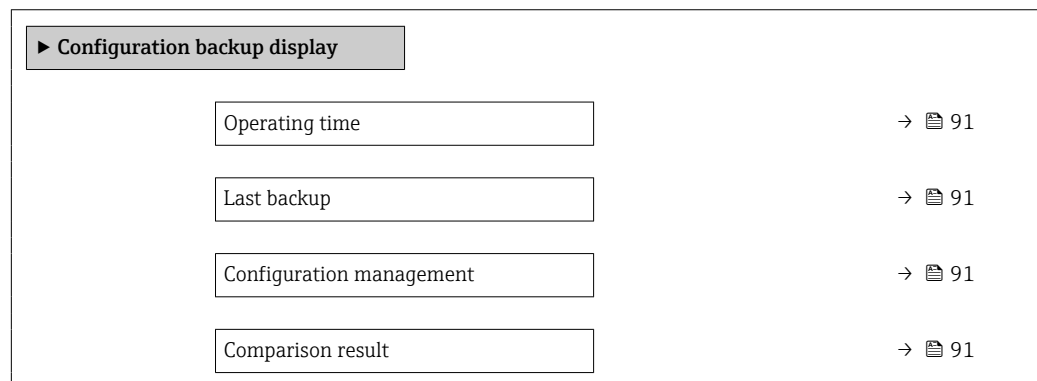

Parameter overview with brief description

Parameter	Prerequisite	Description	User interface / Selection
Operating time	–	Indicates how long the device has been in operation.	Days (d), hours (h), minutes (m) and seconds (s)
Last backup	A local display is provided.	Indicates when the last data backup was saved to the display module.	Days (d), hours (h), minutes (m) and seconds (s)
Configuration management	A local display is provided.	Select action for managing the device data in the display module.	<ul style="list-style-type: none"> ■ Cancel ■ Execute backup ■ Restore ■ Duplicate ■ Compare ■ Clear backup data
Comparison result	A local display is provided.	Comparison between present device data and display backup.	<ul style="list-style-type: none"> ■ Settings identical ■ Settings not identical ■ No backup available ■ Backup settings corrupt ■ Check not done ■ Dataset incompatible

10.7.1 Function scope of the "Configuration management" parameter

Options	Description
Cancel	No action is executed and the user exits the parameter.
Execute backup	A backup copy of the current device configuration is saved from the HistoROM backup to the display module of the device. The backup copy includes the transmitter data of the device.
Restore	The last backup copy of the device configuration is restored from the display module to the device's HistoROM backup. The backup copy includes the transmitter data of the device.
Compare	The device configuration saved in the display module is compared with the current device configuration of the HistoROM backup.
Duplicate	The transmitter configuration from another device is duplicated to the device using the display module.
Clear backup data	The backup copy of the device configuration is deleted from the display module of the device.

 *HistoROM backup*

A HistoROM is a "non-volatile" device memory in the form of an EEPROM.

 While this action is in progress, the configuration cannot be edited via the local display and a message on the processing status appears on the display.

10.8 Simulation

Via the **Simulation** submenu, it is possible to simulate various process variables in the process and the device alarm mode and verify downstream signal chains (switching valves or closed-control loops). The simulation can be performed without a real measurement (no flow of medium through the device).





Navigation

"Diagnostics" menu → Simulation

► Simulation	
Assign simulation process variable	→ 92
Value process variable	→ 92
Frequency simulation	→ 92
Frequency value	→ 93
Pulse simulation	→ 93
Pulse value	→ 93
Switch output simulation	→ 93
Switch status	→ 93
Simulation device alarm	→ 92
Diagnostic event category	→ 92
Simulation diagnostic event	→ 92

Parameter overview with brief description

Parameter	Prerequisite	Description	Selection / User entry
Assign simulation process variable	–	Select a process variable for the simulation process that is activated.	<ul style="list-style-type: none"> ▪ Off ▪ Mass flow ▪ Volume flow ▪ Corrected volume flow ▪ Density ▪ Reference density ▪ Temperature
Value process variable	A process variable is selected in the Assign simulation process variable parameter (→ 92).	Enter the simulation value for the selected process variable.	Depends on the process variable selected
Simulation device alarm	–	Switch the device alarm on and off.	<ul style="list-style-type: none"> ▪ Off ▪ On
Diagnostic event category	–	Select a diagnostic event category.	<ul style="list-style-type: none"> ▪ Sensor ▪ Electronics ▪ Configuration ▪ Process
Simulation diagnostic event	–	Select a diagnostic event to simulate this event.	<ul style="list-style-type: none"> ▪ Off ▪ Diagnostic event picklist (depends on the category selected)
Frequency simulation	In the Operating mode parameter, the Frequency option is selected.	Switch the simulation of the frequency output on and off.	<ul style="list-style-type: none"> ▪ Off ▪ On

Parameter	Prerequisite	Description	Selection / User entry
Frequency value	In the Frequency simulation parameter, the On option is selected.	Enter the frequency value for the simulation.	0.0 to 1250.0 Hz
Pulse simulation	In the Operating mode parameter, the Pulse option is selected.	Set and switch off the pulse output simulation.  For Fixed value option: Pulse width parameter (→  81) defines the pulse width of the pulses output.	<ul style="list-style-type: none"> ▪ Off ▪ Fixed value ▪ Down-counting value
Pulse value	In the Pulse simulation parameter (→  93), the Down-counting value option is selected.	Enter the number of pulses for simulation.	0 to 65 535
Switch output simulation	In the Operating mode parameter, the Switch option is selected.	Switch the simulation of the switch output on and off.	<ul style="list-style-type: none"> ▪ Off ▪ On
Switch status	In the Switch output simulation parameter (→  93) Switch output simulation 1 to n parameter Switch output simulation 1 to n parameter, the On option is selected.	Select the status of the status output for the simulation.	<ul style="list-style-type: none"> ▪ Open ▪ Closed

10.9 Protecting settings from unauthorized access

The following options exist for protecting the configuration of the measuring device from unintentional modification after commissioning:

- Write protection via access code
- Write protection via write protection switch
- Write protection via keypad lock

10.9.1 Write protection via access code



The effects of the user-specific access code are as follows:

- Via local operation, the parameters for the measuring device configuration are write-protected and their values can no longer be changed.
- Device access is protected via the Web browser, as are the parameters for the measuring device configuration.

Defining the access code via the local display

1. Navigate to the **Enter access code** parameter.
2. Maximum of 16-digit character string comprising numbers, letters and special characters as the access code.
3. Enter the access code again in the to confirm.

↳ The  symbol appears in front of all write-protected parameters.

-  Disabling parameter write protection via access code →  50.
- If the access code is lost: Resetting the access code .
- The user role with which the user is currently logged in is displayed in **Access status display** parameter.
 - Navigation path: Operation → Access status display
 - User roles and their access rights →  50
- The device automatically locks the write-protected parameters again if a key is not pressed for 10 minutes in the navigation and editing view.
- The device locks the write-protected parameters automatically after 60 s if the user skips back to the operational display mode from the navigation and editing view.

Parameters which can always be modified via the local display

Certain parameters that do not affect the measurement are excepted from parameter write protection via the local display. Despite the user-specific access code, they can always be modified, even if the other parameters are locked.

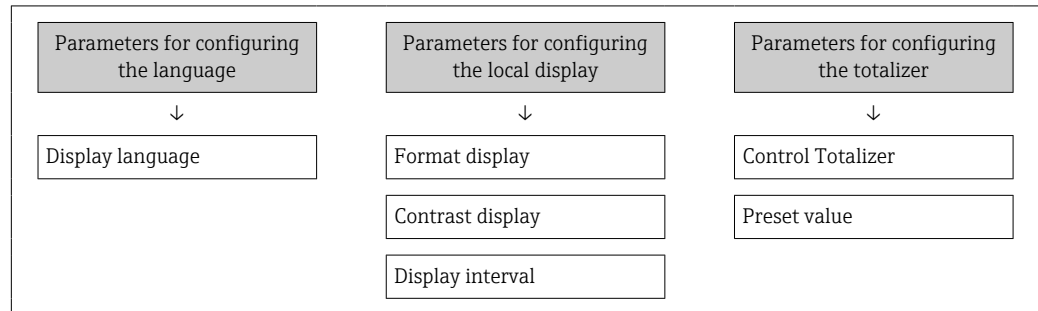

10.9.2 Write protection via write protection switch

Unlike parameter write protection via a user-specific access code, this allows the user to lock write access to the entire operating menu - apart from the **"Contrast display" parameter**.

The parameter values are now read only and cannot be edited any more (exception **"Contrast display" parameter**):

- Via local display
- Via PROFIBUS PA protocol

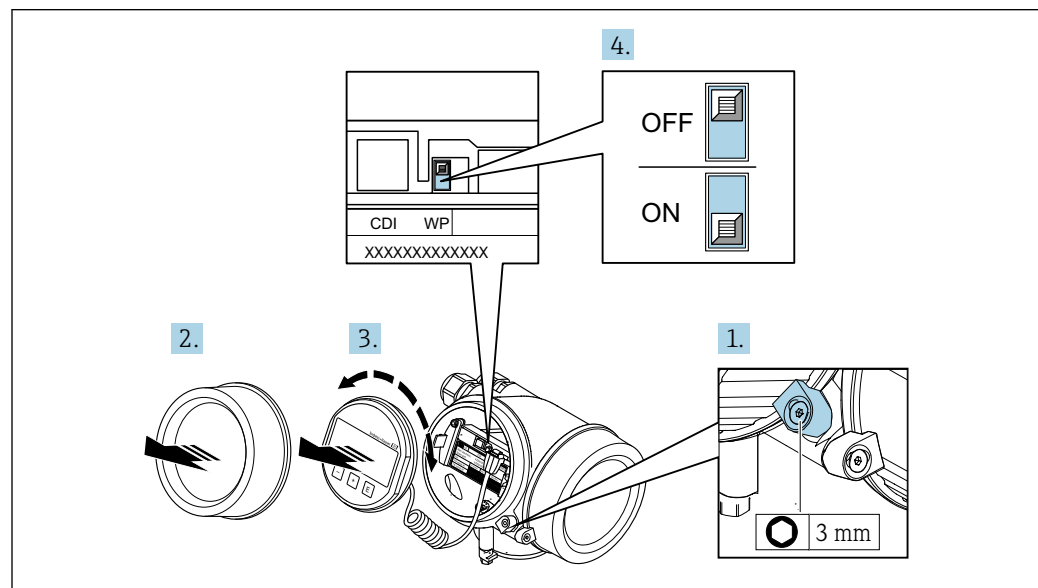

1. Loosen the securing clamp.
2. Unscrew the electronics compartment cover.

3. Pull out the display module with a gentle rotational movement. To make it easier to access the write protection switch, attach the display module to the edge of the electronics compartment.
 - ↳ Display module is attached to the edge of the electronics compartment.

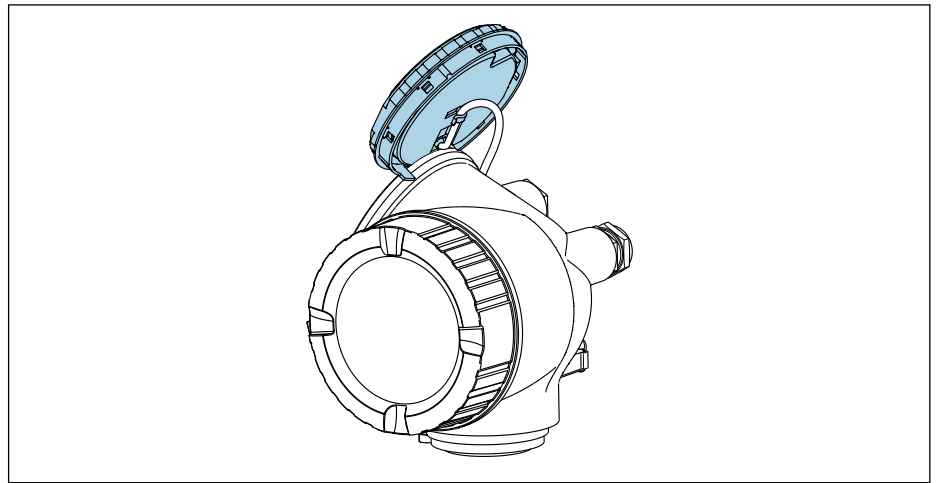

A0032236

4. Setting the write protection switch (WP) on the main electronics module to the **ON** position enables hardware write protection. Setting the write protection switch (WP) on the main electronics module to the **OFF** position (factory setting) disables hardware write protection.
 - ↳ If the hardware write protection is enabled: The **Hardware locked** option is displayed in the **Locking status** parameter . In addition to this, the  symbol appears in the header of the measured value display and in the navigation view in front of the parameters.

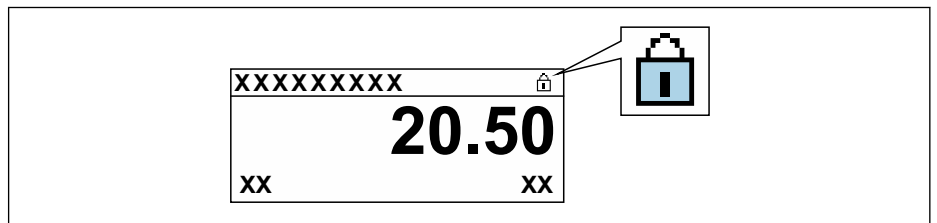

A0029425

If hardware write protection is disabled: No option is displayed in the **Locking status** parameter . On the local display, the  symbol disappears from in front of the parameters in the header of the operational display and in the navigation view.

5. Feed the cable into the gap between the housing and main electronics module and plug the display module into the electronics compartment in the desired direction until it engages.
6. Reassemble the transmitter in the reverse order.



11 Operation

11.1 Reading off the device locking status

Device active write protection: **Locking status** parameter



Operation → Locking status

Function scope of the "Locking status" parameter

Options	Description
None	The access authorization displayed in the Access status display parameter applies →  50. Only appears on local display.
Hardware locked	The DIP switch for hardware locking is activated on the main electronics module. This locks write access to the parameters (e.g. via local display or operating tool) →  94.
Temporarily locked	Write access to the parameters is temporarily locked on account of internal processes running in the device (e.g. data upload/download, reset, etc.). Once the internal processing has been completed, the parameters can be changed once again.



11.2 Adjusting the operating language

 Detailed information:

- To configure the operating language →  64
- For information on the operating languages supported by the measuring device →  156

11.3 Configuring the display

Detailed information:

- On the basic settings for the local display →  70
- On the advanced settings for the local display →  87

11.4 Reading off measured values

With the **Measured values** submenu, it is possible to read all the measured values.

Navigation

"Diagnostics" menu → Measured values

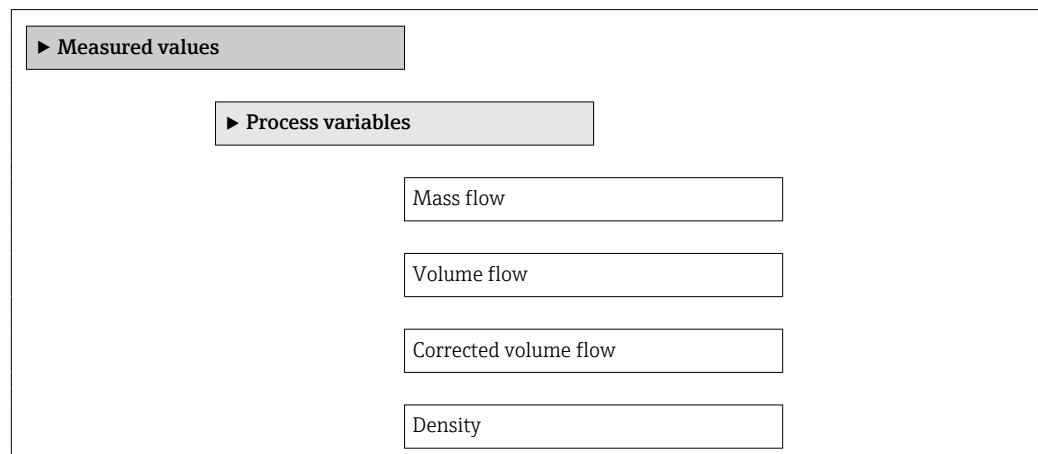

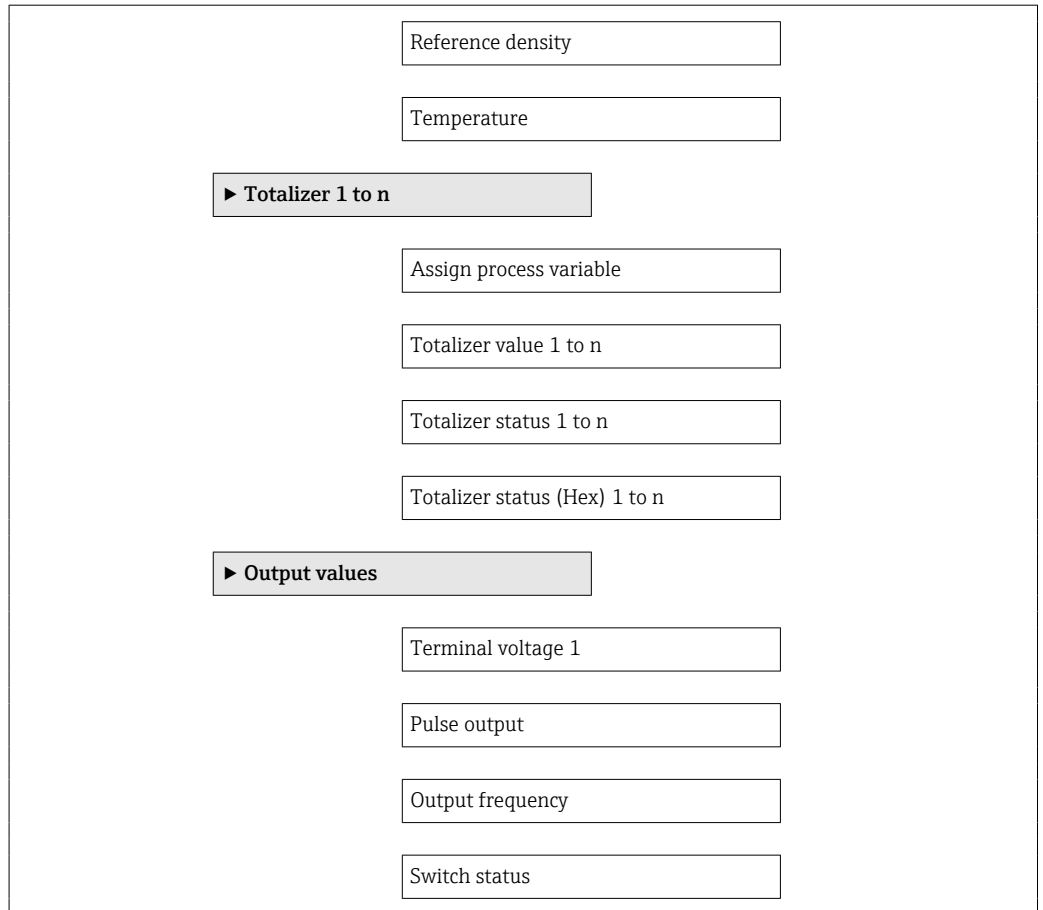

11.4.1 Process variables

The **Process variables** submenu contains all the parameters needed to display the current measured values for each process variable.

Navigation

"Diagnostics" menu → Measured values → Process variables

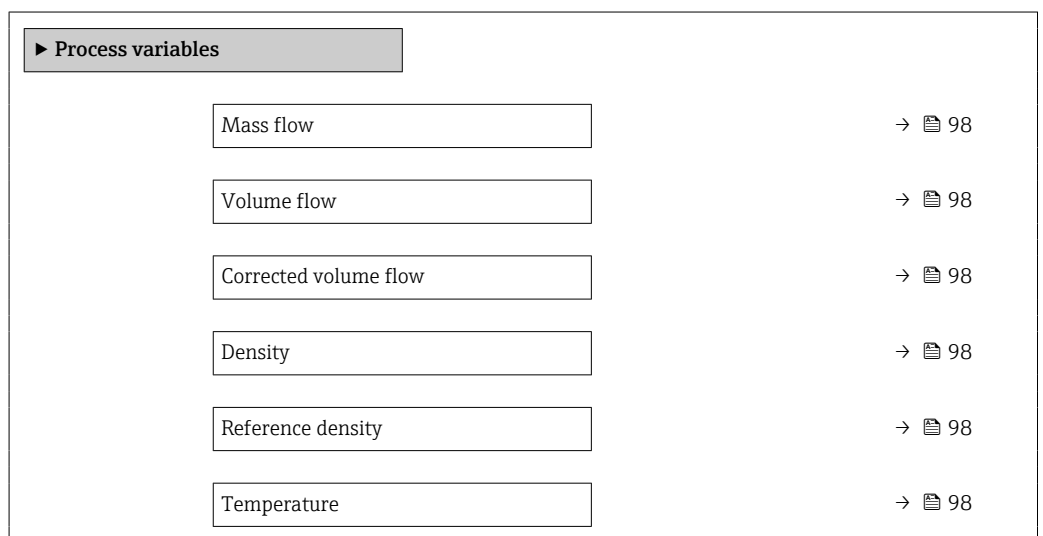

Parameter overview with brief description

Parameter	Description	User interface
Mass flow	Displays the mass flow currently measured. <i>Dependency</i> The unit is taken from the Mass flow unit parameter	Signed floating-point number
Volume flow	Displays the volume flow currently measured. <i>Dependency</i> The unit is taken from the Volume flow unit parameter	Signed floating-point number
Corrected volume flow	Displays the corrected volume flow currently calculated. <i>Dependency</i> The unit is taken from the Corrected volume flow unit parameter	Signed floating-point number
Density	Displays the density or specific density currently measured. <i>Dependency</i> The unit is taken from the Density unit parameter	Positive floating-point number
Reference density	Displays the density at the reference temperature. <i>Dependency</i> The unit is taken from the Reference density unit parameter	Positive floating-point number
Temperature	Displays the temperature currently measured. <i>Dependency</i> The unit is taken from the Temperature unit parameter	Positive floating-point number

11.4.2 Totalizer

The **Totalizer** submenu contains all the parameters needed to display the current measured values for every totalizer.

Navigation

"Diagnostics" menu → Measured values → Totalizer

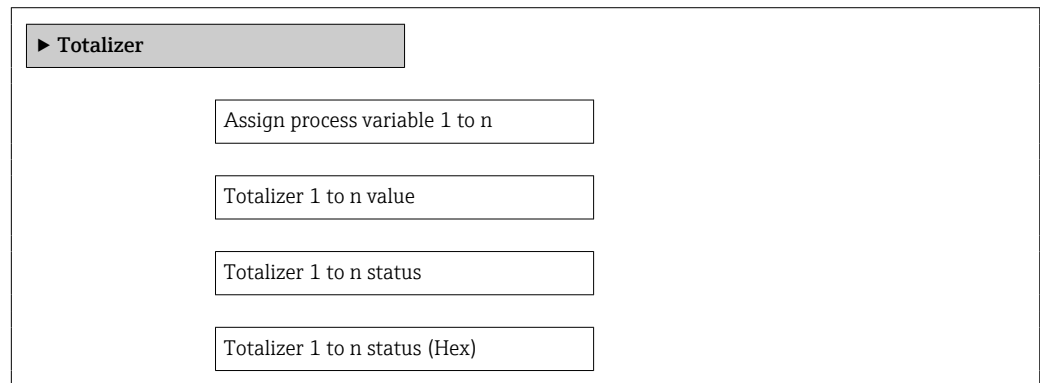

Parameter overview with brief description

Parameter	Prerequisite	Description	Selection / User entry / User interface
Assign process variable	–	Select process variable for totalizer.	<ul style="list-style-type: none"> ■ Mass flow ■ Volume flow ■ Corrected volume flow
Totalizer value 1 to n	One of the following options is selected in the Assign process variable parameter: <ul style="list-style-type: none"> ■ Volume flow ■ Mass flow ■ Corrected volume flow ■ Total mass flow ■ Condensate mass flow ■ Energy flow ■ Heat flow difference 	Displays the current totalizer counter value.	Signed floating-point number
Totalizer status 1 to n	–	Displays the current totalizer status.	<ul style="list-style-type: none"> ■ Good ■ Uncertain ■ Bad
Totalizer status (Hex) 1 to n	In Target mode parameter, the Auto option is selected.	Displays the current status value (hex) of the totalizer.	0 to 0xFF

11.4.3 Output variables

The **Output values** submenu contains all the parameters needed to display the current measured values for every output.

Navigation

"Diagnostics" menu → Measured values → Output values

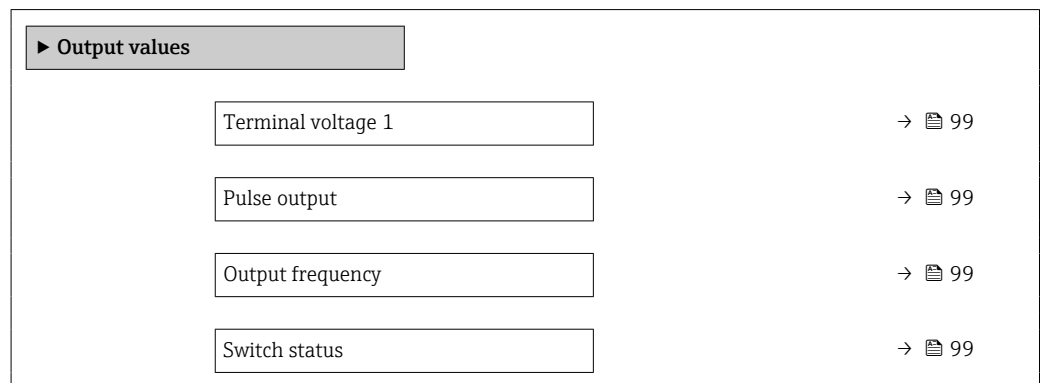

Parameter overview with brief description

Parameter	Prerequisite	Description	User interface
Terminal voltage 1	–	Displays the current terminal voltage that is applied at the output.	0.0 to 50.0 V
Pulse output	The Pulse option is selected in the Operating mode parameter parameter.	Displays the pulse frequency currently output.	Positive floating-point number
Output frequency	In the Operating mode parameter, the Frequency option is selected.	Displays the value currently measured for the frequency output.	0 to 1250 Hz
Switch status	The Switch option is selected in the Operating mode parameter.	Displays the current switch output status.	<ul style="list-style-type: none"> ■ Open ■ Closed

11.5 Adapting the measuring device to the process conditions

The following are available for this purpose:

- Basic settings using the **Setup** menu (→  65)
- Advanced settings using the **Advanced setup** submenu (→  75)

11.6 Performing a totalizer reset



The totalizers are reset in the **Operation** submenu:
Control Totalizer

Function range of "Control Totalizer" parameter

Options	Description
Totalize	The totalizer is started.
Reset + hold	The totaling process is stopped and the totalizer is reset to 0.
Preset + hold	The totaling process is stopped and the totalizer is set to its defined start value from the Preset value 1 to n parameter.
Stop totalizing option	Totalizing is stopped.

Navigation

"Operation" menu → Totalizer handling



<div style="border: 1px solid black; padding: 5px; margin-bottom: 10px;"> ▶ Totalizer handling </div>	
Control Totalizer 1 to n	→  100
Preset value 1 to n	→  100

Parameter overview with brief description

Parameter	Prerequisite	Description	Selection / User entry
Control Totalizer 1 to n	One of the following options is selected in the Assign process variable parameter: <ul style="list-style-type: none"> ▪ Mass flow ▪ Volume flow ▪ Corrected volume flow 	Control the totalizer value.	<ul style="list-style-type: none"> ▪ Totalize ▪ Reset + hold ▪ Preset + hold
Preset value 1 to n	In the Assign process variable parameter one of the following options is selected: <ul style="list-style-type: none"> ▪ Volume flow ▪ Mass flow ▪ Corrected volume flow ▪ Total mass flow ▪ Condensate mass flow ▪ Energy flow ▪ Heat flow difference 	Specify start value for totalizer.	Signed floating-point number
Reset all totalizers	–	Reset all totalizers to 0 and start.	<ul style="list-style-type: none"> ▪ Cancel ▪ Reset + totalize

11.7 Displaying the measured value history

The **Extended HistoROM** application package must be enabled in the device (order option) for the **Data logging** submenu to appear. This contains all the parameters for the measured value history.

 Data logging is also available via:
Plant Asset Management Tool FieldCare →  52.

Function range

- A total of 1000 measured values can be stored
- 4 logging channels
- Adjustable logging interval for data logging
- Measured value trend for each logging channel displayed in the form of a chart

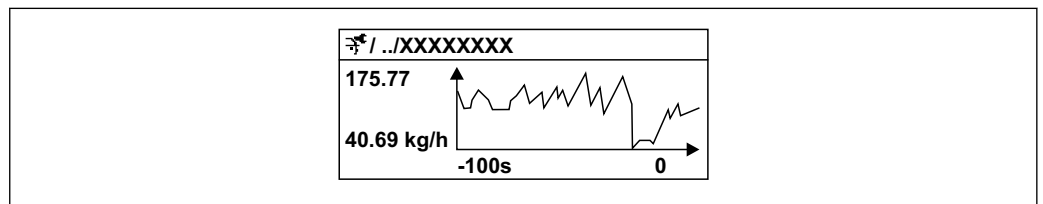

A0016357

 19 Chart of a measured value trend









- x-axis: depending on the number of channels selected displays 250 to 1000 measured values of a process variable.
- y-axis: displays the approximate measured value span and constantly adapts this to the ongoing measurement.

 If the length of the logging interval or the assignment of the process variables to the channels is changed, the content of the data logging is deleted.

Navigation





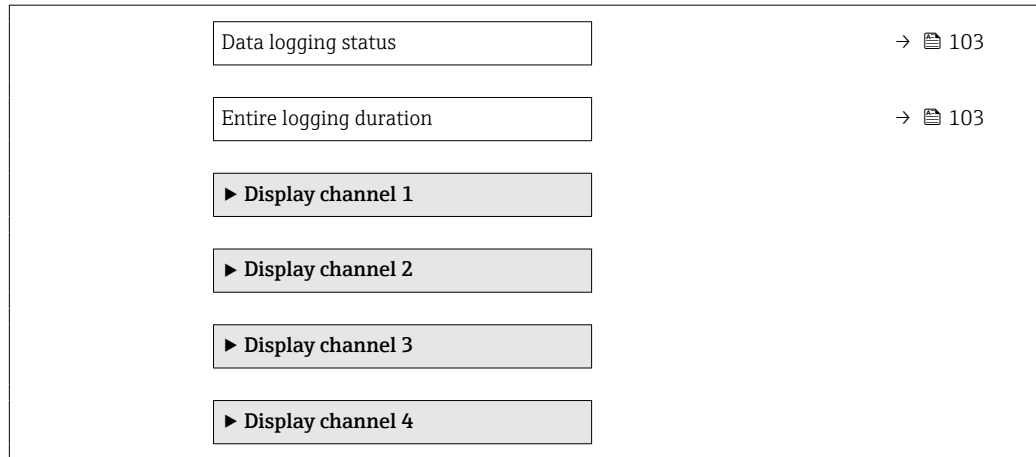

"Diagnostics" menu → Data logging

▶ Data logging

Assign channel 1	→  102
Assign channel 2	→  102
Assign channel 3	→  102
Assign channel 4	→  102
Logging interval	→  102
Clear logging data	→  102
Data logging	→  102
Logging delay	→  102
Data logging control	→  103



Parameter overview with brief description

Parameter	Prerequisite	Description	Selection / User entry / User interface
Assign channel 1	The Extended HistoROM application package is available.	Assign process variable to logging channel.	<ul style="list-style-type: none"> ▪ Off ▪ Mass flow ▪ Volume flow ▪ Corrected volume flow ▪ Density ▪ Reference density ▪ Temperature ▪ Carrier pipe temperature ▪ Electronic temperature ▪ Oscillation frequency ▪ Oscillation amplitude ▪ Oscillation damping ▪ Signal asymmetry
Assign channel 2	The Extended HistoROM application package is available.  The software options currently enabled are displayed in the Software option overview parameter.	Assign a process variable to logging channel.	For the picklist, see Assign channel 1 parameter (→  102)
Assign channel 3	The Extended HistoROM application package is available.  The software options currently enabled are displayed in the Software option overview parameter.	Assign a process variable to logging channel.	For the picklist, see Assign channel 1 parameter (→  102)
Assign channel 4	The Extended HistoROM application package is available.  The software options currently enabled are displayed in the Software option overview parameter.	Assign a process variable to logging channel.	For the picklist, see Assign channel 1 parameter (→  102)
Logging interval	The Extended HistoROM application package is available.	Define the logging interval for data logging. This value defines the time interval between the individual data points in the memory.	1.0 to 3 600.0 s
Clear logging data	The Extended HistoROM application package is available.	Clear the entire logging data.	<ul style="list-style-type: none"> ▪ Cancel ▪ Clear data
Data logging	-	Select the type of data logging.	<ul style="list-style-type: none"> ▪ Overwriting ▪ Not overwriting
Logging delay	In the Data logging parameter, the Not overwriting option is selected.	Enter the time delay for measured value logging.	0 to 999 h

Parameter	Prerequisite	Description	Selection / User entry / User interface
Data logging control	In the Data logging parameter, the Not overwriting option is selected.	Start and stop measured value logging.	<ul style="list-style-type: none"> ■ None ■ Delete + start ■ Stop
Data logging status	In the Data logging parameter, the Not overwriting option is selected.	Displays the measured value logging status.	<ul style="list-style-type: none"> ■ Done ■ Delay active ■ Active ■ Stopped
Entire logging duration	In the Data logging parameter, the Not overwriting option is selected.	Displays the total logging duration.	Positive floating-point number

12 Diagnostics and troubleshooting

12.1 General troubleshooting

For local display

Error	Possible causes	Remedial action
Local display is dark, but signal output is within the valid range	The cable of the display module is not plugged in correctly.	Insert the plug correctly into the main electronics module and display module.
Local display dark and no output signals	Supply voltage does not match the voltage specified on the nameplate.	Apply the correct supply voltage → 31.
Local display dark and no output signals	Supply voltage has incorrect polarity.	Reverse polarity of supply voltage.
Local display dark and no output signals	No contact between connecting cables and terminals.	Ensure electrical contact between the cable and the terminal.
Local display dark and no output signals	<ul style="list-style-type: none"> ▪ Terminals are not plugged into the I/O electronics module correctly. ▪ 	Check terminals.
Local display dark and no output signals	<ul style="list-style-type: none"> ▪ I/O electronics module is defective. ▪ 	Order spare part → 133.
Local display cannot be read, but signal output is within the valid range	Display is set too bright or too dark.	<ul style="list-style-type: none"> ▪ Set the display brighter by simultaneously pressing $\square + \square$. ▪ Set the display darker by simultaneously pressing $\square + \square$.
Local display is dark, but signal output is within the valid range	Display module is defective.	Order spare part → 133.
Backlighting of local display is red	Diagnostic event with "Alarm" diagnostic behavior has occurred.	Take remedial measures → 113
Text on local display appears in a language that cannot be understood.	The selected operating language cannot be understood.	<ol style="list-style-type: none"> 1. Press $\square + \square$ for 2 s ("home position"). 2. Press \square. 3. Configure the required language in the Display language parameter (→ 89).
Message on local display: "Communication Error" "Check Electronics"	Communication between the display module and the electronics is interrupted.	<ul style="list-style-type: none"> ▪ Check the cable and the connector between the main electronics module and display module. ▪ Order spare part → 133.

For output signals

Error	Possible causes	Remedial action
Signal output outside the valid range	Main electronics module is defective.	Order spare part → 133.
Device shows correct value on local display, but signal output is incorrect, though in the valid range.	Parameter configuration error	Check and adjust parameter configuration.
Device measures incorrectly.	Configuration error or device is operated outside the application.	<ol style="list-style-type: none"> 1. Check and correct parameter configuration. 2. Observe limit values specified in the "Technical Data".

For access

Fault	Possible causes	Remedial action
Write access to parameters is not possible.	Hardware write protection is enabled.	Set the write protection switch on the main electronics module to the OFF position → 94.
Write access to parameters is not possible.	Current user role has limited access authorization.	<ol style="list-style-type: none"> 1. Check user role → 50. 2. Enter correct customer-specific access code → 50.

Fault	Possible causes	Remedial action
Connection via PROFIBUS PA is not possible.	PROFIBUS PA cable is incorrectly terminated.	Check the terminating resistor .
Connection via service interface is not possible.	<ul style="list-style-type: none">▪ The USB port on the PC is incorrectly configured.▪ The driver is not installed correctly.	Refer to the documentation on Commubox FXA291:  Technical Information TI00405C

12.2 Diagnostic information on local display

12.2.1 Diagnostic message

Faults detected by the self-monitoring system of the measuring device are displayed as a diagnostic message in alternation with the operational display.

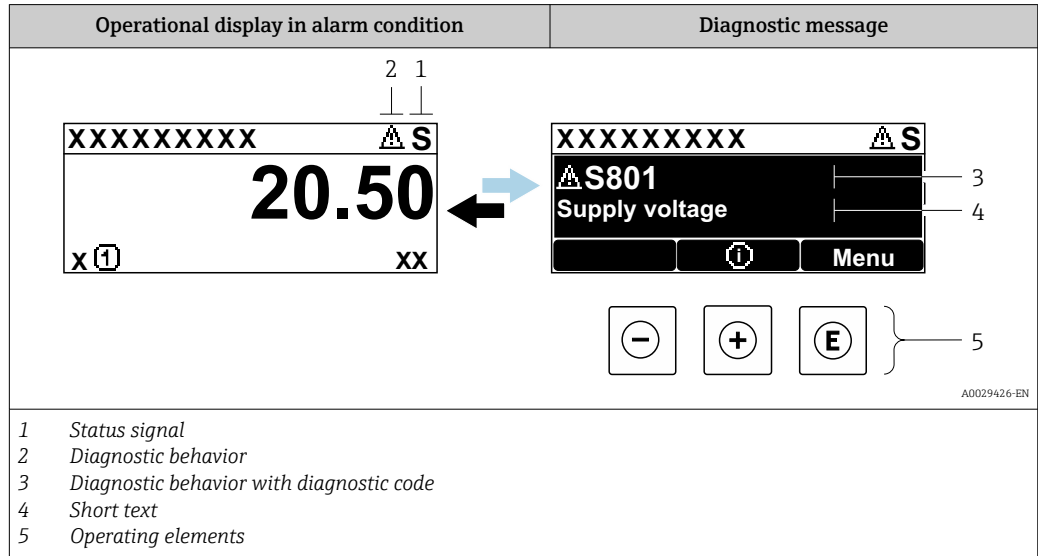

If two or more diagnostic events are pending simultaneously, only the message of the diagnostic event with the highest priority is shown.

- i** Other diagnostic events that have occurred can be displayed in the **Diagnostics** menu:
 - Via parameter → 125
 - Via submenus → 126



Status signals

The status signals provide information on the state and reliability of the device by categorizing the cause of the diagnostic information (diagnostic event).

- i** The status signals are categorized according to VDI/VDE 2650 and NAMUR Recommendation NE 107: F = Failure, C = Function Check, S = Out of Specification, M = Maintenance Required

Symbol	Meaning
F	Failure A device error has occurred. The measured value is no longer valid.
C	Function check The device is in service mode (e.g. during a simulation).
S	Out of specification The device is being operated: Outside its technical specification limits (e.g. outside the process temperature range)
M	Maintenance required Maintenance is required. The measured value remains valid.

Diagnostic behavior

Symbol	Meaning
	Alarm <ul style="list-style-type: none"> Measurement is interrupted. Signal outputs and totalizers assume the defined alarm condition. A diagnostic message is generated. For local display with touch control: the background lighting changes to red.
	Warning <ul style="list-style-type: none"> Measurement is resumed. The signal outputs and totalizers are not affected. A diagnostic message is generated.

Diagnostic information

The fault can be identified using the diagnostic information. The short text helps you by providing information about the fault. In addition, the corresponding symbol for the diagnostic behavior is displayed in front of the diagnostic information on the local display.

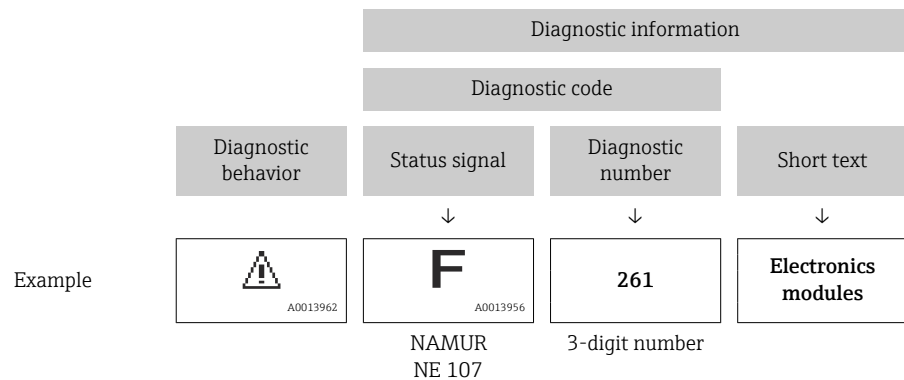

12.2.2 Calling up remedial measures

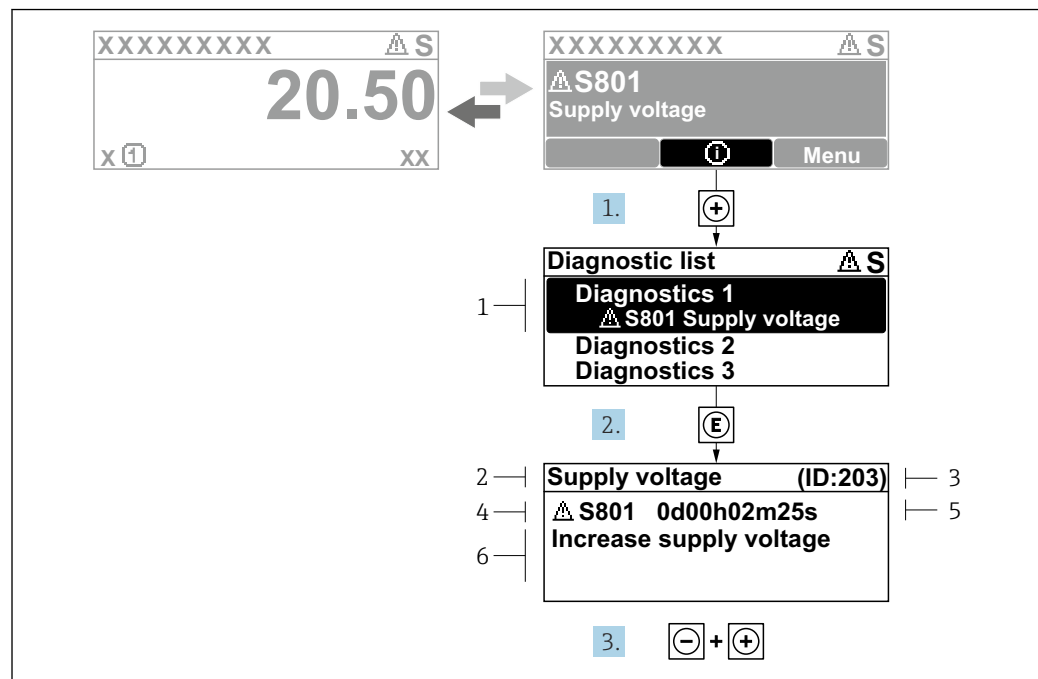

20 Message for remedial measures

- 1 Diagnostic information
- 2 Short text
- 3 Service ID
- 4 Diagnostic behavior with diagnostic code
- 5 Operation time when error occurred
- 6 Remedial measures

1. The user is in the diagnostic message.
Press \oplus (ⓘ symbol).
↳ The **Diagnostic list** submenu opens.
2. Select the desired diagnostic event with \oplus or \ominus and press \boxminus .
↳ The message about the remedial measures opens.
3. Press $\ominus + \oplus$ simultaneously.
↳ The message about the remedial measures closes.

The user is in the **Diagnostics** menu at an entry for a diagnostics event, e.g. in the **Diagnostic list** submenu or **Previous diagnostics** parameter.

1. Press \boxminus .
↳ The message for the remedial measures for the selected diagnostic event opens.
2. Press $\ominus + \oplus$ simultaneously.
↳ The message for the remedial measures closes.

12.3 Diagnostic information in FieldCare or DeviceCare

12.3.1 Diagnostic options

Any faults detected by the measuring device are displayed on the home page of the operating tool once the connection has been established.

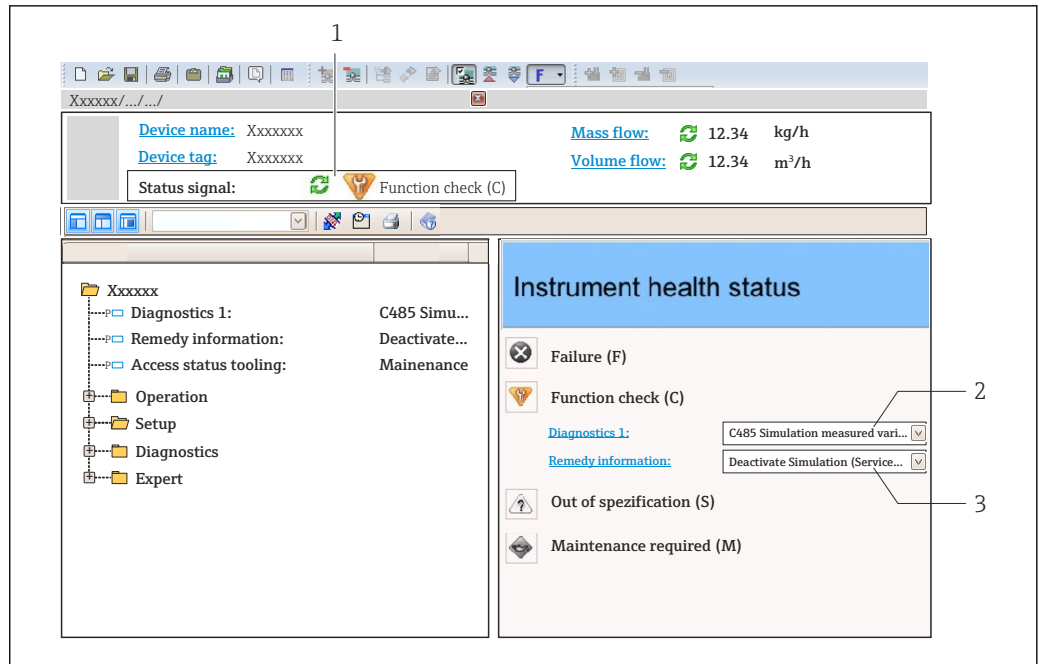

- 1 Status area with status signal → 106
- 2 Diagnostic information → 107
- 3 Remedial measures with service ID

i In addition, diagnostic events which have occurred can be shown in the **Diagnostics** menu:

- Via parameter → 125
- Via submenu → 126

Status signals

The status signals provide information on the state and reliability of the device by categorizing the cause of the diagnostic information (diagnostic event).

Symbol	Meaning
	Failure A device error has occurred. The measured value is no longer valid.
	Function check The device is in service mode (e.g. during a simulation).
	Out of specification The device is being operated: Outside its technical specification limits (e.g. outside the process temperature range)
	Maintenance required Maintenance is required. The measured value remains valid.

i The status signals are categorized in accordance with VDI/VDE 2650 and NAMUR Recommendation NE 107.

Diagnostic information

The fault can be identified using the diagnostic information. The short text helps you by providing information about the fault. In addition, the corresponding symbol for the diagnostic behavior is displayed in front of the diagnostic information on the local display.

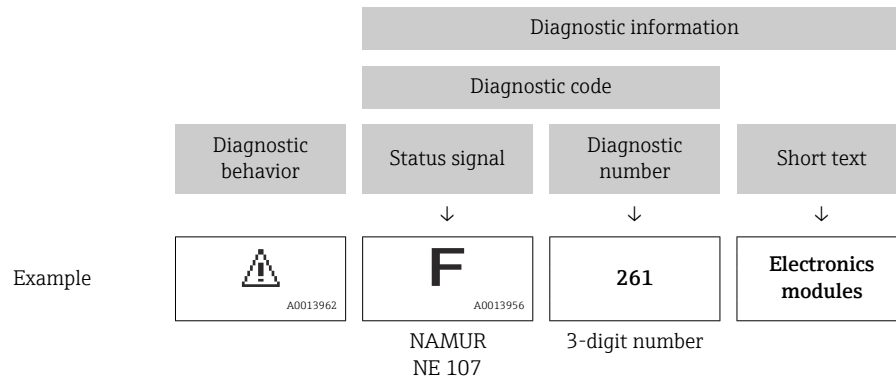

12.3.2 Calling up remedy information

Remedy information is provided for every diagnostic event to ensure that problems can be rectified quickly:

- On the home page
Remedy information is displayed in a separate field below the diagnostics information.
- In the **Diagnostics** menu
Remedy information can be called up in the working area of the user interface.

The user is in the **Diagnostics** menu.

1. Call up the desired parameter.
2. On the right in the working area, mouse over the parameter.
↳ A tool tip with remedy information for the diagnostic event appears.

12.4 Adapting the diagnostic information

12.4.1 Adapting the diagnostic behavior

Each item of diagnostic information is assigned a specific diagnostic behavior at the factory. The user can change this assignment for specific diagnostic information in the **Diagnostic behavior** submenu.

-  Diagnostic behavior in accordance with Specification PROFIBUS PA Profile 3.02, Condensed Status.

Expert → System → Diagnostic handling → Diagnostic behavior

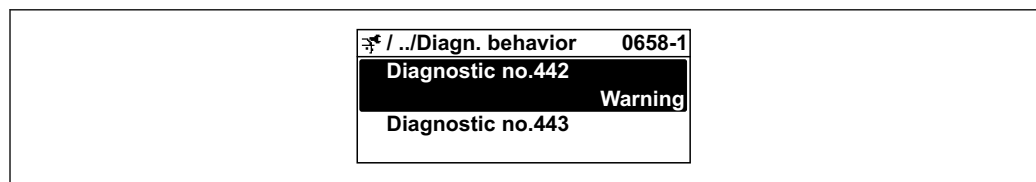

Available diagnostic behaviors

The following diagnostic behaviors can be assigned:

Diagnostic behavior	Description
Alarm	The device stops measurement. The totalizers assume the defined alarm condition. A diagnostic message is generated. For local display with touch control: the background lighting changes to red.
Warning	The device continues to measure. Measured value output via PROFIBUS and totalizers are not affected. A diagnostic message is generated.
Logbook entry only	The device continues to measure. The diagnostic message is only displayed in the Event logbook submenu (Event list submenu) and is not displayed in alternating sequence with the operational display.
Off	The diagnostic event is ignored, and no diagnostic message is generated or entered.

Displaying the measured value status

If the Analog Input, Digital Input and Totalizer function blocks are configured for cyclic data transmission, the device status is coded as per PROFIBUS PA Profile 3.02 Specification and transmitted along with the measured value to the PROFIBUS Master (Class 1) via the coding byte (byte 5). The coding byte is split into three segments: Quality, Quality Substatus and Limits.

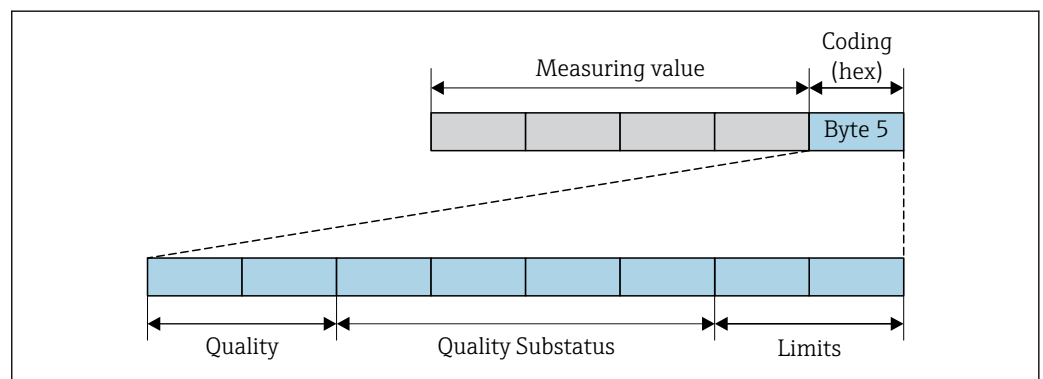

21 Structure of the coding byte

A0032228-EN

The content of the coding byte depends on the configured failure mode in the individual function block. Depending on which failure mode has been configured, status information in accordance with PROFINET PA Profile Specification 4 is transmitted to the PROFIBUS master (Class 1) via the coding byte status information.

Determining the measured value status and device status via the diagnostic behavior

When the diagnostic behavior is assigned, this also changes the measured value status and device status for the diagnostic information. The measured value status and device status depend on the choice of diagnostic behavior and on the group in which the diagnostic information is located.

The diagnostic information is grouped as follows:

- Diagnostic information pertaining to the sensor: diagnostic number 000 to 199
→ 112
- Diagnostic information pertaining to the electronics: diagnostic number 200 to 399
→ 112
- Diagnostic information pertaining to the configuration: diagnostic number 400 to 599
→ 113
- Diagnostic information pertaining to the process: diagnostic number 800 to 999
→ 113

Depending on the group in which the diagnostic information is located, the following measured value status and device status are firmly assigned to the particular diagnostic behavior:

Diagnostic information pertaining to the sensor: diagnostic number 000 to 199

Diagnostic behavior (configurable)	Measured value status (fixed assignment)				Device diagnosis (fixed assignment)
	Quality	Quality Substatus	Coding (hex)	Category (NE107)	
Alarm	BAD	Maintenance alarm	0x24 to 0x27	F (Failure)	Maintenance alarm
Warning	GOOD	Maintenance demanded	0xA8 to 0xAB	M (Maintenance)	Maintenance demanded
Logbook entry only	GOOD	ok	0x80 to 0x8E	-	-
Off					

Diagnostic information pertaining to the electronics: diagnostic number 200 to 399

Diagnostic number 200 to 301, 303 to 399

Diagnostic behavior (configurable)	Measured value status (fixed assignment)				Device diagnostics (fixed assignment)
	Quality	Quality Substatus	Coding (hex)	Category (NE107)	
Alarm	BAD	Maintenance alarm	0x24 to 0x27	F (Failure)	Maintenance alarm
Warning					
Logbook entry only	GOOD	ok	0x80 to 0x8E	-	-
Off					

Diagnostic information 302

Diagnostic behavior (configurable)	Measured value status (fixed assignment)				Device diagnostics (fixed assignment)
	Quality	Quality Substatus	Coding (hex)	Category (NE107)	
Alarm	BAD	Function check, local override	0x24 to 0x27	C	Function check
Warning	GOOD	Function check	0xBC to 0xBF	-	-

Data logging continues when Heartbeat Verification is started. The signal outputs and totalizers are not affected.

- Signal status: Function check
- Choice of diagnostic behavior: alarm or warning (factory setting)

When the Heartbeat Verification is started, data logging is interrupted, the last valid measured value is output and the totalizer counter is stopped.

Diagnostic information pertaining to the configuration: diagnostic number 400 to 599



Diagnostic behavior (configurable)	Measured value status (fixed assignment)				Device diagnosis (fixed assignment)
	Quality	Quality Substatus	Coding (hex)	Category (NE107)	
Alarm	BAD	Process related	0x28 to 0x2B	F (Failure)	Invalid process condition
Warning	UNCERTAIN	Process related	0x78 to 0x7B	S (Out of specification)	Invalid process condition
Logbook entry only	GOOD	ok	0x80 to 0x8E	-	-
Off					

Diagnostic information pertaining to the process: diagnostic number 800 to 999

Diagnostic behavior (configurable)	Measured value status (fixed assignment)				Device diagnosis (fixed assignment)
	Quality	Quality Substatus	Coding (hex)	Category (NE107)	
Alarm	BAD	Process related	0x28 to 0x2B	F (Failure)	Invalid process condition
Warning	UNCERTAIN	Process related	0x78 to 0x7B	S (Out of specification)	Invalid process condition
Logbook entry only	GOOD	ok	0x80 to 0x8E	-	-
Off					

12.5 Overview of diagnostic information

-  The amount of diagnostic information and the number of measured variables affected increase if the measuring device has one or more application packages.
- All of the measured variables affected in the entire Promass instrument family are always listed under "Measured variables affected". The measured variables available for the device in question depend on the device version. When assigning the measured variables to the device functions, for example to the individual outputs, all of the measured variables available for the device version in question are available for selection.

 In the case of some items of diagnostic information, the diagnostic behavior can be changed. Adapting the diagnostic information →  110

12.5.1 Diagnostic of sensor

No.	Diagnostic information		Remedy instructions	Influenced measured variables
	Status signal	Short text		
022	Sensor temperature		1. Change main electronic module 2. Change sensor	<ul style="list-style-type: none"> ▪ Density ▪ Mass flow ▪ Reference density ▪ Corrected volume flow ▪ Temperature ▪ Volume flow
	Status signal	F		
	Diagnostic behavior	Alarm		

Diagnostic information		Remedy instructions	Influenced measured variables	
No.	Short text			
046	Sensor limit exceeded	<ol style="list-style-type: none"> Inspect sensor Check process condition 	<ul style="list-style-type: none"> Density Mass flow Reference density Corrected volume flow Volume flow 	
	Status signal			S
	Diagnostic behavior			Warning

Diagnostic information		Remedy instructions	Influenced measured variables	
No.	Short text			
062	Sensor connection	<ol style="list-style-type: none"> Change main electronic module Change sensor 	<ul style="list-style-type: none"> Mass flow Corrected volume flow Volume flow 	
	Status signal			F
	Diagnostic behavior			Alarm

Diagnostic information		Remedy instructions	Influenced measured variables	
No.	Short text			
082	Data storage	<ol style="list-style-type: none"> Change main electronic module Change sensor 	<ul style="list-style-type: none"> Density Empty pipe detection option Low flow cut off option Mass flow Switch output status option Reference density Corrected volume flow Temperature Volume flow 	
	Status signal			F
	Diagnostic behavior			Alarm

Diagnostic information		Remedy instructions	Influenced measured variables	
No.	Short text			
083	Memory content	<ol style="list-style-type: none"> Restart device Restore S-Dat data Change sensor 	<ul style="list-style-type: none"> Density Empty pipe detection option Low flow cut off option Mass flow Switch output status option Reference density Corrected volume flow Temperature Volume flow 	
	Status signal			F
	Diagnostic behavior			Alarm

Diagnostic information		Remedy instructions	Influenced measured variables	
No.	Short text			
140	Sensor signal	<ol style="list-style-type: none"> Check or change main electronics Change sensor 	<ul style="list-style-type: none"> Density Mass flow Reference density Corrected volume flow Temperature 	
	Status signal			S
	Diagnostic behavior			Warning

12.5.2 Diagnostic of electronic

Diagnostic information		Remedy instructions	Influenced measured variables	
No.	Short text			
242	Software incompatible	1. Check software 2. Flash or change main electronics module	<ul style="list-style-type: none"> ▪ Density ▪ Empty pipe detection option ▪ Low flow cut off option ▪ Mass flow ▪ Switch output status option ▪ Reference density ▪ Corrected volume flow ▪ Temperature ▪ Volume flow 	
	Status signal			F
	Diagnostic behavior			Alarm

Diagnostic information		Remedy instructions	Influenced measured variables	
No.	Short text			
252	Modules incompatible	1. Check electronic modules 2. Change I/O or main electronic module	<ul style="list-style-type: none"> ▪ Density ▪ Empty pipe detection option ▪ Low flow cut off option ▪ Mass flow ▪ Switch output status option ▪ Reference density ▪ Corrected volume flow ▪ Temperature ▪ Volume flow 	
	Status signal			F
	Diagnostic behavior			Alarm

Diagnostic information		Remedy instructions	Influenced measured variables	
No.	Short text			
261	Electronic modules	1. Restart device 2. Check electronic modules 3. Change I/O Modul or main electronics	<ul style="list-style-type: none"> ▪ Density ▪ Empty pipe detection option ▪ Low flow cut off option ▪ Mass flow ▪ Switch output status option ▪ Reference density ▪ Corrected volume flow ▪ Temperature ▪ Volume flow 	
	Status signal			F
	Diagnostic behavior			Alarm

Diagnostic information		Remedy instructions	Influenced measured variables	
No.	Short text			
262	Module connection	1. Check module connections 2. Change electronic modules	<ul style="list-style-type: none"> ▪ Density ▪ Empty pipe detection option ▪ Low flow cut off option ▪ Mass flow ▪ Switch output status option ▪ Reference density ▪ Corrected volume flow ▪ Temperature ▪ Volume flow 	
	Status signal			F
	Diagnostic behavior			Alarm

Diagnostic information		Remedy instructions	Influenced measured variables	
No.	Short text			
270	Main electronic failure	Change main electronic module	<ul style="list-style-type: none"> ▪ Density ▪ Empty pipe detection option ▪ Low flow cut off option ▪ Mass flow ▪ Switch output status option ▪ Reference density ▪ Corrected volume flow ▪ Temperature ▪ Status ▪ Volume flow 	
	Status signal			F
	Diagnostic behavior			Alarm

Diagnostic information		Remedy instructions	Influenced measured variables	
No.	Short text			
271	Main electronic failure	<ol style="list-style-type: none"> 1. Restart device 2. Change main electronic module 	<ul style="list-style-type: none"> ▪ Density ▪ Empty pipe detection option ▪ Low flow cut off option ▪ Mass flow ▪ Switch output status option ▪ Reference density ▪ Corrected volume flow ▪ Temperature ▪ Volume flow 	
	Status signal			F
	Diagnostic behavior			Alarm

Diagnostic information		Remedy instructions	Influenced measured variables	
No.	Short text			
272	Main electronic failure	<ol style="list-style-type: none"> 1. Restart device 2. Contact service 	<ul style="list-style-type: none"> ▪ Density ▪ Empty pipe detection option ▪ Low flow cut off option ▪ Mass flow ▪ Switch output status option ▪ Reference density ▪ Corrected volume flow ▪ Temperature ▪ Volume flow 	
	Status signal			F
	Diagnostic behavior			Alarm

Diagnostic information		Remedy instructions	Influenced measured variables	
No.	Short text			
273	Main electronic failure	<ol style="list-style-type: none"> 1. Emergency operation via display 2. Change main electronics 	<ul style="list-style-type: none"> ▪ Density ▪ Empty pipe detection option ▪ Low flow cut off option ▪ Mass flow ▪ Switch output status option ▪ Reference density ▪ Corrected volume flow ▪ Temperature ▪ Volume flow 	
	Status signal			F
	Diagnostic behavior			Alarm

Diagnostic information		Remedy instructions	Influenced measured variables	
No.	Short text			
274	Main electronic failure	Unstable measurement 1. Change main electronics	<ul style="list-style-type: none"> ▪ Mass flow ▪ Corrected volume flow ▪ Volume flow 	
	Status signal			S
	Diagnostic behavior			Warning

Diagnostic information		Remedy instructions	Influenced measured variables	
No.	Short text			
275	I/O module failure	Change I/O module	<ul style="list-style-type: none"> ▪ Density ▪ Empty pipe detection option ▪ Low flow cut off option ▪ Mass flow ▪ Switch output status option ▪ Reference density ▪ Corrected volume flow ▪ Temperature ▪ Volume flow 	
	Status signal			F
	Diagnostic behavior			Alarm

Diagnostic information		Remedy instructions	Influenced measured variables	
No.	Short text			
276	I/O module failure	1. Restart device 2. Change I/O module	<ul style="list-style-type: none"> ▪ Density ▪ Empty pipe detection option ▪ Low flow cut off option ▪ Mass flow ▪ Switch output status option ▪ Reference density ▪ Corrected volume flow ▪ Temperature ▪ Volume flow 	
	Status signal			F
	Diagnostic behavior			Alarm

Diagnostic information		Remedy instructions	Influenced measured variables	
No.	Short text			
282	Data storage	1. Restart device 2. Contact service	<ul style="list-style-type: none"> ▪ Density ▪ Empty pipe detection option ▪ Low flow cut off option ▪ Mass flow ▪ Switch output status option ▪ Reference density ▪ Corrected volume flow ▪ Temperature ▪ Volume flow 	
	Status signal			F
	Diagnostic behavior			Alarm

Diagnostic information		Remedy instructions	Influenced measured variables	
No.	Short text			
283	Memory content	1. Transfer data or reset device 2. Contact service	<ul style="list-style-type: none"> ▪ Density ▪ Empty pipe detection option ▪ Low flow cut off option ▪ Mass flow ▪ Switch output status option ▪ Reference density ▪ Corrected volume flow ▪ Temperature ▪ Volume flow 	
	Status signal			F
	Diagnostic behavior			Alarm

Diagnostic information		Remedy instructions	Influenced measured variables	
No.	Short text			
302	Device verification active	Device verification active, please wait.	<ul style="list-style-type: none"> ▪ Density ▪ Empty pipe detection option ▪ Low flow cut off option ▪ Mass flow ▪ Switch output status option ▪ Reference density ▪ Corrected volume flow ▪ Temperature ▪ Volume flow 	
	Status signal			C
	Diagnostic behavior			Warning

Diagnostic information		Remedy instructions	Influenced measured variables	
No.	Short text			
311	Electronic failure	1. Transfer data or reset device 2. Contact service	<ul style="list-style-type: none"> ▪ Density ▪ Empty pipe detection option ▪ Low flow cut off option ▪ Mass flow ▪ Switch output status option ▪ Reference density ▪ Corrected volume flow ▪ Temperature ▪ Volume flow 	
	Status signal			F
	Diagnostic behavior			Alarm

Diagnostic information		Remedy instructions	Influenced measured variables	
No.	Short text			
311	Electronic failure	Maintenance required! 1. Do not perform reset 2. Contact service	<ul style="list-style-type: none"> ▪ Density ▪ Empty pipe detection option ▪ Low flow cut off option ▪ Mass flow ▪ Switch output status option ▪ Reference density ▪ Corrected volume flow ▪ Temperature ▪ Volume flow 	
	Status signal			M
	Diagnostic behavior			Warning

Diagnostic information		Remedy instructions	Influenced measured variables	
No.	Short text			
362	Main electronic failure	1. Change main electronic module 2. Change sensor	<ul style="list-style-type: none"> ■ Density ■ Empty pipe detection option ■ Low flow cut off option ■ Mass flow ■ Switch output status option ■ Reference density ■ Corrected volume flow ■ Temperature ■ Volume flow 	
	Status signal			F
	Diagnostic behavior			Alarm

12.5.3 Diagnostic of configuration

Diagnostic information		Remedy instructions	Influenced measured variables	
No.	Short text			
410	Data transfer	1. Check connection 2. Retry data transfer	<ul style="list-style-type: none"> ■ Density ■ Empty pipe detection option ■ Low flow cut off option ■ Mass flow ■ Switch output status option ■ Reference density ■ Corrected volume flow ■ Temperature ■ Volume flow 	
	Status signal			F
	Diagnostic behavior			Alarm

Diagnostic information		Remedy instructions	Influenced measured variables	
No.	Short text			
412	Processing Download	Download active, please wait	<ul style="list-style-type: none"> ■ Density ■ Empty pipe detection option ■ Low flow cut off option ■ Mass flow ■ Switch output status option ■ Reference density ■ Corrected volume flow ■ Temperature ■ Volume flow 	
	Status signal			C
	Diagnostic behavior			Warning

Diagnostic information		Remedy instructions	Influenced measured variables	
No.	Short text			
437	Configuration incompatible	1. Restart device 2. Contact service	<ul style="list-style-type: none"> ■ Density ■ Empty pipe detection option ■ Low flow cut off option ■ Mass flow ■ Switch output status option ■ Reference density ■ Corrected volume flow ■ Temperature ■ Volume flow 	
	Status signal			F
	Diagnostic behavior			Alarm

Diagnostic information		Remedy instructions	Influenced measured variables	
No.	Short text			
438	Dataset	1. Check data set file 2. Check device configuration 3. Up- and download new configuration	<ul style="list-style-type: none"> ▪ Density ▪ Empty pipe detection option ▪ Low flow cut off option ▪ Mass flow ▪ Switch output status option ▪ Reference density ▪ Corrected volume flow ▪ Temperature ▪ Volume flow 	
	Status signal			M
	Diagnostic behavior			Warning

Diagnostic information		Remedy instructions	Influenced measured variables	
No.	Short text			
442	Frequency output	1. Check process 2. Check frequency output settings	-	
	Status signal			S
	Diagnostic behavior			Warning

Diagnostic information		Remedy instructions	Influenced measured variables	
No.	Short text			
443	Pulse output	1. Check process 2. Check pulse output settings	-	
	Status signal			S
	Diagnostic behavior			Warning

Diagnostic information		Remedy instructions	Influenced measured variables	
No.	Short text			
453	Flow override	Deactivate flow override	<ul style="list-style-type: none"> ▪ Density ▪ Empty pipe detection option ▪ Low flow cut off option ▪ Mass flow ▪ Switch output status option ▪ Reference density ▪ Corrected volume flow ▪ Temperature ▪ Volume flow 	
	Status signal			C
	Diagnostic behavior			Warning

Diagnostic information		Remedy instructions	Influenced measured variables	
No.	Short text			
482	FB not Auto/Cas	Set Block in AUTO mode	-	
	Status signal			F
	Diagnostic behavior			Alarm

Diagnostic information		Remedy instructions	Influenced measured variables	
No.	Short text			
484	Simulation failure mode	Deactivate simulation	<ul style="list-style-type: none"> ■ Density ■ Empty pipe detection option ■ Low flow cut off option ■ Mass flow ■ Switch output status option ■ Reference density ■ Corrected volume flow ■ Temperature ■ Volume flow 	
	Status signal			C
	Diagnostic behavior			Alarm

Diagnostic information		Remedy instructions	Influenced measured variables	
No.	Short text			
485	Simulation measured variable	Deactivate simulation	<ul style="list-style-type: none"> ■ Density ■ Empty pipe detection option ■ Low flow cut off option ■ Mass flow ■ Switch output status option ■ Reference density ■ Corrected volume flow ■ Temperature ■ Volume flow 	
	Status signal			C
	Diagnostic behavior			Warning

Diagnostic information		Remedy instructions	Influenced measured variables	
No.	Short text			
492	Simulation frequency output	Deactivate simulation frequency output	<ul style="list-style-type: none"> ■ Density ■ Empty pipe detection option ■ Low flow cut off option ■ Mass flow ■ Switch output status option ■ Reference density ■ Corrected volume flow ■ Temperature ■ Volume flow 	
	Status signal			C
	Diagnostic behavior			Warning

Diagnostic information		Remedy instructions	Influenced measured variables	
No.	Short text			
493	Simulation pulse output	Deactivate simulation pulse output	<ul style="list-style-type: none"> ■ Density ■ Empty pipe detection option ■ Low flow cut off option ■ Mass flow ■ Switch output status option ■ Reference density ■ Corrected volume flow ■ Temperature ■ Volume flow 	
	Status signal			C
	Diagnostic behavior			Warning

Diagnostic information		Remedy instructions	Influenced measured variables	
No.	Short text			
494	Switch output simulation	Deactivate simulation switch output	<ul style="list-style-type: none"> ▪ Density ▪ Empty pipe detection option ▪ Low flow cut off option ▪ Mass flow ▪ Switch output status option ▪ Reference density ▪ Corrected volume flow ▪ Temperature ▪ Volume flow 	
	Status signal			C
	Diagnostic behavior			Warning

Diagnostic information		Remedy instructions	Influenced measured variables	
No.	Short text			
495	Simulation diagnostic event	Deactivate simulation	-	
	Status signal			C
	Diagnostic behavior			Warning

Diagnostic information		Remedy instructions	Influenced measured variables	
No.	Short text			
497	Simulation block output	Deactivate simulation	-	
	Status signal			C
	Diagnostic behavior			Warning

12.5.4 Diagnostic of process

Diagnostic information		Remedy instructions	Influenced measured variables	
No.	Short text			
801	Supply voltage too low	Increase supply voltage	<ul style="list-style-type: none"> ▪ Density ▪ Empty pipe detection option ▪ Low flow cut off option ▪ Mass flow ▪ Switch output status option ▪ Reference density ▪ Corrected volume flow ▪ Temperature ▪ Volume flow 	
	Status signal			S
	Diagnostic behavior			Warning

Diagnostic information		Remedy instructions	Influenced measured variables	
No.	Short text			
830	Sensor temperature too high	Reduce ambient temp. around the sensor housing	<ul style="list-style-type: none"> ▪ Density ▪ Mass flow ▪ Reference density ▪ Corrected volume flow ▪ Volume flow 	
	Status signal			S
	Diagnostic behavior			Warning

Diagnostic information		Remedy instructions	Influenced measured variables	
No.	Short text			
831	Sensor temperature too low	Increase ambient temp. around the sensor housing	<ul style="list-style-type: none"> ■ Density ■ Mass flow ■ Reference density ■ Corrected volume flow ■ Volume flow 	
	Status signal			S
	Diagnostic behavior			Warning

Diagnostic information		Remedy instructions	Influenced measured variables	
No.	Short text			
832	Electronic temperature too high	Reduce ambient temperature	<ul style="list-style-type: none"> ■ Density ■ Empty pipe detection option ■ Low flow cut off option ■ Mass flow ■ Switch output status option ■ Reference density ■ Corrected volume flow ■ Temperature ■ Volume flow 	
	Status signal			S
	Diagnostic behavior			Warning

Diagnostic information		Remedy instructions	Influenced measured variables	
No.	Short text			
833	Electronic temperature too low	Increase ambient temperature	<ul style="list-style-type: none"> ■ Density ■ Empty pipe detection option ■ Low flow cut off option ■ Mass flow ■ Switch output status option ■ Reference density ■ Corrected volume flow ■ Temperature ■ Volume flow 	
	Status signal			S
	Diagnostic behavior			Warning

Diagnostic information		Remedy instructions	Influenced measured variables	
No.	Short text			
834	Process temperature too high	Reduce process temperature	<ul style="list-style-type: none"> ■ Density ■ Mass flow ■ Reference density ■ Corrected volume flow ■ Temperature ■ Volume flow 	
	Status signal			S
	Diagnostic behavior			Warning

Diagnostic information		Remedy instructions	Influenced measured variables	
No.	Short text			
835	Process temperature too low	Increase process temperature	<ul style="list-style-type: none"> ■ Density ■ Mass flow ■ Reference density ■ Corrected volume flow ■ Temperature ■ Volume flow 	
	Status signal			S
	Diagnostic behavior			Warning

Diagnostic information		Remedy instructions	Influenced measured variables	
No.	Short text			
842	Process limit	Low flow cut off active! 1. Check low flow cut off configuration	<ul style="list-style-type: none"> ▪ Density ▪ Empty pipe detection option ▪ Low flow cut off option ▪ Mass flow ▪ Switch output status option ▪ Reference density ▪ Corrected volume flow ▪ Temperature ▪ Volume flow 	
	Status signal			S
	Diagnostic behavior			Warning

Diagnostic information		Remedy instructions	Influenced measured variables	
No.	Short text			
862	Partly filled pipe	1. Check for gas in process 2. Adjust detection limits	<ul style="list-style-type: none"> ▪ Density ▪ Empty pipe detection option ▪ Low flow cut off option ▪ Mass flow ▪ Switch output status option ▪ Reference density ▪ Corrected volume flow ▪ Temperature ▪ Volume flow 	
	Status signal			S
	Diagnostic behavior			Warning

Diagnostic information		Remedy instructions	Influenced measured variables	
No.	Short text			
882	Input signal	1. Check input configuration 2. Check external device or process conditions	<ul style="list-style-type: none"> ▪ Density ▪ Mass flow ▪ Reference density ▪ Corrected volume flow ▪ Volume flow 	
	Status signal			F
	Diagnostic behavior			Alarm





Diagnostic information		Remedy instructions	Influenced measured variables	
No.	Short text			
910	Tubes not oscillating	1. Check process conditions 2. Increase supply 3. Check main electronic or sensor	<ul style="list-style-type: none"> ▪ Density ▪ Empty pipe detection option ▪ Low flow cut off option ▪ Mass flow ▪ Switch output status option ▪ Reference density ▪ Corrected volume flow ▪ Temperature ▪ Volume flow 	
	Status signal			F
	Diagnostic behavior			Alarm



Diagnostic information		Remedy instructions	Influenced measured variables	
No.	Short text			
912	Medium inhomogeneous	1. Check process cond. 2. Increase system pressure	<ul style="list-style-type: none"> ■ Density ■ Empty pipe detection option ■ Low flow cut off option ■ Mass flow ■ Switch output status option ■ Reference density ■ Corrected volume flow ■ Temperature ■ Volume flow 	
	Status signal			S
	Diagnostic behavior			Warning

Diagnostic information		Remedy instructions	Influenced measured variables	
No.	Short text			
913	Medium unsuitable	1. Check process conditions 2. Increase supply 3. Check main electronic or sensor	<ul style="list-style-type: none"> ■ Density ■ Mass flow ■ Reference density ■ Corrected volume flow ■ Volume flow 	
	Status signal			S
	Diagnostic behavior			Warning





12.6 Pending diagnostic events

The **Diagnostics** menu allows the user to view the current diagnostic event and the previous diagnostic event separately.

-  To call up the measures to rectify a diagnostic event:
 - Via local display →  108
 - Via "FieldCare" operating tool →  110
 - Via "DeviceCare" operating tool →  110

-  Other pending diagnostic events can be displayed in the **Diagnostic list** submenu →  126.

Navigation
 "Diagnostics" menu

 Diagnostics	
Actual diagnostics	→  126
Previous diagnostics	→  126
Operating time from restart	→  126
Operating time	→  126

Parameter overview with brief description

Parameter	Prerequisite	Description	User interface
Actual diagnostics	A diagnostic event has occurred.	Shows the current occurred diagnostic event along with its diagnostic information.  If two or more messages occur simultaneously, the message with the highest priority is shown on the display.	Symbol for diagnostic behavior, diagnostic code and short message.
Previous diagnostics	Two diagnostic events have already occurred.	Shows the diagnostic event that occurred prior to the current diagnostic event along with its diagnostic information.	Symbol for diagnostic behavior, diagnostic code and short message.
Operating time from restart	–	Shows the time the device has been in operation since the last device restart.	Days (d), hours (h), minutes (m) and seconds (s)
Operating time	–	Indicates how long the device has been in operation.	Days (d), hours (h), minutes (m) and seconds (s)

12.7 Diagnostics list

Up to 5 currently pending diagnostic events can be displayed in the **Diagnostic list** submenu along with the associated diagnostic information. If more than 5 diagnostic events are pending, the events with the highest priority are shown on the display.

Navigation path

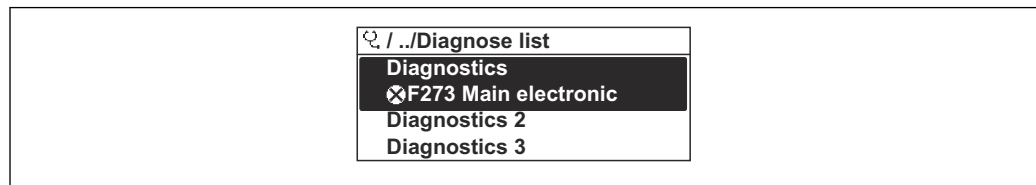

Diagnostics → Diagnostic list



A0014006-EN

 22 Using the example of the local display

 To call up the measures to rectify a diagnostic event:

- Via local display →  108
- Via "FieldCare" operating tool →  110
- Via "DeviceCare" operating tool →  110

12.8 Event logbook

12.8.1 Reading out the event logbook

A chronological overview of the event messages that have occurred is provided in the **Events list** submenu.

Navigation path

Diagnostics menu → **Event logbook** submenu → Events list

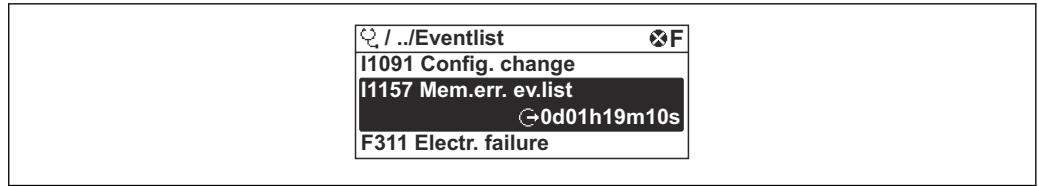

A0014008-EN

23 Using the example of the local display

- A maximum of 20 event messages can be displayed in chronological order.
- If the **Extended HistoROM** application package (order option) is enabled in the device, the event list can contain up to 100 entries.

The event history includes entries for:

- Diagnostic events → 113
- Information events → 127

In addition to the operating time when the event occurred, each event is also assigned a symbol that indicates whether the event has occurred or is finished:

- **Diagnostics event**
 - : Occurrence of the event
 - : End of the event
- **Information event**
 - : Occurrence of the event

To call up the measures to rectify a diagnostic event:

- Via local display → 108
- Via "FieldCare" operating tool → 110
- Via "DeviceCare" operating tool → 110

For filtering the displayed event messages → 127

12.8.2 Filtering the event logbook

Using the **Filter options** parameter you can define which category of event message is displayed in the **Events list** submenu.

Navigation path

Diagnostics → Event logbook → Filter options

Filter categories

- All
- Failure (F)
- Function check (C)
- Out of specification (S)
- Maintenance required (M)
- Information (I)

12.8.3 Overview of information events

Unlike a diagnostic event, an information event is displayed in the event logbook only and not in the diagnostic list.

Info number	Info name
I1000	----- (Device ok)
I1079	Sensor changed
I1089	Power on
I1090	Configuration reset
I1091	Configuration changed

Info number	Info name
I1092	Trend data deleted
I1110	Write protection switch changed
I1111	Density adjust failure
I1137	Electronic changed
I1151	History reset
I1154	Reset terminal voltage min/max
I1155	Reset electronic temperature
I1156	Memory error trend
I1157	Memory error event list
I1185	Display backup done
I1186	Restore via display done
I1187	Settings downloaded with display
I1188	Display data cleared
I1189	Backup compared
I1209	Density adjustment ok
I1221	Zero point adjust failure
I1222	Zero point adjustment ok
I1227	Sensor emergency mode activated
I1228	Sensor emergency mode failed
I1256	Display: access status changed
I1264	Safety sequence aborted
I1335	Firmware changed
I1397	Fieldbus: access status changed
I1398	CDI: access status changed
I1440	Main electronic module changed
I1442	I/O module changed
I1444	Device verification passed
I1445	Device verification failed
I1450	Monitoring off
I1451	Monitoring on
I1459	Failed: I/O module verification
I1461	Failed: Sensor verification
I1512	Download started
I1513	Download finished
I1514	Upload started
I1515	Upload finished
I1552	Failed: Main electronic verification
I1554	Safety sequence started
I1555	Safety sequence confirmed
I1556	Safety mode off

12.9 Resetting the measuring device

The entire device configuration or some of the configuration can be reset to a defined state with the **Device reset** parameter (→  90).

12.9.1 Function range of "Device reset" parameter











Options	Description
Cancel	No action is executed and the user exits the parameter.
To fieldbus defaults	Every parameter is reset to fieldbus default values.
To factory defaults	Every parameter is reset to the factory setting.
To delivery settings	Every parameter for which a customer-specific default setting was ordered is reset to the customer-specific value. All other parameters are reset to the factory setting.  This option is not visible if no customer-specific settings have been ordered.
Restart device	The restart resets every parameter with data stored in volatile memory (RAM) to the factory setting (e.g. measured value data). The device configuration remains unchanged.

12.10 Device information





The **Device information** submenu contains all parameters that display different information for device identification.

Navigation

"Diagnostics" menu → Device information



▶ Device information 	
Device tag	→  130
Serial number	→  130
Firmware version	→  130
Device name	→  130
Order code	→  130
Extended order code 1	→  130
Extended order code 2	→  130
Extended order code 3	→  130
ENP version	→  130

Parameter overview with brief description

Parameter	Description	User interface	Factory setting
Device tag	Shows name of measuring point.	Max. 32 characters, such as letters, numbers or special characters (e.g. @, %, /).	–
Serial number	Shows the serial number of the measuring device.	Max. 11-digit character string comprising letters and numbers.	–
Firmware version	Shows the device firmware version installed.	Character string in the format xx.yy.zz	–
Device name	Shows the name of the transmitter.  The name can be found on the nameplate of the transmitter.	Max. 32 characters such as letters or numbers.	–
Order code	Shows the device order code.  The order code can be found on the nameplate of the sensor and transmitter in the "Order code" field.	Character string composed of letters, numbers and certain punctuation marks (e.g. /).	–
Extended order code 1	Shows the 1st part of the extended order code.  The extended order code can also be found on the nameplate of the sensor and transmitter in the "Ext. ord. cd." field.	Character string	–
Extended order code 2	Shows the 2nd part of the extended order code.  The extended order code can also be found on the nameplate of the sensor and transmitter in the "Ext. ord. cd." field.	Character string	–
Extended order code 3	Shows the 3rd part of the extended order code.  The extended order code can also be found on the nameplate of the sensor and transmitter in the "Ext. ord. cd." field.	Character string	–
ENP version	Shows the version of the electronic nameplate (ENP).	Character string	–
PROFIBUS ident number	Displays the PROFIBUS identification number.	0 to FFFF	0x155F
Status PROFIBUS Master Config	Displays the status of the PROFIBUS Master configuration.	<ul style="list-style-type: none"> ■ Active ■ Not active 	–

12.11 Firmware history

Release date	Firmware version	Order code for "Firmware version"	Firmware changes	Documentation type	Documentation
--------------	------------------	-----------------------------------	------------------	--------------------	---------------

-  It is possible to flash the firmware to the current version or the previous version using the service interface.
-  For the compatibility of the firmware version with the previous version, the installed device description files and operating tools, observe the information about the device in the "Manufacturer's information" document.
-  The manufacturer's information is available:
 - In the Download Area of the Endress+Hauser web site: www.endress.com → Downloads
 - Specify the following details:
 - Product root: e.g. 8E2B
The product root is the first part of the order code: see the nameplate on the device.
 - Text search: Manufacturer's information
 - Media type: Documentation – Technical Documentation

13 Maintenance

13.1 Maintenance work

No special maintenance work is required.

13.1.1 Exterior cleaning

When cleaning the exterior of measuring devices, always use cleaning agents that do not attack the surface of the housing or the seals.

13.1.2 Internal cleaning

Observe the following points for CIP and SIP cleaning:

- Use only cleaning agents to which the process-wetted materials are adequately resistant.
- Observe the maximum permitted medium temperature for the measuring device .

13.2 Measuring and test equipment

Endress+Hauser offers a variety of measuring and testing equipment, such as Netilion or device tests.

 Your Endress+Hauser Sales Center can provide detailed information on the services.

List of some of the measuring and testing equipment: →  138

13.3 Endress+Hauser services

Endress+Hauser offers a wide variety of services for maintenance such as recalibration, maintenance service or device tests.

 Your Endress+Hauser Sales Center can provide detailed information on the services.

14 Repair

14.1 General notes

14.1.1 Repair and conversion concept

The Endress+Hauser repair and conversion concept provides for the following:

- The measuring devices have a modular design.
- Spare parts are grouped into logical kits with the associated Installation Instructions.
- Repairs are carried out by Endress+Hauser Service or by appropriately trained customers.
- Certified devices can only be converted to other certified devices by Endress+Hauser Service or at the factory.

14.1.2 Notes for repair and conversion

For repair and conversion of a measuring device, observe the following notes:

- ▶ Use only original Endress+Hauser spare parts.
- ▶ Carry out the repair according to the Installation Instructions.
- ▶ Observe the applicable standards, federal/national regulations, Ex documentation (XA) and certificates.
- ▶ Document all repairs and conversions and enter the details in Netilion Analytics.

14.2 Spare parts

Some interchangeable measuring device components are listed on an overview sign in the connection compartment cover.

The spare part overview sign contains the following information:

- A list of the most important spare parts for the measuring device, including their ordering information.
- The URL to the *Device Viewer* (www.endress.com/deviceviewer):
All the spare parts for the measuring device, along with the order code, are listed here and can be ordered. If available, users can also download the associated Installation Instructions.

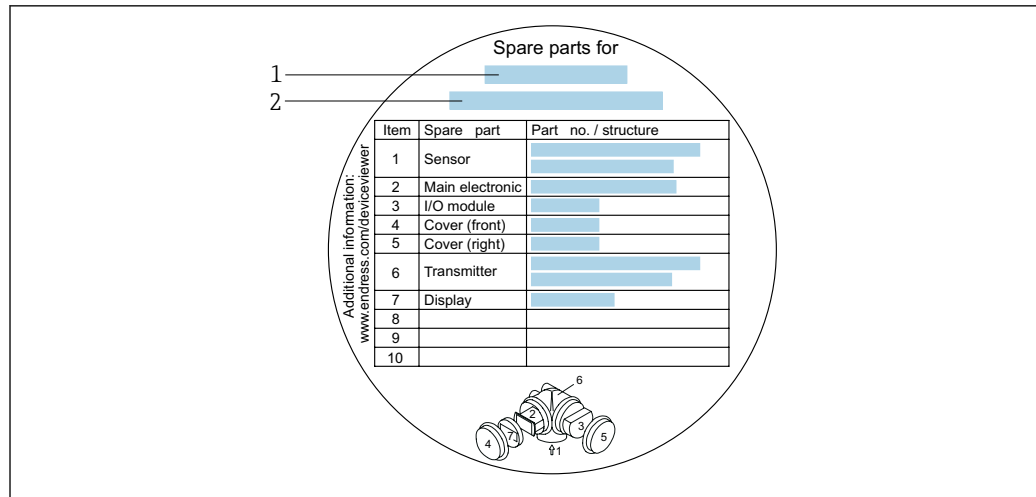

A0032235

24 Example for "Spare part overview sign" in connection compartment cover

- 1 Measuring device name
- 2 Measuring device serial number

- Measuring device serial number:
- Is located on the device nameplate and the spare part overview sign.
 - Can be read out via the **Serial number** parameter (→ 130) in the **Device information** submenu.

14.3 Endress+Hauser services

Endress+Hauser offers a wide range of services.

- Your Endress+Hauser Sales Center can provide detailed information on the services.

14.4 Return

The requirements for safe device return can vary depending on the device type and national legislation.

1. Refer to the web page for information:
<https://www.endress.com/support/return-material>
 ↳ Select the region.
2. If returning the device, pack the device in such a way that it is reliably protected against impact and external influences. The original packaging offers the best protection.

14.5 Disposal

- If required by the Directive 2012/19/EU on waste electrical and electronic equipment (WEEE), the product is marked with the depicted symbol in order to minimize the disposal of WEEE as unsorted municipal waste. Do not dispose of products bearing this marking as unsorted municipal waste. Instead, return them to the manufacturer for disposal under the applicable conditions.

14.5.1 Removing the measuring device

1. Switch off the device.

⚠ WARNING**Danger to persons from process conditions!**

- ▶ Beware of hazardous process conditions such as pressure in the measuring device, high temperatures or aggressive media.
2. Carry out the mounting and connection steps from the "Mounting the measuring device" and "Connecting the measuring device" sections in reverse order. Observe the safety instructions.

14.5.2 Disposing of the measuring device

⚠ WARNING**Danger to personnel and environment from fluids that are hazardous to health.**

- ▶ Ensure that the measuring device and all cavities are free of fluid residues that are hazardous to health or the environment, e.g. substances that have permeated into crevices or diffused through plastic.

Observe the following notes during disposal:



- ▶ Observe valid federal/national regulations.
- ▶ Ensure proper separation and reuse of the device components.



15 Accessories

Various accessories, which can be ordered with the device or subsequently from Endress+Hauser, are available for the device. Detailed information on the order code in question is available from your local Endress+Hauser sales center or on the product page of the Endress+Hauser website: www.endress.com.



15.1 Device-specific accessories

15.1.1 For the transmitter



Accessories	Description
Promass 200 transmitter	<p>Transmitter for replacement or storage. Use the order code to define the following specifications:</p> <ul style="list-style-type: none"> ▪ Approvals ▪ Output ▪ Display/operation ▪ Housing ▪ Software <p> Installation Instructions EA00104D</p> <p> (Order number: 8X2CXX)</p>
Remote display FHX50	<p>FHX50 housing for accommodating a display module .</p> <ul style="list-style-type: none"> ▪ FHX50 housing suitable for: <ul style="list-style-type: none"> ▪ SD02 display module (push buttons) ▪ SD03 display module (touch control) ▪ Length of connecting cable: up to max. 60 m (196 ft) (cable lengths available for order: 5 m (16 ft), 10 m (32 ft), 20 m (65 ft), 30 m (98 ft)) <p>The measuring instrument can be ordered with the FHX50 housing and a display module. The following options must be selected in the separate order codes:</p> <ul style="list-style-type: none"> ▪ Order code for measuring instrument, feature 030: Option L or M "Prepared for FHX50 display" ▪ Order code for FHX50 housing, feature 050 (measuring instrument version): Option A "Prepared for FHX50 display" ▪ Order code for FHX50 housing, depends on the desired display module in feature 020 (display, operation): <ul style="list-style-type: none"> ▪ Option C: for an SD02 display module (push buttons) ▪ Option E: for an SD03 display module (touch control) <p>The FHX50 housing can also be ordered as a retrofit kit. The measuring instrument display module is used in the FHX50 housing. The following options must be selected in the order code for the FHX50 housing:</p> <ul style="list-style-type: none"> ▪ Feature 050 (measuring instrument version): option B "Not prepared for FHX50 display" ▪ Feature 020 (display, operation): option A "None, existing displayed used" <p> Special Documentation SD01007F</p> <p>(Order number: FHX50)</p>



Accessories	Description
Overvoltage protection for 2-wire devices	<p>Ideally, the overvoltage protection module should be ordered directly with the device. See product structure, feature 610 "Accessory mounted", option NA "Overvoltage protection". Separate order necessary only if retrofitting.</p> <ul style="list-style-type: none"> ▪ OVP10: For 1-channel devices (feature 020, option A): ▪ OVP20: For 2-channel devices (feature 020, options B, C, E or G) <p> Special Documentation SD01090F</p> <p>(Order number OVP10: 71128617) (Order number OVP20: 71128619)</p>
Weather protective cover	<p>Is used to protect the measuring instrument from the effects of the weather: e.g. rainwater, excess heating from direct sunlight or extreme cold in winter.</p> <p> Special Documentation SD00333F</p> <p>(Order number: 71162242)</p>

15.1.2 For the sensor



Accessories	Description
Heating jacket	<p>Is used to stabilize the temperature of the fluids in the sensor. Water, water vapor and other non-corrosive liquids are permitted for use as fluids.</p> <p> If using oil as a heating medium, please consult with Endress+Hauser.</p> <p>Heating jackets cannot be used with sensors fitted with a rupture disk.</p> <ul style="list-style-type: none"> ▪ If ordered together with the measuring device: <ul style="list-style-type: none"> Order code for "Accessory enclosed" ▪ Option RB "Heating jacket, G 1/2" female thread" ▪ Option RC "Heating jacket, G 3/4" female thread" ▪ Option RD "Heating jacket, NPT 1/2" female thread" ▪ Option RE "Heating jacket, NPT 3/4" female thread" ▪ If ordered subsequently: <ul style="list-style-type: none"> Use the order code with the product root DK8003. <p> Special Documentation SD02151D</p>

15.2 Communication-specific accessories







Accessories	Description
Commubox FXA291	<p>Connects Endress+Hauser field devices with a CDI interface (= Endress+Hauser Common Data Interface) and the USB port of a computer or laptop.</p> <p> Technical Information TI00405C</p>
Fieldgate FXA42	<p>Transmission of the measured values of connected 4 to 20 mA analog measuring instruments, as well as digital measuring instruments</p> <p> <ul style="list-style-type: none"> ▪ Technical Information TI01297S ▪ Operating Instructions BA01778S ▪ Product page: www.endress.com/fxa42 </p>
Field Xpert SMT50	<p>The Field Xpert SMT50 tablet PC for device configuration enables mobile plant asset management in the non-hazardous areas. It is suitable for commissioning and maintenance staff to manage field instruments with a digital communication interface and to record progress.</p> <p>This tablet PC is designed as an all-in-one solution with a preinstalled driver library and is an easy-to-use, touch-sensitive tool which can be used to manage field instruments throughout their entire life cycle.</p> <p> <ul style="list-style-type: none"> ▪ Technical Information TI01555S ▪ Operating Instructions BA02053S ▪ Product page: www.endress.com/smt50 </p>

Field Xpert SMT70	<p>The Field Xpert SMT70 tablet PC for device configuration enables mobile plant asset management in hazardous and non-hazardous areas. It is suitable for commissioning and maintenance staff to manage field instruments with a digital communication interface and to record progress.</p> <p>This tablet PC is designed as an all-in-one solution with a preinstalled driver library and is an easy-to-use, touch-sensitive tool which can be used to manage the field instruments throughout their entire life cycle.</p> <p> <ul style="list-style-type: none"> ▪ Technical Information TI01342S ▪ Operating Instructions BA01709S ▪ Product page: www.endress.com/smt70 </p>
Field Xpert SMT77	<p>The Field Xpert SMT77 tablet PC for device configuration enables mobile plant asset management in areas categorized as Ex Zone 1.</p> <p> <ul style="list-style-type: none"> ▪ Technical Information TI01418S ▪ Operating Instructions BA01923S ▪ Product page: www.endress.com/smt77 </p>

15.3 Service-specific accessories

Accessories	Description
Applicator	<p>Software for selecting and sizing Endress+Hauser measuring instruments:</p> <ul style="list-style-type: none"> ▪ Choice of measuring instruments for industrial requirements ▪ Calculation of all the necessary data for identifying the optimum flowmeter: e.g. nominal diameter, pressure loss, flow velocity and measurement accuracy. ▪ Graphic display of the calculation results ▪ Determination of the partial order code, administration, documentation and access to all project-related data and parameters over the entire life cycle of a project. <p>Applicator is available: Via the Internet: https://portal.endress.com/webapp/applicator</p>
Netilion	<p>IIoT ecosystem: Unlock knowledge</p> <p>With the Netilion IIoT ecosystem, Endress+Hauser allows you to optimize your plant performance, digitize workflows, share knowledge, and enhance collaboration.</p> <p>Drawing upon decades of experience in process automation, Endress+Hauser offers the process industry an IIoT ecosystem designed to effortlessly extract insights from data. These insights allow process optimization, leading to increased plant availability, efficiency, and reliability - ultimately resulting in a more profitable plant.</p> <p>www.netilion.endress.com</p>
FieldCare	<p>FDT-based plant asset management tool from Endress+Hauser.</p> <p>It can configure all intelligent field units in your system and helps you manage them. By using the status information, it is also a simple but effective way of checking their status and condition.</p> <p> Operating Instructions BA00027S and BA00059S</p>
DeviceCare	<p>Tool to connect and configure Endress+Hauser field devices.</p> <p> Innovation brochure IN01047S</p>

15.4 System components

Accessories	Description
Memograph M graphic data manager	<p>The Memograph M graphic data manager provides information on all the relevant measured variables. Measured values are recorded correctly, limit values are monitored and measuring points analyzed. The data are stored in the 256 MB internal memory and also on a SD card or USB stick.</p> <ul style="list-style-type: none">  Technical Information TI00133R  Operating Instructions BA00247R
Cerabar M	<p>The pressure transmitter for measuring the absolute and gauge pressure of gases, steam and liquids. It can be used to read in the operating pressure value.</p> <ul style="list-style-type: none">  Technical Information TI00426P and TI00436P  Operating Instructions BA00200P and BA00382P
Cerabar S	<p>The pressure transmitter for measuring the absolute and gauge pressure of gases, steam and liquids. It can be used to read in the operating pressure value.</p> <ul style="list-style-type: none">  Technical Information TI00383P  Operating Instructions BA00271P

16 Technical data

16.1 Application

The measuring device is intended only for the flow measurement of liquids and gases.

Depending on the version ordered, the measuring device can also measure potentially explosive, flammable, poisonous and oxidizing media.

To ensure that the device remains in proper operating condition for its service life, use the measuring device only for media against which the process-wetted materials are sufficiently resistant.

16.2 Function and system design

Measuring principle	Mass flow measurement based on the Coriolis measuring principle
Measuring system	<p>The device consists of a transmitter and a sensor.</p> <p>The device is available as a compact version: The transmitter and sensor form a mechanical unit.</p> <p>For information on the structure of the measuring instrument →  13</p>

16.3 Input

Measured variable

Direct measured variables

- Mass flow
- Density
- Temperature

Calculated measured variables

- Volume flow
- Corrected volume flow
- Reference density

Measuring range

Measuring range for liquids

DN		Measuring range full scale values $\dot{m}_{\min(F)}$ to $\dot{m}_{\max(F)}$	
[mm]	[in]	[kg/h]	[lb/min]
8	$\frac{3}{8}$	0 to 2 000	0 to 73.50
15	$\frac{1}{2}$	0 to 6 500	0 to 238.9
25	1	0 to 18 000	0 to 661.5
40	$1\frac{1}{2}$	0 to 45 000	0 to 1 654
50	2	0 to 70 000	0 to 2 573

Measuring range for gases

The full scale value depends on the density and the sound velocity of the gas used. The full scale value can be calculated with the following formulas:

$$\dot{m}_{\max(G)} = \text{Minimum of } (\dot{m}_{\max(F)} \cdot \rho_G \cdot x) \text{ and } (\rho_G \cdot (c_G/2) \cdot d_i^2 \cdot (\pi/4) \cdot 3600 \cdot n)$$

$\dot{m}_{\max(G)}$	Maximum full scale value for gas [kg/h]
$\dot{m}_{\max(F)}$	Maximum full scale value for liquid [kg/h]
$\dot{m}_{\max(G)} < \dot{m}_{\max(F)}$	$\dot{m}_{\max(G)}$ can never be greater than $\dot{m}_{\max(F)}$
ρ_G	Gas density in [kg/m ³] at operating conditions
x	Limitation constant for max. gas flow [kg/m ³]
c_G	Sound velocity (gas) [m/s]
d_i	Measuring tube internal diameter [m]
π	Pi
$n = 2$	Number of measuring tubes



DN		x
[mm]	[in]	[kg/m ³]
8	$\frac{3}{8}$	85
15	$\frac{1}{2}$	110
25	1	125

DN		x
[mm]	[in]	[kg/m ³]
40	1½	125
50	2	125

If calculating the full scale value using the two formulas:

1. Calculate the full scale value with both formulas.
2. The smaller value is the value that must be used.

Recommended measuring range

 Flow limit →  153

Operable flow range

Over 1000 : 1.

Flow rates above the preset full scale value do not override the electronics unit, with the result that the totalizer values are registered correctly.

Input signal

External measured values

To increase the measurement accuracy of certain measured variables or to calculate the corrected volume flow for gases, the automation system can continuously write the operating pressure to the measuring instrument. Endress+Hauser recommends the use of a pressure measuring device for absolute pressure, e.g. Cerabar M or Cerabar S.

 Various pressure transmitters and temperature measuring devices can be ordered from Endress+Hauser: see "Accessories" section →  139

It is recommended to read in external measured values to calculate the following measured variables:

- Mass flow
- Corrected volume flow

Digital communication

The measured values are written by the automation system via PROFIBUS PA.

16.4 Output

Output signal

Pulse/frequency/switch output

Function	Can be configured as pulse, frequency or switch output
Version	Passive, open collector
Maximum input values	<ul style="list-style-type: none"> ▪ DC 35 V ▪ 50 mA
Voltage drop	<ul style="list-style-type: none"> ▪ For ≤ 2 mA: 2 V ▪ For 10 mA: 8 V
Residual current	≤ 0.05 mA
Pulse output	
Pulse width	Configurable: 5 to 2 000 ms
Maximum pulse rate	100 Impulse/s
Pulse value	Configurable

Assignable measured variables	<ul style="list-style-type: none"> ▪ Mass flow ▪ Volume flow ▪ Corrected volume flow
Frequency output	
Output frequency	Configurable: 0 to 1000 Hz
Damping	Configurable: 0 to 999 s
Pulse/pause ratio	1:1
Assignable measured variables	<ul style="list-style-type: none"> ▪ Mass flow ▪ Volume flow ▪ Corrected volume flow ▪ Density ▪ Reference density ▪ Temperature
Switch output	
Switching behavior	Binary, conductive or non-conductive
Switching delay	Configurable: 0 to 100 s
Number of switching cycles	Unlimited
Assignable functions	<ul style="list-style-type: none"> ▪ Off ▪ On ▪ Diagnostic behavior ▪ Limit <ul style="list-style-type: none"> ▪ Mass flow ▪ Volume flow ▪ Corrected volume flow ▪ Density ▪ Reference density ▪ Temperature ▪ Totalizer 1-3 ▪ Flow direction monitoring ▪ Status <ul style="list-style-type: none"> ▪ Partially filled pipe detection ▪ Low flow

PROFIBUS PA

PROFIBUS PA	In accordance with EN 50170 Volume 2, IEC 61158-2 (MBP), galvanically isolated
Data transmission	31.25 kbit/s
Current consumption	16 mA
Permitted supply voltage	9 to 32 V
Bus connection	With integrated reverse polarity protection

Signal on alarm

Depending on the interface, failure information is displayed as follows:

Pulse/frequency/switch output

Pulse output	
Fault mode	Choose from: <ul style="list-style-type: none"> ▪ Actual value ▪ No pulses
Frequency output	

Fault mode	Choose from: <ul style="list-style-type: none"> ▪ Actual value ▪ 0 Hz ▪ Definable value between: 0 to 1250 Hz
Switch output	
Fault mode	Choose from: <ul style="list-style-type: none"> ▪ Current status ▪ Open ▪ Closed

PROFIBUS PA

Status and alarm messages	Diagnostics in accordance with PROFIBUS PA Profile 3.02
Failure current FDE (Fault Disconnection Electronic)	0 mA

Onsite display

Plain text display	With information on cause and remedial measures
Backlight	Additionally for device version with SD03 local display: red lighting indicates a device error.

 Status signal as per NAMUR recommendation NE 107

Interface/protocol

- Via digital communication: PROFIBUS PA
- Via service interface: CDI service interface

Plain text display	With information on cause and remedial measures
---------------------------	---

Low flow cut off The switch points for low flow cut off are user-selectable.

Galvanic isolation All outputs are galvanically isolated from one another.

Protocol-specific data

Manufacturer ID	0x11
Ident number	0x155F
Profile version	3.02
Device description files (GSD, DTM, DD)	Information and files at: <ul style="list-style-type: none"> ▪ www.endress.com → Download Area ▪ https://www.profibus.com
Supported functions	<ul style="list-style-type: none"> ▪ Identification & Maintenance Simple device identification via control system and nameplate ▪ PROFIBUS upload/download Reading and writing parameters is up to ten times faster with PROFIBUS upload/download ▪ Condensed Status Simplest and self-explanatory diagnostic information by categorizing diagnostic messages that occur

Configuration of the device address	<ul style="list-style-type: none"> ▪ DIP switches on the I/O electronics module ▪ Local display ▪ Via operating tools (e.g. FieldCare)
System integration	<p>For information on system integration, see → 57</p> <ul style="list-style-type: none"> ▪ Cyclic data transmission ▪ Block model ▪ Description of the modules

16.5 Power supply

Terminal assignment

Transmitter

Connection version for PROFIBUS PA, pulse/frequency/switch output

<small>A0013570</small>	<small>A0018161</small>
<i>Maximum number of terminals</i>	<i>Maximum number of terminals for order code for "Accessory mounted", option NA "Overvoltage protection"</i>
<p>1 Output 1: PROFIBUS PA 2 Output 2 (passive): pulse/frequency/switch output 3 Ground terminal for cable shield</p>	

Order code for "Output"	Terminal numbers			
	Output 1		Output 2	
	1 (+)	2 (-)	3 (+)	4 (-)
Option G ^{1) 2)}	PROFIBUS PA		Pulse/frequency/switch output (passive)	

- 1) Output 1 must always be used; output 2 is optional.
- 2) PROFIBUS PA with integrated reverse polarity protection.

Supply voltage

Transmitter

An external power supply is required for each output.

The following supply voltage values apply for the outputs available:

Order code for "Output"	Minimum terminal voltage	Maximum terminal voltage
Option G: PROFIBUS PA, pulse/frequency/switch output	≥ DC 9 V	DC 32 V

Power consumption

Transmitter

Order code for "Output; input"	Maximum power consumption
Option G: PROFIBUS PA, pulse/frequency/switch output	<ul style="list-style-type: none"> ▪ Operation with output 1: 512 mW ▪ Operation with output 1 and 2: 2 512 mW

Current consumption

- Power supply failure
- Totalizers stop at the last value measured.
 - Depending on the device version, the configuration is retained in the device memory or in the pluggable data memory (HistoROM DAT).
 - Error messages (incl. total operated hours) are stored.

Electrical connection →  31

Potential equalization

- Terminals
- For device version without integrated overvoltage protection: plug-in spring terminals for wire cross-sections 0.5 to 2.5 mm² (20 to 14 AWG)
 - For device version with integrated overvoltage protection: screw terminals for wire cross-sections 0.2 to 2.5 mm² (24 to 14 AWG)

- Cable entries
- Cable gland: M20 × 1.5 with cable Ø 6 to 12 mm (0.24 to 0.47 in)
 - Thread for cable entry:
 - NPT ½"
 - G ½"

Cable specification →  28

Overvoltage protection The device can be ordered with integrated overvoltage protection for diverse approvals: *Order code for "Accessory mounted", option NA "Overvoltage protection"*

Input voltage range	Values correspond to supply voltage specifications →  145 ¹⁾
Resistance per channel	2 · 0.5 Ω max.
DC sparkover voltage	400 to 700 V
Trip surge voltage	< 800 V
Capacitance at 1 MHz	< 1.5 pF
Nominal discharge current (8/20 µs)	10 kA
Temperature range	-40 to +85 °C (-40 to +185 °F)

1) The voltage is reduced by the amount of the internal resistance $I_{min} \cdot R_i$



 Depending on the temperature class, restrictions apply to the ambient temperature for device versions with overvoltage protection .

 For detailed information on the temperature tables, see the "Safety Instructions" (XA) for the device.

16.6 Performance characteristics

Reference operating conditions

- Error limits based on ISO 11631
- Water
 - +15 to +45 °C (+59 to +113 °F)
 - 2 to 6 bar (29 to 87 psi)
- Data as indicated in the calibration protocol
- Accuracy based on accredited calibration rigs according to ISO 17025

 To obtain measured errors, use the *Applicator* sizing tool →  138

Maximum measurement error

o.r. = of reading; $1 \text{ g/cm}^3 = 1 \text{ kg/l}$; T = medium temperature

Base accuracy

 Design fundamentals →  150

Mass flow and volume flow (liquids)

±0.25 % o.r.

Mass flow (gases)

±0.50 % o.r.

Density (liquids)

Under reference conditions [g/cm ³]	Standard density calibration [g/cm ³]
±0.0005	±0.002

Temperature

±0.5 °C ± 0.005 · T °C (±0.9 °F ± 0.003 · (T – 32) °F)

Zero point stability

DN		Zero point stability	
[mm]	[in]	[kg/h]	[lb/min]
8	$\frac{3}{8}$	0.24	0.0088
15	$\frac{1}{2}$	0.78	0.0287
25	1	2.16	0.0794
40	$1\frac{1}{2}$	5.40	0.1985
50	2	8.40	0.3087

Flow values

Flow values as turndown parameters depending on nominal diameter.

SI units

DN	1:1	1:10	1:20	1:50	1:100	1:500
[mm]	[kg/h]	[kg/h]	[kg/h]	[kg/h]	[kg/h]	[kg/h]
8	2000	200	100	40	20	4
15	6500	650	325	130	65	13
25	18000	1800	900	360	180	36
40	45000	4500	2250	900	450	90
50	70000	7000	3500	1400	700	140

US units

DN	1:1	1:10	1:20	1:50	1:100	1:500
[inch]	[lb/min]	[lb/min]	[lb/min]	[lb/min]	[lb/min]	[lb/min]
$\frac{3}{8}$	73.50	7.350	3.675	1.470	0.735	0.147
$\frac{1}{2}$	238.9	23.89	11.95	4.778	2.389	0.478
1	661.5	66.15	33.08	13.23	6.615	1.323
1½	1654	165.4	82.70	33.08	16.54	3.308
2	2573	257.3	128.7	51.46	25.73	5.146

Accuracy of outputs

The outputs have the following base accuracy specifications.

Pulse/frequency output

o.r. = of reading

Accuracy	Max. ±100 ppm o.r.
-----------------	--------------------

Repeatability o.r. = of reading; 1 g/cm³ = 1 kg/l; T = medium temperature

Base repeatability

 Design fundamentals →  150

Mass flow and volume flow (liquids)

±0.125 % o.r.

Mass flow (gases)

±0.25 % o.r. (up to a Mach number of 0.2)

Density (liquids)

±0.00025 g/cm³

Temperature

±0.25 °C ± 0.0025 · T °C (±0.45 °F ± 0.0015 · (T-32) °F)

Response time

- The response time depends on the configuration (damping).
- Response time in the event of erratic changes in the measured variable: After 500 ms → 95 % of full scale value

Influence of ambient temperature

Pulse/frequency output

o.r. = of reading

Temperature coefficient	Max. ±100 ppm o.r.
--------------------------------	--------------------

Influence of medium temperature

Mass flow

o.f.s. = of full scale value

If there is a difference between the temperature during zero adjustment and the process temperature, the additional measurement error of the sensors is typically ±0.0002 %o.f.s./°C (±0.0001 % o. f.s./°F).

The influence is reduced when the zero adjustment is performed at process temperature.

Density

If there is a difference between the density calibration temperature and the process temperature, the measurement error of the sensors is typically ±0.0001 g/cm³/°C (±0.00005 g/cm³/°F). Field density adjustment is possible.

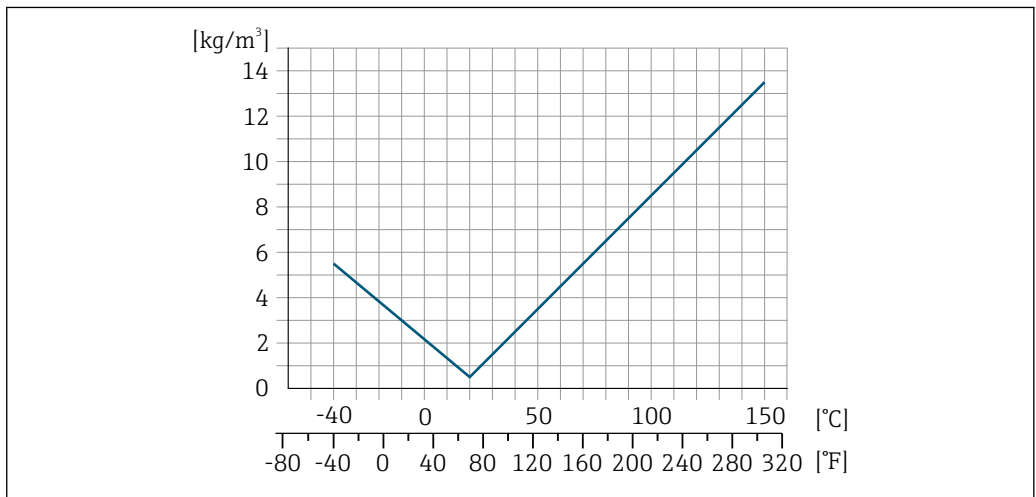

25 Field density adjustment, for example at +20 °C (+68 °F)

Temperature

±0.005 · T °C (± 0.005 · (T - 32) °F)

Influence of medium pressure

The following shows how the process pressure (gauge pressure) affects the accuracy of the mass flow.

o.r. = of reading



It is possible to compensate for the effect by:

- Reading in the current pressure measured value via the current input or a digital input.
- Specifying a fixed value for the pressure in the device parameters.



Operating Instructions .

DN		[% o.r./bar]	[% o.r./psi]
[mm]	[in]		
8	3/8	no influence	
15	1/2	no influence	

DN		[% o.r./bar]	[% o.r./psi]
[mm]	[in]		
25	1	no influence	
40	1½	no influence	
50	2	-0.009	-0.0006

Design fundamentals

o.r. = of reading, o.f.s. = of full scale value

BaseAccu = base accuracy in % o.r., BaseRepeat = base repeatability in % o.r.

MeasValue = measured value; ZeroPoint = zero point stability

Calculation of the maximum measured error as a function of the flow rate

Flow rate	Maximum measured error in % o.r.
$\geq \frac{\text{ZeroPoint}}{\text{BaseAccu}} \cdot 100$ <small>A0021332</small>	$\pm \text{BaseAccu}$ <small>A0021339</small>
$< \frac{\text{ZeroPoint}}{\text{BaseAccu}} \cdot 100$ <small>A0021333</small>	$\pm \frac{\text{ZeroPoint}}{\text{MeasValue}} \cdot 100$ <small>A0021334</small>

Calculation of the maximum repeatability as a function of the flow rate

Flow rate	Maximum repeatability in % o.r.
$\geq \frac{4/3 \cdot \text{ZeroPoint}}{\text{BaseAccu}} \cdot 100$ <small>A0021341</small>	$\pm 1/2 \cdot \text{BaseAccu}$ <small>A0021343</small>
$< \frac{4/3 \cdot \text{ZeroPoint}}{\text{BaseAccu}} \cdot 100$ <small>A0021342</small>	$\pm 2/3 \cdot \frac{\text{ZeroPoint}}{\text{MeasValue}} \cdot 100$ <small>A0021344</small>

Example of maximum measurement error

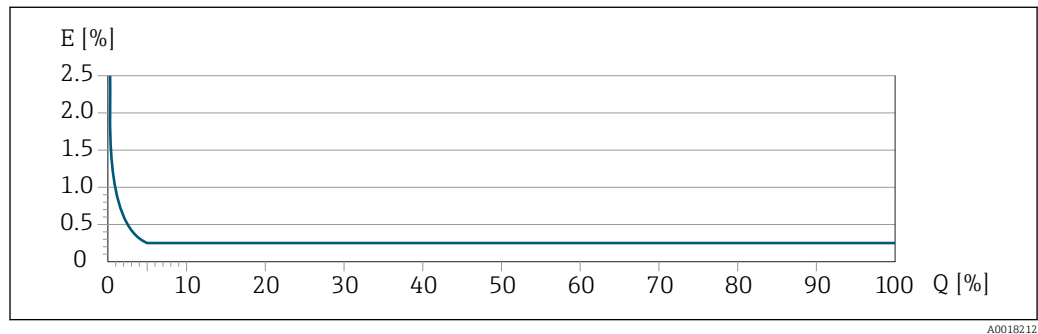



E Maximum measurement error in % o.r. (example: DN 25)
 Q Flow rate in % of maximum full scale value

16.7 Mounting



Mounting requirements

→ 20

16.8 Environment

Ambient temperature range →  22 →  22

Temperature tables

-  Observe the interdependencies between the permitted ambient and fluid temperatures when operating the device in hazardous areas.
-  For detailed information on the temperature tables, see the separate document entitled "Safety Instructions" (XA) for the device.

Storage temperature -40 to +80 °C (-40 to +176 °F), preferably at +20 °C (+68 °F)

Climate class DIN EN 60068-2-38 (test Z/AD)

Degree of protection

Transmitter

- Standard: IP66/67, Type 4X enclosure, suitable for pollution degree 4
- When the housing is open: IP20, Type 1 enclosure, suitable for pollution degree 2
- Display module: IP20, Type 1 enclosure, suitable for pollution degree 2

Sensor

IP66/67, Type 4X enclosure, suitable for pollution degree 4

Device plug

IP67, only in screwed situation

Shock and vibration resistance

Vibration sinusoidal, in accordance with IEC 60068-2-6

- 2 to 8.4 Hz, 3.5 mm peak
- 8.4 to 2 000 Hz, 1 g peak

Vibration broad-band random, according to IEC 60068-2-64

- 10 to 200 Hz, 0.003 g²/Hz
- 200 to 2 000 Hz, 0.001 g²/Hz
- Total: 1.54 g rms

Shock half-sine, according to IEC 60068-2-27

6 ms 30 g

Rough handling shocks according to IEC 60068-2-31

Internal cleaning

- CIP cleaning
- SIP cleaning

Options

Oil- and grease-free version for wetted parts, without declaration
Order code for "Service", option HA ³⁾

³⁾ The cleaning refers to the measuring instrument only. Any accessories supplied are not cleaned.

Electromagnetic compatibility (EMC)

- As per IEC/EN 61326 and NAMUR Recommendation 21 (NE 21)
- As per IEC/EN 61000-6-2 and IEC/EN 61000-6-4



Details are provided in the Declaration of Conformity.



This unit is not intended for use in residential environments and cannot guarantee adequate protection of the radio reception in such environments.

16.9 Process

Medium temperature range -40 to +150 °C (-40 to +302 °F)

Medium density 0 to 2 000 kg/m³ (0 to 125 lb/cf)

Pressure-temperature ratings



For an overview of the pressure-temperature ratings for the process connections, see the Technical Information

Sensor housing

The sensor housing is filled with dry nitrogen gas and protects the electronics and mechanics inside.



If a measuring tube fails (e.g. due to process characteristics like corrosive or abrasive fluids), the fluid will initially be contained by the sensor housing.

In the event of a tube failure, the pressure level inside the sensor housing will rise according to the operating process pressure. If the user judges that the sensor housing burst pressure does not provide an adequate safety margin, the device can be fitted with a rupture disk. This prevents excessively high pressure from forming inside the sensor housing. Therefore, the use of a rupture disk is strongly recommended in applications involving high gas pressures, and particularly in applications in which the process pressure is greater than 2/3 of the sensor housing burst pressure.

Burst pressure of the sensor housing







If the device is fitted with a rupture disk (order code for "Sensor option", option CA "Rupture disk"), the rupture disk trigger pressure is decisive .

The sensor housing burst pressure refers to a typical internal pressure which is reached prior to mechanical failure of the sensor housing and which was determined during type testing. The corresponding type test declaration can be ordered with the device (order code for "Additional approval", option LN "Sensor housing burst pressure, type test").

DN		Sensor housing burst pressure	
[mm]	[in]	[bar]	[psi]
8	3/8	250	3 620
15	1/2	250	3 620
25	1	250	3 620
40	1 1/2	200	2 900
50	2	180	2 610
80	3	120	1 740



For information on the dimensions: see the "Mechanical construction" section of the "Technical Information" document

Rupture disk	<p>To increase the level of safety, a device version with a rupture disk with a trigger pressure of 10 to 15 bar (145 to 217.5 psi) can be used (order code for "Sensor option", option CA "rupture disk").</p> <p>The use of rupture disks cannot be combined with the separately available heating jacket.</p>
Flow limit	<p>Select the nominal diameter by optimizing between the required flow range and permissible pressure loss.</p> <p> For an overview of the full scale values for the measuring range, see the "Measuring range" section →  141</p> <ul style="list-style-type: none"> ▪ The minimum recommended full scale value is approx. 1/20 of the maximum full scale value ▪ In most applications, 20 to 50 % of the maximum full scale value can be considered ideal ▪ A low full scale value must be selected for abrasive media (such as liquids with entrained solids): flow velocity < 1 m/s (< 3 ft/s). ▪ For gas measurement the following rules apply: <ul style="list-style-type: none"> ▪ The flow velocity in the measuring tubes should not exceed half the sound velocity (0.5 Mach). ▪ The maximum mass flow depends on the density of the gas: formula <p> To calculate the flow limit, use the <i>Applicator</i> sizing tool →  138</p>
Pressure loss	<p> To calculate the pressure loss, use the <i>Applicator</i> sizing tool →  138</p>
System pressure	→  22

16.10 Mechanical construction

Design, dimensions	<p> For the dimensions and installation lengths of the device, see the "Technical Information" document, "Mechanical construction" section</p>
Weight	<p>All values (weight exclusive of packaging material) refer to devices with EN/DIN PN 40 flanges.</p>

Weight in SI units

DN [mm]	Weight [kg]
8	5
15	5.5
25	7
40	11
50	16

Weight in US units

DN [in]	Weight [lbs]
3/8	11
1/2	12
1	15
1 1/2	24
2	35

Materials

Transmitter housing

- Order code for "Housing", option C "Compact, aluminum coated":
Aluminum, AlSi10Mg, coated
- Window material: glass

Cable entries/cable glands

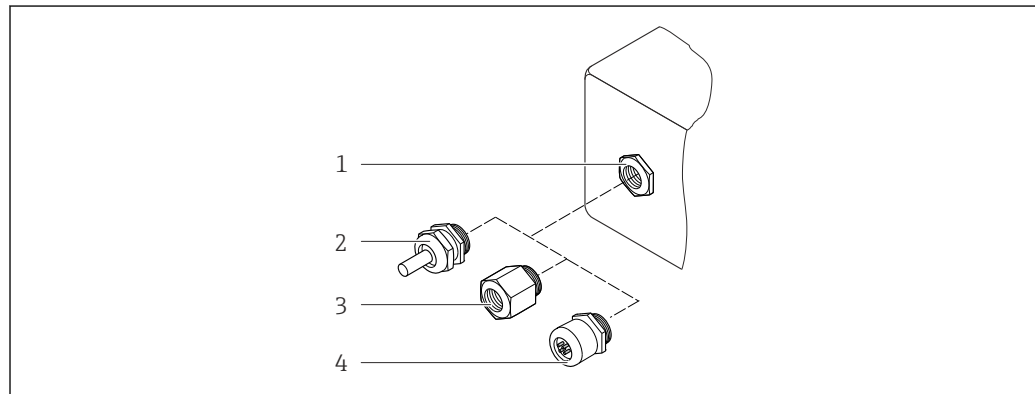

26 Possible cable entries/cable glands

- 1 Female thread M20 × 1.5
- 2 Cable gland M20 × 1.5
- 3 Adapter for cable entry with female thread G 1/2" or NPT 1/2"
- 4 Device plug

Order code for "Housing", option C "GT20 dual compartment, aluminum coated"

Cable entry/cable gland	Type of protection	Material
Cable gland M20 × 1.5	<ul style="list-style-type: none"> ■ Non-hazardous area ■ Ex ia ■ Ex ic 	Plastic
	Adapter for cable entry with female thread G 1/2"	Nickel-plated brass
Adapter for cable entry with female thread NPT 1/2"	Non-hazardous area and hazardous area (except for CSA Ex d/XP)	Nickel-plated brass
Thread NPT 1/2" via adapter	Non-hazardous area and hazardous area	

Device plug

Electrical connection	Material
Plug M12x1	<ul style="list-style-type: none"> ▪ Socket: stainless steel, 1.4401/316 ▪ Contact housing: plastic, PUR, black ▪ Contacts: metal, CuZn, gold-plated ▪ Threaded connection seal: NBR

Sensor housing



- Acid and alkali-resistant outer surface
- Stainless steel 1.4301 (304)

Measuring tubes

Stainless steel, 1.4539 (904L); manifold: stainless steel, 1.4404 (316L)

Process connections

- Flanges according to EN 1092-1 (DIN2501) / according to ASME B 16.5 / as per JIS B2220:
Stainless steel, 1.4404 (F316/F316L)
- All other process connections:
Stainless steel, 1.4404 (316/316L)

 Available process connections →  156

Seals

Welded process connections without internal seals

Accessories*Protective cover*

Stainless steel, 1.4404 (316L)

Remote display FHX50

Housing material:

- Plastic PBT
- Stainless steel CF-3M (316L, 1.4404)

Process connections

- Fixed flange connections:
 - EN 1092-1 (DIN 2501) flange
 - EN 1092-1 (DIN 2512N) flange
 - NAMUR lengths in accordance with NE 132
 - ASME B16.5 flange
 - JIS B2220 flange
 - DIN 11864-2 Form A flange, DIN 11866 series A, flange with notch
- Clamp connections:
 - Tri-Clamp (OD tubes), DIN 11866 series C
- Thread:
 - DIN 11851 thread, DIN 11866 series A
 - SMS 1145 thread
 - ISO 2853 thread, ISO 2037
 - DIN 11864-1 Form A thread, DIN 11866 series A
- VCO connections:
 - 8-VCO-4
 - 12-VCO-4

 Process connection materials

Surface roughness

All data refer to parts in contact with the medium.

The following surface roughness categories can be ordered:

Category	Method	Option(s) order code "Measuring tube mat., wetted surface"
Not polished	–	SA
$Ra \leq 0.76 \mu\text{m}$ (30 μin) ¹⁾	Mechanically polished ²⁾	SB
$Ra \leq 0.76 \mu\text{m}$ (30 μin) ¹⁾	Mechanically polished ²⁾ , welds in as-welded condition	SJ
$Ra \leq 0.38 \mu\text{m}$ (15 μin) ¹⁾	Mechanically polished ²⁾	SC
$Ra \leq 0.38 \mu\text{m}$ (15 μin) ¹⁾	Mechanically polished ²⁾ , welds in as-welded condition	SK

1) Ra according to ISO 21920

2) Except for inaccessible welds between pipe and manifold

16.11 Operability

Languages

Can be operated in the following languages:

- Via local display:
 - English, German, French, Spanish, Italian, Dutch, Portuguese, Polish, Russian, Swedish, Turkish, Chinese, Japanese, Bahasa (Indonesian), Vietnamese, Czech
- Via "FieldCare" operating tool:
 - English, German, French, Spanish, Italian, Chinese, Japanese

Onsite operation

Via display module



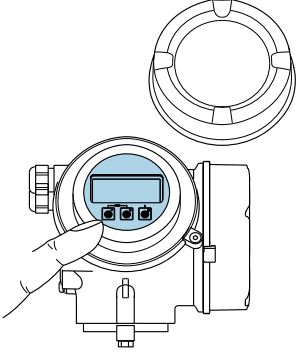
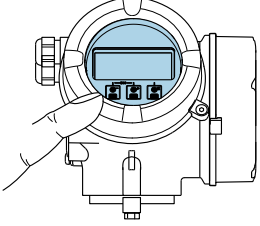



Two display modules are available:

Order code for "Display; Operation", option C "SD02"	Order code for "Display; Operation", option E "SD03"
	
1 Operation with pushbuttons	1 Operation with touch control

Display elements

- 4-line, illuminated, graphic display
- White background lighting; switches to red in event of device errors
- Format for displaying measured variables and status variables can be individually configured



Operating elements

- Operation with 3 push buttons with open housing: , , 
- or
- External operation via touch control (3 optical keys) without opening the housing: , , 
- Operating elements also accessible in the various zones of the hazardous area

Additional functionality

- Data backup function
The device configuration can be saved in the display module.
- Data comparison function
The device configuration saved in the display module can be compared to the current device configuration.
- Data transfer function
The transmitter configuration can be transmitted to another device using the display module.

Via remote display FHX50

 The remote display FHX50 can be ordered as an optional extra →  136.

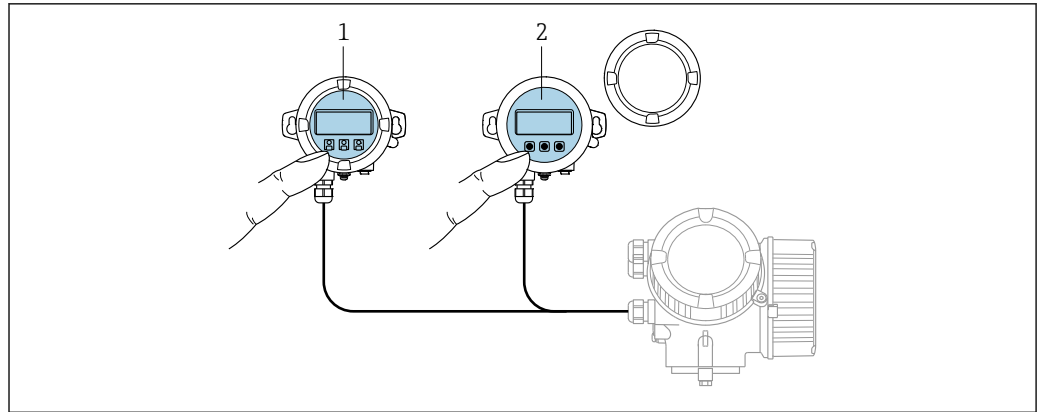

A0032215

27 FHX50 operating options

- 1 SD02 display and operating module, push buttons: cover must be opened for operation
- 2 SD03 display and operating module, optical buttons: operation possible through cover glass

Display and operating elements

The display and operating elements correspond to those of the display module .

Remote operation → 51

Service interface → 52

16.12 Certificates and approvals

Current certificates and approvals for the product are available at www.endress.com on the relevant product page:

1. Select the product using the filters and search field.
2. Open the product page.
3. Select **Downloads**.

CE mark The device meets the legal requirements of the applicable EU Directives. These are listed in the corresponding EU Declaration of Conformity along with the standards applied.
Endress+Hauser confirms successful testing of the device by affixing to it the CE mark.

UKCA marking The device meets the legal requirements of the applicable UK regulations (Statutory Instruments). These are listed in the UKCA Declaration of Conformity along with the designated standards. By selecting the order option for UKCA marking, Endress+Hauser confirms a successful evaluation and testing of the device by affixing the UKCA mark.

Contact address Endress+Hauser UK:
Endress+Hauser Ltd.
Floats Road
Manchester M23 9NF
United Kingdom
www.uk.endress.com

RCM marking The measuring system meets the EMC requirements of the "Australian Communications and Media Authority (ACMA)".

Ex-approval	The devices are certified for use in hazardous areas and the relevant safety instructions are provided in the separate "Safety Instructions" (XA) document. Reference is made to this document on the nameplate.
Hygienic compatibility	<ul style="list-style-type: none"> ■ 3-A approval <ul style="list-style-type: none"> ■ Only measuring instruments with the order code for "Additional approval", option LP "3A" have 3-A approval. ■ The 3-A approval refers to the measuring instrument. ■ When installing the measuring instrument, ensure that no liquid can accumulate on the outside of the measuring instrument. A remote display module must be installed in accordance with the 3-A Standard. ■ Accessories (e.g. heating jacket, weather protection cover, wall holder unit) must be installed in accordance with the 3-A Standard. Each accessory can be cleaned. Disassembly may be necessary under certain circumstances. ■ EHEDG-tested Only devices with the order code for "Additional approval", option LT "EHEDG" have been tested and meet the requirements of the EHEDG. To meet the requirements for EHEDG certification, the device must be used with process connections in accordance with the EHEDG position paper entitled "Easy cleanable Pipe couplings and Process connections" (www.ehedg.org). To meet the requirements for EHEDG certification, the device must be installed in a position that ensures drainability. <p> Observe the special installation instructions</p>
Pharmaceutical compatibility	<ul style="list-style-type: none"> ■ FDA 21 CFR 177 ■ USP <87> ■ USP <88> Class VI 121 °C ■ TSE/BSE Certificate of Suitability
Certification PROFIBUS	<p>PROFIBUS interface</p> <p>The measuring device is certified and registered by the PNO (PROFIBUS Nutzerorganisation e.V./PROFIBUS User Organization). The measuring system meets all the requirements of the following specifications:</p> <ul style="list-style-type: none"> ■ Certified according to PA Profile 3.02 ■ The device can also be operated with certified devices of other manufacturers (interoperability)
Pressure Equipment Directive	<ul style="list-style-type: none"> ■ With the marking <ul style="list-style-type: none"> a) PED/G1/x (x = category) or b) PESR/G1/x (x = category) on the sensor nameplate, Endress+Hauser confirms compliance with the "Essential Safety Requirements" <ul style="list-style-type: none"> a) specified in Annex I of the Pressure Equipment Directive 2014/68/EU or b) Schedule 2 of Statutory Instruments 2016 No. 1105. ■ Devices not bearing this marking (without PED or PESR) are designed and manufactured according to sound engineering practice. They meet the requirements of <ul style="list-style-type: none"> a) Art. 4 Para. 3 of the Pressure Equipment Directive 2014/68/EU or b) Part 1, Para. 8 of Statutory Instruments 2016 No. 1105. The scope of application is indicated <ul style="list-style-type: none"> a) in diagrams 6 to 9 in Annex II of the Pressure Equipment Directive 2014/68/EU or b) Schedule 3, Para. 2 of Statutory Instruments 2016 No. 1105.

External standards and guidelines

- EN 60529
Degrees of protection provided by enclosures (IP code)
- IEC/EN 60068-2-6
Environmental influences: Test procedure - Test Fc: vibrate (sinusoidal).
- IEC/EN 60068-2-31
Environmental influences: Test procedure - Test Ec: shocks due to rough handling, primarily for devices.
- EN 61010-1
Safety requirements for electrical equipment for measurement, control and laboratory use - general requirements
- EN 61326-1/-2-3
EMC requirements for electrical equipment for measurement, control and laboratory use
- IEC 61508
Functional safety of electrical/electronic/programmable electronic safety-related systems
- NAMUR NE 21
Electromagnetic compatibility (EMC) of industrial process and laboratory control equipment
- NAMUR NE 32
Data retention in the event of a power failure in field and control instruments with microprocessors
- NAMUR NE 43
Standardization of the signal level for the breakdown information of digital transmitters with analog output signal.
- NAMUR NE 53
Software of field devices and signal-processing devices with digital electronics
- NAMUR NE 80
The application of the pressure equipment directive to process control devices
- NAMUR NE 105
Specifications for integrating fieldbus devices in engineering tools for field devices
- NAMUR NE 107
Self-monitoring and diagnosis of field devices
- NAMUR NE 131
Requirements for field devices for standard applications
- NAMUR NE 132
Coriolis mass meter
- ETSI EN 300 328
Guidelines for 2.4 GHz radio components.
- EN 301489
Electromagnetic compatibility and radio spectrum matters (ERM).

16.13 Application packages

Many different application packages are available to enhance the functionality of the device. Such packages might be needed to address safety aspects or specific application requirements.

The application packages can be ordered with the device or subsequently from Endress+Hauser. Detailed information on the order code in question is available from your local Endress+Hauser sales center or on the product page of the Endress+Hauser website: www.endress.com.



Detailed information on the application packages:
Special Documentation → 162

Diagnostic functionality

Order code for "Application package", option EA "Extended HistoROM"

Comprises extended functions concerning the event log and the activation of the measured value memory.

Event log:

Memory volume is extended from 20 message entries (standard version) to up to 100 entries.

Data logging (line recorder):

- Memory capacity for up to 1000 measured values is activated.
- 250 measured values can be output via each of the 4 memory channels. The recording interval can be defined and configured by the user.
- Measured value logs can be accessed via the local display or operating tool e.g. FieldCare, DeviceCare or Web server.



For detailed information, see the Operating Instructions for the device.

Heartbeat Technology

Order code for "Application package", option EB "Heartbeat Verification + Monitoring"

Heartbeat Verification

Meets the requirement for traceable verification to DIN ISO 9001:2008 Chapter 7.6 a) "Control of monitoring and measuring equipment".

- Functional testing in the installed state without interrupting the process.
- Traceable verification results on request, including a report.
- Simple testing process via local operation or other operating interfaces.
- Clear measuring point assessment (pass/fail) with high test coverage within the framework of manufacturer specifications.
- Extension of calibration intervals according to operator's risk assessment.



For detailed information, see the Special Documentation for the device.

Petroleum & locking function

Order code for "Application package", option EM "Petroleum & locking function"

The most important parameters for the Oil & Gas Industry can be calculated and displayed with this application package. It is also possible to lock the settings.

- Corrected volume flow and calculated reference density in accordance with the "API Manual of Petroleum Measurement Standards, Chapter 11.1"
- Water content, based on density measurement
- Weighted mean of the density and temperature



For detailed information, see the Special Documentation for the device.

16.14 Accessories



Overview of accessories available to order → 136

16.15 Supplemental documentation



For an overview of the scope of the associated Technical Documentation, refer to the following:

- *Device Viewer* (www.endress.com/deviceviewer): Enter the serial number from the nameplate
- *Endress+Hauser Operations app*: Enter serial number from nameplate or scan matrix code on nameplate.

Standard documentation **Brief operating instructions**

Brief Operating Instructions for the sensor

Measuring instrument	Documentation code
Proline Promass E	KA01260D

Brief Operating Instructions for transmitter

Measuring device	Documentation code
Proline Promass 200	KA01269D

Technical information

Measuring device	Documentation code
Promass E 200	TI01300D



Supplementary device-
dependent documentation **Safety instructions**

Contents	Documentation code
ATEX/IECEX Ex i	XA00144D
ATEX/IECEX Ex d	XA00143D
ATEX/IECEX Ex nA	XA00145D
cCSAus IS	XA00151D
cCSAus XP	XA00152D
INMETRO Ex i	XA01300D
INMETRO Ex d	XA01305D
INMETRO Ex nA	XA01306D
NEPSI Ex i	XA00156D
NEPSI Ex d	XA00155D
NEPSI Ex nA	XA00157D
NEPSI Ex i	XA1755D
NEPSI Ex d	XA1754D
NEPSI Ex nA	XA1756D
JPN Ex d	XA01763D

Special documentation

Contents	Documentation code
Information on the Pressure Equipment Directive	SD01614D
Display and operating module FHX50	SD01007F
Heartbeat Technology	SD01850D

Installation instructions

Contents	Note
Installation instructions for spare part sets and accessories	<ul style="list-style-type: none"><li data-bbox="1026 315 1524 371">▪ Access the overview of all the available spare part sets via <i>Device Viewer</i> →  133<li data-bbox="1026 371 1524 427">▪ Accessories available for order with Installation Instructions →  136

Index

- 0 ... 9**
- 3-A approval 159
- A**
- Access authorization to parameters
 - Read access 50
 - Write access 50
 - Access code 50
 - Incorrect input 50
 - Adapting the diagnostic behavior 110
 - Ambient conditions
 - Shock and vibration resistance 151
 - Storage temperature 151
 - Ambient temperature
 - Influence 149
 - Analog Input module 58
 - Analog Output module 61
 - Application 140
 - Application packages 160
 - Applicator 141
 - Approvals 158
- C**
- Cable entries
 - Technical data 146
 - Cable entry
 - Degree of protection 35
 - CE mark 10, 158
 - Certificates 158
 - Certification PROFIBUS 159
 - cGMP 159
 - Checklist
 - Post-connection check 36
 - Post-installation check 27
 - CIP cleaning 151
 - Cleaning
 - CIP cleaning 132
 - Exterior cleaning 132
 - Internal cleaning 132
 - SIP cleaning 132
 - Climate class 151
 - Commissioning 64
 - Advanced settings 75
 - Configuring the measuring instrument 65
 - Compatibility with previous model 56
 - Connecting cable 28
 - Connecting the measuring instrument 31
 - Connection
 - see Electrical connection
 - Connection examples, potential equalization 33
 - Connection preparations 31
 - Connection tools 28
 - Context menu
 - Calling up 46
 - Closing 46
 - Explanation 46
 - Current consumption 146
 - Cyclic data transmission 57
- D**
- Date of manufacture 15, 16
 - Declaration of Conformity 10
 - Defining the access code 93
 - Degree of protection 35, 151
 - Density adjustment 76
 - Design
 - Operating menu 38
 - Design fundamentals
 - Measurement error 150
 - Repeatability 150
 - Device components 13
 - Device description files 56
 - Device locking, status 96
 - Device master file
 - GSD 56
 - Device name
 - Sensor 16
 - Transmitter 15
 - Device repair 133
 - Device revision 56
 - Device type code 56
 - Device Viewer 133
 - DeviceCare 54
 - Device description file 56
 - Diagnosis
 - Symbols 106
 - Diagnostic behavior
 - Explanation 107
 - Symbols 107
 - Diagnostic information
 - Design, description 107, 109
 - DeviceCare 108
 - FieldCare 108
 - Local display 106
 - Overview 113
 - Remedial measures 113
 - Diagnostic message 106
 - Diagnostics list 126
 - DIP switch
 - see Write protection switch
 - Direct access 47
 - Disabling write protection 93
 - Discrete Input module 61
 - Discrete Output module 62
 - Display
 - see Local display
 - Display area
 - For operational display 40
 - In the navigation view 42
 - Display values
 - For locking status 96
 - Displaying the measured value history 101

- Disposal 134
- Document
 - Function 6
 - Symbols 6
- Document function 6
- Down pipe 20
- E**
- EHEDG-tested 159
- Electrical connection
 - Commubox FXA291 52
 - Degree of protection 35
 - Measuring instrument 28
 - Operating tools
 - Via PROFIBUS PA network 51
 - Via service interface (CDI) 52
- Electromagnetic compatibility 152
- EMPTY_MODULE module 63
- Enabling write protection 93
- Enabling/disabling the keypad lock 51
- Endress+Hauser services
 - Maintenance 132
 - Repair 134
- Error messages
 - see Diagnostic messages
- Event logbook 126
- Events list 126
- Ex-approval 159
- Extended order code
 - Sensor 16
 - Transmitter 15
- Exterior cleaning 132
- F**
- FDA 159
- Field of application
 - Residual risks 10
- FieldCare 52
 - Device description file 56
 - Establishing a connection 53
 - Function 52
 - User interface 54
- Filtering the event logbook 127
- Firmware
 - Release date 56
 - Version 56
- Firmware history 131
- Flow direction 21, 25
- Flow limit 153
- Food Contact Materials Regulation 159
- Function range
 - SIMATIC PDM 55
- Functions
 - see Parameter
- G**
- Galvanic isolation 144
- H**
- Hardware write protection 94
- Help text
 - Calling up 48
 - Closing 48
 - Explanation 48
- HistoROM 90
- Hygienic compatibility 159
- I**
- I/O electronics module 13, 31
- Identifying the measuring instrument 14
- Incoming acceptance 14
- Indication
 - Current diagnostic event 125
 - Previous diagnostic event 125
- Influence
 - Ambient temperature 149
 - Medium pressure 149
 - Medium temperature 149
- Information about this document 6
- Inlet runs 22
- Input screen 44
- Input variables 141
- Inspection
 - Connection 36
 - Installation 27
 - Received goods 14
- Installation 20
- Installation dimensions 22
- Installation point 20
- Intended use 9
- Internal cleaning 132, 151
- L**
- Languages, operation options 156
- Line recorder 101
- Local display
 - Editing view 43
 - Navigation view 42
 - see Diagnostic message
 - see In alarm condition
 - see Operational display
- Low flow cut off 144
- M**
- Main electronics module 13
- Maintenance work 132
- Managing the device configuration 90
- Manufacturer ID 56
- Materials 154
- Maximum measurement error 147
- Measured variables
 - see Process variables
- Measurement accuracy 147
- Measuring and test equipment 132
- Measuring device
 - Conversion 133
 - Disposal 135
 - Mounting the sensor 25
 - Preparing for electrical connection 31

- Removing 134
 - Repairs 133
 - Structure 13
 - Switching on 64
 - Measuring instrument
 - Configuring 65
 - Preparing for mounting 25
 - Measuring principle 140
 - Measuring range
 - For gases 141
 - For liquids 141
 - Measuring range, recommended 153
 - Measuring system 140
 - Medium density 152
 - Medium pressure
 - Influence 149
 - Medium temperature
 - Influence 149
 - Menu
 - Diagnostics 125
 - Setup 66
 - Menus
 - For measuring instrument configuration 65
 - For specific settings 75
 - Module
 - Analog Input 58
 - Analog output 61
 - Discrete Input 61
 - Discrete Output 62
 - EMPTY_MODULE 63
 - Totalizer
 - SET_TOT_TOTAL 60
 - SETTOT_MODETOT_TOTAL 60
 - TOTAL 59
 - Mounting dimensions
 - see Installation dimensions
 - Mounting preparations 25
 - Mounting requirements
 - Down pipe 20
 - Inlet and outlet runs 22
 - Installation dimensions 22
 - Installation point 20
 - Orientation 21
 - Rupture disk 24
 - Sensor heating 23
 - Static pressure 22
 - Thermal insulation 22
 - Vibrations 23
 - Mounting tools 25
- N**
- Nameplate
 - Sensor 16
 - Transmitter 15
 - Navigation path (navigation view) 42
 - Navigation view
 - In the submenu 42
 - In the wizard 42
 - Netilion 132
- Numeric editor 43
- O**
- Onsite display 157
 - Operable flow range 142
 - Operating elements 45, 107
 - Operating keys
 - see Operating elements
 - Operating menu
 - Design 38
 - Menus, submenus 38
 - Submenus and user roles 39
 - Operating philosophy 39
 - Operation 96
 - Operation options 37
 - Operational display 40
 - Operational safety 10
 - Order code 15, 16
 - Orientation (vertical, horizontal) 21
 - Outlet runs 22
 - Output signal 142
 - Output variables 142
- P**
- Packaging disposal 19
 - Parameter settings
 - Administration (Submenu) 89
 - Communication (Submenu) 69
 - Configuration backup display (Submenu) 90
 - Data logging (Submenu) 101
 - Density adjustment (Wizard) 76
 - Device information (Submenu) 129
 - Diagnostics (Menu) 125
 - Display (Submenu) 87
 - Display (Wizard) 70
 - Low flow cut off (Wizard) 72
 - Medium selection (Submenu) 69
 - Output values (Submenu) 99
 - Partially filled pipe detection (Wizard) 73, 74
 - Process variables (Submenu) 97
 - Pulse/frequency/switch output (Wizard)
 - 79, 80, 81, 83
 - Sensor adjustment (Submenu) 76
 - Setup (Menu) 66
 - Simulation (Submenu) 91
 - System units (Submenu) 66
 - Totalizer (Submenu) 98
 - Totalizer 1 to n (Submenu) 85
 - Totalizer handling (Submenu) 100
 - Zero point adjustment (Submenu) 79
 - Parameters
 - Changing 49
 - Enter a value 49
 - Performance characteristics 147
 - Performing density adjustment 76
 - Pharmaceutical compatibility 159
 - Post-connection check 64
 - Post-connection check (checklist) 36
 - Post-installation check 64

- Post-installation check (checklist) 27
- Potential equalization 33
- Power consumption 145
- Power supply failure 146
- Pressure Equipment Directive 159
- Pressure loss 153
- Pressure-temperature ratings 152
- Process connections 156
- Process variables
 - Calculated 141
 - Measured 141
- Product safety 10
- Protecting parameter settings 93
- R**
- RCM marking 158
- Read access 50
- Reading off measured values 96
- Recalibration 132
- Reference operating conditions 147
- Registered trademarks 8
- Remedial measures
 - Calling up 108
 - Closing 108
- Remote operation 158
- Repair 133
 - Notes 133
- Repair of a device 133
- Repeatability 148
- Replacement
 - Device components 133
- Requirements for personnel 9
- Response time 148
- Return 134
- Rupture disk
 - Safety instructions 24
 - Triggering pressure 153
- S**
- Safety 9
- Sensor
 - Installing 25
- Sensor heating 23
- Sensor housing 152
- Serial number 15, 16
- SET_TOT_TOTAL module 60
- Setting the operating language 64
- Settings
 - Adapting the measuring device to the process conditions 100
 - Administration 89
 - Advanced display configurations 87
 - Communication interface 69
 - Local display 70
 - Low flow cut off 72
 - Managing the device configuration 90
 - Medium 69
 - Operating language 64
 - Partial filled pipe detection 74
 - Partially filled pipe detection 73
 - Pulse output 80
 - Pulse/frequency/switch output 79, 81
 - Resetting the device 129
 - Resetting the totalizer 100
 - Sensor adjustment 76
 - Simulation 91
 - Switch output 83
 - System units 66
 - Tag name 66
 - Totalizer 85
 - Totalizer reset 100
 - SETTOT_MODETOT_TOTAL module 60
 - Shock and vibration resistance 151
 - Signal on alarm 143
 - SIMATIC PDM 55
 - Function 55
 - SIP cleaning 151
 - Software release 56
 - Spare part 133
 - Spare parts 133
 - Special connection instructions 33
 - Special mounting instructions
 - Hygienic compatibility 24
 - Standards and guidelines 160
 - Static pressure 22
 - Status area
 - For operational display 40
 - In the navigation view 42
 - Status signals 106, 109
 - Storage conditions 18
 - Storage temperature 18
 - Storage temperature range 151
 - Structure
 - Measuring device 13
 - Submenu
 - Administration 89
 - Advanced setup 75
 - Communication 64, 69
 - Configuration backup display 90
 - Data logging 101
 - Device information 129
 - Display 87
 - Events list 126
 - Measured values 96
 - Medium selection 69
 - Output values 99
 - Overview 39
 - Process variables 97
 - Sensor adjustment 76
 - Simulation 91
 - System units 66
 - Totalizer 98
 - Totalizer 1 to n 85
 - Totalizer handling 100
 - Zero point adjustment 79
 - Supply unit
 - Requirements 31
 - Supply voltage 31, 145

- Surface roughness 156
- Symbols
 - For communication 40
 - For correction 44
 - For diagnostic behavior 40
 - For locking 40
 - For measured variable 40
 - For measurement channel number 40
 - For menus 42
 - For parameters 42
 - For status signal 40
 - For submenu 42
 - For wizards 42
 - In the status area of the local display 40
 - In the text and numeric editor 44
- System design
 - Measuring system 140
 - see Measuring device design
- System integration 56
- T**
- Technical data, overview 140
- Temperature range
 - Medium temperature 152
 - Storage temperature 18
- Terminal assignment 29, 31, 145
- Terminals 146
- Text editor 43
- Thermal insulation 22
- Tool
 - Transport 18
- Tool tip
 - see Help text
- Tools
 - Electrical connection 28
 - Installation 25
- TOTAL module 59
- Totalizer
 - Assign process variable 98
 - Configuring 85
 - Operating 100
 - Reset 100
- Transmitter
 - Connecting the signal cables 31
 - Turning the display module 26
 - Turning the housing 26
- Transporting the measuring device 18
- Troubleshooting
 - General 104
- TSE/BSE Certificate of Suitability 159
- Turning the display module 26
- Turning the electronics housing
 - see Turning the transmitter housing
- Turning the transmitter housing 26
- U**
- UKCA marking 158
- Use of measuring device
 - Borderline cases 9
 - Incorrect use 9
 - Use of measuring instrument
 - see Intended use
 - User roles 39
 - USP Class VI 159
- V**
- Version data for the device 56
- Vibrations 23
- W**
- W@M Device Viewer 14
- Weight
 - SI units 153
 - Transport (notes) 18
 - US units 154
- Wizard
 - Density adjustment 76
 - Display 70
 - Low flow cut off 72
 - Partially filled pipe detection 73, 74
 - Pulse/frequency/switch output 79, 80, 81, 83
- Workplace safety 10
- Write access 50
- Write protection
 - Via access code 93
 - Via write protection switch 94
- Write protection switch 94



www.addresses.endress.com
