

Operating Instructions

Proline Promass E 100

Coriolis flowmeter
PROFINET

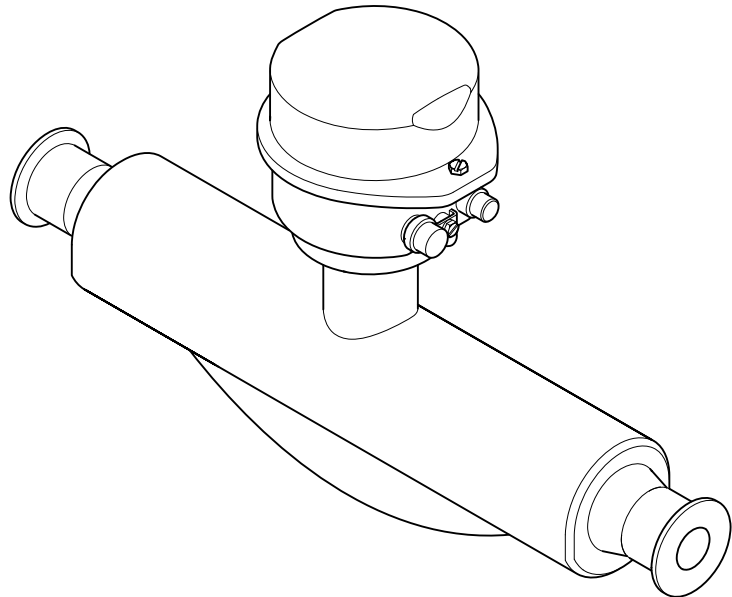

- Make sure the document is stored in a safe place such that it is always available when working on or with the device.
- To avoid danger to individuals or the facility, read the "Basic safety instructions" section carefully, as well as all other safety instructions in the document that are specific to working procedures.
- The manufacturer reserves the right to modify technical data without prior notice. Your Endress+Hauser sales organization will supply you with current information and updates to this manual.

Table of contents

1	About this document	6		
1.1	Document function	6		
1.2	Symbols	6		
1.2.1	Safety symbols	6		
1.2.2	Electrical symbols	6		
1.2.3	Tool symbols	6		
1.2.4	Symbols for certain types of information	7		
1.2.5	Symbols in graphics	7		
1.3	Documentation	7		
1.4	Registered trademarks	8		
2	Safety instructions	9		
2.1	Requirements for the personnel	9		
2.2	Intended use	9		
2.3	Workplace safety	10		
2.4	Operational safety	10		
2.5	Product safety	10		
2.6	IT security	11		
3	Product description	12		
3.1	Product design	12		
3.1.1	Device version with PROFINET communication protocol	12		
4	Incoming acceptance and product identification	13		
4.1	Incoming acceptance	13		
4.2	Product identification	13		
4.2.1	Transmitter nameplate	14		
4.2.2	Sensor nameplate	14		
4.2.3	Symbols on the device	15		
5	Storage and transport	16		
5.1	Storage conditions	16		
5.2	Transporting the product	16		
5.2.1	Measuring devices without lifting lugs	16		
5.2.2	Measuring devices with lifting lugs . .	17		
5.2.3	Transporting with a fork lift	17		
5.3	Packaging disposal	17		
6	Installation	18		
6.1	Installation requirements	18		
6.1.1	Installation position	18		
6.1.2	Environmental and process requirements	20		
6.1.3	Special installation instructions	22		
6.2	Installing the measuring instrument	23		
6.2.1	Required tools	23		
6.2.2	Preparing the measuring instrument .	23		
	6.2.3 Mounting the measuring device	23		
6.3	Post-installation check	24		
7	Electrical connection	25		
7.1	Electrical safety	25		
7.2	Connecting requirements	25		
7.2.1	Required tools	25		
7.2.2	Requirements for connecting cable . .	25		
7.2.3	Terminal assignment	26		
7.2.4	Pin assignment, device plug	27		
7.2.5	Preparing the measuring device	27		
7.3	Connecting the measuring instrument	27		
7.3.1	Connecting the transmitter	28		
7.4	Potential equalization	29		
7.4.1	Requirements	29		
7.5	Special connection instructions	29		
7.5.1	Connection examples	29		
7.6	Hardware settings	30		
7.6.1	Setting the device name	30		
7.7	Ensuring the degree of protection	31		
7.8	Post-connection check	32		
8	Operation options	33		
8.1	Overview of operation options	33		
8.2	Structure and function of the operating menu	34		
8.2.1	Structure of the operating menu	34		
8.2.2	Operating philosophy	35		
8.3	Displaying the measured values via the local display (optionally available)	36		
8.3.1	Operational display	36		
8.3.2	User roles and related access authorization	37		
8.4	Access to operating menu via web browser . .	37		
8.4.1	Function range	37		
8.4.2	Prerequisites	38		
8.4.3	Connecting the device	39		
8.4.4	Logging on	40		
8.4.5	User interface	41		
8.4.6	Disabling the Web server	42		
8.4.7	Logging out	42		
8.5	Access to the operating menu via the operating tool	43		
8.5.1	Connecting the operating tool	43		
8.5.2	FieldCare	44		
8.5.3	DeviceCare	45		
9	System integration	46		
9.1	Overview of device description files	46		
9.1.1	Current version data for the device . .	46		
9.1.2	Operating tools	46		
9.2	Device master file (GSD)	47		
9.2.1	File name of the manufacturer- specific device master file (GSD)	47		

9.2.2	File name of the PA Profile device master file (GSD)	47	12	Diagnostics and troubleshooting . . .	93
9.3	Cyclic data transmission	48	12.1	General troubleshooting	93
9.3.1	Overview of the modules	48	12.2	Diagnostic information via LEDs	95
9.3.2	Description of the modules	48	12.2.1	Transmitter	95
9.3.3	Status coding	56	12.3	Diagnostic information in the web browser . . .	95
9.3.4	Factory setting	57	12.3.1	Diagnostic options	95
9.3.5	Startup configuration	58	12.3.2	Calling up remedy information	97
10	Commissioning	59	12.4	Diagnostic information in FieldCare or DeviceCare	97
10.1	Post-mounting and post-connection check . . .	59	12.4.1	Diagnostic options	97
10.2	Identifying the device in the PROFINET network	59	12.4.2	Calling up remedy information	98
10.3	Startup parameterization	59	12.5	Adapting the diagnostic information	98
10.4	Connecting via FieldCare	59	12.5.1	Adapting the diagnostic behavior	98
10.5	Setting the operating language	59	12.6	Overview of diagnostic information	101
10.6	Configuring the measuring instrument	59	12.6.1	Diagnostic of sensor	102
10.6.1	Defining the tag name	60	12.6.2	Diagnostic of electronic	105
10.6.2	Setting the system units	60	12.6.3	Diagnostic of configuration	111
10.6.3	Displaying the communication interface	62	12.6.4	Diagnostic of process	115
10.6.4	Selecting and setting the medium . . .	64	12.7	Pending diagnostic events	122
10.6.5	Configuring the low flow cut off	66	12.8	Diagnostics list	123
10.6.6	Configuring partially filled pipe detection	67	12.9	Event logbook	123
10.7	Advanced settings	68	12.9.1	Reading out the event logbook	123
10.7.1	Using the parameter to enter the access code	68	12.9.2	Filtering the event logbook	124
10.7.2	Calculated process variables	68	12.9.3	Overview of information events	124
10.7.3	Carrying out a sensor adjustment	70	12.10	Resetting the measuring device	125
10.7.4	Configuring the totalizer	74	12.10.1	Function range of "Device reset" parameter	125
10.7.5	Using parameters for device administration	75	12.11	Device information	126
10.8	Simulation	75	12.12	Firmware history	127
10.9	Protecting settings from unauthorized access .	76	13	Maintenance	128
10.9.1	Write protection via access code	76	13.1	Maintenance work	128
10.9.2	Write protection via write protection switch	77	13.1.1	Exterior cleaning	128
10.9.3	Write protection via startup parameterization	78	13.1.2	Internal cleaning	128
11	Operation	79	13.2	Measuring and test equipment	128
11.1	Reading the device locking status	79	13.3	Endress+Hauser services	128
11.2	Adjusting the operating language	79	14	Repair	129
11.3	Configuring the display	79	14.1	General notes	129
11.4	Reading off measured values	79	14.1.1	Repair and conversion concept	129
11.4.1	"Measured variables" submenu	79	14.1.2	Notes for repair and conversion	129
11.4.2	"Totalizer" submenu	89	14.2	Spare parts	129
11.5	Adapting the measuring device to the process conditions	90	14.3	Endress+Hauser services	129
11.6	Performing a totalizer reset	90	14.4	Return	129
11.6.1	Function scope of "Control Totalizer" parameter	92	14.5	Disposal	130
11.6.2	Function range of "Reset all totalizers" parameter	92	14.5.1	Removing the measuring device	130
			14.5.2	Disposing of the measuring device . . .	130
			15	Accessories	131
			15.1	Device-specific accessories	131
			15.1.1	For the sensor	131
			15.2	Communication-specific accessories	131
			15.3	Service-specific accessories	132
			15.4	System components	133

16	Technical data	134
16.1	Application	134
16.2	Function and system design	134
16.3	Input	135
16.4	Output	136
16.5	Power supply	141
16.6	Performance characteristics	142
16.7	Mounting	146
16.8	Environment	146
16.9	Process	147
16.10	Mechanical construction	149
16.11	Operability	152
16.12	Certificates and approvals	154
16.13	Application packages	156
16.14	Accessories	157
16.15	Supplementary documentation	157
Index		159

1 About this document

1.1 Document function

These Operating Instructions contain all the information required in the various life cycle phases of the device: from product identification, incoming acceptance and storage, to installation, connection, operation and commissioning, through to troubleshooting, maintenance and disposal.

1.2 Symbols

1.2.1 Safety symbols

DANGER

This symbol alerts you to a dangerous situation. Failure to avoid this situation will result in serious or fatal injury.

WARNING

This symbol alerts you to a potentially dangerous situation. Failure to avoid this situation can result in serious or fatal injury.





CAUTION

This symbol alerts you to a potentially dangerous situation. Failure to avoid this situation can result in minor or medium injury.



NOTICE

This symbol alerts you to a potentially harmful situation. Failure to avoid this situation can result in damage to the product or something in its vicinity.













1.2.2 Electrical symbols

Symbol	Meaning
	Direct current
	Alternating current
	Direct current and alternating current
	Ground connection A grounded terminal which, as far as the operator is concerned, is grounded via a grounding system.
	Potential equalization connection (PE: protective earth) Ground terminals that must be connected to ground prior to establishing any other connections. The ground terminals are located on the interior and exterior of the device: <ul style="list-style-type: none"> ▪ Interior ground terminal: potential equalization is connected to the supply network. ▪ Exterior ground terminal: device is connected to the plant grounding system.







1.2.3 Tool symbols

Symbol	Meaning
	Allen key
	Open-ended wrench

1.2.4 Symbols for certain types of information

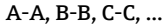
Symbol	Meaning
	Permitted Procedures, processes or actions that are permitted.
	Preferred Procedures, processes or actions that are preferred.
	Forbidden Procedures, processes or actions that are forbidden.
	Tip Indicates additional information.
	Reference to documentation
	Reference to page
	Reference to graphic
	Notice or individual step to be observed
	Series of steps
	Result of a step
	Help in the event of a problem
	Visual inspection

1.2.5 Symbols in graphics

Symbol	Meaning
	Item numbers
	Series of steps
	Views
	Sections
	Hazardous area
	Safe area (non-hazardous area)
	Flow direction

1.3 Documentation

 For an overview of the scope of the associated Technical Documentation, refer to the following:

- *Device Viewer* (www.endress.com/deviceviewer): Enter the serial number from the nameplate
- *Endress+Hauser Operations app*: Enter serial number from nameplate or scan matrix code on nameplate.

The following documentation may be available depending on the device version ordered:

Document type	Purpose and content of the document
Technical Information (TI)	Planning aid for your device The document contains all the technical data on the device and provides an overview of the accessories and other products that can be ordered for the device.
Brief Operating Instructions (KA)	Guide that takes you quickly to the 1st measured value The Brief Operating Instructions contain all the essential information from incoming acceptance to initial commissioning.
Operating Instructions (BA)	Your reference document These Operating Instructions contain all the information that is required in the various life cycle phases of the device: from product identification, incoming acceptance and storage, to mounting, connection, operation and commissioning, through to troubleshooting, maintenance and disposal.
Description of Device Parameters (GP)	Reference for your parameters The document provides a detailed explanation of each individual parameter. The description is aimed at those who work with the device over the entire life cycle and perform specific configurations.
Safety Instructions (XA)	Depending on the approval, safety instructions for electrical equipment in hazardous areas are also supplied with the device. The Safety Instructions are a constituent part of the Operating Instructions.  Information on the Safety Instructions (XA) that are relevant for the device is provided on the nameplate.
Supplementary device-dependent documentation (SD/FY)	Always comply strictly with the instructions in the relevant supplementary documentation. The supplementary documentation is a constituent part of the device documentation.

1.4 Registered trademarks

PROFINET®

Registered trademark of the PROFIBUS Nutzerorganisation e.V. (PROFIBUS User Organization), Karlsruhe, Germany

TRI-CLAMP®

Registered trademark of Ladish & Co., Inc., Kenosha, USA

2 Safety instructions

2.1 Requirements for the personnel

The personnel for installation, commissioning, diagnostics and maintenance must fulfill the following requirements:

- ▶ Trained, qualified specialists must have a relevant qualification for this specific function and task.
- ▶ Are authorized by the plant owner/operator.
- ▶ Are familiar with federal/national regulations.
- ▶ Before starting work, read and understand the instructions in the manual and supplementary documentation as well as the certificates (depending on the application).
- ▶ Follow instructions and comply with basic conditions.

The operating personnel must fulfill the following requirements:

- ▶ Are instructed and authorized according to the requirements of the task by the facility's owner-operator.
- ▶ Follow the instructions in this manual.

2.2 Intended use

Application and media

The measuring instrument described in this manual is intended only for the flow measurement of liquids and gases.

Depending on the version ordered, the measuring instrument can also be used to measure potentially explosive ¹⁾, flammable, toxid and oxidizing media.

Measuring instruments for use in hazardous areas, in hygienic applications, or where there is an increased risk due to pressure, are specially labeled on the nameplate.

To ensure that the measuring instrument is in perfect condition during operation:

- ▶ Only use the measuring instrument in full compliance with the data on the nameplate and the general conditions listed in the Operating Instructions and supplementary documentation.
- ▶ Using the nameplate, check whether the ordered device is permitted for the intended use in the hazardous area (e.g. explosion protection, pressure vessel safety).
- ▶ Use the measuring instrument only for media to which the process-wetted materials are sufficiently resistant.
- ▶ Keep within the specified pressure and temperature range.
- ▶ Keep within the specified ambient temperature range.
- ▶ Protect the measuring instrument permanently against corrosion from environmental influences.

Incorrect use

Non-designated use can compromise safety. The manufacturer is not liable for damage caused by improper or non-designated use.

WARNING

Danger of breakage due to corrosive or abrasive fluids and ambient conditions!

- ▶ Verify the compatibility of the process fluid with the sensor material.
- ▶ Ensure the resistance of all fluid-wetted materials in the process.
- ▶ Keep within the specified pressure and temperature range.

1) Not applicable for IO-Link measuring instruments

NOTICE**Verification for borderline cases:**

- ▶ For special fluids and fluids for cleaning, Endress+Hauser is glad to provide assistance in verifying the corrosion resistance of fluid-wetted materials, but does not accept any warranty or liability as minute changes in the temperature, concentration or level of contamination in the process can alter the corrosion resistance properties.

Residual risks**⚠ CAUTION****Risk of hot or cold burns! The use of media and electronics with high or low temperatures can produce hot or cold surfaces on the device.**

- ▶ Mount suitable touch protection.

⚠ WARNING**Danger of housing breaking due to measuring tube breakage!**

If a measuring tube ruptures, the pressure inside the sensor housing will rise according to the operating process pressure.

- ▶ Use a rupture disk.

⚠ WARNING**Danger from medium escaping!**

For device versions with a rupture disk: medium escaping under pressure can cause injury or material damage.

- ▶ Take precautions to prevent injury and material damage if the rupture disk is actuated.

2.3 Workplace safety

When working on and with the device:

- ▶ Wear the required personal protective equipment as per national regulations.

2.4 Operational safety

Damage to the device!

- ▶ Operate the device in proper technical condition and fail-safe condition only.
- ▶ The operator is responsible for the interference-free operation of the device.

Modifications to the device

Unauthorized modifications to the device are not permitted and can lead to unforeseeable dangers!

- ▶ If modifications are nevertheless required, consult with the manufacturer.

Repair

To ensure continued operational safety and reliability:

- ▶ Carry out repairs on the device only if they are expressly permitted.
- ▶ Observe federal/national regulations pertaining to the repair of an electrical device.
- ▶ Use only original spare parts and accessories.

2.5 Product safety

This measuring device is designed in accordance with good engineering practice to meet state-of-the-art safety requirements, has been tested, and left the factory in a condition in which it is safe to operate.

It meets general safety standards and legal requirements. It also complies with the EU directives listed in the device-specific EU Declaration of Conformity. The manufacturer confirms this by affixing the CE mark to the device..

2.6 IT security

Our warranty is valid only if the product is installed and used as described in the Operating Instructions. The product is equipped with security mechanisms to protect it against any inadvertent changes to the settings.

IT security measures, which provide additional protection for the product and associated data transfer, must be implemented by the operators themselves in line with their security standards.

3 Product description

The device consists of a transmitter and a sensor.

The device is available as a compact version:

The transmitter and sensor form a mechanical unit.

3.1 Product design

3.1.1 Device version with PROFINET communication protocol

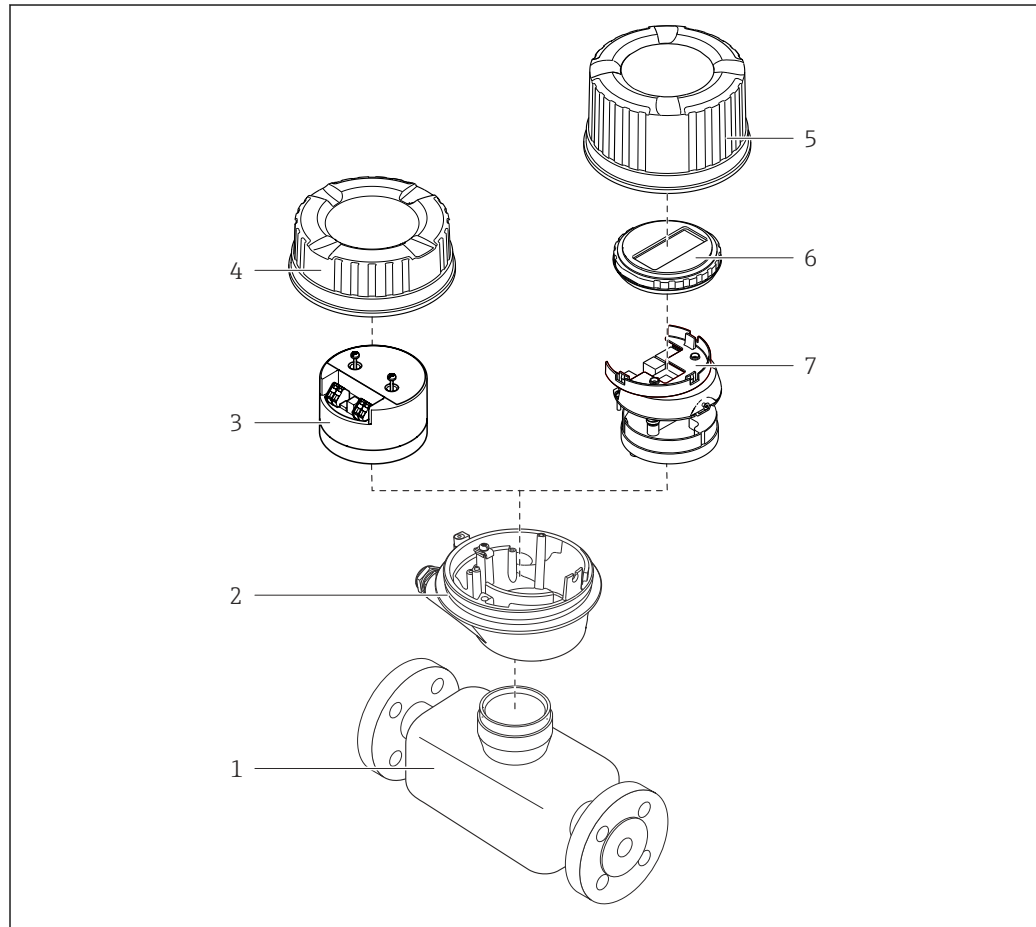

A0023153

1 Important components of a measuring device

- 1 Sensor
- 2 Transmitter housing
- 3 Main electronics module
- 4 Transmitter housing cover
- 5 Transmitter housing cover (version for optional local display)
- 6 Local display (optional)
- 7 Main electronics module (with bracket for optional local display)

4 Incoming acceptance and product identification

4.1 Incoming acceptance

On receipt of the delivery:

1. Check the packaging for damage.
 - ↳ Report all damage immediately to the manufacturer.
Do not install damaged components.
2. Check the scope of delivery using the delivery note.
3. Compare the data on the nameplate with the order specifications on the delivery note.
4. Check the technical documentation and all other necessary documents, e.g. certificates, to ensure they are complete.



If one of the conditions is not satisfied, contact the manufacturer.

4.2 Product identification

The device can be identified in the following ways:

- Nameplate
- Order code with details of the device features on the delivery note
- Enter the serial numbers from the nameplates in the *Device Viewer* (www.endress.com/deviceviewer): all the information about the device is displayed.
- Enter the serial numbers from the nameplates into the *Endress+Hauser Operations app* or scan the DataMatrix code on the nameplate with the *Endress+Hauser Operations app*: all the information about the device is displayed.

For an overview of the scope of the associated Technical Documentation, refer to the following:

- The "Additional standard device documentation" and "Supplementary device-dependent documentation" sections
- The *Device Viewer*: Enter the serial number from the nameplate (www.endress.com/deviceviewer)
- The *Endress+Hauser Operations app*: Enter the serial number from the nameplate or scan the DataMatrix code on the nameplate.

4.2.1 Transmitter nameplate

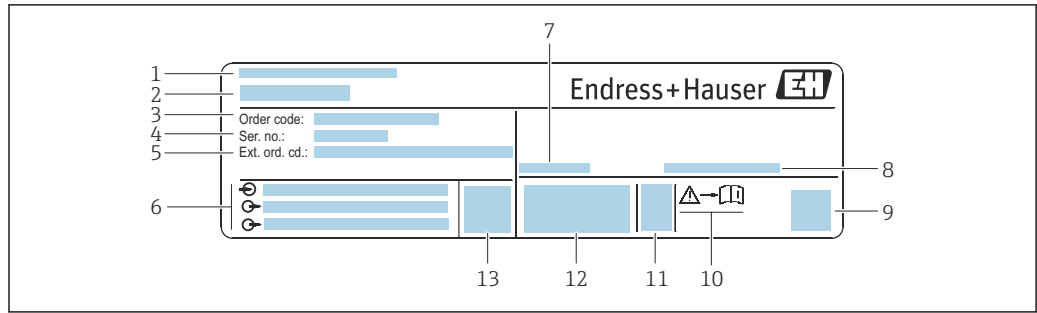

A0030222

2 Example of a transmitter nameplate

- 1 Manufacturer address/certificate holder
- 2 Name of the transmitter
- 3 Order code
- 4 Serial number
- 5 Extended order code
- 6 Electrical connection data, e.g. available inputs and outputs, supply voltage
- 7 Permitted ambient temperature (T_a)
- 8 Degree of protection
- 9 2-D matrix code
- 10 Document number of safety-related supplementary documentation → 157
- 11 Date of manufacture: year-month
- 12 CE mark, RCM-Tick mark
- 13 Firmware version (FW)

4.2.2 Sensor nameplate

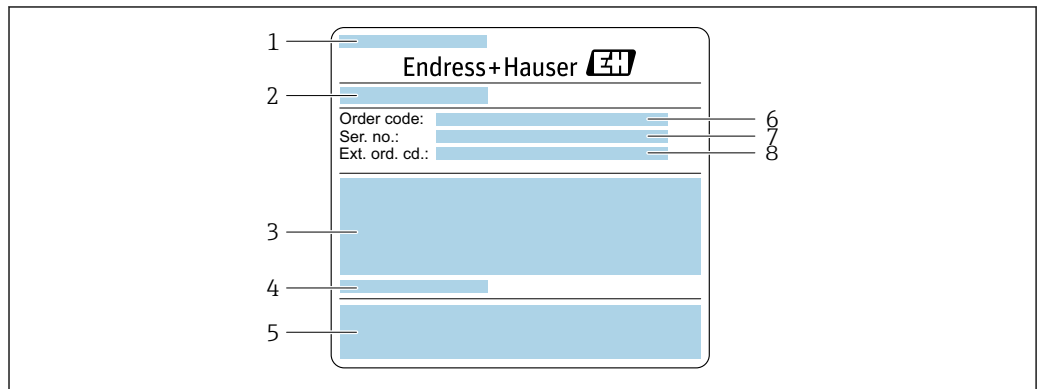

A0029206

3 Example of a sensor nameplate, part 1

- 1 Name of the sensor
- 2 Manufacturer address/certificate holder
- 3 Nominal diameter of the sensor; flange nominal diameter/nominal pressure; sensor test pressure; medium temperature range; material of measuring tube and manifold
- 4 Sensor-specific information
- 5 CE mark, RCM-Tick mark
- 6 Order code
- 7 Serial number (Ser. no.)
- 8 Extended order code (Ext. ord. cd.)

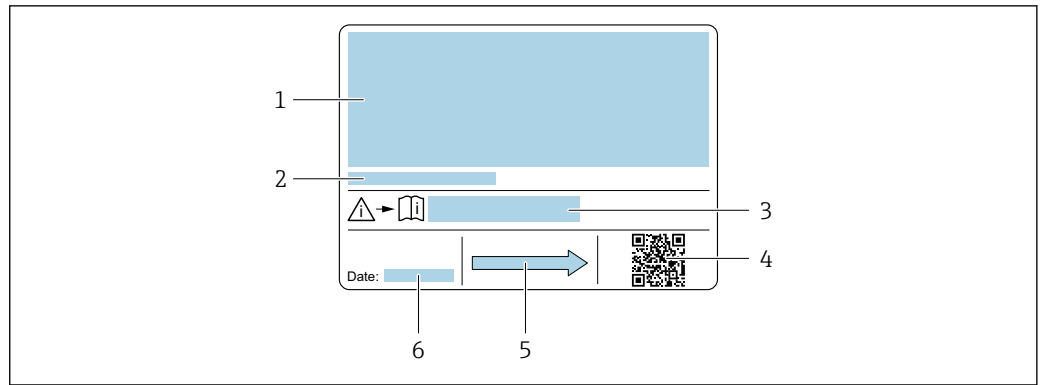

A0029207

4 Example of a sensor nameplate, part 2

- 1 Approval information for explosion protection, Pressure Equipment Directive and degree of protection
- 2 Allowable ambient temperature (T_a)
- 3 Document number of safety-related supplementary documentation
- 4 2-D matrix code
- 5 Flow direction
- 6 Date of manufacture: year-month

i Order code

The measuring device is reordered using the order code.

Extended order code

- The device type (product root) and basic specifications (mandatory features) are always listed.
- Of the optional specifications (optional features), only the safety and approval-related specifications are listed (e.g. LA). If other optional specifications are also ordered, these are indicated collectively using the # placeholder symbol (e.g. #LA#).
- If the ordered optional specifications do not include any safety and approval-related specifications, they are indicated by the + placeholder symbol (e.g. XXXXXX-ABCDE+).

4.2.3 Symbols on the device

Symbol	Meaning
	WARNING! This symbol alerts you to a dangerous situation. Failure to avoid this situation can result in serious or fatal injury. Please consult the documentation for the measuring instrument to discover the type of potential danger and measures to avoid it.
	Reference to documentation Refers to the corresponding device documentation.
	Protective ground connection A terminal that must be connected to the ground prior to establishing any other connections.

5 Storage and transport

5.1 Storage conditions

Observe the following notes for storage:

- ▶ Store in the original packaging to ensure protection from shock.
- ▶ Do not remove protective covers or protective caps installed on process connections. They prevent mechanical damage to the sealing surfaces and contamination in the measuring tube.
- ▶ Protect from direct sunlight. Avoid unacceptably high surface temperatures.
- ▶ Store in a dry and dust-free place.
- ▶ Do not store outdoors.

Storage temperature → 📄 146

5.2 Transporting the product

Transport the measuring device to the measuring point in the original packaging.

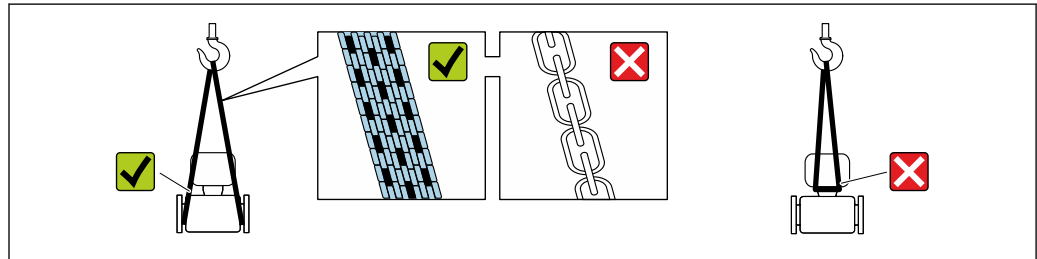

A0029252

i Do not remove protective covers or caps installed on process connections. They prevent mechanical damage to the sealing surfaces and contamination in the measuring tube.

5.2.1 Measuring devices without lifting lugs

⚠ WARNING

Center of gravity of the measuring device is higher than the suspension points of the webbing slings.

Risk of injury if the measuring device slips.

- ▶ Secure the measuring device against slipping or turning.
- ▶ Observe the weight specified on the packaging (stick-on label).

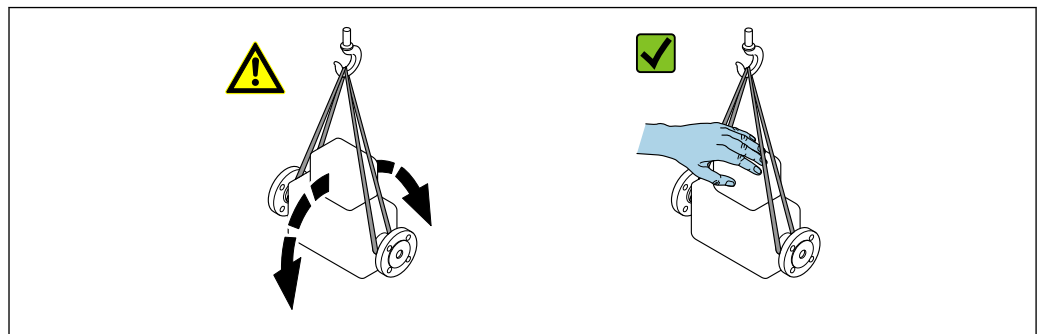

A0029214

5.2.2 Measuring devices with lifting lugs

⚠ CAUTION

Special transportation instructions for devices with lifting lugs

- ▶ Only use the lifting lugs fitted on the device or flanges to transport the device.
- ▶ The device must always be secured at two lifting lugs at least.

5.2.3 Transporting with a fork lift

If transporting in wood crates, the floor structure enables the crates to be lifted lengthwise or at both sides using a forklift.

5.3 Packaging disposal

All packaging materials are environmentally friendly and 100% recyclable:

- Outer packaging of device
 - Stretch wrap made of polymer in accordance with EU Directive 2002/95/EC (RoHS)
- Packaging
 - Wood crate treated in accordance with ISPM 15 standard, confirmed by IPPC logo
 - Cardboard box in accordance with European packaging guideline 94/62/EC, recyclability confirmed by Resy symbol
- Transport material and fastening fixtures
 - Disposable plastic pallet
 - Plastic straps
 - Plastic adhesive strips
- Filler material
 - Paper pads

6 Installation

6.1 Installation requirements

6.1.1 Installation position

Installation point

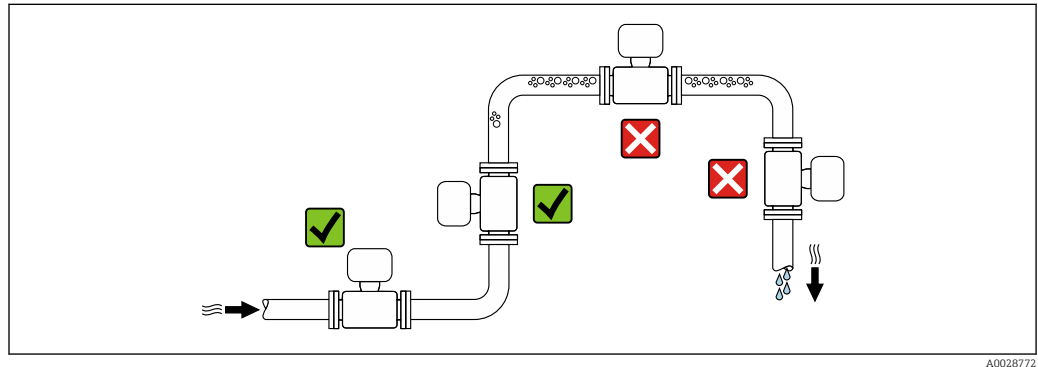

To prevent measuring errors arising from accumulation of gas bubbles in the measuring pipe, avoid the following mounting locations in the piping:

- Highest point of a pipeline.
- Directly upstream of a free pipe outlet in a down pipe.

Installation in down pipes

However, the following installation suggestion allows for installation in an open vertical pipeline. Pipe restrictions or the use of an orifice with a smaller cross-section than the nominal diameter prevent the sensor running empty while measurement is in progress.

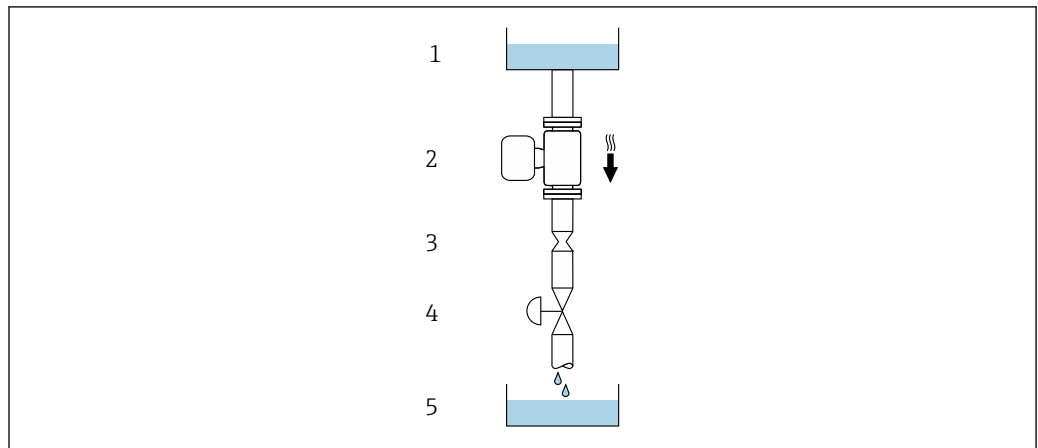



5 Installation in a down pipe (e.g. for batching applications)

- 1 Supply tank
- 2 Sensor
- 3 Orifice plate, pipe restriction
- 4 Valve
- 5 Filling vessel

DN		Ø orifice plate, pipe restriction	
[mm]	[in]	[mm]	[in]
8	3/8	6	0.24
15	1/2	10	0.40
25	1	14	0.55
40	1 1/2	22	0.87
50	2	28	1.10
80	3	50	1.97

Orientation

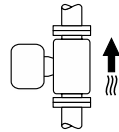
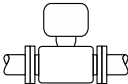
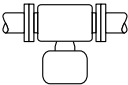
The direction of the arrow on the sensor nameplate helps you to install the sensor according to the flow direction (direction of medium flow through the piping).

Orientation		Recommendation
A	Vertical orientation 	☑☑ ¹⁾
B	Horizontal orientation, transmitter at top 	☑☑ ²⁾ Exception: → ☒ 6, ☒ 19
C	Horizontal orientation, transmitter at bottom 	☑☑ ³⁾ Exception: → ☒ 6, ☒ 19
D	Horizontal orientation, transmitter at side 	☒

- 1) This orientation is recommended to ensure self-draining.
- 2) Applications with low process temperatures may reduce the ambient temperature. To maintain the minimum ambient temperature for the transmitter, this orientation is recommended.
- 3) Applications with high process temperatures may increase the ambient temperature. To maintain the maximum ambient temperature for the transmitter, this orientation is recommended.

If a sensor is installed horizontally with a curved measuring tube, match the position of the sensor to the fluid properties.

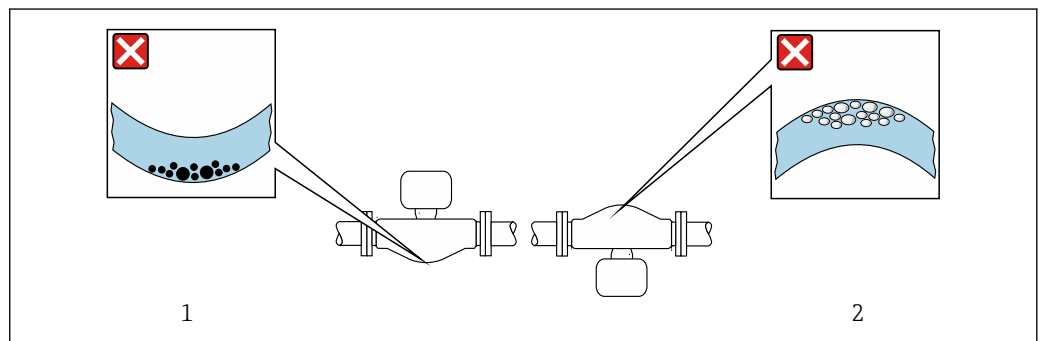

☒ 6 Orientation of sensor with curved measuring tube

- 1 Avoid this orientation for fluids with entrained solids: Risk of solids accumulating
- 2 Avoid this orientation for outgassing fluids: Risk of gas accumulating

Inlet and outlet runs

No special precautions need to be taken for fittings that create turbulence, such as valves, elbows or T-pieces, as long as no cavitation occurs → 20.

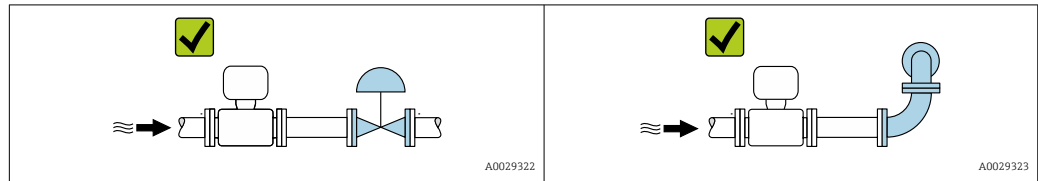

Installation dimensions

 For the dimensions and installation lengths of the device, see the "Technical Information" document, "Mechanical construction" section

6.1.2 Environmental and process requirements

Ambient temperature range

Measuring device	<ul style="list-style-type: none"> ■ -40 to +60 °C (-40 to +140 °F) ■ Order code for "Test, certificate", option JM: -50 to +60 °C (-58 to +140 °F)
------------------	---

- ▶ If operating outdoors:
Avoid direct sunlight, particularly in warm climatic regions.

Static pressure

It is important that cavitation does not occur, or that gases entrained in the liquids do not outgas.

Cavitation is caused if the pressure drops below the vapor pressure:

- In liquids that have a low boiling point (e.g. hydrocarbons, solvents, liquefied gases)
- In suction lines

- ▶ Ensure the static pressure is sufficiently high to prevent cavitation and outgassing.

For this reason, the following mounting locations are recommended:

- At the lowest point in a vertical pipe
- Downstream from pumps (no danger of vacuum)

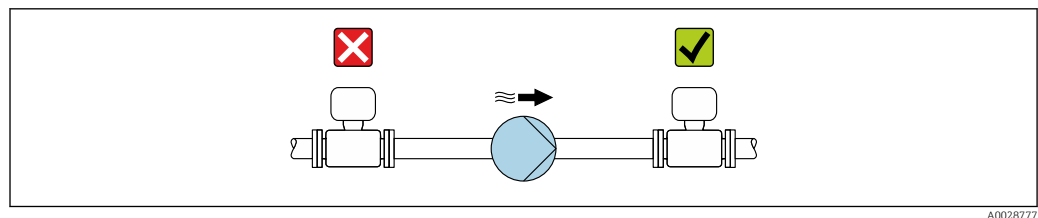

Thermal insulation

In the case of some fluids, it is important to keep the heat radiated from the sensor to the transmitter to a low level. A wide range of materials can be used for the required insulation.

NOTICE**Electronics overheating on account of thermal insulation!**

- ▶ Recommended orientation: horizontal orientation, transmitter housing pointing downwards.
- ▶ Do not insulate the transmitter housing .
- ▶ Maximum permissible temperature at the lower end of the transmitter housing: 80 °C (176 °F)
- ▶ Regarding thermal insulation with an exposed extended neck: We advise against insulating the extended neck to ensure optimal heat dissipation.

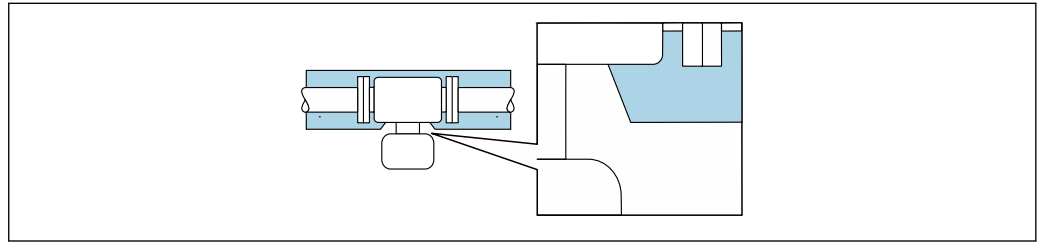

A0034391

 7 Thermal insulation with exposed extended neck

Heating**NOTICE****Electronics can overheat due to elevated ambient temperature!**

- ▶ Observe maximum permitted ambient temperature for the transmitter.
- ▶ Depending on the medium temperature, take the device orientation requirements into account.

NOTICE**Danger of overheating when heating**

- ▶ Ensure that the temperature at the lower end of the transmitter housing does not exceed 80 °C (176 °F).
- ▶ Ensure that sufficient convection takes place at the transmitter neck.
- ▶ Ensure that a sufficiently large area of the transmitter neck remains exposed. The uncovered part serves as a radiator and protects the electronics from overheating and excessive cooling.
- ▶ When using in potentially explosive atmospheres, observe the information in the device-specific Ex documentation. For detailed information on the temperature tables, see the separate document entitled "Safety Instructions" (XA) for the device.
- ▶ Consider the "830 ambient temperature too high" and "832 electronics temperature too high" process diagnostics if overheating cannot be ruled out based on a suitable system design.

Heating options

If a fluid requires that no heat loss should occur at the sensor, users can avail of the following heating options:

- Electrical heating, e.g. with electric band heaters ²⁾
- Via pipes carrying hot water or steam
- Via heating jackets

Vibrations

The high oscillation frequency of the measuring tubes ensures that the correct operation of the measuring system is not influenced by plant vibrations.

2) The use of parallel electric band heaters is generally recommended (bidirectional electricity flow). Particular considerations must be made if a single-wire heating cable is to be used. For additional information, refer to EA01339D "Installation Instructions for Electrical Trace Heating Systems".

6.1.3 Special installation instructions

Drainability

When installed vertically, the measuring tubes can be drained completely and protected against buildup.

Hygienic compatibility

i When installing in hygienic applications, please refer to the information in the "Certificates and approvals/hygienic compatibility" section →  154

Rupture disk

Process-related information: →  148.

WARNING

Danger from medium escaping!

Medium escaping under pressure can cause injury or material damage.

- ▶ Take precautions to prevent danger to persons and damage if the rupture disk is actuated.
- ▶ Observe the information on the rupture disk sticker.
- ▶ Make sure that the function and operation of the rupture disk is not impeded through the installation of the device.
- ▶ Do not use a heating jacket.
- ▶ Do not remove or damage the rupture disk.

- ▶ After the rupture disk is actuated, do not operate the measuring device any more.

The position of the rupture disk is indicated on a sticker applied over it. If the rupture disk is triggered, the sticker is destroyed. The disk can therefore be visually monitored.

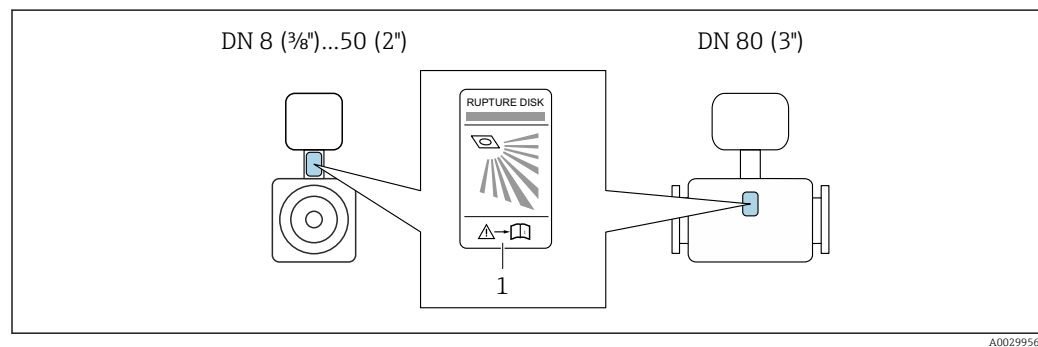

1 Rupture disk label

Zero verification and zero adjustment

All measuring instruments are calibrated in accordance with state-of-the-art technology. Calibration takes place under reference conditions →  142. Therefore, a zero adjustment in the field is generally not required.

Experience shows that zero adjustment is advisable only in special cases:

- To achieve maximum measurement accuracy even with low flow rates.
- Under extreme process or operating conditions (e.g. very high process temperatures or very high-viscosity fluids).
- For gas applications with low pressure

i To achieve the highest possible measurement accuracy at low flow rates, the installation must protect the sensor from mechanical stresses during operation.

To get a representative zero point, ensure that:

- any flow in the device is prevented during the adjustment
- the process conditions (e.g. pressure, temperature) are stable and representative

Verification and adjustment cannot be carried out if the following process conditions are present:

- Gas pockets

Ensure that the system has been sufficiently flushed with the medium. Repeat flushing can help to eliminate gas pockets

- Thermal circulation

In the event of temperature differences (e.g. between the measuring tube inlet and outlet section), induced flow can occur even if the valves are closed due to thermal circulation in the device

- Leaks at the valves

If the valves are not leak-tight, flow is not sufficiently prevented when determining the zero point

If these conditions cannot be avoided, it is advisable to keep the factory setting for the zero point.

6.2 Installing the measuring instrument

6.2.1 Required tools

For sensor

For flanges and other process connections: Use a suitable mounting tool.

6.2.2 Preparing the measuring instrument

1. Remove all remaining transport packaging.
2. Remove any protective covers or protective caps present from the sensor.
3. If present, remove transport protection of the rupture disk.
4. Remove stick-on label on the electronics compartment cover.

6.2.3 Mounting the measuring device

WARNING

Danger due to improper process sealing!

- ▶ Ensure that the inside diameters of the gaskets are greater than or equal to that of the process connections and piping.
- ▶ Ensure that the seals are clean and undamaged.
- ▶ Secure the seals correctly.

1. Ensure that the direction of the arrow on the nameplate of the sensor matches the flow direction of the medium.

2. Install the measuring device or turn the transmitter housing so that the cable entries do not point upwards.

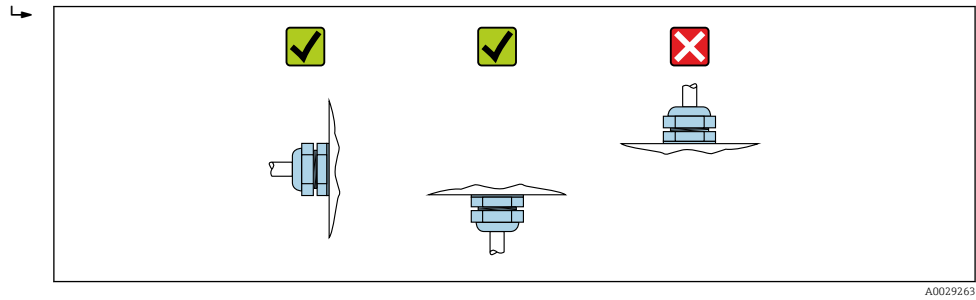

A0029263

6.3 Post-installation check

Is the device undamaged (visual inspection)?	<input type="checkbox"/>
Does the measuring instrument correspond to the measuring point specifications? For example: <ul style="list-style-type: none"> ▪ Process temperature → 147 ▪ Pressure (refer to the "Pressure-temperature ratings" section of the "Technical Information" document). ▪ Ambient temperature → 146 ▪ Measuring range 	<input type="checkbox"/>
Has the correct orientation for the sensor been selected → 19? <ul style="list-style-type: none"> ▪ According to sensor type ▪ According to medium temperature ▪ According to medium properties (outgassing, with entrained solids) 	<input type="checkbox"/>
Does the arrow on the sensor match the direction of flow of the medium? → 19?	<input type="checkbox"/>
Is the tag name and labeling correct (visual inspection)?	<input type="checkbox"/>
Is the device sufficiently protected from precipitation and direct sunlight?	<input type="checkbox"/>
Are the securing screw and securing clamp tightened securely?	<input type="checkbox"/>

7 Electrical connection

WARNING

Live parts! Incorrect work performed on the electrical connections can result in an electric shock.

- ▶ Set up a disconnecting device (switch or power-circuit breaker) to easily disconnect the device from the supply voltage.
- ▶ In addition to the device fuse, include an overcurrent protection unit with max. 16 A in the plant installation.

7.1 Electrical safety

In accordance with applicable national regulations.

7.2 Connecting requirements

7.2.1 Required tools

- For cable entries: Use corresponding tools
- For securing clamp (on aluminum housing): Allen screw 3 mm
- For securing screw (for stainless steel housing): open-ended wrench 8 mm
- Wire stripper
- When using stranded cables: crimper for wire end ferrule

7.2.2 Requirements for connecting cable

The connecting cables provided by the customer must fulfill the following requirements.

Permitted temperature range

- The installation guidelines that apply in the country of installation must be observed.
- The cables must be suitable for the minimum and maximum temperatures to be expected.

Power supply cable (incl. conductor for the inner ground terminal)

Standard installation cable is sufficient.

Signal cable

-  For custody transfer, all signal lines must be shielded cables (tinned copper braiding, optical coverage $\geq 85\%$). The cable shield must be connected on both sides.

PROFINET

Only PROFINET cables.

-  See <https://www.profibus.com> "PROFINET Planning guideline".

Cable diameter

- Cable glands supplied:
 - M20 \times 1.5 with cable \varnothing 6 to 12 mm (0.24 to 0.47 in)
- Spring terminals:
 - Wire cross-sections 0.5 to 2.5 mm² (20 to 14 AWG)

7.2.3 Terminal assignment

Transmitter

PROFINET connection version

Order code for "Output", option R

Depending on the housing version, the transmitters can be ordered with terminals or device plugs.

Order code "Housing"	Connection methods available		Possible options for order code "Electrical connection"
	Output	Power supply	
Options A, B	Device plug connectors → 27	Terminals	<ul style="list-style-type: none"> ▪ Option L: plug M12x1 + thread NPT ½" ▪ Option N: plug M12x1 + coupling M20 ▪ Option P: plug M12x1 + thread G ½" ▪ Option U: plug M12x1 + thread M20
Options A, B, C	Device plug connectors → 27	Device plug connectors → 27	Option Q: 2 x plug M12x1

Order code for "Housing":

- Option A: compact, coated aluminum
- Option B: compact, hygienic, stainless
- Option C: ultra-compact, hygienic, stainless

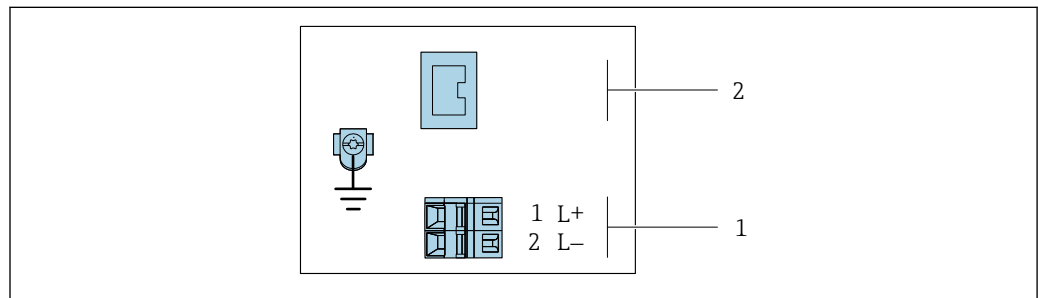

A0017054

8 PROFINET terminal assignment

- 1 Power supply: DC 24 V
- 2 PROFINET

Order code "Output"	Terminal number		Output Device plug M12x1
	Power supply 2 (L-)	1 (L+)	
Option R	DC 24 V		PROFINET

Order code for "Output":
Option R: PROFINET

7.2.4 Pin assignment, device plug

Supply voltage

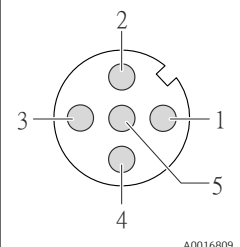
	Pin	Assignment	
	1	L+	DC 24 V
	2		Not assigned
	3		Not assigned
	4	L-	DC 24 V
	5		Grounding/shielding
Coding		Plug/socket	
A		Plug	

Device plug for signal transmission (device side)

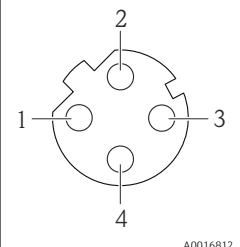
	Pin	Assignment	
	1	+	TD +
	2	+	RD +
	3	-	TD -
	4	-	RD -
	Coding		Plug/socket
D		Socket	

7.2.5 Preparing the measuring device

NOTICE

Insufficient sealing of the housing!

Operational reliability of the measuring device could be compromised.

- Use suitable cable glands corresponding to the degree of protection.

1. Remove dummy plug if present.
2. If the measuring device is supplied without cable glands:
Provide suitable cable gland for corresponding connecting cable.
3. If the measuring device is supplied with cable glands:
Observe requirements for connecting cables → 25.

7.3 Connecting the measuring instrument

NOTICE

An incorrect connection compromises electrical safety!

- Only properly trained specialist staff may perform electrical connection work.
- Observe applicable federal/national installation codes and regulations.
- Comply with local workplace safety regulations.
- Always connect the protective ground cable Ⓢ before connecting additional cables.
- When using in potentially explosive atmospheres, observe the information in the device-specific Ex documentation.

7.3.1 Connecting the transmitter

The connection of the transmitter depends on the following order codes:

- Housing version: compact or ultra-compact
- Connection version: device plug or terminals

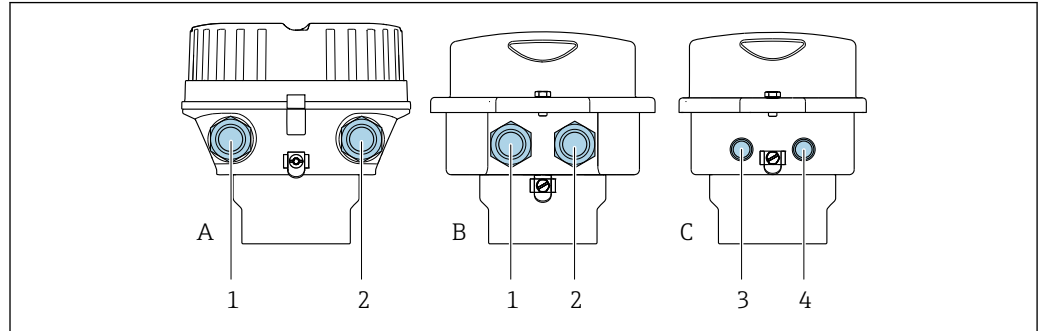

A0016924

9 Housing versions and connection versions

- A Housing version: compact, coated, aluminum
- B Housing version: compact, hygienic, stainless
- 1 Cable entry or device plug for signal transmission
- 2 Cable entry or device plug for supply voltage
- C Housing version: ultra-compact, hygienic, stainless
- 3 Device plug for signal transmission
- 4 Device plug for supply voltage

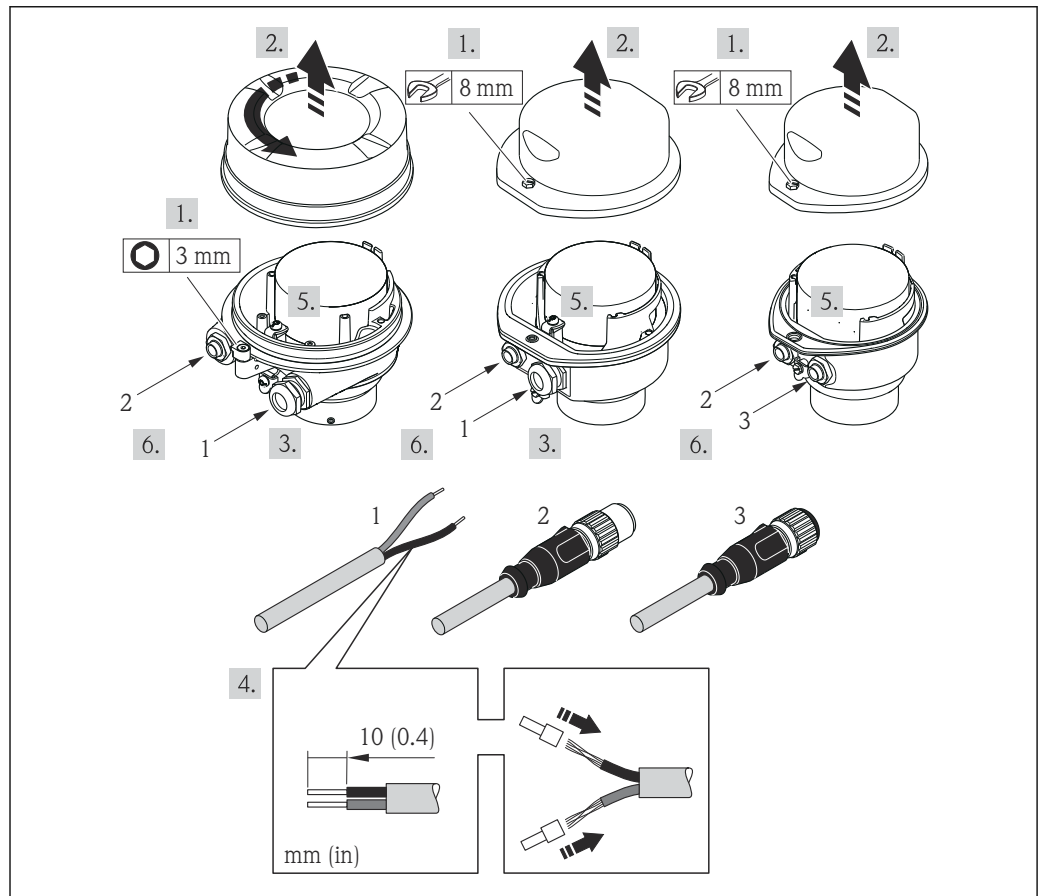

A0017844

10 Device versions with connection examples

- 1 Cable
- 2 Device plug for signal transmission
- 3 Device plug for supply voltage

For device version with device plug: follow step 6 only.

1. Depending on the housing version, loosen the securing clamp or fixing screw of the housing cover.
2. Push the cable through the cable entry . To ensure tight sealing, do not remove the sealing ring from the cable entry.
3. Strip the cable and cable ends. In the case of stranded cables, also fit ferrules.
4. Connect the cable in accordance with the terminal assignment or the device plug pin assignment .
5. Depending on the device version, tighten the cable glands or plug in the device plug and tighten .

6. **⚠ WARNING**

Housing degree of protection may be voided due to insufficient sealing of the housing.

- ▶ Screw in the screw without using any lubricant. The threads on the cover are coated with a dry lubricant.

Reverse the removal procedure to reassemble the transmitter.

7.4 Potential equalization

7.4.1 Requirements

For potential equalization:

- Pay attention to in-house grounding concepts
- Take account of operating conditions, such as the pipe material and grounding
- Connect the medium, sensor and transmitter to the same electric potential
- Use a ground cable with a minimum cross-section of 6 mm² (10 AWG) and a cable lug for potential equalization connections

7.5 Special connection instructions

7.5.1 Connection examples

PROFINET

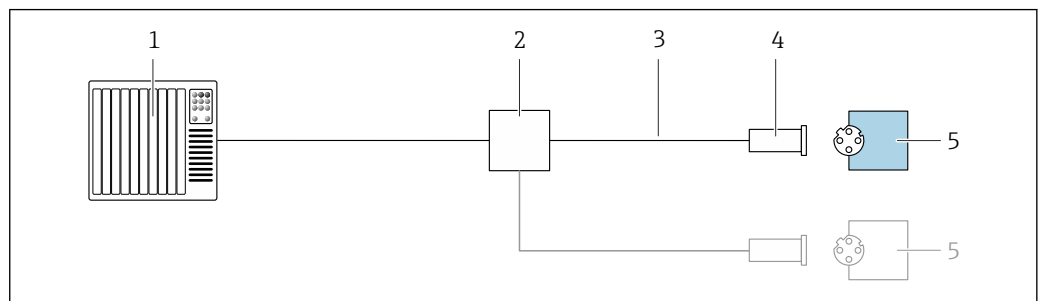

11 Connection example for PROFINET

- 1 Control system (e.g. PLC)
- 2 Ethernet switch
- 3 Observe cable specifications
- 4 Device plug
- 5 Transmitter

7.6 Hardware settings

7.6.1 Setting the device name

A measuring point can be quickly identified within a plant on the basis of the tag name. The tag name is equivalent to the device name (name of station of the PROFINET specification). The factory-assigned device name can be changed using the DIP switches or the automation system.

Example of device name (factory setting): EH-Promass100-XXXXX

EH	Endress+Hauser
Promass	Instrument family
100	Transmitter
XXXXX	Serial number of the device

The device name currently used is displayed in Setup → Name of station .

Setting the device name using the DIP switches

The last part of the device name can be set using DIP switches 1-8. The address range is between 1 and 254 (factory setting: serial number of the device)

Overview of the DIP switches

DIP switches	Bit	Description
1	1	Configurable part of the device name
2	2	
3	4	
4	8	
5	16	
6	32	
7	64	
8	128	
9	–	Enable hardware write protection
10	–	Default IP address: use 192.168.1.212

Example: set the device name EH-PROMASS100-065

DIP switches	ON/OFF	Bit
1	ON	1
2...6	OFF	–
7	ON	64
8	OFF	–

Setting the device name

Risk of electric shock when opening the transmitter housing.

- ▶ Disconnect the device from the power supply before opening the transmitter housing.

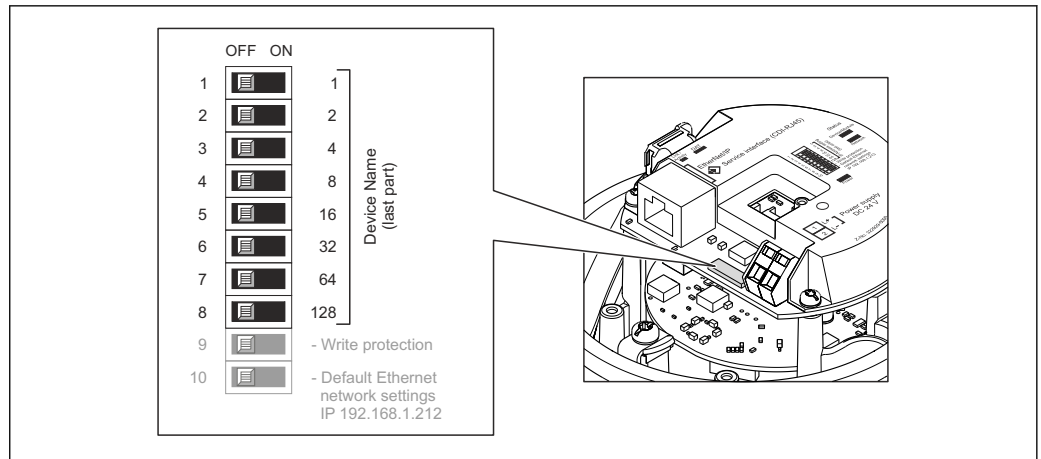

1. Depending on the housing version, loosen the securing clamp or fixing screw of the housing cover.
2. Depending on the housing version, unscrew or open the housing cover and disconnect the local display from the main electronics module where necessary → 152.
3. Set the desired device name using the corresponding DIP switches on the I/O electronics module.
4. Reverse the removal procedure to reassemble the transmitter.
5. Reconnect the device to the power supply. The configured device address is used once the device is restarted.

i If the device is reset via the PROFINET interface, it is not possible to reset the device name to the factory setting. The value 0 is used instead of the device name.

Setting the device name via the automation system

DIP switches 1-8 must all be set to **OFF** (factory setting) or all be set to **ON** to be able to set the device name via the automation system.

The complete device name (name of station) can be changed individually via the automation system.

- i**
 - The serial number used as part of the device name in the factory setting is not saved. It is not possible to reset the device name to the factory setting with the serial number. The value 0 is used instead of the serial number.
 - When assigning the device name via the automation system, enter the device name in lower-case letters.

7.7 Ensuring the degree of protection

The measuring instrument fulfills all the requirements for the degree of protection IP66/67, Type 4X enclosure.

To guarantee the degree of protection IP66/67, Type 4X enclosure, carry out the following steps after the electrical connection:

1. Check that the housing seals are clean and fitted correctly.
2. Dry, clean or replace the seals if necessary.
3. Tighten all housing screws and screw covers.
4. Firmly tighten the cable glands.

5. To ensure that moisture does not enter the cable entry:
Route the cable so that it loops down before the cable entry ("water trap").

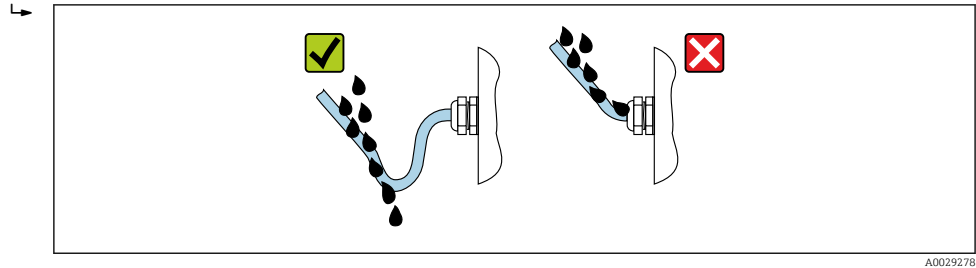

6. The cable glands supplied do not ensure housing protection when not in use. They must therefore be replaced by dummy plugs corresponding to the housing protection.

7.8 Post-connection check

Are the device and cable undamaged (visual inspection)?	<input type="checkbox"/>
Do the cables used comply with the requirements → 25?	<input type="checkbox"/>
Are the installed cables strain-relieved and securely routed?	<input type="checkbox"/>
Are all cable glands installed, securely tightened and leak-tight? Cable run with "water trap" → 31?	<input type="checkbox"/>
Depending on the device version: Are all connectors securely tightened → 28?	<input type="checkbox"/>
Does the supply voltage match the specifications on the transmitter nameplate → 141?	<input type="checkbox"/>
Is the terminal assignment → 26 or the device plug pin assignment → 27 correct?	<input type="checkbox"/>
If supply voltage is present: Is the power LED on the transmitter electronics module lit in green → 12?	<input type="checkbox"/>
Depending on the device version: <ul style="list-style-type: none"> ▪ Have the fixing screws been tightened with the correct tightening torque? ▪ Is the securing clamp securely tightened? 	<input type="checkbox"/>

8 Operation options

8.1 Overview of operation options

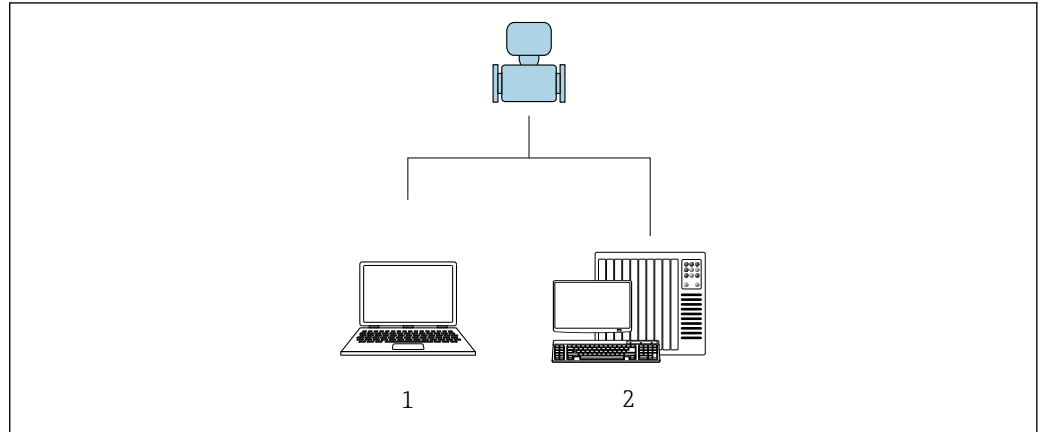



A0017760

- 1 Computer with web browser or with "FieldCare" operating tool
- 2 Automation system, e.g. Siemens S7-300 or S7-1500 with Step7 or TIA portal and latest GSD file.

8.2 Structure and function of the operating menu

8.2.1 Structure of the operating menu

 For an overview of the operating menu for experts: see the "Description of Device Parameters" document supplied with the device →  157

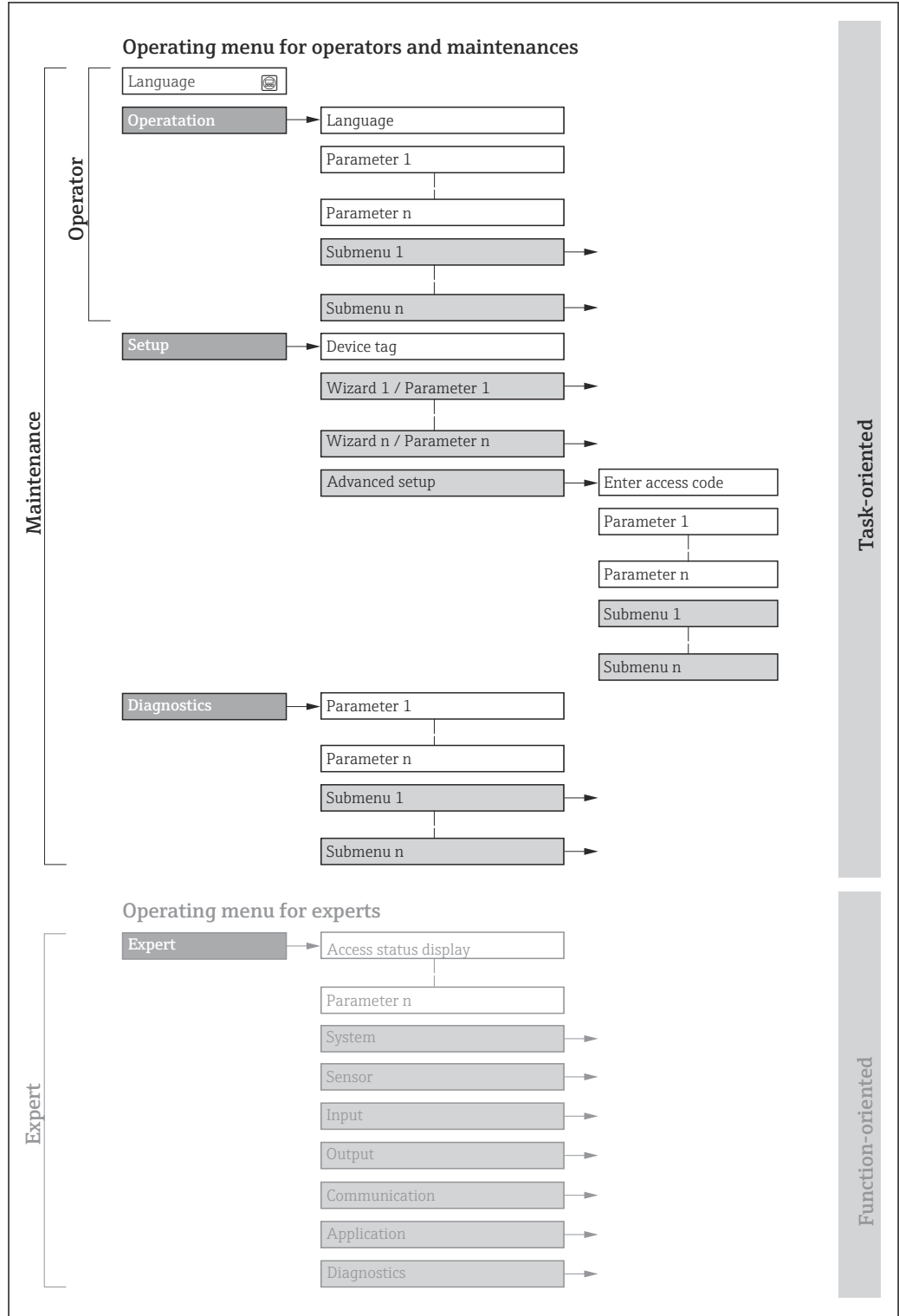

 12 Schematic structure of the operating menu

A0018237-EN

8.2.2 Operating philosophy

The individual parts of the operating menu are assigned to certain user roles (e.g. operator, maintenance etc.). Each user role contains typical tasks within the device life cycle.

Menu/parameter		User role and tasks	Content/meaning
Language	Task-oriented	Role "Operator", "Maintenance" Tasks during operation: <ul style="list-style-type: none"> ▪ Configuration of the operational display ▪ Reading measured values 	<ul style="list-style-type: none"> ▪ Defining the operating language ▪ Defining the Web server operating language ▪ Resetting and controlling totalizers
Operation			<ul style="list-style-type: none"> ▪ Configuration of the operational display (e.g. display format, display contrast) ▪ Resetting and controlling totalizers
Setup		"Maintenance" role Commissioning: Configuration of the measurement	Submenus for fast commissioning: <ul style="list-style-type: none"> ▪ Configuring the system units ▪ Definition of the medium ▪ Configuration of the operational display ▪ Configuring the low flow cut off ▪ Configuring partial and empty pipe detection Advanced setup <ul style="list-style-type: none"> ▪ For more customized configuration of the measurement (adaptation to special measuring conditions) ▪ Configuration of totalizers ▪ Administration (define access code, reset measuring device)
Diagnostics		"Maintenance" role Troubleshooting: <ul style="list-style-type: none"> ▪ Diagnostics and elimination of process and device errors ▪ Measured value simulation 	Contains all parameters for error detection and analyzing process and device errors: <ul style="list-style-type: none"> ▪ Diagnostic list Contains up to 5 currently pending diagnostic messages. ▪ Event logbook Contains event messages that have occurred. ▪ Device information Contains information for identifying the device ▪ Measured values Contains all current measured values. ▪ Heartbeat Technology Verification of device functionality on request and documentation of verification results ▪ Simulation Used to simulate measured values or output values.
Expert	Function-oriented	Tasks that require detailed knowledge of the function of the device: <ul style="list-style-type: none"> ▪ Commissioning measurements under difficult conditions ▪ Optimal adaptation of the measurement to difficult conditions ▪ Detailed configuration of the communication interface ▪ Error diagnostics in difficult cases 	Contains all of the device parameters and allows direct access to these by means of an access code. The structure of this menu is based on the function blocks of the device: <ul style="list-style-type: none"> ▪ System Contains all higher-level device parameters that do not affect measurement or measured value communication ▪ Sensor Configuration of the measurement. ▪ Communication Configuration of the digital communication interface and the Web server ▪ Application Configuration of the functions that go beyond the actual measurement (e.g. totalizer) ▪ Diagnostics Error detection and analysis of process and device errors and for device simulation and Heartbeat Technology.

8.3 Displaying the measured values via the local display (optionally available)

8.3.1 Operational display

 The local display is optionally available:

Order code for "Display; operation", option B "4-line, illuminated; via communication".

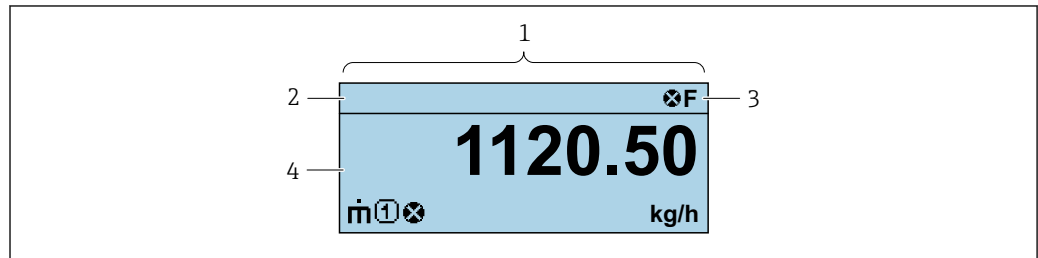





- 1 Operational display
- 2 Tag name
- 3 Status area
- 4 Display area for measured values (4-line)

A0037831

Status area







The following symbols appear in the status area of the operational display at the top right:

- Status signals
 - **F**: Failure
 - **C**: Function check
 - **S**: Out of specification
 - **M**: Maintenance required
- Diagnostic behavior
 - : Alarm
 - : Warning
 - : Locking (the device is locked via the hardware)
 - : Communication (communication via remote operation is active)

Display area

In the display area, each measured value is prefaced by certain symbol types for further description:

Measured variables

Symbol	Meaning
	Mass flow
	<ul style="list-style-type: none"> ▪ Volume flow ▪ Corrected volume flow
	<ul style="list-style-type: none"> ▪ Density ▪ Reference density
	Temperature
	Totalizer  The measurement channel number indicates which of the three totalizers is displayed.

Measurement channel numbers

Symbol	Meaning
	Measurement channel 1 to 4
The measurement channel number is displayed only if more than one channel is present for the same measured variable type (e.g. Totalizer 1 to 3).	

Diagnostic behavior

The diagnostic behavior pertains to a diagnostic event that is relevant to the displayed measured variable. For information on the symbols

 The number and display format of the measured values can only be configured via the control system or Web server.

8.3.2 User roles and related access authorization

The two user roles "Operator" and "Maintenance" have different write access to the parameters if the customer defines a user-specific access code. This protects the device configuration from unauthorized access .

Defining access authorization for user roles

An access code is not yet defined when the device is delivered from the factory. Access authorization (read and write access) to the device is not restricted and corresponds to the "Maintenance" user role.

- ▶ Define the access code.
 - ↳ The "Operator" user role is redefined in addition to the "Maintenance" user role. Access authorization differs for the two user roles.

Access authorization to parameters: "Maintenance" user role

Access code status	Read access	Write access
An access code has not yet been defined (factory setting).	✓	✓
After an access code has been defined.	✓	✓ ¹⁾

1) The user only has write access after entering the access code.

Access authorization to parameters: "Operator" user role

Access code status	Read access	Write access
After an access code has been defined.	✓	- ¹⁾

1) Despite the defined access code, certain parameters can always be modified and thus are excluded from the write protection as they do not affect the measurement: write protection via access code

 The user role with which the user is currently logged on is indicated by the .
Navigation path:

8.4 Access to operating menu via web browser

8.4.1 Function range

With the integrated web server, the device can be operated and configured via a web browser service interface (CDI-RJ45) WLAN interface. In addition to the measured values, status information on the device is displayed and can be used to monitor device health.

Furthermore the device data can be managed and the network parameters can be configured.



 For additional information on the web server, see the Special Documentation for the device.

8.4.2 Prerequisites

Computer hardware

Hardware	Interface	
	CDI-RJ45	WLAN
Interface	The computer must have an RJ45 interface.	The operating unit must have a WLAN interface.
Connection	Standard Ethernet cable with RJ45 connector.	Connection via Wireless LAN.
Display	Recommended size: ≥12" (depends on the screen resolution)	

Computer software



Software	Interface	
	CDI-RJ45	WLAN
Recommended operating systems	<ul style="list-style-type: none"> ▪ Microsoft Windows 8 or higher. ▪ Mobile operating systems: <ul style="list-style-type: none"> ▪ iOS ▪ Android  Microsoft Windows XP is supported.  Microsoft Windows 7 is supported.	
Web browsers supported	<ul style="list-style-type: none"> ▪ Microsoft Internet Explorer 8 or higher ▪ Microsoft Edge ▪ Mozilla Firefox ▪ Google Chrome ▪ Safari 	

Computer settings

User rights	Appropriate user rights (e.g. administrator rights) for TCP/IP and proxy server settings are necessary (for adjusting the IP address, subnet mask etc.).
Proxy server settings of the Web browser	The web browser setting <i>Use a Proxy Server for Your LAN</i> must be deselected .
JavaScript	JavaScript must be enabled.  If JavaScript cannot be enabled: Enter <code>http://XXX.XXX.X.XX/servlet/basic.html</code> in the address bar of the web browser, e.g. <code>http://192.168.1.212/servlet/basic.html</code> . A fully functional but simplified version of the operating menu structure starts in the web browser.
Network connections	Only the active network connections to the measuring device should be used. Switch off all other network connections.

 In the event of connection problems: →  93

Measuring device: Via CDI-RJ45 service interface

Device	CDI-RJ45 service interface
Measuring device	The measuring device has an RJ45 interface.
Web server	Web server must be enabled; factory setting: ON  For information on enabling the Web server →  42

8.4.3 Connecting the device

Via service interface (CDI-RJ45)

Preparing the measuring device

Configuring the Internet protocol of the computer

The IP address can be assigned to the measuring device in a variety of ways:

- Dynamic Configuration Protocol (DCP), factory setting:
The IP address is automatically assigned to the measuring device by the automation system (e.g. Siemens S7).
- Hardware addressing:
The IP address is set via DIP switches .
- Software addressing:
The IP address is entered via the **IP address** parameter (→  62) .
- DIP switch for "Default IP address":
To establish the network connection via the service interface (CDI-RJ45): the fixed IP address 192.168.1.212 is used .

The device works with the Dynamic Configuration Protocol (DCP) ex-works, i.e. the IP address of the measuring device is automatically assigned by the automation system (e.g. Siemens S7).

To establish a network connection via the service interface (CDI-RJ45): set the "Default IP address" DIP switch to **ON**. The measuring device then has the fixed IP address: 192.168.1.212. The fixed IP address 192.168.1.212 can now be used to establish the connection to the network.

1. Via DIP switch 2, activate the default IP address 192.168.1.212: .
2. Switch on the measuring device.
3. Connect the computer to the RJ45 plug via the standard Ethernet cable →  153.
4. If a 2nd network card is not used, close all the applications on the notebook.
 - ↳ Applications requiring Internet or a network, such as e-mail, SAP applications, Internet or Windows Explorer.
5. Close any open Internet browsers.
6. Configure the properties of the Internet protocol (TCP/IP) as defined in the table:

IP address	192.168.1.XXX; for XXX all numerical sequences except: 0, 212 and 255 → e.g. 192.168.1.213
Subnet mask	255.255.255.0
Default gateway	192.168.1.212 or leave cells empty

Starting the web browser

1. Start the web browser on the computer.

2. Enter the IP address of the web server in the address line of the web browser:
192.168.1.212
↳ The login page appears.

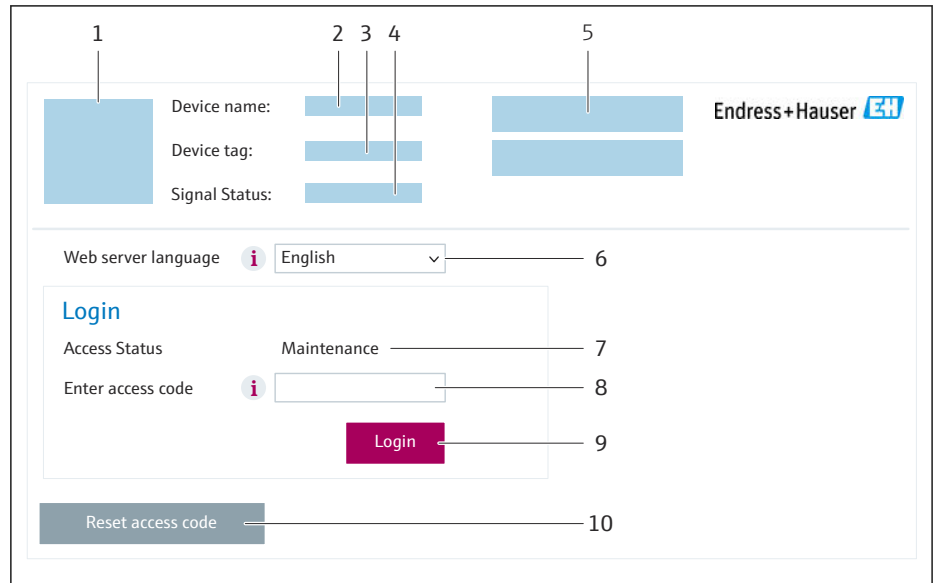

- 1 Picture of device
- 2 Device name
- 3 Device tag
- 4 Status signal
- 5 Current measured values
- 6 Operating language
- 7 User role
- 8 Access code
- 9 Login
- 10 Reset access code

i If a login page does not appear, or if the page is incomplete → 93

8.4.4 Logging on

1. Select the preferred operating language for the Web browser.
2. Enter the user-specific access code.
3. Press **OK** to confirm your entry.

Access code	0000 (factory setting); can be changed by customer
--------------------	--

i If no action is performed for 10 minutes, the Web browser automatically returns to the login page.

8.4.5 User interface

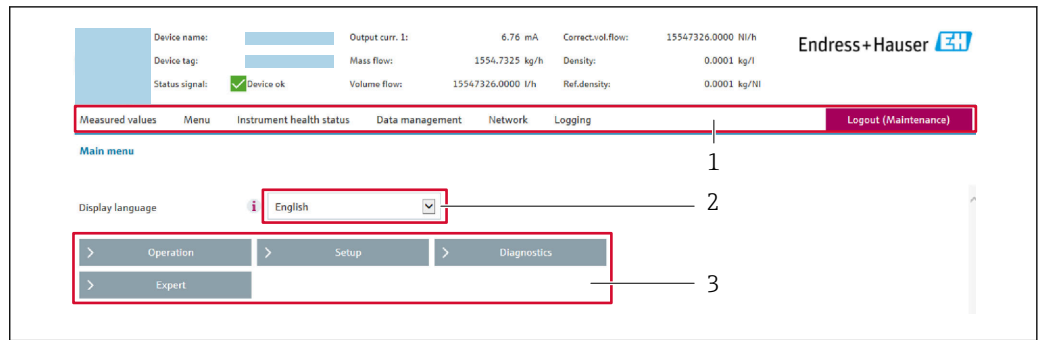

- 1 Function row
- 2 Local display language
- 3 Navigation area

Header

The following information appears in the header:

- Device name
- Device tag
- Device status with status signal → 96
- Current measured values

Function row

Functions	Meaning
Measured values	Displays the measured values of the device
Menu	<ul style="list-style-type: none"> ■ Access to the operating menu from the measuring device ■ The structure of the operating menu is the same as for the operating tools  Detailed information on the operating menu structure: Description of Device Parameters
Device status	Displays the diagnostic messages currently pending, listed in order of priority
Data management	Data exchange between computer and measuring device: <ul style="list-style-type: none"> ■ Device configuration: <ul style="list-style-type: none"> ■ Load settings from the device (XML format, save configuration) ■ Save settings to the device (XML format, restore configuration) ■ Logbook - Export Event logbook (.csv file) ■ Documents - Export documents: <ul style="list-style-type: none"> ■ Export backup data record (.csv file, create documentation of the measuring point configuration) ■ Verification report (PDF file, only available with the "Heartbeat Verification" application package) ■ File for system integration - If using fieldbuses, upload device drivers for system integration from the measuring device: PROFINET: GSD file
Network	Configuration and checking of all the parameters required for establishing the connection to the measuring device: <ul style="list-style-type: none"> ■ Network settings (e.g. IP address, MAC address) ■ Device information (e.g. serial number, firmware version)
Logout	End the operation and call up the login page

Navigation area

The menus, the associated submenus and parameters can be selected in the navigation area.

Working area

Depending on the selected function and the related submenus, various actions can be performed in this area:

- Configuring parameters
- Reading measured values
- Calling up help text
- Starting an upload/download

8.4.6 Disabling the Web server

The Web server of the measuring device can be switched on and off as required using the **Web server functionality** parameter.

Navigation

"Expert" menu → Communication → Web server

Parameter overview with brief description

Parameter	Description	Selection
Web server functionality	Switch the Web server on and off.	<ul style="list-style-type: none"> ▪ Off ▪ HTML Off ▪ On

Function scope of the "Web server functionality" parameter

Option	Description
Off	<ul style="list-style-type: none"> ▪ The Web server is completely disabled. ▪ Port 80 is locked.
On	<ul style="list-style-type: none"> ▪ The complete Web server functionality is available. ▪ JavaScript is used. ▪ The password is transferred in an encrypted state. ▪ Any change to the password is also transferred in an encrypted state.

Enabling the Web server

If the Web server is disabled it can only be re-enabled with the **Web server functionality** parameter via the following operating options:

- Via Bedientool "FieldCare"
- Via "DeviceCare" operating tool

8.4.7 Logging out

 Before logging out, perform a data backup via the **Data management** function (upload configuration from device) if necessary.

1. Select the **Logout** entry in the function row.
↳ The home page with the Login box appears.
2. Close the Web browser.
3. If no longer needed:
Reset the modified properties of the Internet protocol (TCP/IP) →  39.

 If communication with the web server was established via the default IP address 192.168.1.212, DIP switch no. 10 must be reset (from **ON** → **OFF**). Afterwards, the IP address of the device is active again for network communication.

8.5 Access to the operating menu via the operating tool

8.5.1 Connecting the operating tool

Via PROFINET network

This communication interface is available in device versions with PROFINET.

Star topology

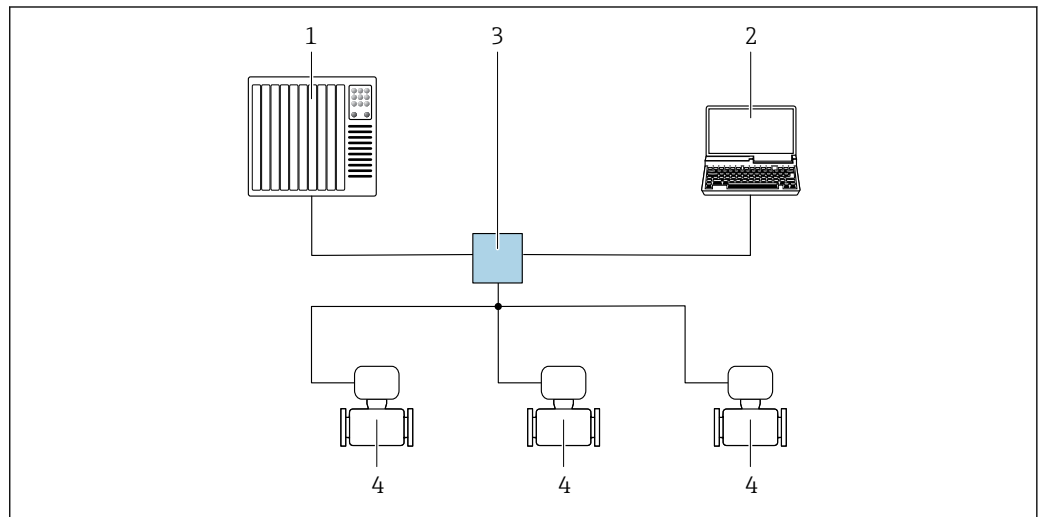

13 Options for remote operation via PROFINET network: star topology

- 1 Automation system, e.g. Simatic S7 (Siemens)
- 2 Computer with Web browser (e.g. Internet Explorer) for accessing the integrated Web server or computer with operating tool (e.g. FieldCare, DeviceCare, SIMATIC PDM) with COM DTM "CDI Communication TCP/IP"
- 3 Standard Ethernet switch, e.g. Scalance X204 (Siemens)
- 4 Measuring device

Via service interface (CDI-RJ45)

PROFINET

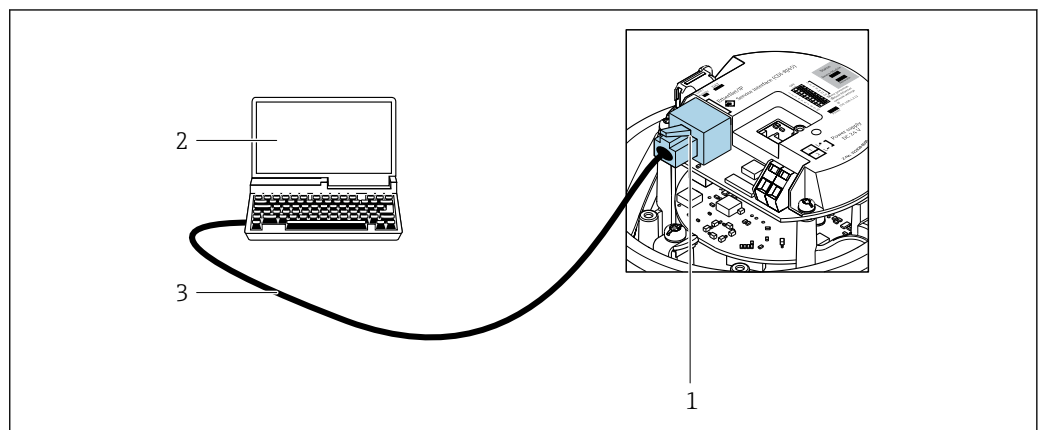

14 Connection for order code for "Output", option R: PROFINET

- 1 Service interface (CDI-RJ45) and PROFINET interface of the measuring device with access to the integrated web server
- 2 Computer with web browser (e.g. Internet Explorer) for accessing the integrated web server or with "FieldCare" operating tool with COM DTM "CDI Communication TCP/IP"
- 3 Standard Ethernet connecting cable with RJ45 plug

8.5.2 FieldCare

Function range

FDT-based (Field Device Technology) plant asset management tool from Endress+Hauser. It can configure all smart field units in a system and helps you manage them. By using the status information, it is also a simple but effective way of checking their status and condition.

Access is via:
CDI-RJ45 service interface

Typical functions:

- Transmitter parameter configuration
- Loading and saving of device data (upload/download)
- Documentation of the measuring point
- Visualization of the measured value memory (line recorder) and event logbook



- Operating Instructions BA00027S
- Operating Instructions BA00059S



Source for device description files → 46

Establishing a connection

1. Start FieldCare and launch the project.
2. In the network: Add a device.
 - ↳ The **Add device** window opens.
3. Select the **CDI Communication TCP/IP** option from the list and press **OK** to confirm.
4. Right-click **CDI Communication TCP/IP** and select the **Add device** option in the context menu that opens.
5. Select the desired device from the list and press **OK** to confirm.
 - ↳ The **CDI Communication TCP/IP (Configuration)** window opens.
6. Enter the device address in the **IP address** field and press **Enter** to confirm: 192.168.1.212 (factory setting); if the IP address is not known .
7. Establish the online connection to the device.



- Operating Instructions BA00027S
- Operating Instructions BA00059S

User interface

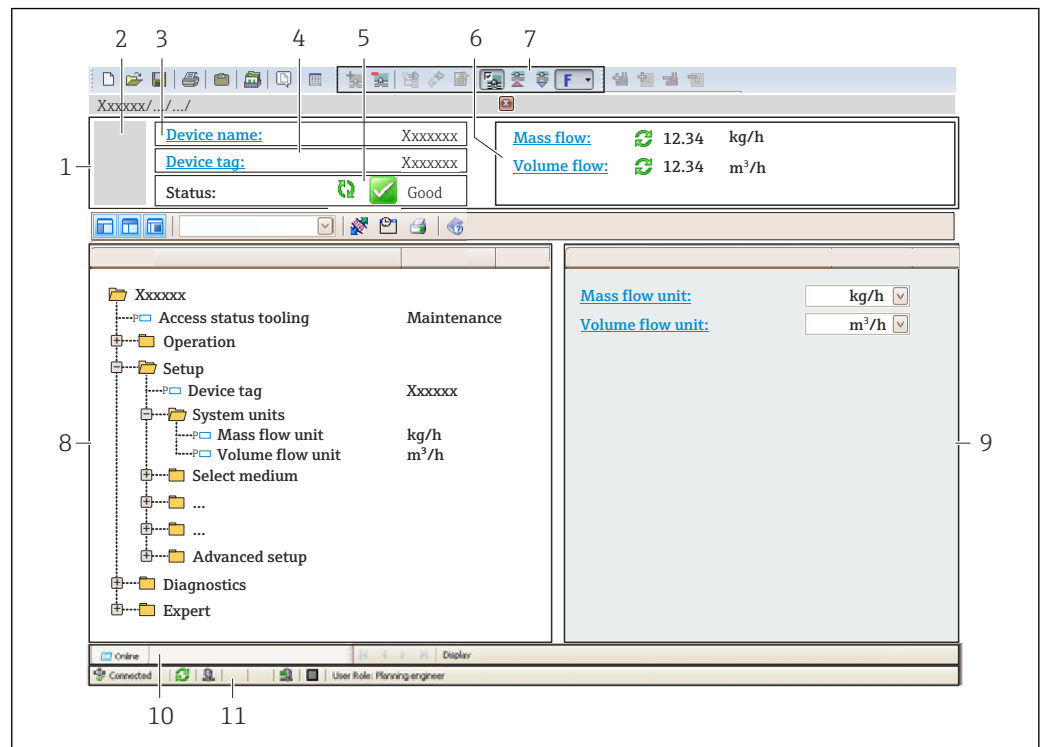

A0021051-EN

- 1 Header
- 2 Picture of device
- 3 Device name
- 4 Device tag
- 5 Status area with status signal → 96
- 6 Display area for current measured values
- 7 Editing toolbar with additional functions such as save/load, event list and create documentation
- 8 Navigation area with operating menu structure
- 9 Work area
- 10 Action area
- 11 Status area

8.5.3 DeviceCare

Function range

Tool for connecting and configuring Endress+Hauser field devices.

The fastest way to configure Endress+Hauser field devices is with the dedicated "DeviceCare" tool. Together with the device type managers (DTMs) it presents a convenient, comprehensive solution.

 Innovation brochure IN01047S

 Source for device description files → 46

9 System integration

9.1 Overview of device description files

9.1.1 Current version data for the device

Firmware version	01.00.zz	<ul style="list-style-type: none"> ▪ On the title page of the manual ▪ On the transmitter nameplate ▪ Firmware version Diagnostics → Device information → Firmware version
Release date of firmware version	12.2015	–
Manufacturer ID	0x11	Manufacturer ID Diagnostics → Device information → Manufacturer ID
Device ID	0x844A	Device ID Expert → Communication → PROFINET configuration → PROFINET information → Device ID
Device type ID	Promass 100	Device Type Expert → Communication → PROFINET configuration → PROFINET information → Device Type
Device revision	1	Device revision Expert → Communication → PROFINET configuration → PROFINET information → Device revision
PROFINET version	2.3.x	–



For an overview of the various firmware versions for the device

9.1.2 Operating tools

The suitable device description file for the individual operating tools is listed in the table below, along with information on where the file can be acquired.

Operating tool via Service interface (CDI-RJ45)	Sources for obtaining device descriptions
FieldCare	<ul style="list-style-type: none"> ▪ www.endress.com → Downloads area ▪ USB stick (contact Endress+Hauser) ▪ DVD (contact Endress+Hauser)
DeviceCare	<ul style="list-style-type: none"> ▪ www.endress.com → Downloads area ▪ CD-ROM (contact Endress+Hauser) ▪ DVD (contact Endress+Hauser)

9.2 Device master file (GSD)

In order to integrate field devices into a bus system, the PROFIBUS system needs a description of the device parameters, such as output data, input data, data format and data volume.

These data are available in the device master file (GSD) which is provided to the automation system when the communication system is commissioned. In addition device bit maps, which appear as icons in the network structure, can also be integrated.

The device master file (GSD) is in XML format, and the file is created in the GSDML description markup language.

With the PA Profile 4.02 device master file (GSD) it is possible to exchange field devices made by different manufacturers without having to reconfigure.

Two different device master files (GSD) can be used: Manufacturer-specific GSD and PA Profile GSD.

9.2.1 File name of the manufacturer-specific device master file (GSD)

Example of the name of a device master file:

GSDML-V2.3.x-EH-PROMASS 100-yyyymmdd.xml







GSDML	Description language
V2.3.x	Version of the PROFINET specification
EH	Endress+Hauser
PROMASS	Instrument family
100	Transmitter
yyyymmdd	Date of issue (yyyy: year, mm: month, dd: day)
.xml	File name extension (XML file)

9.2.2 File name of the PA Profile device master file (GSD)

9.3 Cyclic data transmission

9.3.1 Overview of the modules

The following tables shows which modules are available to the measuring device for cyclic data exchange. Cyclic data exchange is performed with an automation system.

Measuring device		Slot	Direction Data flow	Control system
Modules				
Analog Input module →  48		1 to 14	→	PROFINET
Digital Input module →  49		1 to 14	→	
Diagnose Input module →  50		1 to 14	→	
Analog Output module →  53		18, 19, 20	←	
Digital Output module →  54		21, 22	←	
Totalizer 1 to 3 →  51		15 to 17	← →	
Heartbeat Verification module →  55		23	← →	

9.3.2 Description of the modules

-  The data structure is described from the perspective of the automation system:
- Input data: Are sent from the measuring device to the automation system.
 - Output data: Are sent from the automation device system to the measuring device.

Analog Input module

Transmit input variables from the measuring device to the automation system.

Analog Input modules cyclically transmit the selected input variables, along with the status, from the measuring device to the automation system. The input variable is depicted in the first four bytes in the form of a floating point number as per the IEEE 754 standard. The fifth byte contains status information pertaining to the input variable.

Selection: input variable

Slot	Input variables
1 to 14	<ul style="list-style-type: none"> ▪ Mass flow ▪ Volume flow ▪ Corrected volume flow ▪ Target mass flow ¹⁾ ▪ Carrier mass flow ▪ Density ▪ Reference density ▪ Concentration ▪ Temperature ▪ Electronic temperature ▪ Oscillation frequency ▪ Oscillation amplitude ▪ Frequency fluctuation ▪ Oscillation damping ▪ Tube damping fluctuation ▪ Signal asymmetry ▪ Exciter current

1) Only available with the Concentration application package

*Data structure**Input data of Analog Input*

Byte 1	Byte 2	Byte 3	Byte 4	Byte 5
Measured value: floating point number (IEEE 754)				Status ¹⁾

1) Status coding → 56

Application-specific Input module

Transmit compensation values from the measuring device to the automation system.

The Application-specific Input module cyclically transmits compensation values, including the status, from the measuring device to the automation system. The compensation value is depicted in the first four bytes in the form of a floating point number as per the IEEE 754 standard. The fifth byte contains standardized status information pertaining to the compensation value.

Assigned compensation values

The configuration is performed via: Expert → Application → Application specific calculations → Process variables

Slot	Compensation value
31	Application-specific Input module
32	Application-specific Input module

*Data structure**Input data of Application-specific Input module*

Byte 1	Byte 2	Byte 3	Byte 4	Byte 5
Measured value: floating point number (IEEE 754)				Status ¹⁾

1) Status coding

Failsafe mode

A failsafe mode can be defined for using the compensation values.

If the status is GOOD or UNCERTAIN, the compensation values transmitted by the automation system are used. If the status is BAD, the failsafe mode is activated for the use of the compensation values.

Parameters are available per compensation value to define the failsafe mode: Expert → Application → Application specific calculations → Process variables

Fail safe type parameter

- **Fail safe value** option: The value defined in the Fail safe value parameter is used.
- **Fallback value** option: The last valid value is used.
- **Off** option: Failsafe mode is disabled.

Fail safe value parameter

Use this parameter to enter the compensation value which is used if the Fail safe value option is selected in the Fail safe type parameter.

Digital Input module

Transmit digital input values from the measuring device to the automation system.

Digital input values are used by the measuring device to transmit the state of device functions to the automation system.

Digital Input modules cyclically transmit discrete input values, including the status, from the measuring device to the automation system. The discrete input value is depicted in the first byte. The second byte contains standardized status information pertaining to the input value.

Selection: device function

Slot	Device function	Status (meaning)
1 to 14	Empty pipe detection	<ul style="list-style-type: none"> ■ 0 (device function not active) ■ 1 (device function active)
	Low flow cut off	

Data structure

Input data of Digital Input

Byte 1	Byte 2
Digital Input	Status ¹⁾

1) Status coding →  56

Diagnose Input module



Transmit discrete input values (diagnostic information) from the measuring device to the automation system.

Diagnostic information is used by the measuring device to transmit the device status to the automation system.

Diagnose Input modules transmit discrete input values from the measuring device to the automation system. The first two bytes contain the information regarding the diagnostic information number (→  101). The third byte provides the status.

Selection: device function

Slot	Device function	Status (meaning)
1 to 14	Last diagnostics	Diagnostic information number (→  101) and status
	Current diagnosis	

 Information about pending diagnostic information →  122.

Data structure

Input data of Diagnose Input

Byte 1	Byte 2	Byte 3	Byte 4
Diagnostic information number		Status	Value 0

Status

Coding (hex)	Status
0x00	No device error is present.
0x01	Failure (F): A device error is present. The measured value is no longer valid.

Coding (hex)	Status
0x02	Function check (C): The device is in service mode (e.g. during a simulation).
0x04	Maintenance required (M): Maintenance is required. The measured value is still valid.
0x08	Out of specification (S): The device is being operated outside its technical specification limits (e.g. process temperature range).

Totalizer module

The Totalizer module consists of the Totalizer Value, Totalizer Control and Totalizer Mode submodules.

Totalizer Value submodule

Transmit transmitter value from the device to the automation system.

Totalizer modules cyclically transmit a selected totalizer value, along with the status, from the measuring device to the automation system via the Totalizer Value submodule. The totalizer value is depicted in the first four bytes in the form of a floating point number as per the IEEE 754 standard. The fifth byte contains status information pertaining to the totalizer value.

Selection: input variable

Slot	Sub-slot	Input variable
15...17	1	<ul style="list-style-type: none"> ▪ Mass flow ▪ Volume flow ▪ Corrected volume flow ▪ Target mass flow ¹⁾ ▪ Carrier mass flow ¹⁾

1) Only available with the Concentration application package

Data structure of input data (Totalizer Value submodule)

Byte 1	Byte 2	Byte 3	Byte 4	Byte 5
Measured value: floating point number (IEEE 754)				Status ¹⁾

1) Status coding → 56

Totalizer Control module

Transmit totalizer value from the measuring device to the automation system.

Selection: input variable

Data structure

Totalizer Control input data

Byte 1	Byte 2	Byte 3	Byte 4	Byte 5
Measured value: floating point number (IEEE 754)				Status ¹⁾

1) Status coding

Selection: output variable

Transmit the control value from the automation system to the measuring device.

Slot	Sub-slot	Value	Input variable
70 to 71	1	1	Reset to "0"
		2	Preset value
		3	Stop
		4	Totalize

*Data structure**Totalizer Control output data*

Byte 1
Control variable

Totalizer Control submodule

Control the totalizer via the automation system.

Selection: control totalizer

Slot	Sub-slot	Value	Control totalizer
15...17	2	0	Totalize
		1	Reset + hold
		2	Preset + hold
		3	Reset + totalize
		4	Preset + totalize
		5	Hold

Data structure of output data (Totalizer Control submodule)

Byte 1
Control variable

Totalizer Mode submodule

Configure the totalizer via the automation system.

Selection: totalizer configuration

Slot	Sub-slot	Value	Control totalizer
15...17	3	0	Balancing
		1	Balance the positive flow
		2	Balance the negative flow

Data structure of output data (Totalizer Mode submodule)

Byte 1
Configuration variable

Analog Output module

Transmit compensation values from the automation system to the measuring device.

Analog Output modules cyclically transmit compensation values, along with the status and the associated unit, from the automation system to the measuring device. The compensation value is depicted in the first four bytes in the form of a floating point number as per the IEEE 754 standard. The fifth byte contains standardized status information pertaining to the compensation value. The unit is transmitted in the sixth and seventh byte.

Assigned compensation values

 The configuration is performed via: Expert → Sensor → External compensation

Slot	Compensation value
18	External pressure
19	External temperature
20	External reference density
29	External value for % S&W (sediment and water) ¹⁾
30	External value for % Water cut ¹⁾

1) Only available with the Petroleum application package.

Available units

Pressure		Temperature		Density		Percent	
Unit code	Unit	Unit code	Unit	Unit code	Unit	Unit code	Unit
1610	Pa a	1001	°C	32840	kg/Nm ³	1342	%
1616	kPa a	1002	°F	32841	kg/Nl		
1614	MPa a	1000	K	32842	g/Scm ₃		
1137	bar	1003	°R	32843	kg/Scm ₃		
1611	Pa g			32844	lb/Sft ₃		
1617	kPa g						
1615	MPa g						
32797	bar g						
1142	psi a						
1143	psi g						

Data structure

Output data of Analog Output

Byte 1	Byte 2	Byte 3	Byte 4	Byte 5	Byte 6	Byte 7
Measured value: floating point number (IEEE 754)				Status ¹⁾	Unit code	

1) Status coding →  56

Failsafe mode

A failsafe mode can be defined for using the compensation values.

If the status is GOOD or UNCERTAIN, the compensation values transmitted by the automation system are used. If the status is BAD, the failsafe mode is activated for the use of the compensation values.

Parameters are available per compensation value to define the failsafe mode: Expert
→ Sensor → External compensation

Fail safe type parameter

- Fail safe value option: The value defined in the Fail safe value parameter is used.
- Fallback value option: The last valid value is used.
- Off option: The failsafe mode is disabled.

Fail safe value parameter

Use this parameter to enter the compensation value which is used if the Fail safe value option is selected in the Fail safe type parameter.

Digital Output module

Transmit digital output values from the automation system to the measuring device.

Digital output values are used by the automation system to enable and disable device functions.

Digital output values cyclically transmit discrete output values, including the status, from the automation system to the measuring device. The discrete output value is transmitted in the first byte. The second byte contains status information pertaining to the output value.

Assigned device functions

Slot	Device function	Status (meaning)
21	Flow override	<ul style="list-style-type: none"> ■ 0 (disable device function) ■ 1 (enable device function)
22	Zero adjust	
24 to 26	Relay output	Relay output value: <ul style="list-style-type: none"> ■ 0 ■ 1

Data structure

Output data of Digital Output

Byte 1	Byte 2
Digital Output	Status ^{1) 2)}

1) Status coding → 56

2) If the status is BAD, the control variable is not adopted.

Heartbeat Verification module

Receive discrete output values from the automation system and transmit discrete input values from the measuring instrument to the automation system.

The Heartbeat Verification module receives discrete output data from the automation system and transmits discrete input data from the measuring instrument to the automation system.

The discrete output value is provided by the automation system to start a Heartbeat Verification. The discrete input value is depicted in the first byte. The second byte contains status information pertaining to the input value.

The discrete input value is used by the measuring instrument to send the status of the Heartbeat Verification device functions to the automation system. The module cyclically transmits the discrete input value, along with the status, to the automation system. The

discrete input value is depicted in the first byte. The second byte contains status information pertaining to the input value.

 Only available with the Heartbeat Verification application package.

Assigned device functions

Slot	Device function	Bit	Verification status
23	Verification status (input data)	0	Verification has not been performed
		1	The device has failed the verification
		2	Currently performing verification
		3	Verification finished
	Verification result (input data)	Bit	Verification result
		4	The device has failed the verification
		5	Verification performed successfully
		6	Verification has not been performed
	Start the verification (output data)	Verification control	
		A status change from 0 to 1 starts the verification	

Data structure

Output data of Heartbeat Verification module

Byte 1
Discrete Output

Input data of Heartbeat Verification module

Byte 1	Byte 2
Discrete Input	Status ¹⁾

1) Status coding →  56

Concentration module

 Only available with the Concentration Measurement application package.

Assigned device functions

Slot	Input variables
28	Selection of the liquid type

Data structure

Concentration output data

Byte 1
Control variable

Liquid type	Enum code
Off	0
Sucrose in water	5
Glucose in water	2
Fructose in water	1
Invert sugar in water	6
Corn syrup HFCS42	15
Corn syrup HFCS55	16
Corn syrup HFCS90	17
Original wort	18
Ethanol in water	11
Methanol in water	12
Hydrogen peroxide in water	4
Hydrochloric acid	24
Sulfuric acid	25
Nitric acid	7
Phosphoric acid	8
Sodium hydroxide	10
Potassium hydroxide	9
Ammonium nitrate in water	13
Iron(III) chloride in water	14
% mass / % volume	19
User Profile Coef Set No. 1	21
User Profile Coef Set No. 2	22
User Profile Coef Set No. 3	23

9.3.3 Status coding

Status	Coding (hex)	Meaning
BAD - Maintenance alarm	0x24	A measured value is not available because a device error has occurred.
BAD - Process related	0x28	A measured value is not available because the process conditions are not within the device's technical specification limits.
BAD - Function check	0x3C	A function check is active (e.g. cleaning or calibration)
UNCERTAIN - Initial value	0x4F	A predefined value is output until a correct measured value is available again or corrective measures have been performed that change this status.
UNCERTAIN - Maintenance demanded	0x68	Signs of wear and tear have been detected on the measuring instrument. Short-term maintenance is necessary to ensure that the measuring instrument remains ready for use. The measured value might be invalid. The use of the measured value depends on the application.
UNCERTAIN - Process related	0x78	The process conditions are not within the device's technical specification limits. This could have a negative impact on the quality and accuracy of the measured value. The use of the measured value depends on the application.

Status	Coding (hex)	Meaning
GOOD - OK	0x80	No error has been diagnosed.
GOOD - Maintenance demanded	0xA8	The measured value is valid. It is strongly recommended to service the device in the near future.
GOOD - Function check	0xBC	The measured value is valid. The measuring instrument is performing an internal function check. The function check does not have any noticeable effect on the process.

9.3.4 Factory setting

The slots are already assigned in the automation system for initial commissioning.

Assigned slots

Slot	Factory setting
1	Mass flow
2	Volume flow
3	Corrected volume flow
4	Density
5	Reference density
6	Temperature
7 to 14	-
15	Totalizer 1
16	Totalizer 2
17	Totalizer 3

9.3.5 Startup configuration



If startup configuration is enabled, the configuration of the most important device parameters is taken from the automation system and used. The following configurations are taken from the automation system.

Startup configuration (NSU)	<ul style="list-style-type: none"> ■ Management: <ul style="list-style-type: none"> ■ Software revision ■ Write protection ■ Web server functionality ■ System units: <ul style="list-style-type: none"> ■ Mass flow ■ Mass ■ Volume flow ■ Volume ■ Corrected volume flow ■ Corrected volume ■ Density ■ Reference density ■ Temperature ■ Pressure ■ Concentration application package: <ul style="list-style-type: none"> ■ Coefficients A0 to A4 ■ Coefficients B1 to B3 ■ Medium type ■ Sensor adjustment ■ Process parameter: <ul style="list-style-type: none"> ■ Damping (flow, density, temperature) ■ Flow override ■ Low flow cut off: <ul style="list-style-type: none"> ■ Assign process variable ■ Switch-on/switch-off point ■ Pressure shock suppression ■ Empty pipe detection: <ul style="list-style-type: none"> ■ Assign process variable ■ Limits ■ Response time ■ Max. damping ■ Corrected volume flow calculation: <ul style="list-style-type: none"> ■ External reference density ■ Fixed reference density ■ Reference temperature ■ Linear expansion coefficient ■ Square expansion coefficient ■ Measuring mode: <ul style="list-style-type: none"> ■ Medium ■ Gas type ■ Reference sound velocity ■ Temperature coefficient sound velocity ■ External compensation: <ul style="list-style-type: none"> ■ Pressure compensation ■ Pressure value ■ External pressure ■ Alarm delay ■ Diagnostic settings ■ Diagnostic behavior for diverse diagnostic information ■ Petroleum application package: <ul style="list-style-type: none"> ■ Petroleum mode ■ Water density unit ■ Water reference density unit ■ Oil density unit ■ Oil sample density ■ Oil sample temperature ■ Oil sample pressure ■ Water sample density ■ Water sample temperature ■ API commodity group ■ API table selection ■ Thermal expansion coefficient
-----------------------------	--

10 Commissioning

10.1 Post-mounting and post-connection check

Before commissioning the device:

- ▶ Make sure that the post-installation and post-connection checks have been performed successfully.
- Checklist for "Post-installation" check →  24
- Checklist for "Post-connection" check →  32

10.2 Identifying the device in the PROFINET network

A device can be quickly identified within a plant using the PROFINET flash function. If the PROFINET flash function is activated in the automation system, the LED indicating the network status flashes and the red backlight of the onsite display is switched on.

10.3 Startup parameterization

By activating the startup parameterization function (NSU: Normal Startup Unit), the configuration of the most important measuring device parameters is taken from the automation system.

 Configurations taken from the automation system .

10.4 Connecting via FieldCare

- For connecting FieldCare
- For connecting via FieldCare →  44
- For user interface of FieldCare →  45

10.5 Setting the operating language

Factory setting: English or ordered local language

The operating language can be set in FieldCare, DeviceCare or via the Web server:
Operation → Display language

10.6 Configuring the measuring instrument

The **Setup** menu with its submenus contains all the parameters needed for standard operation.

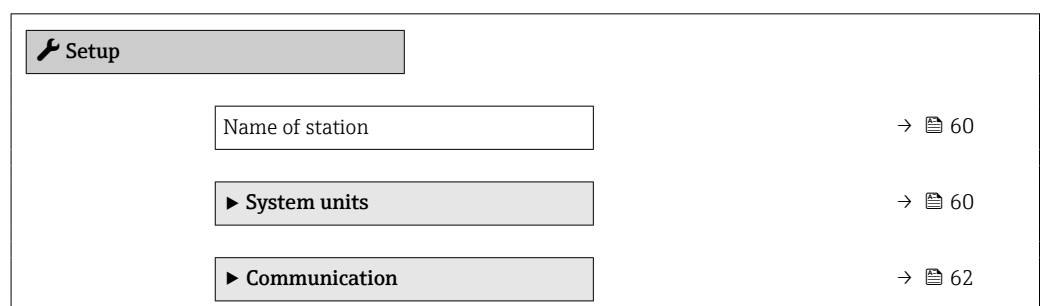

▶ Medium selection	→ 64
▶ Low flow cut off	→ 66
▶ Partially filled pipe detection	→ 67
▶ Advanced setup	→ 68

10.6.1 Defining the tag name

A measuring point can be quickly identified within a plant on the basis of the tag name. The tag name is equivalent to the device name (name of station) of the PROFINET specification (data length: 255 bytes)

The device name can be changed via DIP switches or the automation system → 30.

The device name currently used is displayed in the **Name of station** parameter.

Navigation

"Setup" menu → PROFINET device name

Parameter overview with brief description

Parameter	Description	User interface	Factory setting
Name of station	Name of the measuring point.	Max. 32 characters such as letters and numbers.	EH-PROMASS100 serial number of the device

10.6.2 Setting the system units





In the **System units** submenu the units of all the measured values can be set.

i The number of submenus and parameters can vary depending on the device version. Certain submenus and parameters in these submenus are not described in the Operating Instructions. Instead a description is provided in the Special Documentation for the device ("Supplementary documentation").

Navigation

"Setup" menu → Advanced setup → System units

▶ System units	
Mass flow unit	→ 61
Mass unit	→ 61
Volume flow unit	→ 61
Volume unit	→ 61
Corrected volume flow unit	→ 61
Corrected volume unit	→ 61

Density unit	→  61
Reference density unit	→  61
Temperature unit	→  62
Pressure unit	→  62

Parameter overview with brief description

Parameter	Description	Selection	Factory setting
Mass flow unit	Select mass flow unit. <i>Effect</i> The selected unit applies to: <ul style="list-style-type: none"> ■ Output ■ Low flow cut off ■ Simulation process variable 	Unit choose list	Country-specific: <ul style="list-style-type: none"> ■ kg/h ■ lb/min
Mass unit	Select mass unit.	Unit choose list	Country-specific: <ul style="list-style-type: none"> ■ kg ■ lb
Volume flow unit	Select volume flow unit. <i>Effect</i> The selected unit applies to: <ul style="list-style-type: none"> ■ Output ■ Low flow cut off ■ Simulation process variable 	Unit choose list	Country-specific: <ul style="list-style-type: none"> ■ l/h ■ gal/min (us)
Volume unit	Select volume unit.	Unit choose list	Country-specific: <ul style="list-style-type: none"> ■ l (DN > 150 (6"): m³ option) ■ gal (us)
Corrected volume flow unit	Select corrected volume flow unit. <i>Effect</i> The selected unit applies to: Corrected volume flow parameter (→  82)	Unit choose list	Country-specific: <ul style="list-style-type: none"> ■ NI/h ■ Sft³/min
Corrected volume unit	Select corrected volume unit.	Unit choose list	Country-specific: <ul style="list-style-type: none"> ■ NI ■ Sft³
Density unit	Select density unit. <i>Effect</i> The selected unit applies to: <ul style="list-style-type: none"> ■ Output ■ Simulation process variable ■ Density adjustment (Expert menu) 	Unit choose list	Country-specific: <ul style="list-style-type: none"> ■ kg/l ■ lb/ft³
Reference density unit	Select reference density unit.	Unit choose list	Country-specific <ul style="list-style-type: none"> ■ kg/NI ■ lb/Sft³
Density 2 unit	Select second density unit.	Unit choose list	Country-specific: <ul style="list-style-type: none"> ■ kg/l ■ lb/ft³

Parameter	Description	Selection	Factory setting
Temperature unit	Select temperature unit. <i>Effect</i> The selected unit applies to: <ul style="list-style-type: none"> ▪ Electronic temperature parameter (6053) ▪ Maximum value parameter (6051) ▪ Minimum value parameter (6052) ▪ External temperature parameter (6080) ▪ Maximum value parameter (6108) ▪ Minimum value parameter (6109) ▪ Maximum value parameter (6029) ▪ Minimum value parameter (6030) ▪ Reference temperature parameter (1816) ▪ Temperature parameter 	Unit choose list	Country-specific: <ul style="list-style-type: none"> ▪ °C ▪ °F
Pressure unit	Select process pressure unit. <i>Effect</i> The unit is taken from: <ul style="list-style-type: none"> ▪ Pressure value parameter (→ ⓘ 65) ▪ External pressure parameter (→ ⓘ 65) ▪ Pressure value 	Unit choose list	Country-specific: <ul style="list-style-type: none"> ▪ bar a ▪ psi a

10.6.3 Displaying the communication interface

The **Communication** submenu shows all the current parameter settings for selecting and configuring the communication interface.

Navigation

"Setup" menu → Communication

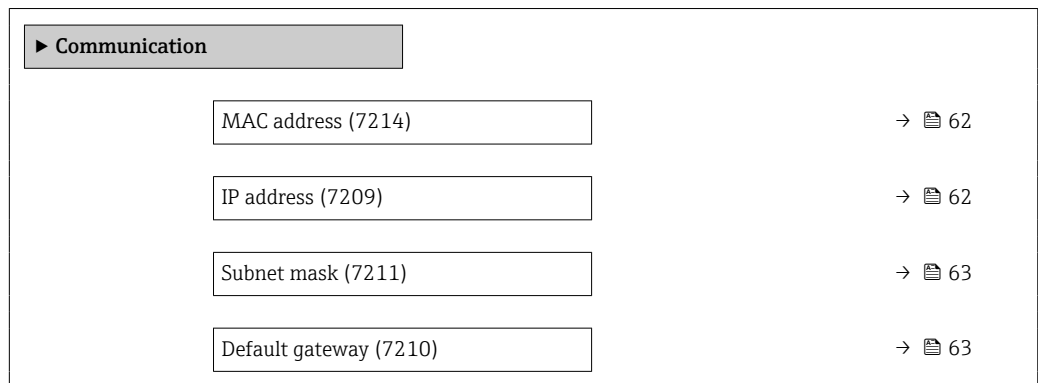

Parameter overview with brief description

Parameter	Description	User interface	Factory setting
MAC address	Displays the MAC address of the measuring device.  MAC = Media Access Control	Unique 12-digit character string comprising letters and numbers, e.g.: 00:07:05:10:01:5F	Each measuring device is given an individual address.
IP address	IP address of the Web server integrated in the measuring device. If the DHCP client is switched off and write access is enabled, the IP address can also be entered.	4 octet: 0 to 255 (in the particular octet)	–

Parameter	Description	User interface	Factory setting
Subnet mask	Displays the subnet mask. If the DHCP client is switched off and write access is enabled, the Subnet mask can also be entered.	4 octet: 0 to 255 (in the particular octet)	–
Default gateway	Displays the default gateway. If the DHCP client is switched off and write access is enabled, the Default gateway can also be entered.	4 octet: 0 to 255 (in the particular octet)	–

10.6.4 Selecting and setting the medium

The **Select medium** wizard submenu contains parameters that must be configured in order to select and set the medium.

Navigation

"Setup" menu → Medium selection

► Medium selection	
Select medium	→ ⓘ 64
Select gas type	→ ⓘ 64
Reference sound velocity	→ ⓘ 65
Temperature coefficient sound velocity	→ ⓘ 65
Pressure compensation	→ ⓘ 65
Pressure value	→ ⓘ 65
External pressure	→ ⓘ 65

Parameter overview with brief description

Parameter	Prerequisite	Description	Selection / User entry
Select medium	–	Use this function to select the type of medium: "Gas" or "Liquid". Select the "Other" option in exceptional cases in order to enter the properties of the medium manually (e.g. for highly compressive liquids such as sulfuric acid).	<ul style="list-style-type: none"> ▪ Liquid ▪ Gas
Select gas type	In the Medium selection submenu, the Gas option is selected.	Select measured gas type.	<ul style="list-style-type: none"> ▪ Air ▪ Ammonia NH₃ ▪ Argon Ar ▪ Sulfur hexafluoride SF₆ ▪ Oxygen O₂ ▪ Ozone O₃ ▪ Nitrogen oxide NO_x ▪ Nitrogen N₂ ▪ Nitrous oxide N₂O ▪ Methane CH₄ ▪ Hydrogen H₂ ▪ Helium He ▪ Hydrogen chloride HCl ▪ Hydrogen sulfide H₂S ▪ Ethylene C₂H₄ ▪ Carbon dioxide CO₂ ▪ Carbon monoxide CO ▪ Chlorine Cl₂ ▪ Butane C₄H₁₀ ▪ Propane C₃H₈ ▪ Propylene C₃H₆ ▪ Ethane C₂H₆ ▪ Others

Parameter	Prerequisite	Description	Selection / User entry
Reference sound velocity	In the Select gas type parameter, the Others option is selected.	Enter sound velocity of gas at 0 °C (32 °F).	1 to 99 999.9999 m/s
Temperature coefficient sound velocity	In the Select gas type parameter, the Others option is selected.	Enter temperature coefficient for the gas sound velocity.	Positive floating-point number
Pressure compensation	–	Select pressure compensation type.	<ul style="list-style-type: none"> ■ Off ■ Fixed value ■ External value
Pressure value	In the Pressure compensation parameter, the Fixed value option or the Current input 1...n option is selected.	Enter process pressure to be used for pressure correction.	Positive floating-point number
External pressure	In the Pressure compensation parameter, the External value option is selected.	Shows the external, fixed process pressure value.	

10.6.5 Configuring the low flow cut off

The **Low flow cut off** submenu contains the parameters that must be set in order to configure the low flow cut off.

Navigation

"Setup" menu → Low flow cut off

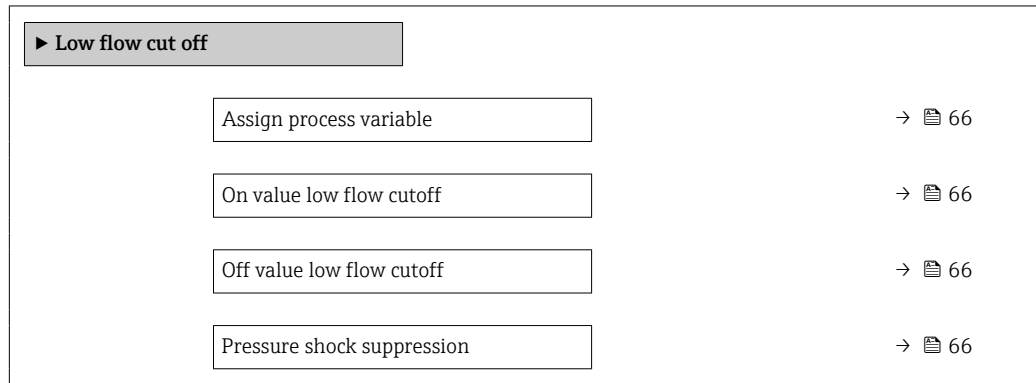

Parameter overview with brief description

Parameter	Prerequisite	Description	Selection / User entry	Factory setting
Assign process variable	–	Select process variable for low flow cut off.	<ul style="list-style-type: none"> ■ Off ■ Mass flow ■ Volume flow ■ Corrected volume flow 	–
On value low flow cutoff	A process variable is selected in the Assign process variable parameter (→ 66).	Enter on value for low flow cut off.	Positive floating-point number	Depends on country and nominal diameter
Off value low flow cutoff	A process variable is selected in the Assign process variable parameter (→ 66).	Enter off value for low flow cut off.	0 to 100.0 %	–
Pressure shock suppression	A process variable is selected in the Assign process variable parameter (→ 66).	Enter time frame for signal suppression (= active pressure shock suppression).	0 to 100 s	–

10.6.6 Configuring partially filled pipe detection

The **Partially filled pipe detection** submenu contains parameters that have to be set for configuring empty pipe detection.

Navigation

"Setup" menu → Partially filled pipe detection

▶ Partially filled pipe detection

Assign process variable	→ 67
Low value partial filled pipe detection	→ 67
High value partial filled pipe detection	→ 67
Response time part. filled pipe detect.	→ 67

Parameter overview with brief description

Parameter	Prerequisite	Description	Selection / User entry	Factory setting
Assign process variable	–	Select process variable for partially filled pipe detection.	<ul style="list-style-type: none"> ■ Off ■ Density ■ Reference density 	Density
Low value partial filled pipe detection	A process variable is selected in the Assign process variable parameter (→ 67).	Enter lower limit value for deactivating partialy filled pipe detection.	Signed floating-point number	Depends on country: <ul style="list-style-type: none"> ■ 200 kg/m³ ■ 12.5 lb/ft³
High value partial filled pipe detection	A process variable is selected in the Assign process variable parameter (→ 67).	Enter upper limit value for deactivating partialy filled pipe detection.	Signed floating-point number	Depends on country: <ul style="list-style-type: none"> ■ 6 000 kg/m³ ■ 374.6 lb/ft³
Response time part. filled pipe detect.	A process variable is selected in the Assign process variable parameter (→ 67).	Use this function to enter the minimum time (hold time) the signal must be present before diagnostic message S962 "Pipe only partly filled" is triggered in the event of a partially filled or empty measuring pipe.	0 to 100 s	–

10.7 Advanced settings

The **Advanced setup** submenu with its submenus contains parameters for specific settings.

 The number of submenus can vary depending on the device version, e.g. viscosity is available only with the Promass I.

Navigation

"Setup" menu → Advanced setup

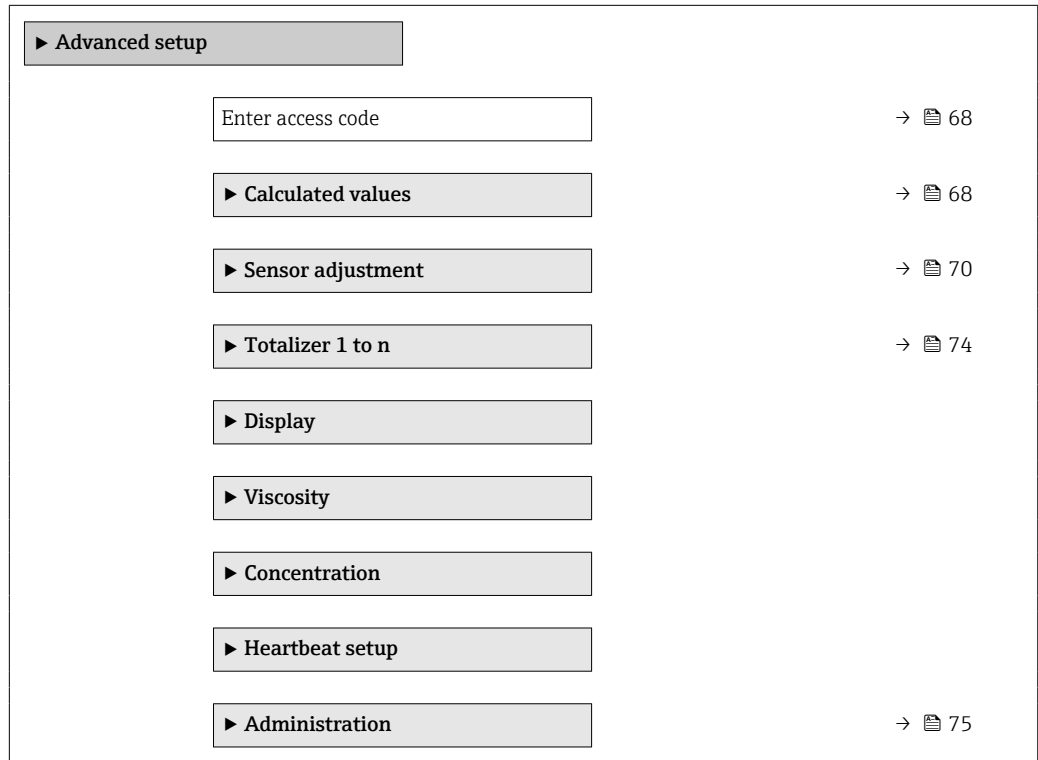

10.7.1 Using the parameter to enter the access code

Navigation

"Setup" menu → Advanced setup

Parameter overview with brief description

Parameter	Description	User entry
Enter access code	Enter access code to disable write protection of parameters.	Max. 16-digit character string comprising numbers, letters and special characters

10.7.2 Calculated process variables

The **Calculated values** submenu contains parameters for calculating the corrected volume flow.

 The **Calculated values** submenu is **not** available if one of the following options was selected in the **Petroleum mode** parameter in the "Application package", option **EJ** "Petroleum": **API referenced correction** option, **Net oil & water cut** option or **ASTM D4311** option

Navigation

"Setup" menu → Advanced setup → Calculated values

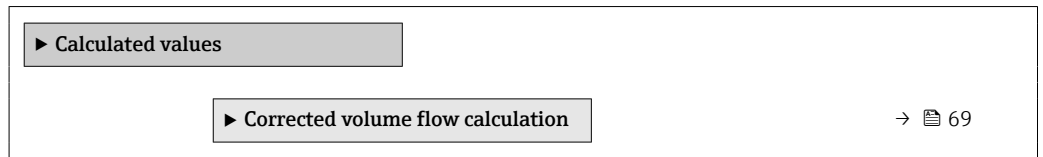

"Corrected volume flow calculation" submenu

Navigation

"Setup" menu → Advanced setup → Calculated values → Corrected volume flow calculation

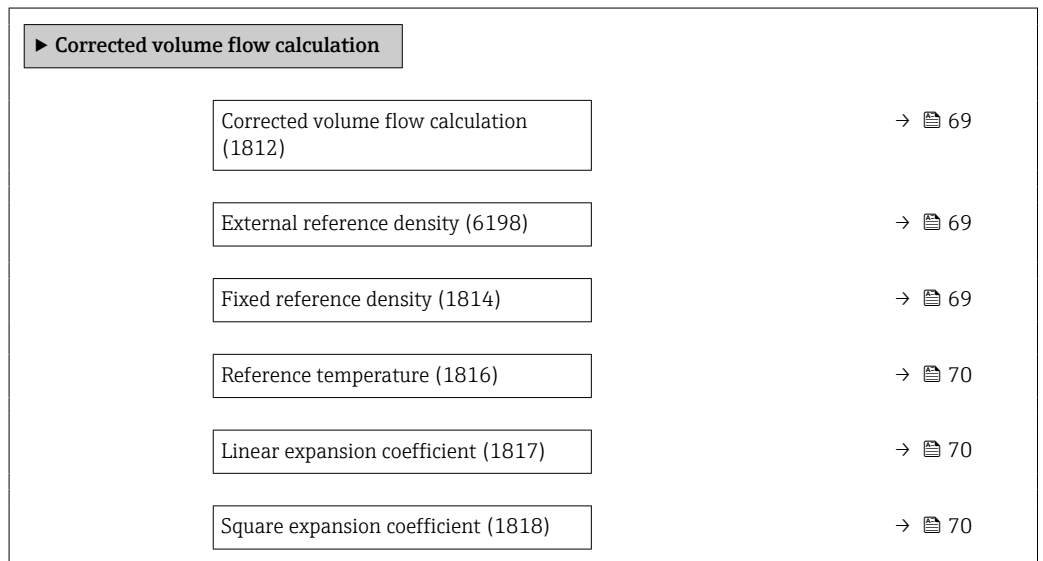

Parameter overview with brief description

Parameter	Prerequisite	Description	Selection / User interface / User entry	Factory setting
Corrected volume flow calculation	–	Select reference density for calculating the corrected volume flow.	<ul style="list-style-type: none"> ■ Fixed reference density ■ Calculated reference density ■ Reference density by API table 53 ■ External reference density 	–
External reference density	In the Corrected volume flow calculation parameter, the External reference density option is selected.	Shows external reference density.	Floating point number with sign	–
Fixed reference density	The Fixed reference density option is selected in the Corrected volume flow calculation parameter.	Enter fixed value for reference density.	Positive floating-point number	–

Parameter	Prerequisite	Description	Selection / User interface / User entry	Factory setting
Reference temperature	The Calculated reference density option is selected in the Corrected volume flow calculation parameter parameter.	Enter reference temperature for calculating the reference density.	-273.15 to 99 999 °C	Country-specific: ■ +20 °C ■ +68 °F
Linear expansion coefficient	The Calculated reference density option is selected in the Corrected volume flow calculation parameter parameter.	Enter linear, medium-specific expansion coefficient for calculating the reference density.	Signed floating-point number	-
Square expansion coefficient	The Calculated reference density option is selected in the Corrected volume flow calculation parameter parameter.	For media with a non-linear expansion pattern: enter the quadratic, medium-specific expansion coefficient for calculating the reference density.	Signed floating-point number	-

10.7.3 Carrying out a sensor adjustment

The **Sensor adjustment** submenu contains parameters that pertain to the functionality of the sensor.

Navigation

"Setup" menu → Advanced setup → Sensor adjustment

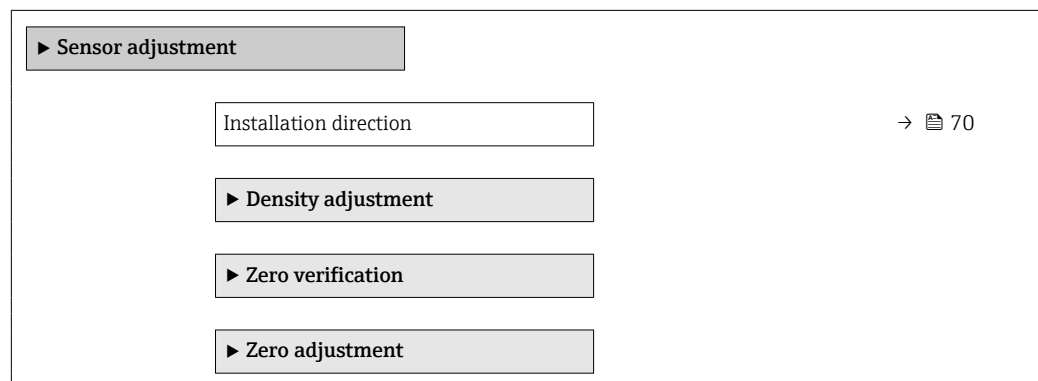

Parameter overview with brief description

Parameter	Description	Selection
Installation direction	Set sign of flow direction to match the direction of the arrow on the sensor.	<ul style="list-style-type: none"> ■ Flow in arrow direction ■ Flow against arrow direction

Density adjustment

i With density adjustment, a high level of accuracy is achieved only at the point of adjustment and at the relevant density and temperature. However, the accuracy of a density adjustment is only ever as good as the quality of the reference measuring data provided. Therefore it is not a substitute for special density calibration.

Performing density adjustment

Note the following before performing the adjustment:

- A density adjustment only makes sense if there is little variation in the operating conditions and the density adjustment is performed under the operating conditions.
- The density adjustment scales the internally computed density value with a user-specific slope and offset.
- A 1-point or 2-point density adjustment can be performed.
- For a 2-point density adjustment, there must be a difference of at least 0.2 kg/l between the two target density values.
- The reference media must be gas-free or pressurized so that any gas they contain is compressed.
- The reference density measurements must be performed at the same medium temperature that prevails in the process, as otherwise the density adjustment will not be accurate.
- The correction resulting from the density adjustment can be deleted with the **Restore original** option.

"1 point adjustment" option

1. In the **Density adjustment mode** parameter, select the **1 point adjustment** option and confirm.
2. In the **Density setpoint 1** parameter, enter the density value and confirm.
 - ↳ In the **Execute density adjustment** parameter the following options are now available:
 - Ok
 - Measure density 1 option**
 - Restore original
3. Select the **Measure density 1** option and confirm.
4. If 100% was reached in the **Progress** parameter on the display and the **Ok** option is displayed in the **Execute density adjustment** parameter, then confirm.
 - ↳ In the **Execute density adjustment** parameter the following options are now available:
 - Ok
 - Calculate
 - Cancel
5. Select the **Calculate** option and confirm.

If the adjustment was completed successfully, the **Density adjustment factor** parameter and the **Density adjustment offset** parameter and the values calculated for them are shown on the display.

"2 point adjustment" option

1. In the **Density adjustment mode** parameter, select the **2 point adjustment** option and confirm.
2. In the **Density setpoint 1** parameter, enter the density value and confirm.
3. In the **Density setpoint 2** parameter, enter the density value and confirm.
 - ↳ In the **Execute density adjustment** parameter the following options are now available:
 - Ok
 - Measure density 1
 - Restore original

4. Select the **Measure density 1** option and confirm.
 - ↳ In the **Execute density adjustment** parameter the following options are now available:
 - Ok
 - Measure density 2
 - Restore original
5. Select the **Measure density 2** option and confirm.
 - ↳ In the **Execute density adjustment** parameter the following options are now available:
 - Ok
 - Calculate
 - Cancel
6. Select the **Calculate** option and confirm.

If the **Density adjust failure** option is displayed in the **Execute density adjustment** parameter, call up the options and select the **Cancel** option. The density adjustment is canceled and can be repeated.

If the adjustment was completed successfully, the **Density adjustment factor** parameter and the **Density adjustment offset** parameter and the values calculated for them are shown on the display.

Navigation

"Expert" menu → Sensor → Sensor adjustment → Density adjustment

► Density adjustment	
Density adjustment mode	→ 72
Density setpoint 1	→ 72
Density setpoint 2	→ 72
Execute density adjustment	→ 73
Progress	→ 73
Density adjustment factor	→ 73
Density adjustment offset	→ 73

Parameter overview with brief description

Parameter	Prerequisite	Description	User interface	Factory setting
Density adjustment mode	–		<ul style="list-style-type: none"> ▪ 1 point adjustment ▪ 2 point adjustment 	–
Density setpoint 1	–		The entry depends on the unit selected in the Density unit parameter (0555).	–
Density setpoint 2	In the Density adjustment mode parameter, the 2 point adjustment option is selected.		The entry depends on the unit selected in the Density unit parameter (0555).	–

Parameter	Prerequisite	Description	User interface	Factory setting
Execute density adjustment	–		<ul style="list-style-type: none"> ■ Cancel ■ Busy ■ Ok ■ Density adjust failure ■ Measure density 1 ■ Measure density 2 ■ Calculate ■ Restore original 	–
Progress	–	Shows the progress of the process.	0 to 100 %	–
Density adjustment factor	–		Signed floating-point number	–
Density adjustment offset	–		Signed floating-point number	–

Zero verification and zero adjustment

All measuring instruments are calibrated in accordance with state-of-the-art technology. Calibration takes place under reference conditions →  142. Therefore, a zero adjustment in the field is generally not required.

Experience shows that zero adjustment is advisable only in special cases:

- To achieve maximum measurement accuracy even with low flow rates.
- Under extreme process or operating conditions (e.g. very high process temperatures or very high-viscosity fluids).
- For gas applications with low pressure

 To achieve the highest possible measurement accuracy at low flow rates, the installation must protect the sensor from mechanical stresses during operation.

To get a representative zero point, ensure that:

- any flow in the device is prevented during the adjustment
- the process conditions (e.g. pressure, temperature) are stable and representative

Zero verification and zero adjustment cannot be performed if the following process conditions are present:

- Gas pockets

Ensure that the system has been sufficiently flushed with the medium. Repeat flushing can help to eliminate gas pockets

- Thermal circulation

In the event of temperature differences (e.g. between the measuring tube inlet and outlet section), induced flow can occur even if the valves are closed due to thermal circulation in the device

- Leaks at the valves

If the valves are not leak-tight, flow is not sufficiently prevented when determining the zero point

If these conditions cannot be avoided, it is advisable to keep the factory setting for the zero point.

Navigation

"Setup" menu → Advanced setup → Sensor adjustment → Zero point adjustment

▶ Zero point adjustment

Zero point adjustment control

→ 74

Progress

→ 74

Parameter overview with brief description

Parameter	Description	Selection / User interface	Factory setting
Zero point adjustment control	Start zero point adjustment.	<ul style="list-style-type: none"> ■ Cancel ■ Busy ■ Zero point adjust failure ■ Start 	–
Progress	Shows the progress of the process.	0 to 100 %	–

10.7.4 Configuring the totalizer

In the "Totalizer 1 to n" submenu, you can configure the specific totalizer.

Navigation

"Setup" menu → Advanced setup → Totalizer 1 to n

▶ Totalizer 1 to n

Assign process variable

→ 74

Unit totalizer

→ 74

Totalizer operation mode

→ 75

Failure mode

→ 75

Parameter overview with brief description

Parameter	Prerequisite	Description	Selection	Factory setting
Assign process variable	–	Select process variable for totalizer.	<ul style="list-style-type: none"> ■ Volume flow ■ Mass flow ■ Corrected volume flow 	–
Unit totalizer	One of the following options is selected in the Assign process variable parameter: <ul style="list-style-type: none"> ■ Mass flow ■ Volume flow ■ Corrected volume flow ■ Target mass flow * ■ Carrier mass flow * 	Select the unit for the process variable of the totalizer.	Unit choose list	Country-specific: <ul style="list-style-type: none"> ■ kg ■ lb

Parameter	Prerequisite	Description	Selection	Factory setting
Totalizer operation mode	In the Assign process variable parameter, one of the following options is selected: <ul style="list-style-type: none"> ■ Mass flow ■ Volume flow ■ Corrected volume flow ■ Target mass flow[*] ■ Carrier mass flow[*] 	Select totalizer calculation mode.	<ul style="list-style-type: none"> ■ Net flow total ■ Forward flow total ■ Reverse flow total ■ Last valid value 	–
Failure mode	In the Assign process variable parameter, one of the following options is selected: <ul style="list-style-type: none"> ■ Mass flow ■ Volume flow ■ Corrected volume flow ■ Target mass flow[*] ■ Carrier mass flow[*] 	Define the totalizer behavior in the event of a device alarm.	<ul style="list-style-type: none"> ■ Stop ■ Actual value ■ Last valid value 	–

* Visibility depends on order options or device settings

10.7.5 Using parameters for device administration

The **Administration** submenu systematically guides the user through all the parameters that can be used for device administration purposes.

Navigation

"Setup" menu → Advanced setup → Administration

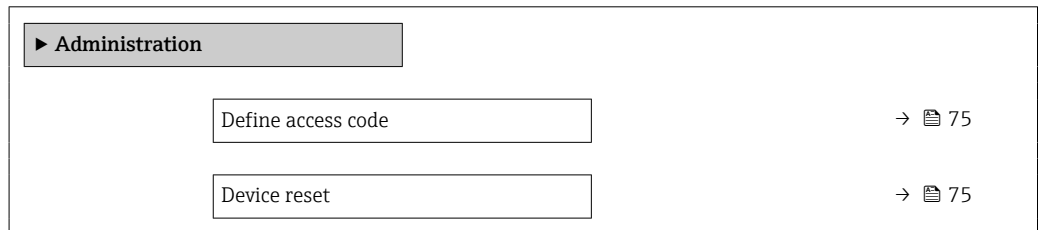

Parameter overview with brief description

Parameter	Description	User entry / Selection
Define access code	Define release code for write access to parameters.	0 to 9999
Device reset	Reset the device configuration - either entirely or in part - to a defined state.	<ul style="list-style-type: none"> ■ Cancel ■ To delivery settings ■ Restart device ■ Delete powerfail storage ■ Delete T-DAT ■ Delete factory data

10.8 Simulation

Via the **Simulation** submenu, it is possible to simulate various process variables in the process and the device alarm mode and verify downstream signal chains (switching valves or closed-control loops). The simulation can be performed without a real measurement (no flow of medium through the device).

Navigation

"Diagnostics" menu → Simulation

▶ Simulation	
Assign simulation process variable	→ 76
Process variable value	→ 76
Simulation device alarm	→ 76
Diagnostic event simulation	→ 76

Parameter overview with brief description

Parameter	Prerequisite	Description	Selection / User entry
Assign simulation process variable	–	Select a process variable for the simulation process that is activated.	<ul style="list-style-type: none"> ▪ Off ▪ Mass flow ▪ Volume flow ▪ Corrected volume flow ▪ Density ▪ Reference density ▪ Temperature ▪ Concentration * ▪ Target mass flow * ▪ Carrier mass flow *
Process variable value	A process variable is selected in the Assign simulation process variable parameter (→ 76).	Enter the simulation value for the selected process variable.	Depends on the process variable selected
Simulation device alarm	–	Switch the device alarm on and off.	<ul style="list-style-type: none"> ▪ Off ▪ On
Diagnostic event category	–	Select a diagnostic event category.	<ul style="list-style-type: none"> ▪ Sensor ▪ Electronics ▪ Configuration ▪ Process
Diagnostic event simulation	–	Select a diagnostic event to simulate this event.	<ul style="list-style-type: none"> ▪ Off ▪ Diagnostic event picklist (depends on the category selected)

* Visibility depends on order options or device settings

10.9 Protecting settings from unauthorized access

The following options exist for protecting the configuration of the measuring device from unintentional modification after commissioning:

- Write protection via access code for Web browser → 76
- Write protection via write protection switch → 77
- Write protection via startup parameterization → 59

10.9.1 Write protection via access code



With the customer-specific access code, access to the measuring instrument via the Web browser is protected, as are the parameters for the measuring instrument configuration.

Navigation

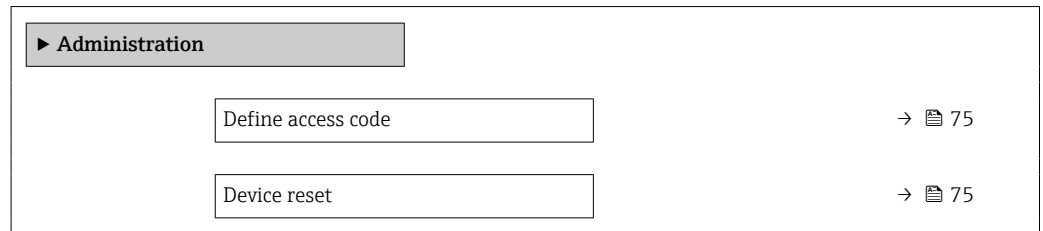
"Setup" menu → Advanced setup → Administration → Define access code

**Defining the access code via the web browser**

1. Navigate to the **Define access code** parameter.
2. Define a 16-digit (max.) numeric code as the access code.
3. Enter the access code again in the to confirm.
 - ↳ The web browser switches to the login page.

- 
 - Disabling parameter write protection via access code .
 - If the access code is lost: Resetting the access code .
 - The **Access status tooling** parameter shows which user role the user is currently logged in with.
 - Navigation path: Operation → Access status tooling
 - User roles and their access rights →  37

If no action is performed for 10 minutes, the web browser automatically returns to the login page.

10.9.2 Write protection via write protection switch

The write protection switch makes it possible to block write access to the entire operating menu with the exception of the following parameters:

- External pressure
- External temperature
- Reference density
- All parameters for configuring the totalizer

The parameter values are now read only and cannot be edited any more:

- Via service interface (CDI-RJ45)
- Via PROFINET

1. Depending on the housing version, loosen the securing clamp or fixing screw of the housing cover.
2. Depending on the housing version, unscrew or open the housing cover and disconnect the local display from the main electronics module where necessary →  152.

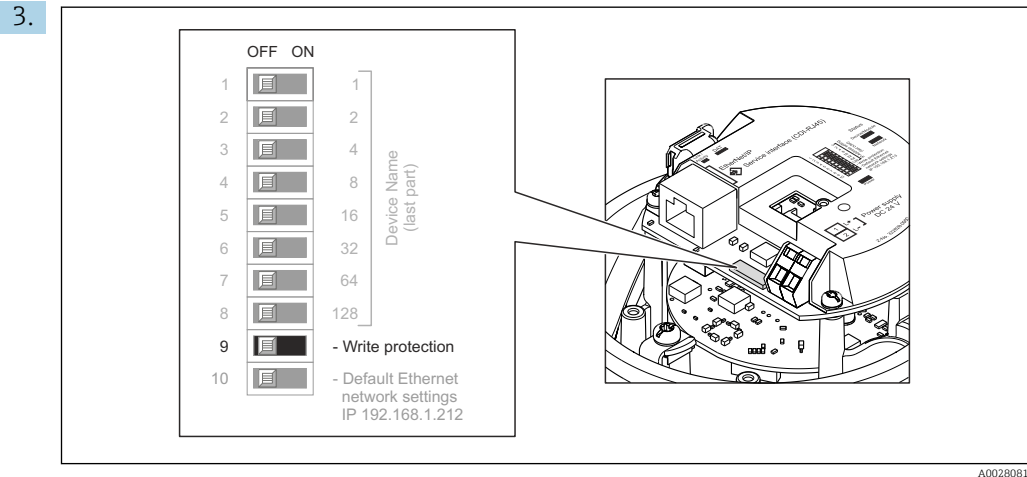

Setting the write protection switch on the main electronics module to the **On** position enables hardware write protection. Setting the write protection switch on the main electronics module to the **Off** position (factory setting) disables hardware write protection.

- ↳ If hardware write protection is enabled: the **Locking status** parameter displays the **Hardware locked** option ; if disabled, the **Locking status** parameter does not display any option .

4. Reverse the removal procedure to reassemble the transmitter.

10.9.3 Write protection via startup parameterization

Software write protection can be enabled via startup parameterization. If software write protection is enabled, device configuration can only be performed via the PROFINET controller. In this case, write access is **no longer** possible via:

- Acyclic PROFINET communication
- Service interface
- Web server

 Startup parameterization settings .

11 Operation

11.1 Reading the device locking status

Device active write protection: **Locking status** parameter

Navigation



"Operation" menu → Locking status

Function scope of "Locking status" parameter

Options	Description
Hardware locked	The write protection switch (DIP switch) for hardware locking is activated on the I/O electronic module. This prevents write access to the parameters .
Temporarily locked	Write access to the parameters is temporarily locked on account of internal processes running in the device (e.g. data upload/download, reset etc.). Once the internal processing has been completed, the parameters can be changed once again.

11.2 Adjusting the operating language

 Detailed information:

- To configure the operating language →  59
- For information on the operating languages supported by the measuring device →  153

11.3 Configuring the display

Detailed information:



On the advanced settings for the local display

11.4 Reading off measured values

With the **Measured values** submenu, it is possible to read all the measured values.

Navigation

"Diagnostics" menu → Measured values

▶ Measured values	
▶ Process variables	→  79
▶ Totalizer	→  89

11.4.1 "Measured variables" submenu

The **Process variables** submenu contains all the parameters needed to display the current measured values for each process variable.









Navigation







"Diagnostics" menu → Measured values → Measured variables

► Measured variables	
Mass flow	→ 82
Volume flow	→ 82
Corrected volume flow	→ 82
Density	→ 82
Reference density	→ 82
Temperature	→ 82
Pressure	→ 82
Concentration	→ 82
Target mass flow	→ 83
Carrier mass flow	→ 83
Target corrected volume flow	→ 83
Carrier corrected volume flow	→ 83
Target volume flow	→ 83
Carrier volume flow	→ 83
CTL	→ 83
CPL	→ 83
CTPL	→ 83
S&W volume flow	→ 84
S&W correction value	→ 84
Reference density alternative	→ 84
GSV flow	→ 84
GSV flow alternative	→ 84





NSV flow	→ 85
NSV flow alternative	→ 85
Oil CTL	→ 85
Oil CPL	→ 85
Oil CTPL	→ 85
Water CTL	→ 86
CTL alternative	→ 86
CPL alternative	→ 86
CTPL alternative	→ 86
Oil reference density	→ 86
Water reference density	→ 87
Oil density	→ 87
Water density	→ 87
Water cut	→ 87
Oil volume flow	→ 87
Oil corrected volume flow	→ 88
Oil mass flow	→ 88
Water volume flow	→ 88
Water corrected volume flow	→ 88
Water mass flow	→ 88
Weighted density average	→ 89
Weighted temperature average	→ 89





Parameter overview with brief description





Parameter	Prerequisite	Description	User interface	Factory setting
Mass flow	–	Displays the mass flow that is currently measured. <i>Dependency</i> The unit is taken from: Mass flow unit parameter (→  61)	Signed floating-point number	–
Volume flow	–	Displays the volume flow that is currently calculated. <i>Dependency</i> The unit is taken from the Volume flow unit parameter (→  61).	Signed floating-point number	–
Corrected volume flow	–	Displays the corrected volume flow that is currently calculated. <i>Dependency</i> The unit is taken from: Corrected volume flow unit parameter (→  61)	Signed floating-point number	–
Density	–	Shows the density currently measured. <i>Dependency</i> The unit is taken from the Density unit parameter (→  61).	Signed floating-point number	–
Reference density	–	Displays the reference density that is currently calculated. <i>Dependency</i> The unit is taken from: Reference density unit parameter (→  61)	Signed floating-point number	–
Temperature	–	Shows the medium temperature currently measured. <i>Dependency</i> The unit is taken from: Temperature unit parameter (→  62)	Signed floating-point number	–
Pressure value	–	Displays either a fixed or external pressure value. <i>Dependency</i> The unit is taken from the Pressure unit parameter (→  62).	Signed floating-point number	–
Concentration	For the following order code: Order code for "Application package", option ED "Concentration"  The software options currently enabled are displayed in the Software option overview parameter.	Displays the concentration that is currently calculated. <i>Dependency</i> The unit is taken from the Concentration unit parameter.	Signed floating-point number	–





Parameter	Prerequisite	Description	User interface	Factory setting
Target mass flow	<p>With the following conditions: Order code for "Application package", option ED "Concentration"</p> <p> The software options currently enabled are displayed in the Software option overview parameter.</p>	<p>Displays the mass flow that is currently measured for the target medium.</p> <p><i>Dependency</i> The unit is taken from: Mass flow unit parameter (→  61)</p>	Signed floating-point number	–
Carrier mass flow	<p>With the following conditions: Order code for "Application package", option ED "Concentration"</p> <p> The software options currently enabled are displayed in the Software option overview parameter.</p>	<p>Displays the mass flow of the carrier medium that is currently measured.</p> <p><i>Dependency</i> The unit is taken from: Mass flow unit parameter (→  61)</p>	Signed floating-point number	–
Target corrected volume flow	–		Signed floating-point number	–
Carrier corrected volume flow	–		Signed floating-point number	–
Target volume flow	–		Signed floating-point number	–
Carrier volume flow	–		Signed floating-point number	–
CTL	<p>For the following order code:</p> <ul style="list-style-type: none"> ▪ "Application package", option EJ "Petroleum" ▪ The API referenced correction option is selected in Petroleum mode parameter. <p> The software options currently enabled are displayed in the Software option overview parameter.</p>	<p>Displays the calibration factor which represents the effect of temperature on the fluid. This is used to convert the measured volume flow and the measured density to values at reference temperature.</p>	Positive floating-point number	–
CPL	<p>For the following order code:</p> <ul style="list-style-type: none"> ▪ "Application package", option EJ "Petroleum" ▪ The API referenced correction option is selected in Petroleum mode parameter. <p> The software options currently enabled are displayed in the Software option overview parameter.</p>	<p>Displays the calibration factor which represents the effect of pressure on the fluid. This is used to convert the measured volume flow and the measured density to values at reference pressure.</p>	Positive floating-point number	–
CTPL	<p>For the following order code:</p> <ul style="list-style-type: none"> ▪ "Application package", option EJ "Petroleum" ▪ The API referenced correction option is selected in Petroleum mode parameter. <p> The software options currently enabled are displayed in the Software option overview parameter.</p>	<p>Displays the combined calibration factor which represents the effect of temperature and pressure on the fluid This is used to convert the measured volume flow and the measured density to values at reference temperature and reference pressure.</p>	Positive floating-point number	–



Parameter	Prerequisite	Description	User interface	Factory setting
S&W volume flow	<p>For the following order code:</p> <ul style="list-style-type: none"> ▪ "Application package", option EJ "Petroleum" ▪ The API referenced correction option is selected in Petroleum mode parameter. <p> The software options currently enabled are displayed in the Software option overview parameter.</p>	<p>Displays the S&W volume flow which is calculated from the measured total volume flow minus the net volume flow.</p> <p><i>Dependency</i> The unit is taken from: Volume flow unit parameter</p>	Signed floating-point number	-
S&W correction value	<p>For the following order code:</p> <ul style="list-style-type: none"> ▪ "Application package", option EJ "Petroleum" ▪ The External value option or Current input 1...n option is selected in the S&W input mode parameter. <p> The software options currently enabled are displayed in the Software option overview parameter.</p>	Shows the correction value for sediment and water.	Positive floating-point number	-
Reference density alternative	<p>For the following order code:</p> <ul style="list-style-type: none"> ▪ "Application package", option EJ "Petroleum" ▪ In the Petroleum mode parameter, the API referenced correction option is selected. <p> The software options currently enabled are displayed in the Software option overview parameter.</p>	<p>Displays the fluid density at the alternative reference temperature.</p> <p><i>Dependency</i> The unit is taken from: Reference density unit parameter</p>	Signed floating-point number	-
GSV flow	<p>For the following order code:</p> <ul style="list-style-type: none"> ▪ "Application package", option EJ "Petroleum" ▪ The API referenced correction option is selected in Petroleum mode parameter. <p> The software options currently enabled are displayed in the Software option overview parameter.</p>	<p>Displays the measured total volume flow, corrected to the reference temperature and the reference pressure.</p> <p><i>Dependency</i> The unit is taken from: Corrected volume flow unit parameter</p>	Signed floating-point number	-
GSV flow alternative	<p>For the following order code:</p> <ul style="list-style-type: none"> ▪ "Application package", option EJ "Petroleum" ▪ In the Petroleum mode parameter, the API referenced correction option is selected. <p> The software options currently enabled are displayed in the Software option overview parameter.</p>	<p>Displays the measured total volume flow, corrected to the alternative reference temperature and the alternative reference pressure.</p> <p><i>Dependency</i> The unit is taken from: Corrected volume flow unit parameter</p>	Signed floating-point number	-

Parameter	Prerequisite	Description	User interface	Factory setting
NSV flow	<p>For the following order code:</p> <ul style="list-style-type: none"> ▪ "Application package", option EJ "Petroleum" ▪ The API referenced correction option is selected in Petroleum mode parameter. <p> The software options currently enabled are displayed in the Software option overview parameter.</p>	<p>Displays the net volume flow which is calculated from the measured total volume flow minus the value for sediment & water and minus the shrinkage.</p> <p><i>Dependency</i> The unit is taken from: Corrected volume flow unit parameter</p>	Signed floating-point number	–
NSV flow alternative	<p>For the following order code:</p> <ul style="list-style-type: none"> ▪ "Application package", option EJ "Petroleum" ▪ In the Petroleum mode parameter, the API referenced correction option is selected. <p> The software options currently enabled are displayed in the Software option overview parameter.</p>	<p>Displays the net volume flow which is calculated from the measured alternative total volume minus the value for sediment & water and minus the shrinkage.</p> <p><i>Dependency</i> The unit is taken from: Corrected volume flow unit parameter</p>	Signed floating-point number	–
Oil CTL	<p>For the following order code:</p> <ul style="list-style-type: none"> ▪ "Application package", option EJ "Petroleum" ▪ In the Petroleum mode parameter, the Net oil & water cut option is selected. <p> The software options currently enabled are displayed in the Software option overview parameter.</p>	<p>Displays the correction factor which represents the effect of temperature on the oil. This is used to convert the measured oil volume flow and the measured oil density to values at reference temperature.</p>	Positive floating-point number	–
Oil CPL	<p>For the following order code:</p> <ul style="list-style-type: none"> ▪ "Application package", option EJ "Petroleum" ▪ In the Petroleum mode parameter, the Net oil & water cut option is selected. <p> The software options currently enabled are displayed in the Software option overview parameter.</p>	<p>Displays the correction factor which represents the effect of pressure on the oil. This is used to convert the measured oil volume flow and the measured oil density to values at reference pressure.</p>	Positive floating-point number	–
Oil CTPL	<p>For the following order code:</p> <ul style="list-style-type: none"> ▪ "Application package", option EJ "Petroleum" ▪ In the Petroleum mode parameter, the Net oil & water cut option is selected. <p> The software options currently enabled are displayed in the Software option overview parameter.</p>	<p>Displays the combined correction factor which represents the effect of temperature and pressure on the oil. This is used to convert the measured oil volume flow and the measured oil density to values at reference temperature and reference pressure.</p>	Positive floating-point number	–

Parameter	Prerequisite	Description	User interface	Factory setting
Water CTL	<p>For the following order code:</p> <ul style="list-style-type: none"> ▪ "Application package", option EJ "Petroleum" ▪ In the Petroleum mode parameter, the Net oil & water cut option is selected. <p> The software options currently enabled are displayed in the Software option overview parameter.</p>	<p>Displays the correction factor which represents the effect of temperature on the water. This is used to convert the measured water volume flow and the measured water density to values at reference temperature.</p>	Positive floating-point number	-
CTL alternative	<p>For the following order code:</p> <ul style="list-style-type: none"> ▪ "Application package", option EJ "Petroleum" ▪ In the Petroleum mode parameter, the API referenced correction option is selected. <p> The software options currently enabled are displayed in the Software option overview parameter.</p>	<p>Displays the correction factor which represents the effect of temperature on the fluid. This is used to convert the measured volume flow and the measured density to values at the alternative reference temperature.</p>	Positive floating-point number	-
CPL alternative	<p>For the following order code:</p> <ul style="list-style-type: none"> ▪ "Application package", option EJ "Petroleum" ▪ In the Petroleum mode parameter, the API referenced correction option is selected. <p> The software options currently enabled are displayed in the Software option overview parameter.</p>	<p>Displays the correction factor which represents the effect of pressure on the fluid. This is used to convert the measured volume flow and the measured density to values at the alternative reference pressure.</p>	Positive floating-point number	-
CTPL alternative	<p>For the following order code:</p> <ul style="list-style-type: none"> ▪ "Application package", option EJ "Petroleum" ▪ In the Petroleum mode parameter, the API referenced correction option is selected. <p> The software options currently enabled are displayed in the Software option overview parameter.</p>	<p>Displays the combined correction factor which represents the effect of temperature and pressure on the fluid. This is used to convert the measured volume flow and the measured density to values at the alternative reference temperature and the alternative reference pressure.</p>	Positive floating-point number	-
Oil reference density	<p>For the following order code:</p> <ul style="list-style-type: none"> ▪ "Application package", option EJ "Petroleum" ▪ In the Petroleum mode parameter, the Net oil & water cut option is selected. <p> The software options currently enabled are displayed in the Software option overview parameter.</p>		Signed floating-point number	-

Parameter	Prerequisite	Description	User interface	Factory setting
Water reference density	<p>For the following order code:</p> <ul style="list-style-type: none"> ▪ "Application package", option EJ "Petroleum" ▪ In the Petroleum mode parameter, the Net oil & water cut option is selected. <p> The software options currently enabled are displayed in the Software option overview parameter.</p>		Signed floating-point number	–
Oil density	<p>For the following order code:</p> <ul style="list-style-type: none"> ▪ "Application package", option EJ "Petroleum" ▪ In the Petroleum mode parameter, the Net oil & water cut option is selected. <p> The software options currently enabled are displayed in the Software option overview parameter.</p>	Displays the density of the oil currently measured.	Signed floating-point number	–
Water density	<p>For the following order code:</p> <ul style="list-style-type: none"> ▪ "Application package", option EJ "Petroleum" ▪ In the Petroleum mode parameter, the Net oil & water cut option is selected. <p> The software options currently enabled are displayed in the Software option overview parameter.</p>	Displays the density of the water currently measured.	Signed floating-point number	–
Water cut	<p>For the following order code:</p> <ul style="list-style-type: none"> ▪ "Application package", option EJ "Petroleum" ▪ In the Petroleum mode parameter, the API referenced correction option is selected. <p> The software options currently enabled are displayed in the Software option overview parameter.</p>	Displays the percentage water volume flow in relation to the total volume flow of the fluid.	0 to 100 %	–
Oil volume flow	<p>For the following order code:</p> <ul style="list-style-type: none"> ▪ "Application package", option EJ "Petroleum" ▪ In the Petroleum mode parameter, the Net oil & water cut option is selected. <p> The software options currently enabled are displayed in the Software option overview parameter.</p>	<p>Displays the currently calculated volume flow of the oil.</p> <p>Dependency:</p> <ul style="list-style-type: none"> ▪ Based on the value displayed in the Water cut parameter ▪ The unit is taken from: Volume flow unit parameter 	Signed floating-point number	–

Parameter	Prerequisite	Description	User interface	Factory setting
Oil corrected volume flow	<p>For the following order code:</p> <ul style="list-style-type: none"> ▪ "Application package", option EJ "Petroleum" ▪ In the Petroleum mode parameter, the Net oil & water cut option is selected. <p> The software options currently enabled are displayed in the Software option overview parameter.</p>	<p>Displays the currently calculated volume flow of the oil, calculated to values at reference temperature and reference pressure.</p> <p>Dependency:</p> <ul style="list-style-type: none"> ▪ Based on the value displayed in the Water cut parameter ▪ The unit is taken from: Corrected volume flow unit parameter 	Signed floating-point number	-
Oil mass flow	<p>For the following order code:</p> <ul style="list-style-type: none"> ▪ "Application package", option EJ "Petroleum" ▪ In the Petroleum mode parameter, the Net oil & water cut option is selected. <p> The software options currently enabled are displayed in the Software option overview parameter.</p>	<p>Displays the currently calculated mass flow of the oil.</p> <p>Dependency:</p> <ul style="list-style-type: none"> ▪ Based on the value displayed in the Water cut parameter ▪ The unit is taken from: Mass flow unit parameter 	Signed floating-point number	-
Water volume flow	<p>For the following order code:</p> <ul style="list-style-type: none"> ▪ "Application package", option EJ "Petroleum" ▪ In the Petroleum mode parameter, the Net oil & water cut option is selected. <p> The software options currently enabled are displayed in the Software option overview parameter.</p>	<p>Displays the currently calculated volume flow of the water.</p> <p>Dependency:</p> <ul style="list-style-type: none"> ▪ Based on the value displayed in the Water cut parameter ▪ The unit is taken from: Volume flow unit parameter 	Signed floating-point number	-
Water corrected volume flow	<p>For the following order code:</p> <ul style="list-style-type: none"> ▪ "Application package", option EJ "Petroleum" ▪ In the Petroleum mode parameter, the Net oil & water cut option is selected. <p> The software options currently enabled are displayed in the Software option overview parameter.</p>	<p>Displays the currently calculated volume flow of the water, calculated to values at reference temperature and reference pressure.</p> <p>Dependency:</p> <ul style="list-style-type: none"> ▪ Based on the value displayed in the Water cut parameter ▪ The unit is taken from: Corrected volume flow unit parameter 	Signed floating-point number	-
Water mass flow	<p>For the following order code:</p> <ul style="list-style-type: none"> ▪ "Application package", option EJ "Petroleum" ▪ In the Petroleum mode parameter, the Net oil & water cut option is selected. <p> The software options currently enabled are displayed in the Software option overview parameter.</p>	<p>Displays the currently calculated mass flow of the water.</p> <p>Dependency:</p> <ul style="list-style-type: none"> ▪ Based on the value displayed in the Water cut parameter ▪ The unit is taken from: Mass flow unit parameter 	Signed floating-point number	-

Parameter	Prerequisite	Description	User interface	Factory setting
Weighted density average	For the following order code: <ul style="list-style-type: none"> ▪ "Application package", option EJ "Petroleum" ▪ "Application package", option EM "Petroleum + Locking function"  The software options currently enabled are displayed in the Software option overview parameter.	Displays the weighted average for the density since the last time the density averages were reset. Dependency: <ul style="list-style-type: none"> ▪ The unit is taken from: Density unit parameter ▪ The value is reset to NaN (Not a Number) via the Reset weighted averages parameter 	Signed floating-point number	-
Weighted temperature average	For the following order code: <ul style="list-style-type: none"> ▪ "Application package", option EJ "Petroleum" ▪ "Application package", option EM "Petroleum + Locking function"  The software options currently enabled are displayed in the Software option overview parameter.	Displays the weighted average for the temperature since the last time the temperature averages were reset. Dependency: <ul style="list-style-type: none"> ▪ The unit is taken from: Temperature unit parameter ▪ The value is reset to NaN (Not a Number) via the Reset weighted averages parameter 	Signed floating-point number	-

11.4.2 "Totalizer" submenu

The **Totalizer** submenu contains all the parameters needed to display the current measured values for every totalizer.

Navigation

"Diagnostics" menu → Measured values → Totalizer

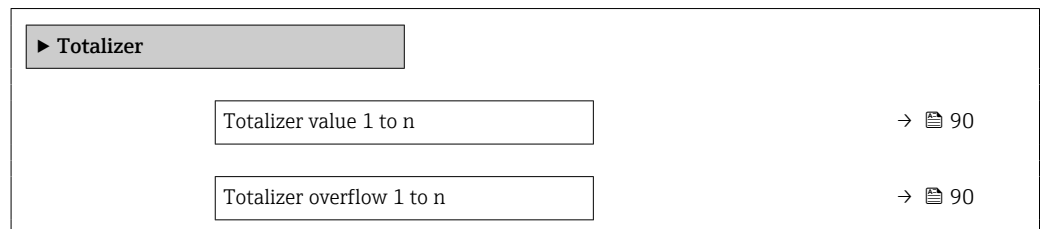



Parameter overview with brief description

Parameter	Prerequisite	Description	User interface
Totalizer value 1 to n	One of the following options is selected in the Assign process variable parameter of the Totalizer 1 to n submenu: <ul style="list-style-type: none"> ■ Volume flow ■ Mass flow ■ Corrected volume flow ■ Target mass flow * ■ Carrier mass flow * 	Displays the current totalizer counter value.	Signed floating-point number
Totalizer overflow 1 to n	One of the following options is selected in the Assign process variable parameter of the Totalizer 1 to n submenu: <ul style="list-style-type: none"> ■ Volume flow ■ Mass flow ■ Corrected volume flow ■ Target mass flow * ■ Carrier mass flow * 	Displays the current totalizer overflow.	Integer with sign

* Visibility depends on order options or device settings

11.5 Adapting the measuring device to the process conditions

The following are available for this purpose:

- Basic settings using the **Setup** menu (→  59)
- Advanced settings using the **Advanced setup** submenu (→  68)





11.6 Performing a totalizer reset



The totalizers are reset in the **Operation** submenu:

- Control Totalizer
- Reset all totalizers



Navigation

"Operation" menu → Totalizer handling

► Totalizer handling		
Control Totalizer 1 to n	→  91	
Preset value 1 to n	→  91	
Totalizer value 1 to n	→  91	
Weighted density average	→  91	
Weighted temperature average	→  91	

Reset weighted averages	→  92
Reset all totalizers	→  92

Parameter overview with brief description

Parameter	Prerequisite	Description	Selection / User entry / User interface	Factory setting
Control Totalizer 1 to n	A process variable is selected in the Assign process variable parameter of the Totalizer 1 to n submenu.	Control totalizer value.	<ul style="list-style-type: none"> ▪ Totalize ▪ Reset + hold ▪ Preset + hold ▪ Reset + totalize ▪ Preset + totalize ▪ Hold 	–
Preset value 1 to n	A process variable is selected in the Assign process variable parameter of the Totalizer 1 to n submenu.	Specify start value for totalizer. <i>Dependency</i>  The unit of the selected process variable is defined in the Unit totalizer parameter for the totalizer.	Signed floating-point number	Depends on country: <ul style="list-style-type: none"> ▪ 0 kg ▪ 0 lb
Totalizer value	One of the following options is selected in the Assign process variable parameter of the Totalizer 1 to n submenu: <ul style="list-style-type: none"> ▪ Volume flow ▪ Mass flow ▪ Corrected volume flow ▪ Target mass flow * ▪ Carrier mass flow * 	Displays the current totalizer counter value.	Signed floating-point number	–
Weighted density average	For the following order code: <ul style="list-style-type: none"> ▪ "Application package", option EJ "Petroleum" ▪ "Application package", option EM "Petroleum + Locking function"  The software options currently enabled are displayed in the Software option overview parameter.	Displays the weighted average for the density since the last time the density averages were reset. <i>Dependency:</i> <ul style="list-style-type: none"> ▪ The unit is taken from: Density unit parameter ▪ The value is reset to NaN (Not a Number) via the Reset weighted averages parameter 	Signed floating-point number	–
Weighted temperature average	For the following order code: <ul style="list-style-type: none"> ▪ "Application package", option EJ "Petroleum" ▪ "Application package", option EM "Petroleum + Locking function"  The software options currently enabled are displayed in the Software option overview parameter.	Displays the weighted average for the temperature since the last time the temperature averages were reset. <i>Dependency:</i> <ul style="list-style-type: none"> ▪ The unit is taken from: Temperature unit parameter ▪ The value is reset to NaN (Not a Number) via the Reset weighted averages parameter 	Signed floating-point number	–

Parameter	Prerequisite	Description	Selection / User entry / User interface	Factory setting
Reset weighted averages	<p>The values can only be reset at zero flow.</p> <p>For the following order code: "Application package", option EJ "Petroleum"</p> <p> The software options currently enabled are displayed in the Software option overview parameter.</p>	Resets the weighted averages for density and temperature to NaN (Not a Number) and then starts determining the weighted averages.	<ul style="list-style-type: none"> ▪ Totalize ▪ Preset + totalize 	–
Reset all totalizers	–	Reset all totalizers to 0 and start.	<ul style="list-style-type: none"> ▪ Cancel ▪ Reset + totalize 	–

* Visibility depends on order options or device settings

11.6.1 Function scope of "Control Totalizer" parameter

Options	Description
Totalize	The totalizer is started or continues running.
Reset + hold	The totaling process is stopped and the totalizer is reset to 0.
Preset + hold ¹⁾	The totaling process is stopped and the totalizer is set to its defined start value from the Preset value parameter.
Reset + totalize	The totalizer is reset to 0 and the totaling process is restarted.
Preset + totalize ¹⁾	The totalizer is set to the defined start value in the Preset value parameter and the totaling process is restarted.

1) Visible depending on the order options or device settings

11.6.2 Function range of "Reset all totalizers" parameter

Options	Description
Cancel	No action is executed and the user exits the parameter.
Reset + totalize	Resets all totalizers to 0 and restarts the totaling process. This deletes all the previously aggregated flow values.

12 Diagnostics and troubleshooting

12.1 General troubleshooting

For local display

Error	Possible causes	Remedial action
Local display is dark, but signal output is within the valid range	The cable of the display module is not plugged in correctly.	Insert the plug correctly into the main electronics module and display module.
Local display dark and no output signals	Supply voltage does not match the voltage specified on the nameplate.	Apply the correct supply voltage → 28.
Local display dark and no output signals	Supply voltage has incorrect polarity.	Reverse polarity of supply voltage.
Local display dark and no output signals	No contact between connecting cables and terminals.	Ensure electrical contact between the cable and the terminal.
Local display dark and no output signals	<ul style="list-style-type: none"> ▪ Terminals are not plugged into the I/O electronics module correctly. ▪ 	Check terminals.
Local display dark and no output signals	<ul style="list-style-type: none"> ▪ I/O electronics module is defective. ▪ 	Order spare part → 129.
Local display cannot be read, but signal output is within the valid range	Display is set too bright or too dark.	<ul style="list-style-type: none"> ▪ Set the display brighter by simultaneously pressing \oplus + \boxplus. ▪ Set the display darker by simultaneously pressing \ominus + \boxplus.
Local display is dark, but signal output is within the valid range	Display module is defective.	Order spare part → 129.
Backlighting of local display is red	Diagnostic event with "Alarm" diagnostic behavior has occurred.	Take remedial measures → 101
Message on local display: "Communication Error" "Check Electronics"	Communication between the display module and the electronics is interrupted.	<ul style="list-style-type: none"> ▪ Check the cable and the connector between the main electronics module and display module. ▪ Order spare part → 129.

For output signals

Error	Possible causes	Remedial action
Green power LED on the main electronics module of the transmitter is dark	Supply voltage does not match the voltage specified on the nameplate.	Apply the correct supply voltage → 28.
Device measures incorrectly.	Configuration error or device is operated outside the application.	<ol style="list-style-type: none"> 1. Check and correct parameter configuration. 2. Observe limit values specified in the "Technical Data".

For access

Fault	Possible causes	Remedial action
Write access to parameters is not possible.	Hardware write protection is enabled.	Set the write protection switch on the main electronics module to the OFF position → 77.
Connection via PROFINET is not possible.	PROFINET bus cable is incorrectly connected.	Check the terminal assignment → 26.
Connection via PROFINET is not possible.	Device plug is incorrectly connected.	Check the pin assignment of the device plugs .
Unable to connect to the web server.	Web server is disabled.	Using the "FieldCare" or "DeviceCare" operating tool, check whether the web server of the device is enabled, and enable it if necessary → 42.

Fault	Possible causes	Remedial action
	The Ethernet interface on the PC is incorrectly configured.	<ul style="list-style-type: none"> ▶ Check the properties of the Internet protocol (TCP/IP). ▶ Check the network settings with the IT manager.
Unable to connect to the web server.	<ul style="list-style-type: none"> ▪ The IP address on the PC is incorrectly configured. ▪ IP address is not known. 	<ul style="list-style-type: none"> ▶ If addressing via hardware: open the transmitter and check the IP address configured (last octet). ▶ Check the IP address of the device with the IT manager. ▶ If the IP address is not known, set DIP switch no.10 on the I/O electronics module 10 to ON, restart the device and enter the factory IP address 192.168.1.212.
	The web browser setting "Use a proxy server for your LAN" is enabled on the PC.	Disable use of the proxy server in the LAN settings. Using the example of MS Internet Explorer: <ul style="list-style-type: none"> ▶ Under <i>Control Panel</i>, open <i>Internet options</i>. ▶ Select the <i>Connections</i> tab. ▶ Double-click <i>LAN Settings</i>. ▶ In <i>LAN Settings</i>, disable use of the proxy server. ▶ Press <i>OK</i> to confirm.
	Apart from the active network connection to the measuring instrument, other network connections are also being used.	<ul style="list-style-type: none"> ▪ Make sure that there are no other network connections from the PC and close other programs on the PC with network access. ▪ If using a docking station for notebooks, make sure that a network connection to another network is not active.
Web browser frozen and operation no longer possible	Data transfer is active.	Wait until data transfer or current action is finished.
	Connection lost	<ul style="list-style-type: none"> ▶ Check cable connection and power supply. ▶ Refresh the web browser and restart if necessary.
Display of web browser content is difficult to read or incomplete.	Web browser version used is not optimal.	<ul style="list-style-type: none"> ▶ Use correct web browser version → 38. ▶ Empty the web browser cache. ▶ Restart the web browser.
	Unsuitable view settings.	Change the font size/display ratio of the Web browser.
Incomplete or no display of content in the web browser	<ul style="list-style-type: none"> ▪ JavaScript is not enabled. ▪ JavaScript cannot be enabled. 	<ul style="list-style-type: none"> ▶ Enable JavaScript. ▶ Enter <code>http://XXX.XXX.X.XX/servlet/basic.html</code> as the IP address.
Operation with FieldCare or DeviceCare via service interface CDI-RJ45 (port 8000) is not possible.	Firewall of the PC or network is blocking communication.	Depending on the settings of the firewall used on the PC or in the network, the firewall must be adapted or disabled to allow FieldCare/ DeviceCare access.
Flashing the firmware with FieldCare or DeviceCare via service interface CDI-RJ45 (port 8000 or TFTP ports) is not possible.	Firewall of the PC or network is blocking communication.	Depending on the settings of the firewall used on the PC or in the network, the firewall must be adapted or disabled to allow FieldCare/ DeviceCare access.

For system integration

Error	Possible causes	Remedy
The PROFINET device name is not displayed correctly and contains coding.	A device name containing one or more underscores has been specified via the automation system.	Specify a correct device name (without underscores) via the automation system.

12.2 Diagnostic information via LEDs

12.2.1 Transmitter

Different LEDs in the transmitter provide information on the device status.

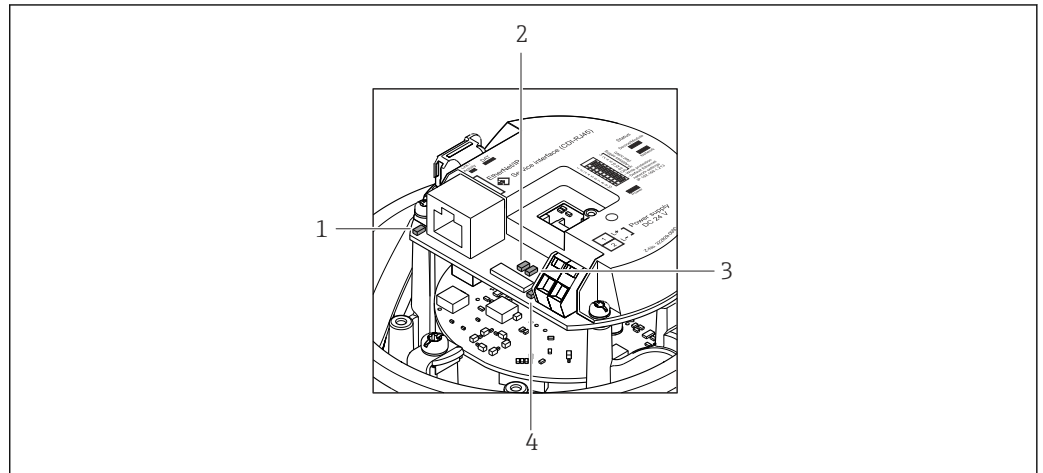

A0027678

- 1 Link/Activity
- 2 Network status
- 3 Device status
- 4 Supply voltage

LED	Color	Meaning
Supply voltage	Off	Supply voltage is off or too low
	Green	Supply voltage is ok
Device status	Green	Device status is ok
	Flashing red	A device error of diagnostic behavior "Warning" has occurred
	Red	A device error of diagnostic behavior "Alarm" has occurred
Network status	Green	Device performing cyclic data exchange
	Flashing green	Following request from automation system: Flash frequency: 1 Hz (flash functionality: 500 ms on, 500 ms off) The device does not have an IP address, no cyclic data exchange Flash frequency: 3 Hz
	Red	IP address is available but no connection to the automation system
	Flashing red	Cyclic connection was established but connection was dropped Flash frequency: 3 Hz
Link/Activity	Orange	Link available but no activity
	Flashing orange	Activity present

12.3 Diagnostic information in the web browser

12.3.1 Diagnostic options

Any faults detected by the measuring device are displayed in the Web browser on the home page once the user has logged on.

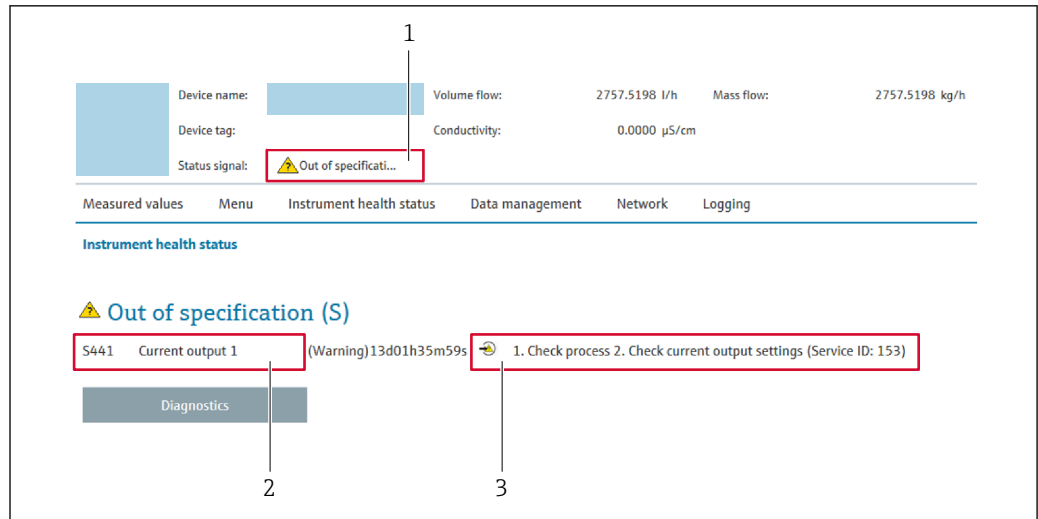

A0031056

- 1 Status area with status signal
- 2 Diagnostic information → 96
- 3 Remedial measures with service ID

i In addition, diagnostic events which have occurred can be shown in the **Diagnostics** menu:

- Via parameter → 122
- Via submenu → 123

Status signals

The status signals provide information on the state and reliability of the device by categorizing the cause of the diagnostic information (diagnostic event).

Symbol	Meaning
	Failure A device error has occurred. The measured value is no longer valid.
	Function check The device is in service mode (e.g. during a simulation).
	Out of specification The device is being operated: Outside its technical specification limits (e.g. outside the process temperature range)
	Maintenance required Maintenance is required. The measured value remains valid.

i The status signals are categorized in accordance with VDI/VDE 2650 and NAMUR Recommendation NE 107.

Diagnostic information

The fault can be identified using the diagnostic information. The short text helps you by providing information about the fault.

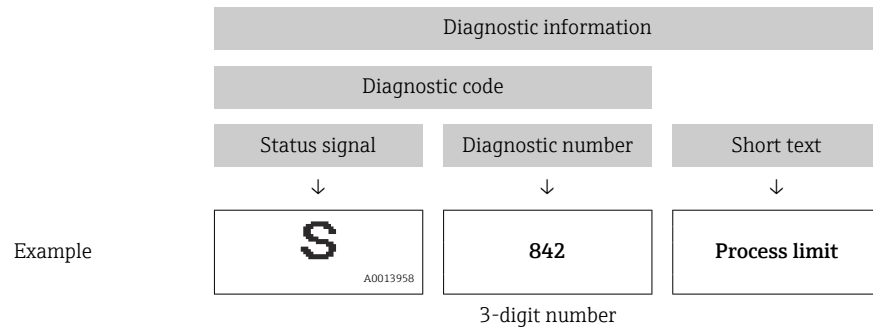

12.3.2 Calling up remedy information

Remedy information is provided for every diagnostic event to ensure that problems can be rectified quickly. These measures are displayed in red along with the diagnostic event and the related diagnostic information.

12.4 Diagnostic information in FieldCare or DeviceCare

12.4.1 Diagnostic options

Any faults detected by the measuring device are displayed on the home page of the operating tool once the connection has been established.

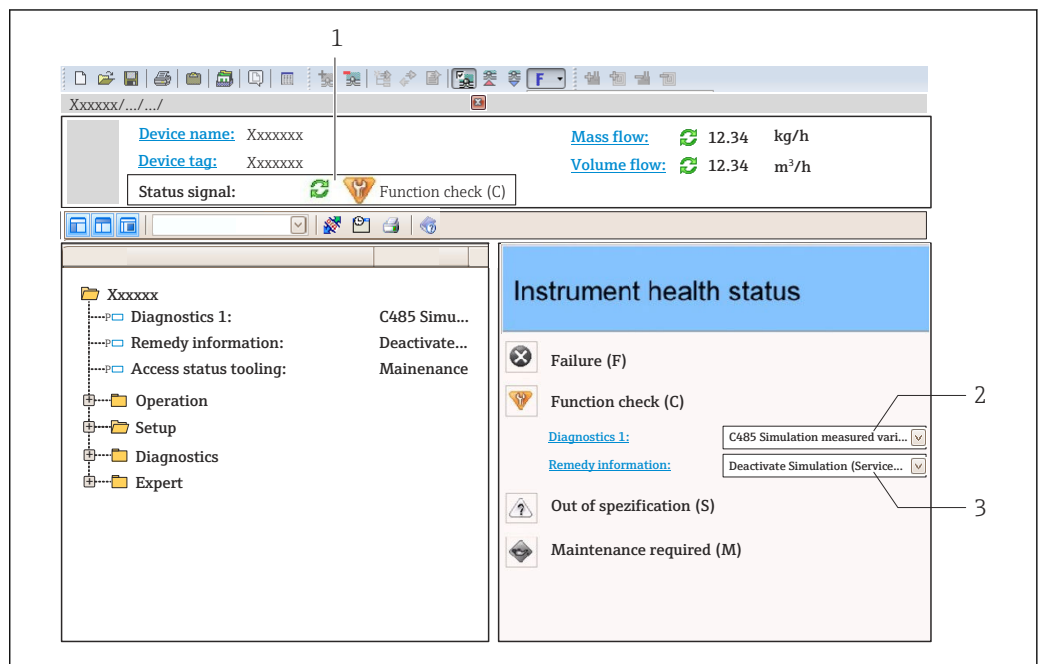

- 1 Status area with status signal
- 2 Diagnostic information → 96
- 3 Remedial measures with service ID

i In addition, diagnostic events which have occurred can be shown in the **Diagnostics** menu:

- Via parameter → 122
- Via submenu → 123

Diagnostic information

The fault can be identified using the diagnostic information. The short text helps you by providing information about the fault.

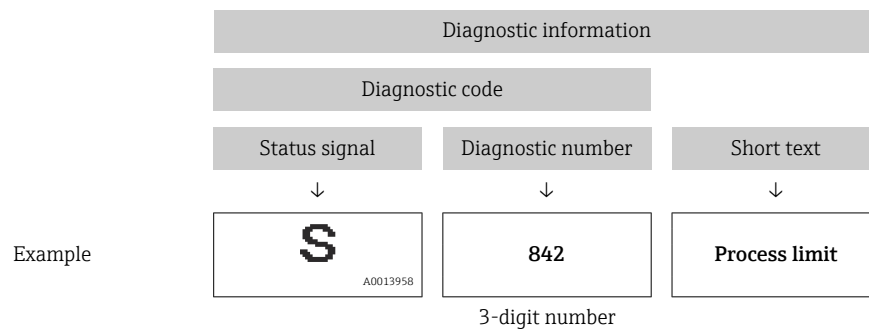

12.4.2 Calling up remedy information

Remedy information is provided for every diagnostic event to ensure that problems can be rectified quickly:

- On the home page
Remedy information is displayed in a separate field below the diagnostics information.
- In the **Diagnostics** menu
Remedy information can be called up in the working area of the user interface.

The user is in the **Diagnostics** menu.

1. Call up the desired parameter.
2. On the right in the working area, mouse over the parameter.
 - ↳ A tool tip with remedy information for the diagnostic event appears.

12.5 Adapting the diagnostic information

12.5.1 Adapting the diagnostic behavior

Each item of diagnostic information is assigned a specific diagnostic behavior at the factory. The user can change this assignment for specific diagnostic information in the **Diagnostic behavior** submenu.

Expert → System → Diagnostic handling → Diagnostic behavior

Available diagnostic behaviors

The following diagnostic behaviors can be assigned:

Diagnostic behavior	Description
Alarm	The device stops measurement. The totalizers assume the defined alarm condition. A diagnostic message is generated.
Warning	The device continues to measure. Measured value output via PROFINET and totalizers are not affected. A diagnostic message is generated.
Logbook entry only	The device continues to measure. The diagnostic message is only displayed in the Event logbook submenu (Event list submenu) and is not displayed in alternating sequence with the operational display.
Off	The diagnostic event is ignored, and no diagnostic message is generated or entered.

Displaying the measured value status

If modules with input data (e.g. Analog Input module, Discrete Input module, Totalizer module, Heartbeat module) are configured for cyclic data transmission, the measured value status is coded as per PROFINET PA Profile 4 Specification and transmitted along with the measured value to the PROFINET Controller via the status byte. The status byte is split into three segments: Quality, Quality Substatus and Limits.

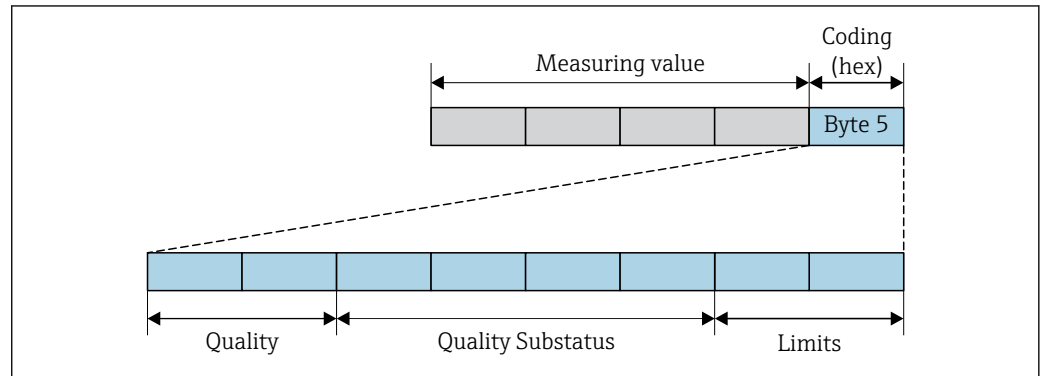

A003228-EN

15 Structure of the status byte

The content of the status byte depends on the configured failure mode in the individual function block. Depending on which failure mode has been configured, status information in accordance with PROFINET PA Profile Specification 4 is transmitted to the the PROFINET controller via the status byte status information. The two bits for the limits always have the value 0.





Supported status information

Status	Coding (hex)
BAD - Maintenance alarm	0x24
BAD - Process related	0x28
BAD - Function check	0x3C
UNCERTAIN - Initial value	0x4F
UNCERTAIN - Maintenance demanded	0x68
UNCERTAIN - Process related	0x78
GOOD - OK	0x80
GOOD - Maintenance demanded	0xA8
GOOD - Function check	0xBC

Determining the measured value status and device status via the diagnostic behavior

When the diagnostic behavior is assigned, this also changes the measured value status and device status for the diagnostic information. The measured value status and device status depend on the choice of diagnostic behavior and on the group in which the diagnostic information is located.

The diagnostic information is grouped as follows:

- Diagnostic information pertaining to the sensor: diagnostic number 000 to 199
→  100
- Diagnostic information pertaining to the electronics: diagnostic number 200 to 399
→  100
- Diagnostic information pertaining to the configuration: diagnostic number 400 to 599
→  101
- Diagnostic information pertaining to the process: diagnostic number 800 to 999
→  101

Depending on the group in which the diagnostic information is located, the following measured value status and device status are firmly assigned to the particular diagnostic behavior:

Diagnostic information pertaining to the sensor: diagnostic number 000 to 199

Diagnostic behavior (configurable)	Measured value status (fixed assignment)				Device diagnosis (fixed assignment)
	Quality	Quality Substatus	Coding (hex)	Category (NE107)	
Alarm	BAD	Maintenance alarm	0x24	F (Failure)	Maintenance alarm
Warning	GOOD	Maintenance demanded	0xA8	M (Maintenance)	Maintenance demanded
Logbook entry only	GOOD	ok	0x80	-	-
Off					

Diagnostic information pertaining to the electronics: diagnostic number 200 to 399

Diagnostic number 200 to 301, 303 to 399

Diagnostic behavior (configurable)	Measured value status (fixed assignment)				Device diagnostics (fixed assignment)
	Quality	Quality Substatus	Coding (hex)	Category (NE107)	
Alarm	BAD	Maintenance alarm	0x24	F (Failure)	Maintenance alarm
Warning					
Logbook entry only	GOOD	ok	0x80 to 0x8E	-	-
Off					

Diagnostic information 302

Diagnostic behavior (configurable)	Measured value status (fixed assignment)				Device diagnostics (fixed assignment)
	Quality	Quality Substatus	Coding (hex)	Category (NE107)	
Alarm	BAD	Function check, local override	0x24	C	Function check
Warning	GOOD	Function check	0xBC to 0xBF	-	-

Diagnostic information 302 (device verification active) is output during internal or external Heartbeat verification.

- Signal status: Function check
- Choice of diagnostic behavior: alarm or warning (factory setting)

When the Heartbeat Verification is started, data logging is interrupted, the last valid measured value is output and the totalizer counter is stopped.

Diagnostic information pertaining to the configuration: diagnostic number 400 to 599



Diagnostic behavior (configurable)	Measured value status (fixed assignment)				Device diagnosis (fixed assignment)
	Quality	Quality Substatus	Coding (hex)	Category (NE107)	
Alarm	BAD	Process related	0x28	F (Failure)	Invalid process condition
Warning	UNCERTAIN	Process related	0x78	S (Out of specification)	Invalid process condition
Logbook entry only	GOOD	ok	0x80	-	-
Off					

Diagnostic information pertaining to the process: diagnostic number 800 to 999

Diagnostic behavior (configurable)	Measured value status (fixed assignment)				Device diagnosis (fixed assignment)
	Quality	Quality Substatus	Coding (hex)	Category (NE107)	
Alarm	BAD	Process related	0x28	F (Failure)	Invalid process condition
Warning	UNCERTAIN	Process related	0x78	S (Out of specification)	Invalid process condition
Logbook entry only	GOOD	ok	0x80	-	-
Off					

12.6 Overview of diagnostic information

-  The amount of diagnostic information and the number of measured variables affected increase if the measuring device has one or more application packages.
- All of the measured variables affected in the entire Promass instrument family are always listed under "Measured variables affected". The measured variables available for the device in question depend on the device version. When assigning the measured variables to the device functions, for example to the individual outputs, all of the measured variables available for the device version in question are available for selection.

-  In the case of some items of diagnostic information, the diagnostic behavior can be changed. Adapting the diagnostic information →  98

12.6.1 Diagnostic of sensor

Diagnostic information		Remedy instructions	Influenced measured variables	
No.	Short text			
022	Sensor temperature	1. Change main electronic module 2. Change sensor	<ul style="list-style-type: none"> ▪ Carrier mass flow ▪ Concentration ▪ Density ▪ Dynamic viscosity ▪ Kinematic viscosity ▪ Mass flow ▪ Sensor integrity ▪ Reference density ▪ Corrected volume flow ▪ Target mass flow ▪ Temp. compensated dynamic viscosity ▪ Temp. compensated kinematic viscosity ▪ Temperature ▪ Status ▪ Volume flow 	
	Measured variable status			
	Quality			Bad
	Quality substatus			Maintenance alarm
	Coding (hex)			0x24 to 0x27
	Status signal			F
	Diagnostic behavior			Alarm

Diagnostic information		Remedy instructions	Influenced measured variables	
No.	Short text			
046	Sensor limit exceeded	1. Inspect sensor 2. Check process condition	<ul style="list-style-type: none"> ▪ Carrier mass flow ▪ Concentration ▪ Density ▪ Dynamic viscosity ▪ Kinematic viscosity ▪ Mass flow ▪ Sensor integrity ▪ Reference density ▪ Corrected volume flow ▪ Target mass flow ▪ Temp. compensated dynamic viscosity ▪ Temp. compensated kinematic viscosity ▪ Volume flow 	
	Measured variable status [from the factory] ¹⁾			
	Quality			Good
	Quality substatus			Ok
	Coding (hex)			0x80 to 0x83
	Status signal			S
	Diagnostic behavior			Warning

1) Diagnostic behavior can be changed. This causes the overall status of the measured variable to change.

Diagnostic information		Remedy instructions	Influenced measured variables	
No.	Short text			
062	Sensor connection	1. Change main electronic module 2. Change sensor	<ul style="list-style-type: none"> ▪ Carrier mass flow ▪ Concentration ▪ Density ▪ Dynamic viscosity ▪ Kinematic viscosity ▪ Mass flow ▪ Sensor integrity ▪ Reference density ▪ Corrected volume flow ▪ Target mass flow ▪ Temp. compensated dynamic viscosity ▪ Temp. compensated kinematic viscosity ▪ Temperature ▪ Status ▪ Volume flow 	
	Measured variable status			
	Quality			Bad
	Quality substatus			Maintenance alarm
	Coding (hex)			0x24 to 0x27
	Status signal			F
	Diagnostic behavior			Alarm

Diagnostic information		Remedy instructions	Influenced measured variables	
No.	Short text			
082	Data storage	1. Check module connections 2. Contact service	<ul style="list-style-type: none"> ▪ Carrier mass flow ▪ Concentration ▪ Density ▪ Dynamic viscosity ▪ Kinematic viscosity ▪ Mass flow ▪ Sensor integrity ▪ Reference density ▪ Corrected volume flow ▪ Target mass flow ▪ Temp. compensated dynamic viscosity ▪ Temp. compensated kinematic viscosity ▪ Temperature ▪ Volume flow 	
	Measured variable status			
	Quality			Bad
	Quality substatus			Maintenance alarm
	Coding (hex)			0x24 to 0x27
	Status signal			F
	Diagnostic behavior			Alarm

Diagnostic information		Remedy instructions	Influenced measured variables	
No.	Short text			
083	Memory content	1. Restart device 2. Contact service	<ul style="list-style-type: none"> ▪ Carrier mass flow ▪ Concentration ▪ Density ▪ Dynamic viscosity ▪ Kinematic viscosity ▪ Mass flow ▪ Sensor integrity ▪ Reference density ▪ Corrected volume flow ▪ Target mass flow ▪ Temp. compensated dynamic viscosity ▪ Temp. compensated kinematic viscosity ▪ Temperature ▪ Status ▪ Volume flow 	
	Measured variable status			
	Quality			Bad
	Quality substatus			Maintenance alarm
	Coding (hex)			0x24 to 0x27
	Status signal			F
	Diagnostic behavior			Alarm

Diagnostic information		Remedy instructions	Influenced measured variables	
No.	Short text			
140	Sensor signal	1. Check or change main electronics 2. Change sensor	<ul style="list-style-type: none"> ▪ Carrier mass flow ▪ Concentration ▪ Density ▪ Dynamic viscosity ▪ Kinematic viscosity ▪ Mass flow ▪ Sensor integrity ▪ Reference density ▪ Corrected volume flow ▪ Target mass flow ▪ Temp. compensated dynamic viscosity ▪ Temp. compensated kinematic viscosity ▪ Temperature 	
	Measured variable status [from the factory] ¹⁾			
	Quality			Good
	Quality substatus			Ok
	Coding (hex)			0x80 to 0x83
	Status signal			S
	Diagnostic behavior			Alarm

1) Diagnostic behavior can be changed. This causes the overall status of the measured variable to change.

Diagnostic information		Remedy instructions	Influenced measured variables	
No.	Short text			
144	Measuring error too high	1. Check or change sensor 2. Check process conditions	<ul style="list-style-type: none"> ▪ Carrier mass flow ▪ Concentration ▪ Density ▪ Dynamic viscosity ▪ Kinematic viscosity ▪ Mass flow ▪ Sensor integrity ▪ Reference density ▪ Corrected volume flow ▪ Target mass flow ▪ Temp. compensated dynamic viscosity ▪ Temp. compensated kinematic viscosity ▪ Temperature 	
	Measured variable status [from the factory] ¹⁾			
	Quality			Good
	Quality substatus			Ok
	Coding (hex)			0x80 to 0x83
	Status signal			F
	Diagnostic behavior			Alarm

1) Diagnostic behavior can be changed. This causes the overall status of the measured variable to change.

Diagnostic information		Remedy instructions	Influenced measured variables	
No.	Short text			
190	Special event 1	Contact service	<ul style="list-style-type: none"> ▪ Carrier mass flow ▪ Concentration ▪ Density ▪ Dynamic viscosity ▪ Kinematic viscosity ▪ Mass flow ▪ Sensor integrity ▪ Reference density ▪ Corrected volume flow ▪ Target mass flow ▪ Temp. compensated dynamic viscosity ▪ Temp. compensated kinematic viscosity ▪ Temperature ▪ Status ▪ Volume flow 	
	Measured variable status			
	Quality			Bad
	Quality substatus			Maintenance alarm
	Coding (hex)			0x24 to 0x27
	Status signal			F
	Diagnostic behavior			Alarm

Diagnostic information		Remedy instructions	Influenced measured variables	
No.	Short text			
191	Special event 5	Contact service	<ul style="list-style-type: none"> ▪ Carrier mass flow ▪ Concentration ▪ Density ▪ Dynamic viscosity ▪ Kinematic viscosity ▪ Mass flow ▪ Sensor integrity ▪ Reference density ▪ Corrected volume flow ▪ Target mass flow ▪ Temp. compensated dynamic viscosity ▪ Temp. compensated kinematic viscosity ▪ Temperature ▪ Status ▪ Volume flow 	
	Measured variable status			
	Quality			Bad
	Quality substatus			Maintenance alarm
	Coding (hex)			0x24 to 0x27
	Status signal			F
	Diagnostic behavior			Alarm

Diagnostic information		Remedy instructions	Influenced measured variables	
No.	Short text			
192	Special event 9	Contact service	<ul style="list-style-type: none"> ■ Carrier mass flow ■ Concentration ■ Density ■ Dynamic viscosity ■ Kinematic viscosity ■ Mass flow ■ Sensor integrity ■ Reference density ■ Corrected volume flow ■ Target mass flow ■ Temp. compensated dynamic viscosity ■ Temp. compensated kinematic viscosity ■ Temperature ■ Status ■ Volume flow 	
	Measured variable status [from the factory] ¹⁾			
	Quality			Good
	Quality substatus			Ok
	Coding (hex)			0x80 to 0x83
	Status signal			F
	Diagnostic behavior			Alarm

1) Diagnostic behavior can be changed. This causes the overall status of the measured variable to change.

12.6.2 Diagnostic of electronic

Diagnostic information		Remedy instructions	Influenced measured variables	
No.	Short text			
201	Device failure	1. Restart device 2. Contact service	<ul style="list-style-type: none"> ■ Carrier mass flow ■ Concentration ■ Density ■ Dynamic viscosity ■ Kinematic viscosity ■ Mass flow ■ Sensor integrity ■ Reference density ■ Corrected volume flow ■ Target mass flow ■ Temp. compensated dynamic viscosity ■ Temp. compensated kinematic viscosity ■ Temperature ■ Status ■ Volume flow 	
	Measured variable status			
	Quality			Bad
	Quality substatus			Maintenance alarm
	Coding (hex)			0x24 to 0x27
	Status signal			F
	Diagnostic behavior			Alarm

Diagnostic information		Remedy instructions	Influenced measured variables	
No.	Short text			
242	Software incompatible	1. Check software 2. Flash or change main electronics module	<ul style="list-style-type: none"> ■ Carrier mass flow ■ Concentration ■ Density ■ Dynamic viscosity ■ Kinematic viscosity ■ Mass flow ■ Sensor integrity ■ Reference density ■ Corrected volume flow ■ Target mass flow ■ Temp. compensated dynamic viscosity ■ Temp. compensated kinematic viscosity ■ Temperature ■ Status ■ Volume flow 	
	Measured variable status			
	Quality			Bad
	Quality substatus			Maintenance alarm
	Coding (hex)			0x24 to 0x27
	Status signal			F
	Diagnostic behavior			Alarm

Diagnostic information		Remedy instructions	Influenced measured variables	
No.	Short text			
252	Modules incompatible	1. Check electronic modules 2. Change electronic modules	<ul style="list-style-type: none"> ▪ Carrier mass flow ▪ Concentration ▪ Density ▪ Dynamic viscosity ▪ Kinematic viscosity ▪ Mass flow ▪ Reference density ▪ Corrected volume flow ▪ Target mass flow ▪ Temp. compensated dynamic viscosity ▪ Temp. compensated kinematic viscosity ▪ Temperature ▪ Status ▪ Volume flow 	
	Measured variable status [from the factory] ¹⁾			
	Quality			Good
	Quality substatus			Ok
	Coding (hex)			0x80 to 0x83
	Status signal			F
	Diagnostic behavior			Alarm

1) Diagnostic behavior can be changed. This causes the overall status of the measured variable to change.

Diagnostic information		Remedy instructions	Influenced measured variables	
No.	Short text			
262	Module connection	1. Check module connections 2. Change main electronics	<ul style="list-style-type: none"> ▪ Carrier mass flow ▪ Concentration ▪ Density ▪ Dynamic viscosity ▪ Kinematic viscosity ▪ Mass flow ▪ Sensor integrity ▪ Reference density ▪ Corrected volume flow ▪ Target mass flow ▪ Temp. compensated dynamic viscosity ▪ Temp. compensated kinematic viscosity ▪ Temperature ▪ Status ▪ Volume flow 	
	Measured variable status			
	Quality			Bad
	Quality substatus			Maintenance alarm
	Coding (hex)			0x24 to 0x27
	Status signal			F
	Diagnostic behavior			Alarm

Diagnostic information		Remedy instructions	Influenced measured variables	
No.	Short text			
270	Main electronic failure	Change main electronic module	<ul style="list-style-type: none"> ▪ Carrier mass flow ▪ Concentration ▪ Density ▪ Dynamic viscosity ▪ Kinematic viscosity ▪ Mass flow ▪ Sensor integrity ▪ Reference density ▪ Corrected volume flow ▪ Target mass flow ▪ Temp. compensated dynamic viscosity ▪ Temp. compensated kinematic viscosity ▪ Temperature ▪ Status ▪ Volume flow 	
	Measured variable status			
	Quality			Bad
	Quality substatus			Maintenance alarm
	Coding (hex)			0x24 to 0x27
	Status signal			F
	Diagnostic behavior			Alarm

Diagnostic information		Remedy instructions	Influenced measured variables	
No.	Short text			
271	Main electronic failure	1. Restart device 2. Change main electronic module	<ul style="list-style-type: none"> ■ Carrier mass flow ■ Concentration ■ Density ■ Dynamic viscosity ■ Kinematic viscosity ■ Mass flow ■ Sensor integrity ■ Reference density ■ Corrected volume flow ■ Target mass flow ■ Temp. compensated dynamic viscosity ■ Temp. compensated kinematic viscosity ■ Temperature ■ Status ■ Volume flow 	
	Measured variable status			
	Quality			Bad
	Quality substatus			Maintenance alarm
	Coding (hex)			0x24 to 0x27
	Status signal			F
	Diagnostic behavior			Alarm

Diagnostic information		Remedy instructions	Influenced measured variables	
No.	Short text			
272	Main electronic failure	1. Restart device 2. Contact service	<ul style="list-style-type: none"> ■ Carrier mass flow ■ Concentration ■ Density ■ Dynamic viscosity ■ Kinematic viscosity ■ Mass flow ■ Sensor integrity ■ Reference density ■ Corrected volume flow ■ Target mass flow ■ Temp. compensated dynamic viscosity ■ Temp. compensated kinematic viscosity ■ Temperature ■ Status ■ Volume flow 	
	Measured variable status			
	Quality			Bad
	Quality substatus			Maintenance alarm
	Coding (hex)			0x24 to 0x27
	Status signal			F
	Diagnostic behavior			Alarm

Diagnostic information		Remedy instructions	Influenced measured variables	
No.	Short text			
273	Main electronic failure	Change electronic	<ul style="list-style-type: none"> ■ Carrier mass flow ■ Concentration ■ Density ■ Dynamic viscosity ■ Kinematic viscosity ■ Mass flow ■ Sensor integrity ■ Reference density ■ Corrected volume flow ■ Target mass flow ■ Temp. compensated dynamic viscosity ■ Temp. compensated kinematic viscosity ■ Temperature ■ Status ■ Volume flow 	
	Measured variable status			
	Quality			Bad
	Quality substatus			Maintenance alarm
	Coding (hex)			0x24 to 0x27
	Status signal			F
	Diagnostic behavior			Alarm

Diagnostic information		Remedy instructions	Influenced measured variables	
No.	Short text			
274	Main electronic failure	Change electronic	<ul style="list-style-type: none"> ▪ Mass flow ▪ Sensor integrity ▪ Corrected volume flow ▪ Volume flow 	
	Measured variable status [from the factory] ¹⁾			
	Quality			Good
	Quality substatus			Ok
	Coding (hex)			0x80 to 0x83
	Status signal			S
	Diagnostic behavior			Warning

1) Diagnostic behavior can be changed. This causes the overall status of the measured variable to change.

Diagnostic information		Remedy instructions	Influenced measured variables	
No.	Short text			
283	Memory content	1. Reset device 2. Contact service	<ul style="list-style-type: none"> ▪ Carrier mass flow ▪ Concentration ▪ Density ▪ Dynamic viscosity ▪ Kinematic viscosity ▪ Mass flow ▪ Reference density ▪ Corrected volume flow ▪ Target mass flow ▪ Temp. compensated dynamic viscosity ▪ Temp. compensated kinematic viscosity ▪ Temperature ▪ Status ▪ Volume flow 	
	Measured variable status			
	Quality			Bad
	Quality substatus			Maintenance alarm
	Coding (hex)			0x24 to 0x27
	Status signal			F
	Diagnostic behavior			Alarm

Diagnostic information		Remedy instructions	Influenced measured variables	
No.	Short text			
311	Electronic failure	1. Reset device 2. Contact service	<ul style="list-style-type: none"> ▪ Carrier mass flow ▪ Concentration ▪ Density ▪ Dynamic viscosity ▪ Kinematic viscosity ▪ Mass flow ▪ Sensor integrity ▪ Reference density ▪ Corrected volume flow ▪ Target mass flow ▪ Temp. compensated dynamic viscosity ▪ Temp. compensated kinematic viscosity ▪ Temperature ▪ Status ▪ Volume flow 	
	Measured variable status			
	Quality			Bad
	Quality substatus			Maintenance alarm
	Coding (hex)			0x24 to 0x27
	Status signal			F
	Diagnostic behavior			Alarm

Diagnostic information		Remedy instructions	Influenced measured variables	
No.	Short text			
311	Electronic failure	1. Do not reset device 2. Contact service	<ul style="list-style-type: none"> ■ Carrier mass flow ■ Concentration ■ Density ■ Dynamic viscosity ■ Kinematic viscosity ■ Mass flow ■ Sensor integrity ■ Reference density ■ Corrected volume flow ■ Target mass flow ■ Temp. compensated dynamic viscosity ■ Temp. compensated kinematic viscosity ■ Temperature ■ Volume flow 	
	Measured variable status			
	Quality			Bad
	Quality substatus			Maintenance alarm
	Coding (hex)			0x24 to 0x27
	Status signal			M
	Diagnostic behavior			Warning

Diagnostic information		Remedy instructions	Influenced measured variables	
No.	Short text			
382	Data storage	1. Insert DAT module 2. Change DAT module	<ul style="list-style-type: none"> ■ Carrier mass flow ■ Concentration ■ Density ■ Dynamic viscosity ■ Kinematic viscosity ■ Mass flow ■ Reference density ■ Corrected volume flow ■ Target mass flow ■ Temp. compensated dynamic viscosity ■ Temp. compensated kinematic viscosity ■ Temperature ■ Status ■ Volume flow 	
	Measured variable status			
	Quality			Bad
	Quality substatus			Maintenance alarm
	Coding (hex)			0x24 to 0x27
	Status signal			F
	Diagnostic behavior			Alarm

Diagnostic information		Remedy instructions	Influenced measured variables	
No.	Short text			
383	Memory content	1. Restart device 2. Check or change DAT module 3. Contact service	<ul style="list-style-type: none"> ■ Carrier mass flow ■ Concentration ■ Density ■ Dynamic viscosity ■ Kinematic viscosity ■ Mass flow ■ Reference density ■ Corrected volume flow ■ Target mass flow ■ Temp. compensated dynamic viscosity ■ Temp. compensated kinematic viscosity ■ Temperature ■ Status ■ Volume flow 	
	Measured variable status			
	Quality			Bad
	Quality substatus			Maintenance alarm
	Coding (hex)			0x24 to 0x27
	Status signal			F
	Diagnostic behavior			Alarm

Diagnostic information		Remedy instructions	Influenced measured variables	
No.	Short text			
390	Special event 2	Contact service	<ul style="list-style-type: none"> ▪ Carrier mass flow ▪ Concentration ▪ Density ▪ Dynamic viscosity ▪ Kinematic viscosity ▪ Mass flow ▪ Sensor integrity ▪ Reference density ▪ Corrected volume flow ▪ Target mass flow ▪ Temp. compensated dynamic viscosity ▪ Temp. compensated kinematic viscosity ▪ Temperature ▪ Status ▪ Volume flow 	
	Measured variable status			
	Quality			Bad
	Quality substatus			Maintenance alarm
	Coding (hex)			0x24 to 0x27
	Status signal			F
	Diagnostic behavior			Alarm

Diagnostic information		Remedy instructions	Influenced measured variables	
No.	Short text			
391	Special event 6	Contact service	<ul style="list-style-type: none"> ▪ Carrier mass flow ▪ Concentration ▪ Density ▪ Dynamic viscosity ▪ Kinematic viscosity ▪ Mass flow ▪ Sensor integrity ▪ Reference density ▪ Corrected volume flow ▪ Target mass flow ▪ Temp. compensated dynamic viscosity ▪ Temp. compensated kinematic viscosity ▪ Temperature ▪ Status ▪ Volume flow 	
	Measured variable status			
	Quality			Bad
	Quality substatus			Maintenance alarm
	Coding (hex)			0x24 to 0x27
	Status signal			F
	Diagnostic behavior			Alarm

Diagnostic information		Remedy instructions	Influenced measured variables	
No.	Short text			
392	Special event 10	Contact service	<ul style="list-style-type: none"> ▪ Carrier mass flow ▪ Concentration ▪ Density ▪ Dynamic viscosity ▪ Kinematic viscosity ▪ Mass flow ▪ Sensor integrity ▪ Reference density ▪ Corrected volume flow ▪ Target mass flow ▪ Temp. compensated dynamic viscosity ▪ Temp. compensated kinematic viscosity ▪ Temperature ▪ Status ▪ Volume flow 	
	Measured variable status [from the factory] ¹⁾			
	Quality			Good
	Quality substatus			Ok
	Coding (hex)			0x80 to 0x83
	Status signal			F
	Diagnostic behavior			Alarm

1) Diagnostic behavior can be changed. This causes the overall status of the measured variable to change.

12.6.3 Diagnostic of configuration

Diagnostic information		Remedy instructions	Influenced measured variables	
No.	Short text			
410	Data transfer	1. Check connection 2. Retry data transfer	<ul style="list-style-type: none"> ▪ Carrier mass flow ▪ Concentration ▪ Density ▪ Dynamic viscosity ▪ Kinematic viscosity ▪ Mass flow ▪ Sensor integrity ▪ Reference density ▪ Corrected volume flow ▪ Target mass flow ▪ Temp. compensated dynamic viscosity ▪ Temp. compensated kinematic viscosity ▪ Temperature ▪ Volume flow 	
	Measured variable status			
	Quality			Bad
	Quality substatus			Maintenance alarm
	Coding (hex)			0x24 to 0x27
	Status signal			F
	Diagnostic behavior			Alarm

Diagnostic information		Remedy instructions	Influenced measured variables	
No.	Short text			
412	Processing download	Download active, please wait	<ul style="list-style-type: none"> ▪ Carrier mass flow ▪ Concentration ▪ Density ▪ Dynamic viscosity ▪ Kinematic viscosity ▪ Mass flow ▪ Sensor integrity ▪ Reference density ▪ Corrected volume flow ▪ Target mass flow ▪ Temp. compensated dynamic viscosity ▪ Temp. compensated kinematic viscosity ▪ Temperature ▪ Volume flow 	
	Measured variable status			
	Quality			Uncertain
	Quality substatus			Initial value
	Coding (hex)			0x4C to 0x4F
	Status signal			C
	Diagnostic behavior			Warning

Diagnostic information		Remedy instructions	Influenced measured variables	
No.	Short text			
437	Configuration incompatible	1. Restart device 2. Contact service	<ul style="list-style-type: none"> ▪ Carrier mass flow ▪ Concentration ▪ Density ▪ Dynamic viscosity ▪ Kinematic viscosity ▪ Mass flow ▪ Reference density ▪ Corrected volume flow ▪ Target mass flow ▪ Temp. compensated dynamic viscosity ▪ Temp. compensated kinematic viscosity ▪ Temperature ▪ Status ▪ Volume flow 	
	Measured variable status			
	Quality			Bad
	Quality substatus			Maintenance alarm
	Coding (hex)			0x24 to 0x27
	Status signal			F
	Diagnostic behavior			Alarm

Diagnostic information		Remedy instructions	Influenced measured variables	
No.	Short text			
438	Dataset	1. Check data set file 2. Check device configuration 3. Up- and download new configuration	<ul style="list-style-type: none"> ▪ Carrier mass flow ▪ Concentration ▪ Density ▪ Dynamic viscosity ▪ Kinematic viscosity ▪ Mass flow ▪ Sensor integrity ▪ Reference density ▪ Corrected volume flow ▪ Target mass flow ▪ Temp. compensated dynamic viscosity ▪ Temp. compensated kinematic viscosity ▪ Temperature ▪ Volume flow 	
	Measured variable status			
	Quality			Uncertain
	Quality substatus			Maintenance demanded
	Coding (hex)			0x68 to 0x6B
	Status signal			M
	Diagnostic behavior			Warning

Diagnostic information		Remedy instructions	Influenced measured variables	
No.	Short text			
453	Flow override	Deactivate flow override	<ul style="list-style-type: none"> ▪ Carrier mass flow ▪ Concentration ▪ Density ▪ Dynamic viscosity ▪ Kinematic viscosity ▪ Mass flow ▪ Sensor integrity ▪ Reference density ▪ Corrected volume flow ▪ Target mass flow ▪ Temp. compensated dynamic viscosity ▪ Temp. compensated kinematic viscosity ▪ Temperature ▪ Volume flow 	
	Measured variable status			
	Quality			Good
	Quality substatus			Function check
	Coding (hex)			0xBC to 0xBF
	Status signal			C
	Diagnostic behavior			Warning

Diagnostic information		Remedy instructions	Influenced measured variables	
No.	Short text			
484	Simulation Failure Mode	Deactivate simulation	<ul style="list-style-type: none"> ▪ Carrier mass flow ▪ Concentration ▪ Density ▪ Dynamic viscosity ▪ Kinematic viscosity ▪ Mass flow ▪ Sensor integrity ▪ Reference density ▪ Corrected volume flow ▪ Target mass flow ▪ Temp. compensated dynamic viscosity ▪ Temp. compensated kinematic viscosity ▪ Temperature ▪ Status ▪ Volume flow 	
	Measured variable status			
	Quality			Bad
	Quality substatus			Function check
	Coding (hex)			0x3C to 0x3F
	Status signal			C
	Diagnostic behavior			Alarm

Diagnostic information		Remedy instructions	Influenced measured variables
No.	Short text		
485	Simulation measured variable		<ul style="list-style-type: none"> ■ Carrier mass flow ■ Concentration ■ Density ■ Dynamic viscosity ■ Kinematic viscosity ■ Mass flow ■ Sensor integrity ■ Reference density ■ Corrected volume flow ■ Target mass flow ■ Temp. compensated dynamic viscosity ■ Temp. compensated kinematic viscosity ■ Temperature ■ Volume flow
	Measured variable status		
	Quality	Good	
	Quality substatus	Function check	
	Coding (hex)	0xBC to 0xBF	
	Status signal	C	
	Diagnostic behavior	Warning	

Diagnostic information		Remedy instructions	Influenced measured variables
No.	Short text		
495	Diagnostic event simulation		-
	Measured variable status		
	Quality	Good	
	Quality substatus	Ok	
	Coding (hex)	0x80 to 0x83	
	Status signal	C	
	Diagnostic behavior	Warning	

Diagnostic information		Remedy instructions	Influenced measured variables
No.	Short text		
537	Configuration		1. Check IP addresses in network 2. Change IP address
	Measured variable status		
	Quality	Good	
	Quality substatus	Ok	
	Coding (hex)	0x80 to 0x83	
	Status signal	F	
	Diagnostic behavior	Warning	

Diagnostic information		Remedy instructions	Influenced measured variables	
No.	Short text			
590	Special event 3	Contact service	<ul style="list-style-type: none"> ▪ Carrier mass flow ▪ Concentration ▪ Density ▪ Dynamic viscosity ▪ Kinematic viscosity ▪ Mass flow ▪ Sensor integrity ▪ Reference density ▪ Corrected volume flow ▪ Target mass flow ▪ Temp. compensated dynamic viscosity ▪ Temp. compensated kinematic viscosity ▪ Status ▪ Volume flow 	
	Measured variable status			
	Quality			Bad
	Quality substatus			Maintenance alarm
	Coding (hex)			0x24 to 0x27
	Status signal			F
	Diagnostic behavior			Alarm

Diagnostic information		Remedy instructions	Influenced measured variables	
No.	Short text			
591	Special event 7	Contact service	<ul style="list-style-type: none"> ▪ Carrier mass flow ▪ Concentration ▪ Density ▪ Dynamic viscosity ▪ Kinematic viscosity ▪ Mass flow ▪ Sensor integrity ▪ Reference density ▪ Corrected volume flow ▪ Target mass flow ▪ Temp. compensated dynamic viscosity ▪ Temp. compensated kinematic viscosity ▪ Temperature ▪ Status ▪ Volume flow 	
	Measured variable status			
	Quality			Bad
	Quality substatus			Maintenance alarm
	Coding (hex)			0x24 to 0x27
	Status signal			F
	Diagnostic behavior			Alarm

Diagnostic information		Remedy instructions	Influenced measured variables	
No.	Short text			
592	Special event 11	Contact service	<ul style="list-style-type: none"> ▪ Carrier mass flow ▪ Concentration ▪ Density ▪ Dynamic viscosity ▪ Kinematic viscosity ▪ Mass flow ▪ Sensor integrity ▪ Reference density ▪ Corrected volume flow ▪ Target mass flow ▪ Temp. compensated dynamic viscosity ▪ Temp. compensated kinematic viscosity ▪ Temperature ▪ Status ▪ Volume flow 	
	Measured variable status [from the factory] ¹⁾			
	Quality			Good
	Quality substatus			Ok
	Coding (hex)			0x80 to 0x83
	Status signal			F
	Diagnostic behavior			Alarm

1) Diagnostic behavior can be changed. This causes the overall status of the measured variable to change.

12.6.4 Diagnostic of process

Diagnostic information		Remedy instructions	Influenced measured variables	
No.	Short text			
825	Operating temperature	1. Check ambient temperature 2. Check process temperature	<ul style="list-style-type: none"> ▪ Carrier mass flow ▪ Concentration ▪ Density ▪ Dynamic viscosity ▪ Kinematic viscosity ▪ Mass flow ▪ Sensor integrity ▪ Reference density ▪ Corrected volume flow ▪ Target mass flow ▪ Temp. compensated dynamic viscosity ▪ Temp. compensated kinematic viscosity ▪ Temperature ▪ Status ▪ Volume flow 	
	Measured variable status			
	Quality			Good
	Quality substatus			Ok
	Coding (hex)			0x80 to 0x83
	Status signal			S
	Diagnostic behavior			Warning

Diagnostic information		Remedy instructions	Influenced measured variables	
No.	Short text			
825	Operating temperature	1. Check ambient temperature 2. Check process temperature	<ul style="list-style-type: none"> ▪ Carrier mass flow ▪ Concentration ▪ Density ▪ Dynamic viscosity ▪ Kinematic viscosity ▪ Mass flow ▪ Sensor integrity ▪ Reference density ▪ Corrected volume flow ▪ Target mass flow ▪ Temp. compensated dynamic viscosity ▪ Temp. compensated kinematic viscosity ▪ Temperature ▪ Status ▪ Volume flow 	
	Measured variable status			
	Quality			Uncertain
	Quality substatus			Process related
	Coding (hex)			0x78 to 0x7B
	Status signal			S
	Diagnostic behavior			Warning

Diagnostic information		Remedy instructions	Influenced measured variables	
No.	Short text			
825	Operating temperature	1. Check ambient temperature 2. Check process temperature	<ul style="list-style-type: none"> ▪ Carrier mass flow ▪ Concentration ▪ Density ▪ Dynamic viscosity ▪ Kinematic viscosity ▪ Mass flow ▪ Reference density ▪ Corrected volume flow ▪ Target mass flow ▪ Temp. compensated dynamic viscosity ▪ Temp. compensated kinematic viscosity ▪ Temperature ▪ Status ▪ Volume flow 	
	Measured variable status			
	Quality			Bad
	Quality substatus			Process related
	Coding (hex)			0x28 to 0x2B
	Status signal			F
	Diagnostic behavior			Alarm

Diagnostic information		Remedy instructions	Influenced measured variables	
No.	Short text			
830	Sensor temperature too high	Reduce ambient temp. around the sensor housing	<ul style="list-style-type: none"> ▪ Carrier mass flow ▪ Concentration ▪ Density ▪ Dynamic viscosity ▪ Kinematic viscosity ▪ Mass flow ▪ Sensor integrity ▪ Reference density ▪ Corrected volume flow ▪ Target mass flow ▪ Temp. compensated dynamic viscosity ▪ Temp. compensated kinematic viscosity ▪ Temperature ▪ Volume flow 	
	Measured variable status			
	Quality			Uncertain
	Quality substatus			Process related
	Coding (hex)			0x78 to 0x7B
	Status signal			S
	Diagnostic behavior			Warning

Diagnostic information		Remedy instructions	Influenced measured variables	
No.	Short text			
831	Sensor temperature too low	Increase ambient temp. around the sensor housing	<ul style="list-style-type: none"> ▪ Carrier mass flow ▪ Concentration ▪ Density ▪ Dynamic viscosity ▪ Kinematic viscosity ▪ Mass flow ▪ Sensor integrity ▪ Reference density ▪ Corrected volume flow ▪ Target mass flow ▪ Temp. compensated dynamic viscosity ▪ Temp. compensated kinematic viscosity ▪ Temperature ▪ Volume flow 	
	Measured variable status			
	Quality			Uncertain
	Quality substatus			Process related
	Coding (hex)			0x78 to 0x7B
	Status signal			S
	Diagnostic behavior			Warning

Diagnostic information		Remedy instructions	Influenced measured variables	
No.	Short text			
832	Electronic temperature too high	Reduce ambient temperature	<ul style="list-style-type: none"> ▪ Carrier mass flow ▪ Concentration ▪ Density ▪ Mass flow ▪ Sensor integrity ▪ Reference density ▪ Corrected volume flow ▪ Target mass flow ▪ Temperature ▪ Volume flow 	
	Measured variable status [from the factory] ¹⁾			
	Quality			Good
	Quality substatus			Ok
	Coding (hex)			0x80 to 0x83
	Status signal			S
	Diagnostic behavior			Warning

1) Diagnostic behavior can be changed. This causes the overall status of the measured variable to change.

Diagnostic information		Remedy instructions	Influenced measured variables	
No.	Short text			
833	Electronic temperature too low	Increase ambient temperature	<ul style="list-style-type: none"> ■ Carrier mass flow ■ Concentration ■ Density ■ Dynamic viscosity ■ Kinematic viscosity ■ Mass flow ■ Sensor integrity ■ Reference density ■ Corrected volume flow ■ Target mass flow ■ Temp. compensated dynamic viscosity ■ Temp. compensated kinematic viscosity ■ Volume flow 	
	Measured variable status [from the factory] ¹⁾			
	Quality			Good
	Quality substatus			Ok
	Coding (hex)			0x80 to 0x83
	Status signal			S
	Diagnostic behavior			Warning

1) Diagnostic behavior can be changed. This causes the overall status of the measured variable to change.

Diagnostic information		Remedy instructions	Influenced measured variables	
No.	Short text			
834	Process temperature too high	Reduce process temperature	<ul style="list-style-type: none"> ■ Carrier mass flow ■ Concentration ■ Density ■ Dynamic viscosity ■ Kinematic viscosity ■ Mass flow ■ Sensor integrity ■ Reference density ■ Corrected volume flow ■ Target mass flow ■ Temp. compensated dynamic viscosity ■ Temp. compensated kinematic viscosity ■ Temperature ■ Volume flow 	
	Measured variable status [from the factory] ¹⁾			
	Quality			Good
	Quality substatus			Ok
	Coding (hex)			0x80 to 0x83
	Status signal			S
	Diagnostic behavior			Warning

1) Diagnostic behavior can be changed. This causes the overall status of the measured variable to change.

Diagnostic information		Remedy instructions	Influenced measured variables	
No.	Short text			
835	Process temperature too low	Increase process temperature	<ul style="list-style-type: none"> ■ Carrier mass flow ■ Concentration ■ Density ■ Dynamic viscosity ■ Kinematic viscosity ■ Mass flow ■ Sensor integrity ■ Reference density ■ Corrected volume flow ■ Target mass flow ■ Temp. compensated dynamic viscosity ■ Temp. compensated kinematic viscosity ■ Temperature ■ Volume flow 	
	Measured variable status [from the factory] ¹⁾			
	Quality			Good
	Quality substatus			Ok
	Coding (hex)			0x80 to 0x83
	Status signal			S
	Diagnostic behavior			Warning

1) Diagnostic behavior can be changed. This causes the overall status of the measured variable to change.

Diagnostic information		Remedy instructions	Influenced measured variables	
No.	Short text			
842	Process limit	Low flow cut off active! 1. Check low flow cut off configuration	<ul style="list-style-type: none"> ▪ Carrier mass flow ▪ Concentration ▪ Density ▪ Dynamic viscosity ▪ Kinematic viscosity ▪ Mass flow ▪ Reference density ▪ Corrected volume flow ▪ Target mass flow ▪ Temp. compensated dynamic viscosity ▪ Temp. compensated kinematic viscosity ▪ Temperature ▪ Volume flow 	
	Measured variable status			
	Quality			Good
	Quality substatus			Ok
	Coding (hex)			0x80 to 0x83
	Status signal			S
	Diagnostic behavior			Warning

Diagnostic information		Remedy instructions	Influenced measured variables	
No.	Short text			
843	Process limit	Check process conditions	<ul style="list-style-type: none"> ▪ Carrier mass flow ▪ Concentration ▪ Density ▪ Dynamic viscosity ▪ Kinematic viscosity ▪ Mass flow ▪ Sensor integrity ▪ Reference density ▪ Corrected volume flow ▪ Target mass flow ▪ Temp. compensated dynamic viscosity ▪ Temp. compensated kinematic viscosity ▪ Temperature ▪ Volume flow 	
	Measured variable status			
	Quality			Good
	Quality substatus			Ok
	Coding (hex)			0x80 to 0x83
	Status signal			S
	Diagnostic behavior			Warning

Diagnostic information		Remedy instructions	Influenced measured variables	
No.	Short text			
862	Partly filled pipe	1. Check for gas in process 2. Adjust detection limits	<ul style="list-style-type: none"> ▪ Carrier mass flow ▪ Concentration ▪ Density ▪ Dynamic viscosity ▪ Kinematic viscosity ▪ Mass flow ▪ Sensor integrity ▪ Reference density ▪ Corrected volume flow ▪ Target mass flow ▪ Temp. compensated dynamic viscosity ▪ Temp. compensated kinematic viscosity ▪ Temperature ▪ Volume flow 	
	Measured variable status			
	Quality			Uncertain
	Quality substatus			Process related
	Coding (hex)			0x78 to 0x7B
	Status signal			S
	Diagnostic behavior			Warning

Diagnostic information		Remedy instructions	Influenced measured variables	
No.	Short text			
882	Input signal	1. Check input configuration 2. Check external device or process conditions	<ul style="list-style-type: none"> ■ Density ■ Mass flow ■ Reference density ■ Corrected volume flow ■ Volume flow 	
	Measured variable status			
	Quality			Bad
	Quality substatus			Maintenance alarm
	Coding (hex)			0x24 to 0x27
	Status signal			F
	Diagnostic behavior			Alarm

Diagnostic information		Remedy instructions	Influenced measured variables	
No.	Short text			
910	Tubes not oscillating	1. Check electronic 2. Inspect sensor	<ul style="list-style-type: none"> ■ Carrier mass flow ■ Concentration ■ Density ■ Mass flow ■ Sensor integrity ■ Reference density ■ Corrected volume flow ■ Target mass flow ■ Temperature ■ Volume flow 	
	Measured variable status			
	Quality			Bad
	Quality substatus			Maintenance alarm
	Coding (hex)			0x24 to 0x27
	Status signal			F
	Diagnostic behavior			Alarm

Diagnostic information		Remedy instructions	Influenced measured variables	
No.	Short text			
912	Medium inhomogeneous	1. Check process cond. 2. Increase system pressure	<ul style="list-style-type: none"> ■ Carrier mass flow ■ Concentration ■ Density ■ Dynamic viscosity ■ Kinematic viscosity ■ Mass flow ■ Sensor integrity ■ Reference density ■ Corrected volume flow ■ Target mass flow ■ Temp. compensated dynamic viscosity ■ Temp. compensated kinematic viscosity ■ Temperature ■ Volume flow 	
	Measured variable status [from the factory] ¹⁾			
	Quality			Good
	Quality substatus			Ok
	Coding (hex)			0x80 to 0x83
	Status signal			S
	Diagnostic behavior			Warning

1) Diagnostic behavior can be changed. This causes the overall status of the measured variable to change.

Diagnostic information		Remedy instructions	Influenced measured variables	
No.	Short text			
912	Inhomogeneous	1. Check process cond. 2. Increase system pressure	<ul style="list-style-type: none"> ▪ Carrier mass flow ▪ Concentration ▪ Density ▪ Dynamic viscosity ▪ Kinematic viscosity ▪ Mass flow ▪ Sensor integrity ▪ Reference density ▪ Corrected volume flow ▪ Target mass flow ▪ Temp. compensated dynamic viscosity ▪ Temp. compensated kinematic viscosity ▪ Temperature ▪ Volume flow 	
	Measured variable status [from the factory] ¹⁾			
	Quality			Good
	Quality substatus			Ok
	Coding (hex)			0x80 to 0x83
	Status signal			S
	Diagnostic behavior			Warning

1) Diagnostic behavior can be changed. This causes the overall status of the measured variable to change.

Diagnostic information		Remedy instructions	Influenced measured variables	
No.	Short text			
913	Medium unsuitable	1. Check process conditions 2. Check electronic modules or sensor	<ul style="list-style-type: none"> ▪ Carrier mass flow ▪ Concentration ▪ Density ▪ Dynamic viscosity ▪ Kinematic viscosity ▪ Mass flow ▪ Sensor integrity ▪ Reference density ▪ Corrected volume flow ▪ Target mass flow ▪ Temp. compensated dynamic viscosity ▪ Temp. compensated kinematic viscosity ▪ Temperature ▪ Volume flow 	
	Measured variable status [from the factory] ¹⁾			
	Quality			Good
	Quality substatus			Ok
	Coding (hex)			0x80 to 0x83
	Status signal			S
	Diagnostic behavior			Warning

1) Diagnostic behavior can be changed. This causes the overall status of the measured variable to change.

Diagnostic information		Remedy instructions	Influenced measured variables	
No.	Short text			
944	Monitoring failed	Check process conditions for Heartbeat Monitoring	<ul style="list-style-type: none"> ▪ Carrier mass flow ▪ Concentration ▪ Density ▪ Mass flow ▪ Sensor integrity ▪ Reference density ▪ Corrected volume flow ▪ Target mass flow ▪ Temperature 	
	Measured variable status [from the factory] ¹⁾			
	Quality			Good
	Quality substatus			Ok
	Coding (hex)			0x80 to 0x83
	Status signal			S
	Diagnostic behavior			Warning

1) Diagnostic behavior can be changed. This causes the overall status of the measured variable to change.

Diagnostic information		Remedy instructions	Influenced measured variables	
No.	Short text			
948	Tube damping too high	Check process conditions	<ul style="list-style-type: none"> ▪ Carrier mass flow ▪ Concentration ▪ Density ▪ Dynamic viscosity ▪ Kinematic viscosity ▪ Mass flow ▪ Sensor integrity ▪ Reference density ▪ Corrected volume flow ▪ Target mass flow ▪ Temp. compensated dynamic viscosity ▪ Temp. compensated kinematic viscosity ▪ Temperature ▪ Status ▪ Volume flow 	
	Measured variable status [from the factory] ¹⁾			
	Quality			Good
	Quality substatus			Ok
	Coding (hex)			0x80 to 0x83
	Status signal			S
	Diagnostic behavior			Warning

1) Diagnostic behavior can be changed. This causes the overall status of the measured variable to change.

Diagnostic information		Remedy instructions	Influenced measured variables	
No.	Short text			
990	Special event 4	Contact service	<ul style="list-style-type: none"> ▪ Carrier mass flow ▪ Concentration ▪ Density ▪ Dynamic viscosity ▪ Kinematic viscosity ▪ Mass flow ▪ Sensor integrity ▪ Reference density ▪ Corrected volume flow ▪ Target mass flow ▪ Temp. compensated dynamic viscosity ▪ Temp. compensated kinematic viscosity ▪ Temperature ▪ Status ▪ Volume flow 	
	Measured variable status			
	Quality			Bad
	Quality substatus			Maintenance alarm
	Coding (hex)			0x24 to 0x27
	Status signal			F
	Diagnostic behavior			Alarm

Diagnostic information		Remedy instructions	Influenced measured variables	
No.	Short text			
991	Special event 8	Contact service	<ul style="list-style-type: none"> ▪ Carrier mass flow ▪ Concentration ▪ Density ▪ Dynamic viscosity ▪ Kinematic viscosity ▪ Mass flow ▪ Sensor integrity ▪ Reference density ▪ Corrected volume flow ▪ Target mass flow ▪ Temp. compensated dynamic viscosity ▪ Temp. compensated kinematic viscosity ▪ Temperature ▪ Status ▪ Volume flow 	
	Measured variable status			
	Quality			Bad
	Quality substatus			Maintenance alarm
	Coding (hex)			0x24 to 0x27
	Status signal			F
	Diagnostic behavior			Alarm



No.	Diagnostic information		Remedy instructions	Influenced measured variables
	Short text			
992	Special event 12		Contact service	<ul style="list-style-type: none"> ▪ Carrier mass flow ▪ Concentration ▪ Density ▪ Dynamic viscosity ▪ Kinematic viscosity ▪ Mass flow ▪ Sensor integrity ▪ Reference density ▪ Corrected volume flow ▪ Target mass flow ▪ Temp. compensated dynamic viscosity ▪ Temp. compensated kinematic viscosity ▪ Temperature ▪ Status ▪ Volume flow
	Measured variable status [from the factory] ¹⁾			
	Quality	Good		
	Quality substatus	Ok		
	Coding (hex)	0x80 to 0x83		
	Status signal	F		
	Diagnostic behavior	Alarm		



1) Diagnostic behavior can be changed. This causes the overall status of the measured variable to change.

12.7 Pending diagnostic events

The **Diagnostics** menu allows the user to view the current diagnostic event and the previous diagnostic event separately.





 To call up the measures to rectify a diagnostic event:

- Via web browser →  97
- Via "FieldCare" operating tool →  98
- Via "DeviceCare" operating tool →  98

 Other pending diagnostic events can be displayed in the **Diagnostic list** submenu →  123.

Navigation

"Diagnostics" menu

 Diagnostics	
Actual diagnostics	→  123
Previous diagnostics	→  123
Operating time from restart	→  123
Operating time	→  123

Parameter overview with brief description





Parameter	Prerequisite	Description	User interface
Actual diagnostics	A diagnostic event has occurred.	Shows the current occurred diagnostic event along with its diagnostic information.  If two or more messages occur simultaneously, the message with the highest priority is shown on the display.	Symbol for diagnostic behavior, diagnostic code and short message.
Previous diagnostics	Two diagnostic events have already occurred.	Shows the diagnostic event that occurred prior to the current diagnostic event along with its diagnostic information.	Symbol for diagnostic behavior, diagnostic code and short message.
Operating time from restart	–	Shows the time the device has been in operation since the last device restart.	Days (d), hours (h), minutes (m) and seconds (s)
Operating time	–	Indicates how long the device has been in operation.	Days (d), hours (h), minutes (m) and seconds (s)

12.8 Diagnostics list

Up to 5 currently pending diagnostic events can be displayed in the **Diagnostic list** submenu along with the associated diagnostic information. If more than 5 diagnostic events are pending, the events with the highest priority are shown on the display.

Navigation path

Diagnostics → Diagnostic list

-  To call up the measures to rectify a diagnostic event:
- Via web browser →  97
 - Via "FieldCare" operating tool →  98
 - Via "DeviceCare" operating tool →  98

12.9 Event logbook



12.9.1 Reading out the event logbook

A chronological overview of the event messages that have occurred is provided in the **Events list** submenu.

Navigation path

Diagnostics menu → **Event logbook** submenu → Events list



The event history includes entries for:

- Diagnostic events →  101
- Information events →  124

In addition to the operating time when the event occurred, each event is also assigned a symbol that indicates whether the event has occurred or is finished:

- Diagnostics event
 - ☺: Occurrence of the event
 - ☹: End of the event
- Information event
 - ☺: Occurrence of the event

 To call up the measures to rectify a diagnostic event:

- Via web browser →  97
- Via "FieldCare" operating tool →  98
- Via "DeviceCare" operating tool →  98

 For filtering the displayed event messages →  124

12.9.2 Filtering the event logbook

Using the **Filter options** parameter you can define which category of event message is displayed in the **Events list** submenu.

Navigation path

Diagnostics → Event logbook → Filter options

Filter categories

- All
- Failure (F)
- Function check (C)
- Out of specification (S)
- Maintenance required (M)
- Information (I)

12.9.3 Overview of information events

Unlike a diagnostic event, an information event is displayed in the event logbook only and not in the diagnostic list.

Info number	Info name
I1000	----- (Device ok)
I1089	Power on
I1090	Configuration reset
I1091	Configuration changed
I1111	Density adjust failure
I1137	Electronic changed
I1151	History reset
I1155	Reset electronic temperature
I1157	Memory error event list
I1185	Display backup done
I1186	Restore via display done
I1187	Settings downloaded with display
I1188	Display data cleared
I1189	Backup compared
I1209	Density adjustment ok
I1221	Zero point adjust failure
I1222	Zero point adjustment ok

Info number	Info name
I1256	Display: access status changed
I1335	Firmware changed
I1361	Web server login failed
I1397	Fieldbus: access status changed
I1398	CDI: access status changed
I1444	Device verification passed
I1445	Device verification failed
I1446	Device verification active
I1447	Record application reference data
I1448	Application reference data recorded
I1449	Recording application ref. data failed
I1450	Monitoring off
I1451	Monitoring on
I1457	Measured error verification failed
I1459	I/O module verification failed
I1460	Sensor integrity verification failed
I1461	Sensor verification failed
I1462	Sensor electronic module verific. failed
I1512	Download started
I1513	Download finished
I1514	Upload started
I1515	Upload finished
I1627	Web server login successful
I1631	Web server access changed
I1649	Hardware write protection activated
I1650	Hardware write protection deactivated

12.10 Resetting the measuring device

The entire device configuration or some of the configuration can be reset to a defined state with the **Device reset** parameter (→  75).

12.10.1 Function range of "Device reset" parameter

Options	Description
Cancel	No action is executed and the user exits the parameter.
To delivery settings	Every parameter for which a customer-specific default setting was ordered is reset to the customer-specific value. All other parameters are reset to the factory setting.  This option is not visible if no customer-specific settings have been ordered.
Restart device	The restart resets every parameter with data stored in volatile memory (RAM) to the factory setting (e.g. measured value data). The device configuration remains unchanged.

12.11 Device information



The **Device information** submenu contains all parameters that display different information for device identification.



Navigation

"Diagnostics" menu → Device information

▶ Device information	
Device tag	→ ⓘ 126
Serial number	→ ⓘ 126
Firmware version	→ ⓘ 126
Device name	→ ⓘ 126
Order code	→ ⓘ 126
Extended order code 1	→ ⓘ 127
Extended order code 2	→ ⓘ 127
Extended order code 3	→ ⓘ 127
ENP version	→ ⓘ 127



Parameter overview with brief description

Parameter	Description	User interface	Factory setting
Device tag	Shows name of measuring point.	Max. 32 characters such as lower-case letters or numbers.	eh-promass100-xxxxx
Serial number	Shows the serial number of the measuring device.	Max. 11-digit character string comprising letters and numbers.	–
Firmware version	Shows the device firmware version installed.	Character string in the format xx.yy.zz	–
Device name	Shows the name of the transmitter.  The name can be found on the nameplate of the transmitter.	Character string comprising numbers, letters and special characters	–
Device name	Shows the name of the transmitter.  The name can be found on the nameplate of the transmitter.	Max. 32 characters such as lower-case letters or numbers.	eh-promass100-xxxxx
Order code	Shows the device order code.  The order code can be found on the nameplate of the sensor and transmitter in the "Order code" field.	Character string composed of letters, numbers and certain punctuation marks (e.g. /).	–

Parameter	Description	User interface	Factory setting
Extended order code 1	Shows the 1st part of the extended order code.  The extended order code can also be found on the nameplate of the sensor and transmitter in the "Ext. ord. cd." field.	Character string	–
Extended order code 2	Shows the 2nd part of the extended order code.  The extended order code can also be found on the nameplate of the sensor and transmitter in the "Ext. ord. cd." field.	Character string	–
Extended order code 3	Shows the 3rd part of the extended order code.  The extended order code can also be found on the nameplate of the sensor and transmitter in the "Ext. ord. cd." field.	Character string	–
ENP version	Shows the version of the electronic nameplate (ENP).	Character string	–

12.12 Firmware history

Release date	Firmware version	Order code for "Firmware version"	Firmware Changes	Documentation type	Documentation
12.2015	01.00.zz	Option 68	Original firmware	Operating Instructions	

-  It is possible to flash the firmware to the current version using the service interface.
-  For the compatibility of the firmware version with the installed device description files and operating tools, observe the information about the device in the "Manufacturer's information" document.
-  The manufacturer's information is available:
 - In the Download Area of the Endress+Hauser web site: www.endress.com → Downloads
 - Specify the following details:
 - Product root, e.g. 8E1B
The product root is the first part of the order code: see the nameplate on the device.
 - Text search: Manufacturer's information
 - Media type: Documentation – Technical Documentation

13 Maintenance

13.1 Maintenance work

No special maintenance work is required.

13.1.1 Exterior cleaning

When cleaning the exterior of measuring devices, always use cleaning agents that do not attack the surface of the housing or the seals.

13.1.2 Internal cleaning

Observe the following points for CIP and SIP cleaning:

- Use only cleaning agents to which the process-wetted materials are adequately resistant.
- Observe the maximum permitted medium temperature for the measuring device .

13.2 Measuring and test equipment

Endress+Hauser offers a variety of measuring and testing equipment, such as Netilion or device tests.

 Your Endress+Hauser Sales Center can provide detailed information on the services.

List of some of the measuring and testing equipment: →  132

13.3 Endress+Hauser services

Endress+Hauser offers a wide variety of services for maintenance such as recalibration, maintenance service or device tests.

 Your Endress+Hauser Sales Center can provide detailed information on the services.

14 Repair

14.1 General notes

14.1.1 Repair and conversion concept

The Endress+Hauser repair and conversion concept provides for the following:

- The measuring devices have a modular design.
- Spare parts are grouped into logical kits with the associated Installation Instructions.
- Repairs are carried out by Endress+Hauser Service or by appropriately trained customers.
- Certified devices can only be converted to other certified devices by Endress+Hauser Service or at the factory.

14.1.2 Notes for repair and conversion



For repair and conversion of a measuring device, observe the following notes:

- ▶ Use only original Endress+Hauser spare parts.
- ▶ Carry out the repair according to the Installation Instructions.
- ▶ Observe the applicable standards, federal/national regulations, Ex documentation (XA) and certificates.
- ▶ Document all repairs and conversions and enter the details in Netilion Analytics.

14.2 Spare parts

Device Viewer (www.endress.com/deviceviewer):

All the spare parts for the measuring device, along with the order code, are listed here and can be ordered. If available, users can also download the associated Installation Instructions.

-  Measuring device serial number:
 - Is located on the nameplate of the device.
 - Can be read out via the **Serial number** parameter (→  126) in the **Device information** submenu.

14.3 Endress+Hauser services

Endress+Hauser offers a wide range of services.

-  Your Endress+Hauser Sales Center can provide detailed information on the services.

14.4 Return

The requirements for safe device return can vary depending on the device type and national legislation.

1. Refer to the web page for information:
<https://www.endress.com/support/return-material>
↳ Select the region.
2. If returning the device, pack the device in such a way that it is reliably protected against impact and external influences. The original packaging offers the best protection.

14.5 Disposal



If required by the Directive 2012/19/EU on waste electrical and electronic equipment (WEEE), the product is marked with the depicted symbol in order to minimize the disposal of WEEE as unsorted municipal waste. Do not dispose of products bearing this marking as unsorted municipal waste. Instead, return them to the manufacturer for disposal under the applicable conditions.

14.5.1 Removing the measuring device

1. Switch off the device.

WARNING

Danger to persons from process conditions!

- ▶ Beware of hazardous process conditions such as pressure in the measuring device, high temperatures or aggressive media.

2. Carry out the mounting and connection steps from the "Mounting the measuring device" and "Connecting the measuring device" sections in reverse order. Observe the safety instructions.

14.5.2 Disposing of the measuring device

WARNING

Danger to personnel and environment from fluids that are hazardous to health.

- ▶ Ensure that the measuring device and all cavities are free of fluid residues that are hazardous to health or the environment, e.g. substances that have permeated into crevices or diffused through plastic.

Observe the following notes during disposal:



- ▶ Observe valid federal/national regulations.
- ▶ Ensure proper separation and reuse of the device components.

15 Accessories



Various accessories, which can be ordered with the device or subsequently from Endress+Hauser, are available for the device. Detailed information on the order code in question is available from your local Endress+Hauser sales center or on the product page of the Endress+Hauser website: www.endress.com.



15.1 Device-specific accessories

15.1.1 For the sensor



Accessories	Description
Heating jacket	<p>Is used to stabilize the temperature of the fluids in the sensor. Water, water vapor and other non-corrosive liquids are permitted for use as fluids.</p> <p> If using oil as a heating medium, please consult with Endress+Hauser.</p> <p>Heating jackets cannot be used with sensors fitted with a rupture disk.</p> <ul style="list-style-type: none"> ▪ If ordered together with the measuring device: <ul style="list-style-type: none"> Order code for "Accessory enclosed" ▪ Option RB "Heating jacket, G 1/2" female thread" ▪ Option RC "Heating jacket, G 3/4" female thread" ▪ Option RD "Heating jacket, NPT 1/2" female thread" ▪ Option RE "Heating jacket, NPT 3/4" female thread" ▪ If ordered subsequently: <ul style="list-style-type: none"> Use the order code with the product root DK8003. <p> Special Documentation SD02151D</p>

15.2 Communication-specific accessories



Accessories	Description
Commubox FXA291	<p>Connects Endress+Hauser field devices with a CDI interface (= Endress+Hauser Common Data Interface) and the USB port of a computer or laptop.</p> <p> Technical Information TI00405C</p>
Fieldgate FXA42	<p>Transmission of the measured values of connected 4 to 20 mA analog measuring instruments, as well as digital measuring instruments</p> <p> <ul style="list-style-type: none"> ▪ Technical Information TI01297S ▪ Operating Instructions BA01778S ▪ Product page: www.endress.com/fxa42 </p>
Field Xpert SMT50	<p>The Field Xpert SMT50 tablet PC for device configuration enables mobile plant asset management in the non-hazardous areas. It is suitable for commissioning and maintenance staff to manage field instruments with a digital communication interface and to record progress.</p> <p>This tablet PC is designed as an all-in-one solution with a preinstalled driver library and is an easy-to-use, touch-sensitive tool which can be used to manage the field instruments throughout their entire life cycle.</p> <p> <ul style="list-style-type: none"> ▪ Technical Information TI01555S ▪ Operating Instructions BA02053S ▪ Product page: www.endress.com/smt50 </p>

Field Xpert SMT70	<p>The Field Xpert SMT70 tablet PC for device configuration enables mobile plant asset management in hazardous and non-hazardous areas. It is suitable for commissioning and maintenance staff to manage field instruments with a digital communication interface and to record progress.</p> <p>This tablet PC is designed as an all-in-one solution with a preinstalled driver library and is an easy-to-use, touch-sensitive tool which can be used to manage the field instruments throughout their entire life cycle.</p> <ul style="list-style-type: none">  ■ Technical Information TI01342S ■ Operating Instructions BA01709S ■ Product page: www.endress.com/smt70
Field Xpert SMT77	<p>The Field Xpert SMT77 tablet PC for device configuration enables mobile plant asset management in areas categorized as Ex Zone 1.</p> <ul style="list-style-type: none">  ■ Technical Information TI01418S ■ Operating Instructions BA01923S ■ Product page: www.endress.com/smt77

15.3 Service-specific accessories

Accessories	Description
Applicator	<p>Software for selecting and sizing Endress+Hauser measuring instruments:</p> <ul style="list-style-type: none"> ■ Choice of measuring instruments for industrial requirements ■ Calculation of all the necessary data for identifying the optimum flowmeter: e.g. nominal diameter, pressure loss, flow velocity and measurement accuracy. ■ Graphic display of the calculation results ■ Determination of the partial order code, administration, documentation and access to all project-related data and parameters over the entire life cycle of a project. <p>Applicator is available: Via the Internet: https://portal.endress.com/webapp/applicator</p>
Netilion	<p>IloT ecosystem: Unlock knowledge</p> <p>With the Netilion IloT ecosystem, Endress+Hauser allows you to optimize your plant performance, digitize workflows, share knowledge, and enhance collaboration.</p> <p>Drawing upon decades of experience in process automation, Endress+Hauser offers the process industry an IloT ecosystem designed to effortlessly extract insights from data. These insights allow process optimization, leading to increased plant availability, efficiency, and reliability - ultimately resulting in a more profitable plant.</p> <p>www.netilion.endress.com</p>
FieldCare	<p>FDT-based plant asset management tool from Endress+Hauser.</p> <p>It can configure all intelligent field units in your system and helps you manage them. By using the status information, it is also a simple but effective way of checking their status and condition.</p> <ul style="list-style-type: none">  Operating Instructions BA00027S and BA00059S
DeviceCare	<p>Tool to connect and configure Endress+Hauser field devices.</p> <ul style="list-style-type: none">  Innovation brochure IN01047S

15.4 System components

Accessories	Description
Memograph M graphic data manager	<p>The Memograph M graphic data manager provides information on all the relevant measured variables. Measured values are recorded correctly, limit values are monitored and measuring points analyzed. The data are stored in the 256 MB internal memory and also on a SD card or USB stick.</p> <ul style="list-style-type: none">  Technical Information TI00133R  Operating Instructions BA00247R
iTEMP	<p>The temperature transmitters can be used in all applications and are suitable for the measurement of gases, steam and liquids. They can be used to read in the medium temperature.</p> <ul style="list-style-type: none">  "Fields of Activity" document FA00006T

16 Technical data

16.1 Application

The measuring device is intended only for the flow measurement of liquids and gases.

Depending on the version ordered, the measuring device can also measure potentially explosive, flammable, poisonous and oxidizing media.

To ensure that the device remains in proper operating condition for its service life, use the measuring device only for media against which the process-wetted materials are sufficiently resistant.

16.2 Function and system design

Measuring principle	Mass flow measurement based on the Coriolis measuring principle
Measuring system	<p>The device consists of a transmitter and a sensor.</p> <p>The device is available as a compact version: The transmitter and sensor form a mechanical unit.</p> <p>For information on the structure of the measuring instrument →  12</p>

16.3 Input

Measured variable

Direct measured variables

- Mass flow
- Density
- Temperature

Calculated measured variables

- Volume flow
- Corrected volume flow
- Reference density

Measuring range

Measuring range for liquids

DN		Measuring range full scale values $\dot{m}_{\min(F)}$ to $\dot{m}_{\max(F)}$	
[mm]	[in]	[kg/h]	[lb/min]
8	$\frac{3}{8}$	0 to 2 000	0 to 73.50
15	$\frac{1}{2}$	0 to 6 500	0 to 238.9
25	1	0 to 18 000	0 to 661.5
40	$1\frac{1}{2}$	0 to 45 000	0 to 1 654
50	2	0 to 70 000	0 to 2 573
80	3	0 to 180 000	0 to 6 615

Measuring range for gases

The full scale value depends on the density and the sound velocity of the gas used. The full scale value can be calculated with the following formulas:

$$\dot{m}_{\max(G)} = \text{Minimum of } (\dot{m}_{\max(F)} \cdot \rho_G : x) \text{ and } (\rho_G \cdot (c_G/2) \cdot d_i^2 \cdot (\pi/4) \cdot 3600 \cdot n)$$

$\dot{m}_{\max(G)}$	Maximum full scale value for gas [kg/h]
$\dot{m}_{\max(F)}$	Maximum full scale value for liquid [kg/h]
$\dot{m}_{\max(G)} < \dot{m}_{\max(F)}$	$\dot{m}_{\max(G)}$ can never be greater than $\dot{m}_{\max(F)}$
ρ_G	Gas density in [kg/m ³] at operating conditions
x	Limitation constant for max. gas flow [kg/m ³]
c_G	Sound velocity (gas) [m/s]
d_i	Measuring tube internal diameter [m]
π	Pi
n = 2	Number of measuring tubes



DN		x
[mm]	[in]	[kg/m ³]
8	$\frac{3}{8}$	85
15	$\frac{1}{2}$	110
25	1	125

DN		x
[mm]	[in]	[kg/m ³]
40	1½	125
50	2	125
80	3	155

If calculating the full scale value using the two formulas:

1. Calculate the full scale value with both formulas.
2. The smaller value is the value that must be used.

Recommended measuring range

 Flow limit →  148

Operable flow range

Over 1000 : 1.

Flow rates above the preset full scale value do not override the electronics unit, with the result that the totalizer values are registered correctly.

Input signal

External measured values

To increase the measurement accuracy of certain measured variables or to calculate the corrected volume flow for gases, the automation system can continuously write different measured values to the measuring instrument:

- Operating pressure to increase measurement accuracy (Endress+Hauser recommends the use of a pressure measuring instrument for absolute pressure, e.g. Cerabar M or Cerabar S)
- Medium temperature to increase measurement accuracy (e.g. iTEMP)
- Reference density for calculating the corrected volume flow for gases

 Various pressure transmitters and temperature measuring instruments can be ordered from Endress+Hauser: see "Accessories" section →  133

It is recommended to read in external measured values to calculate the following measured variables:

- Mass flow
- Corrected volume flow

Digital communication

The measured values are written by the automation system via PROFINET.

16.4 Output

Output signal

PROFINET

Standards	In accordance with IEEE 802.3
-----------	-------------------------------

Signal on alarm

Depending on the interface, failure information is displayed as follows.

PROFINET

Device diagnostics	According to "Application Layer protocol for decentralized periphery", Version 2.3
--------------------	--

Local display

Plain text display	With information on cause and remedial measures
Backlight	Red backlighting indicates a device error.

 Status signal as per NAMUR recommendation NE 107

Interface/protocol

- Via digital communication:
PROFINET
- Via service interface
CDI-RJ45 service interface

Plain text display	With information on cause and remedial measures
---------------------------	---

Web browser

Plain text display	With information on cause and remedial measures
---------------------------	---

Light emitting diodes (LED)

Status information	<p>Status indicated by various light emitting diodes</p> <p>The following information is displayed depending on the device version:</p> <ul style="list-style-type: none"> ■ Supply voltage active ■ Data transmission active ■ Device alarm/error has occurred ■ PROFINET network available ■ PROFINET connection established ■ PROFINET blinking feature <p> Diagnostic information via light emitting diodes</p>
---------------------------	--

Low flow cut off The switch points for low flow cut off are user-selectable.

Galvanic isolation The following connections are galvanically isolated from each other:

- Outputs
- Power supply

Protocol-specific data **protocol-specific data**

Protocol	"Application layer protocol for decentral device periphery and distributed automation", version 2.3
Conformity class	B
Communication type	100 Mbps
Device profile	Application interface identifier 0xF600 Generic device
Manufacturer ID	0x11
Device type ID	0x844A

Device description files (GSD, DTM)	Information and files available at: <ul style="list-style-type: none"> ▪ https://www.endress.com/download On the device product page: PRODUCTS → Product Finder → Links ▪ https://www.profibus.com
Baud rates	Automatic 100 Mbit/s with full-duplex detection
Periods	From 8 ms
Polarity	Auto-polarity for automatic correction of crossed TxD and RxD pairs
Supported connections	<ul style="list-style-type: none"> ▪ 1 x AR (Application Relation) ▪ 1 x Input CR (Communication Relation) ▪ 1 x Output CR (Communication Relation) ▪ 1 x Alarm CR (Communication Relation)
Configuration options for measuring instrument	<ul style="list-style-type: none"> ▪ DIP switches on the electronics module, for device name assignment (last part) ▪ Manufacturer-specific software (FieldCare, DeviceCare) ▪ Web browser ▪ Device master file (GSD), can be read out via the integrated web server of the measuring instrument
Configuration of the device name	<ul style="list-style-type: none"> ▪ DIP switches on the electronics module, for device name assignment (last part) ▪ DCP protocol
Output values (from measuring instrument to automation system)	<p>Analog Input module (slot 1 to 14)</p> <ul style="list-style-type: none"> ▪ Mass flow ▪ Volume flow ▪ Corrected volume flow ▪ Target mass flow ▪ Carrier mass flow ▪ Density ▪ Reference density ▪ Concentration ▪ Temperature ▪ Carrier pipe temperature ▪ Electronics temperature ▪ Oscillation frequency ▪ Oscillation amplitude ▪ Frequency fluctuation ▪ Oscillation damping ▪ Tube damping fluctuation ▪ Signal asymmetry ▪ Exciter current <p>Discrete Input module (slot 1 to 14)</p> <ul style="list-style-type: none"> ▪ Empty pipe detection ▪ Low flow cut off <p>Diagnostics Input module (slot 1 to 14)</p> <ul style="list-style-type: none"> ▪ Last diagnostics ▪ Current diagnostics <p>Totalizer 1 to 3 (slot 15 to 17)</p> <ul style="list-style-type: none"> ▪ Mass flow ▪ Volume flow ▪ Corrected volume flow <p>Heartbeat Verification module (fixed assignment) Verification status (slot 23)</p> <p> The range of options increases if the measuring device has one or more application packages.</p>

<p>Input values (from automation system to measuring instrument)</p>	<p>Analog Output module (fixed assignment)</p> <ul style="list-style-type: none"> ▪ External pressure (slot 18) ▪ External temperature (slot 19) ▪ External reference density (slot 20) <p>Discrete Output module (fixed assignment)</p> <ul style="list-style-type: none"> ▪ Activate/deactivate positive zero return (slot 21) ▪ Perform zero adjustment (slot 22) <p>Totalizer 1 to 3 (slot 15 to 17)</p> <ul style="list-style-type: none"> ▪ Totalize ▪ Reset and hold ▪ Preset and hold ▪ Stop ▪ Operating mode configuration: <ul style="list-style-type: none"> ▪ Net flow total ▪ Forward flow total ▪ Reverse flow total <p>Heartbeat Verification module (fixed assignment) Start verification (slot 23)</p> <p> The range of options increases if the measuring device has one or more application packages.</p>
<p>Supported functions</p>	<ul style="list-style-type: none"> ▪ Identification & maintenance Simple device identification via: <ul style="list-style-type: none"> ▪ Control system ▪ Nameplate ▪ Measured value status The process variables are communicated with a measured value status ▪ Blinking feature via the local display for simple device identification and assignment

Administration of software options

Input/output value	Process variable	Category	Slot
Output value	Mass flow	Process variable	1...14
	Volume flow		
	Corrected volume flow		
	Density		
	Reference density		
	Temperature		
	Electronics temperature		
	Oscillation frequency		
	Frequency fluctuation		
	Oscillation damping		
	Oscillation frequency		
	Signal asymmetry		
	Exciter current		
	Empty pipe detection		
	Low flow cut off		
Output value	Target mass flow	Concentration ¹⁾	1...14
Output value	Carrier mass flow		
Output value	Concentration		
Output value	Oscillation damping 1	Heartbeat Technology ²⁾	1...14

Input/output value	Process variable	Category	Slot
	Oscillation frequency 1		
	Oscillation amplitude 0		
	Oscillation amplitude 1		
	Frequency fluctuation 1		
	Tube damping fluctuation 1		
	Exciter current 1		
Input value	External density	Process monitoring	18
	External temperature		19
	External reference density		20
	Flow override		21
	Zero adjustment		22
	Verification status	Heartbeat Verification	23

- 1) Only available with the "Concentration" application package.
- 2) Only available with the Heartbeat Technology application package.

Startup configuration

Startup configuration (NSU)	<p>If startup configuration is enabled, the configuration of the most important device parameters is taken from the automation system and used.</p> <p>The following configuration is taken from the automation system:</p> <ul style="list-style-type: none"> ▪ Management <ul style="list-style-type: none"> ▪ Software revision ▪ Write protection ▪ System units <ul style="list-style-type: none"> ▪ Mass flow ▪ Mass ▪ Volume flow ▪ Volume ▪ Corrected volume flow ▪ Corrected volume ▪ Density ▪ Reference density ▪ Temperature ▪ Pressure ▪ Concentration application package <ul style="list-style-type: none"> ▪ Coefficients A0 to A4 ▪ Coefficients B1 to B3 ▪ Sensor adjustment ▪ Process parameters <ul style="list-style-type: none"> ▪ Damping (flow, density, temperature) ▪ Flow override ▪ Low flow cut off <ul style="list-style-type: none"> ▪ Assign process variable ▪ Switch-on/switch-off point ▪ Pressure shock suppression ▪ Empty pipe detection <ul style="list-style-type: none"> ▪ Assign process variable ▪ Limit values ▪ Response time ▪ Max. damping ▪ Corrected volume flow calculation <ul style="list-style-type: none"> ▪ External reference density ▪ Fixed reference density ▪ Reference temperature ▪ Linear expansion coefficient ▪ Square expansion coefficient ▪ Measuring mode <ul style="list-style-type: none"> ▪ Medium ▪ Gas type ▪ Reference sound velocity ▪ Temperature coefficient sound velocity ▪ External compensation <ul style="list-style-type: none"> ▪ Pressure compensation ▪ Pressure value ▪ External pressure ▪ Diagnostic settings ▪ Diagnostic behavior for diverse diagnostic information
-----------------------------	--

16.5 Power supplyTerminal assignment →  26

Supply voltage The power unit must be tested to ensure it meets safety requirements (e.g. PELV, SELV).

Power consumption

Transmitter

Order code for "Output"	Maximum Power consumption
Option R: PROFINET	3.5 W

Current consumption

Transmitter

Order code for "Output"	Maximum Current consumption	Maximum switch-on current
Option R: PROFINET	145 mA	18 A (< 0.125 ms)

Device fuse

Fine-wire fuse (slow-blow) T2A

Power supply failure

- Totalizers stop at the last value measured.
- Depending on the device version, the configuration is retained in the device memory or in the pluggable data memory (HistoROM DAT).
- Error messages (incl. total operated hours) are stored.

Electrical connection

→  27

Potential equalization

→  29

Terminals

Transmitter

Spring terminals for wire cross-sections 0.5 to 2.5 mm² (20 to 14 AWG)

Cable entries



- Cable gland: M20 × 1.5 with cable Ø 6 to 12 mm (0.24 to 0.47 in)
- Thread for cable entry:
 - M20
 - G ½"
 - NPT ½"

Cable specification

→  25

16.6 Performance characteristics

Reference operating conditions

- Error limits based on ISO 11631
 - Water
 - +15 to +45 °C (+59 to +113 °F)
 - 2 to 6 bar (29 to 87 psi)
 - Data as indicated in the calibration protocol
 - Accuracy based on accredited calibration rigs according to ISO 17025
-  To obtain measured errors, use the *Applicator* sizing tool →  132

Maximum measurement error

o.r. = of reading; 1 g/cm³ = 1 kg/l; T = medium temperature

Base accuracy

 Design fundamentals →  145

Mass flow and volume flow (liquids)

- ±0.15 % o.r.
- ±0.10 % o.r. (order code for "Calibration flow", option A, B, C, for mass flow)
- ±0.25 % o.r.

Mass flow (gases)

±0.50 % o.r.

Density (liquids)

Under reference conditions [g/cm ³]	Standard density calibration [g/cm ³]
±0.0005	±0.002

Temperature

±0.5 °C ± 0.005 · T °C (±0.9 °F ± 0.003 · (T - 32) °F)

Zero point stability

DN		Zero point stability	
[mm]	[in]	[kg/h]	[lb/min]
8	$\frac{3}{8}$	0.20	0.007
15	$\frac{1}{2}$	0.65	0.024
25	1	1.80	0.066
40	1½	4.50	0.165
50	2	7.0	0.257
80	3	18.0	0.6615

Flow values

Flow values as turndown parameters depending on nominal diameter.

SI units

DN [mm]	1:1	1:10	1:20	1:50	1:100	1:500
	[kg/h]	[kg/h]	[kg/h]	[kg/h]	[kg/h]	[kg/h]
8	2 000	200	100	40	20	4
15	6 500	650	325	130	65	13
25	18 000	1 800	900	360	180	36
40	45 000	4 500	2 250	900	450	90
50	70 000	7 000	3 500	1 400	700	140
80	180 000	18 000	9 000	3 600	1 800	360

US units

DN	1:1	1:10	1:20	1:50	1:100	1:500
[inch]	[lb/min]	[lb/min]	[lb/min]	[lb/min]	[lb/min]	[lb/min]
$\frac{3}{8}$	73.50	7.350	3.675	1.470	0.735	0.147
$\frac{1}{2}$	238.9	23.89	11.95	4.778	2.389	0.478
1	661.5	66.15	33.08	13.23	6.615	1.323
1½	1654	165.4	82.70	33.08	16.54	3.308
2	2573	257.3	128.7	51.46	25.73	5.146
3	6615	661.5	330.8	132.3	66.15	13.23

Accuracy of outputs

 The output accuracy must be factored into the measurement error if analog outputs are used; but can be ignored for fieldbus outputs (e.g. Modbus RS485, EtherNet/IP).

The outputs have the following base accuracy specifications.

Repeatability o.r. = of reading; 1 g/cm³ = 1 kg/l; T = medium temperature

Base repeatability

 Design fundamentals →  145

Mass flow and volume flow (liquids)

±0.075 % o.r.
 ±0.05 % o.r. (calibration option, for mass flow)

Mass flow (gases)

±0.25 % o.r. (up to a Mach number of 0.2)

Density (liquids)

±0.00025 g/cm³

Temperature

±0.25 °C ± 0.0025 · T °C (±0.45 °F ± 0.0015 · (T-32) °F)

Response time The response time depends on the configuration (damping).

Influence of medium temperature

Mass flow

o.f.s. = of full scale value

If there is a difference between the temperature during zero adjustment and the process temperature, the additional measurement error of the sensors is typically ±0.0002 % o.f.s./°C (±0.0001 % o. f.s./°F).

The influence is reduced when the zero adjustment is performed at process temperature.

Density

If there is a difference between the density calibration temperature and the process temperature, the measurement error of the sensors is typically ±0.0001 g/cm³/°C (±0.00005 g/cm³/°F). Field density adjustment is possible.

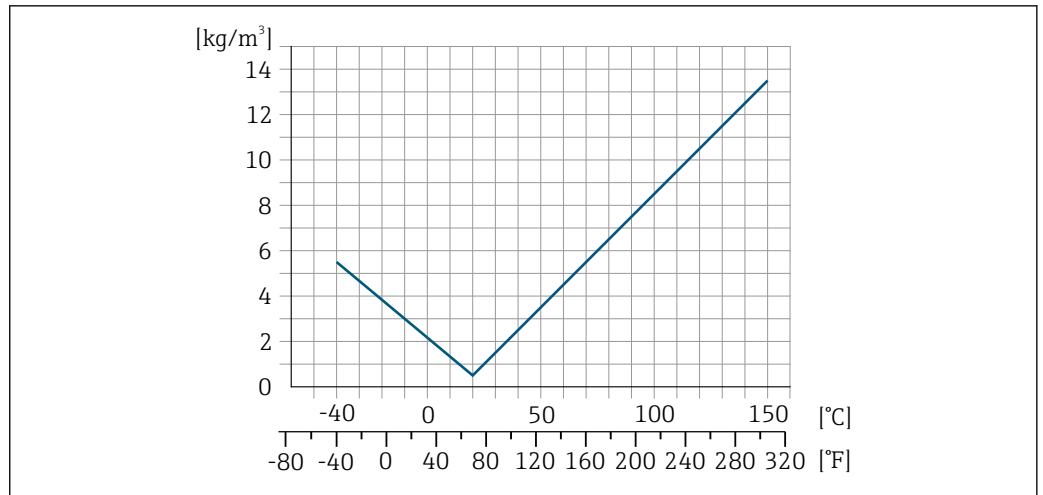

16 Field density adjustment, for example at +20 °C (+68 °F)

Temperature

$$\pm 0.005 \cdot T \text{ } ^\circ\text{C} (\pm 0.005 \cdot (T - 32) \text{ } ^\circ\text{F})$$

Influence of medium pressure

The following shows how the process pressure (gauge pressure) affects the accuracy of the mass flow.

o.r. = of reading

- It is possible to compensate for the effect by:
 - Reading in the current pressure measured value via the current input or a digital input.
 - Specifying a fixed value for the pressure in the device parameters.

Operating Instructions .

DN		[% o.r./bar]	[% o.r./psi]
[mm]	[in]		
8	3/8	no influence	
15	1/2	no influence	
25	1	no influence	
40	1 1/2	no influence	
50	2	-0.009	-0.0006
80	3	-0.020	-0.0014

Design fundamentals

o.r. = of reading, o.f.s. = of full scale value

BaseAccu = base accuracy in % o.r., BaseRepeat = base repeatability in % o.r.

MeasValue = measured value; ZeroPoint = zero point stability

Calculation of the maximum measured error as a function of the flow rate

Flow rate	Maximum measured error in % o.r.
$\geq \frac{\text{ZeroPoint}}{\text{BaseAccu}} \cdot 100$ <small>A0021332</small>	$\pm \text{BaseAccu}$ <small>A0021339</small>
$< \frac{\text{ZeroPoint}}{\text{BaseAccu}} \cdot 100$ <small>A0021333</small>	$\pm \frac{\text{ZeroPoint}}{\text{MeasValue}} \cdot 100$ <small>A0021334</small>

Calculation of the maximum repeatability as a function of the flow rate

Flow rate	Maximum repeatability in % o.r.
$\geq \frac{1/2 \cdot \text{ZeroPoint}}{\text{BaseRepeat}} \cdot 100$ <small>A0021335</small>	$\pm \text{BaseRepeat}$ <small>A0021340</small>
$< \frac{1/2 \cdot \text{ZeroPoint}}{\text{BaseRepeat}} \cdot 100$ <small>A0021336</small>	$\pm 1/2 \cdot \frac{\text{ZeroPoint}}{\text{MeasValue}} \cdot 100$ <small>A0021337</small>

Example of maximum measurement error

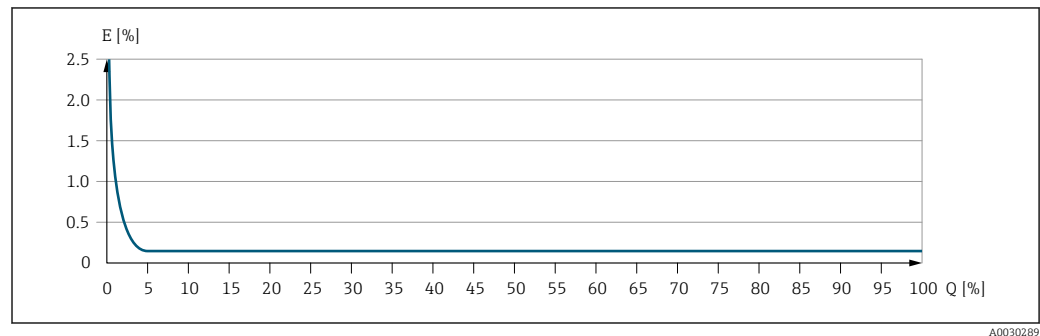

E Maximum measurement error in % o.r. (example)
Q Flow rate in % of maximum full scale value



16.7 Mounting

Mounting requirements → 18

16.8 Environment

Ambient temperature range → 20 → 20

Temperature tables

-  Observe the interdependencies between the permitted ambient and fluid temperatures when operating the device in hazardous areas.
-  For detailed information on the temperature tables, see the separate document entitled "Safety Instructions" (XA) for the device.

Storage temperature -40 to +80 °C (-40 to +176 °F), preferably at +20 °C (+68 °F)

Climate class DIN EN 60068-2-38 (test Z/AD)

Degree of protection **Transmitter and sensor**

- Standard: IP66/67, Type 4X enclosure, suitable for pollution degree 4
- With the order code for "Sensor options", option CM: IP69 can also be ordered
- When the housing is open: IP20, Type 1 enclosure, suitable for pollution degree 2
- Display module: IP20, Type 1 enclosure, suitable for pollution degree 2

Shock and vibration resistance

Vibration sinusoidal, in accordance with IEC 60068-2-6

- 2 to 8.4 Hz, 3.5 mm peak
- 8.4 to 2 000 Hz, 1 g peak

Vibration broad-band random, according to IEC 60068-2-64

- 10 to 200 Hz, 0.003 g²/Hz
- 200 to 2 000 Hz, 0.001 g²/Hz
- Total: 1.54 g rms

Shock half-sine, according to IEC 60068-2-27

6 ms 30 g

Rough handling shocks according to IEC 60068-2-31

Internal cleaning

- CIP cleaning
- SIP cleaning

Options

Oil- and grease-free version for wetted parts, without declaration
Order code for "Service", option HA ³⁾

Electromagnetic compatibility (EMC)

- As per IEC/EN 61326
- Complies with emission limits for industry as per EN 55011 (Class A)



Details are provided in the Declaration of Conformity.



This unit is not intended for use in residential environments and cannot guarantee adequate protection of the radio reception in such environments.

16.9 Process

Medium temperature range -40 to +150 °C (-40 to +302 °F)

Pressure-temperature ratings



For an overview of the pressure-temperature ratings for the process connections, see the Technical Information

Sensor housing

The sensor housing is filled with dry nitrogen gas and protects the electronics and mechanics inside.



If a measuring tube fails (e.g. due to process characteristics like corrosive or abrasive fluids), the fluid will initially be contained by the sensor housing.

In the event of a tube failure, the pressure level inside the sensor housing will rise according to the operating process pressure. If the user judges that the sensor housing burst pressure does not provide an adequate safety margin, the device can be fitted with a rupture disk. This prevents excessively high pressure from forming inside the sensor housing. Therefore, the use of a rupture disk is strongly recommended in applications involving high gas pressures, and particularly in applications in which the process pressure is greater than 2/3 of the sensor housing burst pressure.

³⁾ The cleaning refers to the measuring instrument only. Any accessories supplied are not cleaned.

Burst pressure of the sensor housing

If the device is fitted with a rupture disk (order code for "Sensor option", option CA "Rupture disk"), the rupture disk trigger pressure is decisive .

The sensor housing burst pressure refers to a typical internal pressure which is reached prior to mechanical failure of the sensor housing and which was determined during type testing. The corresponding type test declaration can be ordered with the device (order code for "Additional approval", option LN "Sensor housing burst pressure, type test").

DN		Sensor housing burst pressure	
[mm]	[in]	[bar]	[psi]
8	$\frac{3}{8}$	250	3 620
15	$\frac{1}{2}$	250	3 620
25	1	250	3 620
40	$1\frac{1}{2}$	200	2 900
50	2	180	2 610
80	3	120	1 740

 For information on the dimensions: see the "Mechanical construction" section of the "Technical Information" document

Rupture disk

To increase the level of safety, a device version with a rupture disk with a trigger pressure of 10 to 15 bar (145 to 217.5 psi) can be used (order code for "Sensor option", option CA "rupture disk").



The use of rupture disks cannot be combined with the separately available heating jacket.

Flow limit



Select the nominal diameter by optimizing between the required flow range and permissible pressure loss.

 For an overview of the full scale values for the measuring range, see the "Measuring range" section →  135

- The minimum recommended full scale value is approx. 1/20 of the maximum full scale value
- In most applications, 20 to 50 % of the maximum full scale value can be considered ideal
- A low full scale value must be selected for abrasive media (such as liquids with entrained solids): flow velocity < 1 m/s (< 3 ft/s).
- For gas measurement the following rules apply:
 - The flow velocity in the measuring tubes should not exceed half the sound velocity (0.5 Mach).
 - The maximum mass flow depends on the density of the gas: formula

 To calculate the flow limit, use the *Applicator* sizing tool →  132

Pressure loss

 To calculate the pressure loss, use the *Applicator* sizing tool →  132

System pressure

→  20

16.10 Mechanical construction

Design, dimensions



For the dimensions and installation lengths of the device, see the "Technical Information" document, "Mechanical construction" section

Weight

All values (weight exclusive of packaging material) refer to devices with EN/DIN PN 40 flanges. Weight specifications including transmitter: order code for "Housing", option A "Compact, aluminum coated".

Weight in SI units

DN [mm]	Weight [kg]
8	4.5
15	4.8
25	6.4
40	10.4
50	15.5
80	29

Weight in US units

DN [in]	Weight [lbs]
3/8	10
1/2	11
1	14
1 1/2	23
2	34
3	64

Materials

Transmitter housing

- Order code for "Housing", option **A** "Compact, aluminum coated": Aluminum, AlSi10Mg, coated
- Order code for "Housing", option **B** "Compact, hygienic, stainless": Hygienic version, stainless steel 1.4301 (304)
- Order code for "Housing", option **C** "Ultra-compact, hygienic, stainless": Hygienic version, stainless steel 1.4301 (304)
- Window material for optional local display (→  152):
 - For order code for "Housing", option **A**: glass
 - For order code for "Housing", option **B** and **C**: plastic

Cable entries/cable glands

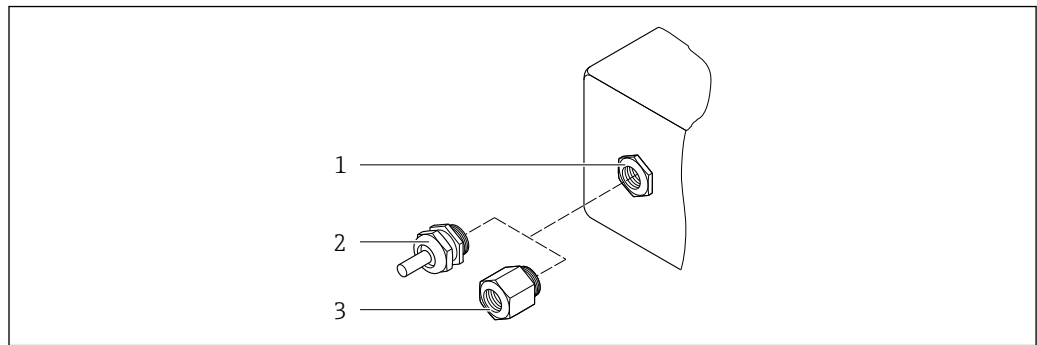

A0020640

17 Possible cable entries/cable glands

- 1 Female thread M20 × 1.5
- 2 Cable gland M20 × 1.5
- 3 Adapter for cable entry with female thread G ½" or NPT ½"

Order code for "Housing", option A "Compact, aluminum, coated"

The various cable entries are suitable for hazardous and non-hazardous areas.

Cable entry/cable gland	Material
Cable gland M20 × 1.5	Nickel-plated brass
Adapter for cable entry with internal thread G ½"	
Adapter for cable entry with internal thread NPT ½"	

Order code for "Housing", option B "Compact, hygienic, stainless"

The various cable entries are suitable for hazardous and non-hazardous areas.

Cable entry/cable gland	Material
Cable gland M20 × 1.5	Stainless steel, 1.4404 (316L)
Adapter for cable entry with internal thread G ½"	
Adapter for cable entry with internal thread NPT ½"	

Device plug

Electrical connection	Material
Plug M12x1	<ul style="list-style-type: none"> ■ Socket: Stainless steel, 1.4404 (316L) ■ Contact housing: Polyamide ■ Contacts: Gold-plated brass

Sensor housing



- Acid and alkali-resistant outer surface
- Stainless steel 1.4301 (304)

Measuring tubes

Stainless steel, 1.4539 (904L); manifold: stainless steel, 1.4404 (316L)

Process connections

- Flanges according to EN 1092-1 (DIN2501) / according to ASME B 16.5 / as per JIS B2220:
Stainless steel, 1.4404 (F316/F316L)
- All other process connections:
Stainless steel, 1.4404 (316/316L)

 Available process connections →  151

Seals

Welded process connections without internal seals

Accessories

Protective cover

Stainless steel, 1.4404 (316L)

Safety Barrier Promass 100

Housing: Polyamide

Process connections

- Fixed flange connections:
 - EN 1092-1 (DIN 2501) flange
 - EN 1092-1 (DIN 2512N) flange
 - NAMUR lengths in accordance with NE 132
 - ASME B16.5 flange
 - JIS B2220 flange
 - DIN 11864-2 Form A flange, DIN 11866 series A, flange with notch
- Clamp connections:
Tri-Clamp (OD tubes), DIN 11866 series C
- Thread:
 - DIN 11851 thread, DIN 11866 series A
 - SMS 1145 thread
 - ISO 2853 thread, ISO 2037
 - DIN 11864-1 Form A thread, DIN 11866 series A
- VCO connections:
 - 8-VCO-4
 - 12-VCO-4

 Process connection materials →  149

Surface roughness

All data refer to parts in contact with the medium.

The following surface roughness categories can be ordered:

Category	Method	Option(s) order code "Measuring tube mat., wetted surface"
Not polished	–	SA
$Ra \leq 0.76 \mu\text{m}$ (30 μin) ¹⁾	Mechanically polished ²⁾	SB
$Ra \leq 0.76 \mu\text{m}$ (30 μin) ¹⁾	Mechanically polished ²⁾ , welds in as-welded condition	SJ

Category	Method	Option(s) order code "Measuring tube mat., wetted surface"
Ra ≤ 0.38 μm (15 μin) ¹⁾	Mechanically polished ²⁾	SC
Ra ≤ 0.38 μm (15 μin) ¹⁾	Mechanically polished ²⁾ , welds in as-welded condition	SK

1) Ra according to ISO 21920

2) Except for inaccessible welds between pipe and manifold

16.11 Operability

Local display

The local display is only available with the following device order code:
Order code for "Display; operation", option **B**: 4-line; illuminated, via communication

Display element

- 4-line liquid crystal display with 16 characters per line.
- White background lighting; switches to red in event of device errors.
- Format for displaying measured variables and status variables can be individually configured.
- Permitted ambient temperature for the display: -20 to +60 °C (-4 to +140 °F). The readability of the display may be impaired at temperatures outside the temperature range.

Disconnecting the local display from the main electronics module

 In the case of the "Compact, aluminum coated" housing version, the local display must only be disconnected manually from the main electronics module. In the case of the "Compact, hygienic, stainless" and "Ultra-compact, hygienic, stainless" housing versions, the local display is integrated in the housing cover and is disconnected from the main electronics module when the housing cover is opened.

"Compact, aluminum coated" housing version

The local display is plugged onto the main electronics module. The electronic connection between the local display and main electronics module is established via a connecting cable.

For some work performed on the measuring device (e.g. electrical connection), it is advisable to disconnect the local display from the main electronics module:

1. Press in the side latches of the local display.
2. Remove the local display from the main electronics module. Pay attention to the length of the connecting cable when doing so.

Once the work is completed, plug the local display back on.

Remote operation

Via PROFINET network

This communication interface is available in device versions with PROFINET.

Star topology

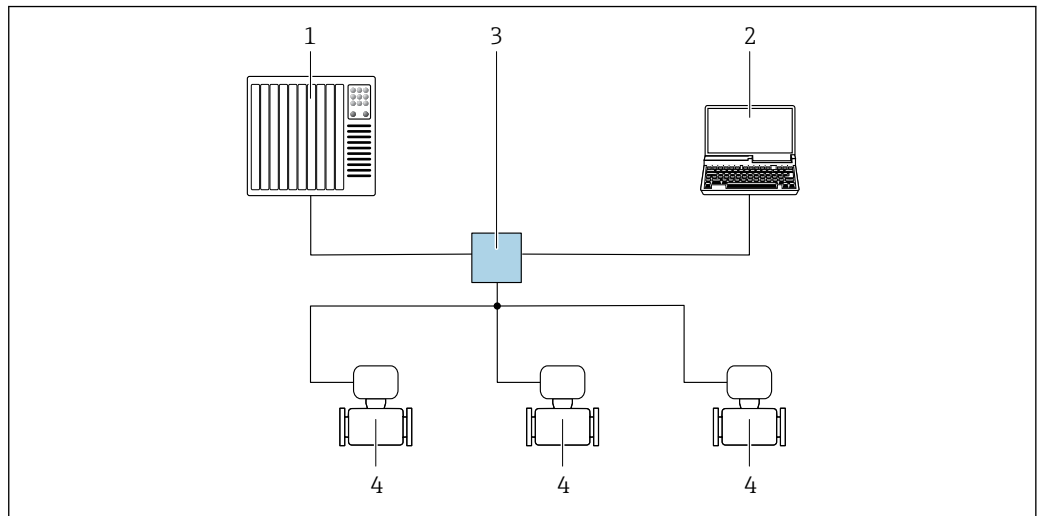

A0026545

18 Options for remote operation via PROFINET network: star topology

- 1 Automation system, e.g. Simatic S7 (Siemens)
- 2 Computer with Web browser (e.g. Internet Explorer) for accessing the integrated Web server or computer with operating tool (e.g. FieldCare, DeviceCare, SIMATIC PDM) with COM DTM "CDI Communication TCP/IP"
- 3 Standard Ethernet switch, e.g. Scalance X204 (Siemens)
- 4 Measuring device

Service interface

Via service interface (CDI-RJ45)

PROFINET

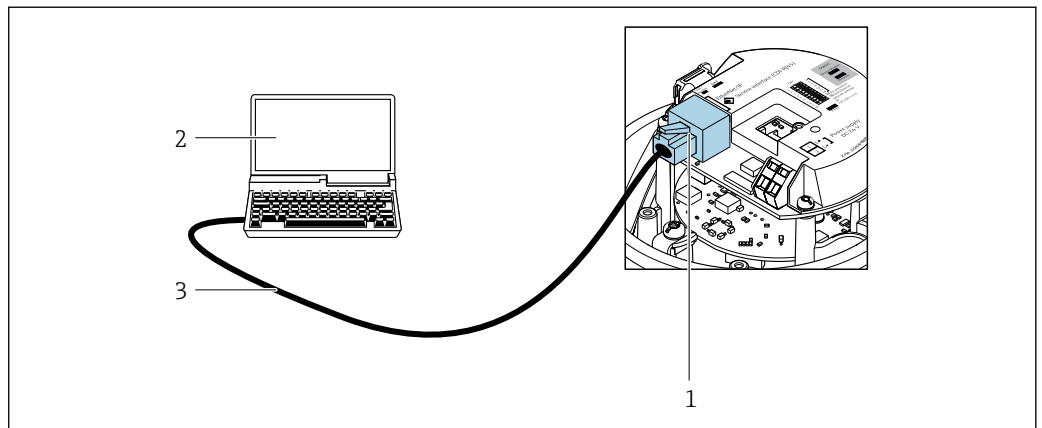

A0016940

19 Connection for order code for "Output", option R: PROFINET

- 1 Service interface (CDI-RJ45) and PROFINET interface of the measuring device with access to the integrated web server
- 2 Computer with web browser (e.g. Internet Explorer) for accessing the integrated web server or with "FieldCare" operating tool with COM DTM "CDI Communication TCP/IP"
- 3 Standard Ethernet connecting cable with RJ45 plug

Languages

Can be operated in the following languages:

Via "FieldCare" operating tool: English, German, French, Spanish, Italian, Chinese, Japanese

16.12 Certificates and approvals

Current certificates and approvals for the product are available at www.endress.com on the relevant product page:

1. Select the product using the filters and search field.
2. Open the product page.
3. Select **Downloads**.

CE mark The device meets the legal requirements of the applicable EU Directives. These are listed in the corresponding EU Declaration of Conformity along with the standards applied.
Endress+Hauser confirms successful testing of the device by affixing to it the CE mark.

UKCA marking The device meets the legal requirements of the applicable UK regulations (Statutory Instruments). These are listed in the UKCA Declaration of Conformity along with the designated standards. By selecting the order option for UKCA marking, Endress+Hauser confirms a successful evaluation and testing of the device by affixing the UKCA mark.

Contact address Endress+Hauser UK:
Endress+Hauser Ltd.
Floats Road
Manchester M23 9NF
United Kingdom
www.uk.endress.com

Ex-approval The devices are certified for use in hazardous areas and the relevant safety instructions are provided in the separate "Safety Instructions" (XA) document. Reference is made to this document on the nameplate.

Hygienic compatibility

- 3-A approval
 - Only measuring instruments with the order code for "Additional approval", option LP "3A" have 3-A approval.
 - The 3-A approval refers to the measuring instrument.
 - When installing the measuring instrument, ensure that no liquid can accumulate on the outside of the measuring instrument.
A remote display module must be installed in accordance with the 3-A Standard.
 - Accessories (e.g. heating jacket, weather protection cover, wall holder unit) must be installed in accordance with the 3-A Standard.
Each accessory can be cleaned. Disassembly may be necessary under certain circumstances.
- EHEDG-tested
Only devices with the order code for "Additional approval", option LT "EHEDG" have been tested and meet the requirements of the EHEDG.
To meet the requirements for EHEDG certification, the device must be used with process connections in accordance with the EHEDG position paper entitled "Easy cleanable Pipe couplings and Process connections" (www.ehedg.org).
To meet the requirements for EHEDG certification, the device must be installed in a position that ensures drainability.

 Observe the special installation instructions

Pharmaceutical compatibility

- FDA 21 CFR 177
- USP <87>
- USP <88> Class VI 121 °C
- TSE/BSE Certificate of Suitability

Certification PROFINET

PROFINET interface

The measuring device is certified and registered by the PNO (PROFIBUS Nutzerorganisation e.V. / PROFIBUS User Organization). The measuring system meets all the requirements of the following specifications:

- Certified according to:
 - Test specification for PROFINET devices
 - PROFINET Security Level 1– Netload Class 2 0 Mbps
- The device can also be operated with certified devices of other manufacturers (interoperability)
- The device supports PROFINET S2 system redundancy.

Pressure Equipment Directive

- With the marking
 - a) PED/G1/x (x = category) or
 - b) PESR/G1/x (x = category)
 on the sensor nameplate, Endress+Hauser confirms compliance with the "Essential Safety Requirements"
 - a) specified in Annex I of the Pressure Equipment Directive 2014/68/EU or
 - b) Schedule 2 of Statutory Instruments 2016 No. 1105.
- Devices not bearing this marking (without PED or PESR) are designed and manufactured according to sound engineering practice. They meet the requirements of
 - a) Art. 4 Para. 3 of the Pressure Equipment Directive 2014/68/EU or
 - b) Part 1, Para. 8 of Statutory Instruments 2016 No. 1105.
 The scope of application is indicated
 - a) in diagrams 6 to 9 in Annex II of the Pressure Equipment Directive 2014/68/EU or
 - b) Schedule 3, Para. 2 of Statutory Instruments 2016 No. 1105.

External standards and guidelines



- EN 60529
Degrees of protection provided by enclosures (IP code)
- IEC/EN 60068-2-6
Environmental influences: Test procedure - Test Fc: vibrate (sinusoidal).
- IEC/EN 60068-2-31
Environmental influences: Test procedure - Test Ec: shocks due to rough handling, primarily for devices.
- EN 61010-1
Safety requirements for electrical equipment for measurement, control and laboratory use - general requirements
- EN 61326-1/-2-3
EMC requirements for electrical equipment for measurement, control and laboratory use
- NAMUR NE 21
Electromagnetic compatibility (EMC) of industrial process and laboratory control equipment
- NAMUR NE 32
Data retention in the event of a power failure in field and control instruments with microprocessors
- NAMUR NE 43
Standardization of the signal level for the breakdown information of digital transmitters with analog output signal.
- NAMUR NE 53
Software of field devices and signal-processing devices with digital electronics
- NAMUR NE 80
The application of the pressure equipment directive to process control devices
- NAMUR NE 105
Specifications for integrating fieldbus devices in engineering tools for field devices
- NAMUR NE 107
Self-monitoring and diagnosis of field devices
- NAMUR NE 131
Requirements for field devices for standard applications

- NAMUR NE 132
Coriolis mass meter
- ETSI EN 300 328
Guidelines for 2.4 GHz radio components.
- EN 301489
Electromagnetic compatibility and radio spectrum matters (ERM).

16.13 Application packages

Many different application packages are available to enhance the functionality of the device. Such packages might be needed to address safety aspects or specific application requirements.

The application packages can be ordered with the device or subsequently from Endress+Hauser. Detailed information on the order code in question is available from your local Endress+Hauser sales center or on the product page of the Endress+Hauser website: www.endress.com.

 Detailed information on the application packages:
Special Documentation →  157

Heartbeat Technology

Order code for "Application package", option EB "Heartbeat Verification + Monitoring"

Heartbeat Verification

Meets the requirement for traceable verification to DIN ISO 9001:2008 Chapter 7.6 a) "Control of monitoring and measuring equipment".

- Functional testing in the installed state without interrupting the process.
- Traceable verification results on request, including a report.
- Simple testing process via local operation or other operating interfaces.
- Clear measuring point assessment (pass/fail) with high test coverage within the framework of manufacturer specifications.
- Extension of calibration intervals according to operator's risk assessment.

Heartbeat Monitoring

Continuously supplies data, which are characteristic of the measuring principle, to an external condition monitoring system for the purpose of preventive maintenance or process analysis. These data enable the operator to:

- Draw conclusions - using these data and other information - about the impact process influences (e.g. corrosion, abrasion, buildup etc.) have on the measuring performance over time.
- Schedule servicing in time.
- Monitor the process or product quality, e.g. gas pockets .

 For detailed information, see the Special Documentation for the device.

Concentration measurement

Order code for "Application package", option ED "Concentration"

Calculation and outputting of fluid concentrations.

The measured density is converted to the concentration of a substance of a binary mixture using the "Concentration" application package:

- Choice of predefined fluids (e.g. various sugar solutions, acids, alkalis, salts, ethanol etc.).
- Common or user-defined units (°Brix, °Plato, % mass, % volume, mol/l etc.) for standard applications.
- Concentration calculation from user-defined tables.

The measured values are output via the digital and analog outputs of the device.

 For detailed information, see the Special Documentation for the device.

Petroleum & locking function



Order code for "Application package", option EM "Petroleum & locking function"

The most important parameters for the Oil & Gas Industry can be calculated and displayed with this application package. It is also possible to lock the settings.

- Corrected volume flow and calculated reference density in accordance with the "API Manual of Petroleum Measurement Standards, Chapter 11.1"
- Water content, based on density measurement
- Weighted mean of the density and temperature

 For detailed information, see the Special Documentation for the device.

16.14 Accessories

 Overview of accessories available to order →  131

16.15 Supplementary documentation

 For an overview of the scope of the associated Technical Documentation, refer to the following:

- *Device Viewer* (www.endress.com/deviceviewer): Enter the serial number from the nameplate
- *Endress+Hauser Operations app*: Enter serial number from nameplate or scan matrix code on nameplate.

Standard documentation

Brief Operating instructions

Brief Operating Instructions for the sensor

Measuring instrument	Documentation code
Proline Promass E	KA01260D

Transmitter Brief Operating Instructions

Measuring device	Documentation code
Proline Promass 100	KA01336D

Technical Information

Measuring device	Documentation code
Proline Promass E 100	TI01351D

Description of Device Parameters

Measuring device	Documentation code
Proline Promass 100	GP01037D

Supplementary device-dependent documentation

Safety Instructions



Content	Documentation code
ATEX/IECEX Ex i	XA00159D
ATEX/IECEX Ex nA	XA01029D

Content	Documentation code
cCSAus IS	XA00160D
INMETRO Ex i	XA01219D
INMETRO Ex nA	XA01220D

Special Documentation

Content	Documentation code
Information on the Pressure Equipment Directive	SD00142D
Concentration measurement	SD01503D
Heartbeat Technology	SD01493D
Web server	SD01823D

Installation instructions

Contents	Note
Installation instructions for spare part sets and accessories	<ul style="list-style-type: none"> ▪ Access the overview of all the available spare part sets via <i>Device Viewer</i> →  129 ▪ Accessories available for order with Installation Instructions →  131

Index

0 ... 9

3-A approval 154

A

Access authorization to parameters

 Read access 37

 Write access 37

Access code 37

 Incorrect input 37

Adapting the diagnostic behavior 98

Ambient conditions

 Shock and vibration resistance 147

 Storage temperature 146

Application 134

Application packages 156

Applicator 135

Approvals 154

C

Cable entries

 Technical data 142

Cable entry

 Degree of protection 31

CE mark 10, 154

Certificates 154

Certification PROFINET 155

cGMP 154

Checklist

 Post-connection check 32

 Post-installation check 24

CIP cleaning 147

Cleaning

 CIP cleaning 128

 Exterior cleaning 128

 Internal cleaning 128

 SIP cleaning 128

Climate class 146

Commissioning 59

 Advanced settings 68

 Configuring the measuring instrument 59

Connecting cable 25

Connecting the measuring instrument 27

Connection

 see Electrical connection

Connection preparations 27

Connection tools 25

Current consumption 142

Cyclic data transmission 48

D

Date of manufacture 14

Declaration of Conformity 10

Defining the access code 77

Degree of protection 31, 146

Density adjustment 70

Design

 Measuring device 12

 Operating menu 34

Design fundamentals

 Measurement error 145

 Repeatability 145

Device components 12

Device description files 46

Device fuse 142

Device locking, status 79

Device master file

 GSD 47

Device name

 Sensor 14

 Transmitter 14

Device repair 129

Device revision 46

Device type ID 46

Device Viewer 129

DeviceCare 45

 Device description file 46

Diagnostic information

 Design, description 96, 98

 DeviceCare 97

 FieldCare 97

 LEDs 95

 Overview 101

 Remedial measures 101

 Web browser 95

Diagnostics list 123

DIP switch

 see Write protection switch

Disabling write protection 76

Display area

 For operational display 36

Display values

 For locking status 79

Disposal 130

Document

 Function 6

 Symbols 6

Document function 6

Down pipe 18

E

EHEDG-tested 154

Electrical connection

 Degree of protection 31

 Measuring instrument 25

 Operating tools

 Via PROFINET network 43, 152

 Via service interface (CDI-RJ45) 43, 153

 RSLogix 5000 43, 152

 Web server 43, 153

Electromagnetic compatibility 147

Enabling write protection 76

- Endress+Hauser services
 - Maintenance 128
 - Repair 129
- Error messages
 - see Diagnostic messages
- Event logbook 123
- Events list 123
- Ex-approval 154
- Extended order code
 - Sensor 14
 - Transmitter 14
- Exterior cleaning 128
- F**
- FDA 154
- Field of application
 - Residual risks 10
- FieldCare 44
 - Device description file 46
 - Establishing a connection 44
 - Function 44
 - User interface 45
- Filtering the event logbook 124
- Firmware
 - Release date 46
 - Version 46
- Firmware history 127
- Flash function 59
- Flow direction 19, 23
- Flow limit 148
- Food Contact Materials Regulation 154
- Functions
 - see Parameters
- G**
- Galvanic isolation 137
- H**
- Hardware write protection 77
- Hygienic compatibility 154
- I**
- I/O electronics module 12, 28
- Identifying the measuring instrument 13
- Incoming acceptance 13
- Indication
 - Current diagnostic event 122
 - Previous diagnostic event 122
- Influence
 - Medium pressure 145
 - Medium temperature 144
- Information about this document 6
- Inlet runs 20
- Input variables 135
- Inspection
 - Connection 32
 - Installation 24
 - Received goods 13
- Installation 18
- Installation dimensions 20
- Installation point 18
- Intended use 9
- Internal cleaning 128, 147
- L**
- Languages, operation options 153
- Local display
 - see Operational display
- Low flow cut off 137
- M**
- Main electronics module 12
- Maintenance work 128
- Manufacturer ID 46
- Materials 149
- Maximum measurement error 142
- Measured variables
 - see Process variables
- Measurement accuracy 142
- Measuring and test equipment 128
- Measuring device
 - Conversion 129
 - Design 12
 - Disposal 130
 - Mounting the sensor 23
 - Preparing for electrical connection 27
 - Removing 130
 - Repairs 129
- Measuring instrument
 - Configuring 59
 - Preparing for mounting 23
- Measuring principle 134
- Measuring range
 - For gases 135
 - For liquids 135
- Measuring range, recommended 148
- Measuring system 134
- Medium pressure
 - Influence 145
- Medium temperature
 - Influence 144
- Menu
 - Diagnostics 122
 - Operation 79
 - Setup 60
- Menus
 - For measuring instrument configuration 59
 - For specific settings 68
- Module
 - Totalizer
 - Totalizer Control 51
- Mounting dimensions
 - see Installation dimensions
- Mounting preparations 23
- Mounting requirements
 - Down pipe 18
 - Inlet and outlet runs 20
 - Installation dimensions 20
 - Installation point 18

Orientation	19	Post-installation check	59
Rupture disk	22	Post-installation check (checklist)	24
Sensor heating	21	Potential equalization	29
Static pressure	20	Power consumption	142
Thermal insulation	20	Power supply failure	142
Vibrations	21	Pressure Equipment Directive	155
Mounting tools	23	Pressure loss	148
N		Pressure-temperature ratings	147
Nameplate		Process connections	151
Sensor	14	Process variables	
Transmitter	14	Calculated	135
Netilion	128	Measured	135
O		Product safety	10
Operable flow range	136	Protecting parameter settings	76
Operating menu		R	
Design	34	Read access	37
Menus, submenus	34	Reading off measured values	79
Submenus and user roles	35	Recalibration	128
Operating philosophy	35	Reference operating conditions	142
Operation	79	Registered trademarks	8
Operation options	33	Remote operation	152
Operational display	36	Repair	129
Operational safety	10	Notes	129
Order code	14	Repair of a device	129
Orientation (vertical, horizontal)	19	Repeatability	144
Outlet runs	20	Replacement	
Output signal	136	Device components	129
Output variables	136	Requirements for personnel	9
P		Response time	144
Packaging disposal	17	Return	129
Parameter settings		Rupture disk	
Administration (Submenu)	75	Safety instructions	22
Advanced setup (Submenu)	68	Triggering pressure	148
Communication (Submenu)	62	S	
Corrected volume flow calculation (Submenu)	69	Safety	9
Density adjustment (Wizard)	71	Sensor	
Device information (Submenu)	126	Installing	23
Diagnostics (Menu)	122	Sensor heating	21
Low flow cut off (Wizard)	66	Sensor housing	147
Measured variables (Submenu)	79	Serial number	14
Medium selection (Submenu)	64	Setting the operating language	59
Partially filled pipe detection (Wizard)	67	Settings	
Sensor adjustment (Submenu)	70	Adapting the measuring device to the process	
Setup (Menu)	60	conditions	90
Simulation (Submenu)	75	Administration	75
System units (Submenu)	60	Communication interface	62
Totalizer (Submenu)	89	Low flow cut off	66
Totalizer 1 to n (Submenu)	74	Medium	64
Totalizer handling (Submenu)	90	Operating language	59
Web server (Submenu)	42	Partially filled pipe detection	67
Zero point adjustment (Submenu)	73	Resetting the device	125
Performance characteristics	142	Resetting the totalizer	90
Performing density adjustment	71	Sensor adjustment	70
Pharmaceutical compatibility	154	Simulation	75
Post-connection check	59	System units	60
Post-connection check (checklist)	32	Tag name	60
		Totalizer	74

- Totalizer reset 90
 - Shock and vibration resistance 147
 - Signal on alarm 136
 - SIP cleaning 147
 - Software release 46
 - Software write protection 78
 - Spare part 129
 - Spare parts 129
 - Special connection instructions 29
 - Special mounting instructions
 - Hygienic compatibility 22
 - Standards and guidelines 155
 - Startup parameterization (NSU) 59
 - Static pressure 20
 - Status area
 - For operational display 36
 - Status signals 96
 - Storage conditions 16
 - Storage temperature 16
 - Storage temperature range 146
 - Submenu
 - Administration 75
 - Advanced setup 68
 - Calculated values 68
 - Communication 62
 - Corrected volume flow calculation 69
 - Device information 126
 - Events list 123
 - Measured values 79
 - Measured variables 79
 - Medium selection 64
 - Overview 35
 - Process variables 68
 - Sensor adjustment 70
 - Simulation 75
 - System units 60
 - Totalizer 89
 - Totalizer 1 to n 74
 - Totalizer handling 90
 - Web server 42
 - Zero point adjustment 73
 - Supply voltage 141
 - Surface roughness 151
 - Symbols
 - For communication 36
 - For diagnostic behavior 36
 - For locking 36
 - For measured variable 36
 - For measurement channel number 36
 - For status signal 36
 - In the status area of the local display 36
 - System design
 - Measuring system 134
 - see Measuring device design
 - System integration 46
- T**
- Technical data, overview 134
- Temperature range
 - Medium temperature 147
 - Storage temperature 16
 - Terminal assignment 26, 28
 - Terminals 142
 - Thermal insulation 20
 - Tool
 - Transport 16
 - Tools
 - Electrical connection 25
 - For mounting 23
 - Totalizer
 - Configuring 74
 - Totalizer Control module 51
 - Transmitter
 - Connecting the signal cables 28
 - Transporting the measuring device 16
 - Troubleshooting
 - General 93
 - TSE/BSE Certificate of Suitability 154
- U**
- UKCA marking 154
 - Use of measuring device
 - Borderline cases 9
 - Incorrect use 9
 - Use of measuring instrument
 - see Intended use
 - User roles 35
 - USP Class VI 154
- V**
- Version data for the device 46
 - Vibrations 21
- W**
- W@M Device Viewer 13
 - Weight
 - SI units 149
 - Transport (notes) 16
 - US units 149
 - Wizard
 - Define access code 76
 - Density adjustment 71
 - Low flow cut off 66
 - Partially filled pipe detection 67
 - Workplace safety 10
 - Write access 37
 - Write protection
 - Via access code 76
 - Via startup parameterization (NSU) 78
 - Via write protection switch 77
 - Write protection switch 77



71674827

www.addresses.endress.com
