

# Operating Instructions

## Proline Promass E 500

Coriolis flowmeter  
EtherNet/IP

**EtherNet/IP**

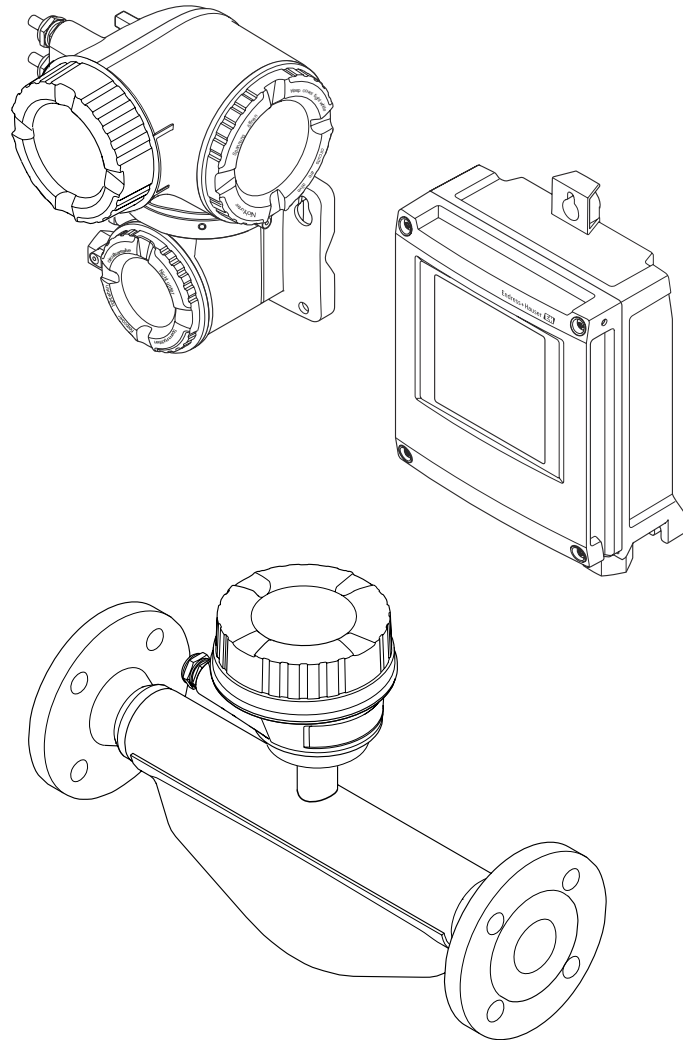

- Make sure the document is stored in a safe place such that it is always available when working on or with the device.
- To avoid danger to individuals or the facility, read the "Basic safety instructions" section carefully, as well as all other safety instructions in the document that are specific to working procedures.
- The manufacturer reserves the right to modify technical data without prior notice. Your Endress+Hauser sales organization will supply you with current information and updates to this manual.

## Table of contents

<b>1</b>	<b>About this document</b> . . . . .	<b>6</b>	<b>6</b>	<b>Installation</b> . . . . .	<b>22</b>
1.1	Document function . . . . .	6	6.1	Mounting requirements . . . . .	22
1.2	Symbols . . . . .	6	6.1.1	Installation position . . . . .	22
1.2.1	Safety symbols . . . . .	6	6.1.2	Environmental and process requirements . . . . .	25
1.2.2	Electrical symbols . . . . .	6	6.1.3	Special installation instructions . . . . .	26
1.2.3	Communication-specific symbols . . . . .	6	6.2	Installing the measuring instrument . . . . .	29
1.2.4	Tool symbols . . . . .	7	6.2.1	Required tools . . . . .	29
1.2.5	Symbols for certain types of information . . . . .	7	6.2.2	Preparing the measuring instrument . . . . .	29
1.2.6	Symbols in graphics . . . . .	7	6.2.3	Mounting the measuring device . . . . .	29
1.3	Documentation . . . . .	8	6.2.4	Mounting the transmitter housing: Proline 500 – digital . . . . .	30
1.4	Registered trademarks . . . . .	8	6.2.5	Mounting the transmitter housing: Proline 500 . . . . .	32
<b>2</b>	<b>Safety instructions</b> . . . . .	<b>9</b>	6.2.6	Turning the transmitter housing: Proline 500 . . . . .	33
2.1	Requirements for the personnel . . . . .	9	6.2.7	Turning the display module: Proline 500 . . . . .	33
2.2	Intended use . . . . .	9	6.3	Post-installation check . . . . .	34
2.3	Workplace safety . . . . .	10	<b>7</b>	<b>Electrical connection</b> . . . . .	<b>35</b>
2.4	Operational safety . . . . .	10	7.1	Electrical safety . . . . .	35
2.5	Product safety . . . . .	10	7.2	Connecting requirements . . . . .	35
2.6	IT security . . . . .	11	7.2.1	Required tools . . . . .	35
2.7	Device-specific IT security . . . . .	11	7.2.2	Requirements for connection cable . . . . .	35
2.7.1	Protecting access via hardware write protection . . . . .	11	7.2.3	Terminal assignment . . . . .	40
2.7.2	Protecting access via a password . . . . .	11	7.2.4	Available device plugs . . . . .	40
2.7.3	Access via web server . . . . .	12	7.2.5	Pin assignment of device plug . . . . .	41
2.7.4	Access via service interface (CDI-RJ45) . . . . .	12	7.2.6	Preparing the measuring device . . . . .	41
<b>3</b>	<b>Product description</b> . . . . .	<b>14</b>	7.3	Connecting the measuring instrument: Proline 500 - digital . . . . .	42
3.1	Product design . . . . .	14	7.3.1	Connecting the connecting cable . . . . .	42
3.1.1	Proline 500 – digital . . . . .	14	7.3.2	Connecting the transmitter . . . . .	47
3.1.2	Proline 500 . . . . .	15	7.3.3	Integrating the transmitter into a network . . . . .	50
<b>4</b>	<b>Incoming acceptance and product identification</b> . . . . .	<b>16</b>	7.4	Connecting the measuring instrument: Proline 500 . . . . .	52
4.1	Incoming acceptance . . . . .	16	7.4.1	Fitting the connecting cable . . . . .	52
4.2	Product identification . . . . .	16	7.4.2	Connecting the transmitter . . . . .	56
4.2.1	Transmitter nameplate . . . . .	17	7.4.3	Integrating the transmitter into a network . . . . .	59
4.2.2	Sensor nameplate . . . . .	19	7.5	Potential equalization . . . . .	60
4.2.3	Symbols on the device . . . . .	20	7.5.1	Requirements . . . . .	60
<b>5</b>	<b>Storage and transport</b> . . . . .	<b>21</b>	7.6	Special connection instructions . . . . .	61
5.1	Storage conditions . . . . .	21	7.6.1	Connection examples . . . . .	61
5.2	Transporting the product . . . . .	21	7.7	Hardware settings . . . . .	64
5.2.1	Measuring devices without lifting lugs . . . . .	21	7.7.1	Setting the device address . . . . .	64
5.2.2	Measuring devices with lifting lugs . . . . .	22	7.7.2	Activating the default IP address . . . . .	65
5.2.3	Transporting with a fork lift . . . . .	22	7.8	Ensuring the degree of protection . . . . .	67
5.3	Packaging disposal . . . . .	22	7.9	Post-connection check . . . . .	67
			<b>8</b>	<b>Operation options</b> . . . . .	<b>68</b>
			8.1	Overview of operation options . . . . .	68

8.2	Structure and function of the operating menu . . . . .	69	10.5.6	Configuring the current input . . . . .	122
8.2.1	Structure of the operating menu . . . . .	69	10.5.7	Configuring the status input . . . . .	123
8.2.2	Operating philosophy . . . . .	70	10.5.8	Configuring the current output . . . . .	124
8.3	Access to operating menu via local display . . . . .	71	10.5.9	Configuring the pulse/frequency/ switch output . . . . .	127
8.3.1	Operational display . . . . .	71	10.5.10	Configuring the relay output . . . . .	135
8.3.2	Navigation view . . . . .	74	10.5.11	Configuring the local display . . . . .	138
8.3.3	Editing view . . . . .	76	10.5.12	Configuring the low flow cut off . . . . .	142
8.3.4	Operating elements . . . . .	78	10.5.13	Configuring partially filled pipe detection . . . . .	143
8.3.5	Opening the context menu . . . . .	78	10.6	Advanced settings . . . . .	144
8.3.6	Navigating and selecting from list . . . . .	80	10.6.1	Using the parameter to enter the access code . . . . .	145
8.3.7	Calling the parameter directly . . . . .	80	10.6.2	Calculated process variables . . . . .	145
8.3.8	Calling up help text . . . . .	81	10.6.3	Carrying out a sensor adjustment . . . . .	147
8.3.9	Changing the parameters . . . . .	81	10.6.4	Configuring the totalizer . . . . .	153
8.3.10	User roles and related access authorization . . . . .	82	10.6.5	Carrying out additional display configurations . . . . .	155
8.3.11	Disabling write protection via access code . . . . .	82	10.6.6	WLAN configuration . . . . .	159
8.3.12	Enabling and disabling the keypad lock . . . . .	83	10.6.7	Configuration management . . . . .	161
8.4	Access to operating menu via web browser . . . . .	83	10.6.8	Using parameters for device administration . . . . .	162
8.4.1	Function range . . . . .	83	10.7	Simulation . . . . .	164
8.4.2	Requirements . . . . .	84	10.8	Protecting settings from unauthorized access	167
8.4.3	Connecting the device . . . . .	85	10.8.1	Write protection via access code . . . . .	167
8.4.4	Logging on . . . . .	88	10.8.2	Write protection via write protection switch . . . . .	169
8.4.5	User interface . . . . .	89	<b>11</b>	<b>Operation . . . . .</b>	<b>171</b>
8.4.6	Disabling the Web server . . . . .	90	11.1	Reading off the device locking status . . . . .	171
8.4.7	Logging out . . . . .	90	11.2	Adjusting the operating language . . . . .	171
8.5	Access to the operating menu via the operating tool . . . . .	91	11.3	Configuring the display . . . . .	171
8.5.1	Connecting the operating tool . . . . .	91	11.4	Reading off measured values . . . . .	171
8.5.2	FieldCare . . . . .	95	11.4.1	"Measured variables" submenu . . . . .	172
8.5.3	DeviceCare . . . . .	96	11.4.2	"Totalizer" submenu . . . . .	182
<b>9</b>	<b>System integration . . . . .</b>	<b>97</b>	11.4.3	"Input values" submenu . . . . .	182
9.1	Overview of device description files . . . . .	97	11.4.4	Output values . . . . .	184
9.1.1	Current version data for the device . . . . .	97	11.5	Adapting the measuring device to the process conditions . . . . .	186
9.1.2	Operating tools . . . . .	97	11.6	Performing a totalizer reset . . . . .	186
9.2	Overview of system files . . . . .	97	11.6.1	Function scope of "Control Totalizer" parameter . . . . .	187
9.3	Integrating the measuring device in the system . . . . .	98	11.6.2	Function range of "Reset all totalizers" parameter . . . . .	188
9.4	Cyclic data transmission . . . . .	98	11.7	Displaying the measured value history . . . . .	188
9.4.1	Block model . . . . .	98	<b>12</b>	<b>Diagnostics and troubleshooting . . . . .</b>	<b>192</b>
9.4.2	Input and output groups . . . . .	99	12.1	General troubleshooting . . . . .	192
9.5	Diagnostic information via EtherNet/IP . . . . .	109	12.2	Diagnostic information via light emitting diodes . . . . .	194
<b>10</b>	<b>Commissioning . . . . .</b>	<b>114</b>	12.2.1	Transmitter . . . . .	194
10.1	Post-mounting and post-connection check . . . . .	114	12.2.2	Sensor connection housing . . . . .	197
10.2	Switching on the measuring device . . . . .	114	12.3	Diagnostic information on local display . . . . .	198
10.3	Connecting via FieldCare . . . . .	114	12.3.1	Diagnostic message . . . . .	198
10.4	Setting the operating language . . . . .	114	12.3.2	Calling up remedial measures . . . . .	200
10.5	Configuring the measuring instrument . . . . .	115	12.4	Diagnostic information in the web browser . . . . .	200
10.5.1	Defining the tag name . . . . .	116	12.4.1	Diagnostic options . . . . .	200
10.5.2	Setting the system units . . . . .	116	12.4.2	Calling up remedy information . . . . .	201
10.5.3	Configuring the communication interface . . . . .	118			
10.5.4	Selecting and setting the medium . . . . .	120			
10.5.5	Displaying the I/O configuration . . . . .	121			

12.5	Diagnostic information in FieldCare or DeviceCare .....	201	16.4	Output .....	234
12.5.1	Diagnostic options .....	201	16.5	Power supply .....	240
12.5.2	Calling up remedy information .....	202	16.6	Performance characteristics .....	241
12.6	Diagnostic information via communication interface .....	203	16.7	Mounting .....	245
12.6.1	Reading out diagnostic information .....	203	16.8	Environment .....	245
12.7	Adapting the diagnostic information .....	203	16.9	Process .....	247
12.7.1	Adapting the diagnostic behavior .....	203	16.10	Mechanical construction .....	248
12.8	Overview of diagnostic information .....	203	16.11	User interface .....	252
12.8.1	Diagnostic of sensor .....	204	16.12	Certificates and approvals .....	255
12.8.2	Diagnostic of electronic .....	205	16.13	Application packages .....	257
12.8.3	Diagnostic of configuration .....	209	16.14	Accessories .....	259
12.8.4	Diagnostic of process .....	213	16.15	Supplemental documentation .....	259
12.9	Pending diagnostic events .....	217			
12.10	Diagnostics list .....	217	<b>Index .....</b>	<b>261</b>	
12.11	Event logbook .....	218			
12.11.1	Reading out the event logbook .....	218			
12.11.2	Filtering the event logbook .....	219			
12.11.3	Overview of information events .....	219			
12.12	Resetting the measuring device .....	220			
12.12.1	Function range of "Device reset" parameter .....	220			
12.13	Device information .....	221			
12.14	Firmware history .....	222			
<b>13</b>	<b>Maintenance .....</b>	<b>223</b>			
13.1	Maintenance work .....	223			
13.1.1	Exterior cleaning .....	223			
13.1.2	Internal cleaning .....	223			
13.2	Measuring and test equipment .....	223			
13.3	Endress+Hauser services .....	223			
<b>14</b>	<b>Repair .....</b>	<b>224</b>			
14.1	General notes .....	224			
14.1.1	Repair and conversion concept .....	224			
14.1.2	Notes for repair and conversion .....	224			
14.2	Spare parts .....	224			
14.3	Endress+Hauser services .....	224			
14.4	Return .....	224			
14.5	Disposal .....	225			
14.5.1	Removing the measuring device .....	225			
14.5.2	Disposing of the measuring device .....	225			
<b>15</b>	<b>Accessories .....</b>	<b>226</b>			
15.1	Device-specific accessories .....	226			
15.1.1	For the transmitter .....	226			
15.1.2	For the sensor .....	227			
15.2	Communication-specific accessories .....	227			
15.3	Service-specific accessories .....	228			
15.4	System components .....	229			
<b>16</b>	<b>Technical data .....</b>	<b>230</b>			
16.1	Application .....	230			
16.2	Function and system design .....	230			
16.3	Input .....	231			

# 1 About this document

## 1.1 Document function

These Operating Instructions contain all the information required in the various life cycle phases of the device: from product identification, incoming acceptance and storage, to installation, connection, operation and commissioning, through to troubleshooting, maintenance and disposal.

## 1.2 Symbols

### 1.2.1 Safety symbols

#### DANGER

This symbol alerts you to a dangerous situation. Failure to avoid this situation will result in serious or fatal injury.

#### WARNING

This symbol alerts you to a potentially dangerous situation. Failure to avoid this situation can result in serious or fatal injury.





#### CAUTION

This symbol alerts you to a potentially dangerous situation. Failure to avoid this situation can result in minor or medium injury.

#### NOTICE

This symbol alerts you to a potentially harmful situation. Failure to avoid this situation can result in damage to the product or something in its vicinity.

### 1.2.2 Electrical symbols

Symbol	Meaning
	Direct current
	Alternating current
	Direct current and alternating current
	<b>Ground connection</b> A grounded terminal which, as far as the operator is concerned, is grounded via a grounding system.
	<b>Potential equalization connection (PE: protective earth)</b> Ground terminals that must be connected to ground prior to establishing any other connections.  The ground terminals are located on the interior and exterior of the device: <ul style="list-style-type: none"> <li>▪ Interior ground terminal: potential equalization is connected to the supply network.</li> <li>▪ Exterior ground terminal: device is connected to the plant grounding system.</li> </ul>

### 1.2.3 Communication-specific symbols

Symbol	Meaning
	<b>Wireless Local Area Network (WLAN)</b> Communication via a wireless, local network.







### 1.2.4 Tool symbols

Symbol	Meaning
	Torx screwdriver
	Phillips head screwdriver
	Open-ended wrench

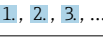
### 1.2.5 Symbols for certain types of information

Symbol	Meaning
	<b>Permitted</b> Procedures, processes or actions that are permitted.
	<b>Preferred</b> Procedures, processes or actions that are preferred.
	<b>Forbidden</b> Procedures, processes or actions that are forbidden.
	<b>Tip</b> Indicates additional information.
	Reference to documentation
	Reference to page
	Reference to graphic
	Notice or individual step to be observed
	Series of steps
	Result of a step
	Help in the event of a problem
	Visual inspection

### 1.2.6 Symbols in graphics

Symbol	Meaning
	Item numbers
	Series of steps
	Views
	Sections
	Hazardous area
	Safe area (non-hazardous area)
	Flow direction

## 1.3 Documentation

 For an overview of the scope of the associated Technical Documentation, refer to the following:

- *Device Viewer* ([www.endress.com/deviceviewer](http://www.endress.com/deviceviewer)): Enter the serial number from the nameplate
- *Endress+Hauser Operations app*: Enter serial number from nameplate or scan matrix code on nameplate.

The following documentation may be available depending on the device version ordered:

Document type	Purpose and content of the document
Technical Information (TI)	<b>Planning aid for your device</b> The document contains all the technical data on the device and provides an overview of the accessories and other products that can be ordered for the device.
Brief Operating Instructions (KA)	<b>Guide that takes you quickly to the 1st measured value</b> The Brief Operating Instructions contain all the essential information from incoming acceptance to initial commissioning.
Operating Instructions (BA)	<b>Your reference document</b> These Operating Instructions contain all the information that is required in the various life cycle phases of the device: from product identification, incoming acceptance and storage, to mounting, connection, operation and commissioning, through to troubleshooting, maintenance and disposal.
Description of Device Parameters (GP)	<b>Reference for your parameters</b> The document provides a detailed explanation of each individual parameter. The description is aimed at those who work with the device over the entire life cycle and perform specific configurations.
Safety Instructions (XA)	Depending on the approval, safety instructions for electrical equipment in hazardous areas are also supplied with the device. The Safety Instructions are a constituent part of the Operating Instructions.   Information on the Safety Instructions (XA) that are relevant for the device is provided on the nameplate.
Supplementary device-dependent documentation (SD/FY)	Always comply strictly with the instructions in the relevant supplementary documentation. The supplementary documentation is a constituent part of the device documentation.

## 1.4 Registered trademarks

### **EtherNet/IP™**

Trademark of ODVA, Inc.

### **TRI-CLAMP®**

Registered trademark of Ladish & Co., Inc., Kenosha, USA



## 2 Safety instructions

### 2.1 Requirements for the personnel

The personnel for installation, commissioning, diagnostics and maintenance must fulfill the following requirements:

- ▶ Trained, qualified specialists must have a relevant qualification for this specific function and task.
- ▶ Are authorized by the plant owner/operator.
- ▶ Are familiar with federal/national regulations.
- ▶ Before starting work, read and understand the instructions in the manual and supplementary documentation as well as the certificates (depending on the application).
- ▶ Follow instructions and comply with basic conditions.

The operating personnel must fulfill the following requirements:

- ▶ Are instructed and authorized according to the requirements of the task by the facility's owner-operator.
- ▶ Follow the instructions in this manual.

### 2.2 Intended use

#### Application and media

The measuring instrument described in this manual is intended only for the flow measurement of liquids and gases.

Depending on the version ordered, the measuring instrument can also be used to measure potentially explosive <sup>1)</sup>, flammable, toxid and oxidizing media.

Measuring instruments for use in hazardous areas, in hygienic applications, or where there is an increased risk due to pressure, are specially labeled on the nameplate.

To ensure that the measuring instrument is in perfect condition during operation:

- ▶ Only use the measuring instrument in full compliance with the data on the nameplate and the general conditions listed in the Operating Instructions and supplementary documentation.
- ▶ Using the nameplate, check whether the ordered device is permitted for the intended use in the hazardous area (e.g. explosion protection, pressure vessel safety).
- ▶ Use the measuring instrument only for media to which the process-wetted materials are sufficiently resistant.
- ▶ Keep within the specified pressure and temperature range.
- ▶ Keep within the specified ambient temperature range.
- ▶ Protect the measuring instrument permanently against corrosion from environmental influences.

#### Incorrect use

Non-designated use can compromise safety. The manufacturer is not liable for damage caused by improper or non-designated use.

#### **WARNING**

#### **Danger of breakage due to corrosive or abrasive fluids and ambient conditions!**

- ▶ Verify the compatibility of the process fluid with the sensor material.
- ▶ Ensure the resistance of all fluid-wetted materials in the process.
- ▶ Keep within the specified pressure and temperature range.

---

1) Not applicable for IO-Link measuring instruments

**NOTICE****Verification for borderline cases:**

- ▶ For special fluids and fluids for cleaning, Endress+Hauser is glad to provide assistance in verifying the corrosion resistance of fluid-wetted materials, but does not accept any warranty or liability as minute changes in the temperature, concentration or level of contamination in the process can alter the corrosion resistance properties.

**Residual risks****⚠ CAUTION****Risk of hot or cold burns! The use of media and electronics with high or low temperatures can produce hot or cold surfaces on the device.**

- ▶ Mount suitable touch protection.

**⚠ WARNING****Danger of housing breaking due to measuring tube breakage!**

If a measuring tube ruptures, the pressure inside the sensor housing will rise according to the operating process pressure.

- ▶ Use a rupture disk.

**⚠ WARNING****Danger from medium escaping!**

For device versions with a rupture disk: medium escaping under pressure can cause injury or material damage.

- ▶ Take precautions to prevent injury and material damage if the rupture disk is actuated.

## 2.3 Workplace safety

When working on and with the device:

- ▶ Wear the required personal protective equipment as per national regulations.

## 2.4 Operational safety

Damage to the device!

- ▶ Operate the device in proper technical condition and fail-safe condition only.
- ▶ The operator is responsible for the interference-free operation of the device.

**Modifications to the device**

Unauthorized modifications to the device are not permitted and can lead to unforeseeable dangers!

- ▶ If modifications are nevertheless required, consult with the manufacturer.

**Repair**

To ensure continued operational safety and reliability:

- ▶ Carry out repairs on the device only if they are expressly permitted.
- ▶ Observe federal/national regulations pertaining to the repair of an electrical device.
- ▶ Use only original spare parts and accessories.

## 2.5 Product safety

This measuring device is designed in accordance with good engineering practice to meet state-of-the-art safety requirements, has been tested, and left the factory in a condition in which it is safe to operate.

It meets general safety standards and legal requirements. It also complies with the EU directives listed in the device-specific EU Declaration of Conformity. The manufacturer confirms this by affixing the CE mark to the device..





## 2.6 IT security

The manufacturer warranty is valid only if the product is installed and used as described in the Operating Instructions. The product is equipped with security mechanisms to protect it against any inadvertent changes to the settings.

IT security measures, which provide additional protection for the product and associated data transfer, must be implemented by the operators themselves in line with their security standards.

## 2.7 Device-specific IT security

The device offers a range of specific functions to support protective measures on the operator's side. These functions can be configured by the user and guarantee greater in-operation safety if used correctly. The following list provides an overview of the most important functions:

Function/interface	Factory setting	Recommendation
Write protection via hardware write protection switch →  11	Not enabled	On an individual basis following risk assessment
Access code (also applies to web server login or FieldCare connection) →  12	Not enabled (0000)	Assign a customized access code during commissioning
WLAN (order option in display module)	Enabled	On an individual basis following risk assessment
WLAN security mode	Enabled (WPA2-PSK)	Do not change
WLAN passphrase (Password) →  12	Serial number	Assign an individual WLAN passphrase during commissioning
WLAN mode	Access point	On an individual basis following risk assessment
Web server →  12	Enabled	On an individual basis following risk assessment
Service interface CDI-RJ45 →  12	–	On an individual basis following risk assessment

### 2.7.1 Protecting access via hardware write protection

Write access to the parameters of the device via the local display, web browser or operating tool (e.g. FieldCare, DeviceCare) can be disabled via a write protection switch (DIP switch on the main electronics module). When hardware write protection is enabled, only read access to the parameters is possible.

Hardware write protection is disabled when the device is delivered →  169.

### 2.7.2 Protecting access via a password

Different passwords are available to protect write access to the device parameters or access to the device via the WLAN interface.

- **User-specific access code**  
Protect write access to the device parameters via the local display, web browser or operating tool (e.g. FieldCare, DeviceCare). Access authorization is clearly regulated through the use of a user-specific access code.
- **WLAN passphrase**  
The network key protects a connection between an operating unit (e.g. notebook or tablet) and the device via the WLAN interface which can be ordered as an option.
- **Infrastructure mode**  
When the device is operated in infrastructure mode, the WLAN passphrase corresponds to the WLAN passphrase configured on the operator side.

### User-specific access code

Write access to the device parameters via the local display, web browser or operating tool (e.g. FieldCare, DeviceCare) can be protected by the modifiable, user-specific access code (→  167).

When the device is delivered, the device does not have an access code and is equivalent to 0000 (open).

### WLAN passphrase: Operation as WLAN access point

A connection between an operating unit (e.g. notebook or tablet) and the device via the WLAN interface (→  93), which can be ordered as an optional extra, is protected by the network key. The WLAN authentication of the network key complies with the IEEE 802.11 standard.

When the device is delivered, the network key is pre-defined depending on the device. It can be changed via the **WLAN settings** submenu in the **WLAN passphrase** parameter (→  161).

### Infrastructure mode

A connection between the device and WLAN access point is protected by means of an SSID and passphrase on the system side. Please contact the relevant system administrator for access.

### General notes on the use of passwords

- The access code and network key supplied with the device should be changed during commissioning for safety reasons.
- Follow the general rules for generating a secure password when defining and managing the access code and network key.
- The user is responsible for the management and careful handling of the access code and network key.
- For information on configuring the access code or on what to do if you lose the password, for example, see "Write protection via access code" →  167.

## 2.7.3 Access via web server

The integrated web server can be used to operate and configure the device via a web browser →  83. The connection is established via the service interface (CDI-RJ45), the terminal connection for signal transmission with EtherNet/IP (RJ45 plug) or the WLAN interface.

The web server is enabled when the device is delivered. The web server can be disabled via the **Web server functionality** parameter if necessary (e.g., after commissioning).

The device and status information can be hidden on the login page. This prevents unauthorized access to the information.



Detailed information on the device parameters:  
"Description of device parameters" document .

## 2.7.4 Access via service interface (CDI-RJ45)



The device can be connected to a network via the service interface (CDI-RJ45). Device-specific functions guarantee the secure operation of the device in a network.

The use of relevant industrial standards and guidelines that have been defined by national and international safety committees, such as IEC/ISA62443 or the IEEE, is recommended.

This includes organizational security measures such as the assignment of access authorization as well as technical measures such as network segmentation.

 Transmitters with an Ex de approval may not be connected via the service interface (CDI-RJ45)!

Order code for "Approval transmitter + sensor", options (Ex de): BA, BB, C1, C2, GA, GB, MA, MB, NA, NB BB, C2, GB, MB, NB

 The device can be integrated into a ring topology. The device is integrated via the terminal connection for signal transmission (output 1) and the connection to the service interface (CDI-RJ45) →  60 or →  51.

## 3 Product description

The measuring system consists of a transmitter and a sensor. The transmitter and sensor are mounted in physically separate locations. They are interconnected by connecting cables.

### 3.1 Product design

Two versions of the transmitter are available.

#### 3.1.1 Proline 500 – digital

Signal transmission: digital

Order code for "Integrated ISEM electronics", option **A** "Sensor"

For use in applications not required to meet special requirements due to ambient or operating conditions.

As the electronics are located in the sensor, the device is ideal:

For simple transmitter replacement.

- A standard cable can be used as the connecting cable.
- Not sensitive to external EMC interference.

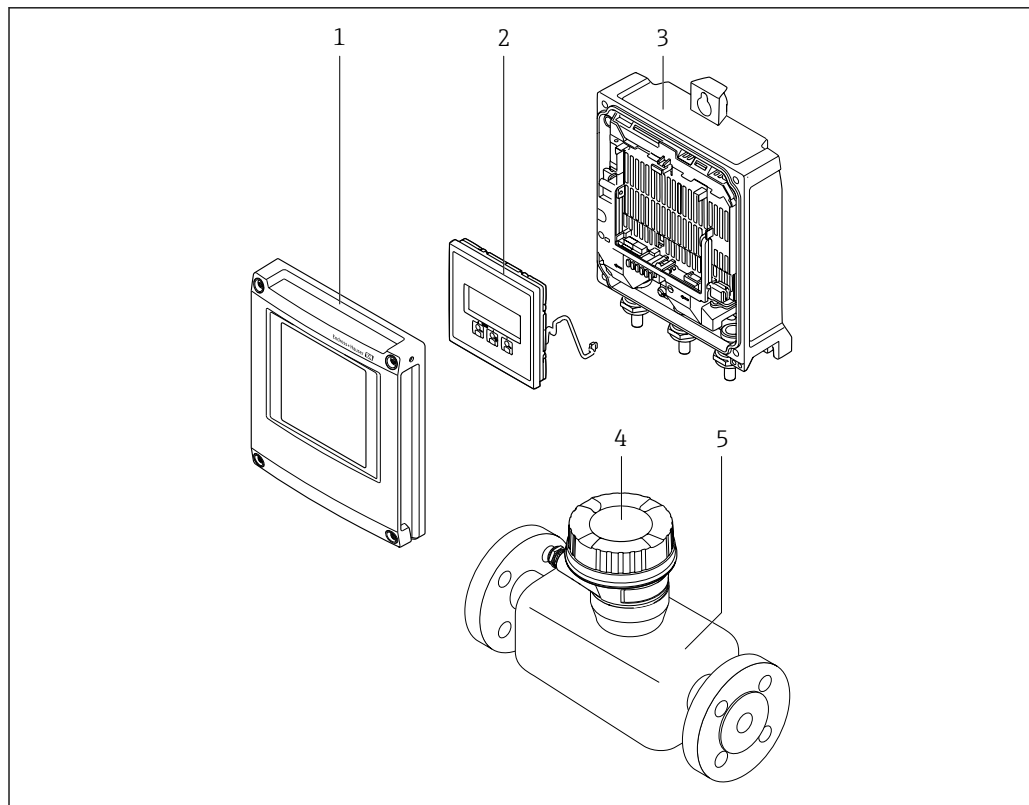

A0029593

#### 1 Important components of a measuring device

- 1 Electronics compartment cover
- 2 Display module
- 3 Transmitter housing
- 4 Sensor connection housing with integrated ISEM electronics: connecting cable connection
- 5 Sensor

### 3.1.2 Proline 500

Signal transmission: analog

Order code for "Integrated ISEM electronics", option **B** "Transmitter"

For use in applications required to meet special requirements due to ambient or operating conditions.

As the electronics are located in the transmitter, the device is ideal in the event of:

- Strong vibrations at the sensor.
- Sensor operation in underground installations.
- Permanent sensor immersion in water.

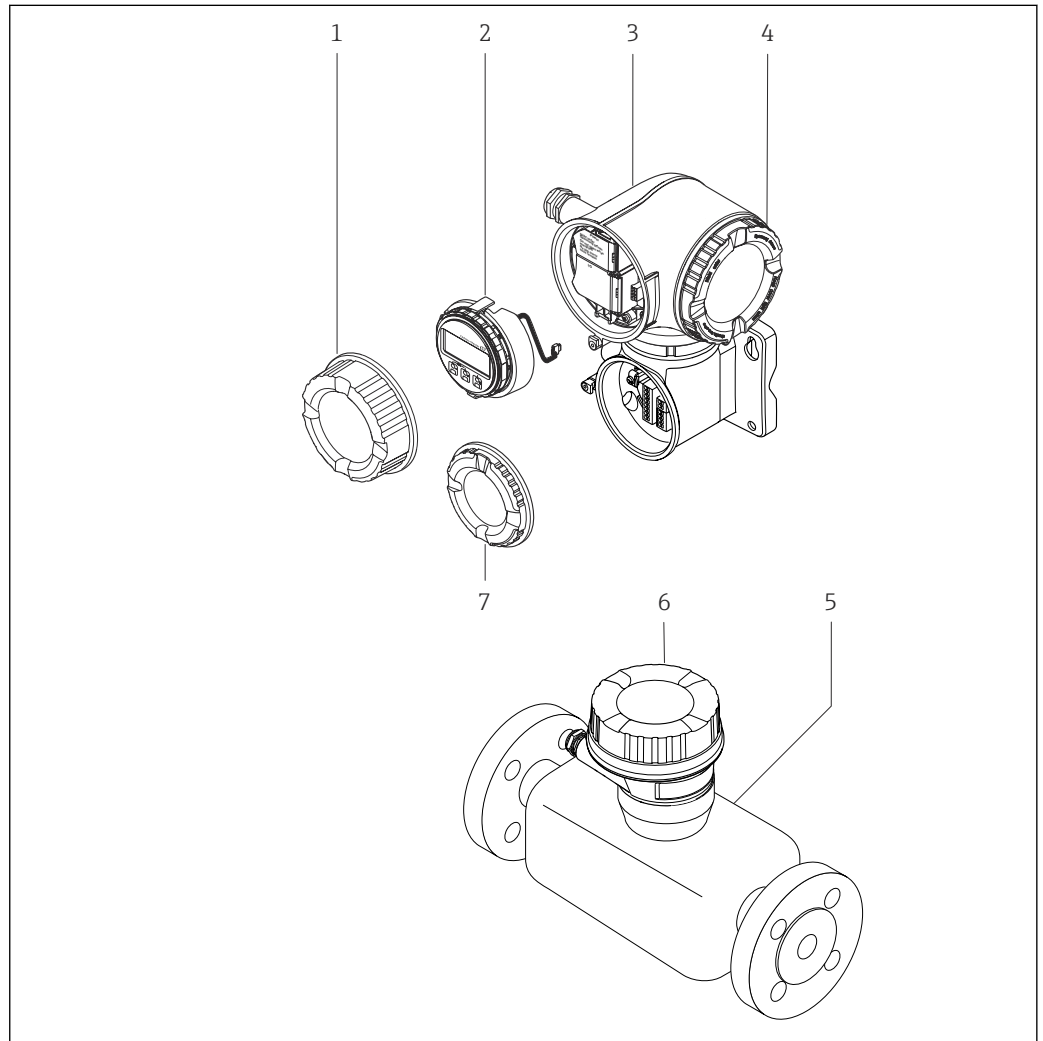

A0029589

#### 2 Important components of a measuring device

- 1 Connection compartment cover
- 2 Display module
- 3 Transmitter housing with integrated ISEM electronics
- 4 Electronics compartment cover
- 5 Sensor
- 6 Sensor connection housing: connecting cable connection
- 7 Connection compartment cover: connecting cable connection

## 4 Incoming acceptance and product identification

### 4.1 Incoming acceptance

On receipt of the delivery:

1. Check the packaging for damage.
  - ↳ Report all damage immediately to the manufacturer.  
Do not install damaged components.
2. Check the scope of delivery using the delivery note.
3. Compare the data on the nameplate with the order specifications on the delivery note.
4. Check the technical documentation and all other necessary documents, e.g. certificates, to ensure they are complete.

 If one of the conditions is not satisfied, contact the manufacturer.

### 4.2 Product identification

The device can be identified in the following ways:

- Nameplate
- Order code with details of the device features on the delivery note
- Enter the serial numbers from the nameplates in the *Device Viewer* ([www.endress.com/deviceviewer](http://www.endress.com/deviceviewer)): all the information about the device is displayed.
- Enter the serial numbers from the nameplates into the *Endress+Hauser Operations app* or scan the DataMatrix code on the nameplate with the *Endress+Hauser Operations app*: all the information about the device is displayed.

For an overview of the scope of the associated Technical Documentation, refer to the following:

- The "Additional standard device documentation" and "Supplementary device-dependent documentation" sections
- The *Device Viewer*: Enter the serial number from the nameplate ([www.endress.com/deviceviewer](http://www.endress.com/deviceviewer))
- The *Endress+Hauser Operations app*: Enter the serial number from the nameplate or scan the DataMatrix code on the nameplate.



## 4.2.1 Transmitter nameplate

### Proline 500 – digital



3 Example of a transmitter nameplate

- 1 Name of the transmitter
- 2 Manufacturer address/certificate holder
- 3 Space for approvals: Use in hazardous areas
- 4 Degree of protection
- 5 Electrical connection data: available inputs and outputs
- 6 Allowable ambient temperature ( $T_a$ )
- 7 2-D matrix code
- 8 Space for approvals and certificates: e.g. CE mark, RCM tick
- 9 Permitted temperature range for cable
- 10 Date of manufacture: year-month
- 11 Firmware version (FW) and device revision (Dev. rev.) from the factory
- 12 Document number of safety-related supplementary documentation
- 13 Space for additional information in the case of special products
- 14 Available inputs and outputs, supply voltage
- 15 Electrical connection data: supply voltage
- 16 Extended order code (Ext. ord. cd.)
- 17 Serial number (Ser. no.)
- 18 Order code

**Proline 500**

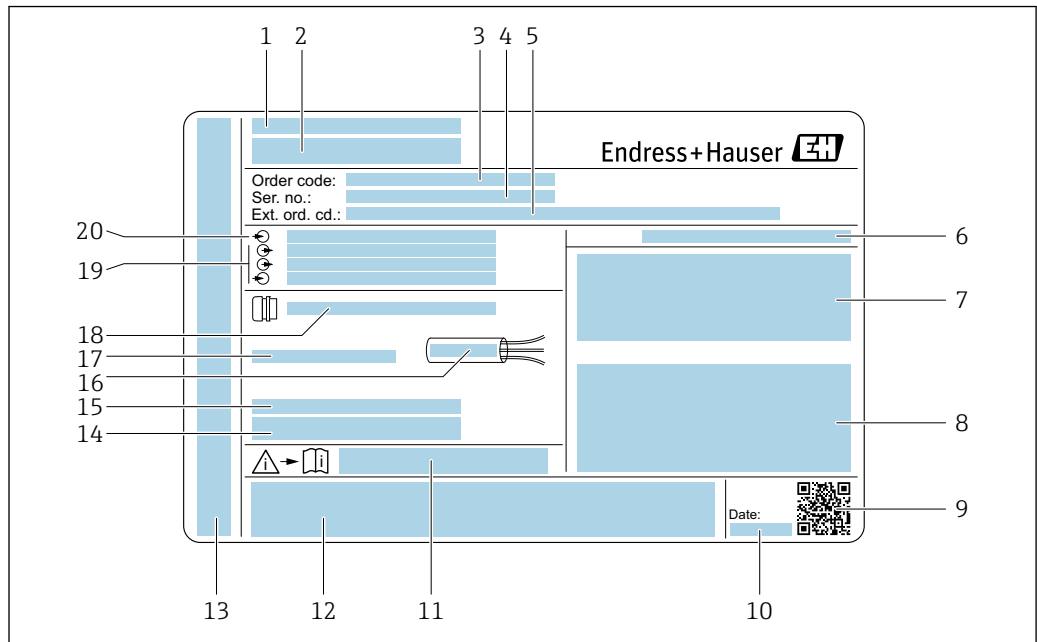

A0029192

**4** Example of a transmitter nameplate

- 1 Manufacturer address/certificate holder
- 2 Name of the transmitter
- 3 Order code
- 4 Serial number (Ser. no.)
- 5 Extended order code (Ext. ord. cd.)
- 6 Degree of protection
- 7 Space for approvals: use in hazardous areas
- 8 Electrical connection data: available inputs and outputs
- 9 2-D matrix code
- 10 Date of manufacture: year-month
- 11 Document number of safety-related supplementary documentation
- 12 Space for approvals and certificates: e.g. CE mark, RCM tick
- 13 Space for degree of protection of connection and electronics compartment when used in hazardous areas
- 14 Firmware version (FW) and device revision (Dev. rev.) from the factory
- 15 Space for additional information in the case of special products
- 16 Permitted temperature range for cable
- 17 Allowable ambient temperature ( $T_a$ )
- 18 Information on cable gland
- 19 Available inputs and outputs, supply voltage
- 20 Electrical connection data: supply voltage

### 4.2.2 Sensor nameplate

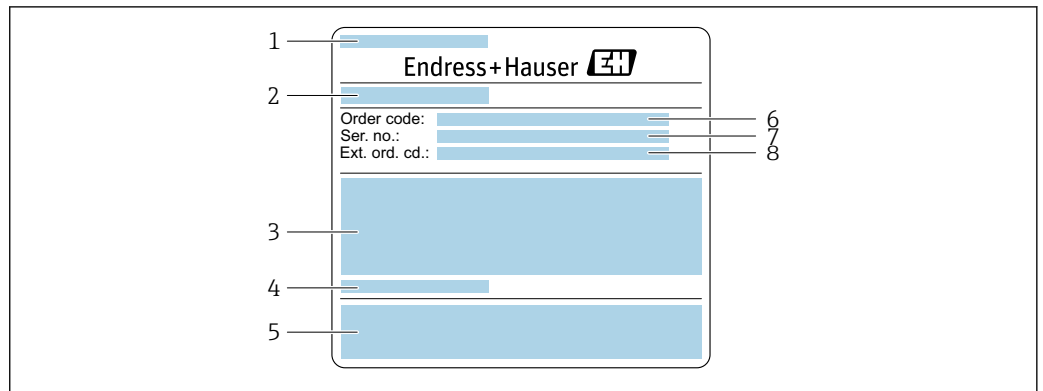

A0029206

5 Example of a sensor nameplate, part 1

- 1 Name of the sensor
- 2 Manufacturer address/certificate holder
- 3 Nominal diameter of the sensor; flange nominal diameter/nominal pressure; sensor test pressure; medium temperature range; material of measuring tube and manifold
- 4 Sensor-specific information
- 5 CE mark, RCM-Tick mark
- 6 Order code
- 7 Serial number (Ser. no.)
- 8 Extended order code (Ext. ord. cd.)

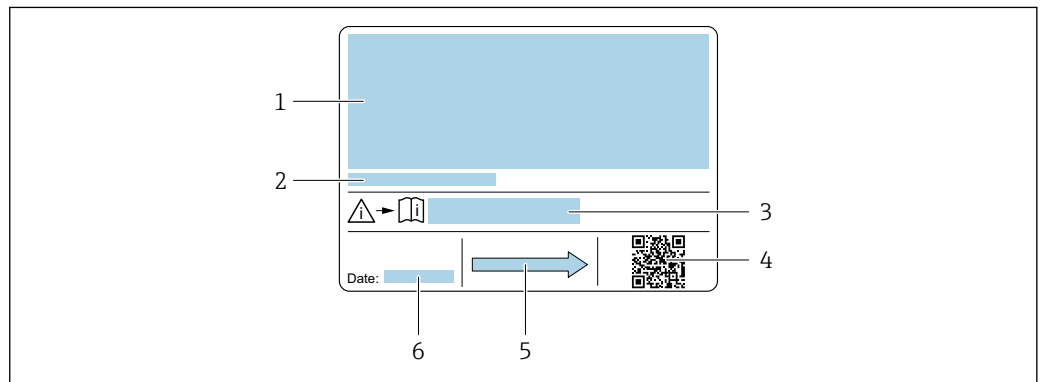

A0029207

6 Example of a sensor nameplate, part 2

- 1 Approval information for explosion protection, Pressure Equipment Directive and degree of protection
- 2 Allowable ambient temperature ( $T_a$ )
- 3 Document number of safety-related supplementary documentation
- 4 2-D matrix code
- 5 Flow direction
- 6 Date of manufacture: year-month





#### Order code

The measuring device is reordered using the order code.

#### Extended order code

- The device type (product root) and basic specifications (mandatory features) are always listed.
- Of the optional specifications (optional features), only the safety and approval-related specifications are listed (e.g. LA). If other optional specifications are also ordered, these are indicated collectively using the # placeholder symbol (e.g. #LA#).
- If the ordered optional specifications do not include any safety and approval-related specifications, they are indicated by the + placeholder symbol (e.g. XXXXXX-ABCDE+).

### 4.2.3 Symbols on the device

Symbol	Meaning
	<b>WARNING!</b> This symbol alerts you to a dangerous situation. Failure to avoid this situation can result in serious or fatal injury. Please consult the documentation for the measuring instrument to discover the type of potential danger and measures to avoid it.
	<b>Reference to documentation</b> Refers to the corresponding device documentation.
	<b>Protective ground connection</b> A terminal that must be connected to the ground prior to establishing any other connections.

## 5 Storage and transport

### 5.1 Storage conditions

Observe the following notes for storage:

- ▶ Store in the original packaging to ensure protection from shock.
- ▶ Do not remove protective covers or protective caps installed on process connections. They prevent mechanical damage to the sealing surfaces and contamination in the measuring tube.
- ▶ Protect from direct sunlight. Avoid unacceptably high surface temperatures.
- ▶ Store in a dry and dust-free place.
- ▶ Do not store outdoors.

Storage temperature →  245

### 5.2 Transporting the product

Transport the measuring device to the measuring point in the original packaging.



A0029252

-  Do not remove protective covers or caps installed on process connections. They prevent mechanical damage to the sealing surfaces and contamination in the measuring tube.

#### 5.2.1 Measuring devices without lifting lugs

##### WARNING

**Center of gravity of the measuring device is higher than the suspension points of the webbing slings.**

Risk of injury if the measuring device slips.

- ▶ Secure the measuring device against slipping or turning.
- ▶ Observe the weight specified on the packaging (stick-on label).



A0029214

## 5.2.2 Measuring devices with lifting lugs

### ⚠ CAUTION

#### Special transportation instructions for devices with lifting lugs

- ▶ Only use the lifting lugs fitted on the device or flanges to transport the device.
- ▶ The device must always be secured at two lifting lugs at least.

## 5.2.3 Transporting with a fork lift

If transporting in wood crates, the floor structure enables the crates to be lifted lengthwise or at both sides using a forklift.

## 5.3 Packaging disposal

All packaging materials are environmentally friendly and 100% recyclable:

- Outer packaging of device
  - Stretch wrap made of polymer in accordance with EU Directive 2002/95/EC (RoHS)
- Packaging
  - Wood crate treated in accordance with ISPM 15 standard, confirmed by IPPC logo
  - Cardboard box in accordance with European packaging guideline 94/62/EC, recyclability confirmed by Resy symbol
- Transport material and fastening fixtures
  - Disposable plastic pallet
  - Plastic straps
  - Plastic adhesive strips
- Filler material
  - Paper pads

## 6 Installation

### 6.1 Mounting requirements

#### 6.1.1 Installation position

##### Installation point

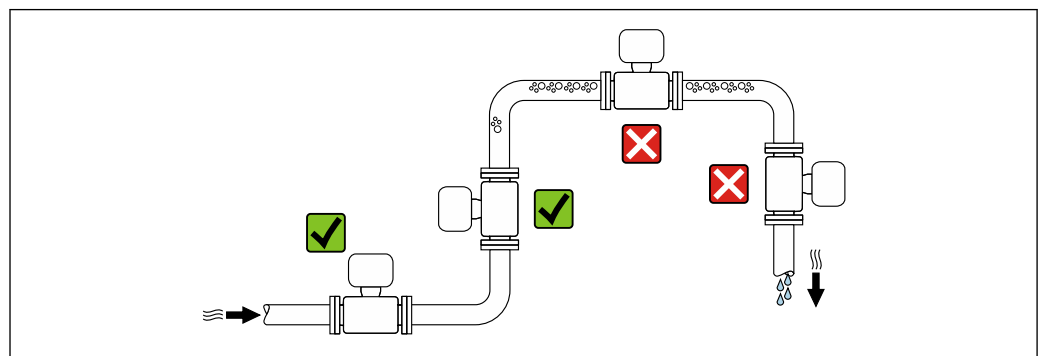

To prevent measuring errors arising from accumulation of gas bubbles in the measuring pipe, avoid the following mounting locations in the piping:

- Highest point of a pipeline.
- Directly upstream of a free pipe outlet in a down pipe.

*Installation in down pipes*

However, the following installation suggestion allows for installation in an open vertical pipeline. Pipe restrictions or the use of an orifice with a smaller cross-section than the nominal diameter prevent the sensor running empty while measurement is in progress.

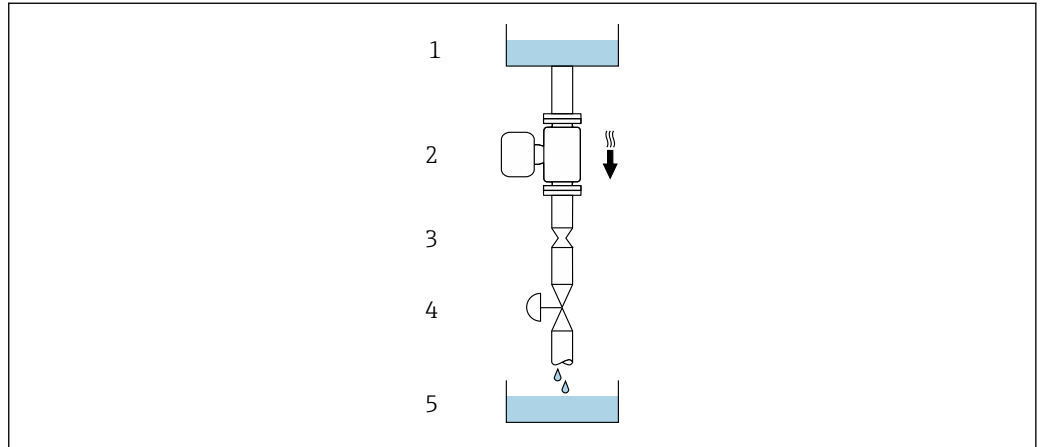

A0028773

**7** Installation in a down pipe (e.g. for batching applications)





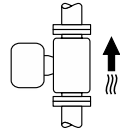
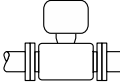

- 1 Supply tank
- 2 Sensor
- 3 Orifice plate, pipe restriction
- 4 Valve
- 5 Filling vessel

DN		Ø orifice plate, pipe restriction	
[mm]	[in]	[mm]	[in]
8	3/8	6	0.24
15	1/2	10	0.40
25	1	14	0.55
40	1 1/2	22	0.87
50	2	28	1.10
80	3	50	1.97

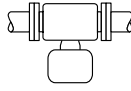
**Orientation**

The direction of the arrow on the sensor nameplate helps you to install the sensor according to the flow direction (direction of medium flow through the piping).

Orientation		Recommendation
<b>A</b>	Vertical orientation	 <small>A0015591</small> ☑☑ <sup>1)</sup>
<b>B</b>	Horizontal orientation, transmitter at top	 <small>A0015589</small> ☑☑ <sup>2)</sup> Exception: → ☑ 8, ☑ 24

Orientation		Recommendation
<b>C</b>	Horizontal orientation, transmitter at bottom	 <small>A0015590</small>   <sup>3)</sup> Exception: →  , 
<b>D</b>	Horizontal orientation, transmitter at side	 <small>A0015592</small> 

- 1) This orientation is recommended to ensure self-draining.
- 2) Applications with low process temperatures may reduce the ambient temperature. To maintain the minimum ambient temperature for the transmitter, this orientation is recommended.
- 3) Applications with high process temperatures may increase the ambient temperature. To maintain the maximum ambient temperature for the transmitter, this orientation is recommended.

If a sensor is installed horizontally with a curved measuring tube, match the position of the sensor to the fluid properties.

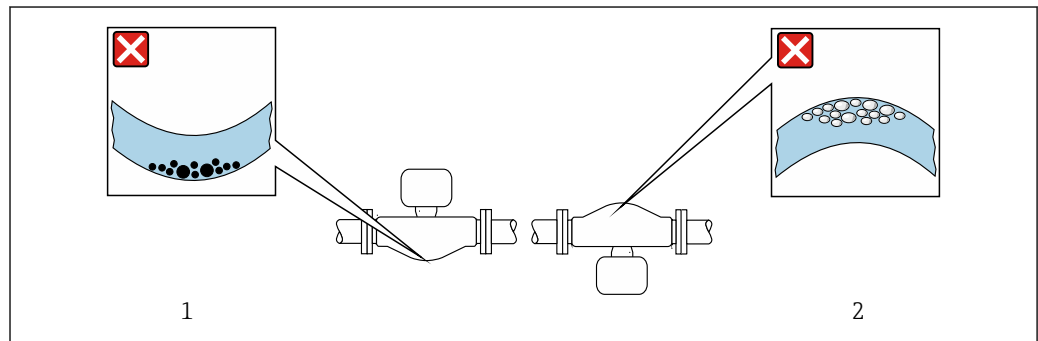

A0028774

 **8** Orientation of sensor with curved measuring tube

- 1 Avoid this orientation for fluids with entrained solids: Risk of solids accumulating
- 2 Avoid this orientation for outgassing fluids: Risk of gas accumulating

### Inlet and outlet runs

No special precautions need to be taken for fittings that create turbulence, such as valves, elbows or T-pieces, as long as no cavitation occurs →  25.

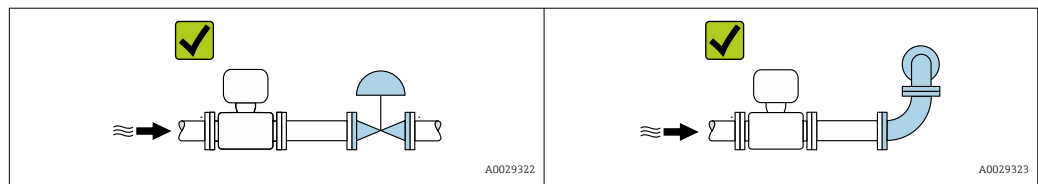

A0029322

A0029323

### Installation dimensions



 For the dimensions and installation lengths of the device, see the "Technical Information" document, "Mechanical construction" section



## 6.1.2 Environmental and process requirements

### Ambient temperature range

Measuring device	<ul style="list-style-type: none"> <li>■ -40 to +60 °C (-40 to +140 °F)</li> <li>■ Order code for "Test, certificate", option JP: -50 to +60 °C (-58 to +140 °F)</li> </ul>
Readability of the local display	-20 to +60 °C (-4 to +140 °F) The readability of the display may be impaired at temperatures outside the temperature range.

 Dependency of ambient temperature on medium temperature →  247

- ▶ If operating outdoors:  
Avoid direct sunlight, particularly in warm climatic regions.

### Static pressure

It is important that cavitation does not occur, or that gases entrained in the liquids do not outgas.

Cavitation is caused if the pressure drops below the vapor pressure:

- In liquids that have a low boiling point (e.g. hydrocarbons, solvents, liquefied gases)
- In suction lines
- ▶ Ensure the static pressure is sufficiently high to prevent cavitation and outgassing.

For this reason, the following mounting locations are recommended:

- At the lowest point in a vertical pipe
- Downstream from pumps (no danger of vacuum)

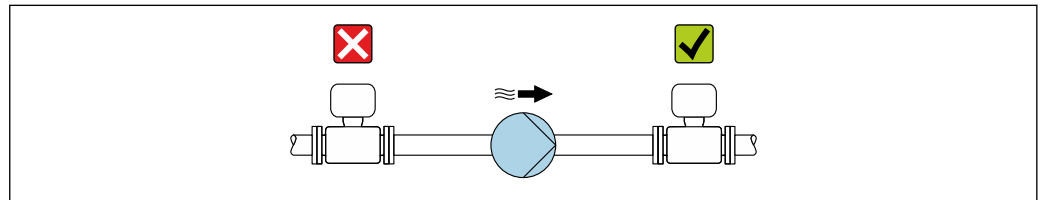

A0028777

### Thermal insulation

In the case of some fluids, it is important to keep the heat radiated from the sensor to the transmitter to a low level. A wide range of materials can be used for the required insulation.

#### NOTICE

#### Electronics overheating on account of thermal insulation!

- ▶ Recommended orientation: horizontal orientation, sensor connection housing pointing downwards.
- ▶ Do not insulate the sensor connection housing.
- ▶ Maximum permissible temperature at the lower end of the sensor connection housing: 80 °C (176 °F)
- ▶ Regarding thermal insulation with an exposed extended neck: We advise against insulating the extended neck to ensure optimal heat dissipation.

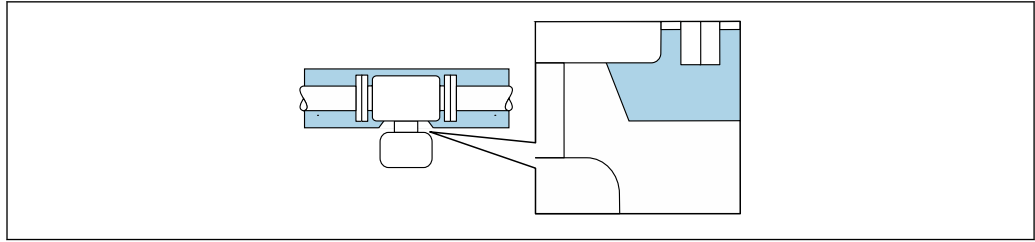

A0034391

9 Thermal insulation with exposed extended neck

## Heating

### NOTICE

#### Electronics can overheat due to elevated ambient temperature!

- ▶ Observe maximum permitted ambient temperature for the transmitter.
- ▶ Depending on the medium temperature, take the device orientation requirements into account.

### NOTICE

#### Danger of overheating when heating

- ▶ Ensure that the temperature at the lower end of the transmitter housing does not exceed 80 °C (176 °F).
- ▶ Ensure that sufficient convection takes place at the transmitter neck.
- ▶ Ensure that a sufficiently large area of the transmitter neck remains exposed. The uncovered part serves as a radiator and protects the electronics from overheating and excessive cooling.
- ▶ When using in potentially explosive atmospheres, observe the information in the device-specific Ex documentation. For detailed information on the temperature tables, see the separate document entitled "Safety Instructions" (XA) for the device.
- ▶ Consider the "830 ambient temperature too high" and "832 electronics temperature too high" process diagnostics if overheating cannot be ruled out based on a suitable system design.

### Heating options

If a fluid requires that no heat loss should occur at the sensor, users can avail of the following heating options:

- Electrical heating, e.g. with electric band heaters <sup>2)</sup>
- Via pipes carrying hot water or steam
- Via heating jackets

## Vibrations

The high oscillation frequency of the measuring tubes ensures that the correct operation of the measuring system is not influenced by plant vibrations.

### 6.1.3 Special installation instructions

#### Drainability

When installed vertically, the measuring tubes can be drained completely and protected against buildup.

2) The use of parallel electric band heaters is generally recommended (bidirectional electricity flow). Particular considerations must be made if a single-wire heating cable is to be used. For additional information, refer to EA01339D "Installation Instructions for Electrical Trace Heating Systems".

### Hygienic compatibility

**i** When installing in hygienic applications, please refer to the information in the "Certificates and approvals/hygienic compatibility" section → 256

### Rupture disk

Process-related information: → 248.

#### **⚠ WARNING**

#### **Danger from medium escaping!**

Medium escaping under pressure can cause injury or material damage.

- ▶ Take precautions to prevent danger to persons and damage if the rupture disk is actuated.
- ▶ Observe the information on the rupture disk sticker.
- ▶ Make sure that the function and operation of the rupture disk is not impeded through the installation of the device.
- ▶ Do not use a heating jacket.
- ▶ Do not remove or damage the rupture disk.
  
- ▶ After the rupture disk is actuated, do not operate the measuring device any more.

The position of the rupture disk is indicated on a sticker applied over it. If the rupture disk is triggered, the sticker is destroyed. The disk can therefore be visually monitored.

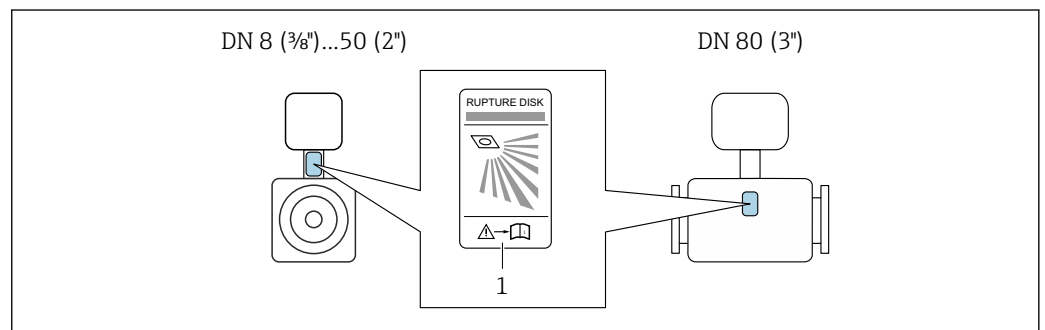

1 Rupture disk label

### Zero verification and zero adjustment

All measuring instruments are calibrated in accordance with state-of-the-art technology. Calibration takes place under reference conditions → 241. Therefore, a zero adjustment in the field is generally not required.

Experience shows that zero adjustment is advisable only in special cases:

- To achieve maximum measurement accuracy even with low flow rates.
- Under extreme process or operating conditions (e.g. very high process temperatures or very high-viscosity fluids).
- For gas applications with low pressure

**i** To achieve the highest possible measurement accuracy at low flow rates, the installation must protect the sensor from mechanical stresses during operation.

To get a representative zero point, ensure that:

- any flow in the device is prevented during the adjustment
- the process conditions (e.g. pressure, temperature) are stable and representative

Verification and adjustment cannot be carried out if the following process conditions are present:

- Gas pockets

Ensure that the system has been sufficiently flushed with the medium. Repeat flushing can help to eliminate gas pockets

- Thermal circulation

In the event of temperature differences (e.g. between the measuring tube inlet and outlet section), induced flow can occur even if the valves are closed due to thermal circulation in the device

- Leaks at the valves

If the valves are not leak-tight, flow is not sufficiently prevented when determining the zero point

If these conditions cannot be avoided, it is advisable to keep the factory setting for the zero point.

### Weather protection cover

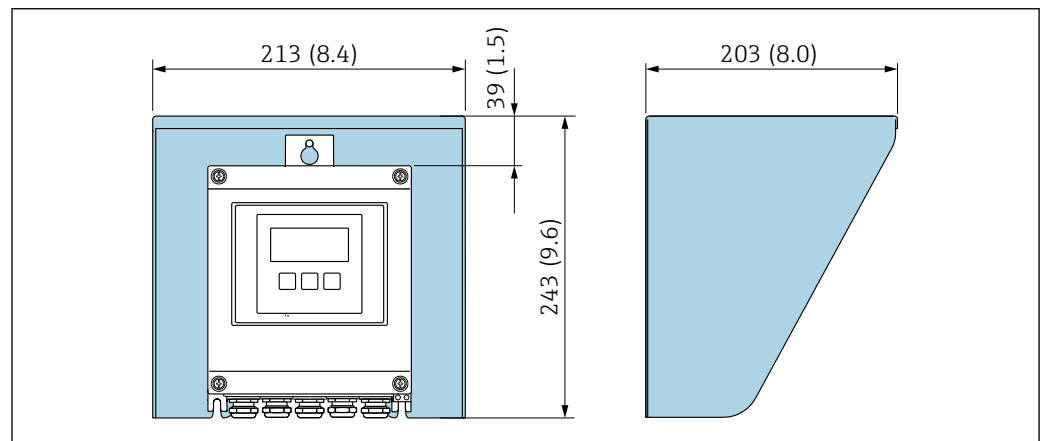

A0029552

10 Weather protection cover for Proline 500 – digital; engineering unit mm (in)

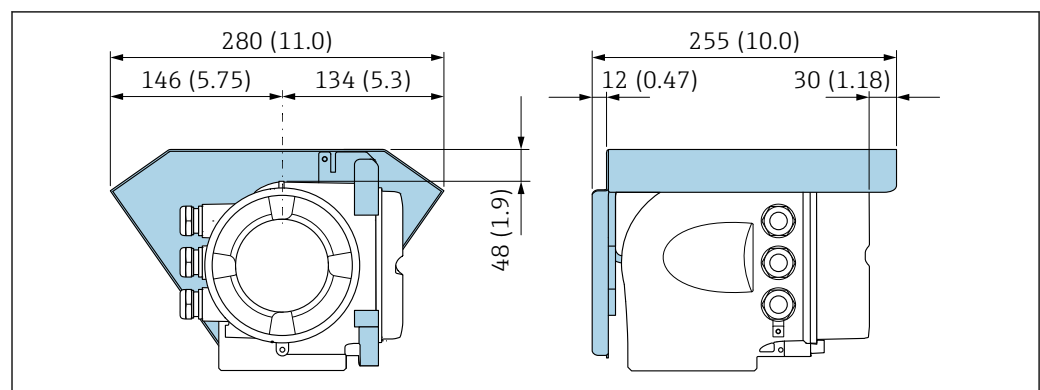

A0029553

11 Weather protection cover for Proline 500; engineering unit mm (in)

### Cover locking: Proline 500

#### NOTICE

**Order code "Transmitter housing", option L "Cast, stainless": The covers of the transmitter housing are provided with a borehole to lock the cover.**

The cover can be locked using screws and a chain or cable provided by the customer on site.

- ▶ The use of stainless steel chains or cables is recommended.
- ▶ If a protective coating is applied, it is recommended to use a heat shrink tube to protect the housing paint.

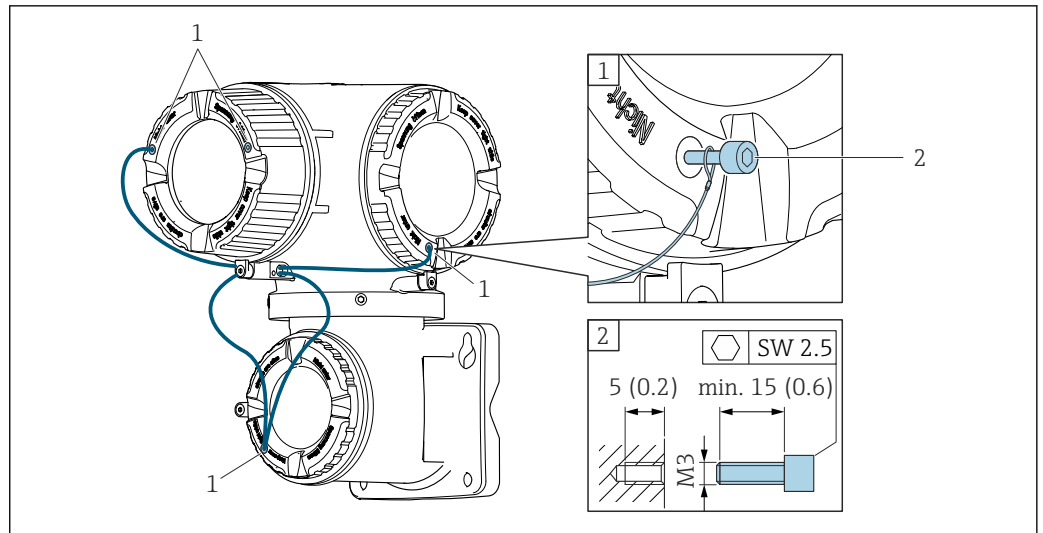

A0029799

- 1 Cover borehole for the securing screw  
 2 Securing screw to lock the cover

## 6.2 Installing the measuring instrument

### 6.2.1 Required tools

#### For transmitter

For mounting on a post:

- Proline 500 – digital transmitter
  - Open-ended wrench AF 10
  - Torx screwdriver TX 25
- Proline 500 transmitter
  - Open-ended wrench AF 13

For wall mounting:

Drill with drill bit  $\varnothing$  6.0 mm

#### For sensor

For flanges and other process connections: Use a suitable mounting tool.

### 6.2.2 Preparing the measuring instrument

1. Remove all remaining transport packaging.
2. Remove any protective covers or protective caps present from the sensor.
3. If present, remove transport protection of the rupture disk.
4. Remove stick-on label on the electronics compartment cover.

### 6.2.3 Mounting the measuring device

#### **⚠ WARNING**

#### **Danger due to improper process sealing!**

- ▶ Ensure that the inside diameters of the gaskets are greater than or equal to that of the process connections and piping.
- ▶ Ensure that the seals are clean and undamaged.
- ▶ Secure the seals correctly.

1. Ensure that the direction of the arrow on the nameplate of the sensor matches the flow direction of the medium.
2. Install the measuring device or turn the transmitter housing so that the cable entries do not point upwards.

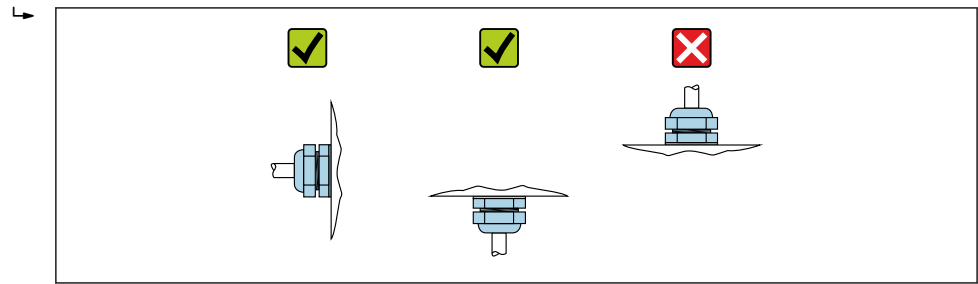

A0029263

#### 6.2.4 Mounting the transmitter housing: Proline 500 – digital

##### ⚠ CAUTION

##### Ambient temperature too high!

Danger of electronics overheating and housing deformation.

- ▶ Do not exceed the permitted maximum ambient temperature.
- ▶ If operating outdoors: Avoid direct sunlight and exposure to weathering, particularly in warm climatic regions.

##### ⚠ CAUTION

##### Excessive force can damage the housing!

- ▶ Avoid excessive mechanical stress.

The transmitter can be mounted in the following ways:

- Post mounting
- Wall mounting

##### Pipe mounting

Required tools:

- Open-ended wrench AF 10
- Torx screwdriver TX 25

##### NOTICE

##### Excessive tightening torque applied to the fixing screws!

Risk of damaging the plastic transmitter.

- ▶ Tighten the fixing screws as per the tightening torque: 2.5 Nm (1.8 lbf ft)

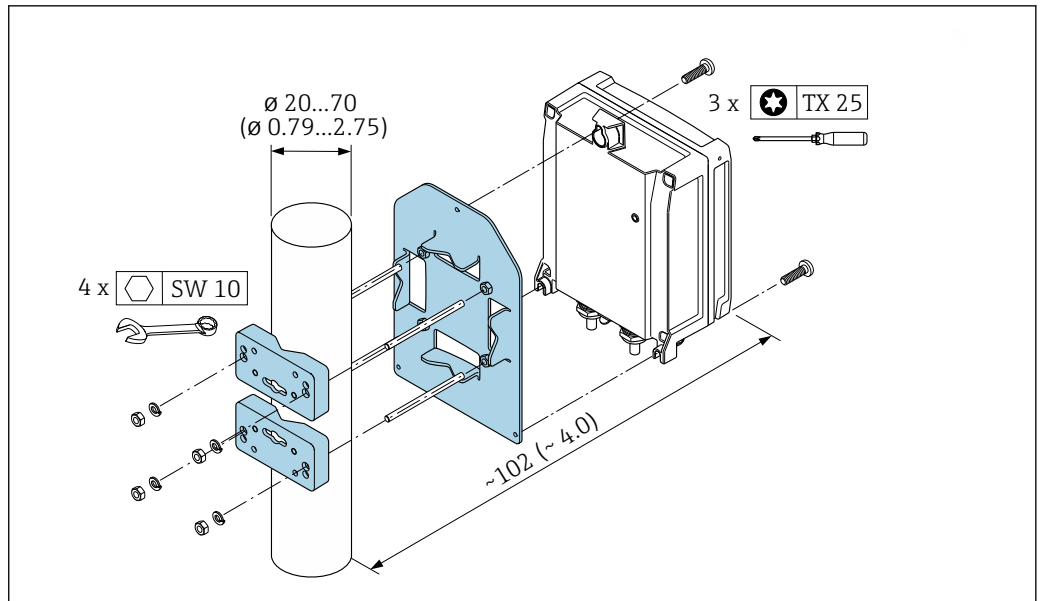

A0029051

12 Unit mm (in)

### Wall mounting

Required tools:

Drill with drill bit  $\varnothing 6.0$  mm

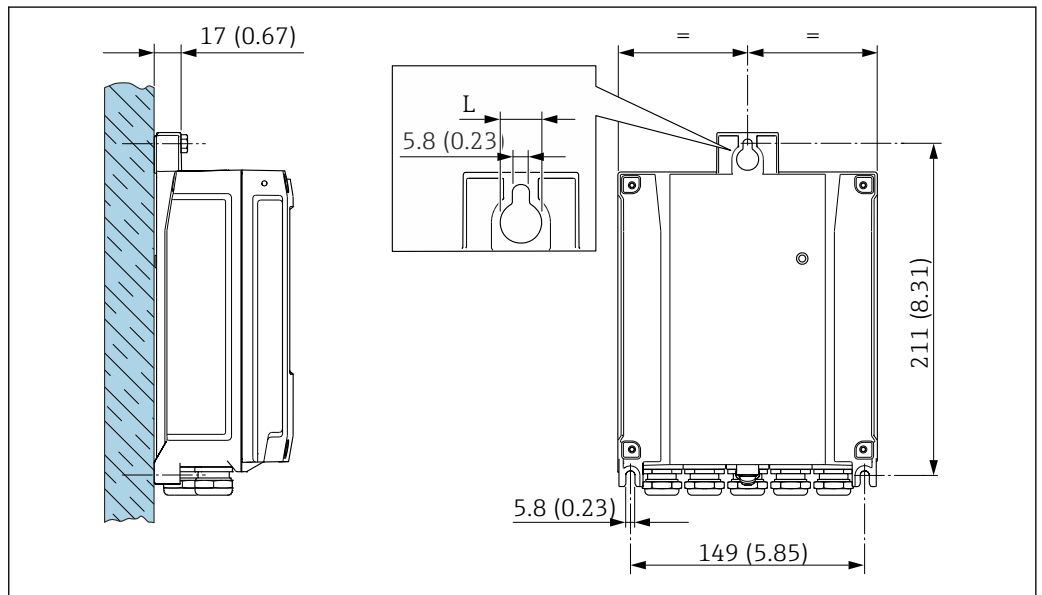

A0029054

13 Engineering unit mm (in)

L Depends on order code for "Transmitter housing"

Order code for "Transmitter housing"

- Option A, aluminum, coated: L = 14 mm (0.55 in)
- Option D, polycarbonate: L = 13 mm (0.51 in)

1. Drill the holes.
2. Insert wall plugs into the drilled holes.
3. Screw in the fixing screws slightly.
4. Fit the transmitter housing over the fixing screws and mount in place.

5. Tighten the fixing screws.

### 6.2.5 Mounting the transmitter housing: Proline 500

#### ⚠ CAUTION

##### Ambient temperature too high!

Danger of electronics overheating and housing deformation.

- ▶ Do not exceed the permitted maximum ambient temperature.
- ▶ If operating outdoors: Avoid direct sunlight and exposure to weathering, particularly in warm climatic regions.

#### ⚠ CAUTION

##### Excessive force can damage the housing!

- ▶ Avoid excessive mechanical stress.

The transmitter can be mounted in the following ways:

- Post mounting
- Wall mounting

#### Wall mounting

Required tools

Drill with drill bit  $\varnothing$  6.0 mm

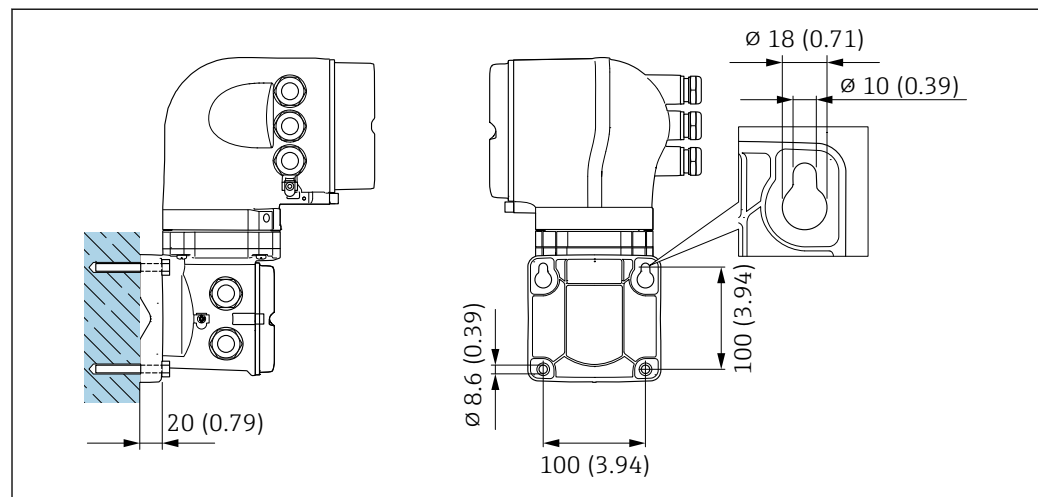

14 Engineering unit mm (in)

1. Drill the holes.
2. Insert wall plugs into the drilled holes.
3. Screw in the fixing screws slightly.
4. Fit the transmitter housing over the fixing screws and mount in place.
5. Tighten the fixing screws.

#### Pipe mounting

Required tools

Open-ended wrench AF 13



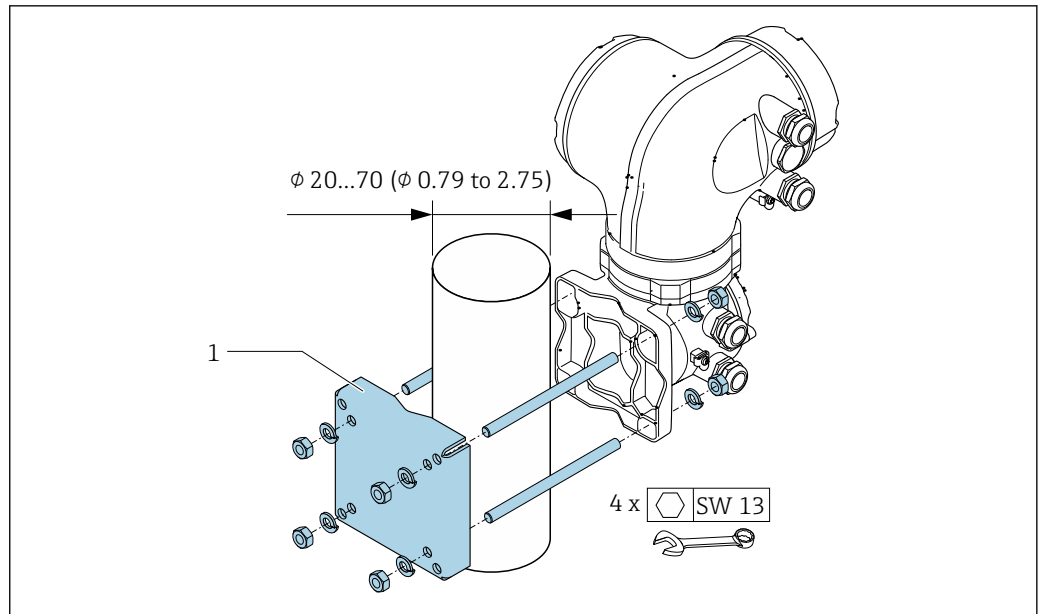

15 Engineering unit mm (in)

### 6.2.6 Turning the transmitter housing: Proline 500

To provide easier access to the connection compartment or display module, the transmitter housing can be turned.

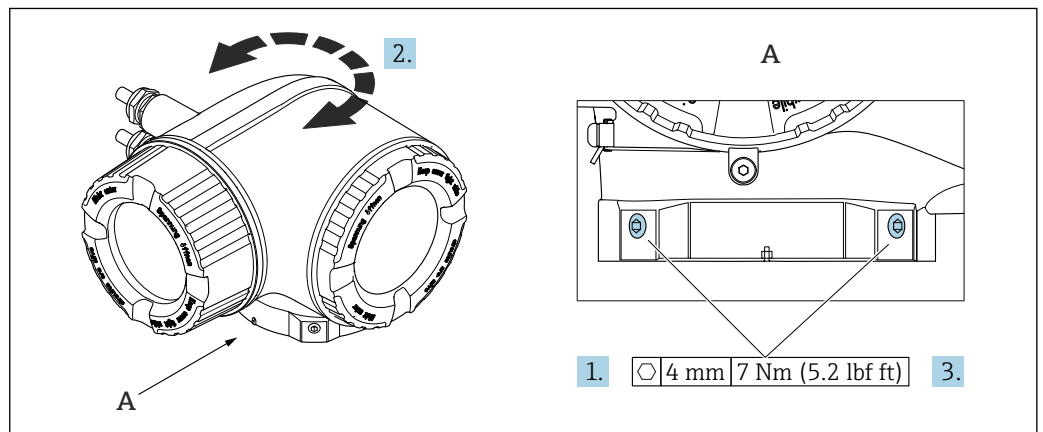

16 Ex housing

1. Loosen the fixing screws.
2. Turn the housing to the desired position.
3. Tighten the securing screws.

### 6.2.7 Turning the display module: Proline 500

The display module can be turned to optimize display readability and operability.

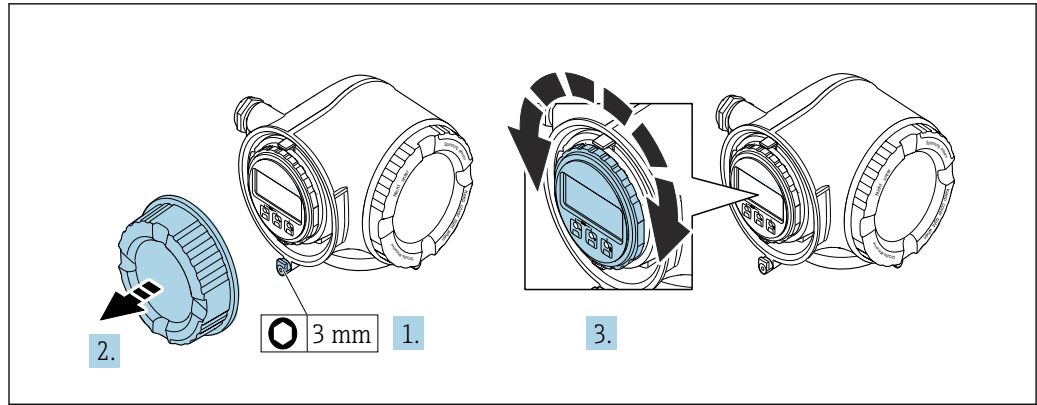

1. Depending on the device version: Loosen the securing clamp of the connection compartment cover.
2. Unscrew the connection compartment cover.
3. Turn the display module to the desired position: max.  $8 \times 45^\circ$  in each direction.
4. Screw on the connection compartment cover.
5. Depending on the device version: Attach the securing clamp of the connection compartment cover.

### 6.3 Post-installation check

Is the device undamaged (visual inspection)?	<input type="checkbox"/>
Does the measuring instrument correspond to the measuring point specifications? For example: <ul style="list-style-type: none"> <li>▪ Process temperature → 247</li> <li>▪ Pressure (refer to the "Pressure-temperature ratings" section of the "Technical Information" document).</li> <li>▪ Ambient temperature</li> <li>▪ Measuring range</li> </ul>	<input type="checkbox"/>
Has the correct orientation for the sensor been selected → 23? <ul style="list-style-type: none"> <li>▪ According to sensor type</li> <li>▪ According to medium temperature</li> <li>▪ According to medium properties (outgassing, with entrained solids)</li> </ul>	<input type="checkbox"/>
Does the arrow on the sensor match the direction of flow of the medium? → 23?	<input type="checkbox"/>
Is the tag name and labeling correct (visual inspection)?	<input type="checkbox"/>
Is the device sufficiently protected from precipitation and direct sunlight?	<input type="checkbox"/>
Are the securing screw and securing clamp tightened securely?	<input type="checkbox"/>

## 7 Electrical connection

### WARNING

**Live parts! Incorrect work performed on the electrical connections can result in an electric shock.**

- ▶ Set up a disconnecting device (switch or power-circuit breaker) to easily disconnect the device from the supply voltage.
- ▶ In addition to the device fuse, include an overcurrent protection unit with max. 10 A in the plant installation.

### 7.1 Electrical safety

In accordance with applicable national regulations.

### 7.2 Connecting requirements

#### 7.2.1 Required tools

- For cable entries: use appropriate tool
- For securing clamp: Allen key 3 mm
- Wire stripper
- When using stranded cables: crimper for wire end ferrule
- For removing cables from terminal: flat blade screwdriver  $\leq 3$  mm (0.12 in)

#### 7.2.2 Requirements for connection cable

The connecting cables provided by the customer must fulfill the following requirements.

##### **Protective grounding cable for the outer ground terminal**

Conductor cross-section  $< 2.1$  mm<sup>2</sup> (14 AWG)

The use of a cable lug enables the connection of larger cross-sections.

The grounding impedance must be less than 2  $\Omega$ .

##### **Permitted temperature range**

- The installation guidelines that apply in the country of installation must be observed.
- The cables must be suitable for the minimum and maximum temperatures to be expected.

##### **Power supply cable (incl. conductor for the inner ground terminal)**

Standard installation cable is sufficient.

##### **Signal cable**

-  For custody transfer, all signal lines must be shielded cables (tinned copper braiding, optical coverage  $\geq 85$  %). The cable shield must be connected on both sides.

*EtherNet/IP*

Twisted-pair Ethernet CAT 5 or better.

-  See <https://www.odva.org>"EtherNet/IP Media Planning & Installation Manual".

*Ethernet-APL*

Shielded twisted-pair cable. Cable type A is recommended.



See <https://www.profibus.com> Ethernet-APL White Paper "

*Current output 0 /4 to 20 mA (excluding HART)*

Standard installation cable is sufficient.

*Pulse /frequency /switch output*

Standard installation cable is sufficient.

*Relay output*

Standard installation cable is sufficient.

*Current input 4 to 20 mA*

Standard installation cable is sufficient.

*Status input*

Standard installation cable is sufficient.

**Cable diameter**

- Cable glands supplied:  
M20 × 1.5 with cable  $\varnothing$  6 to 12 mm (0.24 to 0.47 in)
- Spring-loaded terminals: Suitable for strands and strands with ferrules.  
Conductor cross-section 0.2 to 2.5 mm<sup>2</sup> (24 to 12 AWG).

**Choice of connecting cable between the transmitter and sensor**

Depends on the type of transmitter and the installation zones

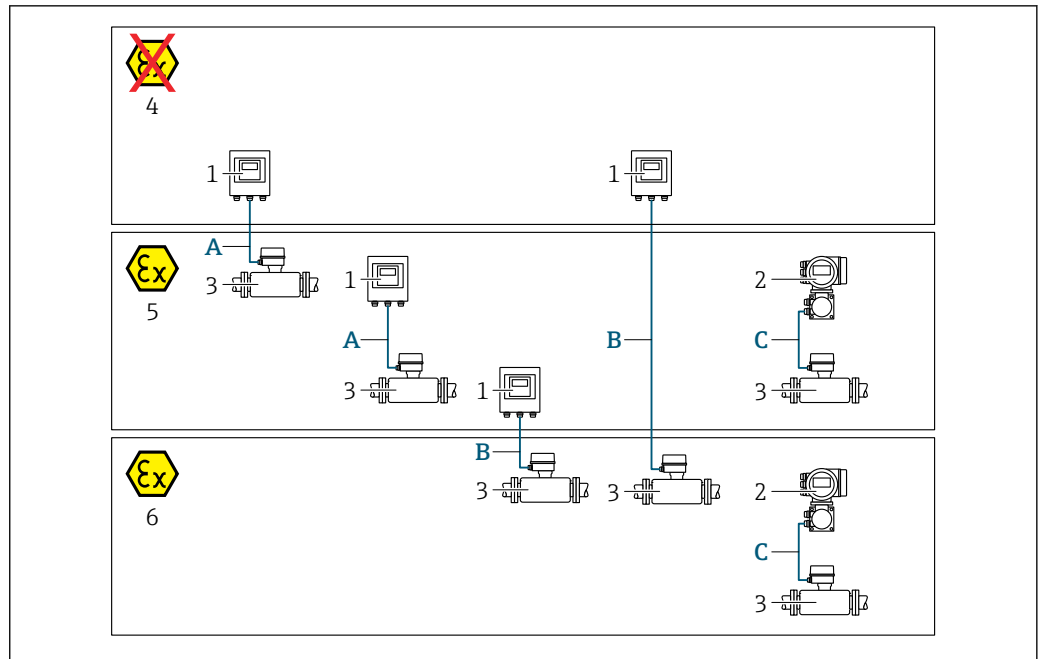

A0032476

- 1 Proline 500 digital transmitter
- 2 Proline 500 transmitter
- 3 Sensor Promass
- 4 Non-hazardous area
- 5 Hazardous area: Zone 2; Class I, Division 2
- 6 Hazardous area: Zone 1; Class I, Division 1
- A Standard cable to 500 digital transmitter → 37  
Transmitter installed in the non-hazardous area or hazardous area: Zone 2; Class I, Division 2/sensor installed in the hazardous area: Zone 2; Class I, Division 2
- B Standard cable to 500 digital transmitter → 38  
Transmitter installed in the hazardous area: Zone 2; Class I, Division 2/sensor installed in the hazardous area: Zone 1; Class I, Division 1
- C Signal cable to 500 transmitter → 40  
Transmitter and sensor installed in the hazardous area: Zone 2; Class I, Division 2 or Zone 1; Class I, Division 1

**A: Connecting cable between sensor and transmitter: Proline 500 – digital Standard cable**

A standard cable with the following specifications can be used as the connecting cable.

<b>Design</b>	4 cores (2 pairs); uninsulated stranded CU wires; pair-stranded with common shield
<b>Shield</b>	Tin-plated copper braid, optical cover ≥ 85 %
<b>Loop resistance</b>	Power supply line (+, -): maximum 10 Ω
<b>Cable length</b>	Maximum 300 m (900 ft), see the following table.
<b>Device plug, side 1</b>	M12 socket, 5-pin, A-coded.
<b>Device plug, side 2</b>	M12 plug, 5-pin, A-coded.
<b>Pins 1+2</b>	Connected cores as twisted pair.
<b>Pins 3+4</b>	Connected cores as twisted pair.

Cross-section	Cable length [max.]
0.34 mm <sup>2</sup> (AWG 22)	80 m (240 ft)
0.50 mm <sup>2</sup> (AWG 20)	120 m (360 ft)
0.75 mm <sup>2</sup> (AWG 18)	180 m (540 ft)

Cross-section	Cable length [max.]
1.00 mm <sup>2</sup> (AWG 17)	240 m (720 ft)
1.50 mm <sup>2</sup> (AWG 15)	300 m (900 ft)

*Optionally available connecting cable*

<b>Design</b>	2 × 2 × 0.34 mm <sup>2</sup> (AWG 22) PVC cable <sup>1)</sup> with common shield (2 pairs, uninsulated stranded CU wires; pair-stranded)
<b>Flame resistance</b>	According to DIN EN 60332-1-2
<b>Oil resistance</b>	According to DIN EN 60811-2-1
<b>Shield</b>	Tin-plated copper braid, optical cover ≥ 85 %
<b>Continuous operating temperature</b>	When mounted in a fixed position: -50 to +105 °C (-58 to +221 °F); when cable can move freely: -25 to +105 °C (-13 to +221 °F)
<b>Available cable length</b>	Fixed: 20 m (60 ft); variable: up to maximum 50 m (150 ft)

1) UV radiation can impair the cable outer sheath. Protect the cable from direct sunshine where possible.

*B: Connecting cable between sensor and transmitter: Proline 500 - digital*

*Standard cable*

A standard cable with the following specifications can be used as the connecting cable.

<b>Design</b>	4, 6, 8 cores (2, 3, 4 pairs); uninsulated stranded CU wires; pair-stranded with common shield
<b>Shielding</b>	Tin-plated copper braid, optical cover ≥ 85 %
<b>Capacitance C</b>	Maximum 760 nF IIC, maximum 4.2 µF IIB
<b>Inductance L</b>	Maximum 26 µH IIC, maximum 104 µH IIB
<b>Inductance/resistance ratio (L/R)</b>	Maximum 8.9 µH/Ω IIC, maximum 35.6 µH/Ω IIB (e.g. according to IEC 60079-25)
<b>Loop resistance</b>	Power supply line (+, -): maximum 5 Ω
<b>Cable length</b>	Maximum 150 m (450 ft), see the following table.

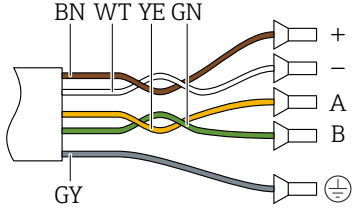
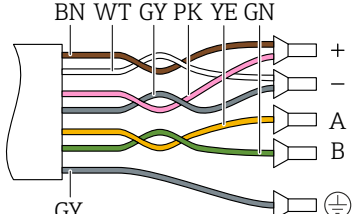
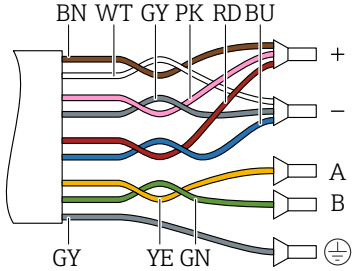
Cross-section	Cable length [max.]	Termination
2 x 2 x 0.50 mm <sup>2</sup> (AWG 20)	50 m (150 ft)	2 x 2 x 0.50 mm <sup>2</sup> (AWG 20)  <ul style="list-style-type: none"> <li>▪ +, - = 0.5 mm<sup>2</sup></li> <li>▪ A, B = 0.5 mm<sup>2</sup></li> </ul>
3 x 2 x 0.50 mm <sup>2</sup> (AWG 20)	100 m (300 ft)	3 x 2 x 0.50 mm <sup>2</sup> (AWG 20)  <ul style="list-style-type: none"> <li>▪ +, - = 1.0 mm<sup>2</sup></li> <li>▪ A, B = 0.5 mm<sup>2</sup></li> </ul>
4 x 2 x 0.50 mm <sup>2</sup> (AWG 20)	150 m (450 ft)	4 x 2 x 0.50 mm <sup>2</sup> (AWG 20)  <ul style="list-style-type: none"> <li>▪ +, - = 1.5 mm<sup>2</sup></li> <li>▪ A, B = 0.5 mm<sup>2</sup></li> </ul>

*Optionally available connecting cable*

<b>Connecting cable for</b>	Zone 1; Class I, Division 1
<b>Standard cable</b>	2 × 2 × 0.5 mm <sup>2</sup> (AWG 20) PVC cable <sup>1)</sup> with common shield (2 pairs, pair-stranded)
<b>Flame resistance</b>	According to DIN EN 60332-1-2
<b>Oil-resistance</b>	According to DIN EN 60811-2-1
<b>Shielding</b>	Tin-plated copper braid, optical cover ≥ 85 %
<b>Operating temperature</b>	When mounted in a fixed position: -50 to +105 °C (-58 to +221 °F); when cable can move freely: -25 to +105 °C (-13 to +221 °F)
<b>Available cable length</b>	Fixed: 20 m (60 ft); variable: up to maximum 50 m (150 ft)

1) UV radiation can impair the cable outer sheath. Protect the cable from direct sunshine where possible.

*C: Connecting cable between sensor and transmitter: Proline 500*

<b>Design</b>	6 × 0.38 mm <sup>2</sup> PVC cable <sup>1)</sup> with individual shielded cores and common copper shield
<b>Conductor resistance</b>	≤ 50 Ω/km (0.015 Ω/ft)
<b>Capacitance: core/shield</b>	≤ 420 pF/m (128 pF/ft)
<b>Cable length (max.)</b>	20 m (60 ft)
<b>Cable lengths (available for order)</b>	5 m (15 ft), 10 m (30 ft), 20 m (60 ft)
<b>Cable diameter</b>	11 mm (0.43 in) ± 0.5 mm (0.02 in)
<b>Continuous operating temperature</b>	Max. 105 °C (221 °F)

1) UV radiation can impair the cable outer sheath. Protect the cable from direct sunshine where possible.

### 7.2.3 Terminal assignment

#### Transmitter: supply voltage, input/outputs



The terminal assignment of the inputs and outputs depends on the individual order version of the device. The device-specific terminal assignment is documented on an adhesive label in the terminal cover.

Supply voltage		Input/output 1	Input/output 2	Input/output 3	Input/output 4
1 (+)	2 (-)	EtherNet/IP (RJ45 connector)	24 (+)   25 (-)	22 (+)   23 (-)	20 (+)   21 (-)
Device-specific terminal assignment: adhesive label in terminal cover.					

#### Transmitter and sensor connection housing: connecting cable

The sensor and transmitter, which are mounted in separate locations, are interconnected by a connecting cable. The cable is connected via the sensor connection housing and the transmitter housing.

Terminal assignment and connection of the connecting cable:

- Proline 500 – digital →  42
- Proline 500 →  52

### 7.2.4 Available device plugs

 Device plugs may not be used in hazardous areas!

#### Order code for "Input; output 1", option NA "EtherNet/IP"

Order code for "Electrical connection"	Cable entry/connection	
	2	3
L, N, P, U	Connector M12 × 1	–
R <sup>1) 2)</sup> , S <sup>1) 2)</sup> , T <sup>1) 2)</sup> , V <sup>1) 2)</sup>	Connector M12 × 1	Connector M12 × 1

- 1) Cannot be combined with an external WLAN antenna (order code for "Enclosed accessories", option P8) of an RJ45 M12 adapter for the service interface (order code for "Accessories mounted", option NB) or of the remote display and operating module DKX001
- 2) Suitable for integrating the device in a ring topology.

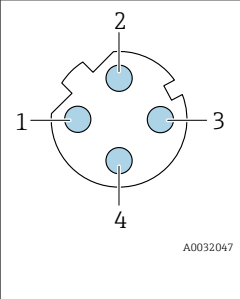

### 7.2.5 Pin assignment of device plug

	Pin		Assignment	
	1	+	Tx	
	2	+	Rx	
	3	-	Tx	
	4	-	Rx	
Coding		Plug/socket		
D		Socket		

### 7.2.6 Preparing the measuring device

Carry out the steps in the following order:

1. Mount the sensor and transmitter.
2. Sensor connection housing: Connect connecting cable.
3. Transmitter: Connect connecting cable.
4. Transmitter: Connect signal cable and cable for supply voltage.

#### NOTICE

##### Insufficient sealing of the housing!

Operational reliability of the measuring device could be compromised.

- Use suitable cable glands corresponding to the degree of protection.

1. Remove dummy plug if present.
2. If the measuring device is supplied without cable glands:  
Provide suitable cable gland for corresponding connecting cable.
3. If the measuring device is supplied with cable glands:  
Observe requirements for connecting cables →  35.

## 7.3 Connecting the measuring instrument: Proline 500 - digital

### NOTICE

#### An incorrect connection compromises electrical safety!

- ▶ Only properly trained specialist staff may perform electrical connection work.
- ▶ Observe applicable federal/national installation codes and regulations.
- ▶ Comply with local workplace safety regulations.
- ▶ Always connect the protective ground cable ⊕ before connecting additional cables.
- ▶ When using in potentially explosive atmospheres, observe the information in the device-specific Ex documentation.

### 7.3.1 Connecting the connecting cable

#### ⚠ WARNING

#### Risk of damaging electronic components!

- ▶ Connect the sensor and transmitter to the same potential equalization.
- ▶ Only connect the sensor to a transmitter with the same serial number.

#### Connecting cable terminal assignment

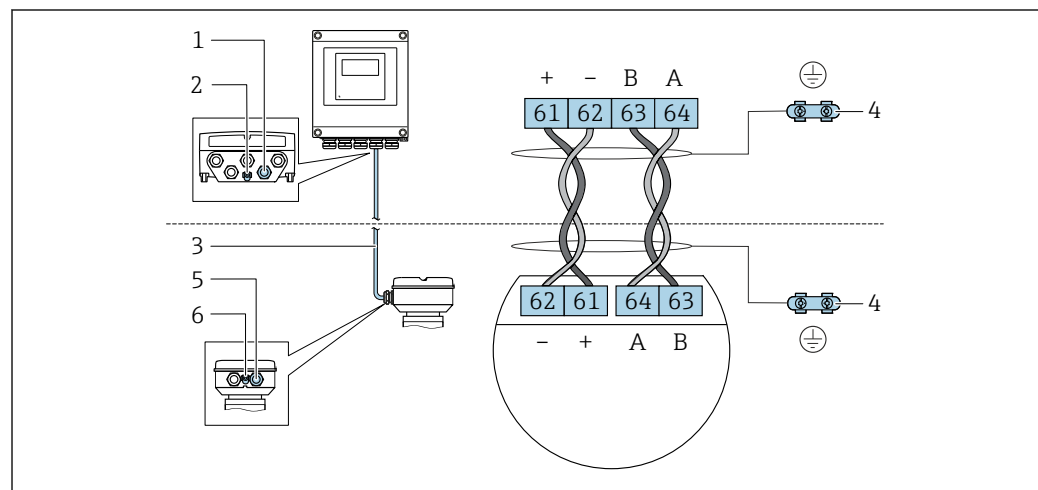

A0028198

- 1 Cable entry for cable on transmitter housing
- 2 Protective earth (PE)
- 3 Connecting cable ISEM communication
- 4 Grounding via ground connection; in the version with a device plug, grounding is ensured through the plug itself
- 5 Cable entry for cable or connection of device plug on sensor connection housing
- 6 Protective earth (PE)

#### Connecting the connecting cable to the sensor connection housing

- Connection via terminals with order code for "Sensor connection housing":
  - Option A "Aluminum, coated" → ☰ 43
  - Option B "Stainless" → ☰ 44
- Connection via connectors with order code for "Sensor connection housing":
  - Option C "Ultra-compact hygienic, stainless" → ☰ 45

#### Connecting the connecting cable to the transmitter

The cable is connected to the transmitter via terminals → ☰ 46.

### Connecting the sensor connection housing via terminals

For the device version with the order code for "Sensor connection housing":  
Option **A** "Aluminum coated"

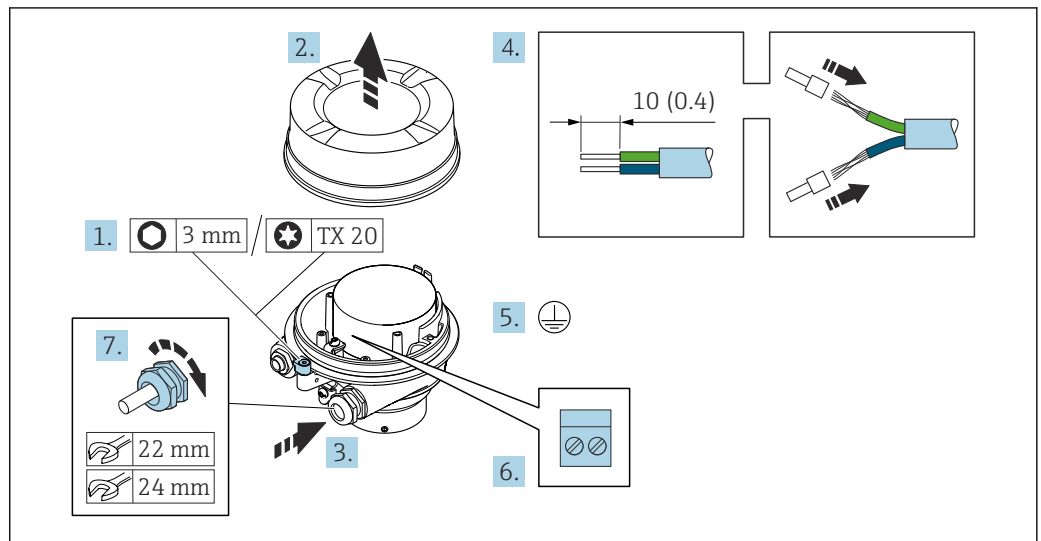

A0029616

1. Loosen the securing clamp of the housing cover.
2. Unscrew the housing cover.
3. Push the cable through the cable entry. To ensure tight sealing, do not remove the sealing ring from the cable entry.
4. Strip the cable and cable ends. In the case of stranded cables, fit ferrules.
5. Connect the protective ground.
6. Connect the cable in accordance with the connecting cable terminal assignment.
7. Firmly tighten the cable glands.
  - ↳ This concludes the process for connecting the connecting cable.

#### **⚠ WARNING**

#### **Housing degree of protection voided due to insufficient sealing of the housing.**

- ▶ Screw in the thread on the cover without using any lubricant. The thread on the cover is coated with a dry lubricant.
8. Screw on the housing cover.
  9. Tighten the securing clamp of the housing cover.

### Connecting the sensor connection housing via terminals

For the device version with the order code for "Sensor connection housing":  
Option B "Stainless"

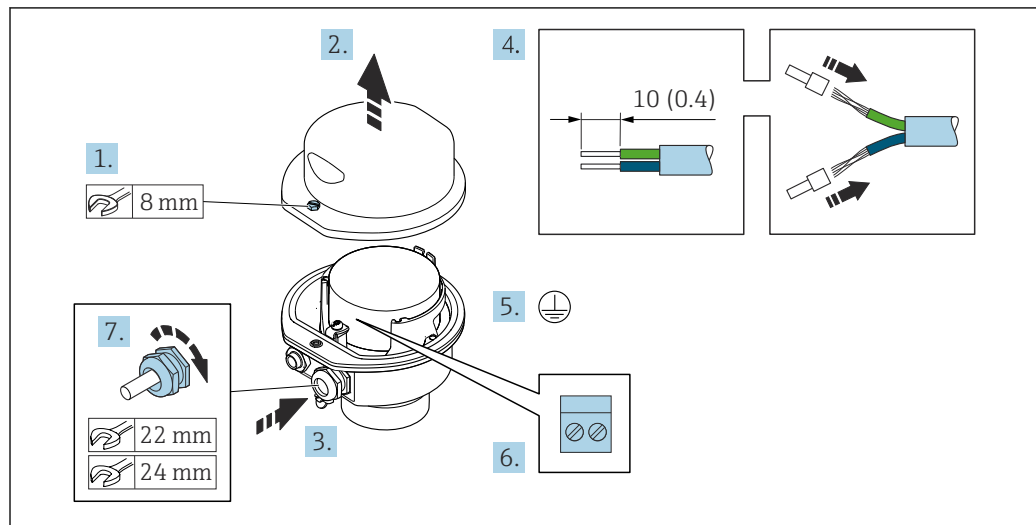

A0029613

1. Release the securing screw of the housing cover.
2. Open the housing cover.
3. Push the cable through the cable entry . To ensure tight sealing, do not remove the sealing ring from the cable entry.
4. Strip the cable and cable ends. In the case of stranded cables, fit ferrules.
5. Connect the protective ground.
6. Connect the cable in accordance with the connecting cable terminal assignment.
7. Firmly tighten the cable glands.
  - ↳ This concludes the process for connecting the connecting cable.
8. Close the housing cover.
9. Tighten the securing screw of the housing cover.

**Connecting the sensor connection housing via the connector**

For the device version with the order code for "Sensor connection housing":  
Option C "Ultra-compact hygienic, stainless"

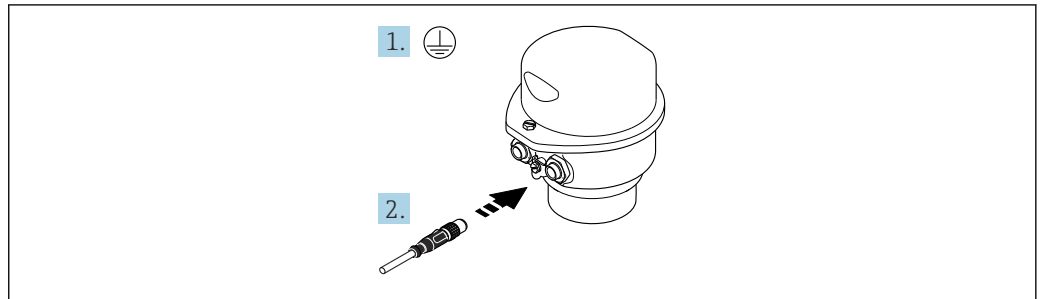

A0029615

1. Connect the protective ground.
2. Connect the connector.

## Connecting the connecting cable to the transmitter

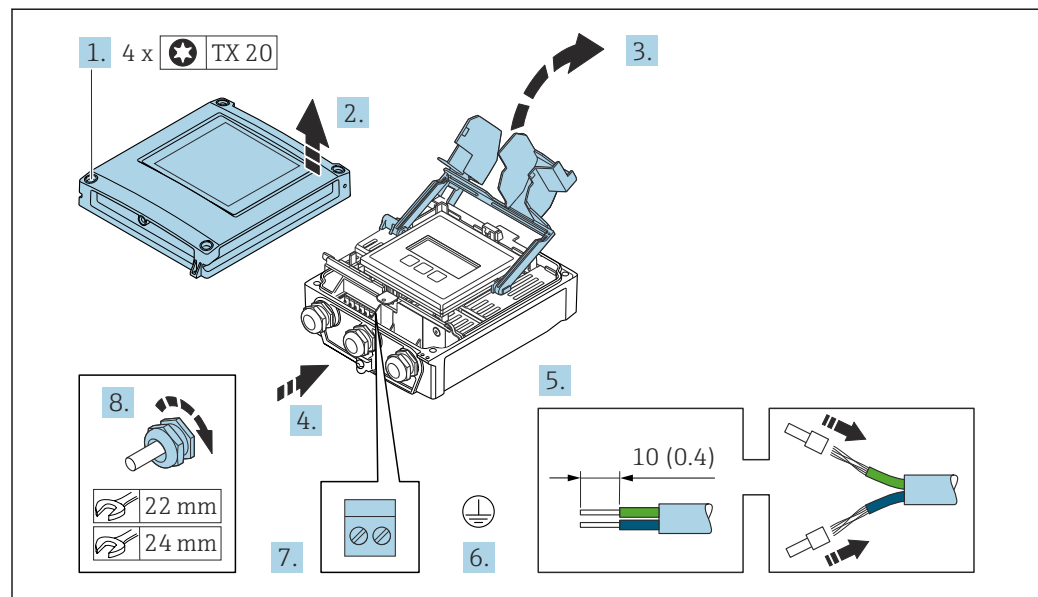

A0029597

1. Loosen the 4 fixing screws on the housing cover.
2. Open the housing cover.
3. Fold open the terminal cover.
4. Push the cable through the cable entry. To ensure tight sealing, do not remove the sealing ring from the cable entry.
5. Strip the cable and cable ends. In the case of stranded cables, fit ferrules.
6. Connect the protective ground.
7. Connect the cable according to the terminal assignment for the connecting cable  
→ 42.
8. Firmly tighten the cable glands.  
↳ The process for connecting the connecting cable is now complete.
9. Close the housing cover.
10. Tighten the securing screw of the housing cover.
11. After connecting the connecting cable:  
Connect the signal cable and the supply voltage cable .

### 7.3.2 Connecting the transmitter

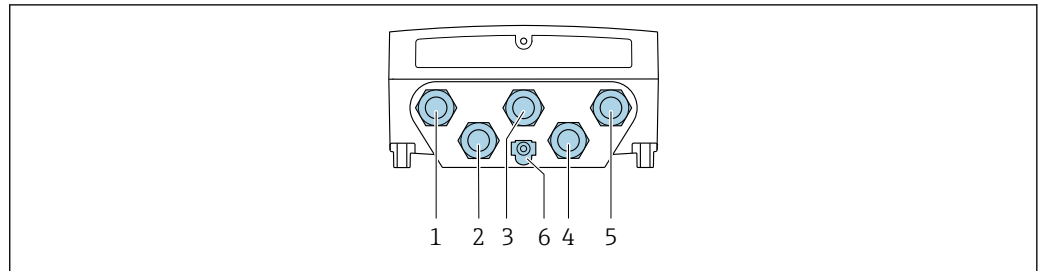

A0028200

- 1 Terminal connection for supply voltage
- 2 Terminal connection for signal transmission, input/output
- 3 Terminal connection for signal transmission, input/output
- 4 Terminal connection for connecting cable between sensor and transmitter
- 5 Terminal connection for signal transmission, input/output or terminal for network connection (DHCP client) via service interface (CDI-RJ45); optional: connection for external WLAN antenna
- 6 Protective earth (PE)

**i** In addition to connecting the device via EtherNet/IP and the available input/outputs, additional connection options are also available:

- Integrate into a network via the service interface (CDI-RJ45) → 50.
- Integrate the device into a ring topology → 51.

#### Connecting the EtherNet/IP plug

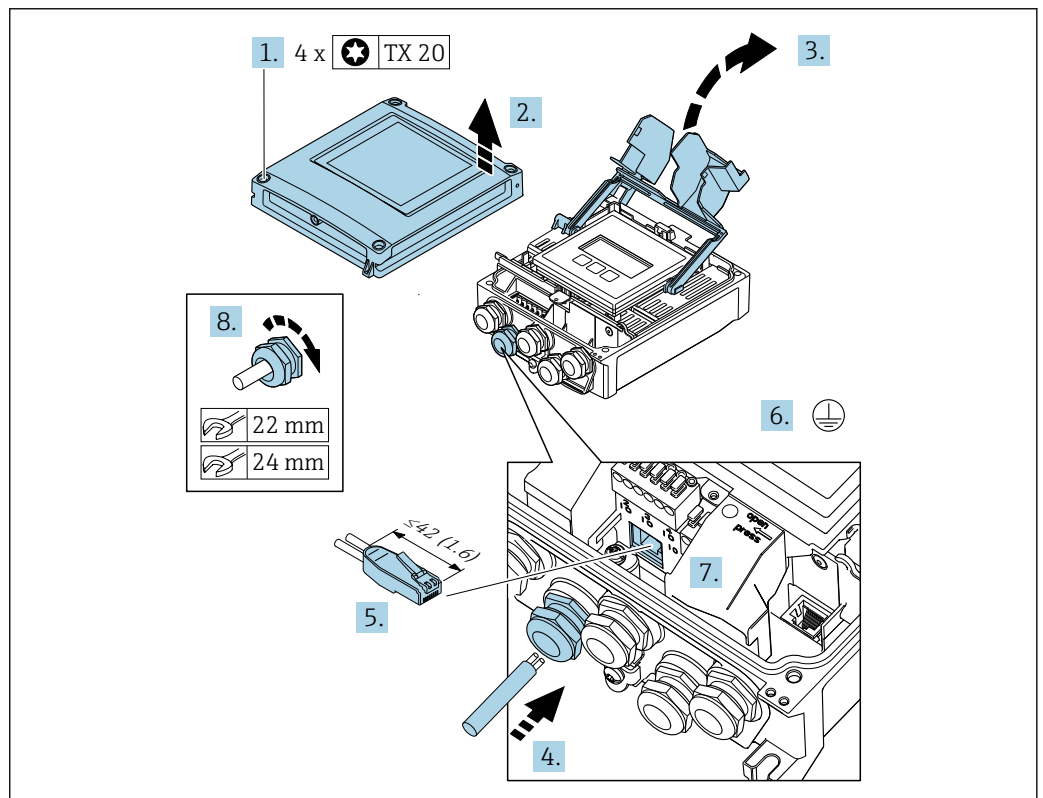

A0033987

1. Loosen the 4 fixing screws on the housing cover.
2. Open the housing cover.
3. Fold open the terminal cover.
4. Push the cable through the cable entry. To ensure tight sealing, do not remove the sealing ring from the cable entry.
5. Strip the cable and cable ends and connect to the RJ45 connector.

6. Connect the protective ground.
7. Plug in the RJ45 connector.
8. Firmly tighten the cable glands.
  - ↳ This concludes the EtherNet/IP connection process.

### Connecting the supply voltage and additional inputs/outputs

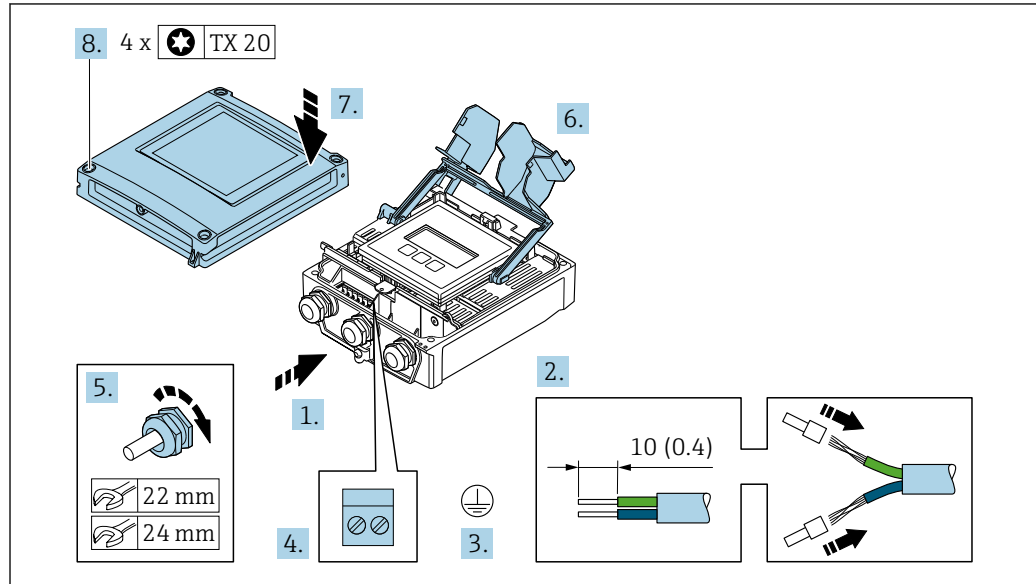

A0033831

1. Push the cable through the cable entry. To ensure tight sealing, do not remove the sealing ring from the cable entry.
2. Strip the cable and cable ends. In the case of stranded cables, fit ferrules.
3. Connect the protective ground.
4. Connect the cable according to the terminal assignment.
  - ↳ **Signal cable terminal assignment:** The device-specific terminal assignment is documented on an adhesive label in the terminal cover.
  - Supply voltage terminal assignment:** Adhesive label in the terminal cover or → 40.
5. Firmly tighten the cable glands.
  - ↳ This concludes the cable connection process.
6. Close the terminal cover.
7. Close the housing cover.

#### **⚠ WARNING**

**Housing degree of protection may be voided due to insufficient sealing of the housing.**

- ▶ Screw in the screw without using any lubricant.

#### **NOTICE**

**Excessive tightening torque applied to the fixing screws!**

Risk of damaging the plastic transmitter.

- ▶ Tighten the fixing screws as per the tightening torque: 2.5 Nm (1.8 lbf ft)

8. Tighten the 4 fixing screws on the housing cover.

### Removing a cable

To remove a cable from the terminal:



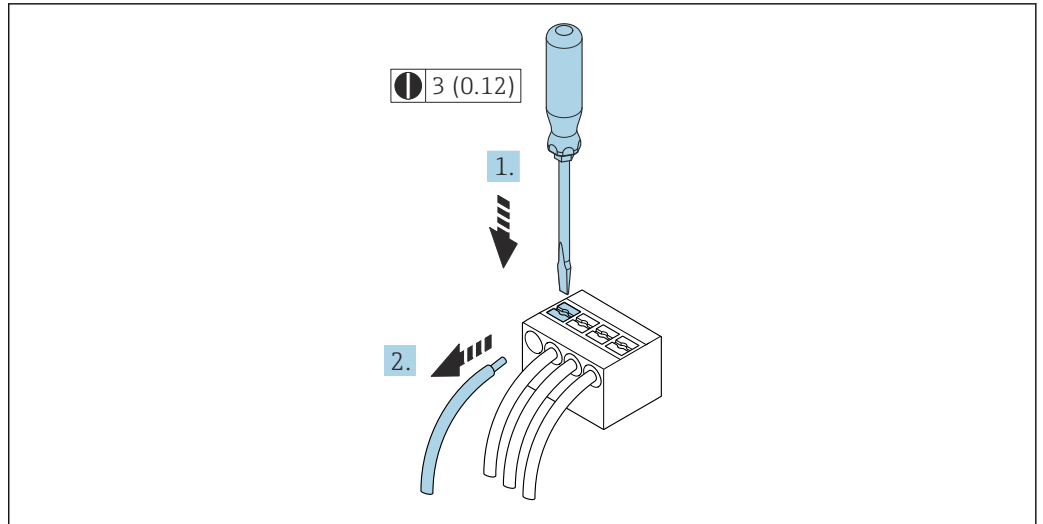

A0029598

17 Engineering unit mm (in)

1. Use a flat-blade screwdriver to press down on the slot between the two terminal holes.
2. Remove the cable end from the terminal.

### 7.3.3 Integrating the transmitter into a network

This section only presents the basic options for integrating the device into a network.

For information on the procedure to follow to connect the transmitter correctly → 42.

#### Integrating via the service interface

The device is integrated via the connection to the service interface (CDI-RJ45).

Note the following when connecting:

- Recommended cable: CAT5e, CAT6 or CAT7, with shielded connector (e.g. brand: YAMAICHI ; Part No. Y-ConProfixPlug63/Prod. ID: 82-006660)
- Maximum cable thickness: 6 mm
- Length of plug including anti-bend protection: 42 mm
- Bending radius: 5 x cable thickness

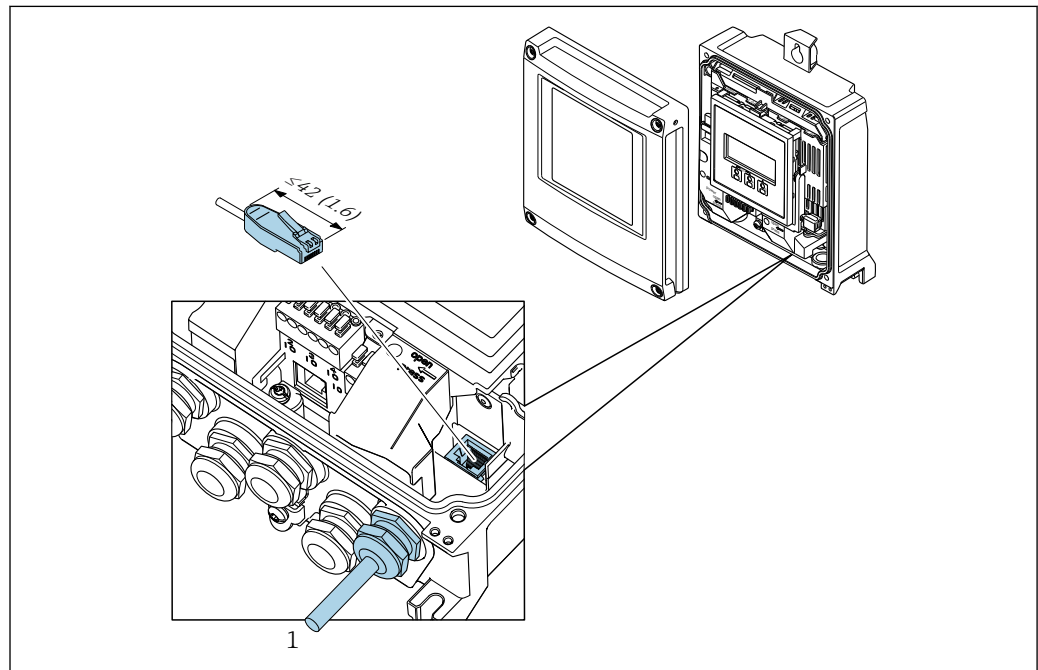

1 Service interface (CDI-RJ45)

**i** An adapter for the RJ45 to the M12 plug is optionally available for the non-hazardous area:

Order code for "Accessories", option **NB**: "Adapter RJ45 M12 (service interface)"

The adapter connects the service interface (CDI-RJ45) to an M12 plug mounted in the cable entry. The connection to the service interface can thus be established via an M12 plug without opening the device.

### Integrating into a ring topology

The device is integrated via the terminal connection for signal transmission (output 1) and the connection to the service interface (CDI-RJ45).

Note the following when connecting:

- Recommended cable: CAT5e, CAT6 or CAT7, with shielded connector (e.g. brand: YAMAICHI ; Part No. Y-ConProfixPlug63/Prod. ID: 82-006660)
- Maximum cable thickness: 6 mm
- Length of plug including anti-bend protection: 42 mm
- Bending radius: 2.5 x cable thickness

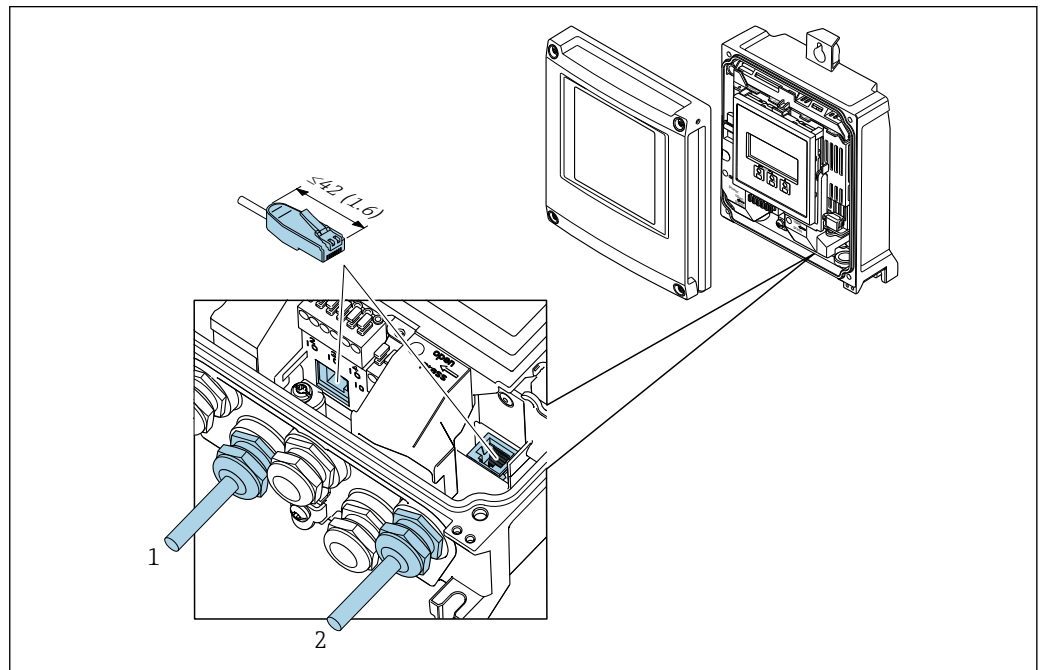

A0033830

- 1 EtherNet/IP connection
- 2 Service interface (CDI-RJ45)

**i** An adapter for the RJ45 to the M12 plug is optionally available:  
Order code for "Accessories", option **NB**: "Adapter RJ45 M12 (service interface)"

The adapter connects the service interface (CDI-RJ45) to an M12 plug mounted in the cable entry. The connection to the service interface can thus be established via an M12 plug without opening the device.

## 7.4 Connecting the measuring instrument: Proline 500

### NOTICE

#### An incorrect connection compromises electrical safety!

- ▶ Only properly trained specialist staff may perform electrical connection work.
- ▶ Observe applicable federal/national installation codes and regulations.
- ▶ Comply with local workplace safety regulations.
- ▶ Always connect the protective ground cable ⊕ before connecting additional cables.
- ▶ When using in potentially explosive atmospheres, observe the information in the device-specific Ex documentation.

### 7.4.1 Fitting the connecting cable

#### ⚠ WARNING

#### Risk of damaging electronic components!

- ▶ Connect the sensor and transmitter to the same potential equalization.
- ▶ Only connect the sensor to a transmitter with the same serial number.

#### ⚠ CAUTION

#### Measurement error due to shortening of the connecting cable

- ▶ The connecting cable is ready for installation and must be used in the length supplied. Shortening the connecting cable can affect the sensor's measurement accuracy.

#### Connecting cable terminal assignment

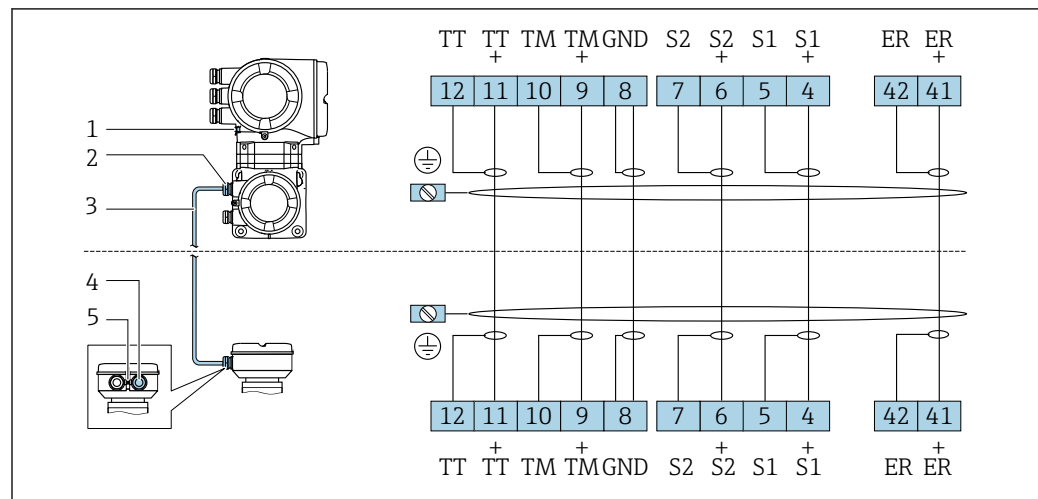

- 1 Protective earth (PE)
- 2 Cable entry for connecting cable on transmitter connection housing
- 3 Connecting cable
- 4 Cable entry for connecting cable on sensor connection housing
- 5 Protective earth (PE)

#### Connecting the connecting cable to the sensor connection housing

Connection via terminals with order code for "Housing":

- Option A "Aluminum coated" → 53
- Option B "Stainless" → 54

### Connecting the sensor connection housing via terminals

For the device version with the order code for "Housing":  
Option **A** "Aluminum coated"

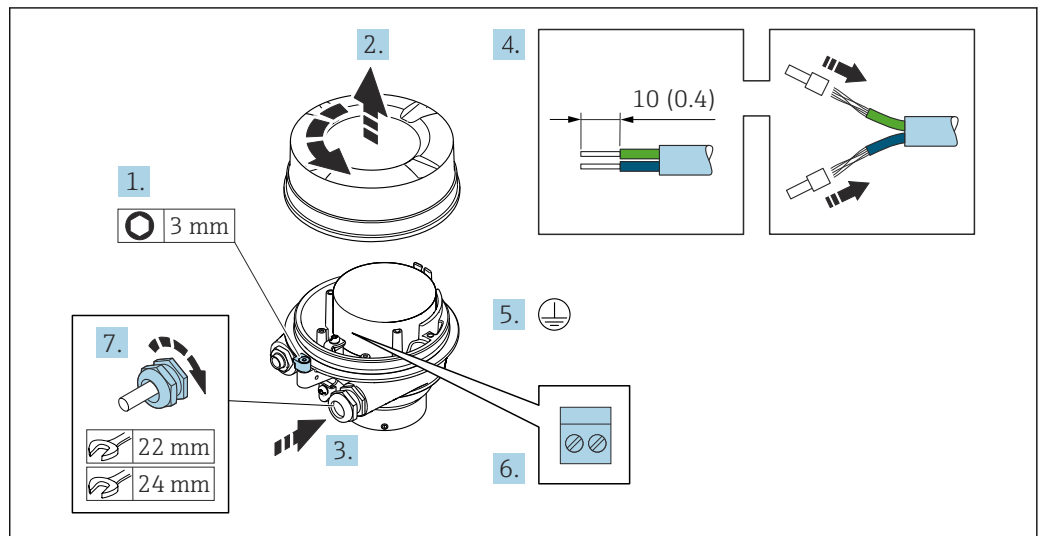

A0029612

1. Loosen the securing clamp of the housing cover.
2. Unscrew the housing cover.
3. Push the cable through the cable entry . To ensure tight sealing, do not remove the sealing ring from the cable entry.
4. Strip the cable and cable ends. In the case of stranded cables, fit ferrules.
5. Connect the protective ground.
6. Connect the cable in accordance with the connecting cable terminal assignment.
7. Firmly tighten the cable glands.
  - ↳ The process for connecting the connecting cable is now complete.

#### **⚠ WARNING**

**Housing degree of protection voided due to insufficient sealing of the housing.**

- ▶ Screw in the thread on the cover without using any lubricant. The thread on the cover is coated with a dry lubricant.
8. Screw on the housing cover.
  9. Tighten the securing clamp of the housing cover.

### Connecting the sensor connection housing via terminals

For the device version with the order code for "Housing":  
Option B "Stainless"

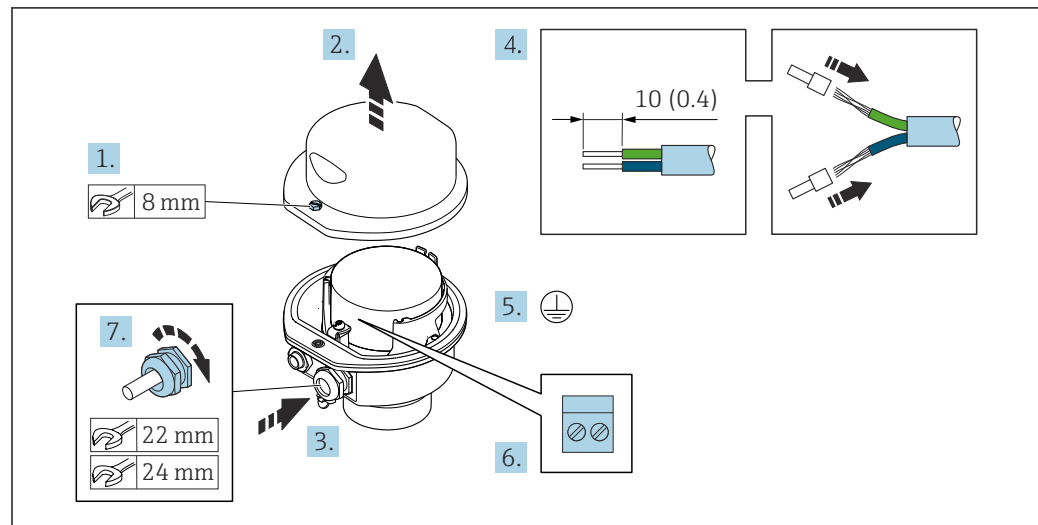

A0029613

1. Release the securing screw of the housing cover.
2. Open the housing cover.
3. Push the cable through the cable entry . To ensure tight sealing, do not remove the sealing ring from the cable entry.
4. Strip the cable and cable ends. In the case of stranded cables, fit ferrules.
5. Connect the protective ground.
6. Connect the cable in accordance with the connecting cable terminal assignment.
7. Firmly tighten the cable glands.
  - ↳ This concludes the process for connecting the connecting cable.
8. Close the housing cover.
9. Tighten the securing screw of the housing cover.

## Attaching the connecting cable to the transmitter

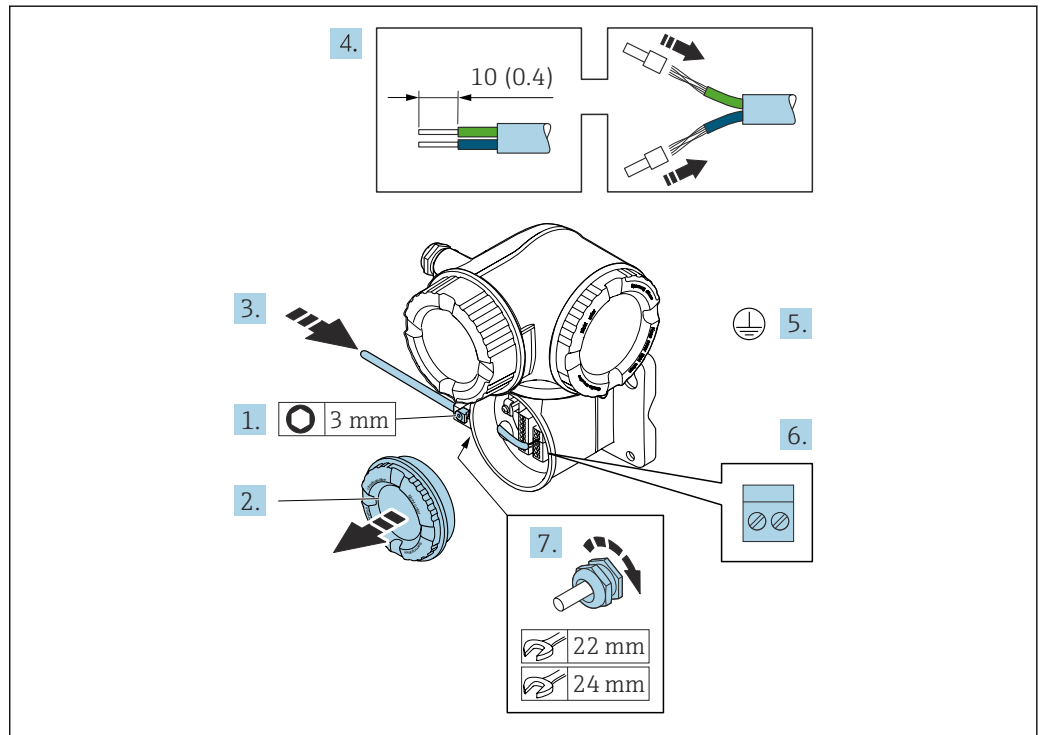

A0029592

1. Loosen the securing clamp of the connection compartment cover.
2. Unscrew the connection compartment cover.
3. Push the cable through the cable entry. To ensure tight sealing, do not remove the sealing ring from the cable entry.
4. Strip the cable and cable ends. In the case of stranded cables, also fit ferrules.
5. Connect the protective ground.
6. Connect the cable in accordance with the connecting cable terminal assignment  
→ 52.
7. Firmly tighten the cable glands.  
↳ This concludes the process for attaching the connecting cable.
8. Screw on the connection compartment cover.
9. Tighten the securing clamp of the connection compartment cover.
10. After connecting the connecting cable:  
Connect the signal cable and the supply voltage cable .

## 7.4.2 Connecting the transmitter

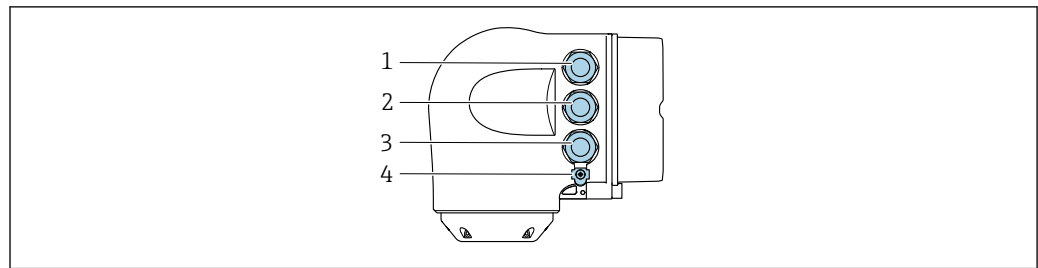

A0026781

- 1 Terminal connection for supply voltage
- 2 Terminal connection for signal transmission, input/output
- 3 Terminal connection for signal transmission, input/output or terminal connection for network connection via service interface (CDI-RJ45)
- 4 Protective earth (PE)

**i** In addition to connecting the device via PROFINET with Ethernet-APL and the available inputs/outputs, an additional connection option is also available: Integrate into a network via the service interface (CDI-RJ45) → 59.

### Connecting connector

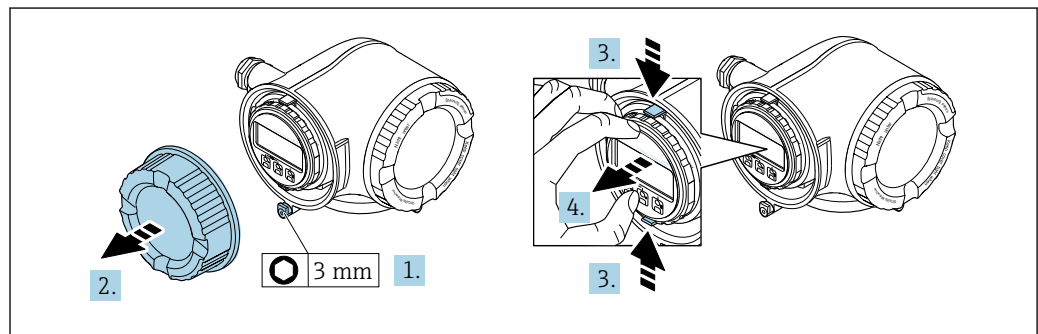

A0029813

1. Loosen the securing clamp of the connection compartment cover.
2. Unscrew the connection compartment cover.
3. Squeeze the tabs of the display module holder together.
4. Remove the display module holder.

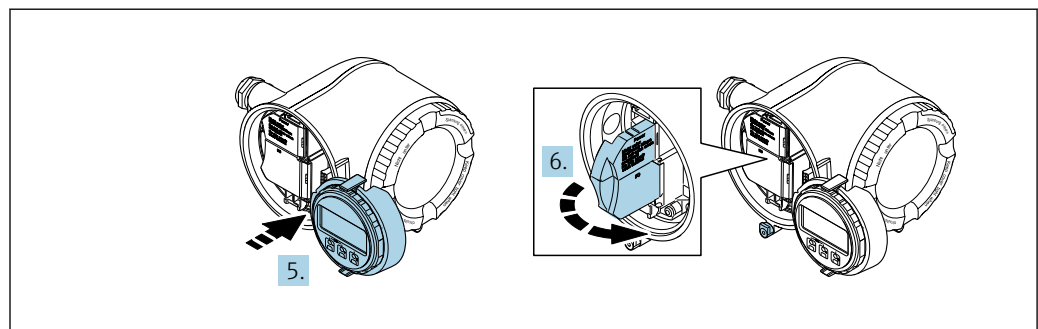

A0029814

5. Attach the holder to the edge of the electronics compartment.
6. Open the terminal cover.



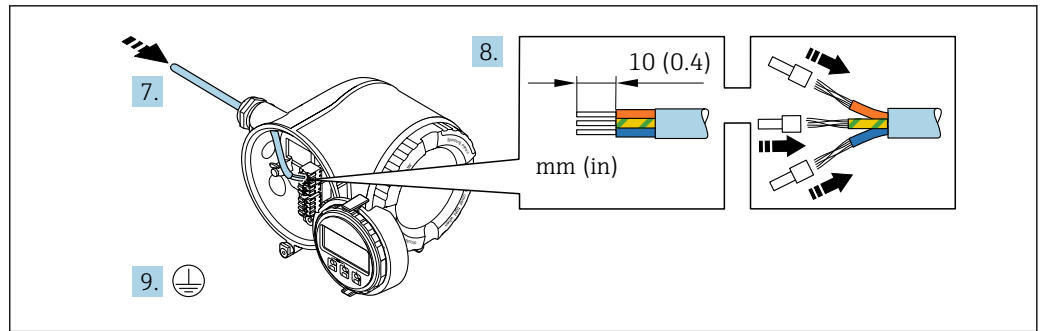

A0029815

7. Push the cable through the cable entry. To ensure tight sealing, do not remove the sealing ring from the cable entry.
8. Strip the cable and cable ends and connect to terminals 26-27. In the case of stranded cables, also fit ferrules.
9. Connect protective earth (PE).
10. Firmly tighten the cable glands.
  - ↳ This concludes the connection via the APL port.

### Connecting the supply voltage and additional inputs/outputs

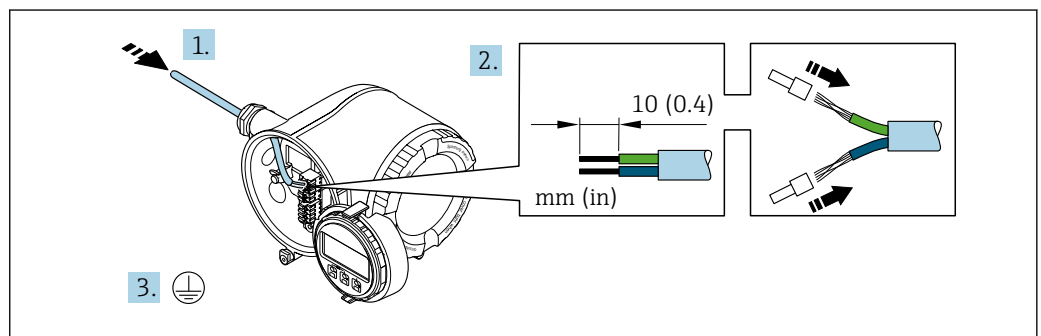

A0033983

1. Push the cable through the cable entry. To ensure tight sealing, do not remove the sealing ring from the cable entry.
2. Strip the cable and cable ends. In the case of stranded cables, also fit ferrules.
3. Connect the protective ground.

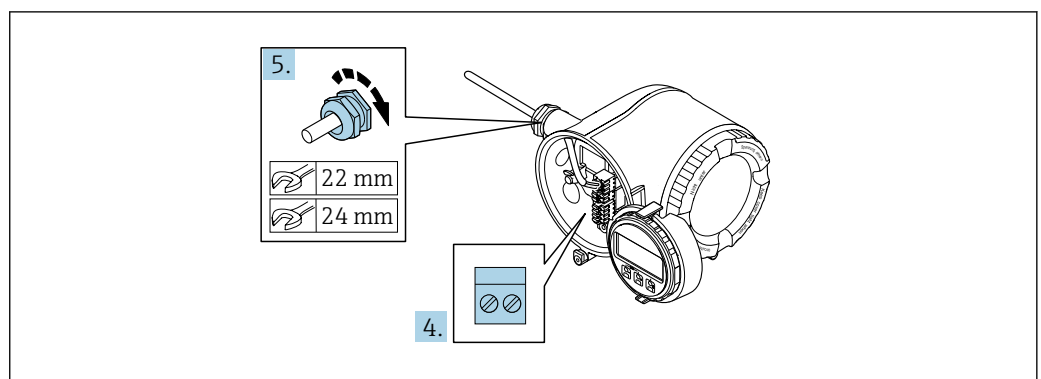

A0033984

4. Connect the cable according to the terminal assignment.
  - ↳ **Signal cable terminal assignment:** The device-specific terminal assignment is documented on an adhesive label in the terminal cover.
  - Supply voltage terminal assignment:** Adhesive label in the terminal cover or → 40.

5. Firmly tighten the cable glands.  
↳ This concludes the cable connection process.
6. Close the terminal cover.
7. Fit the display module holder in the electronics compartment.
8. Screw on the connection compartment cover.
9. Secure the securing clamp of the connection compartment cover.

### Removing a cable

To remove a cable from the terminal:

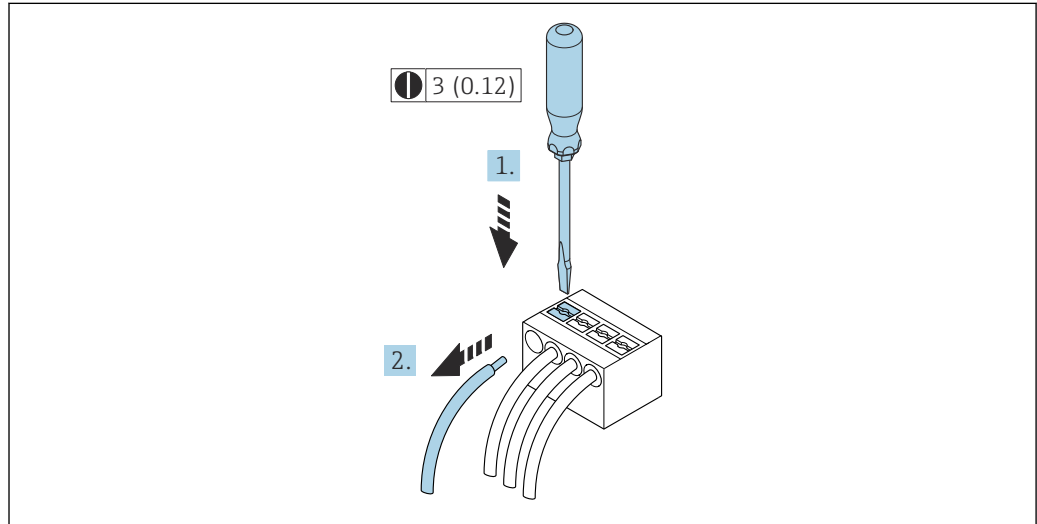

A0029598

18 Engineering unit mm (in)

1. Use a flat-blade screwdriver to press down on the slot between the two terminal holes.
2. Remove the cable end from the terminal.

### 7.4.3 Integrating the transmitter into a network

This section only presents the basic options for integrating the device into a network.

For information on the procedure to follow to connect the transmitter correctly →  52.

#### Integrating via the service interface

The device is integrated via the connection to the service interface (CDI-RJ45).

Note the following when connecting:

- Recommended cable: CAT 5e, CAT 6 or CAT 7, with shielded connector (e.g. brand: YAMAICHI ; Part No Y-ConProfixPlug63 / Prod. ID: 82-006660)
- Maximum cable thickness: 6 mm
- Length of plug including anti-bend protection: 42 mm
- Bending radius: 5 x cable thickness

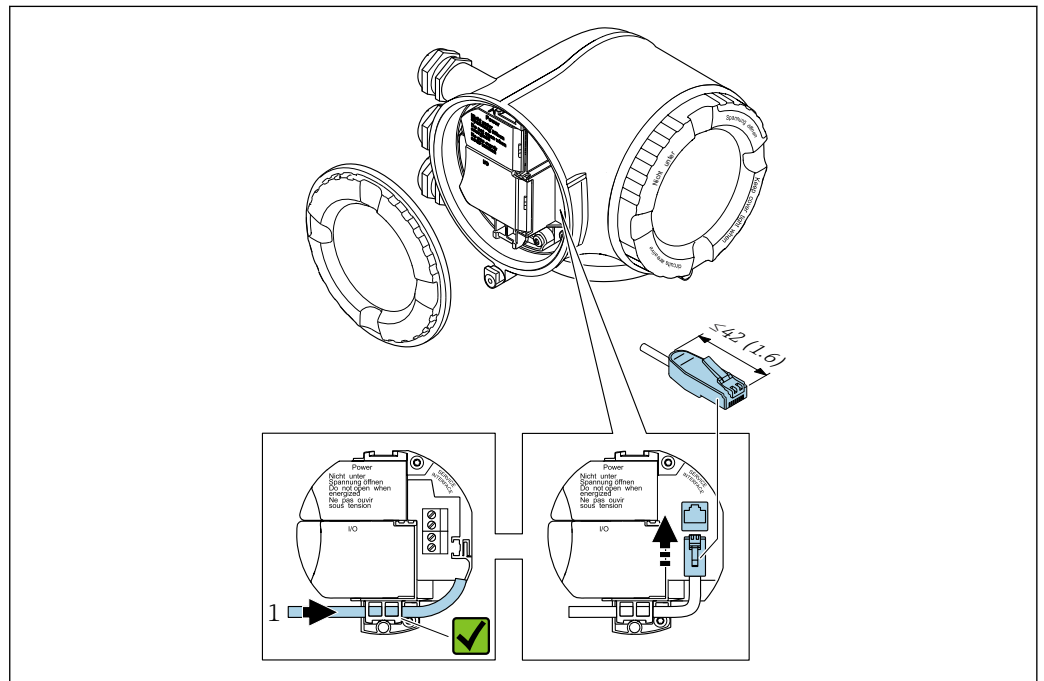

1 Service interface (CDI-RJ45)

-  An adapter for the RJ45 to the M12 plug is optionally available:  
Order code for "Accessories", option **NB**: "Adapter RJ45 M12 (service interface)"

The adapter connects the service interface (CDI-RJ45) to an M12 plug mounted in the cable entry. The connection to the service interface can thus be established via an M12 plug without opening the device.

## Integrating into a ring topology

The device is integrated via the terminal connection for signal transmission (output 1) and the connection to the service interface (CDI-RJ45).

Note the following when connecting:

- Recommended cable: CAT5e, CAT6 or CAT7, with shielded connector (e.g. brand: YAMAICHI ; Part No Y-ConProfixPlug63 / Prod. ID: 82-006660)
- Maximum cable thickness: 6 mm
- Length of plug including anti-bend protection: 42 mm
- Bending radius: 2.5 x cable thickness

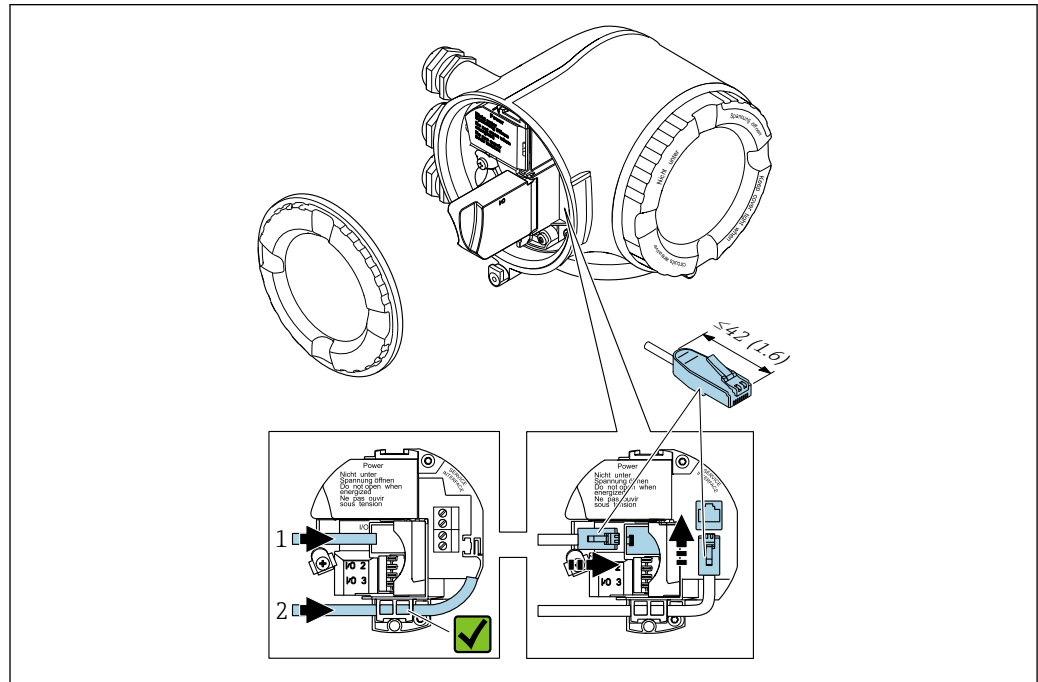

A0033717

- 1 EtherNet/IP connection
- 2 Service interface (CDI-RJ45)

**i** An adapter for the RJ45 to the M12 plug is optionally available:  
Order code for "Accessories", option **NB**: "Adapter RJ45 M12 (service interface)"

The adapter connects the service interface (CDI-RJ45) to an M12 plug mounted in the cable entry. The connection to the service interface can thus be established via an M12 plug without opening the device.

## 7.5 Potential equalization

### 7.5.1 Requirements

For potential equalization:

- Pay attention to in-house grounding concepts
- Take account of operating conditions, such as the pipe material and grounding
- Connect the medium, sensor and transmitter to the same electric potential
- Use a ground cable with a minimum cross-section of 6 mm<sup>2</sup> (10 AWG) and a cable lug for potential equalization connections

## 7.6 Special connection instructions

### 7.6.1 Connection examples

#### EtherNet/IP

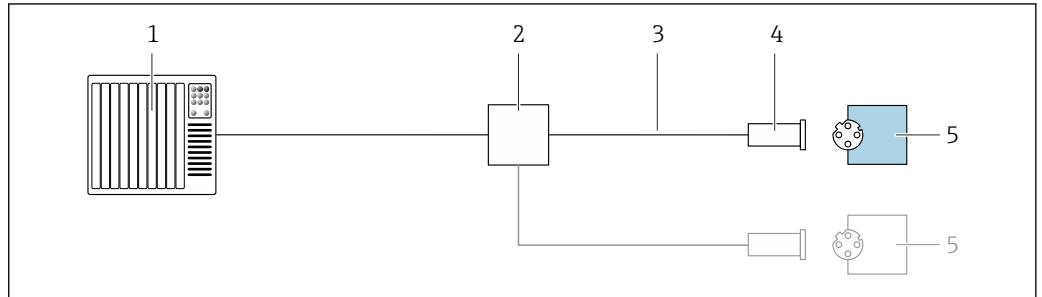

A0028767

19 Connection example for EtherNet/IP

- 1 Control system (e.g. PLC)
- 2 Ethernet switch
- 3 Observe cable specifications
- 4 Device plug
- 5 Transmitter

#### EtherNet/IP: DLR (Device Level Ring)

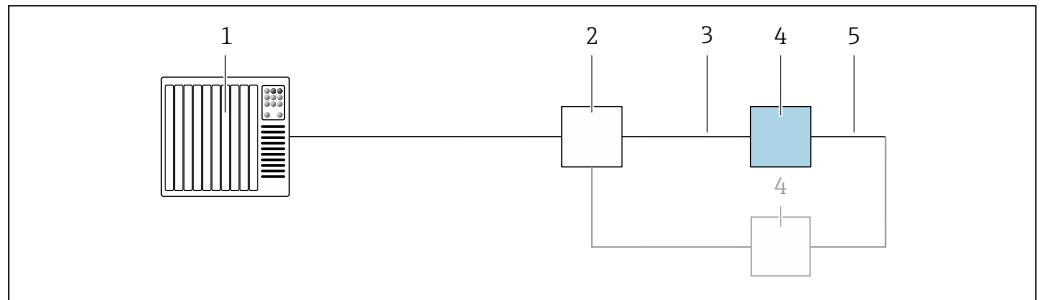

A0027544

- 1 Control system (e.g. PLC)
- 2 Ethernet switch
- 3 Observe cable specifications → 35
- 4 Transmitter
- 5 Connecting cable between the two transmitters

#### Current output 4-20 mA

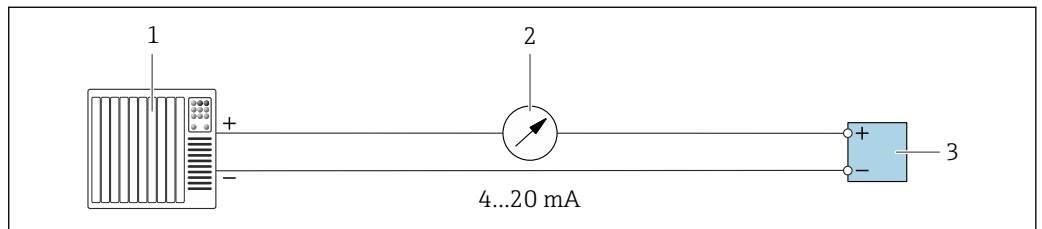

A0028758

20 Connection example for 4-20 mA current output (active)

- 1 Automation system with current input (e.g. PLC)
- 2 Analog display unit: observe maximum load
- 3 Transmitter

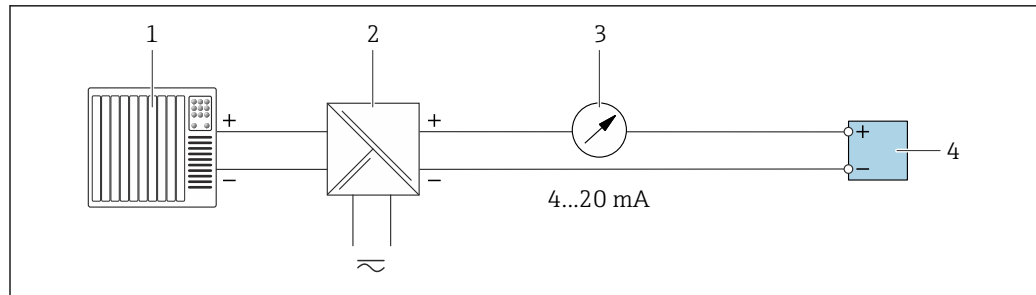

A0028759

21 Connection example for 4-20 mA current output (passive)

- 1 Automation system with current input (e.g. PLC)
- 2 Active barrier for power supply (e.g. RN221N)
- 3 Analog display unit: observe maximum load
- 4 Transmitter

### Pulse/frequency output

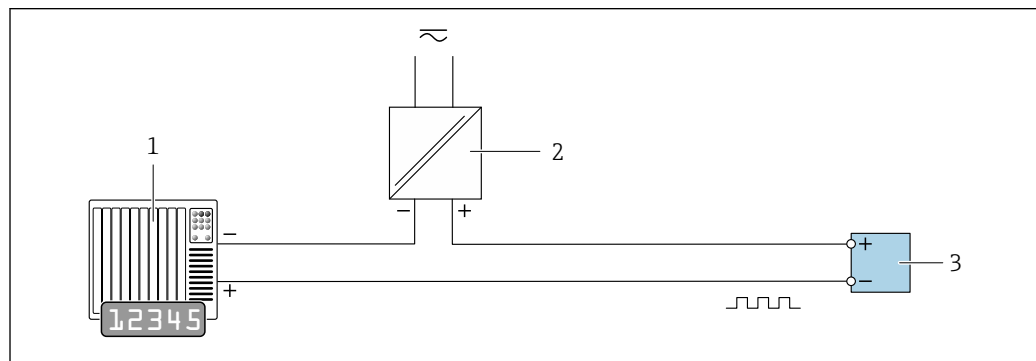

A0028761

22 Connection example for pulse/frequency output (passive)

- 1 Automation system with pulse/frequency input (e.g. PLC with 10 kΩ pull-up or pull-down resistor)
- 2 Power supply
- 3 Transmitter: observe input values → 235

### Switch output

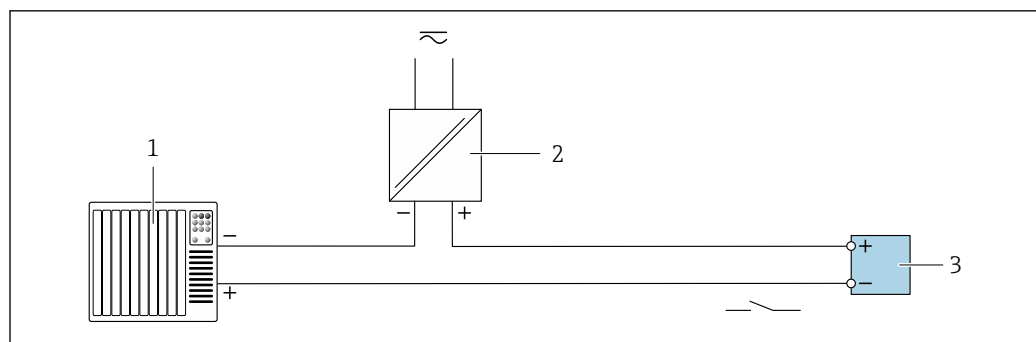

A0028760

23 Connection example for switch output (passive)

- 1 Automation system with switch input (e.g. PLC with a 10 kΩ pull-up or pull-down resistor)
- 2 Power supply
- 3 Transmitter: observe input values → 235

### Relay output

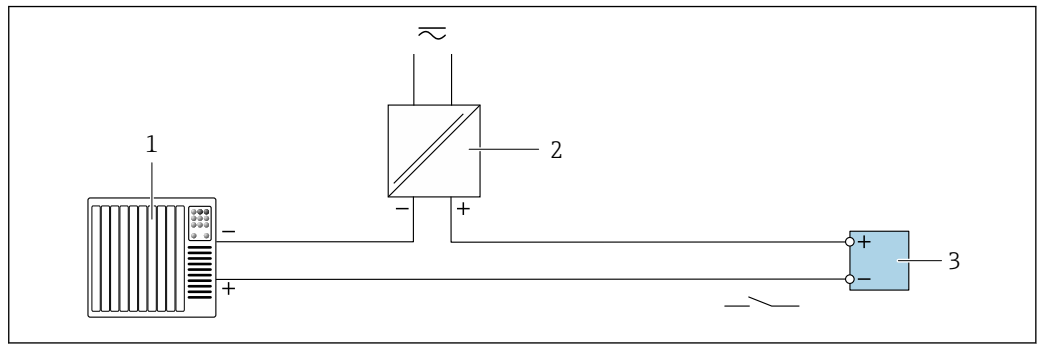

A0028760

24 Connection example for relay output (passive)

- 1 Automation system with relay input (e.g. PLC)
- 2 Power supply
- 3 Transmitter: observe input values → 236

### Current input

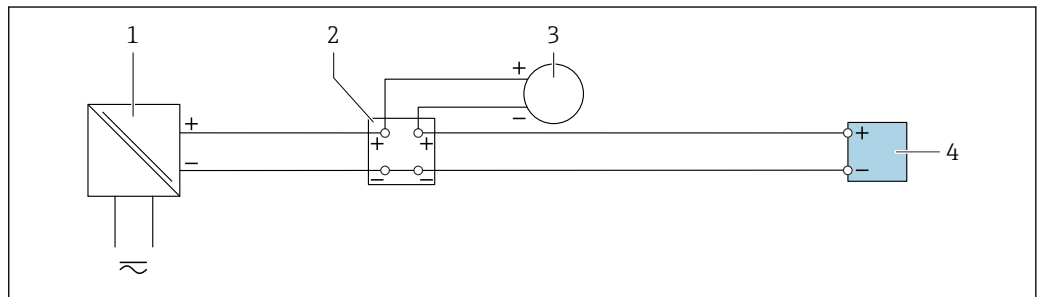

A0028915

25 Connection example for 4 to 20 mA current input

- 1 Power supply
- 2 Terminal box
- 3 External measuring device (to read in pressure or temperature, for instance)
- 4 Transmitter

### Status input

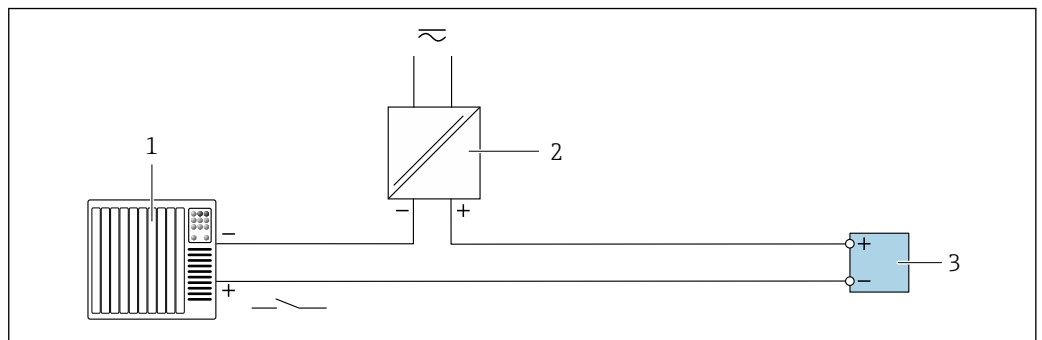

A0028764

26 Connection example for status input

- 1 Automation system with status output (e.g. PLC)
- 2 Power supply
- 3 Transmitter

## 7.7 Hardware settings

### 7.7.1 Setting the device address

The IP address of the measuring device can be configured for the network via DIP switches.

#### Addressing data

IP address and configuration options			
1st octet	2nd octet	3rd octet	4th octet
192.	168.	1.	XXX
	↓		↓
	Can only be configured via software addressing		Can be configured via software addressing and hardware addressing

IP address range	1 to 254 (4th octet)
IP address broadcast	255
Addressing mode ex works	Software addressing; all DIP switches for hardware addressing are set to OFF.
IP address ex works	DHCP server active

**i** Software addressing: The IP address is entered via the **IP address** parameter (→ [119](#)).

#### Setting the IP address: Proline 500 - digital

Risk of electric shock when opening the transmitter housing.

- ▶ Before opening the transmitter housing:
- ▶ Disconnect the device from the power supply.

**i** The default IP address may **not** be activated → [65](#).

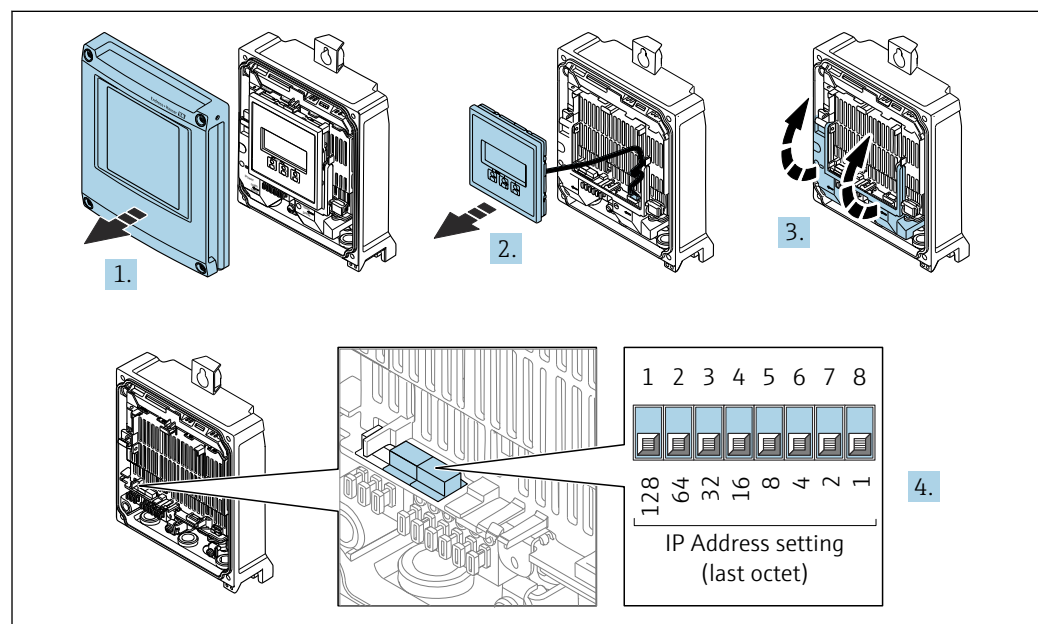

1. Loosen the 4 fixing screws on the housing cover.
2. Open the housing cover.
3. Fold open the terminal cover.





4. Set the desired IP address using the corresponding DIP switches on the I/O electronics module.
5. Reassemble the transmitter in the reverse order.
6. Reconnect the device to the power supply.
  - ↳ The configured device address is used once the device is restarted.

### Setting the IP address: Proline 500

Risk of electric shock when opening the transmitter housing.

- ▶ Before opening the transmitter housing:
- ▶ Disconnect the device from the power supply.

 The default IP address may **not** be activated →  66.

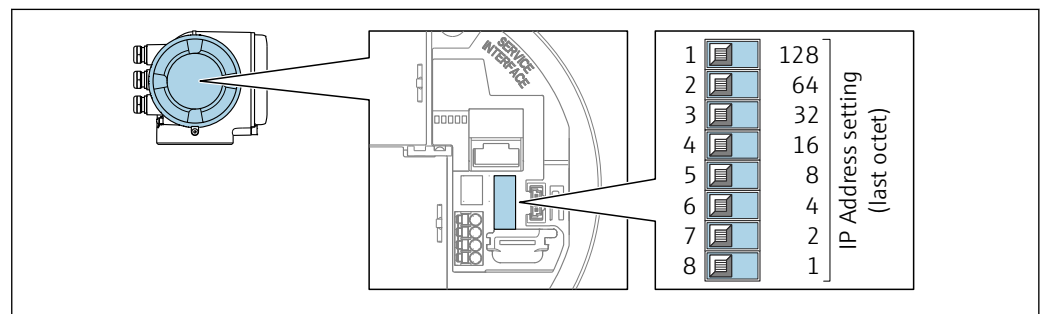

A0029635

1. Depending on the housing version, loosen the securing clamp or fixing screw of the housing cover.
2. Depending on the housing version, unscrew or open the housing cover and disconnect the local display from the main electronics module where necessary.
3. Set the desired IP address using the corresponding DIP switches on the I/O electronics module.
4. Reassemble the transmitter in the reverse order.
5. Reconnect the device to the power supply.
  - ↳ The configured device address is used once the device is restarted.

## 7.7.2 Activating the default IP address

### Activating the default IP address by DIP switch: Proline 500 - digital

Risk of electric shock when opening the transmitter housing.

- ▶ Before opening the transmitter housing:
- ▶ Disconnect the device from the power supply.

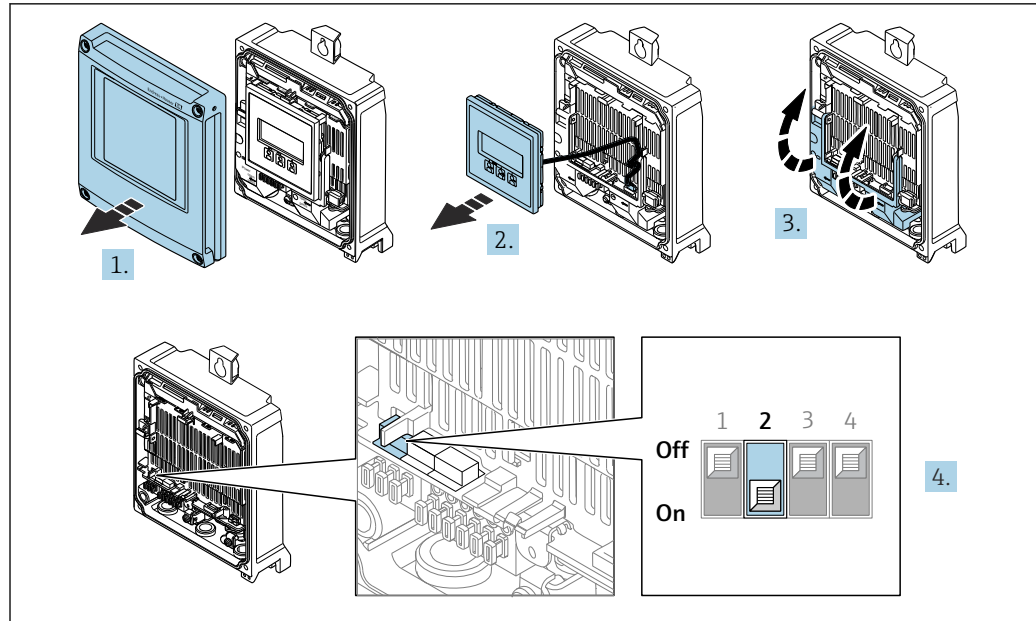

A0034500

1. Loosen the 4 fixing screws on the housing cover.
2. Open the housing cover.
3. Fold open the terminal cover.
4. Set DIP switch no. 2 on the I/O electronics module from **OFF** → **ON**.
5. Reassemble the transmitter in the reverse order.
6. Reconnect the device to the power supply.
  - ↳ The default IP address is used once the device is restarted.

### Activating the default IP address by DIP switch: Proline 500

Risk of electric shock when opening the transmitter housing.

- ▶ Before opening the transmitter housing:
- ▶ Disconnect the device from the power supply.

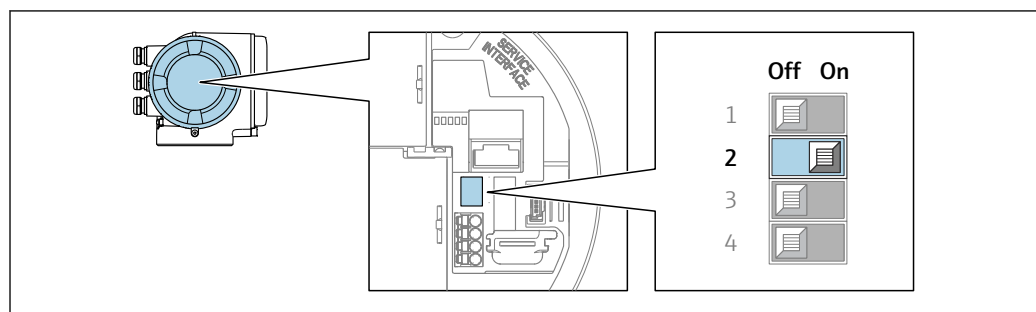

A0034499

1. Depending on the housing version, loosen the securing clamp or fixing screw of the housing cover.
2. Depending on the housing version, unscrew or open the housing cover and disconnect the local display from the main electronics module where necessary .
3. Set DIP switch no. 2 on the I/O electronics module from **OFF** → **ON**.
4. Reassemble the transmitter in the reverse order.
5. Reconnect the device to the power supply.
  - ↳ The default IP address is used once the device is restarted.

### 7.8 Ensuring the degree of protection

The measuring instrument fulfills all the requirements for the degree of protection IP66/67, Type 4X enclosure.

To guarantee the degree of protection IP66/67, Type 4X enclosure, carry out the following steps after the electrical connection:

1. Check that the housing seals are clean and fitted correctly.
2. Dry, clean or replace the seals if necessary.
3. Tighten all housing screws and screw covers.
4. Firmly tighten the cable glands.
5. To ensure that moisture does not enter the cable entry:  
Route the cable so that it loops down before the cable entry ("water trap").

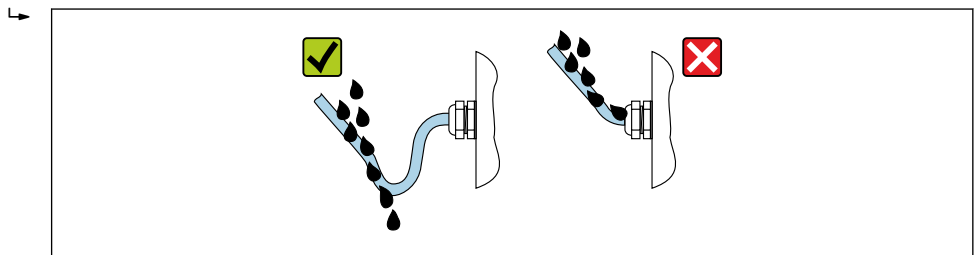

A0029278

6. The cable glands supplied do not ensure housing protection when not in use. They must therefore be replaced by dummy plugs corresponding to the housing protection.

### 7.9 Post-connection check

Are the device and cable undamaged (visual inspection)?	<input type="checkbox"/>
Is the protective earthing established correctly?	<input type="checkbox"/>
Do the cables used comply with the requirements ?	<input type="checkbox"/>
Are the installed cables strain-relieved and securely routed?	<input type="checkbox"/>
Are all cable glands installed, securely tightened and leak-tight? Cable run with "water trap" → 67?	<input type="checkbox"/>
Is the terminal assignment correct ?	<input type="checkbox"/>
Are dummy plugs inserted in unused cable entries and have transportation plugs been replaced with dummy plugs?	<input type="checkbox"/>

## 8 Operation options

### 8.1 Overview of operation options

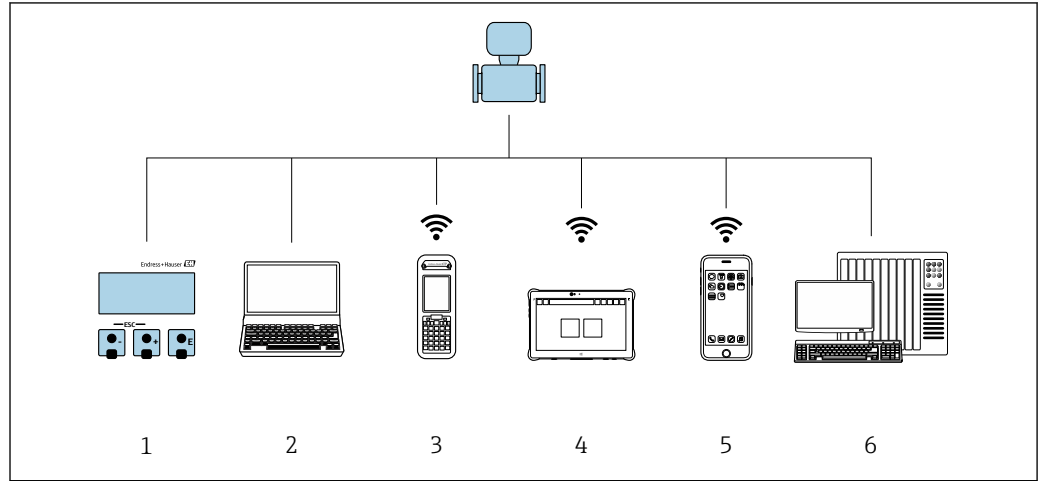



A0034513

- 1 Local operation via display module
- 2 Computer with web browser or operating tool (e.g. FieldCare, DeviceCare, AMS Device Manager, SIMATIC PDM)
- 3 Field Xpert SFX350 or SFX370
- 4 Field Xpert SMT70
- 5 Mobile handheld terminal
- 6 Automation system (e.g. PLC)

## 8.2 Structure and function of the operating menu

### 8.2.1 Structure of the operating menu

 For an overview of the operating menu for experts: see the "Description of Device Parameters" document supplied with the device →  260



 27 Schematic structure of the operating menu

A0018237-EN

### 8.2.2 Operating philosophy

The individual parts of the operating menu are assigned to certain user roles (e.g. operator, maintenance etc.). Each user role contains typical tasks within the device life cycle.

Menu/parameter		User role and tasks	Content/meaning
Language	Task-oriented	<b>Role "Operator", "Maintenance"</b> Tasks during operation: <ul style="list-style-type: none"> <li>Configuration of the operational display</li> <li>Reading measured values</li> </ul>	<ul style="list-style-type: none"> <li>Defining the operating language</li> <li>Defining the Web server operating language</li> <li>Resetting and controlling totalizers</li> </ul>
Operation			<ul style="list-style-type: none"> <li>Configuration of the operational display (e.g. display format, display contrast)</li> <li>Resetting and controlling totalizers</li> </ul>
Setup		<b>"Maintenance" role</b> Commissioning: <ul style="list-style-type: none"> <li>Configuration of the measurement</li> <li>Configuration of the inputs and outputs</li> <li>Configuration of the communication interface</li> </ul>	Wizards for fast commissioning: <ul style="list-style-type: none"> <li>Configuring the system units</li> <li>Configuration of the communication interface</li> <li>Definition of the medium</li> <li>Displaying the I/O configuration</li> <li>Configuring the inputs</li> <li>Configuring the outputs</li> <li>Configuration of the operational display</li> <li>Configuring the low flow cut off</li> <li>Configuring partial and empty pipe detection</li> </ul> Advanced setup <ul style="list-style-type: none"> <li>For more customized configuration of the measurement (adaptation to special measuring conditions)</li> <li>Configuration of totalizers</li> <li>Configuration of WLAN settings</li> <li>Administration (define access code, reset measuring device)</li> </ul>
Diagnostics	<b>"Maintenance" role</b> Troubleshooting: <ul style="list-style-type: none"> <li>Diagnostics and elimination of process and device errors</li> <li>Measured value simulation</li> </ul>	Contains all parameters for error detection and analyzing process and device errors: <ul style="list-style-type: none"> <li>Diagnostics list Contains up to 5 currently pending diagnostic messages.</li> <li>Event logbook Contains event messages that have occurred.</li> <li>Device information Contains information for identifying the device</li> <li>Measured values Contains all current measured values.</li> <li><b>Data logging</b> submenu with the "Extended HistoROM" order option Storage and visualization of measured values</li> <li>Heartbeat Technology Verification of device functionality on request and documentation of verification results</li> <li>Simulation Used to simulate measured values or output values.</li> </ul>	

Menu/parameter		User role and tasks	Content/meaning
Expert	Function-oriented	Tasks that require detailed knowledge of the function of the device: <ul style="list-style-type: none"> <li>▪ Commissioning measurements under difficult conditions</li> <li>▪ Optimal adaptation of the measurement to difficult conditions</li> <li>▪ Detailed configuration of the communication interface</li> <li>▪ Error diagnostics in difficult cases</li> </ul>	Contains all of the device parameters and allows direct access to these by means of an access code. The structure of this menu is based on the function blocks of the device: <ul style="list-style-type: none"> <li>▪ System Contains all higher-level device parameters that do not affect measurement or measured value communication</li> <li>▪ Sensor Configuration of the measurement.</li> <li>▪ Input Configuration of the status input</li> <li>▪ Output Configuration of the analog current outputs as well as the pulse/frequency and switch output</li> <li>▪ Communication Configuration of the digital communication interface and the Web server</li> <li>▪ Application Configuration of the functions that go beyond the actual measurement (e.g. totalizer)</li> <li>▪ Diagnostics Error detection and analysis of process and device errors and for device simulation and Heartbeat Technology.</li> </ul>

### 8.3 Access to operating menu via local display

#### 8.3.1 Operational display

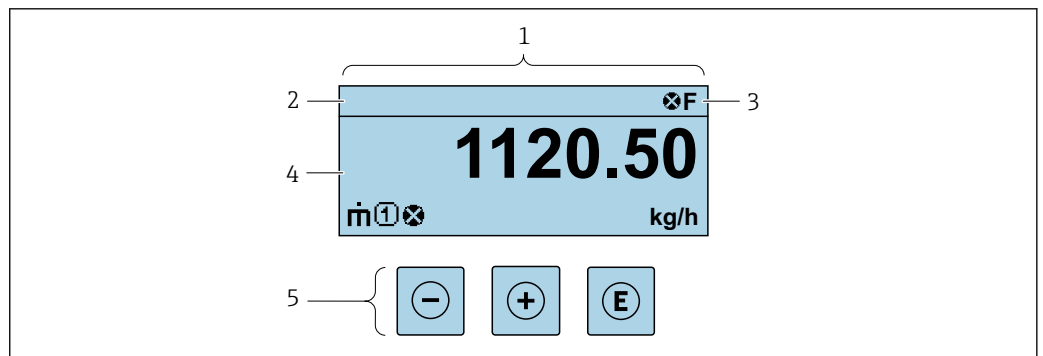

- 1 Operational display
- 2 Device tag
- 3 Status area
- 4 Display range for measured values (up to 4 lines)
- 5 Operating elements → 78

#### Status area

The following symbols appear in the status area of the operational display at the top right:





- Status signals → 198
  - **F**: Failure
  - **C**: Function check
  - **S**: Out of specification
  - **M**: Maintenance required
- Diagnostic behavior → 199
  - : Alarm
  - : Warning
  - : Locking (the device is locked via the hardware)
  - : Communication (communication via remote operation is active)

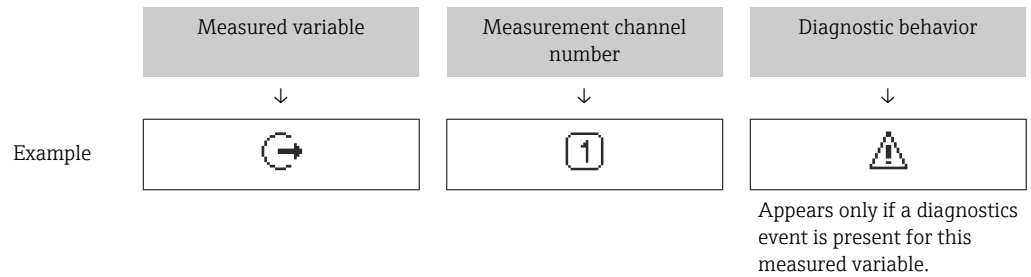

### Display area

In the display area, each measured value is prefaced by certain symbol types for further description:





### Measured variables



Symbol	Meaning
	Mass flow
	<ul style="list-style-type: none"> <li>▪ Volume flow</li> <li>▪ Corrected volume flow</li> </ul>
	<ul style="list-style-type: none"> <li>▪ Density</li> <li>▪ Reference density</li> </ul>
	Temperature

 The number and display format of the measured variables can be configured via the **Format display** parameter (→  139).

### Totalizer

Symbol	Meaning
	Totalizer  The measurement channel number indicates which of the three totalizers is displayed.



### Output

Symbol	Meaning
	Output  The measurement channel number indicates which of the outputs is displayed.

### Input



Symbol	Meaning
	Status input

### Measurement channel numbers

Symbol	Meaning
	Measurement channel 1 to 4  The measurement channel number is displayed only if more than one channel is present for the same measured variable type (e.g. totalizer 1 to 3).



*Diagnostic behavior*

Symbol	Meaning
	<b>Alarm</b> <ul style="list-style-type: none"><li>■ Measurement is interrupted.</li><li>■ Signal outputs and totalizers assume the defined alarm condition.</li><li>■ A diagnostic message is generated.</li></ul>
	<b>Warning</b> <ul style="list-style-type: none"><li>■ Measurement is resumed.</li><li>■ The signal outputs and totalizers are not affected.</li><li>■ A diagnostic message is generated.</li></ul>

 The diagnostic behavior pertains to a diagnostic event that is relevant to the displayed measured variable.

### 8.3.2 Navigation view

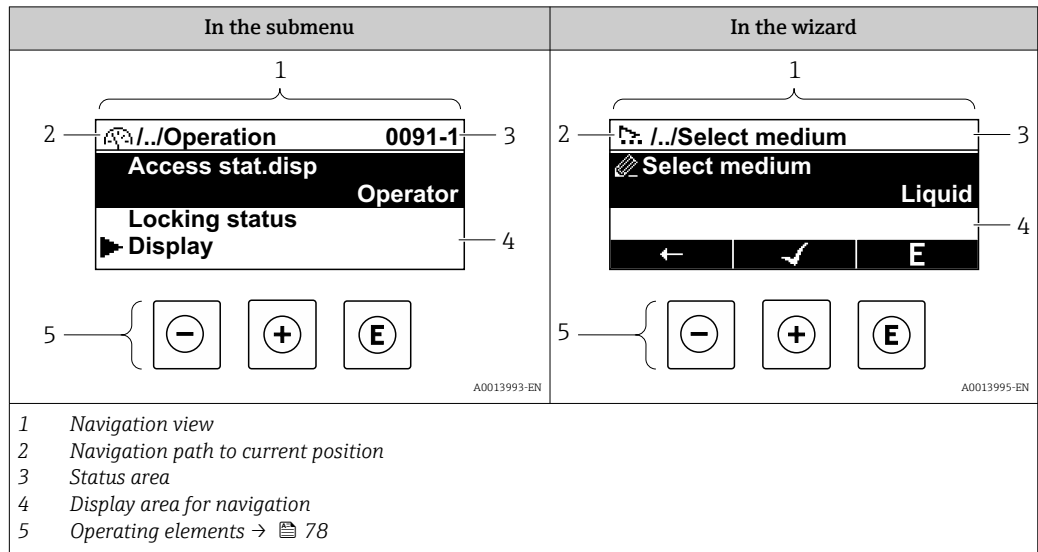

#### Navigation path

The navigation path to the current position is displayed at the top left in the navigation view and consists of the following elements:

- The display symbol for the menu/submenu (▶) or the wizard (➤).
- An omission symbol (/../) for operating menu levels in between.
- Name of the current submenu, wizard or parameter

	Display symbol	Omission symbol	Parameter
	↓	↓	↓
Example	▶	/ ../	Indication

For more information about the icons in the menu, refer to the "Display area" section → 74

#### Status area

The following appears in the status area of the navigation view in the top right corner:



- In the submenu
  - The direct access code to the parameter (e.g., 0022-1)
  - If a diagnostic event is present, the diagnostic behavior and status signal
- In the wizard
  - If a diagnostic event is present, the diagnostic behavior and status signal

- For information on the diagnostic behavior and status signal → 198
- For information on the function and entry of the direct access code → 80





#### Display area

##### Menus

Symbol	Meaning
	<p><b>Operation</b></p> <p>Is displayed:</p> <ul style="list-style-type: none"> <li>▪ In the menu next to the "Operation" selection</li> <li>▪ At the left in the navigation path in the <b>Operation</b> menu</li> </ul>

	<p><b>Setup</b> Is displayed:</p> <ul style="list-style-type: none"> <li>▪ In the menu next to the "Setup" selection</li> <li>▪ At the left in the navigation path in the <b>Setup</b> menu</li> </ul>
	<p><b>Diagnosis</b> Is displayed:</p> <ul style="list-style-type: none"> <li>▪ In the menu next to the "Diagnostics" selection</li> <li>▪ At the left in the navigation path in the <b>Diagnostics</b> menu</li> </ul>
	<p><b>Expert</b> Is displayed:</p> <ul style="list-style-type: none"> <li>▪ In the menu next to the "Expert" selection</li> <li>▪ At the left in the navigation path in the <b>Expert</b> menu</li> </ul>



*Submenus, wizards, parameters*

Symbol	Meaning
	Submenu
	Wizards
	Parameters within a wizard
	No display symbol exists for parameters in submenus.

*Locking procedure*

Symbol	Meaning
	<p><b>Parameter locked</b> When displayed in front of a parameter name, indicates that the parameter is locked.</p> <ul style="list-style-type: none"> <li>▪ By a user-specific access code</li> <li>▪ By the hardware write protection switch</li> </ul>

*Wizards*

Symbol	Meaning
	Switches to the previous parameter.
	Confirms the parameter value and switches to the next parameter.
	Opens the editing view of the parameter.

### 8.3.3 Editing view

#### Numeric editor

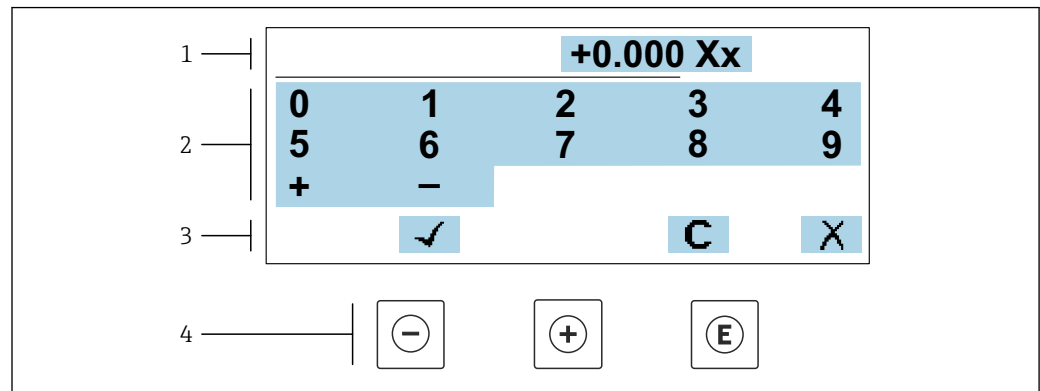

A0034250

28 For entering values in parameters (e.g. limit values)

- 1 Entry display area
- 2 Input screen
- 3 Confirm, delete or reject entry
- 4 Operating elements

#### Text editor

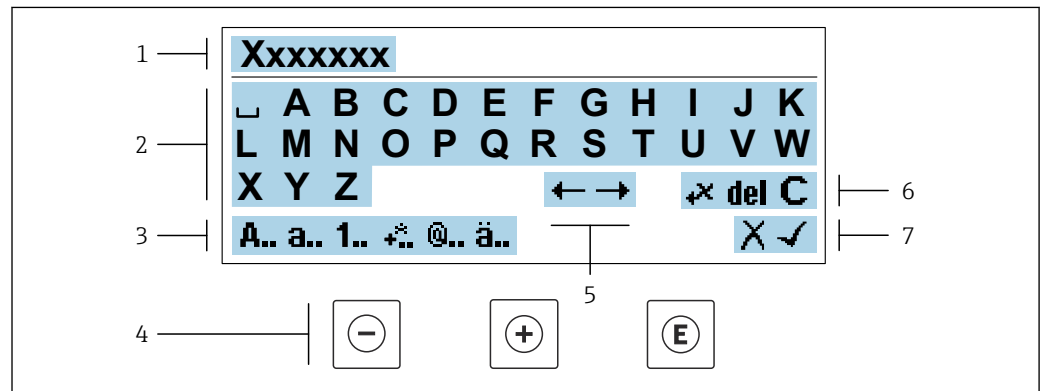

A0034114

29 For entering text in parameters (e.g. device tag)

- 1 Entry display area
- 2 Current input screen
- 3 Change input screen
- 4 Operating elements
- 5 Move entry position
- 6 Delete entry
- 7 Reject or confirm entry

#### Using the operating elements in the editing view



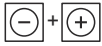

Operating key	Meaning
	<b>Minus key</b> Move the entry position to the left.
	<b>Plus key</b> Move the entry position to the right.

Operating key	Meaning
	<b>Enter key</b> <ul style="list-style-type: none"> <li>Pressing the key briefly confirms your selection.</li> <li>Pressing the key for 2 s confirms your entry.</li> </ul>
	<b>Escape key combination (press keys simultaneously)</b> Close the editing view without accepting a change.





### Input screens

Symbol	Meaning
<b>A..</b>	Upper case
<b>a..</b>	Lower case
<b>1..</b>	Numbers
<b>+..</b>	Punctuation marks and special characters: = + - * / <sup>2</sup> <sup>3</sup> ¼ ½ ¾ ( ) [ ] < > { }
<b>@..</b>	Punctuation marks and special characters: " ' ^ . , ; : ? ! % μ ° € \$ £ ¥ § @ # / \   ~ & _
<b>ä..</b>	Umlauts and accents

### Controlling data entries

Symbol	Meaning
	Move entry position
	Reject entry
	Confirm entry
	Delete character immediately to the left of the entry position
<b>del</b>	Delete character immediately to the right of the entry position
<b>C</b>	Clear all the characters entered

### 8.3.4 Operating elements

Operating key	Meaning
	<p><b>Minus key</b></p> <p><i>In menu, submenu</i> Moves the selection bar upwards in a picklist</p> <p><i>In wizards</i> Goes to previous parameter</p> <p><i>In the text and numeric editor</i> Move the entry position to the left.</p>
	<p><b>Plus key</b></p> <p><i>In menu, submenu</i> Moves the selection bar downwards in a picklist</p> <p><i>In wizards</i> Goes to the next parameter</p> <p><i>In the text and numeric editor</i> Move the entry position to the right.</p>
	<p><b>Enter key</b></p> <p><i>In the operational display</i> Pressing the key briefly opens the operating menu.</p> <p><i>In menu, submenu</i></p> <ul style="list-style-type: none"> <li>▪ Pressing the key briefly: <ul style="list-style-type: none"> <li>▪ Opens the selected menu, submenu or parameter.</li> <li>▪ Starts the wizard.</li> <li>▪ If help text is open, closes the help text of the parameter.</li> </ul> </li> <li>▪ Pressing the key for 2 s in a parameter: <ul style="list-style-type: none"> <li>▪ If present, opens the help text for the function of the parameter.</li> </ul> </li> </ul> <p><i>In wizards</i> Opens the editing view of the parameter and confirms the parameter value</p> <p><i>In the text and numeric editor</i></p> <ul style="list-style-type: none"> <li>▪ Pressing the key briefly confirms your selection.</li> <li>▪ Pressing the key for 2 s confirms your entry.</li> </ul>
	<p><b>Escape key combination (press keys simultaneously)</b></p> <p><i>In menu, submenu</i></p> <ul style="list-style-type: none"> <li>▪ Pressing the key briefly: <ul style="list-style-type: none"> <li>▪ Exits the current menu level and takes you to the next higher level.</li> <li>▪ If help text is open, closes the help text of the parameter.</li> </ul> </li> <li>▪ Pressing the key for 2 s returns you to the operational display ("home position").</li> </ul> <p><i>In wizards</i> Exits the wizard and takes you to the next higher level</p> <p><i>In the text and numeric editor</i> Exits the Editing view without applying the changes.</p>
	<p><b>Minus/Enter key combination (press and hold down the keys simultaneously)</b></p> <ul style="list-style-type: none"> <li>▪ If keypad lock is active: <ul style="list-style-type: none"> <li>▪ Pressing the key for 3 s deactivates the keypad lock.</li> </ul> </li> <li>▪ If keypad lock is not active: <ul style="list-style-type: none"> <li>▪ Pressing the key for 3 s opens the context menu including the option for activating the keypad lock.</li> </ul> </li> </ul>



### 8.3.5 Opening the context menu

Using the context menu, the user can call up the following menus quickly and directly from the operational display:

- Setup
- Data backup
- Simulation



### Calling up and closing the context menu

The user is in the operational display.

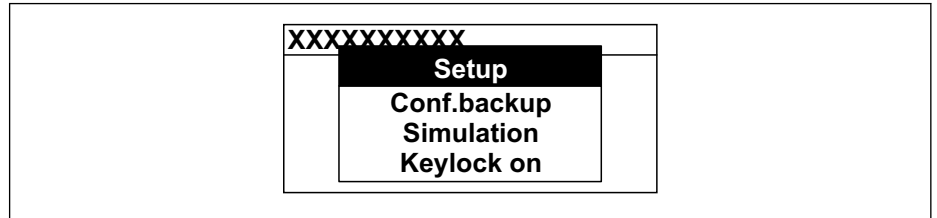

1. Press the  and  keys for longer than 3 seconds.
  - ↳ The context menu opens.



A0034608-EN

2. Press  +  simultaneously.
  - ↳ The context menu is closed and the operational display appears.

### Calling up the menu via the context menu

1. Open the context menu.
2. Press  to navigate to the desired menu.
3. Press  to confirm the selection.
  - ↳ The selected menu opens.

### 8.3.6 Navigating and selecting from list

Different operating elements are used to navigate through the operating menu. The navigation path is displayed on the left in the header. Icons are displayed in front of the individual menus. These icons are also shown in the header during navigation.

**i** For an explanation of the navigation view with symbols and operating elements → 74

**Example: Setting the number of displayed measured values to "2 values"**

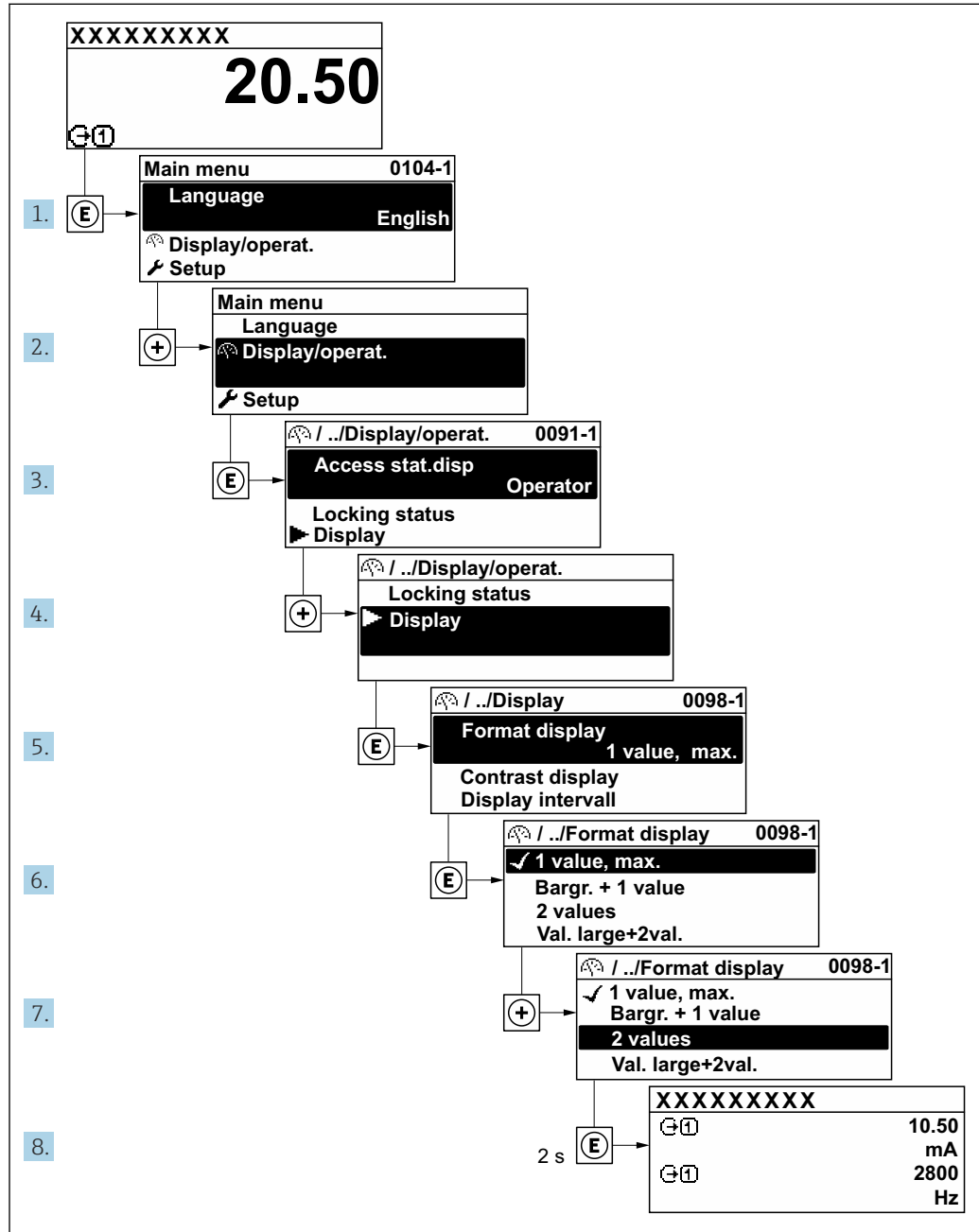

A0029562-EN

### 8.3.7 Calling the parameter directly

A parameter number is assigned to every parameter to be able to access a parameter directly via the onsite display. Entering this access code in the **Direct access** parameter calls up the desired parameter directly.

#### Navigation path

Expert → Direct access



The direct access code consists of a 5-digit number (at maximum) and the channel number, which identifies the channel of a process variable: e.g. 00914-2. In the navigation view, this appears on the right-hand side in the header of the selected parameter.

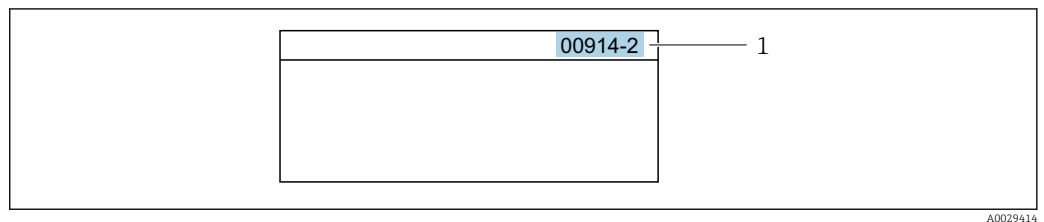

1 Direct access code

Note the following when entering the direct access code:

- The leading zeros in the direct access code do not have to be entered.  
Example: Enter "914" instead of "00914"
- If no channel number is entered, channel 1 is opened automatically.  
Example: Enter 00914 → **Assign process variable** parameter
- If a different channel is opened: Enter the direct access code with the corresponding channel number.  
Example: Enter 00914-2 → **Assign process variable** parameter



For the direct access codes of the individual parameters, see the "Description of Device Parameters" document for the device

### 8.3.8 Calling up help text

Help text is available for some parameters and can be called up from the navigation view. The help text provides a brief explanation of the parameter function and thereby supports swift and safe commissioning.



#### Calling up and closing the help text

The user is in the navigation view and the selection bar is on a parameter.

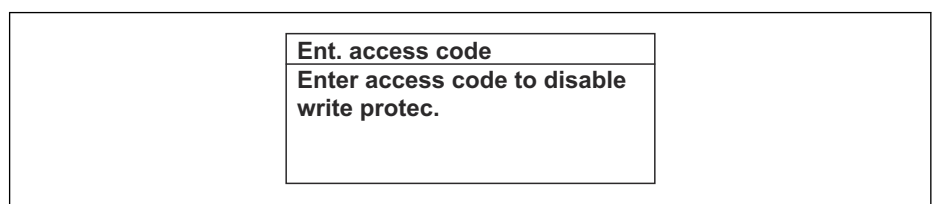
1. Press  for 2 s.  
↳ The help text for the selected parameter opens.



 30 Example: Help text for parameter "Enter access code"

2. Press  +  simultaneously.  
↳ The help text is closed.

### 8.3.9 Changing the parameters

Parameters can be changed via the numeric editor or text editor.

- Numeric editor: Change values in a parameter, e.g. specifications for limit values.
- Text editor: Enter text in a parameter, e.g. tag name.

A message is displayed if the value entered is outside the permitted value range.

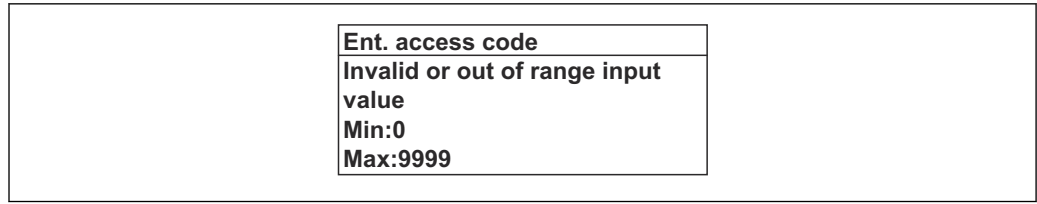

A0014049-EN

**i** For a description of the editing view - consisting of the text editor and numeric editor - with symbols → 76, for a description of the operating elements → 78

### 8.3.10 User roles and related access authorization

The two user roles "Operator" and "Maintenance" have different write access to the parameters if the customer defines a user-specific access code. This protects the device configuration via the local display from unauthorized access → 167.

#### Defining access authorization for user roles

An access code is not yet defined when the device is delivered from the factory. Access authorization (read and write access) to the device is not restricted and corresponds to the "Maintenance" user role.

- ▶ Define the access code.
  - ↳ The "Operator" user role is redefined in addition to the "Maintenance" user role. Access authorization differs for the two user roles.

*Access authorization to parameters: "Maintenance" user role*

Access code status	Read access	Write access
An access code has not yet been defined (factory setting).	✓	✓
After an access code has been defined.	✓	✓ <sup>1)</sup>

1) The user only has write access after entering the access code.

*Access authorization to parameters: "Operator" user role*

Access code status	Read access	Write access
After an access code has been defined.	✓	_ <sup>1)</sup>

1) Despite the defined access code, certain parameters can always be modified and thus are excluded from the write protection as they do not affect the measurement: write protection via access code → 167

**i** The user role with which the user is currently logged on is indicated by the **Access status** parameter. Navigation path: Operation → Access status

### 8.3.11 Disabling write protection via access code

If the -symbol appears on the local display in front of a parameter, the parameter is write-protected by a user-specific access code and its value cannot be changed at the moment using local operation → 167.

Parameter write protection via local operation can be disabled by entering the user-specific access code in the **Enter access code** parameter (→ 145) via the respective access option.

1. After you press , the input prompt for the access code appears.

2. Enter the access code.
  - ↳ The -symbol in front of the parameters disappears; all previously write-protected parameters are now re-enabled.

### 8.3.12 Enabling and disabling the keypad lock



The keypad lock makes it possible to block access to the entire operating menu via local operation. As a result, it is no longer possible to navigate through the operating menu or change the values of individual parameters. Users can only read the measured values on the operational display.

The keypad lock is switched on and off via the context menu.

#### Switching on the keypad lock



-  The keypad lock is switched on automatically:
- If the device has not been operated via the display for > 1 minute.
  - Each time the device is restarted.

#### To activate the keylock manually:

1. The device is in the measured value display.  
Press the  and  keys for 3 seconds.
  - ↳ A context menu appears.
2. In the context menu select the **Keylock on** option.
  - ↳ The keypad lock is switched on.

-  If the user attempts to access the operating menu while the keypad lock is active, the **Keylock on** message appears.

#### Switching off the keypad lock



- ▶ The keypad lock is switched on.  
Press the  and  keys for 3 seconds.
  - ↳ The keypad lock is switched off.

## 8.4 Access to operating menu via web browser

### 8.4.1 Function range

With the integrated web server, the device can be operated and configured via a web browser and via the service interface (CDI-RJ45) or WLAN interface. The structure of the operating menu is the same as for the local display. In addition to the measured values, status information on the device is displayed and can be used to monitor device health. Furthermore the device data can be managed and the network parameters can be configured.

A device that has a WLAN interface (can be ordered as an option) is required for the WLAN connection: order code for "Display; operation", option G "4-line, illuminated; touch control + WLAN". The device acts as an Access Point and enables communication by computer or a mobile handheld terminal.

-  For additional information on the web server, see the Special Documentation for the device. →  260

## 8.4.2 Requirements

### Computer hardware



Hardware	Interface	
	CDI-RJ45	WLAN
Interface	The computer must have a RJ45 interface. <sup>1)</sup>	The operating unit must have a WLAN interface.
Connection	Standard Ethernet cable	Connection via Wireless LAN.
Screen	Recommended size: ≥12" (depends on the screen resolution)	

- 1) Recommended cable: CAT5e, CAT6 or CAT7, with shielded plug (e.g. YAMAICHI product; part no. Y-ConProfixPlug63/Prod. ID: 82-006660)

### Computer software



Software	Interface	
	CDI-RJ45	WLAN
Recommended operating systems	<ul style="list-style-type: none"> <li>▪ Microsoft Windows 8 or higher.</li> <li>▪ Mobile operating systems:                             <ul style="list-style-type: none"> <li>▪ iOS</li> <li>▪ Android</li> </ul> </li> </ul> <p> Microsoft Windows XP and Windows 7 is supported.</p>	
Web browsers supported	<ul style="list-style-type: none"> <li>▪ Microsoft Internet Explorer 8 or higher</li> <li>▪ Microsoft Edge</li> <li>▪ Mozilla Firefox</li> <li>▪ Google Chrome</li> <li>▪ Safari</li> </ul>	

### Computer settings



Settings	Interface	
	CDI-RJ45	WLAN
User rights	Appropriate user rights (e.g. administrator rights) for TCP/IP and proxy server settings are necessary (e.g. for adjusting the IP address, subnet mask etc.).	
Proxy server settings of the web browser	The web browser setting <i>Use a proxy server for your LAN</i> must be <b>disabled</b> .	
JavaScript	<p>JavaScript must be enabled.</p> <p> If JavaScript cannot be enabled: Enter <code>http://192.168.1.212/servlet/basic.html</code> in the address bar of the web browser. A fully functional but simplified version of the operating menu structure starts in the web browser.</p> <p> When installing a new firmware version: To enable correct data display, clear the temporary memory (cache) under <b>Internet options</b> in the web browser.</p>	<p>JavaScript must be enabled.</p> <p> The WLAN display requires JavaScript support.</p>
Network connections	Only use the active network connections to the measuring device.	
	Switch off all other network connections such as WLAN for example.	Switch off all other network connections.

 In the event of connection problems: →  193

*Measuring device: Via CDI-RJ45 service interface*

Device	CDI-RJ45 service interface
Measuring device	The measuring device has an RJ45 interface.
Web server	Web server must be enabled; factory setting: ON  For information on enabling the Web server → 90
IP address	If the IP address of the device is not known: <ul style="list-style-type: none"> <li>▪ The IP address can be read out via local operation: Diagnostics → Device information → IP address</li> <li>▪ Communication with the Web server can be established via the default IP address 192.168.1.212.</li> </ul> <p>The DHCP function is enabled in the device at the factory, i.e. the device expects an IP address to be assigned by the network. This function can be disabled and the device can be set to the default IP address 192.168.1.212: set DIP switch No. 2 from <b>OFF</b> → <b>ON</b>.</p>  Set the default IP address → 65.

*Measuring device: via WLAN interface*

Device	WLAN interface
Measuring device	The measuring device has a WLAN antenna: <ul style="list-style-type: none"> <li>▪ Transmitter with integrated WLAN antenna</li> <li>▪ Transmitter with external WLAN antenna</li> </ul>
Web server	Web server and WLAN must be enabled; factory setting: ON  For information on enabling the Web server → 90
IP address	If the IP address of the device is not known: <ul style="list-style-type: none"> <li>▪ The IP address can be read out via local operation: Diagnostics → Device information → IP address</li> <li>▪ Communication with the Web server can be established via the default IP address 192.168.1.212.</li> </ul> <p>The DHCP function is enabled in the device at the factory, i.e. the device expects an IP address to be assigned by the network. This function can be disabled and the device can be set to the default IP address 192.168.1.212: set DIP switch No. 2 from <b>OFF</b> → <b>ON</b>.</p>  Set the default IP address → 65.

**8.4.3 Connecting the device****Via service interface (CDI-RJ45)***Preparing the measuring device**Proline 500 – digital*

1. Loosen the 4 fixing screws on the housing cover.
2. Open the housing cover.
3. The location of the connection socket depends on the measuring device and the communication protocol.

Connect the computer to the RJ45 plug via the standard Ethernet cable .

*Proline 500*

1. Depending on the housing version:  
Loosen the securing clamp or fixing screw of the housing cover.

2. Depending on the housing version:  
Unscrew or open the housing cover.
3. Connect the computer to the RJ45 plug via the standard Ethernet connecting cable..

*Configuring the Internet protocol of the computer*

The IP address can be assigned to the measuring device in a variety of ways:

- Dynamic Host Configuration Protocol (DHCP), factory setting:  
The IP address is automatically assigned to the measuring device by the automation system (DHCP server).
- Hardware addressing:  
The IP address is set via DIP switches .
- Software addressing:  
The IP address is entered via the **IP address** parameter (→ 📖 119) .
- DIP switch for "Default IP address":  
To establish the network connection via the service interface (CDI-RJ45): the fixed IP address 192.168.1.212 is used .

The device works with the Dynamic Host Configuration Protocol (DHCP) ex-works, i.e. the IP address of the measuring device is automatically assigned by the automation system (DHCP server).

To establish a network connection via the service interface (CDI-RJ45): set the "Default IP address" DIP switch to **ON**. The measuring device then has the fixed IP address: 192.168.1.212. The fixed IP address 192.168.1.212 can now be used to establish the connection to the network.

1. Via DIP switch 2, activate the default IP address 192.168.1.212: .
2. Switch on the measuring device.
3. Connect the computer to the RJ45 plug via the standard Ethernet cable → 📖 92.
4. If a 2nd network card is not used, close all the applications on the notebook.
  - ↳ Applications requiring Internet or a network, such as e-mail, SAP applications, Internet or Windows Explorer.
5. Close any open Internet browsers.
6. Configure the properties of the Internet protocol (TCP/IP) as defined in the table:

<b>IP address</b>	192.168.1.XXX; for XXX all numerical sequences except: 0, 212 and 255 → e.g. 192.168.1.213
<b>Subnet mask</b>	255.255.255.0
<b>Default gateway</b>	192.168.1.212 or leave cells empty

**Via WLAN interface**

*Configuring the Internet protocol of the mobile terminal*

**NOTICE**

**If the WLAN connection is lost during the configuration, settings made may be lost.**

- ▶ Make sure that the WLAN connection is not disconnected while configuring the device.

**NOTICE**

**Note the following to avoid a network conflict:**

- ▶ Avoid accessing the measuring device simultaneously from the same mobile terminal via the service interface (CDI-RJ45) and the WLAN interface.
- ▶ Only activate one service interface (CDI-RJ45 or WLAN interface).
- ▶ If simultaneous communication is necessary: configure different IP address ranges, e.g. 192.168.0.1 (WLAN interface) and 192.168.1.212 (CDI-RJ45 service interface).

### *Preparing the mobile terminal*

- ▶ Enable WLAN on the mobile terminal.

### *Establishing a WLAN connection from the mobile terminal to the measuring device*

1. In the WLAN settings of the mobile terminal:  
Select the measuring device using the SSID (e.g. EH\_Promass\_500\_A802000).
2. If necessary, select the WPA2 encryption method.
3. Enter the password:  
Serial number of the measuring device ex-works (e.g. L100A802000).
  - ↳ The LED on the display module flashes. It is now possible to operate the measuring device with the web browser, FieldCare or DeviceCare.

 The serial number can be found on the nameplate.

 To ensure the safe and swift assignment of the WLAN network to the measuring point, it is advisable to change the SSID name. It should be possible to clearly assign the new SSID name to the measuring point (e.g. tag name) because it is displayed as the WLAN network.

### *Terminating the WLAN connection*

- ▶ After configuring the device:  
Terminate the WLAN connection between the mobile terminal and measuring device.

### **Starting the web browser**

1. Start the web browser on the computer.

2. Enter the IP address of the web server in the address line of the web browser:  
192.168.1.212  
↳ The login page appears.

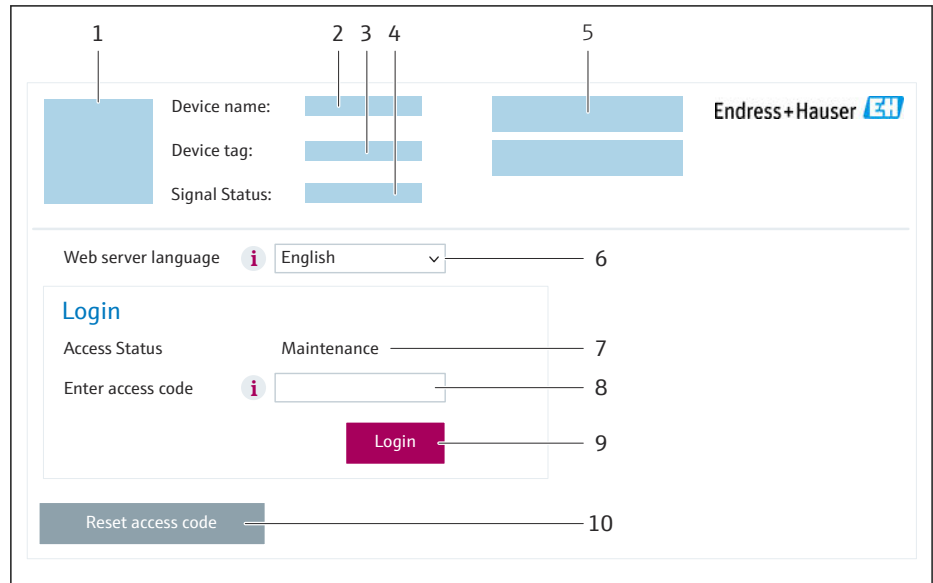

- 1 Picture of device
- 2 Device name
- 3 Device tag
- 4 Status signal
- 5 Current measured values
- 6 Operating language
- 7 User role
- 8 Access code
- 9 Login
- 10 Reset access code (→ 164)

**i** If a login page does not appear, or if the page is incomplete → 193

### 8.4.4 Logging on

1. Select the preferred operating language for the Web browser.
2. Enter the user-specific access code.
3. Press **OK** to confirm your entry.

<b>Access code</b>	0000 (factory setting); can be changed by customer
--------------------	--

**i** If no action is performed for 10 minutes, the Web browser automatically returns to the login page.



### 8.4.5 User interface



A0029418

- 1 Function row
- 2 Local display language
- 3 Navigation area

#### Header

The following information appears in the header:

- Device name
- Device tag
- Device status with status signal → 201
- Current measured values

#### Function row

Functions	Meaning
Measured values	Displays the measured values of the device
Menu	<ul style="list-style-type: none"> <li>■ Access to the operating menu from the measuring device</li> <li>■ The structure of the operating menu is the same as for the local display</li> </ul>  Detailed information on the operating menu structure: Description of Device Parameters
Device status	Displays the diagnostic messages currently pending, listed in order of priority
Data management	Data exchange between computer and measuring device: <ul style="list-style-type: none"> <li>■ Device configuration:                             <ul style="list-style-type: none"> <li>■ Load settings from the device (XML format, save configuration)</li> <li>■ Save settings to the device (XML format, restore configuration)</li> </ul> </li> <li>■ Logbook - Export Event logbook (.csv file)</li> <li>■ Documents - Export documents:                             <ul style="list-style-type: none"> <li>■ Export backup data record (.csv file, create documentation of the measuring point configuration)</li> <li>■ Verification report (PDF file, only available with the "Heartbeat Verification" application package)</li> </ul> </li> <li>■ File for system integration - If using fieldbuses, upload device drivers for system integration from the measuring device:                             <ul style="list-style-type: none"> <li>EtherNet/IP: EDS file</li> </ul> </li> <li>■ Firmware update - Flashing a firmware version</li> </ul>
Network	Configuration and checking of all the parameters required for establishing the connection to the measuring device: <ul style="list-style-type: none"> <li>■ Network settings (e.g. IP address, MAC address)</li> <li>■ Device information (e.g. serial number, firmware version)</li> </ul>
Logout	End the operation and call up the login page

**Navigation area**

The menus, the associated submenus and parameters can be selected in the navigation area.

**Working area**

Depending on the selected function and the related submenus, various actions can be performed in this area:

- Configuring parameters
- Reading measured values
- Calling up help text
- Starting an upload/download

**8.4.6 Disabling the Web server**

The Web server of the measuring device can be switched on and off as required using the **Web server functionality** parameter.

**Navigation**

"Expert" menu → Communication → Web server

**Parameter overview with brief description**

Parameter	Description	Selection
Web server functionality	Switch the Web server on and off.	<ul style="list-style-type: none"> <li>▪ Off</li> <li>▪ HTML Off</li> <li>▪ On</li> </ul>

**Function scope of the "Web server functionality" parameter**

Option	Description
Off	<ul style="list-style-type: none"> <li>▪ The Web server is completely disabled.</li> <li>▪ Port 80 is locked.</li> </ul>
HTML Off	The HTML version of the Web server is not available.
On	<ul style="list-style-type: none"> <li>▪ The complete Web server functionality is available.</li> <li>▪ JavaScript is used.</li> <li>▪ The password is transferred in an encrypted state.</li> <li>▪ Any change to the password is also transferred in an encrypted state.</li> </ul>

**Enabling the Web server**

If the Web server is disabled it can only be re-enabled with the **Web server functionality** parameter via the following operating options:

- Via local display
- Via Bedientool "FieldCare"
- Via "DeviceCare" operating tool

**8.4.7 Logging out**

 Before logging out, perform a data backup via the **Data management** function (upload configuration from device) if necessary.

1. Select the **Logout** entry in the function row.  
↳ The home page with the Login box appears.
2. Close the Web browser.

3. If no longer needed:

Reset the modified properties of the Internet protocol (TCP/IP) → 86.



If communication with the web server was established via the default IP address 192.168.1.212, DIP switch no. 10 must be reset (from **ON** → **OFF**). Afterwards, the IP address of the device is active again for network communication.

## 8.5 Access to the operating menu via the operating tool

The structure of the operating menu in the operating tools is the same as for operation via the local display.

### 8.5.1 Connecting the operating tool

#### Via EtherNet/IP network

This communication interface is available in device versions with EtherNet/IP.

##### Star topology

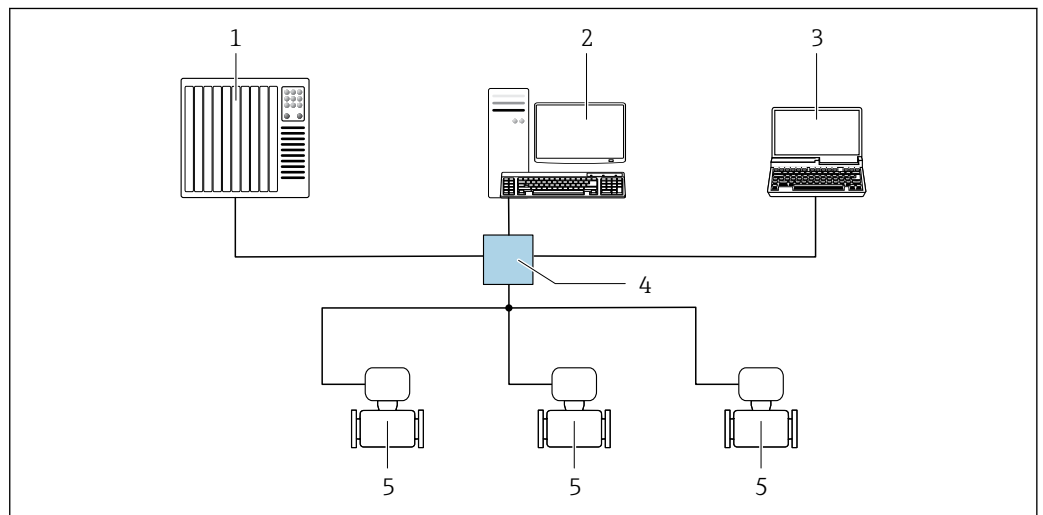

A0032078

31 Options for remote operation via EtherNet/IP network: star topology

- 1 Automation system, e.g. "RSLogix" (Rockwell Automation)
- 2 Workstation for measuring device operation: with Custom Add-On Profile for "RSLogix 5000" (Rockwell Automation) or with Electronic Data Sheet (EDS)
- 3 Computer with Web browser (e.g. Internet Explorer) for accessing the integrated Web server or computer with operating tool (e.g. FieldCare, DeviceCare) with COM DTM "CDI Communication TCP/IP"
- 4 Standard Ethernet switch, e.g. Scalance X204 (Siemens)
- 5 Measuring device

##### Ring topology

The device is integrated via the terminal connection for signal transmission (output 1) and the service interface (CDI-RJ45).

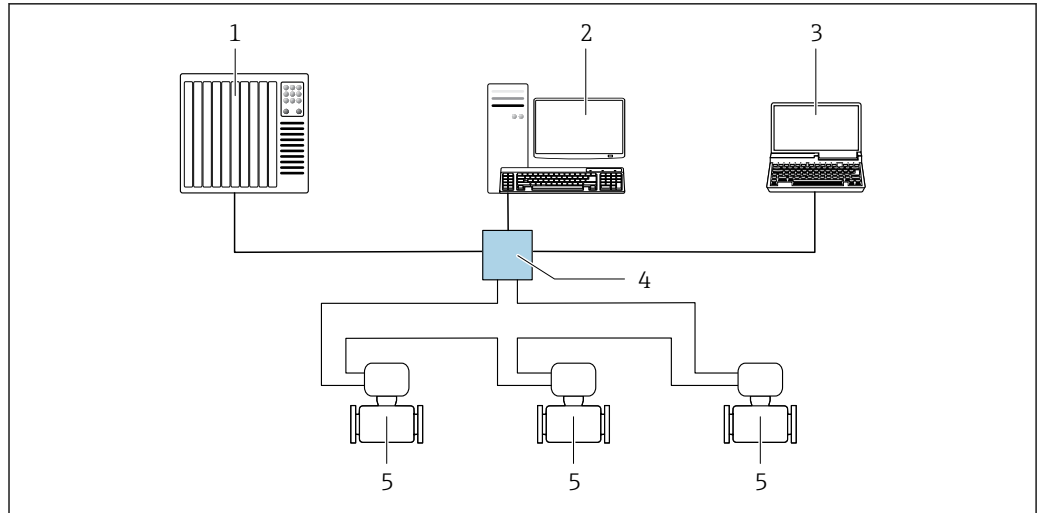

A0033725

32 Options for remote operation via EtherNet/IP network: ring topology

- 1 Automation system, e.g. "RSLogix" (Rockwell Automation)
- 2 Workstation for measuring device operation: with Custom Add-On Profile for "RSLogix 5000" (Rockwell Automation) or with Electronic Data Sheet (EDS)
- 3 Computer with Web browser (e.g. Internet Explorer) for accessing the integrated Web server or computer with operating tool (e.g. FieldCare, DeviceCare) with COM DTM "CDI Communication TCP/IP"
- 4 Standard Ethernet switch, e.g. Scalance X204 (Siemens)
- 5 Measuring device

**Service interface**

Via service interface (CDI-RJ45)

A point-to-point connection can be established to configure the device onsite. With the housing open, the connection is established directly via the service interface (CDI-RJ45) of the device.

**i** An adapter for the RJ45 to the M12 plug is optionally available for the non-hazardous area:

Order code for "Accessories", option **NB**: "Adapter RJ45 M12 (service interface)"

The adapter connects the service interface (CDI-RJ45) to an M12 plug mounted in the cable entry. The connection to the service interface can be established via an M12 plug without opening the device.

*Proline 500 – digital transmitter*

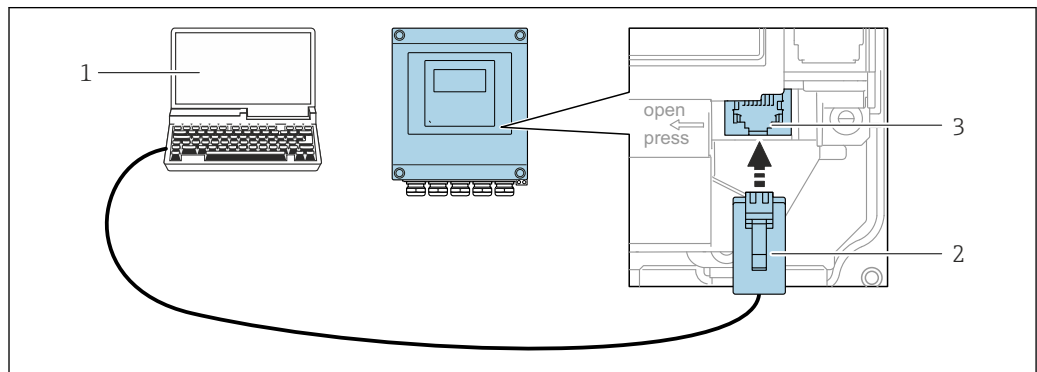

A0029163

33 Connection via service interface (CDI-RJ45)

- 1 Computer with web browser (e.g. Microsoft Internet Explorer, Microsoft Edge) for accessing the integrated web server or with "FieldCare" operating tool, "DeviceCare" with COM DTM "CDI Communication TCP/IP"
- 2 Standard Ethernet connecting cable with RJ45 plug
- 3 Service interface (CDI-RJ45) of the measuring device with access to the integrated Web server

Proline 500 transmitter

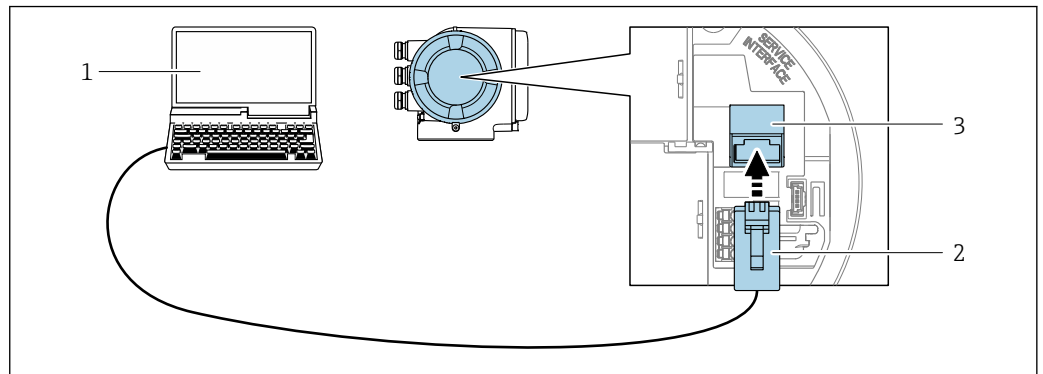

A0027563

34 Connection via service interface (CDI-RJ45)

- 1 Computer with web browser (e.g. Microsoft Internet Explorer, Microsoft Edge) for accessing the integrated web server or with "FieldCare" operating tool, "DeviceCare" with COM DTM "CDI Communication TCP/IP"
- 2 Standard Ethernet connecting cable with RJ45 plug
- 3 Service interface (CDI-RJ45) of the measuring device with access to the integrated Web server

Via WLAN interface

The optional WLAN interface is available on the following device version:

Order code for "Display; operation", option G "4-line, illuminated; touch control + WLAN"

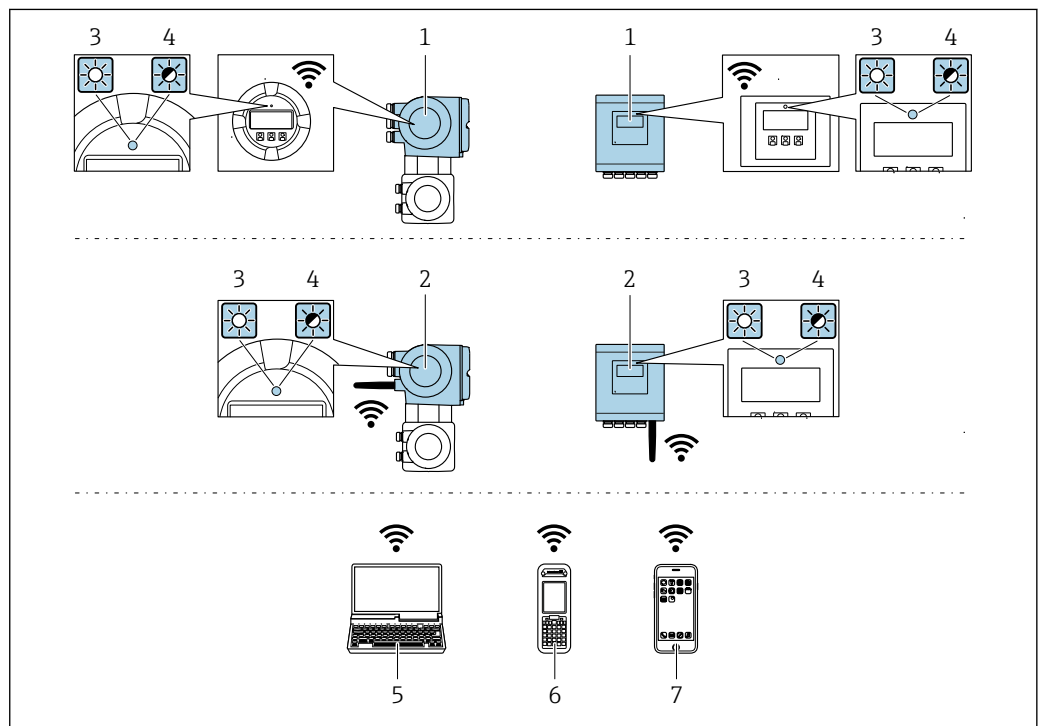

A0034569

- 1 Transmitter with integrated WLAN antenna
- 2 Transmitter with external WLAN antenna
- 3 LED lit constantly: WLAN reception is enabled on measuring device
- 4 LED flashing: WLAN connection established between operating unit and measuring device
- 5 Computer with WLAN interface and web browser (e.g. Microsoft Internet Explorer, Microsoft Edge) for accessing the integrated device web server or with operating tool (e.g. FieldCare, DeviceCare)
- 6 Mobile handheld terminal with WLAN interface and web browser (e.g. Microsoft Internet Explorer, Microsoft Edge) for accessing the integrated device web server or operating tool (e.g. FieldCare, DeviceCare)
- 7 Smart phone or tablet (e.g. Field Xpert SMT70)

Function	WLAN: IEEE 802.11 b/g (2.4 GHz) <ul style="list-style-type: none"> <li>▪ Access Point with DHCP server (factory setting)</li> <li>▪ Network</li> </ul>
Encryption	WPA2-PSK AES-128 (in accordance with IEEE 802.11i)
Configurable WLAN channels	1 to 11
Degree of protection	IP67
Available antennas	<ul style="list-style-type: none"> <li>▪ Internal antenna</li> <li>▪ External antenna (optional) In the event of poor transmission/reception conditions at the place of installation.</li> </ul>  Only 1 antenna is active at any one time!
Range	<ul style="list-style-type: none"> <li>▪ Internal antenna: typically 10 m (32 ft)</li> <li>▪ External antenna: typically 50 m (164 ft)</li> </ul>
Materials (external antenna)	<ul style="list-style-type: none"> <li>▪ Antenna: ASA plastic (acrylonitrile styrene acrylate) and nickel-plated brass</li> <li>▪ Adapter: Stainless steel and nickel-plated brass</li> <li>▪ Cable: Polyethylene</li> <li>▪ Plug: Nickel-plated brass</li> <li>▪ Angle bracket: Stainless steel</li> </ul>

*Configuring the Internet protocol of the mobile terminal*

**NOTICE**

**If the WLAN connection is lost during the configuration, settings made may be lost.**

- ▶ Make sure that the WLAN connection is not disconnected while configuring the device.

**NOTICE**

**Note the following to avoid a network conflict:**

- ▶ Avoid accessing the measuring device simultaneously from the same mobile terminal via the service interface (CDI-RJ45) and the WLAN interface.
- ▶ Only activate one service interface (CDI-RJ45 or WLAN interface).
- ▶ If simultaneous communication is necessary: configure different IP address ranges, e.g. 192.168.0.1 (WLAN interface) and 192.168.1.212 (CDI-RJ45 service interface).

*Preparing the mobile terminal*

- ▶ Enable WLAN on the mobile terminal.

*Establishing a WLAN connection from the mobile terminal to the measuring device*

1. In the WLAN settings of the mobile terminal:  
Select the measuring device using the SSID (e.g. EH\_Promass\_500\_A802000).
2. If necessary, select the WPA2 encryption method.
3. Enter the password:  
Serial number of the measuring device ex-works (e.g. L100A802000).  
↳ The LED on the display module flashes. It is now possible to operate the measuring device with the web browser, FieldCare or DeviceCare.

 The serial number can be found on the nameplate.

 To ensure the safe and swift assignment of the WLAN network to the measuring point, it is advisable to change the SSID name. It should be possible to clearly assign the new SSID name to the measuring point (e.g. tag name) because it is displayed as the WLAN network.



*Terminating the WLAN connection*

- ▶ After configuring the device:  
Terminate the WLAN connection between the mobile terminal and measuring device.

**8.5.2 FieldCare****Function range**

FDT-based (Field Device Technology) plant asset management tool from Endress+Hauser. It can configure all smart field units in a system and helps you manage them. By using the status information, it is also a simple but effective way of checking their status and condition.

Access is via:

- CDI-RJ45 service interface →  92
- WLAN interface →  93

Typical functions:

- Transmitter parameter configuration
- Loading and saving of device data (upload/download)
- Documentation of the measuring point
- Visualization of the measured value memory (line recorder) and event logbook



- Operating Instructions BA00027S
- Operating Instructions BA00059S



Source for device description files →  97

**Establishing a connection**

1. Start FieldCare and launch the project.
2. In the network: Add a device.
  - ↳ The **Add device** window opens.
3. Select the **CDI Communication TCP/IP** option from the list and press **OK** to confirm.
4. Right-click **CDI Communication TCP/IP** and select the **Add device** option in the context menu that opens.
5. Select the desired device from the list and press **OK** to confirm.
  - ↳ The **CDI Communication TCP/IP (Configuration)** window opens.
6. Enter the device address in the **IP address** field: 192.168.1.212 and press **Enter** to confirm.
7. Establish the online connection to the device.



- Operating Instructions BA00027S
- Operating Instructions BA00059S

User interface

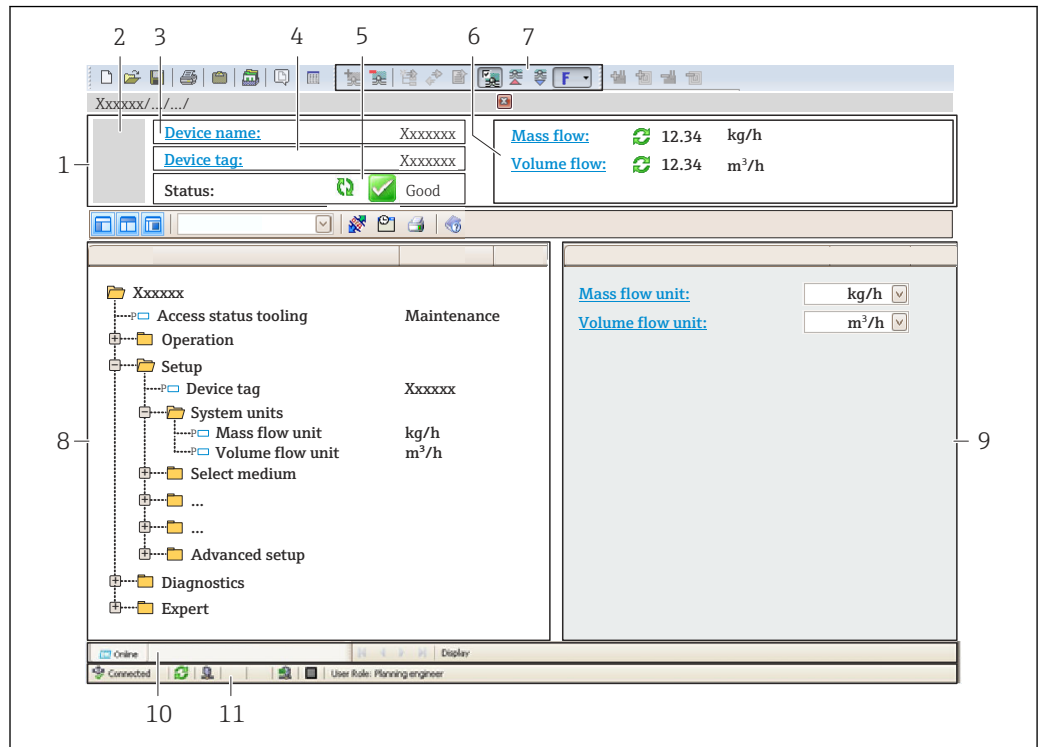

A0021051-EN

- 1 Header
- 2 Picture of device
- 3 Device name
- 4 Device tag
- 5 Status area with status signal → 201
- 6 Display area for current measured values
- 7 Editing toolbar with additional functions such as save/load, event list and create documentation
- 8 Navigation area with operating menu structure
- 9 Work area
- 10 Action area
- 11 Status area

### 8.5.3 DeviceCare

#### Function range

Tool for connecting and configuring Endress+Hauser field devices.

The fastest way to configure Endress+Hauser field devices is with the dedicated "DeviceCare" tool. Together with the device type managers (DTMs) it presents a convenient, comprehensive solution.

 Innovation brochure IN01047S

 Source for device description files → 97





## 9 System integration

### 9.1 Overview of device description files

#### 9.1.1 Current version data for the device

Firmware version	01.00.zz	<ul style="list-style-type: none"> <li>▪ On the title page of the manual</li> <li>▪ On the transmitter nameplate</li> <li>▪ Firmware version Diagnostics → Device information → Firmware version</li> </ul>
Release date of firmware version	10.2017	---
Manufacturer ID	0x11	Manufacturer ID Diagnostics → Device information → Manufacturer ID
Device type code	0x103B	Device type Diagnostics → Device information → Device type
Device revision	<ul style="list-style-type: none"> <li>▪ Major revision 1</li> <li>▪ Minor revision 1</li> </ul>	<ul style="list-style-type: none"> <li>▪ On the transmitter nameplate</li> <li>▪ Device revision Diagnostics → Device information → Device revision</li> </ul>
Device profile	Generic device (product type: 0x2B)	

 For an overview of the various firmware versions for the device →  222

#### 9.1.2 Operating tools

The suitable device description file for the individual operating tools is listed in the table below, along with information on where the file can be acquired.

Operating tool via Service interface (CDI-RJ45)	Sources for obtaining device descriptions
FieldCare	<ul style="list-style-type: none"> <li>▪ <a href="http://www.endress.com">www.endress.com</a> → Downloads area</li> <li>▪ USB stick (contact Endress+Hauser)</li> <li>▪ DVD (contact Endress+Hauser)</li> </ul>
DeviceCare	<ul style="list-style-type: none"> <li>▪ <a href="http://www.endress.com">www.endress.com</a> → Downloads area</li> <li>▪ CD-ROM (contact Endress+Hauser)</li> <li>▪ DVD (contact Endress+Hauser)</li> </ul>

### 9.2 Overview of system files

System files	Version	Description	How to acquire
Electronic Data Sheet (EDS system file)	2.1	Certified in accordance with the following ODVA guidelines: <ul style="list-style-type: none"> <li>▪ Conformance test</li> <li>▪ Performance test</li> <li>▪ PlugFest</li> </ul> Embedded EDS Support (File Object 0x37)	<ul style="list-style-type: none"> <li>▪ <a href="http://www.endress.com">www.endress.com</a> → Download Area</li> <li>▪ EDS system file integrated in the device: can be downloaded via the web browser</li> </ul>
Add-on Profile	<ul style="list-style-type: none"> <li>▪ Major revision 1</li> <li>▪ Minor revision 1</li> </ul>	System file for "Studio 5000" software (Rockwell Automation)	<a href="http://www.endress.com">www.endress.com</a> → Download Area

## 9.3 Integrating the measuring device in the system

 For detailed information on system integration, see the Operating Instructions for the device

A detailed description of how to integrate the device into an automation system (e.g. from Rockwell Automation) is available as a separate document:











[www.endress.com](http://www.endress.com) → Select your country → Solutions → Fieldbus planning  
→ Fieldbus technologies → EtherNet/IP

## 9.4 Cyclic data transmission

Cyclic data transmission when using the device master file (GSD).

### 9.4.1 Block model

The block model shows which input and output data the measuring device makes available for implicit messaging. Cyclical data exchange is performed using an EtherNet/IP scanner, e.g. a distributed control system etc.

Measuring device				Control system
<b>Transducer Block</b>	Input Assembly Fix (Assem100) 44 byte	→  100	Permanently assigned input group	→
	Mass flow fixed input assembly (Assem106) 32 byte	→  101	Permanently assigned input group	→
	Volume flow fixed input assembly (Assem107) 62 byte	→  101	Permanently assigned input group	→
	Concentration fixed input assembly <sup>1)</sup> (Assem109) 66 byte	→  101	Permanently assigned input group	→
	API Referenced corrections fixed input assembly <sup>2)</sup> (Assem110) 64 byte	→  102	Permanently assigned input group	→
	Water cut % fixed input assembly <sup>2)</sup> (Assem111) 80 byte	→  102	Permanently assigned input group	→
	Heartbeat monitoring fixed input assembly <sup>3)</sup> (Assem112) 96 byte	→  102	Permanently assigned input group	→
	Input assembly custom (Assem101) 88 byte	→  103	Configurable input group	→
	Output assembly fix (Assem102) 54 byte	→  104	Permanently assigned output group	←
	Config assembly (Assem104) 2709 byte	→  106	Permanently assigned configuration	→
				<b>EtherNet/IP</b>

1) Only available with the Concentration application package.

2) Only available with the Petroleum application package.

3) Only available with the Heartbeat Verification application package.

## 9.4.2 Input and output groups

### Possible configurations

#### Configuration 1: Exclusive Owner Multicast

Input Assembly Fix		Instance	Size [byte]	Min. RPI (ms)
Input Assembly Configurable	Configuration	0 x 64	398	-
Output Assembly Fix	O → T Configuration	0 x 66	64	5
Input Assembly Fix	T → O Configuration	0 x 64	44	5

#### Configuration 2: Input Only Multicast

Input Assembly Fix		Instance	Size [byte]	Min. RPI (ms)
Input Assembly Configurable	Configuration	0 x 68	398	-
Output Assembly Fix	O → T Configuration	0 x C7	-	-
Input Assembly Fix	T → O Configuration	0 x 64	44	5

#### Configuration 3: Exclusive Owner Multicast

Input Assembly Configurable		Instance	Size [byte]	Min. RPI (ms)
Input Assembly Configurable	Configuration	0 x 68	398	-
Output Assembly Fix	O → T Configuration	0 x 66	64	5
Input Assembly Fix	T → O Configuration	0 x 65	88	5

#### Configuration 4: Input Only Multicast

Input Assembly Configurable		Instance	Size [byte]	Min. RPI (ms)
Input Assembly Configurable	Configuration	0 x 68	398	-
Output Assembly Fix	O → T Configuration	0 x C7	-	-
Input Assembly Fix	T → O Configuration	0 x 64	88	5

#### Configuration 5: Exclusive Owner Multicast

Input Assembly Fix		Instance	Size [byte]	Min. RPI (ms)
Input Assembly Configurable	Configuration	0 x 69	-	-
Output Assembly Fix	O → T Configuration	0 x 66	64	5
Input Assembly Fix	T → O Configuration	0 x 64	44	5

#### Configuration 6: Input Only Multicast

Input Assembly Fix		Instance	Size [byte]	Min. RPI (ms)
Input Assembly Configurable	Configuration	0 x 69	-	-
Output Assembly Fix	O → T Configuration	0 x C7	-	-
Input Assembly Fix	T → O Configuration	0 x 65	44	5

*Configuration 7: Exclusive Owner Multicast*

Input Assembly Configurable		Instance	Size [byte]	Min. RPI (ms)
Input Assembly Configurable	Configuration	0 x 69	-	-
Output Assembly Fix	O → T Configuration	0 x 66	64	5
Input Assembly Fix	T → O Configuration	0 x 64	88	5

*Configuration 8: Input Only Multicast*

Input Assembly Configurable		Instance	Size [byte]	Min. RPI (ms)
Input Assembly Configurable	Configuration	0 x 69	-	-
Output Assembly Fix	O → T Configuration	0 x C7	-	-
Input Assembly Fix	T → O Configuration	0 x 65	88	5

**Possible connections**

No.	#1	#2	#3	#4	#5	#6	#7	#8	#9
<b>Number of connections</b>	<b>1</b>	<b>1</b>	<b>1</b>	<b>1</b>	<b>1</b>	<b>1</b>	<b>1</b>	<b>1</b>	<b>1</b>
Input assembly fixed (Assem100)	X								
Mass flow fixed input assembly (Assem106)		X							
Volume flow fixed input assembly (Assem107)			X						
Input assembly custom (Assem101)				X					
Viscosity fixed input assembly (Assem108)					X				
Concentration fixed input assembly (Assem109)						X			
API Referenced corrections fixed input assembly (Assem110)							X		
Water cut % fixed input assembly (Assem111)								X	
Heartbeat monitoring fixed input assembly (Assem112)									X

**Permanently assigned input group***Input assembly fixed (Assem100), 44 byte*

Description	Byte
1. File header (not visible)	1 to 4
2. Current diagnosis <sup>1)</sup>	5 to 8
3. Mass flow	9 to 12
4. Volume flow	13 to 16
5. Corrected volume flow	17 to 20
6. Temperature	21 to 24
7. Density	25 to 28
8. Reference density	29 to 32
9. Totalizer 1	33 to 36

Description	Byte
10. Totalizer 2	37 to 40
11. Totalizer 3	41 to 44

1) Diagnostic information via EtherNet/IP → ⓘ 109

*Mass flow fixed input assembly (Assem106), 32 byte*

Description	Byte
1. File header (not visible)	1 to 4
2. Current diagnosis <sup>1)</sup>	5 to 8
3. Mass flow	9 to 12
4. Density	13 to 16
5. Temperature	17 to 20
6. Totalizer 1	21 to 24
7. Mass flow unit	25 to 26
8. Density unit	27 to 28
9. Temperature unit	29 to 30
10. Totalizer 1 unit	31 to 32

1) Diagnostic information via EtherNet/IP → ⓘ 109

*Volume flow fixed input assembly (Assem107), 62 byte*

Description	Byte
1. Mass flow fixed input assembly	1 to 32
2. Volume flow	33 to 36
3. Corrected volume flow	37 to 40
4. Reference density	41 to 44
5. Totalizer 2	45 to 48
6. Totalizer 3	49 to 52
7. Volume flow unit	53 to 54
8. Corrected volume flow unit	55 to 56
9. Reference density unit	57 to 58
10. Totalizer 2 unit	59 to 60
11. Totalizer 3 unit	61 to 62

*Concentration fixed input assembly (Assem109), 66 byte <sup>1)</sup>*

Description	Byte
1. Mass flow fixed input assembly	1 to 32
2. Target mass flow	33 to 36
3. Carrier mass flow	37 to 40
4. Target volume flow	41 to 44
5. Carrier volume flow	45 to 48
6. Target corrected volume flow	49 to 52
7. Carrier corrected volume flow	53 to 56

Description	Byte
8. Concentration	57 to 60
9. Volume flow unit	61 to 62
10. Corrected volume flow unit	63 to 64
11. Concentration unit	65 to 66

1) Only available with the Concentration application package.

*API Referenced corrections fixed input assembly (Assem110), 60 byte<sup>1)</sup>*

Description	Byte
1. Mass flow fixed input assembly	1 to 32
2. Alternative reference density	33 to 36
3. GSV flow	37 to 40
4. Alternative GSV flow	41 to 44
5. NSV flow	45 to 48
6. Alternative NSV flow	49 to 52
7. S&W volume flow	53 to 56
8. Volume flow unit	57 to 58
9. Reference density unit	59 to 60

1) Only available with the Petroleum application package.

*Water cut % fixed input assembly (Assem111), 76 byte<sup>1)</sup>*

Description	Byte
1. Mass flow fixed input assembly	1 to 32
2. Oil density	33 to 36
3. Water density	37 to 40
4. Water cut %	41 to 44
5. Oil mass flow	45 to 48
6. Water mass flow	49 to 52
7. Oil volume flow	53 to 56
8. Water volume flow	57 to 60
9. Oil corrected volume flow	61 to 64
10. Water corrected volume flow	65 to 68
11. Volume flow unit	69 to 70
12. Corrected volume flow unit	71 to 72
13. Oil density unit	73 to 74
14. Water density unit	75 to 76

1) Only available with the Petroleum application package

*Heartbeat monitoring fixed input assembly (Assem112), 100 byte<sup>1)</sup>*

Description	Byte
1. Mass flow fixed input assembly	1 to 32
2. Signal asymmetry	33 to 36

Description	Byte
3. Oscillation frequency 0	37 to 40
4. Oscillation frequency 1	41 to 44
5. Oscillation amplitude 0	45 to 48
6. Oscillation amplitude 1	49 to 52
7. Oscillation damping 0	53 to 56
8. Oscillation damping 1	57 to 60
9. Tube damping fluctuation 0	61 to 64
10. Tube damping fluctuation 1	65 to 68
11. Exciter current 0	69 to 72
12. Exciter current 1	73 to 76
13. HBSI	77 to 80
14. Frequency fluctuation 0	81 to 84
15. Frequency fluctuation 1	85 to 88
16. Electronics temperature	89 to 92
17. Carrier pipe temperature	93 to 96
18. Verification status	97 to 98
19. Verification results	99 to 100

1) Only available with the Heartbeat Verification application package.

### Configurable input group

*Input assembly custom (Assem101), 88 byte*

Description	Format
1. - 10. Input values 1 to 10	Real
11. - 20. Input values 11 to 20	Double integer

### Possible input values

Possible input values 1 to 10:		
<ul style="list-style-type: none"> <li>▪ Off</li> <li>▪ Mass flow</li> <li>▪ Volume flow</li> <li>▪ Corrected volume flow</li> <li>▪ Target mass flow <sup>1)</sup></li> <li>▪ Carrier mass flow <sup>1)</sup></li> <li>▪ Target volume flow <sup>1)</sup></li> <li>▪ Carrier volume flow <sup>1)</sup></li> <li>▪ Target corrected volume flow <sup>1)</sup></li> <li>▪ Carrier corrected volume flow <sup>1)</sup></li> <li>▪ Density</li> <li>▪ Reference density</li> <li>▪ Concentration <sup>1)</sup></li> </ul>	<ul style="list-style-type: none"> <li>▪ Temperature</li> <li>▪ Carrier tube temperature <sup>2)</sup></li> <li>▪ Electronics temperature</li> <li>▪ Oscillation frequency 0</li> <li>▪ Oscillation frequency 1 <sup>2)</sup></li> <li>▪ Oscillation amplitude 0</li> <li>▪ Oscillation amplitude 1 <sup>2)</sup></li> <li>▪ Frequency fluctuation 0</li> <li>▪ Frequency fluctuation 1 <sup>2)</sup></li> <li>▪ Oscillation damping 0</li> <li>▪ Oscillation damping 1</li> <li>▪ Tube damping fluctuation 0</li> <li>▪ Tube damping fluctuation 1</li> <li>▪ Signal asymmetry</li> </ul>	<ul style="list-style-type: none"> <li>▪ Exciter current 0</li> <li>▪ Exciter current 1 <sup>2)</sup></li> <li>▪ Monitoring of exciter current 0</li> <li>▪ Monitoring of exciter current 1 <sup>2)</sup></li> <li>▪ HBSI <sup>2)</sup></li> <li>▪ Totalizer 1</li> <li>▪ Totalizer 2</li> <li>▪ Totalizer 3</li> <li>▪ Alternative reference density <sup>3)</sup></li> <li>▪ GSV flow <sup>3)</sup></li> <li>▪ Alternative GSV flow <sup>3)</sup></li> <li>▪ NSV flow <sup>3)</sup></li> <li>▪ Alternative NSV flow <sup>3)</sup></li> <li>▪ S&amp;W volume flow <sup>3)</sup></li> </ul>

1) Only available with the Concentration application package.

2) Only available with the Heartbeat Verification application package.

3) Only available with the Petroleum application package.

Possible input values 11 to 20:		
▪ Off	▪ Temperature unit	▪ Totalizer 1 unit
▪ Current diagnostics	▪ Density unit	▪ Totalizer 2 unit
▪ Previous diagnostics	▪ Reference density unit	▪ Totalizer 3 unit
▪ Mass flow unit	▪ Concentration unit	▪ Verification results
▪ Volume flow unit	▪ Current unit	▪ Verification status
▪ Corrected volume flow unit		▪ Status of zero adjustment

### Permanently assigned output group

Output assembly fix (Assem102), 54 byte

Description (format)	Byte	Bit	Value
1. Totalizer 1	1	0	<ul style="list-style-type: none"> <li>▪ 0: Disable</li> <li>▪ 1: Enable</li> </ul>
2. Totalizer 2		1	
3. Totalizer 3		2	
4. Verification		3	
5. Concentration of medium type		4	
6. Compensation, pressure		5	
7. Reference density compensation		6	
8. Compensation, temperature		7	
9. S&W correction value %	2	0	<ul style="list-style-type: none"> <li>▪ 0: Disable</li> <li>▪ 1: Enable</li> </ul>
10. Water cut %		1	
11. Flow override		2	
12. Zero adjustment		3	
13. Not Used		4	
14. Not Used		5	
15. Not Used		6	
16. Not Used		7	
17. Not Used	3 to 4	16	–
18. Control totalizer 1 (integer)	5 to 6	16	<ul style="list-style-type: none"> <li>▪ -32226 (0): Add</li> <li>▪ -32490 (1): Reset and stop</li> <li>▪ -32228 (2): Default value and stop</li> <li>▪ 198 (3): Reset and add</li> <li>▪ 199 (4): Default value and add</li> <li>▪ 32608 (3): Stop</li> </ul>
19. Control totalizer 2 (integer)	7 to 8	16	
20. Control totalizer 3 (integer)	9 to 10	16	
21. Start verification (integer)	11 to 12	16	



Description (format)	Byte	Bit	Value
22. Select concentration of medium type	13 to 14	16	<ul style="list-style-type: none"> <li>▪ 3062 (0) : Aqueous Fructose</li> <li>▪ 3063 (0) : Aqueous Glucose</li> <li>▪ 3068 (0) : Aqueous Hydrochloric Acid</li> <li>▪ 3077 (0) : Aqueous Hydrogen Peroxide</li> <li>▪ 3065 (0) : Aqueous Sucrose</li> <li>▪ 3064 (0) : Aqueous Invert Sugar</li> <li>▪ 3069 (0) : Aqueous Nitric Acid</li> <li>▪ 3070 (0) : Aqueous Phosphoric Acid</li> <li>▪ 3075 (0) : Aqueous Potassium Hydroxide</li> <li>▪ 3071 (0) : Aqueous Sodium Hydroxide</li> <li>▪ 3060 (0) : Ethanol Water</li> <li>▪ 3061 (0) : Methanol Water</li> <li>▪ 3066 (0) : Ammonium Nitrate In Water</li> <li>▪ 3067 (0) : Ferric Chloride In Water</li> <li>▪ 3073 (0) : High Fructose Corn Syrup 42</li> <li>▪ 3074 (0) : High Fructose Corn Syrup 55</li> <li>▪ 3072 (0) : High Fructose Corn Syrup 90</li> <li>▪ 3092 (0) : Percent Volume / Percent Mass</li> <li>▪ 3081 (0) : Wort</li> <li>▪ 3082 (0) : Coef Set 1</li> <li>▪ 3083 (0) : Coef Set 2</li> <li>▪ 3084 (0) : Coef Set 3</li> </ul>
23. Not Used	15 to 16	16	–
24. External pressure (real)	17 to 20	32	Data format: Byte 1 to 4: External pressure Floating-point number (IEEE754)
25. External pressure unit (integer)	21 to 22	16	<ul style="list-style-type: none"> <li>▪ 1610 (11): Pa a</li> <li>▪ 1616 (12): kPa a</li> <li>▪ 1614 (237): MPa a</li> <li>▪ 1137 (7): bar</li> <li>▪ 1611 (240): Pa g</li> <li>▪ 1617 (240): kPa a</li> <li>▪ 1615 (240): MPa a</li> <li>▪ 32797 (7): bar g</li> <li>▪ 1142 (6): psi a</li> <li>▪ 1143 (240): psi g</li> </ul>
26. Not Used	23 to 24	16	–
27. External reference density (real)	25 to 28	32	Data format: Byte 1 to 4: External ref. density Floating-point number (IEEE754)
28. External reference density unit (integer)	29 to 30	16	<ul style="list-style-type: none"> <li>▪ 32840 (240): kg/Nm<sup>3</sup></li> <li>▪ 32841 (240): kg/Nl</li> <li>▪ 32842 (240): g/Scm<sup>3</sup></li> <li>▪ 32843 (240): kg/Scm<sup>3</sup></li> <li>▪ 32844 (240): lb/Sft<sup>3</sup></li> </ul>
29. Not Used	31 to 32	16	–
30. External temperature (real)	33 to 36	32	Data format: Byte 1 to 4: External temperature Floating-point number (IEEE754)
31. External temperature unit (integer)	37 to 38	16	<ul style="list-style-type: none"> <li>▪ 1001 (32): °C</li> <li>▪ 1002 (33): °F</li> <li>▪ 1000 (35): K</li> <li>▪ 1003 (34): °R</li> </ul>

Description (format)	Byte	Bit	Value
32. Not Used	39 to 40	16	–
33. External value % S&W (real)	41 to 44	32	Data format: Byte 1-4: External value, % S&W Floating-point number (IEEE754)
34. External value, water cut % (real)	45 to 48	32	Data format: Byte 1-4: External value, water cut % Floating-point number (IEEE754)
35 Flow override monitoring	49 to 50	16	<ul style="list-style-type: none"> <li>■ 33004 (0): Off</li> <li>■ 33006 (1): On</li> </ul>
36 Monitoring of zero adjustment	51 to 52	16	<ul style="list-style-type: none"> <li>■ 32823 (0): Cancel</li> <li>■ 33242 (0): Active</li> <li>■ 248 (0): Error zero adjustment</li> <li>■ 33158 (1): Start</li> </ul>

### Permanently assigned configuration group

Config assembly (Assem104), 2704 byte

Description (format)	Bits	Byte	Offset
1. None	32	4	0
2. Parameter 36 – Write protection	8	1	4
3. None	8	1	5
4. Parameter 87 System units Mass flow unit	16	2	6
5. Parameter 86 System units Mass unit	16	2	8
6. Parameter 93 System units Volume flow unit	16	2	10
7. Parameter 92 System units Volume unit	16	2	12
8. Parameter 80 System units Corrected volume flow unit	16	2	14
9. Parameter 79 System units Corrected volume unit	16	2	16
10. Parameter 81 System units Density unit	16	2	18
11. Parameter 89 System units Reference density unit	16	2	20
12. Parameter 91 System units Temperature unit	16	2	22
13. None	16	2	24
14. Parameter 88 System units Pressure unit	16	2	26
15. Parameter 85 System units Kinematic viscosity unit	16	2	28
16. Parameter 84 System units Dynamic viscosity unit	16	2	30
17. Parameter 78 System units Concentration unit	16	2	32
18. Parameter 82 System units Oil density unit	16	2	34
19. Parameter 83 System units Water density unit	16	2	36
20. Parameter 90 System units Water reference density unit	16	2	38
21. None	32	4	40
22. None	16	2	44
23. Parameter 224 – Enter access code	16	2	46
24. Parameter 94 Totalizer 1 Assign process variable	16	2	48
25. Parameter 106 Totalizer 1 Unit totalizer	16	2	50
26. Parameter 103 Totalizer 1 Totalizer operating mode	16	2	52
27. Parameter 100 Totalizer 1 Failure mode	16	2	54

Description (format)				Bits	Byte	Offset
28.	Parameter 244	Totalizer operation	Preset value tot. 1	32	4	56
29.	Parameter 97	Totalizer operation	Control totalizer 1	16	2	60
30.	Parameter 95	Totalizer 2	Assign process variable	16	2	62
31.	Parameter 107	Totalizer 2	Unit totalizer	16	2	64
32.	Parameter 104	Totalizer 2	Totalizer operating mode	16	2	66
33.	Parameter 101	Totalizer 2	Failure mode	16	2	68
34.	Parameter 98	Totalizer operation	Control totalizer 2	16	2	70
35.	Parameter 245	Totalizer operation	Preset value tot. 2	32	4	72
36.	Parameter 96	Totalizer 3	Assign process variable	16	2	76
37.	Parameter 108	Totalizer 3	Unit totalizer	16	2	78
38.	Parameter 105	Totalizer 3	Totalizer operating mode	16	2	80
39.	Parameter 102	Totalizer 3	Failure mode	16	2	82
40.	Parameter 246	Totalizer operation	Preset value tot. 3	32	4	84
41.	Parameter 99	Totalizer operation	Control totalizer 3	16	2	88
42.	Parameter 16	Configurable input assembly	Input assembly position 1	16	2	90
43.	Parameter 27	Configurable input assembly	Input assembly position 2	16	2	92
44.	Parameter 29	Configurable input assembly	Input assembly position 3	16	2	94
45.	Parameter 30	Configurable input assembly	Input assembly position 4	16	2	96
46.	Parameter 31	Configurable input assembly	Input assembly position 5	16	2	98
47.	Parameter 32	Configurable input assembly	Input assembly position 6	16	2	100
48.	Parameter 33	Configurable input assembly	Input assembly position 7	16	2	102
49.	Parameter 34	Configurable input assembly	Input assembly position 8	16	2	104
50.	Parameter 35	Configurable input assembly	Input assembly position 9	16	2	106
51.	Parameter 17	Configurable input assembly	Input assembly position 10	16	2	108
52.	Parameter 18	Configurable input assembly	Input assembly position 11	16	2	110
53.	Parameter 19	Configurable input assembly	Input assembly position 12	16	2	112
54.	Parameter 20	Configurable input assembly	Input assembly position 13	16	2	114
55.	Parameter 21	Configurable input assembly	Input assembly position 14	16	2	116
56.	Parameter 22	Configurable input assembly	Input assembly position 15	16	2	118
57.	Parameter 23	Configurable input assembly	Input assembly position 16	16	2	120
58.	Parameter 24	Configurable input assembly	Input assembly position 17	16	2	122
59.	Parameter 25	Configurable input assembly	Input assembly position 18	16	2	124
60.	Parameter 26	Configurable input assembly	Input assembly position 19	16	2	126
61.	Parameter 28	Configurable input assembly	Input assembly position 20	16	2	128
62.	Parameter 38	Sensor adjustment	Flow direction	16	2	130
63.	Parameter 40	Process parameters	Flow override	16	2	132
64.	Parameter 37	Low flow	Assign process variable	16	2	134
65.	Parameter 39	Empty pipe detection	Assign process variable	16	2	136
66.	Parameter 41	Corrected volume flow calculation	Corrected volume flow calculation	16	2	138
67.	Parameter 188	Low flow	Switch-on point low flow cut off	32	4	140
68.	Parameter 187	Low flow	Off value low flow cutoff	32	4	144
69.	Parameter 209	Low flow	Pressure shock suppression	32	4	148
70.	Parameter 191	Empty pipe detection	Low value partial filled pipe detection	32	4	152

Description (format)				Bits	Byte	Offset
71.	Parameter 189	Partially filled pipe detection	High value partial filled pipe detection	32	4	156
72.	Parameter 190	Empty pipe detection	Response time part. filled pipe detect.	32	4	160
73.	Parameter 182	Corrected volume flow calculation	Fixed reference density	32	4	164
74.	Parameter 186	Corrected volume flow calculation	Linear expansion coefficient	32	4	168
75.	Parameter 211	Corrected volume flow calculation	Square expansion coefficient	32	4	172
76.	Parameter 210	Corrected volume flow calculation	Reference temperature	32	4	176
77.	Parameter 183	Process parameters	Flow damping	32	4	180
78.	Parameter 184	Process parameters	Density damping	32	4	184
79.	Parameter 185	Process parameters	Temperature damping	32	4	188
80.	Parameter 5	External compensation	Pressure compensation	16	2	192
81.	Parameter 6	External compensation	Temperature mode	16	2	194
82.	Parameter 2	Medium selection	Select medium	16	2	196
83.	Parameter 3	Medium selection	Select gas type	16	2	198
84.	Parameter 119	External compensation	Pressure value	32	4	200
85.	Parameter 133	Medium selection	Temperature coefficient sound velocity	32	4	204
86.	Parameter 128	Medium selection	Reference sound velocity	32	4	208
87.	Parameter 115	Empty pipe detection	Max. damping empty pipe detection	32	4	212
88.	Parameter 241	Diagnostic settings	Alarm delay	32	4	216
89.	Parameter 58	Diagnostic behavior	Assign behavior for diagnostic information 046	8	1	220
90.	Parameter 57	Diagnostic behavior	Assign behavior for diagnostic information 140	8	1	221
91.	Parameter 59	Diagnostic behavior	Assign behavior for diagnostic information 144	8	1	222
92.	Parameter 60	Diagnostic behavior	Assign behavior for diagnostic information 374	8	1	223
93.	Parameter 61	Diagnostic behavior	Assign behavior for diagnostic information 302	8	1	224
94.	None			8	1	225
95.	Parameter 74	Diagnostic behavior	Assign behavior for diagnostic information 441	16	2	226
96.	Parameter 75	Diagnostic behavior	Assign behavior for diagnostic information 442	16	2	228
97.	Parameter 76	Diagnostic behavior	Assign behavior for diagnostic information 443	16	2	230
98.	Parameter 73	Diagnostic behavior	Assign behavior for diagnostic information 444	16	2	232
99.	Parameter 62	Diagnostic behavior	Assign behavior for diagnostic information 830	8	1	234
100.	Parameter 63	Diagnostic behavior	Assign behavior for diagnostic information 831	8	1	235
101.	Parameter 64	Diagnostic behavior	Assign behavior for diagnostic information 832	8	1	236
102.	Parameter 65	Diagnostic behavior	Assign behavior for diagnostic information 833	8	1	237
103.	Parameter 66	Diagnostic behavior	Assign behavior for diagnostic information 834	8	1	238

Description (format)				Bits	Byte	Offset
104.	Parameter 67	Diagnostic behavior	Assign behavior for diagnostic information 835	8	1	239
105.	Parameter 72	Diagnostic behavior	Assign behavior for diagnostic information 862	16	2	240
106.	Parameter 68	Diagnostic behavior	Assign behavior for diagnostic information 912	8	1	242
107.	Parameter 69	Diagnostic behavior	Assign behavior for diagnostic information 913	8	1	243
108.	Parameter 70	Diagnostic behavior	Assign behavior for diagnostic information 944	8	1	244
109.	Parameter 71	Diagnostic behavior	Assign behavior for diagnostic information 948	8	1	245
110.	None			32	4	246
111.	None			16	2	250
112.	Parameter 12	Concentration	Liquid type	16	2	252
113.	None			32	4	254
114.	None			16	2	258
115.	Parameter 138	Concentration	Coefficient A0	32	4	260
116.	Parameter 141	Concentration	Coefficient A1	32	4	264
117.	Parameter 144	Concentration	Coefficient A2	32	4	268
118.	Parameter 147	Concentration	Coefficient A3	32	4	272
119.	Parameter 150	Concentration	Coefficient A4	32	4	276
120.	Parameter 153	Concentration	Coefficient B1	32	4	280
121.	Parameter 156	Concentration	Coefficient B2	32	4	284
122.	Parameter 159	Concentration	Coefficient B3	32	4	288
123.	Parameter 162	Concentration	Coefficient D1	32	4	292
124.	Parameter 165	Concentration	Coefficient D2	32	4	296
125.	Parameter 168	Concentration	Coefficient D3	32	4	300
126.	Parameter 171	Concentration	Coefficient D4	32	4	304
127.	Parameter 55		Petroleum mode	16	2	308
128.	Parameter 53		API product group	16	2	310
129.	Parameter 54		API table selection	16	2	312
130.	None			16	2	314
131.	Parameter 237		Thermal expansion coefficient	32	4	316
132.	Parameter 220		Oil density sample	32	4	320
133.	Parameter 235		Oil temperature sample	32	4	324
134.	Parameter 230		Oil pressure sample	32	4	328
135.	Parameter 222		Water density sample	32	4	332
136.	Parameter 236		Water temperature sample	32	4	336

## 9.5 Diagnostic information via EtherNet/IP

Status signal	No.	Short text	Value
	000	-	0
F	882	Input signal	16777265

Status signal	No.	Short text	Value
F	910	Tubes not oscillating	16777296
F	437	Configuration incompatible	16777312
F	242	Software incompatible	16777319
F	252	Modules incompatible	16777323
F	272	Main electronic failure	16777337
F	270	Main electronic failure	16777340
F	271	Main electronic failure	16777341
F	270	Main electronic failure	16777343
F	270	Main electronic failure	16777344
F	825	Operating temperature	16777352
F	410	Data transfer	16777355
F	273	Main electronic failure	16777368
F	270	Main electronic failure	16777375
F	083	Memory content	16777376
F	270	Main electronic failure	16777377
F	022	Sensor temperature	16777406
F	022	Sensor temperature	16777407
F	833	Electronic temperature too low	16777409
F	832	Electronic temperature too high	16777411
F	834	Process temperature too high	16777413
F	835	Process temperature too low	16777414
F	270	Main electronic failure	16777428
F	022	Sensor temperature	16777429
F	022	Sensor temperature	16777430
F	062	Sensor connection	16777435
F	062	Sensor connection	16777436
F	311	Electronic failure	16777441
F	273	Main electronic failure	16777445
F	082	Data storage	16777447
F	190	Special event 2	16777450
F	273	Main electronic failure	16777483
F	390	Special event 3	16777490
F	062	Sensor connection	16777491
F	062	Sensor connection	16777492
F	992	Special event 13	16777503
F	590	Special event 4	16777508
F	990	Special event 5	16777509
F	991	Special event 9	16777510
F	591	Special event 8	16777511
F	391	Special event 7	16777512
F	191	Special event 6	16777513
F	262	Module connection	16777545
F	537	Configuration	16777546

Status signal	No.	Short text	Value
F	201	Device failure	16777547
F	192	Special event 10	16777552
F	392	Special event 11	16777553
F	592	Special event 12	16777554
F	382	Data storage	16777581
F	383	Memory content	16777582
F	283	Memory content	16777583
F	144	Measuring error too high	16777671
C	411	Up-/download active	33554536
C	411	Up-/download active	33554537
C	411	Up-/download active	33554540
C	484	Simulation failure mode	33554576
C	485	Simulation measured variable	33554579
C	453	Flow override	33554580
C	833	Electronic temperature too low	33554625
C	832	Electronic temperature too high	33554627
C	834	Process temperature too high	33554629
C	835	Process temperature too low	33554630
C	992	Special event 13	33554719
C	192	Special event 10	33554768
C	392	Special event 11	33554769
C	592	Special event 12	33554770
C	495	Simulation diagnostic event	33554782
C	302	Device verification active	33554926
M	438	Dataset	67108970
M	833	Electronic temperature too low	67109057
M	832	Electronic temperature too high	67109059
M	834	Process temperature too high	67109061
M	835	Process temperature too low	67109062
M	311	Electronic failure	67109090
M	992	Special event 13	67109151
M	192	Special event 10	67109200
M	392	Special event 11	67109201
M	592	Special event 12	67109202
S	825	Operating temperature	134217861
S	825	Operating temperature	134217863
S	842	Process limit	134217873
S	862	Partly filled pipe	134217874
S	830	Sensor temperature too high	134217920
S	833	Electronic temperature too low	134217921
S	831	Sensor temperature too low	134217922
S	832	Electronic temperature too high	134217923
S	912	Medium inhomogeneous	134217924

Status signal	No.	Short text	Value
S	834	Process temperature too high	134217925
S	835	Process temperature too low	134217926
S	046	Sensor limit exceeded	134217928
S	046	Sensor limit exceeded	134217930
S	140	Sensor signal	134217932
S	913	Medium unsuitable	134217933
S	274	Main electronic failure	134217934
S	274	Main electronic failure	134217935
S	912	Medium inhomogeneous	134217951
S	912	Inhomogeneous	134218005
S	992	Special event 13	134218015
S	843	Process limit	134218019
S	192	Special event 10	134218064
S	392	Special event 11	134218065
S	592	Special event 12	134218066
S	912	Inhomogeneous	134218082
S	948	Tube damping too high	134218088
S	944	Monitoring failed	134218182
I	1089	Power on	268435545
I	1090	Configuration reset	268435546
I	1091	Configuration changed	268435547
I	1110	Write protection switch changed	268435566
I	1111	Density adjust failure	268435567
I	1137	Electronic changed	268435593
I	1151	History reset	268435607
I	1155	Reset electronic temperature	268435611
I	1157	Memory error event list	268435613
I	1185	Display backup done	268435641
I	1186	Restore via display done	268435642
I	1187	Settings downloaded with display	268435643
I	1188	Display data cleared	268435644
I	1189	Backup compared	268435645
I	1209	Density adjustment ok	268435665
I	1221	Zero point adjust failure	268435677
I	1222	Zero point adjustment ok	268435678
I	1256	Display: access status changed	268435712
I	1264	Safety sequence aborted	268435720
I	1335	Firmware changed	268435791
I	1361	Wrong web server login	268435817
I	1397	Fieldbus: access status changed	268435853
I	1398	CDI: access status changed	268435854
I	1444	Device verification passed	268435900
I	1445	Device verification failed	268435901





Status signal	No.	Short text	Value
I	1446	Device verification active	268435902
I	1447	Record application reference data	268435903
I	1448	Application reference data recorded	268435904
I	1449	Recording application ref. data failed	268435905
I	1450	Monitoring off	268435906
I	1451	Monitoring on	268435907
I	1457	Failed: Measured error verification	268435913
I	1459	Failed: I/O module verification	268435915
I	1460	Failed: Sensor integrity verification	268435916
I	1461	Failed: Sensor verification	268435917
I	1462	Failed: Sensor electronic module verific.	268435918

## 10 Commissioning



### 10.1 Post-mounting and post-connection check

Before commissioning the device:



- ▶ Make sure that the post-installation and post-connection checks have been performed successfully.
- Checklist for "Post-installation" check →  34
- Checklist for "Post-connection" check →  67

### 10.2 Switching on the measuring device

- ▶ Switch on the device upon successful completion of the post-mounting and post-connection check.
  - ↳ After a successful startup, the local display switches automatically from the startup display to the operational display.

 If nothing appears on the local display or if a diagnostic message is displayed, refer to the section on "Diagnostics and troubleshooting" →  192.

### 10.3 Connecting via FieldCare

- For connecting FieldCare →  92
- For connecting via FieldCare →  95
- For user interface of FieldCare →  96

### 10.4 Setting the operating language

Factory setting: English or ordered local language

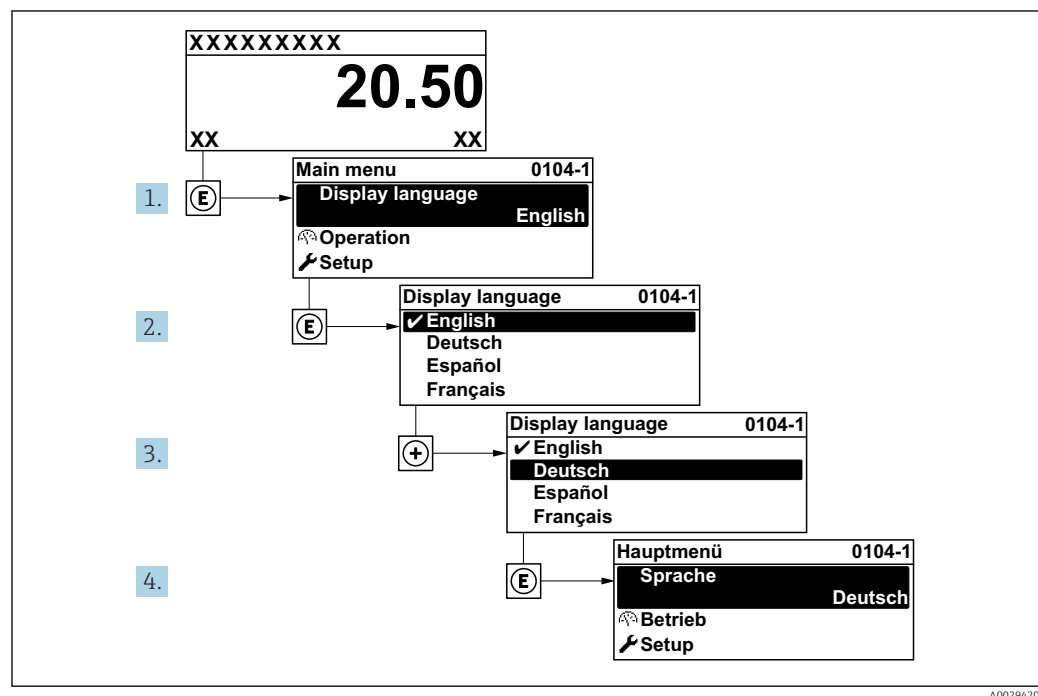

 35 Taking the example of the local display

A0029420

## 10.5 Configuring the measuring instrument

The **Setup** menu with its guided wizards contains all the parameters needed for standard operation.

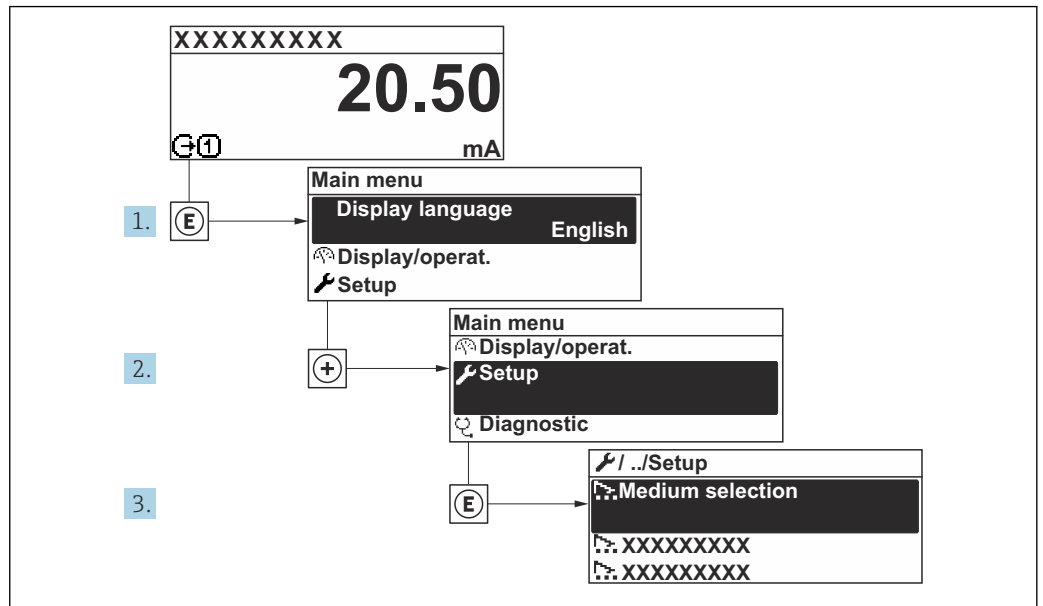

36 Navigation to "Setup" menu using the example of the local display

**i** The number of submenus and parameters can vary depending on the device version. Certain submenus and parameters in these submenus are not described in the Operating Instructions. Instead a description is provided in the Special Documentation for the device ("Supplementary documentation").

🔧 Setup	
Device tag	→ 📖 116
▶ System units	→ 📖 116
▶ Communication	→ 📖 118
▶ Medium selection	→ 📖 120
▶ I/O configuration	→ 📖 121
▶ Current input 1 to n	→ 📖 122
▶ Status input 1 to n	→ 📖 123
▶ Current output 1 to n	→ 📖 124
▶ Pulse/frequency/switch output 1 to n	→ 📖 127
▶ Relay output 1 to n	→ 📖 135

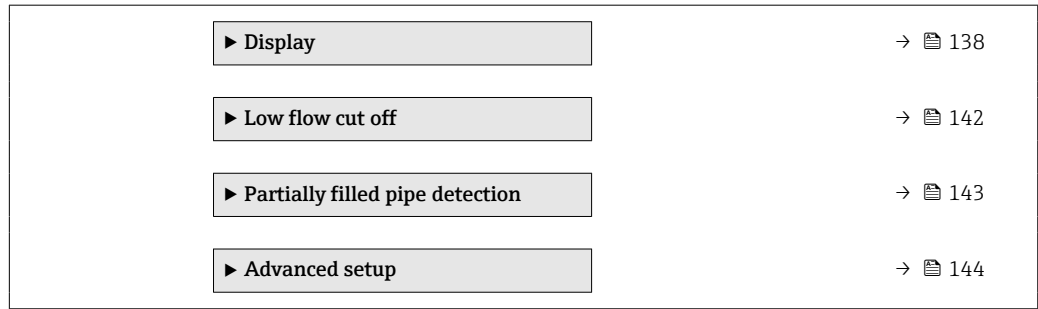

### 10.5.1 Defining the tag name

To enable fast identification of the measuring point within the system, you can enter a unique designation using the **Device tag** parameter and thus change the factory setting.

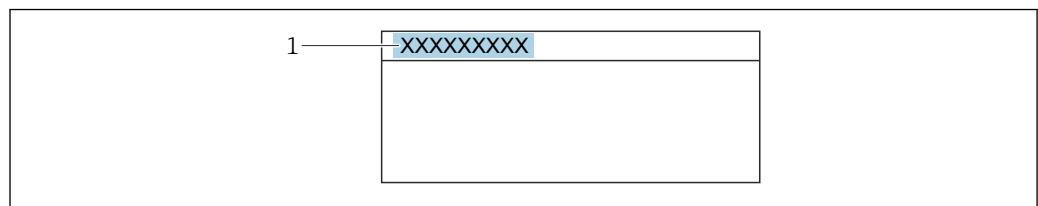

A0029422

37 Header of the operational display with tag name

1 Tag name

**i** Enter the tag name in the "FieldCare" operating tool → 96

#### Navigation

"Setup" menu → Device tag

#### Parameter overview with brief description

Parameter	Description	User entry
Device tag	Enter the name for the measuring point.	Max. 32 characters, such as letters, numbers or special characters (e.g. @, %, /).

### 10.5.2 Setting the system units

In the **System units** submenu the units of all the measured values can be set.

**i** The number of submenus and parameters can vary depending on the device version. Certain submenus and parameters in these submenus are not described in the Operating Instructions. Instead a description is provided in the Special Documentation for the device ("Supplementary documentation").

#### Navigation

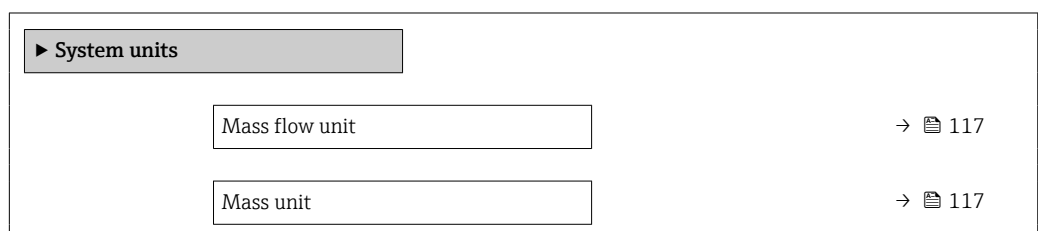

"Setup" menu → System units



Volume flow unit	→ ⓘ 117
Volume unit	→ ⓘ 117
Corrected volume flow unit	→ ⓘ 117
Corrected volume unit	→ ⓘ 117
Density unit	→ ⓘ 117
Reference density unit	→ ⓘ 118
Temperature unit	→ ⓘ 118
Pressure unit	→ ⓘ 118

**Parameter overview with brief description**

Parameter	Description	Selection	Factory setting
Mass flow unit	Select mass flow unit. <i>Effect</i> The selected unit applies to: <ul style="list-style-type: none"> <li>▪ Output</li> <li>▪ Low flow cut off</li> <li>▪ Simulation process variable</li> </ul>	Unit choose list	Country-specific: <ul style="list-style-type: none"> <li>▪ kg/h</li> <li>▪ lb/min</li> </ul>
Mass unit	Select mass unit.	Unit choose list	Country-specific: <ul style="list-style-type: none"> <li>▪ kg</li> <li>▪ lb</li> </ul>
Volume flow unit	Select volume flow unit. <i>Effect</i> The selected unit applies to: <ul style="list-style-type: none"> <li>▪ Output</li> <li>▪ Low flow cut off</li> <li>▪ Simulation process variable</li> </ul>	Unit choose list	Country-specific: <ul style="list-style-type: none"> <li>▪ l/h</li> <li>▪ gal/min (us)</li> </ul>
Volume unit	Select volume unit.	Unit choose list	Country-specific: <ul style="list-style-type: none"> <li>▪ l (DN &gt; 150 (6"): m<sup>3</sup> option)</li> <li>▪ gal (us)</li> </ul>
Corrected volume flow unit	Select corrected volume flow unit. <i>Effect</i> The selected unit applies to: <b>Corrected volume flow</b> parameter (→ ⓘ 174)	Unit choose list	Country-specific: <ul style="list-style-type: none"> <li>▪ NI/h</li> <li>▪ Sft<sup>3</sup>/min</li> </ul>
Corrected volume unit	Select corrected volume unit.	Unit choose list	Country-specific: <ul style="list-style-type: none"> <li>▪ NI</li> <li>▪ Sft<sup>3</sup></li> </ul>
Density unit	Select density unit. <i>Effect</i> The selected unit applies to: <ul style="list-style-type: none"> <li>▪ Output</li> <li>▪ Simulation process variable</li> <li>▪ Density adjustment (<b>Expert</b> menu)</li> </ul>	Unit choose list	Country-specific: <ul style="list-style-type: none"> <li>▪ kg/l</li> <li>▪ lb/ft<sup>3</sup></li> </ul>







Parameter	Description	Selection	Factory setting
Reference density unit	Select reference density unit.	Unit choose list	Country-specific: <ul style="list-style-type: none"> <li>kg/Nl</li> <li>lb/Sft<sup>3</sup></li> </ul>
Density 2 unit	Select second density unit.	Unit choose list	Country-specific: <ul style="list-style-type: none"> <li>kg/l</li> <li>lb/ft<sup>3</sup></li> </ul>
Temperature unit	Select temperature unit. <i>Effect</i> The selected unit applies to: <ul style="list-style-type: none"> <li><b>Electronic temperature</b> parameter (6053)</li> <li><b>Maximum value</b> parameter (6051)</li> <li><b>Minimum value</b> parameter (6052)</li> <li><b>External temperature</b> parameter (6080)</li> <li><b>Maximum value</b> parameter (6108)</li> <li><b>Minimum value</b> parameter (6109)</li> <li><b>Carrier pipe temperature</b> parameter (6027)</li> <li><b>Maximum value</b> parameter (6029)</li> <li><b>Minimum value</b> parameter (6030)</li> <li><b>Reference temperature</b> parameter (1816)</li> <li><b>Temperature</b> parameter</li> </ul>	Unit choose list	Country-specific: <ul style="list-style-type: none"> <li>°C</li> <li>°F</li> </ul>
Pressure unit	Select process pressure unit. <i>Effect</i> The unit is taken from: <ul style="list-style-type: none"> <li><b>Pressure value</b> parameter (→  121)</li> <li><b>External pressure</b> parameter (→  121)</li> <li>Pressure value</li> </ul>	Unit choose list	Country-specific: <ul style="list-style-type: none"> <li>bar a</li> <li>psi a</li> </ul>

### 10.5.3 Configuring the communication interface



The **Communication** submenu guides you systematically through all the parameters that have to be configured for selecting and setting the communication interface.

#### Navigation

"Setup" menu → Communication

► Communication	
MAC address	→  119
Default network settings	→  119
DHCP client	→  119
IP address	→  119
Subnet mask	→  119
Default gateway	→  119

## Parameter overview with brief description

Parameter	Description	User interface / Selection / User entry	Factory setting
MAC address	Displays the MAC address of the measuring device.  MAC = Media Access Control	Unique 12-digit character string comprising letters and numbers, e.g.: 00:07:05:10:01:5F	Each measuring device is given an individual address.
Default network settings	Select whether to restore network settings.	<ul style="list-style-type: none"> <li>▪ Off</li> <li>▪ On</li> </ul>	–
DHCP client	Select to activate/deactivate DHCP client functionality. <b>Effect</b> If the DHCP client functionality of the web server is selected, the IP address, Subnet mask and Default gateway are set automatically.  <ul style="list-style-type: none"> <li>▪ Identification is via the MAC address of the measuring device.</li> <li>▪ The IP address in the <b>IP address</b> parameter is ignored as long as the <b>DHCP client</b> parameter is active. This is also the case, in particular, if the DHCP server cannot be reached. The IP address in the parameter of the same name is only used if the <b>DHCP client</b> parameter is inactive.</li> </ul>	<ul style="list-style-type: none"> <li>▪ Off</li> <li>▪ On</li> </ul>	On
IP address	IP address of the Web server integrated in the measuring device. If the DHCP client is switched off and write access is enabled, the IP address can also be entered.	4 octet: 0 to 255 (in the particular octet)	–
Subnet mask	Displays the subnet mask. If the DHCP client is switched off and write access is enabled, the Subnet mask can also be entered.	4 octet: 0 to 255 (in the particular octet)	–
Default gateway	Displays the default gateway. If the DHCP client is switched off and write access is enabled, the Default gateway can also be entered.	4 octet: 0 to 255 (in the particular octet)	–

### 10.5.4 Selecting and setting the medium

The **Select medium** wizard submenu contains parameters that must be configured in order to select and set the medium.

#### Navigation

"Setup" menu → Medium selection

► Medium selection	
Select medium	→ ⓘ 120
Select gas type	→ ⓘ 120
Reference sound velocity	→ ⓘ 121
Temperature coefficient sound velocity	→ ⓘ 121
Pressure compensation	→ ⓘ 121
Pressure value	→ ⓘ 121
External pressure	→ ⓘ 121

#### Parameter overview with brief description

Parameter	Prerequisite	Description	Selection / User entry / User interface
Select medium	–	Use this function to select the type of medium: "Gas" or "Liquid". Select the "Other" option in exceptional cases in order to enter the properties of the medium manually (e.g. for highly compressive liquids such as sulfuric acid).	<ul style="list-style-type: none"> <li>▪ Liquid</li> <li>▪ Gas</li> </ul>
Select gas type	In the <b>Medium selection</b> submenu, the <b>Gas</b> option is selected.	Select measured gas type.	<ul style="list-style-type: none"> <li>▪ Air</li> <li>▪ Ammonia NH<sub>3</sub></li> <li>▪ Argon Ar</li> <li>▪ Sulfur hexafluoride SF<sub>6</sub></li> <li>▪ Oxygen O<sub>2</sub></li> <li>▪ Ozone O<sub>3</sub></li> <li>▪ Nitrogen oxide NO<sub>x</sub></li> <li>▪ Nitrogen N<sub>2</sub></li> <li>▪ Nitrous oxide N<sub>2</sub>O</li> <li>▪ Methane CH<sub>4</sub></li> <li>▪ Hydrogen H<sub>2</sub></li> <li>▪ Helium He</li> <li>▪ Hydrogen chloride HCl</li> <li>▪ Hydrogen sulfide H<sub>2</sub>S</li> <li>▪ Ethylene C<sub>2</sub>H<sub>4</sub></li> <li>▪ Carbon dioxide CO<sub>2</sub></li> <li>▪ Carbon monoxide CO</li> <li>▪ Chlorine Cl<sub>2</sub></li> <li>▪ Butane C<sub>4</sub>H<sub>10</sub></li> <li>▪ Propane C<sub>3</sub>H<sub>8</sub></li> <li>▪ Propylene C<sub>3</sub>H<sub>6</sub></li> <li>▪ Ethane C<sub>2</sub>H<sub>6</sub></li> <li>▪ Others</li> </ul>



Parameter	Prerequisite	Description	Selection / User entry / User interface
Reference sound velocity	In the <b>Select gas type</b> parameter, the <b>Others</b> option is selected.	Enter sound velocity of gas at 0 °C (32 °F).	1 to 99999.9999 m/s
Reference sound velocity	In the <b>Select medium type</b> parameter, the <b>Others</b> option is selected.	Enter sound velocity of gas at 0 °C (32 °F).	Signed floating-point number
Temperature coefficient sound velocity	In the <b>Select gas type</b> parameter, the <b>Others</b> option is selected.	Enter temperature coefficient for the gas sound velocity.	Positive floating point number
Temperature coefficient sound velocity	In the <b>Select medium type</b> parameter, the <b>Others</b> option is selected.	Enter temperature coefficient for the gas sound velocity.	Signed floating-point number
Pressure compensation	–	Select pressure compensation type.	<ul style="list-style-type: none"> <li>■ Off</li> <li>■ Fixed value</li> <li>■ External value</li> <li>■ Current input 1 *</li> <li>■ Current input 2 *</li> <li>■ Current input 3 *</li> </ul>
Pressure value	In the <b>Pressure compensation</b> parameter, the <b>Fixed value</b> option is selected.	Enter process pressure to be used for pressure correction.	Positive floating-point number
External pressure	In the <b>Pressure compensation</b> parameter, the <b>External value</b> option or the <b>Current input 1...n</b> option is selected.	Shows the external process pressure value.	

\* Visibility depends on order options or device settings

### 10.5.5 Displaying the I/O configuration

The **I/O configuration** submenu guides the user systematically through all the parameters in which the configuration of the I/O modules is displayed.

#### Navigation

"Setup" menu → I/O configuration

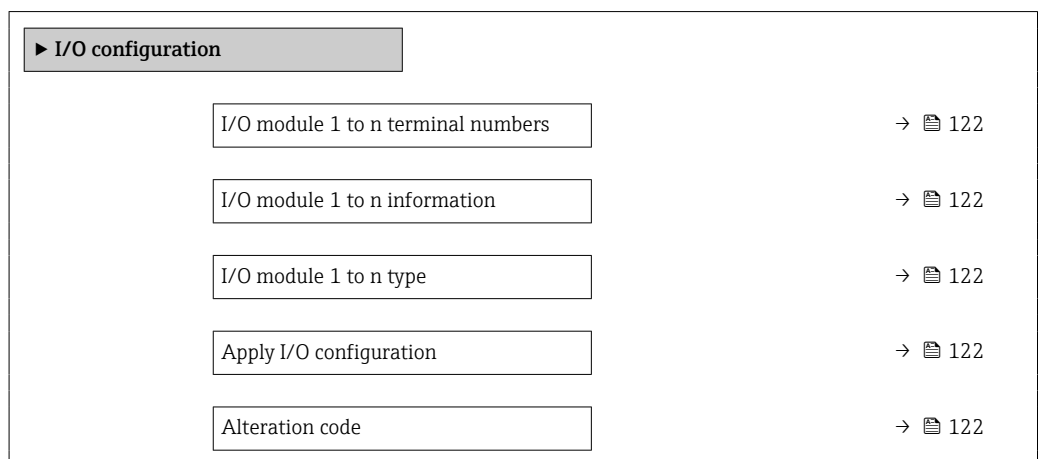

### Parameter overview with brief description

Parameter	Description	User interface / Selection / User entry
I/O module 1 to n terminal numbers	Shows the terminal numbers used by the I/O module.	<ul style="list-style-type: none"> <li>▪ Not used</li> <li>▪ 26-27 (I/O 1)</li> <li>▪ 24-25 (I/O 2)</li> <li>▪ 22-23 (I/O 3)</li> <li>▪ 20-21 (I/O 4) *</li> </ul>
I/O module 1 to n information	Shows information of the plugged I/O module.	<ul style="list-style-type: none"> <li>▪ Not plugged</li> <li>▪ Invalid</li> <li>▪ Not configurable</li> <li>▪ Configurable</li> <li>▪ EtherNet/IP</li> </ul>
I/O module 1 to n type	Shows the I/O module type.	<ul style="list-style-type: none"> <li>▪ Off</li> <li>▪ Current output</li> <li>▪ Current input</li> <li>▪ Status input</li> <li>▪ Pulse/frequency/switch output</li> <li>▪ Double pulse output</li> <li>▪ Relay output</li> </ul>
Apply I/O configuration	Apply parameterization of the freely configurable I/O module.	<ul style="list-style-type: none"> <li>▪ No</li> <li>▪ Yes</li> </ul>
Alteration code	Enter the code in order to change the I/O configuration.	Positive integer







\* Visibility depends on order options or device settings

## 10.5.6 Configuring the current input

The "Current input" wizard guides the user systematically through all the parameters that have to be set for configuring the current input.

### Navigation

"Setup" menu → Current input

▶ Current input 1 to n	
Terminal number	→  123
Signal mode	→  123
0/4 mA value	→  123
20 mA value	→  123
Current span	→  123
Failure mode	→  123
Failure value	→  123

**Parameter overview with brief description**

Parameter	Prerequisite	Description	User interface / Selection / User entry	Factory setting
Terminal number	–	Shows the terminal numbers used by the current input module.	<ul style="list-style-type: none"> <li>▪ Not used</li> <li>▪ 24-25 (I/O 2)</li> <li>▪ 22-23 (I/O 3)</li> <li>▪ 20-21 (I/O 4)*</li> </ul>	–
Signal mode	The measuring device is <b>not</b> approved for use in the hazardous area with type of protection Ex-i.	Select the signal mode for the current input.	<ul style="list-style-type: none"> <li>▪ Passive</li> <li>▪ Active</li> </ul>	Active
0/4 mA value	–	Enter 4 mA value.	Signed floating-point number	–
20 mA value	–	Enter 20 mA value.	Signed floating-point number	Depends on country and nominal diameter
Current span	–	Select current range for process value output and upper/lower level for alarm signal.	<ul style="list-style-type: none"> <li>▪ 4...20 mA</li> <li>▪ 4...20 mA NAMUR</li> <li>▪ 4...20 mA US</li> <li>▪ 0...20 mA</li> </ul>	Country-specific: <ul style="list-style-type: none"> <li>▪ 4...20 mA NAMUR</li> <li>▪ 4...20 mA US</li> </ul>
Failure mode	–	Define input behavior in alarm condition.	<ul style="list-style-type: none"> <li>▪ Alarm</li> <li>▪ Last valid value</li> <li>▪ Defined value</li> </ul>	–
Failure value	In the <b>Failure mode</b> parameter, the <b>Defined value</b> option is selected.	Enter value to be used by the device if input value from external device is missing.	Signed floating-point number	–

\* Visibility depends on order options or device settings

**10.5.7 Configuring the status input**

The **Status input** submenu guides the user systematically through all the parameters that have to be set for configuring the status input.

**Navigation**

"Setup" menu → Status input 1 to n

▶ Status input 1 to n

Assign status input	→  124
Terminal number	→  124
Active level	→  124
Terminal number	→  124
Response time status input	→  124
Terminal number	→  124

### Parameter overview with brief description

Parameter	Description	Selection / User interface / User entry
Assign status input	Select function for the status input.	<ul style="list-style-type: none"> <li>▪ Off</li> <li>▪ Reset totalizer 1</li> <li>▪ Reset totalizer 2</li> <li>▪ Reset totalizer 3</li> <li>▪ Reset all totalizers</li> <li>▪ Flow override</li> </ul>
Terminal number	Shows the terminal numbers used by the status input module.	<ul style="list-style-type: none"> <li>▪ Not used</li> <li>▪ 24-25 (I/O 2)</li> <li>▪ 22-23 (I/O 3)</li> <li>▪ 20-21 (I/O 4) *</li> </ul>
Active level	Define input signal level at which the assigned function is triggered.	<ul style="list-style-type: none"> <li>▪ High</li> <li>▪ Low</li> </ul>
Response time status input	Define the minimum amount of time the input signal level must be present before the selected function is triggered.	5 to 200 ms

\* Visibility depends on order options or device settings

## 10.5.8 Configuring the current output

The **Current output** wizard guides you systematically through all the parameters that have to be set for configuring the current output.







### Navigation

"Setup" menu → Current output

► Current output 1 to n	
Terminal number	→ 126
Signal mode	→ 126
Assign current output 1 to n	→ 126
Current span	→ 126
0/4 mA value	→ 126
20 mA value	→ 126
Fixed current	→ 126
Damping output 1 to n	→ 126
Failure mode	→ 126
Failure current	→ 126

**Parameter overview with brief description**

Parameter	Prerequisite	Description	User interface / Selection / User entry	Factory setting
Terminal number	–	Shows the terminal numbers used by the current output module.	<ul style="list-style-type: none"> <li>■ Not used</li> <li>■ 24-25 (I/O 2)</li> <li>■ 22-23 (I/O 3)</li> <li>■ 20-21 (I/O 4)*</li> </ul>	–
Signal mode	–	Select the signal mode for the current output.	<ul style="list-style-type: none"> <li>■ Passive</li> <li>■ Active</li> </ul>	Active
Assign current output 1 to n	–	Select process variable for current output.	<ul style="list-style-type: none"> <li>■ Off</li> <li>■ Mass flow</li> <li>■ Volume flow</li> <li>■ Corrected volume flow</li> <li>■ Target mass flow*</li> <li>■ Carrier mass flow*</li> <li>■ Target volume flow*</li> <li>■ Carrier volume flow*</li> <li>■ Target corrected volume flow*</li> <li>■ Carrier corrected volume flow*</li> <li>■ Density</li> <li>■ Reference density</li> <li>■ Reference density alternative*</li> <li>■ GSV flow*</li> <li>■ GSV flow alternative*</li> <li>■ NSV flow*</li> <li>■ NSV flow alternative*</li> <li>■ S&amp;W volume flow*</li> <li>■ Water cut*</li> <li>■ Oil density*</li> <li>■ Water density*</li> <li>■ Oil mass flow*</li> <li>■ Water mass flow*</li> <li>■ Oil volume flow*</li> <li>■ Water volume flow*</li> <li>■ Oil corrected volume flow*</li> <li>■ Water corrected volume flow*</li> <li>■ Concentration*</li> <li>■ Temperature</li> <li>■ Electronic temperature</li> <li>■ Oscillation frequency 0</li> <li>■ Oscillation amplitude 0*</li> <li>■ Frequency fluctuation 0</li> <li>■ Oscillation damping 0</li> <li>■ Oscillation damping fluctuation 0</li> <li>■ Signal asymmetry</li> <li>■ Exciter current 0</li> <li>■ HBSI*</li> <li>■ Pressure*</li> </ul>	–

Parameter	Prerequisite	Description	User interface / Selection / User entry	Factory setting
Current span	–	Select current range for process value output and upper/lower level for alarm signal.	<ul style="list-style-type: none"> <li>■ 4...20 mA NAMUR</li> <li>■ 4...20 mA US</li> <li>■ 4...20 mA</li> <li>■ 0...20 mA</li> <li>■ Fixed current</li> </ul>	Depends on country: <ul style="list-style-type: none"> <li>■ 4...20 mA NAMUR</li> <li>■ 4...20 mA US</li> </ul>
0/4 mA value	In <b>Current span</b> parameter (→  126), one of the following options is selected: <ul style="list-style-type: none"> <li>■ 4...20 mA NAMUR</li> <li>■ 4...20 mA US</li> <li>■ 4...20 mA</li> <li>■ 0...20 mA</li> </ul>	Enter 4 mA value.	Signed floating-point number	Depends on country: <ul style="list-style-type: none"> <li>■ 0 kg/h</li> <li>■ 0 lb/min</li> </ul>
20 mA value	In <b>Current span</b> parameter (→  126), one of the following options is selected: <ul style="list-style-type: none"> <li>■ 4...20 mA NAMUR</li> <li>■ 4...20 mA US</li> <li>■ 4...20 mA</li> <li>■ 0...20 mA</li> </ul>	Enter 20 mA value.	Signed floating-point number	Depends on country and nominal diameter
Fixed current	The <b>Fixed current</b> option is selected in the <b>Current span</b> parameter (→  126).	Defines the fixed output current.	0 to 22.5 mA	22.5 mA
Damping output 1 to n	A process variable is selected in the <b>Assign current output</b> parameter (→  125) and one of the following options is selected in the <b>Current span</b> parameter (→  126): <ul style="list-style-type: none"> <li>■ 4...20 mA NAMUR</li> <li>■ 4...20 mA US</li> <li>■ 4...20 mA</li> <li>■ 0...20 mA</li> </ul>	Set reaction time for output signal to fluctuations in the measured value.	0.0 to 999.9 s	–
Failure mode	A process variable is selected in the <b>Assign current output</b> parameter (→  125) and one of the following options is selected in the <b>Current span</b> parameter (→  126): <ul style="list-style-type: none"> <li>■ 4...20 mA NAMUR</li> <li>■ 4...20 mA US</li> <li>■ 4...20 mA</li> <li>■ 0...20 mA</li> </ul>	Define output behavior in alarm condition.	<ul style="list-style-type: none"> <li>■ Min.</li> <li>■ Max.</li> <li>■ Last valid value</li> <li>■ Actual value</li> <li>■ Defined value</li> </ul>	–
Failure current	The <b>Defined value</b> option is selected in the <b>Failure mode</b> parameter.	Enter current output value in alarm condition.	0 to 22.5 mA	22.5 mA

\* Visibility depends on order options or device settings

### 10.5.9 Configuring the pulse/frequency/switch output

The **Pulse/frequency/switch output** wizard guides you systematically through all the parameters that can be set for configuring the selected output type.

#### Navigation

"Setup" menu → Advanced setup → Pulse/frequency/switch output

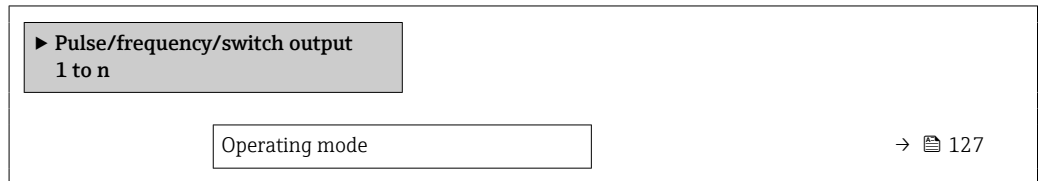

#### Parameter overview with brief description

Parameter	Description	Selection
Operating mode	Define the output as a pulse, frequency or switch output.	<ul style="list-style-type: none"> <li>■ Pulse</li> <li>■ Frequency</li> <li>■ Switch</li> </ul>

#### Configuring the pulse output

#### Navigation

"Setup" menu → Pulse/frequency/switch output

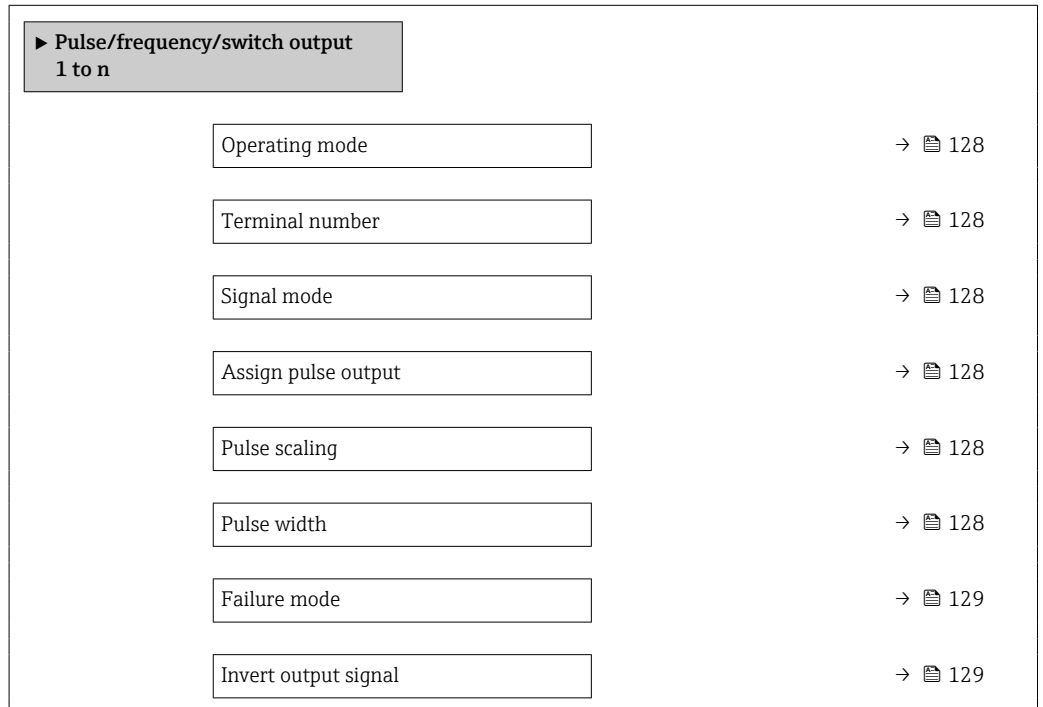

## Parameter overview with brief description

Parameter	Prerequisite	Description	Selection / User interface / User entry	Factory setting
Operating mode	–	Define the output as a pulse, frequency or switch output.	<ul style="list-style-type: none"> <li>▪ Pulse</li> <li>▪ Frequency</li> <li>▪ Switch</li> </ul>	–
Terminal number	–	Shows the terminal numbers used by the PFS output module.	<ul style="list-style-type: none"> <li>▪ Not used</li> <li>▪ 24-25 (I/O 2)</li> <li>▪ 22-23 (I/O 3)</li> <li>▪ 20-21 (I/O 4) *</li> </ul>	–
Signal mode	–	Select the signal mode for the PFS output.	<ul style="list-style-type: none"> <li>▪ Passive</li> <li>▪ Active</li> </ul>	–
Assign pulse output 1 to n	The <b>Pulse</b> option is selected in the <b>Operating mode</b> parameter.	Select process variable for pulse output.	<ul style="list-style-type: none"> <li>▪ Off</li> <li>▪ Mass flow</li> <li>▪ Volume flow</li> <li>▪ Corrected volume flow</li> <li>▪ Target mass flow *</li> <li>▪ Carrier mass flow *</li> <li>▪ Target volume flow *</li> <li>▪ Carrier volume flow *</li> <li>▪ Target corrected volume flow *</li> <li>▪ Carrier corrected volume flow *</li> <li>▪ GSV flow *</li> <li>▪ GSV flow alternative *</li> <li>▪ NSV flow *</li> <li>▪ NSV flow alternative *</li> <li>▪ S&amp;W volume flow *</li> <li>▪ Oil mass flow *</li> <li>▪ Water mass flow *</li> <li>▪ Oil volume flow *</li> <li>▪ Water volume flow *</li> <li>▪ Oil corrected volume flow *</li> <li>▪ Water corrected volume flow *</li> </ul>	–
Value per pulse	The <b>Pulse</b> option is selected in the <b>Operating mode</b> parameter (→ 127) and a process variable is selected in the <b>Assign pulse output</b> parameter (→ 128).	Enter measured value at which a pulse is output.	Positive floating point number	Depends on country and nominal diameter
Pulse width	The <b>Pulse</b> option is selected in the <b>Operating mode</b> parameter (→ 127) and a process variable is selected in the <b>Assign pulse output</b> parameter (→ 128).	Define time width of the output pulse.	0.05 to 2 000 ms	–



Parameter	Prerequisite	Description	Selection / User interface / User entry	Factory setting
Failure mode	The <b>Pulse</b> option is selected in the <b>Operating mode</b> parameter (→ 127) and a process variable is selected in the <b>Assign pulse output</b> parameter (→ 128).	Define output behavior in alarm condition.	<ul style="list-style-type: none"> <li>■ Actual value</li> <li>■ No pulses</li> </ul>	–
Invert output signal	–	Invert the output signal.	<ul style="list-style-type: none"> <li>■ No</li> <li>■ Yes</li> </ul>	–

\* Visibility depends on order options or device settings

### Configuring the frequency output

#### Navigation

"Setup" menu → Pulse/frequency/switch output

**► Pulse/frequency/switch output**  
 1 to n

Operating mode	→ 130
Terminal number	→ 130
Signal mode	→ 130
Assign frequency output	→ 131
Minimum frequency value	→ 131
Maximum frequency value	→ 132
Measuring value at minimum frequency	→ 132
Measuring value at maximum frequency	→ 132
Failure mode	→ 132
Failure frequency	→ 132
Invert output signal	→ 132

## Parameter overview with brief description

Parameter	Prerequisite	Description	Selection / User interface / User entry	Factory setting
Operating mode	–	Define the output as a pulse, frequency or switch output.	<ul style="list-style-type: none"> <li>▪ Pulse</li> <li>▪ Frequency</li> <li>▪ Switch</li> </ul>	–
Terminal number	–	Shows the terminal numbers used by the PFS output module.	<ul style="list-style-type: none"> <li>▪ Not used</li> <li>▪ 24-25 (I/O 2)</li> <li>▪ 22-23 (I/O 3)</li> <li>▪ 20-21 (I/O 4) *</li> </ul>	–
Signal mode	–	Select the signal mode for the PFS output.	<ul style="list-style-type: none"> <li>▪ Passive</li> <li>▪ Active</li> </ul>	–

Parameter	Prerequisite	Description	Selection / User interface / User entry	Factory setting
Assign frequency output	The <b>Frequency</b> option is selected in <b>Operating mode</b> parameter (→ 127).	Select process variable for frequency output.	<ul style="list-style-type: none"> <li>■ Off</li> <li>■ Mass flow</li> <li>■ Volume flow</li> <li>■ Corrected volume flow *</li> <li>■ Density</li> <li>■ Reference density *</li> <li>■ Temperature</li> <li>■ Pressure</li> <li>■ GSV flow *</li> <li>■ GSV flow alternative *</li> <li>■ NSV flow *</li> <li>■ NSV flow alternative *</li> <li>■ S&amp;W volume flow *</li> <li>■ Reference density alternative *</li> <li>■ Water cut *</li> <li>■ Oil density *</li> <li>■ Water density *</li> <li>■ Oil mass flow *</li> <li>■ Water mass flow *</li> <li>■ Oil volume flow *</li> <li>■ Water volume flow *</li> <li>■ Oil corrected volume flow *</li> <li>■ Water corrected volume flow *</li> <li>■ Concentration *</li> <li>■ Target mass flow *</li> <li>■ Carrier mass flow *</li> <li>■ Target volume flow *</li> <li>■ Carrier volume flow *</li> <li>■ Target corrected volume flow *</li> <li>■ Carrier corrected volume flow *</li> <li>■ HBSI *</li> <li>■ Exciter current 0</li> <li>■ Oscillation damping 0</li> <li>■ Oscillation damping fluctuation 0 *</li> <li>■ Oscillation frequency 0</li> <li>■ Frequency fluctuation 0 *</li> <li>■ Oscillation amplitude 0 *</li> <li>■ Signal asymmetry</li> <li>■ Electronic temperature</li> </ul>	-
Minimum frequency value	The <b>Frequency</b> option is selected in the <b>Operating mode</b> parameter (→ 127) and a process variable is selected in the <b>Assign frequency output</b> parameter (→ 131).	Enter minimum frequency.	0.0 to 10000.0 Hz	-

Parameter	Prerequisite	Description	Selection / User interface / User entry	Factory setting
Maximum frequency value	The <b>Frequency</b> option is selected in the <b>Operating mode</b> parameter (→ 127) and a process variable is selected in the <b>Assign frequency output</b> parameter (→ 131).	Enter maximum frequency.	0.0 to 10 000.0 Hz	–
Measuring value at minimum frequency	The <b>Frequency</b> option is selected in the <b>Operating mode</b> parameter (→ 127) and a process variable is selected in the <b>Assign frequency output</b> parameter (→ 131).	Enter measured value for minimum frequency.	Signed floating-point number	Depends on country and nominal diameter
Measuring value at maximum frequency	The <b>Frequency</b> option is selected in the <b>Operating mode</b> parameter (→ 127) and a process variable is selected in the <b>Assign frequency output</b> parameter (→ 131).	Enter measured value for maximum frequency.	Signed floating-point number	Depends on country and nominal diameter
Failure mode	The <b>Frequency</b> option is selected in the <b>Operating mode</b> parameter (→ 127) and a process variable is selected in the <b>Assign frequency output</b> parameter (→ 131).	Define output behavior in alarm condition.	<ul style="list-style-type: none"> <li>▪ Actual value</li> <li>▪ Defined value</li> <li>▪ 0 Hz</li> </ul>	–
Failure frequency	In the <b>Operating mode</b> parameter (→ 127), the <b>Frequency</b> option is selected, in the <b>Assign frequency output</b> parameter (→ 131) a process variable is selected, and in the <b>Failure mode</b> parameter, the <b>Defined value</b> option is selected.	Enter frequency output value in alarm condition.	0.0 to 12 500.0 Hz	–
Invert output signal	–	Invert the output signal.	<ul style="list-style-type: none"> <li>▪ No</li> <li>▪ Yes</li> </ul>	–

\* Visibility depends on order options or device settings

### Configuring the switch output

#### Navigation

"Setup" menu → Pulse/frequency/switch output

► Pulse/frequency/switch output 1 to n	
Operating mode	→ 133
Terminal number	→ 133
Signal mode	→ 133
Switch output function	→ 134
Assign diagnostic behavior	→ 134
Assign limit	→ 134
Assign flow direction check	→ 135
Assign status	→ 135
Switch-on value	→ 135
Switch-off value	→ 135
Switch-on delay	→ 135
Switch-off delay	→ 135
Failure mode	→ 135
Invert output signal	→ 135

#### Parameter overview with brief description

Parameter	Prerequisite	Description	Selection / User interface / User entry	Factory setting
Operating mode	–	Define the output as a pulse, frequency or switch output.	<ul style="list-style-type: none"> <li>■ Pulse</li> <li>■ Frequency</li> <li>■ Switch</li> </ul>	–
Terminal number	–	Shows the terminal numbers used by the PFS output module.	<ul style="list-style-type: none"> <li>■ Not used</li> <li>■ 24-25 (I/O 2)</li> <li>■ 22-23 (I/O 3)</li> <li>■ 20-21 (I/O 4) *</li> </ul>	–
Signal mode	–	Select the signal mode for the PFS output.	<ul style="list-style-type: none"> <li>■ Passive</li> <li>■ Active</li> </ul>	–

Parameter	Prerequisite	Description	Selection / User interface / User entry	Factory setting
Switch output function	The <b>Switch</b> option is selected in the <b>Operating mode</b> parameter.	Select function for switch output.	<ul style="list-style-type: none"> <li>▪ Off</li> <li>▪ On</li> <li>▪ Diagnostic behavior</li> <li>▪ Limit</li> <li>▪ Flow direction check</li> <li>▪ Status</li> </ul>	–
Assign diagnostic behavior	<ul style="list-style-type: none"> <li>▪ In the <b>Operating mode</b> parameter, the <b>Switch</b> option is selected.</li> <li>▪ In the <b>Switch output function</b> parameter, the <b>Diagnostic behavior</b> option is selected.</li> </ul>	Select diagnostic behavior for switch output.	<ul style="list-style-type: none"> <li>▪ Alarm</li> <li>▪ Alarm or warning</li> <li>▪ Warning</li> </ul>	–
Assign limit	<ul style="list-style-type: none"> <li>▪ The <b>Switch</b> option is selected in <b>Operating mode</b> parameter.</li> <li>▪ The <b>Limit</b> option is selected in <b>Switch output function</b> parameter.</li> </ul>	Select process variable for limit function.	<ul style="list-style-type: none"> <li>▪ Mass flow</li> <li>▪ Volume flow</li> <li>▪ Corrected volume flow</li> <li>▪ Target mass flow *</li> <li>▪ Carrier mass flow *</li> <li>▪ Target volume flow *</li> <li>▪ Carrier volume flow *</li> <li>▪ Target corrected volume flow *</li> <li>▪ Carrier corrected volume flow *</li> <li>▪ Density</li> <li>▪ Reference density</li> <li>▪ Reference density alternative *</li> <li>▪ GSV flow *</li> <li>▪ GSV flow alternative *</li> <li>▪ NSV flow *</li> <li>▪ NSV flow alternative *</li> <li>▪ S&amp;W volume flow *</li> <li>▪ Water cut *</li> <li>▪ Oil density *</li> <li>▪ Water density *</li> <li>▪ Oil mass flow *</li> <li>▪ Water mass flow *</li> <li>▪ Oil volume flow *</li> <li>▪ Water volume flow *</li> <li>▪ Oil corrected volume flow *</li> <li>▪ Water corrected volume flow *</li> <li>▪ Concentration *</li> <li>▪ Temperature</li> <li>▪ Totalizer 1</li> <li>▪ Totalizer 2</li> <li>▪ Totalizer 3</li> <li>▪ Oscillation damping</li> <li>▪ Pressure</li> </ul>	–

Parameter	Prerequisite	Description	Selection / User interface / User entry	Factory setting
Assign flow direction check	<ul style="list-style-type: none"> <li>The <b>Switch</b> option is selected in the <b>Operating mode</b> parameter.</li> <li>The <b>Flow direction check</b> option is selected in the <b>Switch output function</b> parameter.</li> </ul>	Select process variable for flow direction monitoring.		–
Assign status	<ul style="list-style-type: none"> <li>The <b>Switch</b> option is selected in <b>Operating mode</b> parameter.</li> <li>The <b>Status</b> option is selected in <b>Switch output function</b> parameter.</li> </ul>	Select device status for switch output.	<ul style="list-style-type: none"> <li>Partially filled pipe detection</li> <li>Low flow cut off</li> </ul>	–
Switch-on value	<ul style="list-style-type: none"> <li>The <b>Switch</b> option is selected in the <b>Operating mode</b> parameter.</li> <li>The <b>Limit</b> option is selected in the <b>Switch output function</b> parameter.</li> </ul>	Enter measured value for the switch-on point.	Signed floating-point number	Depends on country: <ul style="list-style-type: none"> <li>0 kg/h</li> <li>0 lb/min</li> </ul>
Switch-off value	<ul style="list-style-type: none"> <li>The <b>Switch</b> option is selected in the <b>Operating mode</b> parameter.</li> <li>The <b>Limit</b> option is selected in the <b>Switch output function</b> parameter.</li> </ul>	Enter measured value for the switch-off point.	Signed floating-point number	Depends on country: <ul style="list-style-type: none"> <li>0 kg/h</li> <li>0 lb/min</li> </ul>
Switch-on delay	<ul style="list-style-type: none"> <li>The <b>Switch</b> option is selected in the <b>Operating mode</b> parameter.</li> <li>The <b>Limit</b> option is selected in the <b>Switch output function</b> parameter.</li> </ul>	Define delay for the switch-on of status output.	0.0 to 100.0 s	–
Switch-off delay	<ul style="list-style-type: none"> <li>The <b>Switch</b> option is selected in the <b>Operating mode</b> parameter.</li> <li>The <b>Limit</b> option is selected in the <b>Switch output function</b> parameter.</li> </ul>	Define delay for the switch-off of status output.	0.0 to 100.0 s	–
Failure mode	–	Define output behavior in alarm condition.	<ul style="list-style-type: none"> <li>Actual status</li> <li>Open</li> <li>Closed</li> </ul>	–
Invert output signal	–	Invert the output signal.	<ul style="list-style-type: none"> <li>No</li> <li>Yes</li> </ul>	–

\* Visibility depends on order options or device settings









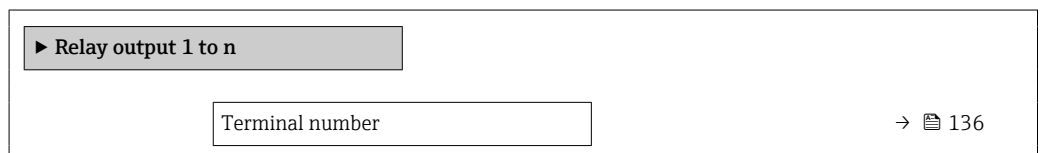



### 10.5.10 Configuring the relay output

The **Relay output** wizard guides the user systematically through all the parameters that have to be set for configuring the relay output.

#### Navigation

"Setup" menu → Relay output 1 to n



Relay output function	→  136
Assign flow direction check	→  136
Assign limit	→  137
Assign diagnostic behavior	→  137
Assign status	→  137
Switch-off value	→  137
Switch-off delay	→  137
Switch-on value	→  137
Switch-on delay	→  137
Failure mode	→  138
Switch status	→  138
Powerless relay status	→  138

### Parameter overview with brief description

Parameter	Prerequisite	Description	User interface / Selection / User entry	Factory setting
Terminal number	–	Shows the terminal numbers used by the relay output module.	<ul style="list-style-type: none"> <li>▪ Not used</li> <li>▪ 24-25 (I/O 2)</li> <li>▪ 22-23 (I/O 3)</li> <li>▪ 20-21 (I/O 4)</li> </ul>	–
Relay output function	–	Select the function for the relay output.	<ul style="list-style-type: none"> <li>▪ Closed</li> <li>▪ Open</li> <li>▪ Diagnostic behavior</li> <li>▪ Limit</li> <li>▪ Flow direction check</li> <li>▪ Digital Output</li> </ul>	–
Assign flow direction check	The <b>Flow direction check</b> option is selected in the <b>Relay output function</b> parameter.	Select process variable for flow direction monitoring.		–



Parameter	Prerequisite	Description	User interface / Selection / User entry	Factory setting
Assign limit	The <b>Limit</b> option is selected in <b>Relay output function</b> parameter.	Select process variable for limit function.	<ul style="list-style-type: none"> <li>■ Mass flow</li> <li>■ Volume flow</li> <li>■ Corrected volume flow</li> <li>■ Target mass flow *</li> <li>■ Carrier mass flow *</li> <li>■ Target volume flow *</li> <li>■ Carrier volume flow *</li> <li>■ Target corrected volume flow *</li> <li>■ Carrier corrected volume flow *</li> <li>■ Density</li> <li>■ Reference density</li> <li>■ Reference density alternative *</li> <li>■ GSV flow *</li> <li>■ GSV flow alternative *</li> <li>■ NSV flow *</li> <li>■ NSV flow alternative *</li> <li>■ S&amp;W volume flow *</li> <li>■ Water cut *</li> <li>■ Oil density *</li> <li>■ Water density *</li> <li>■ Oil mass flow *</li> <li>■ Water mass flow *</li> <li>■ Oil volume flow *</li> <li>■ Water volume flow *</li> <li>■ Oil corrected volume flow *</li> <li>■ Water corrected volume flow *</li> <li>■ Concentration *</li> <li>■ Temperature</li> <li>■ Totalizer 1</li> <li>■ Totalizer 2</li> <li>■ Totalizer 3</li> <li>■ Oscillation damping</li> <li>■ Pressure</li> </ul>	–
Assign diagnostic behavior	In the <b>Relay output function</b> parameter, the <b>Diagnostic behavior</b> option is selected.	Select diagnostic behavior for switch output.	<ul style="list-style-type: none"> <li>■ Alarm</li> <li>■ Alarm or warning</li> <li>■ Warning</li> </ul>	–
Assign status	In the <b>Relay output function</b> parameter, the <b>Digital Output</b> option is selected.	Select device status for switch output.	<ul style="list-style-type: none"> <li>■ Partially filled pipe detection</li> <li>■ Low flow cut off</li> </ul>	–
Switch-off value	The <b>Limit</b> option is selected in the <b>Relay output function</b> parameter.	Enter measured value for the switch-off point.	Signed floating-point number	Depends on country: <ul style="list-style-type: none"> <li>■ 0 kg/h</li> <li>■ 0 lb/min</li> </ul>
Switch-off delay	In the <b>Relay output function</b> parameter, the <b>Limit</b> option is selected.	Define delay for the switch-off of status output.	0.0 to 100.0 s	–
Switch-on value	The <b>Limit</b> option is selected in the <b>Relay output function</b> parameter.	Enter measured value for the switch-on point.	Signed floating-point number	Depends on country: <ul style="list-style-type: none"> <li>■ 0 kg/h</li> <li>■ 0 lb/min</li> </ul>
Switch-on delay	In the <b>Relay output function</b> parameter, the <b>Limit</b> option is selected.	Define delay for the switch-on of status output.	0.0 to 100.0 s	–

Parameter	Prerequisite	Description	User interface / Selection / User entry	Factory setting
Failure mode	–	Define output behavior in alarm condition.	<ul style="list-style-type: none"> <li>▪ Actual status</li> <li>▪ Open</li> <li>▪ Closed</li> </ul>	–
Switch status	–	Shows the current relay switch status.	<ul style="list-style-type: none"> <li>▪ Open</li> <li>▪ Closed</li> </ul>	–
Powerless relay status	–		<ul style="list-style-type: none"> <li>▪ Open</li> <li>▪ Closed</li> </ul>	–

\* Visibility depends on order options or device settings

### 10.5.11 Configuring the local display

The **Display** wizard guides you systematically through all the parameters that can be configured for configuring the local display.

#### Navigation







"Setup" menu → Display

► Display	
Format display	→ ⓘ 139
Value 1 display	→ ⓘ 140
0% bargraph value 1	→ ⓘ 141
100% bargraph value 1	→ ⓘ 141
Value 2 display	→ ⓘ 141
Value 3 display	→ ⓘ 141
0% bargraph value 3	→ ⓘ 141
100% bargraph value 3	→ ⓘ 141
Value 4 display	→ ⓘ 141

**Parameter overview with brief description**

Parameter	Prerequisite	Description	Selection / User entry	Factory setting
Format display	A local display is provided.	Select how measured values are shown on the display.	<ul style="list-style-type: none"><li>■ 1 value, max. size</li><li>■ 1 bargraph + 1 value</li><li>■ 2 values</li><li>■ 1 value large + 2 values</li><li>■ 4 values</li></ul>	–

Parameter	Prerequisite	Description	Selection / User entry	Factory setting
Value 1 display	A local display is provided.	Select the measured value that is shown on the local display.	<ul style="list-style-type: none"> <li>▪ Mass flow</li> <li>▪ Volume flow</li> <li>▪ Corrected volume flow *</li> <li>▪ Density</li> <li>▪ Reference density *</li> <li>▪ Temperature</li> <li>▪ Current output 1</li> <li>▪ Current output 2 *</li> <li>▪ Current output 4 *</li> <li>▪ Pressure</li> <li>▪ Totalizer 1</li> <li>▪ Totalizer 2</li> <li>▪ Totalizer 3</li> <li>▪ GSV flow *</li> <li>▪ GSV flow alternative *</li> <li>▪ NSV flow *</li> <li>▪ NSV flow alternative *</li> <li>▪ S&amp;W volume flow *</li> <li>▪ Reference density alternative *</li> <li>▪ Weighted density average *</li> <li>▪ Weighted temperature average *</li> <li>▪ Water cut *</li> <li>▪ Oil density *</li> <li>▪ Water density *</li> <li>▪ Oil mass flow *</li> <li>▪ Water mass flow *</li> <li>▪ Oil volume flow *</li> <li>▪ Water volume flow *</li> <li>▪ Oil corrected volume flow *</li> <li>▪ Water corrected volume flow *</li> <li>▪ Concentration *</li> <li>▪ Target mass flow *</li> <li>▪ Carrier mass flow *</li> <li>▪ Target volume flow *</li> <li>▪ Carrier volume flow *</li> <li>▪ Target corrected volume flow *</li> <li>▪ Carrier corrected volume flow *</li> <li>▪ HBSI *</li> <li>▪ Exciter current 0</li> <li>▪ Oscillation damping 0</li> <li>▪ Oscillation damping fluctuation 0 *</li> <li>▪ Oscillation frequency 0</li> <li>▪ Frequency fluctuation 0 *</li> <li>▪ Oscillation amplitude 0 *</li> <li>▪ Signal asymmetry</li> <li>▪ Electronic temperature</li> <li>▪ Current output 1</li> </ul>	-

Parameter	Prerequisite	Description	Selection / User entry	Factory setting
			<ul style="list-style-type: none"> <li>■ Current output 2 *</li> <li>■ Current output 3 *</li> </ul>	
0% bargraph value 1	A local display is provided.	Enter 0% value for bar graph display.	Signed floating-point number	Country-specific: <ul style="list-style-type: none"> <li>■ 0 kg/h</li> <li>■ 0 lb/min</li> </ul>
100% bargraph value 1	A local display is provided.	Enter 100% value for bar graph display.	Signed floating-point number	Depends on country and nominal diameter
Value 2 display	A local display is provided.	Select the measured value that is shown on the local display.	For the picklist, see <b>Value 1 display</b> parameter (→  140)	–
Value 3 display	A local display is provided.	Select the measured value that is shown on the local display.	For the picklist, see <b>Value 1 display</b> parameter (→  140)	–
0% bargraph value 3	A selection was made in the <b>Value 3 display</b> parameter.	Enter 0% value for bar graph display.	Signed floating-point number	Country-specific: <ul style="list-style-type: none"> <li>■ 0 kg/h</li> <li>■ 0 lb/min</li> </ul>
100% bargraph value 3	A selection was made in the <b>Value 3 display</b> parameter.	Enter 100% value for bar graph display.	Signed floating-point number	–
Value 4 display	A local display is provided.	Select the measured value that is shown on the local display.	For the picklist, see <b>Value 1 display</b> parameter (→  140)	–
Value 5 display	A local display is provided.	Select the measured value that is shown on the local display.	For the picklist, see <b>Value 1 display</b> parameter (→  140)	–
Value 6 display	A local display is provided.	Select the measured value that is shown on the local display.	For the picklist, see <b>Value 1 display</b> parameter (→  140)	–
Value 7 display	A local display is provided.	Select the measured value that is shown on the local display.	For the picklist, see <b>Value 1 display</b> parameter (→  140)	–
Value 8 display	A local display is provided.	Select the measured value that is shown on the local display.	For the picklist, see <b>Value 1 display</b> parameter (→  140)	–

\* Visibility depends on order options or device settings

### 10.5.12 Configuring the low flow cut off

The **Low flow cut off** wizard systematically guides the user through all the parameters that must be set to configure low flow cut off.

#### Navigation

"Setup" menu → Low flow cut off

► Low flow cut off	
Assign process variable	→ ⓘ 142
On value low flow cutoff	→ ⓘ 142
Off value low flow cutoff	→ ⓘ 142
Pressure shock suppression	→ ⓘ 142

#### Parameter overview with brief description

Parameter	Prerequisite	Description	Selection / User entry	Factory setting
Assign process variable	–	Select process variable for low flow cut off.	<ul style="list-style-type: none"> <li>▪ Off</li> <li>▪ Mass flow</li> <li>▪ Volume flow</li> <li>▪ Corrected volume flow</li> </ul>	–
On value low flow cutoff	A process variable is selected in the <b>Assign process variable</b> parameter (→ ⓘ 142).	Enter on value for low flow cut off.	Positive floating-point number	Depends on country and nominal diameter
Off value low flow cutoff	A process variable is selected in the <b>Assign process variable</b> parameter (→ ⓘ 142).	Enter off value for low flow cut off.	0 to 100.0 %	–
Pressure shock suppression	A process variable is selected in the <b>Assign process variable</b> parameter (→ ⓘ 142).	Enter time frame for signal suppression (= active pressure shock suppression).	0 to 100 s	–

### 10.5.13 Configuring partially filled pipe detection

The **Partial filled pipe detection** wizard guides you systematically through all parameters that have to be set for configuring the monitoring of the pipe filling.

#### Navigation

"Setup" menu → Partially filled pipe detection

► Partially filled pipe detection	
Assign process variable	→ ⓘ 143
Low value partial filled pipe detection	→ ⓘ 143
High value partial filled pipe detection	→ ⓘ 143
Response time part. filled pipe detect.	→ ⓘ 143

#### Parameter overview with brief description

Parameter	Prerequisite	Description	Selection / User entry	Factory setting
Assign process variable	–	Select process variable for partially filled pipe detection.	<ul style="list-style-type: none"> <li>■ Off</li> <li>■ Density</li> <li>■ Reference density</li> </ul>	Density
Low value partial filled pipe detection	A process variable is selected in the <b>Assign process variable</b> parameter (→ ⓘ 143).	Enter lower limit value for deactivating partially filled pipe detection.	Signed floating-point number	Depends on country: <ul style="list-style-type: none"> <li>■ 200 kg/m<sup>3</sup></li> <li>■ 12.5 lb/ft<sup>3</sup></li> </ul>
High value partial filled pipe detection	A process variable is selected in the <b>Assign process variable</b> parameter (→ ⓘ 143).	Enter upper limit value for deactivating partially filled pipe detection.	Signed floating-point number	Depends on country: <ul style="list-style-type: none"> <li>■ 6 000 kg/m<sup>3</sup></li> <li>■ 374.6 lb/ft<sup>3</sup></li> </ul>
Response time part. filled pipe detect.	A process variable is selected in the <b>Assign process variable</b> parameter (→ ⓘ 143).	Use this function to enter the minimum time (hold time) the signal must be present before diagnostic message S962 "Pipe only partly filled" is triggered in the event of a partially filled or empty measuring pipe.	0 to 100 s	–

## 10.6 Advanced settings

The **Advanced setup** submenu with its submenus contains parameters for specific settings.

*Navigation to the "Advanced setup" submenu*

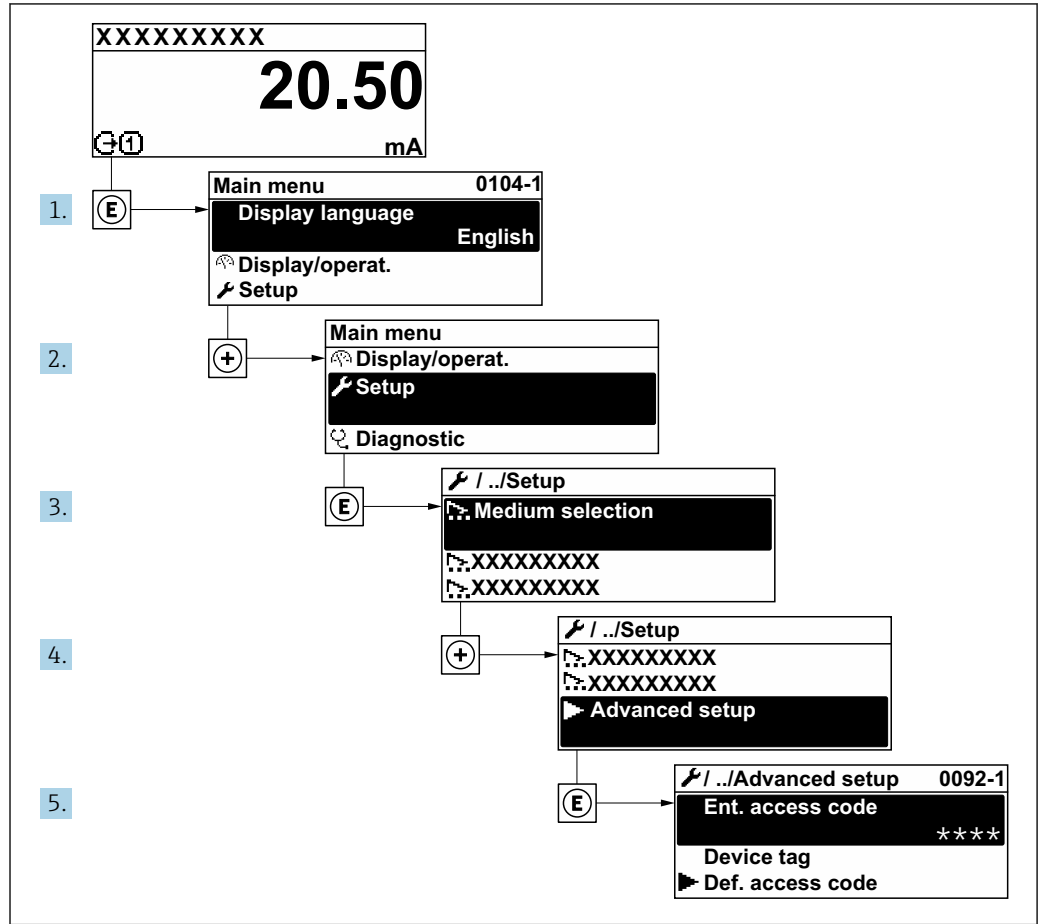

A0032223-EN

**i** The number of submenus and parameters can vary depending on the device version and the available application packages. These submenus and their parameters are explained in the Special Documentation for the device and not in Operating Instructions.

For detailed information on the parameter descriptions for application packages:  
Special Documentation for the device → 260

### Navigation

"Setup" menu → Advanced setup

▶ Advanced setup	
Enter access code	→  145
▶ Calculated values	→  145
▶ Sensor adjustment	→  147



▶ Totalizer 1 to n	→ 153
▶ Display	→ 155
▶ WLAN settings	
▶ Concentration	
▶ Heartbeat setup	
▶ Configuration backup	→ 161
▶ Administration	→ 162

### 10.6.1 Using the parameter to enter the access code

#### Navigation

"Setup" menu → Advanced setup

#### Parameter overview with brief description

Parameter	Description	User entry
Enter access code	Enter access code to disable write protection of parameters.	Max. 16-digit character string comprising numbers, letters and special characters

### 10.6.2 Calculated process variables

The **Calculated values** submenu contains parameters for calculating the corrected volume flow.

 The **Calculated values** submenu is **not** available if one of the following options was selected in the **Petroleum mode** parameter in the "Application package", option **EJ** "Petroleum": **API referenced correction** option, **Net oil & water cut** option or **ASTM D4311** option

#### Navigation

"Setup" menu → Advanced setup → Calculated values

▶ Calculated values	
▶ Corrected volume flow calculation	→ 146

**"Corrected volume flow calculation" submenu****Navigation**

"Setup" menu → Advanced setup → Calculated values → Corrected volume flow calculation

▶ Corrected volume flow calculation	
Corrected volume flow calculation (1812)	→ 146
External reference density (6198)	→ 146
Fixed reference density (1814)	→ 146
Reference temperature (1816)	→ 146
Linear expansion coefficient (1817)	→ 147
Square expansion coefficient (1818)	→ 147

**Parameter overview with brief description**

Parameter	Prerequisite	Description	Selection / User interface / User entry	Factory setting
Corrected volume flow calculation	–	Select reference density for calculating the corrected volume flow.	<ul style="list-style-type: none"> <li>■ Fixed reference density</li> <li>■ Calculated reference density</li> <li>■ External reference density</li> <li>■ Current input 1 *</li> <li>■ Current input 2 *</li> <li>■ Current input 3 *</li> </ul>	–
External reference density	In the <b>Corrected volume flow calculation</b> parameter, the <b>External reference density</b> option is selected.	Shows external reference density.	Floating point number with sign	–
Fixed reference density	The <b>Fixed reference density</b> option is selected in the <b>Corrected volume flow calculation</b> parameter.	Enter fixed value for reference density.	Positive floating-point number	–
Reference temperature	The <b>Calculated reference density</b> option is selected in the <b>Corrected volume flow calculation</b> parameter.	Enter reference temperature for calculating the reference density.	–273.15 to 99 999 °C	Country-specific: <ul style="list-style-type: none"> <li>■ +20 °C</li> <li>■ +68 °F</li> </ul>

Parameter	Prerequisite	Description	Selection / User interface / User entry	Factory setting
Linear expansion coefficient	The <b>Calculated reference density</b> option is selected in the <b>Corrected volume flow calculation</b> parameter parameter.	Enter linear, medium-specific expansion coefficient for calculating the reference density.	Signed floating-point number	-
Square expansion coefficient	The <b>Calculated reference density</b> option is selected in the <b>Corrected volume flow calculation</b> parameter parameter.	For media with a non-linear expansion pattern: enter the quadratic, medium-specific expansion coefficient for calculating the reference density.	Signed floating-point number	-

\* Visibility depends on order options or device settings

### 10.6.3 Carrying out a sensor adjustment

The **Sensor adjustment** submenu contains parameters that pertain to the functionality of the sensor.

#### Navigation

"Setup" menu → Advanced setup → Sensor adjustment

▶ **Sensor adjustment**

Installation direction

→ ⓘ 147

▶ **Density adjustment**

▶ **Zero verification**

→ ⓘ 150

▶ **Zero adjustment**

→ ⓘ 152

#### Parameter overview with brief description

Parameter	Description	Selection
Installation direction	Set sign of flow direction to match the direction of the arrow on the sensor.	<ul style="list-style-type: none"> <li>▪ Flow in arrow direction</li> <li>▪ Flow against arrow direction</li> </ul>

#### Density adjustment

 With density adjustment, a high level of accuracy is achieved only at the point of adjustment and at the relevant density and temperature. However, the accuracy of a density adjustment is only ever as good as the quality of the reference measuring data provided. Therefore it is not a substitute for special density calibration.

*Performing density adjustment*

- i** Note the following before performing the adjustment:
- A density adjustment only makes sense if there is little variation in the operating conditions and the density adjustment is performed under the operating conditions.
  - The density adjustment scales the internally computed density value with a user-specific slope and offset.
  - A 1-point or 2-point density adjustment can be performed.
  - For a 2-point density adjustment, there must be a difference of at least 0.2 kg/l between the two target density values.
  - The reference media must be gas-free or pressurized so that any gas they contain is compressed.
  - The reference density measurements must be performed at the same medium temperature that prevails in the process, as otherwise the density adjustment will not be accurate.
  - The correction resulting from the density adjustment can be deleted with the **Restore original** option.

**"1 point adjustment" option**

1. In the **Density adjustment mode** parameter, select the **1 point adjustment** option and confirm.
2. In the **Density setpoint 1** parameter, enter the density value and confirm.
  - ↳ In the **Execute density adjustment** parameter the following options are now available:
    - Ok
    - Measure density 1 option**
    - Restore original
3. Select the **Measure density 1 option** and confirm.
4. If 100% was reached in the **Progress** parameter on the display and the **Ok** option is displayed in the **Execute density adjustment** parameter, then confirm.
  - ↳ In the **Execute density adjustment** parameter the following options are now available:
    - Ok
    - Calculate
    - Cancel
5. Select the **Calculate** option and confirm.

If the adjustment was completed successfully, the **Density adjustment factor** parameter and the **Density adjustment offset** parameter and the values calculated for them are shown on the display.

**"2 point adjustment" option**

1. In the **Density adjustment mode** parameter, select the **2 point adjustment** option and confirm.
2. In the **Density setpoint 1** parameter, enter the density value and confirm.
3. In the **Density setpoint 2** parameter, enter the density value and confirm.
  - ↳ In the **Execute density adjustment** parameter the following options are now available:
    - Ok
    - Measure density 1
    - Restore original

4. Select the **Measure density 1** option and confirm.
  - ↳ In the **Execute density adjustment** parameter the following options are now available:
    - Ok
    - Measure density 2
    - Restore original
5. Select the **Measure density 2** option and confirm.
  - ↳ In the **Execute density adjustment** parameter the following options are now available:
    - Ok
    - Calculate
    - Cancel
6. Select the **Calculate** option and confirm.

If the **Density adjust failure** option is displayed in the **Execute density adjustment** parameter, call up the options and select the **Cancel** option. The density adjustment is canceled and can be repeated.

If the adjustment was completed successfully, the **Density adjustment factor** parameter and the **Density adjustment offset** parameter and the values calculated for them are shown on the display.

**Navigation**

"Expert" menu → Sensor → Sensor adjustment → Density adjustment

► Density adjustment		
Density adjustment mode		→ ⓘ 149
Density setpoint 1		→ ⓘ 149
Density setpoint 2		→ ⓘ 150
Execute density adjustment		→ ⓘ 150
Progress		→ ⓘ 150
Density adjustment factor		→ ⓘ 150
Density adjustment offset		→ ⓘ 150

**Parameter overview with brief description**

Parameter	Prerequisite	Description	Selection / User entry / User interface	Factory setting
Density adjustment mode	-		<ul style="list-style-type: none"> <li>■ 1 point adjustment</li> <li>■ 2 point adjustment</li> </ul>	-
Density setpoint 1	-		The entry depends on the unit selected in the <b>Density unit</b> parameter (0555).	-

Parameter	Prerequisite	Description	Selection / User entry / User interface	Factory setting
Density setpoint 2	In the <b>Density adjustment mode</b> parameter, the <b>2 point adjustment</b> option is selected.		The entry depends on the unit selected in the <b>Density unit</b> parameter (0555).	–
Execute density adjustment	–		<ul style="list-style-type: none"> <li>■ Cancel</li> <li>■ Busy</li> <li>■ Ok</li> <li>■ Density adjust failure</li> <li>■ Measure density 1</li> <li>■ Measure density 2</li> <li>■ Calculate</li> <li>■ Restore original</li> </ul>	–
Progress	–	Shows the progress of the process.	0 to 100 %	–
Density adjustment factor	–		Signed floating-point number	–
Density adjustment offset	–		Signed floating-point number	–

### Zero verification and zero adjustment

All measuring instruments are calibrated in accordance with state-of-the-art technology. Calibration takes place under reference conditions →  241. Therefore, a zero adjustment in the field is generally not required.

Experience shows that zero adjustment is advisable only in special cases:

- To achieve maximum measurement accuracy even with low flow rates.
- Under extreme process or operating conditions (e.g. very high process temperatures or very high-viscosity fluids).
- For gas applications with low pressure



To achieve the highest possible measurement accuracy at low flow rates, the installation must protect the sensor from mechanical stresses during operation.

To get a representative zero point, ensure that:

- any flow in the device is prevented during the adjustment
- the process conditions (e.g. pressure, temperature) are stable and representative

Zero verification and zero adjustment cannot be performed if the following process conditions are present:

- Gas pockets  
Ensure that the system has been sufficiently flushed with the medium. Repeat flushing can help to eliminate gas pockets
- Thermal circulation  
In the event of temperature differences (e.g. between the measuring tube inlet and outlet section), induced flow can occur even if the valves are closed due to thermal circulation in the device
- Leaks at the valves  
If the valves are not leak-tight, flow is not sufficiently prevented when determining the zero point

If these conditions cannot be avoided, it is advisable to keep the factory setting for the zero point.

#### *Zero point verification*

The zero point can be verified with the **Zero verification** wizard.

**Navigation**

"Setup" menu → Advanced setup → Sensor adjustment → Zero verification

<b>► Zero verification</b>	
Process conditions	→ 151
Progress	→ 151
Status	→ 151
Additional information	→ 151
Recommendation:	→ 151
Root cause	→ 151
Abort cause	→ 151
Zero point measured	→ 152
Zero point standard deviation	→ 152

**Parameter overview with brief description**

Parameter	Description	Selection / User interface	Factory setting
Process conditions	Ensure process conditions as follows.	<ul style="list-style-type: none"> <li>▪ Tubes are completely filled</li> <li>▪ Process operational pressure applied</li> <li>▪ No-flow conditions (closed valves)</li> <li>▪ Process and ambient temperatures stable</li> </ul>	–
Progress	Shows the progress of the process.	0 to 100 %	–
Zero point adjustment status		<ul style="list-style-type: none"> <li>▪ Busy</li> <li>▪ Alarm</li> <li>▪ Ok</li> </ul>	–
Additional information	Indicate whether to display additional information.	<ul style="list-style-type: none"> <li>▪ Hide</li> <li>▪ Show</li> </ul>	–
Recommendation:	Indicates whether an adjustment is recommended. Only recommended if the measured zero point deviates significantly from the current zero point.	<ul style="list-style-type: none"> <li>▪ Do not adjust zero point</li> <li>▪ Adjust zero point</li> </ul>	–
Abort cause	Indicates why the wizard was aborted.	<ul style="list-style-type: none"> <li>▪ Check process conditions!</li> <li>▪ A technical issue has occurred</li> </ul>	–
Root cause	Shows the diagnostic and remedy.	<ul style="list-style-type: none"> <li>▪ Zero point too high. Ensure no-flow.</li> <li>▪ Zero point is unstable. Ensure no-flow.</li> <li>▪ Fluctuation high. Avoid 2-phase medium.</li> </ul>	–

Parameter	Description	Selection / User interface	Factory setting
Zero point measured	Shows the zero point measured for the adjustment.	Signed floating-point number	-
Zero point standard deviation	Shows the standard deviation of the zero point measured.	Positive floating-point number	-













### Zero adjust

The zero point can be adjusted with the **Zero adjustment** wizard.

-  A zero point verification should be performed before a zero adjustment.
- The zero point can also be adjusted manually: Expert → Sensor → Calibration

### Navigation

"Setup" menu → Advanced setup → Sensor adjustment → Zero adjustment

► Zero adjustment	
Process conditions	→  153
Progress	→  153
Status	→  153
Root cause	→  153
Abort cause	→  153
Root cause	→  153
Reliability of measured zero point	→  153
Additional information	→  153
Reliability of measured zero point	→  153
Zero point measured	→  153
Zero point standard deviation	→  153
Select action	→  153



**Parameter overview with brief description**

Parameter	Description	Selection / User interface	Factory setting
Process conditions	Ensure process conditions as follows.	<ul style="list-style-type: none"> <li>▪ Tubes are completely filled</li> <li>▪ Process operational pressure applied</li> <li>▪ No-flow conditions (closed valves)</li> <li>▪ Process and ambient temperatures stable</li> </ul>	–
Progress	Shows the progress of the process.	0 to 100 %	–
Zero point adjustment status		<ul style="list-style-type: none"> <li>▪ Busy</li> <li>▪ Alarm</li> <li>▪ Ok</li> </ul>	–
Abort cause	Indicates why the wizard was aborted.	<ul style="list-style-type: none"> <li>▪ Check process conditions!</li> <li>▪ A technical issue has occurred</li> </ul>	–
Root cause	Shows the diagnostic and remedy.	<ul style="list-style-type: none"> <li>▪ Zero point too high. Ensure no-flow.</li> <li>▪ Zero point is unstable. Ensure no-flow.</li> <li>▪ Fluctuation high. Avoid 2-phase medium.</li> </ul>	–
Reliability of measured zero point	Indicates the reliability of the zero point measured.	<ul style="list-style-type: none"> <li>▪ Not done</li> <li>▪ Good</li> <li>▪ Uncertain</li> </ul>	–
Additional information	Indicate whether to display additional information.	<ul style="list-style-type: none"> <li>▪ Hide</li> <li>▪ Show</li> </ul>	–
Zero point measured	Shows the zero point measured for the adjustment.	Signed floating-point number	–
Zero point standard deviation	Shows the standard deviation of the zero point measured.	Positive floating-point number	–
Select action	Select the zero point value to apply.	<ul style="list-style-type: none"> <li>▪ Keep current zero point</li> <li>▪ Apply zero point measured</li> <li>▪ Apply factory zero point *</li> </ul>	–

\* Visibility depends on order options or device settings

**10.6.4 Configuring the totalizer**

In the "Totalizer 1 to n" submenu, you can configure the specific totalizer.

**Navigation**

"Setup" menu → Advanced setup → Totalizer 1 to n

▶ Totalizer 1 to n

Assign process variable	→ ⓘ 154
Unit totalizer 1 to n	→ ⓘ 154
Totalizer operation mode	→ ⓘ 154
Failure mode	→ ⓘ 154

## Parameter overview with brief description

Parameter	Prerequisite	Description	Selection	Factory setting
Assign process variable	–	Select process variable for totalizer.	<ul style="list-style-type: none"> <li>▪ Off</li> <li>▪ Mass flow</li> <li>▪ Volume flow</li> <li>▪ Corrected volume flow<sup>*</sup></li> <li>▪ Target mass flow<sup>*</sup></li> <li>▪ Carrier mass flow<sup>*</sup></li> <li>▪ Target volume flow<sup>*</sup></li> <li>▪ Carrier volume flow<sup>*</sup></li> <li>▪ Target corrected volume flow<sup>*</sup></li> <li>▪ Carrier corrected volume flow<sup>*</sup></li> <li>▪ GSV flow<sup>*</sup></li> <li>▪ GSV flow alternative<sup>*</sup></li> <li>▪ NSV flow<sup>*</sup></li> <li>▪ NSV flow alternative<sup>*</sup></li> <li>▪ S&amp;W volume flow<sup>*</sup></li> <li>▪ Oil mass flow<sup>*</sup></li> <li>▪ Water mass flow<sup>*</sup></li> <li>▪ Oil volume flow<sup>*</sup></li> <li>▪ Water volume flow<sup>*</sup></li> <li>▪ Oil corrected volume flow<sup>*</sup></li> <li>▪ Water corrected volume flow<sup>*</sup></li> </ul>	–
Unit totalizer 1 to n	A process variable is selected in the <b>Assign process variable</b> parameter (→ 154) of the <b>Totalizer 1 to n</b> submenu.	Select process variable totalizer unit.	Unit choose list	Depends on country: <ul style="list-style-type: none"> <li>▪ kg</li> <li>▪ lb</li> </ul>
Totalizer operation mode	A process variable is selected in the <b>Assign process variable</b> parameter (→ 154) of the <b>Totalizer 1 to n</b> submenu.	Select totalizer calculation mode.	<ul style="list-style-type: none"> <li>▪ Net flow total</li> <li>▪ Forward flow total</li> <li>▪ Reverse flow total</li> </ul>	–
Failure mode	A process variable is selected in the <b>Assign process variable</b> parameter (→ 154) of the <b>Totalizer 1 to n</b> submenu.	Define totalizer behavior in alarm condition.	<ul style="list-style-type: none"> <li>▪ Stop</li> <li>▪ Actual value</li> <li>▪ Last valid value</li> </ul>	–

\* Visibility depends on order options or device settings

### 10.6.5 Carrying out additional display configurations

In the **Display** submenu you can set all the parameters associated with the configuration of the local display.

#### Navigation

"Setup" menu → Advanced setup → Display

► Display	
Format display	→ 156
Value 1 display	→ 157
0% bargraph value 1	→ 158
100% bargraph value 1	→ 158
Decimal places 1	→ 158
Value 2 display	→ 158
Decimal places 2	→ 158
Value 3 display	→ 158
0% bargraph value 3	→ 158
100% bargraph value 3	→ 158
Decimal places 3	→ 158
Value 4 display	→ 158
Decimal places 4	→ 158
Display language	→ 159
Display interval	→ 159
Display damping	→ 159
Header	→ 159
Header text	→ 159
Separator	→ 159
Backlight	→ 159

**Parameter overview with brief description**

Parameter	Prerequisite	Description	Selection / User entry	Factory setting
Format display	A local display is provided.	Select how measured values are shown on the display.	<ul style="list-style-type: none"><li>▪ 1 value, max. size</li><li>▪ 1 bargraph + 1 value</li><li>▪ 2 values</li><li>▪ 1 value large + 2 values</li><li>▪ 4 values</li></ul>	–

Parameter	Prerequisite	Description	Selection / User entry	Factory setting
Value 1 display	A local display is provided.	Select the measured value that is shown on the local display.	<ul style="list-style-type: none"> <li>■ Mass flow</li> <li>■ Volume flow</li> <li>■ Corrected volume flow *</li> <li>■ Density</li> <li>■ Reference density *</li> <li>■ Temperature</li> <li>■ Current output 1</li> <li>■ Current output 2 *</li> <li>■ Current output 4 *</li> <li>■ Pressure</li> <li>■ Totalizer 1</li> <li>■ Totalizer 2</li> <li>■ Totalizer 3</li> <li>■ GSV flow *</li> <li>■ GSV flow alternative *</li> <li>■ NSV flow *</li> <li>■ NSV flow alternative *</li> <li>■ S&amp;W volume flow *</li> <li>■ Reference density alternative *</li> <li>■ Weighted density average *</li> <li>■ Weighted temperature average *</li> <li>■ Water cut *</li> <li>■ Oil density *</li> <li>■ Water density *</li> <li>■ Oil mass flow *</li> <li>■ Water mass flow *</li> <li>■ Oil volume flow *</li> <li>■ Water volume flow *</li> <li>■ Oil corrected volume flow *</li> <li>■ Water corrected volume flow *</li> <li>■ Concentration *</li> <li>■ Target mass flow *</li> <li>■ Carrier mass flow *</li> <li>■ Target volume flow *</li> <li>■ Carrier volume flow *</li> <li>■ Target corrected volume flow *</li> <li>■ Carrier corrected volume flow *</li> <li>■ HBSI *</li> <li>■ Exciter current 0</li> <li>■ Oscillation damping 0</li> <li>■ Oscillation damping fluctuation 0 *</li> <li>■ Oscillation frequency 0</li> <li>■ Frequency fluctuation 0 *</li> <li>■ Oscillation amplitude 0 *</li> <li>■ Signal asymmetry</li> <li>■ Electronic temperature</li> <li>■ Current output 1</li> </ul>	-

Parameter	Prerequisite	Description	Selection / User entry	Factory setting
			<ul style="list-style-type: none"> <li>▪ Current output 2 *</li> <li>▪ Current output 3 *</li> </ul>	
0% bargraph value 1	A local display is provided.	Enter 0% value for bar graph display.	Signed floating-point number	Country-specific: <ul style="list-style-type: none"> <li>▪ 0 kg/h</li> <li>▪ 0 lb/min</li> </ul>
100% bargraph value 1	A local display is provided.	Enter 100% value for bar graph display.	Signed floating-point number	Depends on country and nominal diameter
Decimal places 1	A measured value is specified in the <b>Value 1 display</b> parameter.	Select the number of decimal places for the display value.	<ul style="list-style-type: none"> <li>▪ x</li> <li>▪ x.x</li> <li>▪ x.xx</li> <li>▪ x.xxx</li> <li>▪ x.xxxx</li> </ul>	–
Value 2 display	A local display is provided.	Select the measured value that is shown on the local display.	For the picklist, see <b>Value 1 display</b> parameter (→  140)	–
Decimal places 2	A measured value is specified in the <b>Value 2 display</b> parameter.	Select the number of decimal places for the display value.	<ul style="list-style-type: none"> <li>▪ x</li> <li>▪ x.x</li> <li>▪ x.xx</li> <li>▪ x.xxx</li> <li>▪ x.xxxx</li> </ul>	–
Value 3 display	A local display is provided.	Select the measured value that is shown on the local display.	For the picklist, see <b>Value 1 display</b> parameter (→  140)	–
0% bargraph value 3	A selection was made in the <b>Value 3 display</b> parameter.	Enter 0% value for bar graph display.	Signed floating-point number	Country-specific: <ul style="list-style-type: none"> <li>▪ 0 kg/h</li> <li>▪ 0 lb/min</li> </ul>
100% bargraph value 3	A selection was made in the <b>Value 3 display</b> parameter.	Enter 100% value for bar graph display.	Signed floating-point number	–
Decimal places 3	A measured value is specified in the <b>Value 3 display</b> parameter.	Select the number of decimal places for the display value.	<ul style="list-style-type: none"> <li>▪ x</li> <li>▪ x.x</li> <li>▪ x.xx</li> <li>▪ x.xxx</li> <li>▪ x.xxxx</li> </ul>	–
Value 4 display	A local display is provided.	Select the measured value that is shown on the local display.	For the picklist, see <b>Value 1 display</b> parameter (→  140)	–
Decimal places 4	A measured value is specified in the <b>Value 4 display</b> parameter.	Select the number of decimal places for the display value.	<ul style="list-style-type: none"> <li>▪ x</li> <li>▪ x.x</li> <li>▪ x.xx</li> <li>▪ x.xxx</li> <li>▪ x.xxxx</li> </ul>	–

Parameter	Prerequisite	Description	Selection / User entry	Factory setting
Display language	A local display is provided.	Set display language.	<ul style="list-style-type: none"> <li>■ English</li> <li>■ Deutsch *</li> <li>■ Français *</li> <li>■ Español *</li> <li>■ Italiano *</li> <li>■ Nederlands *</li> <li>■ Portuguesa *</li> <li>■ Polski *</li> <li>■ русский язык (Russian) *</li> <li>■ Svenska *</li> <li>■ Türkçe *</li> <li>■ 中文 (Chinese) *</li> <li>■ 日本語 (Japanese) *</li> <li>■ 한국어 (Korean) *</li> <li>■ tiếng Việt (Vietnamese) *</li> <li>■ čeština (Czech) *</li> </ul>	English (alternatively, the ordered language is preset in the device)
Display interval	A local display is provided.	Set time measured values are shown on display if display alternates between values.	1 to 10 s	–
Display damping	A local display is provided.	Set display reaction time to fluctuations in the measured value.	0.0 to 999.9 s	–
Header	A local display is provided.	Select header contents on local display.	<ul style="list-style-type: none"> <li>■ Device tag</li> <li>■ Free text</li> </ul>	–
Header text	The <b>Free text</b> option is selected in the <b>Header</b> parameter.	Enter display header text.	Max. 12 characters, such as letters, numbers or special characters (e.g. @, %, /)	–
Separator	A local display is provided.	Select decimal separator for displaying numerical values.	<ul style="list-style-type: none"> <li>■ . (point)</li> <li>■ , (comma)</li> </ul>	. (point)
Backlight	One of the following conditions is met: <ul style="list-style-type: none"> <li>■ Order code for "Display; operation", option <b>F</b> "4-line, illum.; touch control"</li> <li>■ Order code for "Display; operation", option <b>G</b> "4-line, illum.; touch control +WLAN"</li> </ul>	Switch the local display backlight on and off.	<ul style="list-style-type: none"> <li>■ Disable</li> <li>■ Enable</li> </ul>	–

\* Visibility depends on order options or device settings









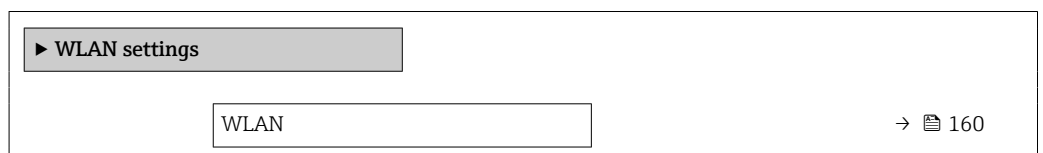



### 10.6.6 WLAN configuration

The **WLAN Settings** submenu guides the user systematically through all the parameters that have to be set for the WLAN configuration.

#### Navigation

"Setup" menu → Advanced setup → WLAN settings





WLAN mode	→  160
SSID name	→  160
Network security	→  160
Security identification	→  160
User name	→  160
WLAN password	→  160
WLAN IP address	→  160
WLAN passphrase	→  161
Assign SSID name	→  161
SSID name	→  161
Connection state	→  161
Received signal strength	→  161

### Parameter overview with brief description

Parameter	Prerequisite	Description	Selection / User entry / User interface	Factory setting
WLAN	–	Switch WLAN on and off.	<ul style="list-style-type: none"> <li>▪ Disable</li> <li>▪ Enable</li> </ul>	–
WLAN mode	–	Select WLAN mode.	<ul style="list-style-type: none"> <li>▪ WLAN access point</li> <li>▪ WLAN Client</li> </ul>	–
SSID name	The client is activated.	Enter the user-defined SSID name (max. 32 characters).	–	–
Network security	–	Select the security type of the WLAN network.	<ul style="list-style-type: none"> <li>▪ Unsecured</li> <li>▪ WPA2-PSK</li> <li>▪ EAP-PEAP with MSCHAPv2</li> <li>▪ EAP-PEAP MSCHAPv2 no server authentic.</li> <li>▪ EAP-TLS</li> </ul>	–
Security identification	–	Select security settings and download these settings via menu Data management > Security > WLAN.	<ul style="list-style-type: none"> <li>▪ Root certificate</li> <li>▪ Device certificate</li> <li>▪ Device private key</li> </ul>	–
User name	–	Enter user name.	–	–
WLAN password	–	Enter WLAN password.	–	–
WLAN IP address	–	Enter IP address of the device WLAN interface.	4 octet: 0 to 255 (in the particular octet)	–



Parameter	Prerequisite	Description	Selection / User entry / User interface	Factory setting
WLAN passphrase	The <b>WPA2-PSK</b> option is selected in the <b>Security type</b> parameter.	Enter the network key (8 to 32 characters).  The network key supplied with the device should be changed during commissioning for security reasons.	8 to 32-digit character string comprising numbers, letters and special characters (without spaces)	Serial number of the measuring device (e.g. L100A802000)
Assign SSID name	–	Select which name will be used for SSID: device tag or user-defined name.	<ul style="list-style-type: none"> <li>▪ Device tag</li> <li>▪ User-defined</li> </ul>	–
SSID name	<ul style="list-style-type: none"> <li>▪ The <b>User-defined</b> option is selected in the <b>Assign SSID name</b> parameter.</li> <li>▪ The <b>WLAN access point</b> option is selected in the <b>WLAN mode</b> parameter.</li> </ul>	Enter the user-defined SSID name (max. 32 characters).  The user-defined SSID name may only be assigned once. If the SSID name is assigned more than once, the devices can interfere with one another.	Max. 32-digit character string comprising numbers, letters and special characters	EH_device designation_last 7 digits of the serial number (e.g. EH_Promass_500_A 802000)
Connection state	–	Displays the connection status.	<ul style="list-style-type: none"> <li>▪ Connected</li> <li>▪ Not connected</li> </ul>	–
Received signal strength	–	Shows the received signal strength.	<ul style="list-style-type: none"> <li>▪ Low</li> <li>▪ Medium</li> <li>▪ High</li> </ul>	–





### 10.6.7 Configuration management

After commissioning, you can save the current device configuration or restore the previous device configuration. The device configuration is managed via the **Configuration management** parameter.

#### Navigation

"Setup" menu → Advanced setup → Configuration backup

▶ Configuration backup

Operating time	→  162
Last backup	→  162
Configuration management	→  162
Backup state	→  162
Comparison result	→  162

### Parameter overview with brief description

Parameter	Description	User interface / Selection
Operating time	Indicates how long the device has been in operation.	Days (d), hours (h), minutes (m) and seconds (s)
Last backup	Shows when the last data backup was saved to HistoROM backup.	Days (d), hours (h), minutes (m) and seconds (s)
Configuration management	Select action for managing the device data in the HistoROM backup.	<ul style="list-style-type: none"> <li>▪ Cancel</li> <li>▪ Execute backup</li> <li>▪ Restore</li> <li>▪ Compare</li> <li>▪ Clear backup data</li> </ul>
Backup state	Shows the current status of data saving or restoring.	<ul style="list-style-type: none"> <li>▪ None</li> <li>▪ Backup in progress</li> <li>▪ Restoring in progress</li> <li>▪ Delete in progress</li> <li>▪ Compare in progress</li> <li>▪ Restoring failed</li> <li>▪ Backup failed</li> </ul>
Comparison result	Comparison of current device data with HistoROM backup.	<ul style="list-style-type: none"> <li>▪ Settings identical</li> <li>▪ Settings not identical</li> <li>▪ No backup available</li> <li>▪ Backup settings corrupt</li> <li>▪ Check not done</li> <li>▪ Dataset incompatible</li> </ul>

### Function scope of the "Configuration management" parameter

Options	Description
Cancel	No action is executed and the user exits the parameter.
Execute backup	A backup copy of the current device configuration is saved from the HistoROM backup to the memory of the device. The backup copy includes the transmitter data of the device.
Restore	The last backup copy of the device configuration is restored from the device memory to the device's HistoROM backup. The backup copy includes the transmitter data of the device.
Compare	The device configuration saved in the device memory is compared with the current device configuration of the HistoROM backup.
Clear backup data	The backup copy of the device configuration is deleted from the memory of the device.



#### *HistoROM backup*

A HistoROM is a "non-volatile" device memory in the form of an EEPROM.



While this action is in progress, the configuration cannot be edited via the local display and a message on the processing status appears on the display.

### 10.6.8 Using parameters for device administration

The **Administration** submenu systematically guides the user through all the parameters that can be used for device administration purposes.

**Navigation**

"Setup" menu → Advanced setup → Administration

▶ Administration

▶ Define access code → ⓘ 163

▶ Reset access code → ⓘ 163

Device reset → ⓘ 164

**Using the parameter to define the access code**

**Navigation**

"Setup" menu → Advanced setup → Administration → Define access code

▶ Define access code

Define access code → ⓘ 163

Confirm access code → ⓘ 163

**Parameter overview with brief description**

Parameter	Description	User entry
Define access code	Restrict write-access to parameters to protect the configuration of the device against unintentional changes.	Max. 16-digit character string comprising numbers, letters and special characters
Confirm access code	Confirm the entered access code.	Max. 16-digit character string comprising numbers, letters and special characters

**Using the parameter to reset the access code**

**Navigation**

"Setup" menu → Advanced setup → Administration → Reset access code

▶ Reset access code

Operating time → ⓘ 164

Reset access code → ⓘ 164

**Parameter overview with brief description**

Parameter	Description	User interface / User entry
Operating time	Indicates how long the device has been in operation.	Days (d), hours (h), minutes (m) and seconds (s)
Reset access code	Reset access code to factory settings.  For a reset code, contact your Endress+Hauser service organization. The reset code can only be entered via: <ul style="list-style-type: none"> <li>▪ Web browser</li> <li>▪ DeviceCare, FieldCare (via CDI-RJ45 service interface)</li> <li>▪ Fieldbus</li> </ul>	Character string comprising numbers, letters and special characters

**Using the parameter to reset the device**

**Navigation**

"Setup" menu → Advanced setup → Administration

**Parameter overview with brief description**

Parameter	Description	Selection
Device reset	Reset the device configuration - either entirely or in part - to a defined state.	<ul style="list-style-type: none"> <li>▪ Cancel</li> <li>▪ To delivery settings</li> <li>▪ Restart device</li> <li>▪ Restore S-DAT backup</li> </ul>

**10.7 Simulation**

Via the **Simulation** submenu, it is possible to simulate various process variables in the process and the device alarm mode and verify downstream signal chains (switching valves or closed-control loops). The simulation can be performed without a real measurement (no flow of medium through the device).

**Navigation**

"Diagnostics" menu → Simulation

<b>► Simulation</b>	
Assign simulation process variable	→ ⓘ 166
Process variable value	→ ⓘ 166
Status input simulation	→ ⓘ 167
Input signal level	→ ⓘ 167
Current input 1 to n simulation	→ ⓘ 167
Value current input 1 to n	→ ⓘ 167
Current output 1 to n simulation	→ ⓘ 166

Value current output 1 to n	→ 166
Frequency output simulation 1 to n	→ 166
Frequency value 1 to n	→ 166
Pulse output simulation 1 to n	→ 166
Pulse value 1 to n	→ 166
Switch output simulation 1 to n	→ 167
Switch status 1 to n	→ 167
Relay output 1 to n simulation	→ 167
Switch status 1 to n	→ 167
Device alarm simulation	→ 167
Diagnostic event category	→ 167
Diagnostic event simulation	→ 167

## Parameter overview with brief description



Parameter	Prerequisite	Description	Selection / User entry
Assign simulation process variable	–	Select a process variable for the simulation process that is activated.	<ul style="list-style-type: none"> <li>■ Off</li> <li>■ Mass flow</li> <li>■ Volume flow</li> <li>■ Corrected volume flow</li> <li>■ Target mass flow *</li> <li>■ Carrier mass flow *</li> <li>■ Target volume flow *</li> <li>■ Carrier volume flow *</li> <li>■ Target corrected volume flow *</li> <li>■ Carrier corrected volume flow *</li> <li>■ Density</li> <li>■ Reference density</li> <li>■ Reference density alternative *</li> <li>■ GSV flow *</li> <li>■ GSV flow alternative *</li> <li>■ NSV flow *</li> <li>■ NSV flow alternative *</li> <li>■ S&amp;W volume flow *</li> <li>■ Water cut *</li> <li>■ Oil density *</li> <li>■ Water density *</li> <li>■ Oil mass flow *</li> <li>■ Water mass flow *</li> <li>■ Oil volume flow *</li> <li>■ Water volume flow *</li> <li>■ Oil corrected volume flow *</li> <li>■ Water corrected volume flow *</li> <li>■ Weighted density average *</li> <li>■ Weighted temperature average *</li> <li>■ Temperature</li> <li>■ Concentration *</li> </ul>
Process variable value	A process variable is selected in the <b>Assign simulation process variable</b> parameter (→ 166).	Enter the simulation value for the selected process variable.	Depends on the process variable selected
Current output 1 to n simulation	–	Switch the simulation of the current output on and off.	<ul style="list-style-type: none"> <li>■ Off</li> <li>■ On</li> </ul>
Value current output 1 to n	In the <b>Current output 1 to n simulation</b> parameter, the <b>On</b> option is selected.	Enter the current value for simulation.	3.59 to 22.5 mA
Frequency output simulation 1 to n	In the <b>Operating mode</b> parameter, the <b>Frequency</b> option is selected.	Switch the simulation of the frequency output on and off.	<ul style="list-style-type: none"> <li>■ Off</li> <li>■ On</li> </ul>
Frequency value 1 to n	In the <b>Frequency output simulation 1 to n</b> parameter, the <b>On</b> option is selected.	Enter the frequency value for the simulation.	0.0 to 12 500.0 Hz
Pulse output simulation 1 to n	In the <b>Operating mode</b> parameter, the <b>Pulse</b> option is selected.	Set and switch off the pulse output simulation.  For <b>Fixed value</b> option: <b>Pulse width</b> parameter (→ 128) defines the pulse width of the pulses output.	<ul style="list-style-type: none"> <li>■ Off</li> <li>■ Fixed value</li> <li>■ Down-counting value</li> </ul>
Pulse value 1 to n	In the <b>Pulse output simulation 1 to n</b> parameter, the <b>Down-counting value</b> option is selected.	Enter the number of pulses for simulation.	0 to 65 535

Parameter	Prerequisite	Description	Selection / User entry
Switch output simulation 1 to n	In the <b>Operating mode</b> parameter, the <b>Switch</b> option is selected.	Switch the simulation of the switch output on and off.	<ul style="list-style-type: none"> <li>▪ Off</li> <li>▪ On</li> </ul>
Switch status 1 to n	–	Select the status of the status output for the simulation.	<ul style="list-style-type: none"> <li>▪ Open</li> <li>▪ Closed</li> </ul>
Relay output 1 to n simulation	–	Switch simulation of the relay output on and off.	<ul style="list-style-type: none"> <li>▪ Off</li> <li>▪ On</li> </ul>
Switch status 1 to n	The <b>On</b> option is selected in the <b>Switch output simulation 1 to n</b> parameter parameter.	Select status of the relay output for the simulation.	<ul style="list-style-type: none"> <li>▪ Open</li> <li>▪ Closed</li> </ul>
Device alarm simulation	–	Switch the device alarm on and off.	<ul style="list-style-type: none"> <li>▪ Off</li> <li>▪ On</li> </ul>
Diagnostic event category	–	Select a diagnostic event category.	<ul style="list-style-type: none"> <li>▪ Sensor</li> <li>▪ Electronics</li> <li>▪ Configuration</li> <li>▪ Process</li> </ul>
Diagnostic event simulation	–	Select a diagnostic event to simulate this event.	<ul style="list-style-type: none"> <li>▪ Off</li> <li>▪ Diagnostic event picklist (depends on the category selected)</li> </ul>
Current input 1 to n simulation	–	Switch simulation of the current input on and off.	<ul style="list-style-type: none"> <li>▪ Off</li> <li>▪ On</li> </ul>
Value current input 1 to n	In the <b>Current input 1 to n simulation</b> parameter, the <b>On</b> option is selected.	Enter the current value for simulation.	0 to 22.5 mA
Status input simulation	–	Switch simulation of the status input on and off.	<ul style="list-style-type: none"> <li>▪ Off</li> <li>▪ On</li> </ul>
Input signal level	In the <b>Status input simulation</b> parameter, the <b>On</b> option is selected.	Select the signal level for the simulation of the status input.	<ul style="list-style-type: none"> <li>▪ High</li> <li>▪ Low</li> </ul>

\* Visibility depends on order options or device settings

## 10.8 Protecting settings from unauthorized access

The following write protection options exist in order to protect the configuration of the measuring device from unintentional modification:

- Protect access to parameters via access code →  167
- Protect access to local operation via key locking →  83
- Protect access to measuring device via write protection switch →  169







### 10.8.1 Write protection via access code

The effects of the user-specific access code are as follows:

- Via local operation, the parameters for the measuring device configuration are write-protected and their values can no longer be changed.
- Device access is protected via the Web browser, as are the parameters for the measuring device configuration.
- Device access is protected via FieldCare or DeviceCare (via CDI-RJ45 service interface), as are the parameters for the measuring device configuration.

#### Defining the access code via the local display

1. Navigate to the **Define access code** parameter (→  163).
2. Maximum of 16-digit character string comprising numbers, letters and special characters as the access code.



3. Enter the access code again in the **Confirm access code** parameter (→  163) to confirm.
    - ↳ The  symbol appears in front of all write-protected parameters.
- 
    - Disabling parameter write protection via access code →  82.
    - If the access code is lost: Resetting the access code →  168.
    - The user role with which the user is currently logged in is displayed in **Access status** parameter.
      - Navigation path: Operation → Access status
      - User roles and their access rights →  82
  - The device automatically locks the write-protected parameters again if a key is not pressed for 10 minutes in the navigation and editing view.
  - The device locks the write-protected parameters automatically after 60 s if the user skips back to the operational display mode from the navigation and editing view.



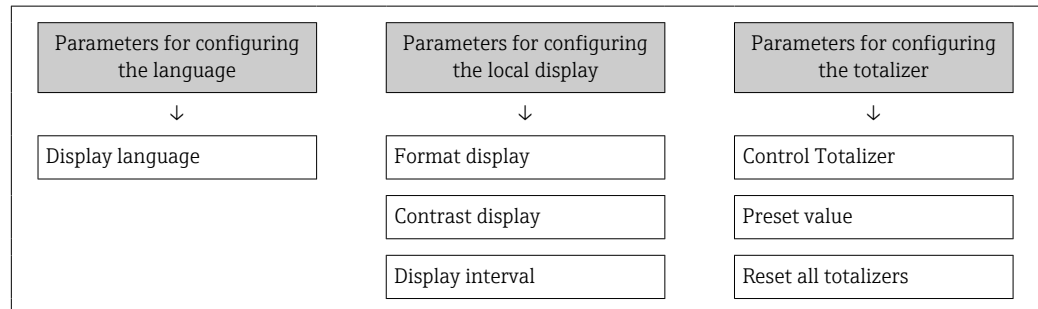

### Parameters which can always be modified via the local display

Certain parameters that do not affect the measurement are excepted from parameter write protection via the local display. Despite the user-specific access code, they can always be modified, even if the other parameters are locked.



### Defining the access code via the web browser

1. Navigate to the **Define access code** parameter (→  163).
2. Define a 16-digit (max.) numeric code as the access code.
3. Enter the access code again in the **Confirm access code** parameter (→  163) to confirm.
  - ↳ The web browser switches to the login page.

- 
  - Disabling parameter write protection via access code →  82.
  - If the access code is lost: Resetting the access code →  168.
  - The **Access status** parameter shows which user role the user is currently logged in with.
    - Navigation path: Operation → Access status
    - User roles and their access rights →  82

If no action is performed for 10 minutes, the web browser automatically returns to the login page.

### Resetting the access code

If you misplace the user-specific access code, it is possible to reset the code to the factory setting. A reset code must be entered for this purpose. The user-specific access code can then be defined again afterwards.



Via Web browser, FieldCare, DeviceCare (via CDI-RJ45 service interface), fieldbus

**i** You can only obtain a reset code from your local Endress+Hauser service organization. The code must be calculated explicitly for every device.

1. Note down the serial number of the device.
2. Read off the **Operating time** parameter.
3. Contact the local Endress+Hauser service organization and tell them the serial number and the operating time.
  - ↳ Get the calculated reset code.
4. Enter the reset code in the **Reset access code** parameter (→ 164).
  - ↳ The access code has been reset to the factory setting **0000**. It can be redefined → 167.

**i** For IT security reasons, the calculated reset code is only valid for 96 hours from the specified operating time and for the specific serial number. If you cannot return to the device within 96 hours, you should either increase the operating time you read out by a few days or switch off the device.

### 10.8.2 Write protection via write protection switch

Unlike parameter write protection via a user-specific access code, this allows the user to lock write access to the entire operating menu - apart from the **"Contrast display" parameter**.

The parameter values are now read only and cannot be edited any more (exception **"Contrast display" parameter**):

- Via local display
- Via EtherNet/IP protocol

#### Proline 500 – digital

##### Enable/disable write protection

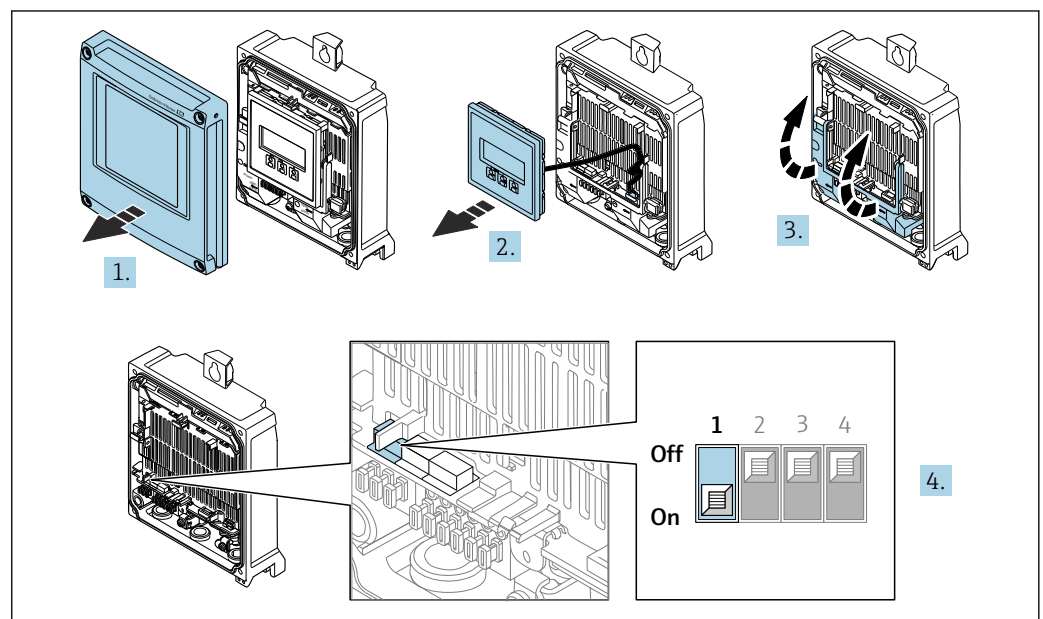

1. Open the housing cover.
2. Remove the display module.
3. Fold open the terminal cover.

A0029673

**4. Enable or disable write protection:**

Setting the write protection (WP) switch on the main electronics module to the **ON** position enables hardware write protection/setting to **OFF** (factory setting) disables hardware write protection.

- ↳ In the **Locking status** parameter, the **Hardware locked** option is displayed → 171. When hardware write protection is enabled, the  symbol appears in the header of the measured value display and in the navigation view in front of the parameters.

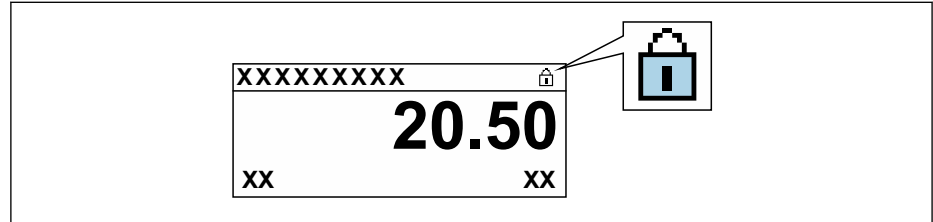

A0029425

5. Insert the display module.

6. Close the housing cover.

**7. NOTICE**

**Excessive tightening torque applied to the fixing screws!**

Risk of damaging the plastic transmitter.

- ▶ Tighten the fixing screws as per the tightening torque: 2.5 Nm (1.8 lbf ft)

Tighten the fixing screws.

**Proline 500**

1.

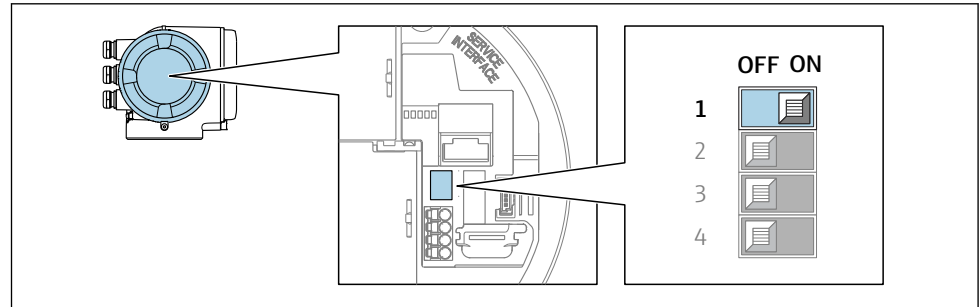

A0029630

Setting the write protection (WP) switch on the main electronics module to the **ON** position enables hardware write protection.

- ↳ In the **Locking status** parameter, the **Hardware locked** option is displayed → 171. In addition, on the local display the  symbol appears in front of the parameters in the header of the operational display and in the navigation view.

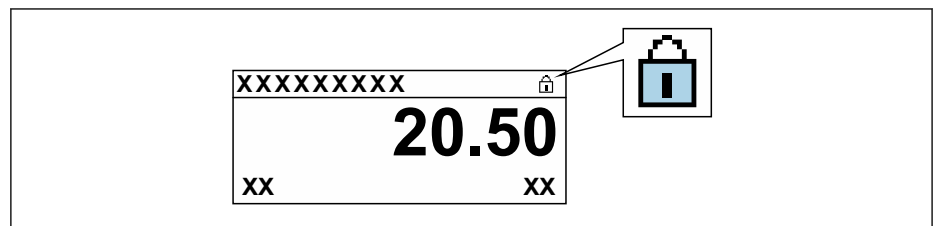

A0029425

2. Setting the write protection (WP) switch on the main electronics module to the **OFF** position (factory setting) disables hardware write protection.

- ↳ No option is displayed in the **Locking status** parameter → 171. On the local display, the  symbol disappears from in front of the parameters in the header of the operational display and in the navigation view.



# 11 Operation

## 11.1 Reading off the device locking status

Device active write protection: **Locking status** parameter



Operation → Locking status

*Function scope of the "Locking status" parameter*

Options	Description
None	The access authorization displayed in the <b>Access status</b> parameter applies →  82. Only appears on local display.
Hardware locked	The DIP switch for hardware locking is activated on the PCB board. This locks write access to the parameters (e.g. via local display or operating tool) →  169.
Temporarily locked	Write access to the parameters is temporarily locked on account of internal processes running in the device (e.g. data upload/download, reset, etc.). Once the internal processing has been completed, the parameters can be changed once again.



## 11.2 Adjusting the operating language

 Detailed information:

- To configure the operating language →  114
- For information on the operating languages supported by the measuring device →  252

## 11.3 Configuring the display

Detailed information:





- On the basic settings for the local display →  138
- On the advanced settings for the local display →  155

## 11.4 Reading off measured values

With the **Measured values** submenu, it is possible to read all the measured values.

### Navigation

"Diagnostics" menu → Measured values





















▶ Measured values	
▶ Measured variables	→  172
▶ Input values	→  182
▶ Output values	→  184
▶ Totalizer	→  182

### 11.4.1 "Measured variables" submenu

The **Measured variables** submenu contains all the parameters needed to display the current measured values for each process variable.









#### Navigation











"Diagnostics" menu → Measured values → Measured variables





► Measured variables	
Mass flow	→  174
Volume flow	→  174
Corrected volume flow	→  174
Density	→  174
Reference density	→  174
Temperature	→  174
Pressure	→  174
Concentration	→  174
Target mass flow	→  175
Carrier mass flow	→  175
Target corrected volume flow	→  175
Carrier corrected volume flow	→  175
Target volume flow	→  175
Carrier volume flow	→  176
CTL	→  176
CPL	→  176
CTPL	→  176
S&W volume flow	→  177
S&W correction value	→  177
Reference density alternative	→  177

GSV flow	→ 177
GSV flow alternative	→ 177
NSV flow	→ 178
NSV flow alternative	→ 178
Oil CTL	→ 178
Oil CPL	→ 178
Oil CTPL	→ 178
Water CTL	→ 179
CTL alternative	→ 179
CPL alternative	→ 179
CTPL alternative	→ 179
Oil reference density	→ 179
Water reference density	→ 180
Oil density	→ 180
Water density	→ 180
Water cut	→ 180
Oil volume flow	→ 180
Oil corrected volume flow	→ 181
Oil mass flow	→ 181
Water volume flow	→ 181
Water corrected volume flow	→ 181
Water mass flow	→ 181
Weighted density average	→ 182
Weighted temperature average	→ 182





## Parameter overview with brief description





Parameter	Prerequisite	Description	User interface	Factory setting
Mass flow	–	Displays the mass flow that is currently measured. <i>Dependency</i> The unit is taken from: <b>Mass flow unit</b> parameter (→  117)	Signed floating-point number	–
Volume flow	–	Displays the volume flow that is currently calculated. <i>Dependency</i> The unit is taken from the <b>Volume flow unit</b> parameter (→  117).	Signed floating-point number	–
Corrected volume flow	–	Displays the corrected volume flow that is currently calculated. <i>Dependency</i> The unit is taken from: <b>Corrected volume flow unit</b> parameter (→  117)	Signed floating-point number	–
Density	–	Shows the density currently measured. <i>Dependency</i> The unit is taken from the <b>Density unit</b> parameter (→  117).	Signed floating-point number	–
Reference density	–	Displays the reference density that is currently calculated. <i>Dependency</i> The unit is taken from: <b>Reference density unit</b> parameter (→  118)	Signed floating-point number	–
Temperature	–	Shows the medium temperature currently measured. <i>Dependency</i> The unit is taken from: <b>Temperature unit</b> parameter (→  118)	Signed floating-point number	–
Pressure value	–	Displays either a fixed or external pressure value. <i>Dependency</i> The unit is taken from the <b>Pressure unit</b> parameter (→  118).	Signed floating-point number	–
Concentration	For the following order code: Order code for "Application package", option <b>ED</b> "Concentration"  The software options currently enabled are displayed in the <b>Software option overview</b> parameter.	Displays the concentration that is currently calculated. <i>Dependency</i> The unit is taken from the <b>Concentration unit</b> parameter.	Signed floating-point number	–





Parameter	Prerequisite	Description	User interface	Factory setting
Target mass flow	<p>With the following conditions: Order code for "Application package", option <b>ED</b> "Concentration"</p> <p> The software options currently enabled are displayed in the <b>Software option overview</b> parameter.</p>	<p>Displays the mass flow that is currently measured for the target medium.</p> <p><i>Dependency</i> The unit is taken from: <b>Mass flow unit</b> parameter (→  117)</p>	Signed floating-point number	–
Carrier mass flow	<p>With the following conditions: Order code for "Application package", option <b>ED</b> "Concentration"</p> <p> The software options currently enabled are displayed in the <b>Software option overview</b> parameter.</p>	<p>Displays the mass flow of the carrier medium that is currently measured.</p> <p><i>Dependency</i> The unit is taken from: <b>Mass flow unit</b> parameter (→  117)</p>	Signed floating-point number	–
Target corrected volume flow	<p>With the following conditions:</p> <ul style="list-style-type: none"> <li>▪ Order code for "Application package", option <b>ED</b> "Concentration"</li> <li>▪ The <b>Ethanol in water</b> option or <b>%mass / %volume</b> option is selected in the <b>Liquid type</b> parameter.</li> </ul> <p> The software options currently enabled are displayed in the <b>Software option overview</b> parameter.</p>	<p>Displays the corrected volume flow that is currently measured for the target fluid.</p> <p><i>Dependency</i> The unit is taken from the <b>Volume flow unit</b> parameter (→  117).</p>	Signed floating-point number	–
Carrier corrected volume flow	<p>With the following conditions:</p> <ul style="list-style-type: none"> <li>▪ Order code for "Application package", option <b>ED</b> "Concentration"</li> <li>▪ In the <b>Liquid type</b> parameter, the <b>Ethanol in water</b> option or <b>%mass / %volume</b> option is selected.</li> </ul> <p> The software options currently enabled are displayed in the <b>Software option overview</b> parameter.</p>	<p>Displays the corrected volume flow currently measured for the carrier fluid.</p> <p><i>Dependency</i> The unit is taken from the <b>Volume flow unit</b> parameter (→  117).</p>	Signed floating-point number	–
Target volume flow	<p>With the following conditions:</p> <ul style="list-style-type: none"> <li>▪ Order code for "Application package", option <b>ED</b> "Concentration"</li> <li>▪ The <b>Ethanol in water</b> option or <b>%mass / %volume</b> option is selected in the <b>Liquid type</b> parameter.</li> <li>▪ The <b>%vol</b> option is selected in the <b>Concentration unit</b> parameter.</li> </ul> <p> The software options currently enabled are displayed in the <b>Software option overview</b> parameter.</p>	<p>Displays the volume flow currently measured for the target medium.</p> <p><i>Dependency</i> The unit is taken from the <b>Volume flow unit</b> parameter (→  117).</p>	Signed floating-point number	–





Parameter	Prerequisite	Description	User interface	Factory setting
Carrier volume flow	<p>With the following conditions:</p> <ul style="list-style-type: none"> <li>▪ Order code for "Application package", option <b>ED</b> "Concentration"</li> <li>▪ The <b>Ethanol in water</b> option or <b>%mass / %volume</b> option is selected in the <b>Liquid type</b> parameter.</li> <li>▪ The <b>%vol</b> option is selected in the <b>Concentration unit</b> parameter.</li> </ul> <p> The software options currently enabled are displayed in the <b>Software option overview</b> parameter.</p>	<p>Displays the volume flow currently measured for the carrier medium.</p> <p><i>Dependency</i> The unit is taken from the <b>Volume flow unit</b> parameter (→  117).</p>	Signed floating-point number	–
CTL	<p>For the following order code:</p> <ul style="list-style-type: none"> <li>▪ "Application package", option EJ "Petroleum"</li> <li>▪ The <b>API referenced correction</b> option is selected in <b>Petroleum mode</b> parameter.</li> </ul> <p> The software options currently enabled are displayed in the <b>Software option overview</b> parameter.</p>	<p>Displays the calibration factor which represents the effect of temperature on the fluid. This is used to convert the measured volume flow and the measured density to values at reference temperature.</p>	Positive floating-point number	–
CPL	<p>For the following order code:</p> <ul style="list-style-type: none"> <li>▪ "Application package", option EJ "Petroleum"</li> <li>▪ The <b>API referenced correction</b> option is selected in <b>Petroleum mode</b> parameter.</li> </ul> <p> The software options currently enabled are displayed in the <b>Software option overview</b> parameter.</p>	<p>Displays the calibration factor which represents the effect of pressure on the fluid. This is used to convert the measured volume flow and the measured density to values at reference pressure.</p>	Positive floating-point number	–
CTPL	<p>For the following order code:</p> <ul style="list-style-type: none"> <li>▪ "Application package", option EJ "Petroleum"</li> <li>▪ The <b>API referenced correction</b> option is selected in <b>Petroleum mode</b> parameter.</li> </ul> <p> The software options currently enabled are displayed in the <b>Software option overview</b> parameter.</p>	<p>Displays the combined calibration factor which represents the effect of temperature and pressure on the fluid. This is used to convert the measured volume flow and the measured density to values at reference temperature and reference pressure.</p>	Positive floating-point number	–









Parameter	Prerequisite	Description	User interface	Factory setting
S&W volume flow	<p>For the following order code:</p> <ul style="list-style-type: none"> <li>▪ "Application package", option EJ "Petroleum"</li> <li>▪ The <b>API referenced correction</b> option is selected in <b>Petroleum mode</b> parameter.</li> </ul> <p> The software options currently enabled are displayed in the <b>Software option overview</b> parameter.</p>	<p>Displays the S&amp;W volume flow which is calculated from the measured total volume flow minus the net volume flow.</p> <p><i>Dependency</i> The unit is taken from: <b>Volume flow unit</b> parameter</p>	Signed floating-point number	–
S&W correction value	<p>For the following order code:</p> <ul style="list-style-type: none"> <li>▪ "Application package", option EJ "Petroleum"</li> <li>▪ The <b>External value</b> option or <b>Current input 1...n</b> option is selected in the <b>S&amp;W input mode</b> parameter.</li> </ul> <p> The software options currently enabled are displayed in the <b>Software option overview</b> parameter.</p>	Shows the correction value for sediment and water.	Positive floating-point number	–
Reference density alternative	<p>For the following order code:</p> <ul style="list-style-type: none"> <li>▪ "Application package", option EJ "Petroleum"</li> <li>▪ In the <b>Petroleum mode</b> parameter, the <b>API referenced correction</b> option is selected.</li> </ul> <p> The software options currently enabled are displayed in the <b>Software option overview</b> parameter.</p>	<p>Displays the fluid density at the alternative reference temperature.</p> <p><i>Dependency</i> The unit is taken from: <b>Reference density unit</b> parameter</p>	Signed floating-point number	–
GSV flow	<p>For the following order code:</p> <ul style="list-style-type: none"> <li>▪ "Application package", option EJ "Petroleum"</li> <li>▪ The <b>API referenced correction</b> option is selected in <b>Petroleum mode</b> parameter.</li> </ul> <p> The software options currently enabled are displayed in the <b>Software option overview</b> parameter.</p>	<p>Displays the measured total volume flow, corrected to the reference temperature and the reference pressure.</p> <p><i>Dependency</i> The unit is taken from: <b>Corrected volume flow unit</b> parameter</p>	Signed floating-point number	–
GSV flow alternative	<p>For the following order code:</p> <ul style="list-style-type: none"> <li>▪ "Application package", option EJ "Petroleum"</li> <li>▪ In the <b>Petroleum mode</b> parameter, the <b>API referenced correction</b> option is selected.</li> </ul> <p> The software options currently enabled are displayed in the <b>Software option overview</b> parameter.</p>	<p>Displays the measured total volume flow, corrected to the alternative reference temperature and the alternative reference pressure.</p> <p><i>Dependency</i> The unit is taken from: <b>Corrected volume flow unit</b> parameter</p>	Signed floating-point number	–

Parameter	Prerequisite	Description	User interface	Factory setting
NSV flow	<p>For the following order code:</p> <ul style="list-style-type: none"> <li>▪ "Application package", option EJ "Petroleum"</li> <li>▪ The <b>API referenced correction</b> option is selected in <b>Petroleum mode</b> parameter.</li> </ul> <p> The software options currently enabled are displayed in the <b>Software option overview</b> parameter.</p>	<p>Displays the net volume flow which is calculated from the measured total volume flow minus the value for sediment &amp; water and minus the shrinkage.</p> <p><i>Dependency</i> The unit is taken from: <b>Corrected volume flow unit</b> parameter</p>	Signed floating-point number	-
NSV flow alternative	<p>For the following order code:</p> <ul style="list-style-type: none"> <li>▪ "Application package", option EJ "Petroleum"</li> <li>▪ In the <b>Petroleum mode</b> parameter, the <b>API referenced correction</b> option is selected.</li> </ul> <p> The software options currently enabled are displayed in the <b>Software option overview</b> parameter.</p>	<p>Displays the net volume flow which is calculated from the measured alternative total volume minus the value for sediment &amp; water and minus the shrinkage.</p> <p><i>Dependency</i> The unit is taken from: <b>Corrected volume flow unit</b> parameter</p>	Signed floating-point number	-
Oil CTL	<p>For the following order code:</p> <ul style="list-style-type: none"> <li>▪ "Application package", option EJ "Petroleum"</li> <li>▪ In the <b>Petroleum mode</b> parameter, the <b>Net oil &amp; water cut</b> option is selected.</li> </ul> <p> The software options currently enabled are displayed in the <b>Software option overview</b> parameter.</p>	<p>Displays the correction factor which represents the effect of temperature on the oil. This is used to convert the measured oil volume flow and the measured oil density to values at reference temperature.</p>	Positive floating-point number	-
Oil CPL	<p>For the following order code:</p> <ul style="list-style-type: none"> <li>▪ "Application package", option EJ "Petroleum"</li> <li>▪ In the <b>Petroleum mode</b> parameter, the <b>Net oil &amp; water cut</b> option is selected.</li> </ul> <p> The software options currently enabled are displayed in the <b>Software option overview</b> parameter.</p>	<p>Displays the correction factor which represents the effect of pressure on the oil. This is used to convert the measured oil volume flow and the measured oil density to values at reference pressure.</p>	Positive floating-point number	-
Oil CTPL	<p>For the following order code:</p> <ul style="list-style-type: none"> <li>▪ "Application package", option EJ "Petroleum"</li> <li>▪ In the <b>Petroleum mode</b> parameter, the <b>Net oil &amp; water cut</b> option is selected.</li> </ul> <p> The software options currently enabled are displayed in the <b>Software option overview</b> parameter.</p>	<p>Displays the combined correction factor which represents the effect of temperature and pressure on the oil. This is used to convert the measured oil volume flow and the measured oil density to values at reference temperature and reference pressure.</p>	Positive floating-point number	-

Parameter	Prerequisite	Description	User interface	Factory setting
Water CTL	<p>For the following order code:</p> <ul style="list-style-type: none"> <li>▪ "Application package", option <b>EJ</b> "Petroleum"</li> <li>▪ In the <b>Petroleum mode</b> parameter, the <b>Net oil &amp; water cut</b> option is selected.</li> </ul> <p> The software options currently enabled are displayed in the <b>Software option overview</b> parameter.</p>	Displays the correction factor which represents the effect of temperature on the water. This is used to convert the measured water volume flow and the measured water density to values at reference temperature.	Positive floating-point number	–
CTL alternative	<p>For the following order code:</p> <ul style="list-style-type: none"> <li>▪ "Application package", option <b>EJ</b> "Petroleum"</li> <li>▪ In the <b>Petroleum mode</b> parameter, the <b>API referenced correction</b> option is selected.</li> </ul> <p> The software options currently enabled are displayed in the <b>Software option overview</b> parameter.</p>	Displays the correction factor which represents the effect of temperature on the fluid. This is used to convert the measured volume flow and the measured density to values at the alternative reference temperature.	Positive floating-point number	–
CPL alternative	<p>For the following order code:</p> <ul style="list-style-type: none"> <li>▪ "Application package", option <b>EJ</b> "Petroleum"</li> <li>▪ In the <b>Petroleum mode</b> parameter, the <b>API referenced correction</b> option is selected.</li> </ul> <p> The software options currently enabled are displayed in the <b>Software option overview</b> parameter.</p>	Displays the correction factor which represents the effect of pressure on the fluid. This is used to convert the measured volume flow and the measured density to values at the alternative reference pressure.	Positive floating-point number	–
CTPL alternative	<p>For the following order code:</p> <ul style="list-style-type: none"> <li>▪ "Application package", option <b>EJ</b> "Petroleum"</li> <li>▪ In the <b>Petroleum mode</b> parameter, the <b>API referenced correction</b> option is selected.</li> </ul> <p> The software options currently enabled are displayed in the <b>Software option overview</b> parameter.</p>	Displays the combined correction factor which represents the effect of temperature and pressure on the fluid. This is used to convert the measured volume flow and the measured density to values at the alternative reference temperature and the alternative reference pressure.	Positive floating-point number	–
Oil reference density	<p>For the following order code:</p> <ul style="list-style-type: none"> <li>▪ "Application package", option <b>EJ</b> "Petroleum"</li> <li>▪ In the <b>Petroleum mode</b> parameter, the <b>Net oil &amp; water cut</b> option is selected.</li> </ul> <p> The software options currently enabled are displayed in the <b>Software option overview</b> parameter.</p>		Signed floating-point number	–

Parameter	Prerequisite	Description	User interface	Factory setting
Water reference density unit	<p>For the following order code:</p> <ul style="list-style-type: none"> <li>▪ "Application package", option <b>EJ</b> "Petroleum"</li> <li>▪ In the <b>Petroleum mode</b> parameter, the <b>Net oil &amp; water cut</b> option is selected.</li> </ul> <p> The software options currently enabled are displayed in the <b>Software option overview</b> parameter.</p>		Signed floating-point number	-
Oil density	<p>For the following order code:</p> <ul style="list-style-type: none"> <li>▪ "Application package", option <b>EJ</b> "Petroleum"</li> <li>▪ In the <b>Petroleum mode</b> parameter, the <b>Net oil &amp; water cut</b> option is selected.</li> </ul> <p> The software options currently enabled are displayed in the <b>Software option overview</b> parameter.</p>	Displays the density of the oil currently measured.	Signed floating-point number	-
Water density	<p>For the following order code:</p> <ul style="list-style-type: none"> <li>▪ "Application package", option <b>EJ</b> "Petroleum"</li> <li>▪ In the <b>Petroleum mode</b> parameter, the <b>Net oil &amp; water cut</b> option is selected.</li> </ul> <p> The software options currently enabled are displayed in the <b>Software option overview</b> parameter.</p>	Displays the density of the water currently measured.	Signed floating-point number	-
Water cut	<p>For the following order code:</p> <ul style="list-style-type: none"> <li>▪ "Application package", option <b>EJ</b> "Petroleum"</li> <li>▪ In the <b>Petroleum mode</b> parameter, the <b>API referenced correction</b> option is selected.</li> </ul> <p> The software options currently enabled are displayed in the <b>Software option overview</b> parameter.</p>	Displays the percentage water volume flow in relation to the total volume flow of the fluid.	0 to 100 %	-
Oil volume flow	<p>For the following order code:</p> <ul style="list-style-type: none"> <li>▪ "Application package", option <b>EJ</b> "Petroleum"</li> <li>▪ In the <b>Petroleum mode</b> parameter, the <b>Net oil &amp; water cut</b> option is selected.</li> </ul> <p> The software options currently enabled are displayed in the <b>Software option overview</b> parameter.</p>	<p>Displays the currently calculated volume flow of the oil.</p> <p>Dependency:</p> <ul style="list-style-type: none"> <li>▪ Based on the value displayed in the <b>Water cut</b> parameter</li> <li>▪ The unit is taken from: <b>Volume flow unit</b> parameter</li> </ul>	Signed floating-point number	-

Parameter	Prerequisite	Description	User interface	Factory setting
Oil corrected volume flow	<p>For the following order code:</p> <ul style="list-style-type: none"> <li>▪ "Application package", option EJ "Petroleum"</li> <li>▪ In the <b>Petroleum mode</b> parameter, the <b>Net oil &amp; water cut</b> option is selected.</li> </ul> <p> The software options currently enabled are displayed in the <b>Software option overview</b> parameter.</p>	<p>Displays the currently calculated volume flow of the oil, calculated to values at reference temperature and reference pressure.</p> <p>Dependency:</p> <ul style="list-style-type: none"> <li>▪ Based on the value displayed in the <b>Water cut</b> parameter</li> <li>▪ The unit is taken from: <b>Corrected volume flow unit</b> parameter</li> </ul>	Signed floating-point number	–
Oil mass flow	<p>For the following order code:</p> <ul style="list-style-type: none"> <li>▪ "Application package", option EJ "Petroleum"</li> <li>▪ In the <b>Petroleum mode</b> parameter, the <b>Net oil &amp; water cut</b> option is selected.</li> </ul> <p> The software options currently enabled are displayed in the <b>Software option overview</b> parameter.</p>	<p>Displays the currently calculated mass flow of the oil.</p> <p>Dependency:</p> <ul style="list-style-type: none"> <li>▪ Based on the value displayed in the <b>Water cut</b> parameter</li> <li>▪ The unit is taken from: <b>Mass flow unit</b> parameter</li> </ul>	Signed floating-point number	–
Water volume flow	<p>For the following order code:</p> <ul style="list-style-type: none"> <li>▪ "Application package", option EJ "Petroleum"</li> <li>▪ In the <b>Petroleum mode</b> parameter, the <b>Net oil &amp; water cut</b> option is selected.</li> </ul> <p> The software options currently enabled are displayed in the <b>Software option overview</b> parameter.</p>	<p>Displays the currently calculated volume flow of the water.</p> <p>Dependency:</p> <ul style="list-style-type: none"> <li>▪ Based on the value displayed in the <b>Water cut</b> parameter</li> <li>▪ The unit is taken from: <b>Volume flow unit</b> parameter</li> </ul>	Signed floating-point number	–
Water corrected volume flow	<p>For the following order code:</p> <ul style="list-style-type: none"> <li>▪ "Application package", option EJ "Petroleum"</li> <li>▪ In the <b>Petroleum mode</b> parameter, the <b>Net oil &amp; water cut</b> option is selected.</li> </ul> <p> The software options currently enabled are displayed in the <b>Software option overview</b> parameter.</p>	<p>Displays the currently calculated volume flow of the water, calculated to values at reference temperature and reference pressure.</p> <p>Dependency:</p> <ul style="list-style-type: none"> <li>▪ Based on the value displayed in the <b>Water cut</b> parameter</li> <li>▪ The unit is taken from: <b>Corrected volume flow unit</b> parameter</li> </ul>	Signed floating-point number	–
Water mass flow	<p>For the following order code:</p> <ul style="list-style-type: none"> <li>▪ "Application package", option EJ "Petroleum"</li> <li>▪ In the <b>Petroleum mode</b> parameter, the <b>Net oil &amp; water cut</b> option is selected.</li> </ul> <p> The software options currently enabled are displayed in the <b>Software option overview</b> parameter.</p>	<p>Displays the currently calculated mass flow of the water.</p> <p>Dependency:</p> <ul style="list-style-type: none"> <li>▪ Based on the value displayed in the <b>Water cut</b> parameter</li> <li>▪ The unit is taken from: <b>Mass flow unit</b> parameter</li> </ul>	Signed floating-point number	–

Parameter	Prerequisite	Description	User interface	Factory setting
Weighted density average	For the following order code: <ul style="list-style-type: none"> <li>▪ "Application package", option <b>EJ</b> "Petroleum"</li> <li>▪ "Application package", option <b>EM</b> "Petroleum + Locking function"</li> </ul>  The software options currently enabled are displayed in the <b>Software option overview</b> parameter.	Displays the weighted average for the density since the last time the density averages were reset. Dependency: <ul style="list-style-type: none"> <li>▪ The unit is taken from: <b>Density unit</b> parameter</li> <li>▪ The value is reset to NaN (Not a Number) via the <b>Reset weighted averages</b> parameter</li> </ul>	Signed floating-point number	-
Weighted temperature average	For the following order code: <ul style="list-style-type: none"> <li>▪ "Application package", option <b>EJ</b> "Petroleum"</li> <li>▪ "Application package", option <b>EM</b> "Petroleum + Locking function"</li> </ul>  The software options currently enabled are displayed in the <b>Software option overview</b> parameter.	Displays the weighted average for the temperature since the last time the temperature averages were reset. Dependency: <ul style="list-style-type: none"> <li>▪ The unit is taken from: <b>Temperature unit</b> parameter</li> <li>▪ The value is reset to NaN (Not a Number) via the <b>Reset weighted averages</b> parameter</li> </ul>	Signed floating-point number	-

### 11.4.2 "Totalizer" submenu



The **Totalizer** submenu contains all the parameters needed to display the current measured values for every totalizer.

#### Navigation

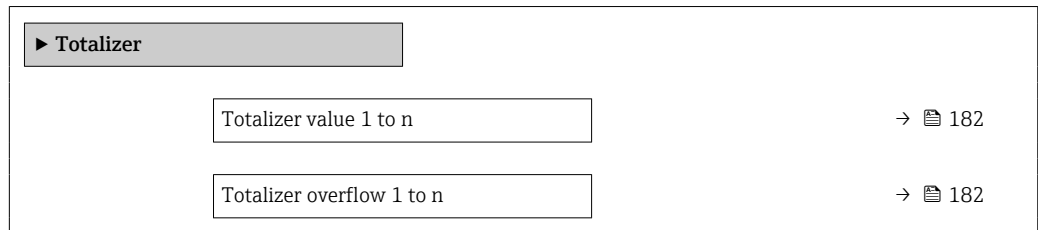
"Diagnostics" menu → Measured values → Totalizer



#### Parameter overview with brief description

Parameter	Prerequisite	Description	User interface
Totalizer value 1 to n	A process variable is selected in the <b>Assign process variable</b> parameter (→  154) of the <b>Totalizer 1 to n</b> submenu.	Displays the current totalizer counter value.	Signed floating-point number
Totalizer overflow 1 to n	A process variable is selected in the <b>Assign process variable</b> parameter (→  154) of the <b>Totalizer 1 to n</b> submenu.	Displays the current totalizer overflow.	Integer with sign

### 11.4.3 "Input values" submenu

The **Input values** submenu guides you systematically to the individual input values.

**Navigation**

"Diagnostics" menu → Measured values → Input values

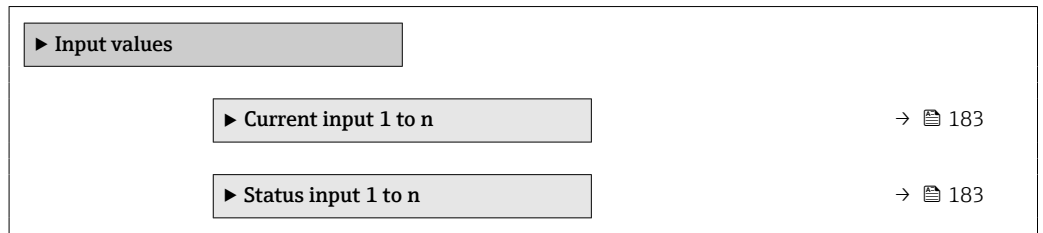

**Input values of current input**

The **Current input 1 to n** submenu contains all the parameters needed to display the current measured values for every current input.

**Navigation**

"Diagnostics" menu → Measured values → Input values → Current input 1 to n

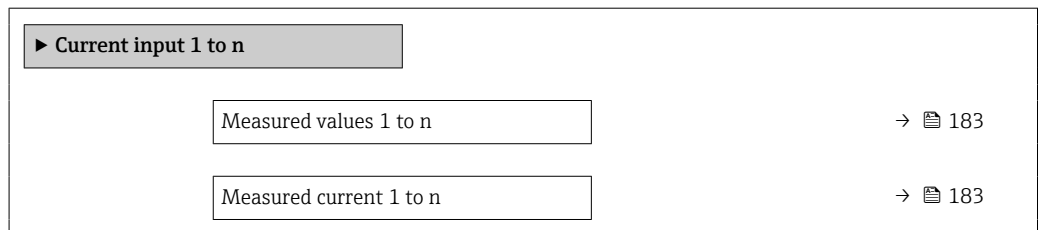

**Parameter overview with brief description**

Parameter	Description	User interface
Measured values 1 to n	Displays the current input value.	Signed floating-point number
Measured current 1 to n	Displays the current value of the current input.	0 to 22.5 mA

**Input values of status input**

The **Status input 1 to n** submenu contains all the parameters needed to display the current measured values for every status input.

**Navigation**

"Diagnostics" menu → Measured values → Input values → Status input 1 to n

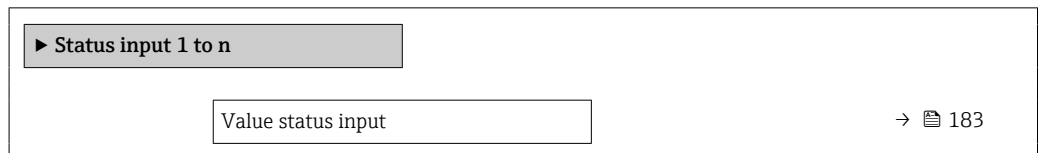

**Parameter overview with brief description**

Parameter	Description	User interface
Value status input	Shows the current input signal level.	<ul style="list-style-type: none"> <li>■ High</li> <li>■ Low</li> </ul>

### 11.4.4 Output values

The **Output values** submenu contains all the parameters needed to display the current measured values for every output.

#### Navigation

"Diagnostics" menu → Measured values → Output values

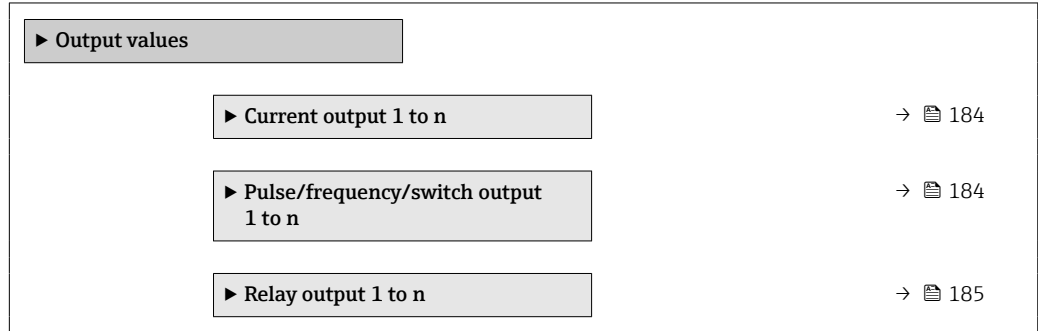

#### Output values of current output

The **Value current output** submenu contains all the parameters needed to display the current measured values for every current output.

#### Navigation

"Diagnostics" menu → Measured values → Output values → Value current output 1 to n

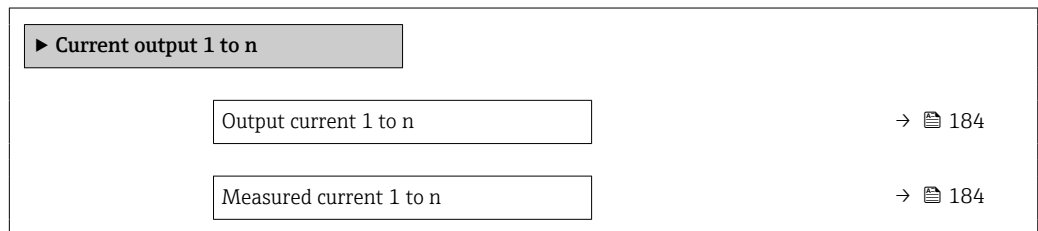

#### Parameter overview with brief description

Parameter	Description	User interface
Output current 1	Displays the current value currently calculated for the current output.	3.59 to 22.5 mA
Measured current	Displays the current value currently measured for the current output.	0 to 30 mA

#### Output values for pulse/frequency/switch output

The **Pulse/frequency/switch output 1 to n** submenu contains all the parameters needed to display the current measured values for every pulse/frequency/switch output.



**Navigation**

"Diagnostics" menu → Measured values → Output values → Pulse/frequency/switch output 1 to n

▶ Pulse/frequency/switch output 1 to n

Output frequency 1 to n	→ ⓘ 185
Pulse output 1 to n	→ ⓘ 185
Switch status 1 to n	→ ⓘ 185

**Parameter overview with brief description**

Parameter	Prerequisite	Description	User interface
Output frequency 1 to n	In the <b>Operating mode</b> parameter, the <b>Frequency</b> option is selected.	Displays the value currently measured for the frequency output.	0.0 to 12 500.0 Hz
Pulse output 1 to n	The <b>Pulse</b> option is selected in the <b>Operating mode</b> parameter parameter.	Displays the pulse frequency currently output.	Positive floating-point number
Switch status 1 to n	The <b>Switch</b> option is selected in the <b>Operating mode</b> parameter.	Displays the current switch output status.	<ul style="list-style-type: none"> <li>■ Open</li> <li>■ Closed</li> </ul>

**Output values for relay output**

The **Relay output 1 to n** submenu contains all the parameters needed to display the current measured values for every relay output.

**Navigation**

"Diagnostics" menu → Measured values → Output values → Relay output 1 to n

▶ Relay output 1 to n

Switch status	→ ⓘ 185
Switch cycles	→ ⓘ 185
Max. switch cycles number	→ ⓘ 185

**Parameter overview with brief description**

Parameter	Description	User interface
Switch status	Shows the current relay switch status.	<ul style="list-style-type: none"> <li>■ Open</li> <li>■ Closed</li> </ul>
Switch cycles	Shows number of all performed switch cycles.	Positive integer
Max. switch cycles number	Shows the maximal number of guaranteed switch cycles.	Positive integer

## 11.5 Adapting the measuring device to the process conditions







The following are available for this purpose:

- Basic settings using the **Setup** menu (→  115)
- Advanced settings using the **Advanced setup** submenu (→  144)





## 11.6 Performing a totalizer reset



### Navigation

"Operation" menu → Totalizer handling

▶ <b>Totalizer handling</b>	
Control Totalizer 1 to n	→  186
Preset value 1 to n	→  186
Totalizer value 1 to n	→  186
Weighted density average	→  187
Weighted temperature average	→  187
Reset weighted averages	→  187
Reset all totalizers	→  187

### Parameter overview with brief description

Parameter	Prerequisite	Description	Selection / User entry / User interface	Factory setting
Control Totalizer 1 to n	A process variable is selected in the <b>Assign process variable</b> parameter (→  154) of the <b>Totalizer 1 to n</b> submenu.	Control totalizer value.	<ul style="list-style-type: none"> <li>▪ Totalize</li> <li>▪ Reset + hold</li> <li>▪ Preset + hold</li> <li>▪ Reset + totalize</li> <li>▪ Preset + totalize</li> <li>▪ Hold</li> </ul>	-
Preset value 1 to n	A process variable is selected in the <b>Assign process variable</b> parameter (→  154) of the <b>Totalizer 1 to n</b> submenu.	Specify start value for totalizer. <i>Dependency</i>  The unit of the selected process variable is defined in the <b>Unit totalizer</b> parameter (→  154) for the totalizer.	Signed floating-point number	Depends on country: <ul style="list-style-type: none"> <li>▪ 0 kg</li> <li>▪ 0 lb</li> </ul>
Totalizer value	A process variable is selected in the <b>Assign process variable</b> parameter (→  154) of the <b>Totalizer 1 to n</b> submenu.	Displays the current totalizer counter value.	Signed floating-point number	-

Parameter	Prerequisite	Description	Selection / User entry / User interface	Factory setting
Weighted density average	<p>For the following order code:</p> <ul style="list-style-type: none"> <li>▪ "Application package", option <b>EJ</b> "Petroleum"</li> <li>▪ "Application package", option <b>EM</b> "Petroleum + Locking function"</li> </ul> <p> The software options currently enabled are displayed in the <b>Software option overview</b> parameter.</p>	<p>Displays the weighted average for the density since the last time the density averages were reset.</p> <p>Dependency:</p> <ul style="list-style-type: none"> <li>▪ The unit is taken from: <b>Density unit</b> parameter</li> <li>▪ The value is reset to NaN (Not a Number) via the <b>Reset weighted averages</b> parameter</li> </ul>	Signed floating-point number	-
Weighted temperature average	<p>For the following order code:</p> <ul style="list-style-type: none"> <li>▪ "Application package", option <b>EJ</b> "Petroleum"</li> <li>▪ "Application package", option <b>EM</b> "Petroleum + Locking function"</li> </ul> <p> The software options currently enabled are displayed in the <b>Software option overview</b> parameter.</p>	<p>Displays the weighted average for the temperature since the last time the temperature averages were reset.</p> <p>Dependency:</p> <ul style="list-style-type: none"> <li>▪ The unit is taken from: <b>Temperature unit</b> parameter</li> <li>▪ The value is reset to NaN (Not a Number) via the <b>Reset weighted averages</b> parameter</li> </ul>	Signed floating-point number	-
Reset weighted averages	<p>The values can only be reset at zero flow.</p> <p>For the following order code: "Application package", option <b>EJ</b> "Petroleum"</p> <p> The software options currently enabled are displayed in the <b>Software option overview</b> parameter.</p>	Resets the weighted averages for density and temperature to NaN (Not a Number) and then starts determining the weighted averages.	<ul style="list-style-type: none"> <li>▪ Totalize</li> <li>▪ Preset + totalize</li> </ul>	-
Reset all totalizers	-	Reset all totalizers to 0 and start.	<ul style="list-style-type: none"> <li>▪ Cancel</li> <li>▪ Reset + totalize</li> </ul>	-

### 11.6.1 Function scope of "Control Totalizer" parameter

Options	Description
Totalize	The totalizer is started or continues running.
Reset + hold	The totaling process is stopped and the totalizer is reset to 0.
Preset + hold <sup>1)</sup>	The totaling process is stopped and the totalizer is set to its defined start value from the <b>Preset value</b> parameter.
Reset + totalize	The totalizer is reset to 0 and the totaling process is restarted.
Preset + totalize <sup>1)</sup>	The totalizer is set to the defined start value in the <b>Preset value</b> parameter and the totaling process is restarted.
Hold	Totalizing is stopped.

1) Visible depending on the order options or device settings

### 11.6.2 Function range of "Reset all totalizers" parameter

Options	Description
Cancel	No action is executed and the user exits the parameter.
Reset + totalize	Resets all totalizers to 0 and restarts the totaling process. This deletes all the previously aggregated flow values.

### 11.7 Displaying the measured value history

The **Extended HistoROM** application package must be enabled in the device (order option) for the **Data logging** submenu to appear. This contains all the parameters for the measured value history.

- i** Data logging is also available via:
  - Plant Asset Management Tool FieldCare → 95.
  - Web browser

#### Function range

- A total of 1000 measured values can be stored
- 4 logging channels
- Adjustable logging interval for data logging
- Measured value trend for each logging channel displayed in the form of a chart

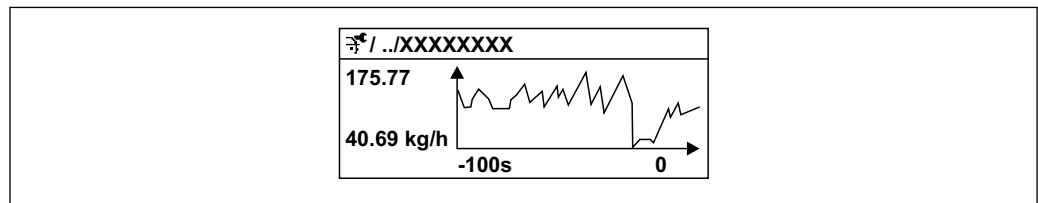

38 Chart of a measured value trend

- x-axis: depending on the number of channels selected displays 250 to 1000 measured values of a process variable.
- y-axis: displays the approximate measured value span and constantly adapts this to the ongoing measurement.

**i** If the length of the logging interval or the assignment of the process variables to the channels is changed, the content of the data logging is deleted.

#### Navigation



"Diagnostics" menu → Data logging





▶ Data logging

Assign channel 1	→ 190
Assign channel 2	→ 190
Assign channel 3	→ 191
Assign channel 4	→ 191
Logging interval	→ 191

Clear logging data	→ 📄 191
Data logging	→ 📄 191
Logging delay	→ 📄 191
Data logging control	→ 📄 191
Data logging status	→ 📄 191
Entire logging duration	→ 📄 191
▶ Display channel 1	
▶ Display channel 2	
▶ Display channel 3	
▶ Display channel 4	

Parameter overview with brief description

Parameter	Prerequisite	Description	Selection / User entry / User interface
Assign channel 1	The <b>Extended HistoROM</b> application package is available.	Assign process variable to logging channel.	<ul style="list-style-type: none"> <li>■ Off</li> <li>■ Mass flow</li> <li>■ Volume flow</li> <li>■ Corrected volume flow *</li> <li>■ Density</li> <li>■ Reference density *</li> <li>■ Temperature</li> <li>■ Oscillation amplitude</li> <li>■ Current output 1</li> <li>■ Current output 2 *</li> <li>■ Current output 3 *</li> <li>■ Current output 4 *</li> <li>■ Pressure</li> <li>■ GSV flow *</li> <li>■ GSV flow alternative *</li> <li>■ NSV flow *</li> <li>■ NSV flow alternative *</li> <li>■ S&amp;W volume flow *</li> <li>■ Reference density alternative *</li> <li>■ Water cut *</li> <li>■ Oil density *</li> <li>■ Water density *</li> <li>■ Oil mass flow *</li> <li>■ Water mass flow *</li> <li>■ Oil volume flow *</li> <li>■ Water volume flow *</li> <li>■ Oil corrected volume flow *</li> <li>■ Water corrected volume flow *</li> <li>■ Concentration *</li> <li>■ Target mass flow *</li> <li>■ Carrier mass flow *</li> <li>■ Target volume flow *</li> <li>■ Carrier volume flow *</li> <li>■ Target corrected volume flow *</li> <li>■ Carrier corrected volume flow *</li> <li>■ Oscillation amplitude</li> <li>■ HBSI *</li> <li>■ Exciter current 0</li> <li>■ Oscillation damping 0</li> <li>■ Oscillation damping fluctuation 0 *</li> <li>■ Oscillation frequency 0</li> <li>■ Oscillation amplitude</li> <li>■ Frequency fluctuation 0 *</li> <li>■ Oscillation amplitude 1 *</li> <li>■ Signal asymmetry</li> <li>■ Electronic temperature</li> </ul>
Assign channel 2	The <b>Extended HistoROM</b> application package is available.  The software options currently enabled are displayed in the <b>Software option overview</b> parameter.	Assign a process variable to logging channel.	For the picklist, see <b>Assign channel 1</b> parameter (→  190)













Parameter	Prerequisite	Description	Selection / User entry / User interface
Assign channel 3	The <b>Extended HistoROM</b> application package is available.  The software options currently enabled are displayed in the <b>Software option overview</b> parameter.	Assign a process variable to logging channel.	For the picklist, see <b>Assign channel 1</b> parameter (→  190)
Assign channel 4	The <b>Extended HistoROM</b> application package is available.  The software options currently enabled are displayed in the <b>Software option overview</b> parameter.	Assign a process variable to logging channel.	For the picklist, see <b>Assign channel 1</b> parameter (→  190)
Logging interval	The <b>Extended HistoROM</b> application package is available.	Define the logging interval for data logging. This value defines the time interval between the individual data points in the memory.	0.1 to 3 600.0 s
Clear logging data	The <b>Extended HistoROM</b> application package is available.	Clear the entire logging data.	<ul style="list-style-type: none"> <li>■ Cancel</li> <li>■ Clear data</li> </ul>
Data logging	–	Select the type of data logging.	<ul style="list-style-type: none"> <li>■ Overwriting</li> <li>■ Not overwriting</li> </ul>
Logging delay	In the <b>Data logging</b> parameter, the <b>Not overwriting</b> option is selected.	Enter the time delay for measured value logging.	0 to 999 h
Data logging control	In the <b>Data logging</b> parameter, the <b>Not overwriting</b> option is selected.	Start and stop measured value logging.	<ul style="list-style-type: none"> <li>■ None</li> <li>■ Delete + start</li> <li>■ Stop</li> </ul>
Data logging status	In the <b>Data logging</b> parameter, the <b>Not overwriting</b> option is selected.	Displays the measured value logging status.	<ul style="list-style-type: none"> <li>■ Done</li> <li>■ Delay active</li> <li>■ Active</li> <li>■ Stopped</li> </ul>
Entire logging duration	In the <b>Data logging</b> parameter, the <b>Not overwriting</b> option is selected.	Displays the total logging duration.	Positive floating-point number

\* Visibility depends on order options or device settings

## 12 Diagnostics and troubleshooting

### 12.1 General troubleshooting

*For local display*

Error	Possible causes	Remedial action
Local display is dark, but signal output is within the valid range	The cable of the display module is not plugged in correctly.	Insert the plug correctly into the main electronics module and display module.
Local display dark and no output signals	Supply voltage does not match the voltage specified on the nameplate.	Apply the correct supply voltage .
Local display dark and no output signals	Supply voltage has incorrect polarity.	Reverse polarity of supply voltage.
Local display dark and no output signals	No contact between connecting cables and terminals.	Ensure electrical contact between the cable and the terminal.
Local display dark and no output signals	<ul style="list-style-type: none"> <li>▪ Terminals are not plugged into the I/O electronics module correctly.</li> <li>▪ Terminals are not plugged into the main electronics module correctly.</li> </ul>	Check terminals.
Local display dark and no output signals	<ul style="list-style-type: none"> <li>▪ I/O electronics module is defective.</li> <li>▪ Main electronics module is defective.</li> </ul>	Order spare part →  224.
Local display dark and no output signals	The connector between the main electronics module and display module is not plugged in correctly.	Check the connection and correct if necessary.
Local display cannot be read, but signal output is within the valid range	Display is set too bright or too dark.	<ul style="list-style-type: none"> <li>▪ Set the display brighter by simultaneously pressing  + .</li> <li>▪ Set the display darker by simultaneously pressing  + .</li> </ul>
Local display is dark, but signal output is within the valid range	Display module is defective.	Order spare part →  224.
Backlighting of local display is red	Diagnostic event with "Alarm" diagnostic behavior has occurred.	Take remedial measures →  203
Text on local display appears in a language that cannot be understood.	The selected operating language cannot be understood.	<ol style="list-style-type: none"> <li>1. Press  +  for 2 s ("home position").</li> <li>2. Press .</li> <li>3. Configure the required language in the <b>Display language</b> parameter (→  159).</li> </ol>
Message on local display: "Communication Error" "Check Electronics"	Communication between the display module and the electronics is interrupted.	<ul style="list-style-type: none"> <li>▪ Check the cable and the connector between the main electronics module and display module.</li> <li>▪ Order spare part →  224.</li> </ul>

*For output signals*

Error	Possible causes	Remedial action
Signal output outside the valid range	Main electronics module is defective.	Order spare part →  224.
Device shows correct value on local display, but signal output is incorrect, though in the valid range.	Parameter configuration error	Check and adjust parameter configuration.
Device measures incorrectly.	Configuration error or device is operated outside the application.	<ol style="list-style-type: none"> <li>1. Check and correct parameter configuration.</li> <li>2. Observe limit values specified in the "Technical Data".</li> </ol>



## For access

Fault	Possible causes	Remedial action
Write access to parameters is not possible.	Hardware write protection is enabled.	Set the write protection switch on the main electronics module to the <b>OFF</b> position →  169.
Write access to parameters is not possible.	Current user role has limited access authorization.	1. Check user role →  82. 2. Enter correct customer-specific access code →  82.
Connection via EtherNet/IP is not possible.	Device plug is incorrectly connected.	Check the pin assignment of the device plugs .
Unable to connect to the web server.	Web server is disabled.	Using the "FieldCare" or "DeviceCare" operating tool, check whether the web server of the device is enabled, and enable it if necessary →  90.
	The Ethernet interface on the PC is incorrectly configured.	<ul style="list-style-type: none"> <li>▶ Check the properties of the Internet protocol (TCP/IP) →  85.</li> <li>▶ Check the network settings with the IT manager.</li> </ul>
Unable to connect to the web server.	<ul style="list-style-type: none"> <li>▪ The IP address on the PC is incorrectly configured.</li> <li>▪ IP address is not known.</li> </ul>	<ul style="list-style-type: none"> <li>▶ If addressing via hardware: open the transmitter and check the IP address configured (last octet).</li> <li>▶ Check the IP address of the device with the IT manager.</li> <li>▶ If the IP address is not known, set DIP switch no.10 on the I/O electronics module 10 to ON, restart the device and enter the factory IP address 192.168.1.212.</li> </ul> <p> EtherNet/IP communication is interrupted by enabling the DIP switch.</p>
	The web browser setting "Use a proxy server for your LAN" is enabled on the PC.	<p>Disable use of the proxy server in the LAN settings. Using the example of MS Internet Explorer:</p> <ul style="list-style-type: none"> <li>▶ Under <i>Control Panel</i>, open <i>Internet options</i>.</li> <li>▶ Select the <i>Connections</i> tab.</li> <li>▶ Double-click <i>LAN Settings</i>.</li> <li>▶ In <i>LAN Settings</i>, disable use of the proxy server.</li> <li>▶ Press <i>OK</i> to confirm.</li> </ul>
	Apart from the active network connection to the measuring instrument, other network connections are also being used.	<ul style="list-style-type: none"> <li>▪ Make sure that there are no other network connections from the PC (including WLAN) and close other programs on the PC with network access.</li> <li>▪ If using a docking station for notebooks, make sure that a network connection to another network is not active.</li> </ul>
Unable to connect to the web server.	WLAN access data are incorrect.	<ul style="list-style-type: none"> <li>▪ Check WLAN network status.</li> <li>▪ Log on to the device again using WLAN access data.</li> <li>▪ Check that WLAN is enabled on the measuring instrument and operating unit →  85.</li> </ul>
	WLAN communication is disabled.	–
Unable to connect to web server, FieldCare or DeviceCare.	WLAN network is not available.	<ul style="list-style-type: none"> <li>▪ Check if WLAN reception is present: LED on display module is lit blue.</li> <li>▪ Check if WLAN connection is enabled: LED on display module flashes blue.</li> <li>▪ Switch on instrument function.</li> </ul>
Network connection not present or unstable	WLAN network is weak.	<ul style="list-style-type: none"> <li>▪ Operating unit outside reception range: Check network status on operating unit.</li> <li>▪ To improve network performance, use an external WLAN antenna.</li> </ul>

Fault	Possible causes	Remedial action
	Parallel WLAN and Ethernet communication	<ul style="list-style-type: none"> <li>▪ Check network settings.</li> <li>▪ Temporarily enable only the WLAN as an interface.</li> </ul>
Web browser frozen and operation no longer possible	Data transfer is active.	Wait until data transfer or current action is finished.
	Connection lost	<ul style="list-style-type: none"> <li>▶ Check cable connection and power supply.</li> <li>▶ Refresh the web browser and restart if necessary.</li> </ul>
Display of web browser content is difficult to read or incomplete.	Web browser version used is not optimal.	<ul style="list-style-type: none"> <li>▶ Use correct web browser version → 84.</li> <li>▶ Empty the web browser cache.</li> <li>▶ Restart the web browser.</li> </ul>
	Unsuitable view settings.	Change the font size/display ratio of the Web browser.
Incomplete or no display of content in the web browser	<ul style="list-style-type: none"> <li>▪ JavaScript is not enabled.</li> <li>▪ JavaScript cannot be enabled.</li> </ul>	<ul style="list-style-type: none"> <li>▶ Enable JavaScript.</li> <li>▶ Enter http://XXX.XXX.X.XX/servlet/basic.html as the IP address.</li> </ul>
Operation with FieldCare or DeviceCare via service interface CDI-RJ45 (port 8000) is not possible.	Firewall of the PC or network is blocking communication.	Depending on the settings of the firewall used on the PC or in the network, the firewall must be adapted or disabled to allow FieldCare/ DeviceCare access.
Flashing the firmware with FieldCare or DeviceCare via service interface CDI-RJ45 (port 8000 or TFTP ports) is not possible.	Firewall of the PC or network is blocking communication.	Depending on the settings of the firewall used on the PC or in the network, the firewall must be adapted or disabled to allow FieldCare/ DeviceCare access.

## 12.2 Diagnostic information via light emitting diodes

### 12.2.1 Transmitter

#### Proline 500 – digital

Different LEDs in the transmitter provide information on the device status.

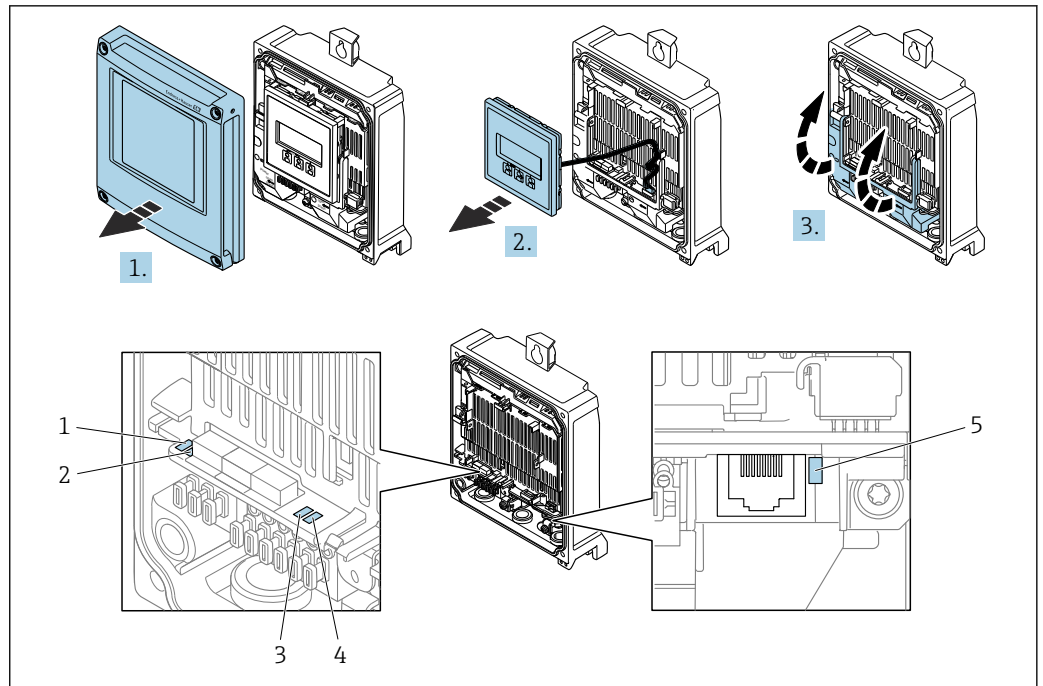

A0029689

- 1 Supply voltage
- 2 Device status
- 3 network status
- 4 Port 1 active: EtherNet/IP
- 5 Port 2 active: EtherNet/IP and service interface (CDI)

1. Open the housing cover.
2. Remove the display module.
3. Fold open the terminal cover.

LED	Color	Meaning
1 Supply voltage	Off	Supply voltage is off or too low.
	Green	Supply voltage is OK.
2 Device status/module status (normal operation)	Off	Firmware error
	Green	Device status is OK.
	Flashing green	Device is not configured.
	Flashing red	A diagnostic event with "Warning" diagnostic behavior has occurred.
	Red	A diagnostic event with "Alarm" diagnostic behavior has occurred.
2 Device status/module status (during start-up)	Flashes red slowly	If > 30 seconds: problem with the boot loader.
	Flashes red quickly	If > 30 seconds: compatibility problem when reading the firmware.
3 Network status	Off	The device does not have an EtherNet/IP address.
	Green	EtherNet/IP connection is active.
	Flashing green	The device has an Ethernet/IP address but no EtherNet/IP connection is active.
	Red	The EtherNet/IP address of the device has been assigned twice.
	Flashing red	EtherNet/IP connection is in the "time out" mode.
	Flashing red/green	The device restarts/self-test.

LED	Color	Meaning
4 Port 1 active: Ethernet/IP	Off	Not connected or no connection established.
	White	Connected and connection established.
	Flashing white	Communication not active.
5 Port 2 active: Ethernet/IP and service interface (CDI)	Off	Not connected or no connection established.
	Yellow	Connected and connection established.
	Flashing yellow	Communication not active.

**Proline 500**

Different LEDs in the transmitter provide information on the device status.

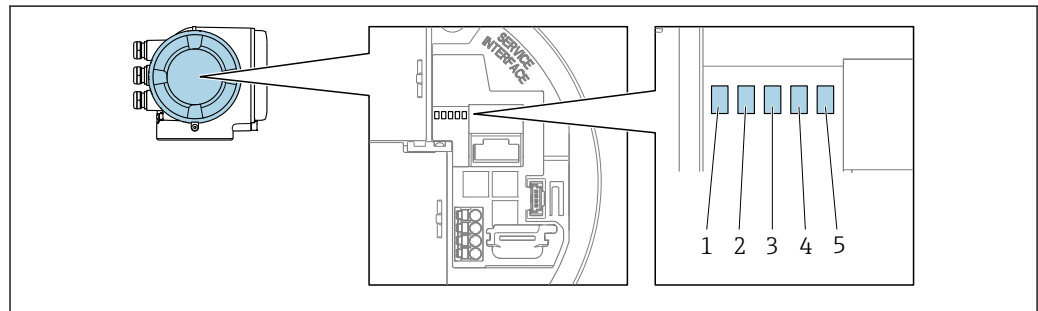

A0029629

- 1 Supply voltage
- 2 Device status
- 3 network status
- 4 Port 1 active: EtherNet/IP
- 5 Port 2 active: EtherNet/IP and service interface (CDI)

LED	Color	Meaning
1 Supply voltage	Off	Supply voltage is off or too low.
	Green	Supply voltage is OK.
2 Device status/module status (normal operation)	Off	Firmware error.
	Green	Device status is OK.
	Flashing green	Device is not configured.
	Flashing red	A diagnostic event with "Warning" diagnostic behavior has occurred.
	Red	A diagnostic event with "Alarm" diagnostic behavior has occurred.
	Flashing red/green	The device restarts/self-test.
2 Device status/module status (during start-up)	Flashes red slowly	If > 30 seconds: problem with the boot loader.
	Flashes red quickly	If > 30 seconds: compatibility problem when reading the firmware.
3 Network status	Off	The device does not have an EtherNet/IP address.
	Green	EtherNet/IP connection is active.
	Flashing green	The device has an Ethernet/IP address but no EtherNet/IP connection is active.
	Red	The EtherNet/IP address of the device has been assigned twice.
	Flashing red	EtherNet/IP connection is in the "time out" mode.
	Flashing red/green	The device restarts/self-test.

LED	Color	Meaning
4 Port 1 active: Ethernet/IP	Off	Not connected or no connection established.
	White	Connected and connection established.
	Flashing white	Communication not active.
5 Port 2 active: Ethernet/IP and service interface (CDI)	Off	Not connected or no connection established.
	Yellow	Connected and connection established.
	Flashing yellow	Communication not active.

### 12.2.2 Sensor connection housing

#### Proline 500 – digital

Various light emitting diodes (LED) on the ISEM electronics unit (intelligent sensor electronics module) in the sensor connection housing provide information about the device status.

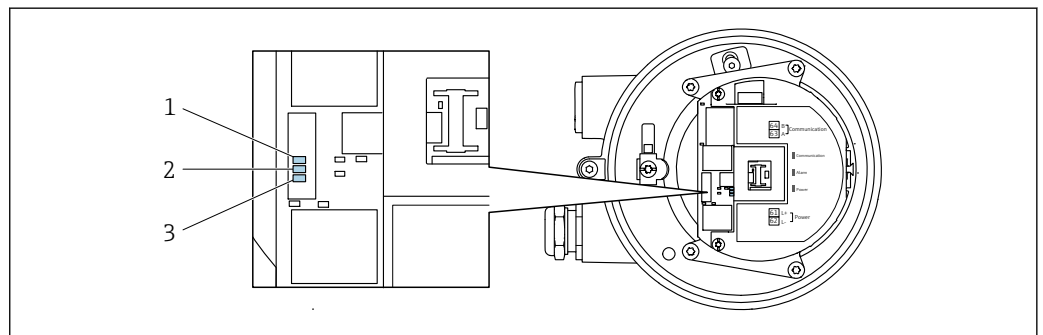

A0029699

- 1 Communication
- 2 Device status
- 3 Supply voltage

LED	Color	Meaning
1 Communication	White	Communication active.
2 Device status (normal operation)	Red	Error
	Flashing red	Warning
2 Device status (during start-up)	Flashes red slowly	If > 30 seconds: problem with the boot loader.
	Flashes red quickly	If > 30 seconds: compatibility problem when reading the firmware.
3 Supply voltage	Green	Supply voltage is ok.
	Off	Supply voltage is off or too low.

## 12.3 Diagnostic information on local display

### 12.3.1 Diagnostic message

Faults detected by the self-monitoring system of the measuring device are displayed as a diagnostic message in alternation with the operational display.

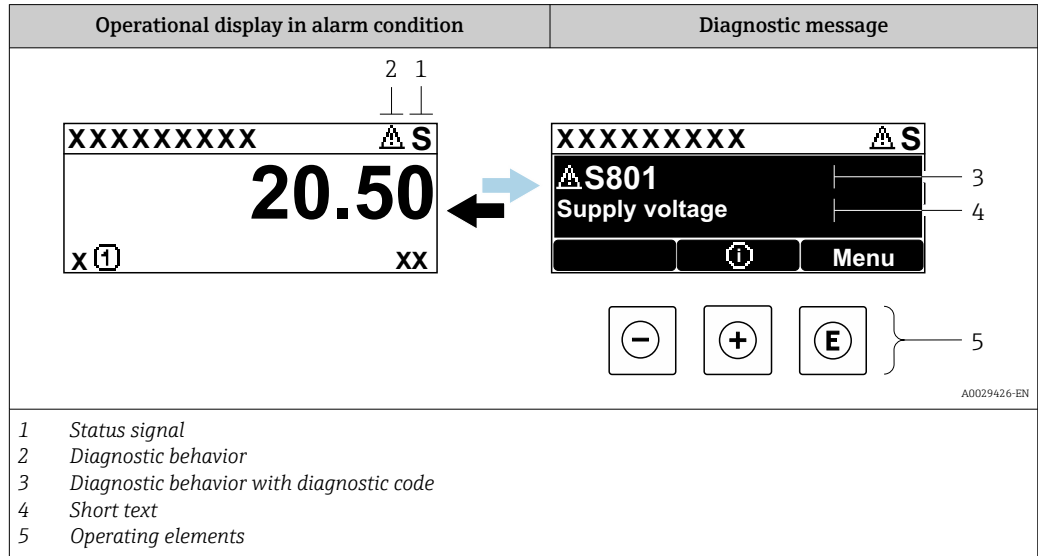

If two or more diagnostic events are pending simultaneously, only the message of the diagnostic event with the highest priority is shown.

- i** Other diagnostic events that have occurred can be displayed in the **Diagnostics** menu:
  - Via parameter → 217
  - Via submenus → 217



#### Status signals

The status signals provide information on the state and reliability of the device by categorizing the cause of the diagnostic information (diagnostic event).

- i** The status signals are categorized according to VDI/VDE 2650 and NAMUR Recommendation NE 107: F = Failure, C = Function Check, S = Out of Specification, M = Maintenance Required

Symbol	Meaning
<b>F</b>	<b>Failure</b> A device error has occurred. The measured value is no longer valid.
<b>C</b>	<b>Function check</b> The device is in service mode (e.g. during a simulation).
<b>S</b>	<b>Out of specification</b> The device is being operated: Outside its technical specification limits (e.g. outside the process temperature range)
<b>M</b>	<b>Maintenance required</b> Maintenance is required. The measured value remains valid.

### Diagnostic behavior



Symbol	Meaning
	<b>Alarm</b> <ul style="list-style-type: none"> <li>Measurement is interrupted.</li> <li>Signal outputs and totalizers assume the defined alarm condition.</li> <li>A diagnostic message is generated.</li> </ul>
	<b>Warning</b> <ul style="list-style-type: none"> <li>Measurement is resumed.</li> <li>The signal outputs and totalizers are not affected.</li> <li>A diagnostic message is generated.</li> </ul>

### Diagnostic information

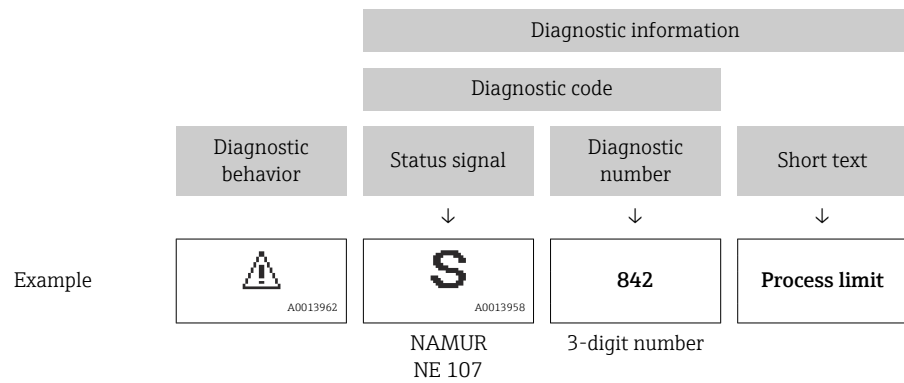
The fault can be identified using the diagnostic information. The short text helps you by providing information about the fault. In addition, the corresponding symbol for the diagnostic behavior is displayed in front of the diagnostic information on the local display.



### Operating elements

Operating key	Meaning
	<b>Plus key</b> <i>In menu, submenu</i> Opens the message about the remedial measures.
	<b>Enter key</b> <i>In menu, submenu</i> Opens the operating menu.

### 12.3.2 Calling up remedial measures

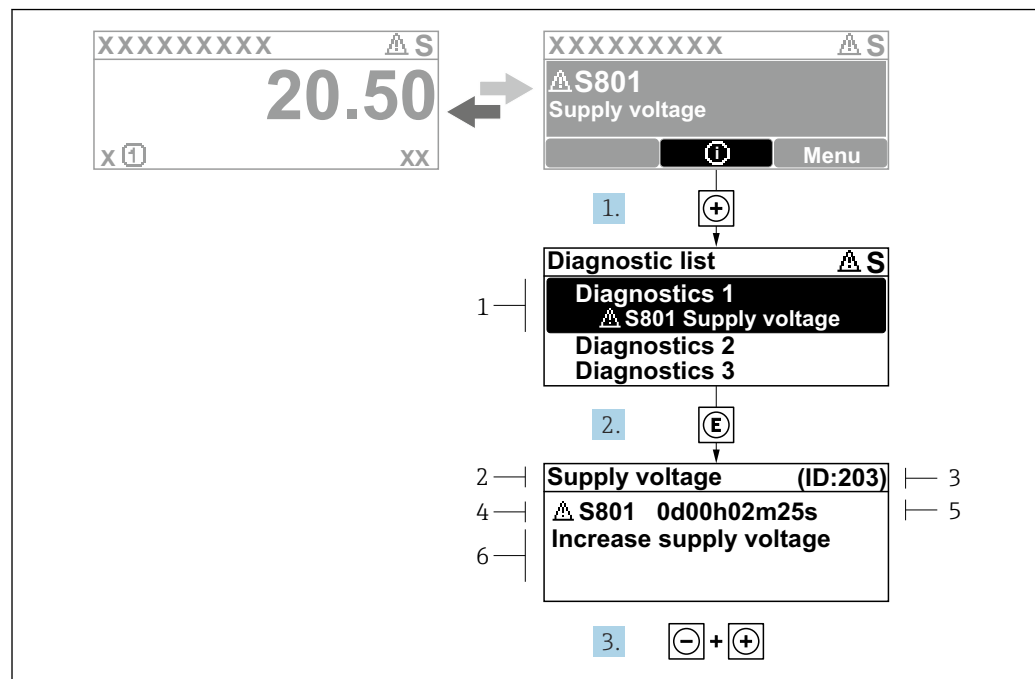

39 Message for remedial measures

- 1 Diagnostic information
- 2 Short text
- 3 Service ID
- 4 Diagnostic behavior with diagnostic code
- 5 Operation time when error occurred
- 6 Remedial measures

1. The user is in the diagnostic message.  
Press  $\oplus$  (ⓘ symbol).  
↳ The **Diagnostic list** submenu opens.
2. Select the desired diagnostic event with  $\oplus$  or  $\ominus$  and press  $\boxplus$ .  
↳ The message about the remedial measures opens.
3. Press  $\ominus + \oplus$  simultaneously.  
↳ The message about the remedial measures closes.

The user is in the **Diagnostics** menu at an entry for a diagnostics event, e.g. in the **Diagnostic list** submenu or **Previous diagnostics** parameter.

1. Press  $\boxplus$ .  
↳ The message for the remedial measures for the selected diagnostic event opens.
2. Press  $\ominus + \oplus$  simultaneously.  
↳ The message for the remedial measures closes.

## 12.4 Diagnostic information in the web browser

### 12.4.1 Diagnostic options

Any faults detected by the measuring device are displayed in the Web browser on the home page once the user has logged on.





- 1 Status area with status signal
- 2 Diagnostic information
- 3 Remedial measures with service ID

**i** In addition, diagnostic events which have occurred can be shown in the **Diagnostics** menu:

- Via parameter → 217
- Via submenu → 217

### Status signals

The status signals provide information on the state and reliability of the device by categorizing the cause of the diagnostic information (diagnostic event).

Symbol	Meaning
	<b>Failure</b> A device error has occurred. The measured value is no longer valid.
	<b>Function check</b> The device is in service mode (e.g. during a simulation).
	<b>Out of specification</b> The device is being operated: Outside its technical specification limits (e.g. outside the process temperature range)
	<b>Maintenance required</b> Maintenance is required. The measured value remains valid.

**i** The status signals are categorized in accordance with VDI/VDE 2650 and NAMUR Recommendation NE 107.

### 12.4.2 Calling up remedy information

Remedy information is provided for every diagnostic event to ensure that problems can be rectified quickly. These measures are displayed in red along with the diagnostic event and the related diagnostic information.

## 12.5 Diagnostic information in FieldCare or DeviceCare

### 12.5.1 Diagnostic options

Any faults detected by the measuring device are displayed on the home page of the operating tool once the connection has been established.

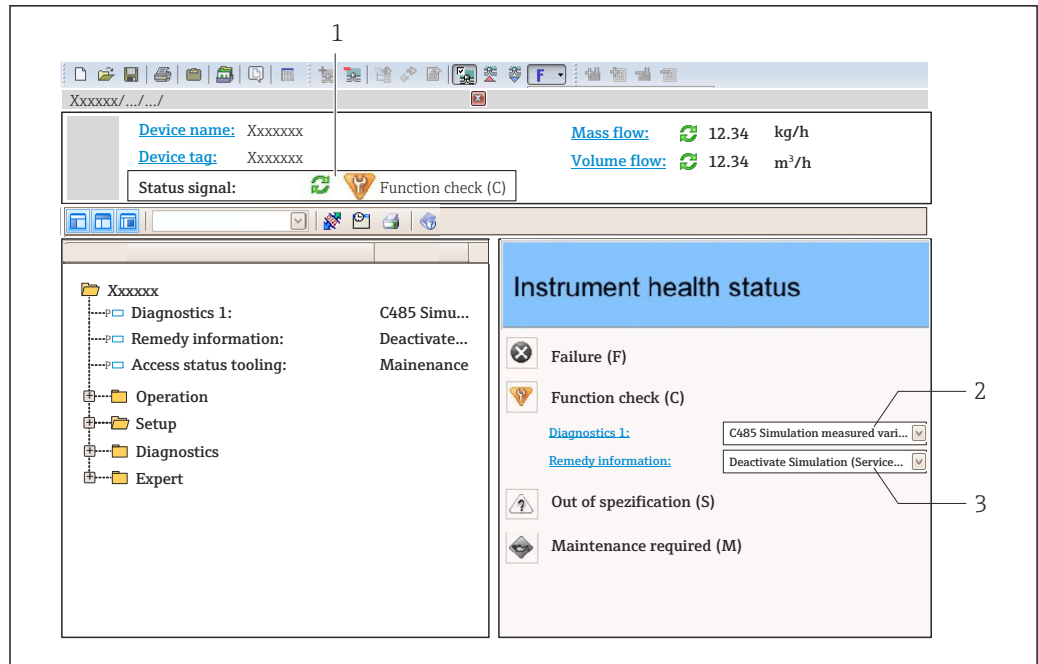

- 1 Status area with status signal → 198
- 2 Diagnostic information → 199
- 3 Remedial measures with service ID

**i** In addition, diagnostic events which have occurred can be shown in the **Diagnostics** menu:

- Via parameter → 217
- Via submenu → 217

### Diagnostic information

The fault can be identified using the diagnostic information. The short text helps you by providing information about the fault. In addition, the corresponding symbol for the diagnostic behavior is displayed in front of the diagnostic information on the local display.

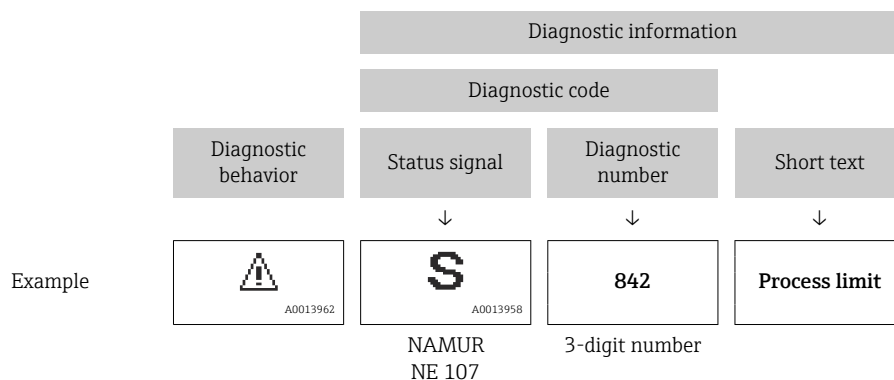

### 12.5.2 Calling up remedy information

Remedy information is provided for every diagnostic event to ensure that problems can be rectified quickly:

- On the home page  
Remedy information is displayed in a separate field below the diagnostics information.
- In the **Diagnostics** menu  
Remedy information can be called up in the working area of the user interface.

The user is in the **Diagnostics** menu.

1. Call up the desired parameter.
2. On the right in the working area, mouse over the parameter.
  - ↳ A tool tip with remedy information for the diagnostic event appears.

## 12.6 Diagnostic information via communication interface

### 12.6.1 Reading out diagnostic information

The current diagnostic event and associated diagnostic information can be read out: **Input Assembly Fix**

Input Fix Assembly byte 1 to 8								
1	2	3	4	5	6	7	8	
File header (not visible)				Diagnostic number		Status signal		-

## 12.7 Adapting the diagnostic information

### 12.7.1 Adapting the diagnostic behavior

Each item of diagnostic information is assigned a specific diagnostic behavior at the factory. The user can change this assignment for specific diagnostic information in the **Diagnostic behavior** submenu.



Expert → System → Diagnostic handling → Diagnostic behavior

You can assign the following options to the diagnostic number as the diagnostic behavior:

Options	Description
Alarm	The device stops measurement. The totalizers assume the defined alarm condition. A diagnostic message is generated. The background lighting changes to red.
Warning	The device continues to measure. The totalizers are not affected. A diagnostic message is generated.
Logbook entry only	The device continues to measure. The diagnostic message is only displayed in the <b>Event logbook</b> submenu ( <b>Event list</b> submenu) and is not displayed in alternating sequence with the operational display.
Off	The diagnostic event is ignored, and no diagnostic message is generated or entered.

## 12.8 Overview of diagnostic information

-  The amount of diagnostic information and the number of measured variables affected increase if the measuring device has one or more application packages.
- All of the measured variables affected in the entire Promass instrument family are always listed under "Measured variables affected". The measured variables available for the device in question depend on the device version. When assigning the measured variables to the device functions, for example to the individual outputs, all of the measured variables available for the device version in question are available for selection.

 In the case of some items of diagnostic information, the diagnostic behavior can be changed. Adapting the diagnostic information →  203

### 12.8.1 Diagnostic of sensor

Diagnostic information		Remedy instructions	Coding of diagnostic information (hex)	
No.	Short text			
022	Temperature sensor defective	<ol style="list-style-type: none"> <li>1. Check or replace sensor electronic module (ISEM)</li> <li>2. If available: Check connection cable between sensor and transmitter</li> <li>3. Replace sensor</li> </ol>	<ul style="list-style-type: none"> <li>▪ 0x10000BE</li> <li>▪ 0x10000BF</li> <li>▪ 0x10000D5</li> <li>▪ 0x10000D6</li> </ul>	
	Status signal			F
	Diagnostic behavior			Alarm

Diagnostic information		Remedy instructions	Coding of diagnostic information (hex)	
No.	Short text			
046	Sensor limit exceeded	<ol style="list-style-type: none"> <li>1. Inspect sensor</li> <li>2. Check process condition</li> </ol>	<ul style="list-style-type: none"> <li>▪ 0x80000C8</li> <li>▪ 0x80000CA</li> </ul>	
	Status signal			S
	Diagnostic behavior [from the factory] <sup>1)</sup>			Alarm

1) Diagnostic behavior can be changed.

Diagnostic information		Remedy instructions	Coding of diagnostic information (hex)	
No.	Short text			
062	Sensor connection faulty	<ol style="list-style-type: none"> <li>1. Check or replace sensor electronic module (ISEM)</li> <li>2. If available: Check connection cable between sensor and transmitter</li> <li>3. Replace sensor</li> </ol>	<ul style="list-style-type: none"> <li>▪ 0x10000DB</li> <li>▪ 0x10000DC</li> <li>▪ 0x1000113</li> <li>▪ 0x1000114</li> </ul>	
	Status signal			F
	Diagnostic behavior			Alarm

Diagnostic information		Remedy instructions	Coding of diagnostic information (hex)	
No.	Short text			
063	Exciter current faulty	<ol style="list-style-type: none"> <li>1. Check or replace sensor electronic module (ISEM)</li> <li>2. If available: Check connection cable between sensor and transmitter</li> <li>3. Replace sensor</li> </ol>	0x80002B3	
	Status signal			S
	Diagnostic behavior			Alarm

Diagnostic information		Remedy instructions	Coding of diagnostic information (hex)	
No.	Short text			
082	Data storage	<ol style="list-style-type: none"> <li>1. Check module connections</li> <li>2. Contact service</li> </ol>	0x10000E7	
	Status signal			F
	Diagnostic behavior			Alarm

Diagnostic information		Remedy instructions	Coding of diagnostic information (hex)	
No.	Short text			
083	Memory content	<ol style="list-style-type: none"> <li>1. Restart device</li> <li>2. Restore HistoROM S-DAT backup ('Device reset' parameter)</li> <li>3. Replace HistoROM S-DAT</li> </ol>	0x10000A0	
	Status signal			F
	Diagnostic behavior			Alarm

Diagnostic information		Remedy instructions	Coding of diagnostic information (hex)	
No.	Short text			
140	Sensor signal asymmetrical	1. Check or replace sensor electronic module (ISEM) 2. If available: Check connection cable between sensor and transmitter 3. Replace sensor	0x8000CC	
	Status signal			S
	Diagnostic behavior [from the factory] <sup>1)</sup>			Alarm

1) Diagnostic behavior can be changed.

Diagnostic information		Remedy instructions	Coding of diagnostic information (hex)	
No.	Short text			
144	Measuring error too high	1. Check or change sensor 2. Check process conditions	0x10001C7	
	Status signal			F
	Diagnostic behavior [from the factory] <sup>1)</sup>			Alarm

1) Diagnostic behavior can be changed.

## 12.8.2 Diagnostic of electronic

Diagnostic information		Remedy instructions	Coding of diagnostic information (hex)	
No.	Short text			
201	Device failure	1. Restart device 2. Contact service	0x100014B	
	Status signal			F
	Diagnostic behavior			Alarm

Diagnostic information		Remedy instructions	Coding of diagnostic information (hex)	
No.	Short text			
242	Software incompatible	1. Check software 2. Flash or change main electronics module	0x1000067	
	Status signal			F
	Diagnostic behavior			Alarm

Diagnostic information		Remedy instructions	Coding of diagnostic information (hex)	
No.	Short text			
252	Modules incompatible	1. Check electronic modules 2. Change electronic modules	0x100006B	
	Status signal			F
	Diagnostic behavior			Alarm

Diagnostic information		Remedy instructions	Coding of diagnostic information (hex)	
No.	Short text			
252	Modules incompatible	1. Check if correct electronic modul is plugged 2. Replace electronic module	0x10002C0	
	Status signal			F
	Diagnostic behavior			Alarm

Diagnostic information		Remedy instructions	Coding of diagnostic information (hex)	
No.	Short text			
262	Sensor electronic connection faulty	1. Check or replace connection cable between sensor electronic module (ISEM) and main electronics 2. Check or replace ISEM or main electronics	0x1000149	
	Status signal			F
	Diagnostic behavior			Alarm

Diagnostic information		Remedy instructions	Coding of diagnostic information (hex)	
No.	Short text			
270	Main electronic failure	Change main electronic module	<ul style="list-style-type: none"> <li>■ 0x1000078</li> <li>■ 0x100007C</li> <li>■ 0x1000080</li> <li>■ 0x100009F</li> <li>■ 0x10002D7</li> </ul>	
	Status signal			F
	Diagnostic behavior			Alarm

Diagnostic information		Remedy instructions	Coding of diagnostic information (hex)	
No.	Short text			
271	Main electronic failure	1. Restart device 2. Change main electronic module	0x100007D	
	Status signal			F
	Diagnostic behavior			Alarm

Diagnostic information		Remedy instructions	Coding of diagnostic information (hex)	
No.	Short text			
272	Main electronic failure	1. Restart device 2. Contact service	0x1000079	
	Status signal			F
	Diagnostic behavior			Alarm

Diagnostic information		Remedy instructions	Coding of diagnostic information (hex)	
No.	Short text			
273	Main electronic failure	Change electronic	<ul style="list-style-type: none"> <li>■ 0x1000098</li> <li>■ 0x10000E5</li> </ul>	
	Status signal			F
	Diagnostic behavior			Alarm

Diagnostic information		Remedy instructions	Coding of diagnostic information (hex)	
No.	Short text			
275	I/O module 1 to n defective	Change I/O module	0x100007A	
	Status signal			F
	Diagnostic behavior			Alarm

Diagnostic information		Remedy instructions	Coding of diagnostic information (hex)	
No.	Short text			
276	I/O module 1 to n faulty	1. Restart device 2. Change I/O module	<ul style="list-style-type: none"> <li>■ 0x100007B</li> <li>■ 0x1000081</li> </ul>	
	Status signal			F
	Diagnostic behavior			Alarm

Diagnostic information		Remedy instructions	Coding of diagnostic information (hex)	
No.	Short text			
283	Memory content	1. Reset device 2. Contact service	<ul style="list-style-type: none"> <li>■ 0x10000E1</li> <li>■ 0x100016F</li> </ul>	
	Status signal			F
	Diagnostic behavior			Alarm

Diagnostic information		Remedy instructions	Coding of diagnostic information (hex)	
No.	Short text			
302	Device verification active	Device verification active, please wait.	0x20001EE	
	Status signal			C
	Diagnostic behavior			Warning

Diagnostic information		Remedy instructions	Coding of diagnostic information (hex)	
No.	Short text			
311	Electronic failure	1. Do not reset device 2. Contact service	0x40000E2	
	Status signal			M
	Diagnostic behavior			Warning

Diagnostic information		Remedy instructions	Coding of diagnostic information (hex)	
No.	Short text			
332	Writing in HistoROM backup failed	Replace user interface board Ex d/XP: replace transmitter	0x10002C7	
	Status signal			F
	Diagnostic behavior			Alarm

Diagnostic information		Remedy instructions	Coding of diagnostic information (hex)	
No.	Short text			
361	I/O module 1 to n faulty	1. Restart device 2. Check electronic modules 3. Change I/O Modul or main electronics	0x1000095	
	Status signal			F
	Diagnostic behavior			Alarm

Diagnostic information		Remedy instructions	Coding of diagnostic information (hex)	
No.	Short text			
372	Sensor electronic (ISEM) faulty	<ol style="list-style-type: none"> <li>Restart device</li> <li>Check if failure recurs</li> <li>Replace sensor electronic module (ISEM)</li> </ol>	<ul style="list-style-type: none"> <li>■ 0x10000A1</li> <li>■ 0x10000C7</li> <li>■ 0x10000C9</li> <li>■ 0x10000D4</li> <li>■ 0x10000DA</li> <li>■ 0x1000120</li> <li>■ 0x10002CB</li> <li>■ 0x10002CC</li> <li>■ 0x10002CD</li> <li>■ 0x10002CE</li> <li>■ 0x10002CF</li> <li>■ 0x10002D0</li> </ul>	
	Status signal			F
	Diagnostic behavior			Alarm

Diagnostic information		Remedy instructions	Coding of diagnostic information (hex)	
No.	Short text			
373	Sensor electronic (ISEM) faulty	<ol style="list-style-type: none"> <li>Transfer data or reset device</li> <li>Contact service</li> </ol>	0x10002D1	
	Status signal			F
	Diagnostic behavior			Alarm

Diagnostic information		Remedy instructions	Coding of diagnostic information (hex)	
No.	Short text			
374	Sensor electronic (ISEM) faulty	<ol style="list-style-type: none"> <li>Restart device</li> <li>Check if failure recurs</li> <li>Replace sensor electronic module (ISEM)</li> </ol>	0x80000CE	
	Status signal			S
	Diagnostic behavior [from the factory] <sup>1)</sup>			Warning

1) Diagnostic behavior can be changed.

Diagnostic information		Remedy instructions	Coding of diagnostic information (hex)	
No.	Short text			
375	I/O- 1 to n communication failed	<ol style="list-style-type: none"> <li>Restart device</li> <li>Check if failure recurs</li> <li>Replace module rack inclusive electronic modules</li> </ol>	0x1000107	
	Status signal			F
	Diagnostic behavior			Alarm

Diagnostic information		Remedy instructions	Coding of diagnostic information (hex)	
No.	Short text			
382	Data storage	<ol style="list-style-type: none"> <li>Insert T-DAT</li> <li>Replace T-DAT</li> </ol>	0x100016D	
	Status signal			F
	Diagnostic behavior			Alarm



Diagnostic information		Remedy instructions	Coding of diagnostic information (hex)	
No.	Short text			
383	Memory content	1. Restart device 2. Delete T-DAT via 'Reset device' parameter 3. Replace T-DAT	0x100016E	
	Status signal			F
	Diagnostic behavior			Alarm

Diagnostic information		Remedy instructions	Coding of diagnostic information (hex)	
No.	Short text			
387	HistoROM backup failed	Contact service organization	0x1000288	
	Status signal			F
	Diagnostic behavior			Alarm

### 12.8.3 Diagnostic of configuration

Diagnostic information		Remedy instructions	Coding of diagnostic information (hex)	
No.	Short text			
303	I/O 1 to n configuration changed	1. Apply I/O module configuration (parameter 'Apply I/O configuration') 2. Afterwards reload device description and check wiring	0x400026C	
	Status signal			M
	Diagnostic behavior			Warning

Diagnostic information		Remedy instructions	Coding of diagnostic information (hex)	
No.	Short text			
330	Flash file invalid	1. Update firmware of device 2. Restart device	0x40002C9	
	Status signal			M
	Diagnostic behavior			Warning

Diagnostic information		Remedy instructions	Coding of diagnostic information (hex)	
No.	Short text			
331	Firmware update failed	1. Update firmware of device 2. Restart device	0x10002CA	
	Status signal			F
	Diagnostic behavior			Warning

Diagnostic information		Remedy instructions	Coding of diagnostic information (hex)	
No.	Short text			
410	Data transfer	1. Check connection 2. Retry data transfer	0x100008B	
	Status signal			F
	Diagnostic behavior			Alarm

Diagnostic information		Remedy instructions	Coding of diagnostic information (hex)	
No.	Short text			
412	Processing download	Download active, please wait	0x2000204	
	Status signal			C
	Diagnostic behavior			Warning

Diagnostic information		Remedy instructions	Coding of diagnostic information (hex)	
No.	Short text			
431	Trim 1 to n	Carry out trim	0x2000004	
	Status signal			C
	Diagnostic behavior			Warning

Diagnostic information		Remedy instructions	Coding of diagnostic information (hex)	
No.	Short text			
437	Configuration incompatible	<ol style="list-style-type: none"> <li>Restart device</li> <li>Contact service</li> </ol>	0x1000060	
	Status signal			F
	Diagnostic behavior			Alarm

Diagnostic information		Remedy instructions	Coding of diagnostic information (hex)	
No.	Short text			
438	Dataset	<ol style="list-style-type: none"> <li>Check data set file</li> <li>Check device configuration</li> <li>Up- and download new configuration</li> </ol>	0x400006A	
	Status signal			M
	Diagnostic behavior			Warning

Diagnostic information		Remedy instructions	Coding of diagnostic information (hex)	
No.	Short text			
441	Current output 1 to n	<ol style="list-style-type: none"> <li>Check process</li> <li>Check current output settings</li> </ol>	<ul style="list-style-type: none"> <li>■ 0x8000099</li> <li>■ 0x80000B6</li> </ul>	
	Status signal			S
	Diagnostic behavior			Warning

Diagnostic information		Remedy instructions	Coding of diagnostic information (hex)	
No.	Short text			
442	Frequency output 1 to n	<ol style="list-style-type: none"> <li>Check process</li> <li>Check frequency output settings</li> </ol>	<ul style="list-style-type: none"> <li>■ 0x800008A</li> <li>■ 0x8000122</li> </ul>	
	Status signal			S
	Diagnostic behavior			Warning

Diagnostic information		Remedy instructions	Coding of diagnostic information (hex)	
No.	Short text			
443	Pulse output 1 to n	1. Check process 2. Check pulse output settings	<ul style="list-style-type: none"> <li>■ 0x800008C</li> <li>■ 0x8000121</li> </ul>	
	Status signal			S
	Diagnostic behavior			Warning

Diagnostic information		Remedy instructions	Coding of diagnostic information (hex)	
No.	Short text			
444	Current input 1 to n	1. Check process 2. Check current input settings	0x80001EB	
	Status signal			S
	Diagnostic behavior			Warning

Diagnostic information		Remedy instructions	Coding of diagnostic information (hex)	
No.	Short text			
453	Flow override	Deactivate flow override	0x2000094	
	Status signal			C
	Diagnostic behavior			Warning

Diagnostic information		Remedy instructions	Coding of diagnostic information (hex)	
No.	Short text			
484	Failure mode simulation	Deactivate simulation	0x2000090	
	Status signal			C
	Diagnostic behavior			Alarm

Diagnostic information		Remedy instructions	Coding of diagnostic information (hex)	
No.	Short text			
485	Measured variable simulation	Deactivate simulation	0x2000093	
	Status signal			C
	Diagnostic behavior			Warning

Diagnostic information		Remedy instructions	Coding of diagnostic information (hex)	
No.	Short text			
486	Current input 1 to n simulation	Deactivate simulation	0x20001EC	
	Status signal			C
	Diagnostic behavior			Warning

Diagnostic information		Remedy instructions	Coding of diagnostic information (hex)	
No.	Short text			
491	Current output 1 to n simulation	Deactivate simulation	0x200000E	
	Status signal			C
	Diagnostic behavior			Warning

Diagnostic information		Remedy instructions	Coding of diagnostic information (hex)	
No.	Short text			
492	Simulation frequency output 1 to n	Deactivate simulation frequency output	0x200008D	
	Status signal			C
	Diagnostic behavior			Warning

Diagnostic information		Remedy instructions	Coding of diagnostic information (hex)	
No.	Short text			
493	Simulation pulse output 1 to n	Deactivate simulation pulse output	0x200008E	
	Status signal			C
	Diagnostic behavior			Warning

Diagnostic information		Remedy instructions	Coding of diagnostic information (hex)	
No.	Short text			
494	Switch output simulation 1 to n	Deactivate simulation switch output	0x200008F	
	Status signal			C
	Diagnostic behavior			Warning

Diagnostic information		Remedy instructions	Coding of diagnostic information (hex)	
No.	Short text			
495	Diagnostic event simulation	Deactivate simulation	0x200015E	
	Status signal			C
	Diagnostic behavior			Warning

Diagnostic information		Remedy instructions	Coding of diagnostic information (hex)	
No.	Short text			
496	Status input simulation	Deactivate simulation status input	0x2000170	
	Status signal			C
	Diagnostic behavior			Warning

Diagnostic information		Remedy instructions	Coding of diagnostic information (hex)	
No.	Short text			
520	I/O 1 to n hardware configuration invalid	1. Check I/O hardware configuration 2. Replace wrong I/O module 3. Plug the module of double pulse output on correct slot	0x1000276	
	Status signal			F
	Diagnostic behavior			Alarm

Diagnostic information		Remedy instructions	Coding of diagnostic information (hex)	
No.	Short text			
528	Concentration settings faulty	1. Check concentration settings 2. Check input values e.g. pressure, temperature	0x8000387	
	Status signal			S
	Diagnostic behavior			Alarm

Diagnostic information		Remedy instructions	Coding of diagnostic information (hex)	
No.	Short text			
529	Concentration settings faulty	1. Check concentration settings 2. Check input values e.g. pressure, temperature	0x8000389	
	Status signal			S
	Diagnostic behavior			Warning

Diagnostic information		Remedy instructions	Coding of diagnostic information (hex)	
No.	Short text			
537	Configuration	1. Check IP addresses in network 2. Change IP address	0x100014A	
	Status signal			F
	Diagnostic behavior			Warning

Diagnostic information		Remedy instructions	Coding of diagnostic information (hex)	
No.	Short text			
594	Relay output simulation	Deactivate simulation switch output	0x20002BA	
	Status signal			C
	Diagnostic behavior			Warning

### 12.8.4 Diagnostic of process

Diagnostic information		Remedy instructions	Coding of diagnostic information (hex)	
No.	Short text			
803	Current loop	1. Check wiring 2. Change I/O module	0x10000AD	
	Status signal			F
	Diagnostic behavior			Alarm

Diagnostic information		Remedy instructions	Coding of diagnostic information (hex)	
No.	Short text			
830	Sensor temperature too high	Reduce ambient temp. around the sensor housing	0x80000C0	
	Status signal			S
	Diagnostic behavior [from the factory] <sup>1)</sup>			Warning

1) Diagnostic behavior can be changed.

Diagnostic information		Remedy instructions	Coding of diagnostic information (hex)	
No.	Short text			
831	Sensor temperature too low	Increase ambient temp. around the sensor housing	0x80000C2	
	Status signal			S
	Diagnostic behavior [from the factory] <sup>1)</sup>			Warning

1) Diagnostic behavior can be changed.

Diagnostic information		Remedy instructions	Coding of diagnostic information (hex)	
No.	Short text			
832	Electronic temperature too high	Reduce ambient temperature	<ul style="list-style-type: none"> <li>■ 0x80000C3</li> <li>■ 0x80002D4</li> </ul>	
	Status signal			S
	Diagnostic behavior [from the factory] <sup>1)</sup>			Warning

1) Diagnostic behavior can be changed.

Diagnostic information		Remedy instructions	Coding of diagnostic information (hex)	
No.	Short text			
833	Electronic temperature too low	Increase ambient temperature	<ul style="list-style-type: none"> <li>■ 0x80000C1</li> <li>■ 0x80002D3</li> </ul>	
	Status signal			S
	Diagnostic behavior [from the factory] <sup>1)</sup>			Warning

1) Diagnostic behavior can be changed.

Diagnostic information		Remedy instructions	Coding of diagnostic information (hex)	
No.	Short text			
834	Process temperature too high	Reduce process temperature	0x80000C5	
	Status signal			S
	Diagnostic behavior [from the factory] <sup>1)</sup>			Warning

1) Diagnostic behavior can be changed.

Diagnostic information		Remedy instructions	Coding of diagnostic information (hex)	
No.	Short text			
835	Process temperature too low	Increase process temperature	0x80000C6	
	Status signal			S
	Diagnostic behavior [from the factory] <sup>1)</sup>			Warning

1) Diagnostic behavior can be changed.

Diagnostic information		Remedy instructions	Coding of diagnostic information (hex)	
No.	Short text			
842	Process limit	Low flow cut off active! 1. Check low flow cut off configuration	0x8000091	
	Status signal			S
	Diagnostic behavior			Warning

Diagnostic information		Remedy instructions	Coding of diagnostic information (hex)	
No.	Short text			
862	Partly filled pipe	1. Check for gas in process 2. Adjust detection limits	0x8000092	
	Status signal			S
	Diagnostic behavior			Warning

Diagnostic information		Remedy instructions	Coding of diagnostic information (hex)	
No.	Short text			
882	Input signal	1. Check input configuration 2. Check external device or process conditions	<ul style="list-style-type: none"> <li>■ 0x1000031</li> <li>■ 0x1000257</li> </ul>	
	Status signal			F
	Diagnostic behavior			Alarm

Diagnostic information		Remedy instructions	Coding of diagnostic information (hex)	
No.	Short text			
910	Tubes not oscillating	1. Check electronic 2. Inspect sensor	0x1000050	
	Status signal			F
	Diagnostic behavior			Alarm

Diagnostic information		Remedy instructions	Coding of diagnostic information (hex)	
No.	Short text			
912	Medium inhomogeneous	1. Check process cond. 2. Increase system pressure	<ul style="list-style-type: none"> <li>■ 0x80000C4</li> <li>■ 0x80000DF</li> <li>■ 0x8000115</li> <li>■ 0x8000162</li> </ul>	
	Status signal			S
	Diagnostic behavior [from the factory] <sup>1)</sup>			Warning

1) Diagnostic behavior can be changed.

Diagnostic information		Remedy instructions	Coding of diagnostic information (hex)	
No.	Short text			
913	Medium unsuitable	1. Check process conditions 2. Check electronic modules or sensor	0x8000CD	
	Status signal			S
	Diagnostic behavior [from the factory] <sup>1)</sup>			Alarm

1) Diagnostic behavior can be changed.

Diagnostic information		Remedy instructions	Coding of diagnostic information (hex)	
No.	Short text			
941	API temperature out of specification	1. Check process temperature with selected API commodity group 2. Check API related parameters	0x8000380	
	Status signal			S
	Diagnostic behavior			Alarm

Diagnostic information		Remedy instructions	Coding of diagnostic information (hex)	
No.	Short text			
942	API density out of specification	1. Check process density with selected API commodity group 2. Check API related parameters	0x800033B	
	Status signal			S
	Diagnostic behavior			Alarm

Diagnostic information		Remedy instructions	Coding of diagnostic information (hex)	
No.	Short text			
943	API pressure out of specification	1. Check process pressure with selected API commodity group 2. Check API related parameters	0x800037F	
	Status signal			S
	Diagnostic behavior			Alarm

Diagnostic information		Remedy instructions	Coding of diagnostic information (hex)	
No.	Short text			
944	Monitoring failed	Check process conditions for Heartbeat Monitoring	0x80001C6	
	Status signal			S
	Diagnostic behavior [from the factory] <sup>1)</sup>			Warning

1) Diagnostic behavior can be changed.





Diagnostic information		Remedy instructions	Coding of diagnostic information (hex)	
No.	Short text			
948	Oscillation damping too high	Check process conditions	0x8000168	
	Status signal			S
	Diagnostic behavior			Warning





## 12.9 Pending diagnostic events

The **Diagnostics** menu allows the user to view the current diagnostic event and the previous diagnostic event separately.

 To call up the measures to rectify a diagnostic event:

- Via local display →  200
- Via web browser →  201
- Via "FieldCare" operating tool →  202
- Via "DeviceCare" operating tool →  202

 Other pending diagnostic events can be displayed in the **Diagnostic list** submenu →  217.

### Navigation

"Diagnostics" menu

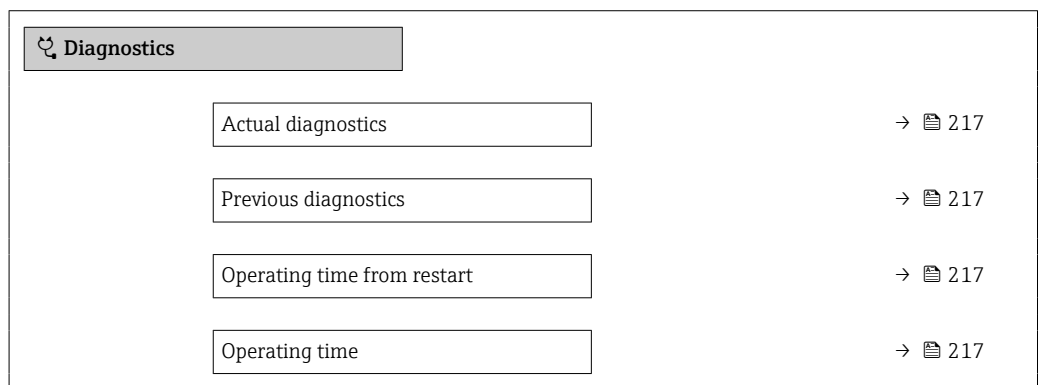

### Parameter overview with brief description

Parameter	Prerequisite	Description	User interface
Actual diagnostics	A diagnostic event has occurred.	Shows the current occurred diagnostic event along with its diagnostic information.  If two or more messages occur simultaneously, the message with the highest priority is shown on the display.	Symbol for diagnostic behavior, diagnostic code and short message.
Previous diagnostics	Two diagnostic events have already occurred.	Shows the diagnostic event that occurred prior to the current diagnostic event along with its diagnostic information.	Symbol for diagnostic behavior, diagnostic code and short message.
Operating time from restart	–	Shows the time the device has been in operation since the last device restart.	Days (d), hours (h), minutes (m) and seconds (s)
Operating time	–	Indicates how long the device has been in operation.	Days (d), hours (h), minutes (m) and seconds (s)

## 12.10 Diagnostics list

Up to 5 currently pending diagnostic events can be displayed in the **Diagnostic list** submenu along with the associated diagnostic information. If more than 5 diagnostic events are pending, the events with the highest priority are shown on the display.

### Navigation path

Diagnostics → Diagnostic list

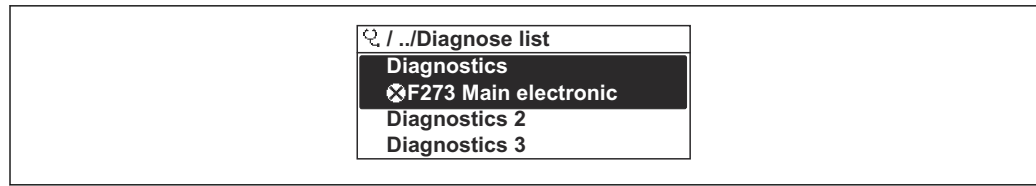

A0014006-EN

40 Using the example of the local display

To call up the measures to rectify a diagnostic event:

- Via local display → 200
- Via web browser → 201
- Via "FieldCare" operating tool → 202
- Via "DeviceCare" operating tool → 202

## 12.11 Event logbook

### 12.11.1 Reading out the event logbook

A chronological overview of the event messages that have occurred is provided in the **Events list** submenu.

#### Navigation path

**Diagnostics** menu → **Event logbook** submenu → Events list

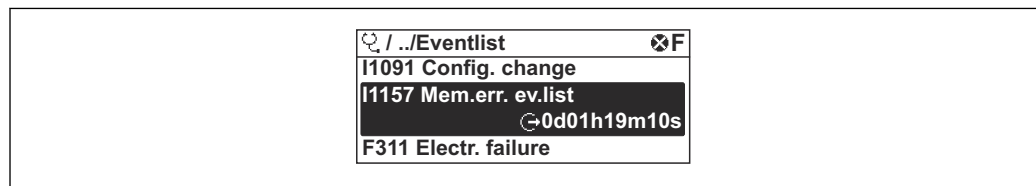

A0014006-EN

41 Using the example of the local display

- A maximum of 20 event messages can be displayed in chronological order.
- If the **Extended HistoROM** application package (order option) is enabled in the device, the event list can contain up to 100 entries.

The event history includes entries for:

- Diagnostic events → 203
- Information events → 219

In addition to the operating time when the event occurred, each event is also assigned a symbol that indicates whether the event has occurred or is finished:

- Diagnostics event
  - ☺: Occurrence of the event
  - ☹: End of the event
- Information event
  - ☺: Occurrence of the event

To call up the measures to rectify a diagnostic event:

- Via local display → 200
- Via web browser → 201
- Via "FieldCare" operating tool → 202
- Via "DeviceCare" operating tool → 202

For filtering the displayed event messages → 219

### 12.11.2 Filtering the event logbook

Using the **Filter options** parameter you can define which category of event message is displayed in the **Events list** submenu.

#### Navigation path

Diagnostics → Event logbook → Filter options

#### Filter categories

- All
- Failure (F)
- Function check (C)
- Out of specification (S)
- Maintenance required (M)
- Information (I)

### 12.11.3 Overview of information events

Unlike a diagnostic event, an information event is displayed in the event logbook only and not in the diagnostic list.

Info number	Info name
I1000	----- (Device ok)
I1079	Sensor changed
I1089	Power on
I1090	Configuration reset
I1091	Configuration changed
I1092	HistoROM backup deleted
I1111	Density adjust failure
I1137	Electronic changed
I1151	History reset
I1155	Reset electronic temperature
I1156	Memory error trend
I1157	Memory error event list
I1184	Display connected
I1209	Density adjustment ok
I1221	Zero point adjust failure
I1222	Zero point adjustment ok
I1256	Display: access status changed
I1278	I/O module reset detected
I1335	Firmware changed
I1361	Web server: login failed
I1397	Fieldbus: access status changed
I1398	CDI: access status changed
I1444	Device verification passed
I1445	Device verification failed
I1447	Record application reference data
I1448	Application reference data recorded
I1449	Recording application ref. data failed
I1450	Monitoring off

Info number	Info name
I1451	Monitoring on
I1457	Measured error verification failed
I1459	I/O module verification failed
I1460	HBSI verification failed
I1461	Sensor verification failed
I1462	Sensor electronic module verific. failed
I1512	Download started
I1513	Download finished
I1514	Upload started
I1515	Upload finished
I1618	I/O module 2 replaced
I1619	I/O module 3 replaced
I1621	I/O module 4 replaced
I1622	Calibration changed
I1624	Reset all totalizers
I1625	Write protection activated
I1626	Write protection deactivated
I1627	Web server: login successful
I1628	Display: login successful
I1629	CDI: login successful
I1631	Web server access changed
I1632	Display: login failed
I1633	CDI: login failed
I1634	Reset to factory settings
I1635	Reset to delivery settings
I1639	Max. switch cycles number reached
I1649	Hardware write protection activated
I1650	Hardware write protection deactivated
I1712	New flash file received
I1725	Sensor electronic module (ISEM) changed
I1726	Configuration backup failed

## 12.12 Resetting the measuring device

The entire device configuration or some of the configuration can be reset to a defined state with the **Device reset** parameter (→  164).

### 12.12.1 Function range of "Device reset" parameter

Options	Description
Cancel	No action is executed and the user exits the parameter.
To delivery settings	Every parameter for which a customer-specific default setting was ordered is reset to the customer-specific value. All other parameters are reset to the factory setting.

Options	Description
Restart device	The restart resets every parameter with data stored in volatile memory (RAM) to the factory setting (e.g. measured value data). The device configuration remains unchanged.
Restore S-DAT backup	Restores the data that is saved on the S-DAT. Additional information: This function can be used to resolve the memory issue "083 Memory content inconsistent" or to restore the S-DAT data when a new S-DAT has been installed.  This option is displayed only in an alarm condition.









### 12.13 Device information

The **Device information** submenu contains all parameters that display different information for device identification.

#### Navigation





"Diagnostics" menu → Device information

**▶ Device information**

Device tag	→  221
Serial number	→  221
Firmware version	→  221
Device name	
Order code	→  222
Extended order code 1	→  222
Extended order code 2	→  222
Extended order code 3	→  222
ENP version	→  222

#### Parameter overview with brief description

Parameter	Description	User interface	Factory setting
Device tag	Shows name of measuring point.	Max. 32 characters, such as letters, numbers or special characters (e.g. @, %, /).	–
Serial number	Shows the serial number of the measuring device.	Max. 11-digit character string comprising letters and numbers.	–
Firmware version	Shows the device firmware version installed.	Character string in the format xx.yy.zz	–
Device name		Max. 32 characters such as letters or numbers.	–

Parameter	Description	User interface	Factory setting
Order code	Shows the device order code.  The order code can be found on the nameplate of the sensor and transmitter in the "Order code" field.	Character string composed of letters, numbers and certain punctuation marks (e.g. /).	–
Extended order code 1	Shows the 1st part of the extended order code.  The extended order code can also be found on the nameplate of the sensor and transmitter in the "Ext. ord. cd." field.	Character string	–
Extended order code 2	Shows the 2nd part of the extended order code.  The extended order code can also be found on the nameplate of the sensor and transmitter in the "Ext. ord. cd." field.	Character string	–
Extended order code 3	Shows the 3rd part of the extended order code.  The extended order code can also be found on the nameplate of the sensor and transmitter in the "Ext. ord. cd." field.	Character string	–
ENP version	Shows the version of the electronic nameplate (ENP).	Character string	–

## 12.14 Firmware history

Release date	Firmware version	Order code for "Firmware version"	Firmware Changes	Documentation type	Documentation
10.2017	01.00.zz	Option 77	Original firmware	Operating Instructions	BA01749D

 It is possible to flash the firmware to the current version or the previous version using the service interface.

 For the compatibility of the firmware version with the previous version, the installed device description files and operating tools, observe the information about the device in the "Manufacturer's information" document.

 The manufacturer's information is available:

- In the Download Area of the Endress+Hauser web site: [www.endress.com](http://www.endress.com) → Downloads
- Specify the following details:
  - Product root: e.g. 8E5B  
The product root is the first part of the order code: see the nameplate on the device.
  - Text search: Manufacturer's information
  - Media type: Documentation – Technical Documentation

## 13 Maintenance

### 13.1 Maintenance work

No special maintenance work is required.

#### 13.1.1 Exterior cleaning

When cleaning the exterior of measuring devices, always use cleaning agents that do not attack the surface of the housing or the seals.

#### 13.1.2 Internal cleaning

Observe the following points for CIP and SIP cleaning:

- Use only cleaning agents to which the process-wetted materials are adequately resistant.
- Observe the maximum permitted medium temperature for the measuring device .

### 13.2 Measuring and test equipment

Endress+Hauser offers a variety of measuring and testing equipment, such as Netilion or device tests.

 Your Endress+Hauser Sales Center can provide detailed information on the services.

List of some of the measuring and testing equipment: →  228

### 13.3 Endress+Hauser services

Endress+Hauser offers a wide variety of services for maintenance such as recalibration, maintenance service or device tests.

 Your Endress+Hauser Sales Center can provide detailed information on the services.

## 14 Repair

### 14.1 General notes

#### 14.1.1 Repair and conversion concept

The Endress+Hauser repair and conversion concept provides for the following:

- The measuring devices have a modular design.
- Spare parts are grouped into logical kits with the associated Installation Instructions.
- Repairs are carried out by Endress+Hauser Service or by appropriately trained customers.
- Certified devices can only be converted to other certified devices by Endress+Hauser Service or at the factory.

#### 14.1.2 Notes for repair and conversion



For repair and conversion of a measuring device, observe the following notes:

- ▶ Use only original Endress+Hauser spare parts.
- ▶ Carry out the repair according to the Installation Instructions.
- ▶ Observe the applicable standards, federal/national regulations, Ex documentation (XA) and certificates.
- ▶ Document all repairs and conversions and enter the details in Netilion Analytics.

### 14.2 Spare parts

*Device Viewer* ([www.endress.com/deviceviewer](http://www.endress.com/deviceviewer)):

All the spare parts for the measuring device, along with the order code, are listed here and can be ordered. If available, users can also download the associated Installation Instructions.

-  Measuring device serial number:
  - Is located on the nameplate of the device.
  - Can be read out via the **Serial number** parameter (→  221) in the **Device information** submenu.

### 14.3 Endress+Hauser services

Endress+Hauser offers a wide range of services.

-  Your Endress+Hauser Sales Center can provide detailed information on the services.

### 14.4 Return

The requirements for safe device return can vary depending on the device type and national legislation.

1. Refer to the web page for information:  
<https://www.endress.com/support/return-material>
  - ↳ Select the region.
2. If returning the device, pack the device in such a way that it is reliably protected against impact and external influences. The original packaging offers the best protection.



## 14.5 Disposal



If required by the Directive 2012/19/EU on waste electrical and electronic equipment (WEEE), the product is marked with the depicted symbol in order to minimize the disposal of WEEE as unsorted municipal waste. Do not dispose of products bearing this marking as unsorted municipal waste. Instead, return them to the manufacturer for disposal under the applicable conditions.

### 14.5.1 Removing the measuring device

1. Switch off the device.

#### **WARNING**

##### **Danger to persons from process conditions!**

- ▶ Beware of hazardous process conditions such as pressure in the measuring device, high temperatures or aggressive media.

2. Carry out the mounting and connection steps from the "Mounting the measuring device" and "Connecting the measuring device" sections in reverse order. Observe the safety instructions.

### 14.5.2 Disposing of the measuring device

#### **WARNING**

##### **Danger to personnel and environment from fluids that are hazardous to health.**

- ▶ Ensure that the measuring device and all cavities are free of fluid residues that are hazardous to health or the environment, e.g. substances that have permeated into crevices or diffused through plastic.

Observe the following notes during disposal:













- ▶ Observe valid federal/national regulations.
- ▶ Ensure proper separation and reuse of the device components.





## 15 Accessories

Various accessories, which can be ordered with the device or subsequently from Endress+Hauser, are available for the device. Detailed information on the order code in question is available from your local Endress+Hauser sales center or on the product page of the Endress+Hauser website: [www.endress.com](http://www.endress.com).



### 15.1 Device-specific accessories

#### 15.1.1 For the transmitter



Accessories	Description
Transmitter <ul style="list-style-type: none"> <li>▪ Proline 500 – digital</li> <li>▪ Proline 500</li> </ul>	Transmitter for replacement or storage. Use the order code to define the following specifications: <ul style="list-style-type: none"> <li>▪ Approvals</li> <li>▪ Output</li> <li>▪ Input</li> <li>▪ Display/operation</li> <li>▪ Housing</li> <li>▪ Software</li> </ul> <p> ▪ Proline 500 – digital transmitter: Order number: 8X5BXX-*****A</p> <p>▪ Proline 500 transmitter: Order number: 8X5BXX-*****B</p> <p> Proline 500 transmitter for replacement: It is essential to specify the serial number of the current transmitter when ordering. On the basis of the serial number, the device-specific data (e.g. calibration factors) of the replaced device can be used for the new transmitter.</p> <p> ▪ Proline 500 – digital transmitter: Installation Instructions EA01151D ▪ Proline 500 transmitter: Installation Instructions EA01152D</p>
External WLAN antenna	External WLAN antenna with 1.5 m (59.1 in) connecting cable and two angle brackets. Order code for "Accessory enclosed", option P8 "Wireless antenna wide area". <ul style="list-style-type: none"> <li> ▪ The external WLAN antenna is not suitable for use in hygienic applications.</li> <li>▪ Additional information regarding the WLAN interface →  93.</li> </ul> <p> Order number: 71351317</p> <p> Installation Instructions EA01238D</p>
Pipe mounting set	Pipe mounting set for transmitter. <ul style="list-style-type: none"> <li> Proline 500 – digital transmitter Order number: 71346427</li> <li> Installation Instructions EA01195D</li> <li> Proline 500 transmitter Order number: 71346428</li> </ul>
Weather protection cover Transmitter <ul style="list-style-type: none"> <li>▪ Proline 500 – digital</li> <li>▪ Proline 500</li> </ul>	Is used to protect the measuring device from the effects of the weather: e.g. rainwater, excess heating from direct sunlight. <ul style="list-style-type: none"> <li> ▪ Proline 500 – digital transmitter Order number: 71343504</li> <li>▪ Proline 500 transmitter Order number: 71343505</li> </ul> <p> Installation Instructions EA01191D</p>



Display guard Proline 500 – digital	Is used to protect the display against impact or scoring, for example from sand in desert areas.  Order number: 71228792  Installation Instructions EA01093D
Connecting cable Proline 500 – digital Sensor – Transmitter	The connecting cable can be ordered directly with the measuring device (order code for "Cable, sensor connection") or as an accessory (order number DK8012). The following cable lengths are available: order code for "Cable, sensor connection" <ul style="list-style-type: none"> <li>▪ Option B: 20 m (65 ft)</li> <li>▪ Option E: User-configurable up to max. 50 m</li> <li>▪ Option F: User-configurable up to max. 165 ft</li> </ul>  Maximum possible cable length for a Proline 500 – digital connecting cable: 300 m (1 000 ft)
Connecting cables Proline 500 Sensor – Transmitter	The connecting cable can be ordered directly with the measuring device (order code for "Cable, sensor connection") or as an accessory (order number DK8012). The following cable lengths are available: order code for "Cable, sensor connection" <ul style="list-style-type: none"> <li>▪ Option 1: 5 m (16 ft)</li> <li>▪ Option 2: 10 m (32 ft)</li> <li>▪ Option 3: 20 m (65 ft)</li> </ul>  Possible cable length for a Proline 500 connecting cable: max. 20 m (65 ft)

### 15.1.2 For the sensor



Accessories	Description
Heating jacket	Is used to stabilize the temperature of the fluids in the sensor. Water, water vapor and other non-corrosive liquids are permitted for use as fluids.  If using oil as a heating medium, please consult with Endress+Hauser.  Heating jackets cannot be used with sensors fitted with a rupture disk. Use the order code with the product root DK8003.  Special Documentation SD02151D

## 15.2 Communication-specific accessories







Accessories	Description
Fieldgate FXA42	Transmission of the measured values of connected 4 to 20 mA analog measuring instruments, as well as digital measuring instruments  <ul style="list-style-type: none"> <li>▪ Technical Information TI01297S</li> <li>▪ Operating Instructions BA01778S</li> <li>▪ Product page: <a href="http://www.endress.com/fxa42">www.endress.com/fxa42</a></li> </ul>
Field Xpert SMT50	The Field Xpert SMT50 tablet PC for device configuration enables mobile plant asset management in the non-hazardous areas. It is suitable for commissioning and maintenance staff to manage field instruments with a digital communication interface and to record progress. This tablet PC is designed as an all-in-one solution with a preinstalled driver library and is an easy-to-use, touch-sensitive tool which can be used to manage field instruments throughout their entire life cycle.  <ul style="list-style-type: none"> <li>▪ Technical Information TI01555S</li> <li>▪ Operating Instructions BA02053S</li> <li>▪ Product page: <a href="http://www.endress.com/smt50">www.endress.com/smt50</a></li> </ul>

Field Xpert SMT70	<p>The Field Xpert SMT70 tablet PC for device configuration enables mobile plant asset management in hazardous and non-hazardous areas. It is suitable for commissioning and maintenance staff to manage field instruments with a digital communication interface and to record progress.</p> <p>This tablet PC is designed as an all-in-one solution with a preinstalled driver library and is an easy-to-use, touch-sensitive tool which can be used to manage the field instruments throughout their entire life cycle.</p> <p> <ul style="list-style-type: none"> <li>▪ Technical Information TI01342S</li> <li>▪ Operating Instructions BA01709S</li> <li>▪ Product page: <a href="http://www.endress.com/smt70">www.endress.com/smt70</a></li> </ul> </p>
Field Xpert SMT77	<p>The Field Xpert SMT77 tablet PC for device configuration enables mobile plant asset management in areas categorized as Ex Zone 1.</p> <p> <ul style="list-style-type: none"> <li>▪ Technical Information TI01418S</li> <li>▪ Operating Instructions BA01923S</li> <li>▪ Product page: <a href="http://www.endress.com/smt77">www.endress.com/smt77</a></li> </ul> </p>

### 15.3 Service-specific accessories

Accessories	Description
Applicator	<p>Software for selecting and sizing Endress+Hauser measuring instruments:</p> <ul style="list-style-type: none"> <li>▪ Choice of measuring instruments for industrial requirements</li> <li>▪ Calculation of all the necessary data for identifying the optimum flowmeter: e.g. nominal diameter, pressure loss, flow velocity and measurement accuracy.</li> <li>▪ Graphic display of the calculation results</li> <li>▪ Determination of the partial order code, administration, documentation and access to all project-related data and parameters over the entire life cycle of a project.</li> </ul> <p>Applicator is available: Via the Internet: <a href="https://portal.endress.com/webapp/applicator">https://portal.endress.com/webapp/applicator</a></p>
Netilion	<p>IIoT ecosystem: Unlock knowledge</p> <p>With the Netilion IIoT ecosystem, Endress+Hauser allows you to optimize your plant performance, digitize workflows, share knowledge, and enhance collaboration.</p> <p>Drawing upon decades of experience in process automation, Endress+Hauser offers the process industry an IIoT ecosystem designed to effortlessly extract insights from data. These insights allow process optimization, leading to increased plant availability, efficiency, and reliability - ultimately resulting in a more profitable plant.</p> <p><a href="http://www.netilion.endress.com">www.netilion.endress.com</a></p>
FieldCare	<p>FDT-based plant asset management tool from Endress+Hauser.</p> <p>It can configure all intelligent field units in your system and helps you manage them. By using the status information, it is also a simple but effective way of checking their status and condition.</p> <p> Operating Instructions BA00027S and BA00059S</p>
DeviceCare	<p>Tool to connect and configure Endress+Hauser field devices.</p> <p> Innovation brochure IN01047S</p>

## 15.4 System components

Accessories	Description
Memograph M graphic data manager	<p>The Memograph M graphic data manager provides information on all the relevant measured variables. Measured values are recorded correctly, limit values are monitored and measuring points analyzed. The data are stored in the 256 MB internal memory and also on a SD card or USB stick.</p> <ul style="list-style-type: none"> <li> Technical Information TI00133R</li> <li> Operating Instructions BA00247R</li> </ul>
Cerabar M	<p>The pressure transmitter for measuring the absolute and gauge pressure of gases, steam and liquids. It can be used to read in the operating pressure value.</p> <ul style="list-style-type: none"> <li> Technical Information TI00426P and TI00436P</li> <li> Operating Instructions BA00200P and BA00382P</li> </ul>
Cerabar S	<p>The pressure transmitter for measuring the absolute and gauge pressure of gases, steam and liquids. It can be used to read in the operating pressure value.</p> <ul style="list-style-type: none"> <li> Technical Information TI00383P</li> <li> Operating Instructions BA00271P</li> </ul>
iTEMP	<p>The temperature transmitters can be used in all applications and are suitable for the measurement of gases, steam and liquids. They can be used to read in the medium temperature.</p> <ul style="list-style-type: none"> <li> "Fields of Activity" document FA00006T</li> </ul>

## 16 Technical data

### 16.1 Application

The measuring device is intended only for the flow measurement of liquids and gases.

Depending on the version ordered, the measuring device can also measure potentially explosive, flammable, poisonous and oxidizing media.

To ensure that the device remains in proper operating condition for its service life, use the measuring device only for media against which the process-wetted materials are sufficiently resistant.

### 16.2 Function and system design

---

#### Measuring principle

Mass flow measurement based on the Coriolis measuring principle

---

#### Measuring system

The measuring system consists of a transmitter and a sensor. The transmitter and sensor are mounted in physically separate locations. They are interconnected by connecting cables.

For information on the structure of the measuring instrument →  14

## 16.3 Input

Measured variable

### Direct measured variables

- Mass flow
- Density
- Temperature

### Calculated measured variables

- Volume flow
- Corrected volume flow
- Reference density

Measuring range

### Measuring range for liquids

DN		Measuring range full scale values $\dot{m}_{\min(F)}$ to $\dot{m}_{\max(F)}$	
[mm]	[in]	[kg/h]	[lb/min]
8	$\frac{3}{8}$	0 to 2 000	0 to 73.50
15	$\frac{1}{2}$	0 to 6 500	0 to 238.9
25	1	0 to 18 000	0 to 661.5
40	$1\frac{1}{2}$	0 to 45 000	0 to 1 654
50	2	0 to 70 000	0 to 2 573
80	3	0 to 180 000	0 to 6 615

### Measuring range for gases

The full scale value depends on the density and the sound velocity of the gas used. The full scale value can be calculated with the following formulas:

$$\dot{m}_{\max(G)} = \text{Minimum of } (\dot{m}_{\max(F)} \cdot \rho_G : x) \text{ and } (\rho_G \cdot (c_G/2) \cdot d_i^2 \cdot (\pi/4) \cdot 3600 \cdot n)$$

$\dot{m}_{\max(G)}$	Maximum full scale value for gas [kg/h]
$\dot{m}_{\max(F)}$	Maximum full scale value for liquid [kg/h]
$\dot{m}_{\max(G)} < \dot{m}_{\max(F)}$	$\dot{m}_{\max(G)}$ can never be greater than $\dot{m}_{\max(F)}$
$\rho_G$	Gas density in [kg/m <sup>3</sup> ] at operating conditions
x	Limitation constant for max. gas flow [kg/m <sup>3</sup> ]
$c_G$	Sound velocity (gas) [m/s]
$d_i$	Measuring tube internal diameter [m]
$\pi$	Pi
n = 2	Number of measuring tubes



DN		x
[mm]	[in]	[kg/m <sup>3</sup> ]
8	$\frac{3}{8}$	85
15	$\frac{1}{2}$	110
25	1	125

DN		x
[mm]	[in]	[kg/m <sup>3</sup> ]
40	1½	125
50	2	125
80	3	155

If calculating the full scale value using the two formulas:

1. Calculate the full scale value with both formulas.
2. The smaller value is the value that must be used.

**Recommended measuring range**

 Flow limit →  248

Operable flow range

Over 1000 : 1.



Flow rates above the preset full scale value do not override the electronics unit, with the result that the totalizer values are registered correctly.

Input signal

**External measured values**

To increase the measurement accuracy of certain measured variables or to calculate the corrected volume flow for gases, the automation system can continuously write different measured values to the measuring instrument:

- Operating pressure to increase measurement accuracy (Endress+Hauser recommends the use of a pressure measuring device for absolute pressure, e.g. Cerabar M or Cerabar S)
- Medium temperature to increase measurement accuracy (e.g. iTEMP)
- Reference density for calculating the corrected volume flow for gases

 Various pressure and temperature measuring devices can be ordered from Endress +Hauser: see "Accessories" section →  229

It is recommended to read in external measured values to calculate the corrected volume flow.

*Current input*

The measured values are written from the automation system to the measuring device via the current input →  232.

*Digital communication*

The measured values are written by the automation system via Ethernet/IP.

**Current input 0/4 to 20 mA**

<b>Current input</b>	0/4 to 20 mA (active/passive)
<b>Current span</b>	<ul style="list-style-type: none"> <li>▪ 4 to 20 mA (active)</li> <li>▪ 0/4 to 20 mA (passive)</li> </ul>
<b>Resolution</b>	1 µA
<b>Voltage drop</b>	Typically: 0.6 to 2 V for 3.6 to 22 mA (passive)
<b>Maximum input voltage</b>	≤ 30 V (passive)



<b>Open-circuit voltage</b>	≤ 28.8 V (active)
<b>Possible input variables</b>	<ul style="list-style-type: none"> <li>▪ Pressure</li> <li>▪ Temperature</li> <li>▪ Density</li> </ul>

### Status input

<b>Maximum input values</b>	<ul style="list-style-type: none"> <li>▪ DC -3 to 30 V</li> <li>▪ If status input is active (ON): <math>R_i &gt; 3 \text{ k}\Omega</math></li> </ul>
<b>Response time</b>	Configurable: 5 to 200 ms
<b>Input signal level</b>	<ul style="list-style-type: none"> <li>▪ Low signal: DC -3 to +5 V</li> <li>▪ High signal: DC 12 to 30 V</li> </ul>
<b>Assignable functions</b>	<ul style="list-style-type: none"> <li>▪ Off</li> <li>▪ Reset the individual totalizers separately</li> <li>▪ Reset all totalizers</li> <li>▪ Flow override</li> </ul>

## 16.4 Output

Output signal

EtherNet/IP

Standards	In accordance with IEEE 802.3
-----------	-------------------------------

### Current output 4 to 20 mA



Signal mode	Can be set to: <ul style="list-style-type: none"> <li>▪ Active</li> <li>▪ Passive</li> </ul>
Current range	Can be set to: <ul style="list-style-type: none"> <li>▪ 4 to 20 mA NAMUR</li> <li>▪ 4 to 20 mA US</li> <li>▪ 4 to 20 mA</li> <li>▪ 0 to 20 mA (only if the signal mode is active)</li> <li>▪ Fixed current</li> </ul>
Maximum output values	22.5 mA
Open-circuit voltage	DC 28.8 V (active)
Maximum input voltage	DC 30 V (passive)
Load	0 to 700 Ω
Resolution	0.38 μA
Damping	Configurable: 0 to 999.9 s
Assignable measured variables	<ul style="list-style-type: none"> <li>▪ Mass flow</li> <li>▪ Volume flow</li> <li>▪ Corrected volume flow</li> <li>▪ Density</li> <li>▪ Reference density</li> <li>▪ Temperature</li> <li>▪ Electronics temperature</li> <li>▪ Oscillation frequency 0</li> <li>▪ Oscillation damping 0</li> <li>▪ Signal asymmetry</li> <li>▪ Exciter current 0</li> </ul> <p> The range of options increases if the measuring device has one or more application packages.</p>



### Current output 4 to 20 mA Ex i passive

Order code	"Output; input 2" (21), "Output; input 3" (022): Option C: current output 4 to 20 mA Ex i passive
Signal mode	Passive
Current range	Can be set to: <ul style="list-style-type: none"> <li>▪ 4 to 20 mA NAMUR</li> <li>▪ 4 to 20 mA US</li> <li>▪ 4 to 20 mA</li> <li>▪ Fixed current</li> </ul>
Maximum output values	22.5 mA
Maximum input voltage	DC 30 V
Load	0 to 700 Ω
Resolution	0.38 μA

<b>Damping</b>	Configurable: 0 to 999 s
<b>Assignable measured variables</b>	<ul style="list-style-type: none"> <li>▪ Mass flow</li> <li>▪ Volume flow</li> <li>▪ Corrected volume flow</li> <li>▪ Density</li> <li>▪ Reference density</li> <li>▪ Temperature</li> <li>▪ Electronics temperature</li> <li>▪ Oscillation frequency 0</li> <li>▪ Oscillation damping 0</li> <li>▪ Signal asymmetry</li> <li>▪ Exciter current 0</li> </ul> <p> The range of options increases if the measuring device has one or more application packages.</p>

### Pulse/frequency/switch output

<b>Function</b>	Can be configured as pulse, frequency or switch output
<b>Version</b>	Open collector Can be set to: <ul style="list-style-type: none"> <li>▪ Active</li> <li>▪ Passive</li> <li>▪ Passive NAMUR</li> </ul> <p> Ex-i, passive</p>
<b>Maximum input values</b>	DC 30 V, 250 mA (passive)
<b>Open-circuit voltage</b>	DC 28.8 V (active)
<b>Voltage drop</b>	For 22.5 mA: ≤ DC 2 V
<b>Pulse output</b>	
<b>Maximum input values</b>	DC 30 V, 250 mA (passive)
<b>Maximum output current</b>	22.5 mA (active)
<b>Open-circuit voltage</b>	DC 28.8 V (active)
<b>Pulse width</b>	Configurable: 0.05 to 2 000 ms
<b>Maximum pulse rate</b>	10 000 Impulse/s
<b>Pulse value</b>	Configurable
<b>Assignable measured variables</b>	<ul style="list-style-type: none"> <li>▪ Mass flow</li> <li>▪ Volume flow</li> <li>▪ Corrected volume flow</li> </ul> <p> The range of options increases if the measuring device has one or more application packages.</p>
<b>Frequency output</b>	
<b>Maximum input values</b>	DC 30 V, 250 mA (passive)
<b>Maximum output current</b>	22.5 mA (active)
<b>Open-circuit voltage</b>	DC 28.8 V (active)
<b>Output frequency</b>	Configurable: end value frequency 2 to 10 000 Hz ( $f_{\max} = 12\,500$ Hz)
<b>Damping</b>	Configurable: 0 to 999.9 s
<b>Pulse/pause ratio</b>	1:1

<b>Assignable measured variables</b>	<ul style="list-style-type: none"> <li>■ Mass flow</li> <li>■ Volume flow</li> <li>■ Corrected volume flow</li> <li>■ Density</li> <li>■ Reference density</li> <li>■ Temperature</li> <li>■ Electronics temperature</li> <li>■ Oscillation frequency 0</li> <li>■ Oscillation damping 0</li> <li>■ Signal asymmetry</li> <li>■ Exciter current 0</li> </ul> <p> The range of options increases if the measuring device has one or more application packages.</p>
<b>Switch output</b>	
<b>Maximum input values</b>	DC 30 V, 250 mA (passive)
<b>Open-circuit voltage</b>	DC 28.8 V (active)
<b>Switching behavior</b>	Binary, conductive or non-conductive
<b>Switching delay</b>	Configurable: 0 to 100 s
<b>Number of switching cycles</b>	Unlimited
<b>Assignable functions</b>	<ul style="list-style-type: none"> <li>■ Disable</li> <li>■ On</li> <li>■ Diagnostic behavior</li> <li>■ Limit                             <ul style="list-style-type: none"> <li>■ Mass flow</li> <li>■ Volume flow</li> <li>■ Corrected volume flow</li> <li>■ Density</li> <li>■ Reference density</li> <li>■ Temperature</li> <li>■ Totalizer 1-3</li> </ul> </li> <li>■ Flow direction monitoring</li> <li>■ Status                             <ul style="list-style-type: none"> <li>■ Partially filled pipe detection</li> <li>■ Low flow cut off</li> </ul> </li> </ul> <p> The range of options increases if the measuring device has one or more application packages.</p>

**Relay output**

<b>Function</b>	Switch output
<b>Version</b>	Relay output, galvanically isolated
<b>Switching behavior</b>	Can be set to: <ul style="list-style-type: none"> <li>■ NO (normally open), factory setting</li> <li>■ NC (normally closed)</li> </ul>

<b>Maximum switching capacity (passive)</b>	<ul style="list-style-type: none"> <li>▪ DC 30 V, 0.1 A</li> <li>▪ AC 30 V, 0.5 A</li> </ul>
<b>Assignable functions</b>	<ul style="list-style-type: none"> <li>▪ Disable</li> <li>▪ On</li> <li>▪ Diagnostic behavior</li> <li>▪ Limit                             <ul style="list-style-type: none"> <li>▪ Mass flow</li> <li>▪ Volume flow</li> <li>▪ Corrected volume flow</li> <li>▪ Density</li> <li>▪ Reference density</li> <li>▪ Temperature</li> <li>▪ Totalizer 1-3</li> </ul> </li> <li>▪ Flow direction monitoring</li> <li>▪ Status                             <ul style="list-style-type: none"> <li>▪ Partially filled pipe detection</li> <li>▪ Low flow cut off</li> </ul> </li> </ul> <p> The range of options increases if the measuring device has one or more application packages.</p>

**User-configurable input/output**

**One** specific input or output is assigned to a user-configurable input/output (configurable I/O) during device commissioning.

The following inputs and outputs are available for assignment:

- Choice of current output: 4 to 20 mA (active), 0/4 to 20 mA (passive)
- Pulse/frequency/switch output
- Choice of current input: 4 to 20 mA (active), 0/4 to 20 mA (passive)
- Status input

Signal on alarm

Depending on the interface, failure information is displayed as follows:

**EtherNet/IP**

<b>Device diagnostics</b>	Device condition can be read out in Input Assembly
---------------------------	--

**Current output 0/4 to 20 mA**

*4 to 20 mA*

<b>Failure mode</b>	Choose from: <ul style="list-style-type: none"> <li>▪ 4 to 20 mA in accordance with NAMUR recommendation NE 43</li> <li>▪ 4 to 20 mA in accordance with US</li> <li>▪ Min. value: 3.59 mA</li> <li>▪ Max. value: 22.5 mA</li> <li>▪ Definable value between: 3.59 to 22.5 mA</li> <li>▪ Actual value</li> <li>▪ Last valid value</li> </ul>
---------------------	---

*0 to 20 mA*

<b>Failure mode</b>	Choose from: <ul style="list-style-type: none"> <li>▪ Maximum alarm: 22 mA</li> <li>▪ Definable value between: 0 to 20.5 mA</li> </ul>
---------------------	--

### Pulse/frequency/switch output

Pulse output	
Fault mode	Choose from: <ul style="list-style-type: none"> <li>■ Actual value</li> <li>■ No pulses</li> </ul>
Frequency output	
Fault mode	Choose from: <ul style="list-style-type: none"> <li>■ Actual value</li> <li>■ 0 Hz</li> <li>■ Definable value between: 2 to 12 500 Hz</li> </ul>
Switch output	
Fault mode	Choose from: <ul style="list-style-type: none"> <li>■ Current status</li> <li>■ Open</li> <li>■ Closed</li> </ul>

### Relay output

Failure mode	Choose from: <ul style="list-style-type: none"> <li>■ Current status</li> <li>■ Open</li> <li>■ Closed</li> </ul>
--------------	---

### Local display

Plain text display	With information on cause and remedial measures
Backlight	Red lighting indicates a device error.

 Status signal as per NAMUR recommendation NE 107

### Interface/protocol



- Via digital communication:
  - EtherNet/IP
- Via service interface
  - CDI-RJ45 service interface
  - WLAN interface

Plain text display	With information on cause and remedial measures
--------------------	---

### Web browser

Plain text display	With information on cause and remedial measures
--------------------	---

**Light emitting diodes (LED)**

<b>Status information</b>	Status indicated by various light emitting diodes The following information is displayed depending on the device version: <ul style="list-style-type: none"> <li>▪ Supply voltage active</li> <li>▪ Data transmission active</li> <li>▪ Device alarm/error has occurred</li> <li>▪ EtherNet/IP network available</li> <li>▪ EtherNet/IP connection established</li> </ul>  Diagnostic information via light emitting diodes →  194
---------------------------	---

Low flow cut off                      The switch points for low flow cut off are user-selectable.

Galvanic isolation                      The outputs are galvanically isolated:

- from the power supply
- from one another
- from the potential equalization (PE) terminal

Protocol-specific data	<b>Protocol</b>	<ul style="list-style-type: none"> <li>▪ The CIP Networks Library Volume 1: Common Industrial Protocol</li> <li>▪ The CIP Networks Library Volume 2: EtherNet/IP Adaptation of CIP</li> </ul>
	<b>Communication type</b>	<ul style="list-style-type: none"> <li>▪ 10Base-T</li> <li>▪ 100Base-TX</li> </ul>
	<b>Device profile</b>	Generic device (product type: 0x2B)
	<b>Manufacturer ID</b>	0x000049E
	<b>Device type ID</b>	0x103B
	<b>Baud rates</b>	Automatic <sup>10</sup> / <sub>100</sub> Mbit with half-duplex and full-duplex detection
	<b>Polarity</b>	Auto-polarity for automatic correction of crossed Tx/D and Rx/D pairs
	<b>Supported CIP connections</b>	Max. 3 connections
	<b>Explicit connections</b>	Max. 6 connections
	<b>I/O connections</b>	Max. 6 connections (scanner)
	<b>Configuration options for measuring device</b>	<ul style="list-style-type: none"> <li>▪ DIP switches on the electronics module for IP addressing</li> <li>▪ Manufacturer-specific software (FieldCare)</li> <li>▪ Add-on Profile Level 3 for Rockwell Automation control systems</li> <li>▪ Web browser</li> <li>▪ Electronic Data Sheet (EDS) integrated in the measuring device</li> </ul>
	<b>Configuration of the EtherNet interface</b>	<ul style="list-style-type: none"> <li>▪ Speed: 10 MBit, 100 MBit, auto (factory setting)</li> <li>▪ Duplex: half-duplex, full-duplex, auto (factory setting)</li> </ul>
	<b>Configuration of the device address</b>	<ul style="list-style-type: none"> <li>▪ DIP switches on the electronics module for IP addressing (last octet)</li> <li>▪ DHCP</li> <li>▪ Manufacturer-specific software (FieldCare)</li> <li>▪ Add-on Profile Level 3 for Rockwell Automation control systems</li> <li>▪ Web browser</li> <li>▪ EtherNet/IP tools, e.g. RSLinx (Rockwell Automation)</li> </ul>
	<b>Device Level Ring (DLR)</b>	Yes
<b>System integration</b>	Information regarding system integration →  98. <ul style="list-style-type: none"> <li>▪ Cyclic data transmission</li> <li>▪ Block model</li> <li>▪ Input and output groups</li> </ul>	

## 16.5 Power supply

Terminal assignment →  40

Available device plugs →  40

Supply voltage	Order code "Power supply"		Terminal voltage	Frequency range
	Option D	DC 24 V	±20%	–
Option E	AC 100 to 240 V	–15...+10%	50/60 Hz	
Option I	DC 24 V	±20%	–	
	AC 100 to 240 V	–15...+10%	50/60 Hz	

Power consumption **Transmitter**  
Max. 10 W (active power)

<b>switch-on current</b>	Max. 36 A (<5 ms) as per NAMUR Recommendation NE 21
--------------------------	---

Current consumption **Transmitter**

- Max. 400 mA (24 V)
- Max. 200 mA (110 V, 50/60 Hz; 230 V, 50/60 Hz)

Power supply failure

- Totalizers stop at the last value measured.
- Depending on the device version, the configuration is retained in the device memory or in the pluggable data memory (HistoROM DAT).
- Error messages (incl. total operated hours) are stored.

Overcurrent protection element

The device must be operated with a dedicated circuit breaker, as it does not have an ON/OFF switch of its own.

- The circuit breaker must be easy to reach and labeled accordingly.
- Permitted nominal current of the circuit breaker: 2 A up to maximum 10 A.

Electrical connection

- →  42
- →  52

Potential equalization →  60

Terminals

Spring-loaded terminals: Suitable for strands and strands with ferrules.  
Conductor cross-section 0.2 to 2.5 mm<sup>2</sup> (24 to 12 AWG).





- Cable entries
- Cable gland: M20 × 1.5 with cable Ø 6 to 12 mm (0.24 to 0.47 in)
  - Thread for cable entry:
    - NPT ½"
    - G ½"
    - M20
  - Device plug for digital communication: M12
  - Device plug for connecting cable: M12
- A device plug is always used for the device version with the order code for "Sensor connection housing", option **C** "Ultra-compact, hygienic, stainless".

Cable specification →  35

Overvoltage protection	<b>Mains voltage fluctuations</b>	→  240
	<b>Overvoltage category</b>	Overvoltage category II
	<b>Short-term, temporary overvoltage</b>	Between cable and ground up to 1200 V, for max. 5 s
	<b>Long-term, temporary overvoltage</b>	Between cable and ground up to 500 V

## 16.6 Performance characteristics

- Reference operating conditions
- Error limits based on ISO 11631
  - Water
    - +15 to +45 °C (+59 to +113 °F)
    - 2 to 6 bar (29 to 87 psi)
  - Data as indicated in the calibration protocol
  - Accuracy based on accredited calibration rigs according to ISO 17025
-  To obtain measured errors, use the *Applicator* sizing tool →  228

Maximum measurement error o.r. = of reading; 1 g/cm<sup>3</sup> = 1 kg/l; T = medium temperature

### Base accuracy

 Design fundamentals →  244

#### *Mass flow and volume flow (liquids)*

±0.15 % o.r.

±0.10 % o.r. (order code for "Calibration flow", option A, B, C, for mass flow)

#### *Mass flow (gases)*

±0.50 % o.r.

#### *Density (liquids)*

Under reference conditions [g/cm <sup>3</sup> ]	Standard density calibration [g/cm <sup>3</sup> ]
±0.0005	±0.002

#### *Temperature*

±0.5 °C ± 0.005 · T °C (±0.9 °F ± 0.003 · (T - 32) °F)

**Zero point stability**

DN		Zero point stability	
[mm]	[in]	[kg/h]	[lb/min]
8	$\frac{3}{8}$	0.20	0.007
15	$\frac{1}{2}$	0.65	0.024
25	1	1.80	0.066
40	$1\frac{1}{2}$	4.50	0.165
50	2	7.0	0.257
80	3	18.0	0.6615

**Flow values**

Flow values as turndown parameters depending on nominal diameter.

*SI units*

DN	1:1	1:10	1:20	1:50	1:100	1:500
[mm]	[kg/h]	[kg/h]	[kg/h]	[kg/h]	[kg/h]	[kg/h]
8	2 000	200	100	40	20	4
15	6 500	650	325	130	65	13
25	18 000	1 800	900	360	180	36
40	45 000	4 500	2 250	900	450	90
50	70 000	7 000	3 500	1 400	700	140
80	180 000	18 000	9 000	3 600	1 800	360

*US units*

DN	1:1	1:10	1:20	1:50	1:100	1:500
[inch]	[lb/min]	[lb/min]	[lb/min]	[lb/min]	[lb/min]	[lb/min]
$\frac{3}{8}$	73.50	7.350	3.675	1.470	0.735	0.147
$\frac{1}{2}$	238.9	23.89	11.95	4.778	2.389	0.478
1	661.5	66.15	33.08	13.23	6.615	1.323
$1\frac{1}{2}$	1 654	165.4	82.70	33.08	16.54	3.308
2	2 573	257.3	128.7	51.46	25.73	5.146
3	6 615	661.5	330.8	132.3	66.15	13.23

**Accuracy of outputs**

The outputs have the following base accuracy specifications.

*Current output*

Accuracy	±5 µA
----------	-------

*Pulse/frequency output*

o.r. = of reading

Accuracy	Max. ±50 ppm o.r. (over the entire ambient temperature range)
----------	---

Repeatability o.r. = of reading;  $1 \text{ g/cm}^3 = 1 \text{ kg/l}$ ; T = medium temperature

### Base repeatability

 Design fundamentals →  244

#### *Mass flow and volume flow (liquids)*

$\pm 0.075 \%$  o.r.

$\pm 0.05 \%$  o.r. (calibration option, for mass flow)

#### *Mass flow (gases)*

$\pm 0.25 \%$  o.r. (up to a Mach number of 0.2)

#### *Density (liquids)*

$\pm 0.00025 \text{ g/cm}^3$

#### *Temperature*

$\pm 0.25 \text{ }^\circ\text{C} \pm 0.0025 \cdot T \text{ }^\circ\text{C}$  ( $\pm 0.45 \text{ }^\circ\text{F} \pm 0.0015 \cdot (T-32) \text{ }^\circ\text{F}$ )

Response time The response time depends on the configuration (damping).

Influence of ambient temperature

### Current output

Temperature coefficient	Max. $1 \mu\text{A}/^\circ\text{C}$
-------------------------	-------------------------------------

### Pulse/frequency output

Temperature coefficient	No additional effect. Included in accuracy.
-------------------------	---

Influence of medium temperature

### Mass flow

o.f.s. = of full scale value

If there is a difference between the temperature during zero adjustment and the process temperature, the additional measurement error of the sensors is typically  $\pm 0.0002 \%$  o.f.s./ $^\circ\text{C}$  ( $\pm 0.0001 \%$  o. f.s./ $^\circ\text{F}$ ).

The influence is reduced when the zero adjustment is performed at process temperature.

### Density

If there is a difference between the density calibration temperature and the process temperature, the measurement error of the sensors is typically  $\pm 0.0001 \text{ g/cm}^3/^\circ\text{C}$  ( $\pm 0.00005 \text{ g/cm}^3/^\circ\text{F}$ ). Field density adjustment is possible.

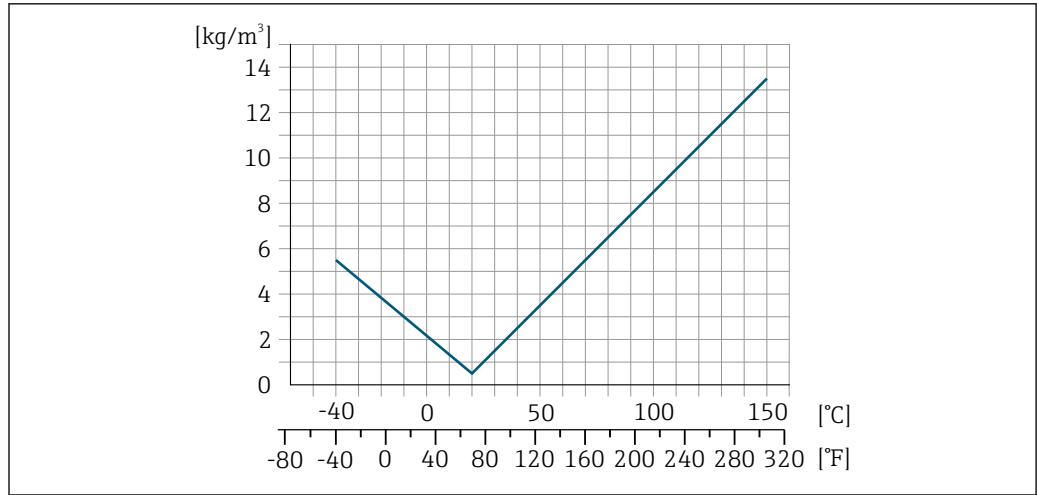

42 Field density adjustment, for example at +20 °C (+68 °F)

**Temperature**

$\pm 0.005 \cdot T \text{ } ^\circ\text{C}$  ( $\pm 0.005 \cdot (T - 32) \text{ } ^\circ\text{F}$ )

**Influence of medium pressure**

The following shows how the process pressure (gauge pressure) affects the accuracy of the mass flow.

o.r. = of reading



It is possible to compensate for the effect by:

- Reading in the current pressure measured value via the current input or a digital input.
- Specifying a fixed value for the pressure in the device parameters.



Operating Instructions .

DN		[% o.r./bar]	[% o.r./psi]
[mm]	[in]		
8	3/8	no influence	
15	1/2	no influence	
25	1	no influence	
40	1 1/2	no influence	
50	2	-0.009	-0.0006
80	3	-0.020	-0.0014

**Design fundamentals**

o.r. = of reading, o.f.s. = of full scale value

BaseAccu = base accuracy in % o.r., BaseRepeat = base repeatability in % o.r.

MeasValue = measured value; ZeroPoint = zero point stability

Calculation of the maximum measured error as a function of the flow rate

Flow rate	Maximum measured error in % o.r.
$\geq \frac{\text{ZeroPoint}}{\text{BaseAccu}} \cdot 100$ <small>A0021332</small>	$\pm \text{BaseAccu}$ <small>A0021339</small>
$< \frac{\text{ZeroPoint}}{\text{BaseAccu}} \cdot 100$ <small>A0021333</small>	$\pm \frac{\text{ZeroPoint}}{\text{MeasValue}} \cdot 100$ <small>A0021334</small>

Calculation of the maximum repeatability as a function of the flow rate

Flow rate	Maximum repeatability in % o.r.
$\geq \frac{1}{2} \cdot \frac{\text{ZeroPoint}}{\text{BaseRepeat}} \cdot 100$ <small>A0021335</small>	$\pm \text{BaseRepeat}$ <small>A0021340</small>
$< \frac{1}{2} \cdot \frac{\text{ZeroPoint}}{\text{BaseRepeat}} \cdot 100$ <small>A0021336</small>	$\pm \frac{1}{2} \cdot \frac{\text{ZeroPoint}}{\text{MeasValue}} \cdot 100$ <small>A0021337</small>

**Example of maximum measurement error**

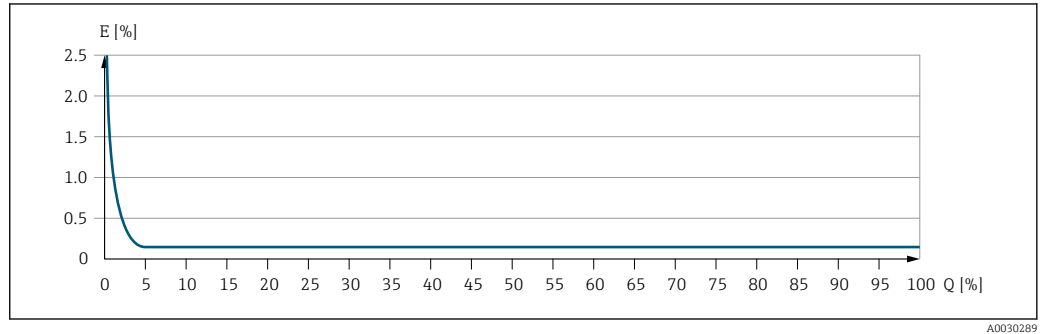

E Maximum measurement error in % o.r. (example)  
 Q Flow rate in % of maximum full scale value

## 16.7 Mounting

Mounting requirements → 22

## 16.8 Environment

Ambient temperature range → 25

**Temperature tables**

- Observe the interdependencies between the permitted ambient and fluid temperatures when operating the device in hazardous areas.
- For detailed information on the temperature tables, see the separate document entitled "Safety Instructions" (XA) for the device.

Storage temperature

Climate class                      DIN EN 60068-2-38 (test Z/AD)

Relative humidity                      The device is suitable for use outdoors and indoors with a relative humidity of 4 to 95 %.

Operating height                      According to EN 61010-1  
 ■ ≤ 2 000 m (6 562 ft)  
 ■ > 2 000 m (6 562 ft) with additional overvoltage protection (e.g. Endress+Hauser HAW Series)

## Degree of protection

**Transmitter**

- IP66/67, Type 4X enclosure, suitable for pollution degree 4
- When the housing is open: IP20, Type 1 enclosure, suitable for pollution degree 2
- Display module: IP20, Type 1 enclosure, suitable for pollution degree 2

**Sensor**

- IP66/67, Type 4X enclosure, suitable for pollution degree 4
- When the housing is open: IP20, Type 1 enclosure, suitable for pollution degree 2

*Optional*

Order code for "Sensor options", option CM "IP69

**External WLAN antenna**

IP67

## Shock and vibration resistance

**Vibration sinusoidal, in accordance with IEC 60068-2-6**

## Sensor

- 2 to 8.4 Hz, 3.5 mm peak
- 8.4 to 2 000 Hz, 1 g peak

## Transmitter

- 2 to 8.4 Hz, 7.5 mm peak
- 8.4 to 2 000 Hz, 2 g peak

**Vibration broad-band random, according to IEC 60068-2-64**

## Sensor

- 10 to 200 Hz, 0.003 g<sup>2</sup>/Hz
- 200 to 2 000 Hz, 0.001 g<sup>2</sup>/Hz
- Total: 1.54 g rms

## Transmitter

- 10 to 200 Hz, 0.01 g<sup>2</sup>/Hz
- 200 to 2 000 Hz, 0.003 g<sup>2</sup>/Hz
- Total: 2.70 g rms

**Shock half-sine, according to IEC 60068-2-27**

- Sensor  
6 ms 30 g
- Transmitter  
6 ms 50 g

**Rough handling shocks according to IEC 60068-2-31**

## Internal cleaning

- CIP cleaning
- SIP cleaning

**Options**

Oil- and grease-free version for wetted parts, without declaration  
Order code for "Service", option HA <sup>3)</sup>

## Mechanical load

Transmitter housing and sensor connection housing:

- Protect against mechanical effects, such as shock or impact
- Do not use as a ladder or climbing aid

3) The cleaning refers to the measuring instrument only. Any accessories supplied are not cleaned.

Electromagnetic compatibility (EMC)

- As per IEC/EN 61326 and NAMUR Recommendation 21 (NE 21)
- As per IEC/EN 61000-6-2 and IEC/EN 61000-6-4



Details are provided in the Declaration of Conformity.



This unit is not intended for use in residential environments and cannot guarantee adequate protection of the radio reception in such environments.

## 16.9 Process

Medium temperature range -40 to +150 °C (-40 to +302 °F)

Pressure-temperature ratings



For an overview of the pressure-temperature ratings for the process connections, see the Technical Information

Sensor housing

The sensor housing is filled with dry nitrogen gas and protects the electronics and mechanics inside.



If a measuring tube fails (e.g. due to process characteristics like corrosive or abrasive fluids), the fluid will initially be contained by the sensor housing.

In the event of a tube failure, the pressure level inside the sensor housing will rise according to the operating process pressure. If the user judges that the sensor housing burst pressure does not provide an adequate safety margin, the device can be fitted with a rupture disk. This prevents excessively high pressure from forming inside the sensor housing. Therefore, the use of a rupture disk is strongly recommended in applications involving high gas pressures, and particularly in applications in which the process pressure is greater than 2/3 of the sensor housing burst pressure.

### Burst pressure of the sensor housing

If the device is fitted with a rupture disk (order code for "Sensor option", option CA "Rupture disk"), the rupture disk trigger pressure is decisive.

The sensor housing burst pressure refers to a typical internal pressure which is reached prior to mechanical failure of the sensor housing and which was determined during type testing. The corresponding type test declaration can be ordered with the device (order code for "Additional approval", option LN "Sensor housing burst pressure, type test").

DN		Sensor housing burst pressure	
[mm]	[in]	[bar]	[psi]
8	$\frac{3}{8}$	250	3 620
15	$\frac{1}{2}$	250	3 620
25	1	250	3 620
40	$1\frac{1}{2}$	200	2 900
50	2	180	2 610
80	3	120	1 740





For information on the dimensions: see the "Mechanical construction" section of the "Technical Information" document



**Rupture disk** To increase the level of safety, a device version with a rupture disk with a trigger pressure of 10 to 15 bar (145 to 217.5 psi) can be used (order code for "Sensor option", option CA "rupture disk").

The use of rupture disks cannot be combined with the separately available heating jacket.

**Flow limit** Select the nominal diameter by optimizing between the required flow range and permissible pressure loss.

 For an overview of the full scale values for the measuring range, see the "Measuring range" section →  231

- The minimum recommended full scale value is approx. 1/20 of the maximum full scale value
- In most applications, 20 to 50 % of the maximum full scale value can be considered ideal
- A low full scale value must be selected for abrasive media (such as liquids with entrained solids): flow velocity < 1 m/s (< 3 ft/s).
- For gas measurement the following rules apply:
  - The flow velocity in the measuring tubes should not exceed half the sound velocity (0.5 Mach).
  - The maximum mass flow depends on the density of the gas: formula

 To calculate the flow limit, use the *Applicator* sizing tool →  228

**Pressure loss**  To calculate the pressure loss, use the *Applicator* sizing tool →  228

**System pressure** →  25

## 16.10 Mechanical construction

**Design, dimensions**  For the dimensions and installation lengths of the device, see the "Technical Information" document, "Mechanical construction" section

**Weight** All values (weight exclusive of packaging material) refer to devices with EN/DIN PN 40 flanges.

**Transmitter**

- Proline 500 – digital polycarbonate: 1.4 kg (3.1 lbs)
- Proline 500 – digital aluminum: 2.4 kg (5.3 lbs)
- Proline 500 aluminum: 6.5 kg (14.3 lbs)

**Sensor**  
Sensor with aluminum connection housing version:

### Weight in SI units

DN [mm]	Weight [kg]
8	4
15	4
25	6
40	10



DN [mm]	Weight [kg]
50	15
80	29

### Weight in US units

DN [in]	Weight [lbs]
3/8	9
1/2	9
1	13
1 1/2	22
2	33
3	64

## Materials

### Transmitter housing

#### *Housing of Proline 500 – digital transmitter*

Order code for "Transmitter housing":

- Option **A** "Aluminum coated": aluminum, AlSi10Mg, coated
- Option **D** "Polycarbonate": polycarbonate

#### *Housing of Proline 500 transmitter*

Order code for "Transmitter housing":

Option **A** "Aluminum coated": aluminum, AlSi10Mg, coated

#### *Window material*

Order code for "Transmitter housing":

- Option **A** "Aluminum, coated": glass
- Option **D** "Polycarbonate": plastic

#### *Fastening components for mounting on a post*

- Screws, threaded bolts, washers, nuts: stainless A2 (chrome-nickel steel)
- Metal plates: stainless steel, 1.4301 (304)

### Sensor connection housing

Order code for "Sensor connection housing":

- Option **A** "Aluminum coated": aluminum, AlSi10Mg, coated
- Option **B** "Stainless":
  - Stainless steel 1.4301 (304)
  - Optional: Order code for "Sensor feature", option **CC** "Hygienic version, for maximum corrosion resistance": stainless steel, 1.4404 (316L)
- Option **C** "Ultra-compact, stainless":
  - Stainless steel 1.4301 (304)
  - Optional: Order code for "Sensor feature", option **CC** "Hygienic version, for maximum corrosion resistance": stainless steel, 1.4404 (316L)

### Cable entries/cable glands

Cable entries and adapters	Material
Cable gland M20 × 1.5	Plastic
<ul style="list-style-type: none"> <li>▪ Adapter for cable entry with female thread G ½"</li> <li>▪ Adapter for cable entry with female thread NPT ½"</li> </ul> <p> Only available for certain device versions:</p> <ul style="list-style-type: none"> <li>▪ Order code for "Transmitter housing": <ul style="list-style-type: none"> <li>▪ Option A "Aluminum, coated"</li> <li>▪ Option D "Polycarbonate"</li> </ul> </li> <li>▪ Order code for "Sensor connection housing": <ul style="list-style-type: none"> <li>▪ Proline 500 – digital: <ul style="list-style-type: none"> <li>Option A "Aluminum coated"</li> <li>Option B "Stainless"</li> </ul> </li> <li>▪ Proline 500: <ul style="list-style-type: none"> <li>Option B "Stainless"</li> </ul> </li> </ul> </li> </ul>	Nickel-plated brass

**Connecting cables**

 UV rays can impair the cable outer sheath. Protect the cable from exposure to sun as much as possible.

*Connecting cable for sensor - Proline 500 – digital transmitter*

PVC cable with copper shield

*Connecting cable for sensor - Proline 500 transmitter*

PVC cable with copper shield

**Sensor housing**



- Acid and alkali-resistant outer surface
- Stainless steel 1.4301 (304)

**Measuring tubes**

Stainless steel, 1.4539 (904L); manifold: stainless steel, 1.4404 (316L)

**Process connections**

- Flanges according to EN 1092-1 (DIN2501) / according to ASME B 16.5 / as per JIS B2220:
  - Stainless steel, 1.4404 (F316/F316L)
- All other process connections:
  - Stainless steel, 1.4404 (316/316L)

 Available process connections →  251

**Seals**

Welded process connections without internal seals

**Accessories**

*Protective cover*

Stainless steel, 1.4404 (316L)

*External WLAN antenna*

- Antenna: ASA plastic (acrylonitrile styrene acrylate) and nickel-plated brass
- Adapter: Stainless steel and nickel-plated brass
- Cable: Polyethylene
- Plug: Nickel-plated brass
- Angle bracket: Stainless steel

## Process connections

- Fixed flange connections:
  - EN 1092-1 (DIN 2501) flange
  - EN 1092-1 (DIN 2512N) flange
  - NAMUR lengths in accordance with NE 132
  - ASME B16.5 flange
  - JIS B2220 flange
  - DIN 11864-2 Form A flange, DIN 11866 series A, flange with notch
- Clamp connections:
  - Tri-Clamp (OD tubes), DIN 11866 series C
- Thread:
  - DIN 11851 thread, DIN 11866 series A
  - SMS 1145 thread
  - ISO 2853 thread, ISO 2037
  - DIN 11864-1 Form A thread, DIN 11866 series A
- VCO connections:
  - 8-VCO-4
  - 12-VCO-4



Process connection materials → 250

## Surface roughness

All data refer to parts in contact with the medium.

*The following surface roughness categories can be ordered:*

Category	Method	Option(s) order code "Measuring tube mat., wetted surface"
Not polished	–	SA
$Ra \leq 0.76 \mu\text{m}$ (30 $\mu\text{in}$ ) <sup>1)</sup>	Mechanically polished <sup>2)</sup>	SB
$Ra \leq 0.76 \mu\text{m}$ (30 $\mu\text{in}$ ) <sup>1)</sup>	Mechanically polished <sup>2)</sup> , welds in as-welded condition	SJ
$Ra \leq 0.38 \mu\text{m}$ (15 $\mu\text{in}$ ) <sup>1)</sup>	Mechanically polished <sup>2)</sup>	SC
$Ra \leq 0.38 \mu\text{m}$ (15 $\mu\text{in}$ ) <sup>1)</sup>	Mechanically polished <sup>2)</sup> , welds in as-welded condition	SK

1) Ra according to ISO 21920

2) Except for inaccessible welds between pipe and manifold

## 16.11 User interface

### Languages

Can be operated in the following languages:

- Via local operation
  - English, German, French, Spanish, Italian, Dutch, Portuguese, Polish, Russian, Turkish, Chinese, Japanese, Korean, Vietnamese, Czech, Swedish
- Via web browser
  - English, German, French, Spanish, Italian, Dutch, Portuguese, Polish, Russian, Turkish, Chinese, Japanese, Vietnamese, Czech, Swedish
- Via "FieldCare", "DeviceCare" operating tool: English, German, French, Spanish, Italian, Chinese, Japanese

### Onsite operation

#### Via display module

Features:

- Order code for "Display; operation", option F "4-line, illuminated, graphic display; touch control"
- Order code for "Display; operation", option G "4-line, illuminated, graphic display; touch control + WLAN"

 Information about WLAN interface →  93

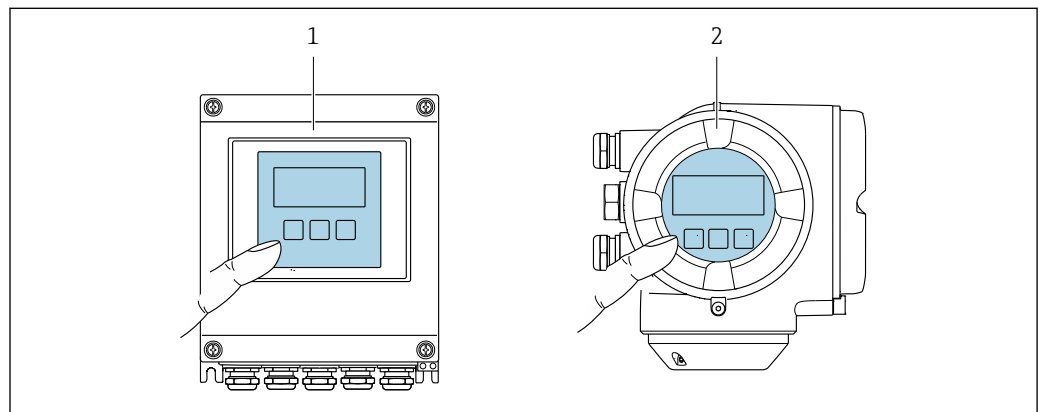



 43 Operation with touch control

- 1 Proline 500 - digital
- 2 Proline 500

#### Display elements

- 4-line, illuminated, graphic display
- White background lighting; switches to red in event of device errors
- Format for displaying measured variables and status variables can be individually configured

#### Operating elements

- External operation via touch control (3 optical keys) without opening the housing: , , 
- Operating elements also accessible in the various zones of the hazardous area





### Remote operation

→  91

### Service interface

→  92

**Supported operating tools** Different operating tools can be used for local or remote access to the measuring device. Depending on the operating tool used, access is possible with different operating units and via a variety of interfaces.

Supported operating tools	Operating unit	Interface	Additional information
Web browser	Notebook, PC or tablet with Web browser	<ul style="list-style-type: none"> <li>■ CDI-RJ45 service interface</li> <li>■ WLAN interface</li> <li>■ Ethernet-based fieldbus (EtherNet/IP, PROFINET)</li> </ul>	Special Documentation for device →  260
DeviceCare SFE100	Notebook, PC or tablet with Microsoft Windows system	<ul style="list-style-type: none"> <li>■ CDI-RJ45 service interface</li> <li>■ WLAN interface</li> <li>■ Fieldbus protocol</li> </ul>	→  228
FieldCare SFE500	Notebook, PC or tablet with Microsoft Windows system	<ul style="list-style-type: none"> <li>■ CDI-RJ45 service interface</li> <li>■ WLAN interface</li> <li>■ Fieldbus protocol</li> </ul>	→  228
Field Xpert	SMT70/77/50	<ul style="list-style-type: none"> <li>■ All fieldbus protocols</li> <li>■ WLAN interface</li> <li>■ Bluetooth</li> <li>■ CDI-RJ45 service interface</li> </ul>	Operating Instructions BA01202S Device description files: Use update function of handheld terminal
SmartBlue app	Smartphone or tablet with iOS or Android	WLAN	→  228



Other operating tools based on FDT technology with a device driver such as DTM/iDTM or DD/EDD can be used for device operation. These operating tools are available from the individual manufacturers. Integration into the following operating tools, among others, is supported:

- Field Device Manager (FDM) from Honeywell → [www.process.honeywell.com](http://www.process.honeywell.com)
- FieldMate from Yokogawa → [www.yokogawa.com](http://www.yokogawa.com)
- PACTWare → [www.pactware.com](http://www.pactware.com)

The related device description files are available: [www.endress.com](http://www.endress.com) → Download Area

### Web server



With the integrated web server, the device can be operated and configured via a web browser and via the service interface (CDI-RJ45) or WLAN interface. The structure of the operating menu is the same as for the local display. In addition to the measured values, status information on the device is displayed and can be used to monitor device health. Furthermore the device data can be managed and the network parameters can be configured.

A device that has a WLAN interface (can be ordered as an option) is required for the WLAN connection: order code for "Display; operation", option G "4-line, illuminated; touch control + WLAN". The device acts as an Access Point and enables communication by computer or a mobile handheld terminal.

#### Supported functions

Data exchange between the operating unit (such as a notebook, for example,) and measuring instrument:

- Upload the configuration from the measuring instrument (XML format, configuration backup)
- Save the configuration to the measuring instrument (XML format, restore configuration)
- Export event list (.csv file)

- Export parameter settings (.csv file or PDF file, document the measuring point configuration)
- Export the Heartbeat Technology verification report (PDF file, only available with the **Heartbeat Verification** →  257 application package)
- Flash firmware version for device firmware upgrade, for example
- Download driver for system integration
- Visualize up to 1000 saved measured values (only available with the **Extended HistoROM** application package →  257)

HistoROM data management

The measuring device features HistoROM data management. HistoROM data management comprises both the storage and import/export of key device and process data, making operation and servicing far more reliable, secure and efficient.

 When the device is delivered, the factory settings of the configuration data are stored as a backup in the device memory. This memory can be overwritten with an updated data record, for example after commissioning.

**Additional information on the data storage concept**

There are different types of data storage units in which device data are stored and used by the device:

	HistoROM backup	T-DAT	S-DAT
<b>Available data</b>	<ul style="list-style-type: none"> <li>■ Event logbook, e.g. diagnostic events</li> <li>■ Parameter data record backup</li> <li>■ Device firmware package</li> <li>■ Driver for system integration for exporting via web server, e.g.: EDS for EtherNet/IP</li> </ul>	<ul style="list-style-type: none"> <li>■ Measured value logging ("Extended HistoROM" order option)</li> <li>■ Current parameter data record (used by firmware at run time)</li> <li>■ Indicator (minimum/maximum values)</li> <li>■ Totalizer value</li> </ul>	<ul style="list-style-type: none"> <li>■ Sensor data: e.g. nominal diameter</li> <li>■ Serial number</li> <li>■ Calibration data</li> <li>■ Device configuration (e.g. SW options, fixed I/O or multi I/O)</li> </ul>
<b>Storage location</b>	Fixed on the user interface PC board in the connection compartment	Can be plugged into the user interface PC board in the connection compartment	In the sensor plug in the transmitter neck part

**Data backup**

**Automatic**

- The most important device data (sensor and transmitter) are automatically saved in the DAT modules
- If the transmitter or measuring device is replaced: once the T-DAT containing the previous device data has been exchanged, the new measuring device is ready for operation again immediately without any errors
- If the sensor is replaced: once the sensor has been replaced, new sensor data are transferred from the S-DAT in the measuring device and the measuring device is ready for operation again immediately without any errors
- If exchanging the electronics module (e.g. I/O electronics module): Once the electronics module has been replaced, the software of the module is compared against the current device firmware. The module software is upgraded or downgraded where necessary. The electronics module is available for use immediately afterwards and no compatibility problems occur.

**Manual**

Additional parameter data record (complete parameter settings) in the integrated device memory HistoROM backup for:

- Data backup function  
Backup and subsequent restoration of a device configuration in the device memory HistoROM backup
- Data comparison function  
Comparison of the current device configuration with the device configuration saved in the device memory HistoROM backup

**Data transmission****Manual**

- Transfer of a device configuration to another device using the export function of the specific operating tool, e.g. with FieldCare, DeviceCare or Web server: to duplicate the configuration or to store in an archive (e.g. for backup purposes)
- Transmission of the drivers for system integration via Web server, e.g.: EDS for EtherNet/IP

**Event list****Automatic**

- Chronological display of up to 20 event messages in the events list
- If the **Extended HistoROM** application package (order option) is enabled: up to 100 event messages are displayed in the events list along with a time stamp, plain text description and remedial measures
- The events list can be exported and displayed via a variety of interfaces and operating tools e.g. DeviceCare, FieldCare or Web server

**Data logging****Manual**

If the **Extended HistoROM** application package (order option) is enabled:

- Recording of 1 to 4 channels of up to 1 000 measured values (up to 250 measured values per channel)
- User configurable recording interval
- Export the measured value log via a variety of interfaces and operating tools e.g. FieldCare, DeviceCare or web server

## 16.12 Certificates and approvals

Current certificates and approvals for the product are available at [www.endress.com](http://www.endress.com) on the relevant product page:

1. Select the product using the filters and search field.
2. Open the product page.
3. Select **Downloads**.

---

**CE mark**

The device meets the legal requirements of the applicable EU Directives. These are listed in the corresponding EU Declaration of Conformity along with the standards applied.

Endress+Hauser confirms successful testing of the device by affixing to it the CE mark.

---

**UKCA marking**

The device meets the legal requirements of the applicable UK regulations (Statutory Instruments). These are listed in the UKCA Declaration of Conformity along with the designated standards. By selecting the order option for UKCA marking, Endress+Hauser confirms a successful evaluation and testing of the device by affixing the UKCA mark.

Contact address Endress+Hauser UK:

Endress+Hauser Ltd.  
Floats Road  
Manchester M23 9NF  
United Kingdom  
[www.uk.endress.com](http://www.uk.endress.com)

---



**RCM marking**

The measuring system meets the EMC requirements of the "Australian Communications and Media Authority (ACMA)".

<p>Hygienic compatibility</p>	<ul style="list-style-type: none"> <li>■ 3-A approval                     <ul style="list-style-type: none"> <li>■ Only measuring instruments with the order code for "Additional approval", option LP "3A" have 3-A approval.</li> <li>■ The 3-A approval refers to the measuring instrument.</li> <li>■ When installing the measuring instrument, ensure that no liquid can accumulate on the outside of the measuring instrument. A remote display module must be installed in accordance with the 3-A Standard.</li> <li>■ Accessories (e.g. heating jacket, weather protection cover, wall holder unit) must be installed in accordance with the 3-A Standard. Each accessory can be cleaned. Disassembly may be necessary under certain circumstances.</li> </ul> </li> <li>■ EHEDG-tested Only devices with the order code for "Additional approval", option LT "EHEDG" have been tested and meet the requirements of the EHEDG. To meet the requirements for EHEDG certification, the device must be used with process connections in accordance with the EHEDG position paper entitled "Easy cleanable Pipe couplings and Process connections" (<a href="http://www.ehedg.org">www.ehedg.org</a>). To meet the requirements for EHEDG certification, the device must be installed in a position that ensures drainability.</li> <li>■ FDA</li> <li>■ Food Contact Materials Regulation (EC) 1935/2004</li> </ul> <p> Observe the special installation instructions</p>
-------------------------------	--

<p>EtherNet/IP certification</p>	<p>The measuring device is certified and registered by the ODVA (Open Device Vendor Association). The measuring system meets all the requirements of the following specifications:</p> <ul style="list-style-type: none"> <li>■ Certified in accordance with the ODVA Conformance Test</li> <li>■ EtherNet/IP Performance Test</li> <li>■ EtherNet/IP PlugFest compliance</li> <li>■ The device can also be operated with certified devices of other manufacturers (interoperability)</li> </ul>
----------------------------------	--

<p>Pressure Equipment Directive</p>	<ul style="list-style-type: none"> <li>■ With the marking                     <ol style="list-style-type: none"> <li>a) PED/G1/x (x = category) or</li> <li>b) PESR/G1/x (x = category)</li> </ol>                     on the sensor nameplate, Endress+Hauser confirms compliance with the "Essential Safety Requirements"                     <ol style="list-style-type: none"> <li>a) specified in Annex I of the Pressure Equipment Directive 2014/68/EU or</li> <li>b) Schedule 2 of Statutory Instruments 2016 No. 1105.</li> </ol> </li> <li>■ Devices not bearing this marking (without PED or PESR) are designed and manufactured according to sound engineering practice. They meet the requirements of                     <ol style="list-style-type: none"> <li>a) Art. 4 Para. 3 of the Pressure Equipment Directive 2014/68/EU or</li> <li>b) Part 1, Para. 8 of Statutory Instruments 2016 No. 1105.</li> </ol>                     The scope of application is indicated                     <ol style="list-style-type: none"> <li>a) in diagrams 6 to 9 in Annex II of the Pressure Equipment Directive 2014/68/EU or</li> <li>b) Schedule 3, Para. 2 of Statutory Instruments 2016 No. 1105.</li> </ol> </li> </ul>
-------------------------------------	--

<p>Radio approval</p>	<p>The measuring device has radio approval.</p> <p> For detailed information on the radio approval, see the Special Documentation →  260</p>
-----------------------	--

<p>Additional certification</p>	<p><b>CRN approval</b></p> <p>Some device versions have CRN approval. A CRN-approved process connection with a CSA approval must be ordered for a CRN-approved device.</p>
---------------------------------	--



## Tests and certificates

### External standards and guidelines

- EN 60529  
Degrees of protection provided by enclosures (IP code)
- IEC/EN 60068-2-6  
Environmental influences: Test procedure - Test Fc: vibrate (sinusoidal).
- IEC/EN 60068-2-31  
Environmental influences: Test procedure - Test Ec: shocks due to rough handling, primarily for devices.
- EN 61010-1  
Safety requirements for electrical equipment for measurement, control and laboratory use - general requirements
- EN 61326-1/-2-3  
EMC requirements for electrical equipment for measurement, control and laboratory use
- NAMUR NE 21  
Electromagnetic compatibility (EMC) of industrial process and laboratory control equipment
- NAMUR NE 32  
Data retention in the event of a power failure in field and control instruments with microprocessors
- NAMUR NE 43  
Standardization of the signal level for the breakdown information of digital transmitters with analog output signal.
- NAMUR NE 53  
Software of field devices and signal-processing devices with digital electronics
- NAMUR NE 80  
The application of the pressure equipment directive to process control devices
- NAMUR NE 105  
Specifications for integrating fieldbus devices in engineering tools for field devices
- NAMUR NE 107  
Self-monitoring and diagnosis of field devices
- NAMUR NE 131  
Requirements for field devices for standard applications
- NAMUR NE 132  
Coriolis mass meter
- ETSI EN 300 328  
Guidelines for 2.4 GHz radio components.
- EN 301489  
Electromagnetic compatibility and radio spectrum matters (ERM).

## 16.13 Application packages

Many different application packages are available to enhance the functionality of the device. Such packages might be needed to address safety aspects or specific application requirements.

The application packages can be ordered with the device or subsequently from Endress+Hauser. Detailed information on the order code in question is available from your local Endress+Hauser sales center or on the product page of the Endress+Hauser website: [www.endress.com](http://www.endress.com).



Detailed information on the application packages:  
Special Documentation → 260

### Diagnostic functionality

Order code for "Application package", option EA "Extended HistoROM"

Comprises extended functions concerning the event log and the activation of the measured value memory.

Event log:

Memory volume is extended from 20 message entries (standard version) to up to 100 entries.

Data logging (line recorder):

- Memory capacity for up to 1000 measured values is activated.
- 250 measured values can be output via each of the 4 memory channels. The recording interval can be defined and configured by the user.
- Measured value logs can be accessed via the local display or operating tool e.g. FieldCare, DeviceCare or Web server.



For detailed information, see the Operating Instructions for the device.

Heartbeat Technology

Order code for "Application package", option EB "Heartbeat Verification + Monitoring"

**Heartbeat Verification**

Meets the requirement for traceable verification to DIN ISO 9001:2008 Chapter 7.6 a) "Control of monitoring and measuring equipment".

- Functional testing in the installed state without interrupting the process.
- Traceable verification results on request, including a report.
- Simple testing process via local operation or other operating interfaces.
- Clear measuring point assessment (pass/fail) with high test coverage within the framework of manufacturer specifications.
- Extension of calibration intervals according to operator's risk assessment.

**Heartbeat Monitoring**

Continuously supplies data, which are characteristic of the measuring principle, to an external condition monitoring system for the purpose of preventive maintenance or process analysis. These data enable the operator to:

- Draw conclusions - using these data and other information - about the impact process influences (e.g. corrosion, abrasion, buildup etc.) have on the measuring performance over time.
- Schedule servicing in time.
- Monitor the process or product quality, e.g. gas pockets .



For detailed information, see the Special Documentation for the device.

Concentration measurement

Order code for "Application package", option ED "Concentration"

Calculation and outputting of fluid concentrations.

The measured density is converted to the concentration of a substance of a binary mixture using the "Concentration" application package:

- Choice of predefined fluids (e.g. various sugar solutions, acids, alkalis, salts, ethanol etc.).
- Common or user-defined units (°Brix, °Plato, % mass, % volume, mol/l etc.) for standard applications.
- Concentration calculation from user-defined tables.



For detailed information, see the Special Documentation for the device.

Petroleum

Order code for "Application package", option EJ "Petroleum"

The most important parameters for the Oil & Gas Industry can be calculated and displayed with this application package.

- Corrected volume flow and calculated reference density in accordance with the "API Manual of Petroleum Measurement Standards, Chapter 11.1"
- Water content, based on density measurement
- Weighted mean of the density and temperature



For detailed information, see the Special Documentation for the device.

Petroleum & locking function

Order code for "Application package", option EM "Petroleum & locking function"

The most important parameters for the Oil & Gas Industry can be calculated and displayed with this application package. It is also possible to lock the settings.

- Corrected volume flow and calculated reference density in accordance with the "API Manual of Petroleum Measurement Standards, Chapter 11.1"
- Water content, based on density measurement
- Weighted mean of the density and temperature



For detailed information, see the Special Documentation for the device.

## 16.14 Accessories



Overview of accessories available to order → 226

## 16.15 Supplemental documentation



For an overview of the scope of the associated Technical Documentation, refer to the following:

- *Device Viewer* ([www.endress.com/deviceviewer](http://www.endress.com/deviceviewer)): Enter the serial number from the nameplate
- *Endress+Hauser Operations app*: Enter serial number from nameplate or scan matrix code on nameplate.

Standard documentation

### Brief operating instructions

*Brief Operating Instructions for the sensor*

Measuring instrument	Documentation code
Proline Promass E	KA01260D

*Brief Operating Instructions for the transmitter*

Measuring device	Documentation code
Proline 500 – digital	KA01346D
Proline 500	KA01347D

### Technical information

Measuring device	Documentation code
Promass E 500	TI01282D

### Description of device parameters

Measuring instrument	Documentation code
Promass 500	GP01120D

Supplementary device-dependent documentation

### Safety instructions



Safety instructions for electrical equipment for hazardous areas.

Contents	Documentation code
	Measuring device
ATEX/IECEX Ex i	XA01473D
ATEX/IECEX Ex ec	XA01474D
cCSAus IS	XA01475D
cCSAus Ex i	XA01509D
cCSAus Ex nA	XA01510D
INMETRO Ex i	XA01476D
INMETRO Ex ec	XA01477D
NEPSI Ex i	XA01478D
NEPSI Ex nA	XA01479D
NEPSI Ex i	XA01658D
NEPSI Ex nA	XA01659D
JPN	XA01780D

### Special documentation

Contents	Documentation code
Information on the Pressure Equipment Directive	SD01614D
Radio approvals for WLAN interface for A309/A310 display module	SD01793D
Web server	SD01970D
Heartbeat Technology	SD01983D
Concentration measurement	SD02006D
Petroleum	SD02012D

### Installation instructions

Contents	Note
Installation instructions for spare part sets and accessories	<ul style="list-style-type: none"> <li>Access the overview of all the available spare part sets via <i>Device Viewer</i> →  224</li> <li>Accessories available for order with Installation Instructions →  226</li> </ul>

# Index

## 0 ... 9

3-A approval . . . . . 256

## A

Access authorization to parameters

    Read access . . . . . 82

    Write access . . . . . 82

Access code . . . . . 82

    Incorrect input . . . . . 82

Adapting the diagnostic behavior . . . . . 203

Additional certification . . . . . 256

Ambient conditions

    Mechanical load . . . . . 246

    Operating height . . . . . 245

    Relative humidity . . . . . 245

    Shock and vibration resistance . . . . . 246

    Storage temperature . . . . . 245

Ambient temperature

    Influence . . . . . 243

Ambient temperature range . . . . . 245

Application . . . . . 230

Application packages . . . . . 257

Applicator . . . . . 231

Approvals . . . . . 255

Attaching the connecting cable

    Proline 500 transmitter . . . . . 55

## C

Cable entries

    Technical data . . . . . 241

Cable entry

    Degree of protection . . . . . 67

CE mark . . . . . 10, 255

Certificates . . . . . 255

Checklist

    Post-connection check . . . . . 67

    Post-installation check . . . . . 34

CIP cleaning . . . . . 246

Cleaning

    CIP cleaning . . . . . 223

    Exterior cleaning . . . . . 223

    Internal cleaning . . . . . 223

    SIP cleaning . . . . . 223

Climate class . . . . . 245

Commissioning . . . . . 114

    Advanced settings . . . . . 144

    Configuring the measuring instrument . . . . . 115

Connecting the connecting cable

    Proline 500 – digital transmitter . . . . . 46

    Sensor connection housing, Proline 500 - digital . . . . . 42

    Terminal assignment of Proline 500 - digital . . . . . 42

Connecting the measuring instrument

    Proline 500 . . . . . 52

    Proline 500 – digital . . . . . 42

Connecting the signal cable/supply voltage cable

    Proline 500 – digital transmitter . . . . . 47

Connecting the signal cables . . . . . 56

Connecting the supply voltage cables . . . . . 56

Connection

    see Electrical connection

Connection cable . . . . . 35

Connection preparations . . . . . 41

Connection tool . . . . . 35

Context menu

    Calling up . . . . . 78

    Closing . . . . . 78

    Explanation . . . . . 78

Current consumption . . . . . 240

Cyclic data transmission . . . . . 98

## D

Date of manufacture . . . . . 17, 19

Declaration of Conformity . . . . . 10

Defining the access code . . . . . 167, 168

Degree of protection . . . . . 67, 246

Density adjustment . . . . . 147

Design

    Measuring device . . . . . 14

    Operating menu . . . . . 69

Design fundamentals

    Measurement error . . . . . 244

    Repeatability . . . . . 244

Device components . . . . . 14

Device description files . . . . . 97

Device locking, status . . . . . 171

Device name

    Sensor . . . . . 19

    Transmitter . . . . . 17

Device repair . . . . . 224

Device revision . . . . . 97

Device type code . . . . . 97

Device Viewer . . . . . 224

DeviceCare . . . . . 96

    Device description file . . . . . 97

Diagnosis

    Symbols . . . . . 198

Diagnostic behavior

    Explanation . . . . . 199

    Symbols . . . . . 199

Diagnostic information

    Communication interface . . . . . 203

    Design, description . . . . . 199, 202

    DeviceCare . . . . . 201

    FieldCare . . . . . 201

    Light emitting diodes . . . . . 194

    Local display . . . . . 198

    Overview . . . . . 203

    Remedial measures . . . . . 203

    Web browser . . . . . 200

Diagnostic message . . . . . 198

Diagnostics list . . . . . 217

- DIP switch
    - see Write protection switch
  - Direct access . . . . . 80
  - Disabling write protection . . . . . 167
  - Display
    - see Local display
  - Display area
    - For operational display . . . . . 72
    - In the navigation view . . . . . 74
  - Display values
    - For locking status . . . . . 171
  - Displaying the measured value history . . . . . 188
  - Disposal . . . . . 225
  - Document
    - Function . . . . . 6
    - Symbols . . . . . 6
  - Document function . . . . . 6
  - Down pipe . . . . . 23
- E**
- Editing view . . . . . 76
    - Input screen . . . . . 77
    - Using operating elements . . . . . 76, 77
  - EHEDG-tested . . . . . 256
  - Electrical connection
    - Degree of protection . . . . . 67
    - Measuring instrument . . . . . 35
    - Operating tools
      - Via Ethernet network . . . . . 91
      - Via service interface (CDI-RJ45) . . . . . 92
      - Via WLAN interface . . . . . 93
    - RSLogix 5000 . . . . . 91
    - Web server . . . . . 92
    - WLAN interface . . . . . 93
  - Electromagnetic compatibility . . . . . 247
  - Electronics module . . . . . 14
  - Enabling write protection . . . . . 167
  - Enabling/disabling the keypad lock . . . . . 83
  - Endress+Hauser services
    - Maintenance . . . . . 223
    - Repair . . . . . 224
  - Error messages
    - see Diagnostic messages
  - EtherNet/IP
    - Diagnostic information . . . . . 203
  - EtherNet/IP certification . . . . . 256
  - Event logbook . . . . . 218
  - Events list . . . . . 218
  - Extended order code
    - Sensor . . . . . 19
    - Transmitter . . . . . 17
  - Exterior cleaning . . . . . 223
- F**
- FDA . . . . . 256
  - Field of application
    - Residual risks . . . . . 10
  - FieldCare . . . . . 95
    - Device description file . . . . . 97
  - Establishing a connection . . . . . 95
  - Function . . . . . 95
    - User interface . . . . . 96
  - Filtering the event logbook . . . . . 219
  - Firmware
    - Release date . . . . . 97
    - Version . . . . . 97
  - Firmware history . . . . . 222
  - Fitting the connecting cable
    - Proline 500 terminal assignment . . . . . 52
    - Sensor connection housing, Proline 500 . . . . . 52
  - Fix assembly . . . . . 203
  - Flow direction . . . . . 23, 29
  - Flow limit . . . . . 248
  - Food Contact Materials Regulation . . . . . 256
  - Functions
    - see Parameters
- G**
- Galvanic isolation . . . . . 239
- H**
- Hardware write protection . . . . . 169
  - Help text
    - Calling up . . . . . 81
    - Closing . . . . . 81
    - Explanation . . . . . 81
  - HistoROM . . . . . 161
  - Hygienic compatibility . . . . . 256
- I**
- Identifying the measuring instrument . . . . . 16
  - Incoming acceptance . . . . . 16
  - Indication
    - Current diagnostic event . . . . . 217
    - Previous diagnostic event . . . . . 217
  - Influence
    - Ambient temperature . . . . . 243
    - Medium pressure . . . . . 244
    - Medium temperature . . . . . 243
  - Information about this document . . . . . 6
  - Inlet runs . . . . . 24
  - Input variables . . . . . 231
  - Inspection
    - Connection . . . . . 67
    - Installation . . . . . 34
    - Received goods . . . . . 16
  - Installation . . . . . 22
  - Installation dimensions . . . . . 24
  - Installation point . . . . . 22
  - Intended use . . . . . 9
  - Internal cleaning . . . . . 223, 246
- L**
- Languages, operation options . . . . . 252
  - Line recorder . . . . . 188
  - Local display . . . . . 252
    - Navigation view . . . . . 74
    - see Diagnostic message
    - see In alarm condition

see Operational display  
 Text editor ..... 76  
 Low flow cut off ..... 239  
**M**  
 Main electronics module ..... 14  
 Maintenance work ..... 223  
 Managing the device configuration ..... 161  
 Manufacturer ID ..... 97  
 Materials ..... 249  
 Maximum measurement error ..... 241  
 Measured variables  
   see Process variables  
 Measurement accuracy ..... 241  
 Measuring and test equipment ..... 223  
 Measuring device  
   Conversion ..... 224  
   Design ..... 14  
   Disposal ..... 225  
   Mounting the sensor ..... 29  
   Preparing for electrical connection ..... 41  
   Removing ..... 225  
   Repairs ..... 224  
   Switching on ..... 114  
 Measuring instrument  
   Configuring ..... 115  
   Preparing for mounting ..... 29  
 Measuring principle ..... 230  
 Measuring range  
   For gases ..... 231  
   For liquids ..... 231  
 Measuring range, recommended ..... 248  
 Measuring system ..... 230  
 Mechanical load ..... 246  
 Medium pressure  
   Influence ..... 244  
 Medium temperature  
   Influence ..... 243  
 Menu  
   Diagnostics ..... 217  
   Setup ..... 116  
 Menus  
   For measuring instrument configuration ..... 115  
   For specific settings ..... 144  
 Mounting dimensions  
   see Installation dimensions  
 Mounting preparations ..... 29  
 Mounting requirements  
   Down pipe ..... 23  
   Inlet and outlet runs ..... 24  
   Installation dimensions ..... 24  
   Installation point ..... 22  
   Orientation ..... 23  
   Rupture disk ..... 27  
   Sensor heating ..... 26  
   Static pressure ..... 25  
   Thermal insulation ..... 25  
   Vibrations ..... 26  
 Mounting tool ..... 29

**N**

Nameplate  
   Sensor ..... 19  
   Transmitter ..... 17  
 Navigation path (navigation view) ..... 74  
 Navigation view  
   In the submenu ..... 74  
   In the wizard ..... 74  
 Netilion ..... 223  
 Numeric editor ..... 76

**O**

Onsite display  
   Numeric editor ..... 76  
 Operable flow range ..... 232  
 Operating elements ..... 78, 199  
 Operating height ..... 245  
 Operating keys  
   see Operating elements  
 Operating menu  
   Design ..... 69  
   Menus, submenus ..... 69  
   Submenus and user roles ..... 70  
 Operating philosophy ..... 70  
 Operation ..... 171  
 Operation options ..... 68  
 Operational display ..... 71  
 Operational safety ..... 10  
 Order code ..... 17, 19  
 Orientation (vertical, horizontal) ..... 23  
 Outlet runs ..... 24  
 Output signal ..... 234  
 Output variables ..... 234

**P**

Packaging disposal ..... 22  
 Parameter  
   Changing ..... 81  
   Entering values or text ..... 81  
 Parameter settings  
   Administration (Submenu) ..... 164  
   Advanced setup (Submenu) ..... 145  
   Communication (Submenu) ..... 118  
   Configuration backup (Submenu) ..... 161  
   Corrected volume flow calculation (Submenu) ... 146  
   Current input ..... 122  
   Current input (Wizard) ..... 122  
   Current input 1 to n (Submenu) ..... 183  
   Current output ..... 124  
   Current output (Wizard) ..... 124  
   Data logging (Submenu) ..... 188  
   Define access code (Wizard) ..... 163  
   Density adjustment (Wizard) ..... 148  
   Device information (Submenu) ..... 221  
   Diagnostics (Menu) ..... 217  
   Display (Submenu) ..... 155  
   Display (Wizard) ..... 138  
   I/O configuration ..... 121  
   I/O configuration (Submenu) ..... 121

- Low flow cut off (Wizard) . . . . . 142
- Measured variables (Submenu) . . . . . 172
- Medium selection (Wizard) . . . . . 120
- Partially filled pipe detection (Wizard) . . . . . 143
- Pulse/frequency/switch output . . . . . 127
- Pulse/frequency/switch output (Wizard) . . . . . 127, 129, 133
- Pulse/frequency/switch output 1 to n (Submenu) . . . . . 184
- Relay output . . . . . 135
- Relay output 1 to n (Submenu) . . . . . 185
- Relay output 1 to n (Wizard) . . . . . 135
- Reset access code (Submenu) . . . . . 163
- Sensor adjustment (Submenu) . . . . . 147
- Setup (Menu) . . . . . 116
- Simulation (Submenu) . . . . . 164
- Status input . . . . . 123
- Status input 1 to n (Submenu) . . . . . 183
- Status input 1 to n (Wizard) . . . . . 123
- System units (Submenu) . . . . . 116
- Totalizer (Submenu) . . . . . 182
- Totalizer 1 to n (Submenu) . . . . . 153
- Totalizer handling (Submenu) . . . . . 186
- Value current output 1 to n (Submenu) . . . . . 184
- Web server (Submenu) . . . . . 90
- WLAN settings (Wizard) . . . . . 159
- Zero adjustment (Wizard) . . . . . 152
- Zero verification (Wizard) . . . . . 150
- Performance characteristics . . . . . 241
- Performing density adjustment . . . . . 148
- Post-connection check . . . . . 114
- Post-connection check (checklist) . . . . . 67
- Post-installation check . . . . . 114
- Post-installation check (checklist) . . . . . 34
- Potential equalization . . . . . 60
- Power consumption . . . . . 240
- Power supply failure . . . . . 240
- Pressure Equipment Directive . . . . . 256
- Pressure loss . . . . . 248
- Pressure-temperature ratings . . . . . 247
- Process connections . . . . . 251
- Process variables
  - Calculated . . . . . 231
  - Measured . . . . . 231
- Product safety . . . . . 10
- Proline 500 – digital transmitter
  - Connecting the signal cable/supply voltage cable . . . . . 47
- Proline 500 connecting cable terminal assignment
  - Sensor connection housing . . . . . 52
- Protecting parameter settings . . . . . 167
- R**
- Radio approval . . . . . 256
- RCM marking . . . . . 255
- Read access . . . . . 82
- Reading off measured values . . . . . 171
- Reading out diagnostic information, EtherNet/IP . . . . . 203
- Recalibration . . . . . 223
- Reference operating conditions . . . . . 241
- Registered trademarks . . . . . 8
- Remedial measures
  - Calling up . . . . . 200
  - Closing . . . . . 200
- Remote operation . . . . . 252
- Repair . . . . . 224
  - Notes . . . . . 224
- Repair of a device . . . . . 224
- Repeatability . . . . . 243
- Replacement
  - Device components . . . . . 224
- Requirements for personnel . . . . . 9
- Response time . . . . . 243
- Return . . . . . 224
- Rupture disk
  - Safety instructions . . . . . 27
  - Triggering pressure . . . . . 248
- S**
- Safety . . . . . 9
- Sensor
  - Installing . . . . . 29
- Sensor heating . . . . . 26
- Sensor housing . . . . . 247
- Serial number . . . . . 17, 19
- Setting the operating language . . . . . 114
- Settings
  - Adapting the measuring device to the process conditions . . . . . 186
  - Administration . . . . . 162
  - Advanced display configurations . . . . . 155
  - Communication interface . . . . . 118
  - Current input . . . . . 122
  - Current output . . . . . 124
  - I/O configuration . . . . . 121
  - Local display . . . . . 138
  - Low flow cut off . . . . . 142
  - Managing the device configuration . . . . . 161
  - Medium . . . . . 120
  - Operating language . . . . . 114
  - Partially filled pipe detection . . . . . 143
  - Pulse output . . . . . 127
  - Pulse/frequency/switch output . . . . . 127, 129
  - Relay output . . . . . 135
  - Resetting the device . . . . . 220
  - Resetting the totalizer . . . . . 186
  - Sensor adjustment . . . . . 147
  - Simulation . . . . . 164
  - Status input . . . . . 123
  - Switch output . . . . . 133
  - System units . . . . . 116
  - Tag name . . . . . 116
  - Totalizer . . . . . 153
  - Totalizer reset . . . . . 186
  - WLAN . . . . . 159
- Shock and vibration resistance . . . . . 246
- Signal on alarm . . . . . 237
- SIP cleaning . . . . . 246
- Software release . . . . . 97
- Spare part . . . . . 224



- Spare parts . . . . . 224
  - Special connection instructions . . . . . 61
  - Special mounting instructions
    - Hygienic compatibility . . . . . 27
  - Standards and guidelines . . . . . 257
  - Static pressure . . . . . 25
  - Status area
    - For operational display . . . . . 71
    - In the navigation view . . . . . 74
  - Status signals . . . . . 198, 201
  - Storage concept . . . . . 254
  - Storage conditions . . . . . 21
  - Storage temperature . . . . . 21
  - Storage temperature range . . . . . 245
  - Submenu
    - Administration . . . . . 162, 164
    - Advanced setup . . . . . 144, 145
    - Calculated values . . . . . 145
    - Communication . . . . . 118
    - Configuration backup . . . . . 161
    - Corrected volume flow calculation . . . . . 146
    - Current input 1 to n . . . . . 183
    - Data logging . . . . . 188
    - Device information . . . . . 221
    - Display . . . . . 155
    - Events list . . . . . 218
    - I/O configuration . . . . . 121
    - Input values . . . . . 182
    - Measured values . . . . . 171
    - Measured variables . . . . . 172
    - Output values . . . . . 184
    - Overview . . . . . 70
    - Process variables . . . . . 145
    - Pulse/frequency/switch output 1 to n . . . . . 184
    - Relay output 1 to n . . . . . 185
    - Reset access code . . . . . 163
    - Sensor adjustment . . . . . 147
    - Simulation . . . . . 164
    - Status input 1 to n . . . . . 183
    - System units . . . . . 116
    - Totalizer . . . . . 182
    - Totalizer 1 to n . . . . . 153
    - Totalizer handling . . . . . 186
    - Value current output 1 to n . . . . . 184
    - Web server . . . . . 90
  - Supply voltage . . . . . 240
  - Surface roughness . . . . . 251
  - Switch output . . . . . 236
  - Symbols
    - Controlling data entries . . . . . 77
    - For communication . . . . . 71
    - For diagnostic behavior . . . . . 71
    - For locking . . . . . 71
    - For measured variable . . . . . 72
    - For measurement channel number . . . . . 72
    - For menus . . . . . 74
    - For parameters . . . . . 74
    - For status signal . . . . . 71
    - For submenu . . . . . 74
  - For wizards . . . . . 74
  - In the status area of the local display . . . . . 71
  - Input screen . . . . . 77
  - Operating elements . . . . . 76
  - System design
    - Measuring system . . . . . 230
    - see Measuring device design
  - System file
    - Release date . . . . . 97
    - Source . . . . . 97
    - Version . . . . . 97
  - System integration . . . . . 97
- T**
- Technical data, overview . . . . . 230
  - Temperature range
    - Ambient temperature range for display . . . . . 252
    - Medium temperature . . . . . 247
    - Storage temperature . . . . . 21
  - Terminal assignment . . . . . 40
  - Terminal assignment of connecting cable for Proline
    - 500- digital
      - Sensor connection housing . . . . . 42
  - Terminals . . . . . 240
  - Tests and certificates . . . . . 257
  - Text editor . . . . . 76
  - Thermal insulation . . . . . 25
  - Tool
    - For electrical connection . . . . . 35
    - For mounting . . . . . 29
    - Transport . . . . . 21
  - Tool tip
    - see Help text
  - Totalizer
    - Configuring . . . . . 153
  - Transmitter
    - Turning the display module . . . . . 33
    - Turning the housing . . . . . 33
  - Transporting the measuring device . . . . . 21
  - Troubleshooting
    - General . . . . . 192
  - Turning the display module . . . . . 33
  - Turning the electronics housing
    - see Turning the transmitter housing
  - Turning the transmitter housing . . . . . 33
- U**
- UKCA marking . . . . . 255
  - Use of measuring device
    - Borderline cases . . . . . 9
    - Incorrect use . . . . . 9
  - Use of measuring instrument
    - see Intended use
  - User roles . . . . . 70
- V**
- Version data for the device . . . . . 97
  - Vibrations . . . . . 26

**W**

W@M Device Viewer . . . . .	16
Weight	
SI units . . . . .	248
Transport (notes) . . . . .	21
US units . . . . .	249
Wizard	
Current input . . . . .	122
Current output . . . . .	124
Define access code . . . . .	163
Density adjustment . . . . .	148
Display . . . . .	138
Low flow cut off . . . . .	142
Medium selection . . . . .	120
Partially filled pipe detection . . . . .	143
Pulse/frequency/switch output . . . . .	127, 129, 133
Relay output 1 to n . . . . .	135
Status input 1 to n . . . . .	123
WLAN settings . . . . .	159
Zero adjustment . . . . .	152
Zero verification . . . . .	150
WLAN settings . . . . .	159
Workplace safety . . . . .	10
Write access . . . . .	82
Write protection	
Via access code . . . . .	167
Via write protection switch . . . . .	169
Write protection switch . . . . .	169





[www.addresses.endress.com](http://www.addresses.endress.com)

---