

# Operating Instructions

## Proline Promass A 300

Coriolis flowmeter  
HART



- Make sure the document is stored in a safe place such that it is always available when working on or with the device.
- To avoid danger to individuals or the facility, read the "Basic safety instructions" section carefully, as well as all other safety instructions in the document that are specific to working procedures.
- The manufacturer reserves the right to modify technical data without prior notice. Your Endress+Hauser sales organization will supply you with current information and updates to this manual.

## Table of contents

<b>1</b>	<b>About this document</b> . . . . .	<b>6</b>	<b>6</b>	<b>Mounting</b> . . . . .	<b>21</b>
1.1	Document function . . . . .	6	6.1	Mounting requirements . . . . .	21
1.2	Symbols . . . . .	6	6.1.1	Installation position . . . . .	21
1.2.1	Safety symbols . . . . .	6	6.1.2	Environmental and process requirements . . . . .	23
1.2.2	Electrical symbols . . . . .	6	6.1.3	Special installation instructions . . . . .	24
1.2.3	Communication-specific symbols . . . . .	6	6.2	Mounting the measuring instrument . . . . .	28
1.2.4	Tool symbols . . . . .	7	6.2.1	Required tools . . . . .	28
1.2.5	Symbols for certain types of information . . . . .	7	6.2.2	Preparing the measuring instrument . . . . .	28
1.2.6	Symbols in graphics . . . . .	7	6.2.3	Mounting the measuring device . . . . .	28
1.3	Documentation . . . . .	8	6.2.4	Turning the transmitter housing . . . . .	29
1.4	Registered trademarks . . . . .	8	6.2.5	Turning the display module . . . . .	30
<b>2</b>	<b>Safety instructions</b> . . . . .	<b>9</b>	6.3	Post-installation check . . . . .	31
2.1	Requirements for the personnel . . . . .	9	<b>7</b>	<b>Electrical connection</b> . . . . .	<b>32</b>
2.2	Intended use . . . . .	9	7.1	Electrical safety . . . . .	32
2.3	Workplace safety . . . . .	10	7.2	Connecting requirements . . . . .	32
2.4	Operational safety . . . . .	10	7.2.1	Required tools . . . . .	32
2.5	Product safety . . . . .	10	7.2.2	Requirements for connection cable . . . . .	32
2.6	IT security . . . . .	11	7.2.3	Terminal assignment . . . . .	35
2.7	Device-specific IT security . . . . .	11	7.2.4	Preparing the measuring device . . . . .	35
2.7.1	Protecting access via hardware write protection . . . . .	11	7.3	Connecting the measuring instrument . . . . .	35
2.7.2	Protecting access via a password . . . . .	11	7.3.1	Connecting the transmitter . . . . .	35
2.7.3	Access via web server . . . . .	12	7.3.2	Connecting the remote display and operating module DKX001 . . . . .	38
2.7.4	Access via OPC-UA . . . . .	12	7.4	Potential equalization . . . . .	38
2.7.5	Access via service interface (CDI-RJ45) . . . . .	13	7.4.1	Requirements . . . . .	38
<b>3</b>	<b>Product description</b> . . . . .	<b>14</b>	7.5	Special connection instructions . . . . .	39
3.1	Product design . . . . .	14	7.5.1	Connection examples . . . . .	39
<b>4</b>	<b>Incoming acceptance and product identification</b> . . . . .	<b>15</b>	7.6	Ensuring the degree of protection . . . . .	43
4.1	Incoming acceptance . . . . .	15	7.7	Post-connection check . . . . .	43
4.2	Product identification . . . . .	15	<b>8</b>	<b>Operation options</b> . . . . .	<b>45</b>
4.2.1	Transmitter nameplate . . . . .	16	8.1	Overview of operation options . . . . .	45
4.2.2	Sensor nameplate . . . . .	17	8.2	Structure and function of the operating menu . . . . .	46
4.2.3	Symbols on the device . . . . .	18	8.2.1	Structure of the operating menu . . . . .	46
<b>5</b>	<b>Storage and transport</b> . . . . .	<b>19</b>	8.2.2	Operating philosophy . . . . .	47
5.1	Storage conditions . . . . .	19	8.3	Access to operating menu via local display . . . . .	48
5.2	Transporting the product . . . . .	19	8.3.1	Operational display . . . . .	48
5.2.1	Measuring devices without lifting lugs . . . . .	19	8.3.2	Navigation view . . . . .	51
5.2.2	Measuring devices with lifting lugs . . . . .	20	8.3.3	Editing view . . . . .	53
5.2.3	Transporting with a fork lift . . . . .	20	8.3.4	Operating elements . . . . .	55
5.3	Packaging disposal . . . . .	20	8.3.5	Opening the context menu . . . . .	55
			8.3.6	Navigating and selecting from list . . . . .	57
			8.3.7	Calling the parameter directly . . . . .	57
			8.3.8	Calling up help text . . . . .	58
			8.3.9	Changing the parameters . . . . .	58
			8.3.10	User roles and related access authorization . . . . .	59
			8.3.11	Disabling write protection via access code . . . . .	59
			8.3.12	Enabling and disabling the keypad lock . . . . .	60

8.4	Access to operating menu via web browser . . .	60	10.6	Simulation . . . . .	132
8.4.1	Function range . . . . .	60	10.7	Protecting settings from unauthorized access	135
8.4.2	Requirements . . . . .	61	10.7.1	Write protection via access code . . .	135
8.4.3	Connecting the device . . . . .	62	10.7.2	Write protection via write protection switch . . . . .	137
8.4.4	Logging on . . . . .	64			
8.4.5	User interface . . . . .	65	<b>11</b>	<b>Operation . . . . .</b>	<b>139</b>
8.4.6	Disabling the Web server . . . . .	66	11.1	Reading off the device locking status . . . . .	139
8.4.7	Logging out . . . . .	66	11.2	Adjusting the operating language . . . . .	139
8.5	Access to the operating menu via the operating tool . . . . .	67	11.3	Configuring the display . . . . .	139
8.5.1	Connecting the operating tool . . . . .	67	11.4	Reading off measured values . . . . .	139
8.5.2	Field Xpert SFX350, SFX370 . . . . .	70	11.4.1	"Measured variables" submenu . . . . .	140
8.5.3	FieldCare . . . . .	70	11.4.2	"Totalizer" submenu . . . . .	142
8.5.4	DeviceCare . . . . .	72	11.4.3	"Input values" submenu . . . . .	143
8.5.5	AMS Device Manager . . . . .	72	11.4.4	Output values . . . . .	144
8.5.6	Field Communicator 475 . . . . .	73	11.5	Adapting the measuring device to the process conditions . . . . .	146
8.5.7	SIMATIC PDM . . . . .	73	11.6	Performing a totalizer reset . . . . .	146
<b>9</b>	<b>System integration . . . . .</b>	<b>74</b>	11.6.1	Function scope of "Control Totalizer" parameter . . . . .	147
9.1	Overview of device description files . . . . .	74	11.6.2	Function range of "Reset all totalizers" parameter . . . . .	147
9.1.1	Current version data for the device . . .	74	11.7	Displaying the measured value history . . . . .	148
9.1.2	Operating tools . . . . .	74	11.8	Gas Fraction Handler . . . . .	151
9.2	Measured variables via HART protocol . . . . .	75	11.8.1	"Measurement mode" submenu . . . . .	152
9.2.1	Device variables . . . . .	77	11.8.2	"Medium index" submenu . . . . .	152
9.3	Other settings . . . . .	78	<b>12</b>	<b>Diagnostics and troubleshooting . .</b>	<b>154</b>
<b>10</b>	<b>Commissioning . . . . .</b>	<b>81</b>	12.1	General troubleshooting . . . . .	154
10.1	Post-mounting and post-connection check . . .	81	12.2	Diagnostic information via light emitting diodes . . . . .	157
10.2	Switching on the measuring device . . . . .	81	12.2.1	Transmitter . . . . .	157
10.3	Setting the operating language . . . . .	81	12.3	Diagnostic information on local display . . . . .	158
10.4	Configuring the measuring instrument . . . . .	81	12.3.1	Diagnostic message . . . . .	158
10.4.1	Defining the tag name . . . . .	83	12.3.2	Calling up remedial measures . . . . .	160
10.4.2	Setting the system units . . . . .	83	12.4	Diagnostic information in the web browser . .	161
10.4.3	Selecting and setting the medium . . . . .	86	12.4.1	Diagnostic options . . . . .	161
10.4.4	Displaying the I/O configuration . . . . .	88	12.4.2	Calling up remedy information . . . . .	162
10.4.5	Configuring the current input . . . . .	89	12.5	Diagnostic information in FieldCare or DeviceCare . . . . .	163
10.4.6	Configuring the status input . . . . .	90	12.5.1	Diagnostic options . . . . .	163
10.4.7	Configuring the current output . . . . .	91	12.5.2	Calling up remedy information . . . . .	164
10.4.8	Configuring the pulse/frequency/ switch output . . . . .	95	12.6	Adapting the diagnostic information . . . . .	165
10.4.9	Configuring the relay output . . . . .	102	12.6.1	Adapting the diagnostic behavior . . . . .	165
10.4.10	Configuring the double pulse output . . . . .	105	12.6.2	Adapting the status signal . . . . .	165
10.4.11	Configuring the local display . . . . .	106	12.7	Overview of diagnostic information . . . . .	167
10.4.12	Configuring the low flow cut off . . . . .	110	12.8	Pending diagnostic events . . . . .	172
10.4.13	Configuring partially filled pipe detection . . . . .	111	12.9	Diagnostics list . . . . .	172
10.5	Advanced settings . . . . .	112	12.10	Event logbook . . . . .	174
10.5.1	Using the parameter to enter the access code . . . . .	113	12.10.1	Reading out the event logbook . . . . .	174
10.5.2	Calculated process variables . . . . .	113	12.10.2	Filtering the event logbook . . . . .	174
10.5.3	Carrying out a sensor adjustment . . . . .	114	12.10.3	Overview of information events . . . . .	175
10.5.4	Configuring the totalizer . . . . .	120	12.11	Resetting the measuring device . . . . .	177
10.5.5	Carrying out additional display configurations . . . . .	122	12.11.1	Function range of "Device reset" parameter . . . . .	177
10.5.6	WLAN configuration . . . . .	128	12.12	Device information . . . . .	178
10.5.7	Configuration management . . . . .	130	12.13	Firmware history . . . . .	180
10.5.8	Using parameters for device administration . . . . .	131	12.14	Device history and compatibility . . . . .	180

---

<b>13</b>	<b>Maintenance</b> .....	<b>181</b>
13.1	Maintenance work .....	181
13.1.1	Exterior cleaning .....	181
13.1.2	Internal cleaning .....	181
13.2	Measuring and test equipment .....	181
13.3	Endress+Hauser services .....	181
<b>14</b>	<b>Repair</b> .....	<b>182</b>
14.1	General notes .....	182
14.1.1	Repair and conversion concept .....	182
14.1.2	Notes for repair and conversion .....	182
14.2	Spare parts .....	182
14.3	Endress+Hauser services .....	182
14.4	Return .....	182
14.5	Disposal .....	183
14.5.1	Removing the measuring device .....	183
14.5.2	Disposing of the measuring device ..	183
<b>15</b>	<b>Accessories</b> .....	<b>184</b>
15.1	Device-specific accessories .....	184
15.1.1	For the transmitter .....	184
15.1.2	For the sensor .....	185
15.2	Communication-specific accessories .....	185
15.3	Service-specific accessories .....	186
15.4	System components .....	186
<b>16</b>	<b>Technical data</b> .....	<b>187</b>
16.1	Application .....	187
16.2	Function and system design .....	187
16.3	Input .....	188
16.4	Output .....	190
16.5	Power supply .....	196
16.6	Performance characteristics .....	198
16.7	Mounting .....	201
16.8	Environment .....	202
16.9	Process .....	203
16.10	Mechanical construction .....	204
16.11	Operability .....	208
16.12	Certificates and approvals .....	213
16.13	Application packages .....	216
16.14	Accessories .....	217
16.15	Supplementary documentation .....	217
<b>Index</b> .....	<b>220</b>	

# 1 About this document

## 1.1 Document function

These Operating Instructions contain all the information required in the various life cycle phases of the device: from product identification, incoming acceptance and storage, to installation, connection, operation and commissioning, through to troubleshooting, maintenance and disposal.

## 1.2 Symbols

### 1.2.1 Safety symbols

#### DANGER

This symbol alerts you to a dangerous situation. Failure to avoid this situation will result in serious or fatal injury.

#### WARNING

This symbol alerts you to a potentially dangerous situation. Failure to avoid this situation can result in serious or fatal injury.





#### CAUTION

This symbol alerts you to a potentially dangerous situation. Failure to avoid this situation can result in minor or medium injury.

#### NOTICE

This symbol alerts you to a potentially harmful situation. Failure to avoid this situation can result in damage to the product or something in its vicinity.

### 1.2.2 Electrical symbols

Symbol	Meaning
	Direct current
	Alternating current
	Direct current and alternating current
	<b>Ground connection</b> A grounded terminal which, as far as the operator is concerned, is grounded via a grounding system.
	<b>Potential equalization connection (PE: protective earth)</b> Ground terminals that must be connected to ground prior to establishing any other connections.  The ground terminals are located on the interior and exterior of the device: <ul style="list-style-type: none"> <li>▪ Interior ground terminal: potential equalization is connected to the supply network.</li> <li>▪ Exterior ground terminal: device is connected to the plant grounding system.</li> </ul>

### 1.2.3 Communication-specific symbols

Symbol	Meaning
	<b>Wireless Local Area Network (WLAN)</b> Communication via a wireless, local network.

### 1.2.4 Tool symbols

Symbol	Meaning
	Flat-blade screwdriver
	Allen key
	Open-ended wrench

### 1.2.5 Symbols for certain types of information

Symbol	Meaning
	<b>Permitted</b> Procedures, processes or actions that are permitted.
	<b>Preferred</b> Procedures, processes or actions that are preferred.
	<b>Forbidden</b> Procedures, processes or actions that are forbidden.
	<b>Tip</b> Indicates additional information.
	Reference to documentation
	Reference to page
	Reference to graphic
	Notice or individual step to be observed
	Series of steps
	Result of a step
	Help in the event of a problem
	Visual inspection

### 1.2.6 Symbols in graphics

Symbol	Meaning
	Item numbers
	Series of steps
	Views
	Sections
	Hazardous area
	Safe area (non-hazardous area)
	Flow direction

## 1.3 Documentation

 For an overview of the scope of the associated Technical Documentation, refer to the following:

- *Device Viewer* ([www.endress.com/deviceviewer](http://www.endress.com/deviceviewer)): Enter the serial number from the nameplate
- *Endress+Hauser Operations app*: Enter serial number from nameplate or scan matrix code on nameplate.

The following documentation may be available depending on the device version ordered:

Document type	Purpose and content of the document
Technical Information (TI)	<b>Planning aid for your device</b> The document contains all the technical data on the device and provides an overview of the accessories and other products that can be ordered for the device.
Brief Operating Instructions (KA)	<b>Guide that takes you quickly to the 1st measured value</b> The Brief Operating Instructions contain all the essential information from incoming acceptance to initial commissioning.
Operating Instructions (BA)	<b>Your reference document</b> These Operating Instructions contain all the information that is required in the various life cycle phases of the device: from product identification, incoming acceptance and storage, to mounting, connection, operation and commissioning, through to troubleshooting, maintenance and disposal.
Description of Device Parameters (GP)	<b>Reference for your parameters</b> The document provides a detailed explanation of each individual parameter. The description is aimed at those who work with the device over the entire life cycle and perform specific configurations.
Safety Instructions (XA)	Depending on the approval, safety instructions for electrical equipment in hazardous areas are also supplied with the device. The Safety Instructions are a constituent part of the Operating Instructions.   Information on the Safety Instructions (XA) that are relevant for the device is provided on the nameplate.
Supplementary device-dependent documentation (SD/FY)	Always comply strictly with the instructions in the relevant supplementary documentation. The supplementary documentation is a constituent part of the device documentation.

## 1.4 Registered trademarks

**HART®**

Registered trademark of the FieldComm Group, Austin, Texas USA

**TRI-CLAMP®**

Registered trademark of Ladish & Co., Inc., Kenosha, USA



## 2 Safety instructions

### 2.1 Requirements for the personnel

The personnel for installation, commissioning, diagnostics and maintenance must fulfill the following requirements:

- ▶ Trained, qualified specialists must have a relevant qualification for this specific function and task.
- ▶ Are authorized by the plant owner/operator.
- ▶ Are familiar with federal/national regulations.
- ▶ Before starting work, read and understand the instructions in the manual and supplementary documentation as well as the certificates (depending on the application).
- ▶ Follow instructions and comply with basic conditions.

The operating personnel must fulfill the following requirements:

- ▶ Are instructed and authorized according to the requirements of the task by the facility's owner-operator.
- ▶ Follow the instructions in this manual.

### 2.2 Intended use

#### Application and media

The measuring instrument described in this manual is intended only for the flow measurement of liquids and gases.

Depending on the version ordered, the measuring instrument can also be used to measure potentially explosive <sup>1)</sup>, flammable, toxid and oxidizing media.

Measuring instruments for use in hazardous areas, in hygienic applications, or where there is an increased risk due to pressure, are specially labeled on the nameplate.

To ensure that the measuring instrument is in perfect condition during operation:

- ▶ Only use the measuring instrument in full compliance with the data on the nameplate and the general conditions listed in the Operating Instructions and supplementary documentation.
- ▶ Using the nameplate, check whether the ordered device is permitted for the intended use in the hazardous area (e.g. explosion protection, pressure vessel safety).
- ▶ Use the measuring instrument only for media to which the process-wetted materials are sufficiently resistant.
- ▶ Keep within the specified pressure and temperature range.
- ▶ Keep within the specified ambient temperature range.
- ▶ Protect the measuring instrument permanently against corrosion from environmental influences.

#### Incorrect use

Non-designated use can compromise safety. The manufacturer is not liable for damage caused by improper or non-designated use.

#### **WARNING**

#### **Danger of breakage due to corrosive or abrasive fluids and ambient conditions!**

- ▶ Verify the compatibility of the process fluid with the sensor material.
- ▶ Ensure the resistance of all fluid-wetted materials in the process.
- ▶ Keep within the specified pressure and temperature range.

1) Not applicable for IO-Link measuring instruments

**NOTICE****Verification for borderline cases:**

- ▶ For special fluids and fluids for cleaning, Endress+Hauser is glad to provide assistance in verifying the corrosion resistance of fluid-wetted materials, but does not accept any warranty or liability as minute changes in the temperature, concentration or level of contamination in the process can alter the corrosion resistance properties.

**Residual risks****⚠ CAUTION****Risk of hot or cold burns! The use of media and electronics with high or low temperatures can produce hot or cold surfaces on the device.**

- ▶ Mount suitable touch protection.

**⚠ WARNING****Danger of housing breaking due to measuring tube breakage!**

If a measuring tube ruptures, the pressure inside the sensor housing will rise according to the operating process pressure.

- ▶ Use a rupture disk.

**⚠ WARNING****Danger from medium escaping!**

For device versions with a rupture disk: medium escaping under pressure can cause injury or material damage.

- ▶ Take precautions to prevent injury and material damage if the rupture disk is actuated.

## 2.3 Workplace safety

When working on and with the device:

- ▶ Wear the required personal protective equipment as per national regulations.

## 2.4 Operational safety

Damage to the device!

- ▶ Operate the device in proper technical condition and fail-safe condition only.
- ▶ The operator is responsible for the interference-free operation of the device.

**Modifications to the device**

Unauthorized modifications to the device are not permitted and can lead to unforeseeable dangers!

- ▶ If modifications are nevertheless required, consult with the manufacturer.

**Repair**

To ensure continued operational safety and reliability:

- ▶ Carry out repairs on the device only if they are expressly permitted.
- ▶ Observe federal/national regulations pertaining to the repair of an electrical device.
- ▶ Use only original spare parts and accessories.

## 2.5 Product safety

This measuring device is designed in accordance with good engineering practice to meet state-of-the-art safety requirements, has been tested, and left the factory in a condition in which it is safe to operate.

It meets general safety standards and legal requirements. It also complies with the EU directives listed in the device-specific EU Declaration of Conformity. The manufacturer confirms this by affixing the CE mark to the device..





## 2.6 IT security

Our warranty is valid only if the product is installed and used as described in the Operating Instructions. The product is equipped with security mechanisms to protect it against any inadvertent changes to the settings.

IT security measures, which provide additional protection for the product and associated data transfer, must be implemented by the operators themselves in line with their security standards.

## 2.7 Device-specific IT security

The device offers a range of specific functions to support protective measures on the operator's side. These functions can be configured by the user and guarantee greater in-operation safety if used correctly. The following list provides an overview of the most important functions:

Function/interface	Factory setting	Recommendation
Write protection via hardware write protection switch →  11	Not enabled	On an individual basis following risk assessment
Access code (also applies to web server login or FieldCare connection) →  12	Not enabled (0000)	Assign a customized access code during commissioning
WLAN (order option in display module)	Enabled	On an individual basis following risk assessment
WLAN security mode	Enabled (WPA2-PSK)	Do not change
WLAN passphrase (Password) →  12	Serial number	Assign an individual WLAN passphrase during commissioning
WLAN mode	Access point	On an individual basis following risk assessment
Web server →  12	Enabled	On an individual basis following risk assessment
Service interface CDI-RJ45 →  13	–	On an individual basis following risk assessment

### 2.7.1 Protecting access via hardware write protection

Write access to the parameters of the device via the local display, web browser or operating tool (e.g. FieldCare, DeviceCare) can be disabled via a write protection switch (DIP switch on the main electronics module). When hardware write protection is enabled, only read access to the parameters is possible.

Hardware write protection is disabled when the device is delivered →  137.

### 2.7.2 Protecting access via a password

Different passwords are available to protect write access to the device parameters or access to the device via the WLAN interface.

- **User-specific access code**  
Protect write access to the device parameters via the local display, web browser or operating tool (e.g. FieldCare, DeviceCare). Access authorization is clearly regulated through the use of a user-specific access code.
- **WLAN passphrase**  
The network key protects a connection between an operating unit (e.g. notebook or tablet) and the device via the WLAN interface which can be ordered as an option.
- **Infrastructure mode**  
When the device is operated in infrastructure mode, the WLAN passphrase corresponds to the WLAN passphrase configured on the operator side.

### User-specific access code

Write access to the device parameters via the local display, web browser or operating tool (e.g. FieldCare, DeviceCare) can be protected by the modifiable, user-specific access code (→  135).

When the device is delivered, the device does not have an access code and is equivalent to 0000 (open).

### WLAN passphrase: Operation as WLAN access point

A connection between an operating unit (e.g. notebook or tablet) and the device via the WLAN interface (→  69), which can be ordered as an optional extra, is protected by the network key. The WLAN authentication of the network key complies with the IEEE 802.11 standard.

When the device is delivered, the network key is pre-defined depending on the device. It can be changed via the **WLAN settings** submenu in the **WLAN passphrase** parameter (→  129).

### Infrastructure mode

A connection between the device and WLAN access point is protected by means of an SSID and passphrase on the system side. Please contact the relevant system administrator for access.

### General notes on the use of passwords

- The access code and network key supplied with the device should be changed during commissioning for safety reasons.
- Follow the general rules for generating a secure password when defining and managing the access code and network key.
- The user is responsible for the management and careful handling of the access code and network key.
- For information on configuring the access code or on what to do if you lose the password, for example, see "Write protection via access code" →  135.

## 2.7.3 Access via web server

The integrated web server can be used to operate and configure the device via a web browser →  60. The connection is established via the service interface (CDI-RJ45) or the WLAN interface.

The web server is enabled when the device is delivered. The web server can be disabled via the **Web server functionality** parameter if necessary (e.g., after commissioning).

The device and status information can be hidden on the login page. This prevents unauthorized access to the information.



Detailed information on the device parameters:  
"Description of device parameters" document .

## 2.7.4 Access via OPC-UA

The device can communicate with OPC UA clients using the "OPC UA Server" application package.

The OPC UA server integrated in the device can be accessed via the WLAN access point using the WLAN interface - which can be ordered as an optional extra - or the service interface (CDI- RJ45) via Ethernet network. Access rights and authorization as per separate configuration.

The following Security Modes are supported as per the OPC UA Specification (IEC 62541):

- None
- Basic128Rsa15 – signed
- Basic128Rsa15 – signed and encrypted

### 2.7.5 Access via service interface (CDI-RJ45)

The device can be connected to a network via the service interface (CDI-RJ45). Device-specific functions guarantee the secure operation of the device in a network.

The use of relevant industrial standards and guidelines that have been defined by national and international safety committees, such as IEC/ISA62443 or the IEEE, is recommended. This includes organizational security measures such as the assignment of access authorization as well as technical measures such as network segmentation.

 Transmitters with an Ex de approval may not be connected via the service interface (CDI-RJ45)!

Order code for "Approval transmitter + sensor", options (Ex de): BA, BB, C1, C2, GA, GB, MA, MB, NA, NB BB, C2, GB, MB, NB

### 3 Product description

The device consists of a transmitter and a sensor.

The device is available as a compact version:

The transmitter and sensor form a mechanical unit.

#### 3.1 Product design



A0029586

☐ 1 *Important components of a measuring device*

- 1 *Connection compartment cover*
- 2 *Display module*
- 3 *Transmitter housing*
- 4 *Electronics compartment cover*
- 5 *Sensor*

## 4 Incoming acceptance and product identification

### 4.1 Incoming acceptance

On receipt of the delivery:

1. Check the packaging for damage.
  - ↳ Report all damage immediately to the manufacturer.  
Do not install damaged components.
2. Check the scope of delivery using the delivery note.
3. Compare the data on the nameplate with the order specifications on the delivery note.
4. Check the technical documentation and all other necessary documents, e.g. certificates, to ensure they are complete.

 If one of the conditions is not satisfied, contact the manufacturer.

### 4.2 Product identification

The device can be identified in the following ways:

- Nameplate
- Order code with details of the device features on the delivery note
- Enter the serial numbers from the nameplates in the *Device Viewer* ([www.endress.com/deviceviewer](http://www.endress.com/deviceviewer)): all the information about the device is displayed.
- Enter the serial numbers from the nameplates into the *Endress+Hauser Operations app* or scan the DataMatrix code on the nameplate with the *Endress+Hauser Operations app*: all the information about the device is displayed.

For an overview of the scope of the associated Technical Documentation, refer to the following:

- The "Additional standard device documentation" and "Supplementary device-dependent documentation" sections
- The *Device Viewer*: Enter the serial number from the nameplate ([www.endress.com/deviceviewer](http://www.endress.com/deviceviewer))
- The *Endress+Hauser Operations app*: Enter the serial number from the nameplate or scan the DataMatrix code on the nameplate.

### 4.2.1 Transmitter nameplate

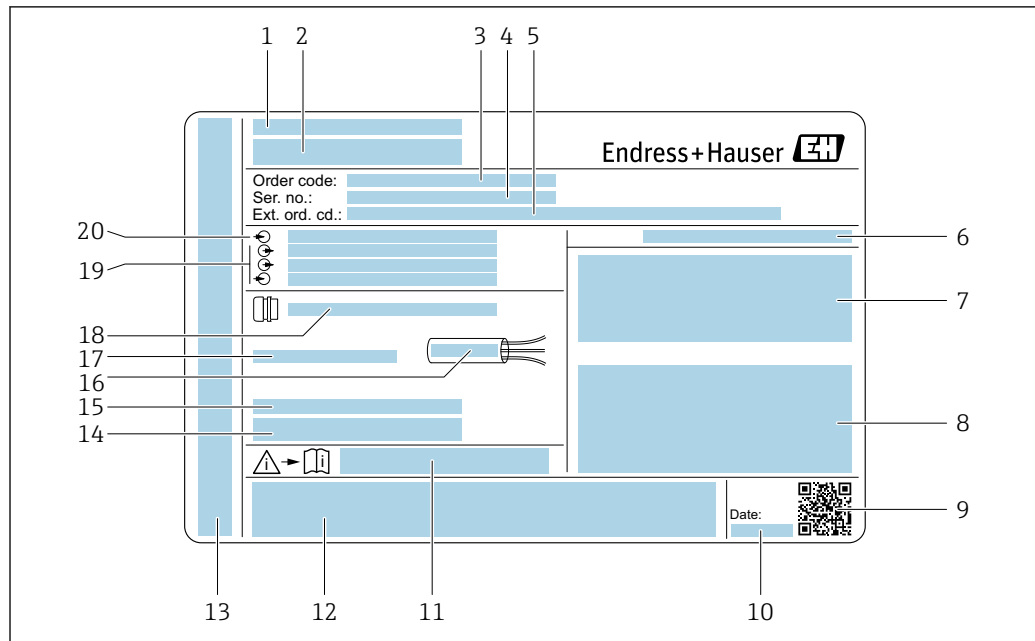

A0029192

**2** Example of a transmitter nameplate

- 1 Manufacturer address/certificate holder
- 2 Name of the transmitter
- 3 Order code
- 4 Serial number
- 5 Extended order code
- 6 Degree of protection
- 7 Space for approvals: use in hazardous areas
- 8 Electrical connection data: available inputs and outputs
- 9 2-D matrix code
- 10 Date of manufacture: year-month
- 11 Document number of safety-related supplementary documentation
- 12 Space for approvals and certificates: e.g. CE mark, RCM tick
- 13 Space for degree of protection of connection and electronics compartment when used in hazardous areas
- 14 Firmware version (FW) and device revision (Dev. rev.) from the factory
- 15 Space for additional information in the case of special products
- 16 Permitted temperature range for cable
- 17 Permitted ambient temperature ( $T_a$ )
- 18 Information on cable gland
- 19 Available inputs and outputs, supply voltage
- 20 Electrical connection data: supply voltage



## 4.2.2 Sensor nameplate

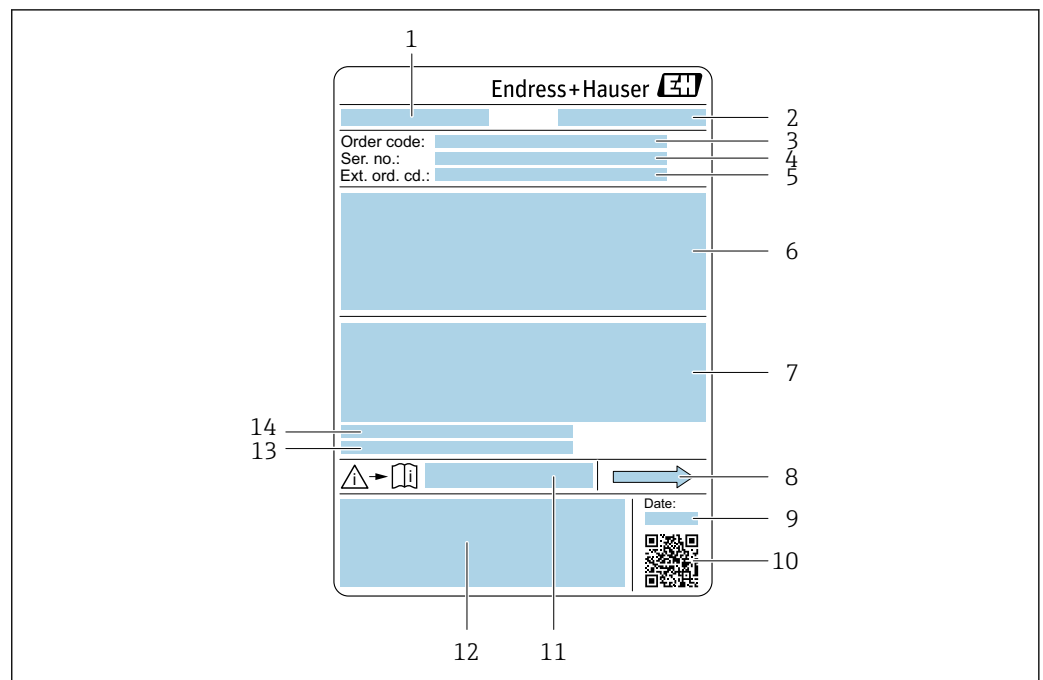

A0029199

 3 Example of a sensor nameplate

- 1 Name of the sensor
- 2 Manufacturer address/certificate holder
- 3 Order code
- 4 Serial number (Ser. no.)
- 5 Extended order code (Ext. ord. cd.)
- 6 Nominal diameter of the sensor; flange nominal diameter/nominal pressure; sensor test pressure; medium temperature range; material of measuring tube and manifold; sensor-specific information: e.g. pressure range of sensor housing, wide-range density specification (special density calibration)
- 7 Approval information for explosion protection, Pressure Equipment Directive and degree of protection
- 8 Flow direction
- 9 Date of manufacture: year-month
- 10 2-D matrix code
- 11 Document number of safety-related supplementary documentation
- 12 CE mark, RCM-Tick mark
- 13 Surface roughness
- 14 Allowable ambient temperature ( $T_a$ )



### Order code

The measuring device is reordered using the order code.

#### Extended order code

- The device type (product root) and basic specifications (mandatory features) are always listed.
- Of the optional specifications (optional features), only the safety and approval-related specifications are listed (e.g. LA). If other optional specifications are also ordered, these are indicated collectively using the # placeholder symbol (e.g. #LA#).
- If the ordered optional specifications do not include any safety and approval-related specifications, they are indicated by the + placeholder symbol (e.g. XXXXXX-ABCDE+).

### 4.2.3 Symbols on the device

Symbol	Meaning
	<b>WARNING!</b> This symbol alerts you to a dangerous situation. Failure to avoid this situation can result in serious or fatal injury. Please consult the documentation for the measuring instrument to discover the type of potential danger and measures to avoid it.
	<b>Reference to documentation</b> Refers to the corresponding device documentation.
	<b>Protective ground connection</b> A terminal that must be connected to the ground prior to establishing any other connections.

## 5 Storage and transport

### 5.1 Storage conditions

Observe the following notes for storage:

- ▶ Store in the original packaging to ensure protection from shock.
- ▶ Do not remove protective covers or protective caps installed on process connections. They prevent mechanical damage to the sealing surfaces and contamination in the measuring tube.
- ▶ Protect from direct sunlight. Avoid unacceptably high surface temperatures.
- ▶ Store in a dry and dust-free place.
- ▶ Do not store outdoors.

Storage temperature →  202

### 5.2 Transporting the product

Transport the measuring device to the measuring point in the original packaging.



A0029252

-  Do not remove protective covers or caps installed on process connections. They prevent mechanical damage to the sealing surfaces and contamination in the measuring tube.

#### 5.2.1 Measuring devices without lifting lugs

##### WARNING

**Center of gravity of the measuring device is higher than the suspension points of the webbing slings.**

Risk of injury if the measuring device slips.

- ▶ Secure the measuring device against slipping or turning.
- ▶ Observe the weight specified on the packaging (stick-on label).

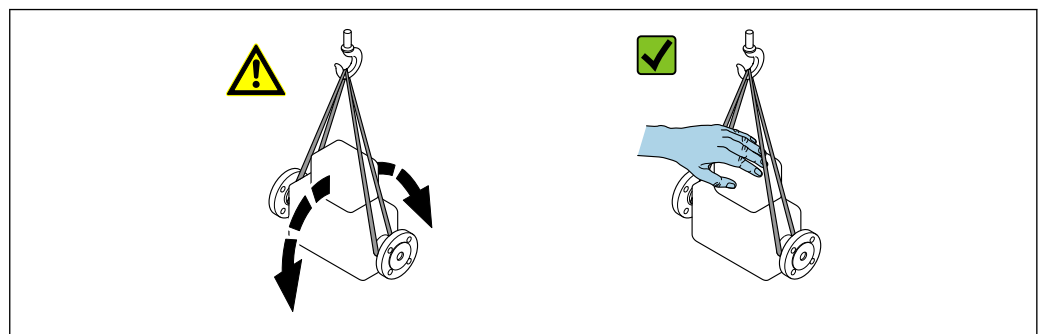

A0029214

## 5.2.2 Measuring devices with lifting lugs

### CAUTION

#### Special transportation instructions for devices with lifting lugs

- ▶ Only use the lifting lugs fitted on the device or flanges to transport the device.
- ▶ The device must always be secured at two lifting lugs at least.

## 5.2.3 Transporting with a fork lift

If transporting in wood crates, the floor structure enables the crates to be lifted lengthwise or at both sides using a forklift.

## 5.3 Packaging disposal

All packaging materials are environmentally friendly and 100% recyclable:

- Outer packaging of device
  - Stretch wrap made of polymer in accordance with EU Directive 2002/95/EC (RoHS)
- Packaging
  - Wood crate treated in accordance with ISPM 15 standard, confirmed by IPPC logo
  - Cardboard box in accordance with European packaging guideline 94/62/EC, recyclability confirmed by Resy symbol
- Transport material and fastening fixtures
  - Disposable plastic pallet
  - Plastic straps
  - Plastic adhesive strips
- Filler material
  - Paper pads

## 6 Mounting

### 6.1 Mounting requirements

#### 6.1.1 Installation position

##### Installation point

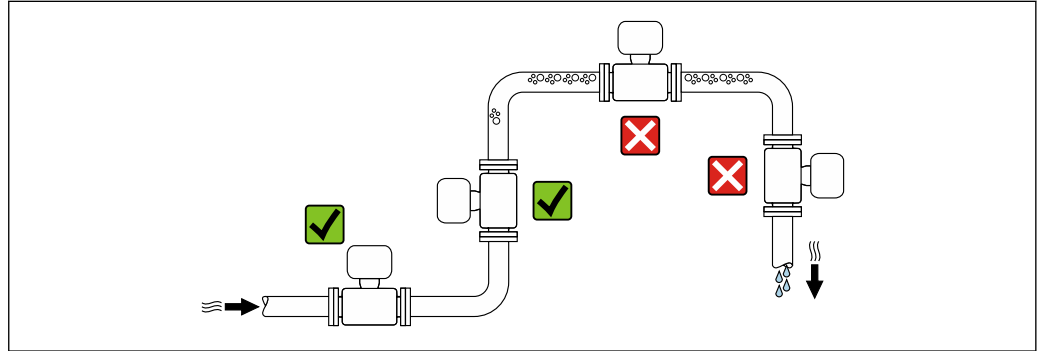

A0028772

To prevent measuring errors arising from accumulation of gas bubbles in the measuring pipe, avoid the following mounting locations in the piping:

- Highest point of a pipeline.
- Directly upstream of a free pipe outlet in a down pipe.

##### Installation in down pipes

However, the following installation suggestion allows for installation in an open vertical pipeline. Pipe restrictions or the use of an orifice with a smaller cross-section than the nominal diameter prevent the sensor running empty while measurement is in progress.

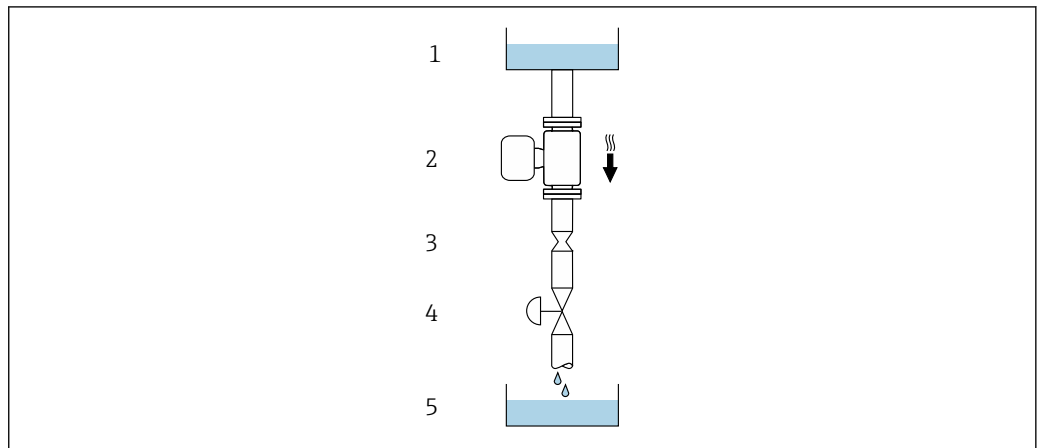

A0028773



4 Installation in a down pipe (e.g. for batching applications)

- 1 Supply tank
- 2 Sensor
- 3 Orifice plate, pipe restriction
- 4 Valve
- 5 Filling vessel

DN		Ø orifice plate, pipe restriction	
[mm]	[in]	[mm]	[in]
1	1/24	0.8	0.03
2	1/12	1.5	0.06
4	1/8	3.0	0.12

**Orientation**

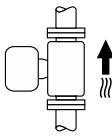
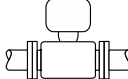
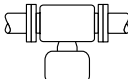
The direction of the arrow on the sensor nameplate helps you to install the sensor according to the flow direction (direction of medium flow through the piping).

Orientation		Recommendation
<b>A</b>	Vertical orientation	 A0015591 ✓✓ <sup>1)</sup>
<b>B</b>	Horizontal orientation, transmitter at top	 A0015589 ✓ <sup>2)</sup>
<b>C</b>	Horizontal orientation, transmitter at bottom	 A0015590 ✓ <sup>3)</sup>
<b>D</b>	Horizontal orientation, transmitter at side	 A0015592 ✓

- 1) This orientation is recommended to ensure self-draining.
- 2) Applications with low process temperatures may reduce the ambient temperature. To maintain the minimum ambient temperature for the transmitter, this orientation is recommended.
- 3) Applications with high process temperatures may increase the ambient temperature. To maintain the maximum ambient temperature for the transmitter, this orientation is recommended.

If a sensor is installed horizontally with a curved measuring tube, match the position of the sensor to the fluid properties.

**Inlet and outlet runs**

No special precautions need to be taken for fittings that create turbulence, such as valves, elbows or T-pieces, as long as no cavitation occurs → 23.

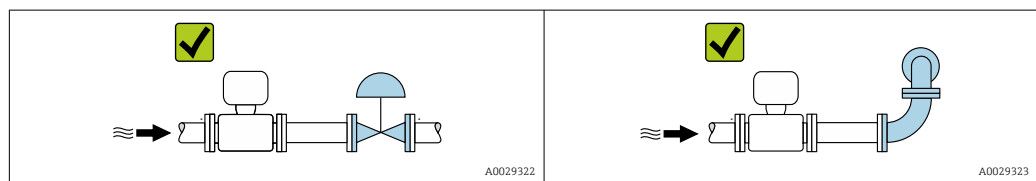



*Installation dimensions*

 For the dimensions and installation lengths of the device, see the "Technical Information" document, "Mechanical construction" section

## 6.1.2 Environmental and process requirements

### Ambient temperature range

Measuring device	<ul style="list-style-type: none"> <li>■ -40 to +60 °C (-40 to +140 °F)</li> <li>■ Order code for "Test, certificate", option JP: -50 to +60 °C (-58 to +140 °F)</li> </ul>
Readability of the local display	-20 to +60 °C (-4 to +140 °F) The readability of the display may be impaired at temperatures outside the temperature range.

 Dependency of ambient temperature on medium temperature →  203

- ▶ If operating outdoors:  
Avoid direct sunlight, particularly in warm climatic regions.

### Static pressure

It is important that cavitation does not occur, or that gases entrained in the liquids do not outgas.

Cavitation is caused if the pressure drops below the vapor pressure:

- In liquids that have a low boiling point (e.g. hydrocarbons, solvents, liquefied gases)
- In suction lines
- ▶ Ensure the static pressure is sufficiently high to prevent cavitation and outgassing.

For this reason, the following mounting locations are recommended:

- At the lowest point in a vertical pipe
- Downstream from pumps (no danger of vacuum)

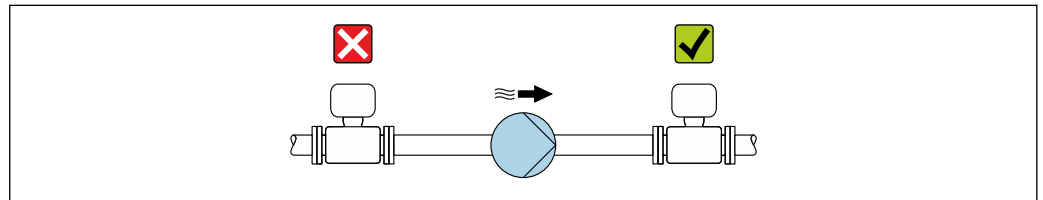

A0028777

### Thermal insulation

In the case of some fluids, it is important to keep the heat radiated from the sensor to the transmitter to a low level. A wide range of materials can be used for the required insulation.

#### NOTICE

#### Electronics overheating on account of thermal insulation!

- ▶ Recommended orientation: horizontal orientation, transmitter housing pointing downwards.
- ▶ Do not insulate the transmitter housing .
- ▶ Maximum permissible temperature at the lower end of the transmitter housing: 80 °C (176 °F)
- ▶ Regarding thermal insulation with an exposed extended neck: We advise against insulating the extended neck to ensure optimal heat dissipation.

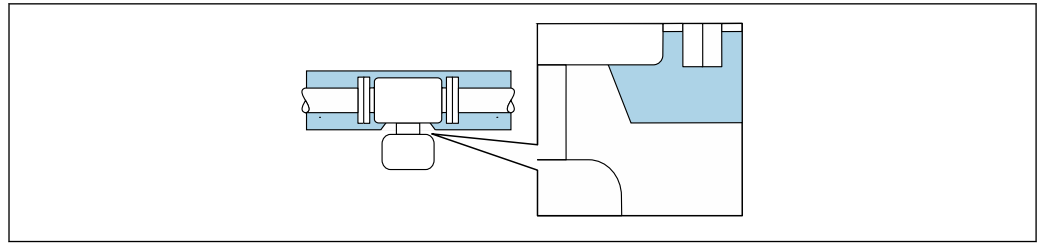

A0034391

5 Thermal insulation with exposed extended neck

## Heating

### NOTICE

#### Electronics can overheat due to elevated ambient temperature!

- ▶ Observe maximum permitted ambient temperature for the transmitter.
- ▶ Depending on the medium temperature, take the device orientation requirements into account.

### NOTICE

#### Danger of overheating when heating

- ▶ Ensure that the temperature at the lower end of the transmitter housing does not exceed 80 °C (176 °F).
- ▶ Ensure that sufficient convection takes place at the transmitter neck.
- ▶ Ensure that a sufficiently large area of the transmitter neck remains exposed. The uncovered part serves as a radiator and protects the electronics from overheating and excessive cooling.
- ▶ When using in potentially explosive atmospheres, observe the information in the device-specific Ex documentation. For detailed information on the temperature tables, see the separate document entitled "Safety Instructions" (XA) for the device.
- ▶ Consider the "830 ambient temperature too high" and "832 electronics temperature too high" process diagnostics if overheating cannot be ruled out based on a suitable system design.

### Heating options

If a fluid requires that no heat loss should occur at the sensor, users can avail of the following heating options:

- Electrical heating, e.g. with electric band heaters <sup>2)</sup>
- Via pipes carrying hot water or steam
- Via heating jackets

## Vibrations

The high oscillation frequency of the measuring tubes ensures that the correct operation of the measuring system is not influenced by plant vibrations.

### 6.1.3 Special installation instructions

#### Drainability



When the device is installed in a vertical position, the measuring tube can be drained completely and protected against deposit buildup if the properties of the measured liquid allow this. Furthermore, as only one measuring tube is used the flow is not impeded and the risk of product being retained in the measuring device is reduced to a minimum. The

2) The use of parallel electric band heaters is generally recommended (bidirectional electricity flow). Particular considerations must be made if a single-wire heating cable is to be used. For additional information, refer to EA01339D "Installation Instructions for Electrical Trace Heating Systems".



larger internal diameter of the measuring tube <sup>3)</sup> also reduces the risk of particles getting trapped in the measuring system. Due to the larger cross-section of the individual measuring tube, the tube is also generally less susceptible to clogging.

### Hygienic compatibility

-  ▪ When installing in hygienic applications, please refer to the information in the "Certificates and approvals/hygienic compatibility" section →  214
- In the case of measuring devices with the order code for "Housing", option B "Stainless, hygienic", to seal the connection compartment cover, screw it closed finger-tight and tighten it by another 45° (corresponds to 15 Nm).

### Rupture disk

Process-related information: →  204.

#### **WARNING**



#### **Danger from medium escaping!**

Medium escaping under pressure can cause injury or material damage.

- ▶ Take precautions to prevent danger to persons and damage if the rupture disk is actuated.
- ▶ Observe the information on the rupture disk sticker.
- ▶ Make sure that the function and operation of the rupture disk is not impeded through the installation of the device.
- ▶ Do not remove or damage the rupture disk, drain connection and warning signs.

The position of the rupture disk is indicated by an affixed sticker. In versions without a drain connection (order option CU), the sticker is destroyed if the rupture disk is triggered. The disk can therefore be visually monitored.

To allow any escaping medium to drain in a controlled manner, a drain connection is available for the rupture disk integrated in the sensor: order code for "Sensor option", option CU "Drain connection for rupture disk". This connection is intended for a pipe connection with a 1/4" NPT thread and sealed with a grip plug for protection. To guarantee the function of the rupture disk with a drain connection, the drain connection must be connected to the drain system in a hermetically tight manner.

-  The drain connection is firmly mounted in place by the manufacturer and may not be removed.
-  It is not possible to use the holder with a measuring device with a drain connection for a rupture disk: order code for "Sensor option", option CU "Drain connection for rupture disk"
-  It is not possible to use a heating jacket if the drain connection is used: order code for "Sensor option", option CU "Drain connection for rupture disk"

3) Compared with the double-tube design with a similar flow capacity and measuring tubes with a smaller internal diameter

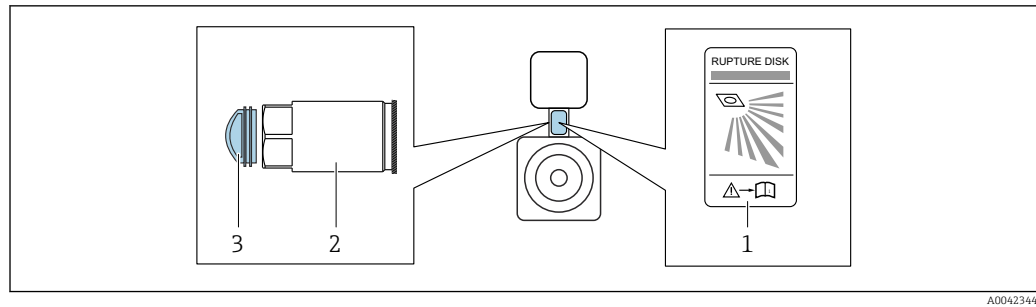

A0042344

- 1 Rupture disk label
- 2 Drain connection for rupture disk with 1/4" NPT internal thread and 17mm width across flats (AF): order code for "Sensor option", option CU, drain connection for rupture disk
- 3 Transportation guard



For information on the dimensions, see the "Technical Information" document, "Mechanical construction" section (accessories).

### Zero verification and zero adjustment

All measuring instruments are calibrated in accordance with state-of-the-art technology. Calibration takes place under reference conditions → 198. Therefore, a zero adjustment in the field is generally not required.

Experience shows that zero adjustment is advisable only in special cases:

- To achieve maximum measurement accuracy even with low flow rates.
- Under extreme process or operating conditions (e.g. very high process temperatures or very high-viscosity fluids).
- For gas applications with low pressure



To achieve the highest possible measurement accuracy at low flow rates, the installation must protect the sensor from mechanical stresses during operation.

To get a representative zero point, ensure that:

- any flow in the device is prevented during the adjustment
- the process conditions (e.g. pressure, temperature) are stable and representative

Verification and adjustment cannot be carried out if the following process conditions are present:

- Gas pockets  
Ensure that the system has been sufficiently flushed with the medium. Repeat flushing can help to eliminate gas pockets
- Thermal circulation  
In the event of temperature differences (e.g. between the measuring tube inlet and outlet section), induced flow can occur even if the valves are closed due to thermal circulation in the device
- Leaks at the valves  
If the valves are not leak-tight, flow is not sufficiently prevented when determining the zero point

If these conditions cannot be avoided, it is advisable to keep the factory setting for the zero point.

### Sensor holder

The sensor holder is used to secure the device to a wall, tabletop or pipe (order code for "Accessory enclosed", option PR).

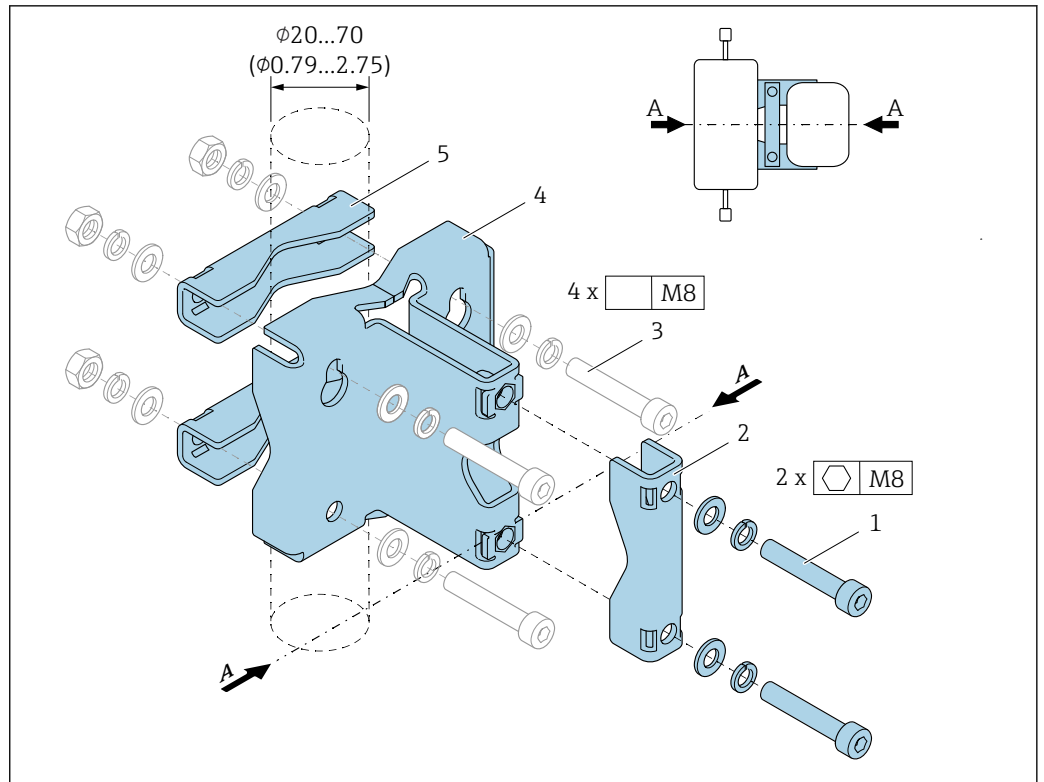

A0036471

- 1 2 x Allen screw M8 x 50, washer and spring washer A4
- 2 1 x clamp (measuring instrument neck)
- 3 4 x securing screw for wall, tabletop or pipe mounting (not supplied)
- 4 1 x base profile
- 5 2 x clamp (pipe mounting)
- A Measuring instrument central line

If the holder is used with a measuring instrument fitted with a rupture disk, it is important to ensure that the rupture disk in the neck is not covered over and that the cover of the rupture disk is not damaged.

**⚠ WARNING**

**Strain on pipes!**

Excessive strain on an unsupported pipe can cause the pipe to break.

- Install the sensor in a sufficiently supported pipe. In addition to the use of the sensor holder, for maximum mechanical stability the sensor can also be supported on the inlet and outlet sides onsite at the installation location with the use of pipe clamps, for example.

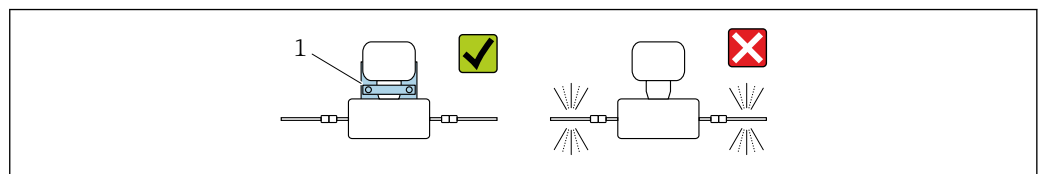

A0036492

- 1 Sensor holder (Order code for "Accessories enclosed", option PR)

**The following mounting versions are recommended for the installation:**

- i** Lubricate all threaded joints prior to mounting. The screws for wall, tabletop or pipe mounting are not supplied with the device and must be chosen to suit the individual installation position.

### Wall mounting

Screw the sensor holder to the wall with four screws. Two of the four holes to secure the holder are designed to hook into the screws.

### Mounting on a table

Screw the sensor holder onto the tabletop with four screws.

### Pipe mounting

Secure the sensor holder to the pipe with two clamps.

### **⚠ WARNING**

**Failure to comply with the specifications for vibration and shock resistance can damage the measuring instrument!**

- ▶ During operation, transportation and storage, ensure compliance with the specifications for maximum vibration and shock resistance →  202.

### Weather protection cover

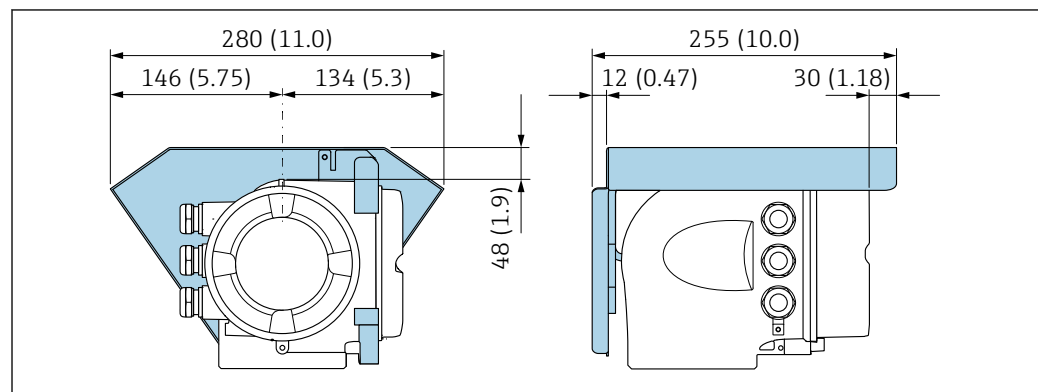

 6 Engineering unit mm (in)

A0029553

## 6.2 Mounting the measuring instrument

### 6.2.1 Required tools

#### For sensor

For flanges and other process connections: Use a suitable mounting tool.

### 6.2.2 Preparing the measuring instrument

1. Remove all remaining transport packaging.
2. Remove any protective covers or protective caps present from the sensor.
3. Remove stick-on label on the electronics compartment cover.

### 6.2.3 Mounting the measuring device

### **⚠ WARNING**

**Danger due to improper process sealing!**

- ▶ Ensure that the inside diameters of the gaskets are greater than or equal to that of the process connections and piping.
- ▶ Ensure that the seals are clean and undamaged.
- ▶ Secure the seals correctly.

1. Ensure that the direction of the arrow on the nameplate of the sensor matches the flow direction of the medium.
2. Install the measuring device or turn the transmitter housing so that the cable entries do not point upwards.

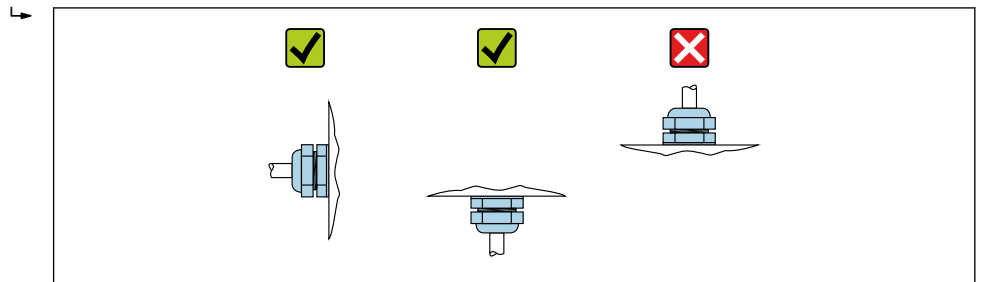

A0029263

### 6.2.4 Turning the transmitter housing

To provide easier access to the connection compartment or display module, the transmitter housing can be turned.

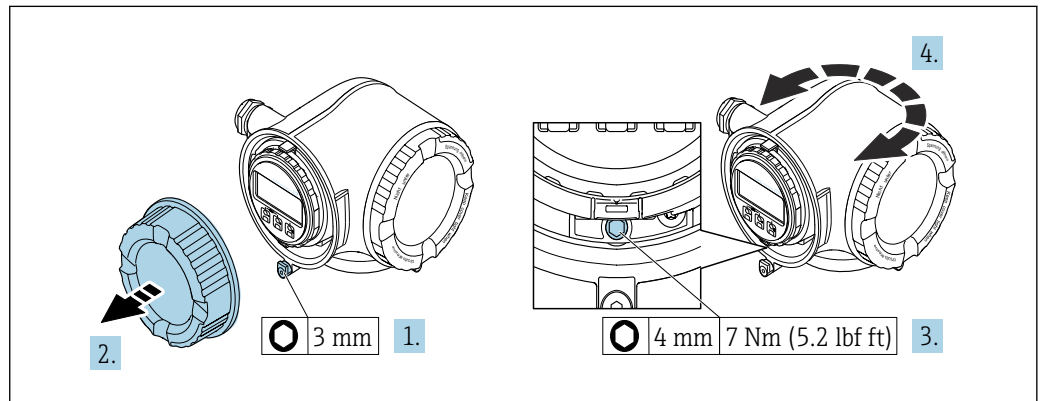

A0029993

7 Housing in non-Ex version

1. Depending on the device version: Loosen the securing clamp of the connection compartment cover.
2. Unscrew the connection compartment cover.
3. Loosen the fixing screw.
4. Turn the housing to the desired position.
5. Tighten the securing screw.
6. Screw on the connection compartment cover.
7. Depending on the device version: Attach the securing clamp of the connection compartment cover.

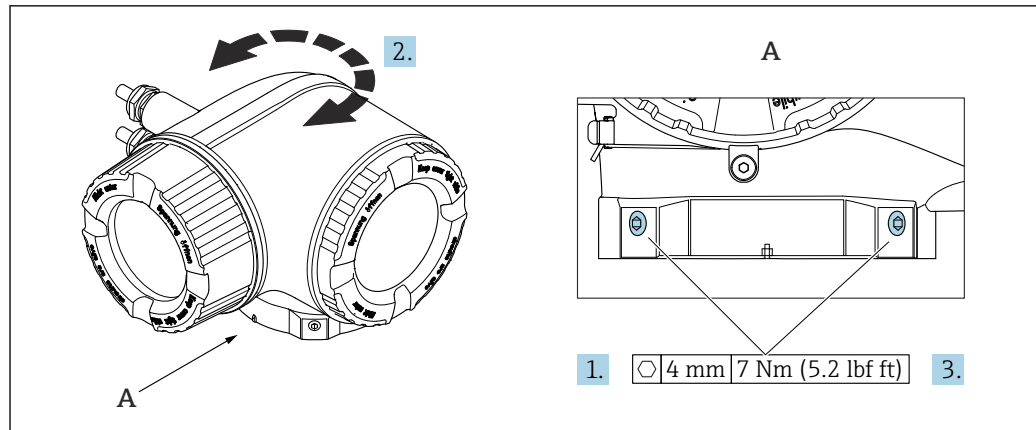

#### 8 Ex housing

1. Loosen the fixing screws.
2. Turn the housing to the desired position.
3. Tighten the securing screws.

### 6.2.5 Turning the display module

The display module can be turned to optimize display readability and operability.

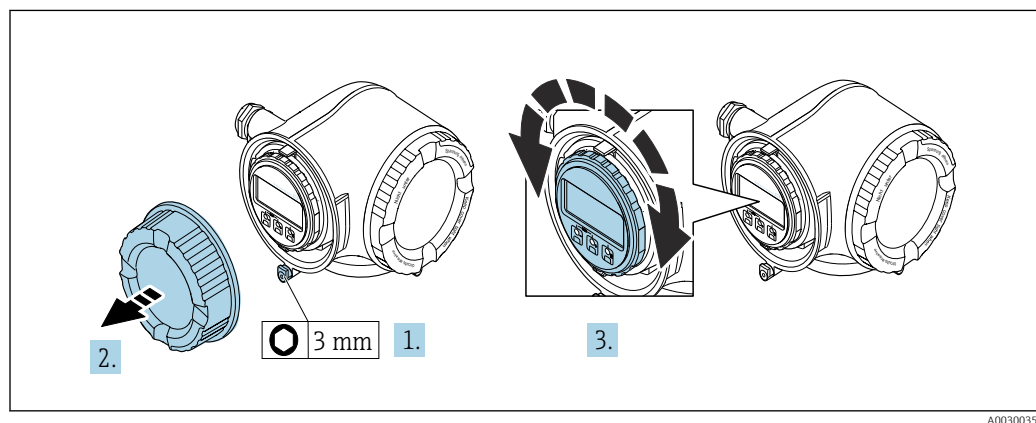

1. Depending on the device version: Loosen the securing clamp of the connection compartment cover.
2. Unscrew the connection compartment cover.
3. Turn the display module to the desired position: max.  $8 \times 45^\circ$  in each direction.
4. Screw on the connection compartment cover.
5. Depending on the device version: Attach the securing clamp of the connection compartment cover.

### 6.3 Post-installation check

Is the device undamaged (visual inspection)?	<input type="checkbox"/>
Does the measuring instrument correspond to the measuring point specifications? For example: <ul style="list-style-type: none"> <li>▪ Process temperature → 203</li> <li>▪ Pressure (refer to the "Pressure-temperature ratings" section of the "Technical Information" document).</li> <li>▪ Ambient temperature</li> <li>▪ Measuring range</li> </ul>	<input type="checkbox"/>
Has the correct orientation for the sensor been selected → 22? <ul style="list-style-type: none"> <li>▪ According to sensor type</li> <li>▪ According to medium temperature</li> <li>▪ According to medium properties (outgassing, with entrained solids)</li> </ul>	<input type="checkbox"/>
Does the arrow on the sensor match the direction of flow of the medium? → 22?	<input type="checkbox"/>
Is the tag name and labeling correct (visual inspection)?	<input type="checkbox"/>
Is the device sufficiently protected from precipitation and direct sunlight?	<input type="checkbox"/>
Are the securing screw and securing clamp tightened securely?	<input type="checkbox"/>

## 7 Electrical connection

### WARNING

**Live parts! Incorrect work performed on the electrical connections can result in an electric shock.**

- ▶ Set up a disconnecting device (switch or power-circuit breaker) to easily disconnect the device from the supply voltage.
- ▶ In addition to the device fuse, include an overcurrent protection unit with max. 10 A in the plant installation.

### 7.1 Electrical safety

In accordance with applicable national regulations.

### 7.2 Connecting requirements

#### 7.2.1 Required tools

- For cable entries: Use corresponding tools
- For securing clamp: Allen key 3 mm
- Wire stripper
- When using stranded cables: Crimper for wire end ferrule
- For removing cables from terminal: Flat blade screwdriver  $\leq 3$  mm (0.12 in)

#### 7.2.2 Requirements for connection cable

The connecting cables provided by the customer must fulfill the following requirements.

##### **Protective grounding cable for the outer ground terminal**

Conductor cross-section  $< 2.1$  mm<sup>2</sup> (14 AWG)

The use of a cable lug enables the connection of larger cross-sections.

The grounding impedance must be less than 2  $\Omega$ .

##### **Permitted temperature range**

- The installation guidelines that apply in the country of installation must be observed.
- The cables must be suitable for the minimum and maximum temperatures to be expected.

##### **Power supply cable (incl. conductor for the inner ground terminal)**

Standard installation cable is sufficient.

##### **Signal cable**

-  For custody transfer, all signal lines must be shielded cables (tinned copper braiding, optical coverage  $\geq 85$  %). The cable shield must be connected on both sides.

*Current output 4 to 20 mA HART*

Shielded twisted-pair cable.

-  See <https://www.fieldcommgroup.org> "HART PROTOCOL SPECIFICATIONS".



*Ethernet-APL*

Shielded twisted-pair cable. Cable type A is recommended.



See <https://www.profibus.com> Ethernet-APL White Paper "

*Current output 0 /4 to 20 mA (excluding HART)*

Standard installation cable is sufficient.

*Pulse /frequency /switch output*

Standard installation cable is sufficient.

*Relay output*

Standard installation cable is sufficient.

*Current input 4 to 20 mA*

Standard installation cable is sufficient.

*Status input*

Standard installation cable is sufficient.

**Cable diameter**

- Cable glands supplied:  
M20 × 1.5 with cable Ø 6 to 12 mm (0.24 to 0.47 in)
- Spring-loaded terminals: Suitable for strands and strands with ferrules.  
Conductor cross-section 0.2 to 2.5 mm<sup>2</sup> (24 to 12 AWG).

**Requirements for connecting cable – remote display and operating module DKX001***Optionally available connecting cable*

A cable is supplied depending on the order option

- Order code for measuring device: order code **030** for "Display; operation", option **O**  
or
- Order code for measuring device: order code **030** for "Display; operation", option **M**  
and
- Order code for DKX001: order code **040** for "Cable", option **A, B, D, E**

<b>Standard cable</b>	2 × 2 × 0.34 mm <sup>2</sup> (22 AWG) PVC cable with common shield (2 pairs, pair-stranded)
<b>Flame resistance</b>	According to DIN EN 60332-1-2
<b>Oil resistance</b>	According to DIN EN 60811-2-1
<b>Shield</b>	Tin-plated copper braid, optical cover ≥ 85 %
<b>Capacitance: core/shield</b>	≤ 200 pF/m
<b>L/R</b>	≤ 24 µH/Ω
<b>Available cable length</b>	5 m (15 ft)/10 m (35 ft)/20 m (65 ft)/30 m (100 ft)
<b>Operating temperature</b>	When mounted in a fixed position: -50 to +105 °C (-58 to +221 °F); when cable can move freely: -25 to +105 °C (-13 to +221 °F)

*Standard cable - customer-specific cable*

With the following order option, no cable is supplied with the device and must be provided by the customer:

Order code for DKX001: Order code **040** for "Cable", option **1** "None, provided by customer, max 300 m"

A standard cable with the following minimum requirements can be used as the connecting cable, even in the hazardous area (Zone 2, Class I, Division 2 and Zone 1, Class I, Division 1):



<b>Standard cable</b>	4 wires (2 pairs); pair-stranded with common shield, minimum wire cross-section 0.34 mm <sup>2</sup> (22 AWG)
<b>Shield</b>	Tin-plated copper braid, optical cover ≥ 85 %
<b>Cable impedance (pair)</b>	Minimum 80 Ω
<b>Cable length</b>	Maximum 300 m (1 000 ft), maximum loop impedance 20 Ω
<b>Capacitance: core/shield</b>	Maximum 1 000 nF for Zone 1, Class I, Division 1
<b>L/R</b>	Maximum 24 μH/Ω for Zone 1, Class I, Division 1

### 7.2.3 Terminal assignment

#### Transmitter: supply voltage, input/outputs

The terminal assignment of the inputs and outputs depends on the individual order version of the device. The device-specific terminal assignment is documented on an adhesive label in the terminal cover.

Supply voltage		Input/output 1		Input/output 2		Input/output 3	
1 (+)	2 (-)	26 (+)	27 (-)	24 (+)	25 (-)	22 (+)	23 (-)
Device-specific terminal assignment: adhesive label in terminal cover.							

 Terminal assignment of the remote display and operating module →  38.

### 7.2.4 Preparing the measuring device

#### NOTICE

#### Insufficient sealing of the housing!

Operational reliability of the measuring device could be compromised.

► Use suitable cable glands corresponding to the degree of protection.

1. Remove dummy plug if present.
2. If the measuring device is supplied without cable glands:  
Provide suitable cable gland for corresponding connecting cable.
3. If the measuring device is supplied with cable glands:  
Observe requirements for connecting cables →  32.

## 7.3 Connecting the measuring instrument

#### NOTICE

#### An incorrect connection compromises electrical safety!

- Only properly trained specialist staff may perform electrical connection work.
- Observe applicable federal/national installation codes and regulations.
- Comply with local workplace safety regulations.
- Always connect the protective ground cable  $\ominus$  before connecting additional cables.
- When using in potentially explosive atmospheres, observe the information in the device-specific Ex documentation.

### 7.3.1 Connecting the transmitter

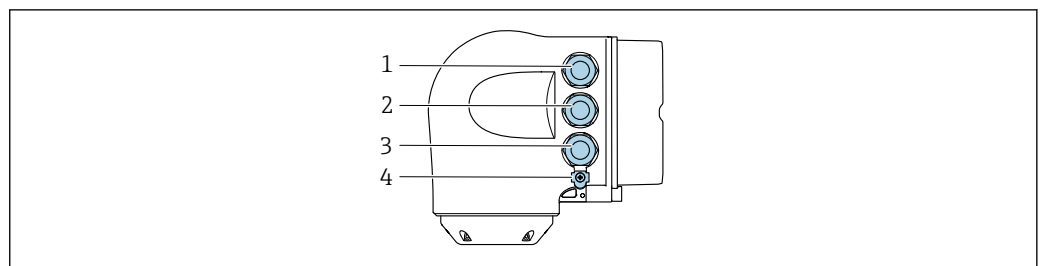

- 1 Terminal connection for supply voltage
- 2 Terminal connection for signal transmission, input/output
- 3 Terminal connection for signal transmission, input/output or terminal connection for network connection via service interface (CDI-RJ45); optional: connection for external WLAN antenna or remote display and operating module DKX001
- 4 Protective earth (PE)

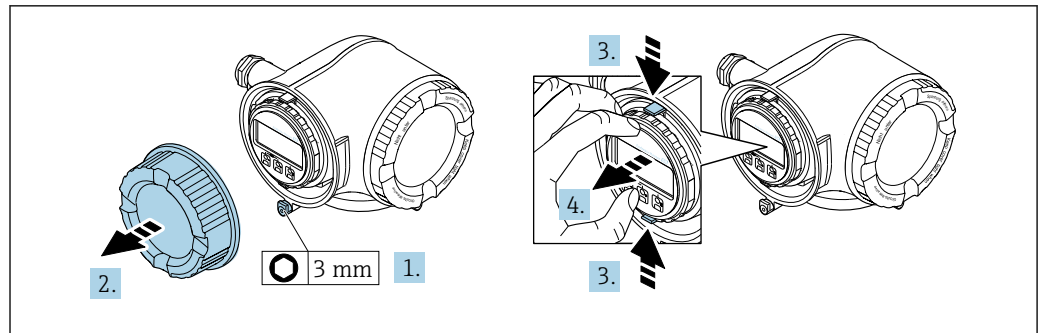

A0029813

1. Loosen the securing clamp of the connection compartment cover.
2. Unscrew the connection compartment cover.
3. Squeeze the tabs of the display module holder together.
4. Remove the display module holder.

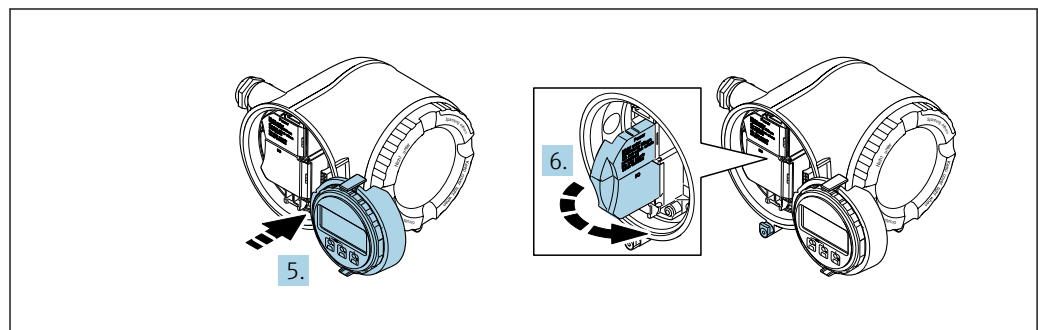

A0029814

5. Attach the holder to the edge of the electronics compartment.
6. Open the terminal cover.

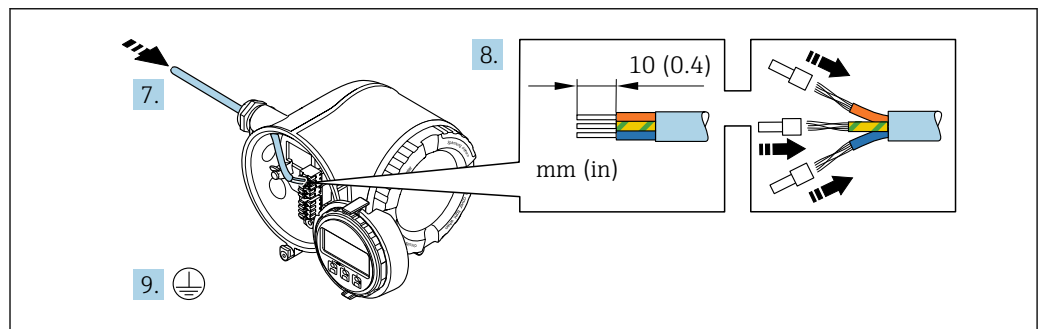

A0029815

7. Push the cable through the cable entry. To ensure tight sealing, do not remove the sealing ring from the cable entry.
8. Strip the cable and cable ends. In the case of stranded cables, also fit ferrules.
9. Connect the protective ground.

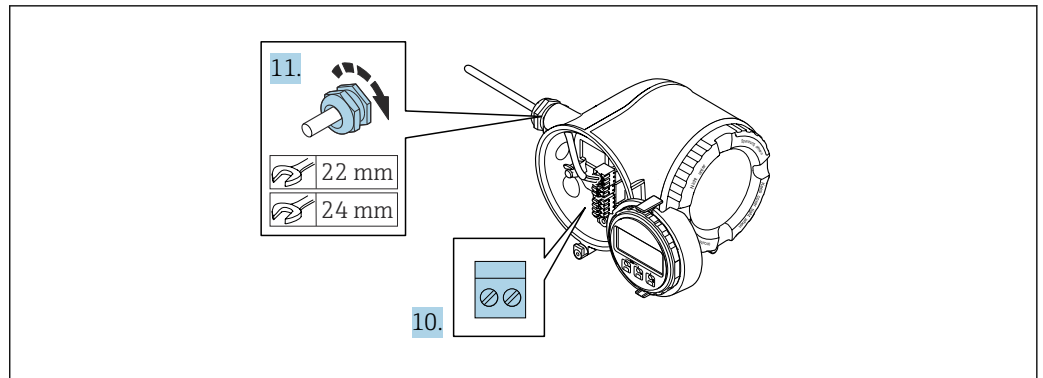

A0029816

10. Connect the cable according to the terminal assignment.
  - ↳ **Signal cable terminal assignment:** The device-specific terminal assignment is documented on an adhesive label in the terminal cover.
  - Supply voltage connection terminal assignment:** Adhesive label in the terminal cover or → 35.
11. Firmly tighten the cable glands.
  - ↳ This concludes the cable connection process.
12. Close the terminal cover.
13. Fit the display module holder in the electronics compartment.
14. Screw on the connection compartment cover.
15. Secure the securing clamp of the connection compartment cover.

### Removing a cable

To remove a cable from the terminal:

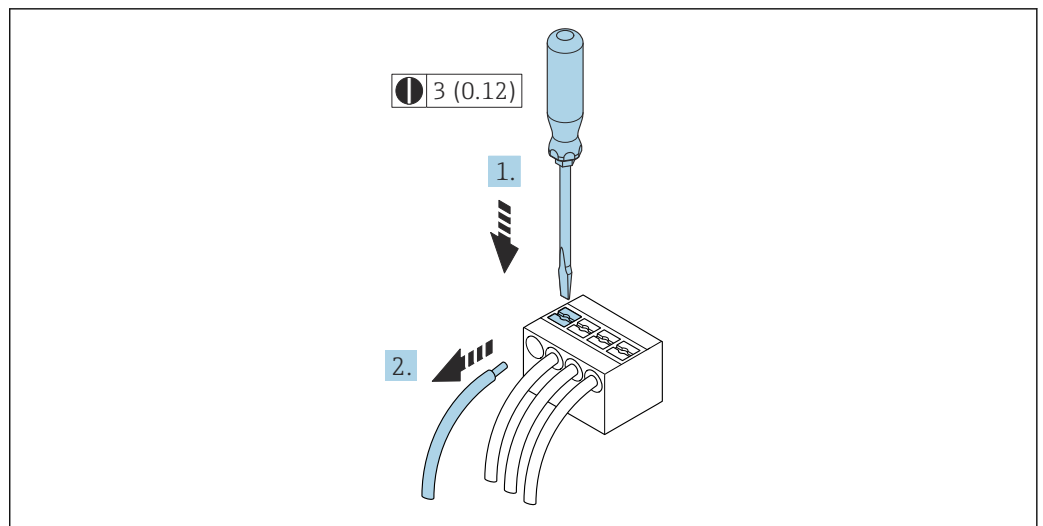

A0029598

9 Engineering unit mm (in)

1. Use a flat-blade screwdriver to press down on the slot between the two terminal holes.
2. Remove the cable end from the terminal.

### 7.3.2 Connecting the remote display and operating module DKX001

**i** The remote display and operating module DKX001 is available as an optional extra  
→ 184..

- The remote display and operating module DKX001 is only available for the following housing version: order code for "Housing": option A "Aluminum, coated"
- The measuring instrument is always supplied with a dummy cover when the remote display and operating module DKX001 is ordered directly with the measuring instrument. Display or operation at the transmitter is not possible in this case.
- If ordered subsequently, the remote display and operating module DKX001 may not be connected at the same time as the existing measuring instrument display module. Only one display or operation unit may be connected to the transmitter at any one time.

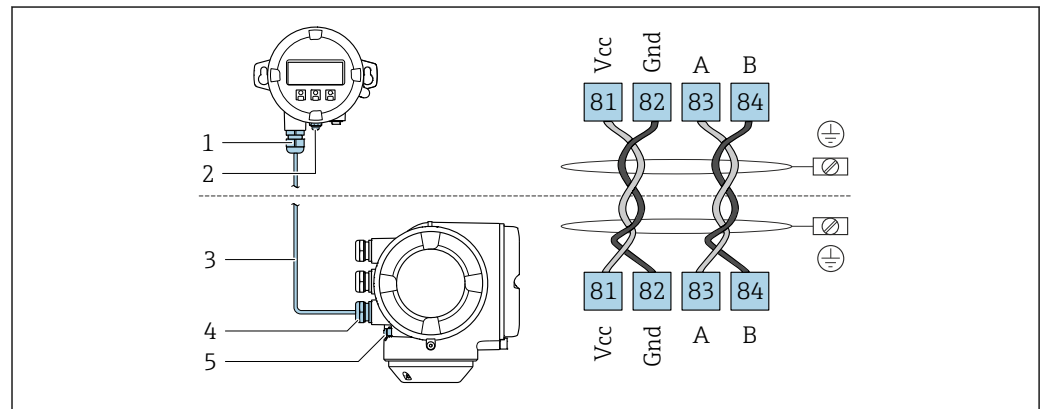

A0027518

- 1 Remote display and operating module DKX001
- 2 Terminal connection for potential equalization (PE)
- 3 Connecting cable
- 4 Measuring instrument
- 5 Terminal connection for potential equalization (PE)

## 7.4 Potential equalization

### 7.4.1 Requirements

For potential equalization:

- Pay attention to in-house grounding concepts
- Take account of operating conditions, such as the pipe material and grounding
- Connect the medium, sensor and transmitter to the same electric potential
- Use a ground cable with a minimum cross-section of 6 mm<sup>2</sup> (10 AWG) and a cable lug for potential equalization connections

## 7.5 Special connection instructions

### 7.5.1 Connection examples

#### Current output 4 to 20 mA HART

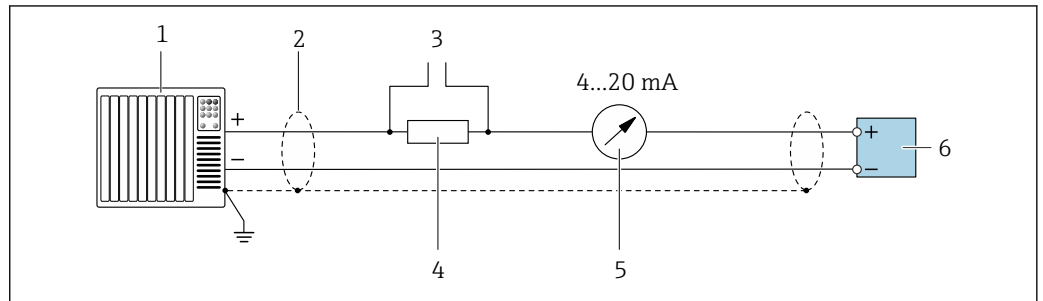

A0029055

10 Connection example for 4 to 20 mA HART current output (active)

- 1 Automation system with current input (e.g. PLC)
- 2 Ground cable shield at one end. The cable shield must be grounded at both ends to comply with EMC requirements; observe cable specifications → 197
- 3 Connection for HART operating devices → 67
- 4 Resistor for HART communication ( $\geq 250 \Omega$ ): observe maximum load → 190
- 5 Analog display unit: observe maximum load → 190
- 6 Transmitter

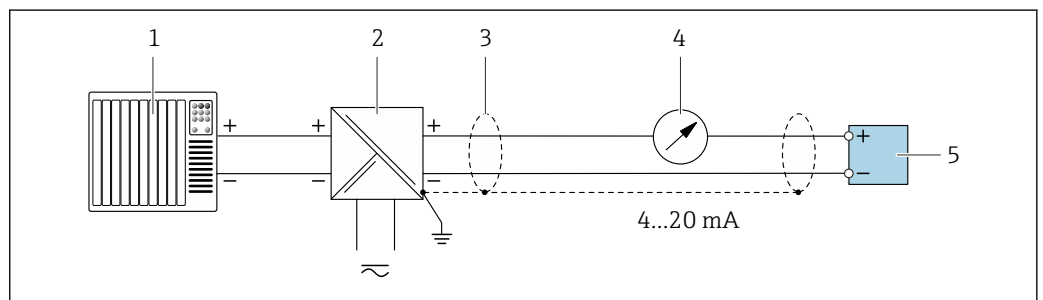

A0028762

11 Connection example for 4 to 20 mA HART current output (passive)

- 1 Automation system with current input (e.g. PLC)
- 2 Power supply
- 3 Ground cable shield at one end. The cable shield must be grounded at both ends to comply with EMC requirements; observe cable specifications
- 4 Analog display unit: observe maximum load → 190
- 5 Transmitter

**HART input**

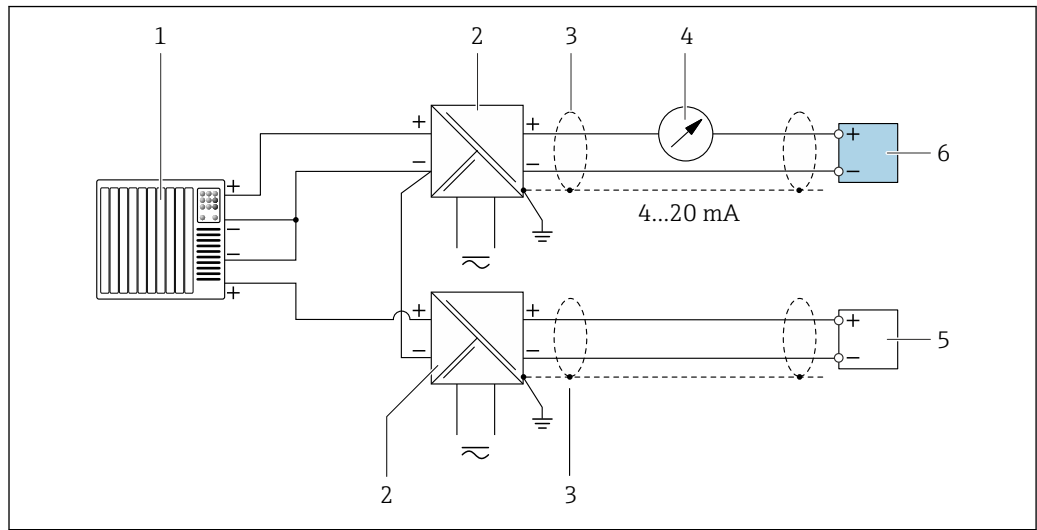

A0028763

12 Connection example for HART input with a common negative (passive)

- 1 Automation system with HART output (e.g. PLC)
- 2 Active barrier for power supply (e.g. RN221N)
- 3 Ground cable shield at one end. The cable shield must be grounded at both ends to comply with EMC requirements; observe cable specifications
- 4 Analog display unit: observe maximum load → 190
- 5 Pressure measuring device (e.g. Cerabar M, Cerabar S): observe requirements
- 6 Transmitter

**Current output 4-20 mA**

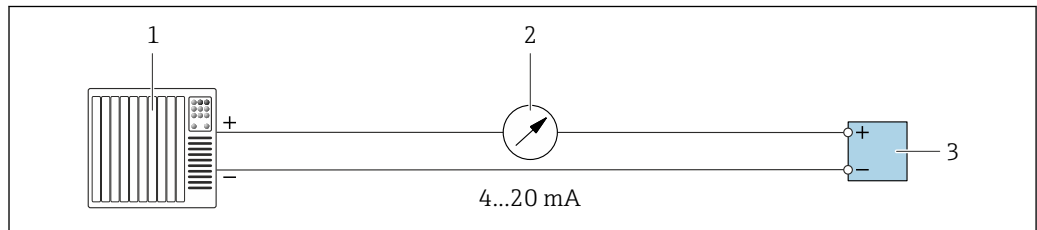

A0028758

13 Connection example for 4-20 mA current output (active)

- 1 Automation system with current input (e.g. PLC)
- 2 Analog display unit: observe maximum load → 190
- 3 Transmitter

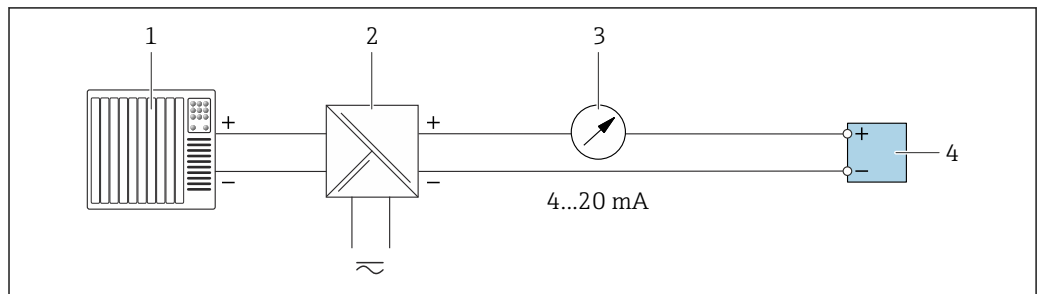

A0028759

14 Connection example for 4-20 mA current output (passive)

- 1 Automation system with current input (e.g. PLC)
- 2 Active barrier for power supply (e.g. RN221N)
- 3 Analog display unit: observe maximum load → 190
- 4 Transmitter



**Pulse/frequency output**

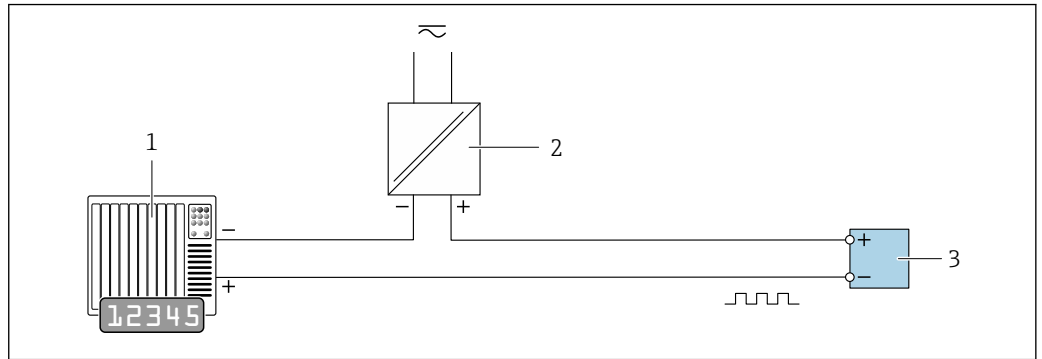

A0028761

15 Connection example for pulse/frequency output (passive)

- 1 Automation system with pulse/frequency input (e.g. PLC with 10 kΩ pull-up or pull-down resistor)
- 2 Power supply
- 3 Transmitter: observe input values → 192

**Switch output**

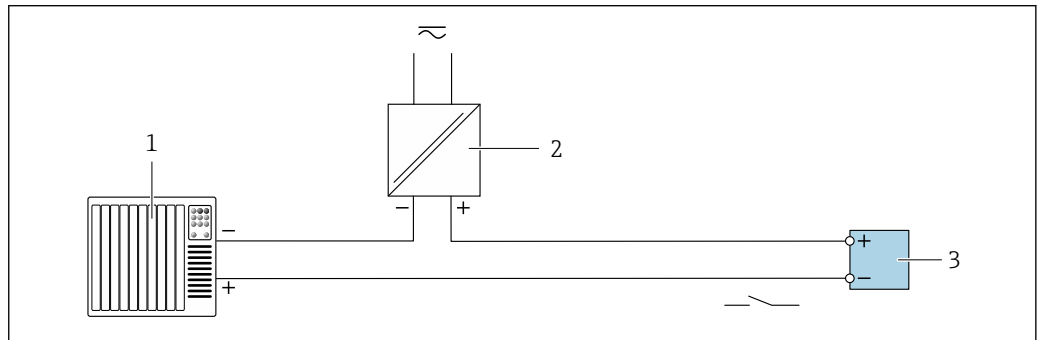

A0028760

16 Connection example for switch output (passive)

- 1 Automation system with switch input (e.g. PLC with a 10 kΩ pull-up or pull-down resistor)
- 2 Power supply
- 3 Transmitter: observe input values → 192

**Double pulse output**

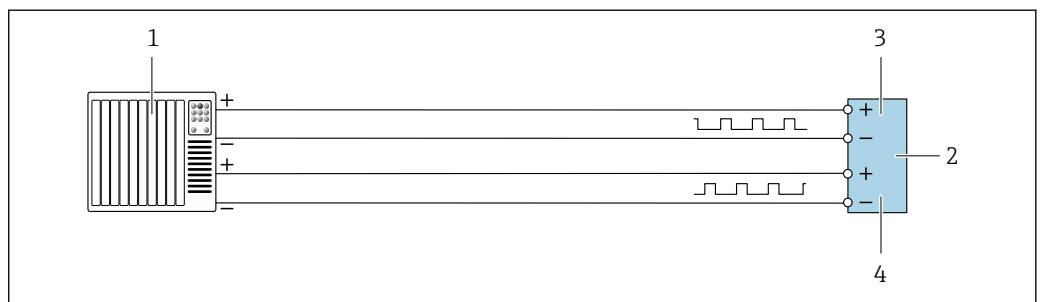

A0029280

17 Connection example for double pulse output (active)

- 1 Automation system with double pulse input (e.g. PLC)
- 2 Transmitter: observe input values → 193
- 3 Double pulse output
- 4 Double pulse output (slave), phase-shifted

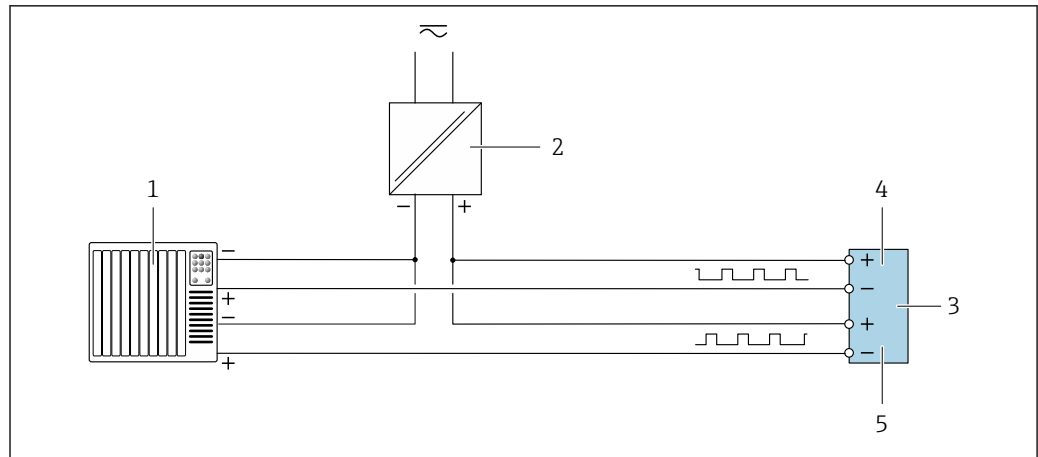

A0029279

18 Connection example for double pulse output (passive)

- 1 Automation system with double pulse input (e.g. PLC with a 10 kΩ pull-up or pull-down resistor)
- 2 Power supply
- 3 Transmitter: observe input values → 193
- 4 Double pulse output
- 5 Double pulse output (slave), phase-shifted

### Relay output

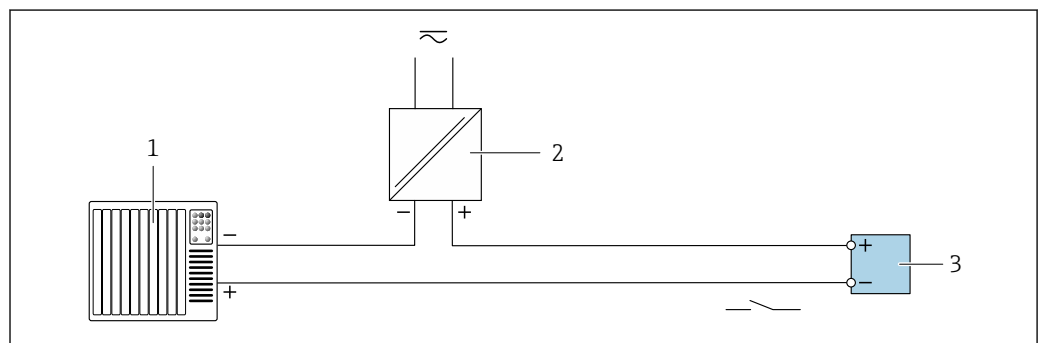

A0028760

19 Connection example for relay output (passive)

- 1 Automation system with relay input (e.g. PLC)
- 2 Power supply
- 3 Transmitter: observe input values → 194

### Current input

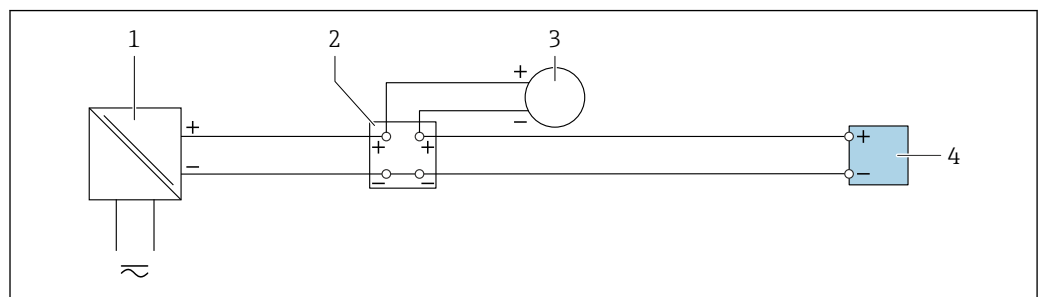

A0028915

20 Connection example for 4 to 20 mA current input

- 1 Power supply
- 2 Terminal box
- 3 External measuring device (to read in pressure or temperature, for instance)
- 4 Transmitter

### Status input

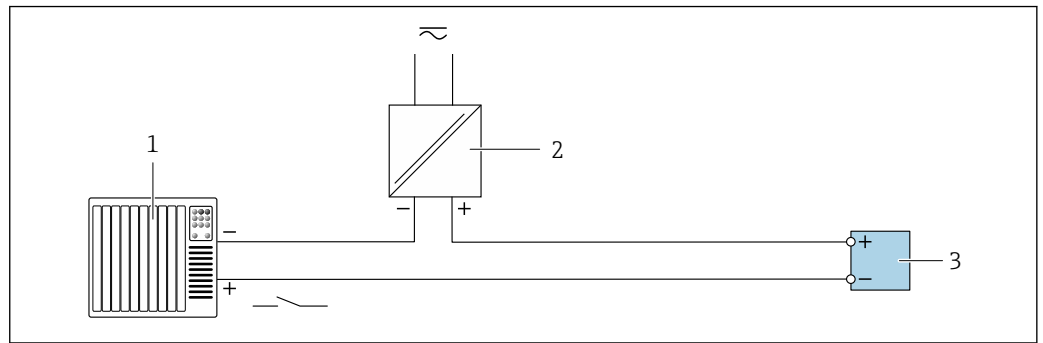

21 Connection example for status input

- 1 Automation system with status output (e.g. PLC)
- 2 Power supply
- 3 Transmitter

## 7.6 Ensuring the degree of protection

The measuring instrument fulfills all the requirements for the degree of protection IP66/67, Type 4X enclosure.

To guarantee the degree of protection IP66/67, Type 4X enclosure, carry out the following steps after the electrical connection:

1. Check that the housing seals are clean and fitted correctly.
2. Dry, clean or replace the seals if necessary.
3. Tighten all housing screws and screw covers.
4. Firmly tighten the cable glands.
5. To ensure that moisture does not enter the cable entry:  
Route the cable so that it loops down before the cable entry ("water trap").

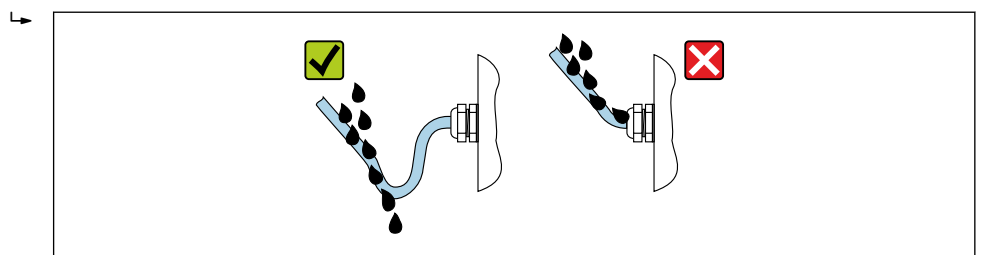

6. The cable glands supplied do not ensure housing protection when not in use. They must therefore be replaced by dummy plugs corresponding to the housing protection.

## 7.7 Post-connection check

Are the device and cable undamaged (visual inspection)?	<input type="checkbox"/>
Is the protective earthing established correctly?	<input type="checkbox"/>
Do the cables used comply with the requirements ?	<input type="checkbox"/>
Are the installed cables strain-relieved and securely routed?	<input type="checkbox"/>
Are all cable glands installed, securely tightened and leak-tight? Cable run with "water trap" → 43?	<input type="checkbox"/>
Is the terminal assignment correct ?	<input type="checkbox"/>

If supply voltage is present: Does an indication appear on the display module?	<input type="checkbox"/>
Are dummy plugs inserted in unused cable entries and have transportation plugs been replaced with dummy plugs?	<input type="checkbox"/>

## 8 Operation options

### 8.1 Overview of operation options



A0034513

- 1 Local operation via display module
- 2 Computer with web browser or operating tool (e.g. FieldCare, DeviceCare, AMS Device Manager, SIMATIC PDM)
- 3 Field Xpert SFX350 or SFX370
- 4 Field Xpert SMT70
- 5 Mobile handheld terminal
- 6 Automation system (e.g. PLC)

## 8.2 Structure and function of the operating menu

### 8.2.1 Structure of the operating menu



For an overview of the operating menu for experts: see the "Description of Device Parameters" document supplied with the device

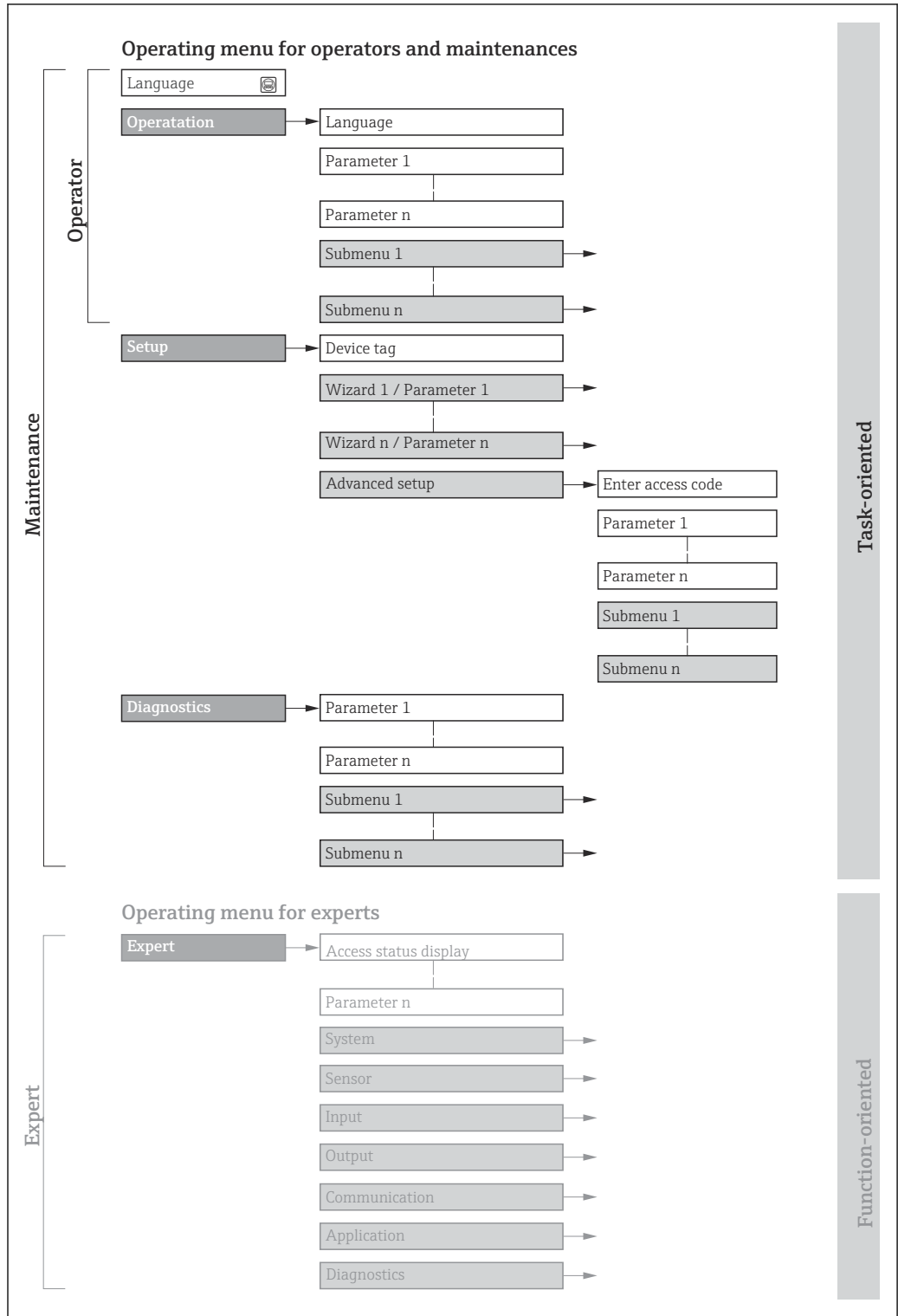

A0018237-EN

22 Schematic structure of the operating menu

### 8.2.2 Operating philosophy

The individual parts of the operating menu are assigned to certain user roles (e.g. operator, maintenance etc.). Each user role contains typical tasks within the device life cycle.

Menu/parameter		User role and tasks	Content/meaning
Language	Task-oriented	<b>Role "Operator", "Maintenance"</b> Tasks during operation: <ul style="list-style-type: none"> <li>▪ Configuration of the operational display</li> <li>▪ Reading measured values</li> </ul>	<ul style="list-style-type: none"> <li>▪ Defining the operating language</li> <li>▪ Defining the Web server operating language</li> <li>▪ Resetting and controlling totalizers</li> </ul>
Operation			<ul style="list-style-type: none"> <li>▪ Configuration of the operational display (e.g. display format, display contrast)</li> <li>▪ Resetting and controlling totalizers</li> </ul>
Setup		<b>"Maintenance" role</b> Commissioning: <ul style="list-style-type: none"> <li>▪ Configuration of the measurement</li> <li>▪ Configuration of the inputs and outputs</li> <li>▪ Configuration of the communication interface</li> </ul>	Wizards for fast commissioning: <ul style="list-style-type: none"> <li>▪ Configuring the system units</li> <li>▪ Configuration of the communication interface</li> <li>▪ Definition of the medium</li> <li>▪ Displaying the I/O configuration</li> <li>▪ Configuring the inputs</li> <li>▪ Configuring the outputs</li> <li>▪ Configuration of the operational display</li> <li>▪ Configuring the low flow cut off</li> <li>▪ Configuring partial and empty pipe detection</li> </ul> Advanced setup <ul style="list-style-type: none"> <li>▪ For more customized configuration of the measurement (adaptation to special measuring conditions)</li> <li>▪ Configuration of totalizers</li> <li>▪ Configuration of WLAN settings</li> <li>▪ Administration (define access code, reset measuring device)</li> </ul>
Diagnostics		<b>"Maintenance" role</b> Troubleshooting: <ul style="list-style-type: none"> <li>▪ Diagnostics and elimination of process and device errors</li> <li>▪ Measured value simulation</li> </ul>	Contains all parameters for error detection and analyzing process and device errors: <ul style="list-style-type: none"> <li>▪ Diagnostic list Contains up to 5 currently pending diagnostic messages.</li> <li>▪ Event logbook Contains event messages that have occurred.</li> <li>▪ Device information Contains information for identifying the device</li> <li>▪ Measured values Contains all current measured values.</li> <li>▪ <b>Data logging</b> submenu with the "Extended HistoROM" order option Storage and visualization of measured values</li> <li>▪ Heartbeat Technology Verification of device functionality on request and documentation of verification results</li> <li>▪ Simulation Used to simulate measured values or output values.</li> </ul>

Menu/parameter	User role and tasks	Content/meaning
Expert	Function-oriented	<p>Tasks that require detailed knowledge of the function of the device:</p> <ul style="list-style-type: none"> <li>▪ Commissioning measurements under difficult conditions</li> <li>▪ Optimal adaptation of the measurement to difficult conditions</li> <li>▪ Detailed configuration of the communication interface</li> <li>▪ Error diagnostics in difficult cases</li> </ul> <p>Contains all of the device parameters and allows direct access to these by means of an access code. The structure of this menu is based on the function blocks of the device:</p> <ul style="list-style-type: none"> <li>▪ System Contains all higher-level device parameters that do not affect measurement or measured value communication</li> <li>▪ Sensor Configuration of the measurement.</li> <li>▪ Input Configuration of the status input</li> <li>▪ Output Configuration of the analog current outputs as well as the pulse/frequency and switch output</li> <li>▪ Communication Configuration of the digital communication interface and the Web server</li> <li>▪ Application Configuration of the functions that go beyond the actual measurement (e.g. totalizer)</li> <li>▪ Diagnostics Error detection and analysis of process and device errors and for device simulation and Heartbeat Technology.</li> </ul>

### 8.3 Access to operating menu via local display

#### 8.3.1 Operational display

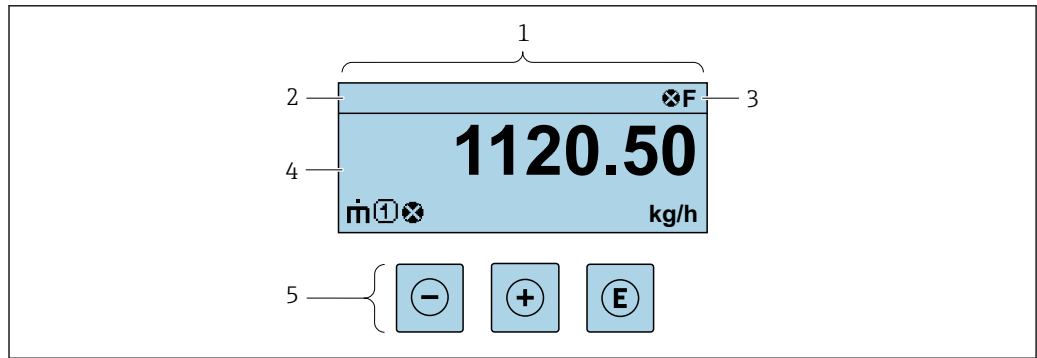

- 1 Operational display
- 2 Device tag
- 3 Status area
- 4 Display range for measured values (up to 4 lines)
- 5 Operating elements → 55

#### Status area

The following symbols appear in the status area of the operational display at the top right:

- Status signals → 158
  - F: Failure
  - C: Function check
  - S: Out of specification
  - M: Maintenance required
- Diagnostic behavior → 159
  - ⊗: Alarm
  - ⚠: Warning
  - 🔒: Locking (the device is locked via the hardware )
  - ↔: Communication (communication via remote operation is active)







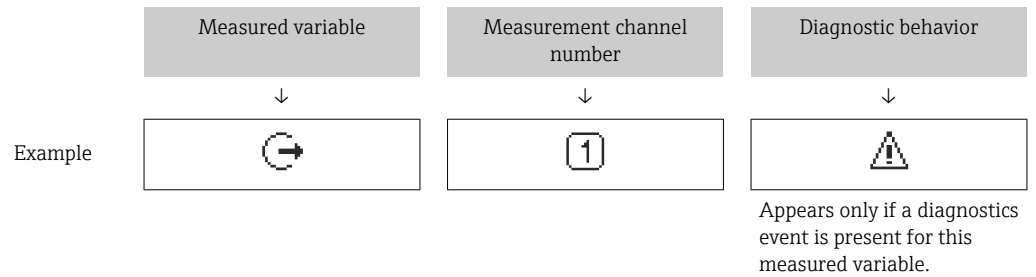

### Display area

In the display area, each measured value is prefaced by certain symbol types for further description:





### Measured variables



Symbol	Meaning
	Mass flow
	<ul style="list-style-type: none"> <li>▪ Volume flow</li> <li>▪ Corrected volume flow</li> </ul>
	<ul style="list-style-type: none"> <li>▪ Density</li> <li>▪ Reference density</li> </ul>
	Temperature

 The number and display format of the measured variables can be configured via the **Format display** parameter (→  107).

### Totalizer

Symbol	Meaning
	Totalizer  The measurement channel number indicates which of the three totalizers is displayed.



### Output

Symbol	Meaning
	Output  The measurement channel number indicates which of the outputs is displayed.



### Input

Symbol	Meaning
	Status input

### Measurement channel numbers

Symbol	Meaning
	Measurement channel 1 to 4  The measurement channel number is displayed only if more than one channel is present for the same measured variable type (e.g. totalizer 1 to 3).

*Diagnostic behavior*

Symbol	Meaning
	<b>Alarm</b> <ul style="list-style-type: none"><li>▪ Measurement is interrupted.</li><li>▪ Signal outputs and totalizers assume the defined alarm condition.</li><li>▪ A diagnostic message is generated.</li></ul>
	<b>Warning</b> <ul style="list-style-type: none"><li>▪ Measurement is resumed.</li><li>▪ The signal outputs and totalizers are not affected.</li><li>▪ A diagnostic message is generated.</li></ul>

 The diagnostic behavior pertains to a diagnostic event that is relevant to the displayed measured variable.

### 8.3.2 Navigation view

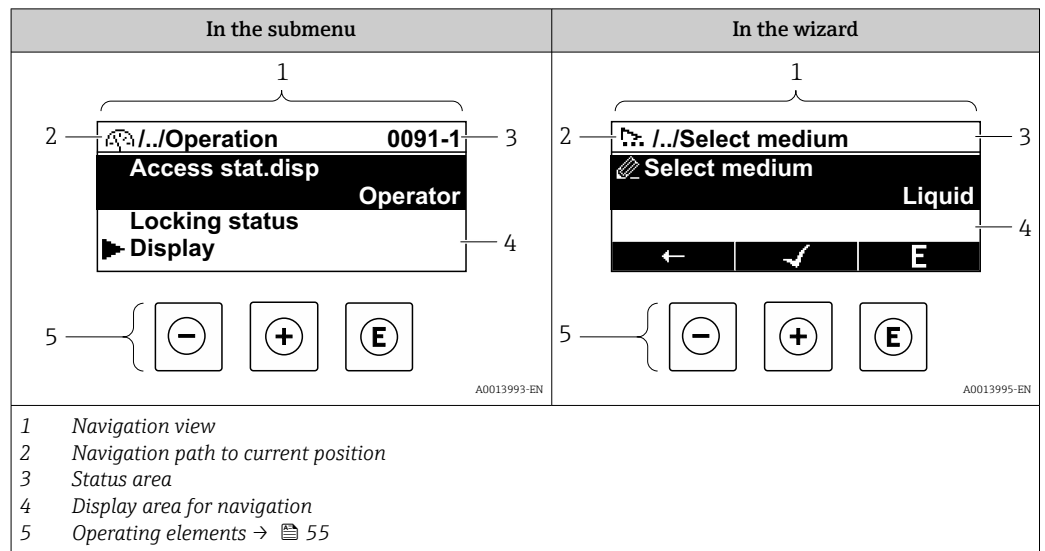

#### Navigation path

The navigation path to the current position is displayed at the top left in the navigation view and consists of the following elements:

- The display symbol for the menu/submenu (▶) or the wizard (⚙).
- An omission symbol (/ ../) for operating menu levels in between.
- Name of the current submenu, wizard or parameter

	Display symbol	Omission symbol	Parameter
	↓	↓	↓
Example	▶	/ ../	Indication

For more information about the icons in the menu, refer to the "Display area" section → 51

#### Status area

The following appears in the status area of the navigation view in the top right corner:



- In the submenu
  - The direct access code to the parameter (e.g., 0022-1)
  - If a diagnostic event is present, the diagnostic behavior and status signal
- In the wizard
  - If a diagnostic event is present, the diagnostic behavior and status signal

- For information on the diagnostic behavior and status signal → 158
- For information on the function and entry of the direct access code → 57





#### Display area

##### Menus

Symbol	Meaning
	<b>Operation</b> Is displayed: <ul style="list-style-type: none"> <li>▪ In the menu next to the "Operation" selection</li> <li>▪ At the left in the navigation path in the <b>Operation</b> menu</li> </ul>

	<p><b>Setup</b> Is displayed:</p> <ul style="list-style-type: none"> <li>▪ In the menu next to the "Setup" selection</li> <li>▪ At the left in the navigation path in the <b>Setup</b> menu</li> </ul>
	<p><b>Diagnosis</b> Is displayed:</p> <ul style="list-style-type: none"> <li>▪ In the menu next to the "Diagnostics" selection</li> <li>▪ At the left in the navigation path in the <b>Diagnostics</b> menu</li> </ul>
	<p><b>Expert</b> Is displayed:</p> <ul style="list-style-type: none"> <li>▪ In the menu next to the "Expert" selection</li> <li>▪ At the left in the navigation path in the <b>Expert</b> menu</li> </ul>



*Submenus, wizards, parameters*

Symbol	Meaning
	Submenu
	Wizards
	Parameters within a wizard  No display symbol exists for parameters in submenus.

*Locking procedure*

Symbol	Meaning
	<p><b>Parameter locked</b> When displayed in front of a parameter name, indicates that the parameter is locked.</p> <ul style="list-style-type: none"> <li>▪ By a user-specific access code</li> <li>▪ By the hardware write protection switch</li> </ul>

*Wizards*

Symbol	Meaning
	Switches to the previous parameter.
	Confirms the parameter value and switches to the next parameter.
	Opens the editing view of the parameter.

### 8.3.3 Editing view

#### Numeric editor



A0034250

23 For entering values in parameters (e.g. limit values)

- 1 Entry display area
- 2 Input screen
- 3 Confirm, delete or reject entry
- 4 Operating elements

#### Text editor

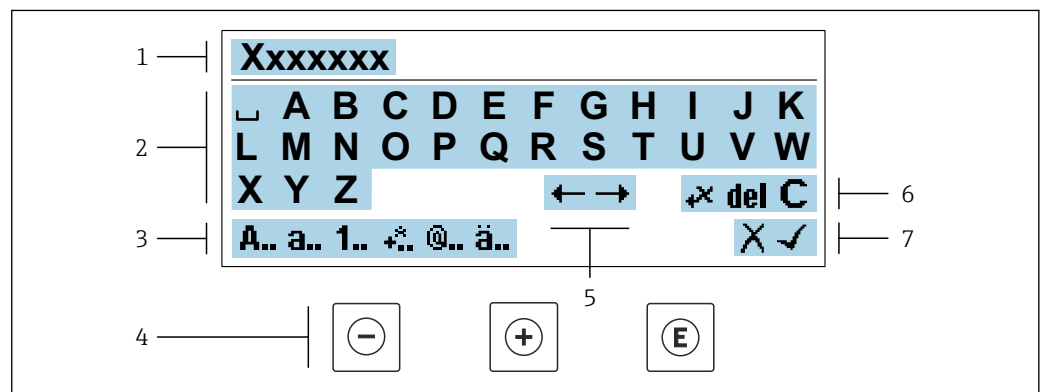



A0034114

24 For entering text in parameters (e.g. device tag)



- 1 Entry display area
- 2 Current input screen
- 3 Change input screen
- 4 Operating elements
- 5 Move entry position
- 6 Delete entry
- 7 Reject or confirm entry

#### Using the operating elements in the editing view





Operating key	Meaning
	<b>Minus key</b> Move the entry position to the left.
	<b>Plus key</b> Move the entry position to the right.

Operating key	Meaning
	<b>Enter key</b> <ul style="list-style-type: none"> <li>Pressing the key briefly confirms your selection.</li> <li>Pressing the key for 2 s confirms your entry.</li> </ul>
	<b>Escape key combination (press keys simultaneously)</b> Close the editing view without accepting a change.





*Input screens*

Symbol	Meaning
<b>A..</b>	Upper case
<b>a..</b>	Lower case
<b>1..</b>	Numbers
	Punctuation marks and special characters: = + - * / <sup>2</sup> <sup>3</sup> ¼ ½ ¾ ( ) [ ] < > { }
	Punctuation marks and special characters: " ` ^ . , ; : ? ! % μ ° € \$ £ ¥ \$ @ # / \   ~ & _
<b>ä..</b>	Umlauts and accents

*Controlling data entries*

Symbol	Meaning
	Move entry position
	Reject entry
	Confirm entry
	Delete character immediately to the left of the entry position
<b>del</b>	Delete character immediately to the right of the entry position
<b>C</b>	Clear all the characters entered

### 8.3.4 Operating elements

Operating key	Meaning
	<p><b>Minus key</b></p> <p><i>In menu, submenu</i> Moves the selection bar upwards in a picklist</p> <p><i>In wizards</i> Goes to previous parameter</p> <p><i>In the text and numeric editor</i> Move the entry position to the left.</p>
	<p><b>Plus key</b></p> <p><i>In menu, submenu</i> Moves the selection bar downwards in a picklist</p> <p><i>In wizards</i> Goes to the next parameter</p> <p><i>In the text and numeric editor</i> Move the entry position to the right.</p>
	<p><b>Enter key</b></p> <p><i>In the operational display</i> Pressing the key briefly opens the operating menu.</p> <p><i>In menu, submenu</i></p> <ul style="list-style-type: none"> <li>▪ Pressing the key briefly: <ul style="list-style-type: none"> <li>▪ Opens the selected menu, submenu or parameter.</li> <li>▪ Starts the wizard.</li> <li>▪ If help text is open, closes the help text of the parameter.</li> </ul> </li> <li>▪ Pressing the key for 2 s in a parameter: <ul style="list-style-type: none"> <li>▪ If present, opens the help text for the function of the parameter.</li> </ul> </li> </ul> <p><i>In wizards</i> Opens the editing view of the parameter and confirms the parameter value</p> <p><i>In the text and numeric editor</i></p> <ul style="list-style-type: none"> <li>▪ Pressing the key briefly confirms your selection.</li> <li>▪ Pressing the key for 2 s confirms your entry.</li> </ul>
	<p><b>Escape key combination (press keys simultaneously)</b></p> <p><i>In menu, submenu</i></p> <ul style="list-style-type: none"> <li>▪ Pressing the key briefly: <ul style="list-style-type: none"> <li>▪ Exits the current menu level and takes you to the next higher level.</li> <li>▪ If help text is open, closes the help text of the parameter.</li> </ul> </li> <li>▪ Pressing the key for 2 s returns you to the operational display ("home position").</li> </ul> <p><i>In wizards</i> Exits the wizard and takes you to the next higher level</p> <p><i>In the text and numeric editor</i> Exits the Editing view without applying the changes.</p>
	<p><b>Minus/Enter key combination (press and hold down the keys simultaneously)</b></p> <ul style="list-style-type: none"> <li>▪ If keypad lock is active: <ul style="list-style-type: none"> <li>▪ Pressing the key for 3 s deactivates the keypad lock.</li> </ul> </li> <li>▪ If keypad lock is not active: <ul style="list-style-type: none"> <li>▪ Pressing the key for 3 s opens the context menu including the option for activating the keypad lock.</li> </ul> </li> </ul>

### 8.3.5 Opening the context menu

Using the context menu, the user can call up the following menus quickly and directly from the operational display:

- Setup
- Data backup
- Simulation

### Calling up and closing the context menu

The user is in the operational display.

1. Press the  $\square$  and  $\boxplus$  keys for longer than 3 seconds.  
↳ The context menu opens.

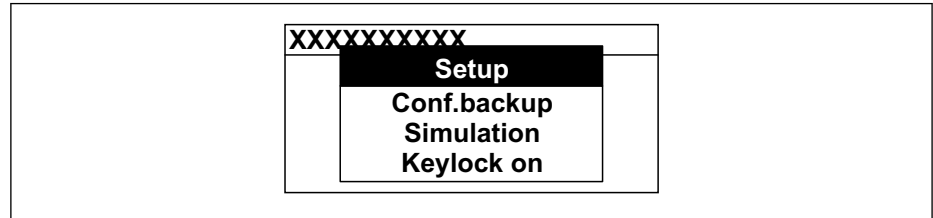

2. Press  $\square$  +  $\boxplus$  simultaneously.  
↳ The context menu is closed and the operational display appears.

### Calling up the menu via the context menu

1. Open the context menu.
2. Press  $\boxplus$  to navigate to the desired menu.
3. Press  $\boxminus$  to confirm the selection.  
↳ The selected menu opens.



### 8.3.6 Navigating and selecting from list

Different operating elements are used to navigate through the operating menu. The navigation path is displayed on the left in the header. Icons are displayed in front of the individual menus. These icons are also shown in the header during navigation.

**i** For an explanation of the navigation view with symbols and operating elements → 51

**Example: Setting the number of displayed measured values to "2 values"**

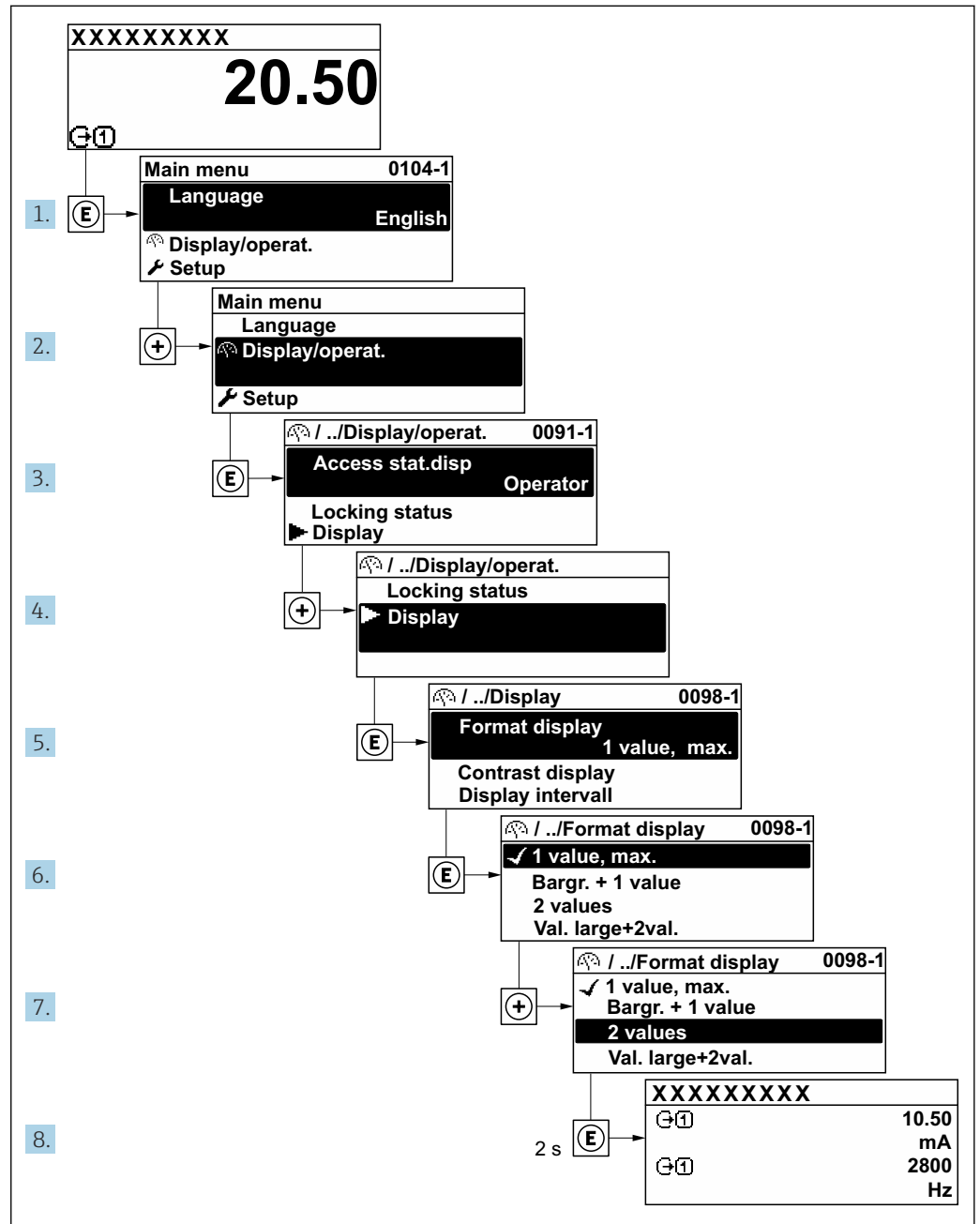

A0029562-EN

### 8.3.7 Calling the parameter directly

A parameter number is assigned to every parameter to be able to access a parameter directly via the onsite display. Entering this access code in the **Direct access** parameter calls up the desired parameter directly.

#### Navigation path

Expert → Direct access

The direct access code consists of a 5-digit number (at maximum) and the channel number, which identifies the channel of a process variable: e.g. 00914-2. In the navigation view, this appears on the right-hand side in the header of the selected parameter.

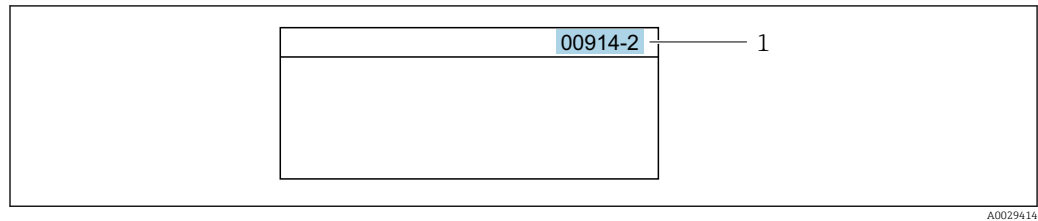

1 Direct access code

Note the following when entering the direct access code:

- The leading zeros in the direct access code do not have to be entered.  
Example: Enter "914" instead of "00914"
- If no channel number is entered, channel 1 is opened automatically.  
Example: Enter 00914 → **Assign process variable** parameter
- If a different channel is opened: Enter the direct access code with the corresponding channel number.  
Example: Enter 00914-2 → **Assign process variable** parameter



For the direct access codes of the individual parameters, see the "Description of Device Parameters" document for the device

### 8.3.8 Calling up help text

Help text is available for some parameters and can be called up from the navigation view. The help text provides a brief explanation of the parameter function and thereby supports swift and safe commissioning.

#### Calling up and closing the help text

The user is in the navigation view and the selection bar is on a parameter.

1. Press  $\square$  for 2 s.  
↳ The help text for the selected parameter opens.

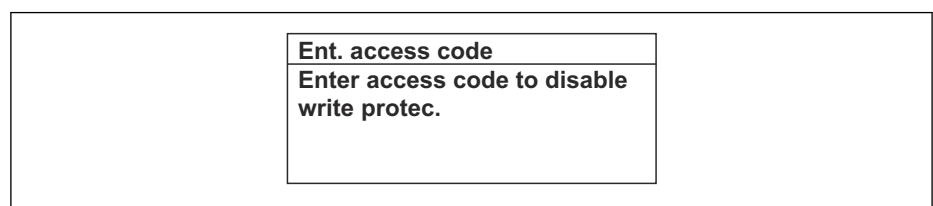

25 Example: Help text for parameter "Enter access code"

2. Press  $\square$  +  $\oplus$  simultaneously.  
↳ The help text is closed.

### 8.3.9 Changing the parameters

Parameters can be changed via the numeric editor or text editor.

- Numeric editor: Change values in a parameter, e.g. specifications for limit values.
- Text editor: Enter text in a parameter, e.g. tag name.

A message is displayed if the value entered is outside the permitted value range.

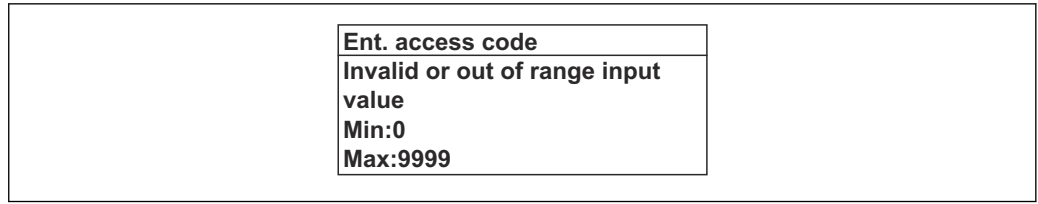

A0014049-EN

For a description of the editing view - consisting of the text editor and numeric editor - with symbols → 53, for a description of the operating elements → 55

### 8.3.10 User roles and related access authorization

The two user roles "Operator" and "Maintenance" have different write access to the parameters if the customer defines a user-specific access code. This protects the device configuration via the local display from unauthorized access → 135.

#### Defining access authorization for user roles

An access code is not yet defined when the device is delivered from the factory. Access authorization (read and write access) to the device is not restricted and corresponds to the "Maintenance" user role.

- ▶ Define the access code.
  - ↳ The "Operator" user role is redefined in addition to the "Maintenance" user role. Access authorization differs for the two user roles.

*Access authorization to parameters: "Maintenance" user role*

Access code status	Read access	Write access
An access code has not yet been defined (factory setting).	✓	✓
After an access code has been defined.	✓	✓ <sup>1)</sup>

1) The user only has write access after entering the access code.

*Access authorization to parameters: "Operator" user role*

Access code status	Read access	Write access
After an access code has been defined.	✓	_ <sup>1)</sup>

1) Despite the defined access code, certain parameters can always be modified and thus are excluded from the write protection as they do not affect the measurement: write protection via access code → 135

The user role with which the user is currently logged on is indicated by the **Access status** parameter. Navigation path: Operation → Access status

### 8.3.11 Disabling write protection via access code

If the -symbol appears on the local display in front of a parameter, the parameter is write-protected by a user-specific access code and its value cannot be changed at the moment using local operation → 135.

Parameter write protection via local operation can be disabled by entering the user-specific access code in the **Enter access code** parameter (→ 113) via the respective access option.

1. After you press , the input prompt for the access code appears.

2. Enter the access code.
  - ↳ The -symbol in front of the parameters disappears; all previously write-protected parameters are now re-enabled.

### 8.3.12 Enabling and disabling the keypad lock



The keypad lock makes it possible to block access to the entire operating menu via local operation. As a result, it is no longer possible to navigate through the operating menu or change the values of individual parameters. Users can only read the measured values on the operational display.

The keypad lock is switched on and off via the context menu.

#### Switching on the keypad lock



-  The keypad lock is switched on automatically:
- If the device has not been operated via the display for > 1 minute.
  - Each time the device is restarted.

#### To activate the keylock manually:

1. The device is in the measured value display.  
Press the  and  keys for 3 seconds.
  - ↳ A context menu appears.
2. In the context menu select the **Keylock on** option.
  - ↳ The keypad lock is switched on.

-  If the user attempts to access the operating menu while the keypad lock is active, the **Keylock on** message appears.

#### Switching off the keypad lock



- ▶ The keypad lock is switched on.  
Press the  and  keys for 3 seconds.
  - ↳ The keypad lock is switched off.

## 8.4 Access to operating menu via web browser

### 8.4.1 Function range

With the integrated web server, the device can be operated and configured via a web browser service interface (CDI-RJ45) or WLAN interface. The structure of the operating menu is the same as for the local display. In addition to the measured values, status information on the device is displayed and can be used to monitor device health. Furthermore the device data can be managed and the network parameters can be configured.

A device that has a WLAN interface (can be ordered as an option) is required for the WLAN connection: order code for "Display; operation", option G "4-line, illuminated; touch control + WLAN". The device acts as an Access Point and enables communication by computer or a mobile handheld terminal.

-  For additional information on the web server, see the Special Documentation for the device. →  218

## 8.4.2 Requirements

### Computer hardware



Hardware	Interface	
	CDI-RJ45	WLAN
Interface	The computer must have a RJ45 interface. <sup>1)</sup>	The operating unit must have a WLAN interface.
Connection	Standard Ethernet cable	Connection via Wireless LAN.
Screen	Recommended size: ≥ 12" (depends on the screen resolution)	

1) Recommended cable: CAT5e, CAT6 or CAT7, with shielded plug (e.g. YAMAICHI product; part no. Y-ConProfixPlug63/Prod. ID: 82-006660)

### Computer software

Software	Interface	
	CDI-RJ45	WLAN
Recommended operating systems	<ul style="list-style-type: none"> <li>▪ Microsoft Windows 8 or higher.</li> <li>▪ Mobile operating systems:                             <ul style="list-style-type: none"> <li>▪ iOS</li> <li>▪ Android</li> </ul> </li> </ul>  Microsoft Windows XP and Windows 7 is supported.	
Web browsers supported	<ul style="list-style-type: none"> <li>▪ Microsoft Internet Explorer 8 or higher</li> <li>▪ Microsoft Edge</li> <li>▪ Mozilla Firefox</li> <li>▪ Google Chrome</li> <li>▪ Safari</li> </ul>	

### Computer settings

Settings	Interface	
	CDI-RJ45	WLAN
User rights	Appropriate user rights (e.g. administrator rights) for TCP/IP and proxy server settings are necessary (e.g. for adjusting the IP address, subnet mask etc.).	
Proxy server settings of the web browser	The web browser setting <i>Use a proxy server for your LAN</i> must be <b>disabled</b> .	
JavaScript	JavaScript must be enabled.  If JavaScript cannot be enabled: Enter <code>http://192.168.1.212/servlet/basic.html</code> in the address bar of the web browser. A fully functional but simplified version of the operating menu structure starts in the web browser.   When installing a new firmware version: To enable correct data display, clear the temporary memory (cache) under <b>Internet options</b> in the web browser.	JavaScript must be enabled.  The WLAN display requires JavaScript support.
Network connections	Only use the active network connections to the measuring device.	
	Switch off all other network connections such as WLAN for example.	Switch off all other network connections.

 In the event of connection problems: →  155

*Measuring device: Via CDI-RJ45 service interface*

Device	CDI-RJ45 service interface
Measuring device	The measuring device has an RJ45 interface.
Web server	Web server must be enabled; factory setting: ON  For information on enabling the Web server → 66

*Measuring device: via WLAN interface*

Device	WLAN interface
Measuring device	The measuring device has a WLAN antenna: <ul style="list-style-type: none"> <li>▪ Transmitter with integrated WLAN antenna</li> <li>▪ Transmitter with external WLAN antenna</li> </ul>
Web server	Web server and WLAN must be enabled; factory setting: ON  For information on enabling the Web server → 66

### 8.4.3 Connecting the device

#### Via service interface (CDI-RJ45)

*Preparing the measuring device*

1. Depending on the housing version:  
Loosen the securing clamp or fixing screw of the housing cover.
2. Depending on the housing version:  
Unscrew or open the housing cover.
3. Connect the computer to the RJ45 plug via the standard Ethernet connecting cable..

*Configuring the Internet protocol of the computer*

The following information refers to the default Ethernet settings of the device.

IP address of the device: 192.168.1.212 (factory setting)

1. Switch on the measuring device.
2. Connect the computer to the RJ45 plug via the standard Ethernet cable → 68.
3. If a 2nd network card is not used, close all the applications on the notebook.
  - ↳ Applications requiring Internet or a network, such as e-mail, SAP applications, Internet or Windows Explorer.
4. Close any open Internet browsers.
5. Configure the properties of the Internet protocol (TCP/IP) as defined in the table:

IP address	192.168.1.XXX; for XXX all numerical sequences except: 0, 212 and 255 → e.g. 192.168.1.213
Subnet mask	255.255.255.0
Default gateway	192.168.1.212 or leave cells empty

#### Via WLAN interface

*Configuring the Internet protocol of the mobile terminal*

**NOTICE**

**If the WLAN connection is lost during the configuration, settings made may be lost.**

- ▶ Make sure that the WLAN connection is not disconnected while configuring the device.

**NOTICE****Note the following to avoid a network conflict:**

- ▶ Avoid accessing the measuring device simultaneously from the same mobile terminal via the service interface (CDI-RJ45) and the WLAN interface.
- ▶ Only activate one service interface (CDI-RJ45 or WLAN interface).
- ▶ If simultaneous communication is necessary: configure different IP address ranges, e.g. 192.168.0.1 (WLAN interface) and 192.168.1.212 (CDI-RJ45 service interface).

*Preparing the mobile terminal*

- ▶ Enable WLAN on the mobile terminal.

*Establishing a WLAN connection from the mobile terminal to the measuring device*

1. In the WLAN settings of the mobile terminal:  
Select the measuring device using the SSID (e.g. EH\_Promass\_300\_A802000).
2. If necessary, select the WPA2 encryption method.
3. Enter the password:  
Serial number of the measuring device ex-works (e.g. L100A802000).
  - ↳ The LED on the display module flashes. It is now possible to operate the measuring device with the web browser, FieldCare or DeviceCare.



The serial number can be found on the nameplate.



To ensure the safe and swift assignment of the WLAN network to the measuring point, it is advisable to change the SSID name. It should be possible to clearly assign the new SSID name to the measuring point (e.g. tag name) because it is displayed as the WLAN network.

*Terminating the WLAN connection*

- ▶ After configuring the device:  
Terminate the WLAN connection between the mobile terminal and measuring device.

**Starting the web browser**

1. Start the web browser on the computer.

2. Enter the IP address of the web server in the address line of the web browser:  
192.168.1.212  
↳ The login page appears.

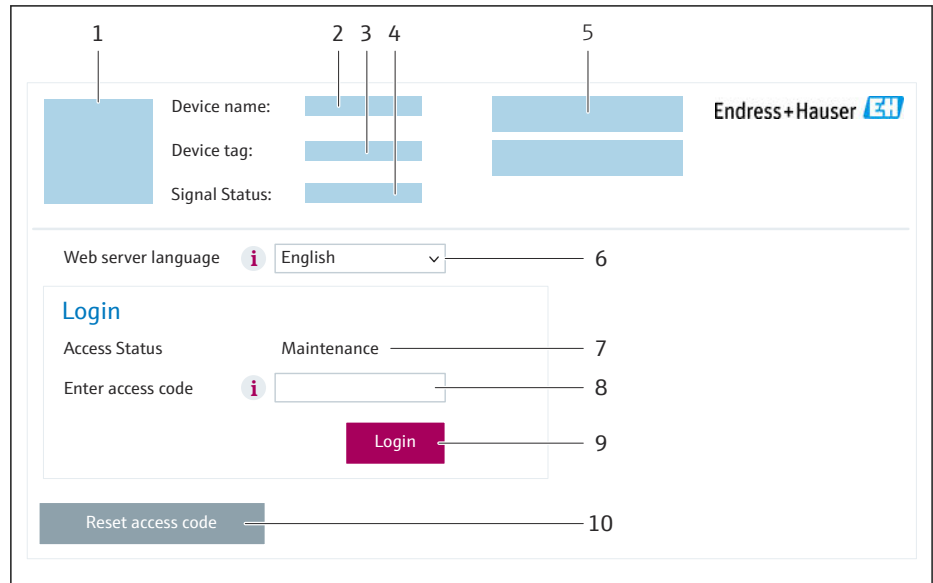

- 1 Picture of device
- 2 Device name
- 3 Device tag (→ ⓘ 83)
- 4 Status signal
- 5 Current measured values
- 6 Operating language
- 7 User role
- 8 Access code
- 9 Login
- 10 Reset access code (→ ⓘ 132)

**i** If a login page does not appear, or if the page is incomplete → ⓘ 155

#### 8.4.4 Logging on

1. Select the preferred operating language for the Web browser.
2. Enter the user-specific access code.
3. Press **OK** to confirm your entry.

Access code	0000 (factory setting); can be changed by customer
-------------	--

**i** If no action is performed for 10 minutes, the Web browser automatically returns to the login page.



### 8.4.5 User interface



A0029418

- 1 Function row
- 2 Local display language
- 3 Navigation area

#### Header

The following information appears in the header:

- Device name
- Device tag
- Device status with status signal → 161
- Current measured values

#### Function row

Functions	Meaning
Measured values	Displays the measured values of the device
Menu	<ul style="list-style-type: none"> <li>■ Access to the operating menu from the measuring device</li> <li>■ The structure of the operating menu is the same as for the local display</li> </ul>  Detailed information on the operating menu structure: Description of Device Parameters
Device status	Displays the diagnostic messages currently pending, listed in order of priority
Data management	Data exchange between computer and measuring device: <ul style="list-style-type: none"> <li>■ Device configuration:                             <ul style="list-style-type: none"> <li>■ Load settings from the device (XML format, save configuration)</li> <li>■ Save settings to the device (XML format, restore configuration)</li> </ul> </li> <li>■ Logbook - Export Event logbook (.csv file)</li> <li>■ Documents - Export documents:                             <ul style="list-style-type: none"> <li>■ Export backup data record (.csv file, create documentation of the measuring point configuration)</li> <li>■ Verification report (PDF file, only available with the "Heartbeat Verification" application package)</li> </ul> </li> <li>■ Firmware update - Flashing a firmware version</li> </ul>
Network	Configuration and checking of all the parameters required for establishing the connection to the measuring device: <ul style="list-style-type: none"> <li>■ Network settings (e.g. IP address, MAC address)</li> <li>■ Device information (e.g. serial number, firmware version)</li> </ul>
Logout	End the operation and call up the login page

#### Navigation area

The menus, the associated submenus and parameters can be selected in the navigation area.

**Working area**

Depending on the selected function and the related submenus, various actions can be performed in this area:

- Configuring parameters
- Reading measured values
- Calling up help text
- Starting an upload/download

**8.4.6 Disabling the Web server**

The Web server of the measuring device can be switched on and off as required using the **Web server functionality** parameter.

**Navigation**

"Expert" menu → Communication → Web server

**Parameter overview with brief description**

Parameter	Description	Selection	Factory setting
Web server functionality	Switch the Web server on and off.	<ul style="list-style-type: none"> <li>▪ Off</li> <li>▪ HTML Off</li> <li>▪ On</li> </ul>	On

**Function scope of the "Web server functionality" parameter**

Option	Description
Off	<ul style="list-style-type: none"> <li>▪ The Web server is completely disabled.</li> <li>▪ Port 80 is locked.</li> </ul>
HTML Off	The HTML version of the Web server is not available.
On	<ul style="list-style-type: none"> <li>▪ The complete Web server functionality is available.</li> <li>▪ JavaScript is used.</li> <li>▪ The password is transferred in an encrypted state.</li> <li>▪ Any change to the password is also transferred in an encrypted state.</li> </ul>

**Enabling the Web server**

If the Web server is disabled it can only be re-enabled with the **Web server functionality** parameter via the following operating options:

- Via local display
- Via Bedientool "FieldCare"
- Via "DeviceCare" operating tool

**8.4.7 Logging out**

 Before logging out, perform a data backup via the **Data management** function (upload configuration from device) if necessary.

1. Select the **Logout** entry in the function row.
  - ↳ The home page with the Login box appears.
2. Close the Web browser.
3. If no longer needed:
  - Reset the modified properties of the Internet protocol (TCP/IP) →  62.

## 8.5 Access to the operating menu via the operating tool

The structure of the operating menu in the operating tools is the same as for operation via the local display.

### 8.5.1 Connecting the operating tool

#### Via HART protocol

This communication interface is available in device versions with a HART output.

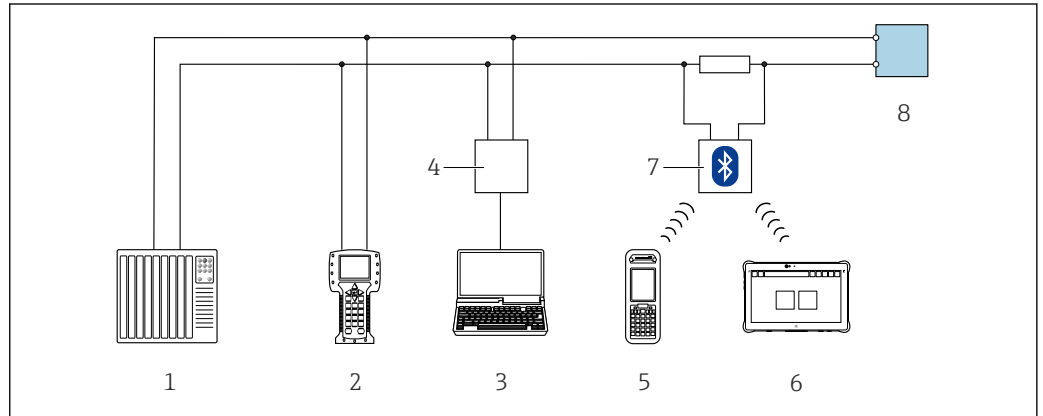

26 Options for remote operation via HART protocol (active)

- 1 Control system (e.g. PLC)
- 2 Field Communicator 475
- 3 Computer with web browser (e.g. Microsoft Edge) to access the integrated device web server or computer with operating tool (e.g. FieldCare, DeviceCare, AMS Device Manager, SIMATIC PDM) with COM DTM "CDI Communication TCP/IP"
- 4 Commbobox FXA195 (USB)
- 5 Field Xpert SFX350 or SFX370
- 6 Field Xpert SMT70
- 7 VIATOR Bluetooth modem with connecting cable
- 8 Transmitter

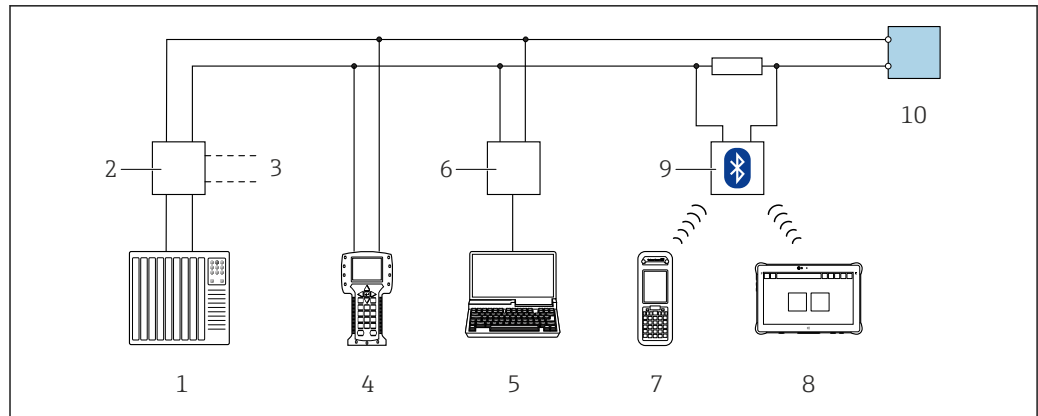

A0028746

27 Options for remote operation via HART protocol (passive)

- 1 Control system (e.g. PLC)
- 2 Transmitter power supply unit, e.g. RN221N (with communication resistor)
- 3 Connection for Commubox FXA195 and Field Communicator 475
- 4 Field Communicator 475
- 5 Computer with web browser (e.g. Microsoft Edge) to access the integrated device web server or computer with operating tool (e.g. FieldCare, DeviceCare, AMS Device Manager, SIMATIC PDM) with COM DTM "CDI Communication TCP/IP"
- 6 Commubox FXA195 (USB)
- 7 Field Xpert SFX350 or SFX370
- 8 Field Xpert SMT70
- 9 VIATOR Bluetooth modem with connecting cable
- 10 Transmitter

### Service interface

Via service interface (CDI-RJ45)

A point-to-point connection can be established to configure the device onsite. With the housing open, the connection is established directly via the service interface (CDI-RJ45) of the device.

**i** An adapter for the RJ45 to the M12 plug is optionally available for the non-hazardous area:

Order code for "Accessories", option **NB**: "Adapter RJ45 M12 (service interface)"

The adapter connects the service interface (CDI-RJ45) to an M12 plug mounted in the cable entry. The connection to the service interface can be established via an M12 plug without opening the device.

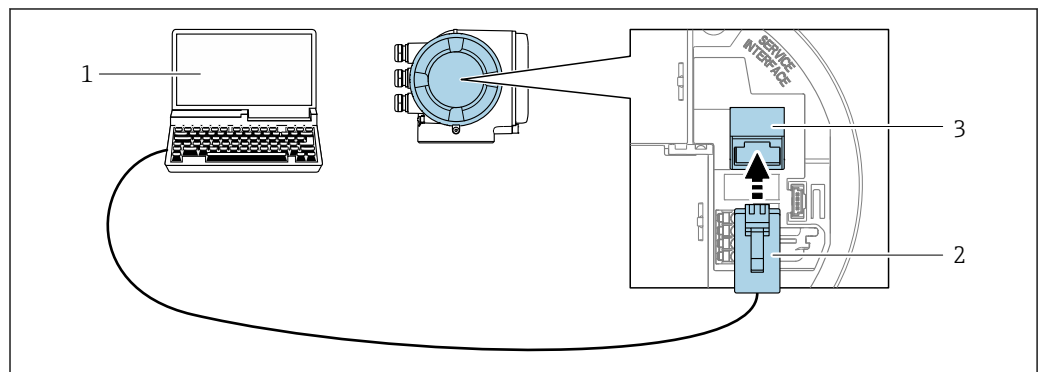

A0027563

28 Connection via service interface (CDI-RJ45)

- 1 Computer with web browser (e.g. Microsoft Internet Explorer, Microsoft Edge) for accessing the integrated web server or with "FieldCare" operating tool, "DeviceCare" with COM DTM "CDI Communication TCP/IP"
- 2 Standard Ethernet connecting cable with RJ45 plug
- 3 Service interface (CDI-RJ45) of the measuring device with access to the integrated Web server

Via WLAN interface

The optional WLAN interface is available on the following device version:  
 Order code for "Display; operation", option G "4-line, illuminated; touch control + WLAN"

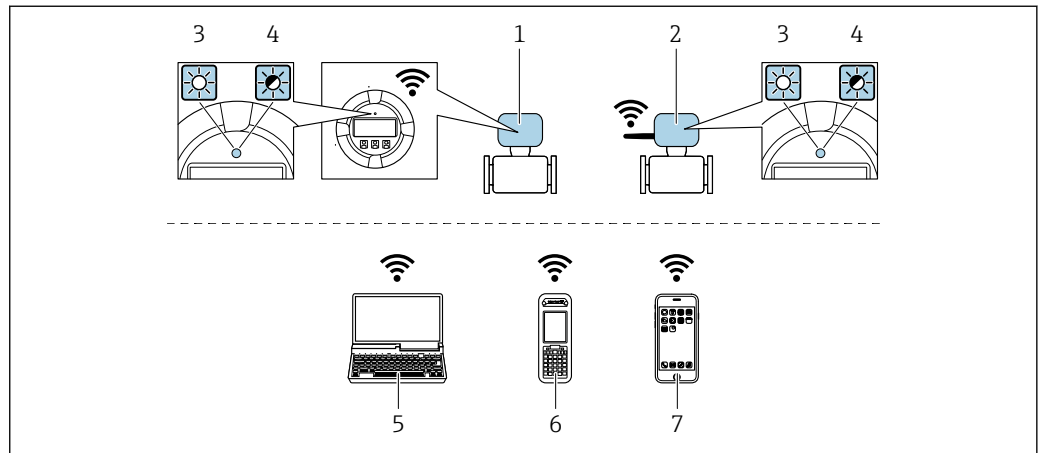

A0034570

- 1 Transmitter with integrated WLAN antenna
- 2 Transmitter with external WLAN antenna
- 3 LED lit constantly: WLAN reception is enabled on measuring device
- 4 LED flashing: WLAN connection established between operating unit and measuring device
- 5 Computer with WLAN interface and web browser (e.g. Microsoft Internet Explorer, Microsoft Edge) for accessing the integrated device web server or with operating tool (e.g. FieldCare, DeviceCare)
- 6 Mobile handheld terminal with WLAN interface and web browser (e.g. Microsoft Internet Explorer, Microsoft Edge) for accessing the integrated device web server or operating tool (e.g. FieldCare, DeviceCare)
- 7 Smart phone or tablet (e.g. Field Xpert SMT70)

Function	WLAN: IEEE 802.11 b/g (2.4 GHz)
Encryption	WPA2-PSK AES-128 (in accordance with IEEE 802.11i)
Configurable WLAN channels	1 to 11
Degree of protection	IP67
Available antennas	<ul style="list-style-type: none"> <li>▪ Internal antenna</li> <li>▪ External antenna (optional)</li> </ul> In the event of poor transmission/reception conditions at the place of installation. ⓘ Only 1 antenna is active at any one time!
Range	<ul style="list-style-type: none"> <li>▪ Internal antenna: typically 10 m (32 ft)</li> <li>▪ External antenna: typically 50 m (164 ft)</li> </ul>
Materials (external antenna)	<ul style="list-style-type: none"> <li>▪ Antenna: ASA plastic (acrylonitrile styrene acrylate) and nickel-plated brass</li> <li>▪ Adapter: Stainless steel and nickel-plated brass</li> <li>▪ Cable: Polyethylene</li> <li>▪ Plug: Nickel-plated brass</li> <li>▪ Angle bracket: Stainless steel</li> </ul>

Configuring the Internet protocol of the mobile terminal

**NOTICE**

**If the WLAN connection is lost during the configuration, settings made may be lost.**

- ▶ Make sure that the WLAN connection is not disconnected while configuring the device.

**NOTICE****Note the following to avoid a network conflict:**

- ▶ Avoid accessing the measuring device simultaneously from the same mobile terminal via the service interface (CDI-RJ45) and the WLAN interface.
- ▶ Only activate one service interface (CDI-RJ45 or WLAN interface).
- ▶ If simultaneous communication is necessary: configure different IP address ranges, e.g. 192.168.0.1 (WLAN interface) and 192.168.1.212 (CDI-RJ45 service interface).

*Preparing the mobile terminal*

- ▶ Enable WLAN on the mobile terminal.

*Establishing a WLAN connection from the mobile terminal to the measuring device*

1. In the WLAN settings of the mobile terminal:  
Select the measuring device using the SSID (e.g. EH\_Promass\_300\_A802000).
2. If necessary, select the WPA2 encryption method.
3. Enter the password:  
Serial number of the measuring device ex-works (e.g. L100A802000).  
↳ The LED on the display module flashes. It is now possible to operate the measuring device with the web browser, FieldCare or DeviceCare.



The serial number can be found on the nameplate.



To ensure the safe and swift assignment of the WLAN network to the measuring point, it is advisable to change the SSID name. It should be possible to clearly assign the new SSID name to the measuring point (e.g. tag name) because it is displayed as the WLAN network.

*Terminating the WLAN connection*

- ▶ After configuring the device:  
Terminate the WLAN connection between the mobile terminal and measuring device.

**8.5.2 Field Xpert SFX350, SFX370****Function scope**

Field Xpert SFX350 and Field Xpert SFX370 are mobile computers for commissioning and maintenance. They enable efficient device configuration and diagnostics for HART and FOUNDATION Fieldbus devices in the **non-hazardous area** (SFX350, SFX370) and **hazardous area** (SFX370).



For details, see Operating Instructions BA01202S



**Source for device description files**

See information → 74

**8.5.3 FieldCare****Function range**

FDT-based (Field Device Technology) plant asset management tool from Endress+Hauser. It can configure all smart field units in a system and helps you manage them. By using the status information, it is also a simple but effective way of checking their status and condition.

Access is via:

- HART protocol →  67
- CDI-RJ45 service interface →  68
- WLAN interface →  69

Typical functions:

- Transmitter parameter configuration
- Loading and saving of device data (upload/download)
- Documentation of the measuring point
- Visualization of the measured value memory (line recorder) and event logbook



- Operating Instructions BA00027S
- Operating Instructions BA00059S



- Source for device description files →  74

### Establishing a connection

1. Start FieldCare and launch the project.
2. In the network: Add a device.
  - ↳ The **Add device** window opens.
3. Select the **CDI Communication TCP/IP** option from the list and press **OK** to confirm.
4. Right-click **CDI Communication TCP/IP** and select the **Add device** option in the context menu that opens.
5. Select the desired device from the list and press **OK** to confirm.
  - ↳ The **CDI Communication TCP/IP (Configuration)** window opens.
6. Enter the device address in the **IP address** field: 192.168.1.212 and press **Enter** to confirm.
7. Establish the online connection to the device.



- Operating Instructions BA00027S
- Operating Instructions BA00059S

User interface

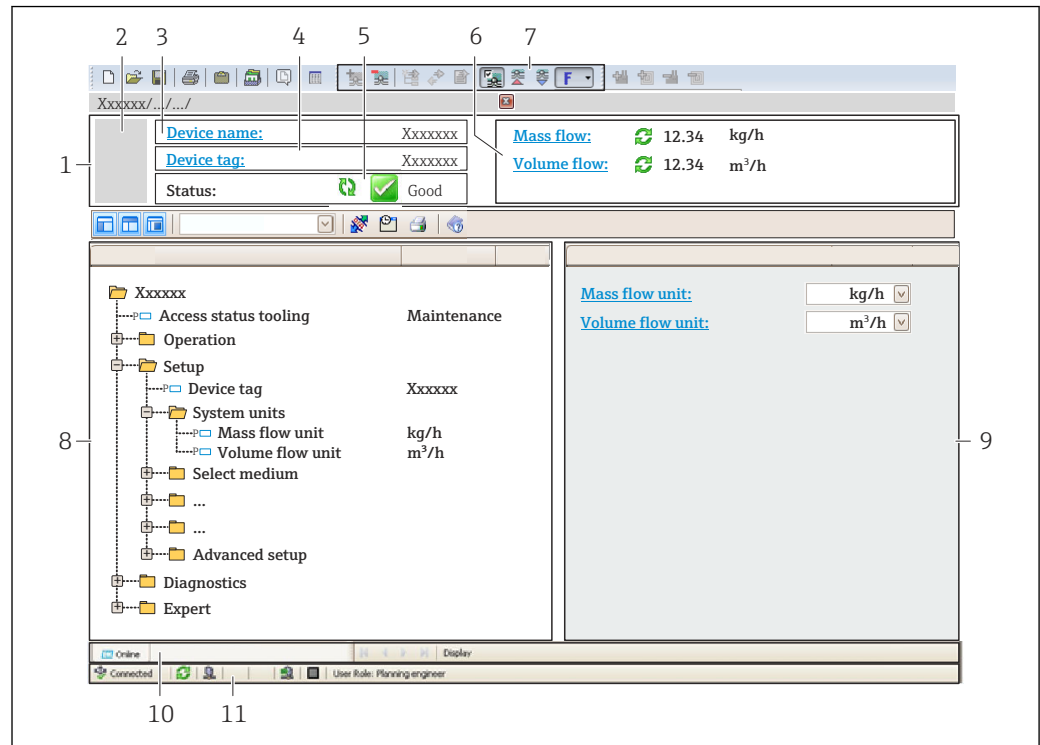

A0021051-EN

- 1 Header
- 2 Picture of device
- 3 Device name
- 4 Device tag
- 5 Status area with status signal → 161
- 6 Display area for current measured values
- 7 Editing toolbar with additional functions such as save/load, event list and create documentation
- 8 Navigation area with operating menu structure
- 9 Work area
- 10 Action area
- 11 Status area

### 8.5.4 DeviceCare

#### Function range

Tool for connecting and configuring Endress+Hauser field devices.

The fastest way to configure Endress+Hauser field devices is with the dedicated "DeviceCare" tool. Together with the device type managers (DTMs) it presents a convenient, comprehensive solution.

 Innovation brochure IN01047S

 Source for device description files → 74

### 8.5.5 AMS Device Manager

#### Function range

Program from Emerson Process Management for operating and configuring measuring devices via the HART protocol.

 Source for device description files → 74



## 8.5.6 Field Communicator 475

### Function scope

Industrial handheld terminal from Emerson Process Management for remote configuration and measured value display via HART protocol.



### Source for device description files

See information →  74

## 8.5.7 SIMATIC PDM

### Function range

SIMATIC PDM is a standardized, manufacturer-independent program from Siemens for the operation, configuration, maintenance and diagnosis of intelligent field devices via HART protocol.

 Source for device description files →  74

## 9 System integration

### 9.1 Overview of device description files

#### 9.1.1 Current version data for the device

Firmware version	01.06.zz	<ul style="list-style-type: none"> <li>▪ On the title page of the manual</li> <li>▪ On the transmitter nameplate</li> <li>▪ Firmware version Diagnostics → Device information → Firmware version</li> </ul>
Release date of firmware version	08.2022	---
Manufacturer ID	0x11	Manufacturer ID Diagnostics → Device information → Manufacturer ID
Device type ID	0x3B	Device type Diagnostics → Device information → Device type
HART protocol revision	7	---
Device revision	7	<ul style="list-style-type: none"> <li>▪ On the transmitter nameplate</li> <li>▪ Device revision Diagnostics → Device information → Device revision</li> </ul>



For an overview of the various firmware versions for the device → 180

#### 9.1.2 Operating tools

The suitable device description file for the individual operating tools is listed in the table below, along with information on where the file can be acquired.

Operating tool via HART protocol	Sources for obtaining device descriptions
FieldCare	<ul style="list-style-type: none"> <li>▪ <a href="http://www.endress.com">www.endress.com</a> → Downloads area</li> <li>▪ USB stick (contact Endress+Hauser)</li> <li>▪ DVD (contact Endress+Hauser)</li> </ul>
DeviceCare	<ul style="list-style-type: none"> <li>▪ <a href="http://www.endress.com">www.endress.com</a> → Downloads area</li> <li>▪ CD-ROM (contact Endress+Hauser)</li> <li>▪ DVD (contact Endress+Hauser)</li> </ul>
<ul style="list-style-type: none"> <li>▪ Field Xpert SMT70</li> <li>▪ Field Xpert SMT77</li> </ul>	Use update function of handheld terminal
AMS Device Manager (Emerson Process Management)	<a href="http://www.endress.com">www.endress.com</a> → Downloads area
SIMATIC PDM (Siemens)	<a href="http://www.endress.com">www.endress.com</a> → Downloads area
Field Communicator 475 (Emerson Process Management)	Use update function of handheld terminal

## 9.2 Measured variables via HART protocol

The following measured variables (HART device variables) are assigned to the dynamic variables at the factory:

Dynamic variables	Measured variables (HART device variables)
Primary dynamic variable (PV)	Mass flow
Secondary dynamic variable (SV)	Totalizer 1
Tertiary dynamic variable (TV)	Density
Quaternary dynamic variable (QV)	Temperature

The assignment of the measured variables to the dynamic variables can be modified and assigned as desired via local operation and the operating tool using the following parameters:

- Expert → Communication → HART output → Output → Assign PV
- Expert → Communication → HART output → Output → Assign SV
- Expert → Communication → HART output → Output → Assign TV
- Expert → Communication → HART output → Output → Assign QV

The following measured variables can be assigned to the dynamic variables:

**Measured variables for PV (primary dynamic variable)**

- Measured variables which are generally available:
  - Mass flow
  - Volume flow
  - Corrected volume flow
  - Density
  - Reference density
  - Temperature
  - Electronics temperature
  - Pressure
  - Raw value mass flow
  - Oscillation frequency 0
  - Oscillation damping 0
  - Signal asymmetry
  - Exciter current 0
  - Inhomogeneous medium index
  - Sensor index coil asymmetry
  - Test point 0
  - Test point 1
  - Torsion signal asymmetry
- Additional measured variables with the Heartbeat Verification + Monitoring application package:
  - Carrier pipe temperature
  - Oscillation amplitude
  - Frequency fluctuation 0
  - Oscillation damping fluctuation 0
  - HBSI
- Additional measured variables with the Concentration application package:
  - Concentration
  - Target mass flow
  - Carrier mass flow
  - Target volume flow
  - Carrier volume flow
  - Target corrected volume flow
  - Carrier corrected volume flow
- With application-specific output
  - Application specific output 0
  - Application specific output 1

**Measured variables for SV, TV, QV (secondary, tertiary and quaternary dynamic variable)**

- Measured variables which are always available:
  - Mass flow
  - Volume flow
  - Corrected volume flow
  - Density
  - Reference density
  - Temperature
  - Electronics temperature
  - Oscillation frequency 0
  - Oscillation damping 0
  - Inhomogeneous medium index
  - Suspended bubbles index
  - Sensor index coil asymmetry
  - Test point 0
  - Test point 1
  - Pressure
  - Totalizer 1
  - Totalizer 2
  - Totalizer 3
- Additional measured variables with the Heartbeat Verification + Monitoring application package:
  - Carrier pipe temperature
  - HBSI
- Additional measured variables with the Concentration application package:
  - Concentration
  - Target mass flow
  - Carrier mass flow
  - Target volume flow
  - Carrier volume flow
  - Target corrected volume flow
  - Carrier corrected volume flow

**9.2.1 Device variables**

Device variables are permanently assigned. A maximum of eight device variables can be transmitted.

Assignment	Device variables
0	Mass flow
1	Volume flow
2	Corrected volume flow
3	Density
4	Reference density
5	Temperature
6	Totalizer 1
7	Totalizer 2
8	Totalizer 3
13	Target mass flow <sup>1)</sup>
14	Carrier mass flow <sup>1)</sup>
15	Concentration <sup>1)</sup>

1) Visible depending on the order options or device settings

### 9.3 Other settings

Burst mode functionality in accordance with HART 7 Specification:

#### Navigation

"Expert" menu → Communication → HART output → Burst configuration → Burst configuration 1 to n

► Burst configuration 1 to n	
Burst mode 1 to n	→ 78
Burst command 1 to n	→ 78
Burst variable 0	→ 79
Burst variable 1	→ 79
Burst variable 2	→ 79
Burst variable 3	→ 79
Burst variable 4	→ 79
Burst variable 5	→ 79
Burst variable 6	→ 79
Burst variable 7	→ 79
Burst trigger mode	→ 79
Burst trigger level	→ 79
Min. update period	→ 80
Max. update period	→ 80

#### Parameter overview with brief description

Parameter	Description	Selection / User entry	Factory setting
Burst mode 1 to n	Activate the HART burst mode for burst message X.	<ul style="list-style-type: none"> <li>■ Off</li> <li>■ On</li> </ul>	Off
Burst command 1 to n	Select the HART command that is sent to the HART master.	<ul style="list-style-type: none"> <li>■ Command 1</li> <li>■ Command 2</li> <li>■ Command 3</li> <li>■ Command 9</li> <li>■ Command 33</li> <li>■ Command 48</li> </ul>	Command 2

Parameter	Description	Selection / User entry	Factory setting
Burst variable 0	For HART command 9 and 33: select the HART device variable or the process variable.	<ul style="list-style-type: none"> <li>■ Mass flow</li> <li>■ Volume flow</li> <li>■ Corrected volume flow *</li> <li>■ Density</li> <li>■ Reference density *</li> <li>■ Temperature</li> <li>■ Totalizer 1</li> <li>■ Totalizer 2</li> <li>■ Totalizer 3</li> <li>■ Target mass flow *</li> <li>■ Carrier mass flow *</li> <li>■ Concentration *</li> <li>■ Totalizer 1</li> <li>■ Totalizer 2</li> <li>■ Totalizer 3</li> <li>■ HBSI *</li> <li>■ Target volume flow *</li> <li>■ Carrier volume flow *</li> <li>■ Target corrected volume flow *</li> <li>■ Carrier corrected volume flow *</li> <li>■ Sensor index coil asymmetry</li> <li>■ Test point 0</li> <li>■ Test point 1</li> <li>■ HART input</li> <li>■ Percent of range</li> <li>■ Measured current</li> <li>■ Primary variable (PV)</li> <li>■ Secondary variable (SV)</li> <li>■ Tertiary variable (TV)</li> <li>■ Quaternary variable (QV)</li> <li>■ Not used</li> </ul>	Volume flow
Burst variable 1	For HART command 9 and 33: select the HART device variable or the process variable.	See the <b>Burst variable 0</b> parameter.	Not used
Burst variable 2	For HART command 9 and 33: select the HART device variable or the process variable.	See the <b>Burst variable 0</b> parameter.	Not used
Burst variable 3	For HART command 9 and 33: select the HART device variable or the process variable.	See the <b>Burst variable 0</b> parameter.	Not used
Burst variable 4	For HART command 9: select the HART device variable or the process variable.	See the <b>Burst variable 0</b> parameter.	Not used
Burst variable 5	For HART command 9: select the HART device variable or the process variable.	See the <b>Burst variable 0</b> parameter.	Not used
Burst variable 6	For HART command 9: select the HART device variable or the process variable.	See the <b>Burst variable 0</b> parameter.	Not used
Burst variable 7	For HART command 9: select the HART device variable or the process variable.	See the <b>Burst variable 0</b> parameter.	Not used
Burst trigger mode	Select the event that triggers burst message X.	<ul style="list-style-type: none"> <li>■ Continuous</li> <li>■ Window *</li> <li>■ Rising *</li> <li>■ Falling *</li> <li>■ On change</li> </ul>	Continuous
Burst trigger level	Enter the burst trigger value. Together with the option selected in the <b>Burst trigger mode</b> parameter the burst trigger value determines the time of burst message X.	Signed floating-point number	–

Parameter	Description	Selection / User entry	Factory setting
Min. update period	Enter the minimum time span between two burst commands of burst message X.	Positive integer	1 000 ms
Max. update period	Enter the maximum time span between two burst commands of burst message X.	Positive integer	2 000 ms

\* Visibility depends on order options or device settings



## 10 Commissioning

### 10.1 Post-mounting and post-connection check

Before commissioning the device:

- ▶ Make sure that the post-installation and post-connection checks have been performed successfully.
- Checklist for "Post-installation" check → 31
- Checklist for "Post-connection" check → 43

### 10.2 Switching on the measuring device

- ▶ Switch on the device upon successful completion of the post-mounting and post-connection check.
  - ↳ After a successful startup, the local display switches automatically from the startup display to the operational display.

If nothing appears on the local display or if a diagnostic message is displayed, refer to the section on "Diagnostics and troubleshooting" → 154.

### 10.3 Setting the operating language

Factory setting: English or ordered local language

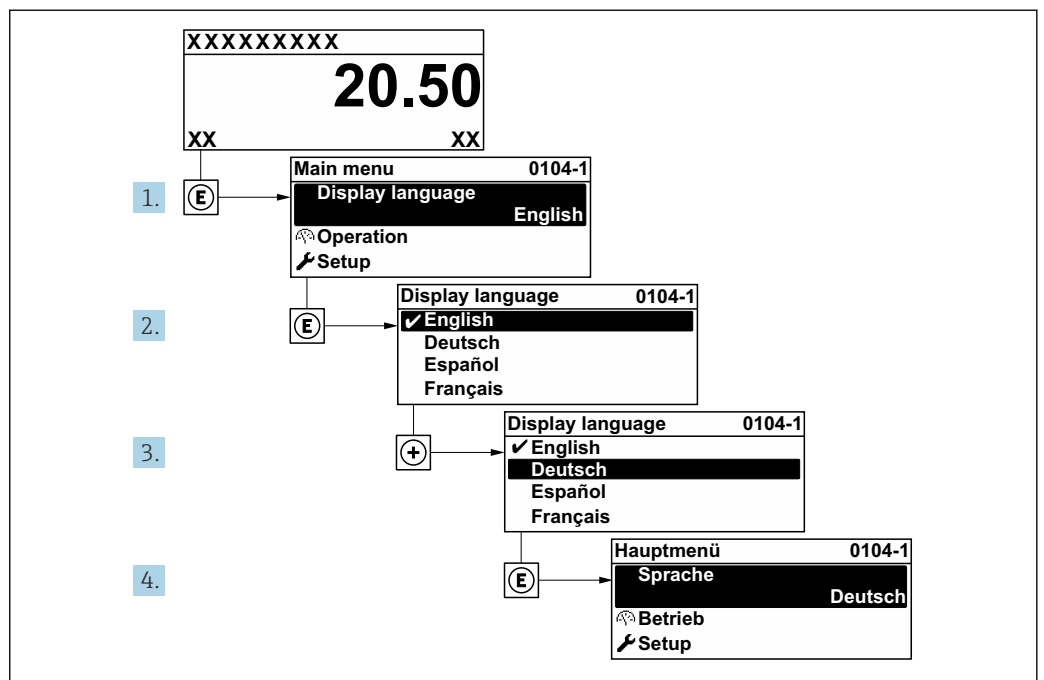

29 Taking the example of the local display

### 10.4 Configuring the measuring instrument

The **Setup** menu with its guided wizards contains all the parameters needed for standard operation.

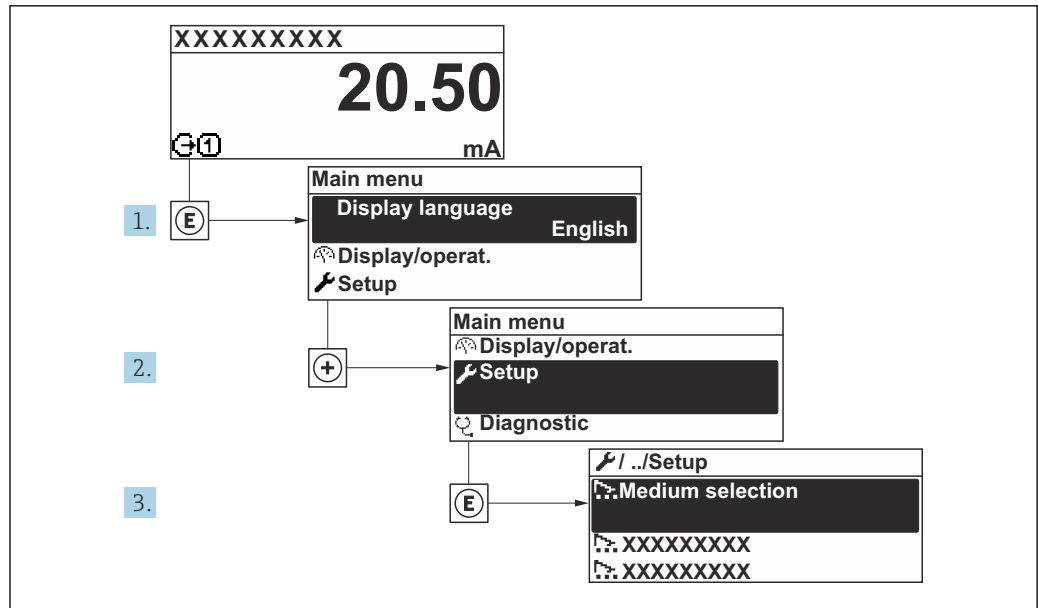

A003222-EN

30 Navigation to "Setup" menu using the example of the local display

**i** The number of submenus and parameters can vary depending on the device version. Certain submenus and parameters in these submenus are not described in the Operating Instructions. Instead a description is provided in the Special Documentation for the device ("Supplementary documentation").

🔧 Setup	
Device tag	→ 83
▶ System units	→ 83
▶ Medium selection	→ 86
▶ I/O configuration	→ 88
▶ Current input 1 to n	→ 89
▶ Status input 1 to n	→ 90
▶ Current output 1 to n	→ 91
▶ Pulse/frequency/switch output 1 to n	→ 95
▶ Relay output 1 to n	→ 102
▶ Double pulse output	→ 105
▶ Display	→ 106
▶ Low flow cut off	→ 110

▶ Partially filled pipe detection	→ 111
▶ Advanced setup	→ 112

### 10.4.1 Defining the tag name

To enable fast identification of the measuring point within the system, you can enter a unique designation using the **Device tag** parameter and thus change the factory setting.

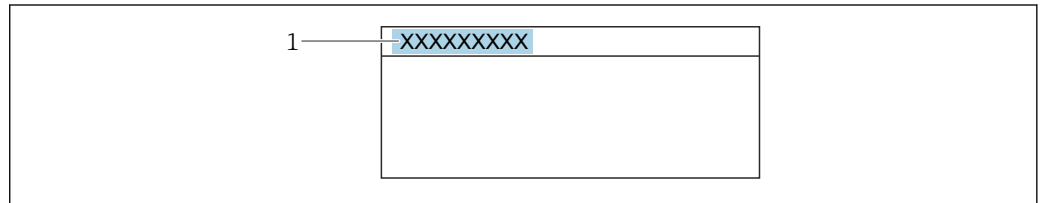

31 Header of the operational display with tag name

1 Tag name

**i** Enter the tag name in the "FieldCare" operating tool → 72

#### Navigation

"Setup" menu → Device tag

#### Parameter overview with brief description

Parameter	Description	User entry	Factory setting
Device tag	Enter the name for the measuring point.	Max. 32 characters, such as letters, numbers or special characters (e.g. @, %, /).	Promass

### 10.4.2 Setting the system units







In the **System units** submenu the units of all the measured values can be set.

**i** The number of submenus and parameters can vary depending on the device version. Certain submenus and parameters in these submenus are not described in the Operating Instructions. Instead a description is provided in the Special Documentation for the device ("Supplementary documentation").

#### Navigation



"Setup" menu → System units

▶ System units	
Mass flow unit	→ 84
Mass unit	→ 84
Volume flow unit	→ 84
Volume unit	→ 84

Corrected volume flow unit	→  84
Corrected volume unit	→  84
Density unit	→  84
Reference density unit	→  84
Density 2 unit	→  85
Temperature unit	→  85
Pressure unit	→  85

### Parameter overview with brief description

Parameter	Description	Selection	Factory setting
Mass flow unit	Select mass flow unit. <i>Effect</i> The selected unit applies to: <ul style="list-style-type: none"> <li>▪ Output</li> <li>▪ Low flow cut off</li> <li>▪ Simulation process variable</li> </ul>	Unit choose list	Country-specific: <ul style="list-style-type: none"> <li>▪ kg/h</li> <li>▪ lb/min</li> </ul>
Mass unit	Select mass unit.	Unit choose list	Country-specific: <ul style="list-style-type: none"> <li>▪ kg</li> <li>▪ lb</li> </ul>
Volume flow unit	Select volume flow unit. <i>Effect</i> The selected unit applies to: <ul style="list-style-type: none"> <li>▪ Output</li> <li>▪ Low flow cut off</li> <li>▪ Simulation process variable</li> </ul>	Unit choose list	Country-specific: <ul style="list-style-type: none"> <li>▪ l/h</li> <li>▪ gal/min (us)</li> </ul>
Volume unit	Select volume unit.	Unit choose list	Country-specific: <ul style="list-style-type: none"> <li>▪ l</li> <li>▪ gal (us)</li> </ul>
Corrected volume flow unit	Select corrected volume flow unit. <i>Effect</i> The selected unit applies to: <b>Corrected volume flow</b> parameter (→  141)	Unit choose list	Country-specific: <ul style="list-style-type: none"> <li>▪ NI/h</li> <li>▪ Sft<sup>3</sup>/min</li> </ul>
Corrected volume unit	Select corrected volume unit.	Unit choose list	Country-specific: <ul style="list-style-type: none"> <li>▪ NI</li> <li>▪ Sft<sup>3</sup></li> </ul>
Density unit	Select density unit. <i>Effect</i> The selected unit applies to: <ul style="list-style-type: none"> <li>▪ Output</li> <li>▪ Simulation process variable</li> <li>▪ Density adjustment (<b>Expert</b> menu)</li> </ul>	Unit choose list	Country-specific: <ul style="list-style-type: none"> <li>▪ kg/l</li> <li>▪ lb/ft<sup>3</sup></li> </ul>
Reference density unit	Select reference density unit.	Unit choose list	Country-specific <ul style="list-style-type: none"> <li>▪ kg/NI</li> <li>▪ lb/Sft<sup>3</sup></li> </ul>

Parameter	Description	Selection	Factory setting
Density 2 unit	Select second density unit.	Unit choose list	Country-specific: <ul style="list-style-type: none"> <li>■ kg/l</li> <li>■ lb/ft<sup>3</sup></li> </ul>
Temperature unit	Select temperature unit. <i>Effect</i> The selected unit applies to: <ul style="list-style-type: none"> <li>■ <b>Electronic temperature</b> parameter (6053)</li> <li>■ <b>Maximum value</b> parameter (6051)</li> <li>■ <b>Minimum value</b> parameter (6052)</li> <li>■ <b>External temperature</b> parameter (6080)</li> <li>■ <b>Maximum value</b> parameter (6108)</li> <li>■ <b>Minimum value</b> parameter (6109)</li> <li>■ <b>Maximum value</b> parameter (6029)</li> <li>■ <b>Minimum value</b> parameter (6030)</li> <li>■ <b>Reference temperature</b> parameter (1816)</li> <li>■ <b>Temperature</b> parameter</li> </ul>	Unit choose list	Country-specific: <ul style="list-style-type: none"> <li>■ °C</li> <li>■ °F</li> </ul>
Pressure unit	Select process pressure unit. <i>Effect</i> The unit is taken from: <ul style="list-style-type: none"> <li>■ <b>Pressure value</b> parameter (→  88)</li> <li>■ <b>External pressure</b> parameter (→  88)</li> <li>■ Pressure value</li> </ul>	Unit choose list	Country-specific: <ul style="list-style-type: none"> <li>■ bar a</li> <li>■ psi a</li> </ul>

### 10.4.3 Selecting and setting the medium

The **Select medium** wizard submenu contains parameters that must be configured in order to select and set the medium.

#### Navigation

"Setup" menu → Medium selection

► Medium selection	
MFT (Multi-Frequency Technology)	
Select medium type	→ 87
Select gas type	→ 87
Reference sound velocity	→ 87
Reference sound velocity	→ 87
Temperature coefficient sound velocity	→ 87
Temperature coefficient sound velocity	→ 87
Pressure compensation	→ 87
Pressure value	→ 88
External pressure	→ 88

## Parameter overview with brief description

Parameter	Prerequisite	Description	Selection / User entry / User interface	Factory setting
Select medium type	–	Use this function to select the type of medium: "Gas" or "Liquid". Select the "Other" option in exceptional cases in order to enter the properties of the medium manually (e.g. for highly compressive liquids such as sulfuric acid).	<ul style="list-style-type: none"> <li>■ Liquid</li> <li>■ Gas</li> <li>■ Other</li> </ul>	Liquid
Select gas type	In the <b>Medium selection</b> submenu, the <b>Gas</b> option is selected.	Select measured gas type.	<ul style="list-style-type: none"> <li>■ Air</li> <li>■ Ammonia NH<sub>3</sub></li> <li>■ Argon Ar</li> <li>■ Sulfur hexafluoride SF<sub>6</sub></li> <li>■ Oxygen O<sub>2</sub></li> <li>■ Ozone O<sub>3</sub></li> <li>■ Nitrogen oxide NO<sub>x</sub></li> <li>■ Nitrogen N<sub>2</sub></li> <li>■ Nitrous oxide N<sub>2</sub>O</li> <li>■ Methane CH<sub>4</sub></li> <li>■ Methane CH<sub>4</sub> + 10% Hydrogen H<sub>2</sub></li> <li>■ Methane CH<sub>4</sub> + 20% Hydrogen H<sub>2</sub></li> <li>■ Methane CH<sub>4</sub> + 30% Hydrogen H<sub>2</sub></li> <li>■ Hydrogen H<sub>2</sub></li> <li>■ Helium He</li> <li>■ Hydrogen chloride HCl</li> <li>■ Hydrogen sulfide H<sub>2</sub>S</li> <li>■ Ethylene C<sub>2</sub>H<sub>4</sub></li> <li>■ Carbon dioxide CO<sub>2</sub></li> <li>■ Carbon monoxide CO</li> <li>■ Chlorine Cl<sub>2</sub></li> <li>■ Butane C<sub>4</sub>H<sub>10</sub></li> <li>■ Propane C<sub>3</sub>H<sub>8</sub></li> <li>■ Propylene C<sub>3</sub>H<sub>6</sub></li> <li>■ Ethane C<sub>2</sub>H<sub>6</sub></li> <li>■ Other</li> </ul>	Methane CH <sub>4</sub>
Reference sound velocity	In the <b>Select gas type</b> parameter, the <b>Other</b> option is selected.	Enter sound velocity of the gas at 0 °C (32 °F).	1 to 99999.9999 m/s	415.0 m/s
Reference sound velocity	In the <b>Select medium type</b> parameter, the <b>Other</b> option is selected.	Enter sound velocity of the medium at 0 °C (32 °F).	Signed floating-point number	1456 m/s
Temperature coefficient sound velocity	In the <b>Select gas type</b> parameter, the <b>Other</b> option is selected.	Enter the temperature coefficient for the gas sound velocity.	Positive floating point number	0.87 (m/s)/K
Temperature coefficient sound velocity	In the <b>Select medium type</b> parameter, the <b>Other</b> option is selected.	Enter temperature coefficient for the medium sound velocity.	Signed floating-point number	1.3 (m/s)/K
Pressure compensation	–	Select pressure compensation type.	<ul style="list-style-type: none"> <li>■ Off</li> <li>■ Fixed value</li> <li>■ External value *</li> <li>■ Current input 1 *</li> <li>■ Current input 2 *</li> </ul>	Off

Parameter	Prerequisite	Description	Selection / User entry / User interface	Factory setting
Pressure value	In the <b>Pressure compensation</b> parameter, the <b>Fixed value</b> option is selected.	Enter process pressure to be used for pressure correction.	Positive floating-point number	1.01325 bar
External pressure	In the <b>Pressure compensation</b> parameter, the <b>External value</b> option or the <b>Current input 1...n</b> option is selected.	Shows the external process pressure value.		-

\* Visibility depends on order options or device settings

### 10.4.4 Displaying the I/O configuration

The **I/O configuration** submenu guides the user systematically through all the parameters in which the configuration of the I/O modules is displayed.

#### Navigation

"Setup" menu → I/O configuration

► I/O configuration	
I/O module 1 to n terminal numbers	→ 88
I/O module 1 to n information	→ 88
I/O module 1 to n type	→ 88
Apply I/O configuration	→ 89
I/O alteration code	→ 89

#### Parameter overview with brief description

Parameter	Description	User interface / Selection / User entry	Factory setting
I/O module 1 to n terminal numbers	Shows the terminal numbers used by the I/O module.	<ul style="list-style-type: none"> <li>■ Not used</li> <li>■ 26-27 (I/O 1)</li> <li>■ 24-25 (I/O 2)</li> <li>■ 22-23 (I/O 3)</li> </ul>	-
I/O module 1 to n information	Shows information of the plugged I/O module.	<ul style="list-style-type: none"> <li>■ Not plugged</li> <li>■ Invalid</li> <li>■ Not configurable</li> <li>■ Configurable</li> <li>■ HART</li> </ul>	-
I/O module 1 to n type	Shows the I/O module type.	<ul style="list-style-type: none"> <li>■ Off</li> <li>■ Current output *</li> <li>■ Current input *</li> <li>■ Status input *</li> <li>■ Pulse/frequency/switch output *</li> <li>■ Double pulse output *</li> <li>■ Relay output *</li> </ul>	Off



Parameter	Description	User interface / Selection / User entry	Factory setting
Apply I/O configuration	Apply parameterization of the freely configurable I/O module.	<ul style="list-style-type: none"> <li>■ No</li> <li>■ Yes</li> </ul>	No
I/O alteration code	Enter the code in order to change the I/O configuration.	Positive integer	0

\* Visibility depends on order options or device settings

### 10.4.5 Configuring the current input

The "Current input" wizard guides the user systematically through all the parameters that have to be set for configuring the current input.

#### Navigation

"Setup" menu → Current input

▶ **Current input 1 to n**

Terminal number	→ ⓘ 89
Signal mode	→ ⓘ 89
0/4 mA value	→ ⓘ 89
20 mA value	→ ⓘ 89
Current span	→ ⓘ 90
Failure mode	→ ⓘ 90
Failure value	→ ⓘ 90

#### Parameter overview with brief description

Parameter	Prerequisite	Description	User interface / Selection / User entry	Factory setting
Terminal number	–	Shows the terminal numbers used by the current input module.	<ul style="list-style-type: none"> <li>■ Not used</li> <li>■ 24-25 (I/O 2)</li> <li>■ 22-23 (I/O 3)</li> </ul>	–
Signal mode	The measuring device is <b>not</b> approved for use in the hazardous area with type of protection Ex-i.	Select the signal mode for the current input.	<ul style="list-style-type: none"> <li>■ Passive*</li> <li>■ Active*</li> </ul>	Active
0/4 mA value	–	Enter 4 mA value.	Signed floating-point number	0
20 mA value	–	Enter 20 mA value.	Signed floating-point number	Depends on country and nominal diameter

Parameter	Prerequisite	Description	User interface / Selection / User entry	Factory setting
Current span	–	Select current range for process value output and upper/lower level for alarm signal.	<ul style="list-style-type: none"> <li>▪ 4...20 mA (4...20.5 mA)</li> <li>▪ 4...20 mA NE (3.8...20.5 mA)</li> <li>▪ 4...20 mA US (3.9...20.8 mA)</li> <li>▪ 0...20 mA (0...20.5 mA)</li> </ul>	Country-specific: <ul style="list-style-type: none"> <li>▪ 4...20 mA NE (3.8...20.5 mA)</li> <li>▪ 4...20 mA US (3.9...20.8 mA)</li> </ul>
Failure mode	–	Define input behavior in alarm condition.	<ul style="list-style-type: none"> <li>▪ Alarm</li> <li>▪ Last valid value</li> <li>▪ Defined value</li> </ul>	Alarm
Failure value	In the <b>Failure mode</b> parameter, the <b>Defined value</b> option is selected.	Enter value to be used by the device if input value from external device is missing.	Signed floating-point number	0

\* Visibility depends on order options or device settings

## 10.4.6 Configuring the status input

The **Status input** submenu guides the user systematically through all the parameters that have to be set for configuring the status input.

### Navigation

"Setup" menu → Status input 1 to n

▶ Status input 1 to n

Assign status input	→ ⓘ 91
Terminal number	→ ⓘ 91
Active level	→ ⓘ 91
Terminal number	→ ⓘ 91
Response time status input	→ ⓘ 91
Terminal number	→ ⓘ 91

**Parameter overview with brief description**

Parameter	Description	Selection / User interface / User entry	Factory setting
Assign status input	Select function for the status input.	<ul style="list-style-type: none"> <li>■ Off</li> <li>■ Reset totalizer 1</li> <li>■ Reset totalizer 2</li> <li>■ Reset totalizer 3</li> <li>■ Reset all totalizers</li> <li>■ Flow override</li> <li>■ Zero adjustment</li> <li>■ Reset weighted averages *</li> <li>■ Reset weighted averages + totalizer 3 *</li> </ul>	Off
Terminal number	Shows the terminal numbers used by the status input module.	<ul style="list-style-type: none"> <li>■ Not used</li> <li>■ 24-25 (I/O 2)</li> <li>■ 22-23 (I/O 3)</li> </ul>	-
Active level	Define input signal level at which the assigned function is triggered.	<ul style="list-style-type: none"> <li>■ High</li> <li>■ Low</li> </ul>	High
Response time status input	Define the minimum amount of time the input signal level must be present before the selected function is triggered.	5 to 200 ms	50 ms

\* Visibility depends on order options or device settings

**10.4.7 Configuring the current output**

The **Current output** wizard guides you systematically through all the parameters that have to be set for configuring the current output.

**Navigation**

"Setup" menu → Current output







▶ **Current output 1 to n**

Terminal number	→ ⓘ 92
Signal mode	→ ⓘ 92
Process variable current output	→ ⓘ 93
Current range output	→ ⓘ 94
Lower range value output	→ ⓘ 94
Upper range value output	→ ⓘ 94
Fixed current	→ ⓘ 94
Damping current output	→ ⓘ 94
Failure behavior current output	→ ⓘ 94
Failure current	→ ⓘ 94

### Parameter overview with brief description

Parameter	Prerequisite	Description	User interface / Selection / User entry	Factory setting
Terminal number	-	Shows the terminal numbers used by the current output module.	<ul style="list-style-type: none"> <li>▪ Not used</li> <li>▪ 26-27 (I/O 1)</li> <li>▪ 24-25 (I/O 2)</li> <li>▪ 22-23 (I/O 3)</li> </ul>	-
Signal mode	-	Select the signal mode for the current output.	<ul style="list-style-type: none"> <li>▪ Active *</li> <li>▪ Passive *</li> </ul>	Active

Parameter	Prerequisite	Description	User interface / Selection / User entry	Factory setting
Process variable current output	-	Select the process variable for the current output.	<ul style="list-style-type: none"> <li>■ Off*</li> <li>■ Mass flow</li> <li>■ Volume flow</li> <li>■ Corrected volume flow*</li> <li>■ Density</li> <li>■ Reference density*</li> <li>■ Temperature</li> <li>■ Target mass flow*</li> <li>■ Carrier mass flow*</li> <li>■ Target volume flow*</li> <li>■ Carrier volume flow*</li> <li>■ Target corrected volume flow*</li> <li>■ Carrier corrected volume flow*</li> <li>■ Concentration*</li> <li>■ Application specific output 0*</li> <li>■ Application specific output 1*</li> <li>■ Inhomogeneous medium index</li> <li>■ Suspended bubbles index*</li> <li>■ Raw value mass flow</li> <li>■ Exciter current 0</li> <li>■ Oscillation damping 0</li> <li>■ Oscillation damping fluctuation 0*</li> <li>■ Oscillation frequency 0</li> <li>■ Frequency fluctuation 0*</li> <li>■ Signal asymmetry</li> <li>■ Torsion signal asymmetry*</li> <li>■ Carrier pipe temperature*</li> <li>■ Frequency fluctuation 0*</li> <li>■ Oscillation amplitude 0*</li> <li>■ Oscillation damping fluctuation 0*</li> <li>■ HBSI*</li> <li>■ Pressure*</li> <li>■ Electronics temperature</li> <li>■ Sensor index coil asymmetry</li> <li>■ Test point 0</li> <li>■ Test point 1</li> </ul>	Mass flow

Parameter	Prerequisite	Description	User interface / Selection / User entry	Factory setting
Current range output	–	Select current range for process value output and upper/lower level for alarm signal.	<ul style="list-style-type: none"> <li>▪ 4...20 mA NE (3.8...20.5 mA)</li> <li>▪ 4...20 mA US (3.9...20.8 mA)</li> <li>▪ 4...20 mA (4... 20.5 mA)</li> <li>▪ 0...20 mA (0... 20.5 mA)</li> <li>▪ Fixed value</li> </ul>	Depends on country: <ul style="list-style-type: none"> <li>▪ 4...20 mA NE (3.8...20.5 mA)</li> <li>▪ 4...20 mA US (3.9...20.8 mA)</li> </ul>
Lower range value output	In <b>Current span</b> parameter (→  94), one of the following options is selected: <ul style="list-style-type: none"> <li>▪ 4...20 mA NE (3.8...20.5 mA)</li> <li>▪ 4...20 mA US (3.9...20.8 mA)</li> <li>▪ 4...20 mA (4... 20.5 mA)</li> <li>▪ 0...20 mA (0... 20.5 mA)</li> </ul>	Enter lower range value for the measured value range.	Signed floating-point number	Depends on country: <ul style="list-style-type: none"> <li>▪ 0 kg/h</li> <li>▪ 0 lb/min</li> </ul>
Upper range value output	In <b>Current span</b> parameter (→  94), one of the following options is selected: <ul style="list-style-type: none"> <li>▪ 4...20 mA NE (3.8...20.5 mA)</li> <li>▪ 4...20 mA US (3.9...20.8 mA)</li> <li>▪ 4...20 mA (4... 20.5 mA)</li> <li>▪ 0...20 mA (0... 20.5 mA)</li> </ul>	Enter upper range value for the measured value range.	Signed floating-point number	Depends on country and nominal diameter
Fixed current	The <b>Fixed current</b> option is selected in the <b>Current span</b> parameter (→  94).	Defines the fixed output current.	0 to 22.5 mA	22.5 mA
Damping current output	A process variable is selected in the <b>Assign current output</b> parameter (→  93) and one of the following options is selected in the <b>Current span</b> parameter (→  94): <ul style="list-style-type: none"> <li>▪ 4...20 mA NE (3.8...20.5 mA)</li> <li>▪ 4...20 mA US (3.9...20.8 mA)</li> <li>▪ 4...20 mA (4... 20.5 mA)</li> <li>▪ 0...20 mA (0... 20.5 mA)</li> </ul>	Set reaction time for output signal to fluctuations in the measured value.	0.0 to 999.9 s	1.0 s
Failure behavior current output	A process variable is selected in the <b>Assign current output</b> parameter (→  93) and one of the following options is selected in the <b>Current span</b> parameter (→  94): <ul style="list-style-type: none"> <li>▪ 4...20 mA NE (3.8...20.5 mA)</li> <li>▪ 4...20 mA US (3.9...20.8 mA)</li> <li>▪ 4...20 mA (4... 20.5 mA)</li> <li>▪ 0...20 mA (0... 20.5 mA)</li> </ul>	Define output behavior in alarm condition.	<ul style="list-style-type: none"> <li>▪ Min.</li> <li>▪ Max.</li> <li>▪ Last valid value</li> <li>▪ Actual value</li> <li>▪ Fixed value</li> </ul>	Max.
Failure current	The <b>Defined value</b> option is selected in the <b>Failure mode</b> parameter.	Enter current output value in alarm condition.	0 to 22.5 mA	22.5 mA

\* Visibility depends on order options or device settings

### 10.4.8 Configuring the pulse/frequency/switch output

The **Pulse/frequency/switch output** wizard guides you systematically through all the parameters that can be set for configuring the selected output type.

#### Navigation

"Setup" menu → Advanced setup → Pulse/frequency/switch output

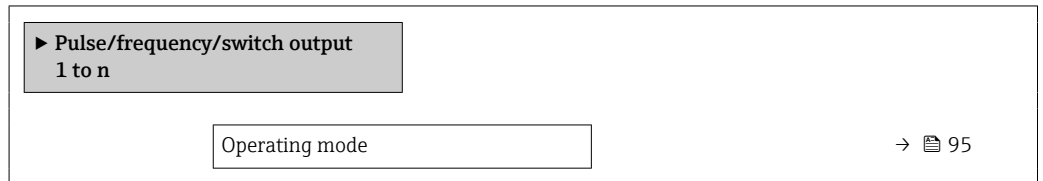

#### Parameter overview with brief description

Parameter	Description	Selection	Factory setting
Operating mode	Define the output as a pulse, frequency or switch output.	<ul style="list-style-type: none"> <li>■ Pulse</li> <li>■ Frequency</li> <li>■ Switch</li> </ul>	Pulse

#### Configuring the pulse output

#### Navigation

"Setup" menu → Pulse/frequency/switch output

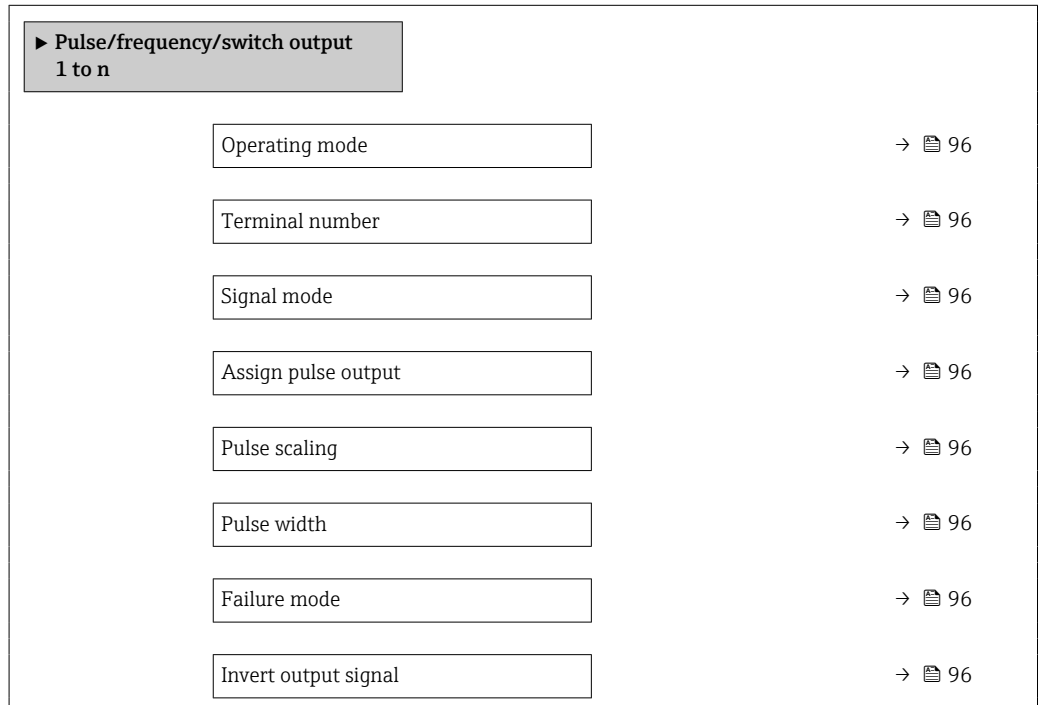

## Parameter overview with brief description

Parameter	Prerequisite	Description	Selection / User interface / User entry	Factory setting
Operating mode	–	Define the output as a pulse, frequency or switch output.	<ul style="list-style-type: none"> <li>▪ Pulse</li> <li>▪ Frequency</li> <li>▪ Switch</li> </ul>	Pulse
Terminal number	–	Shows the terminal numbers used by the PFS output module.	<ul style="list-style-type: none"> <li>▪ Not used</li> <li>▪ 24-25 (I/O 2)</li> <li>▪ 22-23 (I/O 3)</li> </ul>	–
Signal mode	–	Select the signal mode for the PFS output.	<ul style="list-style-type: none"> <li>▪ Passive</li> <li>▪ Active*</li> <li>▪ Passive NE</li> </ul>	Passive
Assign pulse output	The <b>Pulse</b> option is selected in the <b>Operating mode</b> parameter.	Select process variable for pulse output.	<ul style="list-style-type: none"> <li>▪ Off</li> <li>▪ Mass flow</li> <li>▪ Volume flow</li> <li>▪ Corrected volume flow*</li> <li>▪ Target mass flow*</li> <li>▪ Carrier mass flow*</li> <li>▪ Target volume flow*</li> <li>▪ Carrier volume flow*</li> <li>▪ Target corrected volume flow*</li> <li>▪ Carrier corrected volume flow*</li> </ul>	Off
Pulse scaling	The <b>Pulse</b> option is selected in the <b>Operating mode</b> parameter (→ 95) and a process variable is selected in the <b>Assign pulse output</b> parameter (→ 96).	Enter quantity for measured value at which a pulse is output.	Positive floating point number	Depends on country and nominal diameter
Pulse width	The <b>Pulse</b> option is selected in the <b>Operating mode</b> parameter (→ 95) and a process variable is selected in the <b>Assign pulse output</b> parameter (→ 96).	Define time width of the output pulse.	0.05 to 2 000 ms	100 ms
Failure mode	The <b>Pulse</b> option is selected in the <b>Operating mode</b> parameter (→ 95) and a process variable is selected in the <b>Assign pulse output</b> parameter (→ 96).	Define output behavior in alarm condition.	<ul style="list-style-type: none"> <li>▪ Actual value</li> <li>▪ No pulses</li> </ul>	No pulses
Invert output signal	–	Invert the output signal.	<ul style="list-style-type: none"> <li>▪ No</li> <li>▪ Yes</li> </ul>	No

\* Visibility depends on order options or device settings



### Configuring the frequency output

#### Navigation

"Setup" menu → Pulse/frequency/switch output

► Pulse/frequency/switch output 1 to n	
Operating mode	→ 97
Terminal number	→ 97
Signal mode	→ 97
Assign frequency output	→ 98
Minimum frequency value	→ 98
Maximum frequency value	→ 99
Measuring value at minimum frequency	→ 99
Measuring value at maximum frequency	→ 99
Failure mode	→ 99
Failure frequency	→ 99
Invert output signal	→ 99

#### Parameter overview with brief description

Parameter	Prerequisite	Description	Selection / User interface / User entry	Factory setting
Operating mode	–	Define the output as a pulse, frequency or switch output.	<ul style="list-style-type: none"> <li>■ Pulse</li> <li>■ Frequency</li> <li>■ Switch</li> </ul>	Pulse
Terminal number	–	Shows the terminal numbers used by the PFS output module.	<ul style="list-style-type: none"> <li>■ Not used</li> <li>■ 24-25 (I/O 2)</li> <li>■ 22-23 (I/O 3)</li> </ul>	–
Signal mode	–	Select the signal mode for the PFS output.	<ul style="list-style-type: none"> <li>■ Passive</li> <li>■ Active*</li> <li>■ Passive NE</li> </ul>	Passive

Parameter	Prerequisite	Description	Selection / User interface / User entry	Factory setting
Assign frequency output	The <b>Frequency</b> option is selected in <b>Operating mode</b> parameter (→ 95).	Select process variable for frequency output.	<ul style="list-style-type: none"> <li>▪ Off</li> <li>▪ Mass flow</li> <li>▪ Volume flow</li> <li>▪ Corrected volume flow *</li> <li>▪ Density</li> <li>▪ Reference density *</li> <li>▪ Time period signal frequency (TPS) *</li> <li>▪ Temperature</li> <li>▪ Pressure</li> <li>▪ Concentration *</li> <li>▪ Target mass flow *</li> <li>▪ Carrier mass flow *</li> <li>▪ Target volume flow *</li> <li>▪ Carrier volume flow *</li> <li>▪ Target corrected volume flow *</li> <li>▪ Carrier corrected volume flow *</li> <li>▪ Application specific output 0 *</li> <li>▪ Application specific output 1 *</li> <li>▪ Inhomogeneous medium index</li> <li>▪ Suspended bubbles index *</li> <li>▪ HBSI *</li> <li>▪ Raw value mass flow</li> <li>▪ Exciter current 0</li> <li>▪ Oscillation damping 0</li> <li>▪ Oscillation damping fluctuation 0 *</li> <li>▪ Oscillation frequency 0</li> <li>▪ Frequency fluctuation 0 *</li> <li>▪ Oscillation amplitude 0 *</li> <li>▪ Signal asymmetry</li> <li>▪ Torsion signal asymmetry *</li> <li>▪ Carrier pipe temperature *</li> <li>▪ Electronics temperature</li> <li>▪ Sensor index coil asymmetry</li> <li>▪ Test point 0</li> <li>▪ Test point 1</li> </ul>	Off
Minimum frequency value	The <b>Frequency</b> option is selected in the <b>Operating mode</b> parameter (→ 95) and a process variable is selected in the <b>Assign frequency output</b> parameter (→ 98).	Enter minimum frequency.	0.0 to 10 000.0 Hz	0.0 Hz

Parameter	Prerequisite	Description	Selection / User interface / User entry	Factory setting
Maximum frequency value	The <b>Frequency</b> option is selected in the <b>Operating mode</b> parameter (→ 95) and a process variable is selected in the <b>Assign frequency output</b> parameter (→ 98).	Enter maximum frequency.	0.0 to 10000.0 Hz	10000.0 Hz
Measuring value at minimum frequency	The <b>Frequency</b> option is selected in the <b>Operating mode</b> parameter (→ 95) and a process variable is selected in the <b>Assign frequency output</b> parameter (→ 98).	Enter measured value for minimum frequency.	Signed floating-point number	Depends on country and nominal diameter
Measuring value at maximum frequency	The <b>Frequency</b> option is selected in the <b>Operating mode</b> parameter (→ 95) and a process variable is selected in the <b>Assign frequency output</b> parameter (→ 98).	Enter measured value for maximum frequency.	Signed floating-point number	Depends on country and nominal diameter
Failure mode	The <b>Frequency</b> option is selected in the <b>Operating mode</b> parameter (→ 95) and a process variable is selected in the <b>Assign frequency output</b> parameter (→ 98).	Define output behavior in alarm condition.	<ul style="list-style-type: none"> <li>■ Actual value</li> <li>■ Defined value</li> <li>■ 0 Hz</li> </ul>	0 Hz
Failure frequency	In the <b>Operating mode</b> parameter (→ 95), the <b>Frequency</b> option is selected, in the <b>Assign frequency output</b> parameter (→ 98) a process variable is selected, and in the <b>Failure mode</b> parameter, the <b>Defined value</b> option is selected.	Enter frequency output value in alarm condition.	0.0 to 12500.0 Hz	0.0 Hz
Invert output signal	–	Invert the output signal.	<ul style="list-style-type: none"> <li>■ No</li> <li>■ Yes</li> </ul>	No

\* Visibility depends on order options or device settings

## Configuring the switch output

### Navigation

"Setup" menu → Pulse/frequency/switch output

► Pulse/frequency/switch output 1 to n	
Operating mode	→ 100
Terminal number	→ 100
Signal mode	→ 100
Switch output function	→ 101
Assign diagnostic behavior	→ 101
Assign limit	→ 101
Assign flow direction check	→ 101
Assign status	→ 101
Switch-on value	→ 102
Switch-off value	→ 102
Switch-on delay	→ 102
Switch-off delay	→ 102
Failure mode	→ 102
Invert output signal	→ 102

### Parameter overview with brief description

Parameter	Prerequisite	Description	Selection / User interface / User entry	Factory setting
Operating mode	–	Define the output as a pulse, frequency or switch output.	<ul style="list-style-type: none"> <li>▪ Pulse</li> <li>▪ Frequency</li> <li>▪ Switch</li> </ul>	Pulse
Terminal number	–	Shows the terminal numbers used by the PFS output module.	<ul style="list-style-type: none"> <li>▪ Not used</li> <li>▪ 24-25 (I/O 2)</li> <li>▪ 22-23 (I/O 3)</li> </ul>	–
Signal mode	–	Select the signal mode for the PFS output.	<ul style="list-style-type: none"> <li>▪ Passive*</li> <li>▪ Active*</li> <li>▪ Passive NE</li> </ul>	Passive

Parameter	Prerequisite	Description	Selection / User interface / User entry	Factory setting
Switch output function	The <b>Switch</b> option is selected in the <b>Operating mode</b> parameter.	Select function for switch output.	<ul style="list-style-type: none"> <li>■ Off</li> <li>■ On</li> <li>■ Diagnostic behavior</li> <li>■ Limit</li> <li>■ Flow direction check</li> <li>■ Status</li> </ul>	Off
Assign diagnostic behavior	<ul style="list-style-type: none"> <li>■ In the <b>Operating mode</b> parameter, the <b>Switch</b> option is selected.</li> <li>■ In the <b>Switch output function</b> parameter, the <b>Diagnostic behavior</b> option is selected.</li> </ul>	Select diagnostic behavior for switch output.	<ul style="list-style-type: none"> <li>■ Alarm</li> <li>■ Alarm or warning</li> <li>■ Warning</li> </ul>	Alarm
Assign limit	<ul style="list-style-type: none"> <li>■ The <b>Switch</b> option is selected in <b>Operating mode</b> parameter.</li> <li>■ The <b>Limit</b> option is selected in <b>Switch output function</b> parameter.</li> </ul>	Select process variable for limit function.	<ul style="list-style-type: none"> <li>■ Mass flow</li> <li>■ Volume flow</li> <li>■ Corrected volume flow *</li> <li>■ Target mass flow *</li> <li>■ Carrier mass flow *</li> <li>■ Target volume flow *</li> <li>■ Carrier volume flow *</li> <li>■ Target corrected volume flow *</li> <li>■ Carrier corrected volume flow *</li> <li>■ Density</li> <li>■ Reference density *</li> <li>■ Concentration *</li> <li>■ Temperature</li> <li>■ Totalizer 1</li> <li>■ Totalizer 2</li> <li>■ Totalizer 3</li> <li>■ Oscillation damping</li> <li>■ Pressure</li> <li>■ Application specific output 0 *</li> <li>■ Application specific output 1 *</li> <li>■ Inhomogeneous medium index</li> <li>■ Suspended bubbles index</li> </ul>	Volume flow
Assign flow direction check	<ul style="list-style-type: none"> <li>■ The <b>Switch</b> option is selected in the <b>Operating mode</b> parameter.</li> <li>■ The <b>Flow direction check</b> option is selected in the <b>Switch output function</b> parameter.</li> </ul>	Select process variable for flow direction monitoring.		Mass flow
Assign status	<ul style="list-style-type: none"> <li>■ The <b>Switch</b> option is selected in <b>Operating mode</b> parameter.</li> <li>■ The <b>Status</b> option is selected in <b>Switch output function</b> parameter.</li> </ul>	Select device status for switch output.	<ul style="list-style-type: none"> <li>■ Partially filled pipe detection</li> <li>■ Low flow cut off</li> </ul>	Partially filled pipe detection

Parameter	Prerequisite	Description	Selection / User interface / User entry	Factory setting
Switch-on value	<ul style="list-style-type: none"> <li>The <b>Switch</b> option is selected in the <b>Operating mode</b> parameter.</li> <li>The <b>Limit</b> option is selected in the <b>Switch output function</b> parameter.</li> </ul>	Enter measured value for the switch-on point.	Signed floating-point number	Depends on country: <ul style="list-style-type: none"> <li>0 kg/h</li> <li>0 lb/min</li> </ul>
Switch-off value	<ul style="list-style-type: none"> <li>The <b>Switch</b> option is selected in the <b>Operating mode</b> parameter.</li> <li>The <b>Limit</b> option is selected in the <b>Switch output function</b> parameter.</li> </ul>	Enter measured value for the switch-off point.	Signed floating-point number	Depends on country: <ul style="list-style-type: none"> <li>0 kg/h</li> <li>0 lb/min</li> </ul>
Switch-on delay	<ul style="list-style-type: none"> <li>The <b>Switch</b> option is selected in the <b>Operating mode</b> parameter.</li> <li>The <b>Limit</b> option is selected in the <b>Switch output function</b> parameter.</li> </ul>	Define delay for the switch-on of status output.	0.0 to 100.0 s	0.0 s
Switch-off delay	<ul style="list-style-type: none"> <li>The <b>Switch</b> option is selected in the <b>Operating mode</b> parameter.</li> <li>The <b>Limit</b> option is selected in the <b>Switch output function</b> parameter.</li> </ul>	Define delay for the switch-off of status output.	0.0 to 100.0 s	0.0 s
Failure mode	–	Define output behavior in alarm condition.	<ul style="list-style-type: none"> <li>Actual status</li> <li>Open</li> <li>Closed</li> </ul>	Open
Invert output signal	–	Invert the output signal.	<ul style="list-style-type: none"> <li>No</li> <li>Yes</li> </ul>	No

\* Visibility depends on order options or device settings

### 10.4.9 Configuring the relay output

The **Relay output** wizard guides the user systematically through all the parameters that have to be set for configuring the relay output.

#### Navigation

"Setup" menu → Relay output 1 to n

► Relay output 1 to n	
Terminal number	→ ⓘ 103
Relay output function	→ ⓘ 103
Assign flow direction check	→ ⓘ 103
Assign limit	→ ⓘ 104
Assign diagnostic behavior	→ ⓘ 104
Assign status	→ ⓘ 104

Switch-off value	→ ⓘ 104
Switch-off delay	→ ⓘ 104
Switch-on value	→ ⓘ 104
Switch-on delay	→ ⓘ 104
Failure mode	→ ⓘ 104
Switch state	→ ⓘ 104
Powerless relay status	→ ⓘ 104

**Parameter overview with brief description**

Parameter	Prerequisite	Description	User interface / Selection / User entry	Factory setting
Terminal number	-	Shows the terminal numbers used by the relay output module.	<ul style="list-style-type: none"> <li>▪ Not used</li> <li>▪ 24-25 (I/O 2)</li> <li>▪ 22-23 (I/O 3)</li> </ul>	-
Relay output function	-	Select the function for the relay output.	<ul style="list-style-type: none"> <li>▪ Closed</li> <li>▪ Open</li> <li>▪ Diagnostic behavior</li> <li>▪ Limit</li> <li>▪ Flow direction check</li> <li>▪ Digital Output</li> </ul>	Closed
Assign flow direction check	The <b>Flow direction check</b> option is selected in the <b>Relay output function</b> parameter.	Select process variable for flow direction monitoring.		Mass flow

Parameter	Prerequisite	Description	User interface / Selection / User entry	Factory setting
Assign limit	The <b>Limit</b> option is selected in <b>Relay output function</b> parameter.	Select process variable for limit function.	<ul style="list-style-type: none"> <li>■ Mass flow</li> <li>■ Volume flow</li> <li>■ Corrected volume flow<sup>*</sup></li> <li>■ Target mass flow<sup>*</sup></li> <li>■ Carrier mass flow<sup>*</sup></li> <li>■ Target volume flow<sup>*</sup></li> <li>■ Carrier volume flow<sup>*</sup></li> <li>■ Target corrected volume flow<sup>*</sup></li> <li>■ Carrier corrected volume flow<sup>*</sup></li> <li>■ Density</li> <li>■ Reference density<sup>*</sup></li> <li>■ Concentration<sup>*</sup></li> <li>■ Temperature</li> <li>■ Totalizer 1</li> <li>■ Totalizer 2</li> <li>■ Totalizer 3</li> <li>■ Oscillation damping</li> <li>■ Pressure</li> <li>■ Application specific output 0<sup>*</sup></li> <li>■ Application specific output 1<sup>*</sup></li> <li>■ Inhomogeneous medium index</li> <li>■ Suspended bubbles index<sup>*</sup></li> </ul>	Mass flow
Assign diagnostic behavior	In the <b>Relay output function</b> parameter, the <b>Diagnostic behavior</b> option is selected.	Select diagnostic behavior for switch output.	<ul style="list-style-type: none"> <li>■ Alarm</li> <li>■ Alarm or warning</li> <li>■ Warning</li> </ul>	Alarm
Assign status	In the <b>Relay output function</b> parameter, the <b>Digital Output</b> option is selected.	Select device status for switch output.	<ul style="list-style-type: none"> <li>■ Partially filled pipe detection</li> <li>■ Low flow cut off</li> </ul>	Partially filled pipe detection
Switch-off value	The <b>Limit</b> option is selected in the <b>Relay output function</b> parameter.	Enter measured value for the switch-off point.	Signed floating-point number	Depends on country: <ul style="list-style-type: none"> <li>■ 0 kg/h</li> <li>■ 0 lb/min</li> </ul>
Switch-off delay	In the <b>Relay output function</b> parameter, the <b>Limit</b> option is selected.	Define delay for the switch-off of status output.	0.0 to 100.0 s	0.0 s
Switch-on value	The <b>Limit</b> option is selected in the <b>Relay output function</b> parameter.	Enter measured value for the switch-on point.	Signed floating-point number	Depends on country: <ul style="list-style-type: none"> <li>■ 0 kg/h</li> <li>■ 0 lb/min</li> </ul>
Switch-on delay	In the <b>Relay output function</b> parameter, the <b>Limit</b> option is selected.	Define delay for the switch-on of status output.	0.0 to 100.0 s	0.0 s
Failure mode	–	Define output behavior in alarm condition.	<ul style="list-style-type: none"> <li>■ Actual status</li> <li>■ Open</li> <li>■ Closed</li> </ul>	Open
Switch state	–	Shows the current relay switch status.	<ul style="list-style-type: none"> <li>■ Open</li> <li>■ Closed</li> </ul>	–
Powerless relay status	–	Select quiescent state for relay.	<ul style="list-style-type: none"> <li>■ Open</li> <li>■ Closed</li> </ul>	Open

\* Visibility depends on order options or device settings



### 10.4.10 Configuring the double pulse output

The **Double pulse output** submenu guides the user systematically through all the parameters that have to be set for configuring the double pulse output.

#### Navigation

"Setup" menu → Double pulse output

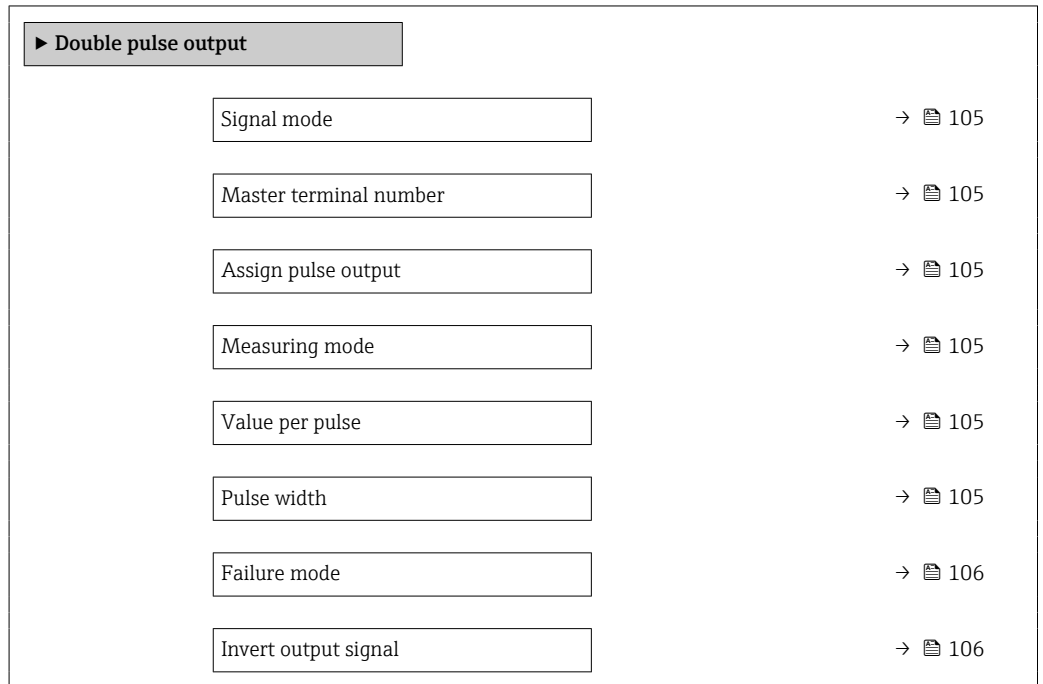

#### Parameter overview with brief description

Parameter	Description	Selection / User interface / User entry	Factory setting
Signal mode	Select the signal mode for the double pulse output.	<ul style="list-style-type: none"> <li>■ Passive</li> <li>■ Active *</li> <li>■ Passive NE</li> </ul>	Passive
Master terminal number	Shows the terminal numbers used by the master of the double pulse output module.	<ul style="list-style-type: none"> <li>■ Not used</li> <li>■ 24-25 (I/O 2)</li> <li>■ 22-23 (I/O 3)</li> </ul>	–
Assign pulse output	Select process variable for pulse output.	<ul style="list-style-type: none"> <li>■ Off</li> <li>■ Mass flow</li> <li>■ Volume flow</li> <li>■ Corrected volume flow *</li> <li>■ Target mass flow *</li> <li>■ Carrier mass flow *</li> <li>■ Target volume flow *</li> <li>■ Carrier volume flow *</li> <li>■ Target corrected volume flow *</li> <li>■ Carrier corrected volume flow *</li> </ul>	Off
Measuring mode	Select measuring mode for pulse output.	<ul style="list-style-type: none"> <li>■ Forward flow</li> <li>■ Forward/Reverse flow</li> <li>■ Reverse flow</li> <li>■ Reverse flow compensation</li> </ul>	Forward flow
Value per pulse	Enter measured value at which a pulse is output.	Signed floating-point number	Depends on country and nominal diameter
Pulse width	Define time width of the output pulse.	0.5 to 2 000 ms	0.5 ms

Parameter	Description	Selection / User interface / User entry	Factory setting
Failure mode	Define output behavior in alarm condition.	<ul style="list-style-type: none"> <li>■ Actual value</li> <li>■ No pulses</li> </ul>	No pulses
Invert output signal	Invert the output signal.	<ul style="list-style-type: none"> <li>■ No</li> <li>■ Yes</li> </ul>	No













\* Visibility depends on order options or device settings

### 10.4.11 Configuring the local display

The **Display** wizard guides you systematically through all the parameters that can be configured for configuring the local display.

#### Navigation

"Setup" menu → Display

► Display	
Format display	→  107
Value 1 display	→  108
0% bargraph value 1	→  108
100% bargraph value 1	→  108
Value 2 display	→  109
Value 3 display	→  109
0% bargraph value 3	→  109
100% bargraph value 3	→  109
Value 4 display	→  109
Value 5 display	→  109
Value 6 display	→  109
Value 7 display	→  109
Value 8 display	→  109

**Parameter overview with brief description**

Parameter	Prerequisite	Description	Selection / User entry	Factory setting
Format display	A local display is provided.	Select how measured values are shown on the display.	<ul style="list-style-type: none"><li>■ 1 value, max. size</li><li>■ 1 bargraph + 1 value</li><li>■ 2 values</li><li>■ 1 value large + 2 values</li><li>■ 4 values</li></ul>	1 value, max. size

Parameter	Prerequisite	Description	Selection / User entry	Factory setting
Value 1 display	A local display is provided.	Select the measured value that is shown on the local display.	<ul style="list-style-type: none"> <li>▪ Mass flow</li> <li>▪ Volume flow</li> <li>▪ Corrected volume flow *</li> <li>▪ Density</li> <li>▪ Reference density *</li> <li>▪ Temperature</li> <li>▪ Pressure</li> <li>▪ Totalizer 1</li> <li>▪ Totalizer 2</li> <li>▪ Totalizer 3</li> <li>▪ Concentration *</li> <li>▪ Target mass flow *</li> <li>▪ Carrier mass flow *</li> <li>▪ Target volume flow *</li> <li>▪ Carrier volume flow *</li> <li>▪ Target corrected volume flow *</li> <li>▪ Carrier corrected volume flow *</li> <li>▪ Application specific output 0 *</li> <li>▪ Application specific output 1 *</li> <li>▪ Inhomogeneous medium index</li> <li>▪ Suspended bubbles index *</li> <li>▪ HBSI *</li> <li>▪ Raw value mass flow</li> <li>▪ Exciter current 0</li> <li>▪ Oscillation damping 0</li> <li>▪ Oscillation damping fluctuation 0 *</li> <li>▪ Oscillation frequency 0</li> <li>▪ Frequency fluctuation 0 *</li> <li>▪ Oscillation amplitude 0 *</li> <li>▪ Signal asymmetry</li> <li>▪ Torsion signal asymmetry *</li> <li>▪ Carrier pipe temperature *</li> <li>▪ Electronics temperature</li> <li>▪ Sensor index coil asymmetry</li> <li>▪ Test point 0</li> <li>▪ Test point 1</li> <li>▪ Current output 1</li> <li>▪ Current output 2 *</li> <li>▪ Current output 3 *</li> </ul>	Mass flow
0% bargraph value 1	A local display is provided.	Enter 0% value for bar graph display.	Signed floating-point number	Country-specific: <ul style="list-style-type: none"> <li>▪ 0 kg/h</li> <li>▪ 0 lb/min</li> </ul>
100% bargraph value 1	A local display is provided.	Enter 100% value for bar graph display.	Signed floating-point number	Depends on country and nominal diameter

Parameter	Prerequisite	Description	Selection / User entry	Factory setting
Value 2 display	A local display is provided.	Select the measured value that is shown on the local display.	For the picklist, see <b>Value 1 display</b> parameter (→ 108)	None
Value 3 display	A local display is provided.	Select the measured value that is shown on the local display.	For the picklist, see <b>Value 1 display</b> parameter (→ 108)	None
0% bargraph value 3	A selection was made in the <b>Value 3 display</b> parameter.	Enter 0% value for bar graph display.	Signed floating-point number	Country-specific: <ul style="list-style-type: none"> <li>■ 0 kg/h</li> <li>■ 0 lb/min</li> </ul>
100% bargraph value 3	A selection was made in the <b>Value 3 display</b> parameter.	Enter 100% value for bar graph display.	Signed floating-point number	0
Value 4 display	A local display is provided.	Select the measured value that is shown on the local display.	For the picklist, see <b>Value 1 display</b> parameter (→ 108)	None
Value 5 display	A local display is provided.	Select the measured value that is shown on the local display.	For the picklist, see <b>Value 1 display</b> parameter (→ 108)	None
Value 6 display	A local display is provided.	Select the measured value that is shown on the local display.	For the picklist, see <b>Value 1 display</b> parameter (→ 108)	None
Value 7 display	A local display is provided.	Select the measured value that is shown on the local display.	For the picklist, see <b>Value 1 display</b> parameter (→ 108)	None
Value 8 display	A local display is provided.	Select the measured value that is shown on the local display.	For the picklist, see <b>Value 1 display</b> parameter (→ 108)	None





\* Visibility depends on order options or device settings

### 10.4.12 Configuring the low flow cut off



The **Low flow cut off** wizard systematically guides the user through all the parameters that must be set to configure low flow cut off.

#### Navigation

"Setup" menu → Low flow cut off

► Low flow cut off	
Assign process variable	→  110
On value low flow cutoff	→  110
Off value low flow cutoff	→  110
Pressure shock suppression	→  110

#### Parameter overview with brief description

Parameter	Prerequisite	Description	Selection / User entry	Factory setting
Assign process variable	–	Select process variable for low flow cut off.	<ul style="list-style-type: none"> <li>▪ Off</li> <li>▪ Mass flow</li> <li>▪ Volume flow</li> <li>▪ Corrected volume flow<sup>*</sup></li> </ul>	Mass flow
On value low flow cutoff	A process variable is selected in the <b>Assign process variable</b> parameter (→  110).	Enter on value for low flow cut off.	Positive floating-point number	Depends on country and nominal diameter
Off value low flow cutoff	A process variable is selected in the <b>Assign process variable</b> parameter (→  110).	Enter off value for low flow cut off.	0 to 100.0 %	50 %
Pressure shock suppression	A process variable is selected in the <b>Assign process variable</b> parameter (→  110).	Enter time frame for signal suppression (= active pressure shock suppression).	0 to 100 s	0 s

\* Visibility depends on order options or device settings

### 10.4.13 Configuring partially filled pipe detection

The **Partial filled pipe detection** wizard guides you systematically through all parameters that have to be set for configuring the monitoring of the pipe filling.

#### Navigation

"Setup" menu → Partially filled pipe detection

▶ Partially filled pipe detection

Assign process variable	→ ⓘ 111
Low value partial filled pipe detection	→ ⓘ 111
High value partial filled pipe detection	→ ⓘ 111
Response time part. filled pipe detect.	→ ⓘ 111

#### Parameter overview with brief description

Parameter	Prerequisite	Description	Selection / User entry	Factory setting
Assign process variable	–	Select process variable for partially filled pipe detection.	<ul style="list-style-type: none"> <li>■ Off</li> <li>■ Density</li> <li>■ Calculated reference density</li> </ul>	Density
Low value partial filled pipe detection	A process variable is selected in the <b>Assign process variable</b> parameter (→ ⓘ 111).	Enter lower limit value for deactivating partialy filled pipe detection.	Signed floating-point number	Depends on country: <ul style="list-style-type: none"> <li>■ 200 kg/m<sup>3</sup></li> <li>■ 12.5 lb/ft<sup>3</sup></li> </ul>
High value partial filled pipe detection	A process variable is selected in the <b>Assign process variable</b> parameter (→ ⓘ 111).	Enter upper limit value for deactivating partialy filled pipe detection.	Signed floating-point number	Depends on country: <ul style="list-style-type: none"> <li>■ 6 000 kg/m<sup>3</sup></li> <li>■ 374.6 lb/ft<sup>3</sup></li> </ul>
Response time part. filled pipe detect.	A process variable is selected in the <b>Assign process variable</b> parameter (→ ⓘ 111).	Use this function to enter the minimum time (hold time) the signal must be present before diagnostic message S962 "Pipe only partly filled" is triggered in the event of a partially filled or empty measuring pipe.	0 to 100 s	1 s

## 10.5 Advanced settings

The **Advanced setup** submenu with its submenus contains parameters for specific settings.

*Navigation to the "Advanced setup" submenu*

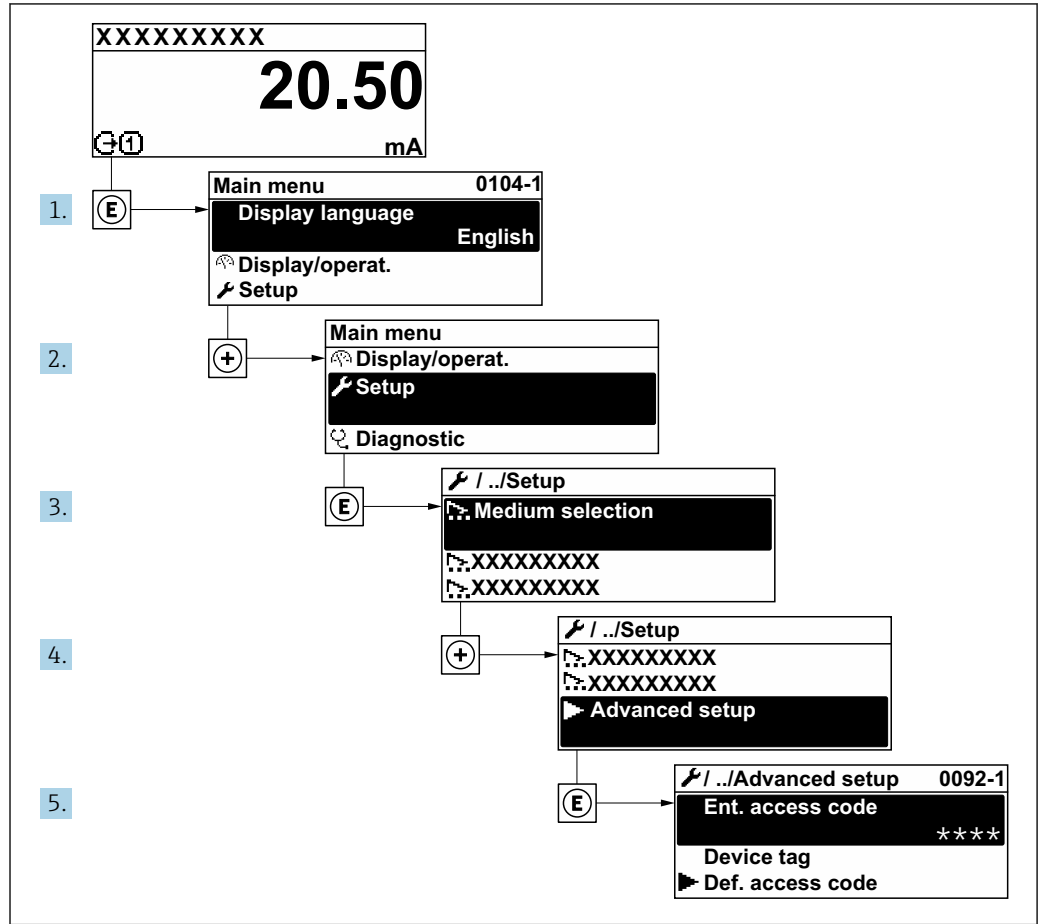

A0032223-EN

**i** The number of submenus and parameters can vary depending on the device version and the available application packages. These submenus and their parameters are explained in the Special Documentation for the device and not in Operating Instructions.

- For detailed information on the parameter descriptions for application packages: Special Documentation for the device → 218
- For detailed information on the SIL parameter descriptions, see the Functional Safety Manual → 218

### Navigation

"Setup" menu → Advanced setup

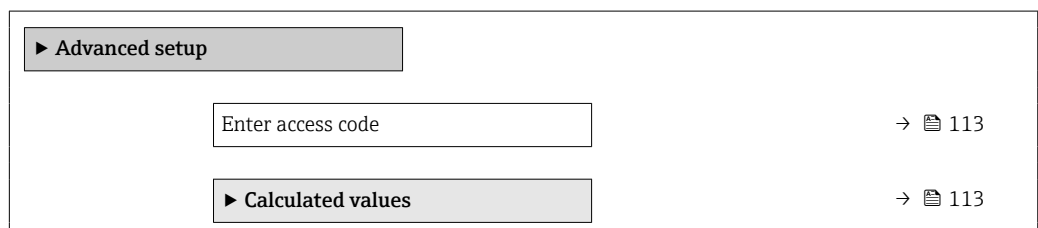



▶ Sensor adjustment	→ 📄 114
▶ Totalizer 1 to n	→ 📄 120
▶ Display	→ 📄 122
▶ WLAN settings	→ 📄 128
▶ Configuration backup	→ 📄 130
▶ Administration	→ 📄 131

### 10.5.1 Using the parameter to enter the access code

#### Navigation

"Setup" menu → Advanced setup

#### Parameter overview with brief description

Parameter	Description	User entry
Enter access code	Enter access code to disable write protection of parameters.	Max. 16-digit character string comprising numbers, letters and special characters

### 10.5.2 Calculated process variables

The **Calculated values** submenu contains parameters for calculating the corrected volume flow.

#### Navigation

"Setup" menu → Advanced setup → Calculated values

▶ Calculated values	
▶ Corrected volume flow calculation	→ 📄 113

#### "Corrected volume flow calculation" submenu

#### Navigation

"Setup" menu → Advanced setup → Calculated values → Corrected volume flow calculation

▶ Corrected volume flow calculation	
Select reference density (1812)	→ 📄 114
External reference density (6198)	→ 📄 114
Fixed reference density (1814)	→ 📄 114

Reference temperature (1816)	→ ⓘ 114
Linear expansion coefficient (1817)	→ ⓘ 114
Square expansion coefficient (1818)	→ ⓘ 114

### Parameter overview with brief description

Parameter	Prerequisite	Description	Selection / User interface / User entry	Factory setting
Select reference density	–	Select reference density for calculating the corrected volume flow.	<ul style="list-style-type: none"> <li>■ Fixed reference density</li> <li>■ Calculated reference density</li> <li>■ Current input 1<sup>*</sup></li> <li>■ Current input 2<sup>*</sup></li> </ul>	Calculated reference density
External reference density	One of the following options is selected in the <b>Corrected volume flow calculation</b> parameter: <ul style="list-style-type: none"> <li>■ Current input 1<sup>*</sup></li> <li>■ Current input 2<sup>*</sup></li> </ul>	Shows external reference density.	Floating point number with sign	–
Fixed reference density	The <b>Fixed reference density</b> option is selected in the <b>Corrected volume flow calculation</b> parameter parameter.	Enter fixed value for reference density.	Positive floating-point number	1 kg/Nl
Reference temperature	The <b>Calculated reference density</b> option is selected in the <b>Corrected volume flow calculation</b> parameter parameter.	Enter reference temperature for calculating the reference density.	–273.15 to 99 999 °C	Country-specific: <ul style="list-style-type: none"> <li>■ +20 °C</li> <li>■ +68 °F</li> </ul>
Linear expansion coefficient	The <b>Calculated reference density</b> option is selected in the <b>Corrected volume flow calculation</b> parameter parameter.	Enter linear, medium-specific expansion coefficient for calculating the reference density.	Signed floating-point number	0.0 1/K
Square expansion coefficient	The <b>Calculated reference density</b> option is selected in the <b>Corrected volume flow calculation</b> parameter parameter.	For media with a non-linear expansion pattern: enter the quadratic, medium-specific expansion coefficient for calculating the reference density.	Signed floating-point number	0.0 1/K <sup>2</sup>

\* Visibility depends on order options or device settings

### 10.5.3 Carrying out a sensor adjustment

The **Sensor adjustment** submenu contains parameters that pertain to the functionality of the sensor.

**Navigation**

"Setup" menu → Advanced setup → Sensor adjustment

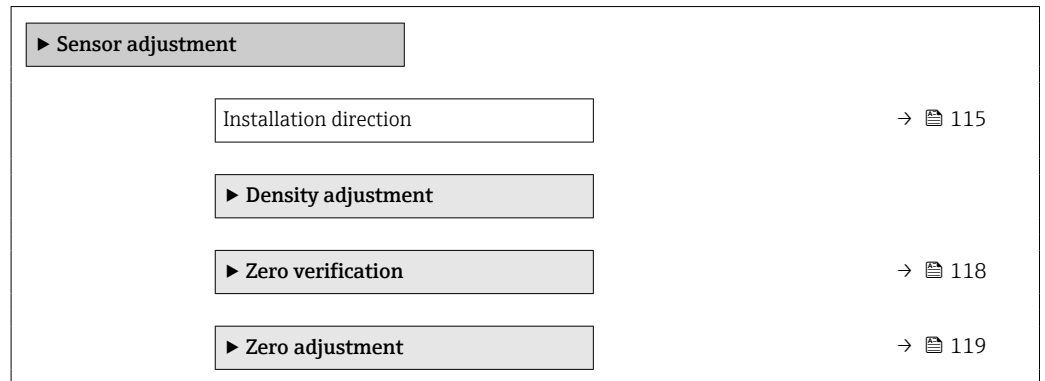

**Parameter overview with brief description**

Parameter	Description	Selection	Factory setting
Installation direction	Select sign of flow direction.	<ul style="list-style-type: none"> <li>■ Forward flow</li> <li>■ Reverse flow</li> </ul>	Forward flow

**Density adjustment**

**i** With density adjustment, a high level of accuracy is achieved only at the point of adjustment and at the relevant density and temperature. However, the accuracy of a density adjustment is only ever as good as the quality of the reference measuring data provided. Therefore it is not a substitute for special density calibration.

*Performing density adjustment*

- i** Note the following before performing the adjustment:
- A density adjustment only makes sense if there is little variation in the operating conditions and the density adjustment is performed under the operating conditions.
  - The density adjustment scales the internally computed density value with a user-specific slope and offset.
  - A 1-point or 2-point density adjustment can be performed.
  - For a 2-point density adjustment, there must be a difference of at least 0.2 kg/l between the two target density values.
  - The reference media must be gas-free or pressurized so that any gas they contain is compressed.
  - The reference density measurements must be performed at the same medium temperature that prevails in the process, as otherwise the density adjustment will not be accurate.
  - The correction resulting from the density adjustment can be deleted with the **Restore original** option.

**"1 point adjustment" option**

1. In the **Density adjustment mode** parameter, select the **1 point adjustment** option and confirm.
2. In the **Density setpoint 1** parameter, enter the density value and confirm.
  - ↳ In the **Execute density adjustment** parameter the following options are now available:
    - Ok
    - Measure density 1 option**
    - Restore original

3. Select the **Measure density 1** option and confirm.
4. If 100% was reached in the **Progress** parameter on the display and the **Ok** option is displayed in the **Execute density adjustment** parameter, then confirm.
  - ↳ In the **Execute density adjustment** parameter the following options are now available:
    - Ok
    - Calculate
    - Cancel
5. Select the **Calculate** option and confirm.

If the adjustment was completed successfully, the **Density adjustment factor** parameter and the **Density adjustment offset** parameter and the values calculated for them are shown on the display.

### "2 point adjustment" option

1. In the **Density adjustment mode** parameter, select the **2 point adjustment** option and confirm.
2. In the **Density setpoint 1** parameter, enter the density value and confirm.
3. In the **Density setpoint 2** parameter, enter the density value and confirm.
  - ↳ In the **Execute density adjustment** parameter the following options are now available:
    - Ok
    - Measure density 1
    - Restore original
4. Select the **Measure density 1** option and confirm.
  - ↳ In the **Execute density adjustment** parameter the following options are now available:
    - Ok
    - Measure density 2
    - Restore original
5. Select the **Measure density 2** option and confirm.
  - ↳ In the **Execute density adjustment** parameter the following options are now available:
    - Ok
    - Calculate
    - Cancel
6. Select the **Calculate** option and confirm.





If the **Density adjust failure** option is displayed in the **Execute density adjustment** parameter, call up the options and select the **Cancel** option. The density adjustment is canceled and can be repeated.

If the adjustment was completed successfully, the **Density adjustment factor** parameter and the **Density adjustment offset** parameter and the values calculated for them are shown on the display.

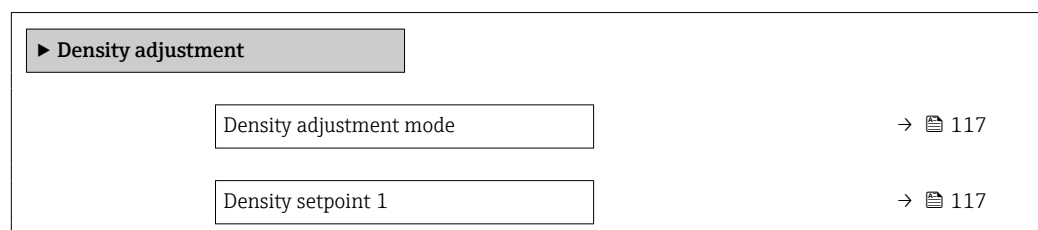
### Navigation

"Expert" menu → Sensor → Sensor adjustment → Density adjustment



Density setpoint 2	→  117
Execute density adjustment	→  117
Progress	→  117
Density adjustment factor	→  117
Density adjustment offset	→  117

**Parameter overview with brief description**

Parameter	Prerequisite	Description	Selection / User entry / User interface	Factory setting
Density adjustment mode	–	Select the method for field density adjustment to correct the factory setting.	<ul style="list-style-type: none"> <li>■ 1 point adjustment</li> <li>■ 2 point adjustment</li> </ul>	1 point adjustment
Density setpoint 1	–	Enter density for the first reference media.	The entry depends on the unit selected in the <b>Density unit</b> parameter (0555).	1 kg/l
Density setpoint 2	In the <b>Density adjustment mode</b> parameter, the <b>2 point adjustment</b> option is selected.	Enter density for the second reference media.	The entry depends on the unit selected in the <b>Density unit</b> parameter (0555).	1 kg/l
Execute density adjustment	–	Select the next step to be performed for the density adjustment.	<ul style="list-style-type: none"> <li>■ Cancel<sup>*</sup></li> <li>■ Busy<sup>*</sup></li> <li>■ Ok</li> <li>■ Density adjust failure<sup>*</sup></li> <li>■ Measure density 1<sup>*</sup></li> <li>■ Measure density 2<sup>*</sup></li> <li>■ Calculate<sup>*</sup></li> <li>■ Restore original<sup>*</sup></li> </ul>	Ok
Progress	–	Shows the progress of the process.	0 to 100 %	–
Density adjustment factor	–	Shows the calculated correction factor for the density.	Signed floating-point number	1
Density adjustment offset	–	Shows the calculated correction offset for the density.	Signed floating-point number	0

\* Visibility depends on order options or device settings

**Zero verification and zero adjustment**

All measuring instruments are calibrated in accordance with state-of-the-art technology. Calibration takes place under reference conditions →  198. Therefore, a zero adjustment in the field is generally not required.

Experience shows that zero adjustment is advisable only in special cases:

- To achieve maximum measurement accuracy even with low flow rates.
- Under extreme process or operating conditions (e.g. very high process temperatures or very high-viscosity fluids).
- For gas applications with low pressure

 To achieve the highest possible measurement accuracy at low flow rates, the installation must protect the sensor from mechanical stresses during operation.

To get a representative zero point, ensure that:

- any flow in the device is prevented during the adjustment
- the process conditions (e.g. pressure, temperature) are stable and representative

Zero verification and zero adjustment cannot be performed if the following process conditions are present:

- Gas pockets  
Ensure that the system has been sufficiently flushed with the medium. Repeat flushing can help to eliminate gas pockets
- Thermal circulation  
In the event of temperature differences (e.g. between the measuring tube inlet and outlet section), induced flow can occur even if the valves are closed due to thermal circulation in the device
- Leaks at the valves  
If the valves are not leak-tight, flow is not sufficiently prevented when determining the zero point









If these conditions cannot be avoided, it is advisable to keep the factory setting for the zero point.

#### *Zero point verification*

The zero point can be verified with the **Zero verification** wizard.

#### **Navigation**

"Setup" menu → Advanced setup → Sensor adjustment → Zero verification

► Zero verification	
Process conditions	→  119
Progress	→  119
Status	→  119
Additional information	→  119
Recommendation:	→  119
Root cause	→  119
Abort cause	→  119
Zero point measured	→  119
Zero point standard deviation	→  119

**Parameter overview with brief description**

Parameter	Description	Selection / User interface	Factory setting
Process conditions	Ensure process conditions as follows.	<ul style="list-style-type: none"> <li>▪ Tubes are completely filled</li> <li>▪ Process operational pressure applied</li> <li>▪ No-flow conditions (closed valves)</li> <li>▪ Process and ambient temperatures stable</li> </ul>	–
Progress	Shows the progress of the process.	0 to 100 %	–
Status	Shows the status of the process.	<ul style="list-style-type: none"> <li>▪ Busy</li> <li>▪ Failed</li> <li>▪ Done</li> </ul>	–
Additional information	Indicate whether to display additional information.	<ul style="list-style-type: none"> <li>▪ Hide</li> <li>▪ Show</li> </ul>	Hide
Recommendation:	Indicates whether an adjustment is recommended. Only recommended if the measured zero point deviates significantly from the current zero point.	<ul style="list-style-type: none"> <li>▪ Do not adjust zero point</li> <li>▪ Adjust zero point</li> </ul>	–
Abort cause	Indicates why the wizard was aborted.	<ul style="list-style-type: none"> <li>▪ Check process conditions!</li> <li>▪ A technical issue has occurred</li> </ul>	–
Root cause	Shows the diagnostic and remedy.	<ul style="list-style-type: none"> <li>▪ Zero point too high. Ensure no-flow.</li> <li>▪ Zero point is unstable. Ensure no-flow.</li> <li>▪ Fluctuation high. Avoid 2-phase medium.</li> </ul>	–
Zero point measured	Shows the zero point measured for the adjustment.	Signed floating-point number	–
Zero point standard deviation	Shows the standard deviation of the zero point measured.	Positive floating-point number	–

*Zero adjust*





The zero point can be adjusted with the **Zero adjustment** wizard.







-  ▪ A zero point verification should be performed before a zero adjustment.
- The zero point can also be adjusted manually: Expert → Sensor → Calibration

**Navigation**

"Setup" menu → Advanced setup → Sensor adjustment → Zero adjustment

▶ **Zero adjustment**

Process conditions	→  120
Progress	→  120
Status	→  120
Root cause	→  120
Abort cause	→  120

Root cause	→  120
Reliability of measured zero point	→  120
Additional information	→  120
Reliability of measured zero point	→  120
Zero point measured	→  120
Zero point standard deviation	→  120
Select action	→  120

### Parameter overview with brief description

Parameter	Description	Selection / User interface	Factory setting
Process conditions	Ensure process conditions as follows.	<ul style="list-style-type: none"> <li>▪ Tubes are completely filled</li> <li>▪ Process operational pressure applied</li> <li>▪ No-flow conditions (closed valves)</li> <li>▪ Process and ambient temperatures stable</li> </ul>	–
Progress	Shows the progress of the process.	0 to 100 %	–
Status	Shows the status of the process.	<ul style="list-style-type: none"> <li>▪ Busy</li> <li>▪ Failed</li> <li>▪ Done</li> </ul>	–
Abort cause	Indicates why the wizard was aborted.	<ul style="list-style-type: none"> <li>▪ Check process conditions!</li> <li>▪ A technical issue has occurred</li> </ul>	–
Root cause	Shows the diagnostic and remedy.	<ul style="list-style-type: none"> <li>▪ Zero point too high. Ensure no-flow.</li> <li>▪ Zero point is unstable. Ensure no-flow.</li> <li>▪ Fluctuation high. Avoid 2-phase medium.</li> </ul>	–
Reliability of measured zero point	Indicates the reliability of the zero point measured.	<ul style="list-style-type: none"> <li>▪ Not done</li> <li>▪ Good</li> <li>▪ Uncertain</li> </ul>	–
Additional information	Indicate whether to display additional information.	<ul style="list-style-type: none"> <li>▪ Hide</li> <li>▪ Show</li> </ul>	Hide
Zero point measured	Shows the zero point measured for the adjustment.	Signed floating-point number	–
Zero point standard deviation	Shows the standard deviation of the zero point measured.	Positive floating-point number	–
Select action	Select the zero point value to apply.	<ul style="list-style-type: none"> <li>▪ Keep current zero point</li> <li>▪ Apply zero point measured</li> <li>▪ Apply factory zero point<sup>*</sup></li> </ul>	Keep current zero point

\* Visibility depends on order options or device settings

## 10.5.4 Configuring the totalizer

In the "Totalizer 1 to n" submenu, you can configure the specific totalizer.



### Navigation

"Setup" menu → Advanced setup → Totalizer 1 to n

▶ Totalizer 1 to n	
Assign process variable	→ ⓘ 121
Unit totalizer 1 to n	→ ⓘ 121
Totalizer operation mode	→ ⓘ 121
Failure mode	→ ⓘ 121

### Parameter overview with brief description

Parameter	Prerequisite	Description	Selection	Factory setting
Assign process variable	–	Select process variable for totalizer.	<ul style="list-style-type: none"> <li>■ Off</li> <li>■ Mass flow</li> <li>■ Volume flow</li> <li>■ Corrected volume flow<sup>*</sup></li> <li>■ Target mass flow<sup>*</sup></li> <li>■ Carrier mass flow<sup>*</sup></li> <li>■ Target volume flow<sup>*</sup></li> <li>■ Carrier volume flow<sup>*</sup></li> <li>■ Target corrected volume flow<sup>*</sup></li> <li>■ Carrier corrected volume flow<sup>*</sup></li> <li>■ Raw value mass flow</li> </ul>	Mass flow
Unit totalizer 1 to n	A process variable is selected in the <b>Assign process variable</b> parameter (→ ⓘ 121) of the <b>Totalizer 1 to n</b> submenu.	Select the unit for the process variable of the totalizer.	Unit choose list	Depends on country: <ul style="list-style-type: none"> <li>■ kg</li> <li>■ lb</li> </ul>
Totalizer operation mode	A process variable is selected in the <b>Assign process variable</b> parameter (→ ⓘ 121) of the <b>Totalizer 1 to n</b> submenu.	Select totalizer calculation mode.	<ul style="list-style-type: none"> <li>■ Net</li> <li>■ Forward</li> <li>■ Reverse</li> </ul>	Net
Failure mode	A process variable is selected in the <b>Assign process variable</b> parameter (→ ⓘ 121) of the <b>Totalizer 1 to n</b> submenu.	Select totalizer behavior in the event of a device alarm.	<ul style="list-style-type: none"> <li>■ Hold</li> <li>■ Continue</li> <li>■ Last valid value + continue</li> </ul>	Hold





















\* Visibility depends on order options or device settings

### 10.5.5 Carrying out additional display configurations

In the **Display** submenu you can set all the parameters associated with the configuration of the local display.

#### Navigation

"Setup" menu → Advanced setup → Display





► Display	
Format display	→  124
Value 1 display	→  125
0% bargraph value 1	→  125
100% bargraph value 1	→  125
Decimal places 1	→  126
Value 2 display	→  126
Decimal places 2	→  126
Value 3 display	→  126
0% bargraph value 3	→  126
100% bargraph value 3	→  126
Decimal places 3	→  126
Value 4 display	→  126
Decimal places 4	→  126
Value 5 display	→  126
0% bargraph value 5	→  126
100% bargraph value 5	→  126
Decimal places 5	→  127
Value 6 display	→  127
Decimal places 6	→  127
Value 7 display	→  127

0% bargraph value 7	→ 127
100% bargraph value 7	→ 127
Decimal places 7	→ 127
Value 8 display	→ 127
Decimal places 8	→ 127
Display language	→ 128
Display interval	→ 128
Display damping	→ 128
Header	→ 128
Header text	→ 128
Separator	→ 128
Backlight	→ 128

**Parameter overview with brief description**

Parameter	Prerequisite	Description	Selection / User entry	Factory setting
Format display	A local display is provided.	Select how measured values are shown on the display.	<ul style="list-style-type: none"><li>▪ 1 value, max. size</li><li>▪ 1 bargraph + 1 value</li><li>▪ 2 values</li><li>▪ 1 value large + 2 values</li><li>▪ 4 values</li></ul>	1 value, max. size

Parameter	Prerequisite	Description	Selection / User entry	Factory setting
Value 1 display	A local display is provided.	Select the measured value that is shown on the local display.	<ul style="list-style-type: none"> <li>■ Mass flow</li> <li>■ Volume flow</li> <li>■ Corrected volume flow *</li> <li>■ Density</li> <li>■ Reference density *</li> <li>■ Temperature</li> <li>■ Pressure</li> <li>■ Totalizer 1</li> <li>■ Totalizer 2</li> <li>■ Totalizer 3</li> <li>■ Concentration *</li> <li>■ Target mass flow *</li> <li>■ Carrier mass flow *</li> <li>■ Target volume flow *</li> <li>■ Carrier volume flow *</li> <li>■ Target corrected volume flow *</li> <li>■ Carrier corrected volume flow *</li> <li>■ Application specific output 0 *</li> <li>■ Application specific output 1 *</li> <li>■ Inhomogeneous medium index</li> <li>■ Suspended bubbles index *</li> <li>■ HBSI *</li> <li>■ Raw value mass flow</li> <li>■ Exciter current 0</li> <li>■ Oscillation damping 0</li> <li>■ Oscillation damping fluctuation 0 *</li> <li>■ Oscillation frequency 0</li> <li>■ Frequency fluctuation 0 *</li> <li>■ Oscillation amplitude 0 *</li> <li>■ Signal asymmetry</li> <li>■ Torsion signal asymmetry *</li> <li>■ Carrier pipe temperature *</li> <li>■ Electronics temperature</li> <li>■ Sensor index coil asymmetry</li> <li>■ Test point 0</li> <li>■ Test point 1</li> <li>■ Current output 1</li> <li>■ Current output 2 *</li> <li>■ Current output 3 *</li> </ul>	Mass flow
0% bargraph value 1	A local display is provided.	Enter 0% value for bar graph display.	Signed floating-point number	Country-specific: <ul style="list-style-type: none"> <li>■ 0 kg/h</li> <li>■ 0 lb/min</li> </ul>
100% bargraph value 1	A local display is provided.	Enter 100% value for bar graph display.	Signed floating-point number	Depends on country and nominal diameter

Parameter	Prerequisite	Description	Selection / User entry	Factory setting
Decimal places 1	A measured value is specified in the <b>Value 1 display</b> parameter.	Select the number of decimal places for the display value.	<ul style="list-style-type: none"> <li>■ x</li> <li>■ x.x</li> <li>■ x.xx</li> <li>■ x.xxx</li> <li>■ x.xxxx</li> <li>■ x.xxxxx</li> <li>■ x.xxxxxx</li> </ul>	x.xx
Value 2 display	A local display is provided.	Select the measured value that is shown on the local display.	For the picklist, see <b>Value 1 display</b> parameter (→  108)	None
Decimal places 2	A measured value is specified in the <b>Value 2 display</b> parameter.	Select the number of decimal places for the display value.	<ul style="list-style-type: none"> <li>■ x</li> <li>■ x.x</li> <li>■ x.xx</li> <li>■ x.xxx</li> <li>■ x.xxxx</li> <li>■ x.xxxxx</li> <li>■ x.xxxxxx</li> </ul>	x.xx
Value 3 display	A local display is provided.	Select the measured value that is shown on the local display.	For the picklist, see <b>Value 1 display</b> parameter (→  108)	None
0% bargraph value 3	A selection was made in the <b>Value 3 display</b> parameter.	Enter 0% value for bar graph display.	Signed floating-point number	Country-specific: <ul style="list-style-type: none"> <li>■ 0 kg/h</li> <li>■ 0 lb/min</li> </ul>
100% bargraph value 3	A selection was made in the <b>Value 3 display</b> parameter.	Enter 100% value for bar graph display.	Signed floating-point number	0
Decimal places 3	A measured value is specified in the <b>Value 3 display</b> parameter.	Select the number of decimal places for the display value.	<ul style="list-style-type: none"> <li>■ x</li> <li>■ x.x</li> <li>■ x.xx</li> <li>■ x.xxx</li> <li>■ x.xxxx</li> <li>■ x.xxxxx</li> <li>■ x.xxxxxx</li> </ul>	x.xx
Value 4 display	A local display is provided.	Select the measured value that is shown on the local display.	For the picklist, see <b>Value 1 display</b> parameter (→  108)	None
Decimal places 4	A measured value is specified in the <b>Value 4 display</b> parameter.	Select the number of decimal places for the display value.	<ul style="list-style-type: none"> <li>■ x</li> <li>■ x.x</li> <li>■ x.xx</li> <li>■ x.xxx</li> <li>■ x.xxxx</li> <li>■ x.xxxxx</li> <li>■ x.xxxxxx</li> </ul>	x.xx
Value 5 display	A local display is provided.	Select the measured value that is shown on the local display.	For the picklist, see <b>Value 1 display</b> parameter (→  108)	None
0% bargraph value 5	An option was selected in the <b>Value 5 display</b> parameter.	Enter 0% value for bar graph display.	Signed floating-point number	Depends on country: <ul style="list-style-type: none"> <li>■ 0 kg/h</li> <li>■ 0 lb/min</li> </ul>
100% bargraph value 5	An option was selected in the <b>Value 5 display</b> parameter.	Enter 100% value for bar graph display.	Signed floating-point number	0

Parameter	Prerequisite	Description	Selection / User entry	Factory setting
Decimal places 5	A measured value is specified in the <b>Value 5 display</b> parameter.	Select the number of decimal places for the display value.	<ul style="list-style-type: none"> <li>■ x</li> <li>■ x.x</li> <li>■ x.xx</li> <li>■ x.xxx</li> <li>■ x.xxxx</li> <li>■ x.xxxxx</li> <li>■ x.xxxxxx</li> </ul>	x.xx
Value 6 display	A local display is provided.	Select the measured value that is shown on the local display.	For the picklist, see <b>Value 1 display</b> parameter (→  108)	None
Decimal places 6	A measured value is specified in the <b>Value 6 display</b> parameter.	Select the number of decimal places for the display value.	<ul style="list-style-type: none"> <li>■ x</li> <li>■ x.x</li> <li>■ x.xx</li> <li>■ x.xxx</li> <li>■ x.xxxx</li> <li>■ x.xxxxx</li> <li>■ x.xxxxxx</li> </ul>	x.xx
Value 7 display	A local display is provided.	Select the measured value that is shown on the local display.	For the picklist, see <b>Value 1 display</b> parameter (→  108)	None
0% bargraph value 7	An option was selected in the <b>Value 7 display</b> parameter.	Enter 0% value for bar graph display.	Signed floating-point number	Depends on country: <ul style="list-style-type: none"> <li>■ 0 kg/h</li> <li>■ 0 lb/min</li> </ul>
100% bargraph value 7	An option was selected in the <b>Value 7 display</b> parameter.	Enter 100% value for bar graph display.	Signed floating-point number	0
Decimal places 7	A measured value is specified in the <b>Value 7 display</b> parameter.	Select the number of decimal places for the display value.	<ul style="list-style-type: none"> <li>■ x</li> <li>■ x.x</li> <li>■ x.xx</li> <li>■ x.xxx</li> <li>■ x.xxxx</li> <li>■ x.xxxxx</li> <li>■ x.xxxxxx</li> </ul>	x.xx
Value 8 display	A local display is provided.	Select the measured value that is shown on the local display.	For the picklist, see <b>Value 1 display</b> parameter (→  108)	None
Decimal places 8	A measured value is specified in the <b>Value 8 display</b> parameter.	Select the number of decimal places for the display value.	<ul style="list-style-type: none"> <li>■ x</li> <li>■ x.x</li> <li>■ x.xx</li> <li>■ x.xxx</li> <li>■ x.xxxx</li> <li>■ x.xxxxx</li> <li>■ x.xxxxxx</li> </ul>	x.xx

Parameter	Prerequisite	Description	Selection / User entry	Factory setting
Display language	A local display is provided.	Set display language.	<ul style="list-style-type: none"> <li>▪ English</li> <li>▪ Deutsch</li> <li>▪ Français</li> <li>▪ Español</li> <li>▪ Italiano</li> <li>▪ Nederlands</li> <li>▪ Portuguesa</li> <li>▪ Polski</li> <li>▪ русский язык (Russian)</li> <li>▪ Svenska</li> <li>▪ Türkçe</li> <li>▪ 中文 (Chinese)</li> <li>▪ 日本語 (Japanese)</li> <li>▪ 한국어 (Korean)</li> <li>▪ tiếng Việt (Vietnamese)</li> <li>▪ čeština (Czech)</li> </ul>	English (alternatively, the ordered language is preset in the device)
Display interval	A local display is provided.	Set time measured values are shown on display if display alternates between values.	1 to 10 s	5 s
Display damping	A local display is provided.	Set display reaction time to fluctuations in the measured value.	0.0 to 999.9 s	0.0 s
Header	A local display is provided.	Select header contents on local display.	<ul style="list-style-type: none"> <li>▪ Device tag</li> <li>▪ Free text</li> </ul>	Device tag
Header text	The <b>Free text</b> option is selected in the <b>Header</b> parameter.	Enter display header text.	Max. 12 characters, such as letters, numbers or special characters (e.g. @, %, /)	-----
Separator	A local display is provided.	Select decimal separator for displaying numerical values.	<ul style="list-style-type: none"> <li>▪ . (point)</li> <li>▪ , (comma)</li> </ul>	. (point)
Backlight	One of the following conditions is met: <ul style="list-style-type: none"> <li>▪ Order code for "Display; operation", option <b>F</b> "4-line, illum.; touch control"</li> <li>▪ Order code for "Display; operation", option <b>G</b> "4-line, illum.; touch control +WLAN"</li> <li>▪ Order code for "Display; operation", option <b>O</b> "Remote display 4-line illuminated; 10m/30ft cable; touch control"</li> </ul>	Switch the local display backlight on and off.	<ul style="list-style-type: none"> <li>▪ Disable</li> <li>▪ Enable</li> </ul>	Enable

\* Visibility depends on order options or device settings

### 10.5.6 WLAN configuration

The **WLAN Settings** submenu guides the user systematically through all the parameters that have to be set for the WLAN configuration.



**Navigation**

"Setup" menu → Advanced setup → WLAN settings

▶ **WLAN settings**

WLAN IP address	→ ⓘ 129
Security type	→ ⓘ 129
WLAN passphrase	→ ⓘ 129
Assign SSID name	→ ⓘ 129
SSID name	→ ⓘ 129
Apply changes	→ ⓘ 129

**Parameter overview with brief description**

Parameter	Prerequisite	Description	User entry / Selection	Factory setting
WLAN IP address	–	Enter IP address of the WLAN interface of the device.	4 octet: 0 to 255 (in the particular octet)	192.168.1.212
Network security	–	Select the security type of the WLAN network.	<ul style="list-style-type: none"> <li>■ Unsecured</li> <li>■ WPA2-PSK</li> <li>■ EAP-PEAP with MSCHAPv2 *</li> <li>■ EAP-PEAP MSCHAPv2 no server authentic. *</li> <li>■ EAP-TLS *</li> </ul>	WPA2-PSK
WLAN passphrase	The <b>WPA2-PSK</b> option is selected in the <b>Security type</b> parameter.	Enter the network key (8 to 32 characters). The network key supplied with the device should be changed during commissioning for security reasons.	8 to 32-digit character string comprising numbers, letters and special characters (without spaces)	Serial number of the measuring device (e.g. L100A802000)
Assign SSID name	–	Select which name will be used for SSID: device tag or user-defined name.	<ul style="list-style-type: none"> <li>■ Device tag</li> <li>■ User-defined</li> </ul>	User-defined
SSID name	<ul style="list-style-type: none"> <li>■ The <b>User-defined</b> option is selected in the <b>Assign SSID name</b> parameter.</li> <li>■ The <b>WLAN access point</b> option is selected in the <b>WLAN mode</b> parameter.</li> </ul>	Enter the user-defined SSID name (max. 32 characters). The user-defined SSID name may only be assigned once. If the SSID name is assigned more than once, the devices can interfere with one another.	Max. 32-digit character string comprising numbers, letters and special characters	EH_device designation_last 7 digits of the serial number (e.g. EH_Promass_300_A 802000)
Apply changes	–	Use changed WLAN settings.	<ul style="list-style-type: none"> <li>■ Cancel</li> <li>■ Ok</li> </ul>	Cancel

\* Visibility depends on order options or device settings

### 10.5.7 Configuration management

After commissioning, you can save the current device configuration or restore the previous device configuration. The device configuration is managed via the **Configuration management** parameter.

**Navigation**

"Setup" menu → Advanced setup → Configuration backup

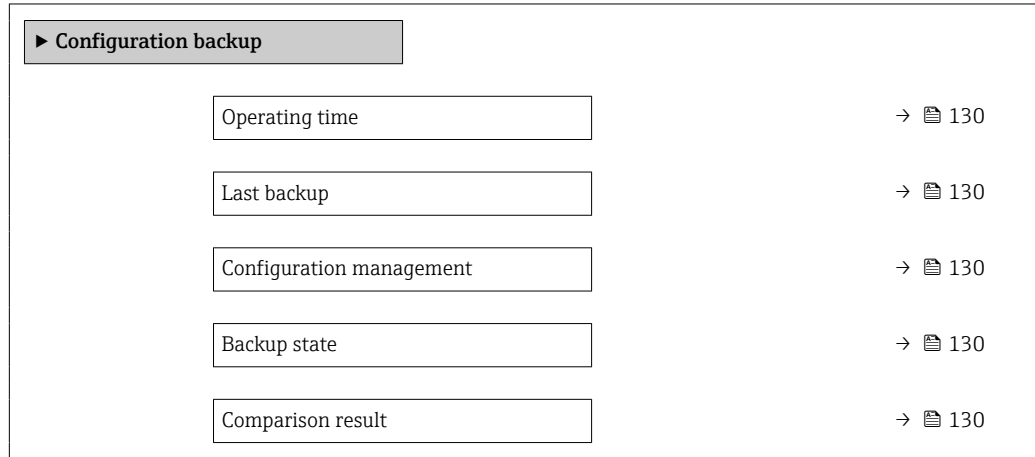

**Parameter overview with brief description**

Parameter	Description	User interface / Selection	Factory setting
Operating time	Indicates how long the device has been in operation.	Days (d), hours (h), minutes (m) and seconds (s)	–
Last backup	Shows when the last data backup was saved to HistoROM backup.	Days (d), hours (h), minutes (m) and seconds (s)	–
Configuration management	Select action for managing the device data in the HistoROM backup.	<ul style="list-style-type: none"> <li>▪ Cancel</li> <li>▪ Execute backup</li> <li>▪ Restore *</li> <li>▪ Compare *</li> <li>▪ Clear backup data</li> </ul>	Cancel
Backup state	Shows the current status of data saving or restoring.	<ul style="list-style-type: none"> <li>▪ None</li> <li>▪ Backup in progress</li> <li>▪ Restoring in progress</li> <li>▪ Delete in progress</li> <li>▪ Compare in progress</li> <li>▪ Restoring failed</li> <li>▪ Backup failed</li> </ul>	None
Comparison result	Comparison of current device data with HistoROM backup.	<ul style="list-style-type: none"> <li>▪ Settings identical</li> <li>▪ Settings not identical</li> <li>▪ No backup available</li> <li>▪ Backup settings corrupt</li> <li>▪ Check not done</li> <li>▪ Dataset incompatible</li> </ul>	Check not done

\* Visibility depends on order options or device settings

**Function scope of the "Configuration management" parameter**

Options	Description
Cancel	No action is executed and the user exits the parameter.
Execute backup	A backup copy of the current device configuration is saved from the HistoROM backup to the memory of the device. The backup copy includes the transmitter data of the device.
Restore	The last backup copy of the device configuration is restored from the device memory to the device's HistoROM backup. The backup copy includes the transmitter data of the device.
Compare	The device configuration saved in the device memory is compared with the current device configuration of the HistoROM backup.
Clear backup data	The backup copy of the device configuration is deleted from the memory of the device.

 *HistoROM backup*

A HistoROM is a "non-volatile" device memory in the form of an EEPROM.



While this action is in progress, the configuration cannot be edited via the local display and a message on the processing status appears on the display.



**10.5.8 Using parameters for device administration**

The **Administration** submenu systematically guides the user through all the parameters that can be used for device administration purposes.

**Navigation**

"Setup" menu → Advanced setup → Administration

▶ Administration

- ▶ Define access code →  131
- ▶ Reset access code →  132
- Device reset →  132



**Using the parameter to define the access code**

Complete this wizard to specify an access code for the Maintenance role.

**Navigation**

"Setup" menu → Advanced setup → Administration → Define access code

▶ Define access code

- Define access code →  132
- Confirm access code →  132

### Parameter overview with brief description

Parameter	Description	User entry
Define access code	Restrict write-access to parameters to protect the configuration of the device against unintentional changes.	Max. 16-digit character string comprising numbers, letters and special characters
Confirm access code	Confirm the entered access code.	Max. 16-digit character string comprising numbers, letters and special characters

### Using the parameter to reset the access code

#### Navigation

"Setup" menu → Advanced setup → Administration → Reset access code

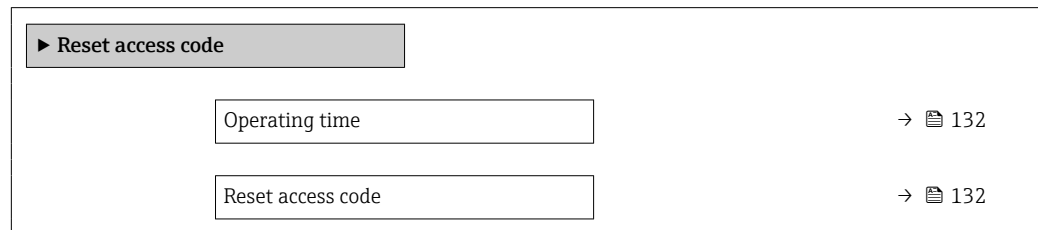

### Parameter overview with brief description

Parameter	Description	User interface / User entry	Factory setting
Operating time	Indicates how long the device has been in operation.	Days (d), hours (h), minutes (m) and seconds (s)	–
Reset access code	Reset access code to factory settings.  For a reset code, contact your Endress+Hauser service organization. The reset code can only be entered via: <ul style="list-style-type: none"> <li>▪ Web browser</li> <li>▪ DeviceCare, FieldCare (via CDI-RJ45 service interface)</li> <li>▪ Fieldbus</li> </ul>	Character string comprising numbers, letters and special characters	0x00

### Using the parameter to reset the device

#### Navigation

"Setup" menu → Advanced setup → Administration

### Parameter overview with brief description

Parameter	Description	Selection	Factory setting
Device reset	Reset the device configuration - either entirely or in part - to a defined state.	<ul style="list-style-type: none"> <li>▪ Cancel</li> <li>▪ To delivery settings</li> <li>▪ Restart device</li> <li>▪ Restore S-DAT backup *</li> </ul>	Cancel

\* Visibility depends on order options or device settings

## 10.6 Simulation

Via the **Simulation** submenu, it is possible to simulate various process variables in the process and the device alarm mode and verify downstream signal chains (switching valves



or closed-control loops). The simulation can be performed without a real measurement (no flow of medium through the device).

### Navigation

"Diagnostics" menu → Simulation

► Simulation	
Assign simulation process variable	→ 134
Process variable value	→ 134
Current output 1 to n simulation	→ 134
Current output value	→ 134
Frequency output 1 to n simulation	→ 134
Frequency output 1 to n value	→ 134
Pulse output simulation 1 to n	→ 134
Pulse value 1 to n	→ 134
Switch output simulation 1 to n	→ 134
Switch state 1 to n	→ 134
Relay output 1 to n simulation	→ 134
Switch state 1 to n	→ 134
Pulse output simulation	→ 135
Pulse value	→ 135
Device alarm simulation	→ 135
Diagnostic event category	→ 135
Diagnostic event simulation	→ 135
Current input 1 to n simulation	→ 135
Value current input 1 to n	→ 135
Status input 1 to n simulation	→ 135
Input signal level 1 to n	→ 135

## Parameter overview with brief description



Parameter	Prerequisite	Description	Selection / User entry	Factory setting
Assign simulation process variable	–	Select a process variable for the simulation process that is activated.	<ul style="list-style-type: none"> <li>▪ Off</li> <li>▪ Mass flow</li> <li>▪ Volume flow</li> <li>▪ Corrected volume flow<sup>*</sup></li> <li>▪ Target mass flow<sup>*</sup></li> <li>▪ Carrier mass flow<sup>*</sup></li> <li>▪ Target volume flow<sup>*</sup></li> <li>▪ Carrier volume flow<sup>*</sup></li> <li>▪ Target corrected volume flow<sup>*</sup></li> <li>▪ Carrier corrected volume flow<sup>*</sup></li> <li>▪ Density</li> <li>▪ Reference density<sup>*</sup></li> <li>▪ Temperature</li> <li>▪ Concentration<sup>*</sup></li> <li>▪ Time period signal frequency (TPS)<sup>*</sup></li> </ul>	Off
Process variable value	A process variable is selected in the <b>Assign simulation process variable</b> parameter (→  134).	Enter the simulation value for the selected process variable.	Depends on the process variable selected	0
Current output 1 to n simulation	–	Switch the simulation of the current output on and off.	<ul style="list-style-type: none"> <li>▪ Off</li> <li>▪ On</li> </ul>	Off
Current output value	In the <b>Current output 1 to n simulation</b> parameter, the <b>On</b> option is selected.	Enter the current value for simulation.	3.59 to 22.5 mA	3.59 mA
Frequency output 1 to n simulation	In the <b>Operating mode</b> parameter, the <b>Frequency</b> option is selected.	Switch the simulation of the frequency output on and off.	<ul style="list-style-type: none"> <li>▪ Off</li> <li>▪ On</li> </ul>	Off
Frequency output 1 to n value	In the <b>Frequency simulation 1 to n</b> parameter, the <b>On</b> option is selected.	Enter the frequency value for the simulation.	0.0 to 12 500.0 Hz	0.0 Hz
Pulse output simulation 1 to n	In the <b>Operating mode</b> parameter, the <b>Pulse</b> option is selected.	Set and switch off the pulse output simulation.  For <b>Fixed value</b> option: <b>Pulse width</b> parameter (→  96) defines the pulse width of the pulses output.	<ul style="list-style-type: none"> <li>▪ Off</li> <li>▪ Fixed value</li> <li>▪ Down-counting value</li> </ul>	Off
Pulse value 1 to n	In the <b>Pulse output simulation 1 to n</b> parameter, the <b>Down-counting value</b> option is selected.	Enter the number of pulses for simulation.	0 to 65 535	0
Switch output simulation 1 to n	In the <b>Operating mode</b> parameter, the <b>Switch</b> option is selected.	Switch the simulation of the switch output on and off.	<ul style="list-style-type: none"> <li>▪ Off</li> <li>▪ On</li> </ul>	Off
Switch state 1 to n	–	Select the status of the status output for the simulation.	<ul style="list-style-type: none"> <li>▪ Open</li> <li>▪ Closed</li> </ul>	Open
Relay output 1 to n simulation	–	Switch simulation of the relay output on and off.	<ul style="list-style-type: none"> <li>▪ Off</li> <li>▪ On</li> </ul>	Off
Switch state 1 to n	The <b>On</b> option is selected in the <b>Switch output simulation 1 to n</b> parameter parameter.	Select status of the relay output for the simulation.	<ul style="list-style-type: none"> <li>▪ Open</li> <li>▪ Closed</li> </ul>	Open

Parameter	Prerequisite	Description	Selection / User entry	Factory setting
Pulse output simulation	–	Set and switch off the pulse output simulation.  For <b>Fixed value</b> option: <b>Pulse width</b> parameter defines the pulse width of the pulses output.	<ul style="list-style-type: none"> <li>▪ Off</li> <li>▪ Fixed value</li> <li>▪ Down-counting value</li> </ul>	Off
Pulse value	In the <b>Pulse output simulation</b> parameter, the <b>Down-counting value</b> option is selected.	Set and switch off the pulse output simulation.	0 to 65 535	0
Device alarm simulation	–	Switch the device alarm on and off.	<ul style="list-style-type: none"> <li>▪ Off</li> <li>▪ On</li> </ul>	Off
Diagnostic event category	–	Select a diagnostic event category.	<ul style="list-style-type: none"> <li>▪ Sensor</li> <li>▪ Electronics</li> <li>▪ Configuration</li> <li>▪ Process</li> </ul>	Process
Diagnostic event simulation	–	Select a diagnostic event to simulate this event.	<ul style="list-style-type: none"> <li>▪ Off</li> <li>▪ Diagnostic event picklist (depends on the category selected)</li> </ul>	Off
Current input 1 to n simulation	–	Switch simulation of the current input on and off.	<ul style="list-style-type: none"> <li>▪ Off</li> <li>▪ On</li> </ul>	Off
Value current input 1 to n	In the <b>Current input 1 to n simulation</b> parameter, the <b>On</b> option is selected.	Enter the current value for simulation.	0 to 22.5 mA	0 mA
Status input 1 to n simulation	–	Switch simulation of the status input on and off.	<ul style="list-style-type: none"> <li>▪ Off</li> <li>▪ On</li> </ul>	Off
Input signal level 1 to n	In the <b>Status input simulation</b> parameter, the <b>On</b> option is selected.	Select the signal level for the simulation of the status input.	<ul style="list-style-type: none"> <li>▪ High</li> <li>▪ Low</li> </ul>	High

\* Visibility depends on order options or device settings

## 10.7 Protecting settings from unauthorized access

The following write protection options exist in order to protect the configuration of the measuring device from unintentional modification:

- Protect access to parameters via access code →  135
- Protect access to local operation via key locking →  60
- Protect access to measuring device via write protection switch →  137







### 10.7.1 Write protection via access code

The effects of the user-specific access code are as follows:

- Via local operation, the parameters for the measuring device configuration are write-protected and their values can no longer be changed.
- Device access is protected via the Web browser, as are the parameters for the measuring device configuration.
- Device access is protected via FieldCare or DeviceCare (via CDI-RJ45 service interface), as are the parameters for the measuring device configuration.

#### Defining the access code via the local display

1. Navigate to the **Define access code** parameter (→  132).





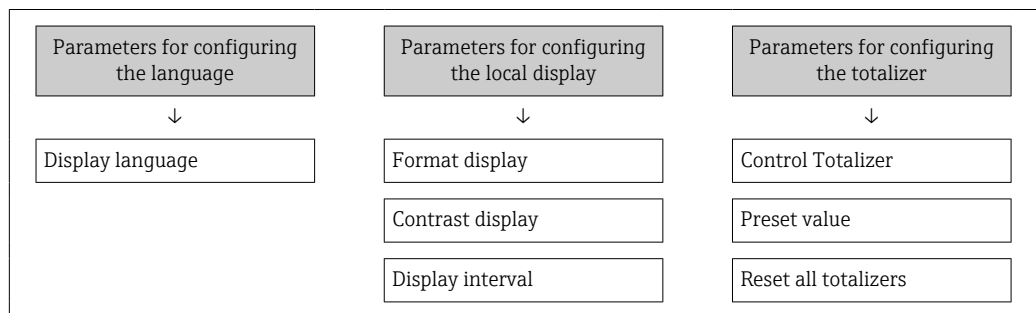

2. Maximum of 16-digit character string comprising numbers, letters and special characters as the access code.
  3. Enter the access code again in the **Confirm access code** parameter (→  132) to confirm.
    - ↳ The  symbol appears in front of all write-protected parameters.
-  ■ Disabling parameter write protection via access code →  59.
- If the access code is lost: Resetting the access code →  136.
  - The user role with which the user is currently logged in is displayed in **Access status** parameter.
    - Navigation path: Operation → Access status
    - User roles and their access rights →  59
  - The device automatically locks the write-protected parameters again if a key is not pressed for 10 minutes in the navigation and editing view.
  - The device locks the write-protected parameters automatically after 60 s if the user skips back to the operational display mode from the navigation and editing view.

### Parameters which can always be modified via the local display

Certain parameters that do not affect the measurement are excepted from parameter write protection via the local display. Despite the user-specific access code, they can always be modified, even if the other parameters are locked.



### Defining the access code via the web browser

1. Navigate to the **Define access code** parameter (→  132).
  2. Define a 16-digit (max.) numeric code as the access code.
  3. Enter the access code again in the **Confirm access code** parameter (→  132) to confirm.
    - ↳ The web browser switches to the login page.
-  ■ Disabling parameter write protection via access code →  59.
- If the access code is lost: Resetting the access code →  136.
  - The **Access status** parameter shows which user role the user is currently logged in with.
    - Navigation path: Operation → Access status
    - User roles and their access rights →  59

If no action is performed for 10 minutes, the web browser automatically returns to the login page.



### Resetting the access code

If you misplace the user-specific access code, it is possible to reset the code to the factory setting. A reset code must be entered for this purpose. The user-specific access code can then be defined again afterwards.



Via Web browser, FieldCare, DeviceCare (via CDI-RJ45 service interface), fieldbus

**i** You can only obtain a reset code from your local Endress+Hauser service organization. The code must be calculated explicitly for every device.

1. Note down the serial number of the device.
2. Read off the **Operating time** parameter.
3. Contact the local Endress+Hauser service organization and tell them the serial number and the operating time.
  - ↳ Get the calculated reset code.
4. Enter the reset code in the **Reset access code** parameter (→  132).
  - ↳ The access code has been reset to the factory setting **0000**. It can be redefined →  135.

**i** For IT security reasons, the calculated reset code is only valid for 96 hours from the specified operating time and for the specific serial number. If you cannot return to the device within 96 hours, you should either increase the operating time you read out by a few days or switch off the device.

### 10.7.2 Write protection via write protection switch

Unlike parameter write protection via a user-specific access code, this allows the user to lock write access to the entire operating menu - apart from the **"Contrast display" parameter**.

The parameter values are now read only and cannot be edited any more (exception **"Contrast display" parameter**):

- Via local display
- Via HART protocol

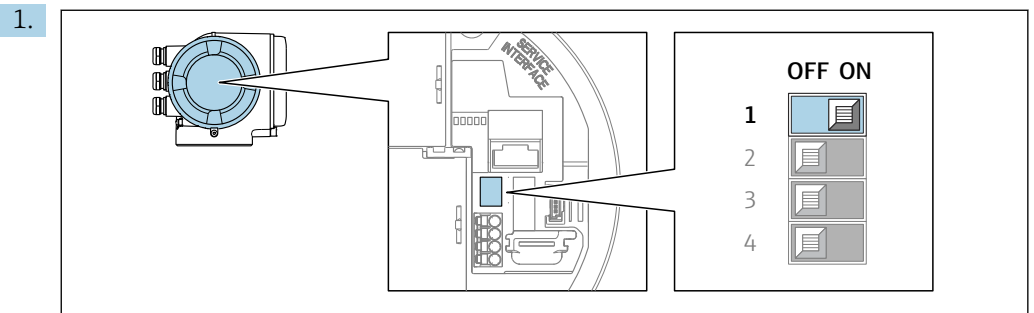



A0029630

Setting the write protection (WP) switch on the main electronics module to the **ON** position enables hardware write protection.

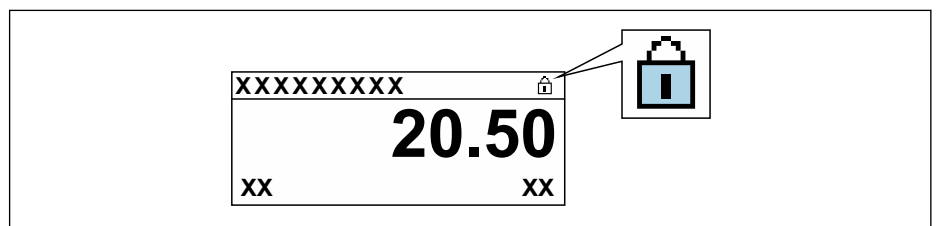
- ↳ In the **Locking status** parameter, the **Hardware locked** option is displayed →  139. In addition, on the local display the  symbol appears in front of the parameters in the header of the operational display and in the navigation view.



A0029425

2. Setting the write protection (WP) switch on the main electronics module to the **OFF** position (factory setting) disables hardware write protection.
  - ↳ No option is displayed in the **Locking status** parameter →  139. On the local display, the  symbol disappears from in front of the parameters in the header of the operational display and in the navigation view.



## 11 Operation

### 11.1 Reading off the device locking status

Device active write protection: **Locking status** parameter



Operation → Locking status

*Function scope of the "Locking status" parameter*

Options	Description
None	The access authorization displayed in the <b>Access status</b> parameter applies →  59. Only appears on local display.
Hardware locked	The DIP switch for hardware locking is activated on the PCB board. This locks write access to the parameters (e.g. via local display or operating tool) →  137.
SIL locked	The SIL mode is enabled. This locks write access to the parameters (e.g. via local display or operating tool).
Temporarily locked	Write access to the parameters is temporarily locked on account of internal processes running in the device (e.g. data upload/download, reset, etc.). Once the internal processing has been completed, the parameters can be changed once again.



### 11.2 Adjusting the operating language

 Detailed information:

- To configure the operating language →  81
- For information on the operating languages supported by the measuring device →  208

### 11.3 Configuring the display

Detailed information:





- On the basic settings for the local display →  106
- On the advanced settings for the local display →  122

### 11.4 Reading off measured values

With the **Measured values** submenu, it is possible to read all the measured values.

#### Navigation

"Diagnostics" menu → Measured values

▶ Measured values	
▶ Measured variables	→  140
▶ Input values	→  143
▶ Output values	→  144
▶ Totalizer	→  142

### 11.4.1 "Measured variables" submenu

The **Measured variables** submenu contains all the parameters needed to display the current measured values for each process variable.





#### Navigation







"Diagnostics" menu → Measured values → Measured variables

► Measured variables	
Mass flow	→ ⓘ 140
Volume flow	→ ⓘ 140
Corrected volume flow	→ ⓘ 141
Density	→ ⓘ 141
Reference density	→ ⓘ 141
Temperature	→ ⓘ 141
Pressure	→ ⓘ 141
Concentration	→ ⓘ 141
Target mass flow	→ ⓘ 141
Carrier mass flow	→ ⓘ 141
Target corrected volume flow	→ ⓘ 141
Carrier corrected volume flow	→ ⓘ 142
Target volume flow	→ ⓘ 142
Carrier volume flow	→ ⓘ 142

#### Parameter overview with brief description

Parameter	Prerequisite	Description	User interface
Mass flow	–	Displays the mass flow that is currently measured. <i>Dependency</i> The unit is taken from: <b>Mass flow unit</b> parameter (→ ⓘ 84)	Signed floating-point number
Volume flow	–	Displays the volume flow that is currently calculated. <i>Dependency</i> The unit is taken from the <b>Volume flow unit</b> parameter (→ ⓘ 84).	Signed floating-point number

Parameter	Prerequisite	Description	User interface
Corrected volume flow	–	Displays the corrected volume flow that is currently calculated. <i>Dependency</i> The unit is taken from: <b>Corrected volume flow unit</b> parameter (→ 84)	Signed floating-point number
Density	–	Shows the density currently measured. <i>Dependency</i> The unit is taken from the <b>Density unit</b> parameter (→ 84).	Signed floating-point number
Reference density	–	Displays the reference density that is currently calculated. <i>Dependency</i> The unit is taken from: <b>Reference density unit</b> parameter (→ 84)	Signed floating-point number
Temperature	–	Shows the medium temperature currently measured. <i>Dependency</i> The unit is taken from: <b>Temperature unit</b> parameter (→ 85)	Signed floating-point number
Pressure	–	Displays either a fixed or external pressure value. <i>Dependency</i> The unit is taken from the <b>Pressure unit</b> parameter (→ 85).	Signed floating-point number
Concentration	For the following order code: Order code for "Application package", option <b>ED</b> "Concentration"  The software options currently enabled are displayed in the <b>Software option overview</b> parameter.	Displays the concentration that is currently calculated. <i>Dependency</i> The unit is taken from the <b>Concentration unit</b> parameter.	Signed floating-point number
Target mass flow	With the following conditions: Order code for "Application package", option <b>ED</b> "Concentration"  The software options currently enabled are displayed in the <b>Software option overview</b> parameter.	Displays the mass flow that is currently measured for the target medium. <i>Dependency</i> The unit is taken from: <b>Mass flow unit</b> parameter (→ 84)	Signed floating-point number
Carrier mass flow	With the following conditions: Order code for "Application package", option <b>ED</b> "Concentration"  The software options currently enabled are displayed in the <b>Software option overview</b> parameter.	Displays the mass flow of the carrier medium that is currently measured. <i>Dependency</i> The unit is taken from: <b>Mass flow unit</b> parameter (→ 84)	Signed floating-point number
Target corrected volume flow	With the following conditions: <ul style="list-style-type: none"> <li>▪ Order code for "Application package", option <b>ED</b> "Concentration"</li> <li>▪ The <b>Ethanol in water</b> option or <b>%mass / %volume</b> option is selected in the <b>Liquid type</b> parameter.</li> </ul>  The software options currently enabled are displayed in the <b>Software option overview</b> parameter.	Displays the corrected volume flow that is currently measured for the target fluid. <i>Dependency</i> The unit is taken from the <b>Volume flow unit</b> parameter (→ 84).	Signed floating-point number

Parameter	Prerequisite	Description	User interface
Carrier corrected volume flow	<p>With the following conditions:</p> <ul style="list-style-type: none"> <li>Order code for "Application package", option <b>ED</b> "Concentration"</li> <li>In the <b>Liquid type</b> parameter, the <b>Ethanol in water</b> option or <b>%mass / %volume</b> option is selected.</li> </ul> <p> The software options currently enabled are displayed in the <b>Software option overview</b> parameter.</p>	<p>Displays the corrected volume flow currently measured for the carrier fluid.</p> <p><i>Dependency</i> The unit is taken from the <b>Volume flow unit</b> parameter (→  84).</p>	Signed floating-point number
Target volume flow	<p>With the following conditions:</p> <ul style="list-style-type: none"> <li>Order code for "Application package", option <b>ED</b> "Concentration"</li> <li>The <b>Ethanol in water</b> option or <b>%mass / %volume</b> option is selected in the <b>Liquid type</b> parameter.</li> <li>The <b>%vol</b> option is selected in the <b>Concentration unit</b> parameter.</li> </ul> <p> The software options currently enabled are displayed in the <b>Software option overview</b> parameter.</p>	<p>Displays the volume flow currently measured for the target medium.</p> <p><i>Dependency</i> The unit is taken from the <b>Volume flow unit</b> parameter (→  84).</p>	Signed floating-point number
Carrier volume flow	<p>With the following conditions:</p> <ul style="list-style-type: none"> <li>Order code for "Application package", option <b>ED</b> "Concentration"</li> <li>The <b>Ethanol in water</b> option or <b>%mass / %volume</b> option is selected in the <b>Liquid type</b> parameter.</li> <li>The <b>%vol</b> option is selected in the <b>Concentration unit</b> parameter.</li> </ul> <p> The software options currently enabled are displayed in the <b>Software option overview</b> parameter.</p>	<p>Displays the volume flow currently measured for the carrier medium.</p> <p><i>Dependency</i> The unit is taken from the <b>Volume flow unit</b> parameter (→  84).</p>	Signed floating-point number

### 11.4.2 "Totalizer" submenu

The **Totalizer** submenu contains all the parameters needed to display the current measured values for every totalizer.

#### Navigation

"Diagnostics" menu → Measured values → Totalizer

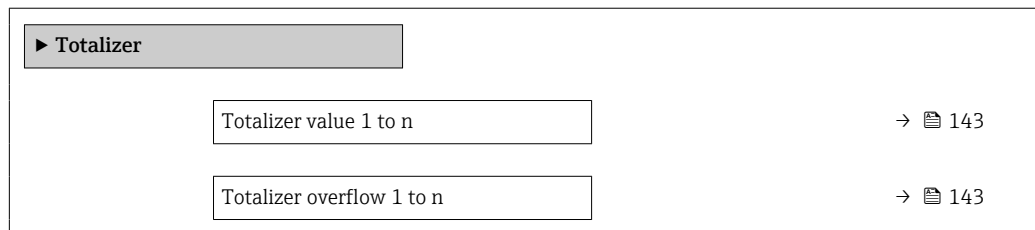

**Parameter overview with brief description**

Parameter	Prerequisite	Description	User interface
Totalizer value 1 to n	A process variable is selected in the <b>Assign process variable</b> parameter (→ 121) of the <b>Totalizer 1 to n</b> submenu.	Displays the current totalizer counter value.	Signed floating-point number
Totalizer overflow 1 to n	A process variable is selected in the <b>Assign process variable</b> parameter (→ 121) of the <b>Totalizer 1 to n</b> submenu.	Displays the current totalizer overflow.	Integer with sign

**11.4.3 "Input values" submenu**

The **Input values** submenu guides you systematically to the individual input values.

**Navigation**

"Diagnostics" menu → Measured values → Input values

▶ <b>Input values</b>	
▶ <b>Current input 1 to n</b>	→ 143
▶ <b>Status input 1 to n</b>	→ 143

**Input values of current input**

The **Current input 1 to n** submenu contains all the parameters needed to display the current measured values for every current input.

**Navigation**

"Diagnostics" menu → Measured values → Input values → Current input 1 to n

▶ <b>Current input 1 to n</b>	
Measured values 1 to n	→ 143
Measured current 1 to n	→ 143

**Parameter overview with brief description**

Parameter	Description	User interface
Measured values 1 to n	Displays the current input value.	Signed floating-point number
Measured current 1 to n	Displays the current value of the current input.	0 to 22.5 mA

**Input values of status input**

The **Status input 1 to n** submenu contains all the parameters needed to display the current measured values for every status input.

**Navigation**

"Diagnostics" menu → Measured values → Input values → Status input 1 to n

▶ Status input 1 to n

Value status input

→ ⓘ 144

**Parameter overview with brief description**

Parameter	Description	User interface
Value status input	Shows the current input signal level.	<ul style="list-style-type: none"> <li>▪ High</li> <li>▪ Low</li> </ul>

**11.4.4 Output values**

The **Output values** submenu contains all the parameters needed to display the current measured values for every output.

**Navigation**

"Diagnostics" menu → Measured values → Output values

▶ Output values

▶ Current output 1 to n

→ ⓘ 144

▶ Pulse/frequency/switch output 1 to n

→ ⓘ 145

▶ Relay output 1 to n

→ ⓘ 145

▶ Double pulse output

→ ⓘ 146

**Output values of current output**

The **Value current output** submenu contains all the parameters needed to display the current measured values for every current output.

**Navigation**

"Diagnostics" menu → Measured values → Output values → Value current output 1 to n

▶ Current output 1 to n

Output current

→ ⓘ 145

Measured current

→ ⓘ 145



**Parameter overview with brief description**

Parameter	Description	User interface
Output current	Displays the current value currently calculated for the current output.	3.59 to 22.5 mA
Measured current	Displays the current value currently measured for the current output.	0 to 30 mA

**Output values for pulse/frequency/switch output**

The **Pulse/frequency/switch output 1 to n** submenu contains all the parameters needed to display the current measured values for every pulse/frequency/switch output.

**Navigation**

"Diagnostics" menu → Measured values → Output values → Pulse/frequency/switch output 1 to n

▶ **Pulse/frequency/switch output 1 to n**

Output frequency	→ ⓘ 145
Pulse output 1 to n	→ ⓘ 145
Switch state	→ ⓘ 145

**Parameter overview with brief description**

Parameter	Prerequisite	Description	User interface
Output frequency	In the <b>Operating mode</b> parameter, the <b>Frequency</b> option is selected.	Displays the value currently measured for the frequency output.	0.0 to 12 500.0 Hz
Pulse output 1 to n	The <b>Pulse</b> option is selected in the <b>Operating mode</b> parameter parameter.	Displays the pulse frequency currently output.	Positive floating-point number
Switch state	The <b>Switch</b> option is selected in the <b>Operating mode</b> parameter.	Displays the current switch output status.	<ul style="list-style-type: none"> <li>▪ Open</li> <li>▪ Closed</li> </ul>

**Output values for relay output**

The **Relay output 1 to n** submenu contains all the parameters needed to display the current measured values for every relay output.

**Navigation**

"Diagnostics" menu → Measured values → Output values → Relay output 1 to n

▶ **Relay output 1 to n**

Switch state	→ ⓘ 146
Switch cycles	→ ⓘ 146
Max. switch cycles number	→ ⓘ 146

**Parameter overview with brief description**

Parameter	Description	User interface
Switch state	Shows the current relay switch status.	<ul style="list-style-type: none"> <li>■ Open</li> <li>■ Closed</li> </ul>
Switch cycles	Shows number of all performed switch cycles.	Positive integer
Max. switch cycles number	Shows the maximal number of guaranteed switch cycles.	Positive integer

**Output values for double pulse output**

The **Double pulse output** submenu contains all the parameters needed to display the current measured values for every double pulse output.

**Navigation**

"Diagnostics" menu → Measured values → Output values → Double pulse output

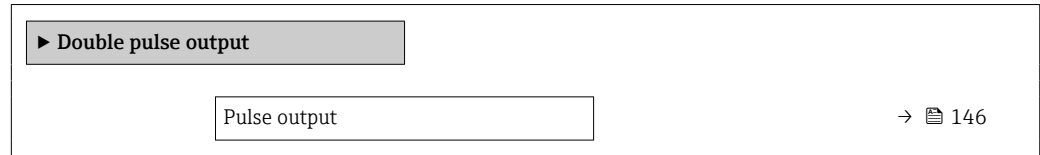

**Parameter overview with brief description**

Parameter	Description	User interface
Pulse output	Shows the currently output pulse frequency.	Positive floating-point number

## 11.5 Adapting the measuring device to the process conditions

The following are available for this purpose:

- Basic settings using the **Setup** menu (→ 📄 81)
- Advanced settings using the **Advanced setup** submenu (→ 📄 112)

## 11.6 Performing a totalizer reset

The totalizers are reset in the **Operation** submenu:

- Control Totalizer
- Reset all totalizers

**Navigation**

"Operation" menu → Totalizer handling

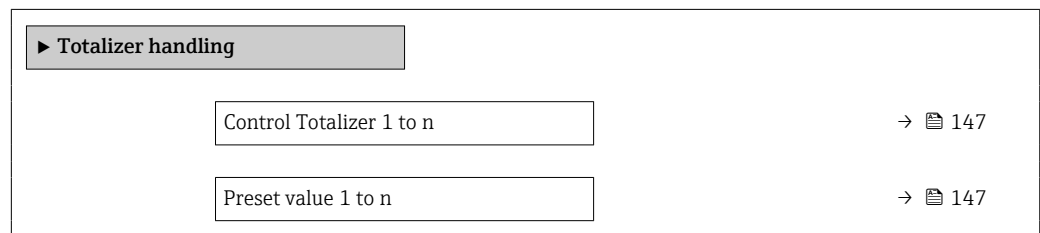

Totalizer value 1 to n	→ ⓘ 147
Reset all totalizers	→ ⓘ 147

### Parameter overview with brief description

Parameter	Prerequisite	Description	Selection / User entry / User interface	Factory setting
Control Totalizer 1 to n	A process variable is selected in the <b>Assign process variable</b> parameter (→ ⓘ 121) of the <b>Totalizer 1 to n</b> submenu.	Control totalizer value.	<ul style="list-style-type: none"> <li>■ Totalize</li> <li>■ Reset + hold *</li> <li>■ Preset + hold *</li> <li>■ Reset + totalize</li> <li>■ Preset + totalize *</li> <li>■ Hold *</li> </ul>	Totalize
Preset value 1 to n	A process variable is selected in the <b>Assign process variable</b> parameter (→ ⓘ 121) of the <b>Totalizer 1 to n</b> submenu.	Specify start value for totalizer. <i>Dependency</i>  The unit of the selected process variable is defined in the <b>Unit totalizer</b> parameter (→ ⓘ 121) for the totalizer.	Signed floating-point number	Depends on country: <ul style="list-style-type: none"> <li>■ 0 kg</li> <li>■ 0 lb</li> </ul>
Totalizer value 1 to n	A process variable is selected in the <b>Assign process variable</b> parameter (→ ⓘ 121) of the <b>Totalizer 1 to n</b> submenu.	Displays the current totalizer counter value.	Signed floating-point number	–
Reset all totalizers	–	Reset all totalizers to 0 and start.	<ul style="list-style-type: none"> <li>■ Cancel</li> <li>■ Reset + totalize</li> </ul>	Cancel

\* Visibility depends on order options or device settings

#### 11.6.1 Function scope of "Control Totalizer" parameter

Options	Description
Totalize	The totalizer is started or continues running.
Reset + hold	The totaling process is stopped and the totalizer is reset to 0.
Preset + hold <sup>1)</sup>	The totaling process is stopped and the totalizer is set to its defined start value from the <b>Preset value</b> parameter.
Reset + totalize	The totalizer is reset to 0 and the totaling process is restarted.
Preset + totalize <sup>1)</sup>	The totalizer is set to the defined start value in the <b>Preset value</b> parameter and the totaling process is restarted.
Hold	Totalizing is stopped.



1) Visible depending on the order options or device settings

#### 11.6.2 Function range of "Reset all totalizers" parameter

Options	Description
Cancel	No action is executed and the user exits the parameter.
Reset + totalize	Resets all totalizers to 0 and restarts the totaling process. This deletes all the previously aggregated flow values.

## 11.7 Displaying the measured value history

The **Extended HistoROM** application package must be enabled in the device (order option) for the **Data logging** submenu to appear. This contains all the parameters for the measured value history.

-  Data logging is also available via:
  - Plant Asset Management Tool FieldCare →  70.
  - Web browser

### Function range

- A total of 1000 measured values can be stored
- 4 logging channels
- Adjustable logging interval for data logging
- Measured value trend for each logging channel displayed in the form of a chart

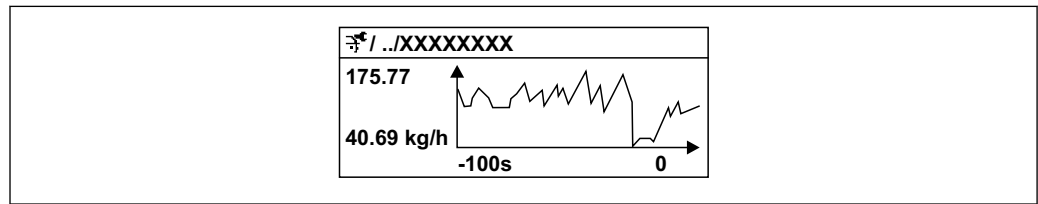

A0016357







 32 Chart of a measured value trend



- x-axis: depending on the number of channels selected displays 250 to 1000 measured values of a process variable.
  - y-axis: displays the approximate measured value span and constantly adapts this to the ongoing measurement.
-  If the length of the logging interval or the assignment of the process variables to the channels is changed, the content of the data logging is deleted.

### Navigation

"Diagnostics" menu → Data logging







▶ Data logging

Assign channel 1	→  150
Assign channel 2	→  151
Assign channel 3	→  151
Assign channel 4	→  151
Logging interval	→  151
Clear logging data	→  151
Data logging	→  151
Logging delay	→  151
Data logging control	→  151

Data logging status	→  151
Entire logging duration	→  151
▶ Display channel 1	
▶ Display channel 2	
▶ Display channel 3	
▶ Display channel 4	

Parameter overview with brief description

Parameter	Prerequisite	Description	Selection / User entry / User interface	Factory setting
Assign channel 1	The <b>Extended HistorOM</b> application package is available.	Assign process variable to logging channel.	<ul style="list-style-type: none"> <li>▪ Off</li> <li>▪ Mass flow</li> <li>▪ Volume flow</li> <li>▪ Corrected volume flow *</li> <li>▪ Density</li> <li>▪ Reference density *</li> <li>▪ Temperature</li> <li>▪ Pressure</li> <li>▪ Concentration *</li> <li>▪ Target mass flow *</li> <li>▪ Carrier mass flow *</li> <li>▪ Target volume flow *</li> <li>▪ Carrier volume flow *</li> <li>▪ Target corrected volume flow *</li> <li>▪ Carrier corrected volume flow *</li> <li>▪ Application specific output 0 *</li> <li>▪ Application specific output 1 *</li> <li>▪ Inhomogeneous medium index</li> <li>▪ Suspended bubbles index *</li> <li>▪ HBSI *</li> <li>▪ Raw value mass flow</li> <li>▪ Exciter current 0</li> <li>▪ Oscillation damping 0</li> <li>▪ Oscillation damping fluctuation 0 *</li> <li>▪ Oscillation frequency 0</li> <li>▪ Frequency fluctuation 0 *</li> <li>▪ Oscillation amplitude *</li> <li>▪ Oscillation amplitude 1 *</li> <li>▪ Signal asymmetry</li> <li>▪ Torsion signal asymmetry *</li> <li>▪ Carrier pipe temperature *</li> <li>▪ Electronics temperature</li> <li>▪ Sensor index coil asymmetry</li> <li>▪ Test point 0</li> <li>▪ Test point 1</li> <li>▪ Current output 1</li> <li>▪ Current output 2 *</li> <li>▪ Current output 3 *</li> </ul>	Off

Parameter	Prerequisite	Description	Selection / User entry / User interface	Factory setting
Assign channel 2	The <b>Extended HistoROM</b> application package is available.  The software options currently enabled are displayed in the <b>Software option overview</b> parameter.	Assign a process variable to logging channel.	For the picklist, see <b>Assign channel 1</b> parameter (→  150)	Off
Assign channel 3	The <b>Extended HistoROM</b> application package is available.  The software options currently enabled are displayed in the <b>Software option overview</b> parameter.	Assign a process variable to logging channel.	For the picklist, see <b>Assign channel 1</b> parameter (→  150)	Off
Assign channel 4	The <b>Extended HistoROM</b> application package is available.  The software options currently enabled are displayed in the <b>Software option overview</b> parameter.	Assign a process variable to logging channel.	For the picklist, see <b>Assign channel 1</b> parameter (→  150)	Off
Logging interval	The <b>Extended HistoROM</b> application package is available.	Define the logging interval for data logging. This value defines the time interval between the individual data points in the memory.	0.1 to 3 600.0 s	1.0 s
Clear logging data	The <b>Extended HistoROM</b> application package is available.	Clear the entire logging data.	<ul style="list-style-type: none"> <li>■ Cancel</li> <li>■ Clear data</li> </ul>	Cancel
Data logging	–	Select the type of data logging.	<ul style="list-style-type: none"> <li>■ Overwriting</li> <li>■ Not overwriting</li> </ul>	Overwriting
Logging delay	In the <b>Data logging</b> parameter, the <b>Not overwriting</b> option is selected.	Enter the time delay for measured value logging.	0 to 999 h	0 h
Data logging control	In the <b>Data logging</b> parameter, the <b>Not overwriting</b> option is selected.	Start and stop measured value logging.	<ul style="list-style-type: none"> <li>■ None</li> <li>■ Delete + start</li> <li>■ Stop</li> </ul>	None
Data logging status	In the <b>Data logging</b> parameter, the <b>Not overwriting</b> option is selected.	Displays the measured value logging status.	<ul style="list-style-type: none"> <li>■ Done</li> <li>■ Delay active</li> <li>■ Active</li> <li>■ Stopped</li> </ul>	Done
Entire logging duration	In the <b>Data logging</b> parameter, the <b>Not overwriting</b> option is selected.	Displays the total logging duration.	Positive floating-point number	0 s

\* Visibility depends on order options or device settings

## 11.8 Gas Fraction Handler

The Gas Fraction Handler improves measurement stability and repeatability in the event of two-phase media and provides valuable diagnostic information for the process.

The function continuously checks for the presence of gas bubbles in liquids or droplets in gases, as this second phase influences the output values for flow and density.

In the case of two-phase media, the Gas Fraction Handler stabilizes the output values and enables better readability for operators and easier interpretation by the distributed control system. The level of smoothing is adjusted according to the severity of the disturbances introduced by the second phase. In the case of single-phase media, the Gas Fraction Handler does not have any influence on the output values.

Possible options in the Gas Fraction Handler parameter:

- Off: Disables the Gas Fraction Handler. When a second phase is present, large fluctuations in the values output for flow and density will occur.
- Moderate: Use for applications with low levels or intermittent levels of second phase.
- Powerful: Use for applications with very significant levels of second phase.

The Gas Fraction Handler is cumulative to any fixed damping constants applied to flow and density that are set elsewhere in the instrument parameterization.

 For detailed information on the parameter descriptions of the Gas Fraction Handler, see the Special Documentation for the device →  218

### 11.8.1 "Measurement mode" submenu

#### Navigation

"Expert" menu → Sensor → Measurement mode

▶ Measurement mode

Gas Fraction Handler (6377)

→  152

#### Parameter overview with brief description

Parameter	Description	Selection	Factory setting
Gas Fraction Handler	Activates the Gas Fraction Handler function for two phase media.	<ul style="list-style-type: none"> <li>▪ Off</li> <li>▪ Moderate</li> <li>▪ Powerful</li> </ul>	Moderate

### 11.8.2 "Medium index" submenu

#### Navigation

"Expert" menu → Application → Medium index

▶ Medium index

Inhomogeneous medium index (6368)

→  153

Cut off inhomogeneous wet gas (6375)

→  153

Cut off inhomogeneous liquid (6374)

→  153

Suspended bubbles index (6376)

→  153

Cut off suspended bubbles (6370)

→  153



**Parameter overview with brief description**

Parameter	Prerequisite	Description	User interface / User entry	Factory setting
Inhomogeneous medium index	–	Shows the degree of inhomogeneity of the medium.	Signed floating-point number	–
Cut off inhomogeneous wet gas	–	Enter cut off value for wet gas applications. Below this value the 'Inhomogeneous medium index' is set to 0.	Positive floating-point number	0.25
Cut off inhomogeneous liquid	–	Enter cut off value for liquid applications. Below this value the 'Inhomogeneous medium index' is set to 0.	Positive floating-point number	0.05
Suspended bubbles index	The diagnostic index is only available for Promass Q.	Shows the relative amount of suspended bubbles in the medium.	Signed floating-point number	–
Cut off suspended bubbles	The parameter is only available for Promass Q.	Enter the cut off value for suspended bubbles. Below this value the 'Index for suspended bubbles' is set to 0.	Positive floating-point number	0.05

## 12 Diagnostics and troubleshooting

### 12.1 General troubleshooting







#### For local display

Error	Possible causes	Remedial action
Local display is dark, but signal output is within the valid range	The cable of the display module is not plugged in correctly.	Insert the plug correctly into the main electronics module and display module.
Local display dark and no output signals	Supply voltage does not match the voltage specified on the nameplate.	Apply the correct supply voltage → 35.
Local display dark and no output signals	Supply voltage has incorrect polarity.	Reverse polarity of supply voltage.
Local display dark and no output signals	No contact between connecting cables and terminals.	Ensure electrical contact between the cable and the terminal.
Local display dark and no output signals	<ul style="list-style-type: none"> <li>▪ Terminals are not plugged into the I/O electronics module correctly.</li> <li>▪ Terminals are not plugged into the main electronics module correctly.</li> </ul>	Check terminals.
Local display dark and no output signals	<ul style="list-style-type: none"> <li>▪ I/O electronics module is defective.</li> <li>▪ Main electronics module is defective.</li> </ul>	Order spare part → 182.
Local display cannot be read, but signal output is within the valid range	Display is set too bright or too dark.	<ul style="list-style-type: none"> <li>▪ Set the display brighter by simultaneously pressing <math>\square + \square</math>.</li> <li>▪ Set the display darker by simultaneously pressing <math>\square + \square</math>.</li> </ul>
Local display is dark, but signal output is within the valid range	Display module is defective.	Order spare part → 182.
Backlighting of local display is red	Diagnostic event with "Alarm" diagnostic behavior has occurred.	Take remedial measures → 167
Text on local display appears in a language that cannot be understood.	The selected operating language cannot be understood.	<ol style="list-style-type: none"> <li>1. Press <math>\square + \square</math> for 2 s ("home position").</li> <li>2. Press <math>\square</math>.</li> <li>3. Configure the required language in the <b>Display language</b> parameter (→ 128).</li> </ol>
Message on local display: "Communication Error" "Check Electronics"	Communication between the display module and the electronics is interrupted.	<ul style="list-style-type: none"> <li>▪ Check the cable and the connector between the main electronics module and display module.</li> <li>▪ Order spare part → 182.</li> </ul>

#### For output signals

Error	Possible causes	Remedial action
Signal output outside the valid range	Main electronics module is defective.	Order spare part → 182.
Signal output outside the valid current range (< 3.6 mA or > 22 mA)	Main electronics module is defective. I/O electronics module is defective.	Order spare part → 182.
Device shows correct value on local display, but signal output is incorrect, though in the valid range.	Parameter configuration error	Check and adjust parameter configuration.
Device measures incorrectly.	Configuration error or device is operated outside the application.	<ol style="list-style-type: none"> <li>1. Check and correct parameter configuration.</li> <li>2. Observe limit values specified in the "Technical Data".</li> </ol>

## For access

Fault	Possible causes	Remedial action
Write access to parameters is not possible.	Hardware write protection is enabled.	Set the write protection switch on the main electronics module to the <b>OFF</b> position →  137.
Write access to parameters is not possible.	Current user role has limited access authorization.	1. Check user role →  59. 2. Enter correct customer-specific access code →  59.
Connection via HART protocol is not possible.	Missing or incorrectly installed communication resistor	Install the communication resistor (250 Ω) correctly. Observe the maximum load →  190.
Connection via HART protocol is not possible.	Commubox <ul style="list-style-type: none"> <li>▪ Incorrectly connected.</li> <li>▪ Incorrectly configured.</li> <li>▪ Driver is not installed correctly.</li> <li>▪ The USB port on the PC is incorrectly configured.</li> </ul>	Refer to the documentation on Commubox FXA195 HART:  Technical Information TI00404F
Unable to connect to the web server.	Web server is disabled.	Using the "FieldCare" or "DeviceCare" operating tool, check whether the web server of the device is enabled, and enable it if necessary →  66.
	The Ethernet interface on the PC is incorrectly configured.	<ul style="list-style-type: none"> <li>▶ Check the properties of the Internet protocol (TCP/IP) →  62.</li> <li>▶ Check the network settings with the IT manager.</li> </ul>
Unable to connect to the web server.	The IP address on the PC is incorrectly configured.	Check the IP address: 192.168.1.212 →  62
Unable to connect to the web server.	WLAN access data are incorrect.	<ul style="list-style-type: none"> <li>▪ Check WLAN network status.</li> <li>▪ Log on to the device again using WLAN access data.</li> <li>▪ Check that WLAN is enabled on the measuring instrument and operating unit →  62.</li> </ul>
	WLAN communication is disabled.	–
Unable to connect to web server, FieldCare or DeviceCare.	WLAN network is not available.	<ul style="list-style-type: none"> <li>▪ Check if WLAN reception is present: LED on display module is lit blue.</li> <li>▪ Check if WLAN connection is enabled: LED on display module flashes blue.</li> <li>▪ Switch on instrument function.</li> </ul>
Network connection not present or unstable	WLAN network is weak.	<ul style="list-style-type: none"> <li>▪ Operating unit outside reception range: Check network status on operating unit.</li> <li>▪ To improve network performance, use an external WLAN antenna.</li> </ul>
	Parallel WLAN and Ethernet communication	<ul style="list-style-type: none"> <li>▪ Check network settings.</li> <li>▪ Temporarily enable only the WLAN as an interface.</li> </ul>
Web browser frozen and operation no longer possible	Data transfer is active.	Wait until data transfer or current action is finished.
	Connection lost	<ul style="list-style-type: none"> <li>▶ Check cable connection and power supply.</li> <li>▶ Refresh the web browser and restart if necessary.</li> </ul>
Display of web browser content is difficult to read or incomplete.	Web browser version used is not optimal.	<ul style="list-style-type: none"> <li>▶ Use correct web browser version →  61.</li> <li>▶ Empty the web browser cache.</li> <li>▶ Restart the web browser.</li> </ul>
	Unsuitable view settings.	Change the font size/display ratio of the Web browser.
Incomplete or no display of content in the web browser	<ul style="list-style-type: none"> <li>▪ JavaScript is not enabled.</li> <li>▪ JavaScript cannot be enabled.</li> </ul>	<ul style="list-style-type: none"> <li>▶ Enable JavaScript.</li> <li>▶ Enter http://XXX.XXX.X.XX/servlet/basic.html as the IP address.</li> </ul>

Fault	Possible causes	Remedial action
Operation with FieldCare or DeviceCare via service interface CDI-RJ45 (port 8000) is not possible.	Firewall of the PC or network is blocking communication.	Depending on the settings of the firewall used on the PC or in the network, the firewall must be adapted or disabled to allow FieldCare/ DeviceCare access.
Flashing the firmware with FieldCare or DeviceCare via service interface CDI-RJ45 (port 8000 or TFTP ports) is not possible.	Firewall of the PC or network is blocking communication.	Depending on the settings of the firewall used on the PC or in the network, the firewall must be adapted or disabled to allow FieldCare/ DeviceCare access.

## 12.2 Diagnostic information via light emitting diodes

### 12.2.1 Transmitter

Different LEDs in the transmitter provide information on the device status.

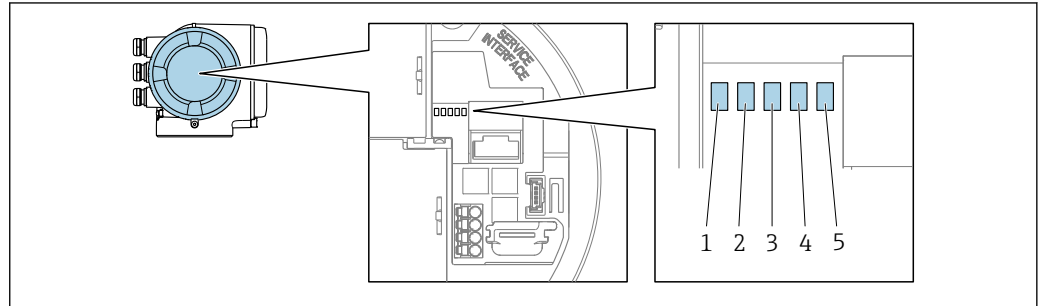

A0029629

- 1 Supply voltage
- 2 Device status
- 3 Not used
- 4 Communication
- 5 Service interface (CDI) active

LED	Color	Meaning
1 Supply voltage	Off	Supply voltage is off or too low.
	Green	Supply voltage is OK.
2 Device status (normal operation)	Off	Firmware error
	Green	Device status is OK.
	Flashing green	Device is not configured.
	Red	A diagnostic event with "Alarm" diagnostic behavior has occurred.
	Flashing red	A diagnostic event with "Warning" diagnostic behavior has occurred.
	Flashing red or green	The device restarts.
2 Device status (during start-up)	Flashes red slowly	If > 30 seconds: problem with the boot loader.
	Flashes red quickly	If > 30 seconds: compatibility problem when reading the firmware.
3 Not used	–	–
4 Communication	Off	Communication not active.
	White	Communication active.
5 Service interface (CDI)	Off	Not connected or no connection established.
	Yellow	Connected and connection established.
	Flashing yellow	Service interface active.

## 12.3 Diagnostic information on local display

### 12.3.1 Diagnostic message

Faults detected by the self-monitoring system of the measuring device are displayed as a diagnostic message in alternation with the operational display.

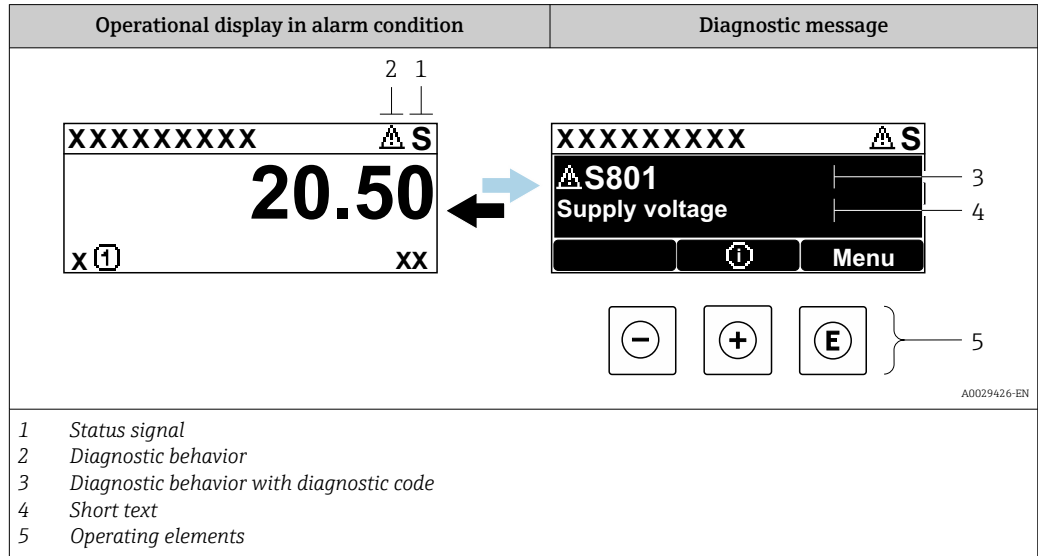

If two or more diagnostic events are pending simultaneously, only the message of the diagnostic event with the highest priority is shown.

- i** Other diagnostic events that have occurred can be displayed in the **Diagnostics** menu:
  - Via parameter → 172
  - Via submenus → 172



#### Status signals

The status signals provide information on the state and reliability of the device by categorizing the cause of the diagnostic information (diagnostic event).

- i** The status signals are categorized according to VDI/VDE 2650 and NAMUR Recommendation NE 107: F = Failure, C = Function Check, S = Out of Specification, M = Maintenance Required

Symbol	Meaning
<b>F</b>	<b>Failure</b> A device error has occurred. The measured value is no longer valid.
<b>C</b>	<b>Function check</b> The device is in service mode (e.g. during a simulation).
<b>S</b>	<b>Out of specification</b> The device is being operated: <ul style="list-style-type: none"> <li>▪ Outside its technical specification limits (e.g. outside the process temperature range)</li> <li>▪ Outside of the configuration carried out by the user (e.g. maximum flow in parameter 20 mA value)</li> </ul>
<b>M</b>	<b>Maintenance required</b> Maintenance is required. The measured value remains valid.

### Diagnostic behavior



Symbol	Meaning
	<b>Alarm</b> <ul style="list-style-type: none"> <li>Measurement is interrupted.</li> <li>Signal outputs and totalizers assume the defined alarm condition.</li> <li>A diagnostic message is generated.</li> </ul>
	<b>Warning</b> <ul style="list-style-type: none"> <li>Measurement is resumed.</li> <li>The signal outputs and totalizers are not affected.</li> <li>A diagnostic message is generated.</li> </ul>

### Diagnostic information

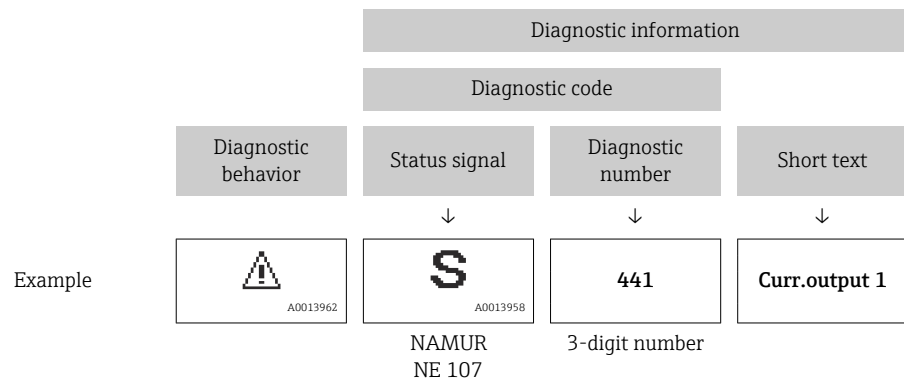
The fault can be identified using the diagnostic information. The short text helps you by providing information about the fault. In addition, the corresponding symbol for the diagnostic behavior is displayed in front of the diagnostic information on the local display.



### Operating elements

Operating key	Meaning
	<b>Plus key</b> <i>In menu, submenu</i> Opens the message about the remedial measures.
	<b>Enter key</b> <i>In menu, submenu</i> Opens the operating menu.

### 12.3.2 Calling up remedial measures

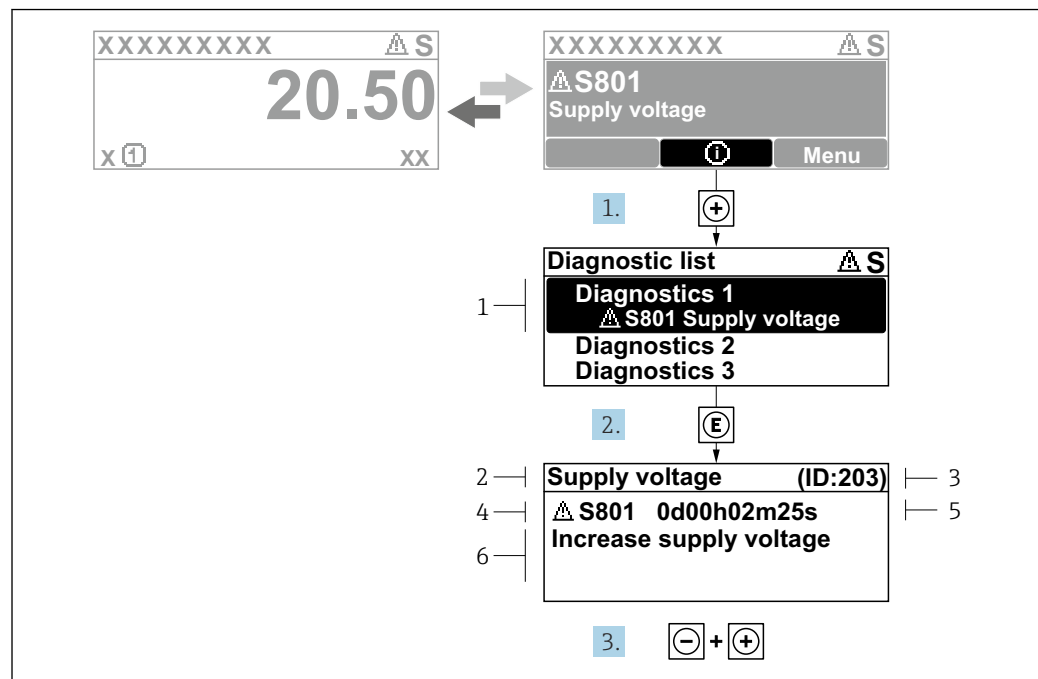

A0029431-EN

33 Message for remedial measures

- 1 Diagnostic information
- 2 Short text
- 3 Service ID
- 4 Diagnostic behavior with diagnostic code
- 5 Operation time when error occurred
- 6 Remedial measures

1. The user is in the diagnostic message.  
Press  $\oplus$  (ⓘ symbol).  
↳ The **Diagnostic list** submenu opens.
2. Select the desired diagnostic event with  $\oplus$  or  $\ominus$  and press  $\text{E}$ .  
↳ The message about the remedial measures opens.
3. Press  $\ominus + \oplus$  simultaneously.  
↳ The message about the remedial measures closes.

The user is in the **Diagnostics** menu at an entry for a diagnostics event, e.g. in the **Diagnostic list** submenu or **Previous diagnostics** parameter.

1. Press  $\text{E}$ .  
↳ The message for the remedial measures for the selected diagnostic event opens.
2. Press  $\ominus + \oplus$  simultaneously.  
↳ The message for the remedial measures closes.



## 12.4 Diagnostic information in the web browser

### 12.4.1 Diagnostic options

Any faults detected by the measuring device are displayed in the Web browser on the home page once the user has logged on.

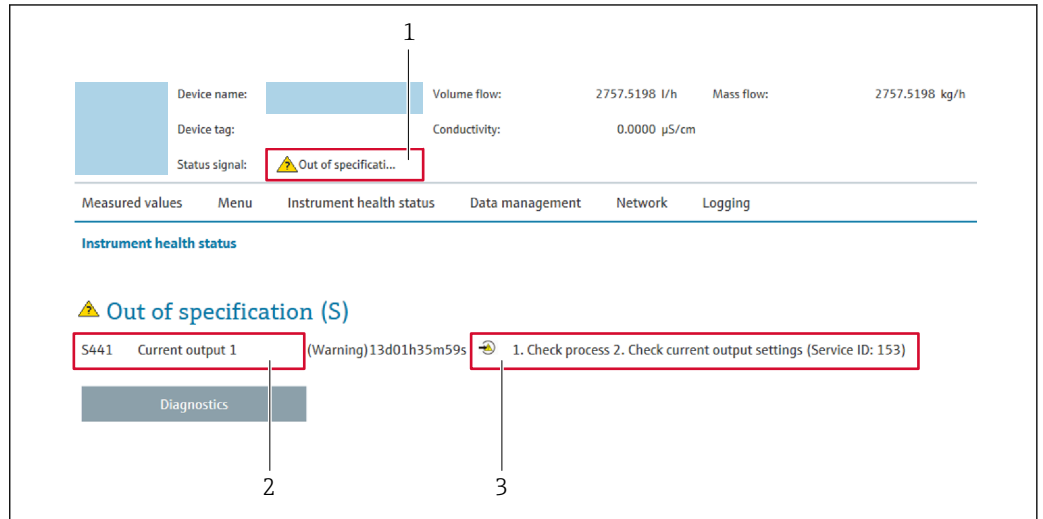

A0031056

- 1 Status area with status signal
- 2 Diagnostic information
- 3 Remedial measures with service ID

**i** In addition, diagnostic events which have occurred can be shown in the **Diagnostics** menu:

- Via parameter → 172
- Via submenu → 172

### Status signals

The status signals provide information on the state and reliability of the device by categorizing the cause of the diagnostic information (diagnostic event).

Symbol	Meaning
	<b>Failure</b> A device error has occurred. The measured value is no longer valid.
	<b>Function check</b> The device is in service mode (e.g. during a simulation).
	<b>Out of specification</b> The device is being operated: <ul style="list-style-type: none"> <li>▪ Outside its technical specification limits (e.g. outside the process temperature range)</li> <li>▪ Outside of the configuration carried out by the user (e.g. maximum flow in parameter <b>20 mA value</b>)</li> </ul>
	<b>Maintenance required</b> Maintenance is required. The measured value remains valid.

**i** The status signals are categorized in accordance with VDI/VDE 2650 and NAMUR Recommendation NE 107.

### **12.4.2 Calling up remedy information**

Remedy information is provided for every diagnostic event to ensure that problems can be rectified quickly. These measures are displayed in red along with the diagnostic event and the related diagnostic information.

## 12.5 Diagnostic information in FieldCare or DeviceCare

### 12.5.1 Diagnostic options

Any faults detected by the measuring device are displayed on the home page of the operating tool once the connection has been established.

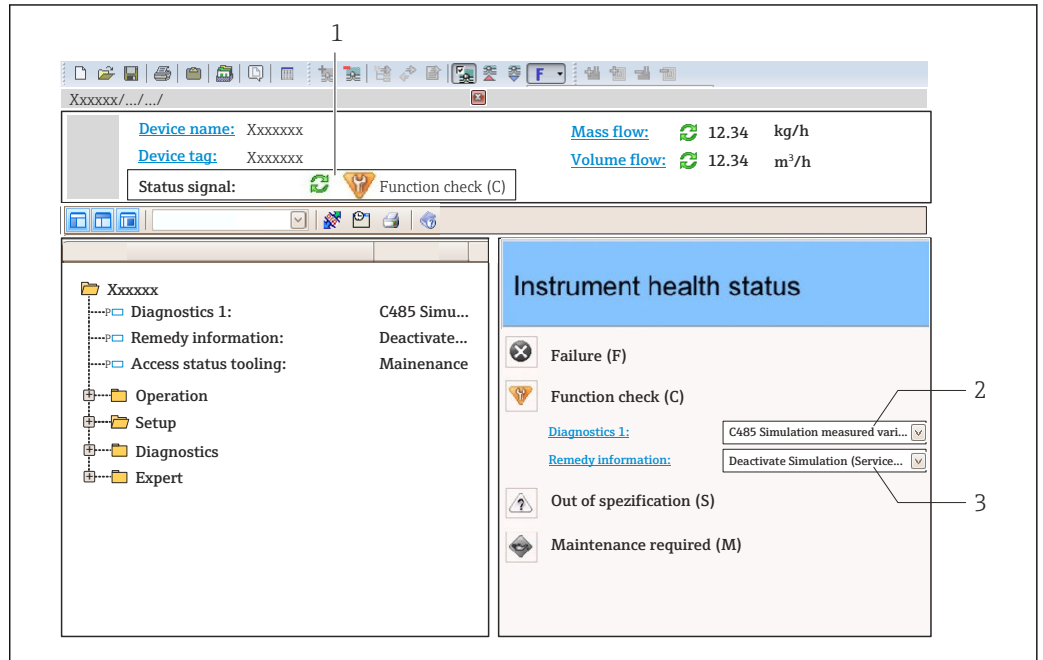

- 1 Status area with status signal → 158
- 2 Diagnostic information → 159
- 3 Remedial measures with service ID

**i** In addition, diagnostic events which have occurred can be shown in the **Diagnostics** menu:

- Via parameter → 172
- Via submenu → 172

### Diagnostic information

The fault can be identified using the diagnostic information. The short text helps you by providing information about the fault. In addition, the corresponding symbol for the diagnostic behavior is displayed in front of the diagnostic information on the local display.

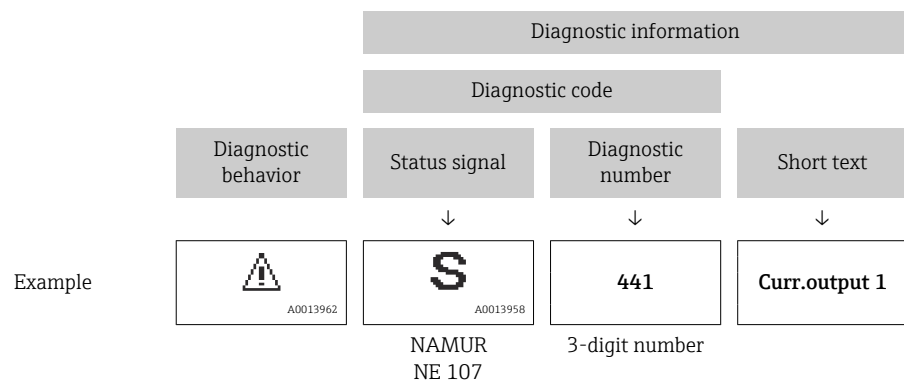

### 12.5.2 Calling up remedy information

Remedy information is provided for every diagnostic event to ensure that problems can be rectified quickly:

- On the home page  
Remedy information is displayed in a separate field below the diagnostics information.
- In the **Diagnostics** menu  
Remedy information can be called up in the working area of the user interface.

The user is in the **Diagnostics** menu.

1. Call up the desired parameter.
2. On the right in the working area, mouse over the parameter.
  - ↳ A tool tip with remedy information for the diagnostic event appears.

## 12.6 Adapting the diagnostic information

### 12.6.1 Adapting the diagnostic behavior

Each item of diagnostic information is assigned a specific diagnostic behavior at the factory. The user can change this assignment for specific diagnostic information in the **Diagnostic behavior** submenu.

Expert → System → Diagnostic handling → Diagnostic behavior

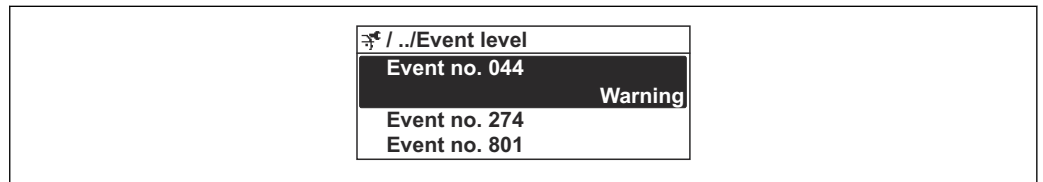

34 Using the example of the local display

A0014048-EN

You can assign the following options to the diagnostic number as the diagnostic behavior:

Options	Description
Alarm	The device stops measurement. The signal outputs and totalizers assume the defined alarm condition. A diagnostic message is generated. The background lighting changes to red.
Warning	The device continues to measure. The signal outputs and totalizers are not affected. A diagnostic message is generated.
Logbook entry only	The device continues to measure. The diagnostic message is only displayed in the <b>Event logbook</b> submenu ( <b>Event list</b> submenu) and is not displayed in alternating sequence with the operational display.
Off	The diagnostic event is ignored, and no diagnostic message is generated or entered.

### 12.6.2 Adapting the status signal

Each item of diagnostic information is assigned a specific status signal at the factory. The user can change this assignment for specific diagnostic information in the **Diagnostic event category** submenu.

Expert → Communication → Diagnostic event category

#### Available status signals



Configuration as per HART 7 Specification (Condensed Status), in accordance with NAMUR NE107.

Symbol	Meaning
<b>F</b> <small>A0013956</small>	<b>Failure</b> A device error has occurred. The measured value is no longer valid.
<b>C</b> <small>A0013959</small>	<b>Function check</b> The device is in service mode (e.g. during a simulation).
<b>S</b> <small>A0013958</small>	<b>Out of specification</b> The device is being operated: <ul style="list-style-type: none"> <li>▪ Outside its technical specification limits (e.g. outside the process temperature range)</li> <li>▪ Outside of the configuration carried out by the user (e.g. maximum flow in parameter 20 mA value)</li> </ul>

Symbol	Meaning
<b>M</b> A0013957	<b>Maintenance required</b> Maintenance is required. The measured value remains valid.
<b>N</b> A0023076	Has no effect on the condensed status.

## 12.7 Overview of diagnostic information

 The amount of diagnostic information and the number of measured variables affected increase if the measuring device has one or more application packages.

 In the case of some items of diagnostic information, the status signal and the diagnostic behavior can be changed. Change the diagnostic information →  165

Diagnostic number	Short text	Remedy instructions	Status signal [from the factory]	Diagnostic behavior [from the factory]
<b>Diagnostic of sensor</b>				
002	Sensor unknown	1. Check if the correct sensor is mounted 2. Check if the 2-D matrix code on the sensor is undamaged	F	Alarm
022	Temperature sensor defective	1. If available: Check connection cable between sensor and transmitter 2. Check or replace sensor electronic module (ISEM) 3. Replace sensor	F	Alarm
046	Sensor limit exceeded	1. Check process conditions 2. Check sensor	S	Warning <sup>1)</sup>
062	Sensor connection faulty	1. If available: Check connection cable between sensor and transmitter 2. Check or replace sensor electronic module (ISEM) 3. Replace sensor	F	Alarm
063	Exciter current faulty	1. If available: Check connection cable between sensor and transmitter 2. Check or replace sensor electronic module (ISEM) 3. Replace sensor	F	Alarm
082	Data storage inconsistent	Check module connections	F	Alarm
083	Memory content inconsistent	1. Restart device 2. Restore S-DAT data 3. Replace S-DAT	F	Alarm
119	Sensor initialization active	Sensor initialization in progress, please wait	C	Warning
140	Sensor signal asymmetrical	1. If available: Check connection cable between sensor and transmitter 2. Check or replace sensor electronic module (ISEM) 3. Replace sensor	S	Alarm <sup>1)</sup>
141	Zero adjustment failed	1. Check process conditions 2. Repeat commissioning procedure 3. Check sensor	F	Alarm
142	Sensor index coil asymmetry too high	Check sensor	S	Warning <sup>1)</sup>
144	Measurement error too high	1. Check process conditions 2. Check or change sensor	F	Alarm <sup>1)</sup>
<b>Diagnostic of electronic</b>				
201	Electronics faulty	1. Restart device 2. Replace electronics	F	Alarm
242	Firmware incompatible	1. Check firmware version 2. Flash or replace electronic module	F	Alarm

Diagnostic number	Short text	Remedy instructions	Status signal [from the factory]	Diagnostic behavior [from the factory]
252	Module incompatible	1. Check electronic modules 2. Check if correct modules are available (e.g. NEx, Ex) 3. Replace electronic modules	F	Alarm
262	Module connection interrupted	1. Check or replace connection cable between sensor electronic module (ISEM) and main electronics 2. Check or replace ISEM or main electronics	F	Alarm
270	Main electronics defective	1. Restart device 2. Replace main electronic module	F	Alarm
271	Main electronics faulty	1. Restart device 2. Replace main electronic module	F	Alarm
272	Main electronics faulty	Restart device	F	Alarm
273	Main electronics defective	1. Pay attention to display emergency operation 2. Replace main electronics	F	Alarm
275	I/O module defective	Change I/O module	F	Alarm
276	I/O module faulty	1. Restart device 2. Change I/O module	F	Alarm
283	Memory content inconsistent	Restart device	F	Alarm
302	Device verification active	Device verification active, please wait.	C	Warning <sup>1)</sup>
303	I/O 1 to n configuration changed	1. Apply I/O module configuration (parameter 'Apply I/O configuration') 2. Afterwards reload device description and check wiring	M	Warning
304	Device verification failed	1. Check verification report 2. Repeat commissioning procedure 3. Check sensor	F	Alarm <sup>1)</sup>
311	Sensor electronics (ISEM) faulty	Maintenance required! Do not reset device	M	Warning
330	Flash file invalid	1. Update firmware of device 2. Restart device	M	Warning
331	Firmware update failed	1. Update firmware of device 2. Restart device	F	Warning
332	Writing in HistoROM backup failed	1. Replace user interface board 2. Ex d/XP: replace transmitter	F	Alarm
361	I/O module 1 to n faulty	1. Restart device 2. Check electronic modules 3. Change I/O module or main electronics	F	Alarm
369	Matrix code scanner defective	Replace matrix code scanner	F	Alarm
371	Temperature sensor defective	Contact service	M	Warning
372	Sensor electronics (ISEM) faulty	1. Restart device 2. Check if failure recurs 3. Replace sensor electronic module (ISEM)	F	Alarm
373	Sensor electronics (ISEM) faulty	Transfer data or reset device	F	Alarm



Diagnostic number	Short text	Remedy instructions	Status signal [from the factory]	Diagnostic behavior [from the factory]
374	Sensor electronics (ISEM) faulty	1. Restart device 2. Check if failure recurs 3. Replace sensor electronic module (ISEM)	S	Warning <sup>1)</sup>
375	I/O- 1 to n communication failed	1. Restart device 2. Check if failure recurs 3. Replace module rack inclusive electronic modules	F	Alarm
378	Supply voltage ISEM faulty	1. If available: Check connection cable between sensor and transmitter 2. Replace main electronic module 3. Replace sensor electronic module (ISEM)	F	Alarm
382	Data storage	1. Insert T-DAT 2. Replace T-DAT	F	Alarm
383	Memory content	Reset device	F	Alarm
387	HistoROM data faulty	Contact service organization	F	Alarm
<b>Diagnostic of configuration</b>				
410	Data transfer failed	1. Retry data transfer 2. Check connection	F	Alarm
412	Processing download	Download active, please wait	C	Warning
431	Trim 1 to n required	Carry out trim	C	Warning
437	Configuration incompatible	1. Update firmware 2. Execute factory reset	F	Alarm
438	Dataset different	1. Check data set file 2. Check device parameterization 3. Download new device parameterization	M	Warning
441	Current output 1 to n faulty	1. Check process 2. Check current output settings	S	Warning <sup>1)</sup>
442	Frequency output faulty	1. Check process 2. Check frequency output settings	S	Warning <sup>1)</sup>
443	Pulse output 1 to n faulty	1. Check process 2. Check pulse output settings	S	Warning <sup>1)</sup>
444	Current input 1 to n faulty	1. Check process 2. Check current input settings	S	Warning <sup>1)</sup>
453	Flow override active	Deactivate flow override	C	Warning
484	Failure mode simulation active	Deactivate simulation	C	Alarm
485	Process variable simulation active	Deactivate simulation	C	Warning
486	Current input simulation active	Deactivate simulation	C	Warning
491	Current output 1 to n simulation active	Deactivate simulation	C	Warning
492	Frequency output simulation active	Deactivate simulation frequency output	C	Warning
493	Pulse output simulation active	Deactivate simulation pulse output	C	Warning
494	Switch output simulation active	Deactivate simulation switch output	C	Warning

Diagnostic number	Short text	Remedy instructions	Status signal [from the factory]	Diagnostic behavior [from the factory]
495	Diagnostic event simulation active	Deactivate simulation	C	Warning
496	Status input simulation active	Deactivate simulation status input	C	Warning
502	CT activation/deactivation failed	Follow the sequence of the custody transfer activation/deactivation: First authorized user login, then set the DIP switch on the main electronic module	C	Warning
520	I/O 1 to n hardware configuration invalid	1. Check I/O hardware configuration 2. Replace wrong I/O module 3. Plug the module of double pulse output on correct slot	F	Alarm
528	Concentration calculation not possible	Out of valid range of the selected calculation algorithm 1. Check concentration settings 2. Check measured values, e.g. density or temperature	S	Alarm
529	Concentration calculation not accurate	Out of valid range of the selected calculation algorithm 1. Check concentration settings 2. Check measured values, e.g. density or temperature	S	Warning
537	Configuration	1. Check IP addresses in network 2. Change IP address	F	Warning
540	Custody transfer mode failed	1. Power off device and toggle DIP switch 2. Deactivate custody transfer mode 3. Reactivate custody transfer mode 4. Check electronic components	F	Alarm
543	Double pulse output	1. Check process 2. Check pulse output settings	S	Warning <sup>1)</sup>
593	Double pulse output simulation	Deactivate simulation pulse output	C	Warning
594	Relay output simulation	Deactivate simulation switch output	C	Warning
599	Custody transfer logbook full	1. Deactivate custody transfer mode 2. Clear custody transfer logbook (all 30 entries) 3. Activate custody transfer mode	F	Warning <sup>1)</sup>
<b>Diagnostic of process</b>				
803	Loop current 1 faulty	1. Check wiring 2. Change I/O module	F	Alarm
830	Ambient temperature too high	Reduce ambient temp. around the sensor housing	S	Warning <sup>1)</sup>
831	Ambient temperature too low	Increase ambient temp. around the sensor housing	S	Warning <sup>1)</sup>
832	Electronics temperature too high	Reduce ambient temperature	S	Warning <sup>1)</sup>
833	Electronics temperature too low	Increase ambient temperature	S	Warning <sup>1)</sup>
834	Process temperature too high	Reduce process temperature	S	Warning <sup>1)</sup>
835	Process temperature too low	Increase process temperature	S	Warning <sup>1)</sup>





Diagnostic number	Short text	Remedy instructions	Status signal [from the factory]	Diagnostic behavior [from the factory]
842	Process value below limit	1. Decrease process value 2. Check application 3. Check sensor	S	Warning <sup>1)</sup>
862	Partly filled pipe	1. Check for gas in process 2. Adjust detection limits	S	Warning <sup>1)</sup>
882	Input signal faulty	1. Check input signal parameterization 2. Check external device 3. Check process conditions	F	Alarm
910	Tubes not oscillating	1. If available: Check connection cable between sensor and transmitter 2. Check or replace sensor electronic module (ISEM) 3. Check sensor	F	Alarm
912	Medium inhomogeneous	1. Check process cond. 2. Increase system pressure	S	Warning <sup>1)</sup>
913	Medium unsuitable	1. Check process conditions 2. Check electronic modules or sensor	S	Warning <sup>1)</sup>
915	Viscosity out of specification	1. Avoid 2-phase flow 2. Increase system pressure 3. Verify viscosity and density are within range 4. Check process conditions	S	Warning <sup>1)</sup>
941	API/ASTM temperature out of specification	1. Check process temperature with selected API/ASTM commodity group 2. Check API/ASTM-related parameters	S	Warning <sup>1)</sup>
942	API/ASTM density out of specification	1. Check process density with selected API/ASTM commodity group 2. Check API/ASTM-related parameters	S	Warning <sup>1)</sup>
943	API pressure out of specification	1. Check process pressure with selected API commodity group 2. Check API related parameters	S	Warning <sup>1)</sup>
944	Monitoring failed	Check process conditions for Heartbeat Monitoring	S	Warning <sup>1)</sup>
948	Oscillation damping too high	Check process conditions	S	Warning <sup>1)</sup>
984	Condensation risk	1. Decrease ambient temperature 2. Increase medium temperature	S	Warning <sup>1)</sup>



1) Diagnostic behavior can be changed.

## 12.8 Pending diagnostic events

The **Diagnostics** menu allows the user to view the current diagnostic event and the previous diagnostic event separately.

 To call up the measures to rectify a diagnostic event:

- Via local display →  160
- Via web browser →  162
- Via "FieldCare" operating tool →  164
- Via "DeviceCare" operating tool →  164

 Other pending diagnostic events can be displayed in the **Diagnostic list** submenu →  172.

### Navigation

"Diagnostics" menu

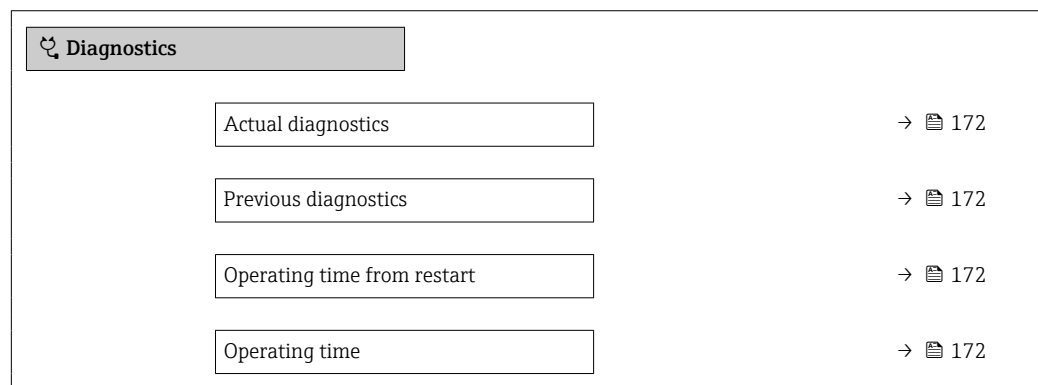

### Parameter overview with brief description

Parameter	Prerequisite	Description	User interface
Actual diagnostics	A diagnostic event has occurred.	Shows the current occurred diagnostic event along with its diagnostic information.  If two or more messages occur simultaneously, the message with the highest priority is shown on the display.	Symbol for diagnostic behavior, diagnostic code and short message.
Previous diagnostics	Two diagnostic events have already occurred.	Shows the diagnostic event that occurred prior to the current diagnostic event along with its diagnostic information.	Symbol for diagnostic behavior, diagnostic code and short message.
Operating time from restart	–	Shows the time the device has been in operation since the last device restart.	Days (d), hours (h), minutes (m) and seconds (s)
Operating time	–	Indicates how long the device has been in operation.	Days (d), hours (h), minutes (m) and seconds (s)

## 12.9 Diagnostics list

Up to 5 currently pending diagnostic events can be displayed in the **Diagnostic list** submenu along with the associated diagnostic information. If more than 5 diagnostic events are pending, the events with the highest priority are shown on the display.



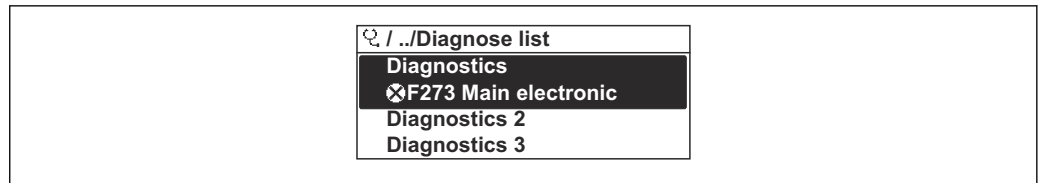

### Navigation path

Diagnostics → Diagnostic list



A0014006-EN

 35 Using the example of the local display

-  To call up the measures to rectify a diagnostic event:
- Via local display →  160
  - Via web browser →  162
  - Via "FieldCare" operating tool →  164
  - Via "DeviceCare" operating tool →  164

## 12.10 Event logbook

### 12.10.1 Reading out the event logbook

A chronological overview of the event messages that have occurred is provided in the **Events list** submenu.

#### Navigation path

Diagnostics menu → **Event logbook** submenu → Events list

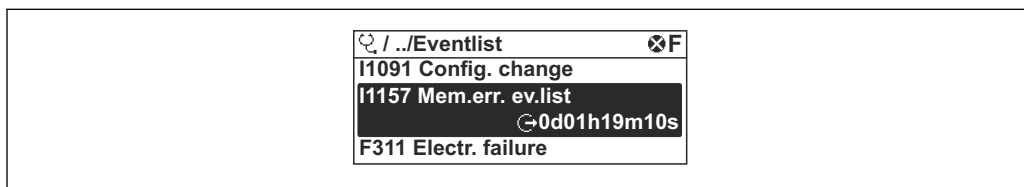



A0014008-EN

 36 Using the example of the local display

- A maximum of 20 event messages can be displayed in chronological order.
- If the **Extended HistoROM** application package (order option) is enabled in the device, the event list can contain up to 100 entries.





The event history includes entries for:

- Diagnostic events →  167
- Information events →  175

In addition to the operating time when the event occurred, each event is also assigned a symbol that indicates whether the event has occurred or is finished:

- Diagnostics event
  - ☹: Occurrence of the event
  - ⌚: End of the event
- Information event
  - ☹: Occurrence of the event

 To call up the measures to rectify a diagnostic event:

- Via local display →  160
- Via web browser →  162
- Via "FieldCare" operating tool →  164
- Via "DeviceCare" operating tool →  164

 For filtering the displayed event messages →  174

### 12.10.2 Filtering the event logbook

Using the **Filter options** parameter you can define which category of event message is displayed in the **Events list** submenu.

#### Navigation path

Diagnostics → Event logbook → Filter options

#### Filter categories

- All
- Failure (F)
- Function check (C)
- Out of specification (S)
- Maintenance required (M)
- Information (I)

### 12.10.3 Overview of information events

Unlike a diagnostic event, an information event is displayed in the event logbook only and not in the diagnostic list.

Info number	Info name
I1000	----- (Device ok)
I1079	Sensor changed
I1089	Power on
I1090	Configuration reset
I1091	Configuration changed
I1092	HistoROM backup deleted
I1111	Density adjust failure
I11280	ZeroPT verified and adjustm. recommended
I11281	ZeroPT verif. and adjust. not recommend.
I1137	Electronics changed
I1151	History reset
I1155	Reset electronics temperature
I1156	Memory error trend
I1157	Memory error event list
I1209	Density adjustment ok
I1221	Zero point adjust failure
I1222	Zero point adjustment ok
I1256	Display: access status changed
I1264	Safety sequence aborted
I1278	I/O module restarted
I1335	Firmware changed
I1361	Web server: login failed
I1397	Fieldbus: access status changed
I1398	CDI: access status changed
I1444	Device verification passed
I1445	Device verification failed
I1447	Record application reference data
I1448	Application reference data recorded
I1449	Recording application ref. data failed
I1450	Monitoring off
I1451	Monitoring on
I1457	Measurement error verification failed
I1459	I/O module verification failed
I1460	HBSI verification failed
I1461	Sensor verification failed
I1462	Sensor electronic module verif. failed
I1512	Download started
I1513	Download finished
I1514	Upload started

Info number	Info name
I1515	Upload finished
I1517	Custody transfer active
I1518	Custody transfer inactive
I1554	Safety sequence started
I1555	Safety sequence confirmed
I1556	Safety mode off
I1618	I/O module 2 replaced
I1619	I/O module 3 replaced
I1621	I/O module 4 replaced
I1622	Calibration changed
I1624	All totalizers reset
I1625	Write protection activated
I1626	Write protection deactivated
I1627	Web server: login successful
I1628	Display: login successful
I1629	CDI: login successful
I1631	Web server access changed
I1632	Display: login failed
I1633	CDI: login failed
I1634	Reset to factory settings
I1635	Reset to delivery settings
I1639	Max. switch cycles number reached
I1643	Custody transfer logbook cleared
I1649	Hardware write protection activated
I1650	Hardware write protection deactivated
I1651	Custody transfer parameter changed
I1712	New flash file received
I1725	Sensor electronic module (ISEM) changed
I1726	Configuration backup failed



## 12.11 Resetting the measuring device

The entire device configuration or some of the configuration can be reset to a defined state with the **Device reset** parameter (→  132).

### 12.11.1 Function range of "Device reset" parameter

Options	Description
Cancel	No action is executed and the user exits the parameter.
To delivery settings	Every parameter for which a customer-specific default setting was ordered is reset to the customer-specific value. All other parameters are reset to the factory setting.
Restart device	The restart resets every parameter with data stored in volatile memory (RAM) to the factory setting (e.g. measured value data). The device configuration remains unchanged.
Restore S-DAT backup	Restores the data that is saved on the S-DAT. Additional information: This function can be used to resolve the memory issue "083 Memory content inconsistent" or to restore the S-DAT data when a new S-DAT has been installed.  This option is displayed only in an alarm condition.

## 12.12 Device information

The **Device information** submenu contains all parameters that display different information for device identification.





### Navigation

"Diagnostics" menu → Device information

▶ Device information	
Device tag	→ 178
Serial number	→ 178
Firmware version	→ 178
Device name	→ 179
Manufacturer	→ 179
Order code	→ 179
Extended order code 1	→ 179
Extended order code 2	→ 179
Extended order code 3	→ 179
ENP version	→ 179
Device revision	→ 179
Device ID	→ 179
Device type	→ 179
Manufacturer ID	→ 179



### Parameter overview with brief description

Parameter	Description	User interface	Factory setting
Device tag	Shows name of measuring point.	Max. 32 characters, such as letters, numbers or special characters (e.g. @, %, /).	Promass
Serial number	Shows the serial number of the measuring device.	Max. 11-digit character string comprising letters and numbers.	–
Firmware version	Shows the device firmware version installed.	Character string in the format xx.yy.zz	–

Parameter	Description	User interface	Factory setting
Device name	Shows the name of the transmitter.  The name can be found on the nameplate of the transmitter.	Promass 300/500	–
Manufacturer	Displays the manufacturer.	Character string comprising numbers, letters and special characters	Endress+Hauser
Order code	Shows the device order code.  The order code can be found on the nameplate of the sensor and transmitter in the "Order code" field.	Character string composed of letters, numbers and certain punctuation marks (e.g. /).	–
Extended order code 1	Shows the 1st part of the extended order code.  The extended order code can also be found on the nameplate of the sensor and transmitter in the "Ext. ord. cd." field.	Character string	–
Extended order code 2	Shows the 2nd part of the extended order code.  The extended order code can also be found on the nameplate of the sensor and transmitter in the "Ext. ord. cd." field.	Character string	–
Extended order code 3	Shows the 3rd part of the extended order code.  The extended order code can also be found on the nameplate of the sensor and transmitter in the "Ext. ord. cd." field.	Character string	–
ENP version	Shows the version of the electronic nameplate (ENP).	Character string	2.02.00
Device revision	Shows the device revision with which the device is registered with the HART Communication Foundation.	2-digit hexadecimal number	7
Device ID	Shows the device ID for identifying the device in a HART network.	6-digit hexadecimal number	–
Device type	Shows the device type with which the measuring device is registered with the HART Communication Foundation.	Hexadecimal number	0x3B (for Promass 300/500)
Manufacturer ID	Shows the device's manufacturer ID registered with the HART Communication Foundation.	2-digit hexadecimal number	0x11 (for Endress+Hauser)

## 12.13 Firmware history

Release date	Firmware version	Order code for "Firmware version"	Firmware Changes	Documentation type	Documentation
08.2022	01.06.zz	Option 60	<ul style="list-style-type: none"> <li>▪ New gas type: methane with hydrogen</li> <li>▪ Eight display values on local display</li> <li>▪ Zero point verification and zero adjustment wizard</li> <li>▪ New density unit: °API</li> <li>▪ New diagnostic parameters</li> <li>▪ Additional languages for Heartbeat Technology Reports</li> </ul>	Operating instructions	BA01816D/06/EN/04.22
09.2019	01.05.zz	Option 66	<ul style="list-style-type: none"> <li>▪ Gas fraction handler Adaptive filter, gas entrainment index</li> <li>▪ Application-specific input module</li> <li>▪ Upgrading of the Petroleum application package</li> </ul>	Operating instructions	BA01816D/06/EN/02.19
05.2018	01.01.zz	Option 71	Original firmware	Operating instructions	BA01816D/06/EN/01.18

 It is possible to flash the firmware to the current version or the previous version using the service interface. For the compatibility of the firmware version, see the "Device history and compatibility" section →  180

 For the compatibility of the firmware version with the previous version, the installed device description files and operating tools, observe the information about the device in the "Manufacturer's information" document.

 The manufacturer's information is available:

- In the Download Area of the Endress+Hauser web site: [www.endress.com](http://www.endress.com) → Downloads
- Specify the following details:
  - Product root: e.g. 8A3B  
The product root is the first part of the order code: see the nameplate on the device.
  - Text search: Manufacturer's information
  - Media type: Documentation – Technical Documentation

## 12.14 Device history and compatibility

The device model is documented in the order code on the nameplate of the device (e.g. 8F3BXX-XXX...XXA1-XXXXXX).

Device model	Release	Change compared with earlier model	Compatibility with earlier model
A2	09.2019	I/O module with enhanced performance and functionality: see device firmware 01.05.zz →  180	No
A1	08.2018	–	–

## 13 Maintenance

### 13.1 Maintenance work

No special maintenance work is required.

#### 13.1.1 Exterior cleaning

When cleaning the exterior of measuring devices, always use cleaning agents that do not attack the surface of the housing or the seals.

#### 13.1.2 Internal cleaning

Observe the following points for CIP and SIP cleaning:

- Use only cleaning agents to which the process-wetted materials are adequately resistant.
- Observe the maximum permitted medium temperature for the measuring device .

### 13.2 Measuring and test equipment

Endress+Hauser offers a variety of measuring and testing equipment, such as Netilion or device tests.

 Your Endress+Hauser Sales Center can provide detailed information on the services.

List of some of the measuring and testing equipment: →  186

### 13.3 Endress+Hauser services

Endress+Hauser offers a wide variety of services for maintenance such as recalibration, maintenance service or device tests.

 Your Endress+Hauser Sales Center can provide detailed information on the services.

## 14 Repair

### 14.1 General notes

#### 14.1.1 Repair and conversion concept

The Endress+Hauser repair and conversion concept provides for the following:

- The measuring devices have a modular design.
- Spare parts are grouped into logical kits with the associated Installation Instructions.
- Repairs are carried out by Endress+Hauser Service or by appropriately trained customers.
- Certified devices can only be converted to other certified devices by Endress+Hauser Service or at the factory.

#### 14.1.2 Notes for repair and conversion



For repair and conversion of a measuring device, observe the following notes:

- ▶ Use only original Endress+Hauser spare parts.
- ▶ Carry out the repair according to the Installation Instructions.
- ▶ Observe the applicable standards, federal/national regulations, Ex documentation (XA) and certificates.
- ▶ Document all repairs and conversions and enter the details in Netilion Analytics.

### 14.2 Spare parts

*Device Viewer* ([www.endress.com/deviceviewer](http://www.endress.com/deviceviewer)):

All the spare parts for the measuring device, along with the order code, are listed here and can be ordered. If available, users can also download the associated Installation Instructions.

-  Measuring device serial number:
  - Is located on the nameplate of the device.
  - Can be read out via the **Serial number** parameter (→  178) in the **Device information** submenu.

### 14.3 Endress+Hauser services

Endress+Hauser offers a wide range of services.

-  Your Endress+Hauser Sales Center can provide detailed information on the services.

### 14.4 Return

The requirements for safe device return can vary depending on the device type and national legislation.

1. Refer to the web page for information:  
<https://www.endress.com/support/return-material>
  - ↳ Select the region.
2. If returning the device, pack the device in such a way that it is reliably protected against impact and external influences. The original packaging offers the best protection.

## 14.5 Disposal



If required by the Directive 2012/19/EU on waste electrical and electronic equipment (WEEE), the product is marked with the depicted symbol in order to minimize the disposal of WEEE as unsorted municipal waste. Do not dispose of products bearing this marking as unsorted municipal waste. Instead, return them to the manufacturer for disposal under the applicable conditions.

### 14.5.1 Removing the measuring device

1. Switch off the device.

#### **WARNING**

##### **Danger to persons from process conditions!**

- ▶ Beware of hazardous process conditions such as pressure in the measuring device, high temperatures or aggressive media.

2. Carry out the mounting and connection steps from the "Mounting the measuring device" and "Connecting the measuring device" sections in reverse order. Observe the safety instructions.

### 14.5.2 Disposing of the measuring device

#### **WARNING**

##### **Danger to personnel and environment from fluids that are hazardous to health.**

- ▶ Ensure that the measuring device and all cavities are free of fluid residues that are hazardous to health or the environment, e.g. substances that have permeated into crevices or diffused through plastic.

Observe the following notes during disposal:











- ▶ Observe valid federal/national regulations.
- ▶ Ensure proper separation and reuse of the device components.

## 15 Accessories

Various accessories, which can be ordered with the device or subsequently from Endress+Hauser, are available for the device. Detailed information on the order code in question is available from your local Endress+Hauser sales center or on the product page of the Endress+Hauser website: [www.endress.com](http://www.endress.com).



### 15.1 Device-specific accessories

#### 15.1.1 For the transmitter







Accessories	Description
Proline 300 transmitter	<p>Transmitter for replacement or storage. Use the order code to define the following specifications:</p> <ul style="list-style-type: none"> <li>▪ Approvals</li> <li>▪ Output</li> <li>▪ Input</li> <li>▪ Display/operation</li> <li>▪ Housing</li> <li>▪ Software</li> </ul> <p> Order code: 8X3BXX</p> <p> Installation Instructions EA01200D</p>
Remote display and operating module DKX001	<ul style="list-style-type: none"> <li>▪ If ordered directly with the measuring device: Order code for "Display; operation", option O "Remote display 4-line, illuminated; 10 m (30 ft) cable; touch control"</li> <li>▪ If ordered separately: <ul style="list-style-type: none"> <li>▪ Measuring device: order code for "Display; operation", option M "W/o, prepared for remote display"</li> <li>▪ DKX001: Via the separate product structure DKX001</li> </ul> </li> <li>▪ If ordered subsequently: DKX001: Via the separate product structure DKX001</li> </ul> <p><b>Mounting bracket for DKX001</b></p> <ul style="list-style-type: none"> <li>▪ If ordered directly: order code for "Accessory enclosed", option RA "Mounting bracket, pipe 1/2"</li> <li>▪ If ordered subsequently: order number: 71340960</li> </ul> <p><b>Connecting cable (replacement cable)</b> Via the separate product structure: DKX002</p> <p> Further information on display and operating module DKX001 →  209.</p> <p> Special Documentation SD01763D</p>
External WLAN antenna	<p>External WLAN antenna with 1.5 m (59.1 in) connecting cable and two angle brackets. Order code for "Accessory enclosed", option P8 "Wireless antenna wide area".</p> <p> <ul style="list-style-type: none"> <li>▪ The external WLAN antenna is not suitable for use in hygienic applications.</li> <li>▪ Additional information regarding the WLAN interface →  69.</li> </ul></p> <p> Order number: 71351317</p> <p> Installation Instructions EA01238D</p>
Weather protection cover	<p>Is used to protect the measuring device from the effects of the weather: e.g. rainwater, excess heating from direct sunlight.</p> <p> Order number: 71343505</p> <p> Installation Instructions EA01160D</p>





### 15.1.2 For the sensor

Accessories	Description
Heating jacket	<p>Is used to stabilize the temperature of the fluids in the sensor. Water, water vapor and other non-corrosive liquids are permitted for use as fluids.</p> <p> If using oil as a heating medium, please consult with Endress+Hauser.</p> <ul style="list-style-type: none"> <li>▪ If ordered together with the measuring device:           <ul style="list-style-type: none"> <li>Order code for "Accessory enclosed"</li> <li>▪ Option RB "Heating jacket, G 1/2" female thread"</li> <li>▪ Option RD "Heating jacket, NPT 1/2" female thread"</li> </ul> </li> <li>▪ If ordered subsequently:           <ul style="list-style-type: none"> <li>Use the order code with the product root DK8003.</li> </ul> </li> </ul> <p> Special Documentation SD02173D</p>
Sensor holder	<p>For wall, tabletop and pipe mounting.</p> <p> Order number: 71392563</p>





## 15.2 Communication-specific accessories

Accessories	Description
Commubox FXA195 HART	<p>For intrinsically safe HART communication with FieldCare via the USB port.</p> <p> Technical Information TI00404F</p>
HART loop converter HMX50	<p>Is used to evaluate and convert dynamic HART process variables to analog current signals or limit values.</p> <p> <ul style="list-style-type: none"> <li>▪ Technical Information TI00429F</li> <li>▪ Operating Instructions BA00371F</li> </ul> </p>
Fieldgate FXA42	<p>Transmission of the measured values of connected 4 to 20 mA analog measuring instruments, as well as digital measuring instruments</p> <p> <ul style="list-style-type: none"> <li>▪ Technical Information TI01297S</li> <li>▪ Operating Instructions BA01778S</li> <li>▪ Product page: <a href="http://www.endress.com/fxa42">www.endress.com/fxa42</a></li> </ul> </p>
Field Xpert SMT50	<p>The Field Xpert SMT50 tablet PC for device configuration enables mobile plant asset management in the non-hazardous areas. It is suitable for commissioning and maintenance staff to manage field instruments with a digital communication interface and to record progress.</p> <p>This tablet PC is designed as an all-in-one solution with a preinstalled driver library and is an easy-to-use, touch-sensitive tool which can be used to manage field instruments throughout their entire life cycle.</p> <p> <ul style="list-style-type: none"> <li>▪ Technical Information TI01555S</li> <li>▪ Operating Instructions BA02053S</li> <li>▪ Product page: <a href="http://www.endress.com/smt50">www.endress.com/smt50</a></li> </ul> </p>
Field Xpert SMT70	<p>The Field Xpert SMT70 tablet PC for device configuration enables mobile plant asset management in hazardous and non-hazardous areas. It is suitable for commissioning and maintenance staff to manage field instruments with a digital communication interface and to record progress.</p> <p>This tablet PC is designed as an all-in-one solution with a preinstalled driver library and is an easy-to-use, touch-sensitive tool which can be used to manage the field instruments throughout their entire life cycle.</p> <p> <ul style="list-style-type: none"> <li>▪ Technical Information TI01342S</li> <li>▪ Operating Instructions BA01709S</li> <li>▪ Product page: <a href="http://www.endress.com/smt70">www.endress.com/smt70</a></li> </ul> </p>
Field Xpert SMT77	<p>The Field Xpert SMT77 tablet PC for device configuration enables mobile plant asset management in areas categorized as Ex Zone 1.</p> <p> <ul style="list-style-type: none"> <li>▪ Technical Information TI01418S</li> <li>▪ Operating Instructions BA01923S</li> <li>▪ Product page: <a href="http://www.endress.com/smt77">www.endress.com/smt77</a></li> </ul> </p>

## 15.3 Service-specific accessories

Accessories	Description
Applicator	<p>Software for selecting and sizing Endress+Hauser measuring instruments:</p> <ul style="list-style-type: none"> <li>Choice of measuring instruments for industrial requirements</li> <li>Calculation of all the necessary data for identifying the optimum flowmeter: e.g. nominal diameter, pressure loss, flow velocity and measurement accuracy.</li> <li>Graphic display of the calculation results</li> <li>Determination of the partial order code, administration, documentation and access to all project-related data and parameters over the entire life cycle of a project.</li> </ul> <p>Applicator is available: Via the Internet: <a href="https://portal.endress.com/webapp/applicator">https://portal.endress.com/webapp/applicator</a></p>
Netilion	<p>IIoT ecosystem: Unlock knowledge</p> <p>With the Netilion IIoT ecosystem, Endress+Hauser allows you to optimize your plant performance, digitize workflows, share knowledge, and enhance collaboration.</p> <p>Drawing upon decades of experience in process automation, Endress+Hauser offers the process industry an IIoT ecosystem designed to effortlessly extract insights from data. These insights allow process optimization, leading to increased plant availability, efficiency, and reliability - ultimately resulting in a more profitable plant.</p> <p><a href="http://www.netilion.endress.com">www.netilion.endress.com</a></p>
FieldCare	<p>FDT-based plant asset management tool from Endress+Hauser. It can configure all intelligent field units in your system and helps you manage them. By using the status information, it is also a simple but effective way of checking their status and condition.</p> <p> Operating Instructions BA00027S and BA00059S</p>
DeviceCare	<p>Tool to connect and configure Endress+Hauser field devices.</p> <p> Innovation brochure IN01047S</p>

## 15.4 System components

Accessories	Description
Memograph M graphic data manager	<p>The Memograph M graphic data manager provides information on all the relevant measured variables. Measured values are recorded correctly, limit values are monitored and measuring points analyzed. The data are stored in the 256 MB internal memory and also on a SD card or USB stick.</p> <p> <ul style="list-style-type: none"> <li>Technical Information TI00133R</li> <li>Operating Instructions BA00247R</li> </ul> </p>
Cerabar M	<p>The pressure transmitter for measuring the absolute and gauge pressure of gases, steam and liquids. It can be used to read in the operating pressure value.</p> <p> <ul style="list-style-type: none"> <li>Technical Information TI00426P and TI00436P</li> <li>Operating Instructions BA00200P and BA00382P</li> </ul> </p>
Cerabar S	<p>The pressure transmitter for measuring the absolute and gauge pressure of gases, steam and liquids. It can be used to read in the operating pressure value.</p> <p> <ul style="list-style-type: none"> <li>Technical Information TI00383P</li> <li>Operating Instructions BA00271P</li> </ul> </p>
iTEMP	<p>The temperature transmitters can be used in all applications and are suitable for the measurement of gases, steam and liquids. They can be used to read in the medium temperature.</p> <p> "Fields of Activity" document FA00006T</p>

## 16 Technical data

### 16.1 Application

The measuring device is intended only for the flow measurement of liquids and gases.

Depending on the version ordered, the measuring device can also measure potentially explosive, flammable, poisonous and oxidizing media.

To ensure that the device remains in proper operating condition for its service life, use the measuring device only for media against which the process-wetted materials are sufficiently resistant.

### 16.2 Function and system design

---

Measuring principle	Mass flow measurement based on the Coriolis measuring principle
Measuring system	<p>The device consists of a transmitter and a sensor.</p> <p>The device is available as a compact version: The transmitter and sensor form a mechanical unit.</p> <p>For information on the structure of the measuring instrument →  14</p>

## 16.3 Input

Measured variable

### Direct measured variables

- Mass flow
- Density
- Temperature

### Calculated measured variables

- Volume flow
- Corrected volume flow
- Reference density

Measuring range

### Measuring range for liquids

DN		Measuring range full scale values $\dot{m}_{\min(F)}$ to $\dot{m}_{\max(F)}$	
[mm]	[in]	[kg/h]	[lb/min]
1	$\frac{1}{24}$	0 to 20	0 to 0.735
2	$\frac{1}{12}$	0 to 100	0 to 3.675
4	$\frac{1}{6}$	0 to 450	0 to 16.54



### Measuring range for gases

The full scale value depends on the density and the sound velocity of the gas used. The full scale value can be calculated with the following formulas:

$$\dot{m}_{\max(G)} = (\rho_G \cdot (c_G/m) \cdot d_i^2 \cdot (\pi/4) \cdot 3600 \cdot n)$$

$\dot{m}_{\max(G)}$	Maximum full scale value for gas [kg/h]
$\rho_G$	Gas density in [kg/m <sup>3</sup> ] at operating conditions
$c_G$	Sound velocity (gas) [m/s]
$d_i$	Measuring tube internal diameter [m]
$\pi$	Pi
$n = 1$	Number of measuring tubes
$m = 2$	For all gases except pure H <sub>2</sub> and He gas
$m = 3$	For pure H <sub>2</sub> and He gas

### Recommended measuring range

 Flow limit →  204

Operable flow range

Over 1000 : 1.



Flow rates above the preset full scale value do not override the electronics unit, with the result that the totalizer values are registered correctly.

## Input signal

**External measured values**

To increase the measurement accuracy of certain measured variables or to calculate the corrected volume flow for gases, the automation system can continuously write different measured values to the measuring instrument:

- Operating pressure to increase measurement accuracy (Endress+Hauser recommends the use of a pressure measuring device for absolute pressure, e.g. Cerabar M or Cerabar S)
- Medium temperature to increase measurement accuracy (e.g. iTEMP)
- Reference density for calculating the corrected volume flow for gases

 Various pressure and temperature measuring devices can be ordered from Endress +Hauser: see "Accessories" section →  186

It is recommended to read in external measured values to calculate the corrected volume flow.

*HART protocol*

The measured values are written from the automation system to the measuring device via the HART protocol. The pressure transmitter must support the following protocol-specific functions:

- HART protocol
- Burst mode

*Current input*

The measured values are written from the automation system to the measuring device via the current input →  189.

**Current input 0/4 to 20 mA**

<b>Current input</b>	0/4 to 20 mA (active/passive)
<b>Current span</b>	<ul style="list-style-type: none"> <li>■ 4 to 20 mA (active)</li> <li>■ 0/4 to 20 mA (passive)</li> </ul>
<b>Resolution</b>	1 µA
<b>Voltage drop</b>	Typically: 0.6 to 2 V for 3.6 to 22 mA (passive)
<b>Maximum input voltage</b>	≤ 30 V (passive)
<b>Open-circuit voltage</b>	≤ 28.8 V (active)
<b>Possible input variables</b>	<ul style="list-style-type: none"> <li>■ Pressure</li> <li>■ Temperature</li> <li>■ Density</li> </ul>

**Status input**

<b>Maximum input values</b>	<ul style="list-style-type: none"> <li>■ DC -3 to 30 V</li> <li>■ If status input is active (ON): <math>R_i &gt; 3 \text{ k}\Omega</math></li> </ul>
<b>Response time</b>	Configurable: 5 to 200 ms
<b>Input signal level</b>	<ul style="list-style-type: none"> <li>■ Low signal: DC -3 to +5 V</li> <li>■ High signal: DC 12 to 30 V</li> </ul>
<b>Assignable functions</b>	<ul style="list-style-type: none"> <li>■ Off</li> <li>■ Reset the individual totalizers separately</li> <li>■ Reset all totalizers</li> <li>■ Flow override</li> </ul>

## 16.4 Output

Output signal

### Current output 4 to 20 mA HART

<b>Order code</b>	"Output; input 1" (20): Option BA: current output 4 to 20 mA HART
<b>Signal mode</b>	Can be set to: <ul style="list-style-type: none"> <li>■ Active</li> <li>■ Passive</li> </ul>
<b>Current range</b>	Can be set to: <ul style="list-style-type: none"> <li>■ 4 to 20 mA NAMUR</li> <li>■ 4 to 20 mA US</li> <li>■ 4 to 20 mA</li> <li>■ 0 to 20 mA (only if the signal mode is active)</li> <li>■ Fixed current</li> </ul>
<b>Open-circuit voltage</b>	DC 28.8 V (active)
<b>Maximum input voltage</b>	DC 30 V (passive)
<b>Load</b>	250 to 700 Ω
<b>Resolution</b>	0.38 μA
<b>Damping</b>	Configurable: 0 to 999.9 s
<b>Assignable measured variables</b>	<ul style="list-style-type: none"> <li>■ Mass flow</li> <li>■ Volume flow</li> <li>■ Corrected volume flow</li> <li>■ Density</li> <li>■ Reference density</li> <li>■ Temperature</li> <li>■ Electronics temperature</li> <li>■ Oscillation frequency 0</li> <li>■ Oscillation damping 0</li> <li>■ Signal asymmetry</li> <li>■ Exciter current 0</li> </ul> <p> The range of options increases if the measuring device has one or more application packages.</p>

### Current output 4 to 20 mA HART Ex i

<b>Order code</b>	"Output; input 1" (20) choose from: <ul style="list-style-type: none"> <li>■ Option CA: current output 4 to 20 mA HART Ex i passive</li> <li>■ Option CC: current output 4 to 20 mA HART Ex i active</li> </ul>
<b>Signal mode</b>	Depends on the selected order version.
<b>Current range</b>	Can be set to: <ul style="list-style-type: none"> <li>■ 4 to 20 mA NAMUR</li> <li>■ 4 to 20 mA US</li> <li>■ 4 to 20 mA</li> <li>■ 0 to 20 mA (only if the signal mode is active)</li> <li>■ Fixed current</li> </ul>
<b>Open-circuit voltage</b>	DC 21.8 V (active)
<b>Maximum input voltage</b>	DC 30 V (passive)
<b>Load</b>	<ul style="list-style-type: none"> <li>■ 250 to 400 Ω (active)</li> <li>■ 250 to 700 Ω (passive)</li> </ul>
<b>Resolution</b>	0.38 μA

<b>Damping</b>	Configurable: 0 to 999.9 s
<b>Assignable measured variables</b>	<ul style="list-style-type: none"> <li>▪ Mass flow</li> <li>▪ Volume flow</li> <li>▪ Corrected volume flow</li> <li>▪ Density</li> <li>▪ Reference density</li> <li>▪ Temperature</li> <li>▪ Electronics temperature</li> <li>▪ Oscillation frequency 0</li> <li>▪ Oscillation damping 0</li> <li>▪ Signal asymmetry</li> <li>▪ Exciter current 0</li> </ul> <p> The range of options increases if the measuring device has one or more application packages.</p>

### Current output 4 to 20 mA



<b>Order code</b>	"Output; input 2" (21), "Output; input 3" (022): Option B: current output 4 to 20 mA
<b>Signal mode</b>	Can be set to: <ul style="list-style-type: none"> <li>▪ Active</li> <li>▪ Passive</li> </ul>
<b>Current range</b>	Can be set to: <ul style="list-style-type: none"> <li>▪ 4 to 20 mA NAMUR</li> <li>▪ 4 to 20 mA US</li> <li>▪ 4 to 20 mA</li> <li>▪ 0 to 20 mA (only if the signal mode is active)</li> <li>▪ Fixed current</li> </ul>
<b>Maximum output values</b>	22.5 mA
<b>Open-circuit voltage</b>	DC 28.8 V (active)
<b>Maximum input voltage</b>	DC 30 V (passive)
<b>Load</b>	0 to 700 Ω
<b>Resolution</b>	0.38 μA
<b>Damping</b>	Configurable: 0 to 999.9 s
<b>Assignable measured variables</b>	<ul style="list-style-type: none"> <li>▪ Mass flow</li> <li>▪ Volume flow</li> <li>▪ Corrected volume flow</li> <li>▪ Density</li> <li>▪ Reference density</li> <li>▪ Temperature</li> <li>▪ Electronics temperature</li> <li>▪ Oscillation frequency 0</li> <li>▪ Oscillation damping 0</li> <li>▪ Signal asymmetry</li> <li>▪ Exciter current 0</li> </ul> <p> The range of options increases if the measuring device has one or more application packages.</p>

### Current output 4 to 20 mA Ex i passive



<b>Order code</b>	"Output; input 2" (21), "Output; input 3" (022): Option C: current output 4 to 20 mA Ex i passive
<b>Signal mode</b>	Passive
<b>Current range</b>	Can be set to: <ul style="list-style-type: none"> <li>▪ 4 to 20 mA NAMUR</li> <li>▪ 4 to 20 mA US</li> <li>▪ 4 to 20 mA</li> <li>▪ Fixed current</li> </ul>

<b>Maximum output values</b>	22.5 mA
<b>Maximum input voltage</b>	DC 30 V
<b>Load</b>	0 to 700 Ω
<b>Resolution</b>	0.38 µA
<b>Damping</b>	Configurable: 0 to 999 s
<b>Assignable measured variables</b>	<ul style="list-style-type: none"> <li>▪ Mass flow</li> <li>▪ Volume flow</li> <li>▪ Corrected volume flow</li> <li>▪ Density</li> <li>▪ Reference density</li> <li>▪ Temperature</li> <li>▪ Electronics temperature</li> <li>▪ Oscillation frequency 0</li> <li>▪ Oscillation damping 0</li> <li>▪ Signal asymmetry</li> <li>▪ Exciter current 0</li> </ul> <p> The range of options increases if the measuring device has one or more application packages.</p>

### Pulse/frequency/switch output

<b>Function</b>	Can be configured as pulse, frequency or switch output
<b>Version</b>	Open collector Can be set to: <ul style="list-style-type: none"> <li>▪ Active</li> <li>▪ Passive</li> <li>▪ Passive NAMUR</li> </ul> <p> Ex-i, passive</p>
<b>Maximum input values</b>	DC 30 V, 250 mA (passive)
<b>Open-circuit voltage</b>	DC 28.8 V (active)
<b>Voltage drop</b>	For 22.5 mA: ≤ DC 2 V
<b>Pulse output</b>	
<b>Maximum input values</b>	DC 30 V, 250 mA (passive)
<b>Maximum output current</b>	22.5 mA (active)
<b>Open-circuit voltage</b>	DC 28.8 V (active)
<b>Pulse width</b>	Configurable: 0.05 to 2 000 ms
<b>Maximum pulse rate</b>	10 000 Impulse/s
<b>Pulse value</b>	Configurable
<b>Assignable measured variables</b>	<ul style="list-style-type: none"> <li>▪ Mass flow</li> <li>▪ Volume flow</li> <li>▪ Corrected volume flow</li> </ul> <p> The range of options increases if the measuring device has one or more application packages.</p>
<b>Frequency output</b>	
<b>Maximum input values</b>	DC 30 V, 250 mA (passive)
<b>Maximum output current</b>	22.5 mA (active)
<b>Open-circuit voltage</b>	DC 28.8 V (active)
<b>Output frequency</b>	Configurable: end value frequency 2 to 10 000 Hz (f <sub>max</sub> = 12 500 Hz)
<b>Damping</b>	Configurable: 0 to 999.9 s
<b>Pulse/pause ratio</b>	1:1



<b>Assignable measured variables</b>	<ul style="list-style-type: none"> <li>▪ Mass flow</li> <li>▪ Volume flow</li> <li>▪ Corrected volume flow</li> <li>▪ Density</li> <li>▪ Reference density</li> <li>▪ Temperature</li> <li>▪ Electronics temperature</li> <li>▪ Oscillation frequency 0</li> <li>▪ Oscillation damping 0</li> <li>▪ Signal asymmetry</li> <li>▪ Exciter current 0</li> </ul> <p> The range of options increases if the measuring device has one or more application packages.</p>
<b>Switch output</b>	
<b>Maximum input values</b>	DC 30 V, 250 mA (passive)
<b>Open-circuit voltage</b>	DC 28.8 V (active)
<b>Switching behavior</b>	Binary, conductive or non-conductive
<b>Switching delay</b>	Configurable: 0 to 100 s
<b>Number of switching cycles</b>	Unlimited
<b>Assignable functions</b>	<ul style="list-style-type: none"> <li>▪ Disable</li> <li>▪ On</li> <li>▪ Diagnostic behavior</li> <li>▪ Limit                             <ul style="list-style-type: none"> <li>▪ Mass flow</li> <li>▪ Volume flow</li> <li>▪ Corrected volume flow</li> <li>▪ Density</li> <li>▪ Reference density</li> <li>▪ Temperature</li> <li>▪ Totalizer 1-3</li> </ul> </li> <li>▪ Flow direction monitoring</li> <li>▪ Status                             <ul style="list-style-type: none"> <li>▪ Partially filled pipe detection</li> <li>▪ Low flow cut off</li> </ul> </li> </ul> <p> The range of options increases if the measuring device has one or more application packages.</p>

### Double pulse output

<b>Function</b>	Double pulse
<b>Version</b>	Open collector Can be set to: <ul style="list-style-type: none"> <li>▪ Active</li> <li>▪ Passive</li> <li>▪ Passive NAMUR</li> </ul>
<b>Maximum input values</b>	DC 30 V, 250 mA (passive)
<b>Open-circuit voltage</b>	DC 28.8 V (active)
<b>Voltage drop</b>	For 22.5 mA: ≤ DC 2 V
<b>Output frequency</b>	Configurable: 0 to 1000 Hz
<b>Damping</b>	Configurable: 0 to 999 s

<b>Pulse/pause ratio</b>	1:1
<b>Assignable measured variables</b>	<ul style="list-style-type: none"> <li>■ Mass flow</li> <li>■ Volume flow</li> <li>■ Corrected volume flow</li> <li>■ Density</li> <li>■ Reference density</li> <li>■ Temperature</li> </ul> <p> The range of options increases if the measuring device has one or more application packages.</p>

**Relay output**

<b>Function</b>	Switch output
<b>Version</b>	Relay output, galvanically isolated
<b>Switching behavior</b>	<p>Can be set to:</p> <ul style="list-style-type: none"> <li>■ NO (normally open), factory setting</li> <li>■ NC (normally closed)</li> </ul>
<b>Maximum switching capacity (passive)</b>	<ul style="list-style-type: none"> <li>■ DC 30 V, 0.1 A</li> <li>■ AC 30 V, 0.5 A</li> </ul>
<b>Assignable functions</b>	<ul style="list-style-type: none"> <li>■ Disable</li> <li>■ On</li> <li>■ Diagnostic behavior</li> <li>■ Limit                             <ul style="list-style-type: none"> <li>■ Mass flow</li> <li>■ Volume flow</li> <li>■ Corrected volume flow</li> <li>■ Density</li> <li>■ Reference density</li> <li>■ Temperature</li> <li>■ Totalizer 1-3</li> </ul> </li> <li>■ Flow direction monitoring</li> <li>■ Status                             <ul style="list-style-type: none"> <li>■ Partially filled pipe detection</li> <li>■ Low flow cut off</li> </ul> </li> </ul> <p> The range of options increases if the measuring device has one or more application packages.</p>

**User-configurable input/output**

**One** specific input or output is assigned to a user-configurable input/output (configurable I/O) during device commissioning.

The following inputs and outputs are available for assignment:

- Choice of current output: 4 to 20 mA (active), 0/4 to 20 mA (passive)
- Pulse/frequency/switch output
- Choice of current input: 4 to 20 mA (active), 0/4 to 20 mA (passive)
- Status input

Signal on alarm

Depending on the interface, failure information is displayed as follows:

**Current output 0/4 to 20 mA**

*4 to 20 mA*

<b>Failure mode</b>	Choose from: <ul style="list-style-type: none"> <li>▪ 4 to 20 mA in accordance with NAMUR recommendation NE 43</li> <li>▪ 4 to 20 mA in accordance with US</li> <li>▪ Min. value: 3.59 mA</li> <li>▪ Max. value: 22.5 mA</li> <li>▪ Definable value between: 3.59 to 22.5 mA</li> <li>▪ Actual value</li> <li>▪ Last valid value</li> </ul>
---------------------	---

*0 to 20 mA*

<b>Failure mode</b>	Choose from: <ul style="list-style-type: none"> <li>▪ Maximum alarm: 22 mA</li> <li>▪ Definable value between: 0 to 20.5 mA</li> </ul>
---------------------	--

**Pulse/frequency/switch output**

<b>Pulse output</b>	
<b>Fault mode</b>	Choose from: <ul style="list-style-type: none"> <li>▪ Actual value</li> <li>▪ No pulses</li> </ul>
<b>Frequency output</b>	
<b>Fault mode</b>	Choose from: <ul style="list-style-type: none"> <li>▪ Actual value</li> <li>▪ 0 Hz</li> <li>▪ Definable value between: 2 to 12 500 Hz</li> </ul>
<b>Switch output</b>	
<b>Fault mode</b>	Choose from: <ul style="list-style-type: none"> <li>▪ Current status</li> <li>▪ Open</li> <li>▪ Closed</li> </ul>

**Relay output**

<b>Failure mode</b>	Choose from: <ul style="list-style-type: none"> <li>▪ Current status</li> <li>▪ Open</li> <li>▪ Closed</li> </ul>
---------------------	---

**Local display**

<b>Plain text display</b>	With information on cause and remedial measures
<b>Backlight</b>	Red lighting indicates a device error.

 Status signal as per NAMUR recommendation NE 107

**Interface/protocol**



- Via digital communication:
  - HART protocol
- Via service interface
  - CDI-RJ45 service interface
  - WLAN interface

<b>Plain text display</b>	With information on cause and remedial measures
---------------------------	---

**Web browser**

<b>Plain text display</b>	With information on cause and remedial measures
---------------------------	---

**Light emitting diodes (LED)**

<b>Status information</b>	Status indicated by various light emitting diodes The following information is displayed depending on the device version: <ul style="list-style-type: none"> <li>▪ Supply voltage active</li> <li>▪ Data transmission active</li> <li>▪ Device alarm/error has occurred</li> </ul>  Diagnostic information via light emitting diodes →  157
---------------------------	--

Low flow cut off                      The switch points for low flow cut off are user-selectable.

Galvanic isolation                      The outputs are galvanically isolated:

- from the power supply
- from one another
- from the potential equalization (PE) terminal

<b>Protocol-specific data</b>	<b>Manufacturer ID</b>	0x11	
	<b>Device type ID</b>	0x3B	
	<b>HART protocol revision</b>	7	
	<b>Device description files (DTM, DD)</b>	Information and files under: <a href="http://www.endress.com">www.endress.com</a>	
	<b>HART load</b>	Min. 250 Ω	
	<b>System integration</b>	Information on system integration →  75. <ul style="list-style-type: none"> <li>▪ Measured variables via HART protocol</li> <li>▪ Burst Mode functionality</li> </ul>	

**16.5 Power supply**

Terminal assignment                      →  35

Supply voltage	Order code "Power supply"	Terminal voltage	Frequency range
	Option <b>D</b>	DC 24 V      ±20%	–
	Option <b>E</b>	AC 100 to 240 V      –15...+10%	50/60 Hz

Order code "Power supply"	Terminal voltage		Frequency range
Option I	DC 24 V	±20%	–
	AC 100 to 240 V	–15...+10%	50/60 Hz

Power consumption

**Transmitter**

Max. 10 W (active power)

<b>switch-on current</b>	Max. 36 A (<5 ms) as per NAMUR Recommendation NE 21
--------------------------	---

Current consumption

**Transmitter**

- Max. 400 mA (24 V)
- Max. 200 mA (110 V, 50/60 Hz; 230 V, 50/60 Hz)

Power supply failure

- Totalizers stop at the last value measured.
- Depending on the device version, the configuration is retained in the device memory or in the pluggable data memory (HistoROM DAT).
- Error messages (incl. total operated hours) are stored.

Overcurrent protection element

The device must be operated with a dedicated circuit breaker, as it does not have an ON/OFF switch of its own.

- The circuit breaker must be easy to reach and labeled accordingly.
- Permitted nominal current of the circuit breaker: 2 A up to maximum 10 A.

Electrical connection

→  35

Potential equalization

→  38

Terminals

Spring-loaded terminals: Suitable for strands and strands with ferrules.  
Conductor cross-section 0.2 to 2.5 mm<sup>2</sup> (24 to 12 AWG).

Cable entries

- Cable gland: M20 × 1.5 with cable Ø 6 to 12 mm (0.24 to 0.47 in)
- Thread for cable entry:
  - NPT ½"
  - G ½"
  - M20

Cable specification

→  32



Overvoltage protection

<b>Mains voltage fluctuations</b>	→  196
<b>Overvoltage category</b>	Overvoltage category II
<b>Short-term, temporary overvoltage</b>	Between cable and ground up to 1200 V, for max. 5 s
<b>Long-term, temporary overvoltage</b>	Between cable and ground up to 500 V

## 16.6 Performance characteristics

Reference operating conditions

- Error limits based on ISO 11631
- Water
  - +15 to +45 °C (+59 to +113 °F)
  - 2 to 6 bar (29 to 87 psi)
- Data as indicated in the calibration protocol
- Accuracy based on accredited calibration rigs according to ISO 17025

 To obtain measured errors, use the *Applicator* sizing tool →  186

Maximum measurement error

o.r. = of reading; 1 g/cm<sup>3</sup> = 1 kg/l; T = medium temperature

### Base accuracy

 Design fundamentals →  201

*Mass flow and volume flow (liquids)*

±0.10 % o.r.

*Mass flow (gases)*

±0.35 % o.r.

*Density (liquids)*

Under reference conditions	Standard density calibration <sup>1)</sup>	Wide-range Density specification <sup>2) 3)</sup>
[g/cm <sup>3</sup> ]	[g/cm <sup>3</sup> ]	[g/cm <sup>3</sup> ]
±0.0005	±0.001	±0.002

- 1) For devices with the order code "Measuring tube material, wetted surface", option HB "Alloy C22, high pressure, not polished", the standard density calibration ±0.002 g/cm<sup>3</sup>
- 2) Valid range for special density calibration: 0 to 2 g/cm<sup>3</sup>, +5 to +80 °C (+41 to +176 °F)
- 3) order code for "Application package", option EE "Special density"

*Temperature*

±0.5 °C ± 0.005 · T °C (±0.9 °F ± 0.003 · (T - 32) °F)

### Zero point stability

Standard version: order code for "Measuring tube mat., wetted surface", option BB, BF, HA, SA

DN		Zero point stability	
[mm]	[in]	[kg/h]	[lb/min]
1	1/24	0.0005	0.000018
2	1/12	0.0025	0.00009
4	1/6	0.0100	0.00036

High-pressure version: order code for "Measuring tube mat., wetted surface", option HB

DN		Zero point stability	
[mm]	[in]	[kg/h]	[lb/min]
1	$\frac{1}{24}$	0.0008	0.0000288
2	$\frac{1}{12}$	0.0040	0.000144
4	$\frac{1}{6}$	0.0160	0.000576

### Flow values

Flow values as turndown parameters depending on nominal diameter.

SI units

DN	1:1	1:10	1:20	1:50	1:100	1:500
[mm]	[kg/h]	[kg/h]	[kg/h]	[kg/h]	[kg/h]	[kg/h]
1	20	2	1	0.4	0.2	0.04
2	100	10	5	2	1	0.2
4	450	45	22.5	9	4.5	0.9

US units

DN	1:1	1:10	1:20	1:50	1:100	1:500
[inch]	[lb/min]	[lb/min]	[lb/min]	[lb/min]	[lb/min]	[lb/min]
$\frac{1}{24}$	0.735	0.074	0.037	0.015	0.007	0.001
$\frac{1}{12}$	3.675	0.368	0.184	0.074	0.037	0.007
$\frac{1}{6}$	16.54	1.654	0.827	0.331	0.165	0.033

### Accuracy of outputs

The outputs have the following base accuracy specifications.

Current output

Accuracy	$\pm 5 \mu\text{A}$
----------	---------------------

Pulse/frequency output

o.r. = of reading

Accuracy	Max. $\pm 50$ ppm o.r. (over the entire ambient temperature range)
----------	--

Repeatability

o.r. = of reading;  $1 \text{ g/cm}^3 = 1 \text{ kg/l}$ ; T = medium temperature

### Base repeatability

 Design fundamentals → 201

Mass flow and volume flow (liquids)

$\pm 0.05$  % o.r.

*Mass flow (gases)*

±0.15 % o.r.

*Density (liquids)*

±0.00025 g/cm<sup>3</sup>

*Temperature*

±0.25 °C ± 0.0025 · T °C (±0.45 °F ± 0.0015 · (T-32) °F)

Response time

The response time depends on the configuration (damping).

Influence of ambient temperature

**Current output**

Temperature coefficient	Max. 1 µA/°C
-------------------------	--------------

**Pulse/frequency output**

Temperature coefficient	No additional effect. Included in accuracy.
-------------------------	---

Influence of medium temperature

**Mass flow**

o.f.s. = of full scale value

If there is a difference between the temperature during zero adjustment and the process temperature, the additional measurement error of the sensors is typically ±0.0002 %o.f.s./°C (±0.0001 % o. f.s./°F).

The influence is reduced when the zero adjustment is performed at process temperature.

**Density**

If there is a difference between the density calibration temperature and the process temperature, the measurement error of the sensors is typically ±0.00005 g/cm<sup>3</sup>/°C (±0.000025 g/cm<sup>3</sup>/°F). Field density adjustment is possible.

**Wide-range density specification (special density calibration)**

If the process temperature is outside the valid range (→ ☰ 198) the measurement error is ±0.00005 g/cm<sup>3</sup> /°C (±0.000025 g/cm<sup>3</sup> /°F)

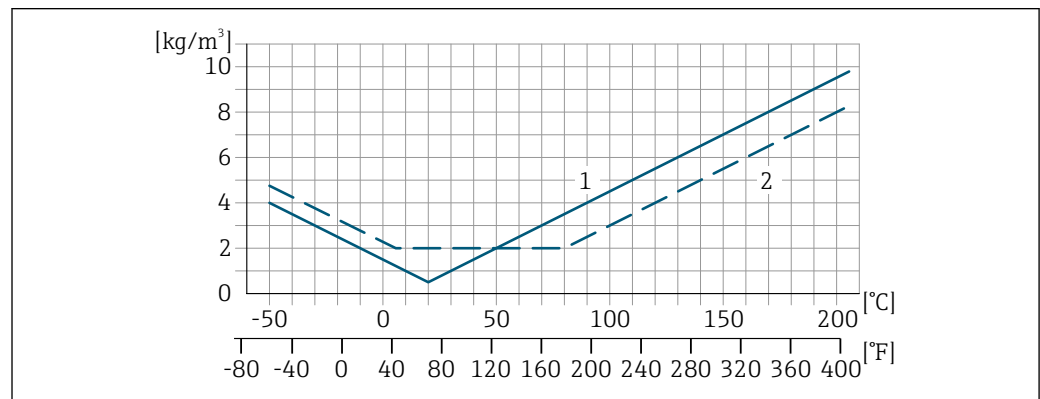

- 1 Field density adjustment, for example at +20 °C (+68 °F)
- 2 Special density calibration

Influence of medium pressure

A difference between the calibration pressure and process pressure does not affect accuracy.



**Influence of process density** If there is a difference in density between the calibration density and the process density, the measurement error for the measured density is typically:

- ±0.6% for nominal diameter DN 4 (1/2<sub>4</sub> in)
- ±1.4% for nominal diameter DN 2 (1/2<sub>12</sub> in)
- ±2.0% for nominal diameter DN 1 (1/2<sub>12</sub> in) and for devices with order code for "Measuring tube material, wetted surface:", option HB "Alloy C22, high pressure, not polished"

 A field density adjustment is possible.

**Design fundamentals** o.r. = of reading, o.f.s. = of full scale value  
 BaseAccu = base accuracy in % o.r., BaseRepeat = base repeatability in % o.r.  
 MeasValue = measured value; ZeroPoint = zero point stability

*Calculation of the maximum measured error as a function of the flow rate*

Flow rate	Maximum measured error in % o.r.
$\geq \frac{\text{ZeroPoint}}{\text{BaseAccu}} \cdot 100$ <small>A0021332</small>	± BaseAccu <small>A0021339</small>
$< \frac{\text{ZeroPoint}}{\text{BaseAccu}} \cdot 100$ <small>A0021333</small>	$\pm \frac{\text{ZeroPoint}}{\text{MeasValue}} \cdot 100$ <small>A0021334</small>

*Calculation of the maximum repeatability as a function of the flow rate*

Flow rate	Maximum repeatability in % o.r.
$\geq \frac{1/2 \cdot \text{ZeroPoint}}{\text{BaseRepeat}} \cdot 100$ <small>A0021335</small>	± BaseRepeat <small>A0021340</small>
$< \frac{1/2 \cdot \text{ZeroPoint}}{\text{BaseRepeat}} \cdot 100$ <small>A0021336</small>	$\pm 1/2 \cdot \frac{\text{ZeroPoint}}{\text{MeasValue}} \cdot 100$ <small>A0021337</small>

**Example of maximum measurement error**

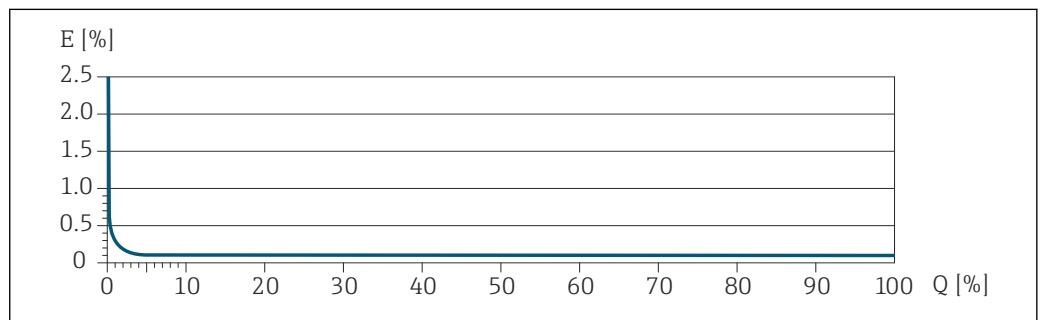

E Maximum measurement error in % o.r. (example)  
 Q Flow rate in % of maximum full scale value



**16.7 Mounting**

Mounting requirements →  21

## 16.8 Environment

Ambient temperature range →  23

### Temperature tables

-  Observe the interdependencies between the permitted ambient and fluid temperatures when operating the device in hazardous areas.
-  For detailed information on the temperature tables, see the separate document entitled "Safety Instructions" (XA) for the device.

Storage temperature

Climate class DIN EN 60068-2-38 (test Z/AD)

Relative humidity The device is suitable for use outdoors and indoors with a relative humidity of 4 to 95 %.

Operating height According to EN 61010-1

- ≤ 2 000 m (6 562 ft)
- > 2 000 m (6 562 ft) with additional overvoltage protection (e.g. Endress+Hauser HAW Series)

Degree of protection

### Transmitter

- IP66/67, Type 4X enclosure, suitable for pollution degree 4
- When the housing is open: IP20, Type 1 enclosure, suitable for pollution degree 2
- Display module: IP20, Type 1 enclosure, suitable for pollution degree 2

### Optional

Order code for "Sensor options", option CM "IP69"

### External WLAN antenna

IP67

Shock and vibration resistance

### Vibration sinusoidal, in accordance with IEC 60068-2-6

- 2 to 8.4 Hz, 3.5 mm peak
- 8.4 to 2 000 Hz, 1 g peak

### Vibration broad-band random, according to IEC 60068-2-64

- 10 to 200 Hz, 0.003 g<sup>2</sup>/Hz
- 200 to 2 000 Hz, 0.001 g<sup>2</sup>/Hz
- Total: 1.54 g rms

### Shock half-sine, according to IEC 60068-2-27

6 ms 30 g

### Rough handling shocks according to IEC 60068-2-31

Internal cleaning

- CIP cleaning
- SIP cleaning

**Options**

Oil- and grease-free version for wetted parts, without declaration  
Order code for "Service", option HA <sup>4)</sup>

**Mechanical load**

Transmitter housing:

- Protect against mechanical effects, such as shock or impact
- Do not use as a ladder or climbing aid

**Electromagnetic compatibility (EMC)**

- As per IEC/EN 61326 and NAMUR Recommendation 21 (NE 21)
- As per IEC/EN 61000-6-2 and IEC/EN 61000-6-4



Details are provided in the Declaration of Conformity.



This unit is not intended for use in residential environments and cannot guarantee adequate protection of the radio reception in such environments.

**16.9 Process****Medium temperature range**

-50 to +205 °C (-58 to +401 °F)

**Pressure-temperature ratings**

For an overview of the pressure-temperature ratings for the process connections, see the Technical Information

**Sensor housing**

The sensor housing is filled with dry nitrogen gas and protects the electronics and mechanics inside.



If a measuring tube fails (e.g. due to process characteristics like corrosive or abrasive fluids), the fluid will initially be contained by the sensor housing.

In the event of a tube failure, the pressure level inside the sensor housing will rise according to the operating process pressure. If the user judges that the sensor housing burst pressure does not provide an adequate safety margin, the device can be fitted with a rupture disk. This prevents excessively high pressure from forming inside the sensor housing. Therefore, the use of a rupture disk is strongly recommended in applications involving high gas pressures, and particularly in applications in which the process pressure is greater than 2/3 of the sensor housing burst pressure.



High-pressure devices are always fitted with a rupture disk: order code for "Measuring tube mat., wetted surface", option HB

**Burst pressure of the sensor housing**

If the device is fitted with a rupture disk (order code for "Sensor option", option CA "Rupture disk"), the rupture disk trigger pressure is decisive .

The sensor housing burst pressure refers to a typical internal pressure which is reached prior to mechanical failure of the sensor housing and which was determined during type

<sup>4)</sup> The cleaning refers to the measuring instrument only. Any accessories supplied are not cleaned.

testing. The corresponding type test declaration can be ordered with the device (order code for "Additional approval", option LN "Sensor housing burst pressure, type test").

DN		Sensor housing burst pressure	
[mm]	[in]	[bar]	[psi]
1	1/24	220	3 190
2	1/12	140	2 030
4	1/6	105	1 520

 For information on the dimensions: see the "Mechanical construction" section of the "Technical Information" document

Rupture disk

To increase the level of safety, a device version with a rupture disk with a trigger pressure of 10 to 15 bar (145 to 217.5 psi) can be used (order code for "Sensor option", option CA "rupture disk").

**Drain connection for rupture disk**

To allow any escaping medium to drain in a controlled manner in the event of an error, an optional drain connection can be ordered in addition to the rupture disk.



 The function of the rupture disk is not compromised in any way.

Flow limit



Select the nominal diameter by optimizing between the required flow range and permissible pressure loss.

 For an overview of the full scale values for the measuring range, see the "Measuring range" section →  188

- The minimum recommended full scale value is approx. 1/20 of the maximum full scale value
- In most applications, 20 to 50 % of the maximum full scale value can be considered ideal
- A low full scale value must be selected for abrasive media (such as liquids with entrained solids): flow velocity < 1 m/s (< 3 ft/s).
- For gas measurement the following rules apply:
  - The flow velocity in the measuring tubes should not exceed half the sound velocity (0.5 Mach).
  - The maximum mass flow depends on the density of the gas: formula

 To calculate the flow limit, use the *Applicator* sizing tool →  186

Pressure loss

 To calculate the pressure loss, use the *Applicator* sizing tool →  186

System pressure

→  23

## 16.10 Mechanical construction

Design, dimensions

 For the dimensions and installation lengths of the device, see the "Technical Information" document, "Mechanical construction" section

## Weight

All values (weight exclusive of packaging material) refer to devices with VCO couplings. Weight specifications including transmitter as per order code for "Housing", option A "Aluminum, coated".

Different values due to different transmitter versions:

- Transmitter version for the hazardous area  
(Order code for "Housing", option A "Aluminum, coated"; Ex d): +2 kg (+4.4 lbs)
- Transmitter version for hygienic area  
(Order code for "Housing", option B "Stainless, hygienic"): +0.2 kg (+0.44 lbs)

**Weight in SI units**

DN [mm]	Weight [kg]
1	5.35
2	6.9
4	8.75

**Weight in US units**

DN [in]	Weight [lbs]
1/24	12
1/12	15
1/8	19

## Materials

**Transmitter housing**

Order code for "Housing":

- Option **A** "Aluminum, coated": aluminum, AlSi10Mg, coated
- Option **B** "Stainless, hygienic": stainless steel, 1.4404 (316L)

*Window material*

Order code for "Housing":

- Option **A** "Aluminum, coated": glass
- Option **B** "Stainless, hygienic": polycarbonate

*Seals*

Order code for "Housing":

Option **B** "Stainless, hygienic": EPDM and silicone

**Cable entries/cable glands**

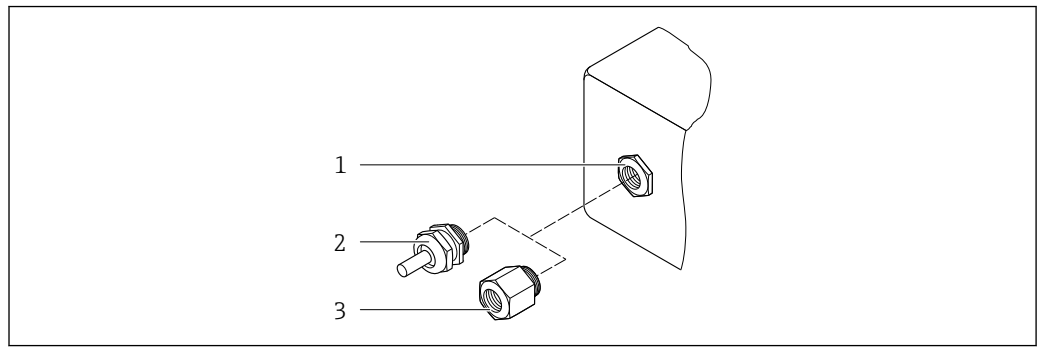

A0020640

37 Possible cable entries/cable glands

- 1 Female thread M20 × 1.5
- 2 Cable gland M20 × 1.5
- 3 Adapter for cable entry with female thread G ½" or NPT ½"

Order code for "Housing", option A "Aluminum, coated"

The various cable entries are suitable for hazardous and non-hazardous areas.

Cable entry/cable gland	Material
Compression fitting M20 × 1.5	Non-Ex: plastic
	Z2, D2, Ex d/de: brass with plastic
Adapter for cable entry with female thread G ½"	Nickel-plated brass
Adapter for cable entry with female thread NPT ½"	

Order code for "Housing", option B "Stainless, hygienic"

The various cable entries are suitable for hazardous and non-hazardous areas.

Cable entry/cable gland	Material
Cable gland M20 × 1.5	Plastic
Adapter for cable entry with female thread G ½"	Nickel-plated brass
Adapter for cable entry with female thread NPT ½"	

**Sensor housing**

- Acid and alkali-resistant outer surface
- Stainless steel, 1.4404 (316L)

**Measuring tubes**

Order code for "Measuring tube mat., wetted surface", option BB, BF, SA  
Stainless steel, 1.4435 (316/316L)

Order code for "Measuring tube mat., wetted surface", option HA, HB, HC, HD  
Alloy C22, 2.4602 (UNS N06022)

**Process connections**

Order code for "Measuring tube mat., wetted surface", option SA

<b>VCO coupling</b>	Stainless steel, 1.4404 (316/316L)
<b>G<math>\frac{1}{4}</math>", G<math>\frac{1}{2}</math>" female thread</b>	Stainless steel, 1.4404 (316/316L)
<b>NPT<math>\frac{1}{4}</math>", NPT<math>\frac{1}{2}</math>" female thread</b>	Stainless steel, 1.4404 (316/316L)
<b>Tri-Clamp<math>\frac{1}{2}</math>"</b>	Stainless steel, 1.4435 (316L)
<b>Fixed flange EN 1092-1, ASME B16.5, JIS B2220</b>	Stainless steel, 1.4404 (316/316L)

Order code for "Measuring tube mat., wetted surface", option BB, BF

<b>VCO coupling</b>	Stainless steel, 1.4404 (316/316L)
<b>Tri-Clamp<math>\frac{1}{2}</math>"</b>	Stainless steel, 1.4435 (316L)

Order code for "Measuring tube mat., wetted surface", option HC, HD



<b>VCO coupling</b>	Alloy C22, 2.4602 (UNS N06022)
<b>Tri-Clamp<math>\frac{1}{2}</math>"</b>	Alloy C22, 2.4602 (UNS N06022)

Order code for "Measuring tube mat., wetted surface", option HA

<b>VCO coupling</b>	Alloy C22, 2.4602 (UNS N06022)
<b>G<math>\frac{1}{4}</math>", G<math>\frac{1}{2}</math>" female thread</b>	Alloy C22, 2.4602 (UNS N06022)
<b>NPT<math>\frac{1}{4}</math>", NPT<math>\frac{1}{2}</math>" female thread</b>	Alloy C22, 2.4602 (UNS N06022)
<b>Fixed flange EN 1092-1, ASME B16.5, JIS B2220</b>	Alloy C22, 2.4602 (UNS N06022)
<b>Lap joint flange EN 1092-1, ASME B16.5, JIS B2220</b>	Stainless steel, 1.4301 (F304), wetted parts Alloy C22, 2.4602 (UNS N06022)

Order code for "Measuring tube mat., wetted surface", option HB (high-pressure option)

<b>VCO coupling</b>	Alloy C22, 2.4602 (UNS N06022)
<b>G<math>\frac{1}{4}</math>", G<math>\frac{1}{2}</math>" female thread</b>	Alloy C22, 2.4602 (UNS N06022)
<b>NPT<math>\frac{1}{4}</math>", NPT<math>\frac{1}{2}</math>" female thread</b>	Alloy C22, 2.4602 (UNS N06022)
<b>Fixed flange EN 1092-1, ASME B16.5, JIS B2220</b>	Stainless steel, 1.4404 (316/316L); Alloy C22, 2.4602 (UNS N06022)

 Available process connections →  208

### Seals

Welded process connections without internal seals

### Accessories

*Sensor holder*

Stainless steel, 1.4404 (316L)

*Heating jacket*

- Heating jacket housing: stainless steel, 1.4571 (316Ti)
- NPT adapter ½": stainless steel, 1.4404 (316)
- G½" adapter: stainless steel, 1.4404

*Protective cover*

Stainless steel, 1.4404 (316L)

*External WLAN antenna*

- Antenna: ASA plastic (acrylonitrile styrene acrylate) and nickel-plated brass
- Adapter: Stainless steel and nickel-plated brass
- Cable: Polyethylene
- Plug: Nickel-plated brass
- Angle bracket: Stainless steel

Process connections

- Fixed flange connections:
  - EN 1092-1 (DIN 2501) flange
  - EN 1092-1 (DIN 2512N) flange
  - ASME B16.5 flange
  - JIS B2220 flange
- Clamp connections:
  - Tri-Clamp (OD tubes), DIN 11866 series C
- VCO connections:
  - 4-VCO-4
- Internal thread:
  - Cylindrical internal thread BSPP (G) in accordance with ISO 228-1
  - NPT

 Process connection materials →  206

Surface roughness

All data refer to parts in contact with the medium.

*The following surface roughness categories can be ordered:*

Category	Method	Option(s) order code "Measuring tube mat., wetted surface"
Not polished	–	HA, HB, SA
Ra ≤ 0.76 µm (30 µin) <sup>1)</sup>	Mechanically polished <sup>2)</sup>	BB, HC
Ra ≤ 0.38 µm (15 µin) <sup>1)</sup>	Mechanically polished <sup>2)</sup>	BF, HD

- 1) Ra according to ISO 21920
- 2) Except for inaccessible welds between pipe and manifold

## 16.11 Operability

Languages

Can be operated in the following languages:

- Via local operation
  - English, German, French, Spanish, Italian, Dutch, Portuguese, Polish, Russian, Turkish, Chinese, Japanese, Korean, Vietnamese, Czech, Swedish
- Via web browser
  - English, German, French, Spanish, Italian, Dutch, Portuguese, Polish, Russian, Turkish, Chinese, Japanese, Vietnamese, Czech, Swedish
- Via "FieldCare", "DeviceCare" operating tool: English, German, French, Spanish, Italian, Chinese, Japanese





## Onsite operation

**Via display module**

Features:

- Order code for "Display; operation", option F "4-line, illuminated, graphic display; touch control"
- Order code for "Display; operation", option G "4-line, illuminated, graphic display; touch control + WLAN"

 Information about WLAN interface →  69

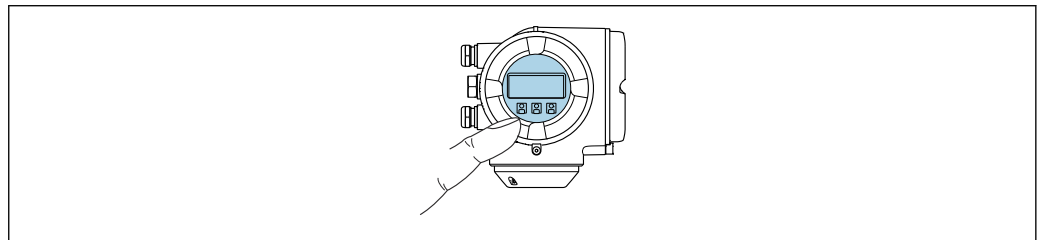



A0026785

 38 Operation with touch control



*Display elements*

- 4-line, illuminated, graphic display
- White background lighting; switches to red in event of device errors
- Format for displaying measured variables and status variables can be individually configured

*Operating elements*

- External operation via touch control (3 optical keys) without opening the housing: , , 
- Operating elements also accessible in the various zones of the hazardous area

**Via remote display and operating module DKX001**

 The remote display and operating module DKX001 is available as an optional extra →  184..

- The remote display and operating module DKX001 is only available for the following housing version: order code for "Housing": option A "Aluminum, coated"
- The measuring instrument is always supplied with a dummy cover when the remote display and operating module DKX001 is ordered directly with the measuring instrument. Display or operation at the transmitter is not possible in this case.
- If ordered subsequently, the remote display and operating module DKX001 may not be connected at the same time as the existing measuring instrument display module. Only one display or operation unit may be connected to the transmitter at any one time.

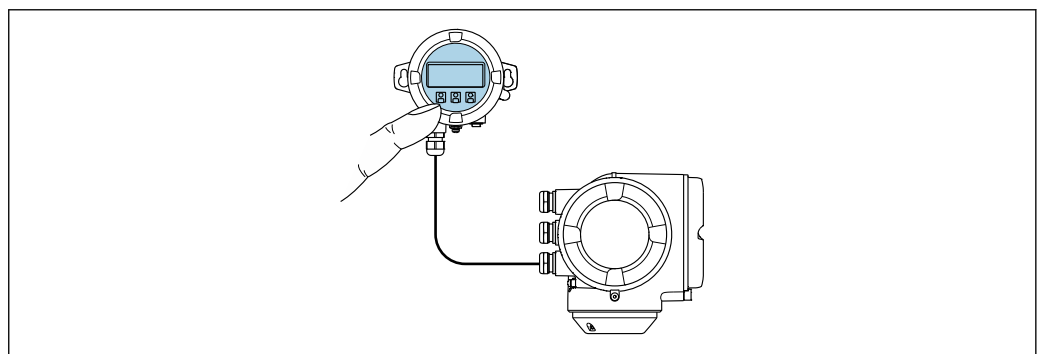

A0026786

 39 Operation via remote display and operating module DKX001

*Display and operating elements*

The display and operating elements correspond to those of the display module →  209.

*Housing material*

The housing material of the display and operating module DKX001 depends on the choice of transmitter housing material.

Transmitter housing		Remote display and operating module
Order code for "Housing"	Material	Material
Option A "Aluminum, coated"	AlSi10Mg, coated	AlSi10Mg, coated

*Cable entry*

Corresponds to the choice of transmitter housing, order code for "Electrical connection".

*Connecting cable*

→  33

*Dimensions*



Information on the dimensions:



"Mechanical construction" section of the "Technical Information" document.

Remote operation →  67

Service interface →  68

Supported operating tools

Different operating tools can be used for local or remote access to the measuring device. Depending on the operating tool used, access is possible with different operating units and via a variety of interfaces.

Supported operating tools	Operating unit	Interface	Additional information
Web browser	Notebook, PC or tablet with Web browser	<ul style="list-style-type: none"> <li>■ CDI-RJ45 service interface</li> <li>■ WLAN interface</li> </ul>	Special Documentation for device →  218
DeviceCare SFE100	Notebook, PC or tablet with Microsoft Windows system	<ul style="list-style-type: none"> <li>■ CDI-RJ45 service interface</li> <li>■ WLAN interface</li> <li>■ Fieldbus protocol</li> </ul>	→  186
FieldCare SFE500	Notebook, PC or tablet with Microsoft Windows system	<ul style="list-style-type: none"> <li>■ CDI-RJ45 service interface</li> <li>■ WLAN interface</li> <li>■ Fieldbus protocol</li> </ul>	→  186

Supported operating tools	Operating unit	Interface	Additional information
Field Xpert	SMT70/77/50	<ul style="list-style-type: none"> <li>■ All fieldbus protocols</li> <li>■ WLAN interface</li> <li>■ Bluetooth</li> <li>■ CDI-RJ45 service interface</li> </ul>	Operating Instructions BA01202S  Device description files: Use update function of handheld terminal
SmartBlue app	Smartphone or tablet with iOS or Android	WLAN	→  186

 Other operating tools based on FDT technology with a device driver such as DTM/iDTM or DD/EDD can be used for device operation. These operating tools are available from the individual manufacturers. Integration into the following operating tools, among others, is supported:

- FactoryTalk AssetCentre (FTAC) from Rockwell Automation → [www.rockwellautomation.com](http://www.rockwellautomation.com)
- Process Device Manager (PDM) from Siemens → [www.siemens.com](http://www.siemens.com)
- Asset Management Solutions (AMS) from Emerson → [www.emersonprocess.com](http://www.emersonprocess.com)
- FieldCommunicator 375/475 from Emerson → [www.emersonprocess.com](http://www.emersonprocess.com)
- Field Device Manager (FDM) from Honeywell → [www.process.honeywell.com](http://www.process.honeywell.com)
- FieldMate from Yokogawa → [www.yokogawa.com](http://www.yokogawa.com)
- PACTWare → [www.pactware.com](http://www.pactware.com)

The related device description files are available: [www.endress.com](http://www.endress.com) → Download Area



### Web server

With the integrated web server, the device can be operated and configured via a web browser service interface (CDI-RJ45) or WLAN interface. The structure of the operating menu is the same as for the local display. In addition to the measured values, status information on the device is displayed and can be used to monitor device health. Furthermore the device data can be managed and the network parameters can be configured.

A device that has a WLAN interface (can be ordered as an option) is required for the WLAN connection: order code for "Display; operation", option G "4-line, illuminated; touch control + WLAN". The device acts as an Access Point and enables communication by computer or a mobile handheld terminal.

### Supported functions

Data exchange between the operating unit (such as a notebook, for example,) and measuring instrument:

- Upload the configuration from the measuring instrument (XML format, configuration backup)
- Save the configuration to the measuring instrument (XML format, restore configuration)
- Export event list (.csv file)
- Export parameter settings (.csv file or PDF file, document the measuring point configuration)
- Export the Heartbeat Technology verification report (PDF file, only available with the **Heartbeat Verification** →  216 application package)
- Flash firmware version for device firmware upgrade, for example
- Download driver for system integration
- Visualize up to 1000 saved measured values (only available with the **Extended HistoROM** application package →  216)

HistoROM data management

The measuring device features HistoROM data management. HistoROM data management comprises both the storage and import/export of key device and process data, making operation and servicing far more reliable, secure and efficient.

 When the device is delivered, the factory settings of the configuration data are stored as a backup in the device memory. This memory can be overwritten with an updated data record, for example after commissioning.

**Additional information on the data storage concept**

There are different types of data storage units in which device data are stored and used by the device:

	HistoROM backup	T-DAT	S-DAT
<b>Available data</b>	<ul style="list-style-type: none"> <li>▪ Event logbook, e.g. diagnostic events</li> <li>▪ Parameter data record backup</li> <li>▪ Device firmware package</li> </ul>	<ul style="list-style-type: none"> <li>▪ Measured value logging ("Extended HistoROM" order option)</li> <li>▪ Current parameter data record (used by firmware at run time)</li> <li>▪ Indicator (minimum/maximum values)</li> <li>▪ Totalizer value</li> </ul>	<ul style="list-style-type: none"> <li>▪ Sensor data: e.g. nominal diameter</li> <li>▪ Serial number</li> <li>▪ Calibration data</li> <li>▪ Device configuration (e.g. SW options, fixed I/O or multi I/O)</li> </ul>
<b>Storage location</b>	Fixed on the user interface PC board in the connection compartment	Can be plugged into the user interface PC board in the connection compartment	In the sensor plug in the transmitter neck part

**Data backup**

**Automatic**

- The most important device data (sensor and transmitter) are automatically saved in the DAT modules
- If the transmitter or measuring device is replaced: once the T-DAT containing the previous device data has been exchanged, the new measuring device is ready for operation again immediately without any errors
- If exchanging the electronics module (e.g. I/O electronics module): Once the electronics module has been replaced, the software of the module is compared against the current device firmware. The module software is upgraded or downgraded where necessary. The electronics module is available for use immediately afterwards and no compatibility problems occur.

**Manual**

Additional parameter data record (complete parameter settings) in the integrated device memory HistoROM backup for:

- Data backup function  
Backup and subsequent restoration of a device configuration in the device memory HistoROM backup
- Data comparison function  
Comparison of the current device configuration with the device configuration saved in the device memory HistoROM backup

**Data transmission**

**Manual**

Transfer of a device configuration to another device using the export function of the specific operating tool, e.g. with FieldCare, DeviceCare or Web server: to duplicate the configuration or to store in an archive (e.g. for backup purposes)

**Event list****Automatic**

- Chronological display of up to 20 event messages in the events list
- If the **Extended HistoROM** application package (order option) is enabled: up to 100 event messages are displayed in the events list along with a time stamp, plain text description and remedial measures
- The events list can be exported and displayed via a variety of interfaces and operating tools e.g. DeviceCare, FieldCare or Web server

**Data logging****Manual**

If the **Extended HistoROM** application package (order option) is enabled:

- Recording of 1 to 4 channels of up to 1 000 measured values (up to 250 measured values per channel)
- User configurable recording interval
- Export the measured value log via a variety of interfaces and operating tools e.g. FieldCare, DeviceCare or web server

## 16.12 Certificates and approvals

Current certificates and approvals for the product are available at [www.endress.com](http://www.endress.com) on the relevant product page:

1. Select the product using the filters and search field.
2. Open the product page.
3. Select **Downloads**.

---

**CE mark**

The device meets the legal requirements of the applicable EU Directives. These are listed in the corresponding EU Declaration of Conformity along with the standards applied.

Endress+Hauser confirms successful testing of the device by affixing to it the CE mark.

---

**UKCA marking**

The device meets the legal requirements of the applicable UK regulations (Statutory Instruments). These are listed in the UKCA Declaration of Conformity along with the designated standards. By selecting the order option for UKCA marking, Endress+Hauser confirms a successful evaluation and testing of the device by affixing the UKCA mark.

Contact address Endress+Hauser UK:

Endress+Hauser Ltd.  
Floats Road  
Manchester M23 9NF  
United Kingdom  
[www.uk.endress.com](http://www.uk.endress.com)



---

**RCM marking**

The measuring system meets the EMC requirements of the "Australian Communications and Media Authority (ACMA)".

Hygienic compatibility	<ul style="list-style-type: none"> <li>■ 3-A approval                             <ul style="list-style-type: none"> <li>■ Only measuring instruments with the order code for "Additional approval", option LP "3A" have 3-A approval.</li> <li>■ The 3-A approval refers to the measuring instrument.</li> <li>■ When installing the measuring instrument, ensure that no liquid can accumulate on the outside of the measuring instrument. A remote display module must be installed in accordance with the 3-A Standard.</li> <li>■ Accessories (e.g. heating jacket, weather protection cover, wall holder unit) must be installed in accordance with the 3-A Standard. Each accessory can be cleaned. Disassembly may be necessary under certain circumstances.</li> </ul> </li> <li>■ FDA</li> <li>■ Food Contact Materials Regulation (EC) 1935/2004</li> </ul> <p> Observe the special installation instructions</p>
------------------------	---

HART certification	<p><b>HART interface</b></p> <p>The measuring device is certified and registered by the FieldComm Group. The measuring system meets all the requirements of the following specifications:</p> <ul style="list-style-type: none"> <li>■ Certified according to HART 7</li> <li>■ The device can also be operated with certified devices of other manufacturers (interoperability)</li> </ul>
--------------------	---

Radio approval	<p>The measuring device has radio approval.</p> <p> For detailed information on the radio approval, see the Special Documentation →  218</p>
----------------	--

Additional certification	<p><b>CRN approval</b></p> <p>Some device versions have CRN approval. A CRN-approved process connection with a CSA approval must be ordered for a CRN-approved device.</p> <p><b>Tests and certificates</b></p> <ul style="list-style-type: none"> <li>■ Radiographic testing ISO 10675-1 ZG1 (RT), process connection, weld seam, Heartbeat Technology verification report</li> <li>■ Radiographic testing ASME B31.3 NFS (RT), process connection, weld seam, Heartbeat Technology verification report</li> <li>■ Radiographic testing ASME VIII Div.1 (RT), process connection, weld seam, Heartbeat Technology verification report</li> <li>■ Radiographic testing NORSOK M-601 (RT), process connection, weld seam, Heartbeat Technology verification report</li> <li>■ Radiographic testing ISO 10675-1 ZG1 (DR), process connection, weld seam, Heartbeat Technology verification report</li> <li>■ Radiographic testing ASME B31.3 NFS (DR), process connection, weld seam, Heartbeat Technology verification report</li> <li>■ Radiographic testing ASME VIII Div.1 (DR), process connection, weld seam, Heartbeat Technology verification report</li> <li>■ Radiographic testing NORSOK M-601 (DR), process connection, weld seam, Heartbeat Technology verification report</li> </ul>
--------------------------	--

*Testing of welded connections*

Option	Test standard				Process connection
	ISO 10675-1 AL1	ASME B31.3 NFS	ASME VIII Div.1	NORSOK M-601	
KE	x				RT
KI		x			RT
KN			x		RT
KS				x	RT
K5	x				DR
K6		x			DR
K7			x		DR
K8				x	DR
RT = Radiographic testing, DR = Digital radiography All options with test report					



## External standards and guidelines



- EN 60529  
Degrees of protection provided by enclosures (IP code)
- IEC/EN 60068-2-6  
Environmental influences: Test procedure - Test Fc: vibrate (sinusoidal).
- IEC/EN 60068-2-31  
Environmental influences: Test procedure - Test Ec: shocks due to rough handling, primarily for devices.
- EN 61010-1  
Safety requirements for electrical equipment for measurement, control and laboratory use - general requirements
- EN 61326-1/-2-3  
EMC requirements for electrical equipment for measurement, control and laboratory use
- NAMUR NE 21  
Electromagnetic compatibility (EMC) of industrial process and laboratory control equipment
- NAMUR NE 32  
Data retention in the event of a power failure in field and control instruments with microprocessors
- NAMUR NE 43  
Standardization of the signal level for the breakdown information of digital transmitters with analog output signal.
- NAMUR NE 53  
Software of field devices and signal-processing devices with digital electronics
- NAMUR NE 105  
Specifications for integrating fieldbus devices in engineering tools for field devices
- NAMUR NE 107  
Self-monitoring and diagnosis of field devices
- NAMUR NE 131  
Requirements for field devices for standard applications
- NAMUR NE 132  
Coriolis mass meter
- ETSI EN 300 328  
Guidelines for 2.4 GHz radio components.
- EN 301489  
Electromagnetic compatibility and radio spectrum matters (ERM).

## 16.13 Application packages

Many different application packages are available to enhance the functionality of the device. Such packages might be needed to address safety aspects or specific application requirements.

The application packages can be ordered with the device or subsequently from Endress+Hauser. Detailed information on the order code in question is available from your local Endress+Hauser sales center or on the product page of the Endress+Hauser website: [www.endress.com](http://www.endress.com).

 Detailed information on the application packages:  
Special Documentation →  218

Diagnostic functionality	<p>Order code for "Application package", option EA "Extended HistoROM"</p> <p>Comprises extended functions concerning the event log and the activation of the measured value memory.</p> <p>Event log: Memory volume is extended from 20 message entries (standard version) to up to 100 entries.</p> <p>Data logging (line recorder):</p> <ul style="list-style-type: none"> <li>▪ Memory capacity for up to 1000 measured values is activated.</li> <li>▪ 250 measured values can be output via each of the 4 memory channels. The recording interval can be defined and configured by the user.</li> <li>▪ Measured value logs can be accessed via the local display or operating tool e.g. FieldCare, DeviceCare or Web server.</li> </ul> <p> For detailed information, see the Operating Instructions for the device.</p>
Heartbeat Technology	<p>Order code for "Application package", option EB "Heartbeat Verification + Monitoring"</p> <p><b>Heartbeat Verification</b> Meets the requirement for traceable verification to DIN ISO 9001:2008 Chapter 7.6 a) "Control of monitoring and measuring equipment".</p> <ul style="list-style-type: none"> <li>▪ Functional testing in the installed state without interrupting the process.</li> <li>▪ Traceable verification results on request, including a report.</li> <li>▪ Simple testing process via local operation or other operating interfaces.</li> <li>▪ Clear measuring point assessment (pass/fail) with high test coverage within the framework of manufacturer specifications.</li> <li>▪ Extension of calibration intervals according to operator's risk assessment.</li> </ul> <p><b>Heartbeat Monitoring</b> Continuously supplies data, which are characteristic of the measuring principle, to an external condition monitoring system for the purpose of preventive maintenance or process analysis. These data enable the operator to:</p> <ul style="list-style-type: none"> <li>▪ Draw conclusions - using these data and other information - about the impact process influences (e.g. corrosion, abrasion, buildup etc.) have on the measuring performance over time.</li> <li>▪ Schedule servicing in time.</li> <li>▪ Monitor the process or product quality, e.g. gas pockets .</li> </ul> <p> For detailed information, see the Special Documentation for the device.</p>
Concentration measurement	<p>Order code for "Application package", option ED "Concentration"</p> <p>Calculation and outputting of fluid concentrations.</p>



The measured density is converted to the concentration of a substance of a binary mixture using the "Concentration" application package:

- Choice of predefined fluids (e.g. various sugar solutions, acids, alkalis, salts, ethanol etc.).
- Common or user-defined units (°Brix, °Plato, % mass, % volume, mol/l etc.) for standard applications.
- Concentration calculation from user-defined tables.



For detailed information, see the Special Documentation for the device.

#### Special density

Order code for "Application package", option EE "Special density"

Many applications use density as a key measured value for monitoring quality or controlling processes. The measuring instrument measures the density of the fluid as standard and makes this value available to the control system.

The "Special Density" application package offers high-precision density measurement over a wide density and temperature range particularly for applications subject to varying process conditions.



For detailed information, see the Operating Instructions for the device.

#### OPC-UA Server

Order code for "Application package", option EL "OPC-UA Server"

The application package provides an integrated OPC-UA server for comprehensive device services for IoT and SCADA applications.



For detailed information, see the Special Documentation for the device.

## 16.14 Accessories



Overview of accessories available to order → 184

## 16.15 Supplementary documentation



For an overview of the scope of the associated Technical Documentation, refer to the following:

- *Device Viewer* ([www.endress.com/deviceviewer](http://www.endress.com/deviceviewer)): Enter the serial number from the nameplate
- *Endress+Hauser Operations app*: Enter serial number from nameplate or scan matrix code on nameplate.

#### Standard documentation

#### Brief Operating Instructions

##### *Brief Operating Instructions for the sensor*

Measuring instrument	Documentation code
Proline Promass A	KA01282D

##### *Brief Operating Instructions for transmitter*

Measuring device	Documentation code
Proline 300	KA01309D

### Technical Information

Measuring device	Documentation code
Promass A 300	TI01374D

### Description of Device Parameters

Measuring device	Documentation code							PROFINET with Ethernet-APL
	HART	FOUNDATION Fieldbus	PROFIBUS PA	PROFIBUS DP	Modbus RS485	EtherNet/IP	PROFINET	
Promass 300	GP01057D	GP01094D	GP01058D	GP01134D	GP01059D	GP01114D	GP01115D	GP01168D

Supplementary device-dependent documentation

#### Safety instructions

Safety instructions for electrical equipment for hazardous areas.

*Remote display and operating module DKX001*

Contents	Documentation code
ATEX/IECEX Ex i	XA01494D
ATEX/IECEX Ex ec	XA01498D
cCSAus IS	XA01499D
cCSAus Ex nA	XA01513D
INMETRO Ex i	XA01500D
INMETRO Ex ec	XA01501D
NEPSI Ex i	XA01502D
NEPSI Ex nA	XA01503D

### Functional Safety Manual

Contents	Documentation code
Proline Promass 300	SD01727D

### Special documentation

Contents	Documentation code
Information on the Pressure Equipment Directive	SD01614D
Remote display and operating module DKX001	SD01763D
Radio approvals for WLAN interface for A309/A310 display module	SD01793D
Web server	SD01662D
OPC-UA Server	SD02039D
Heartbeat Technology	SD01642D
Concentration measurement	SD01644D

**Installation instructions**

Contents	Note
Installation instructions for spare part sets and accessories	<ul style="list-style-type: none"><li>▪ Access the overview of all the available spare part sets via <i>Device Viewer</i> → 📖 182</li><li>▪ Accessories available for order with Installation Instructions → 📖 184</li></ul>

# Index

- 0 ... 9**  
 3-A approval . . . . . 214
- A**  
 Access authorization to parameters  
   Read access . . . . . 59  
   Write access . . . . . 59  
 Access code . . . . . 59  
   Incorrect input . . . . . 59  
 Adapting the diagnostic behavior . . . . . 165  
 Adapting the status signal . . . . . 165  
 Additional certification . . . . . 214  
 Ambient conditions  
   Mechanical load . . . . . 203  
   Operating height . . . . . 202  
   Relative humidity . . . . . 202  
   Shock and vibration resistance . . . . . 202  
   Storage temperature . . . . . 202  
 Ambient temperature  
   Influence . . . . . 200  
 Ambient temperature range . . . . . 202  
 AMS Device Manager . . . . . 72  
   Function . . . . . 72  
 Application . . . . . 187  
 Application packages . . . . . 216  
 Applicator . . . . . 188  
 Approvals . . . . . 213
- B**  
 Burst mode . . . . . 78
- C**  
 Cable entries  
   Technical data . . . . . 197  
 Cable entry  
   Degree of protection . . . . . 43  
 CE mark . . . . . 10, 213  
 Certificates . . . . . 213  
 Checklist  
   Post-connection check . . . . . 43  
   Post-installation check . . . . . 31  
 CIP cleaning . . . . . 202  
 Cleaning  
   CIP cleaning . . . . . 181  
   Exterior cleaning . . . . . 181  
   Internal cleaning . . . . . 181  
   SIP cleaning . . . . . 181  
 Climate class . . . . . 202  
 Commissioning . . . . . 81  
   Advanced settings . . . . . 112  
   Configuring the measuring instrument . . . . . 81  
 Communication-specific data . . . . . 75  
 Compatibility . . . . . 180  
 Connecting cable . . . . . 33  
 Connecting the measuring instrument . . . . . 35  
 Connecting the signal cables . . . . . 35
- Connecting the supply voltage cables . . . . . 35  
 Connection  
   see Electrical connection  
 Connection cable . . . . . 32  
 Connection preparations . . . . . 35  
 Connection tools . . . . . 32  
 Context menu  
   Calling up . . . . . 55  
   Closing . . . . . 55  
   Explanation . . . . . 55  
 Current consumption . . . . . 197
- D**  
 Date of manufacture . . . . . 16, 17  
 Declaration of Conformity . . . . . 10  
 Defining the access code . . . . . 135, 136  
 Degree of protection . . . . . 43, 202  
 Density adjustment . . . . . 115  
 Design  
   Operating menu . . . . . 46  
 Design fundamentals  
   Measurement error . . . . . 201  
   Repeatability . . . . . 201  
 Device components . . . . . 14  
 Device description files . . . . . 74  
 Device history . . . . . 180  
 Device locking, status . . . . . 139  
 Device name  
   Sensor . . . . . 17  
   Transmitter . . . . . 16  
 Device repair . . . . . 182  
 Device revision . . . . . 74  
 Device type ID . . . . . 74  
 Device Viewer . . . . . 182  
 DeviceCare . . . . . 72  
   Device description file . . . . . 74  
 Diagnosis  
   Symbols . . . . . 158  
 Diagnostic behavior  
   Explanation . . . . . 159  
   Symbols . . . . . 159  
 Diagnostic information  
   Design, description . . . . . 159, 163  
   DeviceCare . . . . . 163  
   FieldCare . . . . . 163  
   Light emitting diodes . . . . . 157  
   Local display . . . . . 158  
   Overview . . . . . 167  
   Remedial measures . . . . . 167  
   Web browser . . . . . 161  
 Diagnostic message . . . . . 158  
 Diagnostics list . . . . . 172  
 DIP switch  
   see Write protection switch  
 Direct access . . . . . 57  
 Disabling write protection . . . . . 135

- Display
  - see Local display
- Display and operating module DKX001 . . . . . 209
- Display area
  - For operational display . . . . . 49
  - In the navigation view . . . . . 51
- Display values
  - For locking status . . . . . 139
- Displaying the measured value history . . . . . 148
- Disposal . . . . . 183
- Document
  - Function . . . . . 6
  - Symbols . . . . . 6
- Document function . . . . . 6
- Down pipe . . . . . 21
- E**
- Editing view . . . . . 53
  - Input screen . . . . . 54
  - Using operating elements . . . . . 53, 54
- EHEDG-tested . . . . . 214
- Electrical connection
  - Commubox FXA195 (USB) . . . . . 67
  - Computer with web browser (e.g. Microsoft Edge) . . . . . 67
  - Degree of protection . . . . . 43
  - Field Communicator 475 . . . . . 67
  - Field Xpert SFX350/SFX370 . . . . . 67
  - Field Xpert SMT70 . . . . . 67
  - Measuring instrument . . . . . 32
  - Operating tool (e.g. FieldCare, AMS Device Manager, SIMATIC PDM) . . . . . 67
  - Operating tools
    - Via HART protocol . . . . . 67
    - Via service interface (CDI-RJ45) . . . . . 68
    - Via WLAN interface . . . . . 69
  - VIATOR Bluetooth modem . . . . . 67
  - Web server . . . . . 68
  - WLAN interface . . . . . 69
- Electromagnetic compatibility . . . . . 203
- Electronics module . . . . . 14
- Enabling write protection . . . . . 135
- Enabling/disabling the keypad lock . . . . . 60
- Endress+Hauser services
  - Maintenance . . . . . 181
  - Repair . . . . . 182
- Error messages
  - see Diagnostic messages
- Event logbook . . . . . 174
- Events list . . . . . 174
- Extended order code
  - Sensor . . . . . 17
  - Transmitter . . . . . 16
- Exterior cleaning . . . . . 181
- F**
- FDA . . . . . 214
- Field Communicator
  - Function . . . . . 73
- Field Communicator 475 . . . . . 73
- Field of application
  - Residual risks . . . . . 10
- Field Xpert
  - Function . . . . . 70
- Field Xpert SFX350 . . . . . 70
- FieldCare . . . . . 70
  - Device description file . . . . . 74
  - Establishing a connection . . . . . 71
  - Function . . . . . 70
  - User interface . . . . . 72
- Filtering the event logbook . . . . . 174
- Firmware
  - Release date . . . . . 74
  - Version . . . . . 74
- Firmware history . . . . . 180
- Flow direction . . . . . 22, 28
- Flow limit . . . . . 204
- Food Contact Materials Regulation . . . . . 214
- Function range
  - AMS Device Manager . . . . . 72
  - SIMATIC PDM . . . . . 73
- Function scope
  - Field Communicator . . . . . 73
  - Field Communicator 475 . . . . . 73
  - Field Xpert . . . . . 70
- Functions
  - see Parameters
- G**
- Galvanic isolation . . . . . 196
- Gas Fraction Handler . . . . . 151
- H**
- Hardware write protection . . . . . 137
- HART certification . . . . . 214
- HART protocol
  - Device variables . . . . . 75
  - Measured variables . . . . . 75
- Help text
  - Calling up . . . . . 58
  - Closing . . . . . 58
  - Explanation . . . . . 58
- HistoROM . . . . . 130
- Hygienic compatibility . . . . . 214
- I**
- Identifying the measuring instrument . . . . . 15
- Incoming acceptance . . . . . 15
- Indication
  - Current diagnostic event . . . . . 172
  - Previous diagnostic event . . . . . 172
- Influence
  - Ambient temperature . . . . . 200
  - Medium pressure . . . . . 200
  - Medium temperature . . . . . 200
  - Process density . . . . . 201
- Information about this document . . . . . 6
- Inlet runs . . . . . 22
- Input variables . . . . . 188

- Inspection
  - Connection . . . . . 43
  - Installation . . . . . 31
  - Received goods . . . . . 15
- Installation dimensions . . . . . 22
- Installation point . . . . . 21
- Intended use . . . . . 9
- Internal cleaning . . . . . 181, 202
- L**
- Languages, operation options . . . . . 208
- Line recorder . . . . . 148
- Local display . . . . . 209
  - Navigation view . . . . . 51
    - see Diagnostic message
    - see In alarm condition
    - see Operational display
  - Text editor . . . . . 53
- Low flow cut off . . . . . 196
- M**
- Main electronics module . . . . . 14
- Maintenance work . . . . . 181
- Managing the device configuration . . . . . 130
- Manufacturer ID . . . . . 74
- Materials . . . . . 205
- Maximum measurement error . . . . . 198
- Measured variables
  - see Process variables
- Measurement accuracy . . . . . 198
- Measuring and test equipment . . . . . 181
- Measuring device
  - Conversion . . . . . 182
  - Disposal . . . . . 183
  - Mounting the sensor . . . . . 28
  - Preparing for electrical connection . . . . . 35
  - Removing . . . . . 183
  - Repairs . . . . . 182
  - Structure . . . . . 14
  - Switching on . . . . . 81
- Measuring instrument
  - Configuring . . . . . 81
  - Preparing for mounting . . . . . 28
- Measuring principle . . . . . 187
- Measuring range
  - For gases . . . . . 188
  - For liquids . . . . . 188
- Measuring range, recommended . . . . . 204
- Measuring system . . . . . 187
- Mechanical load . . . . . 203
- Medium pressure
  - Influence . . . . . 200
- Medium temperature
  - Influence . . . . . 200
- Menu
  - Diagnostics . . . . . 172
  - Setup . . . . . 83
- Menus
  - For measuring instrument configuration . . . . . 81
  - For specific settings . . . . . 112
- Mounting . . . . . 21
- Mounting dimensions
  - see Installation dimensions
- Mounting preparations . . . . . 28
- Mounting requirements
  - Down pipe . . . . . 21
  - Inlet and outlet runs . . . . . 22
  - Installation dimensions . . . . . 22
  - Installation point . . . . . 21
  - Orientation . . . . . 22
  - Rupture disk . . . . . 25
  - Sensor heating . . . . . 24
  - Static pressure . . . . . 23
  - Thermal insulation . . . . . 23
  - Vibrations . . . . . 24
- Mounting tool . . . . . 28
- N**
- Nameplate
  - Sensor . . . . . 17
  - Transmitter . . . . . 16
- Navigation path (navigation view) . . . . . 51
- Navigation view
  - In the submenu . . . . . 51
  - In the wizard . . . . . 51
- Netilion . . . . . 181
- Numeric editor . . . . . 53
- O**
- Onsite display
  - Numeric editor . . . . . 53
- Operable flow range . . . . . 188
- Operating elements . . . . . 55, 159
- Operating height . . . . . 202
- Operating keys
  - see Operating elements
- Operating menu
  - Design . . . . . 46
  - Menus, submenus . . . . . 46
  - Submenus and user roles . . . . . 47
- Operating philosophy . . . . . 47
- Operation . . . . . 139
- Operation options . . . . . 45
- Operational display . . . . . 48
- Operational safety . . . . . 10
- Order code . . . . . 16, 17
- Orientation (vertical, horizontal) . . . . . 22
- Outlet runs . . . . . 22
- Output signal . . . . . 190
- Output variables . . . . . 190
- P**
- Packaging disposal . . . . . 20
- Parameter
  - Changing . . . . . 58
  - Entering values or text . . . . . 58
- Parameter settings
  - Administration (Submenu) . . . . . 132

Advanced setup (Submenu) . . . . .	113
Burst configuration 1 to n (Submenu) . . . . .	78
Configuration backup (Submenu) . . . . .	130
Corrected volume flow calculation (Submenu) . . . . .	113
Current input . . . . .	89
Current input (Wizard) . . . . .	89
Current input 1 to n (Submenu) . . . . .	143
Current output . . . . .	91
Current output (Wizard) . . . . .	91
Data logging (Submenu) . . . . .	148
Define access code (Wizard) . . . . .	131
Density adjustment (Wizard) . . . . .	115
Device information (Submenu) . . . . .	178
Diagnostics (Menu) . . . . .	172
Display (Submenu) . . . . .	122
Display (Wizard) . . . . .	106
Double pulse output . . . . .	105
Double pulse output (Submenu) . . . . .	146
Double pulse output (Wizard) . . . . .	105
I/O configuration . . . . .	88
I/O configuration (Submenu) . . . . .	88
Low flow cut off (Wizard) . . . . .	110
Measured variables (Submenu) . . . . .	140
Measurement mode (Submenu) . . . . .	152
Medium index (Submenu) . . . . .	152
Medium selection (Wizard) . . . . .	86
Partially filled pipe detection (Wizard) . . . . .	111
Pulse/frequency/switch output . . . . .	95
Pulse/frequency/switch output (Wizard) . . . . .	95, 97, 100
Pulse/frequency/switch output 1 to n (Submenu) . . . . .	145
Relay output . . . . .	102
Relay output 1 to n (Submenu) . . . . .	145
Relay output 1 to n (Wizard) . . . . .	102
Reset access code (Submenu) . . . . .	132
Sensor adjustment (Submenu) . . . . .	114
Setup (Menu) . . . . .	83
Simulation (Submenu) . . . . .	132
Status input . . . . .	90
Status input 1 to n (Submenu) . . . . .	143
Status input 1 to n (Wizard) . . . . .	90
System units (Submenu) . . . . .	83
Totalizer (Submenu) . . . . .	142
Totalizer 1 to n (Submenu) . . . . .	120
Totalizer handling (Submenu) . . . . .	146
Value current output 1 to n (Submenu) . . . . .	144
Web server (Submenu) . . . . .	66
WLAN settings (Wizard) . . . . .	128
Zero adjustment (Wizard) . . . . .	119
Zero verification (Wizard) . . . . .	118
Performance characteristics . . . . .	198
Performing density adjustment . . . . .	115
Post-connection check . . . . .	81
Post-connection check (checklist) . . . . .	43
Post-installation check . . . . .	81
Post-installation check (checklist) . . . . .	31
Potential equalization . . . . .	38
Power consumption . . . . .	197
Power supply failure . . . . .	197
Pressure loss . . . . .	204
Pressure-temperature ratings . . . . .	203
Process connections . . . . .	208
Process density . . . . .	
Influence . . . . .	201
Process variables . . . . .	
Calculated . . . . .	188
Measured . . . . .	188
Product safety . . . . .	10
Protecting parameter settings . . . . .	135
<b>R</b>	
Radio approval . . . . .	214
RCM marking . . . . .	213
Read access . . . . .	59
Reading off measured values . . . . .	139
Recalibration . . . . .	181
Reference operating conditions . . . . .	198
Registered trademarks . . . . .	8
Remedial measures . . . . .	
Calling up . . . . .	160
Closing . . . . .	160
Remote operation . . . . .	210
Repair . . . . .	182
Notes . . . . .	182
Repair of a device . . . . .	182
Repeatability . . . . .	199
Replacement . . . . .	
Device components . . . . .	182
Requirements for personnel . . . . .	9
Response time . . . . .	200
Return . . . . .	182
Rupture disk . . . . .	
Safety instructions . . . . .	25
Triggering pressure . . . . .	204
<b>S</b>	
Safety . . . . .	9
Sensor . . . . .	
Installing . . . . .	28
Sensor heating . . . . .	24
Sensor housing . . . . .	203
Serial number . . . . .	16, 17
Setting the operating language . . . . .	81
Settings . . . . .	
Adapting the measuring device to the process conditions . . . . .	146
Administration . . . . .	131
Advanced display configurations . . . . .	122
Current input . . . . .	89
Current output . . . . .	91
Double pulse output . . . . .	105
I/O configuration . . . . .	88
Local display . . . . .	106
Low flow cut off . . . . .	110
Managing the device configuration . . . . .	130
Medium . . . . .	86
Operating language . . . . .	81
Partially filled pipe detection . . . . .	111
Pulse output . . . . .	95

- Pulse/frequency/switch output . . . . . 95, 97
  - Relay output . . . . . 102
  - Resetting the device . . . . . 177
  - Resetting the totalizer . . . . . 146
  - Sensor adjustment . . . . . 114
  - Simulation . . . . . 132
  - Status input . . . . . 90
  - Switch output . . . . . 100
  - System units . . . . . 83
  - Tag name . . . . . 83
  - Totalizer . . . . . 120
  - Totalizer reset . . . . . 146
  - WLAN . . . . . 128
  - Shock and vibration resistance . . . . . 202
  - Signal on alarm . . . . . 194
  - SIMATIC PDM . . . . . 73
    - Function . . . . . 73
  - SIP cleaning . . . . . 202
  - Software release . . . . . 74
  - Spare part . . . . . 182
  - Spare parts . . . . . 182
  - Special connection instructions . . . . . 39
  - Special mounting instructions
    - Hygienic compatibility . . . . . 25
  - Standards and guidelines . . . . . 215
  - Static pressure . . . . . 23
  - Status area
    - For operational display . . . . . 48
    - In the navigation view . . . . . 51
  - Status signals . . . . . 158, 161
  - Storage concept . . . . . 212
  - Storage conditions . . . . . 19
  - Storage temperature . . . . . 19
  - Storage temperature range . . . . . 202
  - Structure
    - Measuring device . . . . . 14
  - Submenu
    - Administration . . . . . 131, 132
    - Advanced setup . . . . . 112, 113
    - Burst configuration 1 to n . . . . . 78
    - Calculated values . . . . . 113
    - Configuration backup . . . . . 130
    - Corrected volume flow calculation . . . . . 113
    - Current input 1 to n . . . . . 143
    - Data logging . . . . . 148
    - Device information . . . . . 178
    - Display . . . . . 122
    - Double pulse output . . . . . 146
    - Events list . . . . . 174
    - I/O configuration . . . . . 88
    - Input values . . . . . 143
    - Measured values . . . . . 139
    - Measured variables . . . . . 140
    - Measurement mode . . . . . 152
    - Medium index . . . . . 152
    - Output values . . . . . 144
    - Overview . . . . . 47
    - Process variables . . . . . 113
    - Pulse/frequency/switch output 1 to n . . . . . 145
    - Relay output 1 to n . . . . . 145
    - Reset access code . . . . . 132
    - Sensor adjustment . . . . . 114
    - Simulation . . . . . 132
    - Status input 1 to n . . . . . 143
    - System units . . . . . 83
    - Totalizer . . . . . 142
    - Totalizer 1 to n . . . . . 120
    - Totalizer handling . . . . . 146
    - Value current output 1 to n . . . . . 144
    - Web server . . . . . 66
  - Supply voltage . . . . . 196
  - Surface roughness . . . . . 208
  - Switch output . . . . . 194
  - Symbols
    - Controlling data entries . . . . . 54
    - For communication . . . . . 48
    - For diagnostic behavior . . . . . 48
    - For locking . . . . . 48
    - For measured variable . . . . . 49
    - For measurement channel number . . . . . 49
    - For menus . . . . . 51
    - For parameters . . . . . 51
    - For status signal . . . . . 48
    - For submenu . . . . . 51
    - For wizards . . . . . 51
    - In the status area of the local display . . . . . 48
    - Input screen . . . . . 54
    - Operating elements . . . . . 53
  - System design
    - Measuring system . . . . . 187
    - see Measuring device design
  - System integration . . . . . 74
- ## T
- Technical data, overview . . . . . 187
  - Temperature range
    - Ambient temperature range for display . . . . . 209
    - Medium temperature . . . . . 203
    - Storage temperature . . . . . 19
  - Terminal assignment . . . . . 35
  - Terminals . . . . . 197
  - Tests and certificates . . . . . 214
  - Text editor . . . . . 53
  - Thermal insulation . . . . . 23
  - Tool
    - For mounting . . . . . 28
    - Transport . . . . . 19
  - Tool tip
    - see Help text
  - Tools
    - Electrical connection . . . . . 32
  - Totalizer
    - Configuring . . . . . 120
  - Transmitter
    - Turning the display module . . . . . 30
    - Turning the housing . . . . . 29
  - Transporting the measuring device . . . . . 19



Troubleshooting	
General . . . . .	154
Turning the display module . . . . .	30
Turning the electronics housing	
see Turning the transmitter housing	
Turning the transmitter housing . . . . .	29
<b>U</b>	
UKCA marking . . . . .	213
Use of measuring device	
Borderline cases . . . . .	9
Incorrect use . . . . .	9
Use of measuring instrument	
see Intended use	
User roles . . . . .	47
<b>V</b>	
Version data for the device . . . . .	74
Vibrations . . . . .	24
<b>W</b>	
W@M Device Viewer . . . . .	15
Weight	
SI units . . . . .	205
Transport (notes) . . . . .	19
US units . . . . .	205
Wizard	
Current input . . . . .	89
Current output . . . . .	91
Define access code . . . . .	131
Density adjustment . . . . .	115
Display . . . . .	106
Double pulse output . . . . .	105
Low flow cut off . . . . .	110
Medium selection . . . . .	86
Partially filled pipe detection . . . . .	111
Pulse/frequency/switch output . . . . .	95, 97, 100
Relay output 1 to n . . . . .	102
Status input 1 to n . . . . .	90
WLAN settings . . . . .	128
Zero adjustment . . . . .	119
Zero verification . . . . .	118
WLAN settings . . . . .	128
Workplace safety . . . . .	10
Write access . . . . .	59
Write protection	
Via access code . . . . .	135
Via write protection switch . . . . .	137
Write protection switch . . . . .	137



71675073

[www.addresses.endress.com](http://www.addresses.endress.com)

---